

Introduction	Placing Your Knoll Office Seating Order	3
	Visual Index	4
	Office Seating Control Index	7
	KnollTextiles Fabric Application	8
	COM Seating Process Overview	9
	Spinneybeck Leather Application	17
The Sapper Chair	The Sapper Collection : executive chairs	22
	The Sapper Collection : management chairs	24
	The Sapper Collection : side chairs	26
	Sapper Dimensions and Operating Instructions	28
The Open Up Chair	The Open Up Chair : high-back chairs	30
	The Open Up Chair : mid-back chairs	34
	The Open Up Chair : replacement seat option	38
	The Open Up Chair : side chairs	40
	The Open Up Chair Dimensions and Operating Instructions	42
The Life Chair	The Life Chair : plastic base, no seat or back topper	44
	The Life Chair : plastic base, knitted seat topper, no back topper	46
	The Life Chair : plastic base, seat topper no back topper	48
	The Life Chair : plastic base, seat topper and back topper	50
	The Life Chair : plastic base, replacement parts	52
	The Life Chair : aluminum base, no seat or back topper	54
	The Life Chair : aluminum base, knitted seat topper no back topper	56
	The Life Chair : aluminum base, seat topper no back topper	58
	The Life Chair : aluminum base, seat topper and back topper	60
	The Life Chair : aluminum base, replacement parts	62
	How to Specify a Life Chair	64
	The Life Chair Upholstery Options and Construction Information	66
	The Life Chair Dimensions and Operating Instructions	68
Chadwick™ Chair	Chadwick™ Chair : Tilt Stop Control	70
	Chadwick™ Chair : Basic Control	72
	Chadwick™ Chair : High Task Chair	74
	Chadwick™ Chair : Construction Information	78
	The Chadwick™ Chair Dimensions and Operating Instructions	80
The Bulldog® Chair	The Bulldog Chair : executive chairs	82
	The Bulldog Chair : management chairs	84
	The Bulldog Chair : operational chairs	86
	The Bulldog Chair : high task chairs	88
	The Bulldog Chair : side chairs	90
	Bulldog : Description of Controls, Options and Construction	92
	Bulldog Dimensions and Operating Instructions	94
The RPM® Chair	The RPM Chair : basic model	96
	The RPM Chair : advanced model	98
	The RPM Chair : high task chair	100
	The RPM Chair : side chairs	104
	RPM Chair Dimensions and Operating Instructions	106
	RPM Chair Control Index	108
Essentials Work Chairs	Essentials Pro : upholstered mid-back task chair	110
	Essentials Pro : upholstered high-back task chair	114
	Essentials Pro : upholstered side chair	118
	Essentials Pro : Seat and Back replacements for task and side chairs	120
	Essentials Pro Dimensions and Operating Instructions	122
	Essentials Tech : suspension back task chair	124
	Essentials Tech : suspension back side chair	128
	Essentials Tech : Seat and Back replacements for task and side chairs	130
	Essentials Tech Dimensions and Operating Instructions	132
The SoHo Chair	The SoHo Chair : task chairs	134
	The SoHo Chair : side chairs	136
	The SoHo Dolly	138

The SoHo Chair (cont'd.)	SoHo Dimensions and Operating Instructions	140
The Visor™ Chair	The Visor Chair	142
	Visor Chair Dimensions and Configuration Instructions	144
Alpha-Numeric Index		146
Selling Policy		147
General Ordering Information		149

Use the Following Addresses

If you would like to send a standard lead time order to our order entry department, please use the following address:

For North American orders:
Knoll, Inc.
1235 Water Street
East Greenville, PA 18041
Attn: Order Entry

Fax: 215 679-1788
Tel: 800 343-KNOLL

All accepted orders will be confirmed in writing on the Knoll standard order confirmation form.

For More Information

For complete Knoll Selling Policy and warranty information, please refer to page 147 of this price list.

For additional information on Knoll Office Seating, contact your Knoll representative, a Knoll dealer, or telephone Customer Services at 800 343-KNOLL.

Shipping Method

All RPM chairs, Essentials Work Chairs, Pro and Tech task chairs, and Chadwick task chairs in this price list will ship boxed in two pieces. If you would like a fully assembled, blanket wrapped RPM chair, Essentials Work Chair, Pro or Tech task chair or Chadwick task chair, please consult the Standard Specials price list for pattern numbers and associated upcharges.

Sapper

Executive, p. 22



Management, p. 24



Side, p. 26



Open Up

High Back, p. 30



Mid Back, p. 34



Side Chair, p. 40



Life

Plastic base, p. 44



Aluminum base, p. 54



Chadwick

Tilt Stop Control, p. 70



Basic Control, p. 72



Bulldog

Executive, p. 82



Management, p. 84



Operational, p. 86



Bulldog (continued)

High Task, p. 88



Side, p. 90



RPM

Advanced Control, p. 98



Basic Model, p. 96



High Task, p. 100



Side, p. 104



Essentials

Pro Mid-back, p. 110



Pro High-back, p. 114



Pro Side, p. 118



Tech Task, p. 124



Tech Side, p. 128



SoHo

Task, p. 134



Side, p. 136



Dolly, p. 138

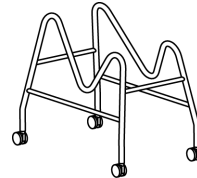

Visor

Armless, p. 142



Arm, p. 142



Cart, p.142

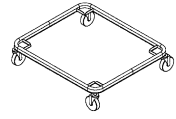

control	illustration	description	application
Synchronized Recline with Auto-Balanced Tension		Utilizes user's body weight for resistance and recline so the chair is perfectly adjusted by sitting in it — no tension knobs or levers needed; allows for constant sightline — no need to refocus; promotes movement and balance; preference control accommodates a wider range of users.	Life Chairs
Synchronized Tilt Control		360° swivel; back and seat recline in one synchronized movement to support the user's back throughout the recline. As back reclines, the seat drops down slightly, relieving pressure points.	Bulldog Executive, Management, High Back Professional, Operational and High Task Chairs Open Up Mid Back and High Back Chairs RPM Advanced and Basic Control Chairs Chadwick Chairs Essentials Work Chairs Pro and Tech
Knee-Tilt Control		360° swivel; seat and back tilt at the same ratio at a pivot point under the front edge of the seat.	Sapper Executive and Management Chairs
Sliding Seat with Synchronized Back Tilt		360° swivel; back tilts while seat slides forward.	SoHo Chairs

Fabric Application

The application of the KnollTextiles collection to Knoll Office Seating provides the broadest and most exciting selection of standard fabrics in the contract furniture industry.

KnollTextiles fabrics are developed in collaboration with the world's leading designers. The collection ranges from worsted wools and combed cottons to elegant tapestries and brocades. Luxurious fiber combinations enhance any environment in weaves that embody visual character, fine craftsmanship, strength and tactile appeal.

KnollTextiles represents the widest range of aesthetic opportunities to define the way offices look, as well as the way they feel.

Fabrics are grouped into categories referred to as "grades." The selection of approved fabrics varies by product. Please refer to the pricing page of each product line for more information.

Always check with KnollTextiles for textile changes or new applications on seating.

CAL 133

See matrix below regarding testing for California Technical Bulletin 133 (CAL 133).

Please refer to the textile matrix for a list of pre-approved CAL 133 upholstery options and specification instructions. The following Knoll Office Seating products can be specified to comply with California Technical Bulletin 133 (CAL133):

- The Sapper Chair
- The Life Chair
- The Bulldog Chair (*CAL133 not available on chairs with upholstered outer backs*)
- The RPM Chair
- The Visor Chair

If any other KnollTextiles fabric or COM is desired, Knoll will test the compliance of the specified fabric on the specified chair. The cost of the test will include the price of the chair and COM fabric plus \$520. The additional fee is to cover the cost of the test. Contact your Knoll customer service representative at 800 343-KNOLL for further test processing instructions.

CAL133 COM Process Overview

CAL133 – California Technical Bulletin 133. The requirements for testing are as described in the matrix. Intek F187 fire barrier is recommended. **Barrier must be attached when fabric arrives at Knoll.**

CAL133			
Seating	Requires PO for:	Yardage	Process Time
Bulldog	Regular price of chair + \$520 testing fee	Unless otherwise noted, standard yardage requirement for chair being tested. Please refer to price list for piece yardage.	4-8 weeks for test results
Life			
RPM			
Sapper			
Open Up			
Visor			
Studio			

*CAL133 not available on chairs with upholstered backs

Seating	Pre-Approval				Application Testing			
	Color Specific Testing?	Send to CSR/PM:	Process Time	Application Test Required?	Requires:	Form:	Yardage Required for Test	Process Time
Sapper	No	COM Seating Form & Memo Sample	2-3 days	No				
Open Up, Life	No	COM Seating Form & Memo Sample	2-3 days	No*				
Bulldog	No	COM Seating Form & Memo Sample	2-3 days	No*	25 chair minimum order OR PO for \$100	COM Testing Order Form	1	2-3 weeks
RPM	No	COM Seating Form & Memo Sample	2-3 days	Yes	25 chair minimum order OR PO for \$300	COM Testing Order Form	1.5	2-3 weeks
RPM Side Chair	Yes	COM Seating Form & Memo Sample	2-3 days	Yes	25 chair minimum order OR PO for \$300	COM Testing Order Form	5	2-3 weeks
Essentials Work Chair	No	COM Seating Form & Memo Sample	2-3 days	No*	25 chair minimum order OR PO for \$100	COM Testing Order Form	1	2-3 weeks
Soho	Yes	COM Seating Form & Memo Sample	2-3 days	Yes	25 chair minimum order OR PO for \$300	COM Testing Order Form	3	2-3 weeks
Visor	No	COM Seating Form & Memo Sample	2-3 days	No*				
Studio	No	COM Seating Form & Memo Sample	varies	No*				
Knoll Extra Fabricboards**	No	COM Seating Form & 1 yd sample	2-3 days	No				
Ped Cushions	No	COM Seating Form & Memo Sample	2-3 days	No				

*Guideline only – subject to the discretion of the production floor. Bulldog requires testing when fabric contains Krypton or Teflon®.

**Knoll Extra Fabricboards are approved as wall mount only. If they are to be panel mounted, they must pass UL testing.

Textile Name	Grade	Direction	Part #	Bulldog Side Chair	Bulldog Two Piece	Essentials Work Chairs	Life Back Topper	Life Seat Topper
3-D	C	NR	K808	■***	■***	■***	■	■
Abacus	B	NR	K715	■♣	■♣	■♣	■♣	■
Acceleration		RR	K998	■	■	○	○	○
Alignment	A	NR	K349	■♣	■♣	■♣	■♣**	■**
Analogy	A	NR	K614	■***	■***	■***	■	■
Arno	H	NR*	K128	■♣	■♣	■	○	○
Autobahn	C	NR	K491	■	■	■♣	○	○
Backdrop	B	NR*	W302	○	■***	■***	○	○
Bank Shot	B	NR*	K134	○	○	○	○	○
Beaumont	C	NR	K675	■♣	■♣	■	■	■
Betwixt	B	NR	K1074	■***♣	■***♣	■***	○	○
Bifold CR	B	RR	HC193	■***	■***	○	○	○
Calais Cotton Velvet	F	NR	K787	○	○	○	○	○
Camo	C	NR	K108	○	○	○	○	○
Campagna	B	NR*	K387	■♣	■♣	■	■	■
Cato	I	RR	KH800	○	○	○	○	○
Cavalier	D	NR	K217	■***♣	■***♣	■***	■♣	■♣
Century	F	NR	K1051	■***	■***	■***	■	■♣
Charade	C	NR	K468	■	■	■	■	■
Charade Healthcare	C	NR	HC468	○	○	○	○	○
Charm	C	NR	K1049	■***	■***	■***	■	■♣
Chroma	B	NR	K345	■***♣	■***♣	■***♣	■♣	■
Circa	C	NR	K1054	○	■***	■***	■	■♣
Classic Boucle	B	NR*	K162	■♣	■♣	■	■♣	■♣
Close Knit	B	NR	K201	■	■	■♣	■	■
Coco	F	NR	K1024	■	■	■	■	■
Common Ground	A	NR*	K448	■***♣	■***♣	■***♣	■♣	■♣
Cotton Duck	A	ND	K131	○	○	○	○	○
Counterbalance	C	NR	K429	○	■***♣	■***♣	○	○
Cross Stitch	E	NR	K1026	■♣	■♣	■	■♣	■♣
Crystal Pleat	C	NR	K559	○	○	○	○	○
Cuddle Cloth	F	NR*	K231	■	■	■	■	■
Cuddle Stripe	G	NR	K526	■	■	■	■	■
Decade	C	NR	K1053	○	■***	■***	■	■♣
Diamond Plate	B	NR	K711	○	○	○	■	■
Digit	B	NR	K891	■	■	■	○	○
Digit CR	C	NR	HC891	○	○	○	○	○
Digital Tape	B	NR	W304	○	■***	■***	○	○
Double Exposure	D	NR	K142	■	■	■	○	○
Dristi	A	NR*	K872	■	■	■	○	○
Echo	C	NR	K1019	■	■	■	■	■
Eclipse	F	NR*	K377	■	■	■	■	■
Empire Stripe	C	NR	K1025	○	■***	■***	■	■♣
English Accent	C	NR	K1027	○	■	■	■	■
Extreme Velvet	B	NR*	K679	○	○	○	○	○
Fast Forward	B	NR*	W301	○	■***	■***	○	○
Field Day	B	NR*	K124	■♣	■♣	■♣	■♣	■♣
Foil Rap	A	NR	W535	○	○	○	○	○

*=Can be Railroad Cut
♣=CAL133 Approved

■=Available ○ =Not Available
**=Only available with CAL133

***=Not available with Upholstered Outside Back

Textile Name	Visor Seat Pad	Open Up Seat Pad	RPM	RPM Side Chair	Sapper	SoHo Uphol.	Pedestal Cushion
3-D	○	○	■	○	○	○	■
Abacus	■	■	■	○	■	○	■
Acceleration	○	○	■	■	○	■	○
Alignment	■	■	■	○	■	○	■
Analogy	■	■	■	○	○	■	■
Arno	■	■	■	■	■	■	■
Autobahn	■	■	■	○	■	○	■
Backdrop	○	○	○	○	○	○	■
Bank Shot	■	○	○	○	■	○	■
Beaumont	■	■	■	○	■	○	■
Betwixt	■	■	■	○	■	○	■
Bifold CR	■	■	■	○	■	○	■
Calais Cotton Velvet	○	○	○	○	○	○	○
Camo	■	■	■	○	■	○	■
Campagna	■	■	■	○	■	○	■
Cato	■	○	■	■	■	○	■
Cavalier	■	■	■	○	○	○	■
Century	■	■	■	■	○	○	■
Charade	■	■	■	■	■	○	■
Charade Healthcare	○	○	○	○	■	○	■
Charm	■	■	■	○	■	○	■
Chroma	■	■	■	■	■	○	■
Circa	■	■	■	○	■	○	■
Classic Boucle	■	■	■	■	■	■	■
Close Knit	■	■	■	■	■	■	■
Coco	■	○	■	■	■	○	■
Common Ground	■	■	■	○	■	■	■
Cotton Duck	○	○	○	○	○	○	○
Counterbalance	■	○	■	○	■	○	■
Cross Stitch	■	■	■	■	■	■	■
Crystal Pleat	○	○	○	○	○	○	○
Cuddle Cloth	■	■	■	■	■	■	■
Cuddle Stripe	■	■	■	■	■	■	■
Decade	■	■	■	○	■	○	■
Diamond Plate	■	■	○	○	■	○	■
Digit	■	■	■	○	■	○	■
Digit CR	○	○	○	○	■	○	■
Digital Tape	○	○	○	○	○	○	■
Double Exposure	■	■	○	○	■	○	■
Dristi	■	○	■	■	○	■	■
Echo	■	■	■	○	■	○	■
Eclipse	■	■	■	○	■	○	■
Empire Stripe	■	○	○	○	■	○	■
English Accent	■	■	■	○	■	○	■
Extreme Velvet	■	■	■	○	■	○	■
Fast Forward	○	○	○	○	○	○	■
Field Day	■	■	■	■	■	■	■
Foil Rap	○	○	○	○	○	■	■

Textile Name	Grade	Direction	Part #	Bulldog Side Chair	Bulldog Two Piece	Essentials Work Chairs	Life Back Topper	Life Seat Topper
Forza	B	NR*	K584	○	○	○	○	○
Fox Trot CR	C	NR	HC777	■	■	■	■	■
Gala	C	NR	K558	■***▲	■***▲	■***▲	■▲	■
Gibson	G	NR	K1086	■***	■***	■***	■	■
Glo	A	NR	K757	■***▲	■***▲	■***▲	■	■
Gordian Knot	C	NR*	K174	■▲	■▲	■▲	■	■
Graffiti Camo	C	NR	K107	○	○	○	○	○
Grande	B	NR*	K180	■***	■***	■***	■	■
Grate	C	NR	K434	○	■***	■***	○	○
Groove Line	F	NR	K488	○	■	■	■	■
Gusto CR	B	NR	HC759	■***	■***	■***	■	■
Harrison	D	NR	K1084	■***	■***	■***	■	■
Haze	G	NR	K109	■	■	■	■	■
Heavy Metal	A	NR	W539	○	○	○	○	○
Highline CR	C	NR	HC1064	■***	■***	■***	■	■
Hologram	D	NR	K500	■***▲	■***▲	■***▲	■	■
Horizontal	C	NR	K197	■	■	■	■	■
Hula Hoop	C	NR	K753	■***	■***	■***	■	■▲
Icon	F	NR	K1028	■	■	■	■	■▲
In The Loop	D	NR	K490	■	■	■	■	■
Ingot	B	NR	K531	■	■	■▲	■	■
Jumpstart	A	NR	K879	■	■	■	○	○
Knoll Velvet	I	RR	K784	○	○	○	○	○
Kora CR	C	NR	HC1010	■***	■***	■***	■	■
Kybos	C	NR	K151	■***▲	■***▲	■***▲	○	○
Luberon	E	NR	K676	■	■	■	■	■
Lyonese Velvet	H	NR*	K530	○	■	■	○	○
Lyric	B	NR	K698	■	■	■	■	■
Madison	E	NR	K1085	○	■***	■***	○	○
Mamba	E	NR	K549	■	■	■	■	■
Mariner	A	NR*	K642	■***	■***	■***	■	■
Market Square	E	NR*	K680	■	■	■	■▲	■▲
Masquerade	D	NR	K806	■	■	■	■	■
Metaphor	A	NR	K612	■***	■***	■***	■	■
Metro	C	NR	K1018	■***	■***	■***	○	○
Mixed Media	E	NR	K600	■***	■***	■***	■	■
Moto CR	C	NR	HC1002	■	■	■▲	■	■
Night Life	B	NR	K181	■	■	■	○	○
Nonchalant CR	B	NR	HC198	○	■***	○	○	○
Odeon	B	NR*	K317	○	○	○	○	○
Panache CR	C	NR	HC1047	■***	■***	■***	■	■
Paradigm	B	NR	K1101	■	■	■	■▲	■▲
Passport	G	NR	K729	○	○	○	■	■
Piazza	C	NR*	K574	■	■	■	■	■
Pinnacle	B	NR	K1102	■***	■***	■***	■	■
Plus	E	NR	K423	■	■	■	■	■
Pogo	B	NR	K1100	■***▲	■***▲	■***▲	■▲	■▲
Pop	B	NR*	K782	○	■***	■***	■	■

*=Can be Railroad Cut
▲=CAL133 Approved

■=Available ○ =Not Available
**=Only available with CAL133

***=Not available with Upholstered Outside Back

Textile Name	Visor Seat Pad	Open Up Seat Pad	RPM	RPM Side Chair	Sapper	SoHo Uphol.	Pedestal Cushion
Forza	■	■	○	○	○	○	■
Fox Trot CR	■	■	■	○	■	○	■
Gala	■	■	■ ♯	○	■ ♯	○	■
Gibson	○	○	■	○	○	○	■
Glo	■ ♯	■ ♯	■ ♯	○	■ ♯	○	■ ♯
Gordian Knot	■ ♯	■ ♯	■	■	■ ♯	■	■ ♯
Graffiti Camo	■ ♯	■ ♯	■ ♯	○	■ ♯	○	■
Grande	■	■	■	○	■	■	■
Grate	■	○	■	○	■	○	■ ♯
Groove Line	■	■	■	○	■	○	■
Gusto CR	■	○	■	○	○	○	■
Harrison	■	■	■	■	■	■	■
Haze	■	■	■	○	■	○	■
Heavy Metal	○	○	○	○	○	■	■
Highline CR	■	■	■	○	■	○	■
Hologram	■	■	■	○	■	○	■
Horizontal	■	■	■	■	■	○	■
Hula Hoop	■	■	■	■	■	■	■
Icon	■	■	■	○	■	○	■
In The Loop	■	■	■	○	■	○	■
Ingot	■ ♯	■ ♯	■	■	○	■	■ ♯
Jumpstart	■	■	■	○	■	■	■
Knoll Velvet	○	○	○	○	○	○	○
Kora CR	■	■	■	○	■	○	■
Kybos	■	■	○	○	■ ♯	○	■ ♯
Luberon	■	■	■	○	■	○	■
Lyonese Velvet	■	○	■	○	■	○	■
Lyric	■	■	■	○	■	■	■
Madison	■	○	○	○	■	○	■
Mamba	■	■	■	○	■	○	■
Mariner	■	■	■	■	■ ♯	■	■
Market Square	■	■	■	■	■	■	■
Masquerade	■	■	■	○	■	○	■
Metaphor	■	■	■	○	■	■	■
Metro	■	■	■	○	■	○	■
Mixed Media	■	■	■	○	■	■	■
Moto CR	■	■	■	○	■	○	■
Night Life	■	■	■	○	■	○	■
Nonchalant CR	■	■	■	○	■	○	■
Odeon	○	○	○	○	○	○	○
Panache CR	■	■	■	■	■	■	■
Paradigm	■	■	■	■	■	○	■
Passport	○	○	■	○	■	○	○
Piazza	■	■	■	○	■	■	■
Pinnacle	■	■	■	○	○	○	■
Plus	■	■	■	○	■	■	■
Pogo	■	■	○	○	■ ♯	○	■
Pop	■	■	■	○	○	○	■

Textile Name	Grade	Direction	Part #	Bulldog Side Chair	Bulldog Two Piece	Essentials Work Chairs	Life Back Topper	Life Seat Topper
Prep	A	NR	K1076	■***♣	■***♣	■***	○	○
Presto	A	NR	K1000	■♣	■♣	■♣	■♣	■♣
Quark	C	NR	K781	■	■	■	■	■
Radial		NR	K997	■	■	○	○	○
Rattan	G	NR*	K138	■***♣	■***♣	■***	■	■
Regard CR	C	NR	HC1063	○	■***	○	■	■♣
Rib Stitch	C	RR	K122	■***♣	■***♣	■***♣	■	■
Ricochet	B	NR*	K498	■♣	■♣	■♣	■♣	■
Rivington	F	NR	K1080	■	■	■	■	■
Rochelle	B	ND	K721	■♣	■♣	■♣	■♣	■♣
Roots & Rhythms	E	NR	K489	■	■	■	■	■
Satellite	D	NR*	K503	■	■	■	■	■
Satin Chisel	D	NR	K487	■	■	■	○	○
Sequin CR	C	NR	HC1009	■	■	■	■	■♣
Shibai	D	NR*	K184	■♣	■♣	■	■	■
Slicker	C	NR	K602	○	○	○	○	○
Spark	B	NR	K1075	■♣	■♣	■	■♣	■♣
Speedway		NR	K999	■	■	○	○	○
Spinoff Nuance	B	NR*	K319	○	○	○	■	■
Spotlight	B	NR	K772	■	■	■	■	■
Stacks	A	NR	K528	■	■	■	■	■
Star Struck	C	NR	K1048	■***	■***	■***	■	■
Starry Night	B	NR*	K529	■♣	■♣	■♣	■♣	■♣
Stepping Stones	C	RR	K346	○	■***	■***	■	■
Striae Epingle	G	NR	K390	■***	■***	■***	■	■
Suburban	F	NR	K407	■	■	■	■	■
Swing	C	NR	K479	■	■	■	■	■
Techno Tweed	B	NR*	K771	■	■	■	○	○
Tides	F	NR*	K442	■	■	■	■	■
Tokay II	B	NR	K353	■***♣	■***♣	■***♣	■♣	■
Topography	F	NR	K1052	■	■	■	■	■♣
Transit	B	NR*	K199	■	■	■	■	■
Transition	C	NR	K816	■***♣	■***♣	■***♣	■♣	■♣
Tread		NR	TR	■	■	○	○	■
Treble CR	C	NR	HC1062	■	■	■	■	■♣
Tsunami	C	NR*	K130	■***♣	■***♣	■***	○	○
Tweed Frieze	F	NR	K754	○	○	○	○	○
Two Step	C	NR	K789	■	■	■	■	■
Ultrasuede	G	NR	K1021	○	■***♣	■***♣	■	■
Una	F	NR	K451	■***	■***	■***	■	■
Urban	I	RR	K438	■***	■***	■***	■	■
Vibe	C	NR	K1029	○	○	○	■	■
Vinyl	B	ND	K242	■***	■***	■***	■	■
Wide Angle	B	NR	K244	■♣	■♣	■♣	■♣	■
Zari CR	C	NR	HC1008	■***	■***	■***	■	■♣
Zephyr	B	NR	K724	■***	■***	■***	○	■
Zoom	D	NR	K113	■***♣	■***♣	■***♣	○	○

*=Can be Railroad Cut
♣=CAL133 Approved

■=Available ○ =Not Available
**=Only available with CAL133

***=Not available with Upholstered Outside Back

Textile Name	Visor Seat Pad	Open Up Seat Pad	RPM	RPM Side Chair	Sapper	SoHo Uphol.	Pedestal Cushion
Prep	■ ♯	■	○	○	■ ♯	○	■
Presto	■ ♯	■ ♯	■ ♯	○	■ ♯	■	■ ♯
Quark	■	■	■	■	■	■	■
Radial	○	○	■	■	○	■	○
Rattan	■	■	■	■	■	○	■
Regard CR	■	■	○	○	■	○	■
Rib Stitch	■	■	○	○	○	○	■
Ricochet	■ ♯	■ ♯	■	■	○	■	■
Rivington	■	■	■	■	■	■	■
Rochelle	■	■	■ ♯	■ ♯	■ ♯	■	■ ♯
Roots & Rhythms	■	■	■	■	■	■	■
Satellite	■	■	■	○	■	○	■
Satin Chisel	■	■	■	■	■	○	■
Sequin CR	■	■	■	○	■	■	■
Shibai	■	■	■	○	■	○	■ ♯
Slicker	■	○	■ ♯	○	○	○	■
Spark	■ ♯	■	■ ♯	○	■ ♯	■	■
Speedway	○	○	■	■	○	■	○
Spinoff Nuance	■	■	■	■ ♯	○	■	■ ♯
Spotlight	■	■	■	○	■	■	■
Stacks	■	■	■	○	■	■	■
Star Struck	■	■	■	○	■	○	■
Starry Night	■ ♯	■ ♯	■	■	■ ♯	■	■ ♯
Stepping Stones	■	○	■	○	■	○	■
Striae Epingle	■	■	■	○	■	○	■
Suburban	■	■	■	○	■	○	■
Swing	■	■	■ ♯	■	■	■	■
Techno Tweed	■	■	■	○	○	■	■
Tides	■	■	■	■	■	■	■
Tokay II	■ ♯	■ ♯	■ ♯	■	■	○	■ ♯
Topography	■	■	○	■	■	○	■
Transit	■	■	■ ♯	○	■	○	■
Transition	■ ♯	■ ♯	■ ♯	■	○	○	■ ♯
Tread	■	○	■	■	○	■	○
Treble CR	■	■	■	○	■	■	■
Tsunami	■	■	■	○	■	○	■
Tweed Frieze	■	■	○	○	■	○	■
Two Step	■	■	■	■	■	■	■
Ultrasuede	■ ♯	■ ♯	○	○	■ ♯	○	■ ♯
Una	■	■	■	○	■	■	■
Urban	■	■	■	○	■	■	○
Vibe	■	■	○	○	○	○	■
Vinyl	■	■	■	○	○	○	■
Wide Angle	■ ♯	■ ♯	■	○	■ ♯	○	■ ♯
Zari CR	■	■	■	○	■	○	■
Zephyr	■	■	■	○	■	○	■
Zoom	■	■	○	○	■	○	■

This page intentionally left blank

For the ultimate in comfort, durability, and prestige, many Knoll Office Seating products can be upholstered in Spinneybeck leathers.

Spinneybeck leathers are made from the top 2% of the world's finest hides, inspected numerous times during production.

After tanning, all Spinneybeck leathers are drum-dyed, a time-consuming procedure which ensures color penetration throughout the hide. Then each hide is finished in the manner which will best bring out its individual character.

Spinneybeck leathers are all full-grain aniline drum-dyed products imported from Italy.

The following Spinneybeck leathers are approved for application on Knoll Office Seating products. Leathers are grouped into five price categories referred to as "grades." The selection of approved leathers varies by product. Please refer to the pricing page for each product line for more information.

Square footage requirements for Customer's Own Leather are listed on the left side of the pricing page. Please refer to General Ordering Information on page 135 for further information regarding COL.

For further information, call Spinneybeck at 1 800 482-7777.

Grades**T**

Vicenza

Characteristics

Heavily finished cowhide, corrected grain.

UVerona
VoloHeavily finished cowhide, slightly raised grain.
Heavily finished cowhide, slightly raised grain; 56 colorways.**V**Acqua
Andes
España
Hand Tipped
Maremma
Velluto PelleHeavily finished cowhide, slightly raised grain, water-repellent; 17 colorways.
Pronounced grain-textured cowhide with a medium finish; 90 colorways.
Cowhide; breathable, protective finish; smooth tight grain; 84 colorways.
Two-toned leather. Pronounceable pebble grain texture.
Full grain; textured suede with impregnated soil-resistant treatment; 17 colorways.
Pronounced grain-textured cowhide with a medium finish; 90 colorways.**W**Alaska
Amazon
Antique
Arizona
Derby
Forte
Lucente
SabrinaPearlized with crushed mother of pearl and fishscales - iridescent, shimmery kip; 14 colorways.
Midweight cowhide; colors of the Amazonian jungle, grainy pebbly texture; 34 colorways.
Smooth tight grain lightly antiqued to produce an elegant patina; 7 colorways.
Lightweight kip; ironed for tight, smooth texture, glove-like hand; 20 colorways.
Combination-tanned kip; visible grain, light finish; 15 colorways.
Multi-use, high performance leather. Full grain, slightly pronounced grain texture. 80 colorways.
Smooth, very tight grain; subtle sheen; light casein finish; 17 colorways.
Kip; breathable protective finish; 102 colorways.**X**Ducale
Ducale
VeloursCowhide; embossed shrunken grain; 15 colorways.
Grain-sueded cowhide; embossed shrunken grain; scotchgarded; 19 colorways.**Y**Capri
Copenhagen
Cordovan
Distressed
Marissa
Prima
Riva
Saddle
SalonLight protective finish; full grain; aniline-dyed, chrome-free leather.
Full aniline, 100% vegetable tanned leather; 14 colorways
Aniline-dyed bull; naked finish, supple and waxy hand; 84 colorways.
Aniline-dyed; paraffin wax and final ironing process; 3 colorways.
Grain-sueded kip, scotchgarded smooth grain; 20 colorways.
Full aniline bull; special oils provide a very elegant, supple hand.
Slightly pronounced grain, water-repellent; 15 colorways.
Full aniline bull; surface takes on a rich patina over time; 15 colorways.
Full aniline cowhide with ironed surface provides lustrous sheen as seen in traditional leathers; 8 colorways.

Leather Name	Grade	Part #	Bulldog Side Chair	Bulldog Two Piece	Essentials Work Chairs	Life Seat Topper	Life Back Topper
Acqua	V	AU	■***	■	■	■	■
Alaska	W	AL	■***	■	■	■	■
Amazon	W	AM	■***	■	○	■	■
Andes	V	AD	■***	■	■	■	■
Antique	W	AQ	■***	■	■	■	■
Arizona	W	AR	■***	■	■	■	■
Capri	Y	CP	■***	■	○	■	■
Copenhagen	Y	CO	■***	■***	■***	■***	■***
Cordovan	Y	CD	■***	■	○	■	■
Derby	W	DE	■***	■	○	■	■
Distressed	Y	DT	■***	■	■***	■	■
Ducale	X	DL	■***	■***	○	○	○
Ducale Velours	X	DV	■***	■***	○	○	○
España	V	ES	■***	■	■	■	■
Forte	W	FE	■***	■	■	■	■
Hand Tipped	V	HT	○	■***	○	■*	○
Lucente	W	LU	○	○	○	○	○
Maremma	V	MM	■	■	○	■	■
Marissa	Y	MA	○	■	■	■	■
Prima	Y	PR	■***	■	■	■	■
Riva	Y	RA	■	■	■	■	■
Sabrina	W	SA	■***	■	■	■	■
Saddle	Y	SL	■***	■	○	○	○
Salon	Y	SN	■***	■	○	○	○
Velluto Pelle	V	VP	■***	■	■	■	■
Verona +++	U	VR	■***	■	■	■	■
Vicenza	T	VZ	■***	■***	■	■	■
Volo	U	VO	■***	■	■♠	■♠*	■♠*

*=Can be Railroad Cut
♠=CAL133 Approved

■=Available ○=Not Available
***=Only available with CAL133

***=Not available with Upholstered Outside Back

Updated as of January 2007

Leather Name	Open Up Seat Pad	RPM Task & High Task	RPM Side Chair	Sapper	Soho Task & Side Chair	Office Visor Seat Pad	Pedestal Cushion
Acqua	■	■	○	■	○	■	■
Alaska	■	■	○	■	○	■	■
Amazon	■	○	○	■	○	■	■
Andes	■	■	○	■	○	■	■
Antique	■	■	○	■	○	■	■
Arizona	■	■	○	■	○	■	■
Capri	■	■	○	■	○	■	○
Copenhagen	■***	■***	○	■***	○	■***	■***
Cordovan	■	■	○	■	○	■	■
Derby	■	■	○	■	○	○	■
Distressed	■	■	○	■	○	■	■
Ducale	○	○	○	■	○	○	■
Ducale Velours	○	○	○	■	○	○	■
España	■	■	○	■	○	■	■
Forte	■	■	○	■	○	■	○
Hand Tipped	○	○	○	■	○	○	○
Lucente	○	○	○	■	○	■	○
Maremma	■	○	○	○	○	■	■
Marissa	■	NT	○	■	○	■	■
Prima	■	○	○	■	○	■	■
Riva	■	○	○	■	○	■	■
Sabrina	■	■	○	■	○	■	■
Saddle	○	○	○	■	○	○	■
Salon	○	○	○	■	○	○	■
Velluto Pelle	■	■	○	■	○	■	■
Verona +++	■	■	○	■	○	■	■
Vizenca	■	■	■***	■	○	■	○
Volo	■	■	■	■	○	■	■

Any of our leather grades may be perforated with any of the patterns shown below to create a crisp, contemporary look.

Perforated Leather is a specialty product, available only on a custom order basis. Please use pattern numbers below. Perforated Leather is available in half hides only. Not recommended on outside back applications (e.g. Bulldog)



Pattern #265
.052 in. diameter
diagonal pattern
8 holes per square inch

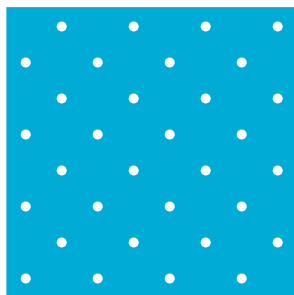

Pattern #330
.052 in. diameter
diagonal pattern
12 holes per square inch

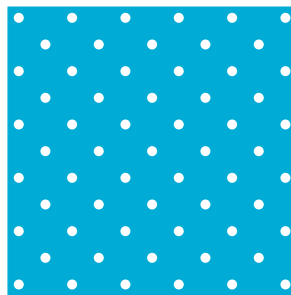

Pattern #457
.052 in. diameter
diagonal pattern
21 holes per square inch

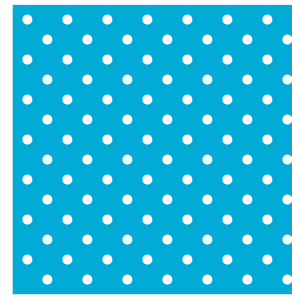

Pattern #914
Mini Perf
.052 in. diameter
straight line pattern
70 holes per square inch

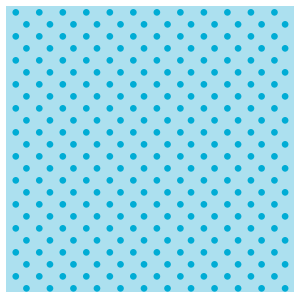

Pattern #528
Emossed Micro Perf
.050 in. diameter
staggered pattern
75 holes per square inch

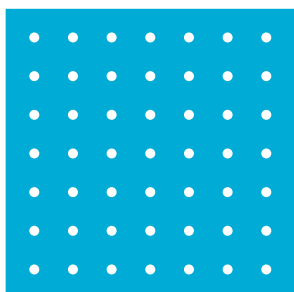

Pattern #1875
.052 in. diameter
diagonal pattern
25 holes per square inch

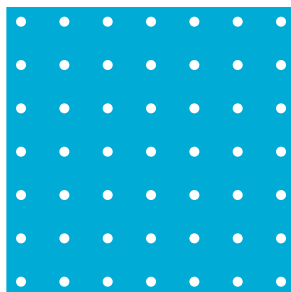

Pattern #0250S
.052 in. diameter
straight line pattern
16 holes per square inch

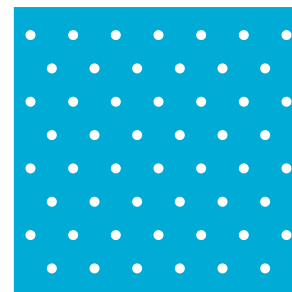

Pattern #560
.052 in. diameter
staggered pattern
22 holes per square inch



Pattern #280*
.052 in. diameter
staggered pattern
7 holes per square inch

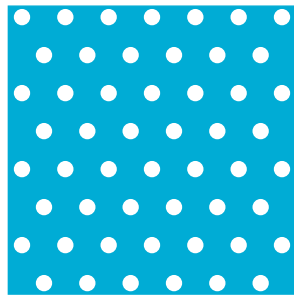

Pattern #560-85
.085 in. diameter
staggered pattern
20 holes per square inch

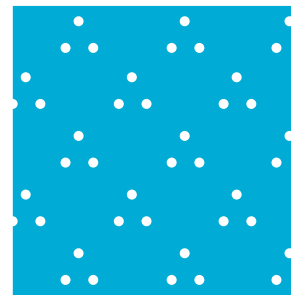

Pattern Tri-Star
Multiple Diamond
.052 in. diameter
staggered pattern
18 holes per square inch

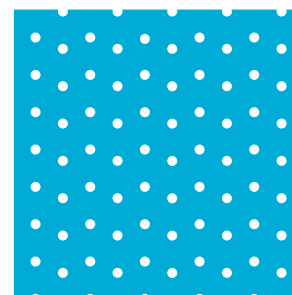

Pattern #1250
.052 in. diameter
staggered pattern
35 holes per square inch

* Not available on Parachute, Soho, Bulldog One-piece, RPM

This page intentionally left blank

The Sapper Collection

executive chairs

	pattern no.	description	seat h min	seat h max	arm h min	arm h max	overall w	overall d	overall h min	overall h max
<p><i>Designer(s):</i> Richard Sapper, 1979</p> <p><i>Award(s):</i> IBD Product Design Award, 1985</p>	45A3-A5G-H	armchair, cantilevered arms, Advanced knee-tilt control, no lumbar, pneumatic seat height adjustment	17 ³ / ₈ "	21 ¹ / ₈ "	24 ³ / ₈ "	27 ⁷ / ₈ "	26 ¹ / ₄ "	28 ³ / ₄ "	40 ³ / ₈ "	43 ⁷ / ₈ "



45C3-A5G-H	armless version, pneumatic seat height adjustment	17 ³ / ₈ "	21 ¹ / ₈ "				23 ¹ / ₄ "	28 ³ / ₄ "	40 ³ / ₈ "	43 ⁷ / ₈ "
-------------------	---	----------------------------------	----------------------------------	--	--	--	----------------------------------	----------------------------------	----------------------------------	----------------------------------



Order Code	Ordering Information	Options	Construction
<i>Example:</i> 45A3-A5G-H-K1021/8	<i>Specify:</i>	<i>Code:</i> <i>Upchg:</i> <i>Description:</i>	<i>Finish color:</i>
45A3 Sapper executive armchair	1. Pattern number	L \$226 Height-adjustable lumbar (5" range) (substitute L for G)	Black
A5G Advanced knee-tilt control with pneumatic seat height adjustment	2. Upholstery selection with color	C \$133 CAL 133 upholstery (add C to end)	<i>Internal construction:</i> Steel perimeter frame. Elastic webbed straps suspended between seat frame. Steel internal back support structure.
H 2" dual, hooded hard-wheel casters	List prices shown include fabric or leather upholstery. Contact your Knoll representative for colors.	R \$46 Soft caster for hardwood floors (substitute R for H)	<i>Upholstery:</i> High resilient, variable density molded urethane foam. Polyester batting with quilted, horizontally stitched cover. Standard upholstered back.
K1021/8 Ultrasuede/Poppy	<i>COM/COL ordering information:</i> For Customer's Own Material/Leather, see approval requirements, important processing instructions and full ordering information in the Fabric Application and Selling Policy sections of the Price List.		<i>Standard cantilevered arms:</i> Integrally colored, textured, self-skinning polyurethane over steel insert.
<i>Example for Cal 133:</i> 45A3-A5G-H-C-K1021/8	When specifying suede and shrunken cowhide, add 10% to the leather square footage requirement. When specifying calf-skin, add 15% to the leather square footage requirement.		

pattern no.	grades A	COM B	C	D	E	F	G	H	I	T	COL U	V	W	X	Y
45A3-A5G-H	\$2,115.	\$2,170.	\$2,226.	\$2,265.	\$2,302.	\$2,333.	\$2,367.	\$2,457.	\$2,617.	\$2,732.	\$2,823.	\$2,971.	\$3,449.	\$3,514.	\$3,538.
45C3-A5G-H	2,023.	2,078.	2,133.	2,171.	2,207.	2,239.	2,276.	2,364.	2,526.	2,640.	2,731.	2,879.	3,355.	3,422.	3,447.

Optional adjustable lumbar:
Lumbar contour mechanically adjusts 4" vertically by activating lever under left side of the seat.

Available on either Advanced or Basic control models.

Column cover:
Integrally colored, textured plastic.

Base:
Die cast aluminum with epoxy finish. Five-star design.

Casters:
Black, integrally colored, textured nylon; 2" dual, hooded hard-wheel or soft-wheel design.

Controls

Advanced knee-tilt control:
360° swivel, knee-tilt with tilt tension, forward tilt, upright and forward tilt lock and pneumatic seat height adjustments.

COM/COL Textile Requirement

	<i>fabric</i> yds	<i>leather</i> sq. ft.
chair	2.0	35

Cal 133:
= Cal 133 upholstery available. See textile matrix at the beginning of the Price List for pre-approved Cal 133 textiles.

See KnollNow! price list for Cal 133 KnollNow! options.

KnollTextiles and Spinneyback Leathers

Please refer to the matrices at the beginning of the price list for Approved Textiles and Leathers.

The Sapper Collection

management chairs

	pattern no.	description	seat h min	seat h max	arm h min	arm h max	overall w	overall d	overall h min	overall h max
<p><i>Designer(s):</i> Richard Sapper, 1979</p> <p><i>Award(s):</i> IBD Product Design Award, 1985</p>	45A1-A5G-H	armchair, cantilevered arms, Advanced knee-tilt control, pneumatic seat height adjustment	17 ³ / ₈ "	21 ¹ / ₈ "	23 ¹ / ₂ "	27"	24 ³ / ₄ "	28"	33 ³ / ₄ "	37 ¹ / ₄ "
	45C1-A5G-H	armless version, pneumatic seat height adjustment	17 ³ / ₈ "	21 ¹ / ₈ "			21 ³ / ₄ "	28"	33 ³ / ₄ "	37 ¹ / ₄ "



Order Code	Ordering Information	Options	Construction
<i>Example:</i> 45A1-A5G-H-K679/13	<i>Specify:</i>	<i>Code: Upchg: Description:</i>	<i>Finish color:</i>
45A1 Sapper management armchair	1. Pattern number	L \$226 Adjustable lumbar (substitute L for G)	Black
A5G Advanced knee-tilt control with pneumatic seat height adjustment	2. Upholstery selection with color	C \$133 CAL 133 upholstery (add C to end)	<i>Internal construction:</i> Steel perimeter frame. Elastic webbed straps suspended between seat frame. Steel internal back support structure.
H 2" dual, hooded hardwheel casters	List prices shown include fabric or leather upholstery. Contact your Knoll representative for colors.	R \$46 Soft caster for hardwood floors (substitute R for H)	<i>Upholstery:</i> High resilient, variable density molded urethane foam. Polyester batting with quilted, horizontally stitched cover. Standard upholstered back.
K679/13 Extreme Velvet/ Tidal Wave	<i>COM/COL ordering information:</i> For Customer's Own Material/Leather, see approval requirements, important processing instructions and full ordering information in the Fabric Application and Selling Policy sections of the Price List.		<i>Standard cantilevered arms:</i> Integrally colored, textured, self-skinning polyurethane over steel insert.
<i>Example for Cal 133:</i> 45A1-A5G-H-C-K679/13	When specifying suede and shrunken cowhide, add 10% to the leather square footage requirement. When specifying calf-skin, add 15% to the leather square footage requirement.		

pattern no.	grades A	COM B	C	D	E	F	G	H	I	T	COL U	V	W	X	Y
45A1-A5G-H	\$1,798.	\$1,843.	\$1,890.	\$1,923.	\$1,955.	\$1,980.	\$2,010.	\$2,085.	\$2,225.	\$2,324.	\$2,398.	\$2,524.	\$2,935.	\$2,992.	\$3,011.
45C1-A5G-H	1,704.	1,750.	1,798.	1,831.	1,862.	1,887.	1,918.	1,993.	2,132.	2,231.	2,306.	2,432.	2,843.	2,900.	2,917.

Optional adjustable lumbar:
Lumbar contour mechanically adjusts 4" vertically by activating lever under left side of the seat.

Available on either Advanced or Basic control models.

Column cover:
Integrally colored, textured plastic.

Base:
Die cast aluminum with epoxy finish. Five-star design.

Standard casters:
Black, integrally colored, textured nylon; 2" dual, hooded hard-wheel design.

Controls

Advanced knee-tilt control:
360° swivel, knee-tilt with tilt tension, forward tilt, upright and forward tilt lock and pneumatic seat height adjustments.

COM/COL Textile Requirement

	<i>fabric</i> yds	<i>leather</i> sq. ft.
chair	1.7	30

Cal 133:
= Cal 133 upholstery available. See textile matrix at the beginning of the Price List for pre-approved Cal 133 textiles.

See KnollNow! price list for Cal 133 KnollNow! options.

KnollTextiles and Spinneybeck Leathers

Please refer to the matrices at the beginning of the price list for Approved Textiles and Leathers.

The Sapper Collection

side chairs

	pattern no.	description	seat h	arm h	overall w	overall d	overall h
<i>Designer(s):</i> Richard Sapper, 1979	45A1-SL	armchair, cantilevered arms	19 1/4"	26 3/4"	24 3/4"	27 1/2"	34 1/4"
	45C1-SL	armless chair	19 1/4"		21 3/4"	27 1/2"	34 1/4"



Order Code

Example: **45A1-SL-K721/1**
45A1 Sapper side armchair
SL sled base
K721/1 Rochelle/merlot
Example for Cal 133:
45A1-SL-C-K721/1

Ordering Information

Specify:

1. Pattern number
2. Upholstery selection with color

List prices shown include fabric or leather upholstery. Contact your Knoll representative for colors.

COM/COL ordering information:
 For Customer's Own Material/Leather, see approval requirements, important processing instructions and full ordering information in the Fabric Application and Selling Policy sections of the Price List.

Options

<i>Code:</i>	<i>Upchg:</i>	<i>Description:</i>
C	\$133	Cal 133 upholstery (add C to end)

When specifying suede and shrunken cowhide, add 10% to the leather square footage requirement. When specifying calf-skin, add 15% to the leather square footage requirement.

pattern no.	grades A	COM B	C	D	E	F	G	H	I	T	COL U	V	W	X	Y
45A1-SL	\$1,426.	\$1,473.	\$1,517.	\$1,553.	\$1,585.	\$1,611.	\$1,639.	\$1,715.	\$1,853.	\$1,946.	\$2,021.	\$2,149.	\$2,584.	\$2,649.	\$2,666.
45C1-SL	1,335.	1,378.	1,425.	1,460.	1,491.	1,517.	1,547.	1,623.	1,760.	1,854.	1,927.	2,056.	2,491.	2,556.	2,574.

Construction	COM/COL Textile Requirement	KnollTextiles and Spinneyback Leathers
<p><i>Finish color:</i> Black.</p> <p><i>Internal construction:</i> Steel perimeter frame. Elastic webbed straps suspended between seat frame. Steel internal back support structure.</p> <p><i>Upholstery:</i> High resilient, variable density molded urethane foam. Polyester batting with quilted, horizontally stitched cover. Standard upholstered back.</p>	<p><i>Standard cantilevered arms:</i> Integrally colored, textured, self-skinning polyurethane over steel insert.</p> <p><i>Frame:</i> 12-gauge, 7/8" diameter round steel tube with epoxy finish.</p> <p><i>Glides:</i> Opaque nylon.</p> <p>chair <i>fabric</i> <i>leather</i> <i>yds</i> <i>sq.ft.</i> 1.7 30</p> <p><i>Cal 133:</i> ‡ = Cal 133 upholstery available. See textile matrix at the beginning of the Price List for pre-approved Cal 133 textiles.</p> <p>See KnollNow! price list for Cal 133 KnollNow! options.</p>	<p>Please refer to the matrices at the beginning of the price list for Approved Textiles and Leathers.</p>

Sapper Dimensions and Operating Instructions

Seat

	Seat Height	Seat Depth	Seat Width	Seat Pan Angle	Seat Back/ Seat Pan Angle
Executive (Pneum.)	17" - 20 1/2"	18"	22 1/2"	6.5°	95°
Manager (Pneum.)	17" - 20 1/2"	18"	20 1/2"	6.5°	95°
Side Chair	17 3/4"	18"	20 1/2"	3°	95°

Back

	Lumbar Support Height	Lumbar Support Width	Lumbar Support Center	Seat Back Width
Executive (Pneum.)	8	16 1/2"	7 1/2"	22 1/2"
Manager (Pneum.)	8	16 1/2"	7 1/2"	22 1/2"
Side Chair	8	16 1/2"	7 1/2"	22 1/2"

Armrests

Width Between Armrests
22 1/2"
20 1/2"
20 1/2"

*Note: Measurements taken with the BIFMA Chair Measuring Device.

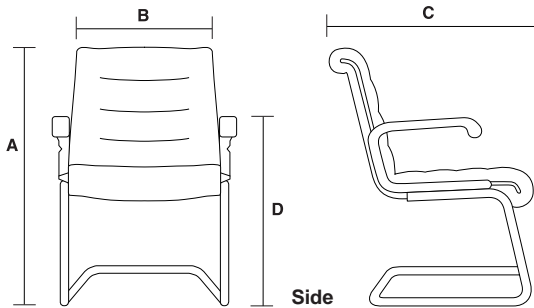
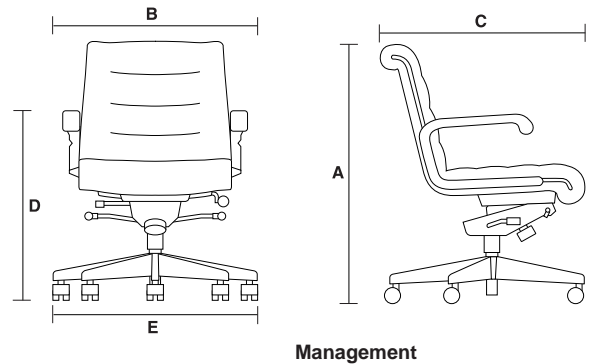
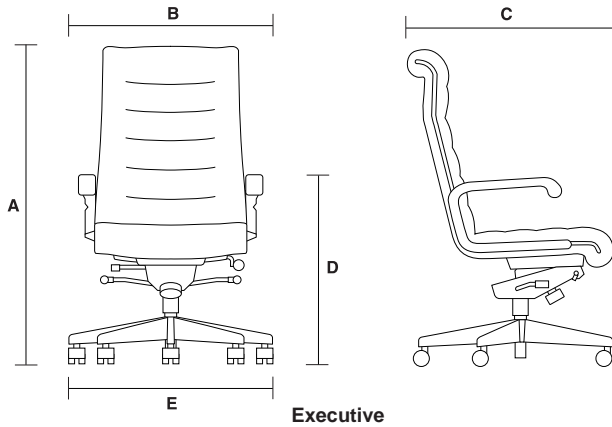

	Executive (pneumatic)	Management (pneumatic)	Side
A overall height	40 3/4" - 43 7/8"	33 3/4" - 37 1/4"	34 3/4"
B overall width	26 3/4"	24 3/4"	24 3/4"
C overall depth	28 3/4"	28"	27 1/2"
D arm height	23 1/2" - 27"	23 1/2" - 27"	26 3/4"
E base dimensions	28" diameter	28" diameter	26" width
weight with arms	55 1/2 lbs.	51 lbs.	36 lbs.



Pneumatic Seat Height Adjustment

To adjust the height, lift the handle on the right side of the seat.

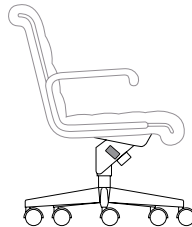

Tilt Lock

To lock the chair upright, push down on the handle under the left side of the chair. Pull up to release.

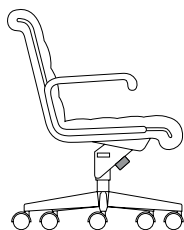

Tension Adjustment

Lean back and recline. If tension needs adjusting, reach under the front-center of the seat and increase tension by turning the knob to the left, or decrease tension by turning the knob to the right.

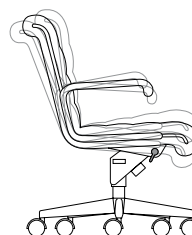

Forward Tilt

Reach under the right side of the chair toward the front and twist the lever to the front while slightly reclining to activate forward tilt. To deactivate forward tilt, recline slightly and twist the lever to the rear.

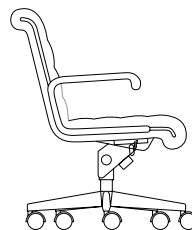

Adjustable Lumbar Support







(optional)

To raise the lumbar support, slide the curved lever on the left side of the chair toward the rear of the chair. To lower the lumbar, slide the lever toward the front edge of the chair.

Compliancy: ANSI/BIFMA x 5.1 – 1993, CAL 133 in leather
Operating Instructions also available online at www.knoll.com

The Open Up Chair

high-back chairs

pattern no.	description	seat h min	seat h max	arm h min	arm h max	overall w, max	overall d, max	overall h min	overall h max		
<i>Designer(s):</i> Mathias Seiler for Sedus, 2001	S901P-(2,4,C)- F5G-D-(S,H)- (1,2,3,4) 	3D plastic arms, advanced control, standard seat	17"	22 1/4"	24 3/4"	34 1/4"	26 1/2"	28 3/4"	48 1/2"	54 3/4"	
<i>Award(s):</i> International Baden - Württemberg 2002 Design Prize, Silver, Germany German Design Prize, 2002, Germany NeoCon Silver, Best of NeoCon, Task Chair Seating Design, June 2001, USA		S901A-(2,4,C)- F5G-D-(S,H)- (1,2,3,4) 	fixed arms, advanced control, standard seat	17"	22 1/4"	31"	26 1/2"	28 3/4"	48 1/2"	54 3/4"	
		S901C-(2,4,C)- F5G-D-(S,H)- (1,2,3,4)	armless, advanced control, standard seat	17"	22 1/4"		26 1/2"	28 3/4"	48 1/2"	54 3/4"	
		S901P-(2,4,C)- B5G-D-(S,H)- (1,2,3,4)	3D plastic arms, basic control, standard seat	17"	22 1/4"	24 3/4"	34 1/4"	26 1/2"	28 3/4"	48 1/2"	54 3/4"
		S901A-(2,4,C)- B5G-D-(S,H)- (1,2,3,4)	fixed arms, basic control, standard seat	17"	22 1/4"	31"	26 1/2"	28 3/4"	48 1/2"	54 3/4"	

Order Code

<i>Example:</i>	S901P-4-F5G-D-H-2- K451/4
S901P	Open Up high-back with 3D plastic arms
4	silver painted base
F5G	advanced control
D	standard seat
H	black hard caster
2	black mesh back
K451/4	Una/Ebony seat pad

Ordering Information

- Specify:*
- Chair family and arm type
 - Specify Finish color
Black painted aluminum (2)
Silver painted aluminum (4)
Polished aluminum (C)
 - Specify mesh color
Navy (1)
Black (2)
Wine (3)
Light Grey (4)
 - Upholstery selection with color

Note: Headrest is always covered in black leather

List prices shown include fabric or leather upholstery. Contact your Knoll representative for colors.

COM/COL ordering information:

For Customer's Own Material/Leather, see approval requirements, important processing instructions and full ordering information in the Fabric Application and Selling Policy sections of the Price List.

When specifying suede and shrunken cowhide, add 10% to the leather square footage requirement. When specifying calf-skin, add 15% to the leather square footage requirement.

Options

Code:	Upchg:	Description:
C	\$306	Polished aluminum finish
G	\$100	Gel armpads (insert a G into the pattern code after the P or A indicating type of arm. Available on both fixed and 3D arms.)

Code:	Upchg:	Description:
J	\$73	Black leather arm pad (substitute J for P) not available on fixed arms
R	n/c	Shorter seat - 16.9" depth (substitute R for D)
L	\$25	Adjustable lumbar (substitute L for G)
H	n/c	Black hard caster
S	n/c	Soft grey caster
Perf- (528)	\$105	For perforated leather insert code Perf-(528) after the leather selection (or see Perforated Leather information sheet in the Spinneybeck Leather Application section at the beginning of this Price List for more codes)

pattern no.	grades A	COM B	C	D	E	F	G	H	I	T	COL U	V	W	X	Y
S901P-(2,4,C)- F5G-D-(S,H)- (1,2,3,4)	\$2,188.	\$2,194.	\$2,242.	\$2,264.	\$2,284.	\$2,298.	\$2,365.	\$2,400.	\$2,420.	\$2,576.	\$2,605.	\$2,674.	\$2,831.	\$2,845.	\$2,914.
S901A-(2,4,C)- F5G-D-(S,H)- (1,2,3,4)	2,093.	2,099.	2,147.	2,169.	2,188.	2,203.	2,270.	2,304.	2,325.	2,481.	2,510.	2,578.	2,736.	2,749.	2,818.
S901C-(2,4,C)- F5G-D-(S,H)- (1,2,3,4)	1,983.	1,990.	2,037.	2,059.	2,079.	2,093.	2,160.	2,194.	2,215.	2,371.	2,400.	2,469.	2,626.	2,640.	2,709.
S901P-(2,4,C)- B5G-D-(S,H)- (1,2,3,4)	2,169.	2,175.	2,221.	2,242.	2,264.	2,276.	2,346.	2,379.	2,400.	2,555.	2,584.	2,653.	2,810.	2,824.	2,892.
S901A-(2,4,C)- B5G-D-(S,H)- (1,2,3,4)	2,071.	2,079.	2,127.	2,147.	2,169.	2,181.	2,249.	2,284.	2,304.	2,459.	2,488.	2,557.	2,715.	2,728.	2,797.

Construction*Inner seat structure:*

Polypropylene.

J-Bar structure:

Die-cast aluminum with vulcanized rubber disk.

Back suspension fabric:

100% polyester.

Control:

Die-cast aluminum with plastic handles.

Cushions:

Insert molded high resilient urethane foam.

Fixed height arms/3-D arms:

Integrally colored, textured glass-reinforced nylon.

Arm-pads:

ABS plastic with optional padded black leather covering.

Base:

Die-cast aluminum with powder coating or polished aluminum.

Casters:

Integrally colored, textured nylon.

Headrest:

Glass-filled nylon molded frame with integrally molded urethane foam and black leather upholstery.

Controls*Advanced control:*Pneumatic seat height, synchronized tilt with side crank tension adjustment, forward tilt, multiple position tilt lock, 360° swivel, adjustable headrest.*Basic control:*Pneumatic seat height, synchronized tilt with side crank tension adjustment, no forward tilt, multiple position tilt lock, 360° swivel, adjustable headrest.**COM/COL Textile Requirement**

	<i>fabric yds</i>	<i>leather sq. ft.</i>
chair	0.8	12

**KnollTextiles and Spinneybeck
Leathers**

Please refer to the matrices at the beginning of the price list for Approved Textiles and Leathers.

The Open Up Chair

high-back chairs

pattern no.	description	seat h min	seat h max	arm h min	arm h max	overall w, max	overall d, max	overall h min	overall h max
<i>Designer(s):</i> Mathias Seiler for Sedus, 2001	S901C-(2,4,C)- B5G-D-(S,H)- (1,2,3,4) armless, basic control, standard seat	17"	22 1/4"			26 1/2"	28 3/4"	48 1/2"	54 1/4"

Award(s):
International Baden -
Württemberg 2002
Design Prize, Silver, Germany
German Design Prize, 2002,
Germany
NeoCon Silver, Best of NeoCon,
Task Chair Seating Design,
June 2001, USA



Order Code

<i>Example:</i>	S901P-4-F5G-D-H-2- K451/4
S901P	Open Up high-back with 3D plastic arms
4	silver painted base
F5G	advanced control
D	standard seat
H	black hard caster
2	black mesh back
K451/4	Una/Ebony seat pad

Ordering Information

- Specify:*
- Chair family and arm type
 - Specify Finish color
Black painted aluminum (2)
Silver painted aluminum (4)
Polished aluminum (C)
 - Specify mesh color
Navy (1)
Black (2)
Wine (3)
Light Grey (4)
 - Upholstery selection with color

Note: Headrest is always covered in black leather

List prices shown include fabric or leather upholstery. Contact your Knoll representative for colors.

COM/COL ordering information:

For Customer's Own Material/Leather, see approval requirements, important processing instructions and full ordering information in the Fabric Application and Selling Policy sections of the Price List.

When specifying suede and shrunken cowhide, add 10% to the leather square footage requirement. When specifying calf-skin, add 15% to the leather square footage requirement.

Options

Code:	Upchg:	Description:
C	\$306	Polished aluminum finish
G	\$100	Gel armpads (insert a G into the pattern code after the P or A indicating type of arm. Available on both fixed and 3D arms.)

Code:	Upchg:	Description:
J	\$73	Black leather arm pad (substitute J for P) not available on fixed arms
R	n/c	Shorter seat - 16.9" depth (substitute R for D)
L	\$25	Adjustable lumbar (substitute L for G)
H	n/c	Black hard caster
S	n/c	Soft grey caster
Perf- (528)	\$105	For perforated leather insert code Perf-(528) after the leather selection (or see Perforated Leather information sheet in the Spinneybeck Leather Application section at the beginning of this Price List for more codes)

pattern no.	grades A	COM B	C	D	E	F	G	H	I	T	COL U	V	W	X	Y
S901C-(2,4,C)- B5G-D-(S,H)- (1,2,3,4)	\$1,963.	\$1,969.	\$2,017.	\$2,037.	\$2,059.	\$2,071.	\$2,141.	\$2,175.	\$2,194.	\$2,350.	\$2,379.	\$2,447.	\$2,605.	\$2,618.	\$2,687.

Construction

Inner seat structure:
Polypropylene.

J-Bar structure:
Die-cast aluminum with vulcanized rubber disk.

Back suspension fabric:
100% polyester.

Control:
Die-cast aluminum with plastic handles.

Cushions:
Insert molded high resilient urethane foam.

Fixed height arms/3-D arms:
Integrally colored, textured glass-reinforced nylon.

Armpads:
ABS plastic with optional padded black leather covering.

Base:
Die-cast aluminum with powder coating or polished aluminum.

Casters:
Integrally colored, textured nylon.

Headrest:
Glass-filled nylon molded frame with integrally molded urethane foam and black leather upholstery.

Controls

Advanced control:
Pneumatic seat height, synchronized tilt with side crank tension adjustment, forward tilt, multiple position tilt lock, 360° swivel, adjustable headrest.

Basic control:
Pneumatic seat height, synchronized tilt with side crank tension adjustment, no forward tilt, multiple position tilt lock, 360° swivel, adjustable headrest.

COM/COL Textile Requirement







	<i>fabric yds</i>	<i>leather sq. ft.</i>
chair	0.8	12

Knoll Textiles and Spinneybeck Leathers

Please refer to the matrices at the beginning of the price list for Approved Textiles and Leathers.

The Open Up Chair

mid-back chairs

	pattern no.	description	seat h min	seat h max	arm h min	arm h max	overall w, max	overall d, max	overall h min	overall h max
Designer(s): Mathias Seiler for Sedus 	S903P-(2,4,C)- F5G-D-(S,H)- (1,2,3,4)	3D plastic arms, advanced control, standard seat	17"	22 1/4"	24 3/4"	34 1/4"	26 1/2"	28 3/4"	39 1/2"	44 3/4"
										
	S903A-(2,4,C)- F5G-D-(S,H)- (1,2,3,4)	fixed arms, advanced control, standard seat	17"	22 1/4"		31"	26 1/2"	28 3/4"	39 1/2"	44 3/4"
										
	S903C-(2,4,C)- F5G-D-(S,H)- (1,2,3,4)	armless, advanced control, standard seat	17"	22 1/4"			26 1/2"	28 3/4"	39 1/2"	44 3/4"
										
S903P-(2,4,C)- B5G-D-(S,H)- (1,2,3,4)	3D plastic arms, basic control, standard seat	17"	22 1/4"	24 3/4"	34 1/4"	26 1/2"	28 3/4"	39 1/2"	44 3/4"	
										
S903A-(2,4,C)- B5G-D-(S,H)- (1,2,3,4)	fixed arms, basic control, standard seat	17"	22 1/4"		31"	26 1/2"	28 3/4"	39 1/2"	44 3/4"	
										

Order Code

<i>Example:</i>	S903P-4-F5G-D-H-2- K451/4
S903P	Open Up mid-back with 3D plastic arms
4	silver painted base
F5G	advanced control
D	standard seat
H	black hard caster
2	black mesh back
K451/4	Una/Ebony seat pad

Ordering Information

Gel armpads (insert a G into the pattern code after the P or A indicating type of arm. Available on both fixed and 3D arms.)

Specify:

- Chair family and arm type
- Finish color
Black painted aluminum (2)
Silver painted aluminum (4)
Polished aluminum (C)
- Specify mesh color
Navy (1)
Black (2)
Wine (3)
Light Grey (4)
- Upholstery selection with color

List prices shown include fabric or leather upholstery. Contact your Knoll representative for colors.

COM/COL ordering information:

For Customer's Own Material/Leather, see approval requirements, important processing instructions and full ordering information in the Fabric Application and Selling Policy sections of the Price List.

When specifying suede and shrunken cowhide, add 10% to the leather square footage requirement. When specifying calf-skin, add 15% to the leather square footage requirement.

Options

Code:	Upchg:	Description:
C	\$306	Polished aluminum finish
G	\$100	Gel armpads (insert a G into the pattern code after the P or A indicating type of arm. Available on both fixed and 3D arms.)

Code:	Upchg:	Description:
J	\$73	Black leather arm pad (substitute J for P) not available on fixed arms
R	n/c	Shorter seat - 16.9" depth (substitute R for D)
L	\$25	Adjustable lumbar (substitute L for G)
H	n/c	Black hard caster
S	n/c	Soft grey caster
Perf- (528)	\$105	For perforated leather insert code Perf-(528) after the leather selection (or see the Perforated Leather sheet in the Spinneybeck Leather Application section at the beginning of this price list for more codes)

pattern no.	grades A	COM B	C	D	E	F	G	H	I	T	COL U	V	W	X	Y
S903P-(2,4,C)- F5G-D-(S,H)- (1,2,3,4)	\$1,614.	\$1,621.	\$1,669.	\$1,690.	\$1,709.	\$1,723.	\$1,792.	\$1,826.	\$1,846.	\$2,002.	\$2,032.	\$2,099.	\$2,257.	\$2,270.	\$2,339.
S903A-(2,4,C)- F5G-D-(S,H)- (1,2,3,4)	1,519.	1,525.	1,572.	1,592.	1,614.	1,626.	1,696.	1,730.	1,751.	1,905.	1,935.	2,003.	2,160.	2,175.	2,242.
S903C-(2,4,C)- F5G-D-(S,H)- (1,2,3,4)	1,409.	1,416.	1,464.	1,483.	1,504.	1,519.	1,587.	1,621.	1,642.	1,796.	1,826.	1,894.	2,051.	2,066.	2,133.
S903P-(2,4,C)- B5G-D-(S,H)- (1,2,3,4)	1,592.	1,599.	1,648.	1,669.	1,690.	1,703.	1,770.	1,805.	1,826.	1,981.	2,010.	2,079.	2,237.	2,249.	2,318.
S903A-(2,4,C)- B5G-D-(S,H)- (1,2,3,4)	1,498.	1,504.	1,553.	1,572.	1,592.	1,608.	1,675.	1,709.	1,730.	1,886.	1,915.	1,983.	2,141.	2,154.	2,221.

Construction*Inner seat structure:*

Polypropylene.

J-Bar structure:

Die-cast aluminum with vulcanized rubber disk.

Back suspension fabric:

100% polyester.

Control:

Die-cast aluminum with plastic handles.

Cushions:

Insert molded high resilient urethane foam.

Fixed height arms/3-D arms:

Integrally colored, textured glass-reinforced nylon.

Armpads:

ABS plastic with optional padded black leather covering.

Base:

Die-cast aluminum with powder coating or polished aluminum.

Casters:

Integrally colored, textured nylon.

Controls*Advanced control:*Pneumatic seat height, synchronized tilt with side crank tension adjustment, forward tilt, multiple position tilt lock, 360° swivel.*Basic control:*Pneumatic seat height, synchronized tilt with side crank tension adjustment, no forward tilt, multiple position tilt lock, 360° swivel.**COM/COL Textile Requirement**

	<i>fabric yds</i>	<i>leather sq. ft.</i>
chair	0.8	12

**KnollTextiles and Spinneybeck
Leathers**

Please refer to the matrices at the beginning of the price list for Approved Textiles and Leathers.

The Open Up Chair

mid-back chairs

Designer(s):	pattern no.	description	seat h min	seat h max	arm h min	arm h max	overall w, max	overall d, max	overall h min	overall h max
Mathias Seiler for Sedus	S903C-(2,4,C)- B5G-D-(S,H)- (1,2,3,4)	armless, basic control, standard seat	17"	22 1/4"			26 1/2"	28 3/4"	39 1/2"	44 1/4"



Order Code

<i>Example:</i>	S903P-4-F5G-D-H-2-K451/4
S903P	Open Up mid-back with 3D plastic arms
4	silver painted base
F5G	advanced control
D	standard seat
H	black hard caster
2	black mesh back
K451/4	Una/Ebony seat pad

Ordering Information

Gel armpads (insert a G into the pattern code after the P or A indicating type of arm. Available on both fixed and 3D arms.)

Specify:

- Chair family and arm type
- Finish color
Black painted aluminum (2)
Silver painted aluminum (4)
Polished aluminum (C)
- Specify mesh color
Navy (1)
Black (2)
Wine (3)
Light Grey (4)
- Upholstery selection with color

List prices shown include fabric or leather upholstery. Contact your Knoll representative for colors.

COM/COL ordering information:

For Customer's Own Material/Leather, see approval requirements, important processing instructions and full ordering information in the Fabric Application and Selling Policy sections of the Price List.

When specifying suede and shrunken cowhide, add 10% to the leather square footage requirement. When specifying calf-skin, add 15% to the leather square footage requirement.

Options

Code:	Upchg:	Description:
C	\$306	Polished aluminum finish
G	\$100	Gel armpads (insert a G into the pattern code after the P or A indicating type of arm. Available on both fixed and 3D arms.)

Code: Upchg: Description:

J	\$73	Black leather arm pad (substitute J for P) not available on fixed arms
R	n/c	Shorter seat - 16.9" depth (substitute R for D)
L	\$25	Adjustable lumbar (substitute L for G)
H	n/c	Black hard caster
S	n/c	Soft grey caster
Perf- (528)	\$105	For perforated leather insert code Perf-(528) after the leather selection (or see the Perforated Leather sheet in the Spinneybeck Leather Application section at the beginning of this price list for more codes)

pattern no.	grades A	COM B	C	D	E	F	G	H	I	T	COL U	V	W	X	Y
S903C-(2,4,C)- B5G-D-(S,H)- (1,2,3,4)	\$1,388.	\$1,394.	\$1,443.	\$1,464.	\$1,483.	\$1,498.	\$1,565.	\$1,599.	\$1,621.	\$1,776.	\$1,805.	\$1,874.	\$2,032.	\$2,044.	\$2,114.

Construction*Inner seat structure:*

Polypropylene.

J-Bar structure:

Die-cast aluminum with vulcanized rubber disk.

Back suspension fabric:

100% polyester.

Control:

Die-cast aluminum with plastic handles.

Cushions:

Insert molded high resilient urethane foam.

Fixed height arms/3-D arms:

Integrally colored, textured glass-reinforced nylon.

Armpads:

ABS plastic with optional padded black leather covering.

Base:

Die-cast aluminum with powder coating or polished aluminum.

Casters:

Integrally colored, textured nylon.

Controls*Advanced control:*Pneumatic seat height, synchronized tilt with side crank tension adjustment, forward tilt, multiple position tilt lock, 360° swivel.*Basic control:*Pneumatic seat height, synchronized tilt with side crank tension adjustment, no forward tilt, multiple position tilt lock, 360° swivel.**COM/COL Textile Requirement**

	<i>fabric yds</i>	<i>leather sq. ft.</i>
chair	0.8	12

**Knoll Textiles and Spinneybeck
Leathers**

Please refer to the matrices at the beginning of the price list for Approved Textiles and Leathers.

The Open Up Chair

replacement seat option

Designer(s):
Mathias Seiler for Sedus



pattern no.	description
S9013DSEAT	seat upholstery assembly - standard, 18.4" depth
S9013RSEAT	seat upholstery assembly - shorter, 16.9" depth

Order Code

Example: **S9013DSEAT**
S9013D SEAT Open Up replacement seat option - Standard Seat depth

K451/4 Una/Ebony seat pad

Ordering Information

Specify:

1. Pattern number
2. Specify upholstery selection with color

List prices shown include fabric or leather upholstery. Contact your Knoll representative for colors.

COM/COL ordering information:
For Customer's Own Material/Leather, see approval requirements, important processing instructions and full ordering information in the Fabric Application and Selling Policy sections of the Price List.

When specifying suede and shrunken cowhide, add 10% to the leather square footage requirement. When specifying calf-skin, add 15% to the leather square footage requirement.

Options

Code:	Upchg:	Description:
Perf-	\$106	For perforated leather insert code
(528)		Perf-(528) after the leather selection (or see Perforated Leather information sheet in the Spinneybeck Leather Application section at the beginning of this Price List for more choices and codes)

pattern no.	grades A	COM B	C	D	E	F	G	H	I	T	COL U	V	W	X	Y
S9013DSEAT	\$191.	\$198.	\$246.	\$266.	\$288.	\$301.	\$370.	\$403.	\$424.	\$579.	\$608.	\$677.	\$834.	\$848.	\$916.
S9013RSEAT	191.	198.	246.	266.	288.	301.	370.	403.	424.	579.	608.	677.	834.	848.	916.

Construction

Inner seat structure:
Polypropylene.

Cushions:
Insert molded high resilient urethane foam.

COM/COL Textile Requirement





	<i>fabric</i> <i>yds</i>	<i>leather</i> <i>sq. ft.</i>
chair	0.8	12

Knoll Textiles and Spinneybeck Leathers

Please refer to the matrices at the beginning of the price list for Approved Textiles and Leathers.

The Open Up Chair

side chairs

	pattern no.	description	seat h	arm h	overall w	overall d	overall h
<i>Designer(s):</i> Mathias Seiler for Sedus 	S908-2-SL-2	Stacking side chair / black painted base	16 1/2"	25 1/4"	22 1/2"	24 1/2"	33 3/4"
							
	S908-4-SL-2	Stacking side chair / silver painted base	16 1/2"	25 1/4"	22 1/2"	24 1/2"	33 3/4"
							
	S908-C-SL-2	Stacking side chair / chrome base	16 1/2"	25 1/4"	22 1/2"	24 1/2"	33 3/4"
							

Order Code

<i>Example:</i>	S908-4-SL-2 K451/4
S908	Open Up stacking side chair (stacks 5-high)
4-SL	silver painted base
2	black mesh back
K451/4	Una/Ebony seat pad
<i>Example for Cal 133:</i>	
S908-4-SL-2-C-K451/4	

Ordering Information

- Specify:*
1. Pattern number
 2. Finish color
Black painted aluminum (2)
Silver painted aluminum (4)
Chrome (C)
 3. Specify mesh color
Black only (2)
 4. Insert C for Cal 133, if applicable
 5. Seat upholstery selection with color

List prices shown include fabric or leather upholstery. Contact your Knoll representative for colors.

COM/COL ordering information:

For Customer's Own Material/Leather, see approval requirements, important processing instructions and full ordering information in the Fabric Application and Selling Policy sections of the Price List.

When specifying suede and shrunken cowhide, add 10% to the leather square footage requirement. When specifying calf-skin, add 15% to the leather square footage requirement.

Options

Code:	Upchg:	Description:
Perf-	\$100	For perforated leather insert code
(528)		Perf-(528) after the leather selection (or see the Perforated Leather sheet in the Spinneybeck Leather Application section at the beginning of this Price List for more choices and codes)
C	\$79	Cal 133 (available for side chair only). Insert C after mesh color in pattern logic.

Note: The Open Up Side Chair stacks 5-high

pattern no.	grades A	COM B	C	D	E	F	G	H	I	T	COL U	V	W	X	Y
S908-2-SL-2	\$887.	\$904.	\$927.	\$944.	\$955.	\$972.	\$995.	\$1,017.	\$1,040.	\$1,091.	\$1,119.	\$1,192.	\$1,305.	\$1,356.	\$1,408.
S908-4-SL-2	887.	904.	927.	944.	955.	972.	995.	1,017.	1,040.	1,091.	1,119.	1,192.	1,305.	1,356.	1,408.
S908-C-SL-2	990.	1,007.	1,031.	1,048.	1,060.	1,077.	1,100.	1,129.	1,146.	1,198.	1,227.	1,301.	1,416.	1,469.	1,521.

Construction

Inner seat structure:
Polypropylene.

Back suspension fabric:
100% polyester.

Cushions:
Insert molded high resilient urethane foam.

Frame:
Black or silver painted aluminum, or chrome.

COM/COL Textile Requirement

	<i>fabric</i>	<i>leather</i>
	<i>yds</i>	<i>sq. ft.</i>
chair	0.8	12

Cal 133:
♣ = Cal 133 upholstery available. See textile matrix at the beginning of the Price List for pre-approved Cal 133 textiles.

See KnollNow! price list for Cal 133 KnollNow! options.

KnollTextiles and Spinneybeck Leathers

Please refer to the matrices at the beginning of the price list for Approved Textiles and Leathers.

The Open Up Chair Dimensions and Operating Instructions

Seat

	Seat Height	Seat Depth	Seat Width
Open Up complies with the BIFMA G1-2002 Ergonomic Standard.			
Mid-Back	16" - 21"	16.9" Shorter 18.4" Standard	19.5"
High-Back	16" - 21"	16.9" Shorter 18.4" Standard	19.5"
Side Chair	18.5"	17"	19.5"

Back

Armrests

	Backrest Height	Head Rest	Backrest Width	Armrest Height (From Floor)	Armrest Height (From Seat)	Width between Armrests
High-Back	22 1/2"	7"	18"	3D 23" - 28 1/2"	7 1/2" - 11 1/2"	20"
Mid-Back	22 1/2"	—	18"	Fixed 26"	8"	20"
Side Chair	17"	—	18.5"	26"	8 1/2"	19 1/4"

*Range achieved with single chair, or combination of chairs. Open Up's low cylinder, medium and high cylinder options exceed the 15" - 19.9" seat height range. Open Up's medium cylinder range is shown above.

Adjustable: Include part of 0° - 4° rearward *Adjustable: Includes part of 5.9" - 9.8"

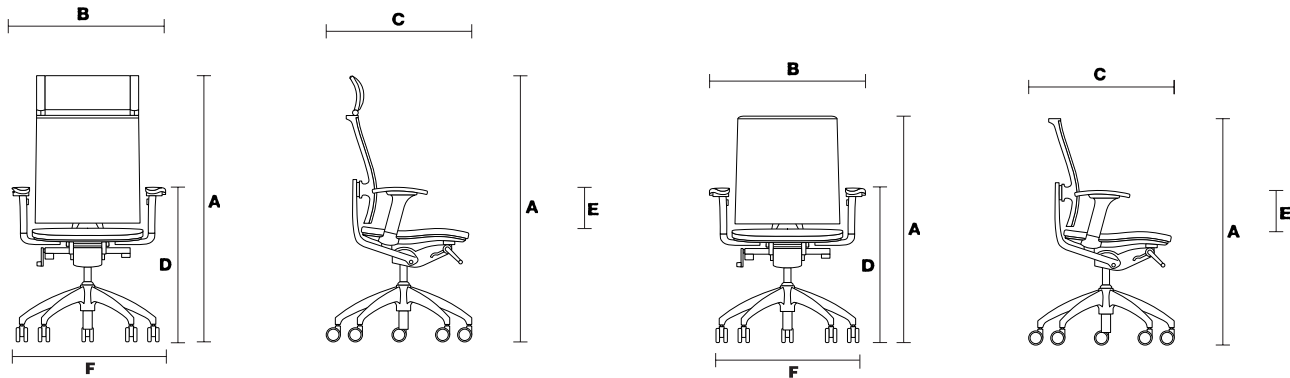

	High-Back	Mid-Back	Side Chair
A overall height	46" - 51 1/4" *	38" - 43 1/4"	35"
B overall width	27"	27"	22 3/4"
C overall depth	26"	26"	25"
D 3D arm height (from floor)	26" - 30"	26" - 30"	26"
E 3D arm height (from seat ref. pt.)	7 1/2" - 11 1/2"	7 1/2" - 11 1/2"	8"
F base diameter	27"	27"	19"

*High-back overall height includes headrest adjustments.



Open Up High Back Chair



Open Up Mid Back Chair



Pneumatic seat height adjustment

To raise seat:

Remove your weight from chair; lift lever on right side of chair, releasing lever at desired seat height.

To lower seat:

While seated, lift lever on right side of chair, releasing lever at desired seat height.



Tilt lock and multiple lock

To unlock backrest:

On left side of chair, pull lever upward and release it. Lean against backrest and it will automatically release.

To lock backrest into position:

Lean back until backrest reaches desired angle. On left side of chair, pull lever down and release it to lock backrest into position.



Tension adjustment

On right side of chair, pull out handle.

Crank handle clockwise (forward) to increase tension or counterclockwise (backward) to decrease tension. Return handle to its original position by pushing it back in and out of way.



Lumbar adjustment - optional

Using both hands, move lumbar support up or down to desired position.



3-D arm adjustment - optional

Armpad height:

Press button on inside of armrest and lift or lower armrest to desired height. Release button and armrest will engage.

Armpad depth:

Push armrest backward or forward to desired position. It will engage automatically.

Armpad pivot:

Grasp armpad at front and back. Pivot armpad clockwise to angle in, or counterclockwise to return to original position.



Headrest adjustment - high-back only

Headrest height:

Grasp headrest from top and bottom, move it up or down to desired position.

Headrest angle:

Grasp headrest from each side, push forward or backward to desired position.







Forward tilt - advanced control only

While standing, twist lever under left side of seat backward 180° to engage forward tilt. Twist lever forward 180° to return seat to level position.

The Life Chair

plastic base, no seat or back topper

	description	arm	lumbar	pattern no. *
<i>Designer(s):</i> Formway Design Studio, 2002	No Seat Topper/No Back Topper	Armless 	None	55C-3-(2 or 6)-A-5-K-GH BSF()-NS-NB
			Height Adj.	55C-3-(2 or 6)-A-5-L()-GH BSF()-NS-NB
<i>Award(s):</i> Good Design Award, Chicago Athenaeum, 2003, USA NeoCon Gold, Best of NeoCon, Task Chair - Seating Design, June 2002, USA IINDEX/NeoCon, Sustainable Design Gold Award, 2002, Canada		Fixed 	None	55A-3-(2 or 6)-A-5-K-GH BSF()-NS-NB
			Height Adj.	55A-3-(2 or 6)-A-5-L()-GH BSF()-NS-NB
		Height Adj. 	None	55H-3-(2 or 6)-A-5-K-GH BSF()-NS-NB
			Height Adj.	55H-3-(2 or 6)-A-5-L()-GH BSF()-NS-NB
		High Perf. 	None	55P-3-(2 or 6)-A-5-K-GH BSF()-NS-NB
			Height Adj.	55P-3-(2 or 6)-A-5-L()-GH BSF()-NS-NB

Leather arm pads add J after the arm pattern number (Example: 55PJ-3-6-)
Only available in Spinneybeck Volo (Grade U) and Sabrina (Grade W) leathers.

*For specification directions, please see page 64.
For upholstery selections and pricing see facing page.

Order Code	Ordering Information	Options
<i>Example:</i> 55H-3-6-A5K-GH-BSF17-ST-K451/4-BT-K451/4	<i>Specify:</i>	<i>Base Options:</i>
55 Life chair	1. Pattern number with back suspension fabric BSF().	<i>Code: Upchg: Description:</i>
H Height adjustable arms	2. Seat topper fabric, if desired, either KST() knitted seat topper or ST() in traditional fabric or leather seat topper.	2 n/c black plastic base
3 High back	3. Back topper fabric, if desired, BT() in traditional fabric or leather topper.	6 n/c grey plastic base
6 Grey base and grey levers	C - CAL 133: Insert C after ST() option. Not available with KST. \$78 upcharge seat only. \$266 upcharge seat and back.	<i>Cylinder Height Options:</i>
A Advanced control with sliding seat	PERF-(560-85): Perforated leather. \$101 upcharge seat only. \$212 upcharge back topper only. For additional perforated leather choices and codes, see Perforated Leather page in Leather Application section of the price list.	Replace 5 in pattern with one of the following options:
5 Standard height cylinder (16" - 21 1/2")		<i>Code: Upchg: Description:</i>
K No lumbar		L n/c low (height range: 15"-19")
GH Grey hard caster		H n/c high (height range: 17 1/2" - 22 3/4")
BSF17 Blackout back suspension fabric		(Std. Cylinder is 16"-21.5")
ST-K451/4 Una Ebony topper		<i>Lumbar Color Options:</i>
BT-K451/4 Una Ebony back topper		Add one of the following options after L.
		<i>Code: Desc.</i>
		K1029/13 Vibe/Glam
		K1029/14 Vibe/Poise
		K1029/BLK Vibe/Black
		<i>Caster Options:</i>
		Replace GH in pattern with one of the following options:
		<i>Code: Upchg: Description:</i>
		BH n/c hard black caster
		BR \$40 soft black caster
		GR \$40 soft grey caster
		CH \$24 hard clear caster
		CR \$64 soft clear caster
		<i>Glides:</i>
		Replace caster option with GG. No upcharge for this option.
		
		<i>Ultra Seat Topper Options:</i>
		(1/2" thicker than standard seat topper)
		<i>Specify in place of KST.</i>
		<i>Code: Upchg: Desc.</i>
		UST \$57 Ultra Seat Topper
		UKST \$57 Ultra Knit Seat Topper

Note: NB means No Back Topper

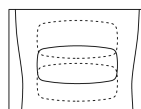





KST or COM	A	B	C	D	E	F	G	H	I	T	COL U	V	W	X	Y
\$1,140.															
1,235.															
1,294.															
1,388.															
1,346.															
1,441.															
1,393.															
1,488.															
											245.		330.		

	KnollTextiles and Spinneybeck Leathers	Required to Select	Seat Topper Only
<i>CAL 133 Options:</i>	Please refer to the matrices at the beginning of the price list for Approved Textiles and Leathers.		
<i>Code Upchg Description:</i>		<i>Life Back Suspension Fabric (BSF)</i>	<i>Life Knit Seat Topper (KST) - Base Grade</i>
C \$78 CAL 133 textile for seat only (add C after ST() in pattern number)	<i>Ordering Samples/Viewing on Line:</i> To view any of these fabrics refer to the Knoll Surface Library on Knoll Exchange: http://exchange.knoll.com/media_lib/surfsearch.jsp To order fabric samples for Life Back Suspension Fabric please send a fax to: 800-308-7765.	BSF 01 Zinc BSF 05 Chamomile BSF 06 Fire BSF 07 Cosmos BSF 08 Currant BSF 09 Earth BSF 10 Fossil BSF 11 Sky BSF 12 Lagoon BSF 14 Cypress BSF 15 Eclipse BSF 16 Electric BSF 17 Blackout BSF 18 Camel BSF 19 Beige BSF 20 Java BSF 21 Patina BSF 22 Grain BSF 50 White	KST 01 Zinc KST 05 Chamomile KST 06 Fire KST 07 Cosmos KST 08 Currant KST 09 Earth KST 10 Fossil KST 11 Sky KST 12 Lagoon KST 14 Cypress KST 15 Eclipse/Blackout KST 16 Electric KST 18 Camel KST 19 Beige KST 20 Java KST 21 Patina
C \$266 CAL 133 textile for seat and back (add C after ST() and BT() in pattern number)			
C \$153 CAL 133 leather seat topper available in Spinneybeck Volo FR. Minimum order required of 3 chairs per customer for chairs with seat topper only.	COL/COM Textile Requirements		
C \$222 CAL 133 leather back topper available in Spinneybeck Volo FR.	<i>Seat Topper:</i> 0.7 yards fabric 9.0 sq ft leather <i>Back Topper:</i> 1.3 yards fabric 16.0 sq ft leather <i>Cal 133:</i> ♣ = Cal 133 upholstery/leather available. See textile matrix at the beginning of the Price List for pre-approved Cal 133 textiles.		*Life KST - Coordinates with Life Back Suspension Fabrics

Note: Order lead time will be strictly based on availability of FR-treated Volo. All existing Volo colors are offered.

The Life Chair

plastic base, knitted seat topper, no back topper



	description	arm	lumbar	pattern no. *
<i>Designer(s):</i> Formway Design Studio, 2002	Life Knit Seat Topper (KST)	Armless	None	55C-3-(2 or 6)-A-5-K-GH BSF()-KST()-NB
	No Back Topper		Height Adj.	55C-3-(2 or 6)-A-5-L()-GH BSF()-KST()-NB
<i>Award(s):</i> Good Design Award, Chicago Athenaeum, 2003, USA NeoCon Gold, Best of NeoCon, Task Chair - Seating Design, June 2002, USA IINDEX/NeoCon, Sustainable Design Gold Award, 2002, Canada		Fixed	None	55A-3-(2 or 6)-A-5-K-GH BSF()-KST()-NB
			Height Adj.	55A-3-(2 or 6)-A-5-L()-GH BSF()-KST()-NB
		Height Adj.	None	55H-3-(2 or 6)-A-5-K-GH BSF()-KST()-NB
			Height Adj.	55H-3-(2 or 6)-A-5-L()-GH BSF()-KST()-NB
		High Perf.	None	55P-3-(2 or 6)-A-5-K-GH BSF()-KST()-NB
			Height Adj.	55P-3-(2 or 6)-A-5-L()-GH BSF()-KST()-NB



Leather arm pads add J after the arm pattern number (Example: 55PJ-3-6-)
Only available in Spinneybeck Volo (Grade U) and Sabrina (Grade W) leathers.

J

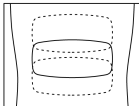
*For specification directions, please see page 64.
For upholstery selections and pricing see facing page.

Order Code	Ordering Information	Options
<i>Example:</i> 55H-3-6-A5K-GH-BSF17-ST-K451/4-BT-K451/4	<i>Specify:</i>	<i>Base Options:</i>
55 Life chair	1. Pattern number with back suspension fabric BSF().	<i>Code: Upchg: Description:</i>
H Height adjustable arms	2. Seat topper fabric, if desired, either KST() knitted seat topper or ST() in traditional fabric or leather seat topper.	2 n/c black plastic base
3 High back	3. Back topper fabric, if desired, BT() in traditional fabric or leather topper.	6 n/c grey plastic base
6 Grey base and grey levers	C - CAL 133: Insert C after ST() option. Not available with KST. \$78 upcharge seat only. \$266 upcharge seat and back.	<i>Cylinder Height Options:</i>
A Advanced control with sliding seat	PERF-(560-85): Perforated leather. \$101 upcharge seat only. \$212 upcharge back topper only. For additional perforated leather choices and codes, see Perforated Leather page in Leather Application section of the price list.	Replace 5 in pattern with one of the following options:
5 Standard height cylinder (16" - 21 1/2")		<i>Code: Upchg: Description:</i>
K No lumbar		L n/c low (height range: 15"-19")
GH Grey hard caster		H n/c high (height range: 17 1/2" - 22 3/4")
BSF17 Blackout back suspension fabric		(Std. Cylinder is 16"-21.5")
ST-K451/4 Una Ebony topper		<i>Lumbar Color Options:</i>
BT-K451/4 Una Ebony back topper		Add one of the following options after L.
		<i>Code: Desc.</i>
		K1029/13 Vibe/Glam
		K1029/14 Vibe/Poise
		K1029/BLK Vibe/Black
		
		<i>Caster Options:</i>
		Replace GH in pattern with one of the following options:
		<i>Code: Upchg: Description:</i>
		BH n/c hard black caster
		BR \$40 soft black caster
		GR \$40 soft grey caster
		CH \$24 hard clear caster
		CR \$64 soft clear caster
		<i>Glides:</i>
		Replace caster option with GG. No upcharge for this option.
		
		<i>Ultra Seat Topper Options:</i>
		(1/2" thicker than standard seat topper)
		<i>Specify in place of KST.</i>
		<i>Code: Upchg: Desc.</i>
		UST \$57 Ultra Seat Topper
		UKST \$57 Ultra Knit Seat Topper





Note: NB means No Back Topper

KST or COM	A	B	C	D	E	F	G	H	I	T	COL U	V	W	X	Y
\$1,189.															
1,283.															
1,342.															
1,437.															
1,394.															
1,489.															
1,442.															
1,536.															
											245.		330.		

			KnollTextiles and Spinneybeck Leathers	Required to Select	Seat Topper Only
<i>CAL 133 Options:</i>			Please refer to the matrices at the beginning of the price list for Approved Textiles and Leathers.	<i>Life Back Suspension Fabric (BSF)</i>	<i>Life Knit Seat Topper (KST) - Base Grade</i>
<i>Code:</i>	<i>Upchg:</i>	<i>Description:</i>	<i>Ordering Samples/Viewing on Line:</i>	BSF 01 Zinc	KST 01 Zinc
C	\$78	CAL 133 textile for seat only (add C after ST() in pattern number)	To view any of these fabrics refer to the Knoll Surface Library on Knoll Exchange: http://exchange.knoll.com/media_lib/surfsearch.jsp	BSF 05 Chamomile	KST 05 Chamomile
C	\$266	CAL 133 textile for seat and back (add C after ST() and BT() in pattern number)	To order fabric samples for Life Back Suspension Fabric please send a fax to: 800-308-7765.	BSF 06 Fire	KST 06 Fire
C	\$153	CAL 133 leather seat topper available in Spinneybeck Volo FR. Minimum order required of 3 chairs per customer for chairs with seat topper only.	COL/COM Textile Requirements	BSF 07 Cosmos	KST 07 Cosmos
C	\$222	CAL 133 leather back topper available in Spinneybeck Volo FR.	<i>Seat Topper:</i> 0.7 yards fabric 9.0 sq ft leather	BSF 08 Currant	KST 08 Currant
			<i>Back Topper:</i> 1.3 yards fabric 16.0 sq ft leather	BSF 09 Earth	KST 09 Earth
			<i>Cal 133:</i> ♣ = Cal 133 upholstery/leather available. See textile matrix at the beginning of the Price List for pre-approved Cal 133 textiles.	BSF 10 Fossil	KST 10 Fossil
				BSF 11 Sky	KST 11 Sky
				BSF 12 Lagoon	KST 12 Lagoon
				BSF 14 Cypress	KST 14 Cypress
				BSF 15 Eclipse	KST 15 Eclipse/Blackout
				BSF 16 Electric	KST 16 Electric
				BSF 17 Blackout	KST 18 Camel
				BSF 18 Camel	KST 19 Beige
				BSF 19 Beige	KST 20 Java
				BSF 20 Java	KST 21 Patina
				BSF 21 Patina	
				BSF 22 Grain	*Life KST - Coordinates with Life Back Suspension Fabrics
				BSF 50 White	

The Life Chair



plastic base, seat topper no back topper

	description	arm	lumbar	pattern no. *
<i>Designer(s):</i> Formway Design Studio, 2002	Knoll Textiles, Spinneybeck Leather, COM or COL No Back Topper	Armless	None	55C-3-(2 or 6)-A-5-K-GH BSF()-ST()-NB
			Height Adj.	55C-3-(2 or 6)-A-5-L()-GH BSF()-ST()-NB
<i>Award(s):</i> Good Design Award, Chicago Athenaeum, 2003, USA NeoCon Gold, Best of NeoCon, Task Chair - Seating Design, June 2002, USA IINDEX/NeoCon, Sustainable Design Gold Award, 2002, Canada		Fixed	None	55A-3-(2 or 6)-A-5-K-GH BSF()-ST()-NB
			Height Adj.	55A-3-(2 or 6)-A-5-L()-GH BSF()-ST()-NB
		Height Adj.	None	55H-3-(2 or 6)-A-5-K-GH BSF()-ST()-NB
			Height Adj.	55H-3-(2 or 6)-A-5-L()-GH BSF()-ST()-NB
		High Perf.	None	55P-3-(2 or 6)-A-5-K-GH BSF()-ST()-NB
			Height adj.	55P-3-(2 or 6)-A-5-L()-GH BSF()-ST()-NB

Leather arm pads add J after the arm pattern number (Example: 55PJ-3-6-)
Only available in Spinneybeck Volo (Grade U) and Sabrina (Grade W) leathers.

J

*For specification directions, please see page 64.
For upholstery selections and pricing see facing page.

Order Code	Ordering Information	Options
<i>Example:</i> 55H-3-6-A5K-GH-BSF17-ST-K451/4-BT-K451/4	<i>Specify:</i>	<i>Base Options:</i>
55 Life chair	1. Pattern number with back suspension fabric BSF().	<i>Code: Upchg: Description:</i>
H Height adjustable arms	2. Seat topper fabric, if desired, either KST() knitted seat topper or ST() in traditional fabric or leather seat topper.	2 n/c black plastic base
3 High back	3. Back topper fabric, if desired, BT() in traditional fabric or leather topper.	6 n/c grey plastic base
6 Grey base and grey levers	C - CAL 133: Insert C after ST() option. Not available with KST. \$78 upcharge seat only. \$266 upcharge seat and back.	<i>Cylinder Height Options:</i>
A Advanced control with sliding seat	PERF-(560-85): Perforated leather. \$101 upcharge seat only. \$212 upcharge back topper only. For additional perforated leather choices and codes, see Perforated Leather page in Leather Application section of the price list.	Replace 5 in pattern with one of the following options:
5 Standard height cylinder (16" - 21 1/2")		<i>Code: Upchg: Description:</i>
K No lumbar		L n/c low (height range: 15"-19")
GH Grey hard caster		H n/c high (height range: 17 1/2" - 22 3/4")
BSF17 Blackout back suspension fabric		(Std. Cylinder is 16"-21.5")
ST-K451/4 Una Ebony topper		<i>Lumbar Color Options:</i>
BT-K451/4 Una Ebony back topper		Add one of the following options after L.
		<i>Code: Desc.</i>
		K1029/13 Vibe/Glam
		K1029/14 Vibe/Poise
		K1029/BLK Vibe/Black
		
		<i>Caster Options:</i>
		Replace GH in pattern with one of the following options:
		<i>Code: Upchg: Description:</i>
		BH n/c hard black caster
		BR \$40 soft black caster
		GR \$40 soft grey caster
		CH \$24 hard clear caster
		CR \$64 soft clear caster
		<i>Glides:</i>
		Replace caster option with GG. No upcharge for this option.
		
		<i>Ultra Seat Topper Options:</i>
		(1/2" thicker than standard seat topper)
		<i>Specify in place of KST.</i>
		<i>Code: Upchg: Desc.</i>
		UST \$57 Ultra Seat Topper
		UKST \$57 Ultra Knit Seat Topper

Note: NB means No Back Topper

KST or COM	A	B	C	D	E	F	G	H	I	T	U	V	W	X	Y
\$1,189.	\$1,237.	\$1,242.	\$1,266.	\$1,289.	\$1,306.	\$1,330.	\$1,342.	\$1,360.	\$1,384.	\$1,561.	\$1,591.	\$1,650.	\$1,790.	\$1,804.	\$1,887.
1,283.	1,331.	1,337.	1,361.	1,384.	1,401.	1,425.	1,436.	1,454.	1,478.	1,656.	1,685.	1,744.	1,885.	1,898.	1,981.
1,342.	1,390.	1,395.	1,420.	1,443.	1,460.	1,484.	1,495.	1,513.	1,537.	1,715.	1,744.	1,803.	1,944.	1,957.	2,040.
1,437.	1,485.	1,490.	1,514.	1,537.	1,554.	1,578.	1,590.	1,608.	1,632.	1,809.	1,839.	1,897.	2,038.	2,052.	2,135.
1,394.	1,443.	1,448.	1,472.	1,495.	1,512.	1,536.	1,548.	1,566.	1,590.	1,767.	1,797.	1,855.	1,996.	2,010.	2,093.
1,489.	1,537.	1,542.	1,567.	1,590.	1,607.	1,631.	1,642.	1,660.	1,684.	1,862.	1,891.	1,950.	2,091.	2,104.	2,187.
1,442.	1,490.	1,495.	1,519.	1,542.	1,559.	1,583.	1,595.	1,613.	1,637.	1,814.	1,844.	1,903.	2,043.	2,057.	2,140.
1,536.	1,584.	1,590.	1,614.	1,637.	1,654.	1,678.	1,689.	1,707.	1,731.	1,909.	1,938.	1,997.	2,138.	2,151.	2,234.





245.

330.

	KnollTextiles and Spinneybeck Leathers	Required to Select	Seat Topper Only
<i>CAL 133 Options:</i>	Please refer to the matrices at the beginning of the price list for Approved Textiles and Leathers.	<i>Life Back Suspension Fabric (BSF)</i>	<i>Life Knit Seat Topper (KST) - Base Grade</i>
Code: Upchg: Description:			
C \$78 CAL 133 textile for seat only (add C after ST() in pattern number)	<i>Ordering Samples/Viewing on Line:</i> To view any of these fabrics refer to the Knoll Surface Library on Knoll Exchange: http://exchange.knoll.com/media_lib/surfsearch.jsp To order fabric samples for Life Back Suspension Fabric please send a fax to: 800-308-7765.	BSF 01 Zinc BSF 05 Chamomile BSF 06 Fire BSF 07 Cosmos BSF 08 Currant BSF 09 Earth BSF 10 Fossil BSF 11 Sky BSF 12 Lagoon BSF 14 Cypress BSF 15 Eclipse BSF 16 Electric BSF 17 Blackout BSF 18 Camel BSF 19 Beige BSF 20 Java BSF 21 Patina BSF 22 Grain BSF 50 White	KST 01 Zinc KST 05 Chamomile KST 06 Fire KST 07 Cosmos KST 08 Currant KST 09 Earth KST 10 Fossil KST 11 Sky KST 12 Lagoon KST 14 Cypress KST 15 Eclipse/Blackout KST 16 Electric KST 18 Camel KST 19 Beige KST 20 Java KST 21 Patina
C \$266 CAL 133 textile for seat and back (add C after ST() and BT() in pattern number)			
C \$153 CAL 133 leather seat topper available in Spinneybeck Volo FR. Minimum order required of 3 chairs per customer for chairs with seat topper only.	COL/COM Textile Requirements <i>Seat Topper:</i> 0.7 yards fabric 9.0 sq ft leather		
C \$222 CAL 133 leather back topper available in Spinneybeck Volo FR.	<i>Back Topper:</i> 1.3 yards fabric 16.0 sq ft leather		*Life KST - Coordinates with Life Back Suspension Fabrics
Note: Order lead time will be strictly based on availability of FR-treated Volo. All existing Volo colors are offered.	<i>Cal 133:</i> ♣ = Cal 133 upholstery/leather available. See textile matrix at the beginning of the Price List for pre-approved Cal 133 textiles.		

The Life Chair

plastic base, seat topper and back topper



	description	arm	lumbar	pattern no. *
<i>Designer(s):</i> Formway Design Studio, 2002	Knoll Textiles, Spinneybeck Leather COM or COL Seat and Back Topper	Armless	None	55C-3-(2 or 6)-A-5-K-GH BSF()-ST()-BT()
			Height Adj.	55C-3-(2 or 6)-A-5-L()-GH BSF()-ST()-BT()
<i>Award(s):</i> Good Design Award, Chicago Athenaeum, 2003, USA NeoCon Gold, Best of NeoCon, Task Chair - Seating Design, June 2002, USA	IIDEX/NeoCon, Sustainable Design Gold Award, 2002, Canada	Fixed	None	55A-3-(2 or 6)-A-5-K-GH BSF()-ST()-BT()
			Height Adj.	55A-3-(2 or 6)-A-5-L()-GH BSF()-ST()-BT()
		Height Adj.	None	55H-3-(2 or 6)-A-5-K-GH BSF()-ST()-BT()
			Height Adj.	55H-3-(2 or 6)-A-5-L()-GH BSF()-ST()-BT()
		High Perf.	None	55P-3-(2 or 6)-A-5-K-GH BSF()-ST()-BT()
			Height Adj.	55P-3-(2 or 6)-A-5-L()-GH BSF()-ST()-BT()



Leather arm pads add J after the arm pattern number (Example: 55PJ-3-6-)
Only available in Spinneybeck Volo (Grade U) and Sabrina (Grade W) leathers.

J

*For specification directions, please see page 64.
For upholstery selections and pricing see facing page.

Order Code	Ordering Information	Options
<i>Example:</i> 55H-3-6-A5K-GH-BSF17-ST-K451/4-BT-K451/4	<i>Specify:</i>	<i>Base Options:</i>
55 Life chair	1. Pattern number with back suspension fabric BSF().	<i>Code: Upchg: Description:</i>
H Height adjustable arms	2. Seat topper fabric, if desired, either KST() knitted seat topper or ST() in traditional fabric or leather seat topper.	2 n/c black plastic base
3 High back	3. Back topper fabric, if desired, BT() in traditional fabric or leather topper.	6 n/c grey plastic base
6 Grey base and grey levers	C - CAL 133: Insert C after ST() option. Not available with KST. \$78 upcharge seat only. \$266 upcharge seat and back.	<i>Cylinder Height Options:</i>
A Advanced control with sliding seat	PERF-(560-85): Perforated leather. \$101 upcharge seat only. \$212 upcharge back topper only. For additional perforated leather choices and codes, see Perforated Leather page in Leather Application section of the price list.	Replace 5 in pattern with one of the following options:
5 Standard height cylinder (16" - 21 1/2")		<i>Code: Upchg: Description:</i>
K No lumbar		L n/c low (height range: 15"-19")
GH Grey hard caster		H n/c high (height range: 17 1/2" - 22 3/4")
BSF17 Blackout back suspension fabric		(Std. Cylinder is 16"-21.5")
ST-K451/4 Una Ebony topper		<i>Lumbar Color Options:</i>
BT-K451/4 Una Ebony back topper		Add one of the following options after L.
		<i>Code: Desc.</i>
		K1029/13 Vibe/Glam
		K1029/14 Vibe/Poise
		K1029/BLK Vibe/Black
		
		<i>Caster Options:</i>
		Replace GH in pattern with one of the following options:
		<i>Code: Upchg: Description:</i>
		BH n/c hard black caster
		BR \$40 soft black caster
		GR \$40 soft grey caster
		CH \$24 hard clear caster
		CR \$64 soft clear caster
		<i>Glides:</i>
		Replace caster option with GG. No upcharge for this option.
		
		<i>Ultra Seat Topper Options:</i>
		(1/2" thicker than standard seat topper)
		<i>Specify in place of KST.</i>
		<i>Code: Upchg: Desc.</i>
		UST \$57 Ultra Seat Topper
		UKST \$57 Ultra Knit Seat Topper

Note: NB means No Back Topper

KST or COM	A	B	C	D	E	F	G	H	I	T	COL U	V	W	X	Y
\$1,389.	\$1,473.	\$1,503.	\$1,556.	\$1,614.	\$1,655.	\$1,684.	\$1,797.	\$1,821.	\$1,856.	\$2,128.	\$2,241.	\$2,353.	\$2,789.	\$2,814.	\$2,939.
1,484.	1,568.	1,597.	1,651.	1,708.	1,749.	1,779.	1,891.	1,915.	1,951.	2,223.	2,335.	2,448.	2,883.	2,909.	3,033.
1,542.	1,626.	1,656.	1,709.	1,767.	1,808.	1,838.	1,950.	1,974.	2,010.	2,282.	2,394.	2,506.	2,942.	2,967.	3,092.
1,637.	1,721.	1,750.	1,804.	1,862.	1,903.	1,932.	2,044.	2,069.	2,104.	2,376.	2,489.	2,601.	3,037.	3,062.	3,187.
1,595.	1,679.	1,708.	1,762.	1,820.	1,861.	1,890.	2,002.	2,027.	2,062.	2,334.	2,447.	2,559.	2,995.	3,020.	3,145.
1,689.	1,773.	1,803.	1,856.	1,914.	1,955.	1,985.	2,097.	2,121.	2,157.	2,429.	2,541.	2,653.	3,089.	3,114.	3,239.
1,642.	1,726.	1,756.	1,809.	1,867.	1,908.	1,937.	2,050.	2,074.	2,109.	2,381.	2,494.	2,606.	3,042.	3,067.	3,192.
1,737.	1,821.	1,850.	1,904.	1,961.	2,002.	2,032.	2,144.	2,168.	2,204.	2,476.	2,588.	2,701.	3,136.	3,162.	3,287.
												245.	330.		

			KnollTextiles and Spinneybeck Leathers	Required to Select	Seat Topper Only
<i>CAL 133 Options:</i>			Please refer to the matrices at the beginning of the price list for Approved Textiles and Leathers.	<i>Life Back Suspension Fabric (BSF)</i>	<i>Life Knit Seat Topper (KST) - Base Grade</i>
<i>Code:</i>	<i>Upchg:</i>	<i>Description:</i>	<i>Ordering Samples/Viewing on Line:</i>	BSF 01 Zinc	KST 01 Zinc
C	\$78	CAL 133 textile for seat only (add C after ST() in pattern number)	To view any of these fabrics refer to the Knoll Surface Library on Knoll Exchange: http://exchange.knoll.com/media_lib/surfsearch.jsp	BSF 05 Chamomile	KST 05 Chamomile
C	\$266	CAL 133 textile for seat and back (add C after ST() and BT() in pattern number)	To order fabric samples for Life Back Suspension Fabric please send a fax to: 800-308-7765.	BSF 06 Fire	KST 06 Fire
C	\$153	CAL 133 leather seat topper available in Spinneybeck Volo FR. Minimum order required of 3 chairs per customer for chairs with seat topper only.	COL/COM Textile Requirements	BSF 07 Cosmos	KST 07 Cosmos
C	\$222	CAL 133 leather back topper available in Spinneybeck Volo FR.	<i>Seat Topper:</i> 0.7 yards fabric 9.0 sq ft leather	BSF 08 Currant	KST 08 Currant
			<i>Back Topper:</i> 1.3 yards fabric 16.0 sq ft leather	BSF 09 Earth	KST 09 Earth
			<i>Cal 133:</i> ♣ = Cal 133 upholstery/leather available. See textile matrix at the beginning of the Price List for pre-approved Cal 133 textiles.	BSF 10 Fossil	KST 10 Fossil
				BSF 11 Sky	KST 11 Sky
				BSF 12 Lagoon	KST 12 Lagoon
				BSF 14 Cypress	KST 14 Cypress
				BSF 15 Eclipse	KST 15 Eclipse/Blackout
				BSF 16 Electric	KST 16 Electric
				BSF 17 Blackout	KST 18 Camel
				BSF 18 Camel	KST 19 Beige
				BSF 19 Beige	KST 20 Java
				BSF 20 Java	KST 21 Patina
				BSF 21 Patina	
				BSF 22 Grain	*Life KST - Coordinates with Life Back Suspension Fabrics
				BSF 50 White	

The Life Chair

plastic base, replacement parts

	description	pattern no. *
<i>Designer(s):</i> Formway Design Studio, 2002	Replacement Seat Topper Upholstery	55SEATTOPPER
	Replacement Back Topper Upholstery	55BACKTOPPER
<i>Award(s):</i> Good Design Award, Chicago Athenaeum, 2003, USA NeoCon Gold, Best of NeoCon, Task Chair - Seating Design, June 2002, USA IINDEX/NeoCon, Sustainable Design Gold Award, 2002, Canada	Replacement or Add on	55LUMBAR



*For specification directions, please see page 64.
For upholstery selections and pricing see facing page.

Order Code	Ordering Information	Options
<i>Example:</i> 55H-3-6-A5K-GH-BSF17-ST-K451/4-BT-K451/4	<i>Specify:</i>	<i>Base Options:</i>
55 Life chair	1. Pattern number with back suspension fabric BSF().	<i>Code: Upchg: Description:</i>
H Height adjustable arms	2. Seat topper fabric, if desired, either KST() knitted seat topper or ST() in traditional fabric or leather seat topper.	2 n/c black plastic base
3 High back	3. Back topper fabric, if desired, BT() in traditional fabric or leather topper.	6 n/c grey plastic base
6 Grey base and grey levers	C - CAL 133: Insert C after ST() option. Not available with KST. \$78 upcharge seat only. \$266 upcharge seat and back.	<i>Cylinder Height Options:</i>
A Advanced control with sliding seat	PERF-(560-85): Perforated leather. \$101 upcharge seat only. \$212 upcharge back topper only. For additional perforated leather choices and codes, see Perforated Leather page in Leather Application section of the price list.	Replace 5 in pattern with one of the following options:
5 Standard height cylinder (16" - 21 1/2")		<i>Code: Upchg: Description:</i>
K No lumbar		L n/c low (height range: 15"-19")
GH Grey hard caster		H n/c high (height range: 17 1/2" - 22 1/4")
BSF17 Blackout back suspension fabric		(Std. Cylinder is 16"-21.5")
ST-K451/4 Una Ebony topper		<i>Lumbar Color Options:</i>
BT-K451/4 Una Ebony back topper		Add one of the following options after L.
		<i>Code: Desc.</i>
		K1029/13 Vibe/Glam
		K1029/14 Vibe/Poise
		K1029/BLK Vibe/Black
		<i>Caster Options:</i>
		Replace GH in pattern with one of the following options:
		<i>Code: Upchg: Description:</i>
		BH n/c hard black caster
		BR \$40 soft black caster
		GR \$40 soft grey caster
		CH \$24 hard clear caster
		CR \$64 soft clear caster
		<i>Glides:</i>
		Replace caster option with GG. No upcharge for this option.
		
		<i>Ultra Seat Topper Options:</i>
		(1/2" thicker than standard seat topper)
		<i>Specify in place of KST.</i>
		<i>Code: Upchg: Desc.</i>
		UST \$57 Ultra Seat Topper
		UKST \$57 Ultra Knit Seat Topper

Note: NB means No Back Topper

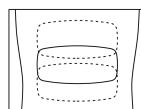





KST or COM	A	B	C	D	E	F	G	H	I	T	COL U	V	W	X	Y
\$48.	\$97.	\$102.	\$126.	\$148.	\$166.	\$190.	\$201.	\$219.	\$244.	\$420.	\$449.	\$509.	\$650.	\$663.	\$746.
201.	236.	260.	290.	324.	349.	354.	455.	461.	473.	567.	650.	704.	999.	1,010.	1,052.
95.															

	KnollTextiles and Spinneybeck Leathers	Required to Select	Seat Topper Only
<i>CAL 133 Options:</i>	Please refer to the matrices at the beginning of the price list for Approved Textiles and Leathers.		
<i>Code: Upchg: Description:</i>		<i>Life Back Suspension Fabric (BSF)</i>	<i>Life Knit Seat Topper (KST) - Base Grade</i>
C \$78 CAL 133 textile for seat only (add C after ST() in pattern number)	<i>Ordering Samples/Viewing on Line:</i> To view any of these fabrics refer to the Knoll Surface Library on Knoll Exchange: http://exchange.knoll.com/media_lib/surfsearch.jsp To order fabric samples for Life Back Suspension Fabric please send a fax to: 800-308-7765.	BSF 01 Zinc BSF 05 Chamomile BSF 06 Fire BSF 07 Cosmos BSF 08 Currant BSF 09 Earth BSF 10 Fossil BSF 11 Sky BSF 12 Lagoon BSF 14 Cypress BSF 15 Eclipse BSF 16 Electric BSF 17 Blackout BSF 18 Camel BSF 19 Beige BSF 20 Java BSF 21 Patina BSF 22 Grain BSF 50 White	KST 01 Zinc KST 05 Chamomile KST 06 Fire KST 07 Cosmos KST 08 Currant KST 09 Earth KST 10 Fossil KST 11 Sky KST 12 Lagoon KST 14 Cypress KST 15 Eclipse/Blackout KST 16 Electric KST 18 Camel KST 19 Beige KST 20 Java KST 21 Patina
C \$266 CAL 133 textile for seat and back (add C after ST() and BT() in pattern number)			
C \$153 CAL 133 leather seat topper available in Spinneybeck Volo FR. Minimum order required of 3 chairs per customer for chairs with seat topper only.	COL/COM Textile Requirements		
C \$222 CAL 133 leather back topper available in Spinneybeck Volo FR.	<i>Seat Topper:</i> 0.7 yards fabric 9.0 sq ft leather <i>Back Topper:</i> 1.3 yards fabric 16.0 sq ft leather <i>Cal 133:</i> ♣ = Cal 133 upholstery/leather available. See textile matrix at the beginning of the Price List for pre-approved Cal 133 textiles.		*Life KST - Coordinates with Life Back Suspension Fabrics

Note: Order lead time will be strictly based on availability of FR-treated Volo. All existing Volo colors are offered.

The Life Chair

aluminum base, no seat or back topper

	description	arm	lumbar	pattern no. *
<i>Designer(s):</i> Formway Design Studio, 2002	No Seat Topper/No Back Topper	Armless 	None	55C-3(3 or 4)-A-5-K-GH BSF()-NS-NB
			Height Adj.	55C-3(3 or 4)-A-5-L()-GH BSF()-NS-NB
			Fixed	55A-3(3 or 4)-A-5-K-GH BSF()-NS-NB
			Height Adj.	55A-3(3 or 4)-A-5-L()-GH BSF()-NS-NB
<i>Award(s):</i> Good Design Award, Chicago Athenaeum, 2003, USA NeoCon Gold, Best of NeoCon, Task Chair - Seating Design, June 2002, USA IINDEX/NeoCon, Sustainable Design Gold Award, 2002, Canada		Fixed 	None	55A-3(3 or 4)-A-5-K-GH BSF()-NS-NB
			Height Adj.	55A-3(3 or 4)-A-5-L()-GH BSF()-NS-NB
			Height Adj.	55H-3(3 or 4)-A-5-K-GH BSF()-NS-NB
			Height Adj.	55H-3(3 or 4)-A-5-L()-GH BSF()-NS-NB
		Height Adj. 	None	55P-3(3 or 4)-A-5-K-GH BSF()-NS-NB
			High Perf.	55P-3(3 or 4)-A-5-L()-GH BSF()-NS-NB
			High Perf.	55P-3(3 or 4)-A-5-L()-GH BSF()-NS-NB
			High Perf.	55P-3(3 or 4)-A-5-L()-GH BSF()-NS-NB

Leather arm pads add J after the arm pattern number (Example: 55PJ-3-6-)
Only available in Spinneybeck Volo (Grade U) and Sabrina (Grade W) leathers.

J

*For specification directions, please see page 64.
For upholstery selections and pricing see facing page.

Order Code	Ordering Information	Options
<i>Example:</i> 55H-3-4-A5K-GH-BSF02-ST-K451/4-BT-K451/4	<i>Specify:</i>	<i>Base Options:</i>
55 Life chair	1. Pattern number with back suspension fabric BSF().	<i>Code: Upchg: Description:</i> 3 n/c painted matte aluminum base
H Height adjustable arms	2. Seat topper fabric, if desired, either KST() knitted seat topper or ST() in traditional fabric or leather seat topper.	4 n/c polished aluminum base
3 High back	3. Back topper fabric, if desired, BT() in traditional fabric or leather topper.	<i>Cylinder Height Options:</i> Replace 5 in pattern with one of the following options:
4 Aluminum base and levers	C - CAL 133: Insert C after ST() option. Not available with KST. \$78 upcharge seat only. \$266 upcharge seat and back.	<i>Code: Upchg: Description:</i> L n/c low (height range: 15"-19") H n/c high (height range: 17 1/2" - 22 3/4") (Std. Cylinder is 16"-21.5")
A Advanced control with sliding seat	PERF-(560-85): Perforated leather. \$101 upcharge seat only. \$212 upcharge back topper only. For additional perforated leather choices and codes, see Perforated Leather page in Leather Application section of the price list.	<i>Ultra Seat Topper Options:</i> (1/2" thicker than standard seat topper) <i>Specify in place of KST.</i> <i>Code: Upchg: Desc.</i> UST \$57 Ultra Seat Topper UKST \$57 Ultra Knit Seat Topper
5 Standard height cylinder (16" - 21 1/2")		
K No lumbar		
GH Grey hard caster		
BSF17 Blackout back suspension fabric		
ST-K451/4 Una Ebony seat topper		
BT-K451/4 Una Ebony back topper		

Note: NB means No Back Topper

* As of May 1, 2004 bases do not have plastic toe-caps.

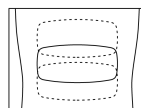





KST or COM	A	B	C	D	E	F	G	H	I	T	COL U	V	W	X	Y
\$1,163.															
1,258.															
1,317.															
1,411.															
1,369.															
1,464.															
1,418.															
1,512.															
											245.				330.

		KnollTextiles and Spinneybeck Leathers	Required to Select	Seat Topper Only
<i>CAL 133 Options:</i>		Please refer to the matrices at the beginning of the price list for Approved Textiles and Leathers.		
<i>Code:</i>	<i>Upchg:</i>	<i>Description:</i>	<i>Life Back Suspension Fabric (BSF)</i>	<i>Life Knit Seat Topper (KST) - Base Grade</i>
C	\$78	CAL 133 textile for seat only (add C after ST() in pattern number)	BSF 01 Zinc BSF 05 Chamomile BSF 06 Fire BSF 07 Cosmos BSF 08 Currant BSF 09 Earth BSF 10 Fossil BSF 11 Sky BSF 12 Lagoon BSF 14 Cypress BSF 15 Eclipse BSF 16 Electric BSF 17 Blackout BSF 18 Camel BSF 19 Beige BSF 20 Java BSF 21 Patina BSF 22 Grain BSF 50 White	KST 01 Zinc KST 05 Chamomile KST 06 Fire KST 07 Cosmos KST 08 Currant KST 09 Earth KST 10 Fossil KST 11 Sky KST 12 Lagoon KST 14 Cypress KST 15 Eclipse/Blackout KST 16 Electric KST 18 Camel KST 19 Beige KST 20 Java KST 21 Patina
C	\$266	CAL 133 textile for seat and back (add C after ST() and BT() in pattern number)	To view any of these fabrics refer to the Knoll Surface Library on Knoll Exchange: http://exchange.knoll.com/media_lib/surfsearch.jsp	
C	\$153	CAL 133 leather seat topper available in Spinneybeck Volo FR. Minimum order required of 3 chairs per customer for chairs with seat topper only.	To order fabric samples for Life Back Suspension Fabric please send a fax to: 800-308-7765.	
		COL/COM Textile Requirements		
		<i>Seat Topper:</i> 0.7 yards fabric 9.0 sq ft leather		
		<i>Back Topper:</i> 1.3 yards fabric 16.0 sq ft leather		
		<i>Cal 133:</i> ♣ = Cal 133 upholstery/leather available. See textile matrix at the beginning of the Price List for pre-approved Cal 133 textiles.		*Life KST - Coordinates with Life Back Suspension Fabrics
C		\$222	CAL 133 leather back topper available in Spinneybeck Volo FR.	

Note: Order lead time will be strictly based on availability of FR-treated Volo. All existing Volo colors are offered.

The Life Chair

aluminum base, knitted seat topper no back topper

	description	arm	lumbar	pattern no. *
<i>Designer(s):</i> Formway Design Studio, 2002	Life Knit Seat Topper (KST)	Armless	None	55C-3(3 or 4)-A-5-K-GH BSF()-KST()-NB
	No Back Topper		Height Adj.	55C-3(3 or 4)-A-5-L()-GH BSF()-KST()-NB
<i>Award(s):</i> Good Design Award, Chicago Athenaeum, 2003, USA NeoCon Gold, Best of NeoCon, Task Chair - Seating Design, June 2002, USA IINDEX/NeoCon, Sustainable Design Gold Award, 2002, Canada		Fixed	None	55A-3(3 or 4)-A-5-K-GH BSF()-KST()-NB
			Height Adj.	55A-3(3 or 4)-A-5-L()-GH BSF()-KST()-NB
		Height Adj.	None	55H-3(3 or 4)-A-5-K-GH BSF()-KST()-NB
			Height Adj.	55H-3(3 or 4)-A-5-L()-GH BSF()-KST()-NB
		High Perf.	None	55P-3(3 or 4)-A-5-K-GH BSF()-KST()-NB
			Height Adj.	55P-3(3 or 4)-A-5-L()-GH BSF()-KST()-NB



Leather arm pads add J after the arm pattern number (Example: 55PJ-3-6-)
Only available in Spinneybeck Volo (Grade U) and Sabrina (Grade W) leathers.

J

*For specification directions, please see page 64.
For upholstery selections and pricing see facing page.

Order Code	Ordering Information	Options
<i>Example:</i> 55H-3-4-A5K-GH-BSF02-ST-K451/4-BT-K451/4	<i>Specify:</i>	<i>Base Options:</i>
55 Life chair	1. Pattern number with back suspension fabric BSF().	<i>Code: Upchg: Description:</i> 3 n/c painted matte
H Height adjustable arms	2. Seat topper fabric, if desired, either KST() knitted seat topper or ST() in traditional fabric or leather seat topper.	4 n/c polished aluminum base
3 High back	3. Back topper fabric, if desired, BT() in traditional fabric or leather topper.	<i>Cylinder Height Options:</i> Replace 5 in pattern with one of the following options:
4 Aluminum base and levers	C - CAL 133: Insert C after ST() option. Not available with KST. \$78 upcharge seat only. \$266 upcharge seat and back.	<i>Code: Upchg: Description:</i> L n/c low (height range: 15"-19") H n/c high (height range: 17 1/2" - 22 3/4") (Std. Cylinder is 16"-21.5")
A Advanced control with sliding seat	PERF-(560-85): Perforated leather. \$101 upcharge seat only. \$212 upcharge back topper only. For additional perforated leather choices and codes, see Perforated Leather page in Leather Application section of the price list.	<i>Ultra Seat Topper Options:</i> Replace GH in pattern with one of the following options: <i>Code: Upchg: Description:</i> BH n/c hard black caster BR \$40 soft black caster GR \$40 soft grey caster CH \$24 hard clear caster CR \$64 soft clear caster
5 Standard height cylinder (16" - 21 1/2")		<i>Glides:</i> Replace caster option with GG. No upcharge for this option.
K No lumbar		
GH Grey hard caster		
BSF17 Blackout back suspension fabric		
ST-K451/4 Una Ebony seat topper		
BT-K451/4 Una Ebony back topper		
Lumbar Color Options: Add one of the following options after L.		
<i>Code: Desc.</i> K1029/13 Vibe/Glam K1029/14 Vibe/Poise K1029/BLK Vibe/Black		
		<i>Ultra Seat Topper Options:</i> (1/2" thicker than standard seat topper) <i>Specify in place of KST.</i> <i>Code: Upchg: Desc.</i> UST \$57 Ultra Seat Topper UKST \$57 Ultra Knit Seat Topper

Note: NB means No Back Topper

* As of May 1, 2004 bases do not have plastic toe-caps.

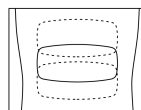

KST or COM	A	B	C	D	E	F	G	H	I	T	COL U	V	W	X	Y
\$1,212.															
1,306.															
1,365.															
1,460.															
1,418.															
1,512.															
1,466.															
1,560.															
											245.		330.		





CAL 133 Options:			KnollTextiles and Spinnebeck Leathers	Required to Select	Seat Topper Only
<i>Code:</i>	<i>Upchg:</i>	<i>Description:</i>	Please refer to the matrices at the beginning of the price list for Approved Textiles and Leathers.	<i>Life Back Suspension Fabric (BSF)</i>	<i>Life Knit Seat Topper (KST) - Base Grade</i>
C	\$78	CAL 133 textile for seat only (add C after ST() in pattern number)	<i>Ordering Samples/Viewing on Line:</i> To view any of these fabrics refer to the Knoll Surface Library on Knoll Exchange: http://exchange.knoll.com/media_lib/surfsearch.jsp	BSF 01 Zinc BSF 05 Chamomile BSF 06 Fire BSF 07 Cosmos BSF 08 Currant BSF 09 Earth BSF 10 Fossil BSF 11 Sky BSF 12 Lagoon BSF 14 Cypress BSF 15 Eclipse BSF 16 Electric BSF 17 Blackout BSF 18 Camel BSF 19 Beige BSF 20 Java BSF 21 Patina BSF 22 Grain BSF 50 White	KST 01 Zinc KST 05 Chamomile KST 06 Fire KST 07 Cosmos KST 08 Currant KST 09 Earth KST 10 Fossil KST 11 Sky KST 12 Lagoon KST 14 Cypress KST 15 Eclipse/Blackout KST 16 Electric KST 18 Camel KST 19 Beige KST 20 Java KST 21 Patina
C	\$266	CAL 133 textile for seat and back (add C after ST() and BT() in pattern number)	To order fabric samples for Life Back Suspension Fabric please send a fax to: 800-308-7765.		
C	\$153	CAL 133 leather seat topper available in Spinneybeck Volo FR. Minimum order required of 3 chairs per customer for chairs with seat topper only.	COL/COM Textile Requirements <i>Seat Topper:</i> 0.7 yards fabric 9.0 sq ft leather <i>Back Topper:</i> 1.3 yards fabric 16.0 sq ft leather		
C	\$222	CAL 133 leather back topper available in Spinneybeck Volo FR.			*Life KST - Coordinates with Life Back Suspension Fabrics

Note: Order lead time will be strictly based on availability of FR-treated Volo. All existing Volo colors are offered.

Cal 133:
♣ = Cal 133 upholstery/leather available. See textile matrix at the beginning of the Price List for pre-approved Cal 133 textiles.

The Life Chair

aluminum base, seat topper no back topper

	description	arm	lumbar	pattern no. *
<i>Designer(s):</i> Formway Design Studio, 2002	Knoll Textiles, Spinneybeck Leather, COM or COL No Back Topper	Armless	None	55C-3(3 or 4)-A-5-K-GH BSF()-ST()-NB
			Height Adj.	55C-3(3 or 4)-A-5-L()-GH BSF()-ST()-NB
<i>Award(s):</i> Good Design Award, Chicago Athenaeum, 2003, USA NeoCon Gold, Best of NeoCon, Task Chair - Seating Design, June 2002, USA	IIDEX/NeoCon, Sustainable Design Gold Award, 2002, Canada	Fixed	None	55A-3(3 or 4)-A-5-K-GH BSF()-ST()-NB
			Height Adj.	55A-3(3 or 4)-A-5-L()-GH BSF()-ST()-NB
		Height Adj.	None	55H-3(3 or 4)-A-5-K-GH BSF()-ST()-NB
			Height Adj.	55H-3(3 or 4)-A-5-L()-GH BSF()-ST()-NB
		High Perf.	None	55P-3(3 or 4)-A-5-K-GH BSF()-ST()-NB
			Height Adj.	55P-3(3 or 4)-A-5-L()-GH BSF()-ST()-NB



Leather arm pads add J after the arm pattern number (Example: 55PJ-3-6-)
Only available in Spinneybeck Volo (Grade U) and Sabrina (Grade W) leathers.

J

*For specification directions, please see page 64.
For upholstery selections and pricing see facing page.

Order Code	Ordering Information	Options
<i>Example:</i> 55H-3-4-A5K-GH-BSF02-ST-K451/4-BT-K451/4	<i>Specify:</i>	<i>Base Options:</i>
55 Life chair	1. Pattern number with back suspension fabric BSF().	<i>Code: Upchg: Description:</i> 3 n/c painted matte
H Height adjustable arms	2. Seat topper fabric, if desired, either KST() knitted seat topper or ST() in traditional fabric or leather seat topper.	4 n/c polished aluminum base
3 High back	3. Back topper fabric, if desired, BT() in traditional fabric or leather topper.	
4 Aluminum base and levers	C - CAL 133: Insert C after ST() option. Not available with KST. \$78 upcharge seat only. \$266 upcharge seat and back.	<i>Cylinder Height Options:</i> Replace 5 in pattern with one of the following options:
A Advanced control with sliding seat		<i>Code: Upchg: Description:</i> L n/c low (height range: 15"-19")
5 Standard height cylinder (16" - 21 1/2")		H n/c high (height range: 17 1/2" - 22 3/4")
K No lumbar		(Std. Cylinder is 16"-21.5")
GH Grey hard caster		<i>Lumbar Color Options:</i> Add one of the following options after L.
BSF17 Blackout back suspension fabric		<i>Code: Desc.</i> K1029/13 Vibe/Glam K1029/14 Vibe/Poise K1029/BLK Vibe/Black
ST-K451/4 Una Ebony seat topper		<i>Ultra Seat Topper Options:</i> (1/2" thicker than standard seat topper) <i>Specify in place of KST.</i>
BT-K451/4 Una Ebony back topper		<i>Code: Upchg: Desc.</i> UST \$57 Ultra Seat Topper UKST \$57 Ultra Knit Seat Topper

Note: NB means No Back Topper

* As of May 1, 2004 bases do not have plastic toe-caps.

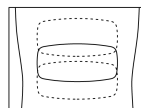





KST or COM	A	B	C	D	E	F	G	H	I	T	COL				
	U	V	W	X	Y										
\$1,212.	\$1,260.	\$1,265.	\$1,289.	\$1,313.	\$1,329.	\$1,353.	\$1,365.	\$1,383.	\$1,407.	\$1,584.	\$1,614.	\$1,673.	\$1,813.	\$1,827.	\$1,910.
1,306.	1,355.	1,360.	1,384.	1,407.	1,424.	1,448.	1,460.	1,477.	1,502.	1,679.	1,708.	1,767.	1,908.	1,922.	2,004.
1,365.	1,413.	1,419.	1,443.	1,466.	1,483.	1,507.	1,518.	1,536.	1,560.	1,738.	1,767.	1,826.	1,967.	1,980.	2,063.
1,460.	1,508.	1,513.	1,537.	1,560.	1,577.	1,601.	1,629.	1,631.	1,655.	1,832.	1,862.	1,920.	2,061.	2,075.	2,158.
1,418.	1,466.	1,471.	1,495.	1,518.	1,535.	1,559.	1,571.	1,589.	1,613.	1,790.	1,820.	1,878.	2,019.	2,033.	2,116.
1,512.	1,560.	1,566.	1,590.	1,613.	1,630.	1,654.	1,591.	1,683.	1,707.	1,885.	1,914.	1,973.	2,114.	2,127.	2,210.
1,466.	1,514.	1,519.	1,544.	1,567.	1,583.	1,608.	1,619.	1,637.	1,661.	1,839.	1,868.	1,927.	2,067.	2,081.	2,164.
1,560.	1,609.	1,614.	1,638.	1,661.	1,678.	1,702.	1,714.	1,731.	1,756.	1,933.	1,962.	2,021.	2,162.	2,176.	2,259.
											245.	330.			

	KnollTextiles and Spinneybeck Leathers	Required to Select	Seat Topper Only
<i>CAL 133 Options:</i>			
<i>Code:</i>	<i>Upchg:</i>	<i>Description:</i>	
C	\$78	CAL 133 textile for seat only (add C after ST() in pattern number)	<i>Life Knit Seat Topper (KST) - Base Grade</i> KST 01 Zinc KST 05 Chamomile KST 06 Fire KST 07 Cosmos KST 08 Currant KST 09 Earth KST 10 Fossil KST 11 Sky KST 12 Lagoon KST 14 Cypress KST 15 Eclipse/Blackout KST 16 Electric KST 18 Camel KST 19 Beige KST 20 Java KST 21 Patina
C	\$266	CAL 133 textile for seat and back (add C after ST() and BT() in pattern number)	
C	\$153	CAL 133 leather seat topper available in Spinneybeck Volo FR. Minimum order required of 3 chairs per customer for chairs with seat topper only.	
C	\$222	CAL 133 leather back topper available in Spinneybeck Volo FR.	*Life KST - Coordinates with Life Back Suspension Fabrics
		<p>Please refer to the matrices at the beginning of the price list for Approved Textiles and Leathers.</p> <p><i>Ordering Samples/Viewing on Line:</i> To view any of these fabrics refer to the Knoll Surface Library on Knoll Exchange: http://exchange.knoll.com/media_lib/surfsearch.jsp To order fabric samples for Life Back Suspension Fabric please send a fax to: 800-308-7765.</p> <p>COL/COM Textile Requirements</p> <p><i>Seat Topper:</i> 0.7 yards fabric 9.0 sq ft leather</p> <p><i>Back Topper:</i> 1.3 yards fabric 16.0 sq ft leather</p> <p><i>Cal 133:</i> ♣ = Cal 133 upholstery/leather available. See textile matrix at the beginning of the Price List for pre-approved Cal 133 textiles.</p>	<p><i>Life Back Suspension Fabric (BSF)</i> BSF 01 Zinc BSF 05 Chamomile BSF 06 Fire BSF 07 Cosmos BSF 08 Currant BSF 09 Earth BSF 10 Fossil BSF 11 Sky BSF 12 Lagoon BSF 14 Cypress BSF 15 Eclipse BSF 16 Electric BSF 17 Blackout BSF 18 Camel BSF 19 Beige BSF 20 Java BSF 21 Patina BSF 22 Grain BSF 50 White</p>

The Life Chair

aluminum base, seat topper and back topper

	description	arm	lumbar	pattern no. *
<i>Designer(s):</i> Formway Design Studio, 2002	Knoll Textiles, Spinneybeck Leather, COM or COL and Back Topper	Armless	None	55C-3(3 or 4)-A-5-K-GH BSF()-ST()-BT()
			Height Adj.	55C-3(3 or 4)-A-5-L()-GH BSF()-ST()-BT()
<i>Award(s):</i> Good Design Award, Chicago Athenaeum, 2003, USA NeoCon Gold, Best of NeoCon, Task Chair - Seating Design, June 2002, USA	IIDEX/NeoCon, Sustainable Design Gold Award, 2002, Canada	Fixed	None	55A-3(3 or 4)-A-5-K-GH BSF()-ST()-BT()
			Height Adj.	55A-3(3 or 4)-A-5-L()-GH BSF()-ST()-BT()
		Height Adj.	None	55H-3(3 or 4)-A-5-K-GH BSF()-ST()-BT()
			Height Adj.	55H-3(3 or 4)-A-5-L()-GH BSF()-ST()-BT()
		High Perf.	None	55P-3(3 or 4)-A-5-K-GH BSF()-ST()-BT()
			Height Adj.	55P-3(3 or 4)-A-5-L()-GH BSF()-ST()-BT()



Leather arm pads add J after the arm pattern number (Example: 55PJ-3-6-)
Only available in Spinneybeck Volo (Grade U) and Sabrina (Grade W) leathers.

J

*For specification directions, please see page 64.
For upholstery selections and pricing see facing page.

Order Code	Ordering Information	Options
<i>Example:</i> 55H-3-4-A5K-GH-BSF02-ST-K451/4-BT-K451/4	<i>Specify:</i>	<i>Base Options:</i>
55 Life chair	1. Pattern number with back suspension fabric BSF().	<i>Code: Upchg: Description:</i> 3 n/c painted matte
H Height adjustable arms	2. Seat topper fabric, if desired, either KST() knitted seat topper or ST() in traditional fabric or leather seat topper.	4 n/c polished aluminum base
3 High back	3. Back topper fabric, if desired, BT() in traditional fabric or leather topper.	
4 Aluminum base and levers	C - CAL 133: Insert C after ST() option. Not available with KST. \$78 upcharge seat only. \$266 upcharge seat and back.	<i>Cylinder Height Options:</i> Replace 5 in pattern with one of the following options:
A Advanced control with sliding seat		<i>Code: Upchg: Description:</i> L n/c low (height range: 15"-19")
5 Standard height cylinder (16" - 21 1/2")		H n/c high (height range: 17 1/2" - 22 3/4") (Std. Cylinder is 16"-21.5")
K No lumbar		<i>Lumbar Color Options:</i> Add one of the following options after L. <i>Code: Desc.</i> K1029/13 Vibe/Glam K1029/14 Vibe/Poise K1029/BLK Vibe/Black
GH Grey hard caster		<i>Ultra Seat Topper Options:</i> (1/2" thicker than standard seat topper) <i>Specify in place of KST.</i> <i>Code: Upchg: Desc.</i> UST \$57 Ultra Seat Topper UKST \$57 Ultra Knit Seat Topper
BSF17 Blackout back suspension fabric	PERF-(560-85): Perforated leather. \$101 upcharge seat only. \$212 upcharge back topper only. For additional perforated leather choices and codes, see Perforated Leather page in Leather Application section of the price list.	
ST-K451/4 Una Ebony seat topper		
BT-K451/4 Una Ebony back topper		

Note: NB means No Back Topper

* As of May 1, 2004 bases do not have plastic toe-caps.

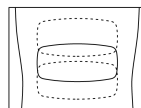

KST or COM	A	B	C	D	E	F	G	H	I	T	COL U	V	W	X	Y	
\$1,412.	\$1,496.	\$1,526.	\$1,579.	\$1,637.	\$1,678.	\$1,707.	\$1,820.	\$1,844.	\$1,880.	\$2,151.	\$2,264.	\$2,376.	\$2,812.	\$2,837.	\$2,962.	
1,507.	1,591.	1,620.	1,674.	1,731.	1,772.	1,802.	1,914.	1,938.	1,974.	2,246.	2,358.	2,471.	2,906.	2,932.	3,057.	
1,566.	1,650.	1,679.	1,733.	1,789.	1,831.	1,861.	1,973.	1,997.	2,033.	2,305.	2,417.	2,529.	2,965.	2,990.	3,115.	
1,660.	1,744.	1,773.	1,827.	1,884.	1,926.	1,955.	2,067.	2,092.	2,127.	2,399.	2,512.	2,624.	3,060.	3,085.	3,210.	
1,618.	1,702.	1,731.	1,785.	1,843.	1,884.	1,913.	2,025.	2,050.	2,085.	2,357.	2,470.	2,582.	3,018.	3,043.	3,168.	
1,713.	1,797.	1,826.	1,880.	1,937.	1,978.	2,008.	2,120.	2,144.	2,180.	2,452.	2,564.	2,676.	3,112.	3,137.	3,262.	
1,666.	1,750.	1,780.	1,833.	1,891.	1,932.	1,961.	2,074.	2,098.	2,134.	2,406.	2,518.	2,630.	3,066.	3,091.	3,216.	
1,761.	1,845.	1,874.	1,928.	1,986.	2,027.	2,056.	2,168.	2,192.	2,228.	2,500.	2,612.	2,725.	3,161.	3,186.	3,311.	
											245.	330.				

	KnollTextiles and Spinneybeck Leathers	Required to Select	Seat Topper Only
<i>CAL 133 Options:</i>			
<i>Code:</i>	<i>Upchg:</i>	<i>Description:</i>	
C	\$78	CAL 133 textile for seat only (add C after ST() in pattern number)	<i>Life Knit Seat Topper (KST) - Base Grade</i> KST 01 Zinc KST 05 Chamomile KST 06 Fire KST 07 Cosmos KST 08 Currant KST 09 Earth KST 10 Fossil KST 11 Sky KST 12 Lagoon KST 14 Cypress KST 15 Eclipse/Blackout KST 16 Electric KST 18 Camel KST 19 Beige KST 20 Java KST 21 Patina
C	\$266	CAL 133 textile for seat and back (add C after ST() and BT() in pattern number)	
C	\$153	CAL 133 leather seat topper available in Spinneybeck Volo FR. Minimum order required of 3 chairs per customer for chairs with seat topper only.	
C	\$222	CAL 133 leather back topper available in Spinneybeck Volo FR.	*Life KST - Coordinates with Life Back Suspension Fabrics
		KnollTextiles and Spinneybeck Leathers Please refer to the matrices at the beginning of the price list for Approved Textiles and Leathers. <i>Ordering Samples/Viewing on Line:</i> To view any of these fabrics refer to the Knoll Surface Library on Knoll Exchange: http://exchange.knoll.com/media_lib/surfsearch.jsp To order fabric samples for Life Back Suspension Fabric please send a fax to: 800-308-7765. COL/COM Textile Requirements <i>Seat Topper:</i> 0.7 yards fabric 9.0 sq ft leather <i>Back Topper:</i> 1.3 yards fabric 16.0 sq ft leather <i>Cal 133:</i> ♣ = Cal 133 upholstery/leather available. See textile matrix at the beginning of the Price List for pre-approved Cal 133 textiles.	<i>Life Back Suspension Fabric (BSF)</i> BSF 01 Zinc BSF 05 Chamomile BSF 06 Fire BSF 07 Cosmos BSF 08 Currant BSF 09 Earth BSF 10 Fossil BSF 11 Sky BSF 12 Lagoon BSF 14 Cypress BSF 15 Eclipse BSF 16 Electric BSF 17 Blackout BSF 18 Camel BSF 19 Beige BSF 20 Java BSF 21 Patina BSF 22 Grain BSF 50 White

The Life Chair

aluminum base, replacement parts

	description	pattern no. *
<i>Designer(s):</i> Formway Design Studio, 2002	Replacement Seat Topper Upholstery	55SEATTOPPER
	Replacement Back Topper Upholstery	55BACKTOPPER
<i>Award(s):</i> Good Design Award, Chicago Athenaeum, 2003, USA NeoCon Gold, Best of NeoCon, Task Chair - Seating Design, June 2002, USA IINDEX/NeoCon, Sustainable Design Gold Award, 2002, Canada	Replacement or Add on	55LUMBAR



*For specification directions, please see page 64.
For upholstery selections and pricing see facing page.

Order Code	Ordering Information	Options
<i>Example:</i> 55H-3-4-A5K-GH-BSF02-ST-K451/4-BT-K451/4	<i>Specify:</i>	<i>Base Options:</i>
55 Life chair	1. Pattern number with back suspension fabric BSF().	<i>Code: Upchg: Description:</i> 3 n/c painted matte
H Height adjustable arms	2. Seat topper fabric, if desired, either KST() knitted seat topper or ST() in traditional fabric or leather seat topper.	4 n/c polished aluminum base
3 High back	3. Back topper fabric, if desired, BT() in traditional fabric or leather topper.	
4 Aluminum base and levers	C - CAL 133: Insert C after ST() option. Not available with KST. \$78 upcharge seat only. \$266 upcharge seat and back.	<i>Cylinder Height Options:</i> Replace 5 in pattern with one of the following options:
A Advanced control with sliding seat		<i>Code: Upchg: Description:</i> L n/c low (height range: 15"-19") H n/c high (height range: 17 1/2" - 22 1/4") (Std. Cylinder is 16"-21.5")
5 Standard height cylinder (16" - 21 1/2")		<i>Caster Options:</i> Replace GH in pattern with one of the following options: <i>Code: Upchg: Description:</i> BH n/c hard black caster BR \$40 soft black caster GR \$40 soft grey caster CH \$24 hard clear caster CR \$64 soft clear caster
K No lumbar		<i>Glides:</i> Replace caster option with GG. No upcharge for this option.
GH Grey hard caster		
BSF17 Blackout back suspension fabric	PERF-(560-85): Perforated leather. \$101 upcharge seat only. \$212 upcharge back topper only. For additional perforated leather choices and codes, see Perforated Leather page in Leather Application section of the price list.	<i>Lumbar Color Options:</i> Add one of the following options after L. <i>Code: Desc.</i> K1029/13 Vibe/Glam K1029/14 Vibe/Poise K1029/BLK Vibe/Black
ST-K451/4 Una Ebony seat topper		<i>Ultra Seat Topper Options:</i> (1/2" thicker than standard seat topper) <i>Specify in place of KST.</i> <i>Code: Upchg: Desc.</i> UST \$57 Ultra Seat Topper UKST \$57 Ultra Knit Seat Topper
BT-K451/4 Una Ebony back topper		

Note: NB means No Back Topper

* As of May 1, 2004 bases do not have plastic toe-caps.

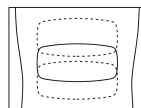

KST or COM	A	B	C	D	E	F	G	H	I	T	COL U	V	W	X	Y
\$48.	\$97.	\$102.	\$126.	\$148.	\$166.	\$190.	\$201.	\$219.	\$244.	\$420.	\$449.	\$509.	\$650.	\$663.	\$746.
201.	236.	260.	290.	324.	349.	354.	455.	461.	473.	567.	650.	704.	999.	1,010.	1,052.
95.															

		KnollTextiles and Spinneybeck Leathers	Required to Select	Seat Topper Only	
<i>CAL 133 Options:</i>					
<i>Code:</i>	<i>Upchg:</i>	<i>Description:</i>			
C	\$78	CAL 133 textile for seat only (add C after ST() in pattern number)	<p>Please refer to the matrices at the beginning of the price list for Approved Textiles and Leathers.</p> <p><i>Ordering Samples/Viewing on Line:</i> To view any of these fabrics refer to the Knoll Surface Library on Knoll Exchange: http://exchange.knoll.com/media_lib/surfsearch.jsp To order fabric samples for Life Back Suspension Fabric please send a fax to: 800-308-7765.</p> <p>COL/COM Textile Requirements</p> <p><i>Seat Topper:</i> 0.7 yards fabric 9.0 sq ft leather</p> <p><i>Back Topper:</i> 1.3 yards fabric 16.0 sq ft leather</p> <p><i>Cal 133:</i> ♣ = Cal 133 upholstery/leather available. See textile matrix at the beginning of the Price List for pre-approved Cal 133 textiles.</p>	<p><i>Life Back Suspension Fabric (BSF)</i> BSF 01 Zinc BSF 05 Chamomile BSF 06 Fire BSF 07 Cosmos BSF 08 Currant BSF 09 Earth BSF 10 Fossil BSF 11 Sky BSF 12 Lagoon BSF 14 Cypress BSF 15 Eclipse BSF 16 Electric BSF 17 Blackout BSF 18 Camel BSF 19 Beige BSF 20 Java BSF 21 Patina BSF 22 Grain BSF 50 White</p>	<p><i>Life Knit Seat Topper (KST) - Base Grade</i> KST 01 Zinc KST 05 Chamomile KST 06 Fire KST 07 Cosmos KST 08 Currant KST 09 Earth KST 10 Fossil KST 11 Sky KST 12 Lagoon KST 14 Cypress KST 15 Eclipse/Blackout KST 16 Electric KST 18 Camel KST 19 Beige KST 20 Java KST 21 Patina</p> <p>*Life KST - Coordinates with Life Back Suspension Fabrics</p>
C	\$266	CAL 133 textile for seat and back (add C after ST() and BT() in pattern number)			
C	\$153	CAL 133 leather seat topper available in Spinneybeck Volo FR. Minimum order required of 3 chairs per customer for chairs with seat topper only.			
C	\$222	CAL 133 leather back topper available in Spinneybeck Volo FR.			

Note: Order lead time will be strictly based on availability of FR-treated Volo. All existing Volo colors are offered.

How to Specify a Life Chair

How to Specify a Life Chair

Step 1 Basic Pattern Number																						
Select a Chair Type (including arm, base, cylinder, lumbar and caster type)																						
	Arm					Base				Cylinder	Lumbar	Caster										
Life Chair	Height Adjustable Arms	High Performance Arms	Fixed Arms	Armless	Leather Armpads	High Back	Grey Base & Levers	Polished Aluminum Base & Levers	Painted Matte Aluminum Base & Levers	Black Base & Levers	Advanced Control with Sliding Seat	Medium Height Cylinder	Low Height Cylinder	High Height Cylinder	Height Adjustable Lumbar, Color #	No Lumbar	Grey Hard Caster	Grey Soft Caster	Clear Hard Caster	Clear Soft Caster	Black Hard Caster	Black Soft Caster
55	H	P	A	C	J	3	6	4	3	2	A	5	L	H	L	K	GH	GR	CH	CR	BH	BR

The basic pattern numbers are configured for you in the price list.

EXAMPLES:

55PJ-3-6-A5L-K1029-13-GH-BSF17-ST-K451/4-BT-K451/4

(Fully upholstered Life with seat and back upholstery topper)

Life / High Performance Arm / Leather Armpads / Grey Base /
Height Adjustable Lumbar, Vibe K1029-13 Glam / Grey Hard Caster /
Life Back Suspension Fabric - Blackout / Seat Topper Fabric-Una, Ebony /
Back Topper Fabric-Una, Ebony

55H-3-4-A5K-CH-BSF16-KST16-NB

(Life Knit seat topper, no back upholstery topper)

Life / Height Adjustable Arms / Polished Aluminum Base / No Lumbar /
Clear Hard Caster / Life Back Suspension Fabric-Electric /
Life Knit Seat Fabric-Electric / No Back Topper

Step 2		Step 3		Step 4	
	Select Back Suspension Fabric color	Select No Seat Topper	or Select Seat Topper and Upholstery Choice	Select No Back Topper	or Select Back Topper and Upholstery Choice
	Life Back Suspension Fabric	No Seat Topper (-\$40 from basic model price)	Seat Topper and Upholstery Number Life Knit Fabrics are the standard seat topper included in basic model pricing. Alternatives include all approved Knoll Textiles, Spinneybeck Leathers, COM or COL	No Back Topper	Back Topper and Upholstery Number Options include all approved Knoll Textiles, Spinneybeck Leathers, COM or COL
	BSF(01-22)	NS	Life Grade Knit Fabric <i>(included in the basic model price)</i> KST(01-21) or UKST(01-21) <i>(for Ultra Seat Topper)</i>	NB	Life Grade Knit Fabric <i>(not available as a Back Topper)</i>
			or ST-(KnollTextile or Spinneybeck Upholstery Code*) <i>(upcharge from basic model)</i> or UST <i>(for Ultra Seat Topper)</i>		or BT-(KnollTextile or Spinneybeck Upholstery Code*) <i>(upcharge from basic model)</i>
			or COM or COL		or COM or COL

* Please refer to the matrices at the beginning of the price list for Approved Textiles and Leathers.

The Life Chair Upholstery Options and Construction Information



Back Suspension Fabric with Unupholstered Seat

Life Back Suspension Fabric is required for every chair, and comes in an amazing 19 color palette, ranging in hue from soft light and vibrant brights to the richest of warm tones and, oh yes, you can still order black.



Back Suspension Fabric with Seat Upholstery Topper

You may choose to add a seat upholstery topper. In addition to a wide range of approved KnollTextiles and Spinneybeck leathers, two exclusive fabrics are available: Life Knit Seat Topper, in a palette to match the Life Back Suspension Fabrics. Life Knit Seat Upholstery Topper is base grade and included in the basic model pricing.



Back Suspension Fabric with Seat and Back Upholstery Toppers

Change the look of Life by adding a back topper. A wide range of approved KnollTextiles and Spinneybeck leathers are available as back toppers. Life Knit Seat Topper (KST) is not available as a back topper.

To view fabrics online, refer to the Knoll Surface Library on knoll.com (go to the menu bar and click on “Products” and click on “Surface Library”).

Construction

The Life Chair is very COM/COL friendly.

COM/COL Approval Procedure

Prior to order placement a sample* of the actual COM/COL must be submitted to Knoll East Greenville, with completed Knoll COM/COL Approval Request Form. Even after such preliminary approval, Knoll reserves the right to reject COM, including, if necessary, the item intended for use with COM, if Knoll considers the customer-supplied material inadequate for any reason. When specifying suede and shrunken cowhide, add 10% to the square footage requirement. When specifying calfskin, add 15% to the square footage requirement. If a COM/COL has been approved for the Bulldog two-piece chair, it is likely to work on Life. However, to be sure, the COM/COL procedure is still required. COM is graded at Life Knit Grade and COL is grade U.

*Sample Requirement: 8" x 8" minimum memo sample if solid; if COM has a repeat, the sample must be large enough to show the repeat.

Call Customer Service at 800-343-5665 to obtain a copy of the COM/COL Approval Request Form.

Cleaning Note:

The Life Back Suspension Fabric (BSF) and the Life Knit Seat Topper (KST) can be spot-cleaned with an upholstery shampoo or mild detergent. Use a soft-bristled polyester brush or cloth. Do not use an abrasive cloth or brush. To clean a large surface area, an extraction or steam cleaner works best. Do not expose the materials to temperatures greater than 160°. To prevent soiling, vacuuming to remove dust and grime is recommended. Cleaning code is W-S.

Back:

Glass filled nylon frame. Polyester yarn with co-polyester elastomeric back suspension fabric.

Upholstery toppers:

3/4" foam - back thickness.
1-3/4" foam - seat thickness.
2-1/4" foam - ultra seat topper thickness
MDI polyurethane foam material.

Flexing Seatpad:

Glass filled nylon seat structure.

Fixed Arms:

Plastic armpost with soft integrally colored thermoplastic urethane pad and glass filled nylon foam insert.

Height Adjustable Arms:

Aluminum armpost with soft integrally colored thermoplastic urethane pad and glass filled nylon foam insert.

High Performance Arms:

Aluminum armpost with soft integrally colored thermoplastic urethane pad and glass filled nylon foam insert.

Black and Grey Base:

Glass filled nylon.

Polished and painted matte

aluminum base:
Aluminum

Height Adjustable Lumbar:

Thermoplastic elastomer pad and frame, polypropylene and neodymium magnets.

Casters:

Nylon 6 hard caster.
Nylon 6 soft caster with urethane overmolding.

Optional Lumbar Attachment:

Slow recovery foam. Attaches with magnets.

Visual impression and scale:

Doesn't dominate the look of the work environment, it complements it. Translucent back, sculpted mechanism and thin profile integrate Life into the landscape. Generous scale and features accommodate all size users.

Synchronized recline with auto-balanced tension:

Utilizes user's body weight for resistance and recline. Allows for constant sightline — no need to refocus. Promotes movement and balance. Preference control accommodates a wider range of users.

Dynamic seat pan with forward flex:

Unique cut-out pattern with ribbed understructure provides dynamic movement and structural stability. Cradles and accommodates ischials (sit bones) without pressure points. Automatic flex responds to user's every move. Flex front automatically supports perching and enables a balanced posture. Flex front includes waterfall edge (gradual radius at the front edge that does not cause pressure under the knee). Ribs prevent "hammocking" or sagging and allow for easier movement.

Back flex:

The back frame is also a flexible plane like the seat that moves with you as you recline in the chair.

Life Back Suspension Fabric (BSF):

3D weave has built in lumbar support and is available in 19 color options. Has a soft feel that is not harsh to skin or clothing.

Arms:

Soft armpads alleviate pressure points. Types available: fixed, height adjustable, high performance (includes adjustment and armpad positioning). Retrofittable or changeable.

High performance arms:

One-hand operation. Armposts are set toward the rear of the seat for a better fit. Soft armpads float in an orbital motion with locked stops. A great deal of adjustment in a surprisingly slim package.

Optional lumbar attachment:

Made of slow recovery foam, it magnetically attaches anywhere on the Life Back Suspension Fabric (BSF), and is covered in Vibe by KnollTextiles.

Low profile base and casters:

Feet can rest on the base comfortably. Low profile enables easier foot movement. Caster ribs absorb energy, flex and spread the static load for easier rolling.

Controls:

Adjustable from the seated position. Easy, obvious and labeled. Automated where possible.

Environmental:

Helps customers meet U.S. Green Building Council's LEED requirements.

Durability:

10 year multishift warranty. See details in the Selling Policy at the end of the Price List.

Life Awards:

Good Design Award, Chicago Athenaeum, 2003, USA
 NeoCon Gold, Best of NeoCon, Task Chair - Seating Design, June 2002, USA
 IDEX/NeoCon, Sustainable Design Gold Award, 2002, Canada
 IDEX/NeoCon, Seating Desk, Workstation Chair Gold Award, 2002, Canada
 FX Awards, Seating Product of the Year, 2002, UK
 FX Awards, Overall Interior Product of the Year, 2002, UK

The Life Chair Dimensions and Operating Instructions

Seat

	Seat Height	Seat Depth (Adjustable)	Seat Width	Seat Pan Angle
Life complies with the BIFMA G1-2002 Ergonomic Standard.				
BIFMA	15" - 19.9"*	16.9" and larger	17.7" min.	0° - 4°**
Life	16" - 21.5"*	15" - 19"	18.75"	4°

Back

	Backrest Height	Backrest Width	Lumbar Support Location	Angle between Seat and Back	Tilt Range of Back
BIFMA	12.2" min.	14.2"	within 5.9" - 9.8"***	90° - 115° (must be >90°)	10° min.
Life	25"	18.25"	7.5" - 11.5"	95° - 119°	24°

Armrests

Armrest Height (Fixed)	Armrest Height Foam seatpad (Adjustable)	Inside Dim. between Armrest
7.9" - 9.8"	6.9" - 10.8"	18.0" min.
9.38"	7.5" - 11.563"	20.5"

*Range achieved with single chair, or combination of chairs. Life's low cylinder, medium and high cylinder options exceed the 15" - 19.9" seat height range. Life's medium cylinder range is shown above. With seat topper, seat height is 16.5" - 22". **Adjustable: Include part of 0° - 4° rearward ***Adjustable: Includes part of 5.9" - 9.8"

A overall height	38.5" - 43.75"
B overall width	26.5"
C overall depth	24.5"
D arm height (from floor)	22.25" - 31.25"
E arm height (from seat ref. pt.)	5.5" - 9.5"
F recline range / ratio seat : back (recline range = trunk to thigh angle)	132° / 1°:4.8°
G base diameter	26"
weight (Plastic base, height adjustable arms, seat topper.)	36 lbs.
weight (aluminum base)	37.5 lbs.

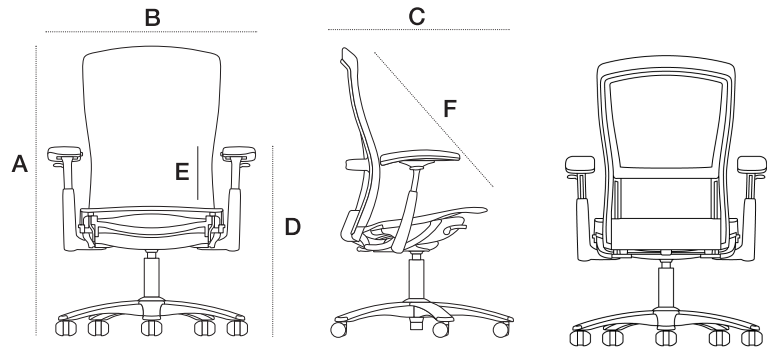

Life Arm Options: All arms have soft armpads. All arms retrofitable or changeable.

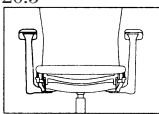
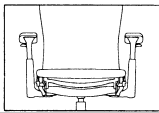
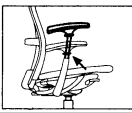
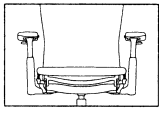
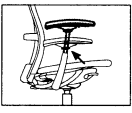
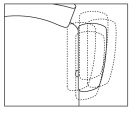
	Distance between Arm Supports	Distance between Armpads	Arm height range (from the seat pan)	Armpad Movement Width	Armpad Movement Fore/Aft	Arm Recess Dimension
Fixed Arms	20.5" 	17.75"	10.43"			
Adjustable Height Arms	20.5" 	18.75"	7.5" - 11.563" 			6" - 10"
High Performance Arms	20.5" 	17.25" - 19.75" (narrowest - widest) (2.5" range / 1.25" per side)	7.5" - 11.563" 	17.25" - 19.75" (2.5" range / 1.25" per side)	3" Fore/Aft movement 	3" - 10"

Lumbar:

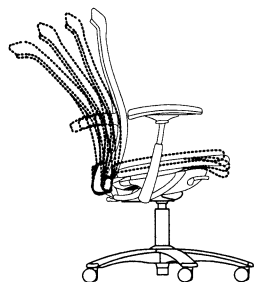

Compliance: ANSI/BIFMA x5.1 - 2002, BIFMA G1-2002 Ergonomic Standard, Cal 117, Cal 133 (with approved FR upholstery)
Operating Instructions also available online at www.knoll.com

**Standard Features:****Synchronized recline with auto-balanced tension**

No need to adjust tension. Automatic recline tension counter-balances your body weight, resulting in perfect balance as you recline.

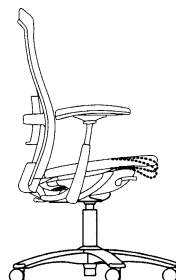
**Forward seat flex**

No knobs or levers needed. Lean forward or perch toward the edge of the seat and Life's seat pan automatically adjusts to support your position.

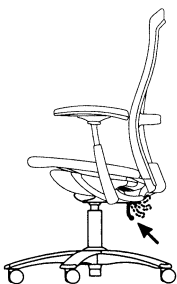
**Tension preference selector**

To perfect the tension adjust the preference lever located at the back left of the chair while in the upright position.

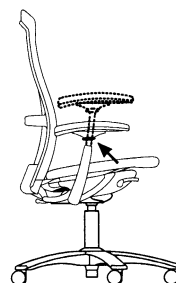
**Arm Options:**

Fixed arms:
Non-adjustable.

Height Adjustable Arms:

Light the lever on the outside of the armrest to adjust arm height.

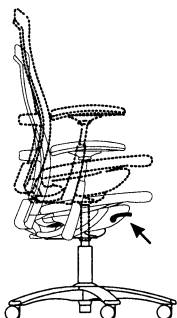
**Seat height adjustment**

To raise or lower the height, lift the lever on the right side of the chair and adjust to the proper height.

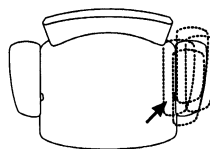
**High Performance Height and Fore/Aft Adjustable Arms:**

Lift the lever on the outside of the armrest to adjust arm height.

The armrests adjust in an orbital motion and lock into a fixed position by pressing the button on the inside of the pad. The armrests can be positioned to the front or back and in width.

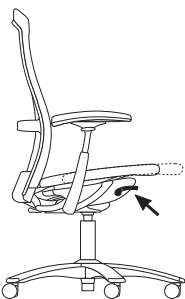
**Sliding seat depth adjustment**

Using the same lever as the seat height, push down to slide the seat within the 4" seat depth range. Release the lever to lock the seat into position.

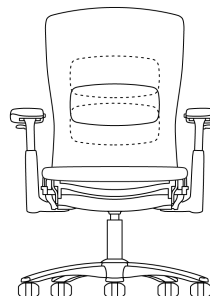
**Lumbar Options:****Height Adjustable Lumbar**

The lumbar support is held on to the chair with magnets for easy installation and a maximum range of adjustability.

To install the lumbar, separate the halves of the magnetic lumbar and place it in the desired position on your chair. Secure it by putting both halves back together around the back suspension fabric on the chair.

Adjust the lumbar by sliding the lumbar pad up and down the back of the chair.

Note: Product contains magnets. Consult the lumbar hangtag for more information.

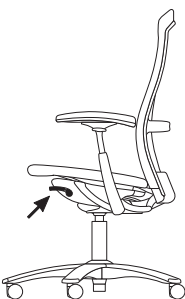
**Upright tilt lock**



To lock the seat in an upright position, push down the lever located on the left side of seat. Lift lever to unlock.

Chadwick™ Chair

Tilt Stop Control

Designer(s):
Don Chadwick, 2005



pattern no.	description	seat h	arm h	overall w	d	h
33-NA-1-BK-T-S-X-HC	Armless, tilt stop control, pneumatic seat height	15 ⁷ / ₁₀ " - 20"		19 ³ / ₈ "	25 ¹ / ₂ "	37 ¹ / ₂ " - 42"
						
33-FA-1-BK-T-S-X-HC	Fixed arms, tilt stop control, pneumatic seat height	15 ⁷ / ₁₀ " - 20"	23 ³ / ₁₀ " - 29 ¹ / ₅ "	26 ¹ / ₂ "	25 ¹ / ₂ "	37 ¹ / ₂ " - 42"
						
33-AA-1-BK-T-S-X-HC	Height and width adjustable arms, tilt stop control, pneumatic seat height. Note: An additional higher adjustable arm option is available. See below for details.	15 ⁷ / ₁₀ " - 20"	23" - 30"	26 ¹ / ₂ "	25 ¹ / ₂ "	37 ¹ / ₂ " - 42"
						
L	Lumbar (Replace X with L in pattern number)					
	Low Cylinder - 15" - 19 ¹ / ₁₀ " (Replace S with L in pattern number)					
H	High Cylinder - 16 ⁷ / ₁₀ " - 21 ³ / ₅ " (Replace S with H in pattern number)					
TA	Tall Adjustable Arm - ³ / ₄ " higher arm height (Replace AA with TA in pattern number)					
SC	Soft Caster (Replace HC with SC in pattern number)					
GL	Glide (Replace HC with GL in pattern number)					
33LUMBAR	Replacement or Add on					

(For Chadwick Fabric Color selections, see below.)

Order Code	Ordering Information	Chadwick Fabric Color Options	Features
<i>Example:</i> 33-AA-1-BK-T-S-X-HC-05	<i>Specify:</i>	Black Monofilament:	<u>Standard Features:</u>
33 Chadwick Chair	1. Pattern number	Code: Desc: Upcharge:	<ul style="list-style-type: none"> Active Suspension™ - including: <ul style="list-style-type: none"> - Synchronized recline with tilt tension - Resilient suspension seat and back fabric Forward-tilt (built-in design with no adjustment necessary) Variable seat depth (built-in design with no adjustment necessary) Pneumatic seat height 360-degree swivel Cal 133 approved
AA Adjustable Arms	2. Fabric color	01 Beige n/c	
1 Task Chair	<i>Finish color:</i>	02 Brown n/c	
BK Black Frame	Black	03 Silver n/c	
T Tilt Stop Control		04 Green n/c	
S Standard Cylinder		05 Black n/c	
X No Lumbar		06 Red n/c	
HC Hard Black Caster		07 Blue n/c	
05 Black Chadwick Fabric		Silver Monofilament:	<u>Optional Features:</u>
		Code: Desc: Upcharge:	<ul style="list-style-type: none"> Fixed arms with spring-loaded armpad Height and width adjustable arms with spring-loaded armpads Adjustable lumbar support magnetically attaches anywhere on the mesh chair back
		08 Jade \$16	
		09 Platinum \$16	

pattern no.	list
33-NA-1-BK-T-S-X-HC#	\$815.
33-FA-1-BK-T-S-X-HC#	880.
33-AA-1-BK-T-S-X-HC#	951.
L	78.
L	n/c
H	n/c
TA	n/c
SC	40.
GL	n/c
33LUMBAR	78.

Options:

L - For lumbar, replace X with L in the pattern number. Add \$78 to list price

Note:
To order a lumbar separately, use pattern number 33LUMBAR. The list price is \$78.

TA - For Tall Adjustable Arm, replace AA with TA in the pattern number. The tall arm is 1/4" higher than the standard adjustable arm.

SC - For soft casters, replace HC with SC in the pattern number, and add \$38 to the list price

GL - For glides, replace HC with GL in the pattern number.

H - For the high cylinder, replace S in the pattern number with H. The high cylinder seat height range is 16 7/10" - 21 7/8". The standard cylinder seat height range is 15 7/10" - 20"

L - For the low cylinder, replace S in the pattern number with L. The low cylinder seat height range is 15" - 19 1/10". The standard cylinder seat height range is 15 7/10" - 20".

Lumbar detail

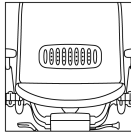

Tall Arm detail

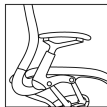





Glide detail



Chadwick™ Chair

Basic Control

pattern no.	description	seat h	arm h	overall w	d	h	
<i>Designer(s):</i> Don Chadwick, 2005	33-NA-1-BK-B-S-X-HC	Armless, basic control, pneumatic seat height	15 ⁷ / ₁₀ " - 20"		19 ³ / ₈ "	25 ¹ / ₂ "	37 ¹ / ₂ " - 42"
							
	33-FA-1-BK-B-S-X-HC	Fixed arms, basic control, pneumatic seat height	15 ⁷ / ₁₀ " - 20"	23 ³ / ₁₀ " - 29 ¹ / ₅ "	26 ¹ / ₂ "	25 ¹ / ₂ "	37 ¹ / ₂ " - 42"
							
	33-AA-1-BK-B-S-X-HC	Height and width adjustable arms, basic control, pneumatic seat height. Note: An additional higher adjustable arm option is available. See below for details.	15 ⁷ / ₁₀ " - 20"	23" - 30"	26 ¹ / ₂ "	25 ¹ / ₂ "	37 ¹ / ₂ " - 42"
							
L	Lumbar (Replace X with L in pattern number)						
	Low Cylinder - 15" - 19 ¹ / ₁₀ " (Replace S with L in pattern number)						
H	High Cylinder - 16 ⁷ / ₁₀ " - 21 ³ / ₅ " (Replace S with H in pattern number)						
TA	Tall Adjustable Arm - ³ / ₄ " higher arm height (Replace AA with TA in pattern number)						
SC	Soft Caster (Replace HC with SC in pattern number)						
GL	Glide (Replace HC with GL in pattern number)						
33LUMBAR	Replacement or Add on						

(For Chadwick Fabric Color selections, see below.)

Order Code	Ordering Information	Color Options	Features
<i>Example:</i> 33-AA-1-BK-B-S-X-HC-05	<i>Specify:</i>	Black Monofilament:	<u>Standard Features:</u>
33 Chadwick Chair	1. Pattern number	Code: Desc: Upcharge:	<ul style="list-style-type: none"> Active Suspension™ - including: <ul style="list-style-type: none"> Synchronized recline with tilt tension Resilient suspension seat and back fabric Forward-tilt (built-in design with no adjustment necessary) Variable seat depth (built-in design with no adjustment necessary) Pneumatic seat height 360-degree swivel Cal 133 approved
AA Adjustable Arms	2. Fabric color	01 Beige n/c	
1 Task Chair	<i>Finish color:</i>	02 Brown n/c	
BK Black Frame	Black	03 Silver n/c	
B Basic Control		04 Green n/c	
S Standard Cylinder		05 Black n/c	
X No Lumbar		06 Red n/c	
HC Hard Black Caster		07 Blue n/c	
05 Black Chadwick Fabric		Silver Monofilament:	<u>Optional Features:</u>
		Code: Desc: Upcharge:	<ul style="list-style-type: none"> Fixed arms with spring-loaded armpad Height and width adjustable arms with spring-loaded armpads Adjustable lumbar support magnetically attaches anywhere on the mesh chair back
		08 Jade \$16	
		09 Platinum \$16	

pattern no.	list
33-NA-1-BK-B-S-X-HC#	\$766.
33-FA-1-BK-B-S-X-HC#	831.
33-AA-1-BK-B-S-X-HC#	902.
L	78.
L	n/c
H	n/c
TA	n/c
SC	40.
GL	n/c
33LUMBAR	78.

Options:

L - For lumbar, replace X with L in the pattern number. Add \$78 to list price

Note:
To order a lumbar separately, use pattern number 33LUMBAR. The list price is \$78.

TA - For Tall Adjustable Arm, replace AA with TA in the pattern number. The tall arm is 1/4" higher than the standard adjustable arm.

SC - For soft casters, replace HC with SC in the pattern number, and add \$37 to the list price

GL - For glides, replace HC with GL in the pattern number.

H - For the high cylinder, replace S in the pattern number with H. The high cylinder seat height range is 16 7/10" - 21 3/8". The standard cylinder seat height range is 15 7/10" - 20"

L - For the low cylinder, replace S in the pattern number with L. The low cylinder seat height range is 15" - 19 1/10". The standard cylinder seat height range is 15 7/10" - 20".

Lumbar detail

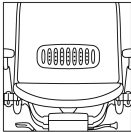

Tall Arm detail

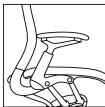

Glide detail





Chadwick™ Chair

High Task Chair

Tilt Stop Control

Designer(s):
Don Chadwick, 2005



pattern no.	description	seat h	arm h	overall w	d	h
33-NA-2-BK-T-S-X- HC	Armless, tilt stop control, pneumatic seat height	23 1/4" - 30 3/4"		26 3/4"	25 1/2"	44 1/2" - 52"
						
33-FA-2-BK-T-S-X- HC	Fixed arms, tilt stop control, pneumatic seat height	23 1/4" - 30 3/4"	32 1/2" - 40"	26 3/4"	25 1/2"	44 1/2" - 52"
						
33-AA-2-BK-T-S-X- HC	Height and width adjustable arms, tilt stop control, pneumatic seat height. Note: An additional higher adjustable arm option is available. See below for details. Cylinder offers 7 1/2" of height adjustability.	23 1/4" - 30 3/4"	31" - 41"	26 3/4"	25 1/2"	44 1/2" - 52"
						
L	Lumbar (Replace X with L in pattern number)					
TA	Tall Adjustable Arm - 3/4" higher arm height (Replace AA with TA in pattern number)					
SC	Soft Caster (Replace HC with SC in pattern number)					
GL	Glide (Replace HC with GL in pattern number)					
33LUMBAR	Replacement or Add on					

(For Chadwick Fabric Color selections, see below.)

Order Code	Ordering Information	Chadwick Fabric Color Options	Features
<i>Example:</i> 33-AA-2-BK-T-S-X-HC-05	<i>Specify:</i>	Black Monofilament:	<u>Standard Features:</u>
33 Chadwick Chair	1. Pattern number	Code: Desc: Upcharge:	<ul style="list-style-type: none"> Black plastic footring with a diameter of 19.875". Single lever mechanism for height adjustability with 11 locking positions for the footring in 1/2" increments. Active Suspension™ - including: <ul style="list-style-type: none"> - Synchronized recline with tilt tension - Resilient suspension seat and back fabric Forward-tilt (built-in design with no adjustment necessary) Variable seat depth (built-in design with no adjustment necessary) Pneumatic seat height 360-degree swivel Cal 133 approved
AA Adjustable Arms	2. Fabric color	01 Beige n/c	
2 High Task Chair	<i>Finish color:</i>	02 Brown n/c	
BK Black Frame	Black	03 Silver n/c	
T Tilt Stop Control		04 Green n/c	
S Standard Cylinder		05 Black n/c	
X No Lumbar		06 Red n/c	
HC Hard Black Caster		07 Blue n/c	
05 Black Chadwick Fabric		Silver Monofilament:	<u>Optional Features:</u>
		Code: Desc: Upcharge:	<ul style="list-style-type: none"> Fixed arms with spring-loaded armpad Height and width adjustable arms with spring-loaded armpads Adjustable lumbar support magnetically attaches anywhere on the mesh chair back
		08 Jade \$16	
		09 Platinum \$16	

pattern no.	list
33-NA-2-BK-T-S-X-HC #	\$1,013.
<hr/>	
33-FA-2-BK-T-S-X-HC #	1,077.
<hr/>	
33-AA-2-BK-T-S-X-HC #	1,148.
<hr/>	
L	78.
TA	n/c
SC	40.
GL	n/c
33LUMBAR	78.

Options

L - For lumbar, replace X with L in the pattern number. Add \$78 to list price

Note:
To order a lumbar separately, use pattern number 33LUMBAR. The list price is \$78.

TA - For Tall Adjustable Arm, replace AA with TA in the pattern number. The tall arm is 3/4" higher than the standard adjustable arm.

SC - For soft casters, replace HC with SC in the pattern number, and add \$37 to the list price.

For Silver Monofilament Color Option 08-Jade and 09-Platinum add \$16 to list price.

GL - For glides, replace HC with GL in the pattern number.

Lumbar detail

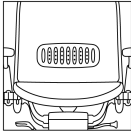

Tall Arm detail



Glide detail





Chadwick™ Chair

High Task Chair

Basic Control

Designer(s):
Don Chadwick, 2005



pattern no.	description	seat h	arm h	overall w	d	h
33-NA-2-BK-B-S-X-HC	Armless, basic control, pneumatic seat height	23 1/4" - 30 3/4"		26 3/4"	25 1/2"	44 1/2" - 52"
						
33-FA-2-BK-B-S-X-HC	Fixed arms, basic control, pneumatic seat height	23 1/4" - 30 3/4"	32 1/2" - 40"	26 3/4"	25 1/2"	44 1/2" - 52"
						
33-AA-2-BK-B-S-X-HC	Height and width adjustable arms, basic control, pneumatic seat height. Note: An additional higher adjustable arm option is available. See below for details.	23 1/4" - 30 3/4"	31" - 41"	26 3/4"	25 1/2"	44 1/2" - 52"
						
L	Lumbar (Replace X with L in pattern number)					
TA	Tall Adjustable Arm - 3/4" higher arm height (Replace AA with TA in pattern number)					
SC	Soft Caster (Replace HC with SC in pattern number)					
GL	Glide (Replace HC with GL in pattern number)					
33LUMBAR	Replacement or Add on					

(For Chadwick Fabric Color selections, see below.)

Order Code	Ordering Information	Chadwick Fabric Color Options	Features
<i>Example:</i> 33-AA-2-BK-T-S-X-HC-05	<i>Specify:</i>	Black Monofilament:	<u>Standard Features:</u>
33 Chadwick Chair	1. Pattern number	Code: Desc: Upcharge:	<ul style="list-style-type: none"> Black plastic footring with a diameter of 19.875". Single lever mechanism for height adjustability with 11 locking positions for the footring in 1/2" increments. Active Suspension™ - including: <ul style="list-style-type: none"> - Synchronized recline with tilt tension - Resilient suspension seat and back fabric Forward-tilt (built-in design with no adjustment necessary) Variable seat depth (built-in design with no adjustment necessary) Pneumatic seat height 360-degree swivel Cal 133 approved
AA Adjustable Arms	2. Fabric color	01 Beige n/c	
2 High Task Chair	<i>Finish color:</i>	02 Brown n/c	
BK Black Frame	Black	03 Silver n/c	
T Tilt Stop Control		04 Green n/c	
S Standard Cylinder		05 Black n/c	
X No Lumbar		06 Red n/c	
HC Hard Black Caster		07 Blue n/c	
05 Black Chadwick Fabric		Silver Monofilament:	<u>Optional Features:</u>
		Code: Desc: Upcharge:	<ul style="list-style-type: none"> Fixed arms with spring-loaded armpad Height and width adjustable arms with spring-loaded armpads Adjustable lumbar support magnetically attaches anywhere on the mesh chair back
		08 Jade \$16	
		09 Platinum \$16	

pattern no.	list
33-NA-2-BK-B-S-X-HC#	\$964.
33-FA-2-BK-B-S-X-HC#	1,029.
33-AA-2-BK-B-S-X-HC#	1,099.
L	78.
TA	n/c
SC	40.
GL	n/c
33LUMBAR	78.

Options

L - For lumbar, replace X with L in the pattern number. Add \$78 to list price

Note:
To order a lumbar separately, use pattern number 33LUMBAR. The list price is \$78.

TA - For Tall Adjustable Arm, replace AA with TA in the pattern number. The tall arm is 3/4" higher than the standard adjustable arm.

SC - For soft casters, replace HC with SC in the pattern number, and add \$37 to the list price.

For Silver Monofilament Color Option 08-Jade and 09-Platinum add \$16 to list price.

GL - For glides, replace HC with GL in the pattern number.

Lumbar detail

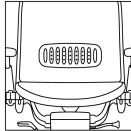

Tall Arm detail

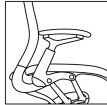

Glide detail



Chadwick™ Chair

Construction Information

Features and Benefits



Standard Features	Benefits
Active Suspension™ includes: 1. Responsive synchronized control and tilt tension	The synchronized control and tilt tension allow the user's torso to open up, promoting healthful circulation and creating a ride that is characterized by a cradled feeling that keeps the user's back in contact with the chair.
2. Resilient, breathable seat and back suspension fabric	Fabric provides inherent, energizing support all day long, conforming to the user's shape and minimizing pressure points. The open weave provides aeration.
Forward Pitch: the recline arch automatically includes a forward pitch	Chadwick offers forward support while typing without requiring any additional adjustments.
Variable Seat Depth: Chadwick's seat depth expands from 16.9" to 19.4" while reclining in the chair	Fits a multitude of users comfortably.
Generous Lumbar Curvature	Chadwick's ample lumbar curvature and tensioning in the back suspension area obviate the need for an additional lumbar pillow or attachment.
Flexing Arm Pads on Fixed and Adjustable Arms	Suspended design and shape allows the arm pads to flex for additional softness to alleviate pressure points on the wrists.
2 Adjustments: Tension Knob and Seat Height	With so much built in, Chadwick only needs two adjustments. They are highly obvious and virtually effortless to operate.

Optional Features	Benefits
Tilt Stop Control	Limits the recline in the upright position to 5 degrees.
Adjustable Arms: include soft suspension arm pads and width adjustment	Quickly adjusts with a single hand to fit multiple users. Width adjustment can be accomplished with 3/32" Allen wrench.
Adjustable Lumbar	Magnetic for easy installation, the additional lumbar provides a maximum range of adjustability.

To view fabrics online, refer to the Knoll Surface Library at knoll.com (go to the menu bar and click on "Products" and click on "Surface Library").

Care:
Frequent vacuuming or light brushing to remove dust and grime is recommended. Spot clean, with a mild upholstery shampoo or the foam from a mild detergent. When using a cleaning product, follow instructions carefully and clean only in a well-ventilated room. Avoid any product that contains carbon tetrachloride or other toxic materials. With any method, pretest a small area before proceeding. Use a professional furniture cleaning service when an overall soiled conditioned has been reached, or call Knoll Field Service at 800-445-5045 with questions.

Cleaning code
W or **W-S**.

Environmental:
GREENGUARD™-certified. Helps customers meet U.S. Green Building Council's LEED® requirements.

Construction:
Back
Frame
Integrally-colored glass filled nylon

Chadwick Fabric
Polyester monofilament warp with multifilament fill fibers

Seat
Frame
Integrally-colored glass filled nylon

Chadwick Fabric
Polyester monofilament warp with multifilament fill fibers

Soft Edge
Polyurethane foam

Arms
Fixed/Adjustable Arm Pads
Urethane armpad with flexible spring steel insert

Fixed/Adjustable Arm Supports
Integrally-colored glass filled nylon

Optional
Lumbar Support

Base & Casters*Base*

Integrally-colored glass filled nylon

Casters and Glides

Integrally-colored nylon

Soft Casters

Integrally-colored urethane covered nylon

Cylinder

Gas-activated steel seat height mechanism with steel tube (contains nitrogen)

Control

Control housing-aluminum casting and ABS top cover
Component parts-steel, rubber and engineered plastics

Optional Lumbar

Neodymium magnets, polypropylene carrier, TPE pad and back frame

Durability

10 year multi-shift warranty

Includes mesh Chadwick

The Chadwick™ Chair Dimensions and Operating Instructions

Operating Instructions also available online at www.knoll.com

Seat

	Seat Height	Seat Depth (Adjustable)	Seat Width	Seat Pan Angle in Degrees
Chadwick complies with the BIFMA G1-2002 Ergonomic Standard.				
BIFMA G1 Requirement	15" - 19.9"*	16.9" or less if fixed and must include 16.9" if adjustable	18" min.	0° - 4°**
Chadwick	15" - 21.6"*	16.9" in upright position 16.9" - 19.4" full range includes the reclined position	19.6"	-5° - +7°

Back

	Backrest Height	Backrest Width	Lumbar Support Location	Angle between Seat and Back in Degrees	Tilt Range of Back
BIFMA G1 Requirement	12.2" min.	14.2" min.	5.9" - 9.8"***	90° - 115°	10° min.
Chadwick	22.8"	18.5"	9" adjustable lumbar exceeds 5.9" - 9.9"	98.3°	29°

Armrests

Armrest Height (Fixed)	Armrest Height (Adjustable)	Inside Distance between Armrest
7.9" - 9.8"	6.9" - 10.8"	18" min.
8.5"	6.9" - 9.4" (std) 8.3" - 10.8" (tall arm)	18.5" - 20.5"

*Range achieved with single cylinder, or combination of cylinders. Chadwick standard cylinder is 15.9" - 20", high cylinder is 16.9" - 21.6", low cylinder is 15" - 19.1"

Adjustable: Include part of 0° to +4° *Adjustable: Includes part of 5.9" - 9.8"

A overall height	37.5" - 42"
B overall width	26.5"
C overall depth	25.5"
D adjustable arm height (from floor)	23" - 30"
fixed arm height (from floor) w/standard cylinder	25.3" - 29.8"
E adj. arm height (from seat reference point)	6.9" - 9.4" (std)
fixed arm height (from seat reference point)	8.3" - 10.8" (tall arm)
	8.5"
F recline range / ratio seat:back	94° - 123°/1 : 1.2°
G base diameter	27.3"
weight	36 lbs.

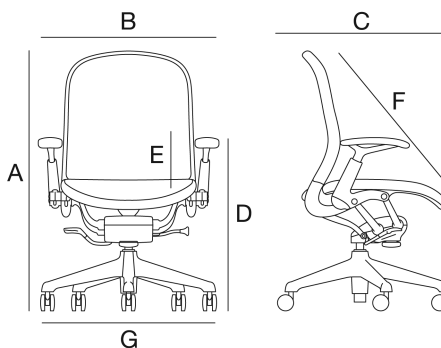

Arm Options

	Arm height (from the seat pan)	Distance between Arm supports	Distance between Armpads	Armpad Movement Width
Fixed Arms	8.5"	21"	19.5"	NA
Adjustable Arms (Height and Width Adjustable)	6.9" - 9.4" (std) 8.3" - 10.8" (tall arm)	20.5"	18.5" - 20.5" (inward to outward)	1" per arm 2" total range

Optional Adjustable Lumbar

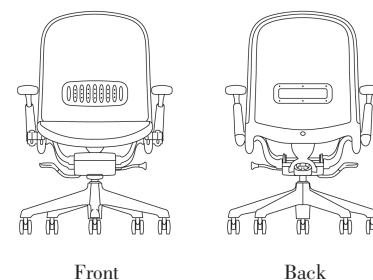

Chadwick Operating Instructions

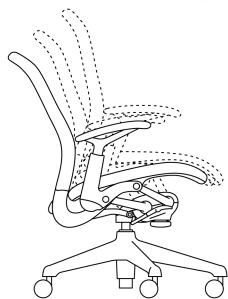

Synchronized Recline with Tilt Tension

Chadwick has a synchronized recline that allows the torso to open up while reclining. To customize the tension of the recline, adjust the tension knob. To decrease the tension, turn the tension knob clockwise (while seated in the chair), and turn it counterclockwise to increase the tension. The underside of the knob also indicates the instructions with arrows.

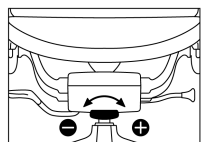

Front View

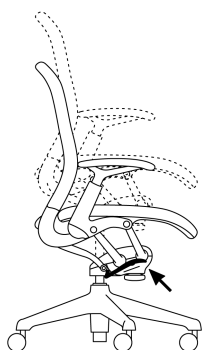

Seat Height Adjustment

To raise the seat height, remove your weight from the chair while lifting the lever on the right side of the chair. To lower the seat height, lift the lever while sitting in the chair.

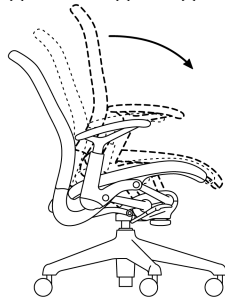

Forward Tilt

Chadwick has a built-in forward tilt that automatically follows and supports the user in the forward posture for typing. No adjustment is required.

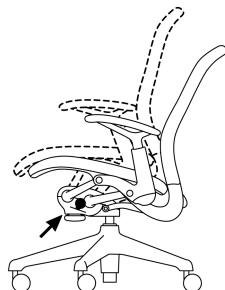

Tilt Stop (Option)

The tilt stop is an upright tilt limiter. When specified, it is the lever on the left side of the chair. If your chair does not have a lever on the left side of the chair, it does not have this feature. The in-and-out lever design operates with an audible click, whereby "out" is engaged, "in" is not engaged.

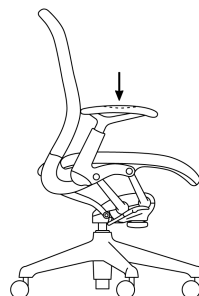

Spring Loaded Arms

Both fixed and adjustable arm pads have a spring suspension, which provides the user with arm pad softness and flexibility.

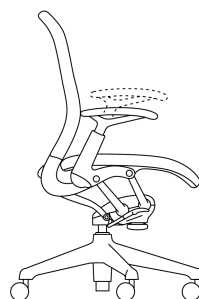

Adjustable Arm Height (Option)

The arm height is adjusted by lifting the arm pads upward. No lever is required. Simply move the arms up in five, $\frac{1}{2}$ " increments for a total of $2\frac{1}{2}$ ". To lower the arms, lift them to the highest point and at the highest point pull up firmly; and they will return to the lowest point. The arm height adjustment is easy to maneuver with one hand.

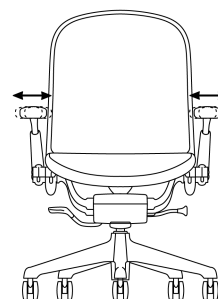

Adjustable Arm Width (Option)

The arm pads have a width adjustment of $\frac{1}{2}$ " inward or $\frac{1}{2}$ " outward for 1" in total adjustability on each side. A $\frac{5}{32}$ " Allen wrench is required to adjust the arm pad width.

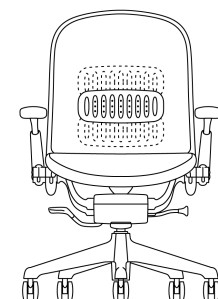

Adjustable Lumbar (Option)

Chadwick has an adjustable lumbar support, if needed. It is secured to the chair with magnets for easy installation and a maximum range of adjustability.

Separate both halves of the lumbar support and place them in the desired position on your chair. Secure the support by putting both halves together around the back suspension fabric of the chair.

Adjust the lumbar by sliding the lumbar pad up and down the back of the chair.

Note: Contains magnets. Consult the Knoll lumbar support hangtag for more information.

The Bulldog Chair

executive chairs

pattern no.	description	seat h	seat h	arm h	arm h	overall	overall	overall	overall
		min	max	min	max	w, min	d, min	h min	h max
7A3-1-A5G-H	armchair, Advanced control Advanced = Synchronized tilt, 4" back height, forward tilt, tilt lock, variable position tilt stop, pneumatic seat height, 360 degree swivel. heavy duty spring	16"	21"	23 3/4"	28 3/4"	25 1/2"	21 1/4"	36"	45"
7C3-1-A5G-H	armless version Advanced = Synchronized tilt, 4" back height, forward tilt, tilt lock, variable position tilt stop, pneumatic seat height, 360 degree swivel. heavy duty spring	16"	21"			21"	21 1/4"	36"	45"
7A3-1-B5G-H	armchair, Basic 2 control Basic 2 = Synchronized tilt, 4" back height, tilt lock, variable position tilt stop, pneumatic seat height, 360 degree swivel. heavy duty spring	16"	21"	23 3/4"	28 3/4"	25 1/2"	21 1/4"	36"	45"
7C3-1-B5G-H	armless version Basic 2 = Synchronized tilt, 4" back height, tilt lock, variable position tilt stop, pneumatic seat height, 360 degree swivel. heavy duty spring	16"	21"			21"	21 1/4"	36"	45"
7RS3	replacement seat								
7RB3	replacement back								
U	upholstered outer back shell (insert U after 7A or 7C in pattern number)								
C	Cal 133 (add C after pattern number and add "133" after upholstery code) Not available on upholstered back chairs.								



Order Code	Ordering Information	Options
<i>Example:</i> 7A3-1-B5G-H-K721/18	<i>Specify:</i>	<i>Code: Upchg: Description:</i>
7A3 Bulldog executive armchair	1. Pattern number with finish color code	K \$106 sliding seat, substitute
1 dark grey finish	2. Upholstery selection with color	H n/c high seat height
B5G Basic 2 control	List prices shown include fabric or leather upholstery. Contact your Knoll representative for colors.	P \$225 high performance arms with soft arm pads, substitute 7P for 7A
H 2" dual, hooded hard-wheel casters	<i>Finish colors:</i>	E \$184 anti-static chair, substitute E for G in pattern number. Cannot be specified with sliding seat feature.
K721/18 Rochelle/regal	Dark grey (code 1)	L n/c low seat height cylinder option (14 1/8" - 19 7/16"), substitute L for 5. Not available on Basic 1 model.
<i>Example for Cal 133:</i>	<i>COM/COL ordering information:</i>	R \$46 soft caster for hardwood floors, substitute R for H
7A3-1-B5G-H-C-K721/18-133	See Fabric Application and Selling Policy sections of the Price List.	G n/c glides, substitute G for H at the end of pattern number. Example: 7A5-1-A5G-G)

For additional Controls and Options information See page 92.

pattern no.	grades A	COM B	C	D	E	F	G	H	I	T	COL U	V	W	X	Y
7A3-1-A5G-H	\$1,431.	\$1,493.	\$1,556.	\$1,600.	\$1,642.	\$1,677.	\$1,718.	\$1,817.	\$1,999.	\$2,168.	\$2,259.	\$2,403.	\$2,874.	\$2,937.	\$2,962.
7C3-1-A5G-H	1,328.	1,390.	1,453.	1,497.	1,538.	1,573.	1,614.	1,712.	1,896.	2,065.	2,157.	2,299.	2,768.	2,834.	2,857.
7A3-1-B5G-H	1,335.	1,395.	1,458.	1,504.	1,543.	1,579.	1,620.	1,719.	1,901.	2,072.	2,163.	2,306.	2,775.	2,841.	2,861.
7C3-1-B5G-H	1,229.	1,291.	1,354.	1,399.	1,439.	1,476.	1,515.	1,615.	1,798.	1,968.	2,058.	2,201.	2,671.	2,736.	2,760.
7RS3	321.	346.	372.	390.	408.	422.	439.	481.	558.	937.	977.	1,046.	1,406.	1,535.	1,590.
7RB3	272.	296.	323.	340.	360.	375.	390.	433.	509.	877.	928.	996.	1,359.	1,484.	1,540.
U	175.	200.	224.	242.	257.	272.	290.	327.	400.	465.	465.	521.	694.	718.	729.
C	71.	71.	71.	71.	71.	71.	71.	71.	71.	99.	99.	99.	99.	99.	99.

Construction

See page 92.

High Performance Arm

arm height/width, pad rotation/slide

COM/COL Textile Requirement*Split upholstery option:*

Bulldog Executive Chair seats and backs can be upholstered in any two approved KnollTextiles or Spinneybeck upholsteries. To specify, first indicate the seat upholstery (labeled "seat upholstery") and then indicate the back upholstery (labeled "back upholstery"). The list price of the chair equals the list price of the higher of the two upholstery grades.

Cal 133:

‡ = Cal 133 upholstery available. See textile matrix at the beginning of the Price List for pre-approved Cal 133 textiles.

See KnollNow! price list for Cal 133 KnollNow! options.





	<i>fabric yds.</i>	<i>leather sq. ft.</i>
chair	2.3	35
outer back shell upholstered	0.9	13
leather standard adjustable arm pads		8

KnollTextiles and Spinneybeck Leathers

Please refer to the matrices at the beginning of the price list for Approved Textiles and Leathers.

The Bulldog Chair

management chairs

pattern no.	description	seat h	seat h	arm h	arm h	overall	overall	overall	overall
		min	max	min	max	w, min	d, min	h min	h max
7A1-1-A5G-H	armchair, Advanced control  Advanced = Synchronized tilt, 4" back height, forward tilt, tilt lock, variable position tilt stop, pneumatic seat height, 360 degree swivel	16"	21"	23 3/4"	28 3/4"	25 1/2"	21 1/4"	30"	39"
7C1-1-A5G-H	armless version  Advanced = Synchronized tilt, 4" back height, forward tilt, tilt lock, variable position tilt stop, pneumatic seat height, 360 degree swivel.	16"	21"			1"	21 1/4"	30"	39"
7A1-1-B5G-H	armchair, Basic 2 control  Basic 2 = Synchronized tilt, 4" back height, tilt lock, variable position tilt stop, pneumatic seat height, 360 degree swivel	16"	21"	23 3/4"	28 3/4"	25 1/2"	21 1/4"	30"	39"
7C1-1-B5G-H	armless version  Basic 2 = Synchronized tilt, 4" back height, tilt lock, variable position tilt stop, pneumatic seat height, 360 degree swivel.	16"	21"			21"	21 1/4"	30"	39"
7RS3	seat reupholstery assembly								
7RB1	back reupholstery assembly								
U	upholstered outer back shell (insert U after 7A or 7C in pattern number)								
C	Cal 133 (add C after pattern number and add "133" after upholstery code) Not available on upholstered back chairs.								



Order Code	Ordering Information	Controls and Options
<i>Example:</i> 7A1-1-B5G-H-K722/2	<i>Specify:</i>	<i>Code: Upchg: Description:</i>
7A1 Bulldog management armchair	1. Pattern number with finish color code 2. Upholstery selection with color	K \$106 sliding seat, substitute K for G Example: 7A1-1-A5 K -H
1 dark grey finish	List prices shown include fabric or leather upholstery. Contact your Knoll representative for colors.	P \$225 high performance arms with soft arm pads, substitute 7P for 7A
B5G Basic 2 control	<i>Finish colors:</i> Dark grey (code 1)	HD \$11 heavy duty spring option, insert HD after A or B
H 2" dual, hooded hard-wheel casters	<i>COM/COL ordering information:</i> See the Fabric Application and Selling Policy sections of the Price List.	L n/c low seat height cylinder option (14 1/2" - 19 7/16"), substitute L for 5. Not available on Basic 1 model.
K721/18 Rochelle/regal		HD \$11 heavy duty spring option, insert HD after A or B
<i>Example for Cal 133:</i> 7A1-1-B5G-H-C-K721/18-133		E \$184 anti-static chair, substitute E for G. Cannot be specified with sliding seat feature.
		R \$46 soft caster for hardwood floors, substitute R for H
		G n/c glides, substitute G for H at the end of pattern number. Example: 7A5-1-A5G-G)

For additional Controls and Options information See page 92.

pattern no.	grades A	COM B	C	D	E	F	G	H	I	T	COL U	V	W	X	Y
7A1-1-A5G-H	\$1,200.	\$1,249.	\$1,299.	\$1,334.	\$1,366.	\$1,393.	\$1,424.	\$1,503.	\$1,646.	\$1,869.	\$1,949.	\$2,076.	\$2,492.	\$2,550.	\$2,570.
7C1-1-A5G-H	1,096.	1,145.	1,194.	1,228.	1,262.	1,288.	1,319.	1,398.	1,542.	1,764.	1,844.	1,971.	2,390.	2,445.	2,466.
7A1-1-B5G-H	1,101.	1,149.	1,200.	1,233.	1,266.	1,294.	1,327.	1,402.	1,548.	1,770.	1,849.	1,978.	2,395.	2,451.	2,472.
7C1-1-B5G-H	997.	1,046.	1,096.	1,130.	1,163.	1,190.	1,223.	1,300.	1,445.	1,667.	1,747.	1,874.	2,289.	2,347.	2,367.
7RS3	321.	346.	372.	390.	408.	422.	439.	481.	558.	937.	977.	1,046.	1,406.	1,535.	1,590.
7RB1	235.	260.	286.	304.	323.	337.	353.	395.	473.	851.	890.	960.	1,321.	1,450.	1,504.
U	118.	138.	156.	171.	181.	195.	205.	236.	291.	373.	373.	418.	565.	587.	595.
C	71.	71.	71.	71.	71.	71.	71.	71.	71.	99.	99.	99.	99.	99.	99.

Construction

See page 92.

High Performance Arm

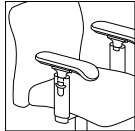

arm height/width, pad rotation/slide

COM/COL Textile Requirement

Split upholstery option:
Bulldog Management Chair seats and backs can be upholstered in any two approved KnollTextiles or Spinneybeck upholsteries. To specify, first indicate the seat upholstery (labeled "seat upholstery") and then indicate the back upholstery (labeled "back upholstery"). The list price of the chair equals the list price of the higher of the two upholstery grades.

	fabric yds.	leather sq. ft.
chair	1.8	31
outer back shell upholstered	0.7	11
leather standard adjustable arm pads		8

KnollTextiles and Spinneybeck Leathers





Please refer to the matrices at the beginning of the price list for Approved Textiles and Leathers.

Cal 133:
▲ = Cal 133 upholstery available. See textile matrix at the beginning of the Price List for pre-approved Cal 133 textiles.

See KnollNow! price list for Cal 133 KnollNow! options.

The Bulldog Chair

operational chairs

pattern no.	description	seat h min	seat h max	arm h min	arm h max	overall w, min	overall d, min	overall h min	overall h max
7A4-1-A5G-H	armchair, Advanced control Advanced = Synchronized tilt, 4" back height, forward tilt, tilt lock, variable position tilt stop, pneumatic seat height, 360 degree swivel.	16"	21"	24"	29"	23 1/2"	21 1/4"	31 3/4"	40 3/4"
									
7C4-1-A5G-H	armless version Advanced = Synchronized tilt, 4" back height, forward tilt, tilt lock, variable position tilt stop, pneumatic seat height, 360 degree swivel.	16"	21"			20"	21 1/4"	31 3/4"	40 3/4"
									
7A4-1-B5G-H	armchair, Basic 2 control Basic 2 = Synchronized tilt, 4" back height, tilt lock, variable position tilt stop, pneumatic seat height, 360 degree swivel.	16"	21"	24"	29"	23 1/2"	21 1/4"	31 3/4"	40 3/4"
									
7C4-1-B5G-H	armless version Basic 2 = Synchronized tilt, 4" back height, tilt lock, variable position tilt stop, pneumatic seat height, 360 degree swivel.	16"	21"			20"	21 1/4"	31 3/4"	40 3/4"
									
7RS2	seat replacement								
7RB4	back replacement								
U	upholstered outer back shell (insert U after 7A or 7C in pattern number)								
C	Cal 133 (add C after pattern number and add "133" after upholstery code) Not available on upholstered back chairs.								



Order Code	Ordering Information	Options
<i>Example:</i> 7A4-1-A5G-H-K909/2	<i>Specify:</i>	<i>Code: Upchg: Description:</i>
7A4 Bulldog operational armchair	1. Pattern number with finish color code 2. Upholstery selection with color	K \$106 sliding seat, substitute K for G Example: 7A4-1-A5 K -H
1 dark grey finish	List prices shown include fabric or leather upholstery. Contact your Knoll representative for colors.	P \$225 high performance arms with soft arm pads, substitute 7P for 7A
A5G Advanced control	<i>Finish colors:</i> Dark grey (code 1)	HD \$11 heavy duty spring option, insert HD after A or B
H 2" dual, hooded hard-wheel casters	<i>COM/COL ordering information:</i> See Fabric Application and Selling Policy sections of the Price List.	L n/c low seat height cylinder option (14 1/2" - 19 7/16"), substitute L for 5. Not available on Basic 1 model.
K721/18 Rochelle/regal		HD \$11 heavy duty spring option, insert HD after A or B
<i>Example for Cal 133:</i> 7A4-1-A5G-H-C-K721/18-133		E \$184 anti-static chair, substitute E for G. Cannot be specified with sliding seat feature.
		R \$46 soft caster for hardwood floors, substitute R for H
		G n/c glides, substitute G for H at the end of pattern number. Example: 7A5-1-A5G-G)

For additional Controls and Options information See page 92.

pattern no.	grades A	COM B	C	D	E	F	G	H	I	T	COL U	V	W	X	Y
7A4-1-A5G-H	\$1,190.	\$1,239.	\$1,281.	\$1,310.	\$1,338.	\$1,360.	\$1,387.	\$1,453.	\$1,571.	\$1,789.	\$1,853.	\$1,948.	\$2,298.	\$2,346.	\$2,363.
7C4-1-A5G-H	1,088.	1,135.	1,177.	1,207.	1,233.	1,255.	1,282.	1,347.	1,465.	1,686.	1,749.	1,843.	2,194.	2,243.	2,258.
7A4-1-B5G-H	1,093.	1,140.	1,182.	1,213.	1,239.	1,262.	1,288.	1,353.	1,474.	1,681.	1,744.	1,848.	2,199.	2,248.	2,265.
7C4-1-B5G-H	989.	1,036.	1,077.	1,108.	1,135.	1,157.	1,185.	1,250.	1,369.	1,575.	1,638.	1,746.	2,094.	2,144.	2,162.
7RS2	283.	308.	333.	352.	369.	384.	403.	444.	520.	652.	686.	746.	915.	963.	970.
7RB4	171.	197.	222.	241.	258.	274.	291.	332.	408.	545.	574.	635.	804.	852.	858.
U	103.	121.	140.	155.	167.	177.	191.	219.	276.	359.	359.	404.	548.	571.	577.
C	71.	71.	71.	71.	71.	71.	71.	71.	71.	99.	99.	99.	99.	99.	99.

Construction

See page 92.

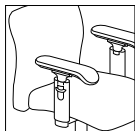
High Performance Arm

arm height/width, pad rotation/slide

COM/COL Textile Requirement*Split upholstery option:*

Bulldog Operational Chair seats and backs can be upholstered in any two approved KnollTextiles or Spinneybeck upholsteries. To specify, first indicate the seat upholstery (labeled "seat upholstery") and then indicate the back upholstery (labeled "back upholstery"). The list price of the chair equals the list price of the higher of the two upholstery grades.

Cal 133:

▲ = Cal 133 upholstery available. See textile matrix at the beginning of the Price List for pre-approved Cal 133 textiles.

See KnollNow! price list for Cal 133 KnollNow! options.

	<i>fabric</i> yds.	<i>leather</i> sq. ft.
chair	1.5	26
outer back shell upholstered	0.7	11
leather standard adjustable arm pads		8

KnollTextiles and Spinneybeck Leathers

Please refer to the matrices at the beginning of the price list for Approved Textiles and Leathers.

The Bulldog Chair

high task chairs

pattern no.	description	seat h	seat h	arm h	arm h	overall	overall	overall	overall
		min	max	min	max	w, min	d, min	h min	h max
7A5-1-A5G-H	armchair, Advanced control Advanced = Synchronized tilt, 4" back height, forward tilt, tilt lock, variable position tilt stop, pneumatic seat height, 360 degree swivel, pneumatic footrest.	22 1/2"	32 1/2"	30 1/4"	40 1/4"	23 1/2"	20 1/2"	36 1/2"	51"
7C5-1-A5G-H	armless version Advanced = Synchronized tilt, 4" back height, forward tilt, tilt lock, variable position tilt stop, pneumatic seat height, 360 degree swivel, pneumatic footrest.	22 1/2"	32 1/2"			20"	20 1/2"	36 1/2"	51"
7A5-1-B5G-H	armchair, Basic 2 control Basic 2 = Synchronized tilt, 4" back height, tilt lock, variable position tilt stop, pneumatic seat height, 360 degree swivel, pneumatic footrest.	22 1/2"	32 1/2"	30 1/4"	40 1/4"	23 1/2"	20 1/2"	36 1/2"	51"
7C5-1-B5G-H	armless version Basic 2 = Synchronized tilt, 4" back height, tilt lock, variable position tilt stop, pneumatic seat height, 360 degree swivel, pneumatic footrest.	22 1/2"	32 1/2"			20"	20 1/2"	36 1/2"	51"
7RS2	seat reupholstery assembly								
7RB4	back reupholstery assembly								
U	upholstered outer shell (insert U after 7A or 7C in pattern number)								
C	Cal 133 (add C after pattern number and add "133" after upholstery code) Not available on upholstered back chairs.								



Order Code	Ordering Information	Options
<i>Example:</i> 7C5-1-B5G-H-K721/18	<i>Specify:</i>	<i>Code: Upchg: Description:</i>
7C5 Bulldog high task armless chair	1. Pattern number with finish color code	P \$225 high performance arms with soft arm pads, substitute 7P for 7A
1 dark grey finish	2. Upholstery selection with color	E \$184 anti-static chair, substitute E for G in pattern number. Cannot be specified with sliding seat feature.
B5G Basic 2 control	List prices shown include fabric or leather upholstery. Contact your Knoll representative for colors.	R \$46 soft caster for hardwood floors, substitute R for H
H 2" dual, hooded hard-wheel casters	<i>Finish colors:</i> Dark grey (code 1)	G n/c glides, substitute G for H at the end of pattern number. Example: 7A5-1-A5G-G)
K721/18 Rochelle/regal	<i>COM/COL ordering information:</i> See Fabric Application and Selling Policy sections of the Price List.	
<i>Example for Cal 133:</i> 7C5-1-B5G-H-C-K721/18-133		

For additional Controls and Options information See page 92.

pattern no.	grades A	COM B	C	D	E	F	G	H	I	T	COL U	V	W	X	Y
7A5-1-A5G-H	\$1,634.	\$1,677.	\$1,720.	\$1,752.	\$1,780.	\$1,804.	\$1,834.	\$1,901.	\$2,029.	\$2,251.	\$2,314.	\$2,427.	\$2,797.	\$2,850.	\$2,865.
7C5-1-A5G-H	1,532.	1,573.	1,616.	1,649.	1,675.	1,701.	1,729.	1,798.	1,924.	2,146.	2,209.	2,322.	2,692.	2,745.	2,763.
7A5-1-B5G-H	1,537.	1,579.	1,623.	1,654.	1,682.	1,707.	1,734.	1,803.	1,931.	2,152.	2,217.	2,327.	2,698.	2,751.	2,768.
7C5-1-B5G-H	1,432.	1,476.	1,517.	1,549.	1,578.	1,601.	1,630.	1,700.	1,828.	2,050.	2,112.	2,224.	2,594.	2,648.	2,664.
7RS2	283.	308.	333.	352.	369.	384.	403.	444.	520.	652.	686.	746.	915.	963.	970.
7RB4	171.	197.	222.	241.	258.	274.	291.	332.	408.	545.	574.	635.	804.	852.	858.
U	103.	121.	140.	155.	167.	177.	191.	219.	276.	359.	359.	404.	548.	571.	577.
C	71.	71.	71.	71.	71.	71.	71.	71.	71.	99.	99.	99.	99.	99.	99.

Construction

See page 92.

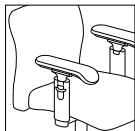
High Performance Arm

arm height/width, pad rotation/slide

COM/COL Textile Requirement*Split upholstery option:*

Bulldog High Task Chair seats and backs can be upholstered in any two approved KnollTextiles or Spinneybeck upholsteries. To specify, first indicate the seat upholstery (labeled "seat upholstery") and then indicate the back upholstery (labeled "back upholstery"). The list price of the chair equals the list price of the higher of the two upholstery grades.

Cal 133:

‡ = Cal 133 upholstery available. See textile matrix at the beginning of the Price List for pre-approved Cal 133 textiles.

See KnollNow! price list for Cal 133 KnollNow! options.



	fabric yds.	leather sq. ft.
chair	1.5	26
outer back shell	0.7	11
upholstered		8
leather		
standard		
adjustable		
armpads		

KnollTextiles and Spinneybeck Leathers

Please refer to the matrices at the beginning of the price list for Approved Textiles and Leathers.

The Bulldog Chair

side chairs

	pattern no.	description	seat h	arm h	w	d	h
Designer(s): Dale Fahnstrom and Michael McCoy Award(s): IDEA Bronze Annual Design Award, 1991; Outstanding Performance, Product Design Achievement Award, IBD Southern California Chapter, 1990; IFMA and Facilities Design&Management Gold Award, 1990; IBD Product Design Bronze Award, 1990	7A8-1-SL	armchair, painted frame	17 1/2"	25 1/8"	25 1/4"	23"	31 1/4"
							
	7C8-1-SL	armless chair, painted frame	17 1/2"		21"	23"	31 1/4"
							
	U	upholstered outer shell (insert U after 7A or 7C in pattern number)					
	C	Cal 133 (add C after pattern number) not available on upholstered back chairs Note: When specifying Cal 133 add "133" after upholstery code * additional for Textiles					



Order Code

Example: **7A8-1-SL-HC1009/7**

7A8 Bulldog side armchair

1 dark grey finish

SL sled base

HC1009/7 Sequin CR/ Array

Example for Cal 133:

7A8-1-SL-C-K909/2-133

Ordering Information

Specify:

1. Pattern number with finish color code
2. Upholstery selection with color

List prices shown include fabric or leather upholstery. Contact your Knoll representative for colors.

Finish colors:

Dark grey (code 1)

COM/COL ordering information:
See Fabric Application and Selling Policy sections of the Price List.

Controls and Options

See page 92.

Construction

See page 92.

pattern no.	grades		COM							COL						
	A	B	C	D	E	F	G	H	I	T	U	V	W	X	Y	
7A8-1-SL	\$635.	\$669.	\$707.	\$732.	\$753.	\$774.	\$798.	\$853.	\$960.	\$1,066.	\$1,106.	\$1,190.	\$1,402.	\$1,433.	\$1,445.	
7C8-1-SL	582.	618.	654.	679.	703.	722.	744.	801.	907.	1,015.	1,054.	1,137.	1,350.	1,381.	1,393.	
U	110.	137.	166.	187.	205.	222.	241.	286.	369.							
C*	71.	71.	71.	71.	71.	71.	71.	71.	71.							

COM/COL Textile Requirement

KnollTextiles and Spinneybeck Leathers

	<i>fabric</i> yds.	<i>leather</i> sq. ft.
chair	1.3	17
outer back shell	1.0	

Please refer to the matrices at the beginning of the price list for Approved Textiles and Leathers.

Cal 133:
 ‡= Cal 133 upholstery available. See textile matrix at the beginning of the Price List for pre-approved Cal 133 textiles.

See KnollNow! price list for Cal 133 KnollNow! options.

Bulldog

Description of Controls, Options and Construction

For Executive, Management, Operational and High Task Chairs:

Executive Chairs, page 82



Management Chairs, page 84



Operational Chairs, page 86



High Task Chairs, page 88



Controls and Options

Advanced control:

360° swivel, synchronized tilt with tilt tension, forward tilt, variable position tilt stop, 4" back height and pneumatic seat height adjustments.

Basic 2 control:

360° swivel, synchronized tilt with tilt tension, tilt lock, variable position tilt stop, 4" back height and pneumatic seat height adjustments.

Sliding seat:

2 1/4" adjustment.

High performance arms:

Arm height adjusts 7" - 11" (4" total range) from the seat reference point. Arm support width adjusts 1 1/2" on each side (3" total range) via lever activation. Armpads rotate 42° (each arm) with locked positions in the rotation range. Armpads slide 1 1/2" forward via push button mechanism. Standard soft armpads.

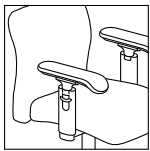

Heavy-Duty Spring:

The heavy duty spring adds approximately 30% more tension to the chair, especially benefiting individuals in the upper percentiles. Please be advised that tension will not be as loose on the low end of the range. The heavy-duty spring is standard on the Executive chair and available as an option in the Management and Operational chairs.

Construction

Outer back shell:

Integrally colored, textured polypropylene.

Internal seat/back support shell:

Glass-reinforced polypropylene.

Upholstery:

High resilient, variable density molded, urethane foam with textile cover; seat cover top-stitched.

Sliding seat:

Steel plate and glass-reinforced nylon and nylon GS components.

Note: Cannot be specified with closed loop arm option.

Arms supports:

Integrally colored, textured, glass-reinforced polyester supports.

High performance arm supports:

Integrally colored, textured, glass-reinforced nylon and all other engineered thermoplastics with zinc die-cast housing.

Soft armpad:

Self skinning urethane molded over steel substrate. Soft armpad is standard on high-performance arm.

Column cover:

Integrally colored, textured polypropylene.

Base:

Integrally colored, textured, glass-reinforced nylon. Five-star design.

Footrest:

Die cast support element with resilient thermoplastic cover. Pneumatic operation.

Casters:



Black, integrally colored, textured nylon; 2" dual, hooded hard- or soft-wheel design.

Glides:



Black, integrally colored, molded nylon; does not reduce height of chair. Substitute "G" for "H" in pattern number; e.g. 7A1-1-B5G-H becomes 7A1-1-B5G-G.

Bulldog Anti-Static Seating

The Bulldog Electro-Static Dissipation (ESD) seating provides a safe solution for areas that are sensitive to static electricity. The chair is built to ground the electrical charge via the fabric to the ground. Special conductive textile (listed below) must be specified on the Bulldog ESD chairs. There is no ESD Option on High Back Professional, Professional and Side Chairs.

For sample cards of the ESD textile color options, please fax your request to Textiles Distribution Center at 800-308-7765.

QK3753901	Bilberry
QK3753902	Mushroom
QK3753903	Red
QK3753904	Persian
QK3753905	Juniper
QK3753906	Pearl Grey
QK3753907	Bordeaux
QK3753908	Corinth
QK3753909	Evergreen
QK3753910	Anthracite
QK3753911	Nut
QK3753912	Twilight
QK3753913	Black

For Side Chairs:

**Side Chairs,
page 90**

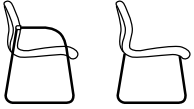

Construction

Outer shell:

Integrally colored, textured polypropylene.

Internal support shell:

Glass-reinforced polypropylene.

Upholstery:

High resilient, molded, urethane foam with top-stitched textile cover.

Frame:

16-gauge steel tube with textured epoxy powder coat paint.

Glides:

Black, integrally colored nylon.

Bulldog Dimensions and Operating Instructions

Seat

	Seat Height*	Seat Depth**	Seat Width	Seat Pan Angle	Seat Back/ Seat Pan Angle
ANSI HFS 100-1988, Compliance Code Standards:					
	16" - 20½"	15" - 17"	18.2" min.	0° - 10° fixed	90°-105° at rest
Executive	16" - 21"*	17½"	21"	2°	101°
Management	16" - 21"*	17½"	21"	2°	101°
Operational	16" - 21"	16⅓/16"	20"	2°	100°
High Task	22½" - 32½"	16⅓/16"	20"	2°	100°

Back

	Backrest	Lumbar Support Height	Lumbar Support Width	Seat Back Width
ANSI HFS 100-1988, Compliance Code Standards:				
	yes	6" - 9"	12" min.	12" min.
Executive	yes	5" - 9"	19"	22½"
Management	yes	5" - 9"	19"	22½"
Operational	yes	5" - 9"	16"	16"
Task	yes	5" - 9"	16"	16"
High Task	yes	5" - 9"	16"	16"

Armrests

Width Between Armrests	Width Between Std. Adjustable	Width Between High Perf. Arm
18.2" min.		
19"	17.5" - 18.5"	19" - 22"
19"	17.5" - 18.5"	19" - 22"
18½"	16.5" - 17.5"	18" - 21"
18½"	16.5" - 17.5"	18" - 21"
18½"	16.5" - 17.5"	18" - 21"

*Three seat height options are available. Medium is displayed above. Low is 14½" - 19⅓". High is 17" - 22". High Task is not included.

**Adjustable seat depth dimensions for Task or Operational are 16⅓/16" - 19⅓" and for Management or Executive are 17½" - 19½" (with back in lowest position).

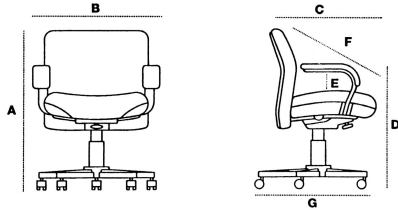

	Executive	Management	Operational	High Task	Side
A overall height	36" - 45"	30" - 39"	31⅓"-40⅓"	36½" - 51"	31⅓"
B overall width	25½"	25½"	23½"	23½"	25⅓"
C overall depth	21⅓"	21⅓"	21⅓"	20½"	23"
D arm height (from floor)	23⅓" - 28⅓"	23⅓" - 28⅓"	24" - 29"	30⅓"-40⅓"	25⅓"
E arm height (from seat ref. pt.)	8½"	8½"	8⅓"	8⅓"	7⅓"
F recline range	17.2°	17.2°	19°	19°	no recline
G base dimension	27" dia.	27" dia.	27" dia.	27" dia.	24" width
H weight (with fixed arms)	50 lbs.	47 lbs.	44 lbs.	52 lbs.	28 lbs.

(Measurements of arm chairs, advanced control with pneumatic seat height adjustment, in inches.)

Adjustable Arm Options:

High Performance Arms

Height
(from Seat Reference Point)

7" - 11" (4" range)

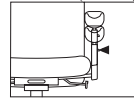

Width Between Arms

Oper. 18½" - 21½"
Mgt/Exec. 21" - 24"
(3" range for supports)
Distance between arm supports

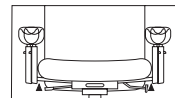

Rotation

42° total
(21° left, 21° right)
(fixed increment rotation)



Pad Slide

1½" forward



Retrofittable

Yes



Seat Height Adjustment

For pneumatic seat height chairs, lift the handle on the right to adjust height. If your chair does not have pneumatic seat height, it has mechanical seat height. To raise, rotate the seat counterclockwise and to lower, rotate the seat clockwise.

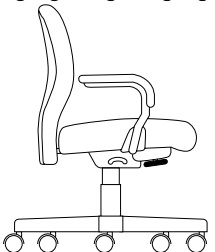

Tension Adjustment

Lean back and recline. Adjust tension if necessary. To adjust tension, reach under the front of the seat to find the knob. Turn left to tighten and right to loosen.

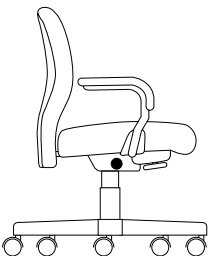

Tilt Lock

On the left side of the chair, push the circular knob in to lock and pull out to unlock the tilt.

Variable Tilt Stop

(on all models with tilt lock)

Using the same control as the tilt lock (see above), recline in the chair and push knob to set. This limits the amount of recline.

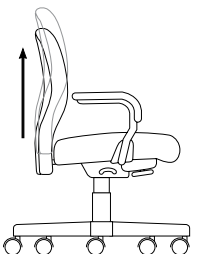

Back Height Adjustment

(2-piece chairs)

Place both hands on the base of the back and lift to raise the back height. The back height adjusts 8 notches upward for a total of 4" adjustability. The 9th notch brings the back down to the lowest position.

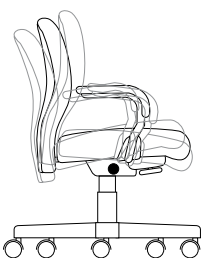

Forward Tilt

(optional)

Recline slightly and rotate the lever on the left side of the chair in a forward motion. Recline and rotate the same knob rearward to return to the original position.

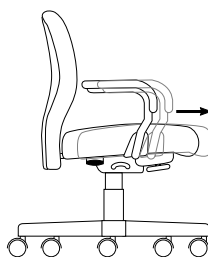

Sliding Seat Depth Adjustment

(optional)

Pull the lever located under the right side of the seat cushion to the rear of the arm. Slide the seat to the desired location. Release the lever in one of the six stops within the 2 1/4" range.

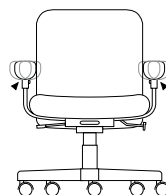

Armpad Width

Remove the two screws under the armpad with a screwdriver. Remount the armpads 1/2" right or left of center for 1" of adjustability. Reinsert the screws.

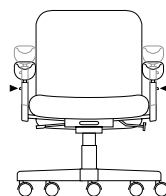

High Performance Arms

(optional):

Armpad Height

Lift the lever on the outside of the arm support for 4" of height adjustability.

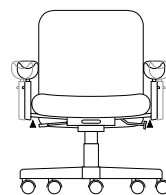

Arm Support Width

Lift the lever located beneath the arm support. Adjust the arm support to the desired width and tighten the lever by pushing it down. The arm supports can be adjusted 1 1/2" on each side for a total of 3" in width adjustment.

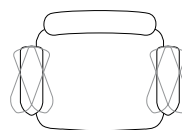

Armpad Rotation

Lift slightly and rotate the armpads 21° right or left of center for a total of 42° in adjustability.

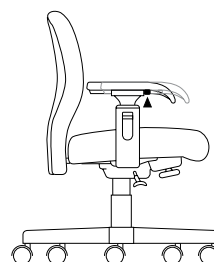

Armpad Slide

Press on the buttons located on either side of the armpad and slide the armpad to the desired position.

The RPM Chair

basic model

Designer(s):
Carl Magnusson, 2000



pattern no.	description	seat h min	seat h max	arm h min	arm h max	over- all w, min	over- all d, max	over- all h min	over- all h max		
8P4-2-A5GH	high performance arm, basic control Basic control: synchronized tilt, 4" back height, forward tilt, tilt lock (5 position), side-position tension knob, pneumatic seat height, 360° swivel, instructions attached to side of control	16 1/2"	21"	25"	33"	24 1/2"	26 1/2"	24"	24"	37 1/8"	45 3/8"
8A4-2-A5GH	fixed height arms, basic control Basic control: synchronized tilt, 4" back height, forward tilt, tilt lock (5 position), side-position tension knob, pneumatic seat height, 360° swivel, instructions attached to side of control	16 1/2"	21"	26"	30 1/2"	26 1/2"	26 1/2"	24"	24"	37 1/8"	45 3/8"
8C4-2-A5GH	armless, basic control Basic control: synchronized tilt, 4" back height, forward tilt, tilt lock (5 position), side-position tension knob, pneumatic seat height, 360° swivel, instructions attached to side of control	16 1/2"	21"			20"	20"	24"	24"	37 1/8"	45 3/8"
8RSEAT	Replacement seat										
8RBACK	Replacement back, prior to 11/01/2005										
8UPHBACK	Replacement back, after 11/01/2005										

Order Code	Ordering Information	Options
<i>Example:</i> 8A4-2-A5GH	<i>Specify:</i>	<i>Code: Upchg: Description:</i>
8A4	1. Pattern number with finish information	H n/c high seat cylinder option (18 3/4" - 23 3/4") (substitute H for 5 in pattern number)
2	2. Upholstery selection with color code	L n/c low seat cylinder option (15" - 17 3/4") (substitute L for 5 in pattern number)
A5G	List prices shown include fabric or upholstery. Contact your KnollTextile representative for colors. For RPM upholstery colors, order an RPM Upholstery card by faxing your request to 800-308-7765 or log on to www.exchange.knoll.com.	G n/c glides (substitute G for H at the end of pattern number. Example: 8A4-2-A5GG)
H	COM/COL ordering information: see page Fabric Application and Selling Policy sections of the Price List.	R \$45 soft caster for hardwood floors (substitute R for H in pattern number)
AC1	<i>Finish colors:</i> Black (code 2)	C \$118 CAL 133 (add C after pattern number and add "133" after upholstery code)
		<i>Back and J-Bar structure:</i> Glass-reinforced nylon, ABS and steel connector plate.
		<i>Cushions and upholstery:</i> Insert molded high resilient urethane foam. Back is permanently bonded to CFC free foam. RPM grade covers are knitted to fit the cushion.
		<i>Fixed height arms/high performance arms:</i> Integrally colored, textured glass-reinforced nylon.
		<i>Armpads:</i> Molded urethane and steel substructure.
		<i>Base:</i> Integrally colored, textured, glass-reinforced nylon.
		<i>Casters and glides:</i> Black, integrally colored, textured nylon.

Construction

Outer shells:
Integrally colored, textured polypropylene.

Seat structure:
Glass-reinforced nylon with steel connectors (for basic control, laminated plywood).

pattern no.	RPM grade	grades											COL		
		A	B	C	D	E	F	G	H	I	T	U	V	W	Y
8P4-2-A5GH	\$856.	\$974.	\$1,016.	\$1,063.	\$1,087.	\$1,116.	\$1,152.	\$1,205.	\$1,270.	\$1,304.	\$1,534.	\$1,612.	\$1,707.	\$2,297.	\$0.
8A4-2-A5GH	791.	910.	951.	997.	1,021.	1,051.	1,087.	1,140.	1,205.	1,241.	1,468.	1,548.	1,642.	2,233.	0.
8C4-2-A5GH	756.	874.	916.	963.	986.	1,016.	1,051.	1,104.	1,170.	1,205.	1,433.	1,512.	1,606.	2,196.	0.
8RSEAT	244.	357.	396.	441.	463.	491.	525.	575.	639.	672.	885.	964.	1,054.	1,616.	1,886.
8RBACK	252.	364.	404.	449.	471.	499.	534.	584.	646.	679.	893.	972.	1,062.	1,624.	1,920.
8UPHBACK	252.	364.	404.	449.	471.	499.	534.	584.	646.	679.	893.	972.	1,062.	1,624.	1,920.

RPM Grade Upholsteries

<i>Radial</i>		<i>Speedway</i>		<i>Tread</i>	
RAD6	Teal/Silver Leaf	SP2	Smoke	TR1	Black/Eggplant
RAD7	Midnight/Huckleberry	SP3	Steel Blue	TR2	ChocolateSmoke
RAD8	Black/Batik	SP5	Midnight	TR3	Cappuccino/Pebble Beige
RAD9	Black/Crimson	SP6	Crimson	TR4	Gourd/Tin
RAD10	Claret/Jute	SP7	Black	TR5	Chocolate/Steel Blue
RAD20	Chocolate/Palomino	SP10	Basil	TR6	Black/Midnight
RAD21	Prune/Ribbon	SP33	Wine	TR7	Smoke/Tin
RAD22	Spice/Jute	SP36	Chocolate		
RAD23	Cappuccino/Pebble Beige				
RAD24	Basil/Tin				
RAD25	Basil/Xanadu				
RAD26	Chocolate/Steel Blue				
RAD27	Black/Smoke				
RAD28	Smoke/Black				
RAD29	Smoke/Pebble Beige				

COM/COL Textile Requirement

	fabric yds.	leather sq. ft.
chair	1.4	25

Cal 133:

♣ = Cal 133 upholstery available. See textile matrix at the beginning of the Price List for pre-approved Cal 133 textiles.

Please see Fabric Application and Selling Policy sections of Price List for more information and instructions.

Knoll Textiles and Spinneybeck Leathers



Please refer to the matrices at the beginning of the price list for Approved Textiles and Leathers.

The RPM Chair

advanced model

Designer(s):
Carl Magnusson, 2000



pattern no.	description	seat h		arm h		over-all w,		over-all d,		over-all h	
		min	max	min	max	min	max	min	max	min	max
8P4-2-A5KH	high performance arm, advanced control (sliding seat pan)  Advanced control: synchronized tilt, 4" back height, sliding seat adjustment, forward tilt, tilt lock (5 position), side-position tension knob, pneumatic seat height, 360° swivel, instructions attached to side of control	16 1/2"	21"	25"	33"	24 1/2"	26 1/2"	22 1/2"	25 1/2"	37 1/8"	45 7/8"
8A4-2-A5KH	fixed height arms, advanced control (sliding seat pan)  Advanced control: synchronized tilt, 4" back height, sliding seat adjustment, forward tilt, tilt lock (5 position), side-position tension knob, pneumatic seat height, 360° swivel, instructions attached to side of control	16 1/2"	21"	26"	30 1/2"	26 1/2"	26 1/2"	22 1/2"	25 1/2"	37 1/8"	45 7/8"
8C4-2-A5KH	armless, advanced control, (sliding seat pan)  Advanced control: synchronized tilt, 4" back height, sliding seat adjustment, forward tilt, tilt lock (5 position), side-position tension knob, pneumatic seat height, 360° swivel, instructions attached to side of control	16 1/2"	21"			20 1/2"	20 1/2"	22 1/2"	25 1/2"	37 1/8"	45 7/8"
8RSEAT	Replacement seat										
8RBACK	Replacement back, prior to 11/01/2005										
8UPHBACK	Replacement back, after 11/01/2005										

Order Code	Ordering Information	Options	
<i>Example:</i> 8A4-2-A5KH	<i>Specify:</i>	<i>Code:</i> <i>Upchg:</i> <i>Description:</i>	<i>Back and J-Bar structure:</i>
8A4	Fixed arms, advanced control	H n/c high seat cylinder option (18 3/4" - 23 3/4") (substitute H for 5 in pattern number)	Glass-reinforced nylon, ABS and steel connector plate.
2	Black finish and black levers	L n/c low seat cylinder option (15" - 17 3/4") (substitute L for 5 in pattern number)	<i>Cushions and upholstery:</i> Insert molded high resilient urethane foam. Back is permanently bonded to CFC free foam. RPM grade covers are knitted to fit the cushion.
A5K	Advanced control with sliding seat	G n/c glides (substitute G for H at the end of pattern number. Example: 8A4-2-A5GG)	<i>Fixed height arms/high performance arms:</i> Integrally colored, textured glass-reinforced nylon.
H	Hard caster for carpet	R \$45 soft caster for hardwood floors (substitute R for H in pattern number)	<i>Armpads:</i> Molded urethane and steel substructure.
AC1	RPM upholstery Acceleration Black to Smoke	C \$118 CAL 133 (add C after pattern number and add "133" after upholstery code)	<i>Base:</i> Integrally colored, textured, glass-reinforced nylon. <i>Casters and glides:</i> Black, integrally colored, textured nylon.
	List prices shown include fabric or upholstery. Contact your KnollTextile representative for colors. For RPM upholstery colors, order an RPM Upholstery card by faxing your request to 800-308-7765 or log on to www.exchange.knoll.com.		
	COM/COL ordering information: see page Fabric Application and Selling Policy sections of the Price List.		
	<i>Finish colors:</i> Black (code 2)		

Construction

Outer shells:
Integrally colored, textured polypropylene.

Seat structure:
Glass-reinforced nylon with steel connectors (for basic control, laminated plywood).

pattern no.	RPM grade	grades											COL		
		A	B	C	D	E	F	G	H	I	T	U	V	W	Y
8P4-2-A5KH	\$889.	\$1,002.	\$1,040.	\$1,086.	\$1,108.	\$1,136.	\$1,170.	\$1,220.	\$1,282.	\$1,317.	\$1,530.	\$1,608.	\$1,698.	\$2,261.	\$0.
8A4-2-A5KH	827.	939.	979.	1,023.	1,046.	1,074.	1,108.	1,159.	1,220.	1,254.	1,467.	1,546.	1,637.	2,199.	0.
8C4-2-A5KH	792.	905.	945.	990.	1,012.	1,040.	1,074.	1,125.	1,187.	1,220.	1,434.	1,513.	1,603.	2,165.	0.
8RSEAT	244.	357.	396.	441.	463.	491.	525.	575.	639.	672.	885.	964.	1,054.	1,616.	1,886.
8RBACK	252.	364.	404.	449.	471.	499.	534.	584.	646.	679.	893.	972.	1,062.	1,624.	1,920.
8UPHBACK	252.	364.	404.	449.	471.	499.	534.	584.	646.	679.	893.	972.	1,062.	1,624.	1,920.

RPM Grade Upholsteries

<i>Radial</i>		<i>Speedway</i>	
RAD6	Teal/Silver Leaf	SP2	Smoke
RAD7	Midnight/Huckleberry	SP3	Steel Blue
RAD8	Black/Batik	SP5	Midnight
RAD9	Black/Crimson	SP6	Crimson
RAD10	Claret/Jute	SP7	Black
RAD20	Chocolate/Palomino	SP10	Basil
RAD21	Prune/Ribbon	SP33	Wine
RAD22	Spice/Jute	SP36	Chocolate
RAD23	Cappuccino/Pebble Beige		
RAD24	Basil/Tin	<i>Tread</i>	
RAD25	Basil/Xanadu	TR1	Black/Eggplant
RAD26	Chocolate/Steel Blue	TR2	ChocolateSmoke
RAD27	Black/Smoke	TR3	Cappuccino/Pebble Beige
RAD28	Smoke/Black	TR4	Gourd/Tin
RAD29	Smoke/Pebble Beige	TR5	Chocolate/Steel Blue
		TR6	Black/Midnight
		TR7	Smoke/Tin

COM/COL Textile Requirement

	fabric yds.	leather sq. ft.
chair	1.4	25

Cal 133:

♣ = Cal 133 upholstery available. See textile matrix at the beginning of the Price List for pre-approved Cal 133 textiles.

Please see Fabric Application and Selling Policy sections of Price List for more information and instructions.

KnollTextiles and Spinneybeck Leathers

Please refer to the matrices at the beginning of the Price List for Approved Textiles and Leathers.

The RPM Chair

high task chair

basic model

Designer(s):
Carl Magnusson, 2000



pattern no.	description	overall w, min	overall w, max	overall d, min	overall d, max
8P5-2-A5GH	high performance arm, basic control, mechanical height footring (9" - 18" height range) Basic control: synchronized tilt, 4" back height adjustment, forward tilt, tilt lock (5 position), side-position tension knob, pneumatic seat height, 360 degree swivel, instructions attached to side of control, mechanical height footring	24 1/2"	26 1/2"	24"	24"
8A5-2-A5GH	fixed height arms, basic control, mechanical height footring (9" - 18" height range) Basic control: synchronized tilt, 4" back height adjustment, forward tilt, tilt lock (5 position), side-position tension knob, pneumatic seat height, 360 degree swivel, instructions attached to side of control, mechanical height footring	26 1/2"	26 1/2"	24"	24"
8C5-2-A5GH	armless, basic control, mechanical height footring (9" - 18" height range) Basic control: synchronized tilt, 4" back height adjustment, forward tilt, tilt lock (5 position), side-position tension knob, pneumatic seat height, 360 degree swivel, instructions attached to side of control, mechanical height footring	20"	20"	24"	24"
8RSEAT	Replacement seat				
8RBACK	Replacement back, prior to 11/01/2005				
8UPHBACK	Replacement back, after 11/01/2005				

Order Code

<i>Example:</i>	8A5-2-A5GH
8A5	High task, footring
2	Black finish and black levers
A5G	Basic control
H	Hard caster for carpet
AC1	RPM upholstery Acceleration Black to Smoke

Ordering Information

Specify:

1. Pattern number with finish information
2. Upholstery selection with color code

List prices shown include fabric or upholstery. Contact your KnollTextile representative for colors. For RPM upholstery colors, order an RPM Upholstery card by faxing your request to 800-308-7765 or log on to www.exchange.knoll.com.

COM/COL ordering information: see page Fabric Application and Selling Policy sections of the Price List.

Finish colors:

Black finish (code 2)
and black levers

Options

Code:	Upchg:	Description:
G	n/c	glides (substitute G for H at the end of pattern number. Example: 8A4-2-A5GG)
R	\$45	soft caster for hardwood floors (substitute R for H in pattern number)
C	\$118	CAL 133 (add C after pattern number and add "133" after upholstery code)

Construction

Outer shells:
Integrally colored, textured polypropylene.

Seat structure:
Glass-reinforced nylon with steel connectors (for basic control, laminated plywood).

Back and J-Bar structure:
Glass-reinforced nylon, ABS and steel connector plate.

Cushions and upholstery:
Insert molded high resilient urethane foam. Back is permanently bonded to CFC free foam. RPM grade covers are knitted to fit the cushion.

Fixed height arms/high performance arms:
Integrally colored, textured glass-reinforced nylon.

Armpads:
Molded urethane and steel substructure.

Base:
Integrally colored, textured, glass-reinforced nylon.

Footring:
Steel chromed tubing, cast aluminum support spokes, rubber bushing with integrally colored nylon knob, mechanical operation.

Casters and glides:
Black, integrally colored, textured nylon.

pattern no.	RPM grade	grades											COL		
		A	B	C	D	E	F	G	H	I	T	U	V	W	Y
8P5-2-A5GH	\$1,103.	\$1,221.	\$1,264.	\$1,310.	\$1,333.	\$1,362.	\$1,400.	\$1,453.	\$1,517.	\$1,552.	\$1,780.	\$1,860.	\$1,953.	\$2,544.	\$2,855.
8A5-2-A5GH	1,039.	1,158.	1,198.	1,245.	1,269.	1,299.	1,333.	1,386.	1,453.	1,488.	1,716.	1,795.	1,890.	2,480.	2,793.
8C5-2-A5GH	1,004.	1,121.	1,163.	1,211.	1,234.	1,264.	1,299.	1,352.	1,416.	1,453.	1,681.	1,760.	1,854.	2,444.	2,764.
8RSEAT	244.	357.	396.	441.	463.	491.	525.	575.	639.	672.	885.	964.	1,054.	1,616.	1,886.
8RBACK	252.	364.	404.	449.	471.	499.	534.	584.	646.	679.	893.	972.	1,062.	1,624.	1,920.
8UPHBACK	252.	364.	404.	449.	471.	499.	534.	584.	646.	679.	893.	972.	1,062.	1,624.	1,920.

RPM Grade Upholsteries

<i>Radial</i>	<i>Speedway</i>	<i>Tread</i>
RAD6 Teal/Silver Leaf	SP2 Smoke	TR1 Black/Eggplant
RAD7 Midnight/Huckleberry	SP3 Steel Blue	TR2 ChocolateSmoke
RAD8 Black/Batik	SP5 Midnight	TR3 Cappuccino/Pebble Beige
RAD9 Black/Crimson	SP6 Crimson	TR4 Gourd/Tin
RAD10 Claret/Jute	SP7 Black	TR5 Chocolate/Steel Blue
RAD20 Chocolate/Palomino	SP10 Basil	TR6 Black/Midnight
RAD21 Prune/Ribbon	SP33 Wine	TR7 Smoke/Tin
RAD22 Spice/Jute	SP36 Chocolate	
RAD23 Cappuccino/Pebble Beige		
RAD24 Basil/Tin		
RAD25 Basil/Xanadu		
RAD26 Chocolate/Steel Blue		
RAD27 Black/Smoke		
RAD28 Smoke/Black		
RAD29 Smoke/Pebble Beige		

COM/COL Textile Requirement

	fabric yds.	leather sq. ft.
chair	1.4	25

Cal 133:
 ‡ = Cal 133 upholstery available. See textile matrix at the beginning of the Price List for pre-approved Cal 133 textiles.

Please see Fabric Application and Selling Policy sections of Price List for more information and instructions.

KnollTextiles and Spinneybeck Leathers

Please refer to the matrices at the beginning of the price list for Approved Textiles and Leathers.

The RPM Chair

high task chair

advanced model

Designer(s):
Carl Magnusson, 2000



pattern no.	description	overall w, min	overall w, max	overall d, min	overall d, max
8P5-2-A5KH	high performance arm, advanced control, mechanical height footring (9" - 18" height range) Advanced control: synchronized tilt, 4" back height, adjustment forward tilt, tilt lock (5 position), sliding seat-depth adjustment, side-position tension knob, pneumatic seat height, 360 degree swivel, instructions, mechanical height footring	24 1/2"	26 1/2"	24"	24"
8A5-2-A5KH	fixed height arms, advanced control, mechanical height footring (9" - 18" height range) Advanced control: synchronized tilt, 4" back height adjustment, forward tilt, tilt lock (5 position), sliding seat-depth adjustment, side-position tension knob, pneumatic seat height, 360 degree swivel, instructions, mechanical height footring	26 1/2"	26 1/2"	24"	24"
8C5-2-A5KH	armless, advanced control, mechanical height footring (9" - 18" height range) Advanced control: synchronized tilt, 4" back height adjustment, forward tilt, tilt lock (5 position), sliding seat-depth adjustment, side-position tension knob, pneumatic seat height, 360 degree swivel, instructions, mechanical height footring	20"	20"	24"	24"
8RBACK	Replacement back, prior to 11/01/2005				
8RSEAT	Replacement seat				
8UPHBACK	Replacement back, after 11/01/2005				

Order Code

<i>Example:</i>	8A5-2-A5KH
8A5	High task, footring
2	Black finish and black levers
A5K	Advanced control
H	Hard caster for carpet
AC1	RPM upholstery Acceleration Black to Smoke

Ordering Information

Specify:

1. Pattern number with finish information
2. Upholstery selection with color code

List prices shown include fabric or upholstery. Contact your KnollTextile representative for colors. For RPM upholstery colors, order an RPM Upholstery card by faxing your request to 800-308-7765 or log on to www.exchange.knoll.com.

COM/COL ordering information: see page Fabric Application and Selling Policy sections of the Price List.

Finish colors:
Black finish (code 2)
and black levers

Options

Code:	Upchg:	Description:
G	n/c	glides (substitute G for H at the end of pattern number. Example: 8A4-2-A5GG)
R	\$45	soft caster for hardwood floors (substitute R for H in pattern number)
C	\$118	CAL 133 (add C after pattern number and add "133" after upholstery code)

Construction

Outer shells:
Integrally colored, textured polypropylene.

Seat structure:
Glass-reinforced nylon with steel connectors (for basic control, laminated plywood).

Back and J-Bar structure:
Glass-reinforced nylon, ABS and steel connector plate.

Cushions and upholstery:
Insert molded high resilient urethane foam. Back is permanently bonded to CFC free foam. RPM grade covers are knitted to fit the cushion.

Fixed height arms/high performance arms:
Integrally colored, textured glass-reinforced nylon.

Armpads:
High-resiliency urethane foam with vinyl skins.

Base:
Integrally colored, textured, glass-reinforced nylon.

Footring:
Steel chromed tubing, cast aluminum support spokes, rubber bushing with integrally colored nylon knob, mechanical operation.

Casters and glides:
Black, integrally colored, textured nylon.

pattern no.	RPM grade	grades										COL			
		A	B	C	D	E	F	G	H	I	T	U	V	W	Y
8P5-2-A5KH	\$1,136.	\$1,248.	\$1,289.	\$1,332.	\$1,355.	\$1,383.	\$1,416.	\$1,467.	\$1,530.	\$1,564.	\$1,777.	\$1,856.	\$1,946.	\$2,508.	\$2,813.

8A5-2-A5KH	1,074.	1,187.	1,226.	1,271.	1,294.	1,322.	1,355.	1,406.	1,467.	1,524.	1,715.	1,794.	1,884.	2,446.	2,755.
-------------------	--------	--------	--------	--------	--------	--------	--------	--------	--------	--------	--------	--------	--------	--------	--------

8C5-2-A5KH	1,040.	1,153.	1,192.	1,238.	1,260.	1,289.	1,322.	1,373.	1,434.	1,467.	1,682.	1,761.	1,850.	2,413.	2,730.
-------------------	--------	--------	--------	--------	--------	--------	--------	--------	--------	--------	--------	--------	--------	--------	--------

8RBACK	252.	364.	404.	449.	471.	499.	534.	584.	646.	679.	893.	972.	1,062.	1,624.	1,920.
8RSEAT	244.	357.	396.	441.	463.	491.	525.	575.	639.	672.	885.	964.	1,054.	1,616.	1,886.
8UPHBACK	252.	364.	404.	449.	471.	499.	534.	584.	646.	679.	893.	972.	1,062.	1,624.	1,920.

RPM Grade Upholsteries

<i>Radial</i>	<i>Speedway</i>
RAD6 Teal/Silver Leaf	SP2 Smoke
RAD7 Midnight/Huckleberry	SP3 Steel Blue
RAD8 Black/Batik	SP5 Midnight
RAD9 Black/Crimson	SP6 Crimson
RAD10 Claret/Jute	SP7 Black
RAD20 Chocolate/Palomino	SP10 Basil
RAD21 Prune/Ribbon	SP33 Wine
RAD22 Spice/Jute	SP36 Chocolate
RAD23 Cappuccino/Pebble Beige	
RAD24 Basil/Tin	
RAD25 Basil/Xanadu	
RAD26 Chocolate/Steel Blue	
RAD27 Black/Smoke	
RAD28 Smoke/Black	
RAD29 Smoke/Pebble Beige	

COM/COL Textile Requirement

<i>Tread</i>		fabric yds.	leather sq. ft.
TR1 Black/Eggplant	chair	1.4	25
TR2 Chocolate/Smoke			
TR3 Cappuccino/Pebble Beige			
TR4 Gourd/Tin			
TR5 Chocolate/Steel Blue			
TR6 Black/Midnight			
TR7 Smoke/Tin			

Cal 133:
 † = Cal 133 upholstery available. See textile matrix at the beginning of the Price List for pre-approved Cal 133 textiles.

Please see Fabric Application and Selling Policy sections of the Price list for more information and instructions.

Knoll Textiles and Spinneybeck Leathers

Please refer to the matrices at the beginning of the price list for Approved Textiles and Leathers.

The RPM Chair

side chairs

	pattern no.	description	seat h	arm h	w	d	h
<i>Designer(s):</i> Dragomir Ivcevic	6A8-(2)-SL	armchair, armcap painted frame	17 ³ / ₄ "	25"	22"	23 ¹ / ₂ "	32 ¹ / ₂ "
	6C8-(2)-SL	armless, painted frame	17 ³ / ₄ "		21"	23 ¹ / ₂ "	32 ¹ / ₂ "
<i>Award(s):</i> Arango Design Foundation Exhibit, Refuse: Good Everyday Products from Reused and Recycled Materials, 1995	6RS8	reupholstery assembly					
	C	Cal 133 (add C after pattern number and add "133" after upholstery code.)					



Order Code

<i>Example:</i>	6A8-2-SL-K721/16
6A8	RPM one-piece armchair
2	black finish
SL	sled base
K721/16	Rochelle/blue bird

Ordering Information

Specify:

1. Pattern number with finish color code.
2. Upholstery selection with color.

List prices shown include fabric or leather upholstery. Contact your Knoll representative for colors.

Finish colors:

Black (code 2)

COM/COL ordering information:
See Fabric Application and Selling Policy sections of the Price List for more information and instructions.

Construction

Outer shell:
Integrally colored, textured polypropylene.

Internal support:
Cold rolled, mild carbon 14-gauge steel J-Bar.

Upholstery:
Integrally colored, textured ABS plastic upholstery liner with molded urethane foam; fabric is permanently bonded to the CFC-free foam.

Frame:
Cold rolled mild carbon 12-gauge steel tube with textured epoxy powder coat paint finish.

Arm caps:
Integrally colored, textured ABS plastic.

Glides:
Black, integrally colored, textured, glass-reinforced nylon.

pattern no.	grades	COM									COL
	A	B	C	D	E	F	G	H	I	T	U
6A8-(2)-SL	\$513.	\$543.	\$571.	\$592.	\$613.	\$627.	\$647.	\$678.	\$688.	\$993.	\$1,021.
6C8-(2)-SL	477.	508.	536.	557.	577.	593.	613.	642.	653.	959.	988.
6RS8	237.	264.	293.	313.	332.	347.	367.	402.	415.	704.	731.
C	88.										

COM/COL Textile Requirement

KnollTextiles and Spinneybeck Leathers

	fabric yds.	leather sq. ft.	
side chair	1.3	17	Please refer to the matrices at the beginning of the price list for Approved Textiles and Leathers.

Cal 133:
 ‡ = Cal 133 upholstery available. See textile matrix at the beginning of the Price List for pre-approved Cal 133 textiles.

See Fabric Application section of Price List for more information and instructions. See KnollNow! price list for Cal 133 KnollNow! options.

RPM Chair Dimensions and Operating Instructions

Seat

	Seat Height*	Seat Depth	Seat Width	Seat Pan Angle	Seat Back/Seat Pan Angle	Forward Tilt
BIFMA G-1 Ergonomic Std. Requirements January 1, 2002:						
	15" - 19.9" May use multiple cylinders	16.2" - 16.9"	17.7" min.	0° - 4° rearward	90° - 115°	
Basic	15" - 23 3/4"*	17.5"	20 1/2"	2°	93° - 109°	3°
Advanced	15" - 23 3/4"*	16.5" - 18.5"	20 1/2"	2°	93° - 109°	3°
High Task	23 1/2" - 31 1/4"*	see basic and advanced	20 1/2"	2°	93° - 109°	3°

*RPM has three seat height options to accommodate more body types: low 15" - 17 1/4", medium (standard) 16 1/2" - 20.5", high 18 1/4" - 23 1/4", and high task 23 1/2" - 31 1/4".

Back

	Backrest	Lumbar Support Height	Lumbar Support Width	Lumbar Support Center Ht.	Seat Back Width
BIFMA Stds.		5.9" - 9.8"	14.2" min.	5.9" - 9.8"	14.2" min.
Basic	yes	5.9" - 9.9"	17"	8"	19"
Advanced	yes	5.9" - 9.9"	17"	8"	19"
High Task	yes	5.9" - 9.9"	17"	8"	19"

		Basic	Advanced	High Task	Side
A	overall height	37 1/8" - 45 3/8"	37 1/8" - 45 3/8"	43 1/4" - 51"	32 1/2"
B	overall width	27"	27"	27"	22"
C	overall depth	21 1/4"	21 1/4"	21 1/4"	23 1/2"
D	arm height (from floor)	Fixed 24 7/8" - 29 7/8" High Performance 23 3/4" - 31 1/2"	24 7/8" - 29 7/8" 23 3/4" - 31 1/2"	32 1/8" - 39 7/8" 31" - 42"	25"
E	arm height (from seat)	Fixed 8 3/8" High Performance 7 1/4" - 10 1/2"	8 3/8" 7 1/4" - 10 1/2"	8 3/8" 7 1/4" - 10 1/2"	7 1/4"
F	recline range	25°	25°	25°	n/a
G	base diameter	27"	27"	27"	22 1/2" wide
	footring (height: 9" - 18")			20" dia.	
H	weight (with fixed arms)	44 lbs.	44 lbs.	51 lbs.	28 lbs.

(Measurements of arm chairs, advanced control with pneumatic seat height adjustment, in inches)

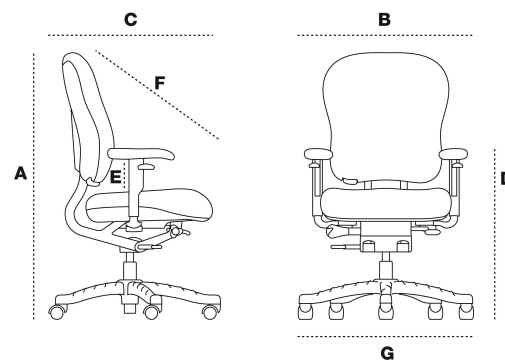

Arm Dimensions	Height from the Seat Reference Point	Width between Arms (at the innermost point on the armpad)	Width between Arms (measured at the inside of the arm support)	Rotation	Slide (to the front or back of the chair)
Fixed arms	8 3/8"	16 1/2" - 19" (2 1/2" range)	20 3/4" - 22 3/4" (2" range)	NA	NA
High performance arms on Advanced Control chair	7 1/4" - 10 1/2" (3 1/4" range)	17 3/4" - 19 3/4" (2" range)	20" - 22" (2" range)	±15°, 30° total (3 fixed positions)	1" range
High performance arms on Basic Control chair	7 1/4" - 10 1/2" (3 1/4" range)	17 3/4" - 19 3/4" (2" range)	20" - 22" (2" range)	±15°, 30° total (3 fixed positions)	NA

Compliance: ANSI/BIFMA x5.1 - 1993, BIFMA G1-2002 Ergonomic Standard, Cal 117, Cal 133 (with approved FR upholstery)
Operating Instructions also available online at www.knoll.com

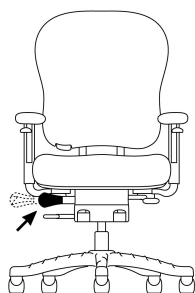

Tilt Tension

On the right side of the seat, there is a retractable knob which facilitates the adjustment when the knob is extended. Turn the knob forward to tighten and backward to loosen. When finished, tuck the knob under the seat.

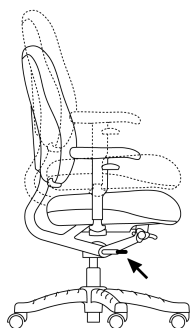

Seat Height

While seated, lift the lever on the right side of the chair to lower seat height. Remove your weight from the chair and lift the handle to raise the chair to the highest position.

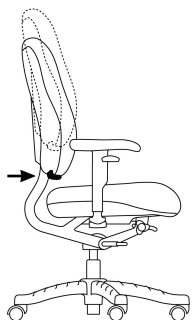

Back Height

Press the lever on the bottom of the right side of the back cushion to reposition the back height within a four inch range. It is necessary to press the lever to make the back move.

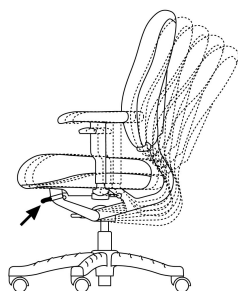

Multiple Stop Tilt Lock and Upright Tilt Lock

To lock the chair upright or in a reclined position, lift the lever on the front left side of the chair. Push down on the lever and recline to unlock the chair.

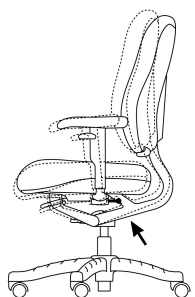

Forward Tilt

The forward tilt button is located on the rear, left-hand side of the control—to activate, push the lever in, lift your weight off the seat, and pull up on the rear of the seat to tilt it forward.

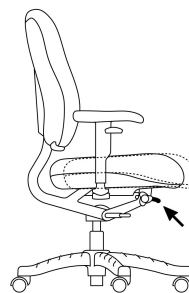

Seat Depth

The sliding seat activation is located underneath the seat on the front, left-hand side of the control. The adjustment mechanism is a button that has a space for two fingers. To activate, push up on the button and move the seat forward or backward. There are 4 positions within a 2" range. *(on Advanced Models only)*

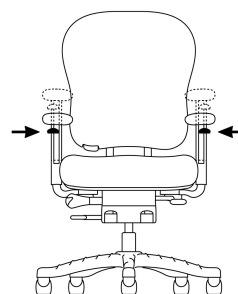

High Performance Arms

High Performance arms are controlled by the lever next to the armpad and from the knob beneath the arm support.

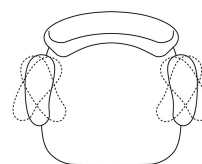

Arm Height and Armpad Pivot

Press the lever next to the armpad to adjust the arm height and to set the arm pivot in one of three fixed positions.

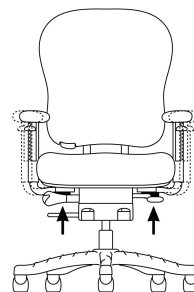

Arm Width

Loosen the knob under the arm support to adjust the arm support placement on the chair. There is a 2" total width adjustment for all arms (fixed and height-adjustable)

RPM Chair Control Index

control	feature	explanation
Advanced Control	Synchronized tilt (1 : 1.9)	back reclines 1.9 times faster than seat
	Tilt lock (5 positions)	chair can be locked in upright and reclined positions
	Forward tilt (3°)	chair locks in a forward tilting position for intensive keyboarding application
	4" back height	allows for correct positioning of lumbar support
	2" seat depth adjustments	seat adjusts in depth to provide proper support under the legs of both taller and shorter users
	Retractable tension	tension knob is easy to reach and tucks out of the way when not in use
	Instructions	easy to reach instruction card attached to chair makes adjusting the chair easy for everyone
	Dual J-Bar	provides additional support for the back
Basic Control	360° swivel	
	Synchronized tilt (1 : 1.9)	back reclines 1.9 times faster than seat
	Tilt lock (5 positions)	chair can be locked in upright and reclined positions
	Forward tilt (3°)	chair locks in a forward tilting position for intensive keyboarding application
	4" back height	allows for correct positioning of lumbar support
	Retractable tension	tension knob is easy to reach and tucks out of the way when not in use
	Instructions	easy to reach instruction card attached to chair makes adjusting the chair easy for everyone
	Dual J-Bar	provides additional support for the back

This page intentionally left blank.

Essentials Pro

upholstered mid-back task chair

synchronized tilt control

Designer(s):
Jeffrey Bennett, 2005



pattern no.	description
77W-MB-2-SY-NA-5-HC	Upholstered mid-back task chair with plastic outer back, back height adjustment, black finish, synchronized control, armless, standard cylinder height, hard black casters



77W-MB-2-SY-FA-5-HC	Upholstered mid-back task chair with plastic outer back, back height adjustment, black finish, synchronized control, fixed arms with width adjustment, standard cylinder height, hard black casters
----------------------------	---



77W-MB-2-SY-HA-5-HC	Upholstered mid-back task chair with plastic outer back, back height adjustment, black finish, synchronized control, height/width adjustable arms, standard cylinder height, hard black casters
----------------------------	---



U	Upholstered outer back (insert U after MB in the pattern number)
L	Low-height cylinder (15" - 19" range, Substitute L for 5 in the pattern number)
SL	Sliding seat option with 2.75" of depth adjustment (insert SL after cylinder choice in the pattern number)
SC	Soft Black Caster for hard floors (Substitute SC for HC in the pattern number)
GL	Glides (Substitute GL for HC in the pattern number)

Order Code	Ordering Information	Essentials Base Fabric	Options
<i>Example:</i> 77W-MB-2-SY-HA-5-SL-HC K1000/8	<i>Specify:</i> 1. Pattern number 2. Seat and back upholstery Split Upholstery Option: Essentials Pro seats and backs can be upholstered in any two approved Knoll Textiles or Spinneybeck upholsteries. To specify, first indicate the seat upholstery (labeled "seat upholstery") and then indicate the back upholstery (labeled "back upholstery"). The list price of the chair equals the list price of the higher of the two upholstery grades. <i>Code:</i> <i>Finish Color:</i> 2 <i>Black</i>	<i>Color options:</i> Presto Winter White K10001 Presto Sand K10002 Presto Stone K10003 Presto Saffron K10004 Presto Spring Green K10005 Presto Blue Chip K10006 Presto Scarlet K10007 Presto Red Carpet K10008 Presto Beige Taupe K10009 Presto Olive K100010 Presto Navy Blue K100011 Presto Clear Gray K100012 Presto Charcoal Gray K100013 Presto Black Tie K100014 <i>For split seat and back upholstery, indicate the words "seat" and "back" before the selected color.</i>	<i>CAL 133 Options:</i> <i>Code: Upchg: Description:</i> C133 \$72 CAL 133 textile on seat and back. No additional upcharge for upholstered outer back (add C133 to the end of the pattern number)
77W	Essentials Pro task chair		
MB	Mid-back		
2	Black finish		
SY	Synchronized tilt control		
HA	Height and width adjustable arms		
5	Standard height cylinder		
SL	Sliding seat		
HC	Hard wheel black casters		
K1000/8	Presto Red Carpet		
COM Upholstery Requirements			
<i>Textile yardage required: 2 yards</i>			
<i>Leather sq. ft. required: 28 sq. ft.</i>			
<i>Outer back shell: .8 yards or 12 sq. ft.</i>			

pattern no.	list price essentials base grade	A	grade COM B	C	D	E	F	G	H	I	leather T	U	V	W	X	Y
77W-MB-2-SY- NA-5-HC	\$572.	\$578.	\$594.	\$616.	\$641.	\$665.	\$693.	\$708.	\$714.	\$731.	\$962.	\$1,087.	\$1,207.	\$1,416.	n/a	\$1,610.

77W-MB-2-SY- FA-5-HC	623.	629.	646.	667.	692.	717.	745.	759.	765.	783.	1,014.	1,138.	1,259.	1,468.	n/a	1,661.
---------------------------------	------	------	------	------	------	------	------	------	------	------	--------	--------	--------	--------	-----	--------

77W-MB-2-SY- HA-5-HC	650.	656.	673.	694.	719.	744.	771.	786.	792.	810.	1,040.	1,165.	1,285.	1,495.	n/a	1,688.
---------------------------------	------	------	------	------	------	------	------	------	------	------	--------	--------	--------	--------	-----	--------

U	67.	69.	76.	84.	95.	104.	115.	122.	124.	131.	224.	273.	321.	405.	n/a	482.
L	67.															
SL	37.															
SC	n/c															
GL	n/c															

Code: *Upchg:*
EXTWARRANTY \$25 net fixed fee per
chair (U.S.)
\$30 net fixed fee per
chair (Canada)

Description:
Addition of 3 years of field labor to the
warranty for the Essentials Work Chairs.
Standard warranty for Essentials Work
Chairs does not include field labor.

Note:
Please specify EXTWARRANTY from
KCH - Knoll Special Charges catalog in
design and specification software tools.



Essentials Pro

upholstered mid-back task chair

swivel tilt control

Designer(s):
Jeffrey Bennett, 2005



pattern no.	description
77W-MB-2-ST-NA-5-HC	Upholstered mid-back task chair with plastic outer back, back height adjustment, black finish, swivel-tilt control, armless, standard cylinder height, hard black casters
	
77W-MB-2-ST-FA-5-HC	Upholstered mid-back task chair with plastic outer back, back height adjustment, black finish, swivel-tilt control, fixed arms with width adjustment, standard cylinder height, hard black casters
	
77W-MB-2-ST-HA-5-HC	Upholstered mid-back task chair with plastic outer back, back height adjustment, black finish, swivel-tilt control, height/width adjustable arms, standard cylinder height, hard black casters
	
U	Upholstered outer back (insert U after MB in the pattern number)
L	Low-height cylinder (15" - 19" range, Substitute L for 5 in the pattern number)
SL	Sliding seat option with 2.75" of depth adjustment (insert SL after cylinder choice in the pattern number)
SC	Soft Black Caster for hard floors (Substitute SC for HC in the pattern number)
GL	Glides (Substitute GL for HC in the pattern number)

Order Code	Ordering Information	Essentials Base Fabric	Options
<i>Example:</i> 77W-MB-2-ST-HA-5-SL-HC K1000/8	<i>Specify:</i> 1. Pattern number 2. Seat and back upholstery Split Upholstery Option: Essentials Pro seats and backs can be upholstered in any two approved Knoll Textiles or Spinneybeck upholsteries. To specify, first indicate the seat upholstery (labeled "seat upholstery") and then indicate the back upholstery (labeled "back upholstery"). The list price of the chair equals the list price of the higher of the two upholstery grades. <i>Code:</i> <i>Finish Color:</i> 2 Black	<i>Color options:</i> Presto Winter White K10001 Presto Sand K10002 Presto Stone K10003 Presto Saffron K10004 Presto Spring Green K10005 Presto Blue Chip K10006 Presto Scarlet K10007 Presto Red Carpet K10008 Presto Beige Taupe K10009 Presto Olive K100010 Presto Navy Blue K100011 Presto Clear Gray K100012 Presto Charcoal Gray K100013 Presto Black Tie K100014 <i>For split seat and back upholstery, indicate the words "seat" and "back" before the selected color.</i>	<i>CAL 133 Options:</i> <i>Code: Upchg: Description:</i> C133 \$72 CAL 133 textile on seat and back. No additional upcharge for upholstered outer back (add C133 to the end of the pattern number)
77W	Essentials Pro task chair		
MB	Mid-back		
2	Black finish		
ST	Swivel tilt control		
HA	Height and width adjustable arms		
5	Standard height cylinder		
SL	Sliding seat		
HC	Hard wheel black casters		
K1000/8	Presto Red Carpet		
COM Upholstery Requirements			
Textile yardage required: 2 yards			
Leather sq. ft. required: 28 sq. ft.			
Outer back shell: .8 yards or 12 sq. ft.			

pattern no.	list price essentials base grade	A	grade COM B	C	D	E	F	G	H	I	leather T	U	V	W	X	Y
77W-MB-2-ST- NA-5-HC	\$474.	\$480.	\$496.	\$518.	\$543.	\$568.	\$595.	\$610.	\$616.	\$633.	\$864.	\$989.	\$1,109.	\$1,318.	n/a	\$1,512.

77W-MB-2-ST- FA-5-HC	525.	531.	548.	570.	594.	619.	647.	661.	667.	685.	916.	1,040.	1,161.	1,370.	n/a	1,564.
---------------------------------	------	------	------	------	------	------	------	------	------	------	------	--------	--------	--------	-----	--------

77W-MB-2-ST- HA-5-HC	552.	558.	575.	596.	621.	646.	674.	688.	694.	712.	942.	1,067.	1,188.	1,397.	n/a	1,590.
---------------------------------	------	------	------	------	------	------	------	------	------	------	------	--------	--------	--------	-----	--------

U	67.	69.	76.	84.	95.	104.	115.	122.	124.	131.	224.	273.	321.	405.	n/a	482.
----------	-----	-----	-----	-----	-----	------	------	------	------	------	------	------	------	------	-----	------

L	67.															
----------	-----	--	--	--	--	--	--	--	--	--	--	--	--	--	--	--

SL	37.															
-----------	-----	--	--	--	--	--	--	--	--	--	--	--	--	--	--	--

SC	n/c															
-----------	-----	--	--	--	--	--	--	--	--	--	--	--	--	--	--	--

GL	n/c															
-----------	-----	--	--	--	--	--	--	--	--	--	--	--	--	--	--	--

Code: Upchg:
 EXTWARRANTY \$25 net fixed fee per
 chair (U.S.)
 \$30 net fixed fee per
 chair (Canada)

Description:
 Addition of 3 years of field labor to the
 warranty for the Essentials Work Chairs.
 Standard warranty for Essentials Work
 Chairs does not include field labor.

Note:
 Please specify EXTWARRANTY from
 KCH - Knoll Special Charges catalog in
 design and specification software tools.

Essentials Pro

upholstered high-back task chair

synchronized tilt control

Designer(s):
Jeffrey Bernett, 2005



pattern no.	description
77W-HB-2-SY-NA-5-HC	Upholstered high-back task chair with plastic outer back, back height adjustment, black finish, synchronized control, armless, standard cylinder height, hard black casters



77W-HB-2-SY-FA-5-HC	Upholstered high-back task chair with plastic outer back, back height adjustment, black finish, synchronized control, fixed arms with width adjustment, standard cylinder height, hard black casters
----------------------------	--



77W-HB-2-SY-HA-5-HC	Upholstered high-back task chair with plastic outer back, back height adjustment, black finish, synchronized control, height/width adjustable arms, standard cylinder height, hard black casters
----------------------------	--



U	Upholstered outer back (insert U after HB in the pattern number)
L	Low-height cylinder (15" - 19" range, Substitute L for 5 in the pattern number)
SL	Sliding seat option with 2.75" of depth adjustment (insert SL after cylinder choice in the pattern number)
SC	Soft Black Caster for hard floors (Substitute SC for HC in the pattern number)
GL	Glides (Substitute GL for HC in the pattern number)

Order Code	Ordering Information	Essentials Base Fabric	Options
<i>Example:</i> 77W-HB-2-SY-HA-5-SL-HC K1000/8	<i>Specify:</i> 1. Pattern number 2. Seat and back upholstery Split Upholstery Option: Essentials Pro seats and backs can be upholstered in any two approved KnollTextiles or Spinneybeck upholsteries. To specify, first indicate the seat upholstery (labeled "seat upholstery") and then indicate the back upholstery (labeled "back upholstery"). The list price of the chair equals the list price of the higher of the two upholstery grades. <i>Code:</i> <i>Finish Color:</i> 2 Black	<i>Color options:</i> Presto Winter White K10001 Presto Sand K10002 Presto Stone K10003 Presto Saffron K10004 Presto Spring Green K10005 Presto Blue Chip K10006 Presto Scarlet K10007 Presto Red Carpet K10008 Presto Beige Taupe K10009 Presto Olive K100010 Presto Navy Blue K100011 Presto Clear Gray K100012 Presto Charcoal Gray K100013 Presto Black Tie K100014 <i>For split seat and back upholstery, indicate the words "seat" and "back" before the selected color.</i>	<i>CAL 133 Options:</i> <i>Code: Upchg: Description:</i> C133 \$72 CAL 133 textile on seat and back. No additional upcharge for upholstered outer back (add C133 to the end of the pattern number)
77W	Essentials Pro task chair		
HB	High-back		
2	Black finish		
SY	Synchronized tilt control		
HA	Height and width adjustable arms		
5	Standard height cylinder		
SL	Sliding seat		
HC	Hard wheel black casters		
K1000/8	Presto Red Carpet		
COM Upholstery Requirements			
<i>Textile yardage required: 2.2 yards</i>			
<i>Leather sq. ft. required: 31 sq. ft.</i>			
<i>Outer back shell: .9 yards or 13.5 sq. ft.</i>			

pattern no.	list price essentials base grade	A	grade COM B	C	D	E	F	G	H	I	leather T	U	V	W	X	Y
77W-HB-2-SY- NA-5-HC	\$623.	\$632.	\$652.	\$678.	\$708.	\$736.	\$770.	\$787.	\$794.	\$816.	\$1,065.	\$1,205.	\$1,341.	\$1,576.	n/a	\$1,796.

77W-HB-2-SY- FA-5-HC	675.	684.	703.	729.	759.	788.	822.	838.	846.	867.	1,117.	1,257.	1,393.	1,627.	n/a	1,848.
---------------------------------	------	------	------	------	------	------	------	------	------	------	--------	--------	--------	--------	-----	--------

77W-HB-2-SY- HA-5-HC	701.	711.	730.	756.	786.	815.	849.	865.	872.	894.	1,143.	1,283.	1,419.	1,654.	n/a	1,875.
---------------------------------	------	------	------	------	------	------	------	------	------	------	--------	--------	--------	--------	-----	--------

U	67.	71.	78.	90.	102.	113.	128.	134.	137.	146.	248.	306.	362.	457.	n/a	548.
L	67.															
SL	37.															
SC	n/c															
GL	n/c															

Code: Upchg:
 EXTWARRANTY \$25 net fixed fee per
 chair (U.S.)
 \$30 net fixed fee per
 chair (Canada)

Description:
 Addition of 3 years of field labor to the
 warranty for the Essentials Work Chairs.
 Standard warranty for Essentials Work
 Chairs does not include field labor.

Note:
 Please specify EXTWARRANTY from
 KCH - Knoll Special Charges catalog in
 design and specification software tools.



Essentials Pro

upholstered high-back task chair

swivel tilt control

Designer(s):
Jeffrey Bernett, 2005



pattern no.	description
77W-HB-2-ST-NA-5-HC	Upholstered high-back task chair with plastic outer back, back height adjustment, black finish, swivel-tilt control, armless, standard cylinder height, hard black casters
	
77W-HB-2-ST-FA-5-HC	Upholstered high-back task chair with plastic outer back, back height adjustment, black finish, swivel-tilt control, fixed arms with width adjustment, standard cylinder height, hard black casters
	
77W-HB-2-ST-HA-5-HC	Upholstered high-back task chair with plastic outer back, back height adjustment, black finish, swivel-tilt control, height/width adjustable arms, standard cylinder height, hard black casters
	
U	Upholstered outer back (insert U after HB in the pattern number)
L	Low-height cylinder (15" - 19" range, Substitute L for 5 in the pattern number)
SL	Sliding seat option with 2.75" of depth adjustment (insert SL after cylinder choice in the pattern number)
SC	Soft Black Caster for hard floors (Substitute SC for HC in the pattern number)
GL	Glides (Substitute GL for HC in the pattern number)

Order Code	Ordering Information	Essentials Base Fabric	Options
<i>Example:</i> 77W-HB-2-ST-HA-5-SL-HC VOBLK	<i>Specify:</i> 1. Pattern number 2. Seat and back upholstery	<i>Color options:</i>	<i>CAL 133 Options:</i>
77W	Essentials Pro task chair	Presto Winter White K10001	<i>Code: Upchg: Description:</i>
HB	High-back	Presto Sand K10002	C133 \$72 CAL 133 textile on
2	Black finish	Presto Stone K10003	seat and back. No
ST	Swivel tilt control	Presto Saffron K10004	additional upcharge
HA	Height and width adjustable arms	Presto Spring Green K10005	for upholstered outer
5	Standard height cylinder	Presto Blue Chip K10006	back (add C133 to
SL	Sliding seat	Presto Scarlet K10007	the end of the pattern
HC	Hard wheel black casters	Presto Red Carpet K10008	number)
VOBLK	Volo black Spinneybeck leather	Presto Beige Taupe K10009	
		Presto Olive K100010	
		Presto Navy Blue K100011	
		Presto Clear Gray K100012	
		Presto Charcoal Gray K100013	
		Presto Black Tie K100014	
	<i>Code:</i> 2 <i>Finish Color:</i> Black	<i>For split seat and back upholstery, indicate the words "seat" and "back" before the selected color.</i>	
	COM Upholstery Requirements		
	<i>Textile yardage required: 2.2 yards</i>		
	<i>Leather sq. ft. required: 31 sq. ft.</i>		
	<i>Outer back shell: .9 yards or 13.5 sq. ft.</i>		

pattern no.	list price essentials base grade	A	grade COM B	C	D	E	F	G	H	I	leather T	U	V	W	X	Y
77W-HB-2-ST- NA-5-HC	\$525.	\$535.	\$554.	\$580.	\$610.	\$639.	\$673.	\$689.	\$696.	\$718.	\$967.	\$1,107.	\$1,243.	\$1,478.	n/a	\$1,698.

77W-HB-2-ST- FA-5-HC	577.	586.	606.	631.	661.	690.	724.	741.	748.	769.	1,019.	1,159.	1,295.	1,530.	n/a	1,750.
---------------------------------	------	------	------	------	------	------	------	------	------	------	--------	--------	--------	--------	-----	--------

77W-HB-2-ST- HA-5-HC	604.	613.	632.	658.	688.	717.	751.	767.	775.	796.	1,045.	1,186.	1,321.	1,556.	n/a	1,777.
---------------------------------	------	------	------	------	------	------	------	------	------	------	--------	--------	--------	--------	-----	--------

U	67.	71.	78.	90.	102.	113.	128.	134.	137.	146.	248.	306.	362.	457.	n/a	548.
L	67.															
SL	37.															
SC	n/c															
GL	n/c															

Code: *Upchg:*
EXTWARRANTY \$25 net fixed fee per
chair (U.S.)
\$30 net fixed fee per
chair (Canada)

Description:
Addition of 3 years of field labor to the
warranty for the Essentials Work Chairs.
Standard warranty for Essentials Work
Chairs does not include field labor.



Note:
Please specify EXTWARRANTY from
KCH - Knoll Special Charges catalog in
design and specification software tools.

Essentials Pro

upholstered side chair

Designer(s):
Jeffrey Bennett, 2005



pattern no.	description
77S-2-FA-HC	Upholstered side chair with plastic outer back, black finish, fixed arms, hard black casters
	
77S-2-NA-HC	Upholstered side chair with plastic outer back, black finish, armless, hard black casters
	
U	Upholstered outer back (insert U after S in the pattern number)
SC	Soft Black Caster for hard floors (Substitute SC for HC in the pattern number)
GL	Glides (Substitute GL for HC in the pattern number)

Order Code	Ordering Information	Essentials Grade Fabric	Options
<i>Example:</i> 77S-2-FA-HC K1000/10	<i>Specify:</i>	<i>Color options:</i>	<i>CAL 133 Options:</i>
77S Essentials Pro side chair	1. Pattern number	Presto Winter White K10001	<i>Code: Upchg: Description:</i>
2 Black finish	2. Seat and back upholstery	Presto Sand K10002	C133 \$52 CAL 133 textile on
FA Fixed arms	Split Upholstery Option:	Presto Stone K10003	seat and back. No
HC Hard wheel black casters	Essentials Pro seats and backs can be	Presto Saffron K10004	additional upcharge
K1000/10 Presto Olive	upholstered in any two approved	Presto Spring Green K10005	for upholstered outer
	KnollTextiles or Spinneybeck	Presto Blue Chip K10006	back (add C133 to
	upholsteries. To specify, first indicate the	Presto Scarlet K10007	the end of the pattern
	seat upholstery (labeled "seat	Presto Red Carpet K10008	number)
	upholstery") and then indicate the back	Presto Beige Taupe K10009	
	upholstery (labeled "back upholstery").	Presto Olive K100010	
	The list price of the chair equals the list	Presto Navy Blue K100011	
	price of the higher of the two upholstery	Presto Clear Gray K100012	
	grades.	Presto Charcoal Gray K100013	
	<i>Code:</i> <i>Finish Color:</i>	Presto Black Tie K100014	
	2 <i>Black</i>		
	COM Upholstery Requirements		
	<i>Textile yardage required: 1.8 yards</i>		
	<i>Leather sq. ft. required: 25 sq. ft.</i>		
	<i>Outer back shell: .6 yards or 9 sq. ft.</i>		
		<i>For split seat and back upholstery,</i>	
		<i>indicate the words "seat" and "back"</i>	
		<i>before the selected color.</i>	

pattern no.	list price essentials base grade	A	grade COM B	C	D	E	F	G	H	I	leather T	U	V	W	X	Y
77S-2-FA-HC	\$351.	\$355.	\$370.	\$389.	\$411.	\$433.	\$457.	\$470.	\$476.	\$491.	\$724.	\$842.	\$957.	\$1,155.	n/a	\$1,339.
77S-2-NA-HC	325.	330.	345.	365.	387.	410.	436.	448.	454.	471.	711.	833.	952.	1,157.	n/a	1,347.
U	46.	47.	53.	59.	66.	73.	81.	85.	88.	93.	169.	208.	246.	311.	n/a	372.
SC	n/c															
GL	n/c															

Warranty

Code: Upchg:
 EXTWARRANTY \$25 net fixed fee per
 chair (U.S.)
 \$30 net fixed fee per
 chair (Canada)

Description:
 Addition of 3 years of field labor to the
 warranty for the Essentials Work Chairs.
 Standard warranty for Essentials Work
 Chairs does not include field labor.

Note:
 Please specify EXTWARRANTY from
 KCH - Knoll Special Charges catalog in
 design and specification software tools.

Essentials Pro

Seat and Back replacements for task and side chairs

Designer(s):
Jeffrey Bennett, 2005



pattern no.	description
ESSENWORK-SEAT	Replacement upholstered seat for Pro and Tech task chair
77WMIDBACK	Replacement upholstered Pro Task Midback with plastic outer back
77WUMIDBACK	Replacement upholstered Pro Task Midback with upholstered outer back
77WHIGHBACK	Replacement upholstered Pro Task Highback with plastic outer back
77WUHIGHBACK	Replacement upholstered Pro Task Highback with upholstered outer back
ESSENSIDESEAT	Replacement upholstered seat for Pro and Tech side chair
77SBACK	Replacement upholstered Pro Side back with plastic outer back
77SUBACK	Replacement upholstered Pro Side back with upholstered outer back

Order Code	Ordering Information	Essentials Base Fabric	Options
<i>Example:</i> ESSENWORKSEAT - K1000/10	<i>Specify:</i> 1. Pattern number 2. Seat and back upholstery	<i>Color options:</i> Presto Winter White K10001 Presto Sand K10002 Presto Stone K10003 Presto Saffron K10004 Presto Spring Green K10005 Presto Blue Chip K10006 Presto Scarlet K10007 Presto Red Carpet K10008 Presto Beige Taupe K10009 Presto Olive K100010 Presto Navy Blue K100011 Presto Clear Gray K100012 Presto Charcoal Gray K100013 Presto Black Tie K100014	<i>CAL 133 Options:</i> <i>Code: Upchg: Description:</i> C133 \$46 CAL 133 textile on seat. (add C133 to the end of the pattern number) <i>Code: Upchg: Description:</i> C133 \$46 CAL 133 textile on back. No additional upcharge for upholstered outer back (add C133 to the end of the pattern number)
ESSENWORK-SEAT	Upholstered seat replacement		
K1000/8	Presto Red Carpet		
	COM Upholstery Requirements Textile yardage required: 2 yards Leather sq. ft. required: 28 sq. ft. Outer back shell: .8 yards or 12 sq. ft.		

pattern no.	list price essentials base grade	grade										leather				
		A	B	C	D	E	F	G	H	I	T	U	V	W	X	Y
ESSENWORK- SEAT	\$99.	\$119.	\$132.	\$148.	\$167.	\$185.	\$207.	\$218.	\$222.	\$237.	\$261.	\$310.	\$358.	\$444.	n/a	\$522.
77WMIDBACK	239.	269.	287.	311.	339.	367.	399.	414.	422.	442.	527.	616.	702.	852.	n/a	991.
77WUMID- BACK	283.	333.	364.	404.	449.	494.	546.	572.	584.	617.	760.	906.	1,049.	1,299.	n/a	1,527.
77WHIGH- BACK	252.	287.	309.	337.	369.	401.	437.	455.	465.	488.	590.	693.	796.	971.	n/a	1,136.
77WUHIGH- BACK	299.	355.	390.	437.	488.	541.	602.	632.	648.	687.	851.	1,020.	1,185.	1,472.	n/a	1,740.
ESSENSIDE- SEAT	101.	124.	136.	151.	170.	187.	208.	218.	224.	237.	260.	308.	355.	437.	n/a	512.
77SBACK	145.	174.	190.	209.	232.	254.	280.	293.	299.	315.	385.	457.	528.	650.	n/a	763.
77SUBACK	186.	234.	258.	289.	324.	359.	400.	420.	430.	456.	568.	681.	794.	988.	n/a	1,166.

Essentials Pro Dimensions and Operating Instructions

Seat

	Mid-back Chair	High-back Chair	Side Chair
Seat Height	without seat slider 16.25" - 20.75" (std.), 15" - 19" (low) with seat slider 16.75" - 21.25" (std.), 15.5" - 19.5 (low)	without seat slider 16.25" - 20.75" (std.), 15" - 19" (low) with seat slider 16.75" - 21.25" (std.), 15.5" - 19.5 (low)	17"
Seat Depth	16.9" (fixed), 16.25" to 19" (adjustable)	16.9" (fixed), 16.25" to 19" (adjustable)	16.9"
Seat Width	19"	19"	19"
Seat Pan Angle (at rest)	2°	2°	2°

Back

Backrest Height	21.5" - 23.75"	24.5" - 26.5"	17.5"
Backrest Width	18"	19"	18.5"
Lumbar support	5.75" - 8.75"	5.75" - 8.75"	6.75"
Angle Between Seat and Back	96°	96°	103°
Tilt Range of Back	31° (synchro) 12° (swivel)	31° (synchro) 12° (swivel)	N/A

Arms

Armrest Height (fixed)	8.2"	8.2"	9.4"
Armrest Height (adjustable)	7" - 10.5"	7" - 10.5"	N/A
Inside Distance Between Armrest	20" - 21"	20" - 21"	19.5"

Chair

A Overall Height (std cylinder)	36.5" - 40.5"	39" - 43.5"	30"
B Overall Width	27"	27"	21.75" (armless) 24" (with arms)
C Overall Depth	27"	27"	24"
D Adj. Arm Height From Floor (std. cylinder)	23" - 31.2"	23" - 31.2"	N/A
Fixed Arm Height From Floor (std. cylinder)	24.2" - 28.7"	24.2" - 28.7"	25.8"
E Adj. Arm Height (seat ref. pt.)	7" - 10.5"	7" - 10.5"	N/A
Fixed Arm Height (seat ref. pt.)	8.2"	8.2"	N/A
F Recline Range	98° - 130° (synchro) 98° - 110° (swivel)	98° - 130° (synchro) 98° - 110° (swivel)	N/A
Back Recline Ratio	1:3 (synchro) 1:1 (swivel)	1:3 (synchro) 1:1 (swivel)	N/A
G Base Diameter	27"	27"	N/A
H Weight	42.3 lbs.	43.3 lbs.	20.2 lbs. (armless) 23.5 lbs. (with arms)

Pro™ Task Chair

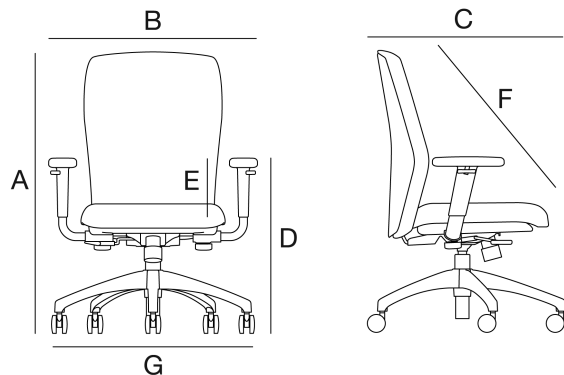

Pro™ Side Chair

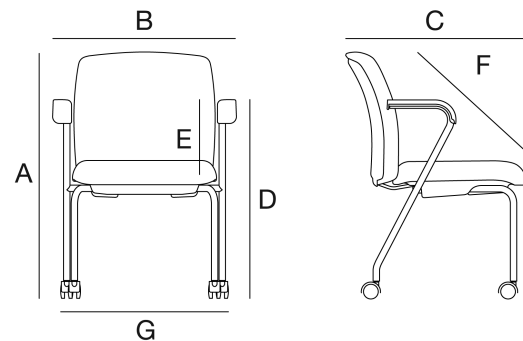

Essential Pro™ Hight-back and Mid-back Task Chairs

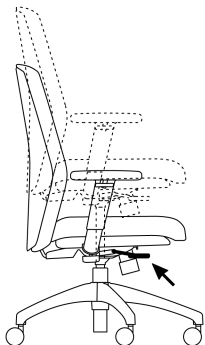

Seat Height

To raise the seat height, remove your weight from the chair while lifting the lever under the right side of the seat. To lower the seat height, lift the lever while sitting in the chair.

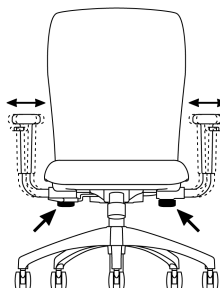

Adjustable Arm Width

To adjust the arm width, loosen the knob under the arm support by turning clockwise. Slide the support toward or away from the seat to adjust the arm width. Tighten the knob under the arm. The arms adjust 1/2" in width per side (1" total).

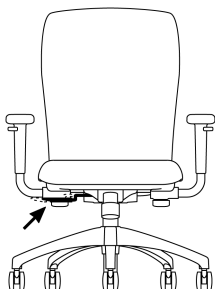

Tilt Lock

To recline, pull out the lever under the right side of the seat. To lock the chair upright, push the lever in.

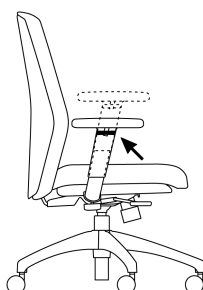

Adjustable Arm Height (Optional)

To adjust the arm pad height, lift the lever on the outside of the arm support and move the arm up or down. Release the lever to lock. The arms have a 3.5" range of adjustment.

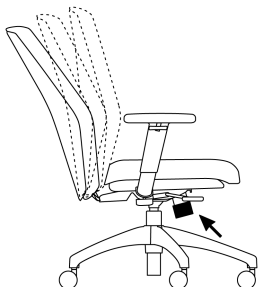

Tilt Tension

To adjust the tilt tension, turn the knob under the front of the seat. Turn counterclockwise to tighten, and clockwise to loosen.

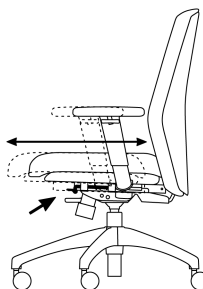

Sliding Seat Depth Adjustment (Optional)

To adjust the seat depth, lift the lever under the left side of the seat and slide the seat to the desired location. Release the lever to lock. There are 6 positions within a 2.75" range.

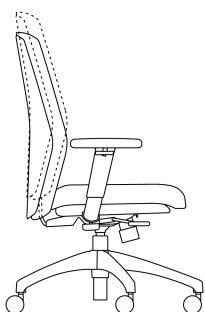

Back Height

To raise the back height, firmly hold both sides of the back and lift. The back height adjust 6 notches upward for a total of 2 7/8" of adjustability. To lower the back height, first raise the back to the highest position; the top notch releases the back to the lowest position.

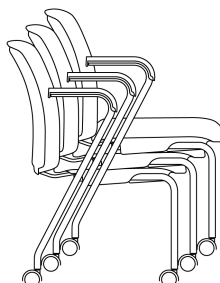

Essentials Pro™ Side Chair

This is a stacking side chair.

Chairs should not be stacked more than 3 units high. To stack chairs, place the rear legs of the top chair in front of the rear legs of the bottom chair. The bottom of the top chair's seat should rest on the lower chair's seat.



Essentials Tech

suspension back task chair

synchronized tilt control

Designer(s):
Jeffrey Bennett, 2005



pattern no.	description
88W-MB-2-SY-NA-5-HC	Suspension mid-back task chair, black finish, synchronized control, armless, standard cylinder height, hard black casters
	
88W-MB-2-SY-FA-5-HC	Suspension mid-back task chair, black finish, synchronized control, fixed arms with width adjustment, standard cylinder height, hard black casters
	
88W-MB-2-SY-HA-5-HC	Suspension mid-back task chair, black finish, synchronized control, height/width adjustable arms, standard cylinder height, hard black casters
	
L	Low-height cylinder (15" - 19" range, Substitute L for 5 in the pattern number)
SL	Sliding seat option with 2.75" of depth adjustment (insert SL after cylinder choice in the pattern number)
SC	Soft Black Caster for hard floors (Substitute SC for HC in the pattern number)
GL	Glides (Substitute GL for HC in the pattern number)

Order Code

Example: **88W-MB-2-SY-HA 5-SL-HC Seat: K1000/8 - Back: S08**

88W	Essentials Tech suspension back task chair
MB	Mid-back
2	Black finish
SY	Synchronized tilt control
HA	Height and width adjustable arms
5	Standard height cylinder
SL	Sliding seat
HC	Hard wheel black caster
SEAT K1000/8	Presto Red Carpet
BACK S08	Red Carpet

Ordering Information

Specify:

1. Pattern number
2. Seat upholstery
3. Suspension back color

Code: Finish Color:
2 Black

COM Upholstery Requirements
Textile yardage required: .8 yards
Leather sq. ft. required: 10 sq. ft.

Essentials Base Seat Options

Color options:

Presto Winter White K10001
Presto Sand K10002
Presto Stone K10003
Presto Saffron K10004
Presto Spring Green K10005
Presto Blue Chip K10006
Presto Scarlet K10007
Presto Red Carpet K10008
Presto Beige Taupe K10009
Presto Olive K100010
Presto Navy Blue K100011
Presto Clear Gray K100012
Presto Charcoal Gray K100013
Presto Black Tie K100014

Suspension Back Color Options

FOR BACK ONLY

Color options:

Red Carpet S08
Beige Taupe S09
Olive S10
Navy Blue S11
Clear Gray S12
Charcoal Gray S13
Black Tie S14

pattern no.	list price essentials base grade	A	grade COM B	C	D	E	F	G	H	I	leather T	U	V	W	X	Y
88W-MB-2-SY- NA-5-HC	\$628.	\$640.	\$651.	\$665.	\$683.	\$699.	\$719.	\$728.	\$732.	\$745.	\$766.	\$812.	\$856.	\$932.	n/a	\$1,004.

88W-MB-2-SY- FA-5-HC	680.	691.	702.	717.	734.	751.	770.	780.	784.	796.	818.	863.	907.	984.	n/a	1,056.
---------------------------------	------	------	------	------	------	------	------	------	------	------	------	------	------	------	-----	--------

88W-MB-2-SY- HA-5-HC	707.	718.	729.	744.	761.	778.	797.	806.	811.	823.	845.	890.	934.	1,010.	n/a	1,083.
---------------------------------	------	------	------	------	------	------	------	------	------	------	------	------	------	--------	-----	--------

L	67.
SL	37.
SC	n/c
GL	n/c

Options

<i>CAL 133 Options:</i>	<i>Code:</i>	<i>Upchg:</i>
<i>Code: Upchg: Description:</i>	EXTWARRANTY	\$25 net fixed fee per chair (U.S.)
C133 \$46 CAL 133 textile on seat only. (add C133 to the end of the pattern number)		\$30 net fixed fee per chair (Canada)
	<i>Description:</i>	Addition of 3 years of field labor to the warranty for the Essentials Work Chairs. Standard warranty for Essentials Work Chairs does not include field labor.
	<i>Note:</i>	Please specify EXTWARRANTY from KCH - Knoll Special Charges catalog in design and specification software tools.



Essentials Tech

suspension back task chair

swivel tilt control

Designer(s):
Jeffrey Bennett, 2005



pattern no.	description
88W-MB-2-ST-NA-5-HC	Suspension mid-back task chair, black finish, swivel-tilt control, armless, standard cylinder height, hard black casters
	
88W-MB-2-ST-FA-5-HC	Suspension mid-back task chair, black finish, swivel-tilt control, fixed arms with width adjustment, standard cylinder height, hard black casters
	
88W-MB-2-ST-HA-5-HC	Suspension mid-back task chair, black finish, swivel-tilt control, height/width adjustable arms, standard cylinder height, hard black casters
	
L	Low-height cylinder (15" - 19" range, Substitute L for 5 in the pattern number)
SL	Sliding seat option with 2.75" of depth adjustment (insert SL after cylinder choice in the pattern number)
SC	Soft Black Caster for hard floors (Substitute SC for HC in the pattern number)
GL	Glides (Substitute GL for HC in the pattern number)

Order Code	Ordering Information	Essentials Base Seat Options	Suspension Back Color Options
<i>Example:</i> 88W-MB-2-ST-HA 5-SL-HC Seat: K1000/8 Back: S08	<i>Specify:</i> 1. Pattern number 2. Seat upholstery 3. Suspension back color <i>Code: Finish Color:</i> 2 <i>Black</i>	<i>Color options:</i> Presto Winter White K10001 Presto Sand K10002 Presto Stone K10003 Presto Saffron K10004 Presto Spring Green K10005 Presto Blue Chip K10006 Presto Scarlet K10007 Presto Red Carpet K10008 Presto Beige Taupe K10009 Presto Olive K100010 Presto Navy Blue K100011 Presto Clear Gray K100012 Presto Charcoal Gray K100013 Presto Black Tie K100014	FOR BACK ONLY <i>Color options:</i> Red Carpet S08 Beige Taupe S09 Olive S10 Navy Blue S11 Clear Gray S12 Charcoal Gray S13 Black Tie S14
88W	Essentials Tech upholstered task chair		
MB	Mid-back		
2	Black finish		
ST	Swivel tilt control		
HA	Height and width adjustable arms		
5	Standard height cylinder		
SL	Sliding seat		
HC	Hard wheel black caster		
SEAT K1000/8	Presto Red Carpet		
BACK S08	Red Carpet		
	COM Upholstery Requirements <i>Textile yardage required: .8 yards</i> <i>Leather sq. ft. required: 10 sq. ft.</i>		

pattern no.	list price essentials base grade	A	grade COM B	C	D	E	F	G	H	I	leather T	U	V	W	X	Y
88W-MB-2-ST-NA-5-HC	\$530.	\$542.	\$553.	\$568.	\$585.	\$602.	\$621.	\$630.	\$634.	\$647.	\$668.	\$714.	\$758.	\$834.	n/a	\$906.

88W-MB-2-ST-FA-5-HC	582.	593.	605.	619.	637.	653.	673.	682.	686.	698.	720.	765.	810.	886.	n/a	958.
----------------------------	------	------	------	------	------	------	------	------	------	------	------	------	------	------	-----	------

88W-MB-2-ST-HA-5-HC	609.	620.	631.	646.	663.	680.	699.	709.	713.	725.	747.	792.	836.	913.	n/a	985.
----------------------------	------	------	------	------	------	------	------	------	------	------	------	------	------	------	-----	------

L	67.
SL	37.
SC	n/c
GL	n/c

Options



<i>CAL 133 Options:</i>	<i>Code:</i>	<i>Upchg:</i>
<i>Code: Upchg: Description:</i>	EXTWARRANTY	\$25 net fixed fee per chair (U.S.)
C133 \$46 CAL 133 textile on seat only. (add C133 to the end of the pattern number)		\$30 net fixed fee per chair (Canada)
	<i>Description:</i>	Addition of 3 years of field labor to the warranty for the Essentials Work Chairs. Standard warranty for Essentials Work Chairs does not include field labor.
	<i>Note:</i>	Please specify EXTWARRANTY from KCH - Knoll Special Charges catalog in design and specification software tools.

Essentials Tech

suspension back side chair

Designer(s):
Jeffrey Bernett, 2005



pattern no.	description
88S-2-FA-HC	Suspension back side chair with black finish, fixed arms, hard black casters
	
88S-2-NA-HC	Suspension back side chair with black finish, armless, hard black casters
	
SC	Soft Black Caster for hard floors (Substitute SC for HC in the pattern number)
GL	Glides (Substitute GL for HC in the pattern number)

Order Code

Example: **88S-2-FA-HC Seat:**
K1000/8 Back: S08

88S	Essentials Tech side chair
2	Black finish
FA	Fixed arms
HC	Hard wheel black caster
SEAT K1000/8	Presto Red Carpet
BACK S08	Red Carpet suspension back

Ordering Information

Specify:

1. Pattern number
2. Seat upholstery
3. Suspension back color

Code: *Finish Color:*
2 Black

COM Upholstery Requirements
Textile yardage required: .8 yards
Leather sq. ft. required: 10 sq. ft.

Essentials Grade Seat Options

Color options:

Presto Winter White	K10001
Presto Sand	K10002
Presto Stone	K10003
Presto Saffron	K10004
Presto Spring Green	K10005
Presto Blue Chip	K10006
Presto Scarlet	K10007
Presto Red Carpet	K10008
Presto Beige Taupe	K10009
Presto Olive	K100010
Presto Navy Blue	K100011
Presto Clear Gray	K100012
Presto Charcoal Gray	K100013
Presto Black Tie	K100014

Suspension Back Color Options

FOR BACK ONLY

Color options:

Red Carpet	S08
Beige Taupe	S09
Olive	S10
Navy Blue	S11
Clear Gray	S12
Charcoal Gray	S13
Black Tie	S14

pattern no.	list price essentials base grade	A	grade COM B	C	D	E	F	G	H	I	leather T	U	V	W	X	Y
88S-2-FA-HC	\$375.	\$388.	\$399.	\$414.	\$431.	\$447.	\$466.	\$476.	\$480.	\$492.	\$513.	\$558.	\$602.	\$677.	n/a	\$747.
88S-2-NA-HC	349.	364.	375.	390.	407.	424.	444.	453.	458.	471.	492.	538.	583.	661.	n/a	732.
SC	n/c															
GL	n/c															

Options

<i>CAL 133 Options:</i>			<i>Code:</i>	<i>Upchg:</i>
<i>Code:</i>	<i>Upchg:</i>	<i>Description:</i>	EXTWARRANTY	\$25 net fixed fee per chair (U.S.)
C133	\$46	CAL 133 textile on seat only. (add C133 to the end of the pattern number)		\$30 net fixed fee per chair (Canada)
<i>Description:</i>				
Addition of 3 years of field labor to the warranty for the Essentials Work Chairs. Standard warranty for Essentials Work Chairs does not include field labor.				
<i>Note:</i>				
Please specify EXTWARRANTY from KCH - Knoll Special Charges catalog in design and specification software tools.				

Essentials Tech

Seat and Back replacements for task and side chairs

pattern no.	description
ESSENWORK-SEAT	Replacement upholstered seat for Pro and Tech task chair
ESSENSIDESEAT	Replacement upholstered seat for Pro and Tech side chair
88WBACK	Replacement Tech task back
88SBACK	Replacement Tech side back

Designer(s):
Jeffrey Bennett, 2005



Order Code	Ordering Information	Essentials Base Seat Options	Suspension Back Color Options
<i>Example:</i> ESSENWORKSEAT - K1000/10	<i>Specify:</i>	<i>Color options:</i>	FOR BACK ONLY
ESSENWORK-SEAT Upholstered seat replacement	1. Pattern number 2. Seat upholstery or Suspension back color	Presto Winter White K10001 Presto Sand K10002 Presto Stone K10003 Presto Saffron K10004 Presto Spring Green K10005 Presto Blue Chip K10006 Presto Scarlet K10007 Presto Red Carpet K10008 Presto Beige Taupe K10009 Presto Olive K100010 Presto Navy Blue K100011 Presto Clear Gray K100012 Presto Charcoal Gray K100013 Presto Black Tie K100014	<i>Color options:</i> Red Carpet S08 Beige Taupe S09 Olive S10 Navy Blue S11 Clear Gray S12 Charcoal Gray S13 Black Tie S14
K1000/8 Presto Red Carpet	COM Upholstery Requirements Textile yardage required: .8 yards Leather sq. ft. required: 10 sq. ft.		

pattern no.	list price essentials base grade	A	grade COM B	C	D	E	F	G	H	I	leather T	U	V	W	X	Y
ESSENWORK-SEAT	\$99.	\$119.	\$132.	\$148.	\$167.	\$185.	\$207.	\$218.	\$222.	\$237.	\$261.	\$310.	\$358.	\$444.	n/a	\$522.
ESSENSIDE-SEAT	101.	124.	136.	151.	170.	187.	208.	218.	224.	237.	260.	308.	355.	437.	n/a	512.
88WBACK	160.															
88SBACK	130.															

Options

CAL 133 Options:

Code: Upchg: Description:
 C133 \$46 CAL 133 textile on seat only. (add C133 to the end of the pattern number)

Essentials Tech Dimensions and Operating Instructions

Seat

	Mid-back Chair	Side Chair
Seat Height	without seat slider 16.25" - 20.75" (std.), 15" - 19" (low) with seat slider 16.75" - 21.25" (std.), 15.5" - 19.5" (low)	17"
Seat Depth	16.9" (fixed), 16.25" to 19" (adjustable)	16.9"
Seat Width	19"	19"
Seat Pan Angle (at rest)	2°	2°

Back

Backrest Height	23"	17.5"
Backrest Width	19"	18.5"
Lumbar support	6.5"	6.25"
Angle Between Seat and Back	96°	103°
Tilt Range of Back	31° (synchro) 12° (swivel)	N/A

Arms

Armrest Height (fixed)	8.2"	9.4"
Armrest Height (adjustable)	7" - 10.5"	N/A
Inside Distance Between Armrest	20" - 21"	19.5"

Chair

A Overall Height (std cylinder)	38.25" - 42.75"	32"
B Overall Width	27"	21.75" (armless) 24" (with arms)
C Overall Depth	27"	24"
D Adj. Arm Height From Floor (std. cylinder) Fixed Arm Height From Floor (std. cylinder)	23" - 31.2" 24.2" - 28.7"	N/A 25.8"
E Adj. Arm Height (seat ref. pt.) Fixed Arm Height (seat ref. pt.)	7" - 10.5" 8.2"	N/A 9.4"
F Recline Range Back Recline Ratio	98° - 130° (synchro) 98° - 110° (swivel) 1:3 (synchro) 1:1 (swivel)	N/A N/A
G Base Diameter	27"	N/A
H Weight	38.6 lbs.	19.2 lbs. (armless) 22.5 lbs. (with arms)

Tech™ Task Chair

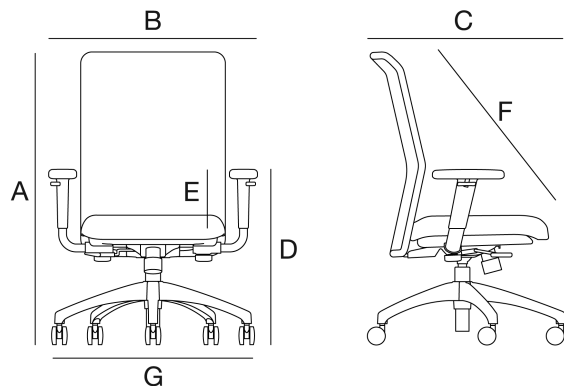

Tech™ Side Chair

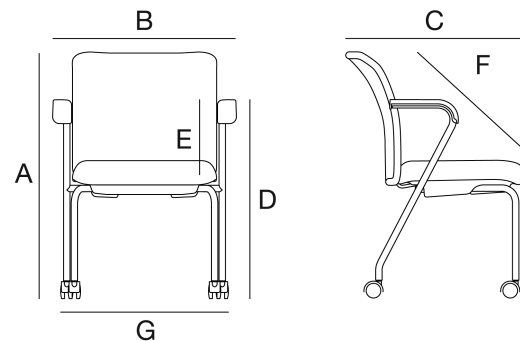

Essential Tech™ Task Chairs

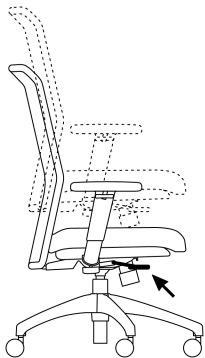

Seat Height

To raise the seat height, remove your weight from the chair while lifting the lever under the right side of the seat. To lower the seat height, lift the lever while sitting in the chair.

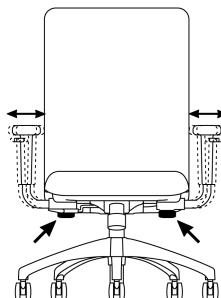

Adjustable Arm Width

To adjust the arm width, loosen the knob under the arm support by turning clockwise. Slide the support toward or away from the seat to adjust the arm width. Tighten the knob under the arm. The arms adjust 1/2" in width per side (1" total).

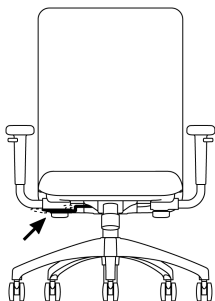

Tilt Lock

To recline, pull out the lever under the right side of the seat. To lock the chair upright, push the lever in.

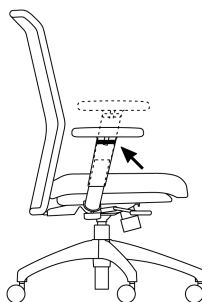

Adjustable Arm Height (Optional)

To adjust the arm pad height, lift the lever on the outside of the arm support and move the arm up or down. Release the lever to lock. The arms have a 3.5" range of adjustment.

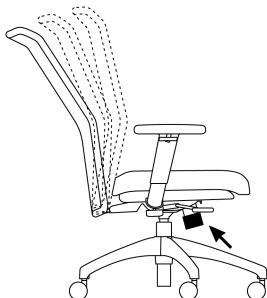

Tilt Tension

To adjust the tilt tension, turn the knob under the front of the seat. Turn counterclockwise to tighten, and clockwise to loosen.

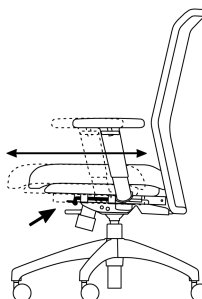

Sliding Seat Depth Adjustment (Optional)

To adjust the seat depth, lift the lever under the left side of the seat and slide the seat to the desired location. Release the lever to lock. There are 6 positions within a 2.75" range.

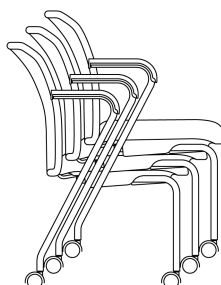







Essentials Tech™ Side Chair

This is a stacking side chair.

Chairs should not be stacked more than 3 units high. To stack chairs, place the rear legs of the top chair in front of the rear legs of the bottom chair. The bottom of the top chair's seat should rest on the lower chair's seat.

The SoHo Chair

task chairs

pattern no.	description	seat h min	seat h max	arm h min	arm h max	overall w, min	overall d, min	overall h min	overall h max
<i>Designer(s):</i> Roberto Lucci and Paolo Orlandini, 1994	28A-1-FD5GH armchair, upholstered seat and back	16"	21"	23 3/4"	28 3/4"	24"	22"	30"	35"
<i>Award(s):</i> I.D. Design Distinction Award, 1996; IIDA, L.A. Chapter, Acclaim Award, 1995	 28A-1-SD5GH armchair, upholstered seat only	16"	21"	23 3/4"	28 3/4"	24"	22"	29 1/2"	34 1/2"
	 28A-1-ND5GH armchair, non-upholstered	15 1/4"	20 1/4"	23 3/4"	28 3/4"	24"	22"	29 1/2"	34 1/2"
	 28C-1-FD5GH armless chair, upholstered seat and back	16"	21"			22"	22"	30"	35"
	 28C-1-SD5GH armless chair, upholstered seat only	16"	21"			22"	22"	29 1/2"	34 1/2"
	 28C-1-ND5GH armless chair, non-upholstered	15 1/4"	20 1/4"			22"	22"	29 1/2"	34 1/2"
	28FSEAT seat reupholstery assembly								
	28F1BACK back reupholstery assembly								

Order Code

<i>Example:</i>	28C-1-SD5GH-K642/28
28C	SoHo armless chair
1	dark grey finish
S	upholstered seat only
D5G	task chair
H	hard-wheel caster
K642/28	Mariner/tomato

Ordering Information

Specify:

1. Pattern number with finish color code.
2. Upholstery selection with color.

List prices shown include fabric or leather upholstery. Contact your Knoll representative for colors.

Finish color:
Dark grey (code 1)

Options

<i>Code:</i>	<i>Upchg:</i>	<i>Description:</i>
R	\$47	soft caster for hardwood floors (substitute R for H in pattern number)
G	n/c	glides (substitute G for H at the end of pattern number.)

Construction

Shell:
Integrally colored, textured polypropylene.

Upholstery:
High density CFC-free molded urethane foam. Fabric is permanently bonded to seat and back cushions.

Arms:
Integrally colored, textured, glass-reinforced nylon with polypropylene arm caps.

Base:
Integrally colored, textured glass-reinforced nylon. Five-star design. *Standard casters:*
Black, integrally colored, textured nylon; 2" dual hooded, hard-wheel design.

Glides:



Black, integrally colored, molded nylon; 2" caster; does not reduce height of chair.

pattern no.	list price	grades A	COM B	C	D	E	F	G	H	I
28A-1-FD5GH		\$624.	\$668.	\$713.	\$741.	\$764.	\$783.	\$811.	\$822.	\$857.
28A-1-SD5GH		568.	612.	656.	684.	707.	729.	753.	771.	800.
28A-1-ND5GH	513.									
28C-1-FD5GH		595.	638.	684.	712.	734.	753.	781.	792.	827.
28C-1-SD5GH		539.	582.	628.	655.	678.	701.	725.	741.	771.
28C-1-ND5GH	482.									
28FSEAT		124.	169.	215.	224.	229.	235.	264.	266.	309.
28F1BACK		124.	169.	215.	224.	229.	235.	264.	266.	309.

COM/COL Textile Requirement

chair fabric yds. .75

COM Policy:
Please see COM Process Overview at the beginning of this Price List.

SoHo chairs are designed to comply with and exceed the safety and durability requirements applicable to office chairs, according to the following national standards:

ANSI-BIFMA x5.1

ANSI-HFES 100 (except nonupholstered version)

California Technical Bulletin 117 (CAL117)

Upholstery on SoHo chairs is standard either on seat only, or on seat and back. Seat and back pads are shipped mounted to the chairs, and can be removed and reattached with special instructions from Customer Service.



Split upholstery option:
SoHo Chair seats and backs can be upholstered in any two fabric colors on standard lead time orders. To specify, first indicate the seat upholstery (labeled “seat upholstery”) and then indicate the back upholstery (labeled “back upholstery”). The list price of the chair equals the list price of the higher of the two upholstery grades.

KnollTextiles and Spinneybeck Leathers

Please refer to the matrices at the beginning of the price list for Approved Textiles and Leathers.

The SoHo Chair

side chairs

	pattern no.	description	seat h	overall w, min	overall d, min	overall h, min
<i>Designer(s):</i> Roberto Lucci and Paolo Orlandini, 1994 	28C-1-NSL	unupholstered seat and back, stacks to 10 high stacks to 10 high	17 1/4"	22"	22"	32"
	28C-1-SSL	upholstered seat only, non-stacking non-stacking	17 1/4"	22"	22"	32"
	28C-1-FSL	fully upholstered, non-stacking non-stacking	17 1/4"	22"	22"	32"
	28FSEAT	seat reupholstery assembly				
	28F1BACK	back reupholstery assembly				

Order Code

<i>Example:</i>	28C-1-SSL-K642/28
28C	SoHo armless chair
1	dark grey finish
S	upholstered seat only
SL	side chair
K642/28	Mariner/tomato

Ordering Information

Specify:

1. Pattern number with finish color code.
2. Upholstery selection with color.

List prices shown include fabric or leather upholstery. Contact your Knoll representative for colors.

Finish color:
Dark grey (code 1)

Construction

Shell:
Integrally colored, textured polypropylene.

Upholstery:
High density CFC-free molded urethane foam. Fabric is permanently bonded to seat and back cushions.

Base:
Powder coated steel frame.

COM/COL Textile Requirement

	fabric
	yds.
chair	.75

COM Policy:
Please see COM Process Overview at the beginning of this Price List.

pattern no.	list price	grades A	COM B	C	D	E	F	G	H	I
28C-1-NSL	\$249.									
28C-1-SSL		367.	409.	449.	475.	495.	514.	540.	557.	586.
28C-1-FSL		445.	485.	526.	552.	572.	592.	618.	633.	663.
28FSEAT		124.	169.	215.	224.	229.	235.	264.	266.	309.
28F1BACK		124.	169.	215.	224.	229.	235.	264.	266.	309.

KnollTextiles and Spinneybeck Leathers

SoHo chairs are designed to comply with and exceed the safety and durability requirements applicable to office chairs, according to the following national standards:

- ANSI-BIFMA x5.1
- ANSI-HFES 100 (except nonupholstered version)
- California Technical Bulletin 117 (CAL117)

Upholstery on SoHo chairs is standard either on seat only, or on seat and back. Seat and back pads are shipped mounted to the chairs, and can be removed and reattached with special instructions from Customer Service.



Split upholstery option:
SoHo Chair seats and backs can be upholstered in any two fabric colors on standard lead time orders. To specify, first indicate the seat upholstery (labeled “seat upholstery”) and then indicate the back upholstery (labeled “back upholstery”). The list price of the chair equals the list price of the higher of the two upholstery grades.

Please refer to the matrices at the beginning of the price list for Approved Textiles and Leathers.

The SoHo Dolly

pattern no.	description	seat h	arm h	w	d	h
28DOLLY	Dolly to transport up to 10 unupholstered SoHo side chairs			18"	30"	23 1/2"



Order Code

Example: **28DOLLY**
28DOLLY SoHo dolly

Specify:
 1. Pattern number.

Construction

Powder coated, silver-grey steel frame with rubber wheels.

Holds up to 10 unupholstered SoHo side chairs.

Upholstered chairs are not stackable.

Dollies can be stacked three high for compact storage.

pattern no.

list price

28DOLLY

\$399.

SoHo Dimensions and Operating Instructions

Seat

	Seat Height	Seat Depth	Seat Width	Seat Pan Angle	Seat Back/ Seat Pan Angle
ANSI HFS 100-1988, Compliance Code Standards:					
	16" - 20 ¹ / ₂ "	15" - 17"	18 ¹ / ₈ " min.	0° - 10°	90° - 105°
Task	16" - 20 ¹ / ₂ "	17" - 18 ¹ / ₂ "	19"	7°	95° - 105°
Side	18 ³ / ₄ "	18"	20"	7°	95° - 105°

Back

	Backrest	Lumbar Support Height	Lumbar Support Width	Lumbar Support Center	Seat Back Width
ANSI HFS 100-1988, Compliance Code Standards:					
	yes	6" - 9"	12" min.	6" - 10"	12" min.
Task	yes	7"	17"	8"	19"
Side	yes	7"	17"	8"	19"

Armrests

Width Between Armrests
18 ¹ / ₈ " min.
19 ¹ / ₄ "
n/a

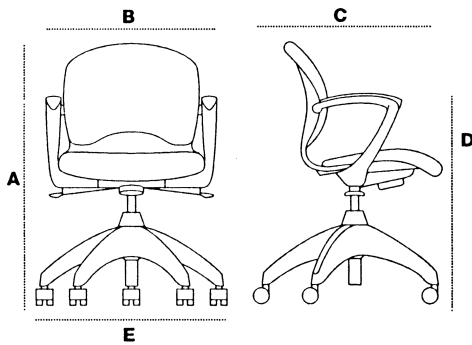

Arm Chair

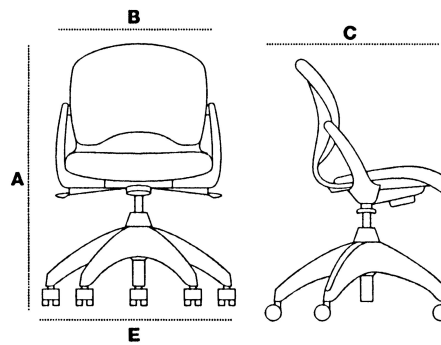

Armless Chair

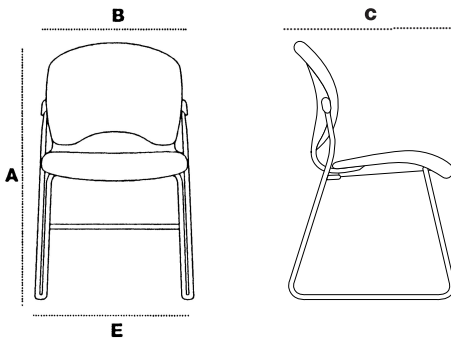

Side Chair

	Task Arm	Task Armless	Side
A overall height	30 ¹ / ₄ " - 35 ¹ / ₄ "	30" - 35"	32 ¹ / ₂ "
B overall width	24"	22"	22"
C overall depth	22"	22"	23"
D arm height	24" - 28 ¹ / ₂ "	n/a	n/a
E base diameter/depth	25 ¹ / ₂ "	25 ¹ / ₂ "	21 ¹ / ₄ "
weight	23 lbs.		

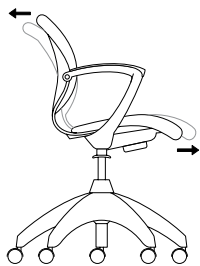
**Synchronized Sliding Seat and Back Tilt Mechanism**

To recline lean back with your weight and allow the seat to slide forward slightly as you recline.

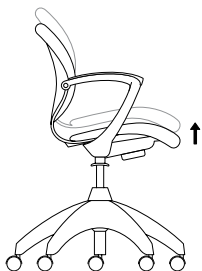
**Seat Height Adjustment**



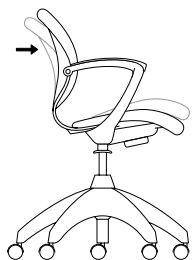

To adjust the height, lift the handle on the right side of the seat.

**Tilt Lock**

To lock the chair upright push down on the handle under the left side of the chair. Pull up on the lever to recline again.

Compliance: ANSI/BIFMA x 5.1 - 1993, ANSI/HFS 100-1988, Cal 117 on seat and back foam
Operating Instructions also available online at www.knoll.com

The Visor Chair

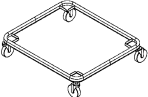
	pattern no.	description	seat h	arm h	w	d	h
<p>Designer(s): Emilio Ambasz</p> 	3C-SN-(3 or J) (BG,SR,FL,WL,CK)	armless chair, pivot back, fixed seat, non-gangling (does not come with ganging devices)	17 1/4"		21 1/4"	20 3/4"	30 1/2"
							
	3C-SG-(3 or J) (BG,SR,FL,WL,CK)	armless chair, pivot back, fixed seat, ganging (chair comes with ganging devices)	17 1/4"		22 7/8"	20 3/4"	30 1/2"
							
	3A-SN-(3 or J) (BG,SR,FL,WL,CK)	armchair, pivot back, fixed seat, non-gangling (does not gang)	17 1/4"	9 1/8"	24 2/3"	20 3/4"	30 1/2"
							
	3A-SG-(3,J) (BG,SR,FL- ,WL,CK)	Armed chairs with ganging hardware (must gang armed to armless; armed chairs with ganging hardware do not stack)					
	U	upholstered seat pad (add U after C or A in pattern number and fabric or leather code)					
	3VSRGANG (3,J)	retrofittable right and left ganging devices for armless chairs, instructions included (pair of gangers)					
	3CART	Cart to transport up to 10 upholstered or unupholstered chairs			20"	22 3/4"	4 1/2"
							

Order Code

<i>Example:</i>	3CU-SN-3CK-K584/2
3C	Visor armless chair
U	upholstered seat
S	fixed seat
N	non-gangling
3	silver frame finish
CK	Chalk shell finish
K584/2	Forza aluminum seat pad

Ordering Information

<i>Specify:</i>
1. Pattern Number
2. Frame finish
3. Shell finish
<i>Frame finishes:</i>
Silver (color code 3)
Medium Grey (color code J)

Options

<i>Shell finish options:</i>		
<i>Code:</i>	<i>Upchg:</i>	<i>Description:</i>
BG	n/c	Black Gloss
SR	n/c	Storm
FL	n/c	Flax
WL	n/c	Willow
CK	n/c	Chalk
<i>Cal 133 Option:</i>		
C	\$70	Insert C after the pattern code and 133 after the fabric selection for upholstered chairs. Please note that all unupholstered Visor Chairs are Cal 133 approved.

Construction

<i>Shell:</i>	Integrally colored ABS.
<i>Frame:</i>	Die cast aluminum frame with textured powder coat and clear coat finish.
<i>Ganging Device:</i>	Nylon with hex drive flathead screws.
<i>Cross tube:</i>	Steel under seat support tube with textured powder coat finish to match frame.

pattern no.	list price	grades A	COM B	C	D	E	F	G	H	I	T	COL U	V	W	X	Y
3C-SN-(3,J) (BG,SR,FL- ,WL,CK)	\$263.															
3C-SG-(3,J) (BG,SR,FL- ,WL,CK)	285.															
3A-SN-(3,J) (BG,SR,FL- ,WL,CK)	326.															
3A-SG-(3,J) (BG,SR,FL- ,WL,CK)	348.															
U		149.	177.	220.	234.	263.	285.	334.	377.	391.	450.	462.	526.	746.	789.	825.
3VSRGANG(3,J)	22.															
3CART	497.															

Specification Information

Recommended Stacking Height:
Arm chairs stack 5 high (58"). Armless chairs stack 10 high (58").

Ganging Information:
When a ganging chair is specified, the ganging hardware ships installed on the chair. Ganging kit may also be ordered for field retrofit. Chairs gang armless to armless or armed to armless. Armless chairs with ganging hardware also stack.

COM/COL Textile Requirement

	fabric yds.	leather sq. ft.
seat pad	.7	.9

Cal 133:
♣ = Cal 133 upholstery available. See textile matrix at the beginning of the Price List for pre-approved Cal 133 textiles.

Cart Construction

Frame:
Grey powder coated, welded oval steel extrusion.

Standard casters:
Black, integrally colored, textured nylon with steel fork and swivel stem.

Holds up to 10 stacked Visor upholstered or unupholstered chairs.

Visor Chair Dimensions and Configuration Instructions

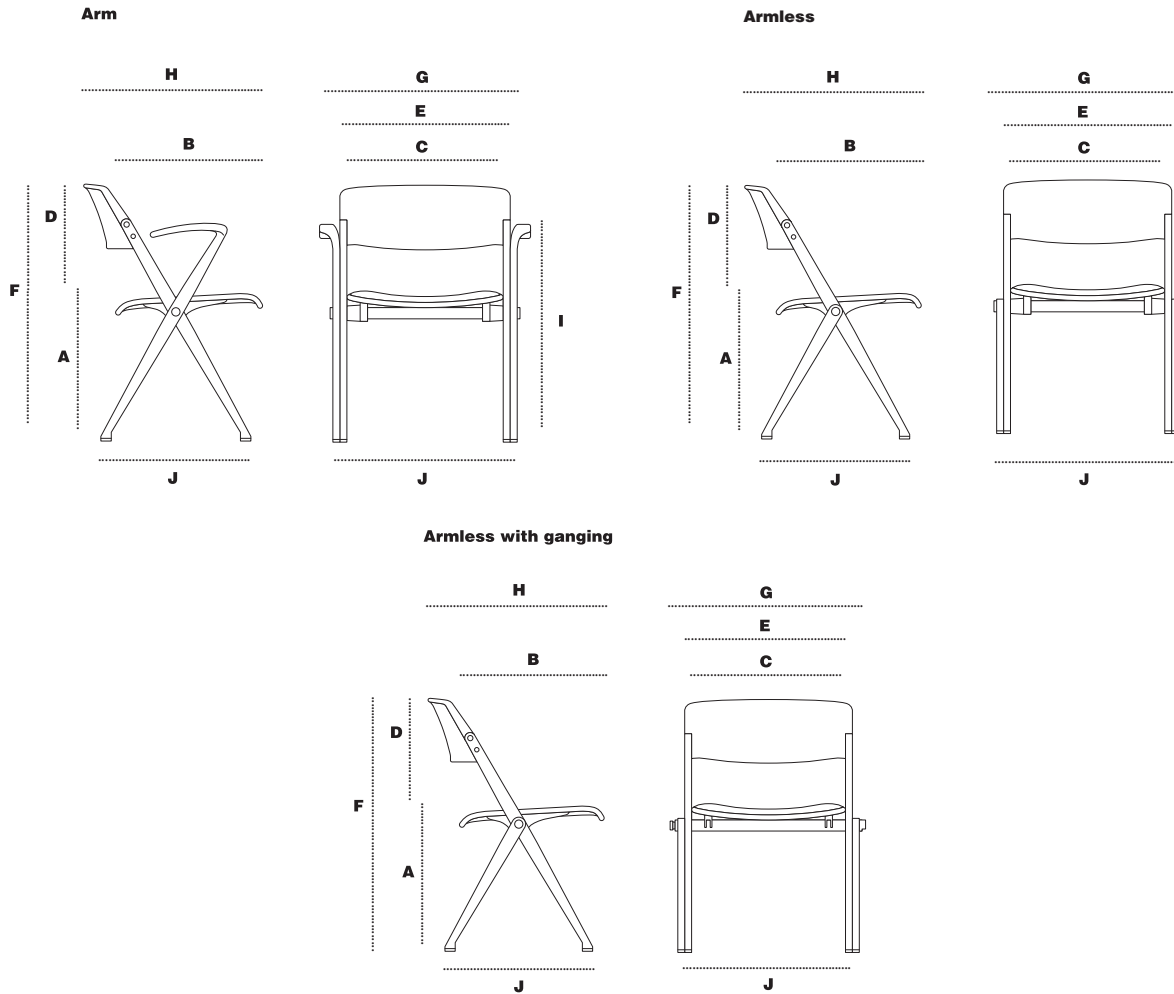

	Arm	Armless	Armless with ganging
A seat height at front edge of chair	17 1/4"	17 1/4"	17 1/4"
B seat depth	17"	17"	17"
C seat width	18"	18"	18"
D back height from seat	16"	16"	16"
E back width	19 1/2"	19 1/2"	19 1/2"
F overall height	30 1/5"	30 1/5"	30 1/5"
G overall width*	24 2/3"	21 1/4"	22 3/4"
H overall depth	20 3/4"	20 3/4"	20 3/4"
I arm height	9 1/8"	9 1/8"	9 1/8"
J footprint	20"W x 17 1/2"D	20"W x 17 1/2"D	20"W x 17 1/2"D
weight	16 lbs.	11 lbs.	11 lbs.

*Measurement changes among chair types.

Visor Armless Chair

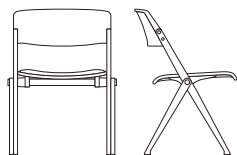
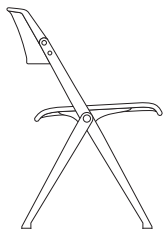

Pivot back is standard.

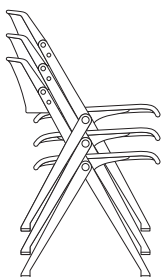

Stacking

- Armless chairs stack 10 high (58") from the floor.
- Chair stack vertically.
- Armless chairs stack by placing one chair directly on top of the other. Be sure the rear legs of the top chair rest directly on the rear legs of the chair below.

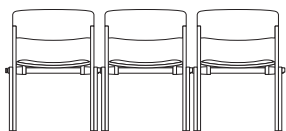

Ganging Option

- Chairs gang armless to armless or armed to armless.
- Ganging hardware ships installed when specified on the chair.
- Ganging hardware may also be installed in field. In this case, the ganging hardware must be ordered as a retrofit kit. When attached, the ganging hardware is a permanent part of the chair.

Visor Arm Chair

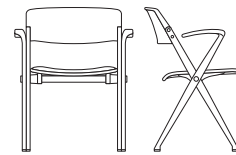
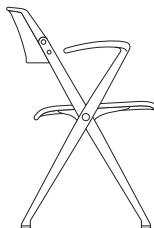

Pivot back is standard.

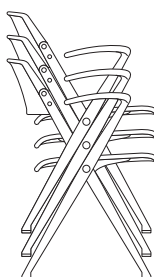

Stacking

- Arm chairs stack 5 high (43 1/2") from the floor.
- Chairs stack vertically.
- Arm chairs stack by placing one chair directly on top of the other. Be sure the rear legs of the top chair rest directly on the rear legs of the chair below.

Configuration Instructions also available online at www.knoll.com

<i>pattern no.</i>	<i>page</i>	<i>pattern no.</i>	<i>page</i>	<i>pattern no.</i>	<i>page</i>
28A-1-FD5GH	134	77W-MB-2-SY-FA-5-HC	110	L 70, 72, 74, 76, 110, 112, 114, 116, 124, 126	
28A-1-ND5GH	134	77W-MB-2-SY-HA-5-HC	110	S9013DSEAT	38
28A-1-SD5GH	134	77W-MB-2-SY-NA-5-HC	110	S9013RSEAT	38
28C-1-FD5GH	134	77WMIDBACK	120	S901A	30
28C-1-FSL	136	77WUHIGHBACK	120	S901C	30, 32
28C-1-ND5GH	134	77WUMIDBACK	120	S901P	30
28C-1-NSL	136	7A1-1-A5G-H	84	S903A	34
28C-1-SD5GH	134	7A1-1-B5G-H	84	S903C	34, 36
28C-1-SSL	136	7A3-1-A5G-H	82	S903P	34
28DOLLY	138	7A3-1-B5G-H	82	S908-2-SL-2	40
28F1BACK	134, 136	7A4-1-A5G-H	86	S908-4-SL-2	40
28FSEAT	134, 136	7A4-1-B5G-H	86	S908-C-SL-2	40
33-AA-1-BK-B-S-X-HC	72	7A5-1-A5G-H	88	SC 70, 72, 74, 76, 110, 112, 114, 116, 118, 124, 126, 128	
33-AA-1-BK-T-S-X-HC	70	7A5-1-B5G-H	88	SL 110, 112, 114, 116, 124, 126	
33-AA-2-BK-B-S-X-HC	76	7A8-1-SL	90	TA 70, 72, 74, 76	
33-AA-2-BK-T-S-X-HC	74	7C1-1-A5G-H	84	U 82, 84, 86, 88, 90, 110, 112, 114, 116, 118, 142	
33-FA-1-BK-B-S-X-HC	72	7C1-1-B5G-H	84		
33-FA-1-BK-T-S-X-HC	70	7C3-1-A5G-H	82		
33-FA-2-BK-B-S-X-HC	76	7C3-1-B5G-H	82		
33-FA-2-BK-T-S-X-HC	74	7C4-1-A5G-H	86		
33LUMBAR	70, 72, 74, 76	7C4-1-B5G-H	86		
33-NA-1-BK-B-S-X-HC	72	7C5-1-A5G-H	88		
33-NA-1-BK-T-S-X-HC	70	7C5-1-B5G-H	88		
33-NA-2-BK-B-S-X-HC	76	7C8-1-SL	90		
33-NA-2-BK-T-S-X-HC	74	7RB1	84		
3A-SG	142	7RB3	82		
3A-SN	142	7RB4	86, 88		
3CART	142	7RS2	86, 88		
3C-SG	142	7RS3	82, 84		
3C-SN	142	88S-2-FA-HC	128		
3VSRGANG	142	88S-2-NA-HC	128		
45A1-A5G-H	24	88SBACK	130		
45A1-SL	26	88WBACK	130		
45A3-A5G-H	22	88W-MB-2-ST-FA-5-HC	126		
45C1-A5G-H	24	88W-MB-2-ST-HA-5-HC	126		
45C1-SL	26	88W-MB-2-ST-NA-5-HC	126		
45C3-A5G-H	22	88W-MB-2-SY-FA-5-HC	124		
55A-3	44, 46, 48, 50, 54, 56, 58, 60	88W-MB-2-SY-HA-5-HC	124		
55BACKTOPPER	52, 62	88W-MB-2-SY-NA-5-HC	124		
55C-3	44, 46, 48, 50, 54, 56, 58, 60	8A4-2-A5GH	96		
55H-3	44, 46, 48, 50, 54, 56, 58, 60	8A4-2-A5KH	98		
55LUMBAR	52, 62	8A5-2-A5GH	100		
55P-3	44, 46, 48, 50, 54, 56, 58, 60	8A5-2-A5KH	102		
55SEATTOPPER	52, 62	8C4-2-A5GH	96		
6A8	104	8C4-2-A5KH	98		
6C8	104	8C5-2-A5GH	100		
6RS8	104	8C5-2-A5KH	102		
77S-2-FA-HC	118	8P4-2-A5GH	96		
77S-2-NA-HC	118	8P4-2-A5KH	98		
77SBACK	120	8P5-2-A5GH	100		
77SUBACK	120	8P5-2-A5KH	102		
77W-HB-2-ST-FA-5-HC	116	8RBACK	96, 98, 100, 102		
77W-HB-2-ST-HA-5-HC	116	8RSEAT	96, 98, 100, 102		
77W-HB-2-ST-NA-5-HC	116	8UPHBACK	96, 98, 100, 102		
77W-HB-2-SY-FA-5-HC	114	C	82, 84, 86, 88, 90, 104		
77W-HB-2-SY-HA-5-HC	114	ESSENSIDSEAT	120, 130		
77W-HB-2-SY-NA-5-HC	114	ESSENWORKSEAT	120, 130		
77WHIGHBACK	120	GL 70, 72, 74, 76, 110, 112, 114, 116, 118, 124, 126, 128			
77W-MB-2-ST-FA-5-HC	112	H	70, 72		
77W-MB-2-ST-HA-5-HC	112	J	44, 46, 48, 50, 54, 56, 58, 60		
77W-MB-2-ST-NA-5-HC	112				

Selling Policy

	<p>This Selling Policy supercedes all previous selling policies. Prices, discounts and product offerings are subject to change without notice.</p>
Terms & Conditions of Sales	<p>Sales by Knoll, Inc. or Knoll North America Corp. ("Seller") of Knoll Product Lines (hereinafter "Products") within the United States and Canada are made only on the terms which are contained in this Selling Policy. Seller hereby gives notice of its objection to any different or additional terms and conditions. This sale is expressly conditional upon Purchaser's assent to the terms and conditions set forth below. Additional terms and conditions may apply to KnollStudio and KnollTextiles orders. These terms and conditions may be modified or supplemented only by a written document signed by an authorized representative of Seller. These terms and conditions supercede any prior and/or contemporaneous agreements or correspondence between Purchaser and Seller. Written quotations expire thirty (30) days from the date of issuance and can be withdrawn by written notice anytime during that period. Where Purchaser and Seller have entered into the Knoll Electronic Terms and Conditions, all orders, acknowledgements, invoices and other business communications placed or transmitted in accordance with the Knoll Electronic Terms and Conditions shall be deemed to be in writing and signed and shall be valid for all purposes as if they were originated and maintained in documentary form.</p>
Ordering Information	<p>All orders must be in writing. The product pattern number(s) contained on Seller's order acknowledgement shall be the final expression of the order.</p>
Order Confirmation	<p>A purchase order is not binding on Seller until Purchaser has received Seller's order confirmation or acknowledgment.</p>
Pricing Policies	<p>List prices are subject to change without notice.</p> <p>List prices shall be those prices in effect on the date of receipt of a complete purchase order unless shipment is requested more than ninety (90) days after order entry in which case prices in effect on the date of shipment apply. List prices include specified freight costs. Unless specified in writing by Seller, no other charges are included in Seller's list prices.</p>
Taxes	<p>All sales, use, excise and other taxes applicable to the sale of the Products shall be paid by Purchaser. If Purchaser claims an exemption from any tax, Purchaser shall submit to Seller the appropriate exemption certificates.</p>
Terms of Payment	<p>Payment for one hundred percent (100%) of the net order amount is due within thirty (30) days of the date of invoice, which is issued upon shipment. In case of any discrepancies, such as shortages, and Seller is notified in writing within ten (10) days of receipt of Product, only that portion may be deducted and the balance paid. For orders greater than \$100,000 net, a one-third (1/3) deposit is due at the time of order placement, with the remainder due within thirty (30) days of the date of invoice.</p> <p>KnollStudio orders less than \$2,000 require payment for one hundred percent (100%) of the net order amount (including any applicable sales tax and charges for inside delivery, special packaging, etc.), due at time of order placement. For KnollStudio orders greater than \$2,000, a one-half (50%) deposit is due at time of order placement with the remainder (including any applicable sales tax and charges for inside delivery, special packaging, etc.) due prior to shipment.</p> <p>If, in the judgment of Seller, Purchaser's financial condition does not justify the terms of the payment, Seller may require full or partial payment in advance.</p> <p>Past due accounts shall be charged one and one-half percent (1.5%) per month, or the highest rate permitted by law, whichever is less, and will be added to the outstanding balance. In the event Purchaser defaults on payment, Purchaser shall be liable for all collection costs, including reasonable attorney's fees and costs.</p>
Changes and Cancellation	<p>Purchase orders may not be changed or cancelled, in whole or in part, without prior written consent of Seller. Changes may effect delivery dates. Expenses incurred because of changes shall be charged to Purchaser. In the event of cancellations, Purchaser will be liable for reasonable cancellation charges established by Seller. Orders for special Product, orders including "COM" (hereinafter defined) material and orders pursuant to expedited delivery programs, may not be canceled.</p>
Freight Prepaid	<p>Freight is prepaid and included in the price of all Products, except KnollTextiles, within the 48 contiguous United States and Canada, excluding the Yukon, Northwest Territories, Nunavut and Newfoundland. Packing is tested for rigorous motion and transportation but is not guaranteed to protect furniture from conditions over which the Seller has no control. If special packaging is required for any reason, please consult with your sales representative or dealer. Seller shall select the method of shipment and routing. All shipments shall be tailgate deliveries. Freight for all KnollTextiles orders is prepaid and added to the invoice.</p>
Delivery/Freight Charges	<p>Shipments outside the contiguous 48 United States and Canada shall be shipped F.O.B. Origin.</p> <p>For shipments outside the contiguous United States and Canada, Purchaser is responsible for the cost of freight from point of embarkation, including any handling and transportation charges incidental to loading at the point of departure and unloading at the final destination.</p> <p>Conditions beyond the control of Seller, including weather, available facilities and traffic conditions, may affect exact time of delivery. Seller shall not be responsible for specific carrier delivery date or time unless it has made a specific delivery commitment, in writing.</p> <p>Nonstandard methods of shipment and/or additional services are available upon request. Purchaser will be billed for the differential cost of any special services in excess of standard surface carrier freight costs. Premium charges, at Purchaser's request, will be added for airfreight, exclusive use of vehicle and extra, export or special packaging. Accessorial charges will be added for inside delivery, extra labor, reconsignment and redelivery.</p> <p>Partial shipments may be made and invoiced by Seller.</p>
Claims	<p>All shipments for all Knoll Products within the contiguous United States and Canada are F.O.B. Origin. Risk of loss passes to Purchaser at time of delivery to carrier. Purchaser shall inspect all Products upon receipt and notify Seller within ten (10) working days after receipt of any damage or defects which are, or should be, apparent from an inspection of the Product and its packaging. Failure of Purchaser to make a claim against carrier or notify Seller during the ten (10) working day period shall constitute acceptance of the Products and waiver of any apparent defects, errors or shortages. Seller will agree to repair or replace Product damaged in shipment if Purchaser has notified Seller of freight damage within ten (10) working days after receipt and assigns its rights against the carrier.</p>
Seller's Security Interest	<p>Until Seller receives the full payment for the Product, Seller shall have a security interest in the Product. Purchaser agrees to perform all acts, including but not limited to the execution and filing of documentation, which may be necessary to perfect and assure the security interest of Seller.</p>
Returns	<p>The return of Products without a written authorization by Seller shall not be accepted. To receive authorization for Product return, please call Customer Service. All Products that are returned pursuant to a valid authorization shall be subject to a twenty-five percent (25%) of list restocking charge. Products not currently offered for sale by Seller (including COM) shall not be authorized for return. All returned Products must be unused, in original condition and in the original Seller packing cartons. No refund or credit shall be given for damaged Products.</p>
Held Orders/Storage	<p>If Purchaser requests that an order be held or delayed, prices and terms and conditions in effect at the time of shipment shall apply. If Purchaser requests a delay after the time when Seller can defer production, Purchaser will be invoiced for the Product, payable in accordance with standard terms, when the order is ready for shipment. Seller may transfer the Product to storage, in which case all expenses incurred in connection with storage, including demurrage, preparation for storage, storage charges and handling shall be payable by Purchaser upon submission of invoices by Seller. Risk of loss to the Product shall pass to the Purchaser upon delivery of the Product into storage.</p>

Selling Policy

Customer's Own Material	<p>A Purchaser who requests a fabric or other surface material not standard to Seller's line of Products ("COM") must submit samples of the requested material to Seller prior to entry of a purchaser order. Seller shall determine if the material is suitable to its manufacturing processes and meets any requirements of Underwriters Laboratories. If the COM is acceptable, Seller will then establish a price for using the COM or the Product in question. For a description of the procedures for submitting samples and testing, contact customer resources or your sales representative. Seller shall have no responsibility for the appearance, condition, performance, durability, colorfastness or any other physical attribute of the COM. Purchaser shall indemnify and hold Seller harmless for any damages, injuries or losses arising out of or related to use of the COM on the Product.</p>
Warranty	<p>Seller warrants to the original Purchaser only that the Products Seller manufactures and sells to Purchaser are free of defects in workmanship and materials, during the applicable warranty period set forth below.</p> <p>Should any failure to conform with this limited warranty appear to a Product listed below during the applicable warranty period from the date of shipment, Seller shall, upon prompt written notice, repair or replace, at its option and costs, the affected part or parts.</p> <p><i>Product and Period of Warranty</i></p> <p><i>Lifetime: AutoStrada, Calibre, Crinion Open Table, Currents, Dividends, Equity, Morrison, Reff</i> laminate and other non-wood components (except cascade edge worksurfaces, operational parts, controls, electrical, special or custom products, see below)</p> <p><i>10 Years: AutoStrada, Crinion Open Table and Reff</i> wood components, wood casegoods, <i>Interaction</i> tables (except height adjustment mechanisms for <i>Counterforce</i>, crank-adjustable, and split-top tables and worksurfaces, see below), <i>Reuter</i> overheads, <i>Reuter</i> vertical storage, <i>Bulldog, Chadwick, Essentials Work Chairs, Life, RPM</i> and <i>Sapper</i> seating structural and operational parts, controls, casters, pneumatic cylinders, seat and back mesh (except seating upholstery, finishes and labor, see below)</p> <p><i>5 Years:</i> Operational parts, controls, electrical (except light ballasts and bulbs, see below), cascade edge worksurfaces, special or custom product, wood veneer products, <i>A3, Currents</i> handcrank, <i>Interaction Counterforce, Interaction</i> crank-adjustable, and split-top mechanisms, <i>KnollStudio, KnollExtra</i> adjustable keyboard supports, VDT carousel, monitor platform, equipment storage drawers and all universal storage drawers, <i>Open Up, Visor</i> and <i>SoHo</i> seating structural and operational parts, controls, pneumatic cylinders (except seating upholstery, finishes and labor, see below)</p> <p><i>3 Years:</i> Upholstery, finishes and labor to repair the following chairs: <i>Bulldog, Chadwick, Life, Open Up, Parachute, RPM, Sapper</i> and <i>SoHo</i>.</p> <p><i>2 Years:</i> All other <i>KnollExtra</i> product</p> <p><i>1 Year:</i> Light ballasts and bulbs and <i>Equity</i> fiberglass panels, seating upholstered armpads and soft armpads, <i>Visor</i> finishes and labor to repair.</p> <p>This warranty does not apply to:</p> <ul style="list-style-type: none">• Damage caused by a carrier other than the Seller.• Normal wear and tear or acts or omissions of parties other than Seller (including user modification).• COM or other third party materials applied to Products.• Products not installed by or under the auspices of a certified dealer of Seller.• Dramatic temperature variations or exposure to unusual conditions.• Except as specifically noted above, textiles and upholstery supplied by <i>KnollTextiles</i> (consult current <i>KnollTextiles</i> price list for applicable warranty).• Labor to repair or replace Essential Work Chairs affected part or parts. <p>Natural variations occurring in wood, marble, and leather shall not be considered defects, and the Seller does not guarantee the colorfastness or matching of the colors, grains or textures, or surface hardness of such materials. The Seller also does not guarantee the colorfastness of fiberglass panel surfaces. THE EXPRESS WARRANTIES CONTAINED HEREIN ARE IN LIEU OF ALL OTHER WARRANTIES, EXPRESS OR IMPLIED, INCLUDING ANY WARRANTIES OF MERCHANTABILITY AND FITNESS FOR PARTICULAR PURPOSE AND ALL OTHER WARRANTIES ARISING FROM COURSE OF DEALING OR USAGE OF TRADE.</p> <p>The remedies provided above are the Purchaser's sole remedies for any failure of Seller to comply with its obligations regarding the workmanship of its Products. Correction of any nonconformity in the manner and for the period of time provided shall constitute complete fulfillment of all liabilities of Seller, with respect to or arising out of the Product furnished hereunder.</p>
Delay/Force Majeure	<p>Seller shall not be liable for failure to perform or for delay in performance due to fire, flood, strike or other labor difficulty, act of God, act of any governmental authority or of the Purchaser, riot, embargo, fuel or energy shortage, wrecks or delay in transportation, inability to obtain necessary labor, materials or manufacturing facilities from usual sources or failure of suppliers to meet their contractual obligations, or due to any cause beyond its reasonable control. If any such event occurs, Seller may extend delivery dates by a period of time necessary to overcome the effect of such delay, allocate available Product or cancel any purchase order.</p>
Compliance with Law	<p>PURCHASER IS SOLELY RESPONSIBLE FOR COMPLIANCE WITH ALL APPLICABLE FEDERAL, STATE AND LOCAL LAWS, ORDINANCES, REGULATIONS, RULES AND STANDARDS RELATING TO THE INSTALLATION, MAINTENANCE, USE AND OPERATION OF THE PRODUCTS.</p>
Patents	<p>Subject to the following provisions, Seller shall, at its own expense, defend or, at its option, settle any claim, suit or proceeding brought against the Purchaser, and/or its vendees, mediate and immediate, so far as based on an allegation that any Product or any part thereof furnished hereunder constitutes a direct or a contributory infringement of any claim of any patent of the United States or Canada. This obligation shall be effective only if Purchaser shall have made all payments then due hereunder and if Seller is notified promptly in writing and given authority, information and assistance for the defense of said claim, suit or proceeding. Seller shall pay all damages and costs awarded in such suit or proceedings so defended.</p> <p>The foregoing indemnity does not apply to the following:</p> <ul style="list-style-type: none">• Products supplied according to a design other than that of Seller, and which is required by the Purchaser.• Combination of the Product with another product not furnished hereunder unless Seller is a contributory infringer.• Any settlements of a suit or proceeding made without Seller's written consent.
Limitations of Liability	<p>SELLER, ITS CONTRACTORS, AUTHORIZED DEALERS AND SUBCONTRACTORS OR SUPPLIERS OF ANY TIER SHALL NOT BE LIABLE TO PURCHASER FOR ANY SPECIAL, INDIRECT, INCIDENTAL OR CONSEQUENTIAL DAMAGES ARISING FROM A BREACH OF THIS AGREEMENT.</p> <p>Purchaser's remedies set forth herein are exclusive and the liability of Seller with respect to the breach of this agreement or any contract entered into between the parties pursuant hereto shall not exceed the price of the Product or part on which such liability is based.</p>

General Ordering Information

The Products

This guide encompasses all standard products for this product group.

Sizes

Dimensions listed in this guide are indicated as:

H = height

W = width

D = depth

Dia. = diameter

Rad. = radius

Pricing

All prices shown are list.

How to Order

Select pattern numbers and quantities required for your complete installation. Product questions can be addressed in the specific sections of this guide or by contacting your sales representative or customer resource representative at 1-800-343-5665.

Next, select options (if required), along with colors and finishes appropriate to each product. Reference the Finishes and Fabrics pages for color designations.

On large installations, an item's "designated area" can be specified to assist in product organization and handling.

To expedite complete / correct entry of your order, be certain all pattern numbers, quantities, colors and area identifications are completely specified. Also, include complete purchase order numbers, bill-to and ship-to addresses, a contact name and specific factory shipping dates required.

Mail all orders to:

Knoll, Inc.

1235 Water Street

P.O. Box 157

East Greenville, PA 18041

Attention: Order Entry

Once your order is entered at Knoll, an acknowledgment will be mailed to you. You will be advised of your scheduled shipping date within five days of the original acknowledgment. If it is necessary to revise your order, please contact your customer resource representative.

Sustainability Statement

Sustainable design is a key component of Knoll's environmental focus. Our commitment to social responsibility and a healthy environment has prompted us to further articulate our longstanding environmental programs and, with encouragement and support from our colleagues in the industry, we have re-energized our focus on such "green" initiatives as life cycle analysis and LEED™ certification. Knoll is proud to have contributed to projects that have received LEED certification from the U.S. Green Building Council.

For the latest information on Knoll products that help our customers achieve LEED certification, log on to knoll.com, click on "About Knoll" and then "Environmental Focus."