

CALIBRE

Price List
July 2014



Knoll

Introduction	Knoll and Sustainable Design	2
	Lateral File Planning Overview	3
	Lateral File Sample Bid Technical Specifications	8
	Built-to-Spec Lateral File Considerations	11
	Ordering Calibre Files and Storage	12
	Ordering the Calibre Pedestal	13
	Ordering the Calibre Desk	14
	Calibre Files and Storage	15
	Calibre Pedestal	17
Calibre File Collection	Calibre Desk	19
	Calibre Front Lateral Files - Preconfigured	20
	Calibre Front Hybrids	38
	Calibre Front Wardrobes	41
	Calibre Front Cabinets	44
	Lateral File Worksurface Tops	51
	Calibre Add-on Modules	57
	Calibre Bookcases	58
	Planning Built-to-Spec Calibre Lateral Files	62
	Built-to-Spec Worksheet	63
	Calibre Front Lateral Files- Built-to-Spec	64
	Calibre Front Lateral Files with Individual Locking Drawers	71
	Series 2 Front Lateral Files	76
Calibre File Accessories	79	
Calibre Front Pedestals	Calibre Pedestals	82
Calibre Front Pedestals with Individual Locking Drawers	Calibre Pedestals	102
	Calibre Pedestal Accessories	107
Calibre Front Storage Towers	15" Wide Storage Towers	110
	24" Wide Storage Towers	118
	24" Wide Storage Towers - Full Height Doors	132
	30" Wide Storage Towers	138
	50" High 3/10/10	147
	57" High 3/10/10	148
	64" High 3/10/10	149
	Calibre Tower Accessories	151
Calibre Desk	Calibre Desk	158
	Task Lights	178
Wall Mounting of Knoll Products		179
Alpha-Numeric Index		181
Selling Policy		186
KnollKey Lock Program		188
General Ordering Information		189

Knoll and Sustainable Design

Each year Knoll sets key initiatives in our journey to sustainability. We are members of a global consortium on energy, have adopted a scientific, metrics-based approach to sustainable product design, and maintain a leadership position in establishing universal, verifiable, sustainability standards for our industry.

Knoll promotes independent third-party certification because it provides the most impartial and trustworthy foundation for industry-wide environmental compliance. Certification by established and respected third parties ensures that all manufacturers are held to the same high standards and that customers can trust a company's declaration about the environmental benefits of its products. Knoll third-party partners include: the International Standards Organization (ISO); Forest Stewardship Council (FSC®); Rainforest Alliance; GREENGUARD® Environmental Institute; and The Business and Institutional Furniture Manufacturer's Association (BIFMA) level® certification from Scientific Certification Systems (SCS).

In addition, Knoll is aligned with the U.S. Green Building Council and can help companies, healthcare organizations and educational institutions achieve Leadership in Energy and Environmental Design (LEED®) workplace certification.

Global Climate Change

- Knoll is a sponsor of the Clinton Global Initiative, which brings together a community of global leaders to devise and implement solutions to some of the world's most pressing challenges, including environmental change.
- Knoll has a comprehensive Energy Management Program to increase energy efficiency in products and processes.

Life Cycle Assessment (LCA) Tool

- Life Cycle Assessment is a science-based measurement of a product's environmental impacts throughout its life cycle, from raw materials sourcing through manufacture, shipping, use and re-use or end-of-life. LCA enables cradle-to-cradle implementation of sustainable practices.
- Knoll has partnered with The Green Standard.org to develop an affordable, universal ISO-compliant computer-based LCA tool that can be used by the entire contract furniture industry and is partnering on the development of an Environmental Product Declaration System (EPDs) for Knoll products. EPDs are verified documents containing LCA results and additional environmental performance information about a product.

Setting Industry Standards

- Knoll partners with MTS (The Institute for Market Transformation to Sustainability) to develop the SMaRT® Consensus Sustainable Products Standards, a set of consensus-based sustainable product standards based on the LEED® model, for all building products, fabric, apparel, flooring and carpet. MTS, the developer of SMaRT®, is an accredited American National Standards Institute (ANSI) standard developer.
- Knoll also partners with BIFMA (Business and Institutional Furniture Manufacturers Association) to promote level® sustainability standards for the contract furniture industry.
- Knoll has established FSC® (Forest Stewardship Council) certified wood as the standard for general office open plan office systems, casegoods and tables.
- Knoll has launched Full Circle, a resource recovery program developed with ANEW, to help customers extend the life cycle of surplus furniture, fixtures and equipment (FF&E) in an economically, socially and environmentally responsible manner.
- Our goal is to encourage all manufacturers in the contract furniture industry and related industries to adopt standards that will lead to sustainable products and practices.

For more information about Knoll and sustainable design, visit knoll.com/environment.

Calibre files are available in pre-configured and built-to-spec models that incorporate a flexible 1.5" planning module to optimize the best use of space within a case. Most applications can be satisfied with pre-configured files, which are available in the most common configurations. For special applications Calibre can be ordered built-to-spec, which allows thousands of drawer and door configurations.

Lateral Files, Pre-configured

Calibre pre-configured files are available in 10 heights and 3 widths. All feature the use of a 1.5" vertical planning module. The 1.5" planning module makes better use of space by more efficiently storing and maintaining files, binders, office supplies and other articles as compared to a traditional 3" planning module. There are 9 drawer/door modules heights available to support front-to-back or side-to-side filing of letter, legal, A4, JIS, standard binders and EDP paper sizes.

Lateral Files, Built-to Spec

Calibre, built-to-spec files allow a wide variety of drawer and shelf

options. Through the combination of the 10 case heights and the 9 drawer modules, thousands of custom case configurations are possible to meet any special application.

Hybrids Pre-configured

Hybrid storage units combine hinged doors to store binders and supplies with 12" file drawers to support filing. Hybrids are available in heights of 55.5", 63" and 64.5" in widths of 30" and 36".

Cabinets Pre-configured

A variety of pre-configured storage cabinets with adjustable shelves are available with or without doors in 6 heights and 2 widths. In addition, 3 heights (55.5", 63" and 64.5") and 2 models (Standard and Vertically divided) of wardrobes are offered: a full width wardrobe with two doors, top shelf and coat rod and a vertically divided wardrobe with adjustable shelves on one side and a coat rod on the other. Think of using a Calibre cabinet without doors when you want to have the appearance of a bookcase when aligning a cabinet next to lateral files. Cabinets have the same base detail (1 1/2" tall) of lateral files, as well as the same

overall depth of 18". A Calibre bookcase on the other hand is only 15" deep and has a 2 1/16" high base.

Doors are available in standard Calibre style or with fronts that complement the aesthetic of the Morrison system. Locks are optional for models with doors.

Note: Morrison front cabinets are 18 7/8" deep compared to Calibre, which are 18" deep.

Add-on Modules

Calibre lateral files maybe augmented with add-on modules that help make maximum use of vertical space. Add-on modules are available in 4 nominal heights and 3 widths and can be mounted to any standard Calibre lateral file. Add-on units come with two hinged doors. 27" and 30" modules include one adjustable shelf. Modules are available with or without locks.

Note: The actual overall exterior height of Calibre Add-on modules is 14 7/8", 16 3/8", 28 3/8" and 31 3/8"

Add-on modules are for use with Calibre files only. Calibre files, and Add-on modules are 18" deep. Morrison or S2 front lateral files are

18 7/8" deep and have overlay fronts instead of inset fronts as is the case with Calibre files. Therefore, neither Morrison nor S2 front lateral files will accept an Add-on module. Add-on modules will attach to Calibre files manufactured prior to 2003. There is a limit of one Add-on module per case.

How would you or why would you use an Add-on module?

1. Add-on modules allow for the creation of 6 high or taller case configurations. Match a 55.5" high case (with 5-10.5" drawers) with a 13.5" nominal height Add-on module and you have a low profile 6 high case that provides high-density filing for hanging file folders with an easily accessed space for binder storage.
2. Add-on modules can provide additional storage capacity for binders and supplies by making better use of vertical space. Both 27" and 30" Add-on modules will accommodate two rows of standard size binders.
3. Add-on modules provide more design flexibility by extending the range of case heights.

Module Application and size

Drawer Modules

	Application	Ext H.	Int H.
15" Rollout drawer with hanging rails	EDP, oversized binders, A4 and standard binders	14 7/8"	14 3/8"
13.5" Rollout drawer with hanging rails	Binders, top tab files or tape seals	13 3/8"	13 1/8"
12" Rollout drawer with hanging rails	Top tab hanging and non-hanging files or end tab files	11 7/8"	11 3/8"
10.5" Rollout drawer with hanging rails	Top tab hanging and non-hanging file folders	10 3/8"	10 1/8"
9" Rollout drawer	Oversized specialty items and supplies	8 3/8"	8 3/8"
7.5" Rollout drawer	5 1/4" diskettes, audio tapes and CD-ROM jewel cases	7 3/8"	7 1/8"
6" Rollout drawer	Index cards, microfilm, 3 1/2" diskettes and video tapes	5 7/8"	5 3/8"
3" Rollout drawer	Pens, pencils, business cards and other smaller office supplies	2 7/8"	2 3/8"
1.5" Reference/posting shelf	Touch down platform for sorting or stacking files or documents	1 3/8"	N/A

Drawer Modules*

	Application	Ext H.	Int H.
15" Receding door fixed shelf	EDP, oversized binders, A4 or standard binders	14 7/8"	13 1/4"
13.5" Receding door fixed shelf	Standard binders or suspended top tab files or tape seals	13 3/8"	11 3/4"
12" Receding door fixed shelf	Top tab hanging and non-hanging files or end tab files	11 7/8"	10"
15" Receding door pullout shelf	EDP, oversized binders, A4 or standard binders	14 7/8"	13 1/4"
13.5" Receding door pullout shelf	Standard binders or suspended top tab files or tape seals	13 3/8"	11 3/4"
12" Receding door pullout shelf	Top tab hanging and non-hanging files or end tab files	11 7/8"	10"

*Interior height is reduced by 15" at hinge location

To prevent lateral file/tower from tipping over and causing injury:

- Read and follow installation instructions shipped with each lateral file/tower before use. Consult your Knoll dealer for further details.
- Lateral files/towers must be leveled using adjustable glides in the base.
- Lateral files should be ganged (connected) to adjacent lateral files or anchored to a floor or wall. If not ganged or anchored the lateral file must be counter-weighted using counter weight kits recommended in the installation instructions.
- Each lateral file and some towers are equipped with a safety interlock system which prevents opening more than one drawer at a time. Do not attempted to override the interlock system by opening two drawers simultaneously, since the lateral file/tower may tip. (Does not apply to all towers.)
- Load tower drawers first and place the heaviest items in the lowest drawer. Reverse the process when unloading. Distribute weight evenly within each drawer.

It is recommended that all 27"h, 34.5"h and 39"h files be ganged together, to a wall/floor or utilized a counter weight kit to prevent topping when fully loaded.

Failure to follow these instructions could result in personal injury or property damage.

Filing Planning

Calibre pre-configured files include 1.5", 3", 6", 7.5", 10.5", 12", 13.5" and 15" drawer and door modules. The 12", 13.5" and 15" drawers are designed to handle all standard paper sizes including:

- Letter (8½" X 11")
- Legal (8½" X 14")
- A4 Foolscap (9½" X 14⅓")
- JIS (9⅓" X 12¼")
- EDP (8½" X 15")

The 10.5" drawer module is designed to handle:

- Letter (8½" X 11")
- Legal (8½" X 14")

Note: Only 12", 13.5" and 15" modules are available as receding doors with either fixed or pull-out shelves.

Filing Volume and Weights

The paper size or media to be stored will determine the best width of file to specify. In applications requiring high-density letter-sized documents filed front-to-back, the most efficient file widths are 30" and 42". Files that are 36" wide work efficiently to store legal-sized documents in front to back configurations and do not efficiently handle letter-sized documents.

Finding the Optimum Storage Configuration:

- 30" width (Front-to-Back) = Letter 31.5 Filing Inches
- 30" width (Side-to-Side) = Legal 26¾ Filing Inches
- 36" width (Front-to-Back) = Letter 31.5 Filing Inches
- 36" widths (Side-to-Side) = Legal 32¾ Filing Inches
- 42" widths (Front-to-Back) = Letter 47 Filing Inches
- 42" widths (Side-to-Side) = Legal 38¾ Filing Inches

Example: If 12' of open wall space were available for 51" high files with 4-12" drawers, two options would be possible:

- Option A:** Four 36" wide files
- Option B:** Two 42" and two 30" wide files

If the usage was for letter-sized documents filed front-to-back, option A would provide 504 total filing inches, while option B would allow 628 total filing inches in the same square footage.

Calibre Lateral File Approximate Case Weights (Empty Units)

27" High File with 2-12" drawers:

- 30"w (98 lbs.)
- 36"w (110 lbs.)
- 42"w (123 lbs.)

39" High File with 3-12" drawers:

- 30"w (133 lbs.)
- 36"w (150 lbs.)
- 42"w (167 lbs.)

51" High File with 4-12" drawers:

- 30"w (169 lbs.)
- 36"w (190 lbs.)
- 42"w (211 lbs.)

63" High File with 5-12" drawers:

- 30"w (208 lbs.)
- 36"w (233 lbs.)
- 42"w (258 lbs.)

All drawers support up to .017 pounds per cubic inch of volume assuming the interior height is no more than 12" high.

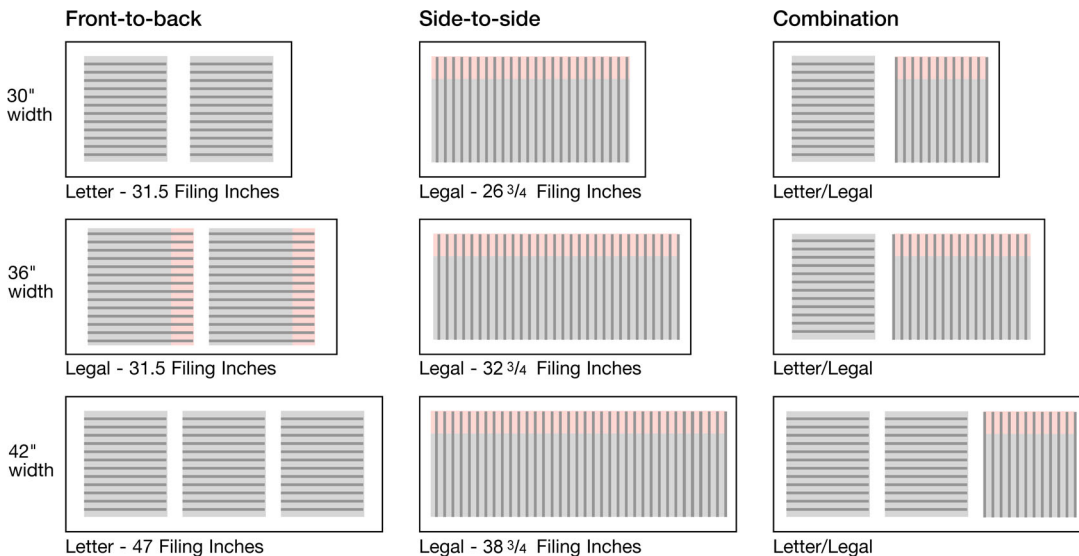

Knoll Panel Height Matrix Alignment to Knoll Calibre Lateral Files

Reff Panel		34	42			49							64		
File Height	26.843		38.843	44.843			50.843	53.843	55.343		58.343		62.843	64.343	
Dividends Panel			42				50			57				64	
File Height	26.843		38.843	44.843			50.843	53.843	55.343		58.343		62.843	64.343	
Currents Panel			39			48								3	64
File Height	26.843		38.843	44.843			50.843	53.843	55.343		58.343		62.843	64.343	
Equity Panel		28		40		48			53				60		65
File Height	27.403		39.403	44.843			51.403						63.403		
Morrison Panel		30		39	42		48			56				64	74
File Height	26.843		38.843	44.843			50.843	53.843	55.343		58.343		62.843	64.343	65.875

Note: Knoll Systems are listed with the Calibre file heights that best match their overall panel heights. Both the files and panels are listed with glides fully retracted. Calibre files provide $\frac{3}{4}$ " vertical glide adjustment. Plan for the optimization of filing and storage rather than the visual alignment of the drawers between storage solutions. Calibre files are built on a 1.5" planning module with a 12" high drawer head that is actually 11.900" tall. Pedestals have 12" high drawer heads that are 11.733" tall. Therefore, pedestals drawers will not align with file drawers when combined within a workstation. If a lateral file look next to a pedestal is desired, then specify a doublewide pedestal in place of the lateral file, below the worksurface. Doublewide pedestals share the same 11.733" tall drawer height of the pedestal.

Understanding Pattern Numbers for Calibre Lateral Files

The first eight characters of the alpha/numeric pattern numbers for Calibre, Morrison or S2 files, refers to the type of front, the height and width of the case and whether it is non-lock or locking.

Example First 8 Characters: C2F5536CDDDDD

C = Calibre front

2 = Generation code

F = File

55 = Nominal height of the case

36 = Width

C = Locking

The remaining characters address the height of the component from the top to the bottom of the file.

Example Last Characters: C2F5536CDDDDD

D = 10.5" Drawer

D = 10.5" Drawer

D = 10.5" Drawer

D = 10.5" Drawer

D = 10.5" Drawer

A character is required at the end of pattern number to designate the finish code. In some instances there may be a need for additional characters or character substitutions to add options to the product. An example of this is the specification of reference/posting shelves. Pre-configured files come standard with a tie bar/lateral spanner that is denoted with a product pattern code of "K" within the parent pattern number. If a reference/posting shelf is required, you must replace the "K" code with a "J" code within the parent product pattern number and add a list price up-charge.

General Product Description

- A.** Files shall be of contemporary styling, with a steel top, side panels, back panel, full bottom, rollout drawers and shelves mounted on ball bearing suspensions, receding doors, fixed shelves, interlocking drawers and individual locking drawers. Available with or without locks. Individual locking drawers are also available with or without security separators.
- B.** Lateral File sizes that must be available:
Depth: 18" (Must accommodate letter or legal width files)
Widths: 30", 36" and 42"
Nominal Drawer Head Heights: 3", 6", 7.5", 9", 10.5", 12", 13.5" and 15"
Nominal reference shelf: 1.5"
Overall height of cases with glides fully retracted: 27", 34.5", 39", 45", 51", 54", 55.5", 58.5", 63" and 64.5"
- C.** Hybrids sizes that must be available:
Depth: 18"
Width: 30" and 36"
Drawer hand heights: 3", 6", 7.5", 9", 10.5", 12", 13.5" and 15"
Overall height of cases with glides fully retracted 55.5", 63" and 64.5"
- D.** Cabinets sizes that must be available
Depth 18"
Widths: 30" and 36"
Overall height of cases with glides fully retracted 27", 34.5", 39", 51", 55.5", 63" and 64.5"
- E.** Add-on Modules
Depth 18"
Widths: 30", 36", 42"
Overall height of cases: 14⁷/₈", 16³/₈", 28³/₈", 31³/₈"

Case

- A.** The wrapper, comprising the side panels and back panel, shall be 22-gauge steel with formed 20 gauge steel vertical channels to support the mounting of drawer slides and shelves. Vertical channels shall be welded to the base assembly. In addition the vertical channels shall be glued and welded to the wrapper.
- B.** Back panel shall be constructed from 22-gauge steel with a formed vertical channel of 20 gauge steel. The vertical channel

shall be welded to the base pan and back, along with the use of an adhesive. In addition to increasing the overall structural integrity of the case, the vertical channel reinforcement shall also support the installation of divider septum's.

- C.** Top pan shall be of 20-gauge steel with a formed channel spanning the width of the case. Top shall support the case lock housing. Top shall be mechanically attached to allow for removal and replacement in the field. The top pan shall be supported by side-to-side cross-rails that are welded to the side vertical channels.
- D.** Steel Bottom pan shall be 20-gauge steel with formed channels spanning the depth and width of the case. Side-to-side and front to back channels are installed and welded to the pan for increased rigidity. The base shall be welded to the vertical channels and bottom flanges of the wrapper assembly. Base shall support four-recessed, extendable glides.
- E.** All drawer bodies and drawer heads shall be constructed from 20-gauge steel. Optional wood composite drawer heads shall be available in painted and powder-coated finishes.

Drawers

- A.** 10.5" and taller drawers shall be able to accommodate standard and legal Pendaflex file folders.
- B.** Drawer bodies shall be 20-gauge steel construction. Load capacity for 3"-15" drawers shall be at least .017 pounds per cubic inch of usable space.
- C.** Drawers shall be supported with full extension, ball-bearing slides with a minimum 150 pound capacity (15" x 42" drawers)
- D.** Overlay drawer fronts shall be available with Morrison and Series 2 drawer fronts.
- E.** Drawer bodies shall be formed from steel with a welded construction.
- F.** Drawer fronts shall have a full width integral drawer pull.
- G.** Drawer fronts shall be available in Calibre, Series 2 and Morrison styles.

Receding Doors

- A.** 13.5" and 15" receding doors shall be available with either fixed or pullout shelves. Fixed shelves shall support standard 8¹/₂" X 11" binders. 15" fixed shelves shall support EDP filing.
- B.** Receding doors shall use a hinge along with a ball-bearing glide suspension. Hinges shall provide clearance for standard size binders when used with a 13.5" or 15" receding door fixed shelf configuration.
- C.** Door front shall have a full width integral drawer pull.

Suspensions (Drawer Slides)

Suspension must be tested and listed to be acceptable. Suspension shall support heavy duty and high-usage application.

- A.** Drawers and pullout shelves shall operate on full extension metal ball-bearing suspensions. Each slide shall have 44, 1/4" ball bearings.
- B.** Ball-bearing suspensions shall be used for reference/ posting shelves, receding doors and file drawers.
- C.** All drawers and shelves must be removable without removing or dismantling the suspension or interlock mechanism.
- D.** Suspension shall provide an interlock system for drawers and pullout shelves (excluding reference shelves).

Locks

- A.** Available in locking or non-locking units.
- B.** Locks shall have a removable lock core.
- C.** Locks may be keyed alike.
- D.** Locks will be master keyed.
- E.** Individual locking drawers shall be supported.

Paint Finish

Finish coat to be baked enamel or electrostatic applied epoxy powder coat with a range of colors with gloss level not to exceed .50. Color selection shall include custom match non-metallic and non-white paints with no up-charge over list.

Labels

Each file is to have a "Caution Label" attached to the top compartment and visible to the user when the

compartments are accessed. Label shall contain safety precautions including leveling, loading and weight distribution.

Accessories

Each file drawer with the exception of the 3", 6", 7.5" and 9" drawers shall come with file bars that support legal and letter filing. Optional label holders shall be available. D-ring dividers shall be available as an accessory for built to spec pullout and fixed shelves and ordered separately. All preconfigured files with receding doors and fixed shelves shall be shipped with D-ring dividers and file bars.

Trim

Pulls shall be full width and integral to the drawer head.

Levelers

Levelers shall be zinc-planted steel treaded rods with nylon pads for 3/4" overall adjustment (base of file is 1 1/2" tall).

Lateral File Sample Bid Technical Specifications

Calibre Lateral File with Series 2 Steel Fronts

Calibre

General Product Description

- A.** Files shall be of contemporary styling, with a steel top, side panels, back panel, full bottom, rollout drawers and shelves mounted on ball bearing suspensions, interlocking drawers. Available with or without locks.
- B.** Lateral File sizes that must be available:
Depth: 18" (must accommodate letter or legal width files)
Widths: 30", 36" and 42"
Drawer Head Heights: 12"
- C.** Overall height of cases with glides fully retracted: 27", 39" and 51"

Case

Inner frame: 20-gauge steel
Wrapper: 22-gauge steel
Case top: 20-gauge steel
Case base: 20-gauge steel

Levelers

Levelers shall be zinc-plated steel threaded rods with nylon pads for $\frac{3}{4}$ " overall adjustment (Base of file is 1 $\frac{1}{2}$ " tall)

Drawer

Drawer body: 20-gauge steel
Drawer front: 20-gauge steel with integral, full width pull

Shelf

$\frac{3}{4}$ " adjustable shelf: 20-gauge steel
Cabinet height adjustment: increments of 2.5"

Lock Assembly

- A.** Lock and interlocking system components are integral to the steel, triple extension ball bearing drawer slides
- B.** Master keys available
- C.** Field-removable lock cores
- D.** Lock cores housings are cast metal with a black anodized finish

Drawer Suspensions

Drawer suspensions shall be triple extension, telescoping suspension fitted with steel ball bearings and retainers. Slides contain an integral, cable actuated interlocking systems

Paint Finish

Paint finish shall be electrostatic applied powder-coat epoxy
Application thickness: 1.5-2.0 mm
Gloss range: non-metallic: 30-40
Gloss range: metallic: 40-50
Paint grades: P1, P2 and P3

Dimensions

Depth: 18 $\frac{7}{8}$ " for lateral files.
Available widths: 30", 36" and 42" for lateral files
Available heights: 27", 39", 51" lateral files

Actual Case Heights:

27"	26 $\frac{27}{32}$ "
39"	38 $\frac{27}{32}$ "
51"	50 $\frac{27}{32}$ "

Lateral File Sample Bid Technical Specifications

Calibre Lateral Files, Hybrids and Cabinets

Calibre

Component	Description	Component	Description
Case	Inner frame: 20-gauge steel Wrapper: 22-gauge steel Case top: 20-gauge steel Case base: 20-gauge steel	Critical Dimensions	External Depth: 18" for Calibre laterals, cabinets, hybrids, wardrobes and add-on units External Depth: 15" for bookcases (Note the base height of Bookcases is 2 1/16" compared to 1 1/2" high for Calibre files) Available widths: 30", 36" and 42" for lateral files and add-on units Available widths: 30" and 36" for cabinets, hybrids, wardrobes and bookcases Available heights: 27", 34.5", 39", 45", 51", 54", 55.5", 58.5", 63" and 64.5" for lateral files (Nominal) Available heights: 55.5", 63" and 64.5" for hybrids, and wardrobes (Nominal). Available heights: 27", 34.5", 39", 51", 55.5", 63" and 64.5" cabinets (Nominal). Bookcases 27.25", 29.875", 39", 43.5", 57.125", 63.375", 70.75", and 84.5" respectively. Available heights: 13.5", 15", 27" and 30" for add-on's units (Heights listed in price list are nominal, the actual heights of add-on modules are 14 7/8", 16 3/8", 28 3/8" and 31 3/8" respectively). Actual Calibre Case Heights: (Standard 1.5" high base) 27" 26 27/32" 34.5" 34 11/32" 39" 38 27/32" 45" 44 27/32" 51" 50 27/32" 54" 53 27/32" 55.5" 55 11/32" 58.5" 58 11/32" 63" 62 27/32" 64.5" 64 11/32"
Drawer	Drawer body: 20-gauge steel Drawer front: 20-gauge steel with integral full width pull		
Shelf	Fixed shelf 1/2": 18-gauge steel (Only used with 13.5" receding door) Shelf adjustable 3/4": 20-gauge steel Cabinet Height adjustment: increments of 2.5"		
Levelers	Zinc-plated steel threaded rods with nylon pads for 3/4" overall adjustment. (Base of file is 1 1/2" tall)		
Lock Assembly	Lock and interlocking system components are integral to the steel, triple extension ball bearing drawer slides Master keys available Field-removable lock cores Lock core housings are cast metal with a black anodized finish		
Drawer and Roll-out Suspensions	Triple extension, telescoping suspension fitted with steel ball bearings and retainers. Slides contain an integral, cable actuated interlocking system		
Receding Door Suspensions	Ball bearing suspension slides		
Reference/Posting Shelf	Ball bearing suspension slides		
Paint Finish	Electrostatic applied powder-coat epoxy Application thickness: 1.5-2.0 mm Gloss range: non-metallic: 30-40 Gloss range: metallic: 40-50 Paint grades: P1, P2 and P3 Custom color match for non-metallic, non-custom paints provided at a P1 list price. All white and silver paints will be processed as a P3 paint grade.		

Create Custom Solutions

To create a built-to-spec file, you must first select from one of 10 standard case heights in 3 widths. Case heights are available in 27", 34.5", 39", 45", 51", 54", 55.5", 58.5", 63" and 64.5" (nominal). Case widths are available in 30", 36" and 42". After you have selected the appropriate case for your application, then you may begin to configure the interior modules that best support the filing and storage requirements as defined by the user. There are 9 standard drawer heights in various configurations to support any number of filing and storage needs. They are 1.5", 3", 6", 7.5", 10.5", 12", 13.5" and 15" high.

Drawer modules are designed to match up with the interior dimensions of the cases. The total number of modules used within a case must not exceed the total interior capacity. Listed here are the actual interior heights of the standard Calibre file cases:

Outside Case	Interior Case
27"	24"
34.5"	31.5"
39"	36"
45"	42"
51"	48"
54"	51"
55.5"	52.5"
58.5"	55.5"
63"	60"
64.5"	61.5"

When compiling a product pattern number and pricing for a built-to-spec case, specify the individual components within the chosen case from the top down. The total height of drawer modules within a case will be 3" less than the total overall height of the case. This is a result of a 1 1/2" deduction for the top and an additional 1 1/2" deduction for the base for a total 3". When creating your pattern number start with the case pattern number first: C2F5530C (55.5" high x 30" wide case with a lock), then add your drawers from the top down. Each drawer will have a letter designating its size, for example a 10.5" high drawer is represented by the character "D". Within a 55.5" high case you may place up to five "D" modules to fill the interior space of 52.5", which is the space available with the 3" deduction for the base and top of the case. The math is simple; just follow the planning rules listed in the document to avoid any mistakes. Also, consult the notes at the bottom of each page for additional specification information.

Please note the following planning considerations when designing a "Built-to-Spec" configuration:

1. Posting shelves nor tie-bars are permitted directly below cupboard doors.
2. Tie-bars and posting shelves are not permitted within the top location or the bottom location of a lateral file.
3. Calibre files are painted with a monochromatic color scheme. If case and drawer fronts are required to be a different color on the same case, this is considered a special and requires a custom product request form from Custom Product Development.
4. Recessing doors with fixed and pullout shelves are not permitted directly below posting shelves or on any lateral file with hybrid unit doors.
5. Cases are limited to either one tie-bar or one posting shelf per case.
6. Individual locking drawers are not available as a "Built-to-Spec" option.
7. Only 63" and 64.5" "Built-to-Spec" Hybrids are permitted.
8. S2 front Calibre lateral files are not available as a "Built-to-Spec".
9. No more than four 6" or 3" drawers may be placed within a case as standard product. More than four 6" or 3" drawers may be specified only as special product. Pricing for these special files may be more than a "built-to-spec" standard file with the same configuration.

Additional Calibre File Planning Considerations:

1. S2 lateral files will not accept standard Calibre worksurface file tops, as the files are 18 7/8" deep. You must use topics specific to S2 front lateral files.
2. Calibre Add-on modules are not designed for use with S2 front lateral files.
3. When using 45" through 64.5" high files, counterweights are recommended for files not ganged together or anchored to walls.
4. Posting shelves are best utilized in case configurations that use recessing doors to support end tab filing.
5. Lateral files may not be placed or stacked on top of one another.
6. Lateral files must be loaded from the bottom up with the heaviest items in the lower drawers.
7. Calibre lateral files utilize a 12" high drawer head that is actually 11.900" tall. Pedestals have 12" high drawer heads that are 11.733" tall. Therefore, pedestals drawers will not align with file drawers when combined within a workstation. If a lateral file look next to a pedestal is desired, then specify a doublewide pedestal in place of the lateral file, below the worksurface. Doublewide pedestals share the same 11.733" tall drawer height of the pedestal as well as the same base profile.

The Product

This section of the Calibre Collection Price List will give you all the information you will need to specify Calibre Files and Storage products.

To meet different aesthetic requirements, Calibre Files and Storage can be specified with the standard Calibre front, or with an optional front designed to match Series 2 products.

The Numbers

The options available in specifying Calibre products are clear, and the ordering process simplified, through the numbering system.

This alphanumeric system is modular, like the files themselves. Each digit stands for a single product variable.

The first three digits specify the case front, generation and product type. The last digits specify the height, width, lock option and module configuration – beginning at the top of the cabinet and descending to the bottom.

Preconfigured

Preconfigured units are available and are intended to simplify your ordering process. Preconfigured units are the most common configurations that are ordered and include files and cabinets.

Built-to-Spec

Calibre can be specified in thousands of configurations using our “built-to-spec” option to meet any storage need.

We have included a worksheet that is designed to help you build an ordering number and determine the price of your file. You will need this information, and a finish code from the Calibre colors card to place an order.

All units need to be specified from the top down.

Built-to-Spec units that include 3”, 6”, 9” or 15” components or include R,S,T, or U door options are subject to extended lead times.

The Worksheet

Page 63 is a worksheet designed to help you build an ordering number and determine the price of your file. You will need this information, and a finish code to place an order.

Color

All inside and outside case surfaces are painted in the same specified paint color.

Interior components and accessories are painted in black. Mechanical parts are zinc plated or painted in a color integral to manufacturing.

Please refer to the Calibre Colors card for Standard Front and Case finishes, or the Morrison card for front finishes. Color codes are not included in the product order number, and must be specified separately to complete your Calibre order. **In addition to the color card, always evaluate an actual paint sample prior to specification.**

Locks

Most Calibre product may be ordered with or without locks. Product ordered without locks include a black Knoll-logo insert in the same position. Insert may be removed to retrofit a lock later.

Statement of line

Calibre fronts are available on case heights of 27”, 39”, 45”, 51”, 54”, 55.5”, 58.5”, 63” and 64.5” with inset fronts in heights of 1.5”, 3”, 6”, 7.5”, 9”, 10.5”, 12”, 13.5” and 15”.

Series 2 fronts are available on 27”, 39” and 51” cases with 12” overlay fronts.

The Product

The Calibre pedestal is a storage solution that incorporates the award winning softly radiused pull of the Calibre file with the state-of-the-art technology of a seamless wrapper. The Calibre pedestal is at home in any office environment.

The Calibre pedestal consists of a strong single piece shell that houses several different configurations. Suspended, floorstanding and mobile pedestals are available in any of the Calibre finish colors.

Calibre pedestals are not compatible with Morrison desk supports.

The Numbers

The specifying process for the Calibre pedestal is clear and simplified through the number system.

The alphanumeric pattern number is 7 digits long with each digit standing for a product variable.

The first digit stands for pedestal case height:

3 = Standard case height

The second digit stands for the style of pedestal:

A = Suspended
B = Floorstanding
C = Mobile

The third and fourth digits stand for depth:

18 = 18" deep
24 = 24" deep
30 = 30" deep

The fifth digit stands for the lock choice:

C = Knoll lock
E = No lock

The sixth and seventh digits stand for the drawer configuration:

01 = box/file
(6/12)
02 = personal/personal/file
(3/3/12)
03 = box/box/box
(6/6/6)
04 = personal/EDP
(3/15)
05 = box/box/file
(6/6/12)
06 = personal/personal/box/file
(3/3/6/12)
07 = file/file
(12/12)
08 = personal/box/EDP
(3/6/15)
09 = personal/box/file
(3/6/15)

Example: **3B18CO5**

Calibre, floorstanding, 18" deep, Knoll lock, box/box/file (6/6/12).

Locks

Follow KnollKey Lock Program listed on page 188.

Base Fascia

The base fascia should be specified when Calibre Pedestals are used near Calibre Files. See page 107 for more information.

Construction and Shipping Information

Worksurfaces

All Calibre worksurfaces are 1 1/4" thick, three-ply solid construction, and are predrilled at all pedestal, end unit and bracket locations.

Front and rear have a 3/8" double post-formed edge; ends are self-edge. Calibre desk worksurfaces are nominally dimensioned and therefore not compatible with Calibre file sizes. See page 79 for Calibre file worksurfaces tops.

End Units for desk planning

Calibre End Units have a unique "L" design, allowing for interchangeable planning between pedestals and end units. The visitor side of the End Unit is the same width as a pedestal. This design allows for the same width of filler panel to be used with both single and double pedestal desks.

End Units are of steel construction.

End Units are non-handed.

Filler Panels

Filler panels install between end units, pedestals, or both.

When installed, a 3/8" wire management slot is created between the top of filler panel and the bottom of the worksurface. This slot allows for wires to be moved to multiple locations without need for more than one grommet.

Grommets

All 18", 24" & 30" deep worksurfaces specified with grommet feature one center grommet on the back side of the worksurface. Together with the filler panel, plugs can be placed through the grommet, and wires moved to the desired location.

36" deep worksurfaces specified with grommet feature two 3" round grommets, positioned inside of filler panel and pedestal locations.

Locks

KnollKey lock program instructions are listed on 188.

Overdesk Units

Calibre Overdesk Units include two stanchions, and one overhead unit. Tackable privacy screens are ordered separately. Locks are available. Calibre Overdesks attach directly to the top of any worksurface.

Vertical slots allow mounting of Orchestra Load Bars to stanchions. A vertical wire manager for task light cords is integral to the design.

Overdesks are painted steel.

Brackets

All returns and bridge units include necessary brackets to attach to desk or credenza units.

Lighting

Task lights can be mounted to Calibre overdesks equal to or greater than their own width.

Task lights are available in black only and include bulbs.

Shipment

All preconfigured units are shipped in a small number of easily assembled sub-components; worksurfaces, pedestals, end units and filler panels are shipped in individual protective corrugated cartons.

Returns, bridges, and overdesk units require in-field attachment.

Note:

The information in this price list represents the latest available information at the time of publication. Knoll reserves the right to make changes and improvements to Calibre products without notice.

Core Finishes Calibre and S2 Front File and Cabinet Colors

P1 Smooth Paint Finishes

111	Jet Black
112	Brown
113	Dark Grey
114	Folkstone Grey
115	Medium Grey
116	SandStone
117	Soft Grey
118	Bright White

P1 Textured Paint Finishes

111T	Textured Jet Black
112T	Textured Brown
113T	Textured Dark Grey
114T	Textured Folkstone Grey
115T	Textured Medium Grey
116T	Textured SandStone
117T	Textured Soft Grey
118T	Textured Bright White

P2 Paint Finishes

611	Beige Mist Metallic
612	Medium Metallic Grey

P2 Textured Paint Finishes

611T	Textured Beige Mist Metallic
612T	Textured Medium Metallic Grey

P3 Paint Finishes

613	Silver
-----	--------

File Top and Worksurface Laminate

111	Jet Black
114	Folkstone Grey
117	Soft Grey
118	Bright White
119	Pumice
121	Micro Grey
122	Brushed Sand
123	Brushed Grey
124	Medium Cherry
125	Natural Maple
126	Natural Cherry
127	Walnut
128	Fog
129	Micro Sand

File Top and Worksurface Edge Bands

111	Jet Black
113	Dark Grey
114	Folkstone Grey
115	Medium Grey
117	Soft Grey
118	Bright White
119	Pumice
124	Medium Cherry
125	Natural Maple
126	Natural Cherry
127	Walnut
128	Fog

Paint Samples

4" x 6" (CALSAMP) or 8" x 8" (CALSAMPLG) metal samples may be ordered in any core paint finish to aid in color selection. Samples are available as a single plate or as a pack of 10 (same color only).

Pattern #	List
CALSAMP	22.
CALSAMP10	170.
CALSAMPLG	22.

Custom File Colors Policy

Paint

Custom paint colors may be applied to Knoll Filing products on a select basis.

For colors outside the standard core palettes for Calibre as identified on this page, Knoll will custom match to your specification according to the following requirements.

The request for a custom paint color must be accompanied by a purchase order and by a master color-match sample of paint applied to metal, having dimensions of at least 3" x 5".

Knoll will evaluate the sample to determine application feasibility. Upon approval for application, Knoll will forward two factory samples with an assigned Knoll color name and code for customer approval. One of the approved samples must be signed and returned to Knoll before an order may be placed.

Upon receiving customer approval, Knoll will enter the order.

Custom non-metallic paint finishes are supported for Calibre lateral files, hybrids, wardrobes and cabinets with no additional upcharge to the P1 list price. This excludes custom metallic and custom white paints, which will be processed as a P3 list price. All other Calibre product i.e., (pedestals, bookcases, overdesks and deskings) and Series 2 lateral file front cases will incur a P2 list price for non-metallic finishes or a P3 list price for metallic or white finishes.

Extended lead times may apply. Please consult your Customer Service Representative for current lead-time information.

Supporting literature for Calibre colors:

For further assistance with ordering or specifying Calibre products, consult your Knoll sales representative.

Knoll Legacy Finish Selections

File Top and Worksurface

Laminate and Edge Colors

Specify Legacy Finishes to match existing product only. Legacy finishes are not available for new customers

Equity/Dividends Laminate Options

MP70	Light Oak
M95	Grey Granite
M96	Rose Granite
MP58	Deep Mahogany
M80	Taupe
M89	Slate
M5	Dark Neutral
MR6	Winter Gray Matrix
PA	Pearwood
SD	Sand
CM	Clear Maple
MC	Carmel Maple
WM	Warm Cherry
B	Snow
CP276	Markerboard Laminate
ES7	White Essence

Equity 2mm Edge Ban Options

D	Dark Neutral
S	Slate
R	Taupe
Y3	Dark Grey
B	Snow
SD	Sand

Legacy Finishes

Calibre and S2 Front File and Cabinet Colors

P1 Paint Finishes

A381	Bone
11	Classic White
D	Dark Neutral
Y1	Pewter
R	Taupe
WLWB	Willow Grey

P2 Paint Finishes

V	Dark Metallic Grey
2	Flint Metallic
U	Light Metallic Grey
W	Light Metallic Tan
H	Metallic Beige

P3 Paint Finishes

B	White
---	-------

Knoll Color Program

Core Paint Finishes

Specify Core finishes for all new customers

P1 Paint Finishes

111	Jet Black (was 27 Matte Black)
112	Brown
113	Dark Grey (was Y3)
114	Folkstone Grey
115	Medium Grey (was Y2)
116	SandStone
117	Soft Grey (was E)
118	Bright White

P1 Textured Paint Finishes

111T	Textured Jet Black
112T	Textured Brown
113T	Textured Dark Grey
114T	Textured Folkstone Grey
115T	Textured Medium Grey
116T	Textured SandStone
117T	Textured Soft Grey
118T	Textured Bright White

P2 Paint Finishes

611	Beige Mist Metallic
612	Medium Metallic Grey (was J)

P2 Textured Paint Finishes

611T	Textured Beige Mist Metallic
612T	Textured Medium Metallic Grey

P3 Paint Finishes

613	Silver (was 3)
-----	----------------

Legacy Paint Finishes

Specify Legacy Finishes to match existing product only. Legacy finishes are not available for new customers

P1 Paint Finishes

A381	Bone
I1	Classic White
D	Dark Neutral
Y1	Pewter
R	Taupe
WLWB	Willow Grey

P2 Paint Finishes

V	Dark Metallic Grey
2	Flint Metallic
U	Light Metallic Grey
W	Light Metallic Tan
H	Metallic Beige

P3 Paint Finishes

B	White
---	-------

Color

All inside and outside pedestal case surfaces are painted in the same specified paint color.

Interior components and accessories are painted in Black. Mechanical parts are zinc plated or painted in a color integral to manufacturing.

Please refer to the Calibre finish card for case and front finishes. Color codes are not included in the product order number and must be specified separately to complete your Calibre pedestal order.

Custom Colors Policy

Paint

Custom paint colors may be applied to Calibre Pedestals on a select basis.

For colors outside the standard palette for Calibre, Knoll will custom match to your specification according to the following requirements.

The request for a custom paint color must be accompanied by a purchase order for the product to be ordered and by a master color-match sample of paint applied to metal, having dimensions of at least 3" x 5".

Knoll will evaluate the sample to determine application feasibility. Upon approval for application, Knoll will forward a two factory samples with an assigned Knoll color name and code for customer approval. One of the approved samples must be signed and returned to Knoll before an order may be placed.

Upon receiving customer approval, Knoll will enter the order.

Calibre pedestals incur a P2 list price for custom non-metallic finishes or a P3 list price for customer metallic or white paint finishes.

**Approved textiles for Calibre
 Mobile Pedestal Cushion**

Abacus 🏹
 Alignment
 Analogy
 Arno 🏹
 Atlas
 Autobahn
 Backdrop
 Bank Shot 🏹
 Beaumont
 Belize
 Betwixt 🏹
 Bifold CR
 Calais Cotton Velvet
 Campagna
 Cato
 Cavalier
 Century
 Charade
 Charade Healthcare
 Charm
 Chroma 🏹
 Circa
 Classic Boucle 🏹
 Close Knit 🏹
 Coco
 Common Ground 🏹
 Compass CR
 Cotton Duck
 Cross Stitch 🏹
 Cuddle Cloth
 Cuddle Stripe
 Decade
 Digit 🏹
 Digit CR
 Digital Tape
 Double Exposure
 Dovetail 🏹
 Dristi
 Echo
 Eclat Weave
 Eclipse
 Empire Stripe
 English Accent
 Enmesh 🏹
 EWC Sport
 Extreme Velvet
 Fable CR
 Fast Forward
 Fibra
 Field Day 🏹
 Foil Rap
 Forza
 Fox Trot CR

Gala
 Gibson
 Grande
 Groove Line
 Gusto CR
 Harrison
 Haze
 Heavy Metal
 Highline CR
 Hologram
 Hula Hoop
 Icon
 In The Loop
 Kaleidoscope CR
 Kimono
 Knoll Felt
 Knoll Hopsack
 Knoll Velvet
 Kora CR
 Legend CR
 Lore CR
 Luberon
 Lyonese Velvet
 Lyric
 Madison
 Mamba
 Mariner 🏹
 Masquerade
 Metaphor
 Metro
 Mini Stitch 🏹
 Mixed Media
 Monarch 🏹
 Moto CR
 Night Life
 Nonchalant CR
 Obi
 Odeon
 Panache CR
 Paradigm
 Plus
 Pogo
 Pop
 Posh
 Prep
 Presto 🏹
 Quark
 Rattan
 Regard CR
 Ricochet 🏹
 Rio
 Rivington
 Rochelle 🏹
 Roots & Rhythms
 Satellite
 Satin Chisel
 Sequin CR

Spark
 Spencer
 Spinoff Nuance 🏹
 Spotlight
 Stacks
 Star Struck
 Starry Night 🏹
 Stepping Stones
 Striae Eingle
 Suburban
 Swing
 Techno Tweed
 Tides
 Topography
 Transit
 Transition 🏹
 Treble CR
 Triple Lace
 Tsunami
 Tweed Frieze
 Ultrasuede 🏹
 Una
 Vibe
 Vinyl
 Wide Angle 🏹
 Zari CR
 Zephyr
 Zoom

**Approved Spinneybeck Leathers for
 Calibre Mobile Pedestal Cushions**

Acqua
 Alaska
 Amazon
 Andes
 Antique
 Arizona
 Copenhagen
 Cordovan
 Derby
 Distressed
 Ducale
 Ducale Velours
 España
 Maremma
 Marissa
 Prima
 Riva
 Sabrina
 Saddle
 Salou
 Velluto Pelle
 Verona
 Volo

Pedestal cushions are upholstered (from the front to the back of the pedestal) with the fabric direction matching the textile sample.

Knoll Color Program

Core Paint Finishes

Specify Core finishes for all new customers

P1 Paint Finishes

111	Jet Black (was 27 Matte Black)
112	Brown
113	Dark Grey (was Y3)
114	Folkstone Grey
115	Medium Grey (was Y2)
116	SandStone
117	Soft Grey (was E)
118	Bright White

P1 Textured Paint Finishes

111T	Textured Jet Black
112T	Textured Brown
113T	Textured Dark Grey
114T	Textured Folkstone Grey
115T	Textured Medium Grey
116T	Textured SandStone
117T	Textured Soft Grey
118T	Textured Bright White

P2 Paint Finishes

611	Beige Mist Metallic
612	Medium Metallic Grey (was J)

P2 Textured Paint Finishes

611T	Textured Beige Mist Metallic
612T	Textured Medium Metallic Grey

P3 Paint Finishes

613	Silver (was 3)
-----	----------------

**File Top and Worksurface
Laminate**

111	Jet Black
114	Folkstone Grey
117	Soft Grey
118	Bright White
119	Pumice
121	Micro Grey
122	Brushed Sand
123	Brushed Grey
124	Medium Cherry
125	Natural Maple
126	Natural Cherry
127	Walnut
128	Fog
129	Micro Sand

**File Top and Worksurface Edge
Bands**

111	Jet Black
113	Dark Grey
114	Folkstone Grey
115	Medium Grey
117	Soft Grey
118	Bright White
119	Pumice
124	Medium Cherry
125	Natural Maple
126	Natural Cherry
127	Walnut
128	Fog

Legacy Paint Finishes

Specify Legacy Finishes to match existing product only. Legacy finishes are not available for new customers

**Calibre Pedestals, End Units, Filler
Panels, Overdesk Units,
Stanchions**

P1 Paint Finishes

A381	Bone
11	Classic White
D	Dark Neutral
Y1	Pewter
R	Taupe
WLWB	Willow Grey

P2 Paint Finishes

V	Dark Metallic Grey
2	Flint Metallic
U	Light Metallic Grey
W	Light Metallic Tan
H	Metallic Beige

P3 Paint Finishes

B	White
---	-------

Laminate and Edge Colors

D	Sand
CM	Clear Maple
PA	Pearwood
WC	Warm Cherry
DC	Deep Cherry
B	Snow

KNOLLTEXTILES

Approved for privacy screens

Fabric Group 10

Annex
Broadcloth
Element
Foundation
Growth Spurt
Symbolic Detail
Tailor Made
Versatility

Fabric Group 20

Banyan
Bauhaus Block
Circle Line
Clarity
Criss Cross
Labyrinth
Melbourne
Nematic
Outback
Photon
Reflect
Resolution
Walkabout
Weave Three

Fabric Group 30

Basket Draft
Flow
Interknit
Harmony
Micro
Progression

Fabric Group 40

Amplify
Bandwidth
Clarkson
Ornament
Palladium

Fabric Group 45

Dristi

Calibre Front Lateral Files

27" High Calibre Front Lateral Files

description	w	h	lock	pattern no.	P1	P2	P3
27" high lateral file, 2-12" drawers with hanging rails	30"	27"		C2F2730ECC	\$787.	\$870.	\$915.
	30"	27"	Y	C2F2730CCC	838.	923.	970.
	36"	27"		C2F2736ECC	889.	979.	1,029.
	36"	27"	Y	C2F2736CCC	941.	1,035.	1,091.
	42"	27"		C2F2742ECC	967.	1,068.	1,117.
	42"	27"	Y	C2F2742CCC	1,017.	1,123.	1,177.

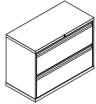

27" high lateral file, 2-12" drawers receding doors with pullout shelves	30"	27"		C2F2730EZZ	906.	1,000.	1,051.
	30"	27"	Y	C2F2730CZZ	957.	1,056.	1,106.
	36"	27"		C2F2736EZZ	1,007.	1,109.	1,171.
	36"	27"	Y	C2F2736CZZ	1,061.	1,169.	1,230.
	42"	27"		C2F2742EZZ	1,085.	1,200.	1,256.
	42"	27"	Y	C2F2742CZZ	1,134.	1,254.	1,314.



Order Code	Specification Information	Application Notes	Critical Dimensions
27" High Calibre Front Lateral Files	P1= painted finishes P2= painted finishes P3= painted finishes	Multiple freestanding files or cabinets (not attached to walls or worksurfaces) should be ganged for security. Single freestanding files (two and three high) should be weighted with a counterweight (see Accessories, page 79).	Actual Outside Case Height 26 ^{27/32} " Actual Inside Case Height 24" Calibre files are 18" deep.
<i>Example:</i> C2F2730CCC-115	Customer's own non-metallic paint finishes available at P1 pricing. This excludes metallic paints and white paints. (see custom color policy page 15)	Rails are provided for filing side-to-side and front-to-back and are adjustable for letter, A4, foolscap, JIS, legal, or EDP paper sizes.	Note: Drawer configurations read from top to bottom of the case. Drawers with hanging rails include front to back and side to side hanging rails. Refer to front planning pages for additional information.
C Calibre Front		See KnollKey lock program on page 188 for keying information.	Label holders are not included with files. Please see Accessories page 79.
2 Generation Code		Dividers and attachment backs must be ordered separately for rollout shelves only.	Calibre files without locks include a black Knoll-logo insert in the same position. Insert may be removed to retrofit a lock later.
F File			
27 27" High			
30 30" Wide			
C Knoll Lock			
C 12" Drawer with Hanging Rails			
C 12" Drawer with Hanging Rails			
115 Medium Grey (P1 paint pricing)			

Calibre Front Lateral Files - Preconfigured
Calibre Front Lateral Files
27" High Calibre Front Lateral Files

description	w	h	lock	pattern no.	P1	P2	P3
27" high lateral file, 1-3", 2-10.5" drawers with hanging rails	30"	27"		C2F2730EIDD	\$1,061.	\$1,173.	\$1,235.
	30"	27"	Y	C2F2730CIDD	1,110.	1,223.	1,285.
	36"	27"		C2F2736EIDD	1,157.	1,279.	1,344.
	36"	27"	Y	C2F2736CIDD	1,207.	1,327.	1,394.
	42"	27"		C2F2742EIDD	1,241.	1,371.	1,441.
	42"	27"	Y	C2F2742CIDD	1,292.	1,422.	1,494.

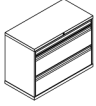

27" high lateral file, 1-13.5" receding door with fixed shelf, 1-10.5" drawer with hanging rails	30"	27"		C2F2730EMD	905.	1,000.	1,056.
	30"	27"	Y	C2F2730CMD	957.	1,051.	1,104.
	36"	27"		C2F2736EMD	955.	1,057.	1,109.
	36"	27"	Y	C2F2736CMD	1,003.	1,105.	1,162.
	42"	27"		C2F2742EMD	1,006.	1,111.	1,173.
	42"	27"	Y	C2F2742CMD	1,059.	1,164.	1,223.

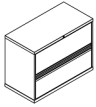

Order Code	Specification Information	Application Notes	Critical Dimensions
27" High Calibre Front Lateral Files	P1= painted finishes P2= painted finishes P3= painted finishes	Multiple freestanding files or cabinets (not attached to walls or worksurfaces) should be ganged for security. Single freestanding files (two and three high) should be weighted with a counterweight (see Accessories, page 79).	Actual Outside Case Height 26 ^{27/32} " Actual Inside Case Height 24" Calibre files are 18" deep.
<i>Example:</i> C2F2730CCC-115	Customer's own non-metallic paint finishes available at P1 pricing. This excludes metallic paints and white paints. (see custom color policy page 15)	Rails are provided for filing side-to-side and front-to-back and are adjustable for letter, A4, foolscap, JIS, legal, or EDP paper sizes.	Note: Drawer configurations read from top to bottom of the case. Drawers with hanging rails include front to back and side to side hanging rails. Refer to front planning pages for additional information.
C Calibre Front		See KnollKey lock program on page 188 for keying information.	Label holders are not included with files. Please see Accessories page 79.
2 Generation Code		Dividers and attachment backs must be ordered separately for rollout shelves only.	Calibre files without locks include a black Knoll-logo insert in the same position. Insert may be removed to retrofit a lock later.
F File			
27 27" High			
30 30" Wide			
C Knoll Lock			
C 12" Drawer with Hanging Rails			
C 12" Drawer with Hanging Rails			
115 Medium Grey (P1 paint pricing)			

Calibre Front Lateral Files - Preconfigured
Calibre Front Lateral Files
34.5" High Calibre Front Lateral Files

Calibre

description	w	h	lock	pattern no.	P1	P2	P3
34.5" high lateral file, 3-10.5" drawers with hanging rails	30"	34.5"		C2F3430EDDD	\$1,078.	\$1,186.	\$1,246.
	30"	34.5"	Y	C2F3430CDDD	1,128.	1,239.	1,301.
	36"	34.5"		C2F3436EDDD	1,203.	1,322.	1,388.
	36"	34.5"	Y	C2F3436CDDD	1,253.	1,381.	1,445.
	42"	34.5"		C2F3442EDDD	1,309.	1,438.	1,511.
	42"	34.5"	Y	C2F3442CDDD	1,357.	1,494.	1,568.

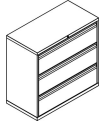

Order Code	Specification Information	Application Notes	Critical Dimensions
34.5" High Calibre Front Lateral Files	P1= painted finishes	Multiple freestanding files or cabinets (not attached to walls or worksurfaces) should be ganged for security. Single freestanding files (two and three high) should be weighted with a counterweight (see Accessories, page 79).	Actual Outside Case Height 34 1/32" Actual Inside Case Height 31 1/2" Calibre files are 18" deep.
<i>Example:</i> C2F3430CDDD-115	P2= painted finishes		
C Calibre Front	P3= painted finishes		
2 Generation Code	Customer's own non-metallic paint finishes available at P1 pricing. This excludes metallic paints and white paints. (see custom color policy page 15)	Rails are provided for filing side-to-side and front-to-back and are adjustable for letter, A4, foolscap, JIS, legal, or EDP paper sizes.	Note: Drawer configurations read from top to bottom of the case. Drawers with hanging rails include front to back and side to side hanging rails. Refer to front planning pages for additional information. Label holders are not included with files. Please see Accessories page 79.
F File			
34 34.5" High			
30 30" Wide			
C Knoll Lock			
D 10.5" Drawer with Hanging Rails	See KnollKey lock program on page 188 for keying information.	Dividers and attachment backs must be ordered separately for rollout shelves only.	Calibre files without locks include a black Knoll-logo insert in the same position. Insert may be removed to retrofit a lock later.
D 10.5" Drawer with Hanging Rails			
D 10.5" Drawer with Hanging Rails			
115 Medium Grey (P1 paint pricing)			

Calibre Front Lateral Files - Preconfigured
Calibre Front Lateral Files
39" High Calibre Front Lateral Files

description	w	h	lock	pattern no.	P1	P2	P3
39" high lateral file, 3-12" drawers with hanging rails	30"	39"		C2F3930ECCC	\$1,087.	\$1,199.	\$1,257.
	30"	39"	Y	C2F3930CCCC	1,135.	1,252.	1,315.
	36"	39"		C2F3936ECCC	1,210.	1,333.	1,404.
	36"	39"	Y	C2F3936CCCC	1,261.	1,391.	1,462.
	42"	39"		C2F3942ECCC	1,323.	1,460.	1,525.
	42"	39"	Y	C2F3942CCCC	1,373.	1,513.	1,589.

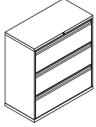

39" high lateral file, 3-12" receding doors with pullout shelves	30"	39"		C2F3930EZZZ	1,262.	1,394.	1,464.
	30"	39"	Y	C2F3930CZZZ	1,313.	1,450.	1,522.
	36"	39"		C2F3936EZZZ	1,392.	1,532.	1,613.
	36"	39"	Y	C2F3936CZZZ	1,441.	1,589.	1,673.
	42"	39"		C2F3942EZZZ	1,500.	1,656.	1,733.
	42"	39"	Y	C2F3942CZZZ	1,549.	1,712.	1,796.

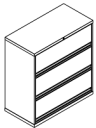

39" high lateral file, 1-13.5" receding door with fixed shelf, 1-12" drawer with hanging rails, 1-10.5" drawer with hanging rails	30"	39"		C2F3930EMCD	1,148.	1,271.	1,336.
	30"	39"	Y	C2F3930CMCD	1,202.	1,321.	1,386.
	36"	39"		C2F3936EMCD	1,281.	1,413.	1,486.
	36"	39"	Y	C2F3936CMCD	1,329.	1,464.	1,537.
	42"	39"		C2F3942EMCD	1,460.	1,610.	1,692.
	42"	39"	Y	C2F3942CMCD	1,510.	1,660.	1,743.

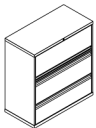

Order Code	Specification Information	Application Notes	Critical Dimensions
39" High Calibre Front Lateral Files	P1= painted finishes	Multiple freestanding files or cabinets (not attached to walls or worksurfaces) should be ganged for security. Single freestanding files (two and three-high) should be weighted with a counterweight (see Accessories, page 79).	Actual Outside Case Height 38 ^{27/32"} Actual Inside Case Height 36"
Example: C2F3930CCCC-115	P2= painted finishes		Calibre files are 18" deep.
C Calibre Front	P3= painted finishes	Rails are provided for filing side-to-side and front-to-back and are adjustable for letter, A4, foolscap, JIS, legal, or EDP paper sizes.	Note: Drawer configurations read from top to bottom of the case. Drawers with hanging rails include front to back and side to side hanging rails. Refer to front planning pages for additional information.
2 Generation Code	Customer's own non-metallic paint finishes available at P1 pricing. This excludes metallic paints and white paints (see color policy page 15)		Per Drawer weight capacity 150 pounds.
F File		See KnollKey lock program on page 188 for keying information.	Calibre files without locks include a black Knoll-logo insert in the same position. Insert may be removed to retrofit a lock later.
39 39" High		Dividers and attachment backs must be ordered separately for rollout shelves only.	
30 30" Wide			
C Knoll Lock			
C 12" Drawer with Hanging Rails			
C 12" Drawer with Hanging Rails			
C 12" Drawer with Hanging Rails			
115 Medium Grey (P1 paint pricing.)			

Calibre Front Lateral Files - Preconfigured
Calibre Front Lateral Files
39" High Calibre Front Lateral Files

Calibre

description	w	h	lock	pattern no.	P1	P2	P3
39" high lateral file, 1-15" receding door with fixed shelf, 2-10.5" drawers with hanging rails	30"	39"		C2F3930ELDD	\$1,148.	\$1,271.	\$1,336.
	30"	39"	Y	C2F3930CLDD	1,202.	1,321.	1,386.
	36"	39"		C2F3936ELDD	1,281.	1,413.	1,486.
	36"	39"	Y	C2F3936CLDD	1,329.	1,464.	1,537.
	42"	39"		C2F3942ELDD	1,508.	1,663.	1,748.
	42"	39"	Y	C2F3942CLDD	1,560.	1,714.	1,799.

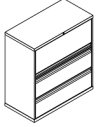

Order Code	Specification Information	Application Notes	Critical Dimensions
39" High Calibre Front Lateral Files	P1= painted finishes	Multiple freestanding files or cabinets (not attached to walls or worksurfaces) should be ganged for security. Single freestanding files (two and three-high) should be weighted with a counterweight (see Accessories, page 79).	Actual Outside Case Height 38 ^{27/32"} Actual Inside Case Height 36"
Example: C2F3930CCCC-115	P2= painted finishes		
C Calibre Front	P3= painted finishes	Rails are provided for filing side-to-side and front-to-back and are adjustable for letter, A4, foolscap, JIS, legal, or EDP paper sizes.	Calibre files are 18" deep.
2 Generation Code	Customer's own non-metallic paint finishes available at P1 pricing. This excludes metallic paints and white paints (see color policy page 15)		
F File		Per Drawer weight capacity 150 pounds.	Note: Drawer configurations read from top to bottom of the case. Drawers with hanging rails include front to back and side to side hanging rails. Refer to front planning pages for additional information.
39 39" High	See KnollKey lock program on page 188 for keying information.		
30 30" Wide		Dividers and attachment backs must be ordered separately for rollout shelves only.	Label holders are not included with files. Please see Accessories page 79.
C Knoll Lock	Calibre files without locks include a black Knoll-logo insert in the same position. Insert may be removed to retrofit a lock later.		
C 12" Drawer with Hanging Rails			
C 12" Drawer with Hanging Rails			
C 12" Drawer with Hanging Rails			
115 Medium Grey (P1 paint pricing.)			

Calibre Front Lateral Files - Preconfigured
Calibre Front Lateral Files
45" High Calibre Front Lateral Files

description	w	h	lock	pattern no.	P1	P2	P3
45" high lateral file, 4-10.5" drawers with hanging rails	30"	45"		C2F4530EDDDD	\$1,385.	\$1,529.	\$1,609.
	30"	45"	Y	C2F4530CDDDD	1,435.	1,578.	1,659.
	36"	45"		C2F4536EDDDD	1,563.	1,723.	1,811.
	36"	45"	Y	C2F4536CDDDD	1,611.	1,772.	1,862.
	42"	45"		C2F4542EDDDD	1,743.	1,923.	2,021.
	42"	45"	Y	C2F4542CDDDD	1,795.	1,974.	2,072.

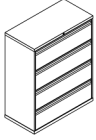

45" high lateral file, 1-13.5" receding door with fixed shelf, 1-1.5" tie bar, 2-13.5" receding doors with fixed shelves	30"	45"		C2F4530EMKMM	1,353.	1,494.	1,570.
	30"	45"	Y	C2F4530CMKMM	1,405.	1,543.	1,622.
	36"	45"		C2F4536EMKMM	1,432.	1,580.	1,662.
	36"	45"	Y	C2F4536CMKMM	1,480.	1,631.	1,713.
	42"	45"		C2F4542EMKMM	1,656.	1,828.	1,919.
	42"	45"	Y	C2F4542CMKMM	1,706.	1,878.	1,972.

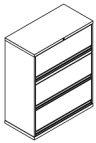

Order Code	Specification Information	Application Notes	Critical Dimensions
45" High Calibre Front Lateral Files	P1= painted finishes	Multiple freestanding files or cabinets (not attached to walls or worksurfaces) should be ganged for security. Single freestanding files (two and three-high) should be weighted with a counterweight (see Accessories page 79).	Actual Outside Case Height 44 ^{27/32"} Actual Inside Case Height 42"
Example: C2F4530CDDDD-115	P2= painted finishes		
C Calibre Front	P3= painted finishes	Rails are provided for filing side-to-side and front-to-back and are adjustable for letter, A4, foolscap, JIS, legal, or EDP paper sizes.	Calibre files are 18" deep.
2 Generation Code	Customer's own non-metallic paint finishes available at P1 pricing.		
F File	This excludes metallic paints and white paints. (see color policy page 15).	See KnollKey lock program on page 188 for keying information.	Note: Drawer configurations read from top to bottom of the case. Drawers with hanging rails include front to back and side to side hanging rails. Refer to front planning pages for additional information.
45 45" High	For reference shelf option substitute the "K" in the pattern number with a "J". Add \$178 list for reference shelf.		
30 30" Wide		Dividers and attachment backs must be ordered separately for rollout shelves only.	Label holders are not included with files. Please see Accessories page 79.
C Knoll Lock			
D 10.5" Drawer with Hanging Rails			
D 10.5" Drawer with Hanging Rails			
D 10.5" Drawer with Hanging Rails			Calibre files without locks include a black Knoll-logo insert in the same position. Insert may be removed to retrofit a lock later.
D 10.5" Drawer with Hanging Rails			
115 Medium Grey (P1 paint pricing)			

Calibre Front Lateral Files

51" High Calibre Front Lateral Files

description	w	h	lock	pattern no.	P1	P2	P3
51" high lateral file, 4-12" drawers with hanging rails	30"	51"		C2F5130ECCCC	\$1,400.	\$1,539.	\$1,620.
	30"	51"	Y	C2F5130CXXXX	1,450.	1,595.	1,678.
	36"	51"		C2F5136ECCCC	1,573.	1,736.	1,824.
	36"	51"	Y	C2F5136CXXXX	1,626.	1,792.	1,881.
	42"	51"		C2F5142ECCCC	1,758.	1,936.	2,029.
	42"	51"	Y	C2F5142CXXXX	1,806.	1,991.	2,091.

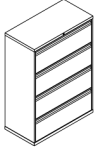

51" high lateral file, 4-12" receding doors with rollout shelves	30"	51"		C2F5130EZZZZ	1,636.	1,802.	1,895.
	30"	51"	Y	C2F5130CZZZZ	1,684.	1,860.	1,954.
	36"	51"		C2F5136EZZZZ	1,816.	1,998.	2,102.
	36"	51"	Y	C2F5136CZZZZ	1,868.	2,055.	2,164.
	42"	51"		C2F5142EZZZZ	1,991.	2,198.	2,305.
	42"	51"	Y	C2F5142CZZZZ	2,044.	2,253.	2,363.

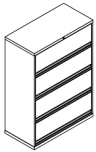

51" high lateral file, 2-13.5" receding doors with fixed shelf, 2-10.5" drawers with hanging rails	30"	51"		C2F5130EMMDD	1,391.	1,536.	1,616.
	30"	51"	Y	C2F5130CMMDD	1,440.	1,585.	1,664.
	36"	51"		C2F5136EMMDD	1,674.	1,847.	1,941.
	36"	51"	Y	C2F5136CMMDD	1,724.	1,896.	1,990.
	42"	51"		C2F5142EMMDD	1,936.	2,132.	2,241.
	42"	51"	Y	C2F5142CMMDD	1,984.	2,182.	2,292.

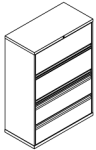

Order Code	Specification Information	Application Notes	Critical Dimensions
51" High Calibre Front Lateral Files	P1= painted finishes	Multiple freestanding files or cabinets (not attached to walls or worksurfaces) should be ganged for security. Single freestanding files (two and three high) should be weighted with a counterweight (see Accessories, page 79)	Actual Outside Case Height 50 ^{27/32"} Actual Inside Case Height 48"
Example: C2F5130CXXXX-115	P2= painted finishes		Calibre files are 18" deep.
C Calibre Front	P3= painted finishes	Rails are provided for filing side-to-side and front-to-back and are adjustable for letter, A4, foolscap, JIS, legal, or EDP paper sizes.	Note: Drawer configurations read from top to bottom of the case. Drawers with hanging rails include front to back and side to side hanging rails. Refer to front planning pages for additional information.
2 Generation Code	Customer's own non-metallic paint finishes available at P1 pricing. This excludes metallic paints and white paints. (see custom color policy page 15)		See KnollKey lock program on page 188 for keying information.
F File	For reference shelf option substitute the "K" in the pattern number with a "J". Add \$178 list for reference shelf.	Dividers and attachment backs must be ordered separately for rollout shelves only.	Calibre files without locks include a black Knoll-logo insert in the same position. Insert may be removed to retrofit a lock later.
51 51" High			
30 30" Wide			
C Knoll Lock			
C 12" Drawer with Hanging Rails			
C 12" Drawer with Hanging Rails			
C 12" Drawer with Hanging Rails			
115 Medium Grey (P1 paint pricing.)			

Calibre Front Lateral Files

51" High Calibre Front Lateral Files

description	w	h	lock	pattern no.	P1	P2	P3
51" high lateral file, 1-10.5" drawer, 1-1.5" tie bar, 3-12" drawers with hanging rails	30"	51"		C2F5130EDKCCC	\$1,434.	\$1,582.	\$1,664.
	30"	51"	Y	C2F5130CDKCCC	1,484.	1,633.	1,715.
	36"	51"		C2F5136EDKCCC	1,672.	1,843.	1,938.
	36"	51"	Y	C2F5136CDKCCC	1,719.	1,893.	1,986.
	42"	51"		C2F5142EDKCCC	1,857.	2,047.	2,153.
	42"	51"	Y	C2F5142CDKCCC	1,907.	2,098.	2,203.

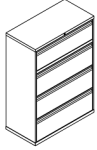

51" high lateral file, 1-13.5" receding door with fixed shelf, 1-1.5" tie bar, 1-12" drawer, 2-10.5" drawers with hanging rails	30"	51"		C2F5130EMKCDD	1,435.	1,583.	1,666.
	30"	51"	Y	C2F5130CMKCDD	1,486.	1,636.	1,716.
	36"	51"		C2F5136EMKCDD	1,714.	1,890.	1,986.
	36"	51"	Y	C2F5136CMKCDD	1,765.	1,942.	2,038.
	42"	51"		C2F5142EMKCDD	1,971.	2,172.	2,282.
	42"	51"	Y	C2F5142CMKCDD	2,020.	2,222.	2,334.

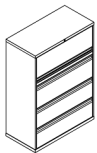

51" high lateral file, 1-15" receding door with fixed shelf, 1-1.5" tie bar, 3-10.5" drawers with hanging rails	30"	51"		C2F5130ELKDDD	1,435.	1,583.	1,666.
	30"	51"	Y	C2F5130CLKDDD	1,486.	1,636.	1,716.
	36"	51"		C2F5136ELKDDD	1,714.	1,890.	1,986.
	36"	51"	Y	C2F5136CLKDDD	1,765.	1,942.	2,038.
	42"	51"		C2F5142ELKDDD	1,971.	2,172.	2,282.
	42"	51"	Y	C2F5142CLKDDD	2,020.	2,222.	2,334.

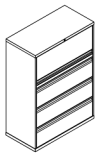

Order Code	Specification Information	Application Notes	Critical Dimensions
51" High Calibre Front Lateral Files	P1= painted finishes	Multiple freestanding files or cabinets (not attached to walls or worksurfaces) should be ganged for security. Single freestanding files (two and three high) should be weighted with a counterweight (see Accessories, page 79)	Actual Outside Case Height 50 ^{27/32} " Actual Inside Case Height 48"
Example: C2F5130CCCC-115	P2= painted finishes		Calibre files are 18" deep.
C Calibre Front	P3= painted finishes		Note: Drawer configurations read from top to bottom of the case. Drawers with hanging rails include front to back and side to side hanging rails. Refer to front planning pages for additional information.
2 Generation Code	Customer's own non-metallic paint finishes available at P1 pricing. This excludes metallic paints and white paints. (see custom color policy page 15)	Rails are provided for filing side-to-side and front-to-back and are adjustable for letter, A4, foolscap, JIS, legal, or EDP paper sizes.	Label holders are not included with files. Please see Accessories page 79.
F File	For reference shelf option substitute the "K" in the pattern number with a "J". Add \$178 list for reference shelf.	See KnollKey lock program on page 188 for keying information.	Calibre files without locks include a black Knoll-logo insert in the same position. Insert may be removed to retrofit a lock later.
51 51" High		Dividers and attachment backs must be ordered separately for rollout shelves only.	
30 30" Wide			
C Knoll Lock			
C 12" Drawer with Hanging Rails			
C 12" Drawer with Hanging Rails			
C 12" Drawer with Hanging Rails			
115 Medium Grey (P1 paint pricing.)			

Calibre Front Lateral Files

54" High Calibre Front Lateral Files

description	w	h	lock	pattern no.	P1	P2	P3
54" high lateral file, 1-13.5" receding door with fixed shelf, 1-1.5" tie bar, 3-12" drawers with hanging rails	30"	54"		C2F5430EMKCCC	\$1,454.	\$1,603.	\$1,684.
	30"	54"	Y	C2F5430CMKCCC	1,505.	1,652.	1,737.
	36"	54"		C2F5436EMKCCC	1,717.	1,895.	1,991.
	36"	54"	Y	C2F5436CMKCCC	1,769.	1,945.	2,043.
	42"	54"		C2F5442EMKCCC	1,964.	2,166.	2,277.
	42"	54"	Y	C2F5442CMKCCC	2,015.	2,215.	2,328.

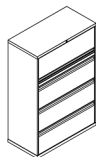

54" high lateral file, 1-15" receding door with fixed shelf, 3-12" drawers with hanging rails	30"	54"		C2F5430ELCCC	1,406.	1,549.	1,631.
	30"	54"	Y	C2F5430CLCCC	1,458.	1,601.	1,681.
	36"	54"		C2F5436ELCCC	1,669.	1,842.	1,937.
	36"	54"	Y	C2F5436CLCCC	1,718.	1,892.	1,985.
	42"	54"		C2F5442ELCCC	1,960.	2,163.	2,275.
	42"	54"	Y	C2F5442CLCCC	2,011.	2,211.	2,324.

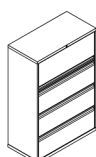

54" high lateral file, 2-13.5" receding doors with fixed shelves, 2-12" drawers with hanging rails	30"	54"		C2F5430EMMCC	1,599.	1,766.	1,856.
	30"	54"	Y	C2F5430CMMCC	1,650.	1,816.	1,906.
	36"	54"		C2F5436EMMCC	1,702.	1,878.	1,975.
	36"	54"	Y	C2F5436CMMCC	1,751.	1,928.	2,026.
	42"	54"		C2F5442EMMCC	1,907.	2,102.	2,209.
	42"	54"	Y	C2F5442CMMCC	1,958.	2,154.	2,260.

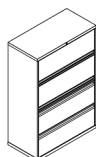

Order Code	Specification Information	Application Notes	Critical Dimensions
54" High Calibre Front Lateral Files	P1= painted finishes	Multiple freestanding files or cabinets (not attached to walls or worksurfaces) should be ganged for security. Single freestanding files (two and three high) should be weighted with a counterweight (see Accessories, page 79)	Actual Outside Case Height 53 ^{27/32"} Actual Inside Case Height 51"
Example: C2F54130CMMCC-115	P2= painted finishes		
C Calibre Front	P3= painted finishes	Rails are provided for filing side-to-side and front-to-back and are adjustable for letter, A4, foolscap, JIS, legal, or EDP paper sizes.	Calibre files are 18" deep.
2 Generation Code	Customer's own non-metallic paint finishes available at P1 pricing. This excludes metallic paints and white paints. (see custom color policy page 15)		
F File	For reference shelf option substitute the "K" in the pattern number with a "J". Add \$178 list for reference shelf.	See KnollKey lock program on page 188 for keying information.	Note: Drawer configurations read from top to bottom of the case. Drawers with hanging rails include front to back and side to side hanging rails. Refer to front planning pages for additional information.
54 54" High			
30 30" Wide			Label holders are not included with files. Please see Accessories page 79.
C Knoll Lock			
M 13.5" Receding Door with Fixed Shelf			Calibre files without locks include a black Knoll-logo insert in the same position. Insert may be removed to retrofit a lock later.
M 13.5" Receding Door with Fixed Shelf			
C 12" Drawer with Hanging Rails			
C 12" Drawer with Hanging Rails			
115 Medium Grey (P1 paint pricing.)			

Calibre Front Lateral Files

55.5" High Calibre Front Lateral Files

description	w	h	lock	pattern no.	P1	P2	P3
55.5" high lateral file, 5-10.5" drawers with hanging rails	30"	55.5"		C2F5530EDDDDD	\$1,573.	\$1,738.	\$1,826.
	30"	55.5"	Y	C2F5530CDDDDDD	1,626.	1,789.	1,877.
	36"	55.5"		C2F5536EDDDDD	1,770.	1,953.	2,051.
	36"	55.5"	Y	C2F5536CDDDDDD	1,820.	2,003.	2,101.
	42"	55.5"		C2F5542EDDDDD	1,964.	2,166.	2,277.
	42"	55.5"	Y	C2F5542CDDDDDD	2,015.	2,215.	2,328.

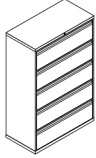

55.5" high lateral file, 1-15" receding door with fixed shelves, 1-1.5" tie bar, 3-12" drawers with hanging rails	30"	55.5"		C2F5530ELKCCC	1,463.	1,616.	1,696.
	30"	55.5"	Y	C2F5530CLKCCC	1,513.	1,664.	1,747.
	36"	55.5"		C2F5536ELKCCC	1,723.	1,900.	1,997.
	36"	55.5"	Y	C2F5536CLKCCC	1,772.	1,949.	2,047.
	42"	55.5"		C2F5542ELKCCC	1,986.	2,192.	2,304.
	42"	55.5"	Y	C2F5542CLKCCC	2,038.	2,241.	2,352.

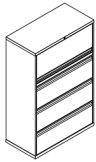

55.5" high lateral file, 2-13.5" receding doors with fixed shelf, 1-1.5" tie bar, 2-12" drawers with hanging rails	30"	55.5"		C2F5530EMMKCC	1,464.	1,617.	1,699.
	30"	55.5"	Y	C2F5530CMMKCC	1,514.	1,666.	1,748.
	36"	55.5"		C2F5536EMMKCC	1,733.	1,908.	2,008.
	36"	55.5"	Y	C2F5536CMMKCC	1,779.	1,959.	2,059.
	42"	55.5"		C2F5542EMMKCC	2,004.	2,208.	2,324.
	42"	55.5"	Y	C2F5542CMMKCC	2,055.	2,259.	2,375.

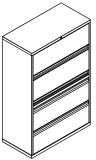

Order Code	Specification Information	Application Notes	Critical Dimensions
55.5" High Calibre Front Lateral Files	P1= painted finishes P2= painted finishes P3 = painted finishes	Multiple freestanding files or cabinets (not attached to walls or worksurfaces) should be ganged for security. Single freestanding files (two and three high) should be weighted with a counterweight (see Accessories, page 79)	Actual Outside Case Height 55 11/32" Actual Inside Case Height 52 1/2" Calibre files are 18" deep.
Example: C2F5530CDDDDDD-115	Customer's own non-metallic paint finishes available at P1 pricing. This excludes metallic paints and white paints. (see custom color policy page 15)	Rails are provided for filing side-to-side and front-to-back and are adjustable for letter, A4, foolscap, JIS, legal, or EDP paper sizes.	Note: Drawer configurations read from top to bottom of the case. Drawers with hanging rails include front to back and side to side hanging rails. Refer to front planning pages for additional information.
C Calibre Front	For reference shelf option substitute the "K" in the pattern number with a "J". Add \$178 list for reference shelf.	See KnollKey lock program on page 188 for keying information.	Label holders are not included with files. Please see Accessories page 79.
2 Generation Code		Dividers and attachment backs must be ordered separately for rollout shelves only.	Calibre files without locks include a black Knoll-logo insert in the same position. Insert may be removed to retrofit a lock later.
F File			
55 55.5" High			
30 30" Wide			
C Knoll Lock			
D 10.5" Drawer with Hanging Rails			
D 10.5" Drawer with Hanging Rails			
D 10.5" Drawer with Hanging Rails			
D 10.5" Drawer with Hanging Rails			
115 Medium Grey (P1 paint pricing.)			

Calibre Front Lateral Files

58.5" High Calibre Front Lateral Files

description	w	h	lock	pattern no.	P1	P2	P3
58.5" high lateral file, 1-13.5" receding door with fixed shelf, 4-10.5" drawers with hanging rails	30"	58.5"		C2F5830EMDDDD	\$1,658.	\$1,829.	\$1,923.
	30"	58.5"	Y	C2F5830CMDDDD	1,709.	1,879.	1,974.
	36"	58.5"		C2F5836EMDDDD	1,942.	2,138.	2,248.
	36"	58.5"	Y	C2F5836CMDDDD	1,991.	2,192.	2,301.
	42"	58.5"		C2F5842EMDDDD	2,104.	2,319.	2,439.
	42"	58.5"	Y	C2F5842CMDDDD	2,156.	2,374.	2,492.

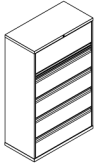

58.5" high lateral file, 1-13.5" receding door with fixed shelf, 1-1.5" tie bar, 3-13.5" receding doors with fixed shelf	30"	58.5"		C2F5830EMKMMM	1,484.	1,639.	1,724.
	30"	58.5"	Y	C2F5830CMKMMM	1,536.	1,688.	1,773.
	36"	58.5"		C2F5836EMKMMM	1,764.	1,944.	2,044.
	36"	58.5"	Y	C2F5836CMKMMM	1,813.	1,993.	2,095.
	42"	58.5"		C2F5842EMKMMM	2,051.	2,260.	2,380.
	42"	58.5"	Y	C2F5842CMKMMM	2,101.	2,310.	2,429.

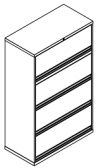

58.5" high lateral file, 1-12" drawer with hanging rails, 1-10.5" drawer, 1-1.5" tie bar, 3-10.5" drawers with hanging rails	30"	58.5"		C2F5830ECDKDDD	1,683.	1,858.	1,954.
	30"	58.5"	Y	C2F5830CCDKDDD	1,736.	1,908.	2,004.
	36"	58.5"		C2F5836ECDKDDD	1,883.	2,079.	2,186.
	36"	58.5"	Y	C2F5836CCDKDDD	1,937.	2,130.	2,237.
	42"	58.5"		C2F5842ECDKDDD	2,082.	2,298.	2,413.
	42"	58.5"	Y	C2F5842CCDKDDD	2,133.	2,347.	2,463.

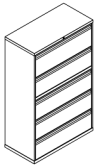

Order Code	Specification Information	Application Notes	Critical Dimensions
58.5" High Calibre Front Lateral Files	P1= painted finishes P2= painted finishes P3= painted finishes	Multiple freestanding files or cabinets (not attached to walls or worksurfaces) should be ganged for security. Single freestanding files (two and three-high) should be weighted with a counterweight (see Accessories page 79).	Actual Outside Case Height 58 11/32" Actual Inside Case Height 55 1/2" Calibre files are 18" deep.
Example: C2F5830CAAKCC-115	Customer's own non-metallic paint finishes available at P1 pricing. This excludes metallic paints and white paints. (see color policy page 15).	Rails are provided for filing side-to-side and front-to-back and are adjustable for letter, A4, foolscap, JIS, legal, or EDP paper sizes.	Note: Drawer configurations read from top to bottom of the case. Drawers with hanging rails include front to back and side to side hanging rails. Refer to front planning pages for additional information.
C Calibre Front	For reference shelf option substitute the "K" in the pattern number with a "J". Add \$178 list for reference shelf.	See KnollKey lock program on page 188 for keying information.	Label holders are not included with files. Please see Accessories page 79.
2 Generation Code		Dividers and attachment backs must be ordered separately for rollout shelves only.	Calibre files without locks include a black Knoll-logo insert in the same position. Insert may be removed to retrofit a lock later.
F File			
58 58.5" High			
30 30" Wide			
C Knoll Lock			
A 10.5" Drawer with Hanging Rails			
A 10.5" Drawer with Hanging Rails			
K 1.5" Tie bar			
C 12" Drawer with Hanging Rails			
C 12" Drawer with Hanging Rails			
115 Medium Grey (P1 paint pricing)			

Calibre Front Lateral Files - Preconfigured
Calibre Front Lateral Files
58.5" High Calibre Front Lateral Files

Calibre

Calibre File Collection

description	w	h	lock	pattern no.	P1	P2	P3
58.5" high lateral file, 2-15" drawers with hanging rails, 1-1.5" tie bar, 2-12" drawers with hanging rails	30"	58.5"		C2F5830EAAKCC	\$1,633.	\$1,801.	\$1,895.
	30"	58.5"	Y	C2F5830CAAKCC	1,683.	1,852.	1,945.
	36"	58.5"		C2F5836EAAKCC	1,792.	1,975.	2,077.
	36"	58.5"	Y	C2F5836CAAKCC	1,842.	2,026.	2,128.
	42"	58.5"		C2F5842EAAKCC	1,930.	2,130.	2,239.
	42"	58.5"	Y	C2F5842CAAKCC	1,981.	2,180.	2,290.

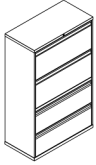

58.5" high lateral file, 3-10.5" drawers with hanging rails, 2-12" drawers with hanging rails	30"	58.5"		C2F5830EDDDCC	1,592.	1,758.	1,847.
	30"	58.5"	Y	C2F5830CDDDDCC	1,643.	1,805.	1,896.
	36"	58.5"		C2F5836EDDDCC	1,790.	1,974.	2,074.
	36"	58.5"	Y	C2F5836CDDDDCC	1,841.	2,024.	2,127.
	42"	58.5"		C2F5842EDDDCC	1,983.	2,187.	2,300.
	42"	58.5"	Y	C2F5842CDDDDCC	2,032.	2,238.	2,349.

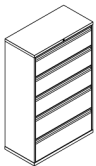

Order Code	Specification Information	Application Notes	Critical Dimensions
58.5" High Calibre Front Lateral Files	P1= painted finishes P2= painted finishes P3= painted finishes	Multiple freestanding files or cabinets (not attached to walls or worksurfaces) should be ganged for security. Single freestanding files (two and three-high) should be weighted with a counterweight (see Accessories page 79).	Actual Outside Case Height 58 ¹¹ / ₃₂ " Actual Inside Case Height 55 ¹ / ₂ " Calibre files are 18" deep.
Example: C2F5830CAAKCC-115	Customer's own non-metallic paint finishes available at P1 pricing. This excludes metallic paints and white paints. (see color policy page 15).	Rails are provided for filing side-to-side and front-to-back and are adjustable for letter, A4, foolscap, JIS, legal, or EDP paper sizes.	Note: Drawer configurations read from top to bottom of the case. Drawers with hanging rails include front to back and side to side hanging rails. Refer to front planning pages for additional information.
C Calibre Front	For reference shelf option substitute the "K" in the pattern number with a "J". Add \$178 list for reference shelf.	See KnollKey lock program on page 188 for keying information.	Label holders are not included with files. Please see Accessories page 79.
2 Generation Code		Dividers and attachment backs must be ordered separately for rollout shelves only.	Calibre files without locks include a black Knoll-logo insert in the same position. Insert may be removed to retrofit a lock later.
F File			
58 58.5" High			
30 30" Wide			
C Knoll Lock			
A 10.5" Drawer with Hanging Rails			
A 10.5" Drawer with Hanging Rails			
K 1.5" Tie bar			
C 12" Drawer with Hanging Rails			
C 12" Drawer with Hanging Rails			
115 Medium Grey (P1 paint pricing)			

Calibre Front Lateral Files

63" High Calibre Front Lateral Files

description	w	h	lock	pattern no.	P1	P2	P3
63" high lateral file, 1-12" receding door with pullout shelf, 4-12" drawers with hanging rails	30"	63"		C2F6330EZCCCC	\$1,676.	\$1,848.	\$1,941.
	30"	63"	Y	C2F6330CZCCCC	1,726.	1,901.	1,997.
	36"	63"		C2F6336EZCCCC	1,878.	2,068.	2,173.
	36"	63"	Y	C2F6336CZCCCC	1,928.	2,124.	2,232.
	42"	63"		C2F6342EZCCCC	2,100.	2,315.	2,430.
	42"	63"	Y	C2F6342CZCCCC	2,150.	2,369.	2,489.

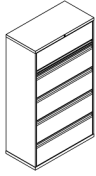

63" high lateral file, 5-12" receding doors with fixed shelves	30"	63"		C2F6330ENNNNN	1,666.	1,837.	1,932.
	30"	63"	Y	C2F6330CNNNNN	1,716.	1,887.	1,983.
	36"	63"		C2F6336ENNNNN	1,940.	2,136.	2,246.
	36"	63"	Y	C2F6336CNNNNN	1,989.	2,188.	2,299.
	42"	63"		C2F6342ENNNNN	2,336.	2,573.	2,707.
	42"	63"	Y	C2F6342CNNNNN	2,387.	2,628.	2,756.

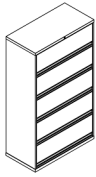

Order Code	Specification Information	Application Notes	Critical Dimensions
63" High Calibre Front Lateral Files	P1= painted finishes P2= painted finishes P3= painted finishes	Multiple freestanding files or cabinets (not attached to walls or worksurfaces) should be ganged for security. Single freestanding files (two and three-high) should be weighted with a counterweight (see Accessories page 79).	Actual Outside Case Height 62 ^{27/32} " Actual Inside Case Height 60" Calibre files are 18" deep.
Example: C2F6330CMMKDDDD-115	Customer's own non-metallic paint finishes available at P1 pricing. This excludes metallic paints and white paints. (see color policy page 15).	Rails are provided for filing side-to-side and front-to-back and are adjustable for letter, A4, foolscap, JIS, legal, or EDP paper sizes.	Note: Drawer configurations read from top to bottom of the case. Drawers with hanging rails include front to back and side to side hanging rails. Refer to front planning pages for additional information.
C Calibre Front	For reference shelf option substitute the "K" in the pattern number with a "J". Add \$178 list for reference shelf.	See KnollKey lock program on page 188 for keying information.	Label holders are not included with files. Please see Accessories page 79.
2 Generation Code		Dividers and attachment backs must be ordered separately for rollout shelves only.	Calibre files without locks include a black Knoll-logo insert in the same position. Insert may be removed to retrofit a lock later.
F File			
63 63" High			
30 30" Wide			
C Knoll Lock			
M 13.5" Receding Door with Fixed Shelf			
M 13.5" Receding Door with Fixed Shelf			
K 1.5" Tie bar			
D 10.5" Drawer with Hanging Rails			
D 10.5" Drawer with Hanging Rails			
D 10.5" Drawer with Hanging Rails			
115 Medium Grey (P1 paint pricing)			

Calibre Front Lateral Files - Preconfigured
Calibre Front Lateral Files
63" High Calibre Front Lateral Files

description	w	h	lock	pattern no.	P1	P2	P3
63" high lateral file, 5-12" receding doors with rollout shelves	30"	63"		C2F6330EZZZZ	\$1,913.	\$2,109.	\$2,214.
	30"	63"	Y	C2F6330CZZZZ	1,960.	2,165.	2,275.
	36"	63"		C2F6336EZZZZ	2,121.	2,331.	2,453.
	36"	63"	Y	C2F6336CZZZZ	2,171.	2,387.	2,512.
	42"	63"		C2F6342EZZZZ	2,337.	2,580.	2,703.
	42"	63"	Y	C2F6342CZZZZ	2,387.	2,636.	2,762.

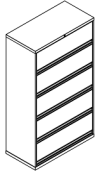

63" high lateral file, 1-15" receding door with fixed shelf, 3-15" drawers with hanging rails	30"	63"		C2F6330ELAAA	1,597.	1,763.	1,852.
	30"	63"	Y	C2F6330CLAAA	1,647.	1,812.	1,903.
	36"	63"		C2F6336ELAAA	1,832.	2,020.	2,125.
	36"	63"	Y	C2F6336CLAAA	1,881.	2,071.	2,174.
	42"	63"		C2F6342ELAAA	2,142.	2,362.	2,486.
	42"	63"	Y	C2F6342CLAAA	2,195.	2,413.	2,534.

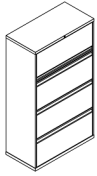

Order Code	Specification Information	Application Notes	Critical Dimensions
63" High Calibre Front Lateral Files	P1= painted finishes P2= painted finishes P3= painted finishes	Multiple freestanding files or cabinets (not attached to walls or worksurfaces) should be ganged for security. Single freestanding files (two and three-high) should be weighted with a counterweight (see Accessories page 79).	Actual Outside Case Height 62 ^{27/32"} Actual Inside Case Height 60" Calibre files are 18" deep.
Example: C2F6330CMMKDDD-115	Customer's own non-metallic paint finishes available at P1 pricing. This excludes metallic paints and white paints. (see color policy page 15).	Rails are provided for filing side-to-side and front-to-back and are adjustable for letter, A4, foolscap, JIS, legal, or EDP paper sizes.	Note: Drawer configurations read from top to bottom of the case. Drawers with hanging rails include front to back and side to side hanging rails. Refer to front planning pages for additional information.
C Calibre Front	For reference shelf option substitute the "K" in the pattern number with a "J". Add \$178 list for reference shelf.	See KnollKey lock program on page 188 for keying information.	Label holders are not included with files. Please see Accessories page 79.
2 Generation Code		Dividers and attachment backs must be ordered separately for rollout shelves only.	Calibre files without locks include a black Knoll-logo insert in the same position. Insert may be removed to retrofit a lock later.
F File			
63 63" High			
30 30" Wide			
C Knoll Lock			
M 13.5" Receding Door with Fixed Shelf			
M 13.5" Receding Door with Fixed Shelf			
K 1.5" Tie bar			
D 10.5" Drawer with Hanging Rails			
D 10.5" Drawer with Hanging Rails			
D 10.5" Drawer with Hanging Rails			
115 Medium Grey (P1 paint pricing)			

Calibre Front Lateral Files

63" High Calibre Front Lateral Files

description	w	h	lock	pattern no.	P1	P2	P3
63" high lateral file, 4-15" receding doors with fixed shelf	30"	63"		C2F6330ELLLL	\$1,552.	\$1,714.	\$1,801.
	30"	63"	Y	C2F6330CLLLL	1,604.	1,765.	1,852.
	36"	63"		C2F6336ELLLL	1,813.	1,999.	2,101.
	36"	63"	Y	C2F6336CLLLL	1,865.	2,050.	2,153.
	42"	63"		C2F6342ELLLL	2,100.	2,315.	2,436.
	42"	63"	Y	C2F6342CLLLL	2,152.	2,364.	2,488.

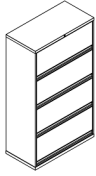

63" high lateral file, 1-13.5" receding door with fixed shelf, 1-10.5" drawer, 3-12" drawers with hanging rails	30"	63"		C2F6330EMDCCC	1,736.	1,914.	2,011.
	30"	63"	Y	C2F6330CMDCCC	1,786.	1,964.	2,062.
	36"	63"		C2F6336EMDCCC	1,938.	2,135.	2,244.
	36"	63"	Y	C2F6336CMDCCC	1,986.	2,187.	2,297.
	42"	63"		C2F6342EMDCCC	2,242.	2,469.	2,600.
	42"	63"	Y	C2F6342CMDCCC	2,293.	2,521.	2,647.

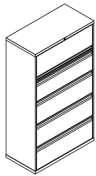

Order Code	Specification Information	Application Notes	Critical Dimensions
63" High Calibre Front Lateral Files	P1= painted finishes P2= painted finishes P3= painted finishes	Multiple freestanding files or cabinets (not attached to walls or worksurfaces) should be ganged for security. Single freestanding files (two and three-high) should be weighted with a counterweight (see Accessories page 79).	Actual Outside Case Height 62 ^{27/32} " Actual Inside Case Height 60" Calibre files are 18" deep.
Example: C2F6330CMMKDDDD-115	Customer's own non-metallic paint finishes available at P1 pricing. This excludes metallic paints and white paints. (see color policy page 15).	Rails are provided for filing side-to-side and front-to-back and are adjustable for letter, A4, foolscap, JIS, legal, or EDP paper sizes.	Note: Drawer configurations read from top to bottom of the case. Drawers with hanging rails include front to back and side to side hanging rails. Refer to front planning pages for additional information.
C Calibre Front	For reference shelf option substitute the "K" in the pattern number with a "J". Add \$178 list for reference shelf.	See KnollKey lock program on page 188 for keying information.	Label holders are not included with files. Please see Accessories page 79.
2 Generation Code		Dividers and attachment backs must be ordered separately for rollout shelves only.	Calibre files without locks include a black Knoll-logo insert in the same position. Insert may be removed to retrofit a lock later.
F File			
63 63" High			
30 30" Wide			
C Knoll Lock			
M 13.5" Receding Door with Fixed Shelf			
M 13.5" Receding Door with Fixed Shelf			
K 1.5" Tie bar			
D 10.5" Drawer with Hanging Rails			
D 10.5" Drawer with Hanging Rails			
D 10.5" Drawer with Hanging Rails			
115 Medium Grey (P1 paint pricing)			

Calibre Front Lateral Files - Preconfigured

Calibre Front Lateral Files

63" High Calibre Front Lateral Files

Calibre

Calibre File Collection

description	w	h	lock	pattern no.	P1	P2	P3
63" high lateral file, 2-13.5" receding doors with fixed shelves, 1-1.5" tie bar, 3-10.5" drawers with hanging rails	30"	63"		C2F6330EMMKDDD	\$1,715.	\$1,892.	\$1,989.
	30"	63"	Y	C2F6330CMMKDDD	1,766.	1,943.	2,040.
	36"	63"		C2F6336EMMKDDD	2,004.	2,208.	2,324.
	36"	63"	Y	C2F6336CMMKDDD	2,055.	2,259.	2,375.
	42"	63"		C2F6342EMMKDDD	2,309.	2,546.	2,674.
	42"	63"	Y	C2F6342CMMKDDD	2,360.	2,599.	2,726.

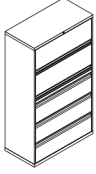

63" high lateral file, 1-12" receding door with fixed shelf, 4-12" drawers with hanging rails	30"	63"		C2F6330ENC CCC	1,676.	1,849.	1,944.
	30"	63"	Y	C2F6330CNC CCC	1,728.	1,900.	1,993.
	36"	63"		C2F6336ENC CCC	1,878.	2,071.	2,178.
	36"	63"	Y	C2F6336CNC CCC	1,928.	2,122.	2,228.
	42"	63"		C2F6342ENC CCC	2,099.	2,312.	2,434.
	42"	63"	Y	C2F6342CNC CCC	2,150.	2,363.	2,482.

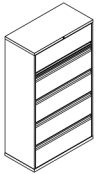

Order Code	Specification Information	Application Notes	Critical Dimensions
63" High Calibre Front Lateral Files	P1= painted finishes P2= painted finishes P3= painted finishes	Multiple freestanding files or cabinets (not attached to walls or worksurfaces) should be ganged for security. Single freestanding files (two and three-high) should be weighted with a counterweight (see Accessories page 79).	Actual Outside Case Height 62 ^{27/32} " Actual Inside Case Height 60" Calibre files are 18" deep.
Example: C2F6330CMMKDDD-115	Customer's own non-metallic paint finishes available at P1 pricing. This excludes metallic paints and white paints. (see color policy page 15).	Rails are provided for filing side-to-side and front-to-back and are adjustable for letter, A4, foolscap, JIS, legal, or EDP paper sizes.	Note: Drawer configurations read from top to bottom of the case. Drawers with hanging rails include front to back and side to side hanging rails. Refer to front planning pages for additional information.
C Calibre Front	For reference shelf option substitute the "K" in the pattern number with a "J". Add \$178 list for reference shelf.	See KnollKey lock program on page 188 for keying information.	Label holders are not included with files. Please see Accessories page 79.
2 Generation Code		Dividers and attachment backs must be ordered separately for rollout shelves only.	Calibre files without locks include a black Knoll-logo insert in the same position. Insert may be removed to retrofit a lock later.
F File			
63 63" High			
30 30" Wide			
C Knoll Lock			
M 13.5" Receding Door with Fixed Shelf			
M 13.5" Receding Door with Fixed Shelf			
K 1.5" Tie bar			
D 10.5" Drawer with Hanging Rails			
D 10.5" Drawer with Hanging Rails			
D 10.5" Drawer with Hanging Rails			
115 Medium Grey (P1 paint pricing)			

Calibre Front Lateral Files

64.5" High Calibre Front Lateral Files

description	w	h	lock	pattern no.	P1	P2	P3
64.5" high lateral file, 1-13.5" receding door with fixed shelf, 4-12" drawers with hanging rails	30"	64.5"		C2F6430EMCCCC	\$1,746.	\$1,925.	\$2,024.
	30"	64.5"	Y	C2F6430CMCCCC	1,797.	1,976.	2,074.
	36"	64.5"		C2F6436EMCCCC	1,949.	2,150.	2,259.
	36"	64.5"	Y	C2F6436CMCCCC	1,999.	2,200.	2,309.
	42"	64.5"		C2F6442EMCCCC	2,177.	2,399.	2,520.
	42"	64.5"	Y	C2F6442CMCCCC	2,227.	2,450.	2,570.

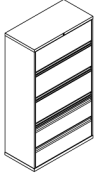

64.5" high lateral file, 1-12" receding door with fixed shelves, 1-12" Drawer, 1-1.5" tie bar, 3-12" drawers with hanging rails	30"	64.5"		C2F6430ENCKCCC	1,688.	1,864.	1,958.
	30"	64.5"	Y	C2F6430CNCKCCC	1,739.	1,914.	2,009.
	36"	64.5"		C2F6436ENCKCCC	1,958.	2,160.	2,273.
	36"	64.5"	Y	C2F6436CNCKCCC	2,009.	2,208.	2,318.
	42"	64.5"		C2F6442ENCKCCC	2,248.	2,480.	2,607.
	42"	64.5"	Y	C2F6442CNCKCCC	2,301.	2,531.	2,658.

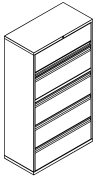

64.5" high lateral file, 2-12" receding doors with fixed shelves, 1-1.5" tie bar, 3-12" receding doors with fixed shelves	30"	64.5"		C2F6430ENNKNNN	1,688.	1,864.	1,958.
	30"	64.5"	Y	C2F6430CNNKNNN	1,739.	1,914.	2,009.
	36"	64.5"		C2F6436ENNKNNN	1,990.	2,194.	2,306.
	36"	64.5"	Y	C2F6436CNNKNNN	2,042.	2,244.	2,356.
	42"	64.5"		C2F6442ENNKNNN	2,228.	2,454.	2,581.
	42"	64.5"	Y	C2F6442CNNKNNN	2,279.	2,506.	2,634.

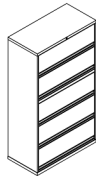

Order Code	Specification Information	Application Notes	Critical Dimensions
64.5" High Calibre Front Lateral Files	P1= painted finishes P2= painted finishes P3= painted finishes	Multiple freestanding files or cabinets (not attached to walls or worksurfaces) should be ganged for security. Single freestanding files (two and three-high) should be weighted with a counterweight (see Accessories page 79).	Actual Outside Case Height 64 ^{11/32"} Actual Inside Case Height 61 ^{1/2"} Calibre files are 18" deep.
Example: C2F6430CNCKCCC-115	Customer's own non-metallic paint finishes available at P1 pricing. This excludes metallic paints and white paints. (see color policy page 15).	Rails are provided for filing side-to-side and front-to-back and are adjustable for letter, A4, foolscap, JIS, legal, or EDP paper sizes.	Note: Drawer configurations read from top to bottom of the case. Drawers with hanging rails include front to back and side to side hanging rails. Refer to front planning pages for additional information.
C Calibre Front	For reference shelf option substitute the "K" in the pattern number with a "J". Add \$178 list for reference shelf.	See KnollKey lock program on page 188 for keying information.	Label holders are not included with files. Please see Accessories page 79.
2 Generation Code		Dividers and attachment backs must be ordered separately for rollout shelves only	Calibre files without locks include a black Knoll-logo insert in the same position. Insert may be removed to retrofit a lock later.
F File			
64 64" High			
30 30" Wide			
C Knoll Lock			
N 12" Receding Door with Fixed Shelf			
C 12" Drawer with Hanging Rails			
K 1.5" Tie bar			
C 12" Drawer with Hanging Rails			
C 12" Drawer with Hanging Rails			
C 12" Drawer with Hanging Rails			
115 Medium Grey (P1 paint pricing)			

Calibre Front Lateral Files

64.5" High Calibre Front Lateral Files

description	w	h	lock	pattern no.	P1	P2	P3
64.5" high lateral file, 2-12" receding doors with pullout shelves, 1-1.5" tie bar, 3-12" receding doors with pullout shelves	30"	64.5"		C2F6430EZZKZZZ	\$1,834.	\$2,021.	\$2,127.
	30"	64.5"	Y	C2F6430CZZKZZZ	1,882.	2,072.	2,177.
	36"	64.5"		C2F6436EZZKZZZ	2,062.	2,276.	2,389.
	36"	64.5"	Y	C2F6436CZZKZZZ	2,112.	2,327.	2,439.
	42"	64.5"		C2F6442EZZKZZZ	2,300.	2,533.	2,664.
	42"	64.5"	Y	C2F6442CZZKZZZ	2,349.	2,583.	2,713.

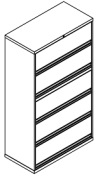

64.5" high lateral file, 2-15" receding doors with fixed shelves, 3-10.5" drawers with hanging rails	30"	64.5"		C2F6430ELLDDD	1,669.	1,842.	1,937.
	30"	64.5"	Y	C2F6430CLLDDD	1,718.	1,892.	1,985.
	36"	64.5"		C2F6436ELLDDD	1,954.	2,154.	2,265.
	36"	64.5"	Y	C2F6436CLLDDD	2,004.	2,205.	2,312.
	42"	64.5"		C2F6442ELLDDD	2,259.	2,493.	2,616.
	42"	64.5"	Y	C2F6442CLLDDD	2,309.	2,543.	2,668.

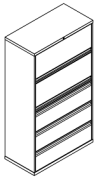

64.5" high lateral file, 3-13.5" receding doors with fixed shelves, 2-10.5" drawers with hanging rails	30"	64.5"		C2F6430EMMMDD	1,672.	1,843.	1,938.
	30"	64.5"	Y	C2F6430CMMMDD	1,719.	1,893.	1,986.
	36"	64.5"		C2F6436EMMMDD	1,964.	2,166.	2,277.
	36"	64.5"	Y	C2F6436CMMMDD	2,015.	2,215.	2,328.
	42"	64.5"		C2F6442EMMMDD	2,277.	2,508.	2,637.
	42"	64.5"	Y	C2F6442CMMMDD	2,328.	2,559.	2,687.

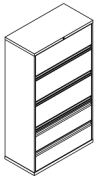

Order Code	Specification Information	Application Notes	Critical Dimensions
64.5" High Calibre Front Lateral Files	P1= painted finishes	Multiple freestanding files or cabinets (not attached to walls or worksurfaces) should be ganged for security. Single freestanding files (two and three-high) should be weighted with a counterweight (see Accessories page 79).	Actual Outside Case Height 64 ^{11/32"} Actual Inside Case Height 61 ^{1/2"} Calibre files are 18" deep.
Example: C2F6430CNCKCCC-115	P2= painted finishes		
C Calibre Front	P3= painted finishes	Rails are provided for filing side-to-side and front-to-back and are adjustable for letter, A4, foolscap, JIS, legal, or EDP paper sizes.	Note: Drawer configurations read from top to bottom of the case. Drawers with hanging rails include front to back and side to side hanging rails. Refer to front planning pages for additional information.
2 Generation Code	Customer's own non-metallic paint finishes available at P1 pricing. This excludes metallic paints and white paints. (see color policy page 15).		
F File	For reference shelf option substitute the "K" in the pattern number with a "J". Add \$178 list for reference shelf.	See KnollKey lock program on page 188 for keying information.	Label holders are not included with files. Please see Accessories page 79.
64 64" High			
30 30" Wide	Dividers and attachment backs must be ordered separately for rollout shelves only		Calibre files without locks include a black Knoll-logo insert in the same position. Insert may be removed to retrofit a lock later.
C Knoll Lock			
N 12" Receding Door with Fixed Shelf			
C 12" Drawer with Hanging Rails			
K 1.5" Tie bar			
C 12" Drawer with Hanging Rails			
C 12" Drawer with Hanging Rails			
C 12" Drawer with Hanging Rails			
115 Medium Grey (P1 paint pricing)			

Calibre Front Hybrids

55.5" High Calibre Front Hybrid Units

Calibre

description	w	h	lock	pattern no.	P1	P2	P3
55.5" high hybrid with 31.5" storage doors and 2-10.5" drawers with hanging rails (one adjustable shelf)	30"	55.5"		C2H5530EXDD	\$1,469.	\$1,618.	\$1,698.
	30"	55.5"	Y	C2H5530CXDD	1,522.	1,673.	1,755.
	36"	55.5"		C2H5536EXDD	1,673.	1,841.	1,930.
	36"	55.5"	Y	C2H5536CXDD	1,724.	1,894.	1,990.

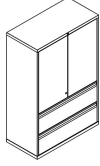

55.5" high hybrid with 21" storage doors and 3-10.5" drawers with hanging rails (no shelf)	30"	55.5"		C2H5530EVDDD	1,620.	1,779.	1,870.
	30"	55.5"	Y	C2H5530CVDDD	1,672.	1,838.	1,929.
	36"	55.5"		C2H5536EVDDD	1,877.	2,066.	2,170.
	36"	55.5"	Y	C2H5536CVDDD	1,927.	2,122.	2,227.

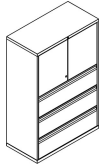

Order Code	Specification Information	Application Notes	Critical Dimensions
55.5" High Calibre Front Hybrid Unit	P1= painted finishes	Multiple freestanding files or cabinets (not attached to walls or worksurfaces) should be ganged for security. Single freestanding files (two and three-high) should be weighted with a counterweight (see Accessories page 79).	Actual Outside Case Height 55 11/32" Actual Inside Case Height 52 1/2" Calibre files are 18" deep.
Example: C2H5530CVDDD-115	P2= painted finishes		
C Calibre Front	P3= painted finishes	Rails are provided for filing side-to-side and front-to-back and are adjustable for letter, A4, foolscap, JIS, legal, or EDP paper sizes.	Note: Drawer configurations read from top to bottom of the case. Drawers with hanging rails include front to back and side to side hanging rails. Refer to front planning pages for additional information.
2 Generation Code	Customer's own non-metallic paint finishes available at P1 pricing. This excludes metallic paints and white paints. (see color policy page 15).		
H Hybrid	Calibre Hybrids are shipped with two locks that are random keyed. For units with like keys, please consult the Keyed Alike policy.	See KnollKey lock program on page 188 for keying.	Label holders are not included with files. Please see Accessories page 79.
55 55.5" High			
30 30" Wide			Calibre files without locks include a black Knoll-logo insert in the same position. Insert may be removed to retrofit a lock later.
C Knoll Lock			
V 21" Storage doors			
D 10.5" Drawer with Hanging Rails			
D 10.5" Drawer with Hanging Rails			
D 10.5" Drawer with Hanging Rails			
115 Medium Grey (P1 paint pricing)			

Calibre Front Hybrids

63" High Calibre Front Hybrid Units

Calibre

Calibre File Collection

description	w	h	lock	pattern no.	P1	P2	P3
63" high hybrid unit with 36" storage doors and 2-12" drawers with hanging rails (two shelves)	30"	63"		C2H6330ETCC	\$1,541.	\$1,696.	\$1,783.
	30"	63"	Y	C2H6330CTCC	1,592.	1,751.	1,841.
	36"	63"		C2H6336ETCC	1,751.	1,927.	2,026.
	36"	63"	Y	C2H6336CTCC	1,802.	1,986.	2,083.

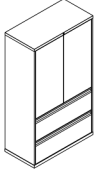

63" high hybrid unit with 24" storage doors and 3-12" drawers with hanging rails (two shelves)	30"	63"		C2H6330ERCCC	1,709.	1,880.	1,974.
	30"	63"	Y	C2H6330CRCCC	1,763.	1,937.	2,032.
	36"	63"		C2H6336ERCCC	1,948.	2,139.	2,248.
	36"	63"	Y	C2H6336CRCCC	1,998.	2,198.	2,307.

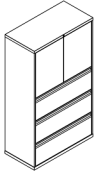

Order Code	Specification Information	Application Notes	Critical Dimensions
63" High Calibre Front Hybrid Unit	P1= painted finishes	Multiple freestanding files or cabinets (not attached to walls or worksurfaces) should be ganged for security. Single freestanding files (two and three-high) should be weighted with a counterweight (see Accessories page 79).	Actual Outside Case Height 62 ^{27/32} " Actual Inside Case Height 60" Calibre files are 18" deep.
Example: C2H6330CRCCC-115	P2= painted finishes		
C Calibre Front	P3= painted finishes	Rails are provided for filing side-to-side and front-to-back and are adjustable for letter, A4, foolscap, JIS, legal, or EDP paper sizes.	Note: Drawer configurations read from top to bottom of the case. Drawers with hanging rails include front to back and side to side hanging rails. Refer to front planning pages for additional information.
2 Generation Code	Customer's own non-metallic paint finishes available at P1 pricing. This excludes metallic paints and white paints. (see color policy page 15).		
H Hybrid	Calibre Hybrids are shipped with two locks that are random keyed. For units with like keys, please consult the Keyed Alike policy.	See KnollKey lock program on page 188 for keying information.	Label holders are not included with files. Please see Accessories page 79.
63 63" High			
30 30" Wide			Calibre files without locks include a black Knoll-logo insert in the same position. Insert may be removed to retrofit a lock later.
C Knoll Lock			
R 24" Storage doors			
C 12" Drawer with Hanging Rails			
C 12" Drawer with Hanging Rails			
C 12" Drawer with Hanging Rails			
115 Medium Grey (P1 paint pricing)			

Calibre Front Hybrids

64.5" High Calibre Front Hybrid Units

Calibre

description	w	h	lock	pattern no.	P1	P2	P3
64.5" high hybrid unit with 37.5" storage doors and 2-12" drawers with hanging rails (two shelves)	30"	64.5"		C2H6430EUCC	\$1,541.	\$1,696.	\$1,783.
	30"	64.5"	Y	C2H6430CUCC	1,592.	1,751.	1,841.
	36"	64.5"		C2H6436EUCC	1,751.	1,927.	2,026.
	36"	64.5"	Y	C2H6436CUCC	1,802.	1,986.	2,083.

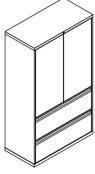

64.5" high hybrid unit with 25.5" storage doors and 3-12" drawers with hanging rails (two shelves)	30"	64.5"		C2H6430ESCCC	1,709.	1,880.	1,974.
	30"	64.5"	Y	C2H6430CSCCC	1,763.	1,937.	2,032.
	36"	64.5"		C2H6436ESCCC	1,948.	2,139.	2,248.
	36"	64.5"	Y	C2H6436CSCCC	1,998.	2,198.	2,307.

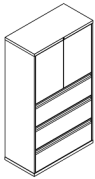

Order Code	Specification Information	Application Notes	Critical Dimensions
64.5" High Calibre Front Hybrid Unit	P1= painted finishes	Multiple freestanding files or cabinets (not attached to walls or worksurfaces) should be ganged for security. Single freestanding files (two and three-high) should be weighted with a counterweight (see Accessories page 79).	Actual Outside Case Height 64 ^{11/32"} Actual Inside Case Height 61 ^{1/2"} Calibre files are 18" deep.
Example: C2H6430CSCCC-115	P2= painted finishes		
C Calibre Front	P3= painted finishes	Rails are provided for filing side-to-side and front-to-back and are adjustable for letter, A4, foolscap, JIS, legal, or EDP paper sizes.	Note: Drawer configurations read from top to bottom of the case. Drawers with hanging rails include front to back and side to side hanging rails. Refer to front planning pages for additional information.
2 Generation Code	Customer's own non-metallic paint finishes available at P1 pricing. This excludes metallic paints and white paints. (see color policy page 15).		
H Hybrid	Calibre Hybrids are shipped with two locks that are random keyed. For like locks please consult the Knoll Keyed Alike policy.	See KnollKey lock program on page 188 for keying information.	Label holders are not included with files. Please see Accessories page 79.
64 64" High			
30 30" Wide			
C Knoll Lock			
S 25.5" Storage doors			
C 12" Drawer with Hanging Rails			
C 12" Drawer with Hanging Rails			
C 12" Drawer with Hanging Rails			
115 Medium Grey (P1 paint pricing)			

Calibre Front Wardrobes

55.5" High Calibre Front Wardrobe Units

Calibre

Calibre File Collection

description	w	h	lock	pattern no.	P1	P2	P3
55.5" high wardrobe with coat rod and shelf	30"	55.5"		C2W5530E	\$898.	\$990.	\$1,038.
	30"	55.5"	Y	C2W5530C	964.	1,059.	1,111.
	36"	55.5"		C2W5536E	983.	1,080.	1,135.
	36"	55.5"	Y	C2W5536C	1,040.	1,144.	1,203.

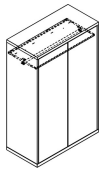

55.5" high vertically divided wardrobe with coat rod and 2 adjustable shelves	30"	55.5"		C2DW5530E	1,552.	1,707.	1,793.
	30"	55.5"	Y	C2DW5530C	1,604.	1,765.	1,853.
	36"	55.5"		C2DW5536E	1,843.	2,027.	2,129.
	36"	55.5"	Y	C2DW5536C	1,891.	2,080.	2,185.

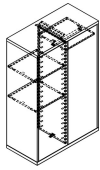

Order Code	Specification Information	Application Notes	Critical Dimensions
55.5" High Calibre Front Wardrobe Unit	P1= painted finishes	Multiple freestanding files or cabinets (not attached to walls or worksurfaces) should be ganged for security. Single freestanding files (two and three-high) should be weighted with a counterweight (see Accessories page 79).	Actual Outside Case Height 55 ¹¹ / ₃₂ " Actual Inside Case Height 52 ¹ / ₂ " Calibre wardrobes are 18" deep.
Example: C2W5530C-115	P2= painted finishes		
C Calibre Front	P3= painted finishes		
2 Generation Code	Customer's own non-metallic paint finishes available at P1 pricing. This excludes metallic paints and white paints. (see color policy page 15).	See KnollKey lock program on page 188 for keying information.	Calibre files without locks include a black Knoll-logo insert in the same position. Insert may be removed to retrofit a lock later.
W Wardrobe			
55 55.5" High			
30 30" Wide			
C Knoll Lock			
115 Medium Grey (P1 paint pricing)			

Calibre Front Wardrobes

63" High Calibre Front Wardrobe Units

Calibre

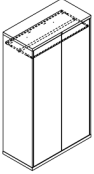
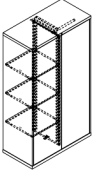
description	w	h	lock	pattern no.	P1	P2	P3
 Wardrobe with coat rod and shelf	30"	63"		C2W6330E	\$912.	\$1,001.	\$1,053.
	30"	63"	Y	C2W6330C	973.	1,072.	1,124.
	36"	63"		C2W6336E	985.	1,085.	1,138.
	36"	63"	Y	C2W6336C	1,042.	1,148.	1,207.
 Vertically divided wardrobe with coat rod and 3 adjustable shelves	30"	63"		C2DW6330E	1,589.	1,745.	1,829.
	30"	63"	Y	C2DW6330C	1,642.	1,799.	1,889.
	36"	63"		C2DW6336E	1,879.	2,063.	2,165.
	36"	63"	Y	C2DW6336C	1,927.	2,119.	2,223.

Order Code	Specification Information	Application Notes	Critical Dimensions
63" High Calibre Front Wardrobe Unit	P1= painted finishes	Multiple freestanding files or cabinets (not attached to walls or worksurfaces) should be ganged for security. Single freestanding files (two and three-high) should be weighted with a counterweight (see Accessories page 79).	Actual Outside Case Height 62 ^{27/32} " Actual Inside Case Height 60" Calibre wardrobes are 18" deep.
Example: C2WM4CD-115	P2= painted finishes		
C Calibre Front	P3= painted finishes		
2 Generation Code	Customer's own non-metallic paint finishes available at P1 pricing.	See KnollKey lock program on page 188 for keying information.	Calibre files without locks include a black Knoll-logo insert in the same position. Insert may be removed to retrofit a lock later.
W Wardrobe	This excludes metallic paints and white paints. (see color policy page 15).		
M Wardrobe Doors			
4 30" Wide			
C Knoll Lock			
D Coat Rod Shelf			
115 Medium Grey (P1 paint pricing)			

Calibre Front Wardrobes

64.5" High Calibre Front Wardrobe Units

Calibre

Calibre File Collection

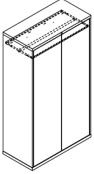
description	w	h	lock	pattern no.	P1	P2	P3
	30"	64.5"		C2W6430E	\$912.	\$1,001.	\$1,053.
	30"	64.5"	Y	C2W6430C	973.	1,072.	1,124.
	36"	64.5"		C2W6436E	985.	1,085.	1,138.
	36"	64.5"	Y	C2W6436C	1,042.	1,148.	1,207.

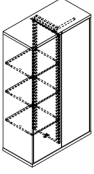
description	w	h	lock	pattern no.	P1	P2	P3
	30"	64.5"		C2DW6430E	1,589.	1,745.	1,829.
	30"	64.5"	Y	C2DW6430C	1,642.	1,799.	1,889.
	36"	64.5"		C2DW6436E	1,879.	2,063.	2,165.
	36"	64.5"	Y	C2DW6436C	1,927.	2,119.	2,223.

Order Code	Specification Information	Application Notes	Critical Dimensions
64.5" High Calibre Front Wardrobe Unit	P1= painted finishes	Multiple freestanding files or cabinets (not attached to walls or worksurfaces) should be ganged for security. Single freestanding files (two and three-high) should be weighted with a counterweight (see Accessories page 79).	Actual Outside Case Height 64 ¹¹ / ₃₂ " Actual Inside Case Height 61 ¹ / ₂ " Calibre wardrobes are 18" deep.
Example: C2WM5CD-115	P2= painted finishes		
C Calibre Front	P3= painted finishes		
2 Generation Code	Customer's own non-metallic paint finishes available at P1 pricing.	See KnollKey lock program on page 188 for keying information.	Calibre files without locks include a black Knoll-logo insert in the same position. Insert may be removed to retrofit a lock later.
W Wardrobe	This excludes metallic paints and white paints. (see color policy page 15).		
M Wardrobe Doors			
5 30" Wide			
C Knoll Lock			
D Coat Rod Shelf			
115 Medium Grey (P1 paint pricing)			

Calibre Front Cabinets

27" High Calibre Front Cabinets

Calibre

description	w	h	lock	pattern no.	P1	P2	P3
27" high cabinet with 1 adjustable shelf and no doors	30"	27"		C2C2730	\$715.	\$787.	\$828.
	36"	27"		C2C2736	742.	814.	854.

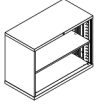

27" high cabinet with 1 adjustable shelf and doors	30"	27"		C2C2730E	802.	882.	927.
	30"	27"	Y	C2C2730C	867.	955.	1,001.
	36"	27"		C2C2736E	823.	906.	955.
	36"	27"	Y	C2C2736C	887.	977.	1,026.

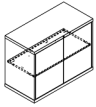

Order Code	Specification Information	Application Notes	Critical Dimensions
27" High Calibre Front Cabinets	P1= painted finishes	Multiple freestanding files or cabinets (not attached to walls or worksurfaces) should be ganged for security. Single freestanding files (two and three-high) should be weighted with a counterweight (see Accessories page 79).	Actual Outside Case Height 26 ^{27/32} " Actual Inside Case Height 24"
Example: C2C2730C-115	P2= painted finishes		
C Calibre	P3= painted finishes	Shelves adjustable on 2 ^{1/2} " increments.	Calibre cabinets are 18" deep.
2 Generation	Customer's own non-metallic paint finishes available at P1 pricing.		
C Cabinet	This excludes metallic paints and white paints. (see color policy page 15).	Cabinet shelves are black. To match shelves to case color, add "P" suffix to pattern number and \$51 to list price.	
27 27" High Case			
30 30" Wide Case		One shelf area of 27" high unit is intended for storage of item 10" or less in height. Height of unit matches that of corresponding file unit.	
C Locking with Doors			
115 Medium Grey (P1 paint pricing)		See KnollKey lock program on page 188 for keying information.	

Calibre Front Cabinets

34.5" High Calibre Front Cabinets

Calibre

Calibre File Collection

description	w	h	lock	pattern no.	P1	P2	P3
34.5" high cabinet with 1 adjustable shelf and no doors	30"	34.5"		C2C3430	\$731.	\$805.	\$846.
	36"	34.5"		C2C3436	746.	818.	861.

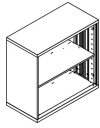

34.5" high cabinet with 1 adjustable shelf and doors	30"	34.5"		C2C3430E	878.	967.	1,016.
	30"	34.5"	Y	C2C3430C	939.	1,033.	1,085.
	36"	34.5"		C2C3436E	886.	976.	1,024.
	36"	34.5"	Y	C2C3436C	954.	1,049.	1,101.

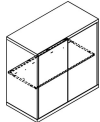

Order Code	Specification Information	Application Notes	Critical Dimensions
34.5" High Calibre Front Cabinets	P1= painted finishes	Multiple freestanding files or cabinets (not attached to walls or worksurfaces) should be ganged for security. Single freestanding files (two and three-high) should be weighted with a counterweight (see Accessories page 79).	Actual Outside Case Height 34 ¹¹ / ₃₂ " Actual Inside Case Height 31 ¹ / ₂ "
Example: C2C3430C-115	P2= painted finishes		
C Calibre	P3= painted finishes	Shelves adjustable on 2 ¹ / ₂ " increments.	Calibre cabinets are 18" deep.
2 Generation	Customer's own non-metallic paint finishes available at P1 pricing.		
C Cabinet	This excludes metallic paints and white paints. (see color policy page 15).	Cabinet shelves are black. To match shelves to case color, add "P" suffix to pattern number and \$51 to list price.	
34 34.5" High Case			
30 30" Wide Case		See KnollKey lock program on page 188 for keying information.	
C Locking with Doors			
115 Medium Grey (P1 paint pricing)			

Calibre Front Cabinets

39" High Calibre Front Cabinets

Calibre

description	w	h	lock	pattern no.	P1	P2	P3
39" high cabinet with 2 adjustable shelves and no doors	30"	39"		C2C3930	\$779.	\$859.	\$899.
	36"	39"		C2C3936	800.	881.	926.

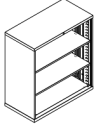

39" high cabinet with 2 adjustable shelves and doors	30"	39"		C2C3930E	887.	977.	1,026.
	30"	39"	Y	C2C3930C	949.	1,043.	1,099.
	36"	39"		C2C3936E	907.	1,001.	1,051.
	36"	39"	Y	C2C3936C	976.	1,075.	1,129.

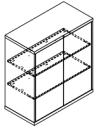

Order Code	Specification Information	Application Notes	Critical Dimensions
39" High Calibre Front Cabinets	P1= painted finishes	Multiple freestanding files or cabinets (not attached to walls or worksurfaces) should be ganged for security. Single freestanding files (two and three-high) should be weighted with a counterweight (see Accessories page 79).	Actual Outside Case Height 38 ^{27/32} " Actual Inside Case Height 36"
Example: C2C3930C-115	P2= painted finishes		
C Calibre	P3= painted finishes	Shelves adjustable on 2 1/2" increments.	Calibre cabinets are 18" deep.
2 Generation	Customer's own non-metallic paint finishes available at P1 pricing.		
C Cabinet	This excludes metallic paints and white paints. (see color policy page 15).	Cabinet shelves are black. To match shelves to case color, add "P" suffix to pattern number and \$51 to list price.	
39 39" High Case			
30 30" Wide Case		One shelf area of each unit is intended for storage of item 10" or less in height. Height of unit matches that of corresponding file unit.	
C Locking with Doors			
115 Medium Grey (P1 paint pricing)		See KnollKey lock program on page 188 for keying information.	

Calibre Front Cabinets

51" High Calibre Front Cabinets

Calibre

Calibre File Collection

description	w	h	lock	pattern no.	P1	P2	P3
51" high cabinet with 2 adjustable shelves and no doors	30"	51"		C2C5130	\$867.	\$955.	\$1,001.
	36"	51"		C2C5136	902.	995.	1,042.

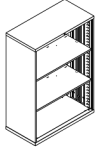

51" high cabinet with 2 adjustable shelves and doors	30"	51"		C2C5130E	988.	1,084.	1,139.
	30"	51"	Y	C2C5130C	1,046.	1,151.	1,210.
	36"	51"		C2C5136E	1,027.	1,131.	1,187.
	36"	51"	Y	C2C5136C	1,088.	1,199.	1,255.

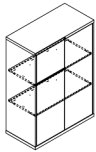

Order Code	Specification Information	Application Notes	Critical Dimensions
51" High Calibre Front Cabinets	P1= painted finishes	Multiple freestanding files or cabinets (not attached to walls or worksurfaces) should be ganged for security. Single freestanding files (two and three-high) should be weighted with a counterweight (see Accessories page 79).	Actual Outside Case Height 50 ^{27/32} " Actual Inside Case Height 48" Calibre cabinets are 18" deep.
Example: C2C5130C-115	P2= painted finishes		
C Calibre	P3= painted finishes		
2 Generation	Customer's own non-metallic paint finishes available at P1 pricing.	Shelves adjustable on 2 1/2" increments.	
C Cabinet	This excludes metallic paints and white paints. (see color policy page 15).		
51 51" High Case		Cabinet shelves are black. To match shelves to case color, add "P" suffix to pattern number and \$51 to list price.	
30 30" Wide Case			
C Locking with Doors			
115 Medium Grey (P1 paint pricing)		See KnollKey lock program on page 188 for keying information.	

Calibre Front Cabinets

55.5" High Calibre Front Cabinets

Calibre

description	w	h	lock	pattern no.	P1	P2	P3
55.5" high cabinet with 2 adjustable shelves and no doors	30"	55.5"		C2C5530	\$912.	\$1,000.	\$1,052.
	36"	55.5"		C2C5536	984.	1,081.	1,136.

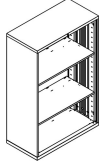

55.5" high cabinet with 2 adjustable shelves with doors	30"	55.5"		C2C5530E	1,073.	1,181.	1,239.
	30"	55.5"	Y	C2C5530C	1,133.	1,247.	1,310.
	36"	55.5"		C2C5536E	1,142.	1,255.	1,317.
	36"	55.5"	Y	C2C5536C	1,208.	1,329.	1,396.

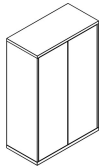

Order Code	Specification Information	Application Notes	Critical Dimensions
55.5" High Calibre Front Cabinets	P1= painted finishes	Multiple freestanding files or cabinets (not attached to walls or worksurfaces) should be ganged for security. Single freestanding files (two and three-high) should be weighted with a counterweight (see Accessories page 79).	Actual Outside Case Height 55 ^{11/32} " Actual Inside Case Height 52 ^{1/2} " Calibre cabinets are 18" deep.
Example: C2C5530C-115	P2= painted finishes		
C Calibre	P3= painted finishes		
2 Generation	Customer's own non-metallic paint finishes available at P1 pricing.	Shelves adjustable on 2 ^{1/2} " increments.	
C Cabinet	This excludes metallic paints and white paints. (see color policy page 15).		
55 55.5" High Case		Cabinet shelves are black. To match shelves to case color, add "P" suffix to pattern number and \$51 to list price.	
30 30" Wide Case			
C Locking with Doors			
115 Medium Grey (P1 paint pricing)		See KnollKey lock program on page 188 for keying information.	

Calibre Front Cabinets

63" High Calibre Front Cabinets

Calibre

Calibre File Collection

description	w	h	lock	pattern no.	P1	P2	P3
63" high cabinet with 3 adjustable shelves and no doors	30"	63"		C2C6330	\$934.	\$1,031.	\$1,084.
	36"	63"		C2C6336	1,009.	1,111.	1,168.

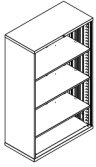

63" high cabinet with 3 adjustable shelves and doors	30"	63"		C2C6330E	1,073.	1,181.	1,240.
	30"	63"	Y	C2C6330C	1,133.	1,247.	1,310.
	36"	63"		C2C6336E	1,146.	1,259.	1,323.
	36"	63"	Y	C2C6336C	1,208.	1,329.	1,396.

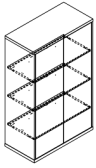

Order Code	Specification Information	Application Notes	Critical Dimensions
63" High Calibre Front Cabinets	P1= painted finishes	Multiple freestanding files or cabinets (not attached to walls or worksurfaces) should be ganged for security. Single freestanding files (two and three-high) should be weighted with a counterweight (see Accessories page 79).	Actual Outside Case Height 62 ^{27/32} " Actual Inside Case Height 60" Calibre cabinets are 18" deep.
Example: C2C6330C-115	P2= painted finishes		
C Calibre	P3= painted finishes		
2 Generation	Customer's own non-metallic paint finishes available at P1 pricing.	Shelves adjustable on 2 1/2" increments.	
C Cabinet	This excludes metallic paints and white paints. (see color policy page 15).		
63 63" High Case		Cabinet shelves are black. To match shelves to case color, add "P" suffix to pattern number and \$51 to list price.	
30 30" Wide Case			
C Locking with Doors			
115 Medium Grey (P1 paint pricing)		See KnollKey lock program on page 188 for keying information.	

Calibre Front Cabinets

64.5" High Calibre Front Cabinets

Calibre

description	w	h	lock	pattern no.	P1	P2	P3
64.5" high cabinet with 3 adjustable shelves and no doors	30"	64.5"		C2C6430	\$981.	\$1,075.	\$1,128.
	36"	64.5"		C2C6436	1,056.	1,156.	1,211.

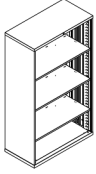

64.5" high cabinet with 3 adjustable shelves and doors	30"	64.5"		C2C6430E	1,115.	1,223.	1,283.
	30"	64.5"	Y	C2C6430C	1,179.	1,289.	1,353.
	36"	64.5"		C2C6436E	1,189.	1,307.	1,367.
	36"	64.5"	Y	C2C6436C	1,251.	1,372.	1,439.

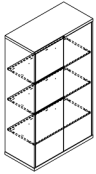



Order Code	Specification Information	Application Notes	Critical Dimensions
64.5" High Calibre Front Cabinets	P1= painted finishes	Multiple freestanding files or cabinets (not attached to walls or worksurfaces) should be ganged for security. Single freestanding files (two and three-high) should be weighted with a counterweight (see Accessories page 79).	Actual Outside Case Height 64 ^{11/32} " Actual Inside Case Height 61 ^{1/2} " Calibre cabinets are 18" deep.
Example: C2C6430C-115	P2= painted finishes		
C Calibre	P3= painted finishes	Shelves adjustable on 2 ^{1/2} " increments.	
2 Generation	Customer's own non-metallic paint finishes available at P1 pricing.		
C Cabinet	This excludes metallic paints and white paints. (see color policy page 15).	Cabinet shelves are black. To match shelves to case color, add "P" suffix to pattern number and \$51 to list price.	
64 64" High Case			
30 30" Wide Case		See KnollKey lock program on page 188 for keying information.	
C Locking with Doors			
115 Medium Grey (P1 paint pricing)			

Lateral File Worksurface Tops
Calibre Front Lateral File Worksurface Tops
Equity / Dividends Style

Calibre

Calibre File Collection

description	d	w	h	pattern no.	list price	woodgrain edge	metal edge
Equity / Dividends Style Rectangular	18"	30"	1 1/4"	CE3018	\$162.	\$180.	\$195.
18"d Laminate File Tops for Calibre Front Files	18"	36"	1 1/4"	CE3618	184.	203.	219.
	18"	42"	1 1/4"	CE4218	199.	215.	236.
	18"	60"	1 1/4"	CE6018	253.	279.	305.
	18"	72"	1 1/4"	CE7218	290.	318.	349.
	18"	84"	1 1/4"	CE8418	323.	356.	388.
	18"	90"	1 1/4"	CE9018	330.	364.	397.
	18"	108"	1 1/4"	CE10818	418.	459.	502.

Equity / Dividends Style Rectangular	36"	30"	1 1/4"	CE3036	190.	210.	228.
36"d Laminate File Tops for Calibre Front Files	36"	36"	1 1/4"	CE3636	225.	249.	271.
	36"	42"	1 1/4"	CE4236	241.	263.	290.
	36"	60"	1 1/4"	CE6036	384.	422.	459.
	36"	72"	1 1/4"	CE7236	431.	476.	520.
	36"	84"	1 1/4"	CE8436	482.	531.	578.
	36"	90"	1 1/4"	CE9036	502.	550.	601.
	36"	108"	1 1/4"	CE10836	622.	684.	747.

Order Code	Specification Information	Application Notes	Critical Dimensions	
30X18 Equity/Dividends Style File Tops (Calibre Files)	CE prefixed lateral file tops are designed to be attached to standard 18" deep (nominal) Calibre lateral files and cabinets. Please note that Calibre bookcases are 15" deep nominal and will not accept a Calibre lateral file laminate tops.	Designed for use with standard 18" deep nominal Calibre lateral files and cabinets only. Actual dimensions are listed in inches	Nominal Dimension	Actual Dimension
Example: CE3018			30x18	30.000 x 18.000
CE Equity/Dividend Edge	Calibre desking surfaces are not designed to serve as lateral file worksurface tops.		30x36	30.000 x 36.000
30 30" Wide			36x18	36.000 x 18.000
18 18" Deep			36x36	36.000 x 36.000
			42x18	42.000 x 18.000
			42x36	42.000 x 36.000
			60x18	60.000 x 18.000
			60x36	60.000 x 36.000
			72x18	72.000 x 18.000
			72x36	72.000 x 36.000
			84x18	84.000 x 18.000
			84x36	84.000 x 36.000
			90x18	90.000 x 18.000
			90x36	90.000 x 36.000
	108x18	108.000 x 18.000		
	108x36	108.000 x 36.000		

Lateral File Worksurface Tops
Calibre Front Lateral File Worksurface Tops
Morrison / Calibre Style

Calibre

description	d	w	h	pattern no.	list price
Morrison / Calibre Style Rectangular 18" d Laminate File Tops for Calibre Front Files	18"	30"	1 1/4"	CM3018	\$162.
	18"	36"	1 1/4"	CM3618	184.
	18"	42"	1 1/4"	CM4218	199.
	18"	60"	1 1/4"	CM6018	253.
	18"	72"	1 1/4"	CM7218	290.
	18"	84"	1 1/4"	CM8418	323.
	18"	90"	1 1/4"	CM9018	330.
	18"	108"	1 1/4"	CM10818	418.

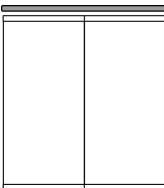
description	d	w	h	pattern no.	list price
Morrison / Calibre Style Rectangular 36" d Laminate File Tops for Calibre Front Files	36"	30"	1 1/4"	CM3036	190.
	36"	36"	1 1/4"	CM3636	225.
	36"	42"	1 1/4"	CM4236	241.
	36"	60"	1 1/4"	CM6036	384.
	36"	72"	1 1/4"	CM7236	431.
	36"	84"	1 1/4"	CM8436	482.
	36"	90"	1 1/4"	CM9036	502.
	36"	108"	1 1/4"	CM10836	622.

Order Code	Specification Information	Application Notes	Critical Dimensions	
30X18 Morrison/Calibre Style File Tops (Calibre Files)	CM prefixed lateral file tops are designed to be attached to standard 18" deep (nominal) Calibre lateral files and cabinets. Please note that Calibre bookcases are 15" deep nominal and will not accept a Calibre lateral file laminate tops.	Designed for use with standard 18" deep nominal Calibre lateral files and cabinets only. Actual dimensions are listed in inches	Nominal Dimension	Actual Dimension
Example: CME3018			30x18	30.125 x 18.375
CM Morrison/Calibre Edge	Calibre desking surfaces are not designed to serve as lateral file worksurface tops.		30x36	30.125 x 36.500
30 30" Wide			36x18	36.125 x 18.375
18 18" Deep			36x36	36.125 x 36.500
			42x18	42.125 x 18.375
			42x36	42.125 x 36.500
			60x18	60.125 x 18.375
			60x36	60.125 x 36.500
			72x18	72.125 x 18.375
			72x36	72.125 x 36.500
			84x18	84.125 x 18.375
			84x36	84.125 x 36.500
			90x18	90.125 x 18.375
			90x36	90.125 x 36.500
	108x18	108.125 x 18.375		
	108x36	108.125 x 36.500		

Lateral File Worksurface Tops
Calibre Front Lateral File Worksurface Tops
AutoStrada Style

Calibre

Calibre File Collection

description	d	w	h	pattern no.	list price
Autostrada Style Rectangular 18"d Laminate File Tops for Calibre Front Files	18"	30"	1 1/4"	CA3018	\$235.
	18"	36"	1 1/4"	CA3618	259.
	18"	42"	1 1/4"	CA4218	276.
	18"	60"	1 1/4"	CA6018	496.
	18"	72"	1 1/4"	CA7218	593.
	18"	84"	1 1/4"	CA8418	646.
	18"	90"	1 1/4"	CA9018	748.
	18"	108"	1 1/4"	CA10818	815.



Autostrada Style Rectangular 36"d Laminate File Tops for Calibre Front Files	36"	30"	1 1/4"	CA3036	425.
	36"	36"	1 1/4"	CA3636	468.
	36"	42"	1 1/4"	CA4236	505.
	36"	60"	1 1/4"	CA6036	695.
	36"	72"	1 1/4"	CA7236	771.
	36"	84"	1 1/4"	CA8436	829.
	36"	90"	1 1/4"	CA9036	842.
	36"	108"	1 1/4"	CA10836	1,072.

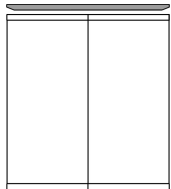

Order Code	Specification Information	Application Notes	Critical Dimensions	
30X18 AutoStrada Style File Tops (Calibre Files)	CA prefixed lateral file tops are designed to be attached to standard 18" deep (nominal) Calibre lateral files and cabinets. Please note that Calibre bookcases are 15" deep nominal and will not accept a Calibre lateral file laminate tops.	Designed for use with standard 18" deep nominal Calibre lateral files and cabinets only. Actual dimensions are listed in inches	Nominal Dimension	Actual Dimension
Example: CA3018			30x18	30.000 x 18.000
CA AutoStrada Edge			30x36	30.000 x 36.000
30 30" Wide			36x18	36.000 x 18.000
18 18" Deep			36x36	36.000 x 36.000
			42x18	42.000 x 18.000
			42x36	42.000 x 36.000
			60x18	60.000 x 18.000
			60x36	60.000 x 36.000
			72x18	72.000 x 18.000
			72x36	72.000 x 36.000
			84x18	84.000 x 18.000
			84x36	84.000 x 36.000
			90x18	90.000 x 18.000
			90x36	90.000 x 36.000
			108x18	108.000 x 18.000
			108x36	108.000 x 36.000

Lateral File Worksurface Tops
S2 Front Calibre Lateral File Worksurface Tops
Equity / Dividends Style

Calibre

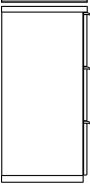
description	d	w	h	pattern no.	list price	woodgrain edge	metal edge
Equity / Dividends Style Rectangular 18"d Laminate File Tops for S2 Front Calibre Files 	18"	30"	1 1/4"	SD3018	\$162.	\$180.	\$195.
	18"	36"	1 1/4"	SD3618	184.	203.	219.
	18"	42"	1 1/4"	SD4218	199.	215.	236.
	18"	60"	1 1/4"	SD6018	253.	279.	305.
	18"	72"	1 1/4"	SD7218	290.	318.	349.
	18"	72"	1 1/4"	SD8418	323.	356.	388.
	18"	90"	1 1/4"	SD9018	330.	364.	397.
	18"	108"	1 1/4"	SD10818	418.	459.	502.

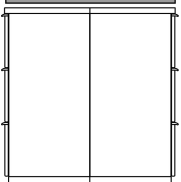
Equity / Dividends Style Rectangular 36"d Laminate File Tops for S2 Front Calibre Files 	36"	30"	1 1/4"	SD3036	190.	210.	228.
	36"	36"	1 1/4"	SD3636	225.	249.	271.
	36"	42"	1 1/4"	SD4236	241.	263.	290.
	36"	60"	1 1/4"	SD6036	384.	422.	459.
	36"	72"	1 1/4"	SD7236	431.	476.	520.
	36"	84"	1 1/4"	SD8436	482.	531.	578.
	36"	90"	1 1/4"	SD9036	502.	550.	601.
	36"	108"	1 1/4"	SD10836	622.	684.	747.

Order Code	Specification Information	Application Notes	Critical Dimensions	
30X18 Equity/Dividends Style File Tops (S2 Front Files)	SD prefixed lateral file tops are designed to be attached to 18 7/8" deep (nominal) Calibre lateral files and cabinets with S2 overlay fronts. Please note that Calibre bookcases are 15" deep nominal and will not accept a Calibre lateral file laminate tops.	Designed for use with 18 7/8" deep nominal Calibre lateral files and cabinets with S2 overlay fronts. Actual dimensions are listed in inches. Note: The 18" deep tops on this page may also be used with double wide pedestals when a nominal 18" deep top is required in panel planning.	Nominal Dimension	Actual Dimension
Example: SD3018				
SD Equity/Dividend Edge	Calibre desking surfaces are not designed to serve as lateral file worksurface tops.		30x18	30.00 x 18.875
30 30" Wide			30x36	30.00 x 37.750
18 18 7/8" Deep			36x18	36.00 x 18.875
			36x36	36.00 x 37.750
			42x18	42.00 x 18.875
			42x36	42.00 x 37.750
			60x18	60.00 x 18.875
			60x36	60.00 x 37.750
			72x18	72.00 x 18.875
			72x36	72.00 x 37.750
	84x18	84.00 x 18.875		
	84x36	84.00 x 37.750		
	90x18	90.00 x 18.875		
	90x36	90.00 x 37.750		
	108x18	108.00 x 18.875		
	108x36	108.00 x 37.750		

Lateral File Worksurface Tops

S2 Front Calibre Lateral File Worksurface Tops

Morrison / Calibre Style

Calibre

Calibre File Collection

description	d	w	h	pattern no.	list price
Morrison / Calibre Style Rectangular 18"d Laminate File Tops for S2 Front Calibre Files	18"	30"	1 1/4"	SC3018	\$162.
	18"	36"	1 1/4"	SC3618	184.
	18"	42"	1 1/4"	SC4218	199.
	18"	60"	1 1/4"	SC6018	253.
	18"	72"	1 1/4"	SC7218	290.
	18"	84"	1 1/4"	SC8418	323.
	18"	90"	1 1/4"	SC9018	330.
	18"	108"	1 1/4"	SC10818	418.

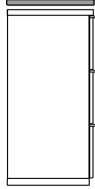

Morrison / Calibre Style Rectangular 36"d Laminate File Tops for S2 Front Calibre Files	36"	30"	1 1/4"	SC3036	190.
	36"	36"	1 1/4"	SC3636	225.
	36"	42"	1 1/4"	SC4236	241.
	36"	60"	1 1/4"	SC6036	384.
	36"	72"	1 1/4"	SC7236	431.
	36"	84"	1 1/4"	SC8436	482.
	36"	90"	1 1/4"	SC9036	502.
	36"	108"	1 1/4"	SC10836	622.

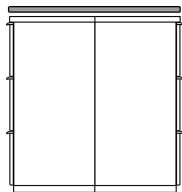

Order Code	Specification Information	Application Notes	Critical Dimensions	
30X18 Morrison/Calibre Style File Tops (S2 Front Files)	SC prefixed lateral file tops are designed to be attached to 18 7/8" deep (nominal) Calibre lateral files and cabinets with S2 overlay fronts. Please note that Calibre bookcases are 15" deep nominal and will not accept a Calibre lateral file laminate tops. Calibre desking surfaces are not designed to serve as lateral file worksurface tops.	Designed for use with 18 7/8" deep nominal Calibre lateral files and cabinets with S2 overlay fronts. Actual dimensions are listed in inches. Note: The 18" deep tops on this page may also be used with double wide pedestals when a nominal 18" deep top is required in panel planning.	Nominal Dimension	Actual Dimension
Example: SC3018			30x18	30.00 x 19.250
SC Morrison/Calibre Edge			30x36	30.00 x 38.500
30 30" Wide			36x18	36.00 x 19.250
18 18 7/8" Deep			36x36	36.00 x 38.500
			42x18	42.00 x 19.250
			42x36	42.00 x 38.500
			60x18	60.00 x 19.250
			60x36	60.00 x 38.500
			72x18	72.00 x 19.250
	72x36	72.00 x 38.500		
	84x18	84.00 x 19.250		
	84x36	84.00 x 38.500		
	90x18	90.00 x 19.250		
	90x36	90.00 x 38.500		
	108x18	108.00 x 19.250		
	108x36	108.00 x 38.500		

Lateral File Worksurface Tops
S2 Front Calibre Lateral File Worksurface Tops
AutoStrada Style

Calibre

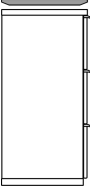
description	d	w	h	pattern no.	list price
Autostrada Style Rectangular 18" d Laminate File Tops for S2 Front Calibre Files	18"	30"	1 1/4"	SA3018	\$235.
	18"	36"	1 1/4"	SA3618	259.
	18"	42"	1 1/4"	SA4218	276.
	18"	60"	1 1/4"	SA6018	496.
	18"	72"	1 1/4"	SA7218	593.
	18"	84"	1 1/4"	SA8418	646.
	18"	90"	1 1/4"	SA9018	748.
	18"	108"	1 1/4"	SA10818	815.

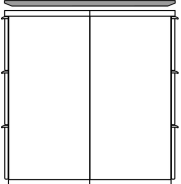
Autostrada Style Rectangular 36" d Laminate File Tops for S2 Front Calibre Files	36"	30"	1 1/4"	SA3036	425.
	36"	36"	1 1/4"	SA3636	468.
	36"	42"	1 1/4"	SA4236	505.
	36"	60"	1 1/4"	SA6036	695.
	36"	72"	1 1/4"	SA7236	771.
	36"	84"	1 1/4"	SA8436	829.
	36"	90"	1 1/4"	SA9036	842.
	36"	108"	1 1/4"	SA10836	1,072.

Order Code	Specification Information	Application Notes	Critical Dimensions	
30X18 AutoStrada Style File Tops (S2 Front Files)	SA prefixed lateral file tops are designed to be attached to 18 7/8" deep (nominal) Calibre lateral files and cabinets with S2 overlay fronts. Please note that Calibre bookcases are 15" deep nominal and will not accept a Calibre lateral file laminate tops.	Designed for use with 18 7/8" deep nominal Calibre lateral files and cabinets with S2 overlay fronts. Actual dimensions are listed in inches	Nominal	Actual Dimension
Example: SA3018			Dimension	
SA AutoStrada Edge			30x18	30.00 x 18.875
30 30" Wide			30x36	30.00 x 37.750
18 18 7/8" Deep			36x18	36.00 x 18.875
			36x36	36.00 x 37.750
			42x18	42.00 x 18.875
			42x36	42.00 x 37.750
			60x18	60.00 x 18.875
			60x36	60.00 x 37.750
			72x18	72.00 x 18.875
			72x36	72.00 x 37.750
			84x18	84.00 x 18.875
			84x36	84.00 x 37.750
			90x18	90.00 x 18.875
			90x36	90.00 x 37.750
			108x18	108.00 x 18.875
			108x36	108.00 x 37.750

description	w	d	pattern no.	P1	P2	P3
27" Add-on (Non-locking) Actual Height 28 ³ / ₈ "	30"	18"	C2S2730E	\$692.	\$762.	\$799.
	36"	18"	C2S2736E	735.	810.	850.
	42"	18"	C2S2742E	770.	846.	887.

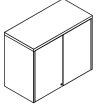

shown with lock option

30" Add-on (Non-locking) Actual Height 31 ³ / ₈ "	30"	18"	C2S3030E	735.	810.	850.
	36"	18"	C2S3036E	779.	857.	900.
	42"	18"	C2S3042E	813.	894.	938.

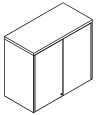

shown with lock option

Order Code	Specification Information	Application Notes
13.5" Add-on Unit		
Example: C2S1330E-115		
C Calibre	P1= painted finishes	Units may be specified with locks only as a "Built to Spec" option. To add a lock substitute the suffix "E" with a "C" and add \$36 to the list.
2 Generation	P2= painted finishes	
S Add-on unit	P3= painted finishes	
13 13" High	Customer's own non-metallic paint finishes available at P1 pricing. This excludes metallic paints and white paints. (see color policy page 15).	Units cannot be stacked in multiples.
30 30" Wide		Units come with double cupboard doors and one shelf for 27" and 30" units. Add-on units are 18" deep.
E Knoll Lock		
115 Medium Grey (P1 paint pricing)	Add-on module shelves are black. To match shelves to case color, add "P" suffix to the pattern number and \$51 to list price.	Add-on units cannot be used in conjunction with Morrison or Calibre Lateral Files with S2 Fronts.
		Actual heights of add-on's, 28³/₈" and 31³/₈".

Calibre Bookcases

Bookcases

Calibre

description	w	d	h	pattern no.	P1	P2	P3	deduct for no top	add for laminate top	add for V1 top
Topless 2-high bookcase for use under a worksurface end, one steel shelf	23 1/2"	14 7/8"	27 1/4"	C4B2723NS	\$549.	\$576.	\$605.			
	29 1/2"	14 7/8"	27 1/4"	C4B2729NS	567.	596.	624.			

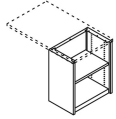

2-high bookcase, steel top, one steel shelf	w	d	h	pattern no.	P1	P2	P3	deduct for no top	add for laminate top	add for V1 top
24"	14 7/8"	29 7/8"	C4B3024(N/S/L/V)S	615.	646.	678.	128.	10.	228.	
30"	14 7/8"	29 7/8"	C4B3030(N/S/L/V)S	635.	667.	701.	132.	13.	273.	
36"	14 7/8"	29 7/8"	C4B3036(N/S/L/V)S	653.	685.	719.	136.	16.	324.	
42"	14 7/8"	29 7/8"	C4B3042(N/S/L/V)S	698.	731.	769.	140.	21.	386.	
48"	14 7/8"	29 7/8"	C4B3048(N/S/L/V)S	749.	785.	825.	144.	26.	460.	
54"	14 7/8"	29 7/8"	C4B3054(N/S/L/V)S	1,062.	1,115.	1,172.	148.	34.	487.	
60"	14 7/8"	29 7/8"	C4B3060(N/S/L/V)S	1,080.	1,134.	1,190.	152.	41.	530.	
66"	14 7/8"	29 7/8"	C4B3066(N/S/L/V)S	1,094.	1,149.	1,207.	156.	52.	581.	
72"	14 7/8"	29 7/8"	C4B3072(N/S/L/V)S	1,109.	1,165.	1,223.	162.	65.	633.	
78"	14 7/8"	29 7/8"	C4B3078(N/S/L/V)S	1,148.	1,206.	1,265.	166.	83.	694.	
84"	14 7/8"	29 7/8"	C4B3084(N/S/L/V)S	1,186.	1,245.	1,308.	171.	102.	756.	



39" high bookcase, steel top, two steel shelves	w	d	h	pattern no.	P1	P2	P3	deduct for no top	add for laminate top	add for V1 top
24"	14 7/8"	39"	C4B3924(N/S/L/V)S	723.	760.	798.	128.	10.	228.	
30"	14 7/8"	39"	C4B3930(N/S/L/V)S	749.	785.	825.	132.	13.	273.	
36"	14 7/8"	39"	C4B3936(N/S/L/V)S	774.	813.	854.	136.	16.	324.	
42"	14 7/8"	39"	C4B3942(N/S/L/V)S	823.	865.	907.	140.	21.	386.	
48"	14 7/8"	39"	C4B3948(N/S/L/V)S	887.	932.	978.	144.	26.	460.	
54"	14 7/8"	39"	C4B3954(N/S/L/V)S	1,252.	1,314.	1,380.	148.	34.	487.	
60"	14 7/8"	39"	C4B3960(N/S/L/V)S	1,273.	1,336.	1,404.	152.	41.	530.	
66"	14 7/8"	39"	C4B3966(N/S/L/V)S	1,294.	1,359.	1,426.	156.	52.	581.	
72"	14 7/8"	39"	C4B3972(N/S/L/V)S	1,316.	1,382.	1,451.	162.	65.	633.	
78"	14 7/8"	39"	C4B3978(N/S/L/V)S	1,358.	1,425.	1,496.	166.	83.	694.	
84"	14 7/8"	39"	C4B3984(N/S/L/V)S	1,399.	1,469.	1,542.	171.	102.	756.	

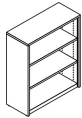

Order Code	Specification Information	Application Notes
Example: C3B2723NS-118	Bookcase top options:	Units 54" and wider utilize a mid panel that divides the unit into the following non-handed configurations:
C Calibre	N No top	54"= 24"/30"
4 Generation 4	S Steel top	60"= 30"/30"
B Bookcase	L Laminate top	66"= 30"/36"
27 27 1/4 High Case	V Veneer top	72"= 36"/36"
23 23 1/2 Wide Case	P1, P2 and P3 pricing listed is for units with steel tops and steel shelves as applicable. All deducts or up charges for top and shelf options are based on these prices.	78"= 36"/42"
N No top	Steel tops and shelves match the case paint finish.	84"= 42"/42"
118 Bright white paint	Bookcases specified without a top are designed to be used with laminate or veneer tops, and are not compatible with steel tops.	3-, 4-, 5- and 6-high units with steel tops include a top trim panel to provide a smooth appearance to the underside of the top. It is not included with 2-high units.
		Note: 6-high units must be ganged back-to-back with the included hardware or against a wall with user supplied hardware.
		All units are shipped knocked down.
		The base, which also functions as the bottom shelf, is only available in steel.
		Standard shelf openings are 12.6" h with the exception of the topless 2-high unit which accommodates two 11.9" openings.
		Shelves are adjustable on 1.05" increments the entire height of the case and include an approximately 3/4" gap in the back of the shelf for future enhancements. Optional shelf filler strip available on page 61.
		Laminate tops are 1.05" thick with 2mm edge banding on all four edges.

Calibre Bookcases

Bookcases

Calibre

Calibre File Collection

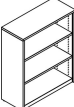
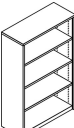
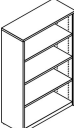
description	w	d	h	pattern no.	P1	P2	P3	deduct for no top	add for laminate top	add for V1 top
 3-high bookcase, steel top, two steel shelves	24"	14 ⁷ / ₈ "	43 ¹ / ₂ "	C4B4424(N/S/L/V)S	\$723.	\$760.	\$798.	\$128.	\$10.	\$228.
	30"	14 ⁷ / ₈ "	43 ¹ / ₂ "	C4B4430(N/S/L/V)S	749.	785.	825.	132.	13.	273.
	36"	14 ⁷ / ₈ "	43 ¹ / ₂ "	C4B4436(N/S/L/V)S	774.	813.	854.	136.	16.	324.
	42"	14 ⁷ / ₈ "	43 ¹ / ₂ "	C4B4442(N/S/L/V)S	823.	865.	907.	140.	21.	386.
	48"	14 ⁷ / ₈ "	43 ¹ / ₂ "	C4B4448(N/S/L/V)S	887.	932.	978.	144.	27.	460.
	54"	14 ⁷ / ₈ "	43 ¹ / ₂ "	C4B4454(N/S/L/V)S	1,252.	1,314.	1,380.	148.	34.	487.
	60"	14 ⁷ / ₈ "	43 ¹ / ₂ "	C4B4460(N/S/L/V)S	1,273.	1,336.	1,404.	152.	41.	530.
	66"	14 ⁷ / ₈ "	43 ¹ / ₂ "	C4B4466(N/S/L/V)S	1,294.	1,359.	1,426.	156.	52.	581.
	72"	14 ⁷ / ₈ "	43 ¹ / ₂ "	C4B4472(N/S/L/V)S	1,316.	1,382.	1,451.	162.	65.	633.
	78"	14 ⁷ / ₈ "	43 ¹ / ₂ "	C4B4478(N/S/L/V)S	1,358.	1,425.	1,496.	166.	83.	694.
84"	14 ⁷ / ₈ "	43 ¹ / ₂ "	C4B4484(N/S/L/V)S	1,399.	1,469.	1,542.	171.	102.	756.	
 4-high bookcase, steel top, three steel shelves	24"	14 ⁷ / ₈ "	57 ¹ / ₈ "	C4B5824(N/S/L/V)S	809.	849.	890.	128.	10.	228.
	30"	14 ⁷ / ₈ "	57 ¹ / ₈ "	C4B5830(N/S/L/V)S	840.	882.	927.	132.	13.	273.
	36"	14 ⁷ / ₈ "	57 ¹ / ₈ "	C4B5836(N/S/L/V)S	872.	917.	963.	136.	16.	324.
	42"	14 ⁷ / ₈ "	57 ¹ / ₈ "	C4B5842(N/S/L/V)S	927.	973.	1,023.	140.	21.	386.
	48"	14 ⁷ / ₈ "	57 ¹ / ₈ "	C4B5848(N/S/L/V)S	1,005.	1,056.	1,108.	144.	26.	460.
	54"	14 ⁷ / ₈ "	57 ¹ / ₈ "	C4B5854(N/S/L/V)S	1,401.	1,471.	1,544.	148.	34.	487.
	60"	14 ⁷ / ₈ "	57 ¹ / ₈ "	C4B5860(N/S/L/V)S	1,428.	1,499.	1,575.	152.	41.	530.
	66"	14 ⁷ / ₈ "	57 ¹ / ₈ "	C4B5866(N/S/L/V)S	1,457.	1,529.	1,605.	156.	52.	581.
	72"	14 ⁷ / ₈ "	57 ¹ / ₈ "	C4B5872(N/S/L/V)S	1,484.	1,559.	1,635.	162.	65.	633.
	78"	14 ⁷ / ₈ "	57 ¹ / ₈ "	C4B5878(N/S/L/V)S	1,529.	1,605.	1,685.	166.	83.	694.
84"	14 ⁷ / ₈ "	57 ¹ / ₈ "	C4B5884(N/S/L/V)S	1,576.	1,654.	1,738.	171.	102.	756.	
 64" high bookcase, steel top, three steel shelves	24"	14 ⁷ / ₈ "	63 ³ / ₈ "	C4B6424(N/S/L/V)S	849.	890.	934.	128.	10.	228.
	30"	14 ⁷ / ₈ "	63 ³ / ₈ "	C4B6430(N/S/L/V)S	882.	927.	973.	132.	13.	273.
	36"	14 ⁷ / ₈ "	63 ³ / ₈ "	C4B6436(N/S/L/V)S	917.	963.	1,009.	136.	16.	324.
	42"	14 ⁷ / ₈ "	63 ³ / ₈ "	C4B6442(N/S/L/V)S	973.	1,023.	1,074.	140.	21.	386.
	48"	14 ⁷ / ₈ "	63 ³ / ₈ "	C4B6448(N/S/L/V)S	1,056.	1,108.	1,164.	144.	26.	460.
	54"	14 ⁷ / ₈ "	63 ³ / ₈ "	C4B6454(N/S/L/V)S	1,471.	1,544.	1,622.	148.	34.	487.
	60"	14 ⁷ / ₈ "	63 ³ / ₈ "	C4B6460(N/S/L/V)S	1,499.	1,575.	1,653.	152.	41.	530.
	66"	14 ⁷ / ₈ "	63 ³ / ₈ "	C4B6466(N/S/L/V)S	1,529.	1,605.	1,685.	156.	52.	581.
	72"	14 ⁷ / ₈ "	63 ³ / ₈ "	C4B6472(N/S/L/V)S	1,559.	1,635.	1,717.	162.	65.	633.
	78"	14 ⁷ / ₈ "	63 ³ / ₈ "	C4B6478(N/S/L/V)S	1,605.	1,685.	1,771.	166.	83.	694.
84"	14 ⁷ / ₈ "	63 ³ / ₈ "	C4B6484(N/S/L/V)S	1,654.	1,738.	1,824.	171.	102.	756.	

Order Code	Specification Information	Application Notes
Example: C3B2723NS-118 C Calibre 4 Generation 4 B Bookcase 27 27 1/4 High Case 23 23 1/2 Wide Case N No top 118 Bright white paint	Bookcase top options: N No top S Steel top L Laminate top V Veneer top P1, P2 and P3 pricing listed is for units with steel tops and steel shelves as applicable. All deducts or up charges for top and shelf options are based on these prices. Steel tops and shelves match the case paint finish. Bookcases specified without a top are designed to be used with laminate or veneer tops, and are not compatible with steel tops.	Units 54" and wider utilize a mid panel that divides the unit into the following non-handed configurations: 54"= 24"/30" 60"= 30"/30" 66"= 30"/36" 72"= 36"/36" 78"= 36"/42" 84"= 42"/42" 3-, 4-, 5- and 6-high units with steel tops include a top trim panel to provide a smooth appearance to the underside of the top. It is not included with 2-high units. Note: 6-high units must be ganged back-to-back with the included hardware or against a wall with user supplied hardware.

All units are shipped knocked down.

The base, which also functions as the bottom shelf, is only available in steel.

Standard shelf openings are 12.6" h with the exception of the topless 2-high unit which accommodates two 11.9" openings.

Shelves are adjustable on 1.05" increments the entire height of the case and include an approximately 3/4" gap in the back of the shelf for future enhancements. Optional shelf filler strip available on page 61.

Laminate tops are 1.05" thick with 2mm edge banding on all four edges.

Calibre Bookcases

Bookcases

Calibre

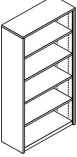
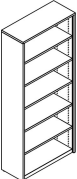
description	w	d	h	pattern no.	P1	P2	P3	deduct for no top	add for laminate top	add for V1 top
5-high bookcase, steel top, four steel shelves 	24"	14 ⁷ / ₈ "	70 ³ / ₄ "	C4B7124(N/S/L/V)S	\$914.	\$959.	\$1,006.	\$128.	\$10.	\$228.
	30"	14 ⁷ / ₈ "	70 ³ / ₄ "	C4B7130(N/S/L/V)S	955.	1,003.	1,053.	132.	13.	273.
	36"	14 ⁷ / ₈ "	70 ³ / ₄ "	C4B7136(N/S/L/V)S	989.	1,038.	1,091.	136.	16.	324.
	42"	14 ⁷ / ₈ "	70 ³ / ₄ "	C4B7142(N/S/L/V)S	1,076.	1,130.	1,186.	140.	21.	386.
	48"	14 ⁷ / ₈ "	70 ³ / ₄ "	C4B7148(N/S/L/V)S	1,168.	1,226.	1,289.	144.	26.	460.
	54"	14 ⁷ / ₈ "	70 ³ / ₄ "	C4B7154(N/S/L/V)S	1,588.	1,669.	1,751.	148.	34.	487.
	60"	14 ⁷ / ₈ "	70 ³ / ₄ "	C4B7160(N/S/L/V)S	1,624.	1,705.	1,790.	152.	41.	530.
	66"	14 ⁷ / ₈ "	70 ³ / ₄ "	C4B7166(N/S/L/V)S	1,652.	1,736.	1,822.	156.	52.	581.
	72"	14 ⁷ / ₈ "	70 ³ / ₄ "	C4B7172(N/S/L/V)S	1,682.	1,766.	1,855.	162.	65.	633.
	78"	14 ⁷ / ₈ "	70 ³ / ₄ "	C4B7178(N/S/L/V)S	1,755.	1,843.	1,935.	166.	83.	694.
84"	14 ⁷ / ₈ "	70 ³ / ₄ "	C4B7184(N/S/L/V)S	1,828.	1,921.	2,016.	171.	102.	756.	
6-high bookcase, steel top, five steel shelves (must be ganged back-to-back or to a wall with included hardware) 	24"	14 ⁷ / ₈ "	84 ¹ / ₂ "	C4B8524(N/S/L/V)S	1,083.	1,138.	1,194.	128.	10.	228.
	30"	14 ⁷ / ₈ "	84 ¹ / ₂ "	C4B8530(N/S/L/V)S	1,135.	1,191.	1,251.	132.	13.	273.
	36"	14 ⁷ / ₈ "	84 ¹ / ₂ "	C4B8536(N/S/L/V)S	1,185.	1,244.	1,307.	136.	16.	324.
	42"	14 ⁷ / ₈ "	84 ¹ / ₂ "	C4B8542(N/S/L/V)S	1,301.	1,366.	1,434.	140.	21.	386.
	48"	14 ⁷ / ₈ "	84 ¹ / ₂ "	C4B8548(N/S/L/V)S	1,348.	1,416.	1,486.	144.	26.	460.
	54"	14 ⁷ / ₈ "	84 ¹ / ₂ "	C4B8554(N/S/L/V)S	1,886.	1,979.	2,079.	148.	34.	487.
	60"	14 ⁷ / ₈ "	84 ¹ / ₂ "	C4B8560(N/S/L/V)S	1,929.	2,026.	2,128.	152.	41.	530.
	66"	14 ⁷ / ₈ "	84 ¹ / ₂ "	C4B8566(N/S/L/V)S	1,972.	2,071.	2,175.	156.	52.	581.
	72"	14 ⁷ / ₈ "	84 ¹ / ₂ "	C4B8572(N/S/L/V)S	2,015.	2,115.	2,222.	162.	65.	633.
	78"	14 ⁷ / ₈ "	84 ¹ / ₂ "	C4B8578(N/S/L/V)S	2,113.	2,220.	2,330.	166.	83.	694.
84"	14 ⁷ / ₈ "	84 ¹ / ₂ "	C4B8584(N/S/L/V)S	2,211.	2,322.	2,438.	171.	102.	756.	

Order Code	Specification Information	Application Notes
Example: C3B2723NS-118	Bookcase top options:	Units 54" and wider utilize a mid panel that divides the unit into the following non-handed configurations:
C Calibre	N No top	54"= 24"/30"
4 Generation 4	S Steel top	60"= 30"/30"
B Bookcase	L Laminate top	66"= 30"/36"
27 27 1/4 High Case	V Veneer top	72"= 36"/36"
23 23 1/2 Wide Case	P1, P2 and P3 pricing listed is for units with steel tops and steel shelves as applicable. All deducts or up charges for top and shelf options are based on these prices.	78"= 36"/42"
N No top	Steel tops and shelves match the case paint finish.	84"= 42"/42"
118 Bright white paint	Bookcases specified without a top are designed to be used with laminate or veneer tops, and are not compatible with steel tops.	3-, 4-, 5- and 6-high units with steel tops include a top trim panel to provide a smooth appearance to the underside of the top. It is not included with 2-high units.
		Note: 6-high units must be ganged back-to-back with the included hardware or against a wall with user supplied hardware.
		All units are shipped knocked down.
		The base, which also functions as the bottom shelf, is only available in steel.
		Standard shelf openings are 12.6" h with the exception of the topless 2-high unit which accommodates two 11.9" openings.
		Shelves are adjustable on 1.05" increments the entire height of the case and include an approximately 3/4" gap in the back of the shelf for future enhancements. Optional shelf filler strip available on page 61.
		Laminate tops are 1.05" thick with 2mm edge banding on all four edges.

description	w	d	h	pattern no.	P1	P2	P3	lam.	V1	list
Steel bookcase shelf with brackets	24"	13"	1 1/4"	C4BSH24S	\$57.	\$60.	\$62.	n/a	n/a	
	30"	13"	1 1/4"	C4BSH30S	61.	64.	67.	n/a	n/a	
	36"	13"	1 1/4"	C4BSH36S	65.	68.	71.	n/a	n/a	
	42"	13"	1 1/4"	C4BSH42S	69.	72.	77.	n/a	n/a	
	48"	13"	1 1/4"	C4BSH48S	73.	77.	83.	n/a	n/a	
Steel bookcase shelf with brackets (package of 5)	24"	13"	1 1/4"	C4BSH24S5	256.	269.	282.	n/a	n/a	
	30"	13"	1 1/4"	C4BSH30S5	275.	290.	305.	n/a	n/a	
	36"	13"	1 1/4"	C4BSH36S5	295.	311.	325.	n/a	n/a	
	42"	13"	1 1/4"	C4BSH42S5	315.	329.	348.	n/a	n/a	
	48"	13"	1 1/4"	C4BSH48S5	334.	351.	368.	n/a	n/a	
30"d bookcase top	24"	29 13/16"	1 1/8"	C4BTOP24(L/V)	n/a	n/a	n/a	166.	343.	
	30"	29 13/16"	1 1/8"	C4BTOP30(L/V)	n/a	n/a	n/a	180.	386.	
	36"	29 13/16"	1 1/8"	C4BTOP36(L/V)	n/a	n/a	n/a	214.	224.	
	42"	29 13/16"	1 1/8"	C4BTOP42(L/V)	n/a	n/a	n/a	227.	240.	
	48"	29 13/16"	1 1/8"	C4BTOP48(L/V)	n/a	n/a	n/a	247.	258.	
	54"	29 13/16"	1 1/8"	C4BTOP54(L/V)	n/a	n/a	n/a	345.	362.	
	60"	29 13/16"	1 1/8"	C4BTOP60(L/V)	n/a	n/a	n/a	364.	383.	
	66"	29 13/16"	1 1/8"	C4BTOP66(L/V)	n/a	n/a	n/a	385.	404.	
	72"	29 13/16"	1 1/8"	C4BTOP72(L/V)	n/a	n/a	n/a	408.	429.	
	78"	29 13/16"	1 1/8"	C4BTOP78(L/V)	n/a	n/a	n/a	432.	455.	
Shelf Filler Strip (package of 5)	24"	3/4"	1 1/4"	C4BSHFS24	126.	141.	147.	n/a	n/a	
	30"	3/4"	1 1/4"	C4BSHFS30	133.	145.	151.	n/a	n/a	
	36"	3/4"	1 1/4"	C4BSHFS36	151.	166.	173.	n/a	n/a	
	42"	3/4"	1 1/4"	C4BSHFS42	154.	169.	176.	n/a	n/a	
	48"	3/4"	1 1/4"	C4BSHFS48	156.	172.	180.	n/a	n/a	
Glide Adjustment Wrench				C4BWRENCH						10.

Order Code	Specification Information	Application Notes
Example: C3BSH42S5-118	Package of 5 shelves must be ordered in a single color per package.	Units 54" and wider utilize a mid panel that divides the unit into the following non-handed configurations:
C Calibre	Bookcase shelves are only available in steel.	54"= 24"/30"
4 Generation 4		60"= 30"/30"
B Bookcase	Bookcase top options:	66"= 30"/36"
SH Shelf		72"= 36"/36"
42 42" wide	L Laminate top V Veneer top	78"= 36"/42"
S Steel		84"= 42"/42"
5 Package of 5		<i>Glide Adjustment Wrench</i> This tool is a long, thin wrench designed to aid in the adjustment of the rear glides when they are not easily accessible.
118 Bright white paint		<i>30"d Bookcase Top</i> These laminate or veneer tops may be utilized with bookcases ordered with the "no top" option. NOTE: These tops will only work with either a "no top" bookcase or those originally ordered with a laminate or veneer top of the same size. Tops are for single bookcases only and are not sized to fit on two bookcases pushed together side by side (ex. 60"w top will not cover two 30"w cases). <i>Ganging Kit</i> Provides necessary attachment bolts/brackets to attach two units together (side to side or back to back) as well as attach a single unit back against a wall. Shelves are adjustable on 1.05" increments the entire height of the case. Laminate tops are 1.05" thick with 2mm edge banding on all four edges.

Built-to-Spec Worksheet

Planning Built-to-Spec Files

Calibre built-to-spec files allow thousands of drawer, shelf and door configurations using a variety of 1.5", 3", 6", 7.5", 10.5", 12", 13.5" and 15" high components.

When compiling a product number for built-to-spec files, specify individual components from the top of the case to the bottom. A letter designation has been assigned to each component.

The total height of components must equal the interior height of the file case, which is 3" less than the total case height provided. Example: A 51" high case must contain components that equal 48" exactly.

Please note the following planning considerations when designing a "Built-to-Spec" configuration:

1. Posting shelves nor tie-bars are permitted directly below cupboard doors.
2. Tie-bars and posting shelves are not permitted within the top location or the bottom location of a lateral file.
3. Calibre files are painted with a monochromatic color scheme. If case and drawer fronts are required to be a different color on the same case, this is considered a special and requires a custom product request form from Custom Product Development.
4. Receding doors with fixed and pullout shelves are not permitted directly below posting shelves or on any lateral file with hybrid unit doors.
5. Cases are limited to either one tie-bar or one posting shelf per case.
6. Individual locking drawers are not available as a "Built-to-Spec" option.
7. Only 63" and 64.5" "Built-to-Spec" Hybrids are permitted.
8. S2 front Calibre lateral files are not available as a "Built-to-Spec".
9. No more than four 6" or 3" drawers may be placed within a case as standard product. More than four 6" or 3" drawers may be specified only as special product. Pricing for these special files may be more than a "built-to-spec" standard file with the same configuration.

To specify Calibre built-to-spec files complete these easy steps:

Step 1 Determine case height, width, base height and lock style

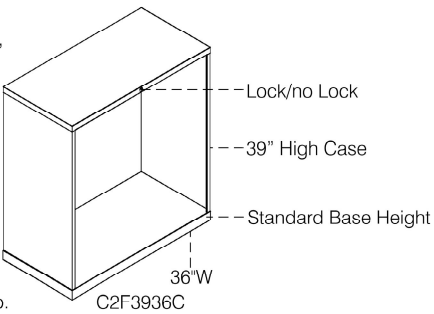

Lock/no Lock
39" High Case
Standard Base Height
36"W
C2F3936C

Step 2 Assign appropriate Pattern No.

Step 3 Determine interior case components from the top down

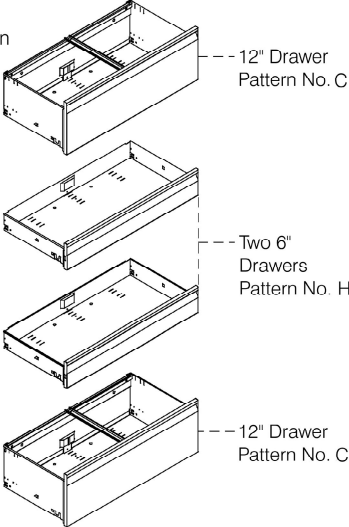

12" Drawer Pattern No. C
Two 6" Drawers Pattern No. H
12" Drawer Pattern No. C

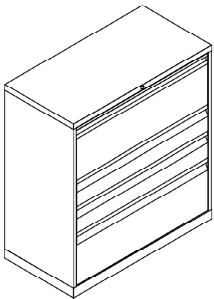

C2F3936C CHHC

Step 4 Add interior component pattern numbers to case pattern number (from top component down)

Step 5 Determine finish code and paint grade

115	PI
-----	----

Step 6 Assign prices to the case and interior components

C2F3936C	425.
C	158.
H	168.
H	168.
C	158.

Step 7 Add together to determine price

Total	1077.
-------	-------

Step 8 Complete Pattern Number with Finish Code

C2F3936CCHHC-115

Date _____

Customer Name _____

Project Name _____

Dealer _____

Customer's Purchase Order No. _____

1. For ease of use, make a photocopy of this worksheet.
2. Make a small sketch of the file product you have in mind in the sketch area provided.
3. Find the appropriate case description from the following pages. (Your selection will be based on height, width, base, and lock option.)
On your worksheet, record the case description, the four-digit code number, and the price.
4. Next, write in the components you'll use to fill your case. The component listing follows the case listing. Start at the top of your case and list each component, its code number, and price. (Be sure your total component height does not exceed the height of the file.)
5. Now transfer and total your figures to fill in the bottom row.
 - Build your pattern number from the column of code numbers, keeping code numbers in consecutive order.
 - Add the prices of the case and components for your total price.
 - To help in your planning and ordering, enter the finish code (from the Calibre Finish card) and the total number of units you'll need.
6. Follow steps 3-6 for each custom file you wish to order.

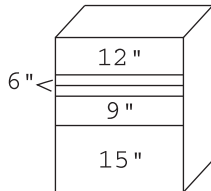
(sketch here)	Description	Order No.	Price
	Case 51"h x 42"w	C2F5142C	
	Components		
	12" rollout shelf	Z	
	Two 6" rollout dwrs.	H	
	9" rollout drawer	F	
	15" rollout drawer	A	
	Pattern No.	Total Price	Finish Code
	C2F5142CZHFFA		No. of Units

(sketch here)	Description	Order No.	Price
	Case		
	Components		
	Pattern No.	Total Price	Finish Code
			No. of Units

Calibre Front Lateral Files- Built-to-Spec

Built-to-Spec Calibre Cases

Calibre

description	w	h	lock	pattern no.	P1	P2	P3
27" High Case with Lock (24" opening)	30"	27"	Y	C2F2730C	\$448.	\$492.	\$515.
	36"	27"	Y	C2F2736C	499.	544.	572.
	42"	27"	Y	C2F2742C	550.	605.	638.
34.5" High Case with Lock (31.5" opening)	30"	34.5"	Y	C2F3430C	540.	594.	623.
	36"	34.5"	Y	C2F3436C	588.	647.	677.
	42"	34.5"	Y	C2F3442C	660.	724.	761.
39" High Case with Lock (36" opening)	30"	39"	Y	C2F3930C	553.	608.	638.
	36"	39"	Y	C2F3936C	596.	658.	690.
	42"	39"	Y	C2F3942C	673.	743.	779.
45" High Case with Lock (42" opening)	30"	45"	Y	C2F4530C	611.	671.	704.
	36"	45"	Y	C2F4536C	672.	742.	777.
	42"	45"	Y	C2F4542C	718.	787.	829.
51" High Case with Lock (48" opening)	30"	51"	Y	C2F5130C	617.	677.	712.
	36"	51"	Y	C2F5136C	689.	758.	794.
	42"	51"	Y	C2F5142C	773.	849.	891.
54" High Case with Lock (51" opening)	30"	54"	Y	C2F5430C	639.	703.	740.
	36"	54"	Y	C2F5436C	701.	773.	812.
	42"	54"	Y	C2F5442C	780.	862.	902.

Order Code	Specification Information	Application Notes
Example: C2F2730C-115		
C Calibre	P1= painted finishes	Multiple freestanding files or cabinets (not attached to walls or worksurfaces) should be ganged for security. Single freestanding files (two and three-high) should be weighted with a counterweight (see Accessories, page 79).
2 Generation	P2= painted finishes	
F File	P3= painted finishes	
27 Height	Customers own non-metallic paint finishes available at P1 pricing. This excludes metallic paints and white paints. (see color policy page 15)	Locks are keyed randomly, unless otherwise specified (see Keys page 188)
30 Width		
C Knoll Lock		Lock cores, keys, change keys are ordered separately (Refer to Calibre Accessories on page 79)
115 Medium Grey (P1 paint pricing)	For cases without locks substitute the last "C" with an "E" and deduct \$36 from the list price. Example, C2F2730E-Y2.	
		Interior modules must equal the overall case height less 3".

Calibre Front Lateral Files- Built-to-Spec

Built-to-Spec Calibre Cases

Calibre

Calibre File Collection

description	w	h	lock	pattern no.	P1	P2	P3
55.5" High Case with Lock (52.5" opening)	30"	55.5"	Y	C2F5530C	\$646.	\$710.	\$746.
	36"	55.5"	Y	C2F5536C	709.	779.	817.
	42"	55.5"	Y	C2F5542C	789.	870.	914.
58.5" High Case with Lock (55.5" opening)	30"	58.5"	Y	C2F5830C	653.	720.	755.
	36"	58.5"	Y	C2F5836C	723.	796.	836.
	42"	58.5"	Y	C2F5842C	805.	883.	928.
63" High Case with Lock (60" opening)	30"	63"	Y	C2F6330C	680.	749.	785.
	36"	63"	Y	C2F6336C	750.	826.	868.
	42"	63"	Y	C2F6342C	810.	890.	931.
64.5" High Case with Lock (61.5" opening)	30"	64.5"	Y	C2F6430C	689.	758.	794.
	36"	64.5"	Y	C2F6436C	759.	835.	876.
	42"	64.5"	Y	C2F6442C	832.	917.	961.

Order Code	Specification Information	Application Notes
Example: C2F2730C-115		
C Calibre	P1= painted finishes	Multiple freestanding files or cabinets (not attached to walls or worksurfaces) should be ganged for security. Single freestanding files (two and three-high) should be weighted with a counterweight (see Accessories, page 79).
2 Generation	P2= painted finishes	
F File	P3= painted finishes	
27 Height	Customers own non-metallic paint finishes available at P1 pricing. This excludes metallic paints and white paints. (see color policy page 15)	Locks are keyed randomly, unless otherwise specified (see Keys page 188)
30 Width		Lock cores, keys, change keys are ordered separately (Refer to Calibre Accessories on page 79)
C Knoll Lock		
115 Medium Grey (P1 paint pricing)	For cases without locks substitute the last "C" with an "E" and deduct \$36 from the list price. Example, C2F2730E-Y2.	Interior modules must equal the overall case height less 3".

Calibre Front Lateral Files- Built-to-Spec

Calibre Built-to-Spec Interior Components

Calibre

description	width	pattern no.	P1	P2	P3
15" Rollout drawer with rails	30"	A	\$333.	\$366.	\$388.
	36"	A	366.	403.	426.
	42"	A	383.	421.	441.
13.5" Rollout drawer with rails	30"	B	313.	343.	362.
	36"	B	349.	387.	403.
	42"	B	379.	417.	438.
12" Rollout drawer with rails	30"	C	195.	214.	225.
	36"	C	221.	245.	256.
	42"	C	233.	257.	270.
10.5" Rollout drawer with rails	30"	D	195.	214.	225.
	36"	D	221.	245.	256.
	42"	D	233.	257.	270.

Special Planning Notes for "Built to Spec" Files

1). Posting shelves nor tie-bars are permitted directly below cupboard doors.2). Tie-bars and posting shelves are not permitted within the upmost top location or the bottom location of a lateral file case.3). Calibre files are painted with a monochromatic color scheme. If seeking case and drawer fronts to be a different color on the same case, this is considered a special.4). Receding doors with fixed and pullout shelves are not permitted directly below posting shelves or on any lateral file with hybrid unit doors.5). Cases are limited to either one tie-bar or one posting shelf per case.6). Individual locking drawers are not available as a "Built to Spec" option.7). Only 63" and 64.5" "Built to Spec" Hybrids are permitted.
8). S2 front Calibre lateral files are not available as a "Built-to-Spec".
9). No more than four 6" or 3" drawers may be placed within a case as standard product. More than four 6" or 3" drawers may be specified only as special product. Pricing for these special files may be more than a "built-to-spec" standard file with the same configurations.

Specification Information

P1= painted finishes
P2= painted finishes
P3= painted finishes
Custom non-metallic paint finishes available at P1 pricing. This excludes metallic paints and white paints. (see color policy page 15).

Application Notes

All 10.5", 12", 13.5" and 15" drawers accommodate side-to-side filing and front-to-back filing.
File bars can be used in 10.5", 12", 13.5" and 15" drawers having side-to-side rails.
No more than four 3" or 6" drawers can be specified in any one-file case as standard product.
Posting shelves are most effective when positioned from desk-to-counter height or 27" to 39" from the floor.
Posting shelves and tie bars cannot be placed within the top 1.5" of a file. Tie bars cannot be placed directly below a posting shelf.
Interior modules must equal the overall case height less 3".

Posting shelves are not available below desk height.
Largest drawers are best positioned near the base of the file.
Fixed shelves are not adjustable.
Dividers and other accessories must be ordered separately.
Label holders are not included with files. Please see Accessories page 79.

Calibre Front Lateral Files- Built-to-Spec

Calibre Built-to-Spec Interior Components

Calibre

Calibre File Collection

description	width	pattern no.	P1	P2	P3
9" Rollout drawer	30"	F	\$254.	\$279.	\$293.
	36"	F	278.	307.	322.
	42"	F	291.	321.	334.
7.5" Rollout drawer	30"	G	254.	279.	293.
	36"	G	278.	307.	322.
	42"	G	291.	321.	334.
6" Rollout drawer	30"	H	212.	233.	245.
	36"	H	236.	259.	272.
	42"	H	259.	288.	301.
3" Rollout drawer	30"	I	194.	213.	222.
	36"	I	202.	220.	231.
	42"	I	207.	226.	240.

Special Planning Notes for "Built to Spec" Files

1). Posting shelves nor tie-bars are permitted directly below cupboard doors.2). Tie-bars and posting shelves are not permitted within the upmost top location or the bottom location of a lateral file case.3). Calibre files are painted with a monochromatic color scheme. If seeking case and drawer fronts to be a different color on the same case, this is considered a special.4). Receding doors with fixed and pullout shelves are not permitted directly below posting shelves or on any lateral file with hybrid unit doors.5). Cases are limited to either one tie-bar or one posting shelf per case.6). Individual locking drawers are not available as a "Built to Spec" option.7). Only 63" and 64.5" "Built to Spec" Hybrids are permitted.8). S2 front Calibre lateral files are not available as a "Built-to-Spec".9). No more than four 6" or 3" drawers may be placed within a case as standard product. More than four 6" or 3" draws may be specified only as special product. Pricing for these special files may be more than a "built-to-spec" standard file with the same configurations.

Specification Information

P1= painted finishes
P2= painted finishes
P3= painted finishes
Custom non-metallic paint finishes available at P1 pricing. This excludes metallic paints and white paints. (see color policy page 15).

Application Notes

All 10.5", 12", 13.5" and 15" drawers accommodate side-to-side filing and front-to-back filing.
File bars can be used in 10.5", 12", 13.5" and 15" drawers having side-to-side rails.
No more than four 3" or 6" drawers can be specified in any one-file case as standard product.
Posting shelves are most effective when positioned from desk-to-counter height or 27" to 39" from the floor.
Posting shelves and tie bars cannot be placed within the top 1.5" of a file. Tie bars cannot be placed directly below a posting shelf.
Interior modules must equal the overall case height less 3".

Posting shelves are not available below desk height.
Largest drawers are best positioned near the base of the file.
Fixed shelves are not adjustable.
Dividers and other accessories must be ordered separately.
Label holders are not included with files. Please see Accessories page 79.

Calibre Front Lateral Files- Built-to-Spec

Calibre Built-to-Spec Interior Components

Calibre

description	width	pattern no.	P1	P2	P3
1.5" Reference/Posting Shelf	30"	J	\$247.	\$271.	\$283.
	36"	J	247.	271.	283.
	42"	J	247.	271.	283.
1.5" Filler/Tie Bar	30"	K	85.	95.	98.
	36"	K	85.	95.	98.
	42"	K	85.	95.	98.
25.5" Hybrid unit doors with 2 shelves (one fixed, one adjustable)	30"	S	470.	516.	542.
	36"	S	560.	614.	646.
24" Hybrid unit doors with (2) shelf (one fixed and one adjustable)	30"	R	470.	516.	542.
	36"	R	560.	614.	646.
36" Hybrid unit doors with (two adjustable and one fixed)	30"	T	505.	557.	581.
	36"	T	593.	651.	683.

Special Planning Notes for "Built to Spec" Files

1). Posting shelves nor tie-bars are permitted directly below cupboard doors.2). Tie-bars and posting shelves are not permitted within the upmost top location or the bottom location of a lateral file case.3). Calibre files are painted with a monochromatic color scheme. If seeking case and drawer fronts to be a different color on the same case, this is considered a special.4). Receding doors with fixed and pullout shelves are not permitted directly below posting shelves or on any lateral file with hybrid unit doors.5). Cases are limited to either one tie-bar or one posting shelf per case.6). Individual locking drawers are not available as a "Built to Spec" option.7). Only 63" and 64.5" "Built to Spec" Hybrids are permitted.
8). S2 front Calibre lateral files are not available as a "Built-to-Spec".
9). No more than four 6" or 3" drawers may be placed within a case as standard product. More than four 6" or 3" drawers may be specified only as special product. Pricing for these special files may be more than a "built-to-spec" standard file with the same configurations.

Specification Information

P1= painted finishes
P2= painted finishes
P3= painted finishes
Custom non-metallic paint finishes available at P1 pricing. This excludes metallic paints and white paints. (see color policy page 15).

Application Notes

All 10.5", 12", 13.5" and 15" drawers accommodate side-to-side filing and front-to-back filing.
File bars can be used in 10.5", 12", 13.5" and 15" drawers having side-to-side rails.
No more than four 3" or 6" drawers can be specified in any one-file case as standard product.
Posting shelves are most effective when positioned from desk-to-counter height or 27" to 39" from the floor.
Posting shelves and tie bars cannot be placed within the top 1.5" of a file. Tie bars cannot be placed directly below a posting shelf.
Interior modules must equal the overall case height less 3".

Posting shelves are not available below desk height.
Largest drawers are best positioned near the base of the file.
Fixed shelves are not adjustable.
Dividers and other accessories must be ordered separately.
Label holders are not included with files. Please see Accessories page 79.

Calibre Front Lateral Files- Built-to-Spec

Calibre Built-to-Spec Interior Components

Calibre

Calibre File Collection

description	width	pattern no.	P1	P2	P3
37.5" Hybrid unit doors with (two adjustable and one fixed)	30"	U	\$505.	\$557.	\$581.
	36"	U	593.	651.	683.
15" Receding Door with Fixed Shelf and Dividers	30"	L	299.	328.	344.
	36"	L	309.	339.	358.
	42"	L	324.	357.	372.
13.5" Receding Door with Fixed Shelf and Dividers	30"	M	299.	328.	344.
	36"	M	309.	339.	358.
	42"	M	324.	357.	372.
12" Receding Door with Fixed Shelf and Dividers	30"	N	235.	258.	271.
	36"	N	259.	288.	301.
	42"	N	291.	321.	339.

Special Planning Notes for "Built to Spec" Files

1). Posting shelves nor tie-bars are permitted directly below cupboard doors.2). Tie-bars and posting shelves are not permitted within the upmost top location or the bottom location of a lateral file case.3). Calibre files are painted with a monochromatic color scheme. If seeking case and drawer fronts to be a different color on the same case, this is considered a special.4). Receding doors with fixed and pullout shelves are not permitted directly below posting shelves or on any lateral file with hybrid unit doors.5). Cases are limited to either one tie-bar or one posting shelf per case.6). Individual locking drawers are not available as a "Built to Spec" option.7). Only 63" and 64.5" "Built to Spec" Hybrids are permitted.
8). S2 front Calibre lateral files are not available as a "Built-to-Spec".
9). No more than four 6" or 3" drawers may be placed within a case as standard product. More than four 6" or 3" drawers may be specified only as special product. Pricing for these special files may be more than a "built-to-spec" standard file with the same configurations.

Specification Information

P1= painted finishes
P2= painted finishes
P3= painted finishes
Custom non-metallic paint finishes available at P1 pricing. This excludes metallic paints and white paints. (see color policy page 15).

Application Notes

All 10.5", 12", 13.5" and 15" drawers accommodate side-to-side filing and front-to-back filing.
File bars can be used in 10.5", 12", 13.5" and 15" drawers having side-to-side rails.
No more than four 3" or 6" drawers can be specified in any one-file case as standard product.
Posting shelves are most effective when positioned from desk-to-counter height or 27" to 39" from the floor.
Posting shelves and tie bars cannot be placed within the top 1.5" of a file. Tie bars cannot be placed directly below a posting shelf.
Interior modules must equal the overall case height less 3".

Posting shelves are not available below desk height.
Largest drawers are best positioned near the base of the file.
Fixed shelves are not adjustable.
Dividers and other accessories must be ordered separately.
Label holders are not included with files. Please see Accessories page 79.

Calibre Front Lateral Files- Built-to-Spec

Calibre Built-to-Spec Interior Components

description	width	pattern no.	P1	P2	P3
15" Receding Door with Pullout Shelf and Rails	30"	O	\$381.	\$420.	\$440.
	36"	O	415.	456.	477.
	42"	O	430.	473.	500.
13.5" Receding Door with Pullout Shelf and Rails	30"	P	373.	414.	431.
	36"	P	407.	448.	470.
	42"	P	426.	468.	491.
12" Receding Door with Pullout Shelf and Rails	30"	Z	292.	322.	335.
	36"	Z	306.	334.	354.
	42"	Z	335.	368.	391.

Special Planning Notes for "Built to Spec" Files

1). Posting shelves nor tie-bars are permitted directly below cupboard doors.2). Tie-bars and posting shelves are not permitted within the upmost top location or the bottom location of a lateral file case.3). Calibre files are painted with a monochromatic color scheme. If seeking case and drawer fronts to be a different color on the same case, this is considered a special.4). Receding doors with fixed and pullout shelves are not permitted directly below posting shelves or on any lateral file with hybrid unit doors.5). Cases are limited to either one tie-bar or one posting shelf per case.6). Individual locking drawers are not available as a "Built to Spec" option.7). Only 63" and 64.5" "Built to Spec" Hybrids are permitted.
8). S2 front Calibre lateral files are not available as a "Built-to-Spec".
9). No more than four 6" or 3" drawers may be placed within a case as standard product. More than four 6" or 3" drawers may be specified only as special product. Pricing for these special files may be more than a "built-to-spec" standard file with the same configurations.

Specification Information

P1= painted finishes
P2= painted finishes
P3= painted finishes
Custom non-metallic paint finishes available at P1 pricing. This excludes metallic paints and white paints. (see color policy page 15).

Application Notes

All 10.5", 12", 13.5" and 15" drawers accommodate side-to-side filing and front-to-back filing.
File bars can be used in 10.5", 12", 13.5" and 15" drawers having side-to-side rails.
No more than four 3" or 6" drawers can be specified in any one-file case as standard product.
Posting shelves are most effective when positioned from desk-to-counter height or 27" to 39" from the floor.
Posting shelves and tie bars cannot be placed within the top 1.5" of a file. Tie bars cannot be placed directly below a posting shelf.
Interior modules must equal the overall case height less 3".

Posting shelves are not available below desk height.
Largest drawers are best positioned near the base of the file.
Fixed shelves are not adjustable.
Dividers and other accessories must be ordered separately.
Label holders are not included with files. Please see Accessories page 79.

Calibre Front Lateral Files with Individual Locking Drawers

27" High Calibre Front Individual Locking Files

Calibre

Calibre File Collection

description	w	h	security separators	pattern no.	P1	P2	P3
27" high lateral file, 2-12" drawers with hanging rails	30"	27"		C2F2730WCC	\$905.	\$985.	\$1,033.
	30"	27"	Y	C2F2730XCC	931.	1,016.	1,068.
	36"	27"		C2F2736WCC	1,002.	1,097.	1,148.
	36"	27"	Y	C2F2736XCC	1,031.	1,124.	1,179.
	42"	27"		C2F2742WCC	1,081.	1,182.	1,241.
	42"	27"	Y	C2F2742XCC	1,110.	1,210.	1,272.

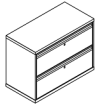

Order Code	Specification Information	Application Notes	Critical Dimensions
Example: C2F2730WCCC-115	P1= painted finishes	Multiple freestanding files or cabinets (not attached to walls or worksurfaces) should be ganged for security. Single freestanding files (two and three-high) should be weighted with a counterweight (see Accessories, page 79).	Actual Outside Case Height 26 ^{27/32} "
C Calibre	P2= painted finishes		Actual Inside Case Height 24"
2 Generation	P3= painted finishes		Calibre files are 18" deep.
27 27" High	Custom non-metallic paint finishes available at P1 pricing. This excludes metallic paints and white paints. (see color policy page 15)	Rails are provided for filing side-to-side and front-to-back and are adjustable for letter, A4, foolscap, JIS, legal, or EDP papers sizes.	Drawer configurations read from top to bottom of case. Interiors noted with rails consist of front to back and side to side hanging rails. Refer to front planning pages for additional information.
30 30" Wide	For individual locking with security separators replace the "W" with an "X"	All locks must be ordered separately for individually locking files.	Label holders are not included with files. Please see Accessories page 79 .
W Individual Locking			
C 12" Drawer with Hanging Rails			
C 12" Drawer with Hanging Rails			
115 Medium Grey (P1 paint pricing)		See KnollKeylock program on page 188 for keying information.	

Calibre Front Lateral Files with Individual Locking Drawers

39" High Calibre Front Individual Locking Files

Calibre

description	w	h	security separator	pattern no.	P1	P2	P3
39" high lateral file, 3-12" drawers with hanging rails	30"	39"		C2F3930WCCC	\$1,260.	\$1,371.	\$1,439.
	30"	39"	Y	C2F3930XCCC	1,303.	1,415.	1,484.
	36"	39"		C2F3936WCCC	1,384.	1,508.	1,582.
	36"	39"	Y	C2F3936XCCC	1,428.	1,549.	1,628.
	42"	39"		C2F3942WCCC	1,496.	1,633.	1,715.
	42"	39"	Y	C2F3942XCCC	1,539.	1,677.	1,763.



Order Code	Specification Information	Application Notes	Critical Dimensions
Example: C2F3930WCCC-115	P1= painted finishes	Multiple freestanding files or cabinets (not attached to walls or worksurfaces) should be ganged for security. Single freestanding files (two and three-high) should be weighted with a counterweight (see Accessories, page 79).	Actual Outside Case Height 38 ^{27/32"}
C Calibre	P2= painted finishes		Actual Inside Case Height 36"
2 Generation	P3= painted finishes		Calibre files are 18" deep.
39 39" High	Custom non-metallic paint finishes available at P1 pricing. This excludes metallic paints and white paints. (see color policy page 15)	Rails are provided for filing side-to-side and front-to-back and are adjustable for letter, A4, foolscap, JIS, legal, or EDP papers sizes.	Drawer configurations read from top to bottom of case. Interiors noted with rails consist of front to back and side to side hanging rails. Refer to front planning pages for additional information.
30 30" Wide			
W Individual Locking	For individual locking with security separators replace the "W" with an "X"	All locks must be ordered separately for individually locking files.	Label holders are not included with files. Please see Accessories page 79.
C 12" Drawer with Hanging Rails			
C 12" Drawer with Hanging Rails			
115 Medium Grey (P1 paint pricing)		See KnollKeylock program on page 188 for keying information.	

Calibre Front Lateral Files with Individual Locking Drawers

51" High Calibre Front Individual Locking Files

Calibre

Calibre File Collection

description	w	h	security separator	pattern no.	P1	P2	P3
51" high lateral file, 4-12" drawers with hanging rails	30"	51"		C2F5130WCCCC	\$1,631.	\$1,773.	\$1,864.
	30"	51"	Y	C2F5130XCCCC	1,688.	1,832.	1,923.
	36"	51"		C2F5136WCCCC	1,802.	1,968.	2,067.
	36"	51"	Y	C2F5136XCCCC	1,864.	2,024.	2,127.
	42"	51"		C2F5142WCCCC	1,985.	2,169.	2,277.
	42"	51"	Y	C2F5142XCCCC	2,044.	2,226.	2,336.



Order Code	Specification Information	Application Notes	Critical Dimensions
Example: C2F5130WCCC-115	P1= painted finishes	Multiple freestanding files or cabinets (not attached to walls or worksurfaces) should be ganged for security. Single freestanding files (two and three-high) should be weighted with a counterweight (see Accessories, page 79).	Actual Outside Case Height 50 ^{27/32} "
C Calibre	P2= painted finishes		Actual Inside Case Height 48"
2 Generation	P3= painted finishes		Calibre files are 18" deep.
51 27" High	Custom non-metallic paint finishes available at P1 pricing. This excludes metallic paints and white paints. (see color policy page 15)	Rails are provided for filing side-to-side and front-to-back and are adjustable for letter, A4, foolscap, JIS, legal, or EDP papers sizes.	Drawer configurations read from top to bottom of case. Interiors noted with rails consist of front to back and side to side hanging rails. Refer to front planning pages for additional information.
30 30" Wide			
W Individual Locking	For individual locking with security separators replace the "W" with an "X"	All locks must be ordered separately for individually locking files.	Label holders are not included with files. Please see Accessories page 79 .
C 12" Drawer with Hanging Rails			
C 12" Drawer with Hanging Rails			
115 Medium Grey (P1 paint pricing)		See KnollKeylock program on page 188 for keying information.	

Calibre Front Lateral Files with Individual Locking Drawers

63" High Calibre Front Individual Locking Files

Calibre

description	w	h	security separator	pattern no.	P1	P2	P3
63" high lateral file, 1-12" receding door with pullout shelf, 4-12" drawers with hanging rails	30"	63"		C2F6330WZCCCC	\$1,968.	\$2,136.	\$2,244.
	30"	63"	Y	C2F6330XZCCCC	2,038.	2,209.	2,319.
	36"	63"		C2F6336WZCCCC	2,165.	2,356.	2,472.
	36"	63"	Y	C2F6336XZCCCC	2,237.	2,429.	2,549.
	42"	63"		C2F6342WZCCCC	2,391.	2,607.	2,739.
	42"	63"	Y	C2F6342XZCCCC	2,461.	2,676.	2,810.

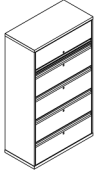

63" high hybrid unit with 24" storage doors and 3-12" drawers with rails	30"	63"		C2H6330WRCCC	1,940.	2,118.	2,223.
	30"	63"	Y	C2H6330XRCCC	1,985.	2,162.	2,273.
	36"	63"		C2H6336WRCCC	2,178.	2,379.	2,496.
	36"	63"	Y	C2H6336XRCCC	2,224.	2,421.	2,544.

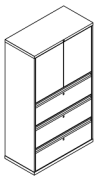

63" high hybrid unit with 36" storage doors and 2-12" drawers with hanging rails	30"	63"		C2H6330WTCC	1,713.	1,871.	1,967.
	30"	63"	Y	C2H6330XTCC	1,743.	1,900.	1,996.
	36"	63"		C2H6336WTCC	1,924.	2,101.	2,206.
	36"	63"	Y	C2H6336XTCC	1,954.	2,133.	2,240.

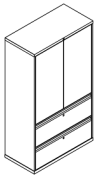

Order Code	Specification Information	Application Notes	Critical Dimensions
Example: C2F6330WZCCCC-115			
C Calibre	P1= painted finishes	Multiple freestanding files or cabinets (not attached to walls or worksurfaces) should be ganged for security. Single freestanding files (two and three-high) should be weighted with a counterweight (see Accessories, page 79).	Actual Outside Case Height 62 ^{27/32} "
2 Generation	P2= painted finishes		Actual Inside Case Height 60"
63 63" High	P3= painted finishes	Rails are provided for filing side-to-side and front-to-back and are adjustable for letter, A4, foolscap, JIS, legal, or EDP papers sizes.	Calibre files are 18" deep
30 30" Wide	Custom non-metallic paint finishes available at P1 pricing. This excludes metallic paints and white paints. (see color policy page 15)		Drawer configurations read from top to bottom of case. Interiors noted with rails consist of front to back and side to side hanging rails. Refer to front planning pages for additional information.
W Individual Locking	For individual locking with security separators replace the "W" with an "X"	Label holders are not included with files. Please see Accessories page 79 .	
Z 12" Receding Door with Pull Out Shelf			
C 12" Drawer with Hanging Rails			
C 12" Drawer with Hanging Rails			
C 12" Drawer with Hanging Rails		All locks must be ordered separately for individually locking files.	
C 12" Drawer with Hanging Rails		See KnollKeylock program on page 188 for keying information.	
115 Medium Grey (P1 paint pricing)			

Calibre Front Lateral Files with Individual Locking Drawers

64.5" High Calibre Front Individual Locking Files

Calibre

Calibre File Collection

description	w	h	security separators	pattern no.	P1	P2	P3
64.5" high hybrid unit with 25.5" storage doors and 3-12" drawers with hanging rails	30"	64.5"		C2H6430WSCCC	\$1,984.	\$2,160.	\$2,263.
	30"	64.5"	Y	C2H6430XSCCC	2,028.	2,202.	2,311.
	36"	64.5"		C2H6436WSCCC	2,223.	2,420.	2,540.
	36"	64.5"	Y	C2H6436XSCCC	2,265.	2,463.	2,586.

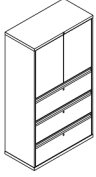

64.5" high hybrid unit with 37.5" storage doors and 2-12" drawers with hanging rails	30"	64.5"		C2H6430WUCC	1,755.	1,916.	2,009.
	30"	64.5"	Y	C2H6430XUCC	1,786.	1,945.	2,038.
	36"	64.5"		C2H6436WUCC	1,968.	2,143.	2,250.
	36"	64.5"	Y	C2H6436XUCC	1,996.	2,177.	2,283.

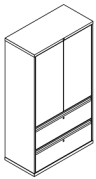

Order Code	Specification Information	Application Notes	Critical Dimensions
Example: C2F6330WZCCCC-115	P1= painted finishes	Multiple freestanding files or cabinets (not attached to walls or worksurfaces) should be ganged for security. Single freestanding files (two and three-high) should be weighted with a counterweight (see Accessories, page 79).	Actual Outside Case Height 64 ^{27/32} "
C Calibre	P2= painted finishes		Actual Inside Case Height 61 1/2"
2 Generation	P3= painted finishes		Calibre files are 18" deep.
63 63" High	Custom non-metallic paint finishes available at P1 pricing. This excludes metallic paints and white paints. (see color policy page 15)	Rails are provided for filing side-to-side and front-to-back and are adjustable for letter, A4, foolscap, JIS, legal, or EDP papers sizes.	Drawer configurations read from top to bottom of case. Interiors noted with rails consist of front to back and side to side hanging rails. Refer to front planning pages for additional information.
30 30" Wide			
W Individual Locking			
S 25.5" Storage Doors			
C 12" Drawer with Hanging Rails	For individual locking with security separators replace the "W" with an "X"	All locks must be ordered separately for individually locking files.	Label holders are not included with files. Please see Accessories page 79 .
C 12" Drawer with Hanging Rails			
C 12" Drawer with Hanging Rails			
C 12" Drawer with Hanging Rails		See KnollKeylock program on page 188 for keying information.	
115 Medium Grey (P1 paint pricing)			

Series 2 Front Lateral Files
 27" High Series 2 Front Lateral Files

Calibre

description	w	h	lock	pattern no.	P1	P2	P3
 27" case with 2-12" drawers with hanging rails	30"	27"		S2F2730ECC	\$787.	\$870.	\$915.
	30"	27"	Y	S2F2730CCC	838.	923.	970.
	36"	27"		S2F2736ECC	889.	979.	1,029.
	36"	27"	Y	S2F2736CCC	941.	1,035.	1,091.
	42"	27"		S2F2742ECC	967.	1,068.	1,117.
	42"	27"	Y	S2F2742CCC	1,017.	1,123.	1,177.

Order Code	Specification Information	Application Notes	Critical Dimensions
Example: S2F2730CCC-115	P1= painted finishes	Multiple freestanding files or cabinets (not attached to walls or worksurfaces) should be ganged for security. Single freestanding files (two and three-high) should be weighted with a counterweight (see Accessories, page 79).	Actual Outside Case Height 26 ^{27/32} "
S Series 2 Front	P2= painted finishes	Rails are provided for filing side-to-side and front-to-back and are adjustable for letter, A4, foolscap, JIS, legal, or EDP papers sizes.	Actual Inside Case Height 24"
2 Generation	P3= painted finishes	See KnollKey lock program on page 188 for keying information.	S2 files are 18 ^{7/8} " deep.
F Lateral File	Note: S2 front lateral files will not accept standard lateral file worksurface tops.		Drawer configurations read from top to bottom of case. Interiors noted with rails includes front to back and side to side hanging rails. Refer to front planning pages for additional information.
27 27" High	Series 2 front files cannot accept add-on modules.		Label holders are not included with files. Please see Accessories page 79 .
30 30" Wide	Series 2 front files without locks include black Knoll-logo insert in the same position. Insert may be removed to retrofit a lock later.		
C Knoll Lock			
C 12" Drawer with Hanging Rails			
C 12" Drawer with Hanging Rails			
115 Medium Grey (P1 paint pricing)			

Series 2 Front Lateral Files

39" High Series 2 Front Lateral Files

Calibre

Calibre File Collection

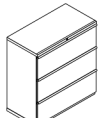
description	w	h	lock	pattern no.	P1	P2	P3
 39" case with 3-12" drawers with hanging rails	30"	39"		S2F3930ECCC	\$1,087.	\$1,199.	\$1,257.
	30"	39"	Y	S2F3930CCCC	1,135.	1,252.	1,315.
	36"	39"		S2F3936ECCC	1,210.	1,333.	1,404.
	36"	39"	Y	S2F3936CCCC	1,261.	1,391.	1,462.
	42"	39"		S2F3942ECCC	1,323.	1,460.	1,525.
	42"	39"	Y	S2F3942CCCC	1,373.	1,513.	1,589.





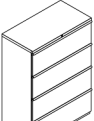

Order Code	Specification Information	Application Notes	Critical Dimensions
Example: S2F3930CCCC-115	P1= painted finishes	Multiple freestanding files or cabinets (not attached to walls or worksurfaces) should be ganged for security. Single freestanding files (two and three-high) should be weighted with a counterweight (see Accessories, page 79).	Actual Outside Case Height 38 ^{27/32} "
S Series 2 Front	P2= painted finishes		Actual Inside Case Height 36"
2 Generation	P3= painted finishes		S2 files are 18 ^{7/8} " deep.
F Lateral File	Note: S2 front lateral files will not accept standard lateral file worksurface tops.	Rails are provided for filing side-to-side and front-to-back and are adjustable for letter, A4, foolscap, JIS, legal, or EDP papers sizes.	Drawer configurations read from top to bottom of case. Interiors noted with rails includes front to back and side to side hanging rails. Refer to front planning pages for additional information.
39 39" High			
30 30" Wide	Series 2 front files cannot accept add-on modules.	See KnollKey lock program on page 188.	Label holders are not included with files. Please see Accessories page 79 .
C Knoll Lock			
C 12" Drawer with Hanging Rails			
C 12" Drawer with Hanging Rails	Series 2 front files without locks include black Knoll-logo insert in the same position. Insert may be removed to retrofit a lock later.		
C 12" Drawer with Hanging Rails			
115 Medium Grey (P1 paint pricing)			

Series 2 Front Lateral Files
51" High Series 2 Front Lateral Files

Calibre

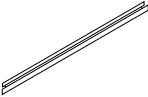
description	w	h	lock	pattern no.	P1	P2	P3
 51" case with 4-12" drawers with hanging rails	30"	51"		S2F5130ECCCC	\$1,400.	\$1,539.	\$1,620.
	30"	51"	Y	S2F5130CCCCC	1,450.	1,595.	1,678.
	36"	51"		S2F5136ECCCC	1,573.	1,736.	1,824.
	36"	51"	Y	S2F5136CCCCC	1,626.	1,792.	1,881.
	42"	51"		S2F5142ECCCC	1,758.	1,936.	2,029.
	42"	51"	Y	S2F5142CCCCC	1,806.	1,991.	2,091.

Order Code	Specification Information	Application Notes	Critical Dimensions
Example: S2F5130CCCCC-115	P1= painted finishes	Multiple freestanding files or cabinets (not attached to walls or worksurfaces) should be ganged for security. Single freestanding files (two and three-high) should be weighted with a counterweight (see Accessories, page 79).	Actual Outside Case Height 50 ^{27/32"}
S Series 2 Front	P2= painted finishes		Actual Inside Case Height 48"
2 Generation	P3= painted finishes		S2 files are 18 ^{7/8"} deep.
F Lateral File	Note: S2 front lateral files will not accept standard lateral file worksurface tops.	Rails are provided for filing side-to-side and front-to-back and are adjustable for letter, A4, foolscap, JIS, legal, or EDP papers sizes.	Drawer configurations read from top to bottom of case. Interiors noted with rails includes front to back and side to side hanging rails. Refer to front planning pages for additional information.
51 51" High	Series 2 front files cannot accept add-on units.	See KnollKey lock program on page 188.	Label holders are not included with files. Please see Accessories page 79 .
30 30" Wide	Series 2 front files without locks include black Knoll-logo insert in the same position. Insert may be removed to retrofit a lock later.		
C Knoll Lock			
C 12" Drawer with Hanging Rails			
C 12" Drawer with Hanging Rails			
C 12" Drawer with Hanging Rails			
C 12" Drawer with Hanging Rails			
115 Medium Grey (P1 paint pricing)			

description	h	d	w	pattern no.	list price	P1	P2	P3
Label holder, (package of 10) 				5ZNNL	\$43.			
Front-to-back hanging rails (2) 				5ZNNF	46.			
Hanging rail (1) 			30"	5Z4NB	16.			
			36"	5Z6NB	16.			
			42"	5Z8NB	16.			
Ganging hardware kit 				5Z4NN	n/c			
Media bar (T-bar) for hanging tape reels/EDP binders 			30"	5Z4NG	117.			
			36"	5Z6NG	117.			
			42"	5Z8NG	117.			
Counterweight kit for freestanding files and cabinets 			30"	5Z4C2NM	117.			
			36"	5Z6C2NM	117.			
			42"	5Z8C2NM	117.			

Application Notes

Label Holders

Label holders are designed for standard Calibre fronts, and are not compatible with Morrison fronts. Paper labels are included.

Hanging Rails

Hanging rails for front-to-back and side-to-side filing are provided standard. Order two hanging rails and front-to-back hanging rails as needed to convert a component.

Note: Fixed shelves include an attachment back and three shelf dividers.

Ganging Hardware Kit

Multiple freestanding files or cabinets should be ganged for security. Hardware and instructions are supplied with each file or cabinet.

Media Bar (T-Bar)

Will accommodate most retail brand tape reels and/or Wrightline™ type EDP printout hanging devices. For use only in 15" fixed shelf components. Media Bars are painted in Black.

Counterweight Kit

Single freestanding files (two and three-high) should be weighted with a counterweight. Specify according to case width.

Lateral file top intended for use with Calibre front files only.

Adjustable Dividers

Adjustable dividers are sized for use in 10.5", 12", 13.5" and 15" components and cannot be used in 3", 6", 7.5" or 9" components.



Drawer Dividers

Drawer dividers are sized for use in any drawer 6" or greater.

Order dividers with attachment back when converting a component. Divider assemblies are painted in Black. Hanging rails are painted in Black.

Adjustable Shelves

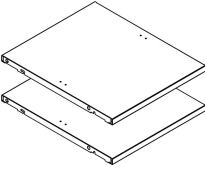
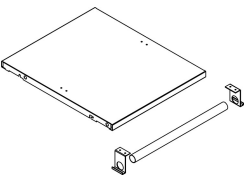
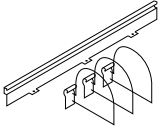
Adjustable shelves are painted in Black standard. If Calibre standard P1, P2 or P3 paints are required add a "P" suffix to the pattern number and select the appropriate paint grade. Example 5ZAC2ASP

description	h	d	w	pattern no.	list price	P1	P2	P3
Adjustable cabinet shelves (package of 2) 			15"	5ZAC2AS	\$58.	\$62.	\$65.	
			18"	5ZCC2AS	58.	62.	65.	
			30"	5Z4C2AS	88.	98.	102.	
			36"	5Z6C2AS	88.	98.	102.	
Coat rod with shelf (package of 1) 			15"	5ZAC2NR	58.			
			18"	5ZCC2NR	58.			
			30"	5Z4C2NR	58.			
			36"	5Z6C2NR	58.			
Adjustable dividers (3) with attachment back for pullout drawer and shelf 	8 3/8"	9 1/2"	30"	5Z4NP	37.			
	8 3/8"	9 1/2"	36"	5Z6NP	37.			
	8 3/8"	9 1/2"	42"	5Z8NP	37.			
Adjustable dividers (package of 3) 	8 3/8"	9 1/2"	2"	5ZNNE	23.			

Application Notes

Label Holders

Label holders are designed for standard Calibre fronts, and are not compatible with Morrison fronts. Paper labels are included.

Hanging Rails

Hanging rails for front-to-back and side-to-side filing are provided standard. Order two hanging rails and front-to-back hanging rails as needed to convert a component.

Note: Fixed shelves include an attachment back and three shelf dividers.

Ganging Hardware Kit

Multiple freestanding files or cabinets should be ganged for security. Hardware and instructions are supplied with each file or cabinet.

Media Bar (T-Bar)

Will accommodate most retail brand tape reels and/or Wrightline™ type EDP printout hanging devices. For use only in 15" fixed shelf components. Media Bars are painted in Black.

Counterweight Kit

Single freestanding files (two and three-high) should be weighted with a counterweight. Specify according to case width.

Lateral file top intended for use with Calibre front files only.

Adjustable Dividers

Adjustable dividers are sized for use in 10.5", 12", 13.5" and 15" components and cannot be used in 3", 6", 7.5" or 9" components.

Drawer Dividers

Drawer dividers are sized for use in any drawer 6" or greater.

Order dividers with attachment back when converting a component. Divider assemblies are painted in Black. Hanging rails are painted in Black.

Adjustable Shelves

Adjustable shelves are painted in Black standard. If Calibre standard P1, P2 or P3 paints are required add a "P" suffix to the pattern number and select the appropriate paint grade. Example 5ZAC2ASP

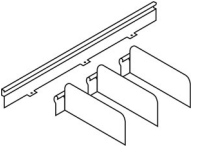
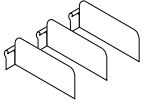
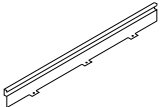
description	h	d	w	pattern no.	list price	P1	P2	P3
 Drawer dividers (3) with attachment back	5"	15"	30"	5Z4N6DP	\$35.			
	5"	15"	36"	5Z6N6DP	36.			
	5"	15"	42"	5Z8N6DP	36.			
 Set of three (3) drawer dividers	5"	15"	2 1/2"	5ZNN6DP	23.			
 Attachment back for pullout shelf/drawer			30"	5Z4NA	16.			
			36"	5Z6NA	16.			
			42"	5Z8NA	16.			

Application Notes

Label Holders

Label holders are designed for standard Calibre fronts, and are not compatible with Morrison fronts. Paper labels are included.

Hanging Rails

Hanging rails for front-to-back and side-to-side filing are provided standard. Order two hanging rails and front-to-back hanging rails as needed to convert a component.

Note: Fixed shelves include an attachment back and three shelf dividers.

Ganging Hardware Kit

Multiple freestanding files or cabinets should be ganged for security. Hardware and instructions are supplied with each file or cabinet.

Media Bar (T-Bar)

Will accommodate most retail brand tape reels and/or Wrightline™ type EDP printout hanging devices. For use only in 15" fixed shelf components. Media Bars are painted in Black.

Counterweight Kit

Single freestanding files (two and three-high) should be weighted with a counterweight. Specify according to case width.

Lateral file top intended for use with Calibre front files only.

Adjustable Dividers

Adjustable dividers are sized for use in 10.5", 12", 13.5" and 15" components and cannot be used in 3", 6", 7.5" or 9" components.

Drawer Dividers

Drawer dividers are sized for use in any drawer 6" or greater.

Order dividers with attachment back when converting a component. Divider assemblies are painted in Black. Hanging rails are painted in Black.

Adjustable Shelves

Adjustable shelves are painted in Black standard. If Calibre standard P1, P2 or P3 paints are required add a "P" suffix to the pattern number and select the appropriate paint grade. Example 5ZAC2ASP

Calibre Pedestals

suspended pedestal - 18" deep

Calibre

description	w	d	h	lock	pattern no.	P1	P2	P3
Suspended pedestal	15"	18"	19"		3A18E01	\$463.	\$487.	\$512.
01 = box/file	15"	18"	19"	Y	3A18C01	499.	524.	551.

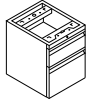

Suspended pedestal	15"	18"	19"		3A18E02	521.	545.	571.
02 = personal/personal/file	15"	18"	19"	Y	3A18C02	555.	582.	613.

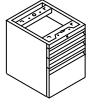

Suspended pedestal	15"	18"	19"		3A18E03	500.	525.	552.
03 = box/box/box	15"	18"	19"	Y	3A18C03	532.	560.	585.

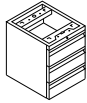

Order Code	Specification Information	Application Notes
Example: 3A18C01-612	<i>To order, specify:</i>	Suspended pedestals to be used beneath 18", 24", 30", or 36" deep worksurfaces, credenzas, and return tops.
3 Standard height	1. Pattern number	Pedestals are attached to either end of any worksurface over 30"W.
A Suspended pedestal	2. Pedestal lock options	Standard depth file drawers accommodate letter-width filing front-to-back and legal width side-to-side.
18 18" deep	3. Pedestal configurations	File drawers include file hanging bars.
C Knoll lock	4. Paint finish options	Additional pedestal accessories must be ordered separately.
1 Box/file	<i>Pedestal lock options:</i>	18" Pedestal file drawers provide 16" of letter filing and 12.5" of legal filing.
612 Medium metallic grey	C Knoll lock	
	E No lock	
	<i>Pedestal configuration options:</i>	
	01 =6/12	
	02 =3/3/12	
	03 =6/6/6	
	See page 17 for paint finishes.	
	Add a "Y" to the end of a pattern number to specify a front color that is different from the case color. P3 pricing automatically applies for all colors when utilizing this option.	
	Add an "F" to the end of the pattern number to receive full extension slides on all box drawers. Upcharge is \$25 list per pedestal.	
		Pedestals are available in painted steel only with standard Calibre fronts.
		Actual dimensions are 14 7/8"W x 17 1/4"D x 19" (± 1/16")H.
		Calibre pedestals are not compatible with Morrison desk supports.
		Calibre pedestals without locks include black, Knoll-logo insert in the same position. Insert may be removed to retrofit a lock later.
		Pedestal accessories, see page 107.

Calibre Pedestals

suspended pedestal - 24" deep

Calibre

description	w	d	h	lock	pattern no.	P1	P2	P3
Suspended pedestal 01 = box/file	15"	24"	19"		3A24E01	\$474.	\$500.	\$525.
	15"	24"	19"	Y	3A24C01	506.	533.	561.
Suspended pedestal 02 = personal/personal/file	15"	24"	19"		3A24E02	537.	564.	593.
	15"	24"	19"	Y	3A24C02	568.	599.	630.
Suspended pedestal 03 = box/box/box	15"	24"	19"		3A24E03	514.	540.	567.
	15"	24"	19"	Y	3A24C03	549.	575.	605.
Suspended pedestal 04 = personal/EDP	15"	24"	19"		3A24E04	499.	524.	551.
	15"	24"	19"	Y	3A24C04	531.	559.	584.

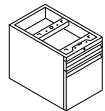
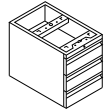
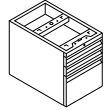
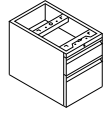

Calibre Front Pedestals

Order Code	Specification Information	Application Notes
Example: 3A24C01-612	<i>To order, specify:</i>	Suspended pedestals to be used beneath 24", 30", or 36" deep worksurfaces, credenzas, and return tops.
3 Standard height	1. Pattern number	Pedestals are attached to either end of any worksurface over 30"W.
A Suspended pedestal	2. Pedestal lock options	Standard depth file drawers accommodate letter-width filing front-to-back and legal width side-to-side.
24 24" deep	3. Pedestal configurations	File drawers include file hanging bars.
C Knoll lock	4. Paint finish options	Additional pedestal accessories must be ordered separately.
1 Box/file	<i>Pedestal lock options:</i>	24" deep pedestal file drawers provide 21.25" of letter filing and 12.5" of legal filing.
612 Medium metallic grey	C Knoll lock	
	E No lock	
	<i>Pedestal configuration options:</i>	
	01 =6/12	
	02 =3/3/12	
	03 =6/6/6	
	04 =3/15	
	See page 17 for paint finishes.	
	Add a "Y" to the end of a pattern number to specify a front color that is different from the case color. P3 pricing automatically applies for all colors when utilizing this option.	
	Add an "F" to the end of the pattern number to receive full extension slides on all box drawers. Upcharge is \$25 list per pedestal.	
		Pedestals are available in painted steel only with standard Calibre fronts, see page 42.
		Actual dimensions are 14 ⁷ / ₈ "W x 23 ¹ / ₄ "D x 19"H (± 1/16").
		Calibre pedestals are not compatible with Morrison desk supports.
		<i>Options:</i>
		Calibre pedestals without locks include black, Knoll-logo insert in the same position. Insert may be removed to retrofit a lock later.
		Pedestal accessories, see page 107.

Calibre Pedestals

floorstanding pedestal - 18" deep

Calibre

description	w	d	h	lock	pattern no.	P1	P2	P3
Floorstanding pedestal	15"	18"	26 ⁷ / ₈ "		3B18E05	\$605.	\$638.	\$669.
05 = box/box/file	15"	18"	26 ⁷ / ₈ "	Y	3B18C05	640.	672.	706.

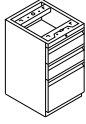

Floorstanding pedestal	15"	18"	26 ⁷ / ₈ "		3B18E06	670.	704.	738.
06 = personal/personal/box/file	15"	18"	26 ⁷ / ₈ "	Y	3B18C06	703.	738.	774.

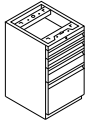

Floorstanding pedestal	15"	18"	26 ⁷ / ₈ "		3B18E07	580.	610.	641.
07 = file/file	15"	18"	26 ⁷ / ₈ "	Y	3B18C07	613.	644.	675.

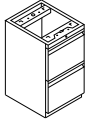

Floorstanding pedestal	15"	18"	26 ⁷ / ₈ "		3B18E10	630.	691.	726.
10 = 3/10.5/10.5	15"	18"	26 ⁷ / ₈ "	Y	3B18C10	660.	727.	764.

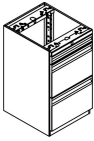

Order Code

Example:	3B18C07-612
3	Standard height
B	Floorstanding pedestal
18	18" deep
C	Knoll lock
7	File/file
612	Medium metallic grey

Specification Information

To order, specify:

1. Pattern number
2. Pedestal lock options
3. Pedestal configurations
4. Paint finish options

Pedestal lock options:

C Knoll lock
E No lock

Pedestal configuration options:

05 = 6/6/12
06 = 3/3/6/12
07 = 12/12

See page 17 for paint finishes.

Add a "Y" to the end of a pattern number to specify a front color that is different from the case color. P3 pricing automatically applies for all colors when utilizing this option.

Add an "F" to the end of the pattern number to receive full extension slides on all box drawers. Upcharge is \$25 list per pedestal.

Application Notes

18" floorstanding pedestals to be used beneath 18" deep worksurfaces, credenzas, and return tops.

Pedestals are attached to either end of any worksurface over 30"W. Case construction allows use of pedestals as worksurface support.

Standard depth file drawers accommodate letter-width filing front-to-back and legal width side-to-side.

File drawers include file hanging bars.

18"d pedestal file drawer provides 16" of letter filing and 12.5" of legal filing.

Pedestals are available in painted steel only with standard Calibre fronts.

Standard = 14⁷/₈"W x 17¹/₄"D x 26⁷/₈"H(±¹/₁₆")

Calibre pedestals are not compatible with Morrison desk supports.

Options:

Calibre pedestals without locks include black, Knoll-logo insert in the same position. Insert may be removed to retrofit a lock later.

Pedestal accessories, see page 107.

Calibre Pedestals

floorstanding pedestal - 24" deep

Calibre

description	w	d	h	lock	pattern no.	P1	P2	P3
Floorstanding pedestal	15"	24"	26 ⁷ / ₈ "		3B24E05	\$674.	\$709.	\$745.
05 = box/box/file	15"	24"	26 ⁷ / ₈ "	Y	3B24C05	707.	744.	780.

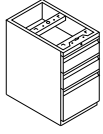

Floorstanding pedestal	15"	24"	26 ⁷ / ₈ "		3B24E06	735.	772.	810.
06 = personal/personal/box/file	15"	24"	26 ⁷ / ₈ "	Y	3B24C06	769.	807.	849.

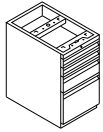

Floorstanding pedestal	15"	24"	26 ⁷ / ₈ "		3B24E07	646.	678.	713.
07 = file/file	15"	24"	26 ⁷ / ₈ "	Y	3B24C07	677.	713.	750.

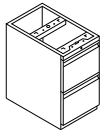

Floorstanding pedestal	15"	24"	26 ⁷ / ₈ "		3B24E08	735.	772.	810.
08 = personal/box/EDP	15"	24"	26 ⁷ / ₈ "	Y	3B24C08	769.	807.	849.

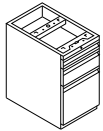

Order Code

Example: 3B24C07-612	
3	Standard height
B	Floorstanding pedestal
24	24" deep
C	Knoll lock
7	File/file
612	Medium metallic grey

Specification Information

To order, specify:

1. Pattern number
2. Pedestal lock options
3. Pedestal configurations
4. Paint finishes

Pedestal lock options:

C Knoll lock
E No lock

Pedestal configuration options:

05 = 6/6/12
06 = 3/3/6/12
07 = 12/12
08 = 3/6/15

See page 17 for paint finishes.

Add a "Y" to the end of a pattern number to specify a front color that is different from the case color. P3 pricing automatically applies for all colors when utilizing this option.

Add an "F" to the end of the pattern number to receive full extension slides on all box drawers. Upcharge is \$25 list per pedestal.

Application Notes

24" floorstanding pedestals to be used beneath 24" deep worksurfaces, credenzas, and return tops.

Pedestals are attached to either end of any worksurface over 30"W. Case construction allows use of pedestals as worksurface support.

Standard depth file drawers accommodate letter-width filing front-to-back and legal width side-to-side.

File drawers include file hanging bars.

Additional pedestal accessories must be ordered separately, see page 42.

24"d pedestal file drawer provides 21.25" of letter filing and 12.5" of legal filing.

Pedestals are available in painted steel only with standard Calibre fronts.

Standard = 14⁷/₈"W x 23¹/₄"D x 26⁷/₈"H(±¹/₁₆")

Calibre pedestals are not compatible with Morrison desk supports.

Options:

Calibre pedestals without locks include black, Knoll-logo insert in the same position. Insert may be removed to retrofit a lock later.

Pedestal accessories, see page 107.

Calibre Pedestals

floorstanding pedestal - 24" deep

Calibre

description	w	d	h	lock	pattern no.	P1	P2	P3
Floorstanding pedestal	15"	24"	26 ⁷ / ₈ "		3B24E10	\$693.	\$764.	\$801.
10 = 3/10.5/10.5	15"	24"	26 ⁷ / ₈ "	Y	3B24C10	726.	798.	837.

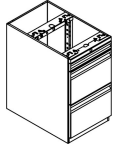

Order Code	Specification Information	Application Notes
Example: 3B24C07-612	<i>To order, specify:</i>	24" floorstanding pedestals to be used beneath 24" deep worksurfaces, credenzas, and return tops.
3 Standard height	1. Pattern number	
B Floorstanding pedestal	2. Pedestal lock options	
24 24" deep	3. Pedestal configurations	
C Knoll lock	4. Paint finish options	
7 File/file	<i>Pedestal lock options:</i>	Pedestals are attached to either end of any worksurface over 30"W. Case construction allows use of pedestals as worksurface support.
612 Medium metallic grey	C Knoll lock	Standard depth file drawers accommodate letter-width filing front-to-back and legal width side-to-side.
	E No lock	File drawers include file hanging bars.
	<i>Pedestal configuration options:</i>	Additional pedestal accessories must be ordered separately, see page 42.
	05 = 6/6/12	24"d pedestal file drawer provides 21.25" of letter filing and 12.5" of legal filing.
	06 = 3/3/6/12	
	07 = 12/12	
	08 = 3/6/15	
	See page 17 for paint finishes.	
	Add a "Y" to the end of a pattern number to specify a front color that is different from the case color. P3 pricing automatically applies for all colors when utilizing this option.	
	Add an "F" to the end of the pattern number to receive full extension slides on all box drawers. Upcharge is \$25 list per pedestal.	
		Pedestals are available in painted steel only with standard Calibre fronts. Standard = 14 ⁷ / ₈ "W x 23 ¹ / ₄ "D x 26 ⁷ / ₈ "H(± ¹ / ₁₆ ") Calibre pedestals are not compatible with Morrison desk supports. <i>Options:</i> Calibre pedestals without locks include black, Knoll-logo insert in the same position. Insert may be removed to retrofit a lock later. Pedestal accessories, see page 107.

Calibre Pedestals

Options - 24" deep without back

Calibre

description	w	d	h	lock	pattern no.	P1	P2	P3
Floorstanding pedestal box/box/file	15"	24"	26 ⁷ / ₈ "		CS2PFN24A	\$509.	\$536.	\$562.
	15"	24"	26 ⁷ / ₈ "	Y	CS2PFL24A	541.	568.	597.

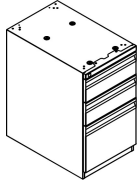

Floorstanding pedestal file/file	15"	24"	26 ⁷ / ₈ "		CS2PFN24B	486.	510.	536.
	15"	24"	26 ⁷ / ₈ "	Y	CS2PFL24B	520.	543.	570.

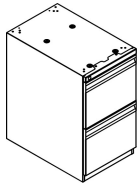

Calibre Options Pedestal Back	15"	n/a	26 ⁷ / ₈ "		CS2XPB	77.	91.	94.
-------------------------------	-----	-----	----------------------------------	--	---------------	-----	-----	-----

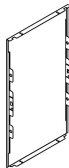

Calibre Front Pedestals

Order Code

Example: CS2PFL24A	
CS2	Calibre Front
P	Pedestal
F	Floorstanding
L	Locking
24	24" Deep
A	Box/Box/File

Specification Information

To order, specify:

1. Pattern number
2. Pedestal lock options
3. Pedestal configurations (Box/Box/File and File/File Only)
4. Paint finish options

Pedestal lock options:

L Knoll lock
N No lock

See page 17 for paint finishes.

Add a "Y" to the end of a pattern number to specify a front color that is different from the case color. P3 pricing automatically applies for all colors when utilizing this option.

Add an "F" to the end of the pattern number to receive full extension slides on all box drawers. Upcharge is \$25 list per pedestal.

Application Notes

24" floorstanding pedestals to be used beneath 24" deep worksurfaces, credenzas, and return tops. Please note that Calibre Options pedestals do not come with a back panel. **Back panels must be ordered separately. Refer to pattern number DS2XPB within the Series 2 Storage price list.**

Pedestals are attached to either end of any worksurface over 30"W. Case construction allows use of pedestals as worksurface support.

Standard depth file drawers accommodate letter-width filing front-to-back and legal width side-to-side.

File drawers do not include file hanging bars.

Additional pedestal accessories must be ordered separately, see page 42.

24"d Calibre Options pedestal file drawer provides 18.25" of letter filing and 12" of legal filing.

Critical Dimensions

Pedestals are available in painted steel only with standard Calibre fronts.

Calibre pedestals are not compatible with Morrison desk supports.

Pedestal accessories, see page 107.

Dimensions under, **w**, **d** and **h** are actual to the nearest ¹/₁₆"

24" Deep Floorstanding Pedestal Internal Drawer Dimensions

Standard = 14⁷/₈"W x 23¹/₄"D x 26⁷/₈"H(±¹/₁₆")

- Box drawer height: 4³/₁₆"
- Box drawer width: 12¹/₁₆"
- Box drawer depth: 18³/₈"
- File drawer height: 9¹/₄"
- File drawer width: 12¹/₁₆"
- File drawer depth: 18³/₈"

Calibre Pedestals

floorstanding pedestal - 30" deep

Calibre

description	w	d	h	lock	pattern no.	P1	P2	P3
Floorstanding pedestal	15"	30"	26 ⁷ / ₈ "		3B30E05	\$709.	\$745.	\$781.
05 = box/box/file	15"	30"	26 ⁷ / ₈ "	Y	3B30C05	743.	778.	819.

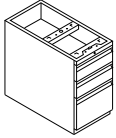

Floorstanding pedestal	15"	30"	26 ⁷ / ₈ "		3B30E06	810.	854.	896.
06 = personal/personal/box/file	15"	30"	26 ⁷ / ₈ "	Y	3B30C06	845.	885.	930.

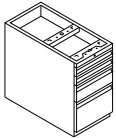

Floorstanding pedestal	15"	30"	26 ⁷ / ₈ "		3B30E07	677.	713.	750.
07 = file/file	15"	30"	26 ⁷ / ₈ "	Y	3B30C07	712.	747.	784.

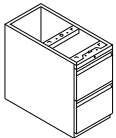

Floorstanding pedestal	15"	30"	26 ⁷ / ₈ "		3B30E10	728.	801.	840.
10 = 3/10.5/10.5	15"	30"	26 ⁷ / ₈ "	Y	3B30C10	761.	835.	879.

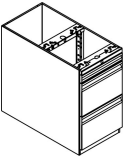

Order Code

Example:	3B30C07-612
3	Standard height
B	Floorstanding pedestal
30	30" deep
C	Knoll lock
7	File/file
612	Medium metallic grey

Specification Information

To order, specify:

1. Pattern number
2. Pedestal lock options
3. Pedestal configurations
4. Paint finish options

Pedestal lock options:

C Knoll lock
E No lock

Pedestal configuration options:

05 = 6/6/12
06 = 3/3/6/12
07 = 12/12

See page 17 for paint finishes.

Add a "Y" to the end of a pattern number to specify a front color that is different from the case color. P3 pricing automatically applies for all colors when utilizing this option.

Add an "F" to the end of the pattern number to receive full extension slides on all box drawers. Upcharge is \$25 list per pedestal.

Application Notes

30" floorstanding pedestals to be used beneath 30" deep worksurfaces, credenzas, and return tops.

Pedestals are attached to either end of any worksurface over 30"W. Case construction allows use of pedestals as worksurface support.

Standard depth file drawers accommodate letter-width filing front-to-back and legal width side-to-side.

File drawers include file hanging bars.

Additional pedestal accessories must be ordered separately, see page 42.

30"d pedestal file drawer provides 27.25" of letter filing and 12.5" of legal filing.

Pedestals are available in painted steel only with standard Calibre fronts.

Standard = 14⁷/₈"W x 29¹/₄"D x 26⁷/₈"H(+/- 1/16")

Calibre pedestals are not compatible with Morrison desk supports.

Options:

Calibre pedestals without locks include black, Knoll-logo insert in the same position. Insert may be removed to retrofit a lock later.

Pedestal accessories, see page 107.

Calibre Pedestals

double-wide floorstanding pedestal w/lock - 19" deep

Calibre

description	type	w	d	h	lock	pattern no.	P1	P2	P3
Double-wide pedestal	std height	30"	18 ³ / ₄ "	26 ⁷ / ₈ "	Y	3DW4CC	\$765.	\$837.	\$882.
	std height	36"	18 ³ / ₄ "	26 ⁷ / ₈ "	Y	3DW6CC	837.	923.	971.

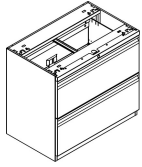

Double-wide pedestal		30"	18 ³ / ₄ "	26 ⁷ / ₈ "	Y	3DW4IDD	996.	1,095.	1,150.
3/10.5/10.5 drawer configuration		36"	18 ³ / ₄ "	26 ⁷ / ₈ "	Y	3DW6IDD	1,094.	1,205.	1,262.

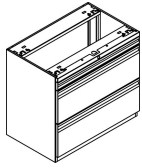

Calibre Front Pedestals

Order Code

Example: 3DW4CC-613
3 Standard height
DW Double-wide
4 30" wide
C Calibre front
C Knoll lock
613 Silver paint finish

Specification Information

To order, specify:

1. Pattern number
2. Paint finish

See page 17 for paint finishes.

Add a "Y" to the end of a pattern number to specify a front color that is different from the case color. P3 pricing automatically applies for all colors when utilizing this option.

Application Notes

The double-wide pedestal incorporates two 12" drawers in a 30" or 36" width and is intended for below workstation applications only.

The double-wide pedestal cannot be used as a freestanding standalone item. It is designed to attach to a systems worksurface and therefore does not have a finished top or interlock mechanism to prevent both drawers from being opened simultaneously.

Includes hanging file bars for letter, legal, front-to-back and side-to-side filing.

Double-wide pedestal is nominally 19"D and will not fit under 18"D worksurfaces.

The actual depth of doublewide pedestals is 18³/₄"

See page 5 for 30"w and 36"w filing capacities.

Calibre Pedestals
*mobile pedestal - 18" deep
 without handle*

Calibre

description	w	d	h	lock	pattern no.	P1	P2	P3
Mobile pedestal 01 = box/file	15"	18"	20 ³ / ₈ "	Y	3C18(C/A)01	\$824.	\$865.	\$908.



Mobile pedestal 05 = box/box/file	15"	18"	26 ³ / ₈ "	Y	3C18(C/A)05	881.	924.	973.
--------------------------------------	-----	-----	----------------------------------	---	--------------------	------	------	------



Mobile pedestal 07 = file/file	15"	18"	26 ³ / ₈ "	Y	3C18(C/A)07	846.	886.	932.
-----------------------------------	-----	-----	----------------------------------	---	--------------------	------	------	------

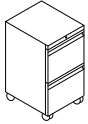

Order Code	Specification Information	Application Notes
Example: 3C18C01-612	To order specify:	Mobile pedestals to be used beneath 24", 30" or 36" deep worksurfaces, credenzas, and return tops.
3 Standard height	1. Pattern number	Actual dimensions are: 14 ⁷ / ₈ " W x 16 ³ / ₄ " D
C Mobile pedestal	2. Pedestal lock options	Options: Pedestal accessories, see page 107.
18 17 1/2" deep	3. Pedestal configurations	18" d pedestal file drawer provides 16" of letter filing or 12.5" of legal filing.
C Knoll lock	4. Paint finish options	
01 box/file	Pedestal lock options: C Knoll lock	Mobile pedestals include locking casters.
612 Medium metallic grey	Pedestal configuration options: 01 = 6/12 05 = 6/6/12 07 = 12/12	Mobile pedestals will not fit under machine height worksurfaces.
	See page 17 for paint finishes.	File drawers include file hanging bars.
	Add a "Y" to the end of a pattern number to specify a front color that is different from the case color. P3 pricing automatically applies for all colors when utilizing this option.	Pedestals are available in painted steel and are offered with standard Calibre fronts only.
	Add an "F" to the end of the pattern number to receive full extension slides on all box drawers. Upcharge is \$25 list per pedestal.	

Calibre Pedestals

mobile pedestal - 18" deep with handle

Calibre

description	w	d	h	lock	pattern no.	P1	P2	P3
Mobile pedestal 01 = box / file	15"	18"	20 ³ / ₈ "	Y	3C18(C/A)P01	\$889.	\$933.	\$980.



Mobile pedestal 05 = box / box / file	15"	18"	26 ³ / ₈ "	Y	3C18(C/A)P05	951.	993.	1,043.
--	-----	-----	----------------------------------	---	---------------------	------	------	--------



Mobile pedestal 07 = file / file	15"	18"	26 ³ / ₈ "	Y	3C18(C/A)P07	915.	957.	1,006.
-------------------------------------	-----	-----	----------------------------------	---	---------------------	------	------	--------



Calibre Front Pedestals

Order Code	Specification Information	Application Notes
Example: 3C18CP01-612	To order specify:	Mobile pedestals to be used beneath 24", 30" or 36" deep worksurfaces, credenzas, and return tops.
3 Standard height	1. Pattern number	Actual dimensions are: 14 ⁷ / ₈ " W x 16 ³ / ₄ " D
C Mobile pedestal	2. Pedestal lock options	Options: Pedestal accessories, see page 107.
18 17 1/2" deep	3. Pedestal configurations	18" d pedestal file drawer provides 16" of letter filing or 12.5" of legal filing.
C Knoll lock	4. Paint finish options	
P with handle	Pedestal lock options: C Knoll lock	Mobile pedestals include locking casters.
01 box/file	Pedestal configuration options: 01 = 6/12 05 = 6/6/12 07 = 12/12	Mobile pedestals will not fit under machine height worksurfaces.
612 Medium metallic grey	See page 17 for paint finishes.	File drawers include file hanging bars.
	Add a "Y" to the end of a pattern number to specify a front color that is different from the case color. P3 pricing automatically applies for all colors when utilizing this option.	Pedestals are available in painted steel and are offered with standard Calibre fronts only.
	Add an "F" to the end of the pattern number to receive full extension slides on all box drawers. Upcharge is \$25 list per pedestal.	Pedestal handle is black.

Calibre Pedestals
*mobile pedestal - 18" deep
 without top and without handle
 (pedestal cushion ordered separately)*

Calibre

description	w	d	h	locks	pattern no.	P1	P2	P3
Mobile pedestal 01 = box / file	15"	18"	20 ³ / ₈ "	Y	3O18(C/A)01	\$774.	\$818.	\$860.

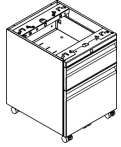

Mobile pedestal 05 = box / box / file	15"	18"	26 ³ / ₈ "	Y	3O18(C/A)05	832.	878.	920.
--	-----	-----	----------------------------------	---	--------------------	------	------	------



Mobile pedestal 07 = file / file	15"	18"	26 ³ / ₈ "	Y	3O18(C/A)07	797.	837.	881.
-------------------------------------	-----	-----	----------------------------------	---	--------------------	------	------	------

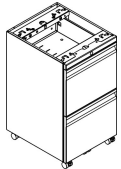

Order Code	Specification Information	Application Notes
Example: 3O18C01-612	To order specify:	Mobile pedestals to be used beneath 24", 30" or 36" deep worksurfaces, credenzas, and return tops.
3 Standard height	1. Pattern number	Actual dimensions are: 14 ⁷ / ₈ " W x 16 ³ / ₄ " D
O Mobile pedestal without top	2. Pedestal lock options	Options:
18 17 ¹ / ₂ " deep	3. Pedestal configurations	Pedestal accessories, see page 107
C Knoll lock	4. Paint finish options	18"d pedestal file drawer provides 16" of letter filing or 12.5" of legal filing.
01 box/file	Pedestal lock options: C Knoll lock	Mobile pedestals include locking casters.
612 Medium metallic grey	Pedestal configuration options: 01 = 6/12 05 = 6/6/12 07 = 12/12	Mobile pedestals will not fit under machine height worksurfaces.
	See page 17 for paint finishes	File drawers include file hanging bars.
	Add a "Y" to the end of a pattern number to specify a front color that is different from the case color. P3 pricing automatically applies for all colors when utilizing this option.	Pedestals are available in painted steel and are offered with standard Calibre fronts only.
	Add an "F" to the end of the pattern number to receive full extension slides on all box drawers. Upcharge is \$25 list per pedestal.	

Calibre Pedestals
*mobile pedestal - 18" deep
 without top and with handle
 (pedestal cushion ordered separately)*

Calibre

description	w	d	h	lock	pattern no.	P1	P2	P3
Mobile pedestal 01 = box / file	15"	18"	20 ³ / ₈ "	Y	3O18(C/A)P01	\$845.	\$834.	\$929.

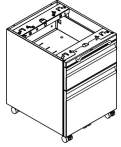

Mobile pedestal 05 = box / box / file	15"	18"	26 ³ / ₈ "	Y	3O18(C/A)P05	903.	946.	992.
--	-----	-----	----------------------------------	---	---------------------	------	------	------

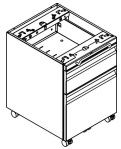

Mobile pedestal 07 = file / file	15"	18"	26 ³ / ₈ "	Y	3O18(C/A)P07	866.	909.	954.
-------------------------------------	-----	-----	----------------------------------	---	---------------------	------	------	------

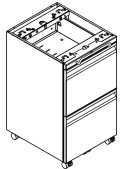

Calibre Front Pedestals

Order Code	Specification Information	Application Notes
Example: 3O18P01-612	To order specify:	Mobile pedestals to be used beneath 24", 30" or 36" deep worksurfaces, credenzas, and return tops.
3 Standard height	1. Pattern number	Actual dimensions are: 14 ⁷ / ₈ " W x 16 ³ / ₄ " D
O Mobile pedestal without top	2. Pedestal lock options	18" d pedestal file drawer provides 16" of letter filing or 12.5" of legal filing.
18 17 ¹ / ₂ " deep	3. Pedestal configurations	Mobile pedestals include locking casters.
C Knoll lock	4. Paint finish options	Mobile pedestals will not fit under machine height worksurfaces.
P with handle	Pedestal lock options: C Knoll lock	File drawers include file hanging bars.
01 box/file	Pedestal configuration options: 01 = 6/12 05 = 6/6/12 07 = 12/12	Pedestals are available in painted steel and are offered with standard Calibre fronts only.
612 Medium metallic grey	See page 17 for paint finishes.	Pedestal handle is black.
	Add a "Y" to the end of a pattern number to specify a front color that is different from the case color. P3 pricing automatically applies for all colors when utilizing this option.	
	Add an "F" to the end of the pattern number to receive full extension slides on all box drawers. Upcharge is \$25 list per pedestal.	

Calibre Pedestals

mobile pedestal - 24" deep without handle

Calibre

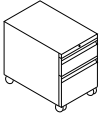
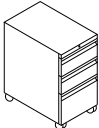
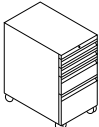
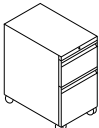
description	w	d	h	lock	pattern no.	P1	P2	P3
Mobile pedestal 01 = box/file 	15"	24"	20 ³ / ₈ "	Y	3C24(C/A)01	\$916.	\$964.	\$1,011.
Mobile pedestal 05 = box/box/file 	15"	24"	26 ³ / ₈ "	Y	3C24(C/A)05	977.	1,025.	1,076.
Mobile pedestal 06 = personal/ personal/box/file 	15"	24"	26 ³ / ₈ "	Y	3C24(C/A)06	1,033.	1,086.	1,141.
Mobile pedestal 07 = file/file 	15"	24"	26 ³ / ₈ "	Y	3C24(C/A)07	936.	985.	1,035.

Order Code

Example: 3C24C01-612	
3	Standard height
C	Mobile pedestal
24	23 ¹ / ₂ " deep
C	Knoll lock
01	box/file
612	Medium metallic grey

Specification Information

To order specify:

1. Pattern number
2. Pedestal lock options
3. Pedestal configurations
4. Paint finish options

Pedestal lock options:
C Knoll lock

Pedestal configuration options:
01 = 6/12
05 = 6/6/12
06 = 3/3/6/12
07 = 12/12
08 = 3/6/15
09 = 3/6/12

See page 17 for paint finishes.

Add a "Y" to the end of a pattern number to specify a front color that is different from the case color. P3 pricing automatically applies for all colors when utilizing this option.

Add an "F" to the end of the pattern number to receive full extension slides on all box drawers. Upcharge is \$25 list per pedestal.

Application Notes

Mobile pedestals to be used beneath 24", 30" or 36" deep worksurfaces, credenzas, and return tops.

Mobile pedestals include locking casters.

26³/₈" Mobile pedestals will not fit under machine height worksurfaces.

File drawers include file hanging bars.

Additional pedestal accessories must be ordered separately.

Pedestals are available in painted steel and are offered with standard Calibre fronts only.

Actual dimensions are:
14⁷/₈" W x 22³/₄" D

Options:
Pedestal accessories, see page 107.

24"d pedestal file drawer provides 21.25" of letter filing or 12.5" of legal filing.

Calibre Pedestals

mobile pedestal - 24" deep without handle

Calibre

description	w	d	h	lock	pattern no.	P1	P2	P3
Mobile pedestal 08 = personal/box/EDP	15"	24"	26 ³ / ₈ "	Y	3C24(C/A)08	\$1,000.	\$1,052.	\$1,104.

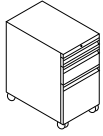

Mobile pedestal 09 = personal/box/file	15"	24"	23 ⁵ / ₈ "	Y	3C24(C/A)09	960.	1,009.	1,060.
---	-----	-----	----------------------------------	---	--------------------	------	--------	--------

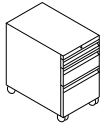

Calibre Front Pedestals

Order Code	Specification Information	Application Notes
Example: 3C24C01-612	To order specify:	Mobile pedestals to be used beneath 24", 30" or 36" deep worksurfaces, credenzas, and return tops.
3 Standard height	1. Pattern number	Actual dimensions are: 14 ⁷ / ₈ " W x 22 ³ / ₄ " D
C Mobile pedestal	2. Pedestal lock options	Options:
24 23 ¹ / ₂ " deep	3. Pedestal configurations	Pedestal accessories, see page 107.
C Knoll lock	4. Paint finish options	24"d pedestal file drawer provides 21.25" of letter filing or 12.5" of legal filing.
01 box/file	Pedestal lock options: C Knoll lock	26 ³ / ₈ " Mobile pedestals will not fit under machine height worksurfaces.
612 Medium metallic grey	Pedestal configuration options: 01 = 6/12 05 = 6/6/12 06 = 3/3/6/12 07 = 12/12 08 = 3/6/15 09 = 3/6/12	File drawers include file hanging bars.
	See page 17 for paint finishes.	Additional pedestal accessories must be ordered separately.
	Add a "Y" to the end of a pattern number to specify a front color that is different from the case color. P3 pricing automatically applies for all colors when utilizing this option.	Pedestals are available in painted steel and are offered with standard Calibre fronts only.
	Add an "F" to the end of the pattern number to receive full extension slides on all box drawers. Upcharge is \$25 list per pedestal.	

Calibre Pedestals

*mobile pedestal - 24" deep
with handle*

Calibre

description	w	d	h	lock	pattern no.	P1	P2	P3
Mobile pedestal 01 = box / file	15"	24"	20 ⁵ / ₈ "	Y	3C24(C/A)P01	\$984.	\$1,030.	\$1,084.

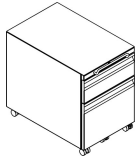

Mobile pedestal 05 = box / box / file	15"	24"	26 ³ / ₈ "	Y	3C24(C/A)P05	1,044.	1,094.	1,149.
--	-----	-----	----------------------------------	---	---------------------	--------	--------	--------

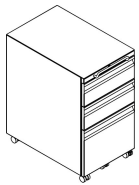

Mobile pedestal 06 = personal / personal / box / file	15"	24"	26 ³ / ₈ "	Y	3C24(C/A)P06	1,102.	1,152.	1,211.
--	-----	-----	----------------------------------	---	---------------------	--------	--------	--------

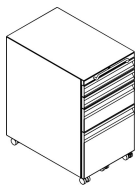

Order Code	Specification Information	Application Notes
Example: 3C24CP01-612	To order specify:	Mobile pedestals to be used beneath 24", 30" or 36" deep worksurfaces, credenzas, and return tops.
3 Standard height	1. Pattern number	Actual dimensions are: 14 ⁷ / ₈ " W x 22 ³ / ₄ " D
C Mobile pedestal	2. Pedestal lock options	Options: Pedestal accessories, see page 107.
24 23 ¹ / ₂ " deep	3. Pedestal configurations	24"d pedestal file drawer provides 21.25" of letter filing or 12.5" of legal filing.
C Knoll lock	4. Paint finish options	
P with handle	Pedestal lock options: C Knoll lock	26 ⁵ / ₈ " Mobile pedestals will not fit under machine height worksurfaces.
01 box/file	Pedestal configuration options: 01 = 6/12 05 = 6/6/12 06 = 3/3/6/12 07 = 12/12 08 = 3/6/15 09 = 3/6/12	File drawers include file hanging bars.
612 Medium metallic grey	See page 17 for paint finishes.	Additional pedestal accessories must be ordered separately.
	Add a "Y" to the end of a pattern number to specify a front color that is different from the case color. P3 pricing automatically applies for all colors when utilizing this option.	Pedestals are available in painted steel and are offered with standard Calibre fronts only.
	Add an "F" to the end of the pattern number to receive full extension slides on all box drawers. Upcharge is \$25 list per pedestal.	Pedestal handle is black.

Calibre Pedestals

mobile pedestal - 24" deep with handle

Calibre

description	w	d	h	lock	pattern no.	P1	P2	P3
Mobile pedestal 07 = file / file	15"	24"	26 ³ / ₈ "	Y	3C24(C/A)P07	\$1,007.	\$1,055.	\$1,106.



Mobile pedestal 08 = personal / box / EDP	15"	24"	26 ³ / ₈ "	Y	3C24(C/A)P08	1,071.	1,121.	1,178.
--	-----	-----	----------------------------------	---	---------------------	--------	--------	--------

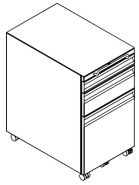

Mobile pedestal 09 = personal / box / file	15"	24"	23 ⁵ / ₈ "	Y	3C24(C/A)P09	1,029.	1,077.	1,131.
---	-----	-----	----------------------------------	---	---------------------	--------	--------	--------

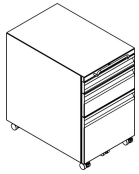

Calibre Front Pedestals

Order Code	Specification Information	Application Notes
Example: 3C24CP01-612	To order specify:	Mobile pedestals to be used beneath 24", 30" or 36" deep worksurfaces, credenzas, and return tops.
3 Standard height	1. Pattern number	Actual dimensions are: 14 ⁷ / ₈ " W x 22 ³ / ₄ " D
C Mobile pedestal	2. Pedestal lock options	Options: Pedestal accessories, see page 107.
24 23 ¹ / ₂ " deep	3. Pedestal configurations	24"d pedestal file drawer provides 21.25" of letter filing or 12.5" of legal filing.
C Knoll lock	4. Paint finish options	
P with handle	Pedestal lock options: C Knoll lock	26 ⁵ / ₈ " Mobile pedestals will not fit under machine height worksurfaces.
01 box/file	Pedestal configuration options: 01 = 6/12 05 = 6/6/12 06 = 3/3/6/12 07 = 12/12 08 = 3/6/15 09 = 3/6/12	File drawers include file hanging bars.
612 Medium metallic grey	See page 17 for paint finishes.	Additional pedestal accessories must be ordered separately.
	Add a "Y" to the end of a pattern number to specify a front color that is different from the case color. P3 pricing automatically applies for all colors when utilizing this option.	Pedestals are available in painted steel and are offered with standard Calibre fronts only.
	Add an "F" to the end of the pattern number to receive full extension slides on all box drawers. Upcharge is \$25 list per pedestal.	Pedestal handle is black.

Calibre Pedestals
*mobile pedestal - 24" deep
 without top
 (pedestal cushion ordered separately)*

Calibre

description	w	d	h	lock	pattern no.	P1	P2	P3
Mobile pedestal 01 = box / file	15"	24"	20 ³ / ₈ "	Y	3024(C/A)01	\$867.	\$915.	\$959.

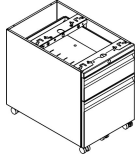

Mobile pedestal 05 = box / box / file	15"	24"	26 ³ / ₈ "	Y	3024(C/A)05	927.	978.	1,026.
--	-----	-----	----------------------------------	---	--------------------	------	------	--------

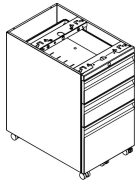

Mobile pedestal 06 = personal / box / file	15"	24"	26 ³ / ₈ "	Y	3024(C/A)06	984.	1,037.	1,090.
---	-----	-----	----------------------------------	---	--------------------	------	--------	--------

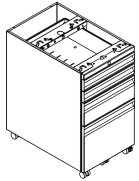

Order Code	Specification Information	Application Notes
Example: 3024C01-612	To order specify:	Mobile pedestals to be used beneath 24", 30" or 36" deep worksurfaces, credenzas, and return tops.
3 Standard height	1. Pattern number	Actual dimensions are: 14 ⁷ / ₈ " W x 22 ³ / ₄ " D
O Mobile pedestal without top	2. Pedestal lock options	Options:
24 23 1/2" deep	3. Pedestal configurations	Pedestal accessories, see page 107.
C Knoll lock	4. Paint finish options	24"d pedestal file drawer provides 21.25" of letter filing or 12.5" of legal filing.
01 box/file	Pedestal lock options: C Knoll lock	26 ³ / ₈ " Mobile pedestals will not fit under machine height worksurfaces.
612 Medium metallic grey	Pedestal configuration options: 01 = 6/12 05 = 6/6/12 06 = 3/3/6/12 07 = 12/12 08 = 3/6/15 09 = 3/6/12	File drawers include file hanging bars.
	See page 17 for paint finishes.	Additional pedestal accessories must be ordered separately.
	Add a "Y" to the end of a pattern number to specify a front color that is different from the case color. P3 pricing automatically applies for all colors when utilizing this option.	Pedestals are available in painted steel and are offered with standard Calibre fronts only.
	Add an "F" to the end of the pattern number to receive full extension slides on all box drawers. Upcharge is \$25 list per pedestal.	

Calibre Pedestals
*mobile pedestal - 24" deep
 without top
 (pedestal cushion ordered separately)*

Calibre

description	w	d	h	lock	pattern no.	P1	P2	P3
Mobile pedestal 07 = file / file	15"	24"	26 ³ / ₈ "	Y	3024(C/A)07	\$887.	\$936.	\$984.

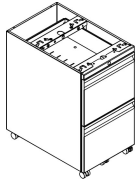

Mobile pedestal 08 = personal / box / EDP	15"	24"	26 ³ / ₈ "	Y	3024(C/A)08	953.	1,005.	1,055.
--	-----	-----	----------------------------------	---	--------------------	------	--------	--------

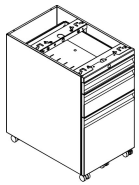

Mobile pedestal 09 = personal / box / file	15"	24"	23 ⁵ / ₈ "	Y	3024(C/A)09	914.	960.	1,009.
---	-----	-----	----------------------------------	---	--------------------	------	------	--------

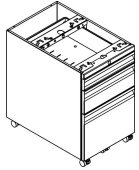

Calibre Front Pedestals

Order Code	Specification Information	Application Notes
Example: 3024C01-612	To order specify:	Mobile pedestals to be used beneath 24", 30" or 36" deep worksurfaces, credenzas, and return tops.
3 Standard height	1. Pattern number	Actual dimensions are: 14 ⁷ / ₈ " W x 22 ³ / ₄ " D
O Mobile pedestal without top	2. Pedestal lock options	Options: Pedestal accessories, see page 107.
24 23 ¹ / ₂ " deep	3. Pedestal configurations	24"d pedestal file drawer provides 21.25" of letter filing or 12.5" of legal filing.
C Knoll lock	4. Paint finish options	File drawers include file hanging bars.
01 box/file	Pedestal lock options: C Knoll lock	Additional pedestal accessories must be ordered separately.
612 Medium metallic grey	Pedestal configuration options: 01 = 6/12 05 = 6/6/12 06 = 3/3/6/12 07 = 12/12 08 = 3/6/15 09 = 3/6/12	Pedestals are available in painted steel and are offered with standard Calibre fronts only.
	See page 17 for paint finishes.	
	Add a "Y" to the end of a pattern number to specify a front color that is different from the case color. P3 pricing automatically applies for all colors when utilizing this option.	
	Add an "F" to the end of the pattern number to receive full extension slides on all box drawers. Upcharge is \$25 list per pedestal.	

Calibre Pedestals
*mobile pedestal - 24" deep
 without top and with handle
 (pedestal cushion ordered separately)*

Calibre

description	w	d	h	lock	pattern no.	P1	P2	P3
Mobile pedestal 01 = box / file	15"	24"	20 ⁵ / ₈ "	Y	3O24(C/A)P01	\$935.	\$983.	\$1,032.

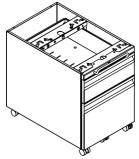

Mobile pedestal 05 = box / box / file	15"	24"	26 ³ / ₈ "	Y	3O24(C/A)P05	996.	1,046.	1,099.
--	-----	-----	----------------------------------	---	---------------------	------	--------	--------

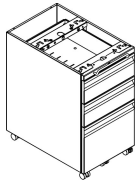

Mobile pedestal 06 = personal / personal / box / file	15"	24"	26 ³ / ₈ "	Y	3O24(C/A)P06	1,053.	1,105.	1,159.
--	-----	-----	----------------------------------	---	---------------------	--------	--------	--------

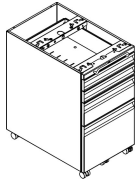

Order Code	Specification Information	Application Notes
Example: 3O24CP01-612	To order specify:	Mobile pedestals to be used beneath 24", 30" or 36" deep worksurfaces, credenzas, and return tops.
3 Standard height	1. Pattern number	Actual dimensions are: 14 ⁷ / ₈ " W x 22 ³ / ₄ " D
O Mobile pedestal without top	2. Pedestal lock options	Options: Pedestal accessories, see page 107.
24 23 1/2" deep	3. Pedestal configurations	24"d pedestal file drawer provides 21.25" of letter filing or 12.5" of legal filing.
C Knoll lock	4. Paint finish options	
P with handle	Pedestal lock options: C Knoll lock	26 ⁵ / ₈ " Mobile pedestals will not fit under machine height worksurfaces.
01 box/file	Pedestal configuration options: 01 = 6/12 05 = 6/6/12 06 = 3/3/6/12 07 = 12/12 08 = 3/6/15 09 = 3/6/12	File drawers include file hanging bars.
612 Medium metallic grey	See page 17 for paint finishes.	Additional pedestal accessories must be ordered separately.
	Add a "Y" to the end of a pattern number to specify a front color that is different from the case color. P3 pricing automatically applies for all colors when utilizing this option.	Pedestals are available in painted steel and are offered with standard Calibre fronts only.
	Add an "F" to the end of the pattern number to receive full extension slides on all box drawers. Upcharge is \$25 list per pedestal.	Pedestal handle is black.

Calibre Pedestals
*mobile pedestal - 24" deep
 without top and with handle
 (pedestal cushion ordered separately)*

Calibre

description	w	d	h	lock	pattern no.	P1	P2	P3
Mobile pedestal 07 = file / file	15"	24"	26 ³ / ₈ "	Y	3O24(C/A)P07	\$958.	\$1,007.	\$1,058.

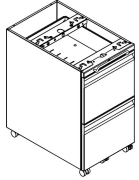

Mobile pedestal 08 = personal / box / EDP	15"	24"	26 ³ / ₈ "	Y	3O24(C/A)P08	1,022.	1,073.	1,126.
--	-----	-----	----------------------------------	---	---------------------	--------	--------	--------

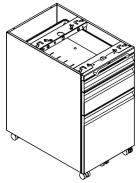

Mobile pedestal 09 = personal / box / file	15"	24"	23 ⁵ / ₈ "	Y	3O24(C/A)P09	981.	1,029.	1,082.
---	-----	-----	----------------------------------	---	---------------------	------	--------	--------

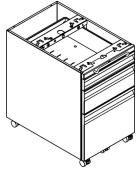

Calibre Front Pedestals

Order Code	Specification Information	Application Notes
Example: 3O24CP01-612	To order specify:	Mobile pedestals to be used beneath 24", 30" or 36" deep worksurfaces, credenzas, and return tops.
3 Standard height	1. Pattern number	Actual dimensions are: 14 ⁷ / ₈ " W x 22 ³ / ₄ " D
O Mobile pedestal without top	2. Pedestal lock options	Options: Pedestal accessories, see page 107.
24 23 ¹ / ₂ " deep	3. Pedestal configurations	24"d pedestal file drawer provides 21.25" of letter filing or 12.5" of legal filing.
C Knoll lock	4. Paint finish options	
P with handle	Pedestal lock options: C Knoll lock	26 ⁵ / ₈ " Mobile pedestals will not fit under machine height worksurfaces.
01 box/file	Pedestal configuration options: 01 = 6/12 05 = 6/6/12 06 = 3/3/6/12 07 = 12/12 08 = 3/6/15 09 = 3/6/12	File drawers include file hanging bars.
612 Medium metallic grey	See page 17 for paint finishes.	Additional pedestal accessories must be ordered separately.
	Add a "Y" to the end of a pattern number to specify a front color that is different from the case color. P3 pricing automatically applies for all colors when utilizing this option.	Pedestals are available in painted steel and are offered with standard Calibre fronts only.
	Add an "F" to the end of the pattern number to receive full extension slides on all box drawers. Upcharge is \$25 list per pedestal.	Pedestal handle is black.

Floorstanding pedestals with individual drawer locks - 18", 24" and 30" deep

description	w	d	h	Security Separator	pattern no.	P1	P2	P3
Floorstanding pedestal 05 = box/box/file	15"	18"	26 ⁷ / ₈ "		3B18W05	\$771.	\$800.	\$838.
	15"	18"	26 ⁷ / ₈ "	Y	3B18X05	812.	842.	884.
	15"	24"	26 ⁷ / ₈ "		3B24W05	837.	874.	918.
	15"	24"	26 ⁷ / ₈ "	Y	3B24X05	881.	916.	960.
	15"	30"	26 ⁷ / ₈ "		3B30W05	874.	912.	955.
	15"	30"	26 ⁷ / ₈ "	Y	3B30X05	916.	952.	999.

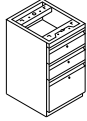

Floorstanding pedestal 07 = file/file	15"	18"	26 ⁷ / ₈ "		3B18W07	690.	721.	758.
	15"	18"	26 ⁷ / ₈ "	Y	3B18X07	730.	763.	800.
	15"	24"	26 ⁷ / ₈ "		3B24W07	764.	796.	834.
	15"	24"	26 ⁷ / ₈ "	Y	3B24X07	791.	824.	865.
	15"	30"	26 ⁷ / ₈ "		3B30W07	789.	824.	865.
	15"	30"	26 ⁷ / ₈ "	Y	3B30X07	830.	865.	908.

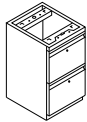

Order Code	Specification Information	Application Notes
Example: 3B18W07-612	<i>To order, specify:</i>	18" floorstanding pedestals to be used beneath 18" deep worksurfaces, credenzas, and return tops.
3 Standard height	1. Pattern number	Pedestals are attached to either end of any worksurface over 30"W. Case construction allows use of pedestals as worksurface support.
B Floorstanding pedestal	2. Pedestal configurations	
18 18" deep	3. Paint finish options	
W Individual locking drawers	<i>Pedestal configuration options:</i> 05 =6/6/12 07 =12/12	Standard depth file drawers accommodate letter-width filing front-to-back and legal width side-to-side. File drawers include file hanging bars.
7 File/file	See page 17 for paint finishes.	Additional pedestal accessories must be ordered separately. See page 107.
612 Medium metallic grey	All locks on individually locking components must be specified as key-alike using the KnollKey lock program as listed on page 188.	Actual dimensions are: Standard = 14 ⁷ / ₈ "W x 17 ¹ / ₄ "D x 26 ⁷ / ₈ "H(± ¹ / ₁₆ ") Equity = 14 ⁷ / ₈ "W x 17 ¹ / ₄ "D x 27 ³ / ₄ "H(± ¹ / ₁₆ ")
	Add an "F" to the end of the pattern number to receive full extension slides on all box drawers. Upcharge is \$25 list per pedestal.	Calibre pedestals are not compatible with Morrison desk supports. <i>Options:</i> Pedestal accessories, see page 107.

Mobile pedestal with individual locks - 18" and 24" deep without handle

description	w	d	h	Security separator	pattern no.	P1	P2	P3
Mobile pedestal	15"	18"	20 ⁵ / ₈ "		3C18W01	\$900.	\$942.	\$988.
01 = box/file	15"	18"	20 ⁵ / ₈ "	Y	3C18X01	927.	970.	1,017.
	15"	24"	20 ⁵ / ₈ "		3C24W01	992.	1,039.	1,092.
	15"	24"	20 ⁵ / ₈ "	Y	3C24X01	1,020.	1,069.	1,121.



Mobile pedestal	15"	18"	26 ⁵ / ₈ "		3C18W05	1,013.	1,058.	1,111.
05 = box/box/file	15"	18"	26 ⁵ / ₈ "	Y	3C18X05	1,055.	1,099.	1,152.
	15"	24"	26 ⁵ / ₈ "		3C24W05	1,107.	1,156.	1,214.
	15"	24"	26 ⁵ / ₈ "	Y	3C24X05	1,149.	1,201.	1,259.

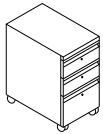

Mobile pedestal	15"	18"	26 ⁵ / ₈ "		3C18W07	922.	966.	1,013.
07 = file/file	15"	18"	26 ⁵ / ₈ "	Y	3C18X07	951.	992.	1,042.
	15"	24"	26 ⁵ / ₈ "		3C24W07	1,015.	1,062.	1,115.
	15"	24"	26 ⁵ / ₈ "	Y	3C24X07	1,042.	1,091.	1,145.

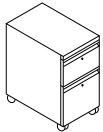

Order Code

Example: 3C24W05-613	
3	Standard height
C	Mobile pedestal
24	23 1/2" deep
W	Individual locks
05	Box/box/file
613	Silver paint finish

Specification Information

To order, specify:

1. Pattern number
2. Pedestal configurations
3. Paint finish options

P pedestal configuration options:

01 =6/12
 05 =6/6/12
 07 =12/12

See page 17 for paint finishes.

All locks on individually locking components must be specified as key-alike using KnollKey lock program as listed on page 188.

Add an "F" to the end of the pattern number to receive full extension slides on all box drawers. Upcharge is \$25 list per pedestal.

Application Notes

Mobile pedestals to be used beneath 24", 30", and 36" deep worksurfaces, credenzas, and return tops.

Actual dimensions are: 14⁷/₈"W x 29¹/₄"D(± 1/16")

Mobile pedestals include locking casters.

26⁵/₈" mobile pedestals will not fit under machine height worksurfaces.

File drawers include file hanging bars.

Additional pedestal accessories must be ordered separately.

Pedestals are available in painted steel and are offered with standard Calibre fronts only.

Mobile pedestal with individual locks - 18" and 24" deep with handle

description	w	d	h	separator	pattern no.	P1	P2	P3
Mobile pedestal 01 = box / file	15"	18"	20 ⁵ / ₈ "		3C18WP01	\$970.	\$1,011.	\$1,061.
	15"	18"	20 ⁵ / ₈ "	Y	3C18XP01	996.	1,038.	1,091.
	15"	24"	20 ⁵ / ₈ "		3C24WP01	1,061.	1,107.	1,164.
	15"	24"	20 ⁵ / ₈ "	Y	3C24XP01	1,090.	1,137.	1,194.

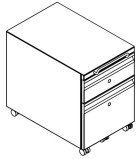

Mobile pedestal 05 = box / box / file	15"	18"	26 ⁵ / ₈ "		3C18WP05	1,084.	1,127.	1,183.
	15"	18"	26 ⁵ / ₈ "	Y	3C18XP05	1,084.	1,127.	1,183.
	15"	24"	26 ⁵ / ₈ "		3C24WP05	1,179.	1,227.	1,289.
	15"	24"	26 ⁵ / ₈ "	Y	3C24XP05	1,218.	1,266.	1,331.



Mobile pedestal 07 = file / file	15"	18"	26 ⁵ / ₈ "		3C18WP07	991.	1,035.	1,087.
	15"	18"	26 ⁵ / ₈ "	Y	3C18XP07	1,019.	1,061.	1,114.
	15"	24"	26 ⁵ / ₈ "		3C24WP07	1,085.	1,132.	1,187.
	15"	24"	26 ⁵ / ₈ "	Y	3C24XP07	1,111.	1,157.	1,216.



Order Code	Specification Information	Application Notes
Example: 3C18WP01-612	To order specify:	Mobile pedestals to be used beneath 24", 30" or 36" deep worksurfaces, credenzas, and return tops.
3 Standard height	1. Pattern number	Actual dimensions are: 14 ⁷ / ₈ " W x 17 ¹ / ₄ "D
C Mobile pedestal	2. Pedestal lock options	14 ⁷ / ₈ " W x 23 ¹ / ₄ "D
18 17 1/2" deep	3. Pedestal configurations	Pedestal accessories, see page 107.
W Without separator	4. Paint finish options	
P with handle	Pedestal lock options: C Knoll lock	Mobile pedestals include locking casters.
01 box/file		Mobile pedestals will not fit under machine height worksurfaces.
612 Medium metallic grey	Pedestal configuration options: 01 = 6/12 05 = 6/6/12 07 = 12/12	File drawers include file hanging bars.
	See page 17 for paint finishes.	Pedestals are available in painted steel and are offered with standard Calibre fronts only.
	All locks on individually locking components must be specified as key-alike using KnollKey lock program as listed on page 188.	
	Add an "F" to the end of the pattern number to receive full extension slides on all box drawers. Upcharge is \$25 list per pedestal.	
	X units include security separator(s)	

Mobile pedestal with individual locks - 18" and 24" deep without top (pedestal cushion ordered separately)

description	w	d	h	separator	pattern no.	P1	P2	P3
Mobile pedestal 01 = box / file	15"	18"	20 ⁵ / ₈ "		3O18W01	\$854.	\$893.	\$936.
	15"	18"	20 ⁵ / ₈ "	Y	3O18X01	880.	920.	968.
	15"	24"	20 ⁵ / ₈ "		3O24W01	945.	991.	1,040.
	15"	24"	20 ⁵ / ₈ "	Y	3O24X01	973.	1,019.	1,071.

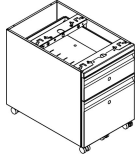

Mobile pedestal 05 = box / box / file	15"	18"	26 ⁵ / ₈ "		3O18W05	966.	1,009.	1,060.
	15"	18"	26 ⁵ / ₈ "	Y	3O18X05	1,007.	1,051.	1,103.
	15"	24"	26 ⁵ / ₈ "		3O24W05	1,060.	1,110.	1,166.
	15"	24"	26 ⁵ / ₈ "	Y	3O24X05	1,102.	1,150.	1,209.

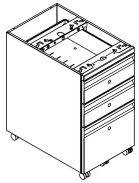

Mobile pedestal 07 = file / file	15"	18"	26 ⁵ / ₈ "		3O18W07	874.	917.	964.
	15"	18"	26 ⁵ / ₈ "	Y	3O18X07	903.	945.	991.
	15"	24"	26 ⁵ / ₈ "		3O24W07	968.	1,015.	1,064.
	15"	24"	26 ⁵ / ₈ "	Y	3O24X07	993.	1,042.	1,094.

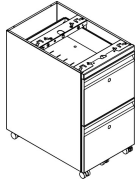

Calibre Front Pedestals with Individual Locking Drawers

Order Code	Specification Information	Application Notes
Example: 3O18W01-612	To order specify:	Mobile pedestals to be used beneath 24", 30" or 36" deep worksurfaces, credenzas, and return tops.
3 Standard height	1. Pattern number	Actual dimensions are: 14 ⁷ / ₈ " W x 17 ¹ / ₄ "D
O Mobile pedestal without top	2. Pedestal lock options	14 ⁷ / ₈ " W x 23 ¹ / ₄ "D
18 17 ¹ / ₂ " deep	3. Pedestal configurations	Pedestal accessories, see page 107.
W Without separator	4. Paint finish options	
01 box/file	Pedestal lock options: C Knoll lock	Mobile pedestals include locking casters.
612 Medium metallic grey	Pedestal configuration options: 01 = 6/12 05 = 6/6/12 07 = 12/12	Mobile pedestals will not fit under machine height worksurfaces.
	See page 17 for paint finishes.	File drawers include file hanging bars.
	All locks on individually locking components must be specified as key-alike using KnollKey lock program as listed on page 188.	Pedestals are available in painted steel and are offered with standard Calibre fronts only.
	Add an "F" to the end of the pattern number to receive full extension slides on all box drawers. Upcharge is \$25 list per pedestal.	
	X units include security separator(s)	

Calibre Pedestals

Calibre

*Mobile pedestal with individual locks - 18" and 24" deep
without top and with handle
(pedestal cushion ordered separately)*

description	w	d	h	separator	pattern no.	P1	P2	P3
Mobile pedestal 01 = box / file	15"	18"	20 5/8"		3O18WP01	\$920.	\$938.	\$1,011.
	15"	18"	20 5/8"	Y	3O18XP01	950.	989.	1,039.
	15"	24"	20 5/8"		3O24WP01	1,013.	1,060.	1,113.
	15"	24"	20 5/8"	Y	3O24XP01	1,040.	1,088.	1,143.

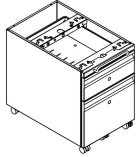

Mobile pedestal 05 = box / box / file	15"	18"	26 5/8"		3O18WP05	1,035.	1,077.	1,131.
	15"	18"	26 5/8"	Y	3O18XP05	1,075.	1,119.	1,177.
	15"	24"	26 5/8"		3O24WP05	1,129.	1,180.	1,238.
	15"	24"	26 5/8"	Y	3O24XP05	1,172.	1,219.	1,282.



Mobile pedestal 07 = file / file	15"	18"	26 5/8"		3O18WP07	944.	985.	1,035.
	15"	18"	26 5/8"	Y	3O18XP07	971.	1,013.	1,063.
	15"	24"	26 5/8"		3O24WP07	1,036.	1,085.	1,140.
	15"	24"	26 5/8"	Y	3O24XP07	1,062.	1,111.	1,167.

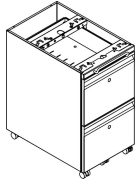





Order Code	Specification Information	Application Notes
<p>Example: 3O18WP01-612</p> <p>3 Standard height</p> <p>O Mobile pedestal without top</p> <p>18 17 1/2" deep</p> <p>W Without separator</p> <p>P with handle</p> <p>01 box/file</p> <p>612 Medium metallic grey</p>	<p>To order specify:</p> <ol style="list-style-type: none"> 1. Pattern number 2. Pedestal lock options 3. Pedestal configurations 4. Paint finish options <p>Pedestal lock options: C Knoll lock</p> <p>Pedestal configuration options: 01 = 6/12 05 = 6/6/12 07 = 12/12</p> <p>See page 17 for paint finishes.</p> <p>All locks on individually locking components must be specified as key-alike using KnollKey lock program as listed on page 188.</p> <p>Add an "F" to the end of the pattern number to receive full extension slides on all box drawers. Upcharge is \$25 list per pedestal.</p> <p>X units include security separator(s)</p>	<p>Mobile pedestals to be used beneath 24", 30" or 36" deep worksurfaces, credenzas, and return tops.</p> <p>Mobile pedestals include locking casters.</p> <p>Mobile pedestals will not fit under machine height worksurfaces.</p> <p>File drawers include file hanging bars.</p> <p>Pedestals are available in painted steel and are offered with standard Calibre fronts only.</p>

Actual dimensions are:
14 7/8"W x 23 1/4"D
Pedestal accessories, see page 107.

Calibre Pedestal Accessories

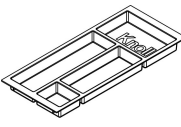
Drawer Inserts

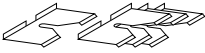
Calibre

description	type	pattern no.	list price
File hanging bars 		CD1-FS	\$31.
Pencil tray 	black	CD2PTN	40.
	clear	CD2PTC	47.
Drawer divider, box 		CD1-BD	31.
Drawer divider, file 		CD1-FD	31.
Stationery inserts, four trays, for box drawer 		CD1-ST	150.
Base fascia 	Standard height	CPKP	27.
Pedestal Lock Kit		CD1LKKT	49.

Calibre Front Pedestals with Individual Locking Drawers

Order Code	Specification Information	Application Notes
Example: CPKP-613	<i>To order, specify:</i>	
C Calibre	1. Pattern number	File hanging bars come in a set of two.
P Pedestal	2. Paint finish for base fascia	Pencil tray works in both personal and box drawer sizes.
K Kick		Dimensions listed are actual ($\pm 1/16''$).
P Plate		Stationery inserts (four trays, for box drawer).
613 Silver paint finish		All accessories are finished in black.
		The base fascia should be specified when pedestals are to be used near Calibre Files. The fascia extends the base forward to match the drawer front. Specify paint finish.

Calibre Pedestal Accessories
*pedestal cushion
 fabric*

Calibre

description	w	d	h	pattern no.	COM		C	D	E	F	G	H	I
					A	B							
Cushion	15"	18"	1"	C1PAD18 ()	\$162.	\$188.	\$212.	\$223.	\$237.	\$261.	\$288.	\$325.	\$337.
	15"	24"	1"	C1PAD24 ()	201.	223.	261.	274.	299.	325.	362.	400.	413.

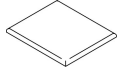

Order Code	Specification Information	Application Notes
Example: C1PAD24B-K124-9		
C Calibre	There is a \$76 upcharge on CAL133 backing on the cushion.	Pedestal cushions are for use on mobile pedestals without tops.
1 Generation 1	Consult page 17 for available fabrics.	
PAD Cushion		
24 24"d	Pedestal cushions are upholstered (from the front to the back of the pedestal) with the fabric direction matching the textile sample.	
B Grade B		
K124/9 Dristi Cumin		For Customers Own Material (COM) applications, specify .75 yards of fabric for 17 inch deep mobile pedestal seat cushions, and .90 yards for 23 inch deep seat cushion.

Calibre Pedestal Accessories
pedestal cushion
leather

Calibre

description	w	d	h	pattern no.	COM U	V	W	X	Y
Cushion	15"	18"	1"	C1PAD18 ()	\$313.	\$372.	\$460.	\$474.	\$499.
	15"	24"	1"	C1PAD24 ()	400.	474.	584.	612.	648.

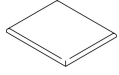

Calibre Front Pedestals with Individual Locking Drawers

Order Code	Specification Information	Application Notes
Example: C1PAD24B-K124-9		
C Calibre	There is a \$101 upcharge for perforated leather.	Pedestal cushions are for use on mobile pedestals without tops.
1 Generation 1	Consult page 17 for available leathers.	For Customers Own Leather (COL) applications, specify 11.5 sq. feet of leather for 17 inch deep mobile pedestal seat cushions, and 14.5 sq. feet for 23 inch deep seat cushion.
PAD Cushion		
24 24" d		
B Grade B		
K124/9 Dristi Cumin		

description	type	w	d	height	lock	pattern no.	P1	P2	P3
42" High Side Access Bookcase tower with two file drawers (right hand shown)	left hand	14 ⁷ / ₈ "	23 ¹ / ₂ "	41 ⁵ / ₁₆ "	Y	CT3SBLH4215FFL	\$1,088.	\$1,200.	\$1,258.
	right hand	14 ⁷ / ₈ "	23 ¹ / ₂ "	41 ⁵ / ₁₆ "	Y	CT3SBRH4215FFL	1,088.	1,200.	1,258.



42" High Side Access Bookcase tower with two box and one file drawer (right hand shown)	left hand	14 ⁷ / ₈ "	23 ¹ / ₂ "	41 ⁵ / ₁₆ "	Y	CT3SBLH4215BBFL	1,159.	1,278.	1,340.
	right hand	14 ⁷ / ₈ "	23 ¹ / ₂ "	41 ⁵ / ₁₆ "	Y	CT3SBRH4215BBFL	1,159.	1,278.	1,340.

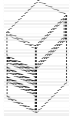

50" High Single Door tower with two file drawers (right hand shown)	left hand	14 ⁷ / ₈ "	23 ¹ / ₂ "	48 ⁵ / ₁₆ "	Y	CT3SLH5015FFL	1,204.	1,323.	1,389.
	right hand	14 ⁷ / ₈ "	23 ¹ / ₂ "	48 ⁵ / ₁₆ "	Y	CT3SRH5015FFL	1,204.	1,323.	1,389.

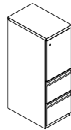

Order Code	Specification Information	Application Notes	Critical Dimensions
Example: CT3SBLH5715BBFL-111	For non-locking towers, deduct as follows from the list price for each unit: Deduct \$30 for (1) lock unit, \$60 for a (2) lock unit, and \$75 for a (3) lock unit. Substitute the "L" suffix with an "N" within the pattern number to designate a non-locking unit, example (CT3SLH5015BBFN)	Hanging rails and other accessories are not included and must be ordered separately. Hanging rails are included with 24" and 30" wide lateral drawers only. (See <i>Tower Accessories for pricing and order entry information</i>)	Dimensions under w , d and h are actual to the nearest ¹ / ₁₆ "
CT3 Calibre Storage Tower	<p>"M" drawer consisting of a box drawer body with a file drawer head are available by substituting any two "B" or any one "F" character within the pattern number, example (CT3SLH6415BBFFL1) Note: 6" drawers behind doors are not available within the wardrobe portion of towers. Drawers behind doors have painted black fronts.</p> <p>A 6" drawer, behind a cupboard door is available by adding the numeral 1 to the end of the pattern number, example (CT3SLH6415BBFFL1) Note: 6" drawers behind doors are not available within the wardrobe portion of towers. Drawers behind doors have painted black fronts.</p>	Half depth adjustable shelves and coat hooks may be ordered separately allowing the cupboard area of 15", 24" and 30" wide towers to support binders as well as shorter coats. (See <i>Tower Accessories for pricing and order entry information</i>)	42", 50", 57" and 64" Tower Internal Dimensions
SB Side Access Bookcase		15" w Side Access and Display towers include (1) lock.	<ul style="list-style-type: none"> Box and M drawer height: 4⁵/₁₆" Box and M drawer width: 12¹/₁₆" Box and M drawer depth: 18³/₈" File drawer height: 9¹/₄" File drawer width: 12³/₁₆" File drawer depth: 18³/₈"
LH Left Hand Access		Single door towers, double door towers, 24" w and 30" w Side Access and Display towers include (2) locks. (Except full-height doors which include (1) lock)	<p>Note: All towers are configured from the top down with standard combinations of box and file drawers.</p> <p>Note: Drawer behind door list pricing is as follows: 1=\$255</p>
57 57" High		Front Access (only) towers with wardrobe include (3) locks. (Except full-height doors with wardrobe which include (2) locks)	
15 15" Wide			
B Box Drawer			
B Box Drawer			
F File Drawer			
L Locking			
111 Black paint finish			

All Towers are standard with (1) full depth adjustable shelf, except the 64" h side access display and bookcase towers which have (2) full depth adjustable shelves.

description	type	w	d	height	lock	pattern no.	P1	P2	P3
50" High Single Door tower with two box and one file drawer (right hand shown)	left hand	14 ⁷ / ₈ "	23 ¹ / ₂ "	48 ⁵ / ₁₆ "	Y	CT3SLH5015BBFL	\$1,349.	\$1,484.	\$1,559.
	right hand	14 ⁷ / ₈ "	23 ¹ / ₂ "	48 ⁵ / ₁₆ "	Y	CT3SRH5015BBFL	1,349.	1,484.	1,559.

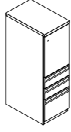

50" High Single Door tower with two box and two file drawers (right hand shown)	left hand	14 ⁷ / ₈ "	23 ¹ / ₂ "	48 ⁵ / ₁₆ "	Y	CT3SLH5015BBFFL	1,489.	1,639.	1,719.
	right hand	14 ⁷ / ₈ "	23 ¹ / ₂ "	48 ⁵ / ₁₆ "	Y	CT3SRH5015BBFFL	1,489.	1,639.	1,719.

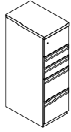

50" High Single Door tower with three file drawers (right hand shown)	left hand	14 ⁷ / ₈ "	23 ¹ / ₂ "	48 ⁵ / ₁₆ "	Y	CT3SLH5015FFFL	1,321.	1,454.	1,527.
	right hand	14 ⁷ / ₈ "	23 ¹ / ₂ "	48 ⁵ / ₁₆ "	Y	CT3SRH5015FFFL	1,321.	1,454.	1,527.

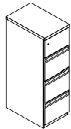

Order Code	Specification Information	Application Notes	Critical Dimensions
Example: CT3SBLH5715BBFL-111			
CT3 Calibre Storage Tower	For non-locking towers, deduct as follows from the list price for each unit: Deduct \$30 for (1) lock unit, \$60 for a (2) lock unit, and \$75 for a (3) lock unit. Substitute the "L" suffix with an "N" within the pattern number to designate a non-locking unit, example (CT3SLH5015BBFN) "M" drawer consisting of a box drawer body with a file drawer head are available by substituting any two "B" or any one "F" character within the pattern number, example (CT3SLH5015MFN). Multiple "M" drawers may be specified providing they equal the total modules available.	Hanging rails and other accessories are not included and must be ordered separately. Hanging rails are included with 24" and 30" wide lateral drawers only. (See Tower Accessories for pricing and order entry information) Half depth adjustable shelves and coat hooks may be ordered separately allowing the cupboard area of 15", 24" and 30" wide towers to support binders as well as shorter coats. (See Tower Accessories for pricing and order entry information) 15"w Side Access and Display towers include (1) lock. Single door towers, double door towers, 24"w and 30"w Side Access and Display towers include (2) locks. (Except full-height doors which include (1) lock) Front Access (only) towers with wardrobe include (3) locks. (Except full-height doors with wardrobe which include (2) locks)	Dimensions under w , d and h are actual to the nearest 1/16" 42", 50", 57" and 64" Tower Internal Dimensions <ul style="list-style-type: none"> Box and M drawer height: 4⁵/₁₆" Box and M drawer width: 12¹/₁₆" Box and M drawer depth: 18³/₈" File drawer height: 9¹/₄" File drawer width: 12¹/₁₆" File drawer depth: 18³/₈" Note: All towers are configured from the top down with standard combinations of box and file drawers. Note: Drawer behind door list pricing is as follows: 1=\$255
SB Side Access Bookcase			
LH Left Hand Access			
57 57" High			
15 15" Wide			
B Box Drawer			
B Box Drawer			
F File Drawer			
L Locking			
111 Black paint finish			

All Towers are standard with (1) full depth adjustable shelf, except the 64" h side access display and bookcase towers which have (2) full depth adjustable shelves.

A 6" drawer, behind a cupboard door is available by adding the numeral 1 to the end of the pattern number, example (CT3SLH6415BBFFL1) **Note:** 6" drawers behind doors are not available within the wardrobe portion of towers. Drawers behind doors have painted black fronts.

description	type	w	d	height	lock	pattern no.	P1	P2	P3
50" High Side Access Bookcase tower with two box and one file drawer (right hand shown)	left hand	14 ⁷ / ₈ "	23 ¹ / ₂ "	48 ⁵ / ₁₆ "	Y	CT3SBLH5015BBFL	\$1,169.	\$1,285.	\$1,349.
	right hand	14 ⁷ / ₈ "	23 ¹ / ₂ "	48 ⁵ / ₁₆ "	Y	CT3SBRH5015BBFL	1,169.	1,285.	1,349.



50" High Side Access Bookcase tower with two file drawers (right hand shown)	left hand	14 ⁷ / ₈ "	23 ¹ / ₂ "	48 ⁵ / ₁₆ "	Y	CT3SBLH5015FFL	1,139.	1,254.	1,317.
	right hand	14 ⁷ / ₈ "	23 ¹ / ₂ "	48 ⁵ / ₁₆ "	Y	CT3SBRH5015FFL	1,139.	1,254.	1,317.



57" High Single Door tower with two file drawers (right hand shown)	left hand	14 ⁷ / ₈ "	23 ¹ / ₂ "	56 ³ / ₁₆ "	Y	CT3SLH5715FFL	1,259.	1,386.	1,455.
	right hand	14 ⁷ / ₈ "	23 ¹ / ₂ "	56 ³ / ₁₆ "	Y	CT3SRH5715FFL	1,259.	1,386.	1,455.

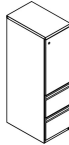

Order Code	Specification Information	Application Notes	Critical Dimensions
Example: CT3SBLH5715BBFL-111	For non-locking towers, deduct as follows from the list price for each unit: Deduct \$30 for (1) lock unit, \$60 for a (2) lock unit, and \$75 for a (3) lock unit. Substitute the "L" suffix with an "N" within the pattern number to designate a non-locking unit, example (CT3SLH5015BBFN)	Hanging rails and other accessories are not included and must be ordered separately. Hanging rails are included with 24" and 30" wide lateral drawers only. (See <i>Tower Accessories for pricing and order entry information</i>)	Dimensions under w , d and h are actual to the nearest ¹ / ₁₆ "
CT3 Calibre Storage Tower	"M" drawer consisting of a box drawer body with a file drawer head are available by substituting any two "B" or any one "F" character within the pattern number, example (CT3SLH6415BBFFL1) Note: 6" drawers behind doors are not available within the wardrobe portion of towers. Drawers behind doors have painted black fronts.	Half depth adjustable shelves and coat hooks may be ordered separately allowing the cupboard area of 15", 24" and 30" wide towers to support binders as well as shorter coats. (See <i>Tower Accessories for pricing and order entry information</i>)	42", 50", 57" and 64" Tower Internal Dimensions
SB Side Access Bookcase		15" w Side Access and Display towers include (1) lock.	<ul style="list-style-type: none"> Box and M drawer height: 4⁵/₁₆" Box and M drawer width: 12¹/₁₆" Box and M drawer depth: 18³/₈" File drawer height: 9¹/₄" File drawer width: 12¹/₁₆" File drawer depth: 18³/₈"
LH Left Hand Access		Single door towers, double door towers, 24" w and 30" w Side Access and Display towers include (2) locks. (Except full-height doors which include (1) lock)	Note: All towers are configured from the top down with standard combinations of box and file drawers.
57 57" High		Front Access (only) towers with wardrobe include (3) locks. (Except full-height doors with wardrobe which include (2) locks)	Note: Drawer behind door list pricing is as follows: 1=\$255
15 15" Wide			
B Box Drawer			
B Box Drawer			
F File Drawer			
L Locking			
111 Black paint finish			

All Towers are standard with (1) full depth adjustable shelf, except the 64" h side access display and bookcase towers which have (2) full depth adjustable shelves.

description	type	w	d	height	lock	pattern no.	P1	P2	P3
57" High Single Door tower with two box and one file drawer (right hand shown)	left hand	14 ⁷ / ₈ "	23 ¹ / ₂ "	56 ³ / ₁₆ "	Y	CT3SLH5715BBFL	\$1,407.	\$1,546.	\$1,624.
	right hand	14 ⁷ / ₈ "	23 ¹ / ₂ "	56 ³ / ₁₆ "	Y	CT3SRH5715BBFL	1,407.	1,546.	1,624.

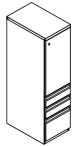

57" High Single Door tower with three file drawers (right hand shown)	left hand	14 ⁷ / ₈ "	23 ¹ / ₂ "	56 ³ / ₁₆ "	Y	CT3SLH5715FFFL	1,397.	1,537.	1,615.
	right hand	14 ⁷ / ₈ "	23 ¹ / ₂ "	56 ³ / ₁₆ "	Y	CT3SRH5715FFFL	1,397.	1,537.	1,615.

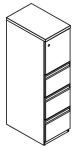

57" High Side Access Bookcase tower with two file drawers (right hand shown)	left hand	14 ⁷ / ₈ "	23 ¹ / ₂ "	56 ³ / ₁₆ "	Y	CT3SBLH5715FFFL	1,160.	1,278.	1,341.
	right hand	14 ⁷ / ₈ "	23 ¹ / ₂ "	56 ³ / ₁₆ "	Y	CT3SBRH5715FFFL	1,160.	1,278.	1,341.



Order Code	Specification Information	Application Notes	Critical Dimensions
Example: CT3SBLH5715BBFL-111	For non-locking towers, deduct as follows from the list price for each unit: Deduct \$30 for (1) lock unit, \$60 for a (2) lock unit, and \$75 for a (3) lock unit. Substitute the "L" suffix with an "N" within the pattern number to designate a non-locking unit, example (CT3SLH5015BBFN)	Hanging rails and other accessories are not included and must be ordered separately. Hanging rails are included with 24" and 30" wide lateral drawers only. (See <i>Tower Accessories for pricing and order entry information</i>)	Dimensions under w , d and h are actual to the nearest ¹ / ₁₆ "
CT3 Calibre Storage Tower	"M" drawer consisting of a box drawer body with a file drawer head are available by substituting any two "B" or any one "F" character within the pattern number, example (CT3SLH5015MFN). Multiple "M" drawers may be specified providing they equal the total modules available.	Half depth adjustable shelves and coat hooks may be ordered separately allowing the cupboard area of 15", 24" and 30" wide towers to support binders as well as shorter coats. (See <i>Tower Accessories for pricing and order entry information</i>)	42", 50", 57" and 64" Tower Internal Dimensions
SB Side Access Bookcase	A 6" drawer, behind a cupboard door is available by adding the numeral 1 to the end of the pattern number, example (CT3SLH6415BBFFL1) Note: 6" drawers behind doors are not available within the wardrobe portion of towers. Drawers behind doors have painted black fronts.	15" w Side Access and Display towers include (1) lock.	<ul style="list-style-type: none"> Box and M drawer height: 4³/₁₆" Box and M drawer width: 12¹/₁₆" Box and M drawer depth: 18³/₈" File drawer height: 9¹/₄" File drawer width: 12³/₁₆" File drawer depth: 18³/₈"
LH Left Hand Access		Single door towers, double door towers, 24" w and 30" w Side Access and Display towers include (2) locks. (Except full-height doors which include (1) lock)	Note: All towers are configured from the top down with standard combinations of box and file drawers.
57 57" High		Front Access (only) towers with wardrobe include (3) locks. (Except full-height doors with wardrobe which include (2) locks)	Note: Drawer behind door list pricing is as follows: 1=\$255
15 15" Wide			
B Box Drawer			
B Box Drawer			
F File Drawer			
L Locking			
111 Black paint finish			

All Towers are standard with (1) full depth adjustable shelf, except the 64" h side access display and bookcase towers which have (2) full depth adjustable shelves.

description	type	w	d	height	lock	pattern no.	P1	P2	P3
57" High Side Access Bookcase tower with two box and one file drawer (right hand shown)	left hand	14 ⁷ / ₈ "	23 ¹ / ₂ "	56 ⁵ / ₁₆ "	Y	CT3SBLH5715BBFL	\$1,213.	\$1,335.	\$1,404.
	right hand	14 ⁷ / ₈ "	23 ¹ / ₂ "	56 ⁵ / ₁₆ "	Y	CT3SBRH5715BBFL	1,213.	1,335.	1,404.

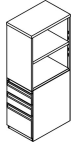

64" High Single Door tower with two file drawers (right hand shown)	left hand	14 ⁷ / ₈ "	23 ¹ / ₂ "	63 ⁵ / ₁₆ "	Y	CT3SLH6415FFL	1,263.	1,390.	1,461.
	right hand	14 ⁷ / ₈ "	23 ¹ / ₂ "	63 ⁵ / ₁₆ "	Y	CT3SRH6415FFL	1,263.	1,390.	1,461.



64" High Single Door tower with two box and one file drawer (right hand shown)	left hand	14 ⁷ / ₈ "	23 ¹ / ₂ "	63 ⁵ / ₁₆ "	Y	CT3SLH6415BBFL	1,414.	1,556.	1,633.
	right hand	14 ⁷ / ₈ "	23 ¹ / ₂ "	63 ⁵ / ₁₆ "	Y	CT3SRH6415BBFL	1,414.	1,556.	1,633.



Order Code	Specification Information	Application Notes	Critical Dimensions
Example: CT3SBLH5715BBFL-111	For non-locking towers, deduct as follows from the list price for each unit: Deduct \$30 for (1) lock unit, \$60 for a (2) lock unit, and \$75 for a (3) lock unit. Substitute the "L" suffix with an "N" within the pattern number to designate a non-locking unit, example (CT3SLH5015BBFN)	Hanging rails and other accessories are not included and must be ordered separately. Hanging rails are included with 24" and 30" wide lateral drawers only. (See <i>Tower Accessories for pricing and order entry information</i>)	Dimensions under w , d and h are actual to the nearest ¹ / ₁₆ "
CT3 Calibre Storage Tower	"M" drawer consisting of a box drawer body with a file drawer head are available by substituting any two "B" or any one "F" character within the pattern number, example (CT3SLH5015MFN). Multiple "M" drawers may be specified providing they equal the total modules available.	Half depth adjustable shelves and coat hooks may be ordered separately allowing the cupboard area of 15", 24" and 30" wide towers to support binders as well as shorter coats. (See <i>Tower Accessories for pricing and order entry information</i>)	42", 50", 57" and 64" Tower Internal Dimensions
SB Side Access Bookcase		15" w Side Access and Display towers include (1) lock.	<ul style="list-style-type: none"> Box and M drawer height: 4⁵/₁₆" Box and M drawer width: 12¹/₁₆" Box and M drawer depth: 18³/₈" File drawer height: 9¹/₄" File drawer width: 12¹/₁₆" File drawer depth: 18³/₈"
LH Left Hand Access		Single door towers, double door towers, 24" w and 30" w Side Access and Display towers include (2) locks. (Except full-height doors which include (1) lock)	
57 57" High		Front Access (only) towers with wardrobe include (3) locks. (Except full-height doors with wardrobe which include (2) locks)	
15 15" Wide			
B Box Drawer			
B Box Drawer			
F File Drawer			
L Locking			
111 Black paint finish			

All Towers are standard with (1) full depth adjustable shelf, except the 64" h side access display and bookcase towers which have (2) full depth adjustable shelves.

A 6" drawer, behind a cupboard door is available by adding the numeral 1 to the end of the pattern number, example (CT3SLH6415BBFFL1) **Note:** 6" drawers behind doors are not available within the wardrobe portion of towers. Drawers behind doors have painted black fronts.

Note: All towers are configured from the top down with standard combinations of box and file drawers.

Note: Drawer behind door list pricing is as follows: 1=\$255

description	type	w	d	height	lock	pattern no.	P1	P2	P3
64" High Single Door tower with two box and two file drawers (right hand shown)	left hand	14 ⁷ / ₈ "	23 ¹ / ₂ "	63 ⁵ / ₁₆ "	Y	CT3SLH6415BBFFL	\$1,537.	\$1,689.	\$1,775.
	right hand	14 ⁷ / ₈ "	23 ¹ / ₂ "	63 ⁵ / ₁₆ "	Y	CT3SRH6415BBFFL	1,537.	1,689.	1,775.

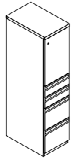

64" High Single Door tower with three file drawers (right hand shown)	left hand	14 ⁷ / ₈ "	23 ¹ / ₂ "	63 ⁵ / ₁₆ "	Y	CT3SLH6415FFFL	1,420.	1,563.	1,641.
	right hand	14 ⁷ / ₈ "	23 ¹ / ₂ "	63 ⁵ / ₁₆ "	Y	CT3SRH6415FFFL	1,420.	1,563.	1,641.



64" High Single Door tower with four file drawers (right hand shown)	right hand	14 ⁷ / ₈ "	23 ¹ / ₂ "	63 ⁵ / ₁₆ "	Y	CT3SRH6415FFFL	1,557.	1,710.	1,797.
--	------------	----------------------------------	----------------------------------	-----------------------------------	---	-----------------------	--------	--------	--------

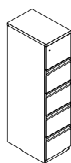

Order Code	Specification Information
Example: CT3SBLH5715BBFL-111	
CT3	Calibre Storage Tower
SB	Side Access Bookcase
LH	Left Hand Access
57	57" High
15	15" Wide
B	Box Drawer
B	Box Drawer
F	File Drawer
L	Locking
111	Black paint finish

All Towers are standard with (1) full depth adjustable shelf, except the 64" h side access display and bookcase towers which have (2) full depth adjustable shelves.

For non-locking towers, deduct as follows from the list price for each unit: Deduct \$30 for (1) lock unit, \$60 for a (2) lock unit, and \$75 for a (3) lock unit. Substitute the "L" suffix with an "N" within the pattern number to designate a non-locking unit, example (CT3SLH5015BBFN)

"M" drawer consisting of a box drawer body with a file drawer head are available by substituting any two "B" or any one "F" character within the pattern number, example (CT3SLH5015MFN). Multiple "M" drawers may be specified providing they equal the total modules available.

A 6" drawer, behind a cupboard door is available by adding the numeral 1 to the end of the pattern number, example (CT3SLH6415BBFFL1) **Note:** 6" drawers behind doors are not available within the wardrobe portion of towers. Drawers behind doors have painted black fronts.

Application Notes

Hanging rails and other accessories are not included and must be ordered separately. Hanging rails are included with 24" and 30" wide lateral drawers only. (See *Tower Accessories for pricing and order entry information*)

Half depth adjustable shelves and coat hooks may be ordered separately allowing the cupboard area of 15", 24" and 30" wide towers to support binders as well as shorter coats. (See *Tower Accessories for pricing and order entry information*)

15" w Side Access and Display towers include (1) lock.

Single door towers, double door towers, 24" w and 30" w Side Access and Display towers include (2) locks. (Except full-height doors which include (1) lock)

Front Access (only) towers with wardrobe include (3) locks. (Except full-height doors with wardrobe which include (2) locks)

Critical Dimensions

Dimensions under **w**, **d** and **h** are actual to the nearest 1/16"

42", 50", 57" and 64" Tower Internal Dimensions

- Box and M drawer height: 4⁵/₁₆"
- Box and M drawer width: 12¹/₁₆"
- Box and M drawer depth: 18³/₈"
- File drawer height: 9¹/₄"
- File drawer width: 12¹/₁₆"
- File drawer depth: 18³/₈"

Note: All towers are configured from the top down with standard combinations of box and file drawers.

Note: Drawer behind door list pricing is as follows: 1=\$255

description	type	w	d	height	lock	pattern no.	P1	P2	P3
64" High Side Access Bookcase tower with two box and one file drawer (right hand shown)	left hand	14 ⁷ / ₈ "	23 ¹ / ₂ "	63 ³ / ₁₆ "	Y	CT3SBLH6415BBFL	\$1,260.	\$1,388.	\$1,457.
	right hand	14 ⁷ / ₈ "	23 ¹ / ₂ "	63 ³ / ₁₆ "	Y	CT3SBRH6415BBFL	1,260.	1,388.	1,457.



64" High Side Access Bookcase tower with two file drawers (right hand shown)	left hand	14 ⁷ / ₈ "	23 ¹ / ₂ "	63 ³ / ₁₆ "	Y	CT3SBLH6415FFL	1,180.	1,299.	1,362.
	right hand	14 ⁷ / ₈ "	23 ¹ / ₂ "	63 ³ / ₁₆ "	Y	CT3SBRH6415FFL	1,180.	1,299.	1,362.



64" High Side Access Bookcase tower with two box and one file drawer (right hand shown)	left hand	14 ⁷ / ₈ "	23 ¹ / ₂ "	63 ³ / ₁₆ "	Y	CT3BDLH6415BBFL	1,278.	1,405.	1,471.
	right hand	14 ⁷ / ₈ "	23 ¹ / ₂ "	63 ³ / ₁₆ "	Y	CT3BDRH6415BBFL	1,278.	1,405.	1,471.



Order Code	Specification Information	Application Notes	Critical Dimensions
Example: CT3SBLH5715BBFL-111	For non-locking towers, deduct as follows from the list price for each unit: Deduct \$30 for (1) lock unit, \$60 for a (2) lock unit, and \$75 for a (3) lock unit. Substitute the "L" suffix with an "N" within the pattern number to designate a non-locking unit, example (CT3SLH5015BBFN)	Hanging rails and other accessories are not included and must be ordered separately. Hanging rails are included with 24" and 30" wide lateral drawers only. (See <i>Tower Accessories for pricing and order entry information</i>)	Dimensions under w , d and h are actual to the nearest ¹ / ₁₆ "
CT3 Calibre Storage Tower	"M" drawer consisting of a box drawer body with a file drawer head are available by substituting any two "B" or any one "F" character within the pattern number, example (CT3SLH5015MFN). Multiple "M" drawers may be specified providing they equal the total modules available.	Half depth adjustable shelves and coat hooks may be ordered separately allowing the cupboard area of 15", 24" and 30" wide towers to support binders as well as shorter coats. (See <i>Tower Accessories for pricing and order entry information</i>)	42", 50", 57" and 64" Tower Internal Dimensions
SB Side Access Bookcase			
LH Left Hand Access			
57 57" High			
15 15" Wide			
B Box Drawer			
B Box Drawer			
F File Drawer			
L Locking			
111 Black paint finish			

All Towers are standard with (1) full depth adjustable shelf, except the 64" h side access display and bookcase towers which have (2) full depth adjustable shelves.

A 6" drawer, behind a cupboard door is available by adding the numeral 1 to the end of the pattern number, example (CT3SLH6415BBFFL1) **Note:** 6" drawers behind doors are not available within the wardrobe portion of towers. Drawers behind doors have painted black fronts.

15" w Side Access and Display towers include (1) lock.

Single door towers, double door towers, 24" w and 30" w Side Access and Display towers include (2) locks. (Except full-height doors which include (1) lock)

Front Access (only) towers with wardrobe include (3) locks. (Except full-height doors with wardrobe which include (2) locks)

Note: All towers are configured from the top down with standard combinations of box and file drawers.

Note: Drawer behind door list pricing is as follows: 1=\$255

description	type	w	d	height	lock	pattern no.	P1	P2	P3
64" High Side Access Bookcase tower with two file drawers (right hand shown)	left hand	14 ⁷ / ₈ "	23 ¹ / ₂ "	63 ³ / ₁₆ "	Y	CT3BDLH6415FFL	\$1,197.	\$1,316.	\$1,382.
	right hand	14 ⁷ / ₈ "	23 ¹ / ₂ "	63 ³ / ₁₆ "	Y	CT3BDRH6415FFL	1,197.	1,316.	1,382.

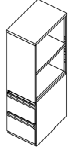

64" High Single Door tower with four file drawers (right hand shown)	left hand	14 ⁷ / ₈ "	23 ¹ / ₂ "	63 ³ / ₁₆ "	Y	CT3SLH6415FFFLL	1,557.	1,710.	1,797.
--	-----------	----------------------------------	----------------------------------	-----------------------------------	---	------------------------	--------	--------	--------



Order Code	Specification Information	Application Notes	Critical Dimensions
Example: CT3SBLH5715BBFL-111	For non-locking towers, deduct as follows from the list price for each unit: Deduct \$30 for (1) lock unit, \$60 for a (2) lock unit, and \$75 for a (3) lock unit. Substitute the "L" suffix with an "N" within the pattern number to designate a non-locking unit, example (CT3SLH5015BBFN)	Hanging rails and other accessories are not included and must be ordered separately. Hanging rails are included with 24" and 30" wide lateral drawers only. (See <i>Tower Accessories for pricing and order entry information</i>)	Dimensions under w , d and h are actual to the nearest 1/16"
CT3 Calibre Storage Tower	"M" drawer consisting of a box drawer body with a file drawer head are available by substituting any two "B" or any one "F" character within the pattern number, example (CT3SLH5015MFN). Multiple "M" drawers may be specified providing they equal the total modules available.	Half depth adjustable shelves and coat hooks may be ordered separately allowing the cupboard area of 15", 24" and 30" wide towers to support binders as well as shorter coats. (See <i>Tower Accessories for pricing and order entry information</i>)	42", 50", 57" and 64" Tower Internal Dimensions
SB Side Access Bookcase	A 6" drawer, behind a cupboard door is available by adding the numeral 1 to the end of the pattern number, example (CT3SLH6415BBFFL1) Note: 6" drawers behind doors are not available within the wardrobe portion of towers. Drawers behind doors have painted black fronts.	15" w Side Access and Display towers include (1) lock.	<ul style="list-style-type: none"> Box and M drawer height: 4³/₁₆" Box and M drawer width: 12¹/₁₆" Box and M drawer depth: 18³/₈" File drawer height: 9¹/₄" File drawer width: 12¹/₁₆" File drawer depth: 18³/₈"
LH Left Hand Access		Single door towers, double door towers, 24" w and 30" w Side Access and Display towers include (2) locks. (Except full-height doors which include (1) lock)	Note: All towers are configured from the top down with standard combinations of box and file drawers.
57 57" High		Front Access (only) towers with wardrobe include (3) locks. (Except full-height doors with wardrobe which include (2) locks)	Note: Drawer behind door list pricing is as follows: 1=\$255
15 15" Wide			
B Box Drawer			
B Box Drawer			
F File Drawer			
L Locking			
111 Black paint finish			

All Towers are standard with (1) full depth adjustable shelf, except the 64" h side access display and bookcase towers which have (2) full depth adjustable shelves.

description	type	w	d	h	lock	pattern no.	P1	P2	P3
50" High Single Door with one wide drawer (right hand shown)	left hand	23 7/8"	23 1/2"	48 5/16"	Y	CT3SLH5024WL	\$1,212.	\$1,333.	\$1,401.
	right hand	23 7/8"	23 1/2"	48 5/16"	Y	CT3SRH5024WL	1,212.	1,333.	1,401.

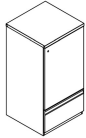

50" High Single Door with two wide drawers (right hand shown)	left hand	23 7/8"	23 1/2"	48 5/16"	Y	CT3SLH5024WWL	1,457.	1,599.	1,682.
	right hand	23 7/8"	23 1/2"	48 5/16"	Y	CT3SRH5024WWL	1,457.	1,599.	1,682.

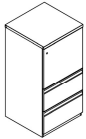

50" High Double Door tower with one wide drawer		23 7/8"	23 1/2"	48 5/16"	Y	CT3D5024WL	1,414.	1,556.	1,633.
---	--	---------	---------	----------	---	-------------------	--------	--------	--------

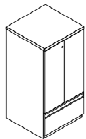

Order Code	Specification Information	Application Notes	Critical Dimensions
Example: CT3SBLH5724BBFL-111	For non-locking towers, deduct as follows from the list price for each unit: Deduct \$30 for (1) lock unit, \$60 for a (2) lock unit, and \$75 for a (3) lock unit. Substitute the "L" suffix with an "N" within the pattern number to designate a non-locking unit, example (CT3SLH6424BBFN)	Hanging rails and other accessories are not included and must be ordered separately. Hanging rails are included with 24" and 30" wide lateral drawers only. (See <i>Tower Accessories for pricing and order entry information</i>)	Dimensions under w , d and h are actual to the nearest 1/16"
CT3 Calibre Storage Tower		Half depth adjustable shelves and coat hooks may be ordered separately allowing the cupboard area of 15", 24" and 30" wide towers to support binders as well as shorter coats. (See <i>Tower Accessories for pricing and order entry information</i>)	24" Wide 50", 57" and 64" Tower Internal Dimensions
SB Side Access Bookcase	"M" drawer consisting of a box drawer body with a file drawer head are available by substituting any two "B" or any one "F" character within the pattern number, example (CT3SLH6424MBFN). Multiple "M" drawers may be specified providing they equal the total modules available.	15" w Side Access and Display towers include (1) lock.	<ul style="list-style-type: none"> Box and M drawer height: 4 5/16" Box and M drawer width: 12 1/16" Box and M drawer depth: 18 3/8" File drawer height: 9 1/4" File drawer width: 12 1/16" File drawer depth: 18 3/8" Wide drawer height: 9 9/16" Wide drawer width: 20 3/4" Wide drawer depth: 22 7/8"
LH Left Hand Access		Single door towers, double door towers, 24" w and 30" w Side Access and Display towers include (2) locks. (Except full-height doors which include (1) lock)	Note: All towers are configured from the top down with standard combinations of box and file drawers.
57 64" High		Front Access (only) towers with wardrobe include (3) locks. (Except full-height doors with wardrobe which include (2) locks)	Note: Drawer behind door list pricing is as follows: 1=\$255
24 24" Wide			
B Box Drawer			
B Box Drawer			
F File Drawer			
L Locking			
111 Black paint finish			

All towers are standard with (1) full depth adjustable shelf, except the 64" h side access display and bookcase towers which have (2) full depth adjustable shelves.

A 6" drawer, behind a cupboard door is available by adding the numeral 1 to the end of the pattern number, example (CT3SLH6424BBFFL1). **Note:** 6" drawers behind doors are not available within the wardrobe portion of towers. Drawers behind doors have painted black fronts.

description	type	w	d	h	lock	pattern no.	P1	P2	P3
50" High Double Door tower with two wide drawers		23 7/8"	23 1/2"	48 5/16"	Y	CT3D5024WWL	\$1,621.	\$1,783.	\$1,872.

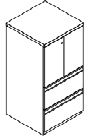

50" High tower with two file drawers and door and wardrobe (left hand shown)	left hand	23 7/8"	23 1/2"	48 5/16"	Y	CT3WSLH5024FFL	1,487.	1,636.	1,717.
	right hand	23 7/8"	23 1/2"	48 5/16"	Y	CT3WSRH5024FFL	1,487.	1,636.	1,717.

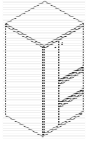

50" High tower with two box, one file drawer and door and wardrobe (left hand shown)	left hand	23 7/8"	23 1/2"	48 5/16"	Y	CT3WSLH5024BBFL	1,627.	1,789.	1,878.
	right hand	23 7/8"	23 1/2"	48 5/16"	Y	CT3WSRH5024BBFL	1,627.	1,789.	1,878.

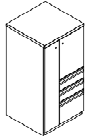

Order Code	Specification Information	Application Notes	Critical Dimensions
Example: CT3SBLH5724BBFL-111	For non-locking towers, deduct as follows from the list price for each unit: Deduct \$30 for (1) lock unit, \$60 for a (2) lock unit, and \$75 for a (3) lock unit. Substitute the "L" suffix with an "N" within the pattern number to designate a non-locking unit, example (CT3SLH6424BBFN)	Hanging rails and other accessories are not included and must be ordered separately. Hanging rails are included with 24" and 30" wide lateral drawers only. (See <i>Tower Accessories for pricing and order entry information</i>)	Dimensions under w , d and h are actual to the nearest 1/16"
CT3	Calibre Storage Tower		24" Wide 50", 57" and 64" Tower Internal Dimensions <ul style="list-style-type: none"> • Box and M drawer height: 4 5/16" • Box and M drawer width: 12 1/16" • Box and M drawer depth: 18 3/8" • File drawer height: 9 1/4" • File drawer width: 12 1/16" • File drawer depth: 18 3/8" • Wide drawer height: 9 9/16" • Wide drawer width: 20 3/4" • Wide drawer depth: 22 7/8"
SB	Side Access Bookcase		
LH	Left Hand Access		
57	64" High		
24	24" Wide		
B	Box Drawer		
B	Box Drawer		
F	File Drawer		
L	Locking		
111	Black paint finish		

All towers are standard with (1) full depth adjustable shelf, except the 64" h side access display and bookcase towers which have (2) full depth adjustable shelves.

"M" drawer consisting of a box drawer body with a file drawer head are available by substituting any two "B" or any one "F" character within the pattern number, example (CT3SLH6424BBFN). Multiple "M" drawers may be specified providing they equal the total modules available.

A 6" drawer, behind a cupboard door is available by adding the numeral 1 to the end of the pattern number, example (CT3SLH6424BBFFL1). **Note:** 6" drawers behind doors are not available within the wardrobe portion of towers. Drawers behind doors have painted black fronts.

15" w Side Access and Display towers include (1) lock.

Single door towers, double door towers, 24" w and 30" w Side Access and Display towers include (2) locks. (Except full-height doors which include (1) lock)

Front Access (only) towers with wardrobe include (3) locks. (Except full-height doors with wardrobe which include (2) locks)

Note: All towers are configured from the top down with standard combinations of box and file drawers.

Note: Drawer behind door list pricing is as follows: 1=\$255

description	type	w	d	h	lock	pattern no.	P1	P2	P3
50" High tower with one box, two file drawers and door and wardrobe (left hand shown)	left hand	23 ⁷ / ₈ "	23 ¹ / ₂ "	48 ⁵ / ₁₆ "	Y	CT3WSLH5024BBFFL	\$1,647.	\$1,813.	\$1,905.
	right hand	23 ⁷ / ₈ "	23 ¹ / ₂ "	48 ⁵ / ₁₆ "	Y	CT3WSRH5024BBFFL	1,647.	1,813.	1,905.

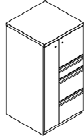

50" High tower with three file drawers and door and wardrobe (left hand shown)	left hand	23 ⁷ / ₈ "	23 ¹ / ₂ "	48 ⁵ / ₁₆ "	Y	CT3WSLH5024FFFL	1,660.	1,826.	1,918.
	right hand	23 ⁷ / ₈ "	23 ¹ / ₂ "	48 ⁵ / ₁₆ "	Y	CT3WSRH5024FFFL	1,660.	1,826.	1,918.

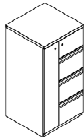

50" High tower with two box, two file drawers and door and wardrobe (left hand shown)	left hand	23 ⁷ / ₈ "	23 ¹ / ₂ "	48 ⁵ / ₁₆ "	Y	CT3WSLH5024BBFFL	1,824.	2,005.	2,107.
	right hand	23 ⁷ / ₈ "	23 ¹ / ₂ "	48 ⁵ / ₁₆ "	Y	CT3WSRH5024BBFFL	1,824.	2,005.	2,107.

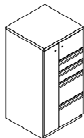

Order Code	Specification Information	Application Notes	Critical Dimensions
Example: CT3SBLH5724BBFL-111	For non-locking towers, deduct as follows from the list price for each unit: Deduct \$30 for (1) lock unit, \$60 for a (2) lock unit, and \$75 for a (3) lock unit. Substitute the "L" suffix with an "N" within the pattern number to designate a non-locking unit, example (CT3SLH6424BBFN)	Hanging rails and other accessories are not included and must be ordered separately. Hanging rails are included with 24" and 30" wide lateral drawers only. (See <i>Tower Accessories for pricing and order entry information</i>)	Dimensions under w , d and h are actual to the nearest 1/16"
CT3 Calibre Storage Tower		Half depth adjustable shelves and coat hooks may be ordered separately allowing the cupboard area of 15", 24" and 30" wide towers to support binders as well as shorter coats. (See <i>Tower Accessories for pricing and order entry information</i>)	24" Wide 50", 57" and 64" Tower Internal Dimensions
SB Side Access Bookcase	"M" drawer consisting of a box drawer body with a file drawer head are available by substituting any two "B" or any one "F" character within the pattern number, example (CT3SLH6424MFN). Multiple "M" drawers may be specified providing they equal the total modules available.	15" w Side Access and Display towers include (1) lock.	<ul style="list-style-type: none"> Box and M drawer height: 4⁵/₁₆" Box and M drawer width: 12¹/₁₆" Box and M drawer depth: 18³/₈" File drawer height: 9¹/₄" File drawer width: 12¹/₁₆" File drawer depth: 18³/₈" Wide drawer height: 9⁹/₁₆" Wide drawer width: 20³/₄" Wide drawer depth: 22⁷/₈"
LH Left Hand Access		Single door towers, double door towers, 24" w and 30" w Side Access and Display towers include (2) locks. (Except full-height doors which include (1) lock)	Note: All towers are configured from the top down with standard combinations of box and file drawers.
57 64" High		Front Access (only) towers with wardrobe include (3) locks. (Except full-height doors with wardrobe which include (2) locks)	Note: Drawer behind door list pricing is as follows: 1=\$255
24 24" Wide			
B Box Drawer			
B Box Drawer			
F File Drawer			
L Locking			
111 Black paint finish			

All towers are standard with (1) full depth adjustable shelf, except the 64" h side access display and bookcase towers which have (2) full depth adjustable shelves.

A 6" drawer, behind a cupboard door is available by adding the numeral 1 to the end of the pattern number, example (CT3SLH6424BBFFL1). **Note:** 6" drawers behind doors are not available within the wardrobe portion of towers. Drawers behind doors have painted black fronts.

description	type	w	d	h	lock	pattern no.	P1	P2	P3
42" High Side Access Bookcase with two box, one file drawer and wardrobe (left hand shown)	left hand	23 ⁷ / ₈ "	23 ¹ / ₂ "	41 ⁵ / ₁₆ "	Y	CT3WSBLH4224BBFL	\$1,650.	\$1,817.	\$1,907.
	right hand	23 ⁷ / ₈ "	23 ¹ / ₂ "	41 ⁵ / ₁₆ "	Y	CT3WSBRH4224BBFL	1,650.	1,817.	1,907.



42" High Side Access Bookcase with two file drawers and wardrobe (left hand shown)	left hand	23 ⁷ / ₈ "	23 ¹ / ₂ "	41 ⁵ / ₁₆ "	Y	CT3WSBLH4224FFL	1,568.	1,728.	1,800.
	right hand	23 ⁷ / ₈ "	23 ¹ / ₂ "	41 ⁵ / ₁₆ "	Y	CT3WSBRH4224FFL	1,568.	1,728.	1,800.



50" High Side Access Bookcase with two file drawers and wardrobe (left hand shown)	left hand	23 ⁷ / ₈ "	23 ¹ / ₂ "	48 ⁵ / ₁₆ "	Y	CT3WSBLH5024FFL	1,580.	1,740.	1,826.
	right hand	23 ⁷ / ₈ "	23 ¹ / ₂ "	48 ⁵ / ₁₆ "	Y	CT3WSBRH5024FFL	1,580.	1,740.	1,826.



Order Code	Specification Information	Application Notes	Critical Dimensions
Example: CT3SBLH5724BBFL-111	For non-locking towers, deduct as follows from the list price for each unit: Deduct \$30 for (1) lock unit, \$60 for a (2) lock unit, and \$75 for a (3) lock unit. Substitute the "L" suffix with an "N" within the pattern number to designate a non-locking unit, example (CT3SLH6424BBFN)	Hanging rails and other accessories are not included and must be ordered separately. Hanging rails are included with 24" and 30" wide lateral drawers only. (See <i>Tower Accessories for pricing and order entry information</i>)	Dimensions under w , d and h are actual to the nearest 1/16"
CT3 Calibre Storage Tower		Half depth adjustable shelves and coat hooks may be ordered separately allowing the cupboard area of 15", 24" and 30" wide towers to support binders as well as shorter coats. (See <i>Tower Accessories for pricing and order entry information</i>)	24" Wide 50", 57" and 64" Tower Internal Dimensions
SB Side Access Bookcase	"M" drawer consisting of a box drawer body with a file drawer head are available by substituting any two "B" or any one "F" character within the pattern number, example (CT3SLH6424MFN). Multiple "M" drawers may be specified providing they equal the total modules available.	15" w Side Access and Display towers include (1) lock.	<ul style="list-style-type: none"> Box and M drawer height: 4⁵/₁₆" Box and M drawer width: 12¹/₁₆" Box and M drawer depth: 18³/₈" File drawer height: 9¹/₄" File drawer width: 12¹/₁₆" File drawer depth: 18³/₈" Wide drawer height: 9⁹/₁₆" Wide drawer width: 20³/₄" Wide drawer depth: 22⁷/₈"
LH Left Hand Access		Single door towers, double door towers, 24" w and 30" w Side Access and Display towers include (2) locks. (Except full-height doors which include (1) lock)	Note: All towers are configured from the top down with standard combinations of box and file drawers.
57 64" High		Front Access (only) towers with wardrobe include (3) locks. (Except full-height doors with wardrobe which include (2) locks)	Note: Drawer behind door list pricing is as follows: 1=\$255
24 24" Wide			
B Box Drawer			
B Box Drawer			
F File Drawer			
L Locking			
111 Black paint finish			

All towers are standard with (1) full depth adjustable shelf, except the 64" h side access display and bookcase towers which have (2) full depth adjustable shelves.

A 6" drawer, behind a cupboard door is available by adding the numeral 1 to the end of the pattern number, example (CT3SLH6424BBFFL1). **Note:** 6" drawers behind doors are not available within the wardrobe portion of towers. Drawers behind doors have painted black fronts.

description	type	w	d	h	lock	pattern no.	P1	P2	P3
50" High Side Access Bookcase with two box, one file drawer and wardrobe (left hand shown)	left hand	23 ⁷ / ₈ "	23 ¹ / ₂ "	48 ³ / ₁₆ "	Y	CT3WSBLH5024BBFL	\$1,663.	\$1,828.	\$1,920.
	right hand	23 ⁷ / ₈ "	23 ¹ / ₂ "	48 ³ / ₁₆ "	Y	CT3WSBRH5024BBFL	1,663.	1,828.	1,920.



57" High tower with two file drawers and door and wardrobe (left hand shown)	left hand	23 ⁷ / ₈ "	23 ¹ / ₂ "	56 ³ / ₁₆ "	Y	CT3WSLH5724FFL	1,577.	1,735.	1,822.
	right hand	23 ⁷ / ₈ "	23 ¹ / ₂ "	56 ³ / ₁₆ "	Y	CT3WSRH5724FFL	1,577.	1,735.	1,822.

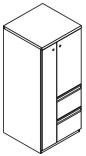

57" High tower with three file drawers and door and wardrobe (left hand shown)	left hand	23 ⁷ / ₈ "	23 ¹ / ₂ "	56 ³ / ₁₆ "	Y	CT3WSLH5724FFFL	1,726.	1,896.	1,991.
	right hand	23 ⁷ / ₈ "	23 ¹ / ₂ "	56 ³ / ₁₆ "	Y	CT3WSRH5724FFFL	1,726.	1,896.	1,991.

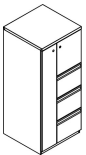

Order Code	Specification Information	Application Notes	Critical Dimensions
Example: CT3SBLH5724BBFL-111	For non-locking towers, deduct as follows from the list price for each unit: Deduct \$30 for (1) lock unit, \$60 for a (2) lock unit, and \$75 for a (3) lock unit. Substitute the "L" suffix with an "N" within the pattern number to designate a non-locking unit, example (CT3SLH6424BBFN)	Hanging rails and other accessories are not included and must be ordered separately. Hanging rails are included with 24" and 30" wide lateral drawers only. (See <i>Tower Accessories for pricing and order entry information</i>)	Dimensions under w , d and h are actual to the nearest 1/16"
CT3	Calibre Storage Tower		24" Wide 50", 57" and 64" Tower Internal Dimensions
SB	Side Access Bookcase		<ul style="list-style-type: none"> Box and M drawer height: 4³/₁₆" Box and M drawer width: 12¹/₁₆" Box and M drawer depth: 18³/₈" File drawer height: 9¹/₄" File drawer width: 12¹/₁₆" File drawer depth: 18³/₈" Wide drawer height: 9⁹/₁₆" Wide drawer width: 20³/₄" Wide drawer depth: 22⁷/₈"
LH	Left Hand Access		
57	64" High		
24	24" Wide		
B	Box Drawer	Half depth adjustable shelves and coat hooks may be ordered separately allowing the cupboard area of 15", 24" and 30" wide towers to support binders as well as shorter coats. (See <i>Tower Accessories for pricing and order entry information</i>)	
B	Box Drawer		
F	File Drawer		
L	Locking		
111	Black paint finish	15" w Side Access and Display towers include (1) lock.	Note: All towers are configured from the top down with standard combinations of box and file drawers.
	All towers are standard with (1) full depth adjustable shelf, except the 64" h side access display and bookcase towers which have (2) full depth adjustable shelves.	Single door towers, double door towers, 24" w and 30" w Side Access and Display towers include (2) locks. (Except full-height doors which include (1) lock)	Note: Drawer behind door list pricing is as follows: 1=\$255
	A 6" drawer, behind a cupboard door is available by adding the numeral 1 to the end of the pattern number, example (CT3SLH6424BBFFL1). Note: 6" drawers behind doors are not available within the wardrobe portion of towers. Drawers behind doors have painted black fronts.	Front Access (only) towers with wardrobe include (3) locks. (Except full-height doors with wardrobe which include (2) locks)	

description	type	w	d	h	lock	pattern no.	P1	P2	P3
57" High tower with one box, two file drawers and door and wardrobe (left hand shown)	left hand	23 ⁷ / ₈ "	23 ¹ / ₂ "	56 ³ / ₁₆ "	Y	CT3WSLH5724BBFL	\$1,733.	\$1,905.	\$2,000.
	right hand	23 ⁷ / ₈ "	23 ¹ / ₂ "	56 ³ / ₁₆ "	Y	CT3WSRH5724BBFL	1,733.	1,905.	2,000.

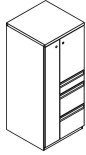

57" High tower with two box, one file drawer and door and wardrobe (left hand shown)	left hand	23 ⁷ / ₈ "	23 ¹ / ₂ "	56 ³ / ₁₆ "	Y	CT3WSLH5724BBFL	1,722.	1,893.	1,988.
	right hand	23 ⁷ / ₈ "	23 ¹ / ₂ "	56 ³ / ₁₆ "	Y	CT3WSRH5724BBFL	1,722.	1,893.	1,988.

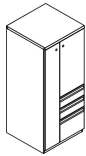

57" High tower with two box, two file drawers and door and wardrobe (left hand shown)	left hand	23 ⁷ / ₈ "	23 ¹ / ₂ "	56 ³ / ₁₆ "	Y	CT3WSLH5724BBFL	1,890.	2,078.	2,183.
	right hand	23 ⁷ / ₈ "	23 ¹ / ₂ "	56 ³ / ₁₆ "	Y	CT3WSRH5724BBFL	1,890.	2,078.	2,183.

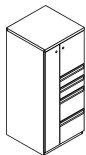

Order Code	Specification Information	Application Notes	Critical Dimensions
Example: CT3SBLH5724BBFL-111	For non-locking towers, deduct as follows from the list price for each unit: Deduct \$30 for (1) lock unit, \$60 for a (2) lock unit, and \$75 for a (3) lock unit. Substitute the "L" suffix with an "N" within the pattern number to designate a non-locking unit, example (CT3SLH6424BBFN)	Hanging rails and other accessories are not included and must be ordered separately. Hanging rails are included with 24" and 30" wide lateral drawers only. (See <i>Tower Accessories for pricing and order entry information</i>)	Dimensions under w , d and h are actual to the nearest 1/16"
CT3 Calibre Storage Tower		Half depth adjustable shelves and coat hooks may be ordered separately allowing the cupboard area of 15", 24" and 30" wide towers to support binders as well as shorter coats. (See <i>Tower Accessories for pricing and order entry information</i>)	24" Wide 50", 57" and 64" Tower Internal Dimensions
SB Side Access Bookcase	"M" drawer consisting of a box drawer body with a file drawer head are available by substituting any two "B" or any one "F" character within the pattern number, example (CT3SLH6424MBFN). Multiple "M" drawers may be specified providing they equal the total modules available.	15"w Side Access and Display towers include (1) lock.	<ul style="list-style-type: none"> Box and M drawer height: 4³/₁₆" Box and M drawer width: 12¹/₁₆" Box and M drawer depth: 18³/₈" File drawer height: 9¹/₄" File drawer width: 12¹/₁₆" File drawer depth: 18³/₈" Wide drawer height: 9⁹/₁₆" Wide drawer width: 20³/₄" Wide drawer depth: 22⁷/₈"
LH Left Hand Access		Single door towers, double door towers, 24"w and 30"w Side Access and Display towers include (2) locks. (Except full-height doors which include (1) lock)	Note: All towers are configured from the top down with standard combinations of box and file drawers.
57 64" High		Front Access (only) towers with wardrobe include (3) locks. (Except full-height doors with wardrobe which include (2) locks)	Note: Drawer behind door list pricing is as follows: 1=\$255
24 24" Wide	A 6" drawer, behind a cupboard door is available by adding the numeral 1 to the end of the pattern number, example (CT3SLH6424BBFFL1). Note: 6" drawers behind doors are not available within the wardrobe portion of towers. Drawers behind doors have painted black fronts.		
B Box Drawer			
B Box Drawer			
F File Drawer			
L Locking			
111 Black paint finish			

All towers are standard with (1) full depth adjustable shelf, except the 64" h side access display and bookcase towers which have (2) full depth adjustable shelves.

description	type	w	d	h	lock	pattern no.	P1	P2	P3
57" High Side Access Bookcase with two file drawers and wardrobe (left hand shown)	left hand	23 ⁷ / ₈ "	23 ¹ / ₂ "	56 ³ / ₁₆ "	Y	CT3WSBLH5724FFL	\$1,646.	\$1,811.	\$1,900.
	right hand	23 ⁷ / ₈ "	23 ¹ / ₂ "	56 ³ / ₁₆ "	Y	CT3WSBRH5724FFL	1,646.	1,811.	1,900.

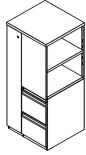

57" High Side Access Bookcase with two box, one file drawer and wardrobe (left hand shown)	left hand	23 ⁷ / ₈ "	23 ¹ / ₂ "	56 ³ / ₁₆ "	Y	CT3WSBLH5724BBFL	1,728.	1,900.	1,996.
	right hand	23 ⁷ / ₈ "	23 ¹ / ₂ "	56 ³ / ₁₆ "	Y	CT3WSBRH5724BBFL	1,728.	1,900.	1,996.

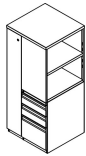

57" High Single Door with wide drawer (right hand shown)	left hand	23 ⁷ / ₈ "	23 ¹ / ₂ "	56 ³ / ₁₆ "	Y	CT3SLH5724WL	1,258.	1,384.	1,454.
	right hand	23 ⁷ / ₈ "	23 ¹ / ₂ "	56 ³ / ₁₆ "	Y	CT3SRH5724WL	1,258.	1,384.	1,454.

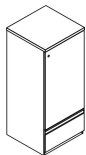

Order Code	Specification Information	Application Notes	Critical Dimensions																				
<p>Example: CT3SBLH5724BBFL-111</p> <table border="1"> <tr><td>CT3</td><td>Calibre Storage Tower</td></tr> <tr><td>SB</td><td>Side Access Bookcase</td></tr> <tr><td>LH</td><td>Left Hand Access</td></tr> <tr><td>57</td><td>64" High</td></tr> <tr><td>24</td><td>24" Wide</td></tr> <tr><td>B</td><td>Box Drawer</td></tr> <tr><td>B</td><td>Box Drawer</td></tr> <tr><td>F</td><td>File Drawer</td></tr> <tr><td>L</td><td>Locking</td></tr> <tr><td>111</td><td>Black paint finish</td></tr> </table> <p>All towers are standard with (1) full depth adjustable shelf, except the 64" h side access display and bookcase towers which have (2) full depth adjustable shelves.</p>	CT3	Calibre Storage Tower	SB	Side Access Bookcase	LH	Left Hand Access	57	64" High	24	24" Wide	B	Box Drawer	B	Box Drawer	F	File Drawer	L	Locking	111	Black paint finish	<p>For non-locking towers, deduct as follows from the list price for each unit: Deduct \$30 for (1) lock unit, \$60 for a (2) lock unit, and \$75 for a (3) lock unit. Substitute the "L" suffix with an "N" within the pattern number to designate a non-locking unit, example (CT3SLH6424BBFN)</p> <p>"M" drawer consisting of a box drawer body with a file drawer head are available by substituting any two "B" or any one "F" character within the pattern number, example (CT3SLH6424MFN). Multiple "M" drawers may be specified providing they equal the total modules available.</p> <p>A 6" drawer, behind a cupboard door is available by adding the numeral 1 to the end of the pattern number, example (CT3SLH6424BBFFL1). Note: 6" drawers behind doors are not available within the wardrobe portion of towers. Drawers behind doors have painted black fronts.</p>	<p>Hanging rails and other accessories are not included and must be ordered separately. Hanging rails are included with 24" and 30" wide lateral drawers only. (See <i>Tower Accessories for pricing and order entry information</i>)</p> <p>Half depth adjustable shelves and coat hooks may be ordered separately allowing the cupboard area of 15", 24" and 30" wide towers to support binders as well as shorter coats. (See <i>Tower Accessories for pricing and order entry information</i>)</p> <p>15" w Side Access and Display towers include (1) lock.</p> <p>Single door towers, double door towers, 24" w and 30" w Side Access and Display towers include (2) locks. (Except full-height doors which include (1) lock)</p> <p>Front Access (only) towers with wardrobe include (3) locks. (Except full-height doors with wardrobe which include (2) locks)</p>	<p>Dimensions under w, d and h are actual to the nearest 1/16"</p> <p>24" Wide 50", 57" and 64" Tower Internal Dimensions</p> <ul style="list-style-type: none"> • Box and M drawer height: 4³/₁₆" • Box and M drawer width: 12¹/₁₆" • Box and M drawer depth: 18³/₈" • File drawer height: 9¹/₄" • File drawer width: 12¹/₁₆" • File drawer depth: 18³/₈" • Wide drawer height: 9⁹/₁₆" • Wide drawer width: 20³/₄" • Wide drawer depth: 22⁷/₈" <p>Note: All towers are configured from the top down with standard combinations of box and file drawers.</p> <p>Note: Drawer behind door list pricing is as follows: 1=\$255</p>
CT3	Calibre Storage Tower																						
SB	Side Access Bookcase																						
LH	Left Hand Access																						
57	64" High																						
24	24" Wide																						
B	Box Drawer																						
B	Box Drawer																						
F	File Drawer																						
L	Locking																						
111	Black paint finish																						

description	type	w	d	h	lock	pattern no.	P1	P2	P3
57" High Single Door with two wide drawers (right hand shown)	left hand	23 ⁷ / ₈ "	23 ¹ / ₂ "	56 ³ / ₁₆ "	Y	CT3SLH5724WWL	\$1,516.	\$1,668.	\$1,749.
	right hand	23 ⁷ / ₈ "	23 ¹ / ₂ "	56 ³ / ₁₆ "	Y	CT3SRH5724WWL	1,516.	1,668.	1,749.

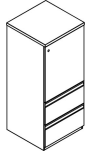

57" High Double Door tower with one wide drawer		23 ⁷ / ₈ "	23 ¹ / ₂ "	56 ³ / ₁₆ "	Y	CT3D5724WL	1,441.	1,585.	1,666.
---	--	----------------------------------	----------------------------------	-----------------------------------	---	-------------------	--------	--------	--------

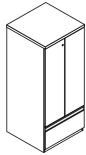

57" High Double Door tower with two wide drawers		23 ⁷ / ₈ "	23 ¹ / ₂ "	56 ³ / ₁₆ "	Y	CT3D5724WWL	1,699.	1,868.	1,962.
--	--	----------------------------------	----------------------------------	-----------------------------------	---	--------------------	--------	--------	--------

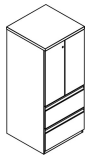

Order Code	Specification Information	Application Notes	Critical Dimensions
Example: CT3SBLH5724BBFL-111	For non-locking towers, deduct as follows from the list price for each unit: Deduct \$30 for (1) lock unit, \$60 for a (2) lock unit, and \$75 for a (3) lock unit. Substitute the "L" suffix with an "N" within the pattern number to designate a non-locking unit, example (CT3SLH6424BBFN)	Hanging rails and other accessories are not included and must be ordered separately. Hanging rails are included with 24" and 30" wide lateral drawers only. (See <i>Tower Accessories for pricing and order entry information</i>)	Dimensions under w , d and h are actual to the nearest ¹ / ₁₆ "
CT3 Calibre Storage Tower		Half depth adjustable shelves and coat hooks may be ordered separately allowing the cupboard area of 15", 24" and 30" wide towers to support binders as well as shorter coats. (See <i>Tower Accessories for pricing and order entry information</i>)	24" Wide 50", 57" and 64" Tower Internal Dimensions
SB Side Access Bookcase	"M" drawer consisting of a box drawer body with a file drawer head are available by substituting any two "B" or any one "F" character within the pattern number, example (CT3SLH6424MFN). Multiple "M" drawers may be specified providing they equal the total modules available.	15" w Side Access and Display towers include (1) lock.	<ul style="list-style-type: none"> Box and M drawer height: 4³/₁₆" Box and M drawer width: 12¹/₁₆" Box and M drawer depth: 18³/₈" File drawer height: 9¹/₄" File drawer width: 12¹/₁₆" File drawer depth: 18³/₈" Wide drawer height: 9⁹/₁₆" Wide drawer width: 20³/₄" Wide drawer depth: 22⁷/₈"
LH Left Hand Access		Single door towers, double door towers, 24" w and 30" w Side Access and Display towers include (2) locks. (Except full-height doors which include (1) lock)	Note: All towers are configured from the top down with standard combinations of box and file drawers.
57 64" High		Front Access (only) towers with wardrobe include (3) locks. (Except full-height doors with wardrobe which include (2) locks)	Note: Drawer behind door list pricing is as follows: 1=\$255
24 24" Wide	A 6" drawer, behind a cupboard door is available by adding the numeral 1 to the end of the pattern number, example (CT3SLH6424BBFFL1). Note: 6" drawers behind doors are not available within the wardrobe portion of towers. Drawers behind doors have painted black fronts.		
B Box Drawer			
B Box Drawer			
F File Drawer			
L Locking			
111 Black paint finish			

All towers are standard with (1) full depth adjustable shelf, except the 64" h side access display and bookcase towers which have (2) full depth adjustable shelves.

description	type	w	d	h	lock	pattern no.	P1	P2	P3
64" High Single Door with wide drawer (right hand shown)	left hand	23 7/8"	23 1/2"	63 3/16"	Y	CT3SLH6424WL	\$1,281.	\$1,409.	\$1,478.
	right hand	23 7/8"	23 1/2"	63 3/16"	Y	CT3SRH6424WL	1,281.	1,409.	1,478.

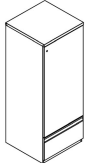

64" High Single Door with two wide drawers (right hand shown)	left hand	23 7/8"	23 1/2"	63 3/16"	Y	CT3SLH6424WWL	1,529.	1,682.	1,766.
	right hand	23 7/8"	23 1/2"	63 3/16"	Y	CT3SRH6424WWL	1,529.	1,682.	1,766.

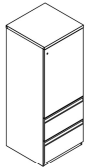

64" High Double Door tower with one wide drawer		23 7/8"	23 1/2"	63 3/16"	Y	CT3D6424WL	1,469.	1,617.	1,699.
---	--	---------	---------	----------	---	-------------------	--------	--------	--------

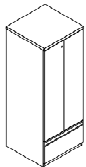

Order Code	Specification Information	Application Notes	Critical Dimensions
Example: CT3SBLH5724BBFL-111	For non-locking towers, deduct as follows from the list price for each unit: Deduct \$30 for (1) lock unit, \$60 for a (2) lock unit, and \$75 for a (3) lock unit. Substitute the "L" suffix with an "N" within the pattern number to designate a non-locking unit, example (CT3SLH6424BBFN)	Hanging rails and other accessories are not included and must be ordered separately. Hanging rails are included with 24" and 30" wide lateral drawers only. (See <i>Tower Accessories for pricing and order entry information</i>)	Dimensions under w , d and h are actual to the nearest 1/16"
CT3 Calibre Storage Tower		Half depth adjustable shelves and coat hooks may be ordered separately allowing the cupboard area of 15", 24" and 30" wide towers to support binders as well as shorter coats. (See <i>Tower Accessories for pricing and order entry information</i>)	24" Wide 50", 57" and 64" Tower Internal Dimensions
SB Side Access Bookcase	"M" drawer consisting of a box drawer body with a file drawer head are available by substituting any two "B" or any one "F" character within the pattern number, example (CT3SLH6424MFN). Multiple "M" drawers may be specified providing they equal the total modules available.	15" w Side Access and Display towers include (1) lock.	<ul style="list-style-type: none"> Box and M drawer height: 4 3/16" Box and M drawer width: 12 1/16" Box and M drawer depth: 18 3/8" File drawer height: 9 1/4" File drawer width: 12 1/16" File drawer depth: 18 3/8" Wide drawer height: 9 9/16" Wide drawer width: 20 3/4" Wide drawer depth: 22 7/8"
LH Left Hand Access		Single door towers, double door towers, 24" w and 30" w Side Access and Display towers include (2) locks. (Except full-height doors which include (1) lock)	Note: All towers are configured from the top down with standard combinations of box and file drawers.
57 64" High		Front Access (only) towers with wardrobe include (3) locks. (Except full-height doors with wardrobe which include (2) locks)	Note: Drawer behind door list pricing is as follows: 1=\$255
24 24" Wide			
B Box Drawer			
B Box Drawer			
F File Drawer			
L Locking			
111 Black paint finish			

All towers are standard with (1) full depth adjustable shelf, except the 64" h side access display and bookcase towers which have (2) full depth adjustable shelves.

A 6" drawer, behind a cupboard door is available by adding the numeral 1 to the end of the pattern number, example (CT3SLH6424BBFFL1). **Note:** 6" drawers behind doors are not available within the wardrobe portion of towers. Drawers behind doors have painted black fronts.

description	type	w	d	h	lock	pattern no.	P1	P2	P3
64" High Double Door tower with two wide drawers		23 7/8"	23 1/2"	63 3/16"	Y	CT3D6424WWL	\$1,744.	\$1,919.	\$2,015.

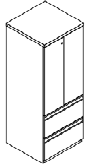

64" High tower with two file drawers and door and wardrobe (left hand shown)	left hand	23 7/8"	23 1/2"	63 3/16"	Y	CT3WSLH6424FFL	1,572.	1,731.	1,816.
	right hand	23 7/8"	23 1/2"	63 3/16"	Y	CT3WSRH6424FFL	1,572.	1,731.	1,816.

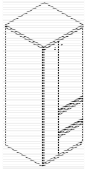

Order Code	Specification Information	Application Notes	Critical Dimensions
Example: CT3SBLH5724BBFL-111	For non-locking towers, deduct as follows from the list price for each unit: Deduct \$30 for (1) lock unit, \$60 for a (2) lock unit, and \$75 for a (3) lock unit. Substitute the "L" suffix with an "N" within the pattern number to designate a non-locking unit, example (CT3SLH6424BBFN)	Hanging rails and other accessories are not included and must be ordered separately. Hanging rails are included with 24" and 30" wide lateral drawers only. (See <i>Tower Accessories for pricing and order entry information</i>)	Dimensions under w , d and h are actual to the nearest 1/16"
CT3 Calibre Storage Tower		Half depth adjustable shelves and coat hooks may be ordered separately allowing the cupboard area of 15", 24" and 30" wide towers to support binders as well as shorter coats. (See <i>Tower Accessories for pricing and order entry information</i>)	24" Wide 50", 57" and 64" Tower Internal Dimensions
SB Side Access Bookcase	"M" drawer consisting of a box drawer body with a file drawer head are available by substituting any two "B" or any one "F" character within the pattern number, example (CT3SLH6424MFN). Multiple "M" drawers may be specified providing they equal the total modules available.	15" w Side Access and Display towers include (1) lock.	<ul style="list-style-type: none"> Box and M drawer height: 4 3/16" Box and M drawer width: 12 1/16" Box and M drawer depth: 18 3/8" File drawer height: 9 1/4" File drawer width: 12 1/16" File drawer depth: 18 3/8" Wide drawer height: 9 9/16" Wide drawer width: 20 3/4" Wide drawer depth: 22 7/8"
LH Left Hand Access		Single door towers, double door towers, 24" w and 30" w Side Access and Display towers include (2) locks. (Except full-height doors which include (1) lock)	<p>Note: All towers are configured from the top down with standard combinations of box and file drawers.</p> <p>Note: Drawer behind door list pricing is as follows: 1=\$255</p>
57 64" High		Front Access (only) towers with wardrobe include (3) locks. (Except full-height doors with wardrobe which include (2) locks)	
24 24" Wide			
B Box Drawer			
B Box Drawer			
F File Drawer			
L Locking			
111 Black paint finish			

All towers are standard with (1) full depth adjustable shelf, except the 64" h side access display and bookcase towers which have (2) full depth adjustable shelves.

A 6" drawer, behind a cupboard door is available by adding the numeral 1 to the end of the pattern number, example (CT3SLH6424BBFFL1). **Note:** 6" drawers behind doors are not available within the wardrobe portion of towers. Drawers behind doors have painted black fronts.

description	type	w	d	h	lock	pattern no.	P1	P2	P3
64" High tower with two box, one file drawer and door and wardrobe (left hand shown)	left hand	23 ⁷ / ₈ "	23 ¹ / ₂ "	63 ⁵ / ₁₆ "	Y	CT3WSLH6424BBFL	\$1,717.	\$1,889.	\$1,981.
	right hand	23 ⁷ / ₈ "	23 ¹ / ₂ "	63 ⁵ / ₁₆ "	Y	CT3WSRH6424BBFL	1,717.	1,889.	1,981.

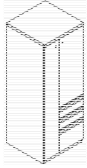

64" High tower with one box, two file drawers and door and wardrobe (left hand shown)	left hand	23 ⁷ / ₈ "	23 ¹ / ₂ "	63 ⁵ / ₁₆ "	Y	CT3WSLH6424BBFL	1,745.	1,920.	2,016.
	right hand	23 ⁷ / ₈ "	23 ¹ / ₂ "	63 ⁵ / ₁₆ "	Y	CT3WSRH6424BBFL	1,745.	1,920.	2,016.

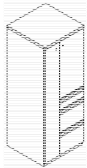

Order Code	Specification Information	Application Notes	Critical Dimensions																				
<p>Example: CT3SBLH5724BBFL-111</p> <table border="1"> <tr><td>CT3</td><td>Calibre Storage Tower</td></tr> <tr><td>SB</td><td>Side Access Bookcase</td></tr> <tr><td>LH</td><td>Left Hand Access</td></tr> <tr><td>57</td><td>64" High</td></tr> <tr><td>24</td><td>24" Wide</td></tr> <tr><td>B</td><td>Box Drawer</td></tr> <tr><td>B</td><td>Box Drawer</td></tr> <tr><td>F</td><td>File Drawer</td></tr> <tr><td>L</td><td>Locking</td></tr> <tr><td>111</td><td>Black paint finish</td></tr> </table> <p>All towers are standard with (1) full depth adjustable shelf, except the 64" h side access display and bookcase towers which have (2) full depth adjustable shelves.</p>	CT3	Calibre Storage Tower	SB	Side Access Bookcase	LH	Left Hand Access	57	64" High	24	24" Wide	B	Box Drawer	B	Box Drawer	F	File Drawer	L	Locking	111	Black paint finish	<p>For non-locking towers, deduct as follows from the list price for each unit: Deduct \$30 for (1) lock unit, \$60 for a (2) lock unit, and \$75 for a (3) lock unit. Substitute the "L" suffix with an "N" within the pattern number to designate a non-locking unit, example (CT3SLH6424BBFN)</p> <p>"M" drawer consisting of a box drawer body with a file drawer head are available by substituting any two "B" or any one "F" character within the pattern number, example (CT3SLH6424MFN). Multiple "M" drawers may be specified providing they equal the total modules available.</p> <p>A 6" drawer, behind a cupboard door is available by adding the numeral 1 to the end of the pattern number, example (CT3SLH6424BBFFL1). Note: 6" drawers behind doors are not available within the wardrobe portion of towers. Drawers behind doors have painted black fronts.</p>	<p>Hanging rails and other accessories are not included and must be ordered separately. Hanging rails are included with 24" and 30" wide lateral drawers only. (See <i>Tower Accessories for pricing and order entry information</i>)</p> <p>Half depth adjustable shelves and coat hooks may be ordered separately allowing the cupboard area of 15", 24" and 30" wide towers to support binders as well as shorter coats. (See <i>Tower Accessories for pricing and order entry information</i>)</p> <p>15" w Side Access and Display towers include (1) lock.</p> <p>Single door towers, double door towers, 24" w and 30" w Side Access and Display towers include (2) locks. (Except full-height doors which include (1) lock)</p> <p>Front Access (only) towers with wardrobe include (3) locks. (Except full-height doors with wardrobe which include (2) locks)</p>	<p>Dimensions under w, d and h are actual to the nearest ¹/₁₆"</p> <p>24" Wide 50", 57" and 64" Tower Internal Dimensions</p> <ul style="list-style-type: none"> • Box and M drawer height: 4⁵/₁₆" • Box and M drawer width: 12¹/₁₆" • Box and M drawer depth: 18³/₈" • File drawer height: 9¹/₄" • File drawer width: 12¹/₁₆" • File drawer depth: 18³/₈" • Wide drawer height: 9⁹/₁₆" • Wide drawer width: 20³/₄" • Wide drawer depth: 22⁷/₈" <p>Note: All towers are configured from the top down with standard combinations of box and file drawers.</p> <p>Note: Drawer behind door list pricing is as follows: 1=\$255</p>
CT3	Calibre Storage Tower																						
SB	Side Access Bookcase																						
LH	Left Hand Access																						
57	64" High																						
24	24" Wide																						
B	Box Drawer																						
B	Box Drawer																						
F	File Drawer																						
L	Locking																						
111	Black paint finish																						

description	type	w	d	h	lock	pattern no.	P1	P2	P3
64" High tower with three file drawers and door and wardrobe (left hand shown)	left hand	23 ⁷ / ₈ "	23 ¹ / ₂ "	63 ⁵ / ₁₆ "	Y	CT3WSLH6424FFFL	\$1,739.	\$1,913.	\$2,005.
	right hand	23 ⁷ / ₈ "	23 ¹ / ₂ "	63 ⁵ / ₁₆ "	Y	CT3WSRH6424FFFL	1,739.	1,913.	2,005.

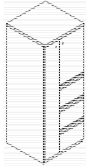

64" High tower with two box, two file drawers and door and wardrobe (left hand shown)	left hand	23 ⁷ / ₈ "	23 ¹ / ₂ "	63 ⁵ / ₁₆ "	Y	CT3WSLH6424BBFFL	1,902.	2,094.	2,197.
	right hand	23 ⁷ / ₈ "	23 ¹ / ₂ "	63 ⁵ / ₁₆ "	Y	CT3WSRH6424BBFFL	1,902.	2,094.	2,197.

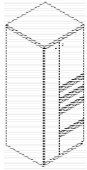

Order Code	Specification Information	Application Notes	Critical Dimensions
Example: CT3SBLH5724BBFL-111	For non-locking towers, deduct as follows from the list price for each unit: Deduct \$30 for (1) lock unit, \$60 for a (2) lock unit, and \$75 for a (3) lock unit. Substitute the "L" suffix with an "N" within the pattern number to designate a non-locking unit, example (CT3SLH6424BBFN)	Hanging rails and other accessories are not included and must be ordered separately. Hanging rails are included with 24" and 30" wide lateral drawers only. (See <i>Tower Accessories for pricing and order entry information</i>)	Dimensions under w , d and h are actual to the nearest 1/16"
CT3 Calibre Storage Tower			24" Wide 50", 57" and 64" Tower Internal Dimensions
SB Side Access Bookcase			<ul style="list-style-type: none"> Box and M drawer height: 4⁵/₁₆" Box and M drawer width: 12¹/₁₆" Box and M drawer depth: 18³/₈" File drawer height: 9¹/₄" File drawer width: 12¹/₁₆" File drawer depth: 18³/₈" Wide drawer height: 9⁹/₁₆" Wide drawer width: 20³/₄" Wide drawer depth: 22⁷/₈"
LH Left Hand Access	"M" drawer consisting of a box drawer body with a file drawer head are available by substituting any two "B" or any one "F" character within the pattern number, example (CT3SLH6424MFN). Multiple "M" drawers may be specified providing they equal the total modules available.	Half depth adjustable shelves and coat hooks may be ordered separately allowing the cupboard area of 15", 24" and 30" wide towers to support binders as well as shorter coats. (See <i>Tower Accessories for pricing and order entry information</i>)	Note: All towers are configured from the top down with standard combinations of box and file drawers.
57 64" High		15"w Side Access and Display towers include (1) lock.	Note: Drawer behind door list pricing is as follows: 1=\$255
24 24" Wide		Single door towers, double door towers, 24"w and 30"w Side Access and Display towers include (2) locks. (Except full-height doors which include (1) lock)	
B Box Drawer		Front Access (only) towers with wardrobe include (3) locks. (Except full-height doors with wardrobe which include (2) locks)	
B Box Drawer			
F File Drawer			
L Locking			
111 Black paint finish			

All towers are standard with (1) full depth adjustable shelf, except the 64" h side access display and bookcase towers which have (2) full depth adjustable shelves.

A 6" drawer, behind a cupboard door is available by adding the numeral 1 to the end of the pattern number, example (CT3SLH6424BBFFL1). **Note:** 6" drawers behind doors are not available within the wardrobe portion of towers. Drawers behind doors have painted black fronts.

description	type	w	d	h	lock	pattern no.	P1	P2	P3
64" High tower with four file drawers and door and wardrobe (left hand shown)	left hand	23 ⁷ / ₈ "	23 ¹ / ₂ "	63 ⁵ / ₁₆ "	Y	CT3WSLH6424FFFL	\$1,923.	\$2,118.	\$2,224.
	right hand	23 ⁷ / ₈ "	23 ¹ / ₂ "	63 ⁵ / ₁₆ "	Y	CT3WSRH6424FFFL	1,923.	2,118.	2,224.

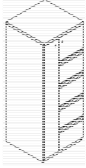

64" High Side Access Bookcase with two file drawers and wardrobe (left hand shown)	left hand	23 ⁷ / ₈ "	23 ¹ / ₂ "	63 ⁵ / ₁₆ "	Y	CT3WSBLH6424FFL	1,683.	1,852.	1,945.
	right hand	23 ⁷ / ₈ "	23 ¹ / ₂ "	63 ⁵ / ₁₆ "	Y	CT3WSBRH6424FFL	1,683.	1,852.	1,945.

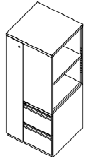

Order Code	Specification Information	Application Notes	Critical Dimensions
Example: CT3SBLH5724BBFL-111	For non-locking towers, deduct as follows from the list price for each unit: Deduct \$30 for (1) lock unit, \$60 for a (2) lock unit, and \$75 for a (3) lock unit. Substitute the "L" suffix with an "N" within the pattern number to designate a non-locking unit, example (CT3SLH6424BBFN)	Hanging rails and other accessories are not included and must be ordered separately. Hanging rails are included with 24" and 30" wide lateral drawers only. (See <i>Tower Accessories for pricing and order entry information</i>)	Dimensions under w , d and h are actual to the nearest 1/16"
CT3 Calibre Storage Tower		Half depth adjustable shelves and coat hooks may be ordered separately allowing the cupboard area of 15", 24" and 30" wide towers to support binders as well as shorter coats. (See <i>Tower Accessories for pricing and order entry information</i>)	24" Wide 50", 57" and 64" Tower Internal Dimensions
SB Side Access Bookcase	"M" drawer consisting of a box drawer body with a file drawer head are available by substituting any two "B" or any one "F" character within the pattern number, example (CT3SLH6424MFN). Multiple "M" drawers may be specified providing they equal the total modules available.	15" w Side Access and Display towers include (1) lock.	<ul style="list-style-type: none"> Box and M drawer height: 4⁵/₁₆" Box and M drawer width: 12¹/₁₆" Box and M drawer depth: 18³/₈" File drawer height: 9¹/₄" File drawer width: 12¹/₁₆" File drawer depth: 18³/₈" Wide drawer height: 9⁹/₁₆" Wide drawer width: 20³/₄" Wide drawer depth: 22⁷/₈"
LH Left Hand Access		Single door towers, double door towers, 24" w and 30" w Side Access and Display towers include (2) locks. (Except full-height doors which include (1) lock)	<p>Note: All towers are configured from the top down with standard combinations of box and file drawers.</p> <p>Note: Drawer behind door list pricing is as follows: 1=\$255</p>
57 64" High		Front Access (only) towers with wardrobe include (3) locks. (Except full-height doors with wardrobe which include (2) locks)	
24 24" Wide			
B Box Drawer			
B Box Drawer			
F File Drawer			
L Locking			
111 Black paint finish			

All towers are standard with (1) full depth adjustable shelf, except the 64" h side access display and bookcase towers which have (2) full depth adjustable shelves.

A 6" drawer, behind a cupboard door is available by adding the numeral 1 to the end of the pattern number, example (CT3SLH6424BBFFL1). **Note:** 6" drawers behind doors are not available within the wardrobe portion of towers. Drawers behind doors have painted black fronts.

description	type	w	d	h	lock	pattern no.	P1	P2	P3
64" High Side Access Bookcase with two box, one file drawer and wardrobe (left hand shown)	left hand	23 ⁷ / ₈ "	23 ¹ / ₂ "	63 ⁵ / ₁₆ "	Y	CT3WSBLH6424BBFL	\$1,765.	\$1,942.	\$2,036.
	right hand	23 ⁷ / ₈ "	23 ¹ / ₂ "	63 ⁵ / ₁₆ "	Y	CT3WSBRH6424BBFL	1,765.	1,942.	2,036.

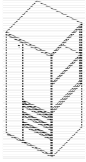

64" High Display tower with two file drawers and wardrobe (left hand shown)	left hand	23 ⁷ / ₈ "	23 ¹ / ₂ "	63 ⁵ / ₁₆ "	Y	CT3WBDLH6424FFL	1,702.	1,872.	1,967.
	right hand	23 ⁷ / ₈ "	23 ¹ / ₂ "	63 ⁵ / ₁₆ "	Y	CT3WBDRH6424FFL	1,702.	1,872.	1,967.

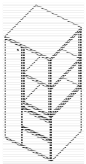

64" High Display tower with two box, one file drawer and wardrobe (left hand shown)	left hand	23 ⁷ / ₈ "	23 ¹ / ₂ "	63 ⁵ / ₁₆ "	Y	CT3WBDLH6424BBFL	1,780.	1,958.	2,058.
	right hand	23 ⁷ / ₈ "	23 ¹ / ₂ "	63 ⁵ / ₁₆ "	Y	CT3WBDRH6424BBFL	1,780.	1,958.	2,058.

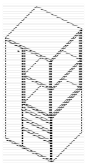

Order Code	Specification Information	Application Notes	Critical Dimensions
Example: CT3SBLH5724BBFL-111	For non-locking towers, deduct as follows from the list price for each unit: Deduct \$30 for (1) lock unit, \$60 for a (2) lock unit, and \$75 for a (3) lock unit. Substitute the "L" suffix with an "N" within the pattern number to designate a non-locking unit, example (CT3SLH6424BBFN)	Hanging rails and other accessories are not included and must be ordered separately. Hanging rails are included with 24" and 30" wide lateral drawers only. (See <i>Tower Accessories for pricing and order entry information</i>)	Dimensions under w , d and h are actual to the nearest 1/16"
CT3	Calibre Storage Tower	Half depth adjustable shelves and coat hooks may be ordered separately allowing the cupboard area of 15", 24" and 30" wide towers to support binders as well as shorter coats. (See <i>Tower Accessories for pricing and order entry information</i>)	24" Wide 50", 57" and 64" Tower Internal Dimensions
SB	Side Access Bookcase	15" w Side Access and Display towers include (1) lock.	<ul style="list-style-type: none"> Box and M drawer height: 4⁵/₁₆" Box and M drawer width: 12¹/₁₆" Box and M drawer depth: 18³/₈" File drawer height: 9¹/₄" File drawer width: 12¹/₁₆" File drawer depth: 18³/₈" Wide drawer height: 9⁹/₁₆" Wide drawer width: 20³/₄" Wide drawer depth: 22⁷/₈"
LH	Left Hand Access	Single door towers, double door towers, 24" w and 30" w Side Access and Display towers include (2) locks. (Except full-height doors which include (1) lock)	<p>Note: All towers are configured from the top down with standard combinations of box and file drawers.</p> <p>Note: Drawer behind door list pricing is as follows: 1=\$255</p>
57	64" High	Front Access (only) towers with wardrobe include (3) locks. (Except full-height doors with wardrobe which include (2) locks)	
24	24" Wide		
B	Box Drawer		
B	Box Drawer		
F	File Drawer		
L	Locking		
111	Black paint finish		

All towers are standard with (1) full depth adjustable shelf, except the 64" h side access display and bookcase towers which have (2) full depth adjustable shelves.

"M" drawer consisting of a box drawer body with a file drawer head are available by substituting any two "B" or any one "F" character within the pattern number, example (CT3SLH6424MFN). Multiple "M" drawers may be specified providing they equal the total modules available.

A 6" drawer, behind a cupboard door is available by adding the numeral 1 to the end of the pattern number, example (CT3SLH6424BBFFL1). **Note:** 6" drawers behind doors are not available within the wardrobe portion of towers. Drawers behind doors have painted black fronts.

description	type	w	d	h	lock	pattern no.	P1	P2	P3
50" High, tower with two box and one file drawer and door and wardrobe (Left hand shown)	left hand	23 7/8"	23 1/2"	48 3/16"	Y	CT3FWSLH5024BBFL	\$1,656.	\$1,819.	\$1,907.
	right hand	23 7/8"	23 1/2"	48 3/16"	Y	CT3FWSRH5024BBFL	1,656.	1,819.	1,907.

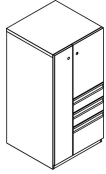

50" High, tower with two file drawers and door and wardrobe (Left hand shown)	left hand	23 7/8"	23 1/2"	48 3/16"	Y	CT3FWSLH5024FFL	1,517.	1,666.	1,747.
	right hand	23 7/8"	23 1/2"	48 3/16"	Y	CT3FWSRH5024FFL	1,517.	1,666.	1,747.

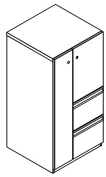

Order Code	Specification Information	Application Notes	Critical Dimensions																				
<p>Example: CT3SBLH5724BBFL-111</p> <table border="1"> <tr><td>CT3</td><td>Calibre Storage Tower</td></tr> <tr><td>SB</td><td>Side Access Bookcase</td></tr> <tr><td>LH</td><td>Left Hand Access</td></tr> <tr><td>57</td><td>64" High</td></tr> <tr><td>24</td><td>24" Wide</td></tr> <tr><td>B</td><td>Box Drawer</td></tr> <tr><td>B</td><td>Box Drawer</td></tr> <tr><td>F</td><td>File Drawer</td></tr> <tr><td>L</td><td>Locking</td></tr> <tr><td>111</td><td>Black paint finish</td></tr> </table> <p>All towers are standard with (1) full depth adjustable shelf, except the 64" h side access display and bookcase towers which have (2) full depth adjustable shelves.</p>	CT3	Calibre Storage Tower	SB	Side Access Bookcase	LH	Left Hand Access	57	64" High	24	24" Wide	B	Box Drawer	B	Box Drawer	F	File Drawer	L	Locking	111	Black paint finish	<p>For non-locking towers, deduct as follows from the list price for each unit: Deduct \$30 for (1) lock unit, \$60 for a (2) lock unit, and \$75 for a (3) lock unit. Substitute the "L" suffix with an "N" within the pattern number to designate a non-locking unit, example (CT3SLH6424BBFN)</p> <p>"M" drawer consisting of a box drawer body with a file drawer head are available by substituting any two "B" or any one "F" character within the pattern number, example (CT3SLH6424MBFN). Multiple "M" drawers may be specified providing they equal the total modules available.</p> <p>A 6" drawer, behind a cupboard door is available by adding the numeral 1 to the end of the pattern number, example (CT3SLH6424BBFFL1). Note: 6" drawers behind doors are not available within the wardrobe portion of towers. Drawers behind doors have painted black fronts.</p>	<p>Hanging rails and other accessories are not included and must be ordered separately. Hanging rails are included with 24" and 30" wide lateral drawers only. (See <i>Tower Accessories for pricing and order entry information</i>)</p> <p>Half depth adjustable shelves and coat hooks may be ordered separately allowing the cupboard area of 15", 24" and 30" wide towers to support binders as well as shorter coats. (See <i>Tower Accessories for pricing and order entry information</i>)</p> <p>15" w Side Access and Display towers include (1) lock.</p> <p>Single door towers, double door towers, 24" w and 30" w Side Access and Display towers include (2) locks. (Except full-height doors which include (1) lock)</p> <p>Front Access (only) towers with wardrobe include (3) locks. (Except full-height doors with wardrobe which include (2) locks)</p> <p>Full height door towers are designed to compliment the aesthetic of Dividends Horizon storage components.</p> <p>Full height door towers (50" h and 57" h) include one fixed shelf and one adjustable shelf. 64" h full height door tower includes one fixed shelf and two adjustable shelves.</p>	<p>Dimensions under w, d and h are actual to the nearest 1/16"</p> <p>24" Wide 50", 57" and 64" Tower Internal Dimensions</p> <ul style="list-style-type: none"> • Box and M drawer height: 4 5/16" • Box and M drawer width: 12 1/16" • Box and M drawer depth: 18 3/8" • File drawer height: 9 1/4" • File drawer width: 12 1/16" • File drawer depth: 18 3/8" • Wide drawer height: 9 3/16" • Wide drawer width: 20 3/4" • Wide drawer depth: 22 7/8" <p>Note: All towers are configured from the top down with standard combinations of box and file drawers.</p> <p>Note: Drawer behind door list pricing is as follows: 1=\$255</p> <p>Add a "Y" to the end of a pattern number to specify a front color that is different from the case color. P3 pricing automatically applies for all colors when utilizing this option.</p>
CT3	Calibre Storage Tower																						
SB	Side Access Bookcase																						
LH	Left Hand Access																						
57	64" High																						
24	24" Wide																						
B	Box Drawer																						
B	Box Drawer																						
F	File Drawer																						
L	Locking																						
111	Black paint finish																						

description	type	w	d	h	lock	pattern no.	P1	P2	P3
57" High, tower with two box and one file drawer and door and wardrobe (Left hand shown)	left hand	23 7/8"	23 1/2"	56 3/16"	Y	CT3FWSLH5724BBFL	\$1,751.	\$1,923.	\$2,018.
	right hand	23 7/8"	23 1/2"	56 3/16"	Y	CT3FWSRH5724BBFL	1,751.	1,923.	2,018.

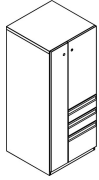

57" High, tower with two file drawers and door and wardrobe (Left hand shown)	left hand	23 7/8"	23 1/2"	56 3/16"	Y	CT3FWSLH5724FFL	1,608.	1,764.	1,852.
	right hand	23 7/8"	23 1/2"	56 3/16"	Y	CT3FWSRH5724FFL	1,608.	1,764.	1,852.

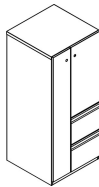

Order Code	Specification Information	Application Notes	Critical Dimensions																				
<p>Example: CT3SBLH5724BBFL-111</p> <table border="1"> <tr><td>CT3</td><td>Calibre Storage Tower</td></tr> <tr><td>SB</td><td>Side Access Bookcase</td></tr> <tr><td>LH</td><td>Left Hand Access</td></tr> <tr><td>57</td><td>64" High</td></tr> <tr><td>24</td><td>24" Wide</td></tr> <tr><td>B</td><td>Box Drawer</td></tr> <tr><td>B</td><td>Box Drawer</td></tr> <tr><td>F</td><td>File Drawer</td></tr> <tr><td>L</td><td>Locking</td></tr> <tr><td>111</td><td>Black paint finish</td></tr> </table> <p>All towers are standard with (1) full depth adjustable shelf, except the 64" h side access display and bookcase towers which have (2) full depth adjustable shelves.</p>	CT3	Calibre Storage Tower	SB	Side Access Bookcase	LH	Left Hand Access	57	64" High	24	24" Wide	B	Box Drawer	B	Box Drawer	F	File Drawer	L	Locking	111	Black paint finish	<p>For non-locking towers, deduct as follows from the list price for each unit: Deduct \$30 for (1) lock unit, \$60 for a (2) lock unit, and \$75 for a (3) lock unit. Substitute the "L" suffix with an "N" within the pattern number to designate a non-locking unit, example (CT3SLH6424BBFN)</p> <p>"M" drawer consisting of a box drawer body with a file drawer head are available by substituting any two "B" or any one "F" character within the pattern number, example (CT3SLH6424MBFN). Multiple "M" drawers may be specified providing they equal the total modules available.</p> <p>A 6" drawer, behind a cupboard door is available by adding the numeral 1 to the end of the pattern number, example (CT3SLH6424BBFFL1). Note: 6" drawers behind doors are not available within the wardrobe portion of towers. Drawers behind doors have painted black fronts.</p>	<p>Hanging rails and other accessories are not included and must be ordered separately. Hanging rails are included with 24" and 30" wide lateral drawers only. (See <i>Tower Accessories for pricing and order entry information</i>)</p> <p>Half depth adjustable shelves and coat hooks may be ordered separately allowing the cupboard area of 15", 24" and 30" wide towers to support binders as well as shorter coats. (See <i>Tower Accessories for pricing and order entry information</i>)</p> <p>15" w Side Access and Display towers include (1) lock.</p> <p>Single door towers, double door towers, 24" w and 30" w Side Access and Display towers include (2) locks. (Except full-height doors which include (1) lock)</p> <p>Front Access (only) towers with wardrobe include (3) locks. (Except full-height doors with wardrobe which include (2) locks)</p> <p>Full height door towers are designed to compliment the aesthetic of Dividends Horizon storage components.</p> <p>Full height door towers (50" h and 57" h) include one fixed shelf and one adjustable shelf. 64" h full height door tower includes one fixed shelf and two adjustable shelves.</p>	<p>Dimensions under w, d and h are actual to the nearest 1/16"</p> <p>24" Wide 50", 57" and 64" Tower Internal Dimensions</p> <ul style="list-style-type: none"> • Box and M drawer height: 4 5/16" • Box and M drawer width: 12 1/16" • Box and M drawer depth: 18 3/8" • File drawer height: 9 1/4" • File drawer width: 12 1/16" • File drawer depth: 18 3/8" • Wide drawer height: 9 3/16" • Wide drawer width: 20 3/4" • Wide drawer depth: 22 7/8" <p>Note: All towers are configured from the top down with standard combinations of box and file drawers.</p> <p>Note: Drawer behind door list pricing is as follows: 1=\$255</p> <p>Add a "Y" to the end of a pattern number to specify a front color that is different from the case color. P3 pricing automatically applies for all colors when utilizing this option.</p>
CT3	Calibre Storage Tower																						
SB	Side Access Bookcase																						
LH	Left Hand Access																						
57	64" High																						
24	24" Wide																						
B	Box Drawer																						
B	Box Drawer																						
F	File Drawer																						
L	Locking																						
111	Black paint finish																						

description	type	w	d	h	lock	pattern no.	P1	P2	P3
64" High, tower with two box and one file drawer and door and wardrobe (Left hand shown)	left hand	23 7/8"	23 1/2"	63 3/16"	Y	CT3FWSLH6424BBFL	\$1,747.	\$1,919.	\$2,011.
	right hand	23 7/8"	23 1/2"	63 3/16"	Y	CT3FWSRH6424BBFL	1,747.	1,919.	2,011.

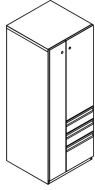

64" High, tower with two file drawers and door and wardrobe (Left hand shown)	left hand	23 7/8"	23 1/2"	63 3/16"	Y	CT3FWSLH6424FFL	1,603.	1,761.	1,847.
	right hand	23 7/8"	23 1/2"	63 3/16"	Y	CT3FWSRH6424FFL	1,603.	1,761.	1,847.

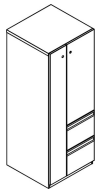

Order Code	Specification Information	Application Notes	Critical Dimensions																				
<p>Example: CT3SBLH5724BBFL-111</p> <table border="1"> <tr><td>CT3</td><td>Calibre Storage Tower</td></tr> <tr><td>SB</td><td>Side Access Bookcase</td></tr> <tr><td>LH</td><td>Left Hand Access</td></tr> <tr><td>57</td><td>64" High</td></tr> <tr><td>24</td><td>24" Wide</td></tr> <tr><td>B</td><td>Box Drawer</td></tr> <tr><td>B</td><td>Box Drawer</td></tr> <tr><td>F</td><td>File Drawer</td></tr> <tr><td>L</td><td>Locking</td></tr> <tr><td>111</td><td>Black paint finish</td></tr> </table> <p>All towers are standard with (1) full depth adjustable shelf, except the 64" h side access display and bookcase towers which have (2) full depth adjustable shelves.</p>	CT3	Calibre Storage Tower	SB	Side Access Bookcase	LH	Left Hand Access	57	64" High	24	24" Wide	B	Box Drawer	B	Box Drawer	F	File Drawer	L	Locking	111	Black paint finish	<p>For non-locking towers, deduct as follows from the list price for each unit: Deduct \$30 for (1) lock unit, \$60 for a (2) lock unit, and \$75 for a (3) lock unit. Substitute the "L" suffix with an "N" within the pattern number to designate a non-locking unit, example (CT3SLH6424BBFN)</p> <p>"M" drawer consisting of a box drawer body with a file drawer head are available by substituting any two "B" or any one "F" character within the pattern number, example (CT3SLH6424MBFN). Multiple "M" drawers may be specified providing they equal the total modules available.</p> <p>A 6" drawer, behind a cupboard door is available by adding the numeral 1 to the end of the pattern number, example (CT3SLH6424BBFFL1). Note: 6" drawers behind doors are not available within the wardrobe portion of towers. Drawers behind doors have painted black fronts.</p>	<p>Hanging rails and other accessories are not included and must be ordered separately. Hanging rails are included with 24" and 30" wide lateral drawers only. (See <i>Tower Accessories for pricing and order entry information</i>)</p> <p>Half depth adjustable shelves and coat hooks may be ordered separately allowing the cupboard area of 15", 24" and 30" wide towers to support binders as well as shorter coats. (See <i>Tower Accessories for pricing and order entry information</i>)</p> <p>15" w Side Access and Display towers include (1) lock.</p> <p>Single door towers, double door towers, 24" w and 30" w Side Access and Display towers include (2) locks. (Except full-height doors which include (1) lock)</p> <p>Front Access (only) towers with wardrobe include (3) locks. (Except full-height doors with wardrobe which include (2) locks)</p> <p>Full height door towers are designed to compliment the aesthetic of Dividends Horizon storage components.</p> <p>Full height door towers (50" h and 57" h) include one fixed shelf and one adjustable shelf. 64" h full height door tower includes one fixed shelf and two adjustable shelves.</p>	<p>Dimensions under w, d and h are actual to the nearest 1/16"</p> <p>24" Wide 50", 57" and 64" Tower Internal Dimensions</p> <ul style="list-style-type: none"> • Box and M drawer height: 4 5/16" • Box and M drawer width: 12 1/16" • Box and M drawer depth: 18 3/8" • File drawer height: 9 1/4" • File drawer width: 12 1/16" • File drawer depth: 18 3/8" • Wide drawer height: 9 3/16" • Wide drawer width: 20 3/4" • Wide drawer depth: 22 7/8" <p>Note: All towers are configured from the top down with standard combinations of box and file drawers.</p> <p>Note: Drawer behind door list pricing is as follows: 1=\$255</p> <p>Add a "Y" to the end of a pattern number to specify a front color that is different from the case color. P3 pricing automatically applies for all colors when utilizing this option.</p>
CT3	Calibre Storage Tower																						
SB	Side Access Bookcase																						
LH	Left Hand Access																						
57	64" High																						
24	24" Wide																						
B	Box Drawer																						
B	Box Drawer																						
F	File Drawer																						
L	Locking																						
111	Black paint finish																						

description	type	w	d	h	lock	pattern no.	P1	P2	P3
50" High, tower with one single (full height door) (Left hand shown)	left hand	23 ⁷ / ₈ "	23 ¹ / ₂ "	48 ⁵ / ₁₆ "	Y	CT3FSLH5024L	\$1,152.	\$1,275.	\$1,341.
	right hand	23 ⁷ / ₈ "	23 ¹ / ₂ "	48 ⁵ / ₁₆ "	Y	CT3FSRH5024L	1,152.	1,275.	1,341.

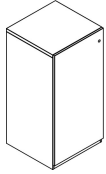

50" High, tower with wardrobe/cabinet (full height door)(Left hand shown)	left hand	23 ⁷ / ₈ "	23 ¹ / ₂ "	48 ⁵ / ₁₆ "	Y	CT3FWSLH5024L	1,354.	1,495.	1,572.
	right hand	23 ⁷ / ₈ "	23 ¹ / ₂ "	48 ⁵ / ₁₆ "	Y	CT3FWSRH5024L	1,354.	1,495.	1,572.

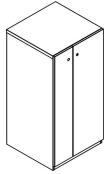

Order Code	Specification Information	Application Notes	Critical Dimensions
Example: CT3SBLH5724BBFL-111			
CT3 Calibre Storage Tower	<p>For non-locking towers, deduct as follows from the list price for each unit: Deduct \$30 for (1) lock unit, \$60 for a (2) lock unit, and \$75 for a (3) lock unit. Substitute the "L" suffix with an "N" within the pattern number to designate a non-locking unit, example (CT3SLH6424BBFN)</p> <p>"M" drawer consisting of a box drawer body with a file drawer head are available by substituting any two "B" or any one "F" character within the pattern number, example (CT3SLH6424MFN). Multiple "M" drawers may be specified providing they equal the total modules available.</p> <p>A 6" drawer, behind a cupboard door is available by adding the numeral 1 to the end of the pattern number, example (CT3SLH6424BBFFL1). Note: 6" drawers behind doors are not available within the wardrobe portion of towers. Drawers behind doors have painted black fronts.</p>	<p>Hanging rails and other accessories are not included and must be ordered separately. Hanging rails are included with 24" and 30" wide lateral drawers only. (See <i>Tower Accessories for pricing and order entry information</i>)</p> <p>Half depth adjustable shelves and coat hooks may be ordered separately allowing the cupboard area of 15", 24" and 30" wide towers to support binders as well as shorter coats. (See <i>Tower Accessories for pricing and order entry information</i>)</p> <p>15" w Side Access and Display towers include (1) lock.</p> <p>Single door towers, double door towers, 24" w and 30" w Side Access and Display towers include (2) locks. (Except full-height doors which include (1) lock)</p> <p>Front Access (only) towers with wardrobe include (3) locks. (Except full-height doors with wardrobe which include (2) locks)</p> <p>Full height door towers are designed to compliment the aesthetic of Dividends Horizon storage components.</p> <p>Full height door towers (50" h and 57" h) include one fixed shelf and one adjustable shelf. 64" h full height door tower includes one fixed shelf and two adjustable shelves.</p>	<p>Dimensions under w, d and h are actual to the nearest ¹/₁₆"</p> <p>24" Wide 50", 57" and 64" Tower Internal Dimensions</p> <ul style="list-style-type: none"> • Box and M drawer height: 4⁵/₁₆" • Box and M drawer width: 12¹/₁₆" • Box and M drawer depth: 18³/₈" • File drawer height: 9¹/₄" • File drawer width: 12¹/₁₆" • File drawer depth: 18³/₈" • Wide drawer height: 9⁷/₁₆" • Wide drawer width: 20³/₄" • Wide drawer depth: 22⁷/₈" <p>Note: All towers are configured from the top down with standard combinations of box and file drawers.</p> <p>Note: Drawer behind door list pricing is as follows: 1=\$255</p> <p>Add a "Y" to the end of a pattern number to specify a front color that is different from the case color. P3 pricing automatically applies for all colors when utilizing this option.</p>
SB Side Access Bookcase			
LH Left Hand Access			
57 64" High			
24 24" Wide			
B Box Drawer			
B Box Drawer			
F File Drawer			
L Locking			
111 Black paint finish			

All towers are standard with (1) full depth adjustable shelf, except the 64" h side access display and bookcase towers which have (2) full depth adjustable shelves.

description	type	w	d	h	lock	pattern no.	P1	P2	P3
57" High, tower with one single (full height door) (Left hand shown)	left hand	23 ⁷ / ₈ "	23 ¹ / ₂ "	56 ³ / ₁₆ "	Y	CT3FSLH5724L	\$1,200.	\$1,323.	\$1,392.
	right hand	23 ⁷ / ₈ "	23 ¹ / ₂ "	56 ³ / ₁₆ "	Y	CT3FSRH5724L	1,200.	1,323.	1,392.

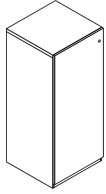

57" High, tower with wardrobe/cabinet (full height door)(Left hand shown)	left hand	23 ⁷ / ₈ "	23 ¹ / ₂ "	56 ³ / ₁₆ "	Y	CT3FWSLH5724L	1,383.	1,527.	1,607.
	right hand	23 ⁷ / ₈ "	23 ¹ / ₂ "	56 ³ / ₁₆ "	Y	CT3FWSRH5724L	1,383.	1,527.	1,607.

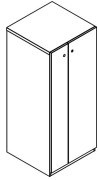

Order Code	Specification Information	Application Notes	Critical Dimensions
Example: CT3SBLH5724BBFL-111			
CT3 Calibre Storage Tower	<p>For non-locking towers, deduct as follows from the list price for each unit: Deduct \$30 for (1) lock unit, \$60 for a (2) lock unit, and \$75 for a (3) lock unit. Substitute the "L" suffix with an "N" within the pattern number to designate a non-locking unit, example (CT3SLH6424BBFN)</p> <p>"M" drawer consisting of a box drawer body with a file drawer head are available by substituting any two "B" or any one "F" character within the pattern number, example (CT3SLH6424MBFN). Multiple "M" drawers may be specified providing they equal the total modules available.</p> <p>A 6" drawer, behind a cupboard door is available by adding the numeral 1 to the end of the pattern number, example (CT3SLH6424BBFFL1). Note: 6" drawers behind doors are not available within the wardrobe portion of towers. Drawers behind doors have painted black fronts.</p>	<p>Hanging rails and other accessories are not included and must be ordered separately. Hanging rails are included with 24" and 30" wide lateral drawers only. (See <i>Tower Accessories for pricing and order entry information</i>)</p> <p>Half depth adjustable shelves and coat hooks may be ordered separately allowing the cupboard area of 15", 24" and 30" wide towers to support binders as well as shorter coats. (See <i>Tower Accessories for pricing and order entry information</i>)</p> <p>15" w Side Access and Display towers include (1) lock.</p> <p>Single door towers, double door towers, 24" w and 30" w Side Access and Display towers include (2) locks. (Except full-height doors which include (1) lock)</p> <p>Front Access (only) towers with wardrobe include (3) locks. (Except full-height doors with wardrobe which include (2) locks)</p> <p>Full height door towers are designed to compliment the aesthetic of Dividends Horizon storage components.</p> <p>Full height door towers (50" h and 57" h) include one fixed shelf and one adjustable shelf. 64" h full height door tower includes one fixed shelf and two adjustable shelves.</p>	<p>Dimensions under w, d and h are actual to the nearest ¹/₁₆"</p> <p>24" Wide 50", 57" and 64" Tower Internal Dimensions</p> <ul style="list-style-type: none"> • Box and M drawer height: 4⁵/₁₆" • Box and M drawer width: 12¹/₁₆" • Box and M drawer depth: 18³/₈" • File drawer height: 9¹/₄" • File drawer width: 12¹/₁₆" • File drawer depth: 18³/₈" • Wide drawer height: 9³/₁₆" • Wide drawer width: 20³/₄" • Wide drawer depth: 22⁷/₈" <p>Note: All towers are configured from the top down with standard combinations of box and file drawers.</p> <p>Note: Drawer behind door list pricing is as follows: 1=\$255</p> <p>Add a "Y" to the end of a pattern number to specify a front color that is different from the case color. P3 pricing automatically applies for all colors when utilizing this option.</p>
SB Side Access Bookcase			
LH Left Hand Access			
57 64" High			
24 24" Wide			
B Box Drawer			
B Box Drawer			
F File Drawer			
L Locking			
111 Black paint finish			

All towers are standard with (1) full depth adjustable shelf, except the 64" h side access display and bookcase towers which have (2) full depth adjustable shelves.

description	type	w	d	h	lock	pattern no.	P1	P2	P3
64" High, tower with one single (full height door) (Left hand shown)	left hand	23 ⁷ / ₈ "	23 ¹ / ₂ "	63 ⁵ / ₁₆ "	Y	CT3FSLH6424L	\$1,220.	\$1,349.	\$1,419.
	right hand	23 ⁷ / ₈ "	23 ¹ / ₂ "	63 ⁵ / ₁₆ "	Y	CT3FSRH6424L	1,220.	1,349.	1,419.

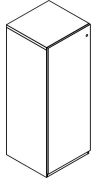

64" High, tower with wardrobe/cabinet (full height door)(Left hand shown)	left hand	23 ⁷ / ₈ "	23 ¹ / ₂ "	63 ⁵ / ₁₆ "	Y	CT3FWSLH6424L	1,410.	1,557.	1,640.
	right hand	23 ⁷ / ₈ "	23 ¹ / ₂ "	63 ⁵ / ₁₆ "	Y	CT3FWSRH6424L	1,410.	1,557.	1,640.

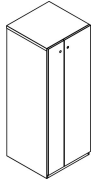

Order Code	Specification Information	Application Notes	Critical Dimensions																				
<p>Example: CT3SBLH5724BBFL-111</p> <table border="1"> <tr><td>CT3</td><td>Calibre Storage Tower</td></tr> <tr><td>SB</td><td>Side Access Bookcase</td></tr> <tr><td>LH</td><td>Left Hand Access</td></tr> <tr><td>57</td><td>64" High</td></tr> <tr><td>24</td><td>24" Wide</td></tr> <tr><td>B</td><td>Box Drawer</td></tr> <tr><td>B</td><td>Box Drawer</td></tr> <tr><td>F</td><td>File Drawer</td></tr> <tr><td>L</td><td>Locking</td></tr> <tr><td>111</td><td>Black paint finish</td></tr> </table> <p>All towers are standard with (1) full depth adjustable shelf, except the 64" h side access display and bookcase towers which have (2) full depth adjustable shelves.</p>	CT3	Calibre Storage Tower	SB	Side Access Bookcase	LH	Left Hand Access	57	64" High	24	24" Wide	B	Box Drawer	B	Box Drawer	F	File Drawer	L	Locking	111	Black paint finish	<p>For non-locking towers, deduct as follows from the list price for each unit: Deduct \$30 for (1) lock unit, \$60 for a (2) lock unit, and \$75 for a (3) lock unit. Substitute the "L" suffix with an "N" within the pattern number to designate a non-locking unit, example (CT3SLH6424BBFN)</p> <p>"M" drawer consisting of a box drawer body with a file drawer head are available by substituting any two "B" or any one "F" character within the pattern number, example (CT3SLH6424MBFN). Multiple "M" drawers may be specified providing they equal the total modules available.</p> <p>A 6" drawer, behind a cupboard door is available by adding the numeral 1 to the end of the pattern number, example (CT3SLH6424BBFFL1). Note: 6" drawers behind doors are not available within the wardrobe portion of towers. Drawers behind doors have painted black fronts.</p>	<p>Hanging rails and other accessories are not included and must be ordered separately. Hanging rails are included with 24" and 30" wide lateral drawers only. (See <i>Tower Accessories for pricing and order entry information</i>)</p> <p>Half depth adjustable shelves and coat hooks may be ordered separately allowing the cupboard area of 15", 24" and 30" wide towers to support binders as well as shorter coats. (See <i>Tower Accessories for pricing and order entry information</i>)</p> <p>15" w Side Access and Display towers include (1) lock.</p> <p>Single door towers, double door towers, 24" w and 30" w Side Access and Display towers include (2) locks. (Except full-height doors which include (1) lock)</p> <p>Front Access (only) towers with wardrobe include (3) locks. (Except full-height doors with wardrobe which include (2) locks)</p> <p>Full height door towers are designed to compliment the aesthetic of Dividends Horizon storage components.</p> <p>Full height door towers (50" h and 57" h) include one fixed shelf and one adjustable shelf. 64" h full height door tower includes one fixed shelf and two adjustable shelves.</p>	<p>Dimensions under w, d and h are actual to the nearest ¹/₁₆"</p> <p>24" Wide 50", 57" and 64" Tower Internal Dimensions</p> <ul style="list-style-type: none"> • Box and M drawer height: 4⁵/₁₆" • Box and M drawer width: 12¹/₁₆" • Box and M drawer depth: 18³/₈" • File drawer height: 9¹/₄" • File drawer width: 12¹/₁₆" • File drawer depth: 18³/₈" • Wide drawer height: 9⁷/₁₆" • Wide drawer width: 20³/₄" • Wide drawer depth: 22⁷/₈" <p>Note: All towers are configured from the top down with standard combinations of box and file drawers.</p> <p>Note: Drawer behind door list pricing is as follows: 1=\$255</p> <p>Add a "Y" to the end of a pattern number to specify a front color that is different from the case color. P3 pricing automatically applies for all colors when utilizing this option.</p>
CT3	Calibre Storage Tower																						
SB	Side Access Bookcase																						
LH	Left Hand Access																						
57	64" High																						
24	24" Wide																						
B	Box Drawer																						
B	Box Drawer																						
F	File Drawer																						
L	Locking																						
111	Black paint finish																						

description	type	w	d	h	pattern no.	P1	P2	P3
50" High Double Door tower with one wide drawer		29 ⁷ / ₈ "	23 1/2"	48 ⁵ / ₁₆ "	CT3D5030WL	\$1,560.	\$1,716.	\$1,800.

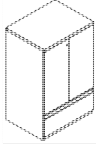

50" High Double Door tower with two wide drawers		29 ⁷ / ₈ "	23 1/2"	48 ⁵ / ₁₆ "	CT3D5030WWL	1,865.	2,051.	2,152.
--	--	----------------------------------	---------	-----------------------------------	--------------------	--------	--------	--------

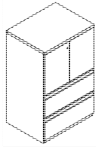

50" High tower with two file drawers and door and wardrobe (left hand shown)	left hand	29 ⁷ / ₈ "	23 1/2"	48 ⁵ / ₁₆ "	CT3WSLH5030FFL	1,469.	1,617.	1,699.
	right hand	29 ⁷ / ₈ "	23 1/2"	48 ⁵ / ₁₆ "	CT3WSRH5030FFL	1,469.	1,617.	1,699.

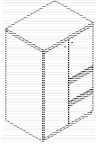

Order Code	Specification Information	Application Notes	Critical Dimensions
Example: CT3WSLH5730BBFL-111	For non-locking towers, deduct \$60 from the list price for single door and double door units or \$75 list for units with wardrobe. Substitute the "L" suffix with a "N" within the pattern number to designate a non-locking unit, example (CT3WSLH5030BBFN)	Hanging rails and other accessories are not included and must be ordered separately. Hanging rails are included with 24" and 30" wide lateral drawers only. (See <i>Tower Accessories for pricing and order entry information</i>)	Dimensions under w , d and h are actual to the nearest 1/16"
CT3	Calibre Storage Tower		24" Wide 50", 57" and 64" Tower Internal Dimensions <ul style="list-style-type: none"> • Box and M drawer height: 4³/₁₆" • Box and M drawer width: 12¹/₁₆" • Box and M drawer depth: 18³/₈" • File drawer height: 9¹/₄" • File drawer width: 12¹/₁₆" • File drawer depth: 18³/₈" • Wide drawer height: 9⁹/₁₆" • Wide drawer width: 20³/₄" • Wide drawer depth: 22⁷/₈"
WS	Wardrobe and Single Door		
LH	Left Hand Access		
57	50" High		
30	30" Wide		
B	Box Drawer	Half depth adjustable shelves and coat hooks may be ordered separately allowing the cupboard area of 15", 24" and 30" wide towers to support binders as well as shorter coats. (See <i>Tower Accessories for pricing and order entry information</i>)	
B	Box Drawer		
F	File Drawer		
L	Locking		
111	Black paint finish	15" w Side Access and Display towers include (1) lock.	

All towers are standard with (1) full depth adjustable shelf, except the 64" h side access display and bookcase towers which have (2) full depth adjustable shelves.

A 6" drawer, behind a cupboard door is available by adding the numeral 1 to the end of the pattern number, example (CT3SLH6424BBFFL1). **Note:** 6" drawers behind doors are not available within the wardrobe portion of towers. Drawers behind doors have painted black fronts.

Single door towers, double door towers, 24" w and 30" w Side Access and Display towers include (2) locks. (Except full-height doors which include (1) lock)

Front Access (only) towers with wardrobe include (3) locks. (Except full-height doors with wardrobe which include (2) locks)

Note: All towers are configured from the top down with standard combinations of box and file drawers.

Note: Drawer behind door list pricing is as follows: 1=\$255

description	type	w	d	h	pattern no.	P1	P2	P3
50" High tower with two box, one file drawer and door and wardrobe (left hand shown)	left hand	29 ⁷ / ₈ "	23 ¹ / ₂ "	48 ⁵ / ₁₆ "	CT3WSLH5030BBFL	\$1,598.	\$1,762.	\$1,849.
	right hand	29 ⁷ / ₈ "	23 ¹ / ₂ "	48 ⁵ / ₁₆ "	CT3WSRH5030BBFL	1,598.	1,762.	1,849.

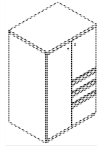

50" High tower with one box, two file drawers and door and wardrobe (left hand shown)	left hand	29 ⁷ / ₈ "	23 ¹ / ₂ "	48 ⁵ / ₁₆ "	CT3WSLH5030BBFL	1,614.	1,773.	1,864.
	right hand	29 ⁷ / ₈ "	23 ¹ / ₂ "	48 ⁵ / ₁₆ "	CT3WSRH5030BBFL	1,614.	1,773.	1,864.

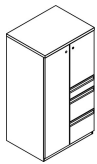

50" High tower with two box, two file drawers and door and wardrobe (left hand shown)	left hand	29 ⁷ / ₈ "	23 ¹ / ₂ "	48 ⁵ / ₁₆ "	CT3WSLH5030BBFL	1,749.	1,925.	2,022.
	right hand	29 ⁷ / ₈ "	23 ¹ / ₂ "	48 ⁵ / ₁₆ "	CT3WSRH5030BBFL	1,749.	1,925.	2,022.



Order Code	Specification Information	Application Notes	Critical Dimensions
Example: CT3WSLH5730BBFL-111	For non-locking towers, deduct \$60 from the list price for single door and double door units or \$75 list for units with wardrobe. Substitute the "L" suffix with a "N" within the pattern number to designate a non-locking unit, example (CT3WSLH5030BBFN)	Hanging rails and other accessories are not included and must be ordered separately. Hanging rails are included with 24" and 30" wide lateral drawers only. (See <i>Tower Accessories for pricing and order entry information</i>)	Dimensions under w , d and h are actual to the nearest 1/16"
CT3 Calibre Storage Tower	"M" drawer consisting of a box drawer body with a file drawer head are available by substituting any two "B" or any one "F" character within the pattern number, example (CT3WSLH5030MFN). Multiple "M" drawers may be specified providing they equal the total modules available.	Half depth adjustable shelves and coat hooks may be ordered separately allowing the cupboard area of 15", 24" and 30" wide towers to support binders as well as shorter coats. (See <i>Tower Accessories for pricing and order entry information</i>)	24" Wide 50", 57" and 64" Tower Internal Dimensions
WS Wardrobe and Single Door		15" w Side Access and Display towers include (1) lock.	<ul style="list-style-type: none"> Box and M drawer height: 4⁵/₁₆" Box and M drawer width: 12¹/₁₆" Box and M drawer depth: 18³/₈" File drawer height: 9¹/₄" File drawer width: 12¹/₁₆" File drawer depth: 18³/₈" Wide drawer height: 9⁹/₁₆" Wide drawer width: 20³/₄" Wide drawer depth: 22⁷/₈"
LH Left Hand Access		Single door towers, double door towers, 24" w and 30" w Side Access and Display towers include (2) locks. (Except full-height doors which include (1) lock)	Note: All towers are configured from the top down with standard combinations of box and file drawers.
57 50" High		Front Access (only) towers with wardrobe include (3) locks. (Except full-height doors with wardrobe which include (2) locks)	Note: Drawer behind door list pricing is as follows: 1=\$255
30 30" Wide			
B Box Drawer			
B Box Drawer			
F File Drawer			
L Locking			
111 Black paint finish			

All towers are standard with (1) full depth adjustable shelf, except the 64" h side access display and bookcase towers which have (2) full depth adjustable shelves.

A 6" drawer, behind a cupboard door is available by adding the numeral 1 to the end of the pattern number, example (CT3SLH6424BBFFL1). **Note:** 6" drawers behind doors are not available within the wardrobe portion of towers. Drawers behind doors have painted black fronts.

description	type	w	d	h	pattern no.	P1	P2	P3
50" High tower with three file drawers and door and wardrobe (left hand shown)	left hand	29 ⁷ / ₈ "	23 ¹ / ₂ "	48 ⁵ / ₁₆ "	CT3WSLH5030FFFL	\$1,614.	\$1,773.	\$1,864.
	right hand	29 ⁷ / ₈ "	23 ¹ / ₂ "	48 ⁵ / ₁₆ "	CT3WSRH5030FFFL	1,614.	1,773.	1,864.

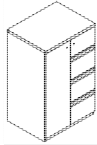

57" High tower with two file drawers and door and wardrobe (left hand shown)	left hand	29 ⁷ / ₈ "	23 ¹ / ₂ "	56 ³ / ₁₆ "	CT3WSLH5730FFFL	1,569.	1,726.	1,812.
	right hand	29 ⁷ / ₈ "	23 ¹ / ₂ "	56 ³ / ₁₆ "	CT3WSRH5730FFFL	1,569.	1,726.	1,812.

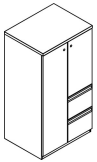

57" High tower with three file drawers and door and wardrobe (left hand shown)	left hand	29 ⁷ / ₈ "	23 ¹ / ₂ "	56 ³ / ₁₆ "	CT3WSLH5730FFFL	1,682.	1,851.	1,943.
	right hand	29 ⁷ / ₈ "	23 ¹ / ₂ "	56 ³ / ₁₆ "	CT3WSRH5730FFFL	1,682.	1,851.	1,943.

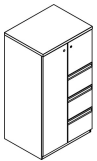

Order Code	Specification Information	Application Notes	Critical Dimensions	
Example: CT3WSLH5730BBFL-111	<p>For non-locking towers, deduct \$60 from the list price for single door and double door units or \$75 list for units with wardrobe. Substitute the "L" suffix with a "N" within the pattern number to designate a non-locking unit, example (CT3WSLH5030BBFN)</p> <p>"M" drawer consisting of a box drawer body with a file drawer head are available by substituting any two "B" or any one "F" character within the pattern number, example (CT3WSLH5030MFN). Multiple "M" drawers may be specified providing they equal the total modules available.</p>	<p>Hanging rails and other accessories are not included and must be ordered separately. Hanging rails are included with 24" and 30" wide lateral drawers only. (See <i>Tower Accessories for pricing and order entry information</i>)</p> <p>Half depth adjustable shelves and coat hooks may be ordered separately allowing the cupboard area of 15", 24" and 30" wide towers to support binders as well as shorter coats. (See <i>Tower Accessories for pricing and order entry information</i>)</p> <p>15" w Side Access and Display towers include (1) lock.</p>	<p>Dimensions under w, d and h are actual to the nearest 1/16"</p> <p>24" Wide 50", 57" and 64" Tower Internal Dimensions</p> <ul style="list-style-type: none"> • Box and M drawer height: 4³/₁₆" • Box and M drawer width: 12¹/₁₆" • Box and M drawer depth: 18³/₈" • File drawer height: 9¹/₄" • File drawer width: 12¹/₁₆" • File drawer depth: 18³/₈" • Wide drawer height: 9⁹/₁₆" • Wide drawer width: 20³/₄" • Wide drawer depth: 22⁷/₈" 	
CT3				Calibre Storage Tower
WS				Wardrobe and Single Door
LH				Left Hand Access
57				50" High
30				30" Wide
B				Box Drawer
B				Box Drawer
F				File Drawer
L				Locking
111				Black paint finish

All towers are standard with (1) full depth adjustable shelf, except the 64" h side access display and bookcase towers which have (2) full depth adjustable shelves.

A 6" drawer, behind a cupboard door is available by adding the numeral 1 to the end of the pattern number, example (CT3SLH6424BBFFL1). **Note:** 6" drawers behind doors are not available within the wardrobe portion of towers. Drawers behind doors have painted black fronts.

Single door towers, double door towers, 24" w and 30" w Side Access and Display towers include (2) locks. (Except full-height doors which include (1) lock)

Front Access (only) towers with wardrobe include (3) locks. (Except full-height towers with wardrobe which include (2) locks)

Note: All towers are configured from the top down with standard combinations of box and file drawers.

Note: Drawer behind door list pricing is as follows: 1=\$255

description	type	w	d	h	pattern no.	P1	P2	P3
57" High tower with two box, one file drawer and door and wardrobe (left hand shown)	left hand	29 ⁷ / ₈ "	23 ¹ / ₂ "	56 ³ / ₁₆ "	CT3WSLH5730BBFL	\$1,689.	\$1,860.	\$1,954.
	right hand	29 ⁷ / ₈ "	23 ¹ / ₂ "	56 ³ / ₁₆ "	CT3WSRH5730BBFL	1,689.	1,860.	1,954.

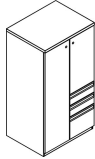

57" High tower with two box, two file drawers and door and wardrobe (left hand shown)	left hand	29 ⁷ / ₈ "	23 ¹ / ₂ "	56 ³ / ₁₆ "	CT3WSLH5730BBFFL	1,823.	2,005.	2,104.
	right hand	29 ⁷ / ₈ "	23 ¹ / ₂ "	56 ³ / ₁₆ "	CT3WSRH5730BBFFL	1,823.	2,005.	2,104.

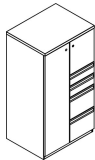

57" High tower with one box, two file drawers and door and wardrobe (left hand shown)	left hand	29 ⁷ / ₈ "	23 ¹ / ₂ "	56 ³ / ₁₆ "	CT3WSLH5730BFFL	1,682.	1,851.	1,943.
	right hand	29 ⁷ / ₈ "	23 ¹ / ₂ "	56 ³ / ₁₆ "	CT3WSRH5730BFFL	1,682.	1,851.	1,943.

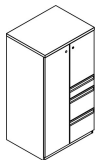

Order Code	Specification Information	Application Notes	Critical Dimensions
Example: CT3WSLH5730BBFL-111	<p>For non-locking towers, deduct \$60 from the list price for single door and double door units or \$75 list for units with wardrobe. Substitute the "L" suffix with a "N" within the pattern number to designate a non-locking unit, example (CT3WSLH5030BBFN)</p> <p>"M" drawer consisting of a box drawer body with a file drawer head are available by substituting any two "B" or any one "F" character within the pattern number, example (CT3WSLH5030MFN). Multiple "M" drawers may be specified providing they equal the total modules available.</p>	<p>Hanging rails and other accessories are not included and must be ordered separately. Hanging rails are included with 24" and 30" wide lateral drawers only. (See <i>Tower Accessories for pricing and order entry information</i>)</p> <p>Half depth adjustable shelves and coat hooks may be ordered separately allowing the cupboard area of 15", 24" and 30" wide towers to support binders as well as shorter coats. (See <i>Tower Accessories for pricing and order entry information</i>)</p> <p>15" w Side Access and Display towers include (1) lock.</p>	<p>Dimensions under w, d and h are actual to the nearest 1/16"</p> <p>24" Wide 50", 57" and 64" Tower Internal Dimensions</p> <ul style="list-style-type: none"> • Box and M drawer height: 4³/₁₆" • Box and M drawer width: 12¹/₁₆" • Box and M drawer depth: 18³/₈" • File drawer height: 9¹/₄" • File drawer width: 12¹/₁₆" • File drawer depth: 18³/₈" • Wide drawer height: 9⁹/₁₆" • Wide drawer width: 20³/₄" • Wide drawer depth: 22⁷/₈"
CT3 Calibre Storage Tower			
WS Wardrobe and Single Door			
LH Left Hand Access			
57 50" High			
30 30" Wide			
B Box Drawer			
B Box Drawer			
F File Drawer			
L Locking			
111 Black paint finish			

All towers are standard with (1) full depth adjustable shelf, except the 64" h side access display and bookcase towers which have (2) full depth adjustable shelves.

A 6" drawer, behind a cupboard door is available by adding the numeral 1 to the end of the pattern number, example (CT3SLH6424BBFFL1). **Note:** 6" drawers behind doors are not available within the wardrobe portion of towers. Drawers behind doors have painted black fronts.

Single door towers, double door towers, 24" w and 30" w Side Access and Display towers include (2) locks. (Except full-height doors which include (1) lock)

Front Access (only) towers with wardrobe include (3) locks. (Except full-height towers with wardrobe which include (2) locks)

Note: All towers are configured from the top down with standard combinations of box and file drawers.

Note: Drawer behind door list pricing is as follows: 1=\$255

description	type	w	d	h	pattern no.	P1	P2	P3
57" High Double Door tower with one wide drawer		29 ⁷ / ₈ "	23 ¹ / ₂ "	56 ³ / ₁₆ "	CT3D5730WL	\$1,598.	\$1,761.	\$1,849.

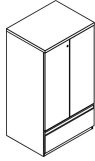

57" High Double Door tower with two wide drawers		29 ⁷ / ₈ "	23 ¹ / ₂ "	56 ³ / ₁₆ "	CT3D5730WWL	1,943.	2,136.	2,244.
--	--	----------------------------------	----------------------------------	-----------------------------------	--------------------	--------	--------	--------

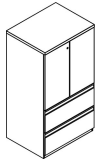

64" High Double Door tower with one wide drawer		29 ⁷ / ₈ "	23 ¹ / ₂ "	63 ³ / ₁₆ "	CT3D6430WL	1,636.	1,799.	1,889.
---	--	----------------------------------	----------------------------------	-----------------------------------	-------------------	--------	--------	--------



Order Code	Specification Information	Application Notes	Critical Dimensions
Example: CT3WSLH5730BBFL-111	For non-locking towers, deduct \$60 from the list price for single door and double door units or \$75 list for units with wardrobe. Substitute the "L" suffix with a "N" within the pattern number to designate a non-locking unit, example (CT3WSLH5030BBFN)	Hanging rails and other accessories are not included and must be ordered separately. Hanging rails are included with 24" and 30" wide lateral drawers only. (See <i>Tower Accessories for pricing and order entry information</i>)	Dimensions under w , d and h are actual to the nearest 1/16"
CT3	Calibre Storage Tower		24" Wide 50", 57" and 64" Tower Internal Dimensions
WS	Wardrobe and Single Door		<ul style="list-style-type: none"> Box and M drawer height: 4³/₁₆" Box and M drawer width: 12¹/₁₆" Box and M drawer depth: 18³/₈" File drawer height: 9¹/₄" File drawer width: 12¹/₁₆" File drawer depth: 18³/₈" Wide drawer height: 9⁹/₁₆" Wide drawer width: 20³/₄" Wide drawer depth: 22⁷/₈"
LH	Left Hand Access		
57	50" High		
30	30" Wide	Half depth adjustable shelves and coat hooks may be ordered separately allowing the cupboard area of 15", 24" and 30" wide towers to support binders as well as shorter coats. (See <i>Tower Accessories for pricing and order entry information</i>)	
B	Box Drawer	15" w Side Access and Display towers include (1) lock.	
B	Box Drawer	Single door towers, double door towers, 24" w and 30" w Side Access and Display towers include (2) locks. (Except full-height doors which include (1) lock)	
F	File Drawer	Front Access (only) towers with wardrobe include (3) locks. (Except full-height doors with wardrobe which include (2) locks)	
L	Locking		
111	Black paint finish		Note: All towers are configured from the top down with standard combinations of box and file drawers. Note: Drawer behind door list pricing is as follows: 1=\$255
	All towers are standard with (1) full depth adjustable shelf, except the 64" h side access display and bookcase towers which have (2) full depth adjustable shelves.	A 6" drawer, behind a cupboard door is available by adding the numeral 1 to the end of the pattern number, example (CT3SLH6424BBFFL1). Note: 6" drawers behind doors are not available within the wardrobe portion of towers. Drawers behind doors have painted black fronts.	

description	type	w	d	h	pattern no.	P1	P2	P3
64" High Double Door tower with two wide drawers		29 ⁷ / ₈ "	23 1/2"	63 ⁵ / ₁₆ "	CT3D6430WWL	\$1,959.	\$2,156.	\$2,263.

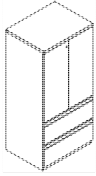

64" High tower with two file drawers and door and wardrobe (left hand shown)	left hand	29 ⁷ / ₈ "	23 1/2"	63 ⁵ / ₁₆ "	CT3WSLH6430FFL	1,572.	1,731.	1,816.
	right hand	29 ⁷ / ₈ "	23 1/2"	63 ⁵ / ₁₆ "	CT3WSRH6430FFL	1,572.	1,731.	1,816.

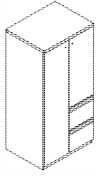

Order Code	Specification Information	Application Notes	Critical Dimensions																				
<p>Example: CT3WSLH5730BBFL-111</p> <table border="1"> <tr><td>CT3</td><td>Calibre Storage Tower</td></tr> <tr><td>WS</td><td>Wardrobe and Single Door</td></tr> <tr><td>LH</td><td>Left Hand Access</td></tr> <tr><td>57</td><td>50" High</td></tr> <tr><td>30</td><td>30" Wide</td></tr> <tr><td>B</td><td>Box Drawer</td></tr> <tr><td>B</td><td>Box Drawer</td></tr> <tr><td>F</td><td>File Drawer</td></tr> <tr><td>L</td><td>Locking</td></tr> <tr><td>111</td><td>Black paint finish</td></tr> </table>	CT3	Calibre Storage Tower	WS	Wardrobe and Single Door	LH	Left Hand Access	57	50" High	30	30" Wide	B	Box Drawer	B	Box Drawer	F	File Drawer	L	Locking	111	Black paint finish	<p>For non-locking towers, deduct \$60 from the list price for single door and double door units or \$75 list for units with wardrobe. Substitute the "L" suffix with a "N" within the pattern number to designate a non-locking unit, example (CT3WSLH5030BBFN)</p> <p>"M" drawer consisting of a box drawer body with a file drawer head are available by substituting any two "B" or any one "F" character within the pattern number, example (CT3WSLH5030MFN). Multiple "M" drawers may be specified providing they equal the total modules available.</p> <p>A 6" drawer, behind a cupboard door is available by adding the numeral 1 to the end of the pattern number, example (CT3SLH6424BBFFL1). Note: 6" drawers behind doors are not available within the wardrobe portion of towers. Drawers behind doors have painted black fronts.</p>	<p>Hanging rails and other accessories are not included and must be ordered separately. Hanging rails are included with 24" and 30" wide lateral drawers only. (See <i>Tower Accessories for pricing and order entry information</i>)</p> <p>Half depth adjustable shelves and coat hooks may be ordered separately allowing the cupboard area of 15", 24" and 30" wide towers to support binders as well as shorter coats. (See <i>Tower Accessories for pricing and order entry information</i>)</p> <p>15" w Side Access and Display towers include (1) lock.</p> <p>Single door towers, double door towers, 24" w and 30" w Side Access and Display towers include (2) locks. (Except full-height doors which include (1) lock)</p> <p>Front Access (only) towers with wardrobe include (3) locks. (Except full-height doors with wardrobe which include (2) locks)</p>	<p>Dimensions under w, d and h are actual to the nearest 1/16"</p> <p>24" Wide 50", 57" and 64" Tower Internal Dimensions</p> <ul style="list-style-type: none"> • Box and M drawer height: 4⁵/₁₆" • Box and M drawer width: 12¹/₁₆" • Box and M drawer depth: 18³/₈" • File drawer height: 9¹/₄" • File drawer width: 12¹/₁₆" • File drawer depth: 18³/₈" • Wide drawer height: 9⁹/₁₆" • Wide drawer width: 20³/₄" • Wide drawer depth: 22⁷/₈" <p>Note: All towers are configured from the top down with standard combinations of box and file drawers.</p> <p>Note: Drawer behind door list pricing is as follows: 1=\$255</p>
CT3	Calibre Storage Tower																						
WS	Wardrobe and Single Door																						
LH	Left Hand Access																						
57	50" High																						
30	30" Wide																						
B	Box Drawer																						
B	Box Drawer																						
F	File Drawer																						
L	Locking																						
111	Black paint finish																						
<p>All towers are standard with (1) full depth adjustable shelf, except the 64" h side access display and bookcase towers which have (2) full depth adjustable shelves.</p>																							

description	type	w	d	h	pattern no.	P1	P2	P3
64" High tower with two box, one file drawer and door and wardrobe (left hand shown)	left hand	29 ⁷ / ₈ "	23 ¹ / ₂ "	63 ³ / ₁₆ "	CT3WSLH6430BBFL	\$1,685.	\$1,855.	\$1,949.
	right hand	29 ⁷ / ₈ "	23 ¹ / ₂ "	63 ³ / ₁₆ "	CT3WSRH6430BBFL	1,685.	1,855.	1,949.

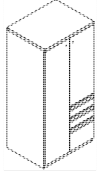

64" High tower with one box, two file drawers and door and wardrobe (left hand shown)	left hand	29 ⁷ / ₈ "	23 ¹ / ₂ "	63 ³ / ₁₆ "	CT3WSLH6430BFFL	1,707.	1,878.	1,973.
	right hand	29 ⁷ / ₈ "	23 ¹ / ₂ "	63 ³ / ₁₆ "	CT3WSRH6430BFFL	1,707.	1,878.	1,973.

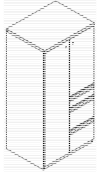

Order Code	Specification Information	Application Notes	Critical Dimensions
Example: CT3WSLH5730BBFL-111	For non-locking towers, deduct \$60 from the list price for single door and double door units or \$75 list for units with wardrobe. Substitute the "L" suffix with a "N" within the pattern number to designate a non-locking unit, example (CT3WSLH5030BBFN)	Hanging rails and other accessories are not included and must be ordered separately. Hanging rails are included with 24" and 30" wide lateral drawers only. (See <i>Tower Accessories for pricing and order entry information</i>)	Dimensions under w , d and h are actual to the nearest 1/16"
CT3	Calibre Storage Tower		24" Wide 50", 57" and 64" Tower Internal Dimensions
WS	Wardrobe and Single Door		<ul style="list-style-type: none"> Box and M drawer height: 4³/₁₆" Box and M drawer width: 12¹/₁₆" Box and M drawer depth: 18³/₈" File drawer height: 9¹/₄" File drawer width: 12¹/₁₆" File drawer depth: 18³/₈" Wide drawer height: 9⁹/₁₆" Wide drawer width: 20³/₄" Wide drawer depth: 22⁷/₈"
LH	Left Hand Access		
57	50" High		
30	30" Wide		
B	Box Drawer	Half depth adjustable shelves and coat hooks may be ordered separately allowing the cupboard area of 15", 24" and 30" wide towers to support binders as well as shorter coats. (See <i>Tower Accessories for pricing and order entry information</i>)	
B	Box Drawer		
F	File Drawer		
L	Locking	15" w Side Access and Display towers include (1) lock.	
111	Black paint finish	Single door towers, double door towers, 24" w and 30" w Side Access and Display towers include (2) locks. (Except full-height doors which include (1) lock)	Note: All towers are configured from the top down with standard combinations of box and file drawers.

All towers are standard with (1) full depth adjustable shelf, except the 64" h side access display and bookcase towers which have (2) full depth adjustable shelves.

A 6" drawer, behind a cupboard door is available by adding the numeral 1 to the end of the pattern number, example (CT3SLH6424BBFFL1). **Note:** 6" drawers behind doors are not available within the wardrobe portion of towers. Drawers behind doors have painted black fronts.

Front Access (only) towers with wardrobe include (3) locks. (Except full-height doors with wardrobe which include (2) locks)

Note: Drawer behind door list pricing is as follows: 1=\$255

description	type	w	d	h	pattern no.	P1	P2	P3
64" High tower with three file drawers and door and wardrobe (left hand shown)	left hand	29 ⁷ / ₈ "	23 ¹ / ₂ "	63 ⁵ / ₁₆ "	CT3WSLH6430FFFL	\$1,700.	\$1,870.	\$1,962.
	right hand	29 ⁷ / ₈ "	23 ¹ / ₂ "	63 ⁵ / ₁₆ "	CT3WSRH6430FFFL	1,700.	1,870.	1,962.

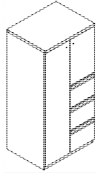

64" High tower with two box, two file drawers and door and wardrobe (left hand shown)	left hand	29 ⁷ / ₈ "	23 ¹ / ₂ "	63 ⁵ / ₁₆ "	CT3WSLH6430BBFFL	1,844.	2,028.	2,129.
	right hand	29 ⁷ / ₈ "	23 ¹ / ₂ "	63 ⁵ / ₁₆ "	CT3WSRH6430BBFFL	1,844.	2,028.	2,129.

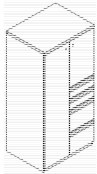

Order Code	Specification Information	Application Notes	Critical Dimensions
Example: CT3WSLH5730BBFL-111	For non-locking towers, deduct \$60 from the list price for single door and double door units or \$75 list for units with wardrobe. Substitute the "L" suffix with a "N" within the pattern number to designate a non-locking unit, example (CT3WSLH5030BBFN)	Hanging rails and other accessories are not included and must be ordered separately. Hanging rails are included with 24" and 30" wide lateral drawers only. (See <i>Tower Accessories for pricing and order entry information</i>)	Dimensions under w , d and h are actual to the nearest 1/16"
CT3	Calibre Storage Tower		24" Wide 50", 57" and 64" Tower Internal Dimensions
WS	Wardrobe and Single Door		<ul style="list-style-type: none"> Box and M drawer height: 4⁵/₁₆" Box and M drawer width: 12¹/₁₆" Box and M drawer depth: 18³/₈" File drawer height: 9¹/₄" File drawer width: 12¹/₁₆" File drawer depth: 18³/₈" Wide drawer height: 9⁹/₁₆" Wide drawer width: 20³/₄" Wide drawer depth: 22⁷/₈"
LH	Left Hand Access		
57	50" High		
30	30" Wide	Half depth adjustable shelves and coat hooks may be ordered separately allowing the cupboard area of 15", 24" and 30" wide towers to support binders as well as shorter coats. (See <i>Tower Accessories for pricing and order entry information</i>)	
B	Box Drawer	15" w Side Access and Display towers include (1) lock.	
B	Box Drawer	Single door towers, double door towers, 24" w and 30" w Side Access and Display towers include (2) locks. (Except full-height doors which include (1) lock)	
F	File Drawer	Front Access (only) towers with wardrobe include (3) locks. (Except full-height doors with wardrobe which include (2) locks)	
L	Locking		
111	Black paint finish		Note: All towers are configured from the top down with standard combinations of box and file drawers. Note: Drawer behind door list pricing is as follows: 1=\$255

All towers are standard with (1) full depth adjustable shelf, except the 64" h side access display and bookcase towers which have (2) full depth adjustable shelves.

A 6" drawer, behind a cupboard door is available by adding the numeral 1 to the end of the pattern number, example (CT3SLH6424BBFFL1). **Note:** 6" drawers behind doors are not available within the wardrobe portion of towers. Drawers behind doors have painted black fronts.

description	type	w	d	h	pattern no.	P1	P2	P3
64" High tower with four file drawers and door and wardrobe (left hand shown)	left hand	29 ⁷ / ₈ "	23 ¹ / ₂ "	63 ⁵ / ₁₆ "	CT3WSLH6430FFFL	\$1,865.	\$2,051.	\$2,152.
	right hand	29 ⁷ / ₈ "	23 ¹ / ₂ "	63 ⁵ / ₁₆ "	CT3WSRH6430FFFL	1,865.	2,051.	2,152.

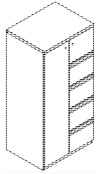

Order Code	Specification Information	Application Notes	Critical Dimensions
Example: CT3WSLH5730BBFL-111	For non-locking towers, deduct \$60 from the list price for single door and double door units or \$75 list for units with wardrobe. Substitute the "L" suffix with a "N" within the pattern number to designate a non-locking unit, example (CT3WSLH5030BBFN)	Hanging rails and other accessories are not included and must be ordered separately. Hanging rails are included with 24" and 30" wide lateral drawers only. (See <i>Tower Accessories for pricing and order entry information</i>)	Dimensions under w , d and h are actual to the nearest 1/16"
CT3 Calibre Storage Tower			24" Wide 50", 57" and 64" Tower Internal Dimensions <ul style="list-style-type: none"> • Box and M drawer height: 4⁵/₁₆" • Box and M drawer width: 12¹/₁₆" • Box and M drawer depth: 18³/₈" • File drawer height: 9¹/₄" • File drawer width: 12¹/₁₆" • File drawer depth: 18³/₈" • Wide drawer height: 9⁹/₁₆" • Wide drawer width: 20³/₄" • Wide drawer depth: 22⁷/₈"
WS Wardrobe and Single Door			
LH Left Hand Access			
57 50" High			
30 30" Wide			
B Box Drawer	"M" drawer consisting of a box drawer body with a file drawer head are available by substituting any two "B" or any one "F" character within the pattern number, example (CT3WSLH5030MFN). Multiple "M" drawers may be specified providing they equal the total modules available.	Half depth adjustable shelves and coat hooks may be ordered separately allowing the cupboard area of 15", 24" and 30" wide towers to support binders as well as shorter coats. (See <i>Tower Accessories for pricing and order entry information</i>)	
B Box Drawer			
F File Drawer			
L Locking			
111 Black paint finish			
All towers are standard with (1) full depth adjustable shelf, except the 64" h side access display and bookcase towers which have (2) full depth adjustable shelves.	A 6" drawer, behind a cupboard door is available by adding the numeral 1 to the end of the pattern number, example (CT3SLH6424BBFFL1). Note: 6" drawers behind doors are not available within the wardrobe portion of towers. Drawers behind doors have painted black fronts.	15" w Side Access and Display towers include (1) lock. Single door towers, double door towers, 24" w and 30" w Side Access and Display towers include (2) locks. (Except full-height doors which include (1) lock) Front Access (only) towers with wardrobe include (3) locks. (Except full-height doors with wardrobe which include (2) locks)	Note: All towers are configured from the top down with standard combinations of box and file drawers. Note: Drawer behind door list pricing is as follows: 1=\$255

description	type	w	d	h	lock	pattern no.	P1	P2	P3
50" High Calibre Side Access Bookcase Wardrobe Tower	left hand	23 ⁷ / ₈ "	23 ¹ / ₂ "	48 ⁵ / ₁₆ "	Y	CT3WSBLH5024PDDL	\$1,676.	\$1,847.	\$1,937.
3/10.5/10.5 drawer configuration	right hand	23 ⁷ / ₈ "	23 ¹ / ₂ "	48 ⁵ / ₁₆ "	Y	CT3WSBRH5024PDDL	1,676.	1,847.	1,937.

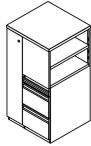

50" High, Calibre Wardrobe Tower	left hand	23 ⁷ / ₈ "	23 ¹ / ₂ "	48 ⁵ / ₁₆ "	Y	CT3WSLH5024PDDL	1,641.	1,803.	1,894.
3/10.5/10.5 drawer configuration	right hand	23 ⁷ / ₈ "	23 ¹ / ₂ "	48 ⁵ / ₁₆ "	Y	CT3WSRH5024PDDL	1,641.	1,803.	1,894.

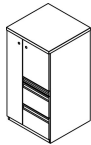

Order Code	Specification Information	Application Notes	Critical Dimensions
Example: CT3WSLH5030BBFL-111	For non-locking towers, deduct as follows from the list price for each unit: Deduct \$30 for (1) lock unit, \$60 for a (2) lock unit, and \$75 for a (3) lock unit. Substitute the "L" suffix with an "N" within the pattern number to designate a non-locking unit, example (CT3WSLH5030BBFN)	Hanging rails and other accessories are not included and must be ordered separately. Hanging rails are included with 24" and 30" wide lateral drawers only. (See <i>Tower Accessories for pricing and order entry information</i>)	Note: All towers are configured from the top down with standard combinations of box and file drawers.
CT3 Calibre Storage Tower			Note: Drawer behind door list pricing is as follows: 1=\$255
WS Wardrobe and Single Door			
LH Left Hand Access			
50 50" High			
30 30" Wide		Half depth adjustable shelves and coat hooks may be ordered separately allowing the cupboard area of 15", 24" and 30" wide towers to support binders as well as shorter coats. (See <i>Tower Accessories for pricing and order entry information</i>)	
B Box Drawer	"M" drawer consisting of a box drawer body with a file drawer head are available by substituting any two "B" or any one "F" character within the pattern number, example (CT3WSLH5030MFN). Multiple "M" drawers may be specified providing they equal the total modules available.	15"w Side Access and Display towers include (1) lock.	
B Box Drawer		Single door towers, double door towers, 24"w and 30"w Side Access and Display towers include (2) locks. (Except full-height doors which include (1) lock)	
F File Drawer		Front Access (only) towers with wardrobe include (3) locks. (Except full-height doors with wardrobe which include (2) locks)	
L Locking			
111 Black paint finish	A 6" drawer, behind a cupboard door is available by adding the numeral 1 to the end of the pattern number, example (CT3SLH6424BBFFL1). Note: 6" drawers behind doors are not available within the wardrobe portion of towers. Drawers behind doors have painted black fronts.		

description	type	w	d	h	lock	pattern no.	P1	P2	P3
57" High Calibre Side Access Bookcase Wardrobe Tower	left hand	23 ⁷ / ₈ "	23 ¹ / ₂ "	56 ³ / ₁₆ "	Y	CT3WSBLH5724PDDL	\$1,728.	\$1,901.	\$1,996.
3/10.5/10.5 drawer configuration	right hand	23 ⁷ / ₈ "	23 ¹ / ₂ "	56 ³ / ₁₆ "	Y	CT3WSBRH5724PDDL	1,728.	1,901.	1,996.

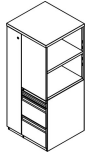

57" High Calibre Wardrobe Tower	left hand	23 ⁷ / ₈ "	23 ¹ / ₂ "	56 ³ / ₁₆ "	Y	CT3WSLH5724PDDL	1,748.	1,924.	2,021.
3/10.5/10.5 drawer configuration	right hand	23 ⁷ / ₈ "	23 ¹ / ₂ "	56 ³ / ₁₆ "	Y	CT3WSRH5724PDDL	1,748.	1,924.	2,021.

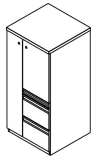

Order Code	Specification Information	Application Notes	Critical Dimensions
Example: CT3WSLH5730BBFL-111	<p>For non-locking towers, deduct as follows from the list price for each unit: Deduct \$30 for (1) lock unit, \$60 for a (2) lock unit, and \$75 for a (3) lock unit. Substitute the "L" suffix with an "N" within the pattern number to designate a non-locking unit, example (CT3WSLH5730BBFN)</p> <p>"M" drawer consisting of a box drawer body with a file drawer head are available by substituting any two "B" or any one "F" character within the pattern number, example (CT3WSLH5730MFN). Multiple "M" drawers may be specified providing they equal the total modules available.</p> <p>A 6" drawer, behind a cupboard door is available by adding the numeral 1 to the end of the pattern number, example (CT3SLH6424BBFFL1). Note: 6" drawers behind doors are not available within the wardrobe portion of towers. Drawers behind doors painted black fronts.</p>	<p>Hanging rails and other accessories are not included and must be ordered separately. Hanging rails are included with 24" and 30" wide lateral drawers only. (See <i>Tower Accessories for pricing and order entry information</i>)</p> <p>Half depth adjustable shelves and coat hooks may be ordered separately allowing the cupboard area of 15", 24" and 30" wide towers to support binders as well as shorter coats. (See <i>Tower Accessories for pricing and order entry information</i>)</p> <p>15"w Side Access and Display towers include (1) lock.</p> <p>Single door towers, double door towers, 24"w and 30"w Side Access and Display towers include (2) locks. (Except full-height doors which include (1) lock)</p> <p>Front Access (only) towers with wardrobe include (3) locks. (Except full-height doors with wardrobe which include (2) locks)</p>	<p>Note: All towers are configured from the top down with standard combinations of box and file drawers.</p> <p>Note: Drawer behind door list pricing is as follows: 1=\$255</p>
CT3 Calibre Storage Tower			
WS Wardrobe and Single Door			
LH Left Hand Access			
57 57" High			
30 30" Wide			
B Box Drawer			
B Box Drawer			
F File Drawer			
L Locking			
111 Black paint finish			

description	type	w	d	h	pattern no.	P1	P2	P3
64" High Calibre Wardrobe Tower 3/10.5/10.5 drawer configuration (right hand)	left hand	23 ⁷ / ₈ "	23 ¹ / ₂ "	63 ⁵ / ₁₆ "	CT3WSLH6424PDDL	\$1,857.	\$2,043.	\$2,145.
	right hand	23 ⁷ / ₈ "	23 ¹ / ₂ "	63 ⁵ / ₁₆ "	CT3WSRH6424PDDL	1,857.	2,043.	2,145.

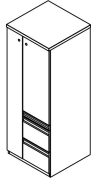

64" High Calibre Side Access Bookcase Wardrobe Tower 3/10.5/10.5 drawer configuration	left hand	23 ⁷ / ₈ "	23 ¹ / ₂ "	63 ⁵ / ₁₆ "	CT3WSBLH6424PDDL	1,779.	1,958.	2,057.
	right hand	23 ⁷ / ₈ "	23 ¹ / ₂ "	63 ⁵ / ₁₆ "	CT3WSBRH6424PDDL	1,779.	1,958.	2,057.

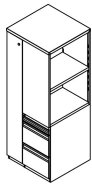

Order Code	Specification Information	Application Notes	Critical Dimensions
Example: CT3WSLH5030BBFL-111	For non-locking towers, deduct as follows from the list price for each unit: Deduct \$30 for (1) lock unit, \$60 for a (2) lock unit, and \$75 for a (3) lock unit. Substitute the "L" suffix with an "N" within the pattern number to designate a non-locking unit, example (CT3WSLH5030BBFN)	Hanging rails and other accessories are not included and must be ordered separately. Hanging rails are included with 24" and 30" wide lateral drawers only. (See <i>Tower Accessories for pricing and order entry information</i>)	Note: All towers are configured from the top down with standard combinations of box and file drawers.
CT3 Calibre Storage Tower			Note: Drawer behind door list pricing is as follows: 1=\$255
WS Wardrobe and Single Door			
LH Left Hand Access			
50 50" High			
30 30" Wide			
B Box Drawer	"M" drawer consisting of a box drawer body with a file drawer head are available by substituting any two "B" or any one "F" character within the pattern number, example (CT3WSLH5030MFN). Multiple "M" drawers may be specified providing they equal the total modules available.	Half depth adjustable shelves and coat hooks may be ordered separately allowing the cupboard area of 15", 24" and 30" wide towers to support binders as well as shorter coats. (See <i>Tower Accessories for pricing and order entry information</i>)	
B Box Drawer		15"w Side Access and Display towers include (1) lock.	
F File Drawer		Single door towers, double door towers, 24"w and 30"w Side Access and Display towers include (2) locks. (Except full-height doors which include (1) lock)	
L Locking		Front Access (only) towers with wardrobe include (3) locks. (Except full-height doors with wardrobe which include (2) locks)	
111 Black paint finish	A 6" drawer, behind a cupboard door is available by adding the numeral 1 to the end of the pattern number, example (CT3SLH6424BBFFL1). Note: 6" drawers behind doors are not available within the wardrobe portion of towers. Drawers behind doors have painted black fronts.		

description	type	w	d	h	pattern no.	P1	P2	P3
64" High Calibre Side Access Display Wardrobe Tower	left hand	23 ⁷ / ₈ "	23 ¹ / ₂ "	63 ⁵ / ₁₆ "	CT3WBDLH6424PDDL	\$1,793.	\$1,974.	\$2,073.
3/10.5/10.5 drawer configuration	right hand	23 ⁷ / ₈ "	23 ¹ / ₂ "	63 ⁵ / ₁₆ "	CT3WBDRH6424PDDL	1,793.	1,974.	2,073.

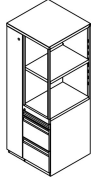

Order Code	Specification Information	Application Notes	Critical Dimensions
Example: CT3WSLH5030BBFL-111	<p>For non-locking towers, deduct as follows from the list price for each unit: Deduct \$30 for (1) lock unit, \$60 for a (2) lock unit, and \$75 for a (3) lock unit. Substitute the "L" suffix with an "N" within the pattern number to designate a non-locking unit, example (CT3WSLH5030BBFN)</p> <p>"M" drawer consisting of a box drawer body with a file drawer head are available by substituting any two "B" or any one "F" character within the pattern number, example (CT3WSLH5030MFN). Multiple "M" drawers may be specified providing they equal the total modules available.</p> <p>A 6" drawer, behind a cupboard door is available by adding the numeral 1 to the end of the pattern number, example (CT3SLH6424BBFFL1). Note: 6" drawers behind doors are not available within the wardrobe portion of towers. Drawers behind doors have painted black fronts.</p>	<p>Hanging rails and other accessories are not included and must be ordered separately. Hanging rails are included with 24" and 30" wide lateral drawers only. (See <i>Tower Accessories for pricing and order entry information</i>)</p> <p>Half depth adjustable shelves and coat hooks may be ordered separately allowing the cupboard area of 15", 24" and 30" wide towers to support binders as well as shorter coats. (See <i>Tower Accessories for pricing and order entry information</i>)</p> <p>15" w Side Access and Display towers include (1) lock.</p> <p>Single door towers, double door towers, 24" w and 30" w Side Access and Display towers include (2) locks. (Except full-height doors which include (1) lock)</p> <p>Front Access (only) towers with wardrobe include (3) locks. (Except full-height doors with wardrobe which include (2) locks)</p>	<p>Note: All towers are configured from the top down with standard combinations of box and file drawers.</p> <p>Note: Drawer behind door list pricing is as follows: 1=\$255</p>
CT3 Calibre Storage Tower			
WS Wardrobe and Single Door			
LH Left Hand Access			
50 50" High			
30 30" Wide			
B Box Drawer			
B Box Drawer			
F File Drawer			
L Locking			
111 Black paint finish			

description	type	w	d	h	pattern no.	list	P1	P2	P3
-------------	------	---	---	---	-------------	------	----	----	----

Pedestal Drawer Divider Kit (For use in Calibre tower or Calibre pedestal box and file drawers as well as Calibre lateral file drawers 6" or larger. Not intended for 3" drawers.)

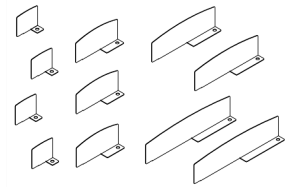

DT3PDD \$404.

File Drawer Divider Kit (For use with all Calibre/S2/Morrison front lateral file drawers with the exception of 3" high drawers)

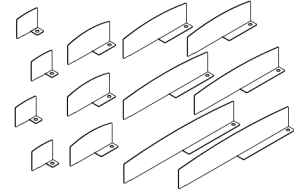

DT3FDD 503.

Specification Information

DT3PDD Pedestal Drawer Dividers and **DT3RT** Pedestal Drawer Reference Tablets are supported with a black painted finish standard.

Application Notes

The **DT3PDD** Pedestal Drawer Divider Kit is comprised of a series of magnetic fences that attach to the bottom of steel pedestal (Calibre and S2) pedestal drawer bodies to support space division. May also be used within S2 and Calibre Tower File and Box drawers. Each kit contains (4) 3" wide, (3) 6" wide, (2) 9" wide and (2) 12" wide dividers. Dividers are constructed from steel. **DT3PDD** dividers are not designed to work with 3" high lateral file or pedestal drawers.

The **DT3FDD** File Drawer Divider Kit is comprised of a series of magnetic fences that attach to the bottom of (Calibre/S2/Morrison Font) lateral file drawer bodies to support space division. Each kit contains (4) 3" wide, (3) 6" wide, (2) 9" wide, (2) 12" and (2) 15" dividers. Dividers are constructed from steel. **DT3FDD** dividers are not designed to work with 3" high lateral file or pedestal drawers.

The **DT3SDD** File Drawer Divider Kit is comprised of a series of magnetic fences that attach to the bottom of (Calibre/S2/Morrison Font) lateral file drawer bodies to support space division. Each kit contains (4) 3" wide, (3) 6" wide, (2) 9" wide, (2) 12" and (2) 15" dividers. Dividers are constructed from steel. **DT3SDD** dividers are designed to work with 3" high lateral file or pedestal drawers.

Note: Worksurface Splice Plate Kits are intended for use with Side Access Bookcase and Display Towers only.

Note: 15" wide half depth shelves are suitable for use with 15" wide single door towers or within the wardrobe portion of a 30" wide wardrobe tower.

Note: 24" wide half depth shelves are suitable for use with 24" wide single door towers or 24" wide double door towers. 30" wide half depth shelves are suitable for use in with 30" wide double door towers only.

description	type	w	d	h	pattern no.	list	P1	P2	P3
-------------	------	---	---	---	-------------	------	----	----	----

File Drawer Divider Kit for 3" high lateral drawers

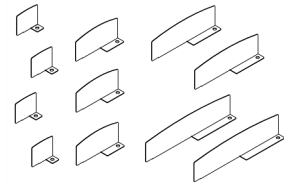

DT3SDD \$503.

Pencil Tray (Calibre/Dividends/S2 pedestals and towers)

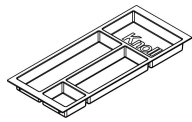

black	DS2PPTN	40.
clear	DS2PPTC	47.

Reference Tablet with Plexi Glass Cover (For use with Calibre/S2 pedestals and towers)

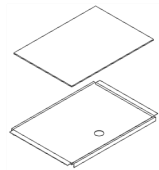

DT3RT 116.

Specification Information

DT3PDD Pedestal Drawer Dividers and **DT3RT** Pedestal Drawer Reference Tablets are supported with a black painted finish standard.

Application Notes

The **DT3PDD** Pedestal Drawer Divider Kit is comprised of a series of magnetic fences that attach to the bottom of steel pedestal (Calibre and S2) pedestal drawer bodies to support space division. May also be used within S2 and Calibre Tower File and Box drawers. Each kit contains (4) 3" wide, (3) 6" wide, (2) 9" wide and (2) 12" wide dividers. Dividers are constructed from steel. **DT3PDD** dividers are not designed to work with 3" high lateral file or pedestal drawers.

The **DT3FDD** File Drawer Divider Kit is comprised of a series of magnetic fences that attach to the bottom of (Calibre/S2/Morrison Font) lateral file drawer bodies to support space division. Each kit contains (4) 3" wide, (3) 6" wide, (2) 9" wide, (2) 12" and (2) 15" dividers. Dividers are constructed from steel. **DT3FDD** dividers are not designed to work with 3" high lateral file or pedestal drawers.

The **DT3SDD** File Drawer Divider Kit is comprised of a series of magnetic fences that attach to the bottom of (Calibre/S2/Morrison Font) lateral file drawer bodies to support space division. Each kit contains (4) 3" wide, (3) 6" wide, (2) 9" wide, (2) 12" and (2) 15" dividers. Dividers are constructed from steel. **DT3SDD** dividers are designed to work with 3" high lateral file or pedestal drawers.

Note: Worksurface Splice Plate Kits are intended for use with Side Access Bookcase and Display Towers only.

Note: 15" wide half depth shelves are suitable for use with 15" wide single door towers or within the wardrobe portion of a 30" wide wardrobe tower.

Note: 24" wide half depth shelves are suitable for use with 24" wide single door towers or 24" wide double door towers. 30" wide half depth shelves are suitable for use in with 30" wide double door towers only.

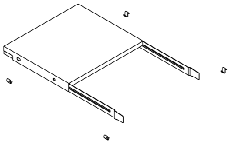
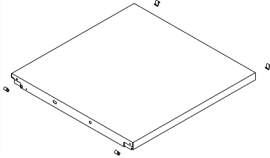
description	type	w	d	h	pattern no.	list	P1	P2	P3
15" Wide Half Depth Shelf (black only)	Half Depth	15"	12"	3/4"	DT3HDS15	\$137.			
									
24" Wide Half Depth Shelf (black only)	Half Depth	24"	12"	3/4"	DT3HDS24	146.			
30" Wide Half Depth Shelf (black only)	Half Depth	30"	12"	3/4"	DT3HDS30	174.			
15" Wide Full Depth Shelf (black only)	Full Depth	15"	22 3/8"	1"	DT3FDS15	98.			
									
24" Wide Full Depth Shelf (black only)	Full Depth	24"	22 3/8"	1"	DT3FDS24	107.			

Specification Information

DT3PDD Pedestal Drawer Dividers and **DT3RT** Pedestal Drawer Reference Tablets are supported with a black painted finish standard.

Application Notes

The **DT3PDD** Pedestal Drawer Divider Kit is comprised of a series of magnetic fences that attach to the bottom of steel pedestal (Calibre and S2) pedestal drawer bodies to support space division. May also be used within S2 and Calibre Tower File and Box drawers. Each kit contains (4) 3" wide, (3) 6" wide, (2) 9" wide and (2) 12" wide dividers. Dividers are constructed from steel. **DT3PDD** dividers are not designed to work with 3" high lateral file or pedestal drawers.

The **DT3FDD** File Drawer Divider Kit is comprised of a series of magnetic fences that attach to the bottom of (Calibre/S2/Morrison Font) lateral file drawer bodies to support space division. Each kit contains (4) 3" wide, (3) 6" wide, (2) 9" wide, (2) 12" and (2) 15" dividers. Dividers are constructed from steel. **DT3FDD** dividers are not designed to work with 3" high lateral file or pedestal drawers.

The **DT3SDD** File Drawer Divider Kit is comprised of a series of magnetic fences that attach to the bottom of (Calibre/S2/Morrison Font) lateral file drawer bodies to support space division. Each kit contains (4) 3" wide, (3) 6" wide, (2) 9" wide, (2) 12" and (2) 15" dividers. Dividers are constructed from steel. **DT3SDD** dividers are designed to work with 3" high lateral file or pedestal drawers.

Note: Worksurface Splice Plate Kits are intended for use with Side Access Bookcase and Display Towers only.

Note: 15" wide half depth shelves are suitable for use with 15" wide single door towers or within the wardrobe portion of a 30" wide wardrobe tower.

Note: 24" wide half depth shelves are suitable for use with 24" wide single door towers or 24" wide double door towers. 30" wide half depth shelves are suitable for use in with 30" wide double door towers only.

description	type	w	d	h	pattern no.	list	P1	P2	P3
30" Wide Full Depth Shelf (black only)	Full Depth	30"	22 ³ / ₈ "	1"	DT3FDS30	\$114.			

Glass Shelf for Side Access Bookcase and Display Tower	Qty 2 shelves				DT3GBCDS	428.			
--	---------------	--	--	--	-----------------	------	--	--	--

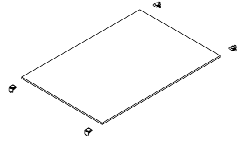

Metal Shelf for Side Access Bookcase and Display Towers	Qty 2 Shelves				DT3MBCDS		225.	245.	259.
---	---------------	--	--	--	-----------------	--	------	------	------

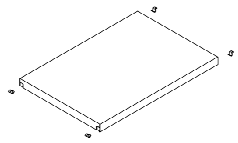

Worksurface Splice Plate Kit for Display and Side Access Bookcase Towers					DT3WSP		150.	166.	175.
--	--	--	--	--	---------------	--	------	------	------

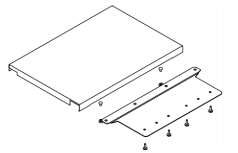

Specification Information

DT3PDD Pedestal Drawer Dividers and **DT3RT** Pedestal Drawer Reference Tablets are supported with a black painted finish standard.

Application Notes

The **DT3PDD** Pedestal Drawer Divider Kit is comprised of a series of magnetic fences that attach to the bottom of steel pedestal (Calibre and S2) pedestal drawer bodies to support space division. May also be used within S2 and Calibre Tower File and Box drawers. Each kit contains (4) 3" wide, (3) 6" wide, (2) 9" wide and (2) 12" wide dividers. Dividers are constructed from steel. **DT3PDD** dividers are not designed to work with 3" high lateral file or pedestal drawers.

The **DT3FDD** File Drawer Divider Kit is comprised of a series of magnetic fences that attach to the bottom of (Calibre/S2/Morrison Font) lateral file drawer bodies to support space division. Each kit contains (4) 3" wide, (3) 6" wide, (2) 9" wide, (2) 12" and (2) 15" dividers. Dividers are constructed from steel. **DT3FDD** dividers are not designed to work with 3" high lateral file or pedestal drawers.

The **DT3SDD** File Drawer Divider Kit is comprised of a series of magnetic fences that attach to the bottom of (Calibre/S2/Morrison Font) lateral file drawer bodies to support space division. Each kit contains (4) 3" wide, (3) 6" wide, (2) 9" wide, (2) 12" and (2) 15" dividers. Dividers are constructed from steel. **DT3SDD** dividers are designed to work with 3" high lateral file or pedestal drawers.

Note: Worksurface Splice Plate Kits are intended for use with Side Access Bookcase and Display Towers only.

Note: 15" wide half depth shelves are suitable for use with 15" wide single door towers or within the wardrobe portion of a 30" wide wardrobe tower.

Note: 24" wide half depth shelves are suitable for use with 24" wide single door towers or 24" wide double door towers. 30" wide half depth shelves are suitable for use in with 30" wide double door towers only.

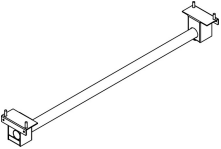
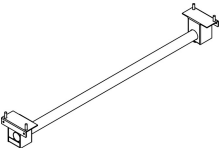
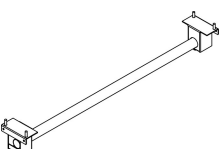
description	type	w	d	h	pattern no.	list	P1	P2	P3
Coat bar kit for 9" wide wardrobe					DT3CB9	\$130.			
									
Coat Bar Kit for 15" wide single door or 15" wide wardrobe					DT3CB15	136.			
									
Coat Bar for 24" wide single and double door towers					DT3CB24	146.			
									

Specification Information

DT3PDD Pedestal Drawer Dividers and **DT3RT** Pedestal Drawer Reference Tablets are supported with a black painted finish standard.

Application Notes

The **DT3PDD** Pedestal Drawer Divider Kit is comprised of a series of magnetic fences that attach to the bottom of steel pedestal (Calibre and S2) pedestal drawer bodies to support space division. May also be used within S2 and Calibre Tower File and Box drawers. Each kit contains (4) 3" wide, (3) 6" wide, (2) 9" wide and (2) 12" wide dividers. Dividers are constructed from steel. **DT3PDD** dividers are not designed to work with 3" high lateral file or pedestal drawers.

The **DT3FDD** File Drawer Divider Kit is comprised of a series of magnetic fences that attach to the bottom of (Calibre/S2/Morrison Font) lateral file drawer bodies to support space division. Each kit contains (4) 3" wide, (3) 6" wide, (2) 9" wide, (2) 12" and (2) 15" dividers. Dividers are constructed from steel. **DT3FDD** dividers are not designed to work with 3" high lateral file or pedestal drawers.

The **DT3SDD** File Drawer Divider Kit is comprised of a series of magnetic fences that attach to the bottom of (Calibre/S2/Morrison Font) lateral file drawer bodies to support space division. Each kit contains (4) 3" wide, (3) 6" wide, (2) 9" wide, (2) 12" and (2) 15" dividers. Dividers are constructed from steel. **DT3SDD** dividers are designed to work with 3" high lateral file or pedestal drawers.

Note: Worksurface Splice Plate Kits are intended for use with Side Access Bookcase and Display Towers only.

Note: 15" wide half depth shelves are suitable for use with 15" wide single door towers or within the wardrobe portion of a 30" wide wardrobe tower.

Note: 24" wide half depth shelves are suitable for use with 24" wide single door towers or 24" wide double door towers. 30" wide half depth shelves are suitable for use in with 30" wide double door towers only.

description	type	w	d	h	pattern no.	list	P1	P2	P3
-------------	------	---	---	---	-------------	------	----	----	----

Coat Bar for 30" wide double door towers

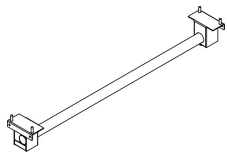

DT3CB30 \$158.

Drop Down Coat Hook for use in towers without a standard wardrobe

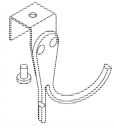

DT3DCH 87.

Floor Cover for 9" Wide Wardrobe

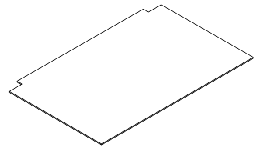

DT3FM9 63.

Specification Information

DT3PDD Pedestal Drawer Dividers and **DT3RT** Pedestal Drawer Reference Tablets are supported with a black painted finish standard.

Application Notes

The **DT3PDD** Pedestal Drawer Divider Kit is comprised of a series of magnetic fences that attach to the bottom of steel pedestal (Calibre and S2) pedestal drawer bodies to support space division. May also be used within S2 and Calibre Tower File and Box drawers. Each kit contains (4) 3" wide, (3) 6" wide, (2) 9" wide and (2) 12" wide dividers. Dividers are constructed from steel. **DT3PDD** dividers are not designed to work with 3" high lateral file or pedestal drawers.

The **DT3FDD** File Drawer Divider Kit is comprised of a series of magnetic fences that attach to the bottom of (Calibre/S2/Morrison Font) lateral file drawer bodies to support space division. Each kit contains (4) 3" wide, (3) 6" wide, (2) 9" wide, (2) 12" and (2) 15" dividers. Dividers are constructed from steel. **DT3FDD** dividers are not designed to work with 3" high lateral file or pedestal drawers.

The **DT3SDD** File Drawer Divider Kit is comprised of a series of magnetic fences that attach to the bottom of (Calibre/S2/Morrison Font) lateral file drawer bodies to support space division. Each kit contains (4) 3" wide, (3) 6" wide, (2) 9" wide, (2) 12" and (2) 15" dividers. Dividers are constructed from steel. **DT3SDD** dividers are designed to work with 3" high lateral file or pedestal drawers.

Note: Worksurface Splice Plate Kits are intended for use with Side Access Bookcase and Display Towers only.

Note: 15" wide half depth shelves are suitable for use with 15" wide single door towers or within the wardrobe portion of a 30" wide wardrobe tower.

Note: 24" wide half depth shelves are suitable for use with 24" wide single door towers or 24" wide double door towers. 30" wide half depth shelves are suitable for use in with 30" wide double door towers only.

description	type	w	d	h	pattern no.	list	P1	P2	P3
Floor Cover for 15" Wide Wardrobe					DT3FM15	\$76.			

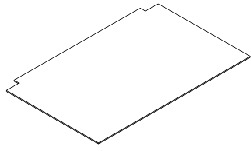

Specification Information

DT3PDD Pedestal Drawer Dividers and **DT3RT** Pedestal Drawer Reference Tablets are supported with a black painted finish standard.

Application Notes

The **DT3PDD** Pedestal Drawer Divider Kit is comprised of a series of magnetic fences that attach to the bottom of steel pedestal (Calibre and S2) pedestal drawer bodies to support space division. May also be used within S2 and Calibre Tower File and Box drawers. Each kit contains (4) 3" wide, (3) 6" wide, (2) 9" wide and (2) 12" wide dividers. Dividers are constructed from steel. **DT3PDD** dividers are not designed to work with 3" high lateral file or pedestal drawers.

The **DT3FDD** File Drawer Divider Kit is comprised of a series of magnetic fences that attach to the bottom of (Calibre/S2/Morrison Font) lateral file drawer bodies to support space division. Each kit contains (4) 3" wide, (3) 6" wide, (2) 9" wide, (2) 12" and (2) 15" dividers. Dividers are constructed from steel. **DT3FDD** dividers are not designed to work with 3" high lateral file or pedestal drawers.

The **DT3SDD** File Drawer Divider Kit is comprised of a series of magnetic fences that attach to the bottom of (Calibre/S2/Morrison Font) lateral file drawer bodies to support space division. Each kit contains (4) 3" wide, (3) 6" wide, (2) 9" wide, (2) 12" and (2) 15" dividers. Dividers are constructed from steel. **DT3SDD** dividers are designed to work with 3" high lateral file or pedestal drawers.

Note: Worksurface Splice Plate Kits are intended for use with Side Access Bookcase and Display Towers only.

Note: 15" wide half depth shelves are suitable for use with 15" wide single door towers or within the wardrobe portion of a 30" wide wardrobe tower.

Note: 24" wide half depth shelves are suitable for use with 24" wide single door towers or 24" wide double door towers. 30" wide half depth shelves are suitable for use in with 30" wide double door towers only.

Calibre Desk

single pedestal - 24" deep

Calibre

description	w	d	h	lock	pattern no.	P1	P2	P3
Single-pedestal desk	60"	24"	28 1/2"		CS1-6024(5)N	\$1,674.	\$1,737.	\$1,824.
	60"	24"	28 1/2"	Y	CS1-6024(5)L	1,703.	1,769.	1,857.
	66"	24"	28 1/2"		CS1-6624(5)N	1,713.	1,774.	1,865.
	66"	24"	28 1/2"	Y	CS1-6624(5)L	1,743.	1,806.	1,899.
	72"	24"	28 1/2"		CS1-7224(5)N	1,751.	1,819.	1,910.
	72"	24"	28 1/2"	Y	CS1-7224(5)L	1,786.	1,850.	1,943.

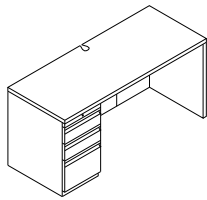

Order Code

Example:	CS1-6624(5)L-111 F
C	Calibre
S1	Single pedestal desk
66	66" wide
24	24" deep
5	Box/box/file
L	Lock
111	Paint - black
F	Laminate - pumice

Specification Information

To order, specify:

1. Pattern number
2. Pedestal options
3. Lock option
4. Paint finish
5. Laminate finish

The standard pedestal configuration for single pedestal desks is "5" box/box/file pedestal. For other configurations, substitute the appropriate pedestal codes and upcharges where necessary.

Pedestal upcharges:

Order Code	Config.	Upcharge
6	3/3/6/12	\$44.
7	12/12	-\$21.
8	3/6/15	\$44.

See page 19 for Calibre desk finishes.

Application Notes

Single pedestal desks are standard with one box/box/file pedestal matching the worksurface depth. For other drawer combinations, see Specification Information.

File drawers include hanging bars for side to side filing.

Desks will support Overdesk Units. See page 169.

See KnollKey lock program on page 188 for keying information.

Grommet:

Center rear grommet is standard on all preconfigured units. Finish is black, and includes cover.

Construction:

Worksurfaces are 1/4" thick, 3-ply solid construction and are predrilled at all pedestal, end unit, and bracket locations.

Pedestals, end units, and filler panels are painted steel.

Calibre Desk

single pedestal - 30" deep

Calibre

description	w	d	h	lock	pattern no.	P1	P2	P3
Single-pedestal desk	60"	30"	28 1/2"		CS1-6030(5)N	\$1,784.	\$1,850.	\$1,943.
	60"	30"	28 1/2"	Y	CS1-6030(5)L	1,816.	1,881.	1,976.
	66"	30"	28 1/2"		CS1-6630(5)N	1,828.	1,893.	1,986.
	66"	30"	28 1/2"	Y	CS1-6630(5)L	1,860.	1,925.	2,023.
	72"	30"	28 1/2"		CS1-7230(5)N	1,871.	1,940.	2,034.
	72"	30"	28 1/2"	Y	CS1-7230(5)L	1,902.	1,972.	2,070.

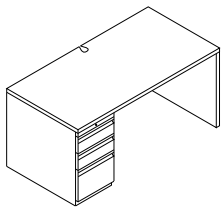

Order Code

Example:	CS1-7230(5)N-111 F
C	Calibre
S1	Single pedestal desk
72	72" wide
30	30" deep
5	Box/box/file
N	No lock
111	Paint - black
F	Laminate - pumice

Specification Information

To order, specify:

1. Pattern number
2. Pedestal options
3. Lock option
4. Paint finish
5. Laminate finish

The standard pedestal configuration for single pedestal desks is "5" box/box/file pedestal. For other configurations, substitute the appropriate pedestal codes and upcharges where necessary.

Pedestal upcharges:

Order Code	Config.	Upcharge
6	3/3/6/12	\$75.
7	12/12	-\$22.

See page 19 for Calibre desk finishes.

Application Notes

Single pedestal desks are standard with one box/box/file pedestal matching the worksurface depth. For other drawer combinations, see Specification Information.

File drawers include hanging bars for side to side filing.

Desks will support Overdesk Units. See page 169.

Grommet:
Center rear grommet is standard on all preconfigured units. Finish is black, and includes cover.

Construction:
Worksurfaces are 1/4" thick, 3-ply solid construction and are predrilled at all pedestal, end unit, and bracket locations.

Pedestals, end units, and filler panels are painted steel.

Calibre Desk

single pedestal - 36" deep

Calibre

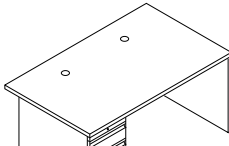
description	w	d	h	lock	pattern no.	P1	P2	P3
 Single-pedestal desk	60"	36"	28 1/2"		CS1-6036(5)N	\$1,823.	\$1,889.	\$1,983.
	60"	36"	28 1/2"	Y	CS1-6036(5)L	1,857.	1,924.	2,021.
	66"	36"	28 1/2"		CS1-6636(5)N	1,862.	1,929.	2,027.
	66"	36"	28 1/2"	Y	CS1-6636(5)L	1,895.	1,967.	2,066.
	72"	36"	28 1/2"		CS1-7236(5)N	1,936.	2,003.	2,101.
	72"	36"	28 1/2"	Y	CS1-7236(5)L	1,971.	2,035.	2,137.

Order Code

Example:	CS1-7236(5)N-111 F
C	Calibre
S1	Single pedestal desk
72	72" wide
36	36" deep
5	Box/box/file
N	No lock
111	Paint - black
F	Laminate - pumice

Specification Information

To order, specify:

1. Pattern number
2. Pedestal options
3. Lock option
4. Paint finish
5. Laminate finish

The standard pedestal configuration for single pedestal desks is "5" box/box/file pedestal. For other configurations, substitute the appropriate pedestal codes and upcharges where necessary.

Pedestal upcharges:

Order Code	Config.	Upcharge
6	3/3/6/12	\$75.
7	12/12	-\$22.

See page 19 for Calibre desk finishes.

Application Notes

Single pedestal desks are standard with one box/box/file pedestal matching the worksurface depth. For other drawer combinations, see Specification Information.

File drawers include hanging bars for side to side filing.

Desks will support Overdesk Units. See page 169.

Grommet:

36"D desks include two 3" round black grommets with covers, located inside kneespace.

Construction:

Worksurfaces are 1/4" thick, 3-ply solid construction and are predrilled at all pedestal, end unit, and bracket locations.

Pedestals, end units, and filler panels are painted steel.

Calibre Desk

double pedestal - 24" deep

Calibre

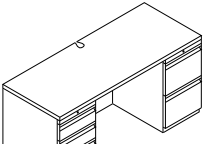
description	w	d	h	lock	pattern no.	P1	P2	P3
	60"	24"	28 1/2"		CD1-6024(5)(7)N	\$2,009.	\$2,091.	\$2,194.
	60"	24"	28 1/2"	Y	CD1-6024(5)(7)L	2,072.	2,154.	2,263.
	66"	24"	28 1/2"		CD1-6624(5)(7)N	2,046.	2,130.	2,237.
	66"	24"	28 1/2"	Y	CD1-6624(5)(7)L	2,109.	2,194.	2,304.
	72"	24"	28 1/2"		CD1-7224(5)(7)N	2,087.	2,173.	2,281.
	72"	24"	28 1/2"	Y	CD1-7224(5)(7)L	2,153.	2,237.	2,348.

Order Code	Specification Information	Application Notes
Example: CD1-7224(5)(7)L-612 D	<i>To order, specify:</i>	Double pedestal desks are standard with one box/box/file pedestal and one file/file pedestal matching the worksurface depth. For other drawer combinations, see Specification Information.
C Calibre	1. Pattern number	
D1 Double pedestal desk	2. Pedestal options	File drawers include hanging bars for side to side filing.
72 72" wide	3. Lock option	Desks will support Overdesk Units. See page 169.
24 24" deep	4. Paint finish	See KnollKey lock program on page 188 for keying information.
5 Box/box/file	5. Laminate finish	
7 File/file	The standard pedestal configuration for double pedestal desks is "5" box/box/file pedestal and "7" file/file pedestal. For other configurations, substitute the appropriate pedestal codes and upcharges where necessary.	
L Lock		
612 Paint - medium metallic grey		
D Laminate - Sand		
	<i>Pedestal upcharges:</i>	<i>Grommet:</i>
	Order Code Config. Upcharge	Center rear grommet is standard on all preconfigured units. Finish is black, and includes cover.
	5 6/6/12 \$ 0.	
	6 3/3/6/12 \$44.	<i>Construction:</i>
	7 12/12 -\$22.	Worksurfaces are 1 1/4" thick, 3-ply solid construction and are predrilled at all pedestal, end unit, and bracket locations.
	8 3/6/15 \$44.	
	See page 19 for Calibre desk finishes.	Pedestals, end units, and filler panels are painted steel.

Calibre Desk

double pedestal - 30" deep

Calibre

description	w	d	h	lock	pattern no.	P1	P2	P3
Double-pedestal desk	60"	30"	28 1/2"		CD1-6030(5)(7)N	\$2,125.	\$2,208.	\$2,318.
	60"	30"	28 1/2"	Y	CD1-6030(5)(7)L	2,187.	2,275.	2,387.
	66"	30"	28 1/2"		CD1-6630(5)(7)N	2,169.	2,250.	2,363.
	66"	30"	28 1/2"	Y	CD1-6630(5)(7)L	2,230.	2,315.	2,434.
	72"	30"	28 1/2"		CD1-7230(5)(7)N	2,209.	2,299.	2,412.
	72"	30"	28 1/2"	Y	CD1-7230(5)(7)L	2,276.	2,360.	2,478.

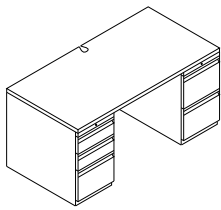

Order Code	Specification Information	Application Notes
Example: CD1-7230(5)(7)N-612 G	<i>To order, specify:</i>	Double pedestal desks are standard with one box/box/file pedestal and one file/file pedestal matching the worksurface depth. For other drawer combinations, see Specification Information.
C Calibre	1. Pattern number	
D1 Double pedestal desk	2. Pedestal options	File drawers include hanging bars for side to side filing.
72 72" wide	3. Lock option	Desks will support Overdesk Units. See page 169.
30 30" deep	4. Paint finish	See KnollKey lock program on page 188 for keying information.
5 Box/box/file	5. Laminate finish	
7 File/file	The standard pedestal configuration for double pedestal desks is "5" box/box/file pedestal and "7" file/file pedestal. For other configurations, substitute the appropriate pedestal codes and upcharges where necessary.	
N No lock		
612 Paint - medium metallic grey		
G Laminate - medium grey		
	<i>Pedestal upcharges:</i>	<i>Grommet:</i>
	Order Code Config. Upcharge	Center rear grommet is standard on all preconfigured units. Finish is black, and includes cover.
	5 6/6/12 \$ 0.	
	6 3/3/6/12 \$75.	<i>Construction:</i>
	7 12/12 -\$22.	Worksurfaces are 1/4" thick, 3-ply solid construction and are predrilled at all pedestal, end unit, and bracket locations.
	See page 19 for Calibre desk finishes.	Pedestals, end units, and filler panels are painted steel.

Calibre Desk

double pedestal - 36" deep

Calibre

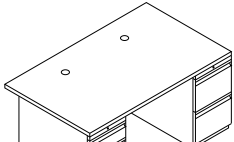
description	w	d	h	lock	pattern no.	P1	P2	P3
	60"	36"	28 1/2"		CD1-6036(5)(7)N	\$2,159.	\$2,242.	\$2,353.
	60"	36"	28 1/2"	Y	CD1-6036(5)(7)L	2,221.	2,306.	2,420.
	66"	36"	28 1/2"		CD1-6636(5)(7)N	2,197.	2,281.	2,394.
	66"	36"	28 1/2"	Y	CD1-6636(5)(7)L	2,259.	2,345.	2,462.
	72"	36"	28 1/2"		CD1-7236(5)(7)N	2,273.	2,356.	2,472.
	72"	36"	28 1/2"	Y	CD1-7236(5)(7)L	2,334.	2,419.	2,542.

Order Code

Example:	CD1-7236(5)(7)N-612 G
C	Calibre
D1	Double pedestal desk
72	72" wide
36	36" deep
5	Box/box/file
7	File/file
N	No lock
612	Paint - medium metallic grey
G	Laminate - medium grey

Specification Information

To order, specify:

1. Pattern number
2. Pedestal options
3. Lock option
4. Paint finish
5. Laminate finish

The standard pedestal configuration for double pedestal desks is "5" box/box/file pedestal and "7" file/file pedestal. For other configurations, substitute the appropriate pedestal codes and upcharges where necessary.

Pedestal upcharges:

Order Code	Config.	Upcharge
5	6/6/12	\$ 0.
6	3/3/6/12	\$75.
7	12/12	-\$22.

See page 19 for Calibre desk finishes.

Application Notes

36" deep double pedestal desks are standard with one box/box/file pedestal and one file/file pedestal. For other drawer combinations, see Specification Information.

36"D desks have a 6" overhang at the rear.

File drawers include hanging bars for side to side filing.

Desks will support Overdesk Units. See page 169.

See KnollKey lock program on page 188 for keying information.

Grommet:
36"D desks include two 3" round black grommets, located inside kneespace.

Construction:
Worksurfaces are 1 1/4" thick, 3-ply solid construction and are predrilled at all pedestal, end unit, and bracket locations.

Pedestals, end units, and filler panels are painted steel.

Calibre Desk
 return - 18" and 24" deep
 with end unit

Calibre

description	w	d	h	pattern no.	P1	P2	P3
Returns with end unit	36"	18"	28 1/2"	CR1-3618	\$753.	\$775.	\$814.
	36"	24"	28 1/2"	CR1-3624	835.	861.	902.
	42"	18"	28 1/2"	CR1-4218	789.	814.	854.
	42"	24"	28 1/2"	CR1-4224	874.	899.	946.
	48"	18"	28 1/2"	CR1-4818	832.	859.	900.
	48"	24"	28 1/2"	CR1-4824	917.	942.	990.
	60"	18"	28 1/2"	CR1-6018	914.	933.	983.
	60"	24"	28 1/2"	CR1-6024	997.	1,023.	1,073.

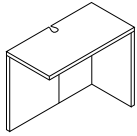

Order Code

Example: CR1-4218-612 F
C Calibre
R1 Return
42 42" wide
18 18" deep
612 Paint - medium metallic grey
F Laminate - pumice

Specification Information

To order, specify:

1. Pattern number
2. Paint finish
3. Laminate finish

See page 19 for Calibre desk finishes.

Application Notes

Returns include flat brackets for attachment to desks or corner units.

Construction:
 Worksurfaces are 1 1/4" thick, 3-ply solid construction and are predrilled at all pedestal, end unit, and bracket locations.

End units, and filler panels are painted steel.

Grommet:
 Center rear grommet is standard on all preconfigured units. Finish is black, and includes cover.

Calibre Desk
return - 18" and 24" deep
with pedestal

Calibre

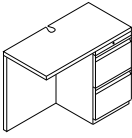
description	w	d	h	lock	pattern no.	P1	P2	P3
Returns with pedestal	36"	18"	28 1/2"		CR1-3618(7)N	\$1,050.	\$1,092.	\$1,144.
	36"	18"	28 1/2"	Y	CR1-3618(7)L	1,080.	1,123.	1,178.
	36"	24"	28 1/2"		CR1-3624(7)N	1,171.	1,211.	1,273.
	36"	24"	28 1/2"	Y	CR1-3624(7)L	1,203.	1,244.	1,309.
	42"	18"	28 1/2"		CR1-4218(7)N	1,091.	1,130.	1,183.
	42"	18"	28 1/2"	Y	CR1-4218(7)L	1,122.	1,162.	1,216.
	42"	24"	28 1/2"		CR1-4224(7)N	1,209.	1,254.	1,316.
	42"	24"	28 1/2"	Y	CR1-4224(7)L	1,241.	1,286.	1,350.
	48"	18"	28 1/2"		CR1-4818(7)N	1,131.	1,173.	1,233.
	48"	18"	28 1/2"	Y	CR1-4818(7)L	1,163.	1,205.	1,263.
	48"	24"	28 1/2"		CR1-4824(7)N	1,251.	1,296.	1,359.
	48"	24"	28 1/2"	Y	CR1-4824(7)L	1,283.	1,327.	1,394.
	60"	18"	28 1/2"		CR1-6018(7)N	1,209.	1,252.	1,315.
	60"	18"	28 1/2"	Y	CR1-6018(7)L	1,241.	1,285.	1,349.
	60"	24"	28 1/2"		CR1-6024(7)N	1,331.	1,376.	1,444.
	60"	24"	28 1/2"	Y	CR1-6024(7)L	1,362.	1,408.	1,477.

Order Code	Specification Information	Application Notes
Example: CR1-6024(7)L-612 L	<i>To order, specify:</i>	Returns with pedestal are standard with one file/file pedestal. For other drawer combinations, see Specification Information.
C Calibre	1. Pattern number	File drawers include hanging bars for side to side filing.
R1 Return	2. Pedestal options	
60 60" wide	3. Lock option	
24 24" deep	4. Paint finish	
7 File/file	5. Laminate finish	
L Lock	The standard pedestal configuration for returns with pedestal is "7" file/file pedestal. For other configurations, substitute the appropriate pedestal codes and upcharges where necessary.	Returns include flat brackets for attachment to desks or corner units.
612 Paint - medium metallic grey		See KnollKey lock program on page 188 for keying information.
L Laminate - light grey		<i>Grommet:</i> Center rear grommet is standard on all preconfigured units. Finish is black, and includes cover.
	<i>Pedestal upcharges:</i>	<i>Construction:</i> Worksurfaces are 1/4" thick, 3-ply solid construction and are predrilled at all pedestal, end unit, and bracket locations.
	Order Code Config. Upcharge	Pedestals, end units, and filler panels are painted steel.
	5 6/6/12 \$21.	
	6(24" only) 3/3/6/12 \$66.	
	8(24" only) 3/6/15 \$66.	
	See page 19 for Calibre desk finishes.	

Calibre Desk
bridge unit for "U" configuration
18" and 24" deep

Calibre

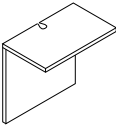
description	w	d	h	pattern no.	P1	P2	P3
	30"	18"	28½"	CB1-3018	\$443.	\$451.	\$472.
	30"	24"	28½"	CB1-3024	500.	507.	532.
	36"	18"	28½"	CB1-3618	469.	475.	502.
	36"	24"	28½"	CB1-3624	524.	531.	559.
	42"	18"	28½"	CB1-4218	508.	513.	540.
	42"	24"	28½"	CB1-4224	564.	570.	599.
	48"	18"	28½"	CB1-4818	548.	560.	588.
	48"	24"	28½"	CB1-4824	605.	613.	644.

Order Code

Example: CB1-4218-612 F
C Calibre
B1 Bridge unit
42 42" wide
18 18" deep
612 Paint - medium metallic grey
F Laminate - pumice

Specification Information

To order, specify:

1. Pattern number
2. Paint finish
3. Laminate finish

See page 19 for Calibre desk finishes.

Application Notes

Bridge units include flat brackets for attachment to desks or corner units.

Grommet:
 Center rear grommet is standard on all preconfigured units. Finish is black, and includes cover.

Construction:
 Worksurfaces are 1¼" thick, 3-ply solid construction and are predrilled at all pedestal, end unit, and bracket locations.

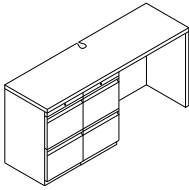

Filler panels are painted steel.

Calibre Desk
credenza - 18" and 24" deep
for "U" configurations with pedestals

description	w	d	h	lock	pattern no.	P1	P2	P3
 Credenzas for "U" configurations	66"	18"	28 1/2"		CU1-6618(7)(7)N	\$2,178.	\$2,272.	\$2,383.
	66"	18"	28 1/2"	Y	CU1-6618(7)(7)L	2,208.	2,301.	2,415.
	66"	24"	28 1/2"		CU1-6624(7)(7)N	2,394.	2,494.	2,616.
	66"	24"	28 1/2"	Y	CU1-6624(7)(7)L	2,426.	2,525.	2,648.
	72"	18"	28 1/2"		CU1-7218(7)(7)N	2,220.	2,310.	2,427.
	72"	18"	28 1/2"	Y	CU1-7218(7)(7)L	2,249.	2,344.	2,461.
	72"	24"	28 1/2"		CU1-7224(7)(7)N	2,437.	2,536.	2,664.
	72"	24"	28 1/2"	Y	CU1-7224(7)(7)L	2,466.	2,566.	2,694.

Order Code	Specification Information	Application Notes
Example: CU1-6624(7)(7)L-117 G	<i>To order, specify:</i>	U credenzas are standard with two file/file pedestal. For other drawer combinations, see Specification Information.
C Calibre	1. Pattern number	File drawers include hanging bars for side to side filing.
U1 U credenza	2. Pedestal options	
66 66" wide	3. Lock option	
24 24" deep	4. Paint finish	
7 File/file	5. Laminate finish	
7 File/file	The standard pedestal configuration for U Credenzas is "77", two file/file pedestals. For other configurations, substitute the appropriate pedestal codes and upcharges where necessary.	Desks will support Overdesk Units. See page 169.
L Lock		See KnollKey lock program on page 188 for keying information.
117 Paint - soft grey		<i>Grommet:</i> Center rear grommet is standard on all preconfigured units. Finish is black, and includes cover.
G Laminate - medium grey	<i>Pedestal upcharges:</i>	<i>Construction:</i> Worksurfaces are 1 1/4" thick, 3-ply solid construction and are predrilled at all pedestal, end unit, and bracket locations.
	Order Code Config. Upcharge	Pedestals, end units, and filler panels are painted steel.
	5 6/6/12 \$21.	
	6(24" only) 3/3/6/12 \$66.	
	8(24" only) 3/6/15 \$66.	
	See page 19 for Calibre desk finishes.	

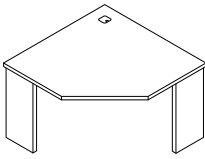
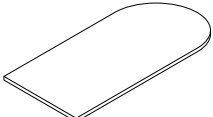
VDT corners, rounded end worksurfaces and brackets

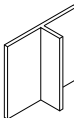
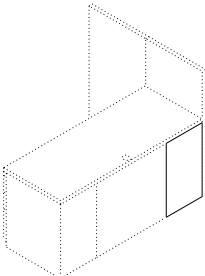
description	w	d	h	pattern no.	P1	P2	P3
 <p>VDT corner unit</p>	36"	24"	28 1/2"	CV1-3624	\$1,221.	\$1,283.	\$1,348.
	42"	24"	28 1/2"	CV1-4224	1,314.	1,382.	1,450.
	48"	24"	28 1/2"	CV1-4824	1,427.	1,496.	1,570.
 <p>Rounded end workspace</p>	62 5/8"	30"	1 1/4"	CW1-R6330B	893.		
	74 5/8"	30"	1 1/4"	CW1-R7530B	919.		
 <p>Support column</p>	5"	-	27"	CB1-L26	177.		
 <p>T-shaped end unit</p>	9"	30"	27 1/4"	CDE1-T30	314.	329.	347.
 <p>Desk integration bracket</p>	15"	1 1/2"	27 1/4"	CB1-I18	174.	183.	192.
	15"	1 1/2"	27 1/4"	CB1-I24	188.	200.	208.
	15"	1 1/2"	27 1/4"	CB1-I30	199.	207.	215.

Order Code

Example:	CV1-3624-117 F
C	Calibre
V1	VDT corner unit
36	36" width
24	24" depth
117	Soft grey paint
F	Pumice laminate

Specification Information

VDT corner unit:
To order, specify:

1. Pattern number
2. Paint finish
3. Laminate finish

Rounded end workspace:
To order, specify:

1. Pattern number
2. Laminate finish

T-shaped end unit and desk integration bracket:
To order, specify:

1. Pattern number
2. Paint color

See page 19 for Calibre desk finishes.

Application Notes

VDT corner units:
 Freestanding VDT corner units must have returns attached to both sides.

Rounded end workspaces:
 Calibre rounded end worksurfaces can be supported by a support column and T-shape end units or made into a desk with Calibre pedestals, end units and filler panels. Specify support components separately.

Rounded end tops with woodgrain laminate have a black 10mm T-mold edge.

Support column:
 Used to support end of rounded end workspace. Available in black only.

Desk integration bracket:
 Can be used in place of a Calibre end unit when end of desk is modular with Morrison panel. Maintains filler panel modularity while supporting desk end and allowing access to duplex receptacles in panel raceway.

Calibre Desk overdesk unit with pass through

Calibre

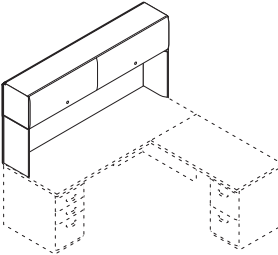
description	w	d	h	lock	pattern no.	P1	P2	P3
	36"	13"	35 1/2"		COD2-36N	\$1,060.	\$1,111.	\$1,171.
	36"	13"	35 1/2"	Y	COD2-36L	1,122.	1,178.	1,237.
	42"	13"	35 1/2"		COD2-42N	1,122.	1,177.	1,236.
	42"	13"	35 1/2"	Y	COD2-42L	1,183.	1,242.	1,308.
	48"	13"	35 1/2"		COD2-48N	1,183.	1,242.	1,308.
	48"	13"	35 1/2"	Y	COD2-48L	1,246.	1,311.	1,374.
	60"	13"	35 1/2"		COD2-60N	1,246.	1,311.	1,374.
	60"	13"	35 1/2"	Y	COD2-60L	1,371.	1,440.	1,513.
	66"	13"	35 1/2"		COD2-66N	1,310.	1,374.	1,442.
	66"	13"	35 1/2"	Y	COD2-66L	1,434.	1,507.	1,581.
	72"	13"	35 1/2"		COD2-72N	1,371.	1,440.	1,513.
	72"	13"	35 1/2"	Y	COD2-72L	1,496.	1,571.	1,650.
Overhead lock retrofit kit					DSIOHL	59.		
Vertical dividers (6)					CO1-VD	156.	168.	174.



Order Code	Specification Information	Application Notes
Example: COD2-72L-612	<i>To order, specify:</i>	
C Calibre	1. Pattern number	Overdesk Units can be used over desks or credenzas alone, or a combination of desks, credenzas, returns, and corner units. Spans of greater than 72" require two units. Not for use with 36"D desks.
OD2 Overdesk unit	2. Lock options	36"-48" overdesks have a single door; 60" - 72" units have two doors.
72 72" wide	3. Paint finish	66" Overdesk ships with one 30" and one 36" door. Either door can be placed on either side of cabinet (30" on left, 30" on right).
L Lock	See page 19 for Calibre desk finishes.	<i>Construction:</i> Stanchions and overheads are painted steel.
612 Medium metallic grey		Calibre overdesk units ordered without locks include black lock plug in each door to allow for lock retrofit.
		Overall height of Overdesk Units, when mounted on Calibre Desk components, is compatible with 64" Morrison panels. Task lights are not included. See page 162.
		Overdesk units include overhead and 2 stanchions. Order privacy screens on page 171.
		Overdesk units must be modular with worksurfaces.
		Overdesk stanchions include a concealed vertical wire manager, and slots for Orchestra load bars.
		Two lock retrofit kits are required for each 60", 66" and 72" unit.
		See KnollKey lock program on page 188 for keying information.

Calibre Desk
overdesk unit
with pass through and touchdown hinge mechanism

Calibre

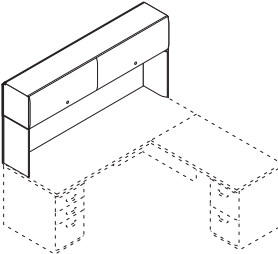
description	w	d	h	lock	pattern no.	P1	P2	P3
	36"	13"	35 1/2"		COD2-36EN	\$1,271.	\$1,323.	\$1,381.
	36"	13"	35 1/2"	Y	COD2-36EL	1,329.	1,388.	1,447.
	42"	13"	35 1/2"		COD2-42EN	1,329.	1,386.	1,445.
	42"	13"	35 1/2"	Y	COD2-42EL	1,396.	1,457.	1,516.
	48"	13"	35 1/2"		COD2-48EN	1,396.	1,457.	1,516.
	48"	13"	35 1/2"	Y	COD2-48EL	1,459.	1,520.	1,585.
	60"	13"	35 1/2"		COD2-60EN	1,668.	1,733.	1,797.
	60"	13"	35 1/2"	Y	COD2-60EL	1,793.	1,864.	1,936.
	66"	13"	35 1/2"		COD2-66EN	1,731.	1,797.	1,866.
	66"	13"	35 1/2"	Y	COD2-66EL	1,856.	1,927.	2,003.
	72"	13"	35 1/2"		COD2-72EN	1,793.	1,864.	1,936.
	72"	13"	35 1/2"	Y	COD2-72EL	1,917.	1,992.	2,071.
Overhead lock retrofit kit					DS1OHL	58.		
Vertical dividers (6)					CO1-VD	156.	168.	174.

Order Code	Specification Information	Application Notes
Example: COD2-72EL-612	<i>To order, specify:</i>	
C Calibre	1. Pattern number	Overdesk Units can be used over desks or credenzas alone, or a combination of desks, credenzas, returns, and corner units. Spans of greater than 72" require two units. Not for use with 36"D desks.
OD2 Overdesk unit	2. Lock options	36"-48" overdesks have a single door; 60" - 72" units have two doors.
72 72" wide	3. Paint finish	66" Overdesk ships with one 30" and one 36" door. Either door can be placed on either side of cabinet (30" on left, 30" on right).
E Touchdown hinge	See page 19 for Calibre desk finishes.	<i>Construction:</i> Stanchions and overheads are painted steel.
L Lock		Calibre overdesk units ordered without locks include black lock plug in each door to allow for lock retrofit.
612 Medium metallic grey		Two lock retrofit kits are required for each 60", 66" and 72" unit. See KnollKey lock program on page 188 for keying information.
		Overdesk units include overhead and 2 stanchions. Order privacy screens on page 171.
		Overdesk units must be modular with worksurfaces.
		Overall height of Overdesk Units, when mounted on Calibre Desk components, is compatible with 64" Morrison panels. Task lights are not included. See page 162.
		Overdesk stanchions include a concealed vertical wire manager, and slots for Orchestra load bars.

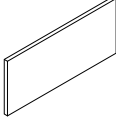
description	w	h	worksurface w	pattern no.	grade							
					10	15	20	25	30	35	40	45
Privacy screen 	18"	20"	30"	CSC3-A30	\$231.	\$240.	\$250.	\$254.	\$260.	\$266.	\$271.	\$278.
	24"	20"	36"	CSC3-A36	248.	254.	268.	272.	279.	287.	290.	297.
	30"	20"	42"	CSC3-A42	257.	262.	278.	283.	291.	297.	301.	309.
	36"	20"	48"	CSC3-A48	272.	281.	293.	299.	307.	311.	319.	327.
	42"	20"	54"	CSC3-A54	282.	291.	306.	310.	319.	325.	329.	337.
	48"	20"	60"	CSC3-A60	290.	298.	311.	319.	327.	332.	337.	347.
	54"	20"	66"	CSC3-A66	310.	321.	334.	342.	353.	358.	364.	372.
	60"	20"	72"	CSC3-A72	324.	332.	348.	356.	364.	368.	377.	389.

Order Code

Example:	CSC3-A30
CSC3	Calibre screen
30	30" wide
T302	Smoke

Specification Information

To order privacy screens, specify:

1. Pattern number
2. Fabric selection

Fabric finish options for screen:
See fabric selection on page 19.

See page 19 for Calibre desk finishes.

Application Notes

Privacy Screens:
Privacy screens can be used with overdesk units only.

Order screen width to match overall width of desk, or combination of worksurfaces.

Screens are tackable on both sides, and include a black PVC trim at the top to prevent fabric wear and soiling.

Screens include an integral wire manager that conceals cables wrapping around the rear of worksurfaces.

Calibre Desk
 1 1/4" worksurfaces
 18" deep

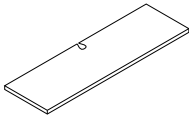
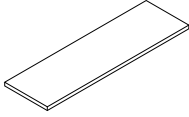
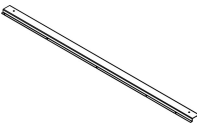
description	type	w	d	h	pattern no.	laminate
Straight worksurface, with grommets 		30"	18"	1 1/4"	CW1-S3018-A	\$252.
		36"	18"	1 1/4"	CW1-S3618-A	268.
		42"	18"	1 1/4"	CW1-S4218-A	298.
		48"	18"	1 1/4"	CW1-S4818-A	329.
		60"	18"	1 1/4"	CW1-S6018-A	393.
		66"	18"	1 1/4"	CW1-S6618-A	425.
		72"	18"	1 1/4"	CW1-S7218-A	455.
Straight worksurface, no grommets 		30"	18"	1 1/4"	CW1-S3018-B	228.
		36"	18"	1 1/4"	CW1-S3618-B	245.
		42"	18"	1 1/4"	CW1-S4218-B	277.
		48"	18"	1 1/4"	CW1-S4818-B	308.
		60"	18"	1 1/4"	CW1-S6018-B	367.
		66"	18"	1 1/4"	CW1-S6618-B	400.
		72"	18"	1 1/4"	CW1-S7218-B	431.
Worksurface reinforcements 	For use with a 60" worksurface				CRB60	37.
	For use with a 66" worksurface				CRB66	46.
	For use with a 72" worksurface				CRB72	54.

Order Code	Specification Information	Application Notes
Example: CW1-S3618-B G	<i>To order, specify:</i>	18"D worksurfaces can be used as main worksurfaces, returns, bridge units, or credenza tops. They can be supported by end units, pedestals, or flat brackets.
C Calibre	1. Pattern number	
W1 Calibre worksurface 1 1/4" thick	2. Laminate finish	<i>Grommet:</i> Center rear grommet is standard on all preconfigured units. Finish is black, and includes cover.
S Straight	See page 19 for Calibre desk finishes.	
36 36" wide	<i>Grommets/no grommets:</i>	<i>Construction:</i> Worksurfaces are 1 1/4" thick, 3-ply solid construction, and are predrilled at all pedestal, end unit, and bracket locations.
18 18" deep	A = worksurface include grommets	
B No grommet	B = worksurface does not include grommets	
G Laminate - medium grey		
		Worksurface reinforcements are required when two end units are used to support a 60", 66", or 72" worksurface.

Calibre Desk
 1 1/4" worksurfaces
 24" deep

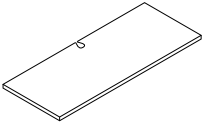
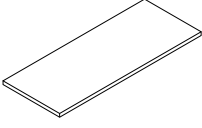
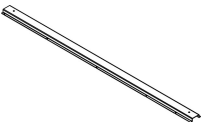
description	type	w	d	h	pattern no.	laminate
Straight worksurface, with grommets 		30"	24"	1 1/4"	CW1-S3024-A	\$297.
		36"	24"	1 1/4"	CW1-S3624-A	311.
		42"	24"	1 1/4"	CW1-S4224-A	343.
		48"	24"	1 1/4"	CW1-S4824-A	373.
		60"	24"	1 1/4"	CW1-S6024-A	437.
		66"	24"	1 1/4"	CW1-S6624-A	469.
		72"	24"	1 1/4"	CW1-S7224-A	502.
Straight worksurface, no grommets 		30"	24"	1 1/4"	CW1-S3024-B	274.
		36"	24"	1 1/4"	CW1-S3624-B	290.
		42"	24"	1 1/4"	CW1-S4224-B	322.
		48"	24"	1 1/4"	CW1-S4824-B	354.
		60"	24"	1 1/4"	CW1-S6024-B	415.
		66"	24"	1 1/4"	CW1-S6624-B	445.
		72"	24"	1 1/4"	CW1-S7224-B	476.
Worksurface reinforcements 	For use with a 60" worksurface				CRB60	37.
	For use with a 66" worksurface				CRB66	46.
	For use with a 72" worksurface				CRB72	54.

Order Code	Specification Information	Application Notes
Example: CW1-S3624-B D	<i>To order, specify:</i>	24"D worksurfaces can be used as main worksurfaces, returns, bridge units, or credenza tops. They can be supported by end units, pedestals, or flat brackets.
C Calibre	1. Pattern number	
W1 Calibre worksurface 1 1/4" thick	2. Laminate finish	<i>Grommet:</i> Center rear grommet is standard on all preconfigured units. Finish is black, and includes cover.
S Straight	See page 19 for Calibre desk finishes.	
36 36" wide	<i>Grommets/no grommets:</i>	<i>Construction:</i> Worksurfaces are 1 1/4" thick, 3-ply solid construction, and are predrilled at all pedestal, end unit, and bracket locations. Worksurface reinforcements are required when two end units are used to support a 60", 66", or 72" worksurface.
24 24" deep	A = worksurface include grommets	
B No grommet	B = worksurface does not include grommets	
D Laminate - sand		

Calibre Desk
 1 1/4" worksurfaces
 30" deep

Calibre

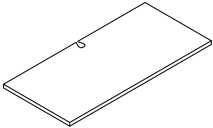
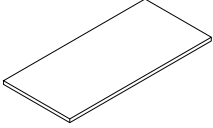
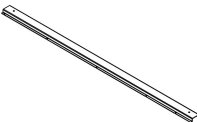
description	type	w	d	h	pattern no.	laminate
Straight worksurface, with grommets 		30"	30"	1 1/4"	CW1-S3030-A	\$327.
		36"	30"	1 1/4"	CW1-S3630-A	342.
		42"	30"	1 1/4"	CW1-S4230-A	372.
		48"	30"	1 1/4"	CW1-S4830-A	403.
		60"	30"	1 1/4"	CW1-S6030-A	468.
		66"	30"	1 1/4"	CW1-S6630-A	500.
		72"	30"	1 1/4"	CW1-S7230-A	531.
Straight worksurface, no grommets 		30"	30"	1 1/4"	CW1-S3030-B	306.
		36"	30"	1 1/4"	CW1-S3630-B	321.
		42"	30"	1 1/4"	CW1-S4230-B	353.
		48"	30"	1 1/4"	CW1-S4830-B	383.
		60"	30"	1 1/4"	CW1-S6030-B	443.
		66"	30"	1 1/4"	CW1-S6630-B	475.
		72"	30"	1 1/4"	CW1-S7230-B	508.
Worksurface reinforcements 	For use with a 60" worksurface				CRB60	37.
	For use with a 66" worksurface				CRB66	46.
	For use with a 72" worksurface				CRB72	54.

Order Code	Specification Information	Application Notes
Example: CW1-S3630-B G	<i>To order, specify:</i>	30"D worksurfaces can be used as main worksurfaces, returns, bridge units, or credenza tops. They can be supported by end units, pedestals, or flat brackets.
C Calibre	1. Pattern number	
W1 Calibre worksurface 1 1/4" thick	2. Laminate finish	<i>Grommet:</i> Center rear grommet is standard on all preconfigured units. Finish is black, and includes cover.
S Straight	See page 19 for Calibre desk finishes.	
36 36" wide	<i>Grommets/no grommets:</i>	<i>Construction:</i> Worksurfaces are 1 1/4" thick, 3-ply solid construction, and are predrilled at all pedestal, end unit, and bracket locations.
30 30" deep	A = worksurface include grommets	
B No grommet	B = worksurface does not include grommets	
G Laminate - medium grey		
		Worksurface reinforcements are required when two end units are used to support a 60", 66", or 72" worksurface.

Calibre Desk
 1 1/4" worksurfaces
 36" deep

Calibre

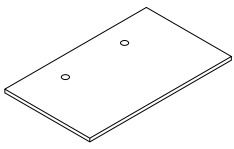
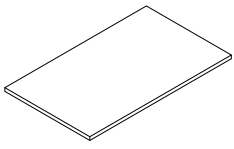
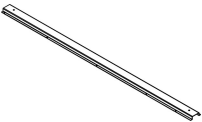
description	type	w	d	h	pattern no.	laminate
Straight worksurface with grommets 		60"	36"	1 1/4"	CW1-S6036-A	\$516.
		66"	36"	1 1/4"	CW1-S6636-A	547.
		72"	36"	1 1/4"	CW1-S7236-A	612.
Straight worksurface, no grommets 		60"	36"	1 1/4"	CW1-S6036-B	498.
		66"	36"	1 1/4"	CW1-S6636-B	527.
		72"	36"	1 1/4"	CW1-S7236-B	590.
Worksurface reinforcements 	For use with a 60" worksurface				CRB60	37.
	For use with a 66" worksurface				CRB66	46.
	For use with a 72" worksurface				CRB72	54.

Order Code

Example:	CW1-S7236-A G
C	Calibre
W1	Calibre worksurface 1 1/4" T
S	Straight
72	72" wide
36	36" deep
A	Grommets
G	Laminate - medium grey

Specification Information

To order, specify:

1. Pattern number
2. Laminate finish

See page 19 for Calibre desk finishes.

Grommets/no grommets:

A = worksurface include grommets

B = worksurface does not include grommets

Application Notes

36"D worksurfaces can be used as main worksurfaces and can be supported by 30" end units or pedestals.

Grommet:
 36"D worksurfaces feature two round grommets.



Construction:
 Worksurfaces are 1 1/4" thick, 3-ply solid construction, and are predrilled at all pedestal, end unit, and bracket locations.

Worksurface reinforcements are required when two end units are used to support a 60", 66", or 72" worksurface.

Calibre Desk

desk end unit

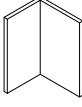
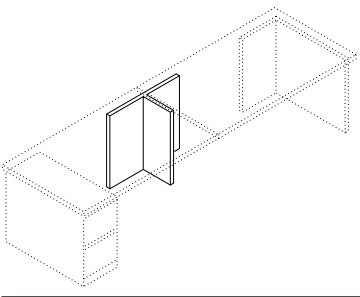
Calibre

description	w	d	h	pattern no.	P1	P2	P3	list price
End unit	15"	18"	27 1/4"	CDE1-18	\$314.	\$329.	\$347.	
	15"	24"	27 1/4"	CDE1-24	344.	363.	381.	
	15"	30"	27 1/4"	CDE1-30	376.	395.	415.	
Intermediate end unit	30"	14"	27 1/4"	CDE1-I30	314.	329.	347.	
								
Flat brackets for worksurface	3 1/2"	8"	–	CB1-F18				33.
	3 1/2"	14"	–	CB1-F24				36.
	3 1/2"	20"	–	CB1-F30				40.
Wire management clips (10)				CB1-WC				35.
								

Order Code

Example:	CDE1-30 613
C	Calibre
DE1	End unit
30	30" deep
613	Silver paint finish

Specification Information

To order, specify:

1. Pattern number
2. Lock options
3. Paint finish

See page 19 for Calibre desk finishes.

Application Notes





End units are available in 18", 24" and 30" depths. For maximum planning flexibility, end units have an "L" design, allowing for interchangeable planning with Calibre pedestals. While only 1.5" thick at the user side, the rear of end units have the same 15" nominal dimension of pedestals.

Construction:
End units are painted steel.

Intermediate end unit:
Allows free knee access when used in end-to-end worksurface spans. Replaces two standard end units and is modular with desk filler panels.

Calibre Desk filler panels

Calibre

description	w	h	size	pattern no.	P1	P2	P3
 Desk	18"	26 ⁷ / ₈ "	48"	CF1-D48	\$163.	\$174.	\$183.
	30"	26 ⁷ / ₈ "	60"	CF1-D60	185.	194.	205.
	36"	26 ⁷ / ₈ "	66"	CF1-D66	194.	205.	213.
	42"	26 ⁷ / ₈ "	72"	CF1-D72	205.	214.	225.
 Return	15"	26 ⁷ / ₈ "	30"	CF1-R30	139.	145.	151.
	21"	26 ⁷ / ₈ "	36"	CF1-R36	146.	154.	162.
	27"	26 ⁷ / ₈ "	42"	CF1-R42	155.	163.	173.
	33"	26 ⁷ / ₈ "	48"	CF1-R48	168.	175.	185.
	45"	26 ⁷ / ₈ "	60"	CF1-R60	185.	194.	205.
 Bridge	30"	26 ⁷ / ₈ "	30"	CF1-B30	139.	145.	151.
	36"	26 ⁷ / ₈ "	36"	CF1-B36	146.	154.	162.
	42"	26 ⁷ / ₈ "	42"	CF1-B42	155.	163.	173.
	48"	26 ⁷ / ₈ "	48"	CF1-B48	168.	175.	185.
 U-Credenza	21"	26 ⁷ / ₈ "	66"	CF1-C66	146.	154.	162.
	27"	26 ⁷ / ₈ "	72"	CF1-C72	155.	163.	173.

Order Code

Example:	CF1-R42-612
C	Calibre
F1	Filler panel
R	Return
42	42" wide
612	Medium metallic grey

Specification Information

To order, specify:



1. Pattern number
2. Paint finish

See page 19 for Calibre desk finishes.

Application Notes

There are four versions of filler panels: desks, returns, bridges and U-credenzas. Calibre's design allows a single size of filler panel to be used for single pedestal, double pedestal, and double end panel desks of a given width.

When assembled, filler panels create a 1/2" slot below the worksurface for wire management. Together with the central worksurface grommet, this allows for easy wire management without dedicating worksurfaces with right, left or center grommets.

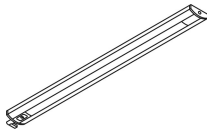
description	type	w	d	h	pattern no.	list
 T5 Standard Task Light	Use with 24" and wider overhead	19"	4"	1 1/2"	CL3T5E19S	\$190.
	Use with 30" and wider overhead	25"	4"	1 1/2"	CL3T5E25S	207.
	Use with 42" and wider overhead	37"	4"	1 1/2"	CL3T5E37S	211.
	Use with 60" and wider overhead	49"	4"	1 1/2"	CL3T5E49S	240.
 T5 Advanced Task Light	Use with 30" and wider overhead	25"	4"	1 1/2"	CL3T5E25A	485.
	Use with 42" and wider overhead	37"	4"	1 1/2"	CL3T5E37A	510.
	Use with 60" and wider overhead	49"	4"	1 1/2"	CL3T5E49A	529.
 LED Task Light	Use with 24" and wider overhead (3 LED's)	19"	2"	5/8"	CL3L193M	321.
	Use with 24" and wider overhead (6 LED's)	19"	2"	5/8"	CL3L196M	405.
	Use with 24" and wider overhead (9 LED's)	19"	2"	5/8"	CL3L199M	551.
	Use with 42" and wider overhead (6 LED's)	37"	2"	5/8"	CL3L376M	648.
	Use with 42" and wider overhead (12 LED's)	37"	2"	5/8"	CL3L3712M	731.
	Use with 42" and wider overhead (18 LED's)	37"	2"	5/8"	CL3L3718M	906.

Order Code	Specification Information	Application Notes
T5 Standard Task Light Example: CL3T5E19S CL3 Task Light T5 T5 lamp E Electronic ballast 19 Width S Standard LED Task Light Example: CL3L193M CL3 Task Light L LED 19 Width 3 # of LED's M Metal Overhead Attachment	T5 Task Lights: 120v and includes T5 cool white (4100K) fluorescent lamp, electronic ballast, 9' grounded cordset, prismatic lens, rocker switch, one cord exit management clip and mounting hardware. Housings are black. LED Task Lights: Includes LED's, power supply with 12' cord and mounting hardware. Housings are clear anodized aluminum with grey color end-caps.	T5 Task Lights: Specify suffix -CH and add \$46 list for City of Chicago installations. Example: DL3T5E25S-CH Cordset is center exit. On smaller units cord exit is off-center, but still not handed. T5 advanced task lights are fitted with ballasts and lamps compliant with LEED requirements, meeting the LEED EB standard for mercury content. LED Task Lights: Power cord is able to attach to either end of fixture. Notes: All task lights mount into the recess in the underside of overhead cabinets and shelves at least 6" wider than task light width. All task lights are TCLP compliant and meet requirements of California Title 20 and Title 24.

Wall Mounting Suggestions

The following information is provided only as a guide, and represents minimum recommendations only. Knoll does not accept responsibility for the attachment of any Knoll product to a Customer's site wall. Wall specification/construction is the responsibility of the Customer and its structural engineer/architect. Failure to properly attach Knoll products to adequate wall structures can lead to property damage and/or personal injury.

You should consult your own structural engineers and/or architects and must not rely on the information provided herein.

It is the responsibility of the Customer and its structural engineers/architects to verify that the permanent structural walls (studs, blocks, solid masonry, etc.) on which the Knoll products are intended to be mounted are designed appropriately to support the product weight, PLUS 3 lbs. per linear inch for each useable shelf length

NOTE: A cabinet's top is considered a "useable shelf" and MUST be included in the calculation of the total load for an overhead cabinet.

It is the responsibility of the Customer and its structural engineer/architects to specify the fasteners and method for attaching the Knoll supplied wall mounting cleat, bracket, frame, etc. to the supporting wall and to confirm that the installers have adhered to these specifications. For all local building standards and codes, and additional requirements (including, but not limited to, seismic conditions) the Customer should always consult local code agencies.

	EXISTING CONSTRUCTION					
	NEW CONSTRUCTION	Cinder Block or Poured Concrete Masonry Wall	Wood Stud Wall, the studs being FULL HEIGHT to the roof/floor above	Wood Stud Wall, the studs being only Ceiling Height	Steel Stud Wall, the studs being FULL HEIGHT to the roof/floor above	Steel Stud Wall, the studs being only Ceiling Height
Stud Specification	Wood studs, grade #2 or better, 3 1/2" minimum width, OR Metal studs, minimum 25 gage thickness, 3 5/8" minimum width	The wall must be a minimum of 6" thick, and must be full height to the roof/ floor structure above	Wood studs must be Grade #2, or better, 3 1/2" minimum width	Wood studs must be Grade #2, or better, 3 1/2" minimum width	Metal studs must be minimum 25 gage thickness, 3 5/8" minimum width	Metal studs must be minimum 25 gage thickness, 3 5/8" minimum width
Stud Centers	Metal and wood studs must be spaced at 16" c/c maximum	N/A	Wood studs must be spaced at 16" c/c maximum	Wood studs must be spaced at 16" c/c maximum"	Metal studs must be spaced at 16" c/c maximum	Metal studs must be spaced at 16" c/c maximum
Stud Height	Metal and wood studs must extend upwards, and be securely attached to the roof/ floor structure above			Wood studs must be braced above the ceiling, and be securely attached to the roof/floor structure above Affix #2 grade 'cap' across the top of the studs, then place diagonal studs from the top cap up to underside of the roof/ floor structure above		Metal studs must be braced above the ceiling, and be securely attached to the roof/floor structure above Affix metal bracing 'cap' across the top of the studs, then place diagonal studs from the top cap up to underside of the roof / floor structure above
Mounting the Knoll Supplied Cleat, Bracket, Frame, etc*	Insert a 2" X 6" wood block, #2 grade or better, [or a Danback™ flexible wood backing system] horizontally between each of the studs to accommodate the full width of the cabinet, and beyond to the next stud. Fasten the wood block to each stud using three screws at the ends of each block. (Fasten the Danback™ as directed by the manufacturer) Fasten the Knoll supplied wall mounting cleat, bracket, frame, etc directly to each wood block every 6" For wall mounting structures that have a rectangular frame-like configuration: fasten the top horizontal element of the frame to the wood blocking every 6", and fasten the lower horizontal element to each wall stud, using one fastener per stud.	Fasten the Knoll supplied cabinet wall mounting cleat, bracket, frame, etc. directly to the masonry wall every 6" For wall mounting structures that have a rectangular frame-like configuration: fasten the top horizontal element of the frame to the wall every 6", and fasten the lower horizontal element to the wall every 16"	In the desired location of the cabinet mounting rail, remove an 8" high section of drywall the width of the cabinet, and beyond to the next stud. Insert a 2" X 6" wood block, #2 grade or better, horizontally between each of the exposed studs. Fasten the wood block to each stud using three screws at the ends of each block. Replace the drywall and repair as desired. Fasten the Knoll supplied wall mounting cleat, rail, frame, etc directly to the wood block every 6" For wall mounting structures that have a rectangular frame-like configuration: fasten the top horizontal element of the frame to the wood blocking every 6", and fasten the lower horizontal element to each wall stud, using one fastener per stud.	In the desired location of the cabinet mounting rail, remove an 8" high section of drywall the width of the cabinet, and beyond to the next stud. Insert a 2" X 6" wood block, #2 grade or better, horizontally between each of the exposed studs. Fasten the wood block to each stud using three screws at the ends of each block. Replace the drywall and repair as desired. Fasten the Knoll supplied wall mounting cleat, rail, frame, etc directly to the wood block every 6" For wall mounting structures that have a rectangular frame-like configuration: fasten the top horizontal element of the frame to the wood blocking every 6", and fasten the lower horizontal element to each wall stud, using one fastener per stud.	In the desired location of the cabinet mounting rail, remove an 8" high section of drywall the width of the cabinet, and beyond to the next stud. Insert a 2" X 6" wood block, #2 grade or better, [or a Danback™ flexible wood backing system] horizontally between each of the exposed studs. Fasten the wood block to each stud using three screws at the ends of each block. Replace the drywall and repair as desired. Fasten the Knoll supplied wall mounting cleat, rail, frame, etc directly to the wood block every 6" For wall mounting structures that have a rectangular frame-like configuration: fasten the top horizontal element of the frame to the wood blocking every 6", and fasten the lower horizontal element to each wall stud, using one fastener per stud.	In the desired location of the cabinet mounting rail, remove an 8" high section of drywall the width of the cabinet, and beyond to the next stud. Insert a 2" X 6" wood block, #2 grade or better, [or a Danback™ flexible wood backing system] horizontally between each of the exposed studs. Fasten the wood block to each stud using three screws at the ends of each block. Replace the drywall and repair as desired. Fasten the Knoll supplied wall mounting cleat, rail, frame, etc directly to the wood block every 6" For wall mounting structures that have a rectangular frame-like configuration: fasten the top horizontal element of the frame to the wood blocking every 6", and fasten the lower horizontal element to each wall stud, using one fastener per stud.
*Graham Wall Hung Shelf	The Graham Wall Hung Shelf Bracket (and others like it) requires full support behind the full height of the bracket This should be accomplished by insertion of additional 2"X 6" wood blocking between the studs as defined above	Fasten the Knoll supplied wall mounting brackets directly to the masonry wall, using the holes provided in each bracket	The Graham Wall Hung Shelf Bracket (and others like it) requires full support behind the full height of the bracket This should be accomplished by insertion of additional 2"X 6" wood blocking between the studs as defined above	The Graham Wall Hung Shelf Bracket (and others like it) requires full support behind the full height of the bracket This should be accomplished by insertion of additional 2"X 6" wood blocking between the studs as defined above	The Graham Wall Hung Shelf Bracket (and others like it) requires full support behind the full height of the bracket This should be accomplished by insertion of additional 2"X 6" wood blocking between the studs as defined above	The Graham Wall Hung Shelf Bracket (and others like it) requires full support behind the full height of the bracket This should be accomplished by insertion of additional 2"X 6" wood blocking between the studs as defined above
Fasten the Knoll supplied wall cleat with...	#10 x 2 1/2" Grabber Woodys Screws or equiv. @ 6" c/c, screwed directly into the wood blocking	3/16" x 3 1/2" Tapcon Masonry Screws or equiv. @ 6" c/c with 1-1/4" embedment, screwed directly into the masonry wall	#10 x 2 1/2" Grabber Woodys Screws or equiv. @ 6" c/c, screwed directly into the wood blocking	#10 x 2 1/2" Grabber Woodys Screws or equiv. @ 6" c/c, screwed directly into the wood blocking	#10 x 2 1/2" Grabber Woodys Screws or equiv. @ 6" c/c, screwed directly into the wood blocking	#10 x 2 1/2" Grabber Woodys Screws or equiv. @ 6" c/c, screwed directly into the wood blocking

Alpha-Numeric Index

<i>pattern no.</i>	<i>page</i>	<i>pattern no.</i>	<i>page</i>	<i>pattern no.</i>	<i>page</i>	<i>pattern no.</i>	<i>page</i>
3A18C01	82	3C18WP01	104	3O24(C/A)P01	100	C2C3430C	45
3A18C02	82	3C18WP05	104	3O24(C/A)P05	100	C2C3430E	45
3A18C03	82	3C18WP07	104	3O24(C/A)P06	100	C2C3436	45
3A18E01	82	3C18X01	103	3O24(C/A)P07	101	C2C3436C	45
3A18E02	82	3C18X05	103	3O24(C/A)P08	101	C2C3436E	45
3A18E03	82	3C18X07	103	3O24(C/A)P09	101	C2C3930	46
3A24C01	83	3C18XP01	104	3O24W01	105	C2C3930C	46
3A24C02	83	3C18XP05	104	3O24W05	105	C2C3930E	46
3A24C03	83	3C18XP07	104	3O24W07	105	C2C3936	46
3A24C04	83	3C24(C/A)01	94	3O24WP01	106	C2C3936C	46
3A24E01	83	3C24(C/A)05	94	3O24WP05	106	C2C3936E	46
3A24E02	83	3C24(C/A)06	94	3O24WP07	106	C2C5130	47
3A24E03	83	3C24(C/A)07	94	3O24X01	105	C2C5130C	47
3A24E04	83	3C24(C/A)08	95	3O24X05	105	C2C5130E	47
3B18C05	84	3C24(C/A)09	95	3O24X07	105	C2C5136	47
3B18C06	84	3C24(C/A)P01	96	3O24XP01	106	C2C5136C	47
3B18C07	84	3C24(C/A)P05	96	3O24XP05	106	C2C5136E	47
3B18C10	84	3C24(C/A)P06	96	3O24XP07	106	C2C5530	48
3B18E05	84	3C24(C/A)P07	97	5Z4C2AS	80	C2C5530C	48
3B18E06	84	3C24(C/A)P08	97	5Z4C2NM	79	C2C5530E	48
3B18E07	84	3C24(C/A)P09	97	5Z4C2NR	80	C2C5536	48
3B18E10	84	3C24W01	103	5Z4N6DP	81	C2C5536C	48
3B18W05	102	3C24W05	103	5Z4NA	81	C2C5536E	48
3B18W07	102	3C24W07	103	5Z4NB	79	C2C6330	49
3B18X05	102	3C24WP01	104	5Z4NG	79	C2C6330C	49
3B18X07	102	3C24WP05	104	5Z4NN	79	C2C6330E	49
3B24C05	85	3C24WP07	104	5Z4NP	80	C2C6336	49
3B24C06	85	3C24X01	103	5Z6C2AS	80	C2C6336C	49
3B24C07	85	3C24X05	103	5Z6C2NM	79	C2C6336E	49
3B24C08	85	3C24X07	103	5Z6C2NR	80	C2C6430	50
3B24C10	86	3C24XP01	104	5Z6N6DP	81	C2C6430C	50
3B24E05	85	3C24XP05	104	5Z6NA	81	C2C6430E	50
3B24E06	85	3C24XP07	104	5Z6NB	79	C2C6436	50
3B24E07	85	3DW4CC	89	5Z6NG	79	C2C6436C	50
3B24E08	85	3DW4IDD	89	5Z6NP	80	C2C6436E	50
3B24E10	86	3DW6CC	89	5Z8C2NM	79	C2DW5530C	41
3B24W05	102	3DW6IDD	89	5Z8N6DP	81	C2DW5530E	41
3B24W07	102	3O18(C/A)01	92	5Z8NA	81	C2DW5536C	41
3B24X05	102	3O18(C/A)05	92	5Z8NB	79	C2DW5536E	41
3B24X07	102	3O18(C/A)07	92	5Z8NG	79	C2DW6330C	42
3B30C05	88	3O18(C/A)P01	93	5Z8NP	80	C2DW6330E	42
3B30C06	88	3O18(C/A)P05	93	5ZAC2AS	80	C2DW6336C	42
3B30C07	88	3O18(C/A)P07	93	5ZAC2NR	80	C2DW6336E	42
3B30C10	88	3O18W01	105	5ZCC2AS	80	C2DW6430C	43
3B30E05	88	3O18W05	105	5ZCC2NR	80	C2DW6430E	43
3B30E06	88	3O18W07	105	5ZNN6DP	81	C2DW6436C	43
3B30E07	88	3O18WP01	106	5ZNNNE	80	C2DW6436E	43
3B30E10	88	3O18WP05	106	5ZNNF	79	C2F2730C	64
3B30W05	102	3O18WP07	106	5ZNNL	79	C2F2730CCC	20
3B30W07	102	3O18X01	105	A	66	C2F2730CIDD	21
3B30X05	102	3O18X05	105	B	66	C2F2730CMD	21
3B30X07	102	3O18X07	105	C	66	C2F2730CZZ	20
3C18(C/A)01	90	3O18XP01	106	C1PAD18	108, 109	C2F2730ECC	20
3C18(C/A)05	90	3O18XP05	106	C1PAD24	108, 109	C2F2730EIDD	21
3C18(C/A)07	90	3O18XP07	106	C2C2730	44	C2F2730EMD	21
3C18(C/A)P01	91	3O24(C/A)01	98	C2C2730C	44	C2F2730EZZ	20
3C18(C/A)P05	91	3O24(C/A)05	98	C2C2730E	44	C2F2730WCC	71
3C18(C/A)P07	91	3O24(C/A)06	98	C2C2736	44	C2F2730XCC	71
3C18W01	103	3O24(C/A)07	99	C2C2736C	44	C2F2736C	64
3C18W05	103	3O24(C/A)08	99	C2C2736E	44	C2F2736CCC	20
3C18W07	103	3O24(C/A)09	99	C2C3430	45	C2F2736CIDD	21

<i>pattern no.</i>	<i>page</i>	<i>pattern no.</i>	<i>page</i>	<i>pattern no.</i>	<i>page</i>	<i>pattern no.</i>	<i>page</i>
C2F2736CMD	21	C2F4530EMKMM	25	C2F5436CMKCCC	28	C2F5842EMKMMM	30
C2F2736CZZ	20	C2F4536C	64	C2F5436CMMCC	28	C2F6330C	65
C2F2736ECC	20	C2F4536CDDDD	25	C2F5436ELCCC	28	C2F6330CLAAA	33
C2F2736EIDD	21	C2F4536CMKMM	25	C2F5436EMKCCC	28	C2F6330CLLLL	34
C2F2736EMD	21	C2F4536EDDDD	25	C2F5436EMMCC	28	C2F6330CMDCCC	34
C2F2736EZZ	20	C2F4536EMKMM	25	C2F5442C	64	C2F6330CMMKDDD	35
C2F2736WCC	71	C2F4542C	64	C2F5442CLCCC	28	C2F6330CNCCCC	35
C2F2736XCC	71	C2F4542CDDDD	25	C2F5442CMKCCC	28	C2F6330CNNNNN	32
C2F2742C	64	C2F4542CMKMM	25	C2F5442CMMCC	28	C2F6330CZCCCC	32
C2F2742CCC	20	C2F4542EDDDD	25	C2F5442ELCCC	28	C2F6330CZZZZZ	33
C2F2742CIDD	21	C2F4542EMKMM	25	C2F5442EMKCCC	28	C2F6330ELAAA	33
C2F2742CMD	21	C2F5130C	64	C2F5442EMMCC	28	C2F6330ELLLL	34
C2F2742CZZ	20	C2F5130CCECC	26	C2F5530C	65	C2F6330EMDCCC	34
C2F2742ECC	20	C2F5130CDKCCC	27	C2F5530CDDDDD	29	C2F6330EMMKDDD	35
C2F2742EIDD	21	C2F5130CLKDDD	27	C2F5530CLKCCC	29	C2F6330ENCCCC	35
C2F2742EMD	21	C2F5130CMKCDD	27	C2F5530CMMKCC	29	C2F6330ENNNNN	32
C2F2742EZZ	20	C2F5130CMMDD	26	C2F5530EDDDDD	29	C2F6330EZCCCC	32
C2F2742WCC	71	C2F5130CZZZZ	26	C2F5530ELKCCC	29	C2F6330EZZZZZ	33
C2F2742XCC	71	C2F5130CECCC	26	C2F5530EMMKCC	29	C2F6330WZCCCC	74
C2F3430C	64	C2F5130EDKCCC	27	C2F5536C	65	C2F6330XZCCCC	74
C2F3430CDDD	22	C2F5130ELKDDD	27	C2F5536CDDDDD	29	C2F6336C	65
C2F3430CDDDD	22	C2F5130EMKCDD	27	C2F5536CLKCCC	29	C2F6336CLAAA	33
C2F3436C	64	C2F5130EMMDD	26	C2F5536CMMKCC	29	C2F6336CLLLL	34
C2F3436CDDD	22	C2F5130EZZZZ	26	C2F5536EDDDDD	29	C2F6336CMDCCC	34
C2F3436EDDD	22	C2F5130WCCCC	73	C2F5536ELKCCC	29	C2F6336CMMKDDD	35
C2F3442C	64	C2F5130XCXXX	73	C2F5536EMMKCC	29	C2F6336CNCXXX	35
C2F3442CDDD	22	C2F5136C	64	C2F5542C	65	C2F6336CNNNNN	32
C2F3442EDDD	22	C2F5136CCECC	26	C2F5542CDDDDD	29	C2F6336CZCCCC	32
C2F3930C	64	C2F5136CDKCCC	27	C2F5542CLKCCC	29	C2F6336CZZZZZ	33
C2F3930CCECC	23	C2F5136CLKDDD	27	C2F5542CMMKCC	29	C2F6336ELAAA	33
C2F3930CLDD	24	C2F5136CMKCDD	27	C2F5542EDDDDD	29	C2F6336ELLLL	34
C2F3930CMCD	23	C2F5136CMMDD	26	C2F5542ELKCCC	29	C2F6336EMDCCC	34
C2F3930CZZZ	23	C2F5136CZZZZ	26	C2F5542EMMKCC	29	C2F6336EMMKDDD	35
C2F3930ECCC	23	C2F5136CECCC	26	C2F5830C	65	C2F6336ENCXXX	35
C2F3930ELDD	24	C2F5136EDKCCC	27	C2F5830CAAKCC	31	C2F6336ENNNNN	32
C2F3930EMCD	23	C2F5136ELKDDD	27	C2F5830CCDKDDD	30	C2F6336EZCCCC	32
C2F3930EZZZ	23	C2F5136EMKCDD	27	C2F5830CDDDDC	31	C2F6336EZZZZZ	33
C2F3930WCC	72	C2F5136EMMDD	26	C2F5830CDDDDD	30	C2F6336WZCCCC	74
C2F3930XCCC	72	C2F5136EZZZZ	26	C2F5830CMKMMM	30	C2F6336XZCCCC	74
C2F3936C	64	C2F5136WCCCC	73	C2F5830EAAKCC	31	C2F6342C	65
C2F3936CCECC	23	C2F5136XCXXX	73	C2F5830ECDKDDD	30	C2F6342CLAAA	33
C2F3936CLDD	24	C2F5142C	64	C2F5830EDDDCC	31	C2F6342CLLLL	34
C2F3936CMCD	23	C2F5142CCECC	26	C2F5830EMDDDD	30	C2F6342CMDCCC	34
C2F3936CZZZ	23	C2F5142CDKCCC	27	C2F5830EMKMMM	30	C2F6342CMMKDDD	35
C2F3936ECCC	23	C2F5142CLKDDD	27	C2F5836C	65	C2F6342CNCXXX	35
C2F3936ELDD	24	C2F5142CMKCDD	27	C2F5836CAAKCC	31	C2F6342CNNNNN	32
C2F3936EMCD	23	C2F5142CMMDD	26	C2F5836CCDKDDD	30	C2F6342CZCCCC	32
C2F3936EZZZ	23	C2F5142CZZZZ	26	C2F5836CDDDDC	31	C2F6342CZZZZZ	33
C2F3936WCC	72	C2F5142CECCC	26	C2F5836CDDDDD	30	C2F6342ELAAA	33
C2F3936XCCC	72	C2F5142EDKCCC	27	C2F5836CMKMMM	30	C2F6342ELLLL	34
C2F3942C	64	C2F5142ELKDDD	27	C2F5836EAAKCC	31	C2F6342EMDCCC	34
C2F3942CCECC	23	C2F5142EMKCDD	27	C2F5836ECDKDDD	30	C2F6342EMMKDDD	35
C2F3942CLDD	24	C2F5142EMMDD	26	C2F5836EDDDCC	31	C2F6342ENCXXX	35
C2F3942CMCD	23	C2F5142EZZZZ	26	C2F5836EMDDDD	30	C2F6342ENNNNN	32
C2F3942CZZZ	23	C2F5142WCCCC	73	C2F5836EMKMMM	30	C2F6342EZCCCC	32
C2F3942ECCC	23	C2F5142XCXXX	73	C2F5842C	65	C2F6342EZZZZZ	33
C2F3942ELDD	24	C2F5430C	64	C2F5842CAAKCC	31	C2F6342WZCCCC	74
C2F3942EMCD	23	C2F5430CLCCC	28	C2F5842CCDKDDD	30	C2F6342XZCCCC	74
C2F3942EZZZ	23	C2F5430CMKCCC	28	C2F5842CDDDDC	31	C2F6430C	65
C2F3942WCC	72	C2F5430CMMCC	28	C2F5842CDDDDD	30	C2F6430CLLDDD	37
C2F3942XCCC	72	C2F5430ELCCC	28	C2F5842CMKMMM	30	C2F6430CMCECC	36
C2F4530C	64	C2F5430EMKCCC	28	C2F5842EAAKCC	31	C2F6430CMMDD	37
C2F4530CDDDD	25	C2F5430EMMCC	28	C2F5842ECDKDDD	30	C2F6430CNCCKCC	36
C2F4530CMKMM	25	C2F5436C	64	C2F5842EDDDCC	31	C2F6430CNNNNN	36
C2F4530EDDDD	25	C2F5436CLCCC	28	C2F5842EMDDDD	30	C2F6430CZZKZZZ	37

<i>pattern no.</i>	<i>page</i>	<i>pattern no.</i>	<i>page</i>	<i>pattern no.</i>	<i>page</i>	<i>pattern no.</i>	<i>page</i>
C2F6430ELLDDD	37	C2H6436CUCC	40	C4B5854(N/S/L/V)S	59	C4BWRENCH	61
C2F6430EMCCCC	36	C2H6436ESCCC	40	C4B5860(N/S/L/V)S	59	CA10818	53
C2F6430EMMMDD	37	C2H6436EUCC	40	C4B5866(N/S/L/V)S	59	CA10836	53
C2F6430ENCKCCC	36	C2H6436WSCCC	75	C4B5872(N/S/L/V)S	59	CA3018	53
C2F6430ENNKNNN	36	C2H6436WUCC	75	C4B5878(N/S/L/V)S	59	CA3036	53
C2F6430EZZKZZZ	37	C2H6436XSCCC	75	C4B5884(N/S/L/V)S	59	CA3618	53
C2F6436C	65	C2H6436XUCC	75	C4B6424(N/S/L/V)S	59	CA3636	53
C2F6436CLLDDD	37	C2S2730E	57	C4B6430(N/S/L/V)S	59	CA4218	53
C2F6436CMCCCC	36	C2S2736E	57	C4B6436(N/S/L/V)S	59	CA4236	53
C2F6436CMMDD	37	C2S2742E	57	C4B6442(N/S/L/V)S	59	CA6018	53
C2F6436CNCKCCC	36	C2S3030E	57	C4B6448(N/S/L/V)S	59	CA6036	53
C2F6436CNNKNNN	36	C2S3036E	57	C4B6454(N/S/L/V)S	59	CA7218	53
C2F6436CZZKZZZ	37	C2S3042E	57	C4B6460(N/S/L/V)S	59	CA7236	53
C2F6436ELLDDD	37	C2W5530C	41	C4B6466(N/S/L/V)S	59	CA8418	53
C2F6436EMCCCC	36	C2W5530E	41	C4B6472(N/S/L/V)S	59	CA8436	53
C2F6436EMMMDD	37	C2W5536C	41	C4B6478(N/S/L/V)S	59	CA9018	53
C2F6436ENCKCCC	36	C2W5536E	41	C4B6484(N/S/L/V)S	59	CA9036	53
C2F6436ENNKNNN	36	C2W6330C	42	C4B7124(N/S/L/V)S	60	CB1-3018	166
C2F6436EZZKZZZ	37	C2W6330E	42	C4B7130(N/S/L/V)S	60	CB1-3024	166
C2F6442C	65	C2W6336C	42	C4B7136(N/S/L/V)S	60	CB1-3618	166
C2F6442CLLDDD	37	C2W6336E	42	C4B7142(N/S/L/V)S	60	CB1-3624	166
C2F6442CMCCCC	36	C2W6430C	43	C4B7148(N/S/L/V)S	60	CB1-4218	166
C2F6442CMMDD	37	C2W6430E	43	C4B7154(N/S/L/V)S	60	CB1-4224	166
C2F6442CNCKCCC	36	C2W6436C	43	C4B7160(N/S/L/V)S	60	CB1-4818	166
C2F6442CNNKNNN	36	C2W6436E	43	C4B7166(N/S/L/V)S	60	CB1-4824	166
C2F6442CZZKZZZ	37	C4B2723NS	58	C4B7172(N/S/L/V)S	60	CB1-F18	176
C2F6442ELLDDD	37	C4B2729NS	58	C4B7178(N/S/L/V)S	60	CB1-F24	176
C2F6442EMCCCC	36	C4B3024(N/S/L/V)S	58	C4B7184(N/S/L/V)S	60	CB1-F30	176
C2F6442EMMMDD	37	C4B3030(N/S/L/V)S	58	C4B8524(N/S/L/V)S	60	CB1-118	168
C2F6442ENCKCCC	36	C4B3036(N/S/L/V)S	58	C4B8530(N/S/L/V)S	60	CB1-124	168
C2F6442ENNKNNN	36	C4B3042(N/S/L/V)S	58	C4B8536(N/S/L/V)S	60	CB1-130	168
C2F6442EZZKZZZ	37	C4B3048(N/S/L/V)S	58	C4B8542(N/S/L/V)S	60	CB1-L26	168
C2H5530CVDDD	38	C4B3054(N/S/L/V)S	58	C4B8548(N/S/L/V)S	60	CB1-WC	176
C2H5530CXDD	38	C4B3060(N/S/L/V)S	58	C4B8554(N/S/L/V)S	60	CD1-6024(5)(7)L	161
C2H5530EVDDD	38	C4B3066(N/S/L/V)S	58	C4B8560(N/S/L/V)S	60	CD1-6024(5)(7)N	161
C2H5530EXDD	38	C4B3072(N/S/L/V)S	58	C4B8566(N/S/L/V)S	60	CD1-6030(5)(7)L	162
C2H5536CVDDD	38	C4B3078(N/S/L/V)S	58	C4B8572(N/S/L/V)S	60	CD1-6030(5)(7)N	162
C2H5536CXDD	38	C4B3084(N/S/L/V)S	58	C4B8578(N/S/L/V)S	60	CD1-6036(5)(7)L	163
C2H5536EVDDD	38	C4B3924(N/S/L/V)S	58	C4B8584(N/S/L/V)S	60	CD1-6036(5)(7)N	163
C2H5536EXDD	38	C4B3930(N/S/L/V)S	58	C4BSH24S	61	CD1-6624(5)(7)L	161
C2H6330CRCCC	39	C4B3936(N/S/L/V)S	58	C4BSH24S5	61	CD1-6624(5)(7)N	161
C2H6330CTCC	39	C4B3942(N/S/L/V)S	58	C4BSH30S	61	CD1-6630(5)(7)L	162
C2H6330ERCCC	39	C4B3948(N/S/L/V)S	58	C4BSH30S5	61	CD1-6630(5)(7)N	162
C2H6330ETCC	39	C4B3954(N/S/L/V)S	58	C4BSH36S	61	CD1-6636(5)(7)L	163
C2H6330WRCCC	74	C4B3960(N/S/L/V)S	58	C4BSH36S5	61	CD1-6636(5)(7)N	163
C2H6330WTCC	74	C4B3966(N/S/L/V)S	58	C4BSH42S	61	CD1-7224(5)(7)L	161
C2H6330XRCCC	74	C4B3972(N/S/L/V)S	58	C4BSH42S5	61	CD1-7224(5)(7)N	161
C2H6330XTCC	74	C4B3978(N/S/L/V)S	58	C4BSH48S	61	CD1-7230(5)(7)L	162
C2H6336CRCCC	39	C4B3984(N/S/L/V)S	58	C4BSH48S5	61	CD1-7230(5)(7)N	162
C2H6336CTCC	39	C4B4424(N/S/L/V)S	59	C4BSHFS24	61	CD1-7236(5)(7)L	163
C2H6336ERCCC	39	C4B4430(N/S/L/V)S	59	C4BSHFS30	61	CD1-7236(5)(7)N	163
C2H6336ETCC	39	C4B4436(N/S/L/V)S	59	C4BSHFS36	61	CD1-BD	107
C2H6336WRCCC	74	C4B4442(N/S/L/V)S	59	C4BSHFS42	61	CD1-FD	107
C2H6336WTCC	74	C4B4448(N/S/L/V)S	59	C4BSHFS48	61	CD1-FS	107
C2H6336XRCCC	74	C4B4454(N/S/L/V)S	59	C4BTOP24(L/V)	61	CD1LKKT	107
C2H6336XTCC	74	C4B4460(N/S/L/V)S	59	C4BTOP30(L/V)	61	CD1-ST	107
C2H6430CSCCCC	40	C4B4466(N/S/L/V)S	59	C4BTOP36(L/V)	61	CD2PTC	107
C2H6430CUCC	40	C4B4472(N/S/L/V)S	59	C4BTOP42(L/V)	61	CD2PTN	107
C2H6430ESCCC	40	C4B4478(N/S/L/V)S	59	C4BTOP48(L/V)	61	CDE1-18	176
C2H6430EUCC	40	C4B4484(N/S/L/V)S	59	C4BTOP54(L/V)	61	CDE1-24	176
C2H6430WSCCCC	75	C4B5824(N/S/L/V)S	59	C4BTOP60(L/V)	61	CDE1-30	176
C2H6430WUCC	75	C4B5830(N/S/L/V)S	59	C4BTOP66(L/V)	61	CDE1-I30	176
C2H6430XSCCC	75	C4B5836(N/S/L/V)S	59	C4BTOP72(L/V)	61	CDE1-T30	168
C2H6430XUCC	75	C4B5842(N/S/L/V)S	59	C4BTOP78(L/V)	61	CE10818	51
C2H6436CSCCCC	40	C4B5848(N/S/L/V)S	59	C4BTOP84(L/V)	61	CE10836	51

<i>pattern no.</i>	<i>page</i>	<i>pattern no.</i>	<i>page</i>	<i>pattern no.</i>	<i>page</i>	<i>pattern no.</i>	<i>page</i>
CE3018	51	COD2-42L	169	CS2PFL24B	87	CT3SBRH5715FFL	113
CE3036	51	COD2-42N	169	CS2PFN24A	87	CT3SBRH6415BBFL	116
CE3618	51	COD2-48EL	170	CS2PFN24B	87	CT3SBRH6415FFL	116
CE3636	51	COD2-48EN	170	CS2XPB	87	CT3SLH5015BBFFL	111
CE4218	51	COD2-48L	169	CSC3-A30	171	CT3SLH5015BBFL	111
CE4236	51	COD2-48N	169	CSC3-A36	171	CT3SLH5015FFFL	111
CE6018	51	COD2-60EL	170	CSC3-A42	171	CT3SLH5015FFL	110
CE6036	51	COD2-60EN	170	CSC3-A48	171	CT3SLH5024WL	118
CE7218	51	COD2-60L	169	CSC3-A54	171	CT3SLH5024WWL	118
CE7236	51	COD2-60N	169	CSC3-A60	171	CT3SLH5715BBFL	113
CE8418	51	COD2-66EL	170	CSC3-A66	171	CT3SLH5715FFFL	113
CE8436	51	COD2-66EN	170	CSC3-A72	171	CT3SLH5715FFL	112
CE9018	51	COD2-66L	169	CT3BDLH6415BBFL	116	CT3SLH5724WL	124
CE9036	51	COD2-66N	169	CT3BDLH6415FFL	117	CT3SLH5724WWL	125
CF1-B30	177	COD2-72EL	170	CT3BDRH6415BBFL	116	CT3SLH6415BBFFL	115
CF1-B36	177	COD2-72EN	170	CT3BDRH6415FFL	117	CT3SLH6415BBFL	114
CF1-B42	177	COD2-72L	169	CT3D5024WL	118	CT3SLH6415FFFL	117
CF1-B48	177	COD2-72N	169	CT3D5024WWL	119	CT3SLH6415FFFL	115
CF1-C66	177	CPKP	107	CT3D5030WL	138	CT3SLH6415FFL	114
CF1-C72	177	CRI-3618	164	CT3D5030WWL	138	CT3SLH6424WL	126
CF1-D48	177	CRI-3618(7)L	165	CT3D5724WL	125	CT3SLH6424WWL	126
CF1-D60	177	CRI-3618(7)N	165	CT3D5724WWL	125	CT3SRH5015BBFFL	111
CF1-D66	177	CRI-3624	164	CT3D5730WL	142	CT3SRH5015BBFL	111
CF1-D72	177	CRI-3624(7)L	165	CT3D5730WWL	142	CT3SRH5015FFFL	111
CF1-R30	177	CRI-3624(7)N	165	CT3D6424WL	126	CT3SRH5015FFL	110
CF1-R36	177	CRI-4218	164	CT3D6424WWL	127	CT3SRH5024WL	118
CF1-R42	177	CRI-4218(7)L	165	CT3D6430WL	142	CT3SRH5024WWL	118
CF1-R48	177	CRI-4218(7)N	165	CT3D6430WWL	143	CT3SRH5715BBFL	113
CF1-R60	177	CRI-4224	164	CT3FSLH5024L	135	CT3SRH5715FFFL	113
CL3L193M	178	CRI-4224(7)L	165	CT3FSLH5724L	136	CT3SRH5715FFL	112
CL3L196M	178	CRI-4224(7)N	165	CT3FSLH6424L	137	CT3SRH5724WL	124
CL3L199M	178	CRI-4818	164	CT3FSRH5024L	135	CT3SRH5724WWL	125
CL3L3712M	178	CRI-4818(7)L	165	CT3FSRH5724L	136	CT3SRH6415BBFFL	115
CL3L3718M	178	CRI-4818(7)N	165	CT3FSRH6424L	137	CT3SRH6415BBFL	114
CL3L376M	178	CRI-4824	164	CT3FWSLH5024BBFL	132	CT3SRH6415FFFL	115
CL3T5E19S	178	CRI-4824(7)L	165	CT3FWSLH5024FFL	132	CT3SRH6415FFFL	115
CL3T5E25A	178	CRI-4824(7)N	165	CT3FWSLH5024L	135	CT3SRH6415FFL	114
CL3T5E25S	178	CRI-6018	164	CT3FWSLH5724BBFL	133	CT3SRH6424WL	126
CL3T5E37A	178	CRI-6018(7)L	165	CT3FWSLH5724FFL	133	CT3SRH6424WWL	126
CL3T5E37S	178	CRI-6018(7)N	165	CT3FWSLH5724L	136	CT3WBDDLH6424BBFL	131
CL3T5E49A	178	CRI-6024	164	CT3FWSLH6424BBFL	134	CT3WBDDLH6424FFL	131
CL3T5E49S	178	CRI-6024(7)L	165	CT3FWSLH6424FFL	134	CT3WBDDLH6424PDDL	150
CM10818	52	CRI-6024(7)N	165	CT3FWSLH6424L	137	CT3WBDRH6424BBFL	131
CM10836	52	CRB60	172, 173, 174, 175	CT3FWSRH5024BBFL	132	CT3WBDRH6424FFL	131
CM3018	52	CRB66	172, 173, 174, 175	CT3FWSRH5024FFL	132	CT3WBDRH6424PDDL	150
CM3036	52	CRB72	172, 173, 174, 175	CT3FWSRH5024L	135	CT3WSBLH4224BBFL	121
CM3618	52	CS1-6024(5)L	158	CT3FWSRH5724BBFL	133	CT3WSBLH4224FFL	121
CM3636	52	CS1-6024(5)N	158	CT3FWSRH5724FFL	133	CT3WSBLH5024BBFL	122
CM4218	52	CS1-6030(5)L	159	CT3FWSRH5724L	136	CT3WSBLH5024FFL	121
CM4236	52	CS1-6030(5)N	159	CT3FWSRH6424BBFL	134	CT3WSBLH5024PDDL	147
CM6018	52	CS1-6036(5)L	160	CT3FWSRH6424FFL	134	CT3WSBLH5724BBFL	124
CM6036	52	CS1-6036(5)N	160	CT3FWSRH6424L	137	CT3WSBLH5724FFL	124
CM7218	52	CS1-6624(5)L	158	CT3SBLH4215BBFL	110	CT3WSBLH5724PDDL	148
CM7236	52	CS1-6624(5)N	158	CT3SBLH4215FFL	110	CT3WSBLH6424BBFL	131
CM8418	52	CS1-6630(5)L	159	CT3SBLH5015BBFL	112	CT3WSBLH6424FFL	130
CM8436	52	CS1-6630(5)N	159	CT3SBLH5015FFL	112	CT3WSBLH6424PDDL	149
CM9018	52	CS1-6636(5)L	160	CT3SBLH5715BBFL	114	CT3WSBRH4224BBFL	121
CM9036	52	CS1-6636(5)N	160	CT3SBLH5715FFL	113	CT3WSBRH4224FFL	121
CO1-VD	169, 170	CS1-7224(5)L	158	CT3SBLH6415BBFL	116	CT3WSBRH5024BBFL	122
COD2-36EL	170	CS1-7224(5)N	158	CT3SBLH6415FFL	116	CT3WSBRH5024FFL	121
COD2-36EN	170	CS1-7230(5)L	159	CT3SBRH4215BBFL	110	CT3WSBRH5024PDDL	147
COD2-36L	169	CS1-7230(5)N	159	CT3SBRH4215FFL	110	CT3WSBRH5724BBFL	124
COD2-36N	169	CS1-7236(5)L	160	CT3SBRH5015BBFL	112	CT3WSBRH5724FFL	124
COD2-42EL	170	CS1-7236(5)N	160	CT3SBRH5015FFL	112	CT3WSBRH5724PDDL	148
COD2-42EN	170	CS2PFL24A	87	CT3SBRH5715BBFL	114	CT3WSBRH6424BBFL	131

<i>pattern no.</i>	<i>page</i>	<i>pattern no.</i>	<i>page</i>	<i>pattern no.</i>	<i>page</i>	<i>pattern no.</i>	<i>page</i>
CT3WSBRH6424FFL	130	CT3WSRH6424PDDL	149	CW1-S7230-B	174	SA4218	56
CT3WSBRH6424PDDL	149	CT3WSRH6430BBFFL	145	CW1-S7236-A	175	SA4236	56
CT3WSLH5024BBFFL	120	CT3WSRH6430BBFL	144	CW1-S7236-B	175	SA6018	56
CT3WSLH5024BBFL	119	CT3WSRH6430BFFL	144	D	66	SA6036	56
CT3WSLH5024BFFL	120	CT3WSRH6430FFFL	146	DS1OHL	170	SA7218	56
CT3WSLH5024FFFL	120	CT3WSRH6430FFFL	145	DS2PPTC	152	SA7236	56
CT3WSLH5024FFL	119	CT3WSRH6430FFL	143	DS2PPTN	152	SA8418	56
CT3WSLH5024PDDL	147	CU1-6618(7)(7)L	167	DSIOHL	169	SA8436	56
CT3WSLH5030BBFFL	139	CU1-6618(7)(7)N	167	DT3CB15	155	SA9018	56
CT3WSLH5030BBFL	139	CU1-6624(7)(7)L	167	DT3CB24	155	SA9036	56
CT3WSLH5030BFFL	139	CU1-6624(7)(7)N	167	DT3CB30	156	SC10818	55
CT3WSLH5030FFFL	140	CU1-7218(7)(7)L	167	DT3CB9	155	SC10836	55
CT3WSLH5030FFL	138	CU1-7218(7)(7)N	167	DT3DCH	156	SC3018	55
CT3WSLH5724BBFFL	123	CU1-7224(7)(7)L	167	DT3FDD	151	SC3036	55
CT3WSLH5724BBFL	123	CU1-7224(7)(7)N	167	DT3FDS15	153	SC3618	55
CT3WSLH5724BFFL	123	CV1-3624	168	DT3FDS24	153	SC3636	55
CT3WSLH5724FFFL	122	CV1-4224	168	DT3FDS30	154	SC4218	55
CT3WSLH5724FFL	122	CV1-4824	168	DT3FM15	157	SC4236	55
CT3WSLH5730PDDL	148	CW1-R6330B	168	DT3FM9	156	SC6018	55
CT3WSLH5730BBFFL	141	CW1-R7530B	168	DT3GBCDS	154	SC6036	55
CT3WSLH5730BBFL	141	CW1-S3018-A	172	DT3HDS15	153	SC7218	55
CT3WSLH5730BFFL	141	CW1-S3018-B	172	DT3HDS24	153	SC7236	55
CT3WSLH5730FFFL	140	CW1-S3024-A	173	DT3HDS30	153	SC8418	55
CT3WSLH5730FFL	140	CW1-S3024-B	173	DT3MBCDS	154	SC8436	55
CT3WSLH6424BBFFL	129	CW1-S3030-A	174	DT3PDD	151	SC9018	55
CT3WSLH6424BBFL	128	CW1-S3030-B	174	DT3RT	152	SC9036	55
CT3WSLH6424BFFL	128	CW1-S3618-A	172	DT3SDD	152	SD10818	54
CT3WSLH6424FFFL	130	CW1-S3618-B	172	DT3WSP	154	SD10836	54
CT3WSLH6424FFFL	129	CW1-S3624-A	173	F	67	SD3018	54
CT3WSLH6424FFL	127	CW1-S3624-B	173	G	67	SD3036	54
CT3WSLH6424PDDL	149	CW1-S3630-A	174	H	67	SD3618	54
CT3WSLH6430BBFFL	145	CW1-S3630-B	174	I	67	SD3636	54
CT3WSLH6430BBFL	144	CW1-S4218-A	172	J	68	SD4218	54
CT3WSLH6430BFFL	144	CW1-S4218-B	172	K	68	SD4236	54
CT3WSLH6430FFFL	146	CW1-S4224-A	173	L	69	SD6018	54
CT3WSLH6430FFFL	145	CW1-S4224-B	173	M	69	SD6036	54
CT3WSLH6430FFL	143	CW1-S4230-A	174	N	69	SD7218	54
CT3WSRH5024BBFFL	120	CW1-S4230-B	174	O	70	SD7236	54
CT3WSRH5024BBFL	119	CW1-S4818-A	172	P	70	SD8418	54
CT3WSRH5024BFFL	120	CW1-S4818-B	172	R	68	SD8436	54
CT3WSRH5024FFFL	120	CW1-S4824-A	173	S	68	SD9018	54
CT3WSRH5024FFL	119	CW1-S4824-B	173	S2F2730CCC	76	SD9036	54
CT3WSRH5024PDDL	147	CW1-S4830-A	174	S2F2730ECC	76	T	68
CT3WSRH5030BBFFL	139	CW1-S4830-B	174	S2F2736CCC	76	U	69
CT3WSRH5030BBFL	139	CW1-S6018-A	172	S2F2736ECC	76	Z	70
CT3WSRH5030BFFL	139	CW1-S6018-B	172	S2F2742CCC	76		
CT3WSRH5030FFFL	140	CW1-S6024-A	173	S2F2742ECC	76		
CT3WSRH5030FFL	138	CW1-S6024-B	173	S2F3930CCCC	77		
CT3WSRH5724BBFFL	123	CW1-S6030-A	174	S2F3930ECCC	77		
CT3WSRH5724BBFL	123	CW1-S6030-B	174	S2F3936CCCC	77		
CT3WSRH5724BFFL	123	CW1-S6036-A	175	S2F3936ECCC	77		
CT3WSRH5724FFFL	122	CW1-S6036-B	175	S2F3942CCCC	77		
CT3WSRH5724FFL	122	CW1-S6618-A	172	S2F3942ECCC	77		
CT3WSRH5724PDDL	148	CW1-S6618-B	172	S2F5130CCCC	78		
CT3WSRH5730BBFFL	141	CW1-S6624-A	173	S2F5130ECCC	78		
CT3WSRH5730BBFL	141	CW1-S6624-B	173	S2F5136CCCC	78		
CT3WSRH5730BFFL	141	CW1-S6630-A	174	S2F5136ECCC	78		
CT3WSRH5730FFFL	140	CW1-S6630-B	174	S2F5142CCCC	78		
CT3WSRH5730FFL	140	CW1-S6636-A	175	S2F5142ECCC	78		
CT3WSRH6424BBFFL	129	CW1-S6636-B	175	SA10818	56		
CT3WSRH6424BBFL	128	CW1-S7218-A	172	SA10836	56		
CT3WSRH6424BFFL	128	CW1-S7218-B	172	SA3018	56		
CT3WSRH6424FFFL	130	CW1-S7224-A	173	SA3036	56		
CT3WSRH6424FFFL	129	CW1-S7224-B	173	SA3618	56		
CT3WSRH6424FFL	127	CW1-S7230-A	174	SA3636	56		

Selling Policy

	<p>This Selling Policy supercedes all previous selling policies. Prices, discounts and product offerings are subject to change without notice.</p>
Terms & Conditions of Sales	<p>Sales by Knoll, Inc. or Knoll North America Corp. ("Seller") of Knoll Product Lines (hereinafter "Products") within the United States and Canada are made only on the terms which are contained in this Selling Policy. Seller hereby gives notice of its objection to any different or additional terms and conditions. This sale is expressly conditional upon Purchaser's assent to the terms and conditions set forth below. Additional terms and conditions may apply to KnollStudio and KnollTextiles orders. These terms and conditions may be modified or supplemented only by a written document signed by an authorized representative of Seller. These terms and conditions supercede any prior and/or contemporaneous agreements or correspondence between Purchaser and Seller. Written quotations expire thirty (30) days from the date of issuance and can be withdrawn by written notice anytime during that period. Where Purchaser and Seller have entered into the Knoll Electronic Terms and Conditions, all orders, acknowledgements, invoices and other business communications placed or transmitted in accordance with the Knoll Electronic Terms and Conditions shall be deemed to be in writing and signed and shall be valid for all purposes as if they were originated and maintained in documentary form.</p>
Ordering Information	<p>All orders must be in writing. The product pattern number(s) contained on Seller's order acknowledgement shall be the final expression of the order.</p>
Order Confirmation	<p>A purchase order is not binding on Seller until Purchaser has received Seller's order confirmation or acknowledgment.</p>
Pricing Policies	<p>List prices are subject to change without notice.</p> <p>List prices shall be those prices in effect on the date of receipt of a complete purchase order unless shipment is requested more than ninety (90) days after order entry in which case prices in effect on the date of shipment apply. List prices include specified freight costs. Unless specified in writing by Seller, no other charges are included in Seller's list prices.</p>
Taxes	<p>All sales, use, excise and other taxes applicable to the sale of the Products shall be paid by Purchaser. If Purchaser claims an exemption from any tax, Purchaser shall submit to Seller the appropriate exemption certificates.</p>
Terms of Payment	<p>Payment for one hundred percent (100%) of the net order amount is due within thirty (30) days of the date of invoice, which is generally issued upon shipment. In case of any discrepancies, such as shortages, and Seller is notified in writing within ten (10) days of receipt of Product, only that portion may be deducted and the balance paid. For orders greater than \$100,000 net, a fifty percent (50%) deposit is due at the time of order placement, with the remainder due within thirty (30) days of the date of invoice.</p> <p>KnollStudio orders less than \$2,000 require payment for one hundred percent (100%) of the net order amount (including any applicable sales tax and charges for inside delivery, special packaging, etc.), due at time of order placement. For KnollStudio orders greater than \$2,000, a one-half (50%) deposit is due at time of order placement with the remainder (including any applicable sales tax and charges for inside delivery, special packaging, etc.) due prior to shipment.</p> <p>If, in the judgment of Seller, Purchaser's financial condition does not justify the terms of the payment, Seller may require full or partial payment in advance.</p> <p>Past due accounts shall be charged one and one-half percent (1.5%) per month, or the highest rate permitted by law, whichever is less, and will be added to the outstanding balance. In the event Purchaser defaults on payment, Purchaser shall be liable for all collection costs, including reasonable attorney's fees and costs.</p>
Changes and Cancellation	<p>Purchase orders may not be changed or cancelled, in whole or in part, without prior written consent of Seller. Changes may effect delivery dates. Expenses incurred because of changes shall be charged to Purchaser. In the event of cancellations, Purchaser will be liable for reasonable cancellation charges established by Seller. Orders for special Product, orders including "COM" (hereinafter defined) material and orders pursuant to expedited delivery programs, may not be canceled.</p>
Freight Prepaid	<p>Freight is prepaid and included in the price of all Products, except KnollTextiles, within the 48 contiguous United States for orders placed with Knoll, Inc. and within Canada, excluding the Yukon, Northwest Territories, Nunavut and Newfoundland for orders placed with Knoll North America Corp. Packing is tested for rigorous motion and transportation but is not guaranteed to protect furniture from all conditions. If special packaging is required for any reason, please consult with your sales representative or dealer. Seller shall select the method of shipment and routing. Freight for all KnollTextiles orders is prepaid and added to the invoice.</p>
Delivery/Freight Charges	<p>Shipments outside the contiguous 48 United States and Canada shall be shipped F.O.B. Origin.</p> <p>For shipments outside the contiguous United States and Canada, Purchaser is responsible for the cost of freight from point of embarkation, including any handling and transportation charges incidental to loading at the point of departure and unloading at the final destination.</p> <p>Conditions beyond the control of Seller, including weather, available facilities and traffic conditions, may affect exact time of delivery. Seller shall not be responsible for specific carrier delivery date or time unless it has made a specific delivery commitment, in writing.</p> <p>Nonstandard methods of shipment and/or additional services are available upon request. Purchaser will be billed for the differential cost of any special services in excess of standard surface carrier freight costs. Premium charges, at Purchaser's request, will be added for airfreight, exclusive use of vehicle and extra, export or special packaging. Accessorial charges will be added for inside delivery, extra labor, reassignment and redelivery.</p> <p>Partial shipments may be made and invoiced by Seller.</p>
Claims	<p>All shipments for Knoll Products within the contiguous United States and Canada are F.O.B. Origin. All risk of loss passes to Purchaser at time of delivery to carrier. Purchaser shall inspect all Products upon receipt and notify Seller within ten (10) working days after receipt of any damage or defects which are, or should be, apparent from an inspection of the Product and its packaging. Failure of Purchaser to notify Seller during the ten (10) working day period shall constitute acceptance of the Products and waiver of any apparent defects, errors or shortages. For all claims relating to Product damaged in transit or for any other claims relating to or arising out of the transportation of the Product, Purchaser must seek recovery from the carrier and Seller has no liability to Purchaser for such claims. Seller may, upon request, assist Purchaser with filing of such claims with the carrier, but Seller will not be liable for any of these transportation related claims.</p>
Seller's Security Interest	<p>Until Seller receives the full payment for the Product, Seller shall have a security interest in the Product. Purchaser agrees to perform all acts, including but not limited to the execution and filing of documentation, which may be necessary to perfect and assure the security interest of Seller.</p>
Returns	<p>The return of Products without a written authorization by Seller shall not be accepted. To receive authorization for Product return, please call Customer Service. All Products that are returned pursuant to a valid authorization shall be subject to a twenty-five percent (25%) of list restocking charge. Products not currently offered for sale by Seller (including COM) shall not be authorized for return. All returned Products must be unused, in original condition and in the original Seller packing cartons. No refund or credit shall be given for damaged Products.</p>
Held Orders/Storage	<p>If Purchaser requests that an order be held or delayed, prices and terms and conditions in effect at the time of shipment shall apply. If Purchaser requests a delay after the time when Seller can defer production, Purchaser will be invoiced for the Product, payable in accordance with standard terms, when the order is ready for shipment. Seller may transfer the Product to storage, in which case all expenses incurred in connection with storage, including demurrage, preparation for storage, storage charges and handling shall be payable by Purchaser upon submission of invoices by Seller. Risk of loss to the Product shall pass to the Purchaser upon delivery of the Product into storage.</p>

Selling Policy

Customer's Own Material	A Purchaser who requests a fabric or other surface material not standard to Seller's line of Products ("COM") must submit samples of the requested material to Seller prior to entry of a purchaser order. Seller shall determine if the material is suitable to its manufacturing processes and meets any requirements of Underwriters Laboratories. If the COM is acceptable, Seller will then establish a price for using the COM or the Product in question. For a description of the procedures for submitting samples and testing, contact customer resources or your sales representative. Seller shall have no responsibility for the appearance, condition, performance, durability, colorfastness or any other physical attribute of the COM. Purchaser shall indemnify and hold Seller harmless for any damages, injuries or losses arising out of or related to use of the COM on the Product.
Warranty	Seller warrants to the original Purchaser only that the Products Seller manufactures and sells to Purchaser are free of defects in workmanship and materials, during the applicable warranty period set forth below. Warranty period set forth below is for 24-hour, 7 days a week, multi shift use (includes parts and labor to repair). Should any failure to conform with this limited warranty appear to a Product listed below during the applicable warranty period from the date of shipment, Seller shall, upon prompt written notice, repair or replace, at its option and costs, the affected part or parts. <i>Product and Period of Warranty</i> <i>Lifetime: Antenna Workspaces, AutoStrada, Calibre, Crinion Open Table, Currents, Dividends Horizon, Equity, Morrison, Reff Profiles laminate, Series 2 Storage, Template and other non-wood components (except cascade edge worksurfaces, operational parts, controls, electrical, Lighting, Series 2 Veneer Front Storage, special or custom products, see below)</i> <i>12 Years: Chadwick, Essentials Work Chairs, Generation by Knoll, Life, Moment, MultiGeneration by Knoll, ReGeneration by Knoll, RPM, Sapper and Toboggan seating (except seating upholstery, textiles, leathers and finishes, see below).</i> <i>10 Years: Anchor Storage except digital keypad lock, Antenna Workspaces, AutoStrada, Crinion Open Table, Dividends Horizon, Reff Profiles, Template wood components, Series 2 Veneer Front Storage, cascade edge worksurfaces, Wood Casegoods (The Graham Collection) (except wood casegoods upholstered surfaces, see below), Interaction tables (except height adjustment mechanisms for Counterforce, crank-adjustable, and split-top tables and worksurfaces, see below), Reuter overheads, Reuter vertical storage, KnollExtra Sapper Monitor Arm Collection, Adjustable keyboard mechanisms and platforms, Communication Boards (except fabric board textiles, see below), Smokador collection (except leathers, see below), and Orchestra Universal Systems Accessories.</i> <i>5 Years: Operational parts, controls, electrical, Lighting (except light ballasts, bulbs and power supply, see below), special or custom product, wood veneer products, Currents handerank, Interaction Counterforce, Interaction crank-adjustable, and split-top mechanisms, KnollStudio, Spark Series seating structural elements, structural elements of all KnollStudio outdoor products including all Richard Schultz designed products, KnollExtra CPU storage and all universal storage drawers and Power Collection.</i> <i>3 Years: Seating upholstery, textiles, leathers and finishes. Fabric boards textiles and Smokador Collection leathers.</i> <i>2 Years: Anchor Storage digital keypad lock, all other KnollExtra product</i> <i>1 Year: Light ballasts, bulbs and power supply, seating upholstered armpads and soft armpads, wood casegoods upholstered surfaces. KnollStudio, outdoor product finishes.</i> This warranty does not apply to: <ul style="list-style-type: none">• Damage caused by a carrier other than the Seller.• Normal wear and tear or acts or omissions of parties other than Seller (including user modification, improper use or installation of Products).• COM or other third party materials applied to Products.• Products not installed by or under the auspices of a Knoll Dealer.• Dramatic temperature variations or exposure to unusual conditions.• Changes in surface finishes, including colorfastness due to aging or exposure to light.• Except as specifically noted above, textiles and upholstery supplied by <i>KnollTextiles</i> (consult current <i>KnollTextiles</i> price list for applicable warranty). Natural variations occurring in wood, marble, and leather shall not be considered defects, and the Seller does not guarantee the colorfastness or matching of the colors, grains or textures, or surface hardness of such materials. The Seller also does not guarantee the colorfastness of fiberglass panel surfaces. THE EXPRESS WARRANTIES CONTAINED HEREIN ARE IN LIEU OF ALL OTHER WARRANTIES, EXPRESS OR IMPLIED, INCLUDING ANY WARRANTIES OF MERCHANTABILITY AND FITNESS FOR PARTICULAR PURPOSE AND ALL OTHER WARRANTIES ARISING FROM COURSE OF DEALING OR USAGE OF TRADE. The remedies provided above are the Purchaser's sole remedies for any failure of Seller to comply with its obligations regarding the workmanship of its Products. Correction of any nonconformity in the manner and for the period of time provided shall constitute complete fulfillment of all liabilities of Seller, with respect to or arising out of the Product furnished hereunder.
Delay/Force Majeure	Seller shall not be liable for failure to perform or for delay in performance due to fire, flood, strike or other labor difficulty, act of God, act of any governmental authority or of the Purchaser, riot, embargo, fuel or energy shortage, wrecks or delay in transportation, inability to obtain necessary labor, materials or manufacturing facilities from usual sources or failure of suppliers to meet their contractual obligations, or due to any cause beyond its reasonable control. If any such event occurs, Seller may extend delivery dates by a period of time necessary to overcome the effect of such delay, allocate available Product or cancel any purchase order.
Compliance with Law	PURCHASER IS SOLELY RESPONSIBLE FOR COMPLIANCE WITH ALL APPLICABLE FEDERAL, STATE AND LOCAL LAWS, ORDINANCES, REGULATIONS, RULES AND STANDARDS RELATING TO THE INSTALLATION, MAINTENANCE, USE AND OPERATION OF THE PRODUCTS.
Patents	Subject to the following provisions, Seller shall, at its own expense, defend or, at its option, settle any claim, suit or proceeding brought against the Purchaser, and/or its vendees, mediate and immediate, so far as based on an allegation that any Product or any part thereof furnished hereunder constitutes a direct or a contributory infringement of any claim of any patent of the United States or Canada. This obligation shall be effective only if Purchaser shall have made all payments then due hereunder and if Seller is notified promptly in writing and given authority, information and assistance for the defense of said claim, suit or proceeding. Seller shall pay all damages and costs awarded in such suit or proceedings so defended. The foregoing indemnity does not apply to the following: <ul style="list-style-type: none">• Products supplied according to a design other than that of Seller, and which is required by the Purchaser.• Combination of the Product with another product not furnished hereunder unless Seller is a contributory infringer.• Any settlements of a suit or proceeding made without Seller's written consent.
Limitations of Liability	SELLER, ITS CONTRACTORS, AUTHORIZED DEALERS AND SUBCONTRACTORS OR SUPPLIERS OF ANY TIER SHALL NOT BE LIABLE TO PURCHASER FOR ANY SPECIAL, INDIRECT, INCIDENTAL OR CONSEQUENTIAL DAMAGES ARISING FROM A BREACH OF THIS AGREEMENT. Purchaser's remedies set forth herein are exclusive and the liability of Seller with respect to the breach of this agreement or any contract entered into between the parties pursuant hereto shall not exceed the price of the Product or part on which such liability is based.

KnollKey Lock Program

KnollKey Lock Program General Information

Following is the KnollKey lock policy, applicable to all products.

Knoll furniture can be ordered keyed-alike or random keyed. Key-alike and random keying instructions cannot be mixed on any single order. Only one of the two instructions can be used on an individual order. When an order is submitted with mixed (key-alike and random) instructions, Knoll will release the order as key-alike only and lock cores will have to be specified separately.

Key-alike

For the convenience of the user, furniture may be keyed alike at no charge. Write "Key-alike" in the description of your purchase order for any pedestal, overhead, file or other item you wish to have keyed alike.

Using the key-alike instructions, order cores and keys as line items on your purchase order. Do NOT submit a key-alike form. The Knoll East Greenville Lock Center will select key numbers from the standard range of K 001 - K 250. Key numbers will not be repeated unless over 250 sets are ordered. Lock cores keyed-alike will ship separately from the product, ready for field installation.

There is no charge for key-alike orders if placed with the furniture order.

IF THE KEY-ALIKE ORDER IS NOT PLACED AT LEAST TWO WEEKS PRIOR TO THE FURNITURE SHIP DATE, A \$50 HANDLING CHARGE AND AIR FREIGHT CHARGES WILL APPLY.

If product is ordered and shipped random-keyed, additional lock cores for key-alike are billable.

Random-Keying

To specify product keyed-random, write "key-random" in the product description. Random-keyed product is shipped with the lock core factory installed. A shrouded key is included. Random means no effort has been made to match key numbers, or to make them different.

Keys

A Knoll shrouded key is shipped with every lock core. 250 Key numbers are available. For numbers above 250, contact Custom Product Development. Additional keys and key blanks are available. See service parts for more information.

Master Keying

Knoll locks can be controlled by means of a master key. There is no additional per-lock charge for master keying. A letter of approval from the client must accompany orders for master keys.

Installing Lock Cores

Lock cores can be installed or removed in the field by using a change key. Cores must be in the unlocked position to be removed. See service parts for change key pattern number and pricing.

Lock Distribution

All orders for key-alike lock cores/keys are packaged and shipped from the East Greenville Lock Center, regardless of where the pedestals, overhead, or other units are produced. Random keyed product will have cores factory-installed.

How to Specify Key-Alike

Following is an example of how to specify key-alike for a cluster of 10 workstations.

Step 1 - Using the project floorplan, count the number of locks in each workstation.

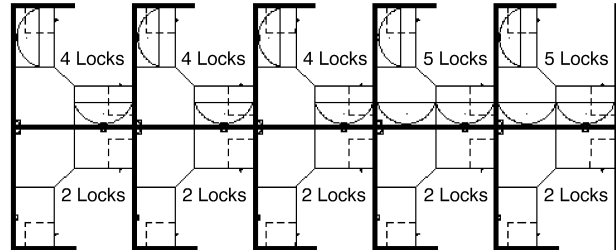

Step 2 - Count the number of workstations with the same quantity of locks. Group together the workstations with a like number of locks.

5 workstations with 2 locks per station
3 workstations with 4 locks per station
2 workstations with 5 locks per station

Step 3 - For the first group (5 sets of 2 locks), enter the number of workstations in the quantity column.

Qty	Pattern #	Description	Unit List	Ext. List
5				

Step 4 - Then enter the pattern number "KSPEC_ _" and add a suffix for the number of locks for that group (i.e., for 2 locks per station, add the suffix "2"). Up to 30 lock cores are available in a set (i.e., KSPEC 30).

Qty	Pattern #	Description	Unit List	Ext. List
5	KSPEC 2	Set of 2 cores/keys	N / C	N / C

Step 5 - Repeat for other groups.

Qty	Pattern #	Description	Unit List	Ext. List
5	KSPEC 2	Set of 2 cores/keys	N / C	N / C
3	KSPEC 4	Set of 4 cores/keys	N / C	N / C
2	KSPEC 5	Set of 5 cores/keys	N / C	N / C

Your Key instructions are complete.

Knoll will select key numbers for each set from 250 available numbers. Additional key numbers are available through Custom Product Development. **For additions to existing installations, specify desired key numbers in the description.**

Service Parts

Pattern #	Description	List Price
KKEY_ _ _	Shrouded Key Specify key number desired	\$10
KBLANK	Shrouded Key Blank	\$10
KSPECB_ _ _	Retrofit Universal Core/Key Specify key number desired	\$22
KCHANGE	Change Key	\$10
HLKRKMASTER*	Master Key	\$10

*Note: A letter of approval on company letterhead from the client must accompany all orders for master keys.

General Ordering Information

The Products

This guide encompasses all standard products for this product group.

Sizes

Dimensions listed in this guide are indicated as:

H = height

W = width

D = depth

Dia. = diameter

Rad. = radius

Pricing

All prices shown are list.

How to Order

Select pattern numbers and quantities required for your complete installation. Product questions can be addressed in the specific sections of this guide or by contacting your sales representative or customer resource representative at 1-800-343-5665.

Next, select options (if required), along with colors and finishes appropriate to each product. Reference the Finishes and Fabrics pages for color designations.

On large installations, an item's "designated area" can be specified to assist in product organization and handling.

To expedite complete / correct entry of your order, be certain all pattern numbers, quantities, colors and area identifications are completely specified. Also, include complete purchase order numbers, bill-to and ship-to addresses, a contact name and specific factory shipping dates required.

Mail all orders to:

Knoll, Inc.

1235 Water Street

P.O. Box 157

East Greenville, PA 18041

Attention: Order Entry

Once your order is entered at Knoll, an acknowledgment will be mailed to you. You will be advised of your scheduled shipping date within five days of the original acknowledgment. If it is necessary to revise your order, please contact your customer resource representative.

Sustainability Statement

Sustainable design is a key component of Knoll's environmental focus. Our commitment to social responsibility and a healthy environment has prompted us to further articulate our longstanding environmental programs and, with encouragement and support from our colleagues in the industry, we have re-energized our focus on such "green" initiatives as life cycle analysis and LEED™ certification. Knoll is proud to have contributed to projects that have received LEED certification from the U.S. Green Building Council.

For the latest information on Knoll products that help our customers achieve LEED certification, log on to knoll.com, click on "About Knoll" and then "Environmental Focus."