

Introduction	Knoll and Sustainable Design	2
	GREENGUARD Indoor Air Quality Certified®	3
	Using the KnollExtra Price List	4
	Placing Your Order	5
	KnollExtra Visual Index	6
	KnollExtra Bracket Chart	12
	Maintaining Your Purchase	13
Desktop Accessories	The Smokador™ Collection : Exec Rectilinear	14
	The Smokador™ Collection : Contemporary Leather	22
	The Smokador™ Collection : Traditional Leather	28
	The Smokador™ Collection : Replacement Parts	32
Boardroom Accessories	International Collection : Glassware	34
	International Collection : Stainless Boardroom Accessories	36
	International Collection : Plastic Boardroom Accessories	42
	International Collection : Umbrella Stand and Clocks	44
	International Collection : Replacement Parts	46
Organizational Tools	Orchestra® Universal System Accessories : by Bruce Hannah & Ayse Birsel	48
Technology Management	Sapper™ Monitor Arm Collection : Easy Order Single Arm Kits	72
	Sapper™ Monitor Arm Collection : Easy Order Double Arm Kits	78
	Sapper™ Monitor Arm Collection : Easy Order Triple Monitor Support Kits	82
	Sapper™ Monitor Arm Collection : Easy Order Quadruple Mount Support Kits	86
	Sapper™ Monitor Arm Collection : Monitor Arms, Brackets and Movement Joints	88
	Sapper™ Monitor Arm Collection : Masts	92
	Sapper™ Monitor Arm Collection : Adjustment Knobs and Mast Cable Management Clips	94
	Sapper™ Monitor Arm Collection : Mounting Options	96
	Sapper™ Monitor Arm Collection : Mounting, Construction and Application Information	100
	Adjustable Keyboard Supports : Romeo and Juliet Platform/Mechanism Configurations	106
	Adjustable Keyboard Supports : Prospero Platform/Mechanism Configurations	108
	Adjustable Keyboard Supports : Caesar Platform/Mechanism Configurations	110
	Adjustable Keyboard Supports : Act I	112
	Adjustable Keyboard Supports : Act II	114
	Adjustable Keyboard Supports : Mousing Solutions	116
	Freestanding Surf® Ergonomic Accessories : by Ross Lovegrove & Stephen Peart	118
	Freestanding Ergonomic Accessories	120
Worksurface Support : Adjustable CPU Holders	122	
Storage	BackPack® Universal Storage Drawers : by Robert Reuter	124
	Universal Pencil Drawer : by Brooks Rorke	132
Communication Boards	Universal Marker Boards : by Bruce Hannah&Ayse Birsel	134
	Universal Fabric Boards : Standard Sizes	136
	Universal Fabric Boards : Options and Mounting Information	140
	Universal Fabric Boards : Top Cap Hung Marker Board	142
Lighting	Copeland™ Light : by Stephan Copeland	144
	Little Dipper and Big Dipper : Lighting System	148
	Desktop Lamp : By John Rizzi and Brooks Rorke	150
Alpha-Numeric Index		152
Selling Policy		154
General Ordering Information		156

Knoll and Sustainable Design

Each year Knoll sets key initiatives in our journey to sustainability. We are members of a global consortium on energy, have adopted a scientific, metrics-based approach to sustainable product design, and maintain a leadership position in establishing universal, verifiable, sustainability standards for our industry.

Knoll promotes independent third-party certification because it provides the most impartial and trustworthy foundation for industry-wide environmental compliance. Certification by established and respected third parties ensures that all manufacturers are held to the same high standards and that customers can trust a company's declaration about the environmental benefits of its products. Knoll third-party partners include: the International Standards Organization (ISO); Forest Stewardship Council (FSC®); Rainforest Alliance; GREENGUARD® Environmental Institute; and The Business and Institutional Furniture Manufacturer's Association (BIFMA) level™ certification from Scientific Certification Systems (SCS).

In addition, Knoll is aligned with the U.S. Green Building Council and can help companies, healthcare organizations and educational institutions achieve Leadership in Energy and Environmental Design (LEED®) workplace certification.

Global Climate Change

- Knoll is a sponsor of the Clinton Global Initiative, which brings together a community of global leaders to devise and implement solutions to some of the world's most pressing challenges, including environmental change.
- Knoll has a comprehensive Energy Management Program to increase energy efficiency in products and processes.

Life Cycle Assessment (LCA) Tool

- Life Cycle Assessment is a science-based measurement of a product's environmental impacts throughout its life cycle, from raw materials sourcing through manufacture, shipping, use and re-use or end-of-life. LCA enables cradle-to-cradle implementation of sustainable practices.
- Knoll has partnered with The Green Standard.org to develop an affordable, universal ISO-compliant computer-based LCA tool that can be used by the entire contract furniture industry and is partnering on the development of an Environmental Product Declaration System (EPDs) for Knoll products. EPDs are verified documents containing LCA results and additional environmental performance information about a product.

Setting Industry Standards

- Knoll partners with MTS (The Institute for Market Transformation to Sustainability) to develop the SMaRT® Consensus Sustainable Products Standards, a set of consensus-based sustainable product standards based on the LEED® model, for all building products, fabric, apparel, flooring and carpet. MTS, the developer of SMaRT®, is an accredited American National Standards Institute (ANSI) standard developer.
- Knoll also partners with BIFMA (Business and Institutional Furniture Manufacturers Association) to promote level™ sustainability standards for the contract furniture industry.
- Knoll has established FSC® (Forest Stewardship Council) certified wood as the standard for general office open plan office systems, casegoods and tables.
- Knoll has launched Full Circle, a resource recovery program developed with ANEW, to help customers extend the life cycle of surplus furniture, fixtures and equipment (FF&E) in an economically, socially and environmentally responsible manner.
- Our goal is to encourage all manufacturers in the contract furniture industry and related industries to adopt standards that will lead to sustainable products and practices.

For more information about Knoll and sustainable design, visit knoll.com/environment.

All Knoll Office Seating is GREENGUARD Indoor Air Quality® certified and GREENGUARD for Children & SchoolsSM certified.

All KnollExtra® products are GREENGUARD Indoor Air Quality® certified.

Visit GREENGUARD.org for more information and to find printable certificates for Knoll Office Seating that can be used for verification and LEED® submission.

GREENGUARD provides the only guide to certified low-emitting interior products and building materials. Its goal is to help building owners and managers, architects, interior designers and product specifiers build and furnish healthier offices, hospitals, schools and homes by providing a register of tested and certified low-emitting products and materials.

GREENGUARD certification is recognized by the U.S. Green Building Council's LEED® Program. Air Quality Science, an independent indoor air quality laboratory, tests products submitted for certification using stringent environmental chamber testing protocols and current indoor air quality standard. Certification is administered by the GREENGUARD Environmental Institute (GEI), an industry-independent, non-profit organization.

GREENGUARD for Children & SchoolsSM certification complies with the State of California's Department of Health Services Standard Practice (CA Section 01350) for testing chemical emissions from building products used in schools, offices and other sensitive environments. Certified products can contribute to achieving credits in the CHPS Best Practices Manual for K-12 schools, the LEED® Green Building Rating System, Green Guide for Healthcare™, NAHB Green Building Guidelines, Green Globes, Regreen and numerous other local authorities' green building codes.

Knoll Office Seating and KnollExtra® products can contribute to achieving LEED® credits. GREENGUARD-tested and certified office furniture is required for Credit 4.5 in the LEED-CI Indoor Environmental Quality section.

GREENGUARD Certification Program

- Internationally recognized for evaluating product emissions and certifying building materials, furnishings, finishes and cleaning products and processes that meet stringent indoor air quality criteria defined by GEL.
- Products undergo rigorous, third-party testing to determine their impact on indoor air pollution with requirements for ongoing testing and verification.
- Certification confirms a manufacturer's environmental responsibility, and signifies their environmental achievements through independent, third-party testing and verification.
- GREENGUARD Certified products are recommended by leading sustainable building programs, including:
 - U.S Green Building Council's (USGBC) LEED Rating System,
 - National Association of Home Builders (NAHB) Green Building Guidelines,
 - Green Guide for Health Care (GGHC),
 - Collaborative for High Performance Schools (CHPS) Best Practices Manual,
 - New York City Department of Design and Construction Sustainable Design Specifications, among others.

An Overview

In the first part of the Price List you'll find a full range of desktop accessories, including the Smokador and the International Collection of boardroom accessories.

The second part features Orchestra Universal System Accessories, a complete scope of paper management accessories perfect for panel-mounted or freestanding application.

Part three offers a broad range of systems support products, including computer accessories, storage drawers, communications boards, and lighting.

Can't find it? Consult the Table of Contents on page 1 or the Alpha-numeric Index on page 152.

Product Information on Each Page

The KnollExtra Price List was designed to provide you with everything you need to know in order to understand, specify, and care for KnollExtra products. On each page, the following features will assist you:

Description/Construction explains salient features, capabilities, materials, and country of origin.

Dimensions provide the overall space the product will require. Statistics are based on the maximum width, depth and height of the product.

Weight is based on the product itself. It does not include packaging or complementary items such as pens, memo paper or calendars.

Order Code/Ordering Information outlines exactly how to specify KnollExtra product and the full scope of finish options. The Order Code provides an example of how one pattern number is specified.

Custom Options reviews availability of special sizes, finishes etc.

For More Information

For more information, contact your Knoll sales representative, telephone Customer Service at 1-800-343-5665, or visit one of the Knoll showrooms listed on the last page of this book.

A Word About Finishes

KnollExtra finishes are designed to complement a broad range of interiors and office products.

Key KnollExtra finishes coordinate with specific Knoll systems finishes:

<i>Product</i>	<i>Core Finish</i>	<i>Office System Finishes</i>
Orchestra Load bar / Slat board	Medium grey (115)	Medium grey (115)
	Soft grey (117)	Soft grey (117)
	Black (111)	Black (111)
	Beige Mist (611)	Beige Mist (611)

Use the Following Addresses

If you would like to send a standard lead time order to our order entry department, please use the following address:

For North American orders:
Knoll, Inc.
1235 Water Street
East Greenville, PA 18041
Attn: Order Entry

Fax: 215 679-1788
Tel: 800 343-KNOLL

All accepted orders will be confirmed in writing on the Knoll standard order confirmation form.

Ship-Complete Orders

Orders that must ship complete are to be so stated on the purchase order. Products with different lead times, combined on one order, can be acknowledged for shipment based on the longest of those lead times. Orders not marked “ship complete” will be released according to the confirmation, and invoiced in increments.





For More Information

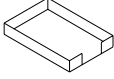
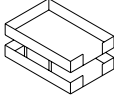
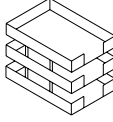

For complete Knoll Selling Policy and warranty information, please refer to page 154 of this price list.

For additional information on KnollExtra, contact your Knoll representative, a Knoll dealer, or telephone Customer Services at 800 343-KNOLL.

Page **THE SMOKADOR COLLECTION ● Exec Rectilinear**

14-15	Single Letter Tray	Double Letter Tray	Triple Letter Tray
			

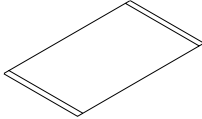
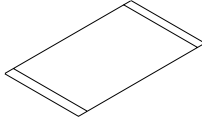
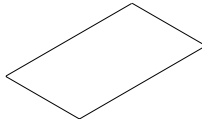
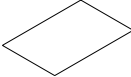
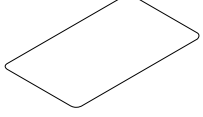
16-17	Memo Box	Business Card Holder	Round Pencil Cup	Round Clip cup
				

18-19	Desk Pad: 3/4" Side Panels	Desk Pad: 1 1/2" Side Panels	Rectilinear Desk Pad	Conference Pad	Radiused Desk Pad	Oval Conference Pad
						

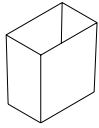
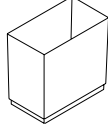
20-1	Round Wastebasket	Rectilinear Wastebasket	Rectilinear Plastic Wastebasket
			

Page **THE SMOKADOR COLLECTION ● Contemporary Leather**

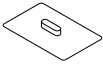
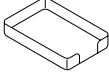
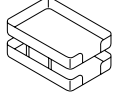

22-23	Letter Tray Cover	Single Letter Tray	Double Letter Tray
			

24-29	Memo Box	Pencil Cup	Coasters
			

Picture Frame



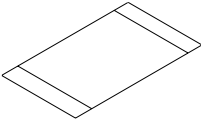
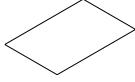

Page THE SMOKADOR COLLECTION ● Contemporary Leather

26-27	Desk Pad: 4'' Side Panels	Rectilinear Conference Pad	Oval Conference Pad	Round Wastebasket
				

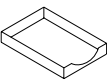
Page THE SMOKADOR COLLECTION ● Traditional Leather

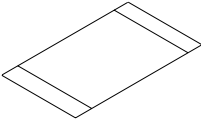
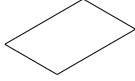

28-29	Single Letter Tray	Book Ends	Memo Box	Pencil Cup
				





Page THE SMOKADOR COLLECTION ● Contemporary Leather

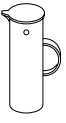
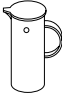

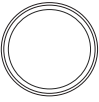
30-31	Desk Pad: 3 1/2'' Side Panels	Rectilinear Conference Pad	Oval Conference Pad	Round Wastebasket
				









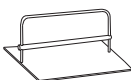

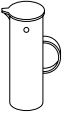

Page THE INTERNATIONAL COLLECTION

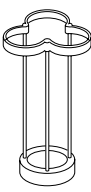
34-35	Aalto Vase	Savoy Vase	Aarne Glassware
			

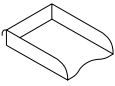
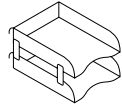
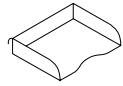
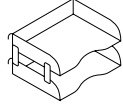
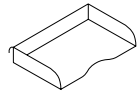
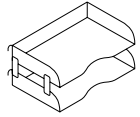
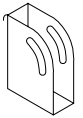
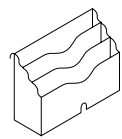
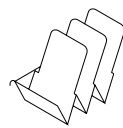
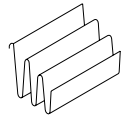
36-37	Large Stainless Carafe	Small Stainless Carafe	Stainless Creamer	Stainless Sugar Bowl	Serving Tray
					

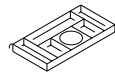
38-39	Stainless Coffee Pot	Stainless Tea Pot	Stainless Creamer and Sugar Bowl	Stainless Serving Tray with Handles	Stainless Ice Bucket
					

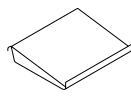
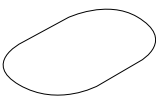
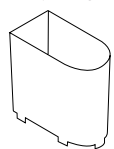

40-41	Stainless Ice Tongs	Stainless Coaster Set	Napkin Holder
			

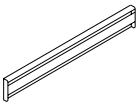
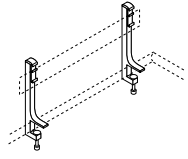
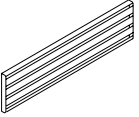
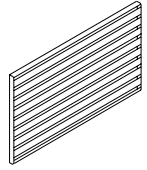

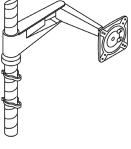
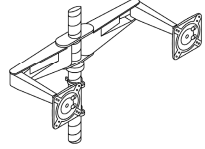
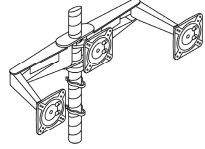
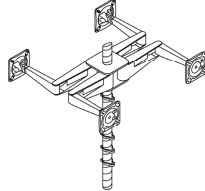
Page	THE INTERNATIONAL COLLECTION					
42-43	Large Plastic Carafe 	Small Plastic Carafe 	Plastic Water Pitcher 	Plastic Creamer 	Plastic Sugar Bowl 	
44-45	Ivy Umbrella Stand 	Mathiesen Wall Clock 				
Page	ORCHESTRA UNIVERSAL SYSTEM ACCESSORIES					
48-51	Front Single Letter Tray 	Front Double Letter Tray 	Side Single Letter Tray 	Side Double Letter Tray 	Side Single Legal Tray 	Side Double Legal Tray 
52-53	2-Way Binder Bin 	Vertical Paper Pack 	Slanted Sorter 	File Sorter 		
54-55	Hanging File Holders 	Pencil Cup 	Utility Tray 			
56-57	Tape Dispenser 	Memo Tray 				
58-59	Clip/Cup Holder 	Bud Vase 	Telephone Shelf 			
60-61	Racetack Desk Pad 	Wastebasket & Recycling Wastebasket 				

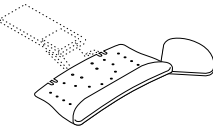
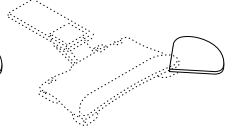
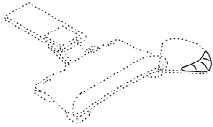
Page	ORCHESTRA UNIVERSAL SYSTEM ACCESSORIES			
62-68	Load Bar/Info Rail	Worksurface: Mounted Bracket	Slat board: 6½''H	Slat board: 14¾''H
				

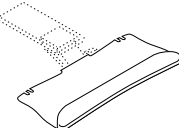
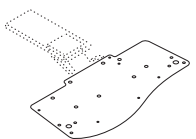
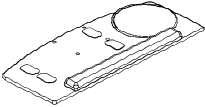
Page	TECHNOLOGY MANAGEMENT : SAPPER™ MONITOR ARM COLLECTION			
72-27	Single Arm Kits	Double Arm Kits	Triple Support Kits	Quadruple Support Kits
				

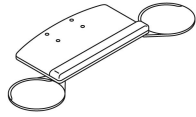
Page	TECHNOLOGY MANAGEMENT		
106-117	Adjustable Keyboard Support - Romeo and Juliet	Juliet	Juliet with Palm Rest
			

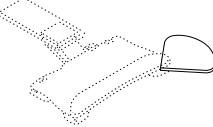
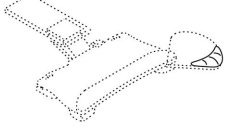
Adjustable Keyboard Support - Prospero	Adjustable Keyboard Support - Caesar	Act I	Act II	Act II Two Mouse Pads
				

Juliet Mouse Pad	Juliet Palm Rest	Over-ten Mouse Pad
		

Page **TECHNOLOGY MANAGEMENT : SURF® ERGONOMIC ACCESSORIES**

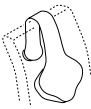
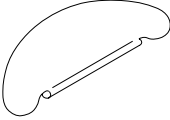
118	Wrist Rest	Lumbar support	Surf Board or VDT Corner
			

Page **TECHNOLOGY MANAGEMENT**

120	VDT Sleeve	Adjustable Foot Rest
		

122-143	Adjustable Vertical Metal CPU Holder	Adjustable Vertical Sling CPU Holder
		

Page **STORAGE**

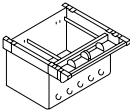
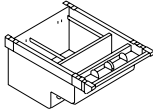
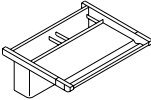
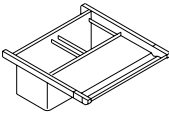
124-127	BackPack® Universal Standard Suspended File	BackPack® Universal Deep Suspended File	Standard Center File	Deep Center File
				

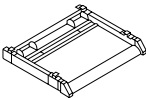
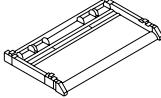
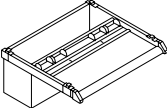
128-151	Narrow Keyboard Drawer	Wide Keyboard Drawer with Mouse Pad	Keyboard/Filing Drawer
			

Page **STORAGE**

130-133 Pencil Drawer Top Drawer Universal Pencil Drawer

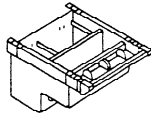
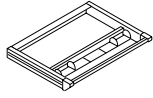

Page **COMMUNICATIONS BOARDS**

134-143 Marker Board Marker Tray Fabric Boards Top Cap Hung Marker Board

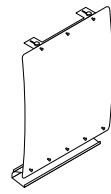
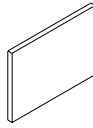
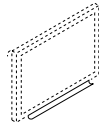
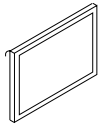

Page **LIGHTING**

144-151 Copeland Standard Copeland Compact

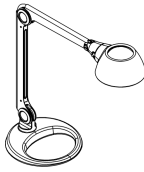
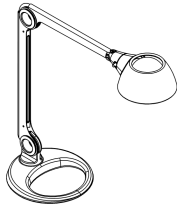

Big Dipper

Little Dipper

Desktop Lamp

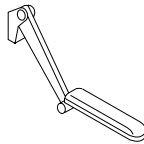
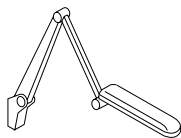

Manufacturer	System	Bracket Suffix
Knoll	Equity	E(Y)*
	<i>(stanchion-mounted)</i> Equity	ES
	Morrison	M
	<i>(stanchion-mounted)</i> Morrison Network	N
	Reff	R
	Dividends	DV
	<i>(stanchion-mounted)</i> Dividends	DS
	Calibre	CE
	Currents	C
	<i>(stanchion-mounted)</i> Currents	CS

*EY for orchestra brackets. If your system is not listed, please consult your Knoll sales representative or Customer Service at 1-800-343-5665.

For system and bracket information on the manufacturer's listed below or any other manufacturer, please consult your sales representative or Customer Service at 1-800-343-5665.

All-Steel	Herman Miller
American Seating	Kimball
Gunlocke	Smed
Hon	Steelcase
Haworth	Teknion

Maintenance

While KnollExtra relies on highly durable materials in each product line, regular basic maintenance will ensure the longevity of your product. Most stains, marks, and discolorations can be removed by following the simple instructions outlined on this page.

Plastic

Windex and a dry cloth.

SofStone

Early removal of a stain makes SofStone care much easier. This is especially true of coated areas which are frequently handled. If oil smudges are allowed to build up, they can soften the suede coating, and become very difficult to remove. Most dirt and smudges can be removed by the following methods:

1. *Greasy stains* (crayon, oil, lipstick, etc.): remove grease and wax stains with a naphtha-dampened lint-free cloth. Change the cloth frequently to remove as much grease as possible without spreading the stain.

2. *Non-greasy stains* (dirt, coffee, mustard, catsup, etc.): dirt and smudge areas can generally be removed by using a sponge or soft bristle brush with Liquid Ajax, Mr. Clean, Lestoil, or 3M brand carpet spot remover and upholstery cleaner. Follow the instructions on the label, and rinse thoroughly with clear water and a lint-free cloth.

3. *Combination stains* (chocolate, ice cream, gravy, soup, etc.): combination stains are caused by materials that contain both greasy and non-greasy substances. First use the procedures for non-greasy stains as stated above. Then, rinse thoroughly with clear water and thoroughly dry with a lint-free cloth. If greasy stain persists, follow the procedure for greasy stains as stated above. Repeat as necessary.

Stainless Steel:

Windex and a dry cloth.

Antique Brass, Brushed Zinc and Black Oxide:

A damp cloth with no cleaning agents.

Satin Brass:

Pledge.

Linoleum:

Windex and a dry cloth.

Contemporary and Traditional Standard Leathers:

Mild soap and water on a soft cloth.

Spinneybeck Leathers:

As a result of the high quality aniline dye process, most scratches or minor stains can be removed simply by gently rubbing them with your fingers. The body's natural oils revitalize the leather. For stubborn stains, use mild soap and water. Take care to wash the surface evenly since soaps may slightly alter the leather's tonality.

Surf Collection:

Wipe nylon skin using warm water and mild detergent. Do not use abrasives.

Office Automation

Accessories/Storage Drawers:

Clean with a soft cloth and Windex, Fantastik, Endust or other non-abrasive household cleaners. Remove stubborn stains with SofScrub.

For Surf Board and VDT Sleeve soft touch paints, never use abrasives. Clean with lukewarm water and a soft cloth.

Marker Boards:

For day-to-day use, surface requires only a dry cleaning with a standard felt eraser or dry cloth. For best results, keep marker board and marker pens at room temperature. KnollExtra suggests Alliance Rite-On Wipe-Off marker pens which are designed for use on marker boards. All marker pens should be tightly capped and stored horizontally when not in use. If Expo brand markers are used, use the manufacturer's recommended cleaning solution, Expo Dry Erase Cleaner.

Follow the instructions below as a periodic maintenance program, or to remove stubborn stains:

1. Clean with EV-1 or any liquid ammonia-added cleaner and rinse with clean water, then dry. For best results, wash board like a window with sponge and squeegee.

2. Interim cleaning may be done by sprinkling a dry powdered cleanser on an eraser and applying to the board in a circular motion. Rinse with clean water, then dry.

3. To remove crayon, scotch tape, or other stubborn materials, apply a mild solvent or paste made with scouring powder and water.

Fabric Boards:

Despite the durability of most panel textiles, fabric boards are subject to long-term soiling and wear. A regular maintenance program will significantly lessen soil and dirt build up or staining on your fabric boards. Cleaning is particularly important in areas adjacent to air conditioning or ventilation systems.

Remember to consult the care instructions provided by the fabric manufacturer. The general recommendations below should apply to most fabric boards.

1. Avoid excessive heat or moisture which can affect finishes and adhesives. Never allow fabric panels to become wet inside the core. Room temperature should be maintained between 50 and 85 degrees; humidity should be maintained between 20 and 50%.

2. Avoid contact with sharp edges which could puncture the surface.

3. Do not handle fabric boards more than necessary. Avoid bending or flexing the panels; this could break the bond between the surface and core materials.

4. Grease or oil should be wiped off immediately upon contact. Remove excess grease or oil by blotting. Use hot water and mild soap to remove any remaining residue.

5. Whenever possible, clean only with warm water and mild soap. Use caution when applying cleaning agents, particularly those that contain alcohol, strong alkalis, or solvents. These ingredients may react to the vinyl backing or adhesives used in the fabric boards. Always test cleaning agents on fabric from the rear of the panel before using on the front.

6. Care should be taken in using strong room cleaners or pesticides. Their fumes may contain agents which lead to the loosening of the fabric board glue bond.

The Smokador™ Collection
Exec Rectilinear
 letter trays

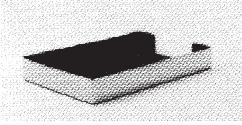
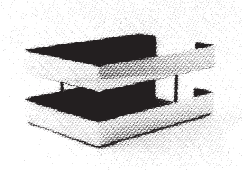
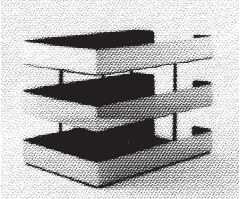
product	description	w	d	h	wgt.
Single Letter Tray 	Legal size. Matte black interior with black linoleum floor pad. Recessed rubber feet and black felt bottom prevent scuffing.	10"	15"	2 1/4"	4 lbs. 5 ozs.
Double Letter Tray 	Legal size. Matte black interiors with black linoleum floor pads and matte black posts. 2 1/2" between trays. Recessed rubber feet and black felt bottom prevent scuffing. Shipped fully assembled.	10"	15"	6 1/2"	9 lbs. 2 ozs.
Triple Letter Tray 	Legal size. Matte black interiors with black linoleum floor pads and matte black posts. 2 1/2" between trays. Recessed rubber feet and black felt bottom prevent scuffing. Shipped fully assembled.	10"	15"	11 1/2"	13 lbs. 2 ozs.

Order Code

Example: 1901-BO	
1901	Single letter tray
BO	Black oxide

Ordering Information

Specify:

1. Pattern number
2. Finish
3. Pattern suffix (Pen Set only)

Metal finishes:
 Black Oxide (BO)
 Brushed Zinc (BZ)
 Brushed Steel (BS)

Custom Options

Special sized letter and memo trays available. 100 piece minimum per line item.

Custom finishes available upon sample chip approval. 25 piece minimum per line item. Production set up fee varies by product. Contact your Knoll sales representative or Customer Service for complete pricing information.

Construction

Black Oxide (BO) finish is a matte black hand-applied coating over steel.



Brushed Zinc (BZ) is zinc-plated brushed steel with a semi-gloss lacquer finish.

Brushed Steel (BS) is brushed steel with a lacquer finish.

Manufactured in the United States.

pattern no.	black oxide	brushed steel and brushed zinc
1901	\$188.	\$236.
1901-2	422.	521.
1901-3	643.	791.

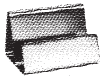
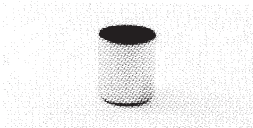
The Smokador™ Collection
Exec Rectilinear
desk accessories

product	description	w	d	h	wgt.
Memo Box 	Matte black interior. Includes 4" x 6" memo paper. Non-skid rubber pad on bottom.	4 1/4"	6 1/4"	3/8"	1 lb. 4 ozs.
Business Card Holder 	Felt base. Available in black oxide only.	3 1/2"	2"	2"	6 ozs.
Round Pencil Cup 	Matte black interior. Non-skid rubber pad on bottom.	3 1/8"		3 1/2"	9 ozs.
Round Clip Cup 	Matte black interior. Non-skid rubber pad on bottom.	3"		2"	8 ozs.

Order Code

Example: 1905-BZ	
1905	Memo box
BZ	Brushed zinc

Ordering Information

Specify:
 1. Pattern number
 2. Finish

Metal finishes:
 Black Oxide (BO)
 Brushed Zinc (BZ)
 Brushed Steel (BS)

Custom Options

Special sized letter and memo trays available. 100 piece minimum per line item.

Custom finishes available upon sample chip approval. 25 piece minimum per line item. Production set up fee varies by product. Contact your Knoll sales representative or Customer Service for complete pricing information.

Construction



Brushed zinc is zinc-plated brushed steel with a semi-gloss lacquer finish.

Brushed steel is brushed steel with a lacquer finish.

Black oxide finish is a matte black hand-applied coating over steel.

pattern no.	black oxide	brushed steel and brushed zinc
1905	\$114.	\$122.
1906	83.	
1915	89.	97.
1916	106.	114.

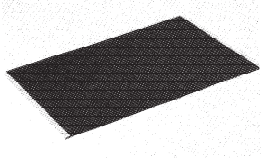
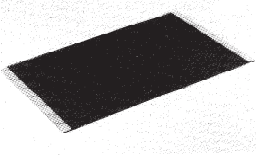
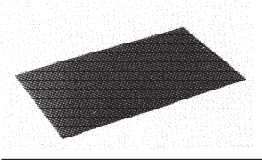
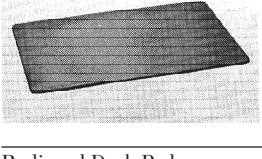
The Smokador™ Collection
Exec Rectilinear
desk pads

product	description	w	d	wgt.
Desk Pad: 3/4" Side Panels 	Black linoleum with felt back. 3/4" wide flush rectilinear side panels in specified finish.	34"	20"	5 lbs.
		38"	24"	7 lbs. 12 ozs.
Desk Pad: 1 1/2" Side Panels 	Black linoleum with felt back. 1 1/2" wide raised rectilinear side panels in specified finish.	34"	20"	5 lbs.
		38"	24"	7 lbs. 12 ozs.
Rectilinear Desk Pad 	Black linoleum with felt back. Rectilinear edge detail. No side panels.	34"	20"	4 lbs.
		38"	24"	5 lbs.
Conference Pad 	Black linoleum with felt back. Rectilinear edge detail.	18"	12"	1 lb. 6 ozs.
Radiused Desk Pad 	Black linoleum with felt back. Radiused edge detail. No side panels.	23"	17"	3 lbs. 8 ozs.
		30"	18"	3 lbs. 12 ozs.
		34"	20"	4 lbs.
		38"	24"	5 lbs.
Oval Conference Pad 	Black linoleum with felt back.	18"	12"	1 lbs. 4 ozs.

Order Code	Ordering Information	Custom Options	Construction
Example: 1912-31-BO	<i>Specify:</i>	Additional linoleum colors available. Special sizes available up to 34"W x 28"D. 50 piece minimum on all custom desk pads. Contact your Knoll sales representative or Customer Service for complete pricing information.	<i>Desk accessories:</i> Brushed zinc is zinc-plated brushed steel with a semi-gloss lacquer finish. Brushed steel is brushed steel with a lacquer finish. Black oxide finish is a matte black hand-applied coating over steel. All items are manufactured in the United States.
1912-31 Desk pad with 3/4" side panels	1. Pattern number 2. Finish (when applicable)		
BO Black Oxide	<i>Metal finishes:</i> Black Oxide (BO) Brushed Zinc (BZ) Brushed Steel (BS)		

pattern no.	black linoleum	black oxide	brushed steel and brushed zinc
1912-31		\$245.	
1912-41		258.	

1912-32		258.	285.
1912-42		269.	

1912-30	106.		
1912-40	122.		

1912-20	58.		
---------	-----	--	--

012-1	76.		
012-2	95.		
012-3	106.		
012-4	122.		

512-20	58.		
--------	-----	--	--

The Smokador™ Collection
Exec Rectilinear
waste baskets

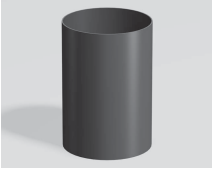
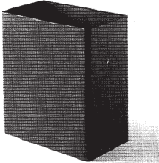
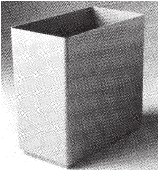
product	description	w	d	h	wgt.
	Round Wastebasket Black oxide exterior with matte black interior. Non-toxic. 15 qt. capacity.	10"		14 3/4"	5 lbs.
	Rectilinear Wastebasket Black oxide exterior with matte black interior. Non-toxic. 24 qt. capacity.	8"	13"	13 1/2"	7 lbs.
	Rectilinear Plastic Wastebasket 24 qt. capacity.	8 3/8"	15"	13 3/4"	5 lbs.

Order Code

Example: 050-BO
050 Round wastebasket
BO Black Oxide

Ordering Information

Specify:

1. Pattern number
2. Finish(when applicable)

Round wastebasket Metal finishes:
 Black Oxide (BO)

Standard plastic finishes:
 Black (BK)

Custom Options

Custom finishes available upon sample chip approval. 750 piece minimum on plated finishes; 100 piece minimum on painted finishes. Production set up fee varies by finish. Contact your Knoll sales representative or Customer Service for complete pricing information.

Plastic Wastebaskets:
 Custom colors available upon sample chip approval. \$250 color match fee and 500 piece minimum per line item. Contact your KnollExtra representative or Customer Service for complete pricing information.

pattern no.	standard plastic	black oxide
050	n/a	\$122.
055-BO	n/a	212.
255	76.	n/a



Construction

Metal Wastebaskets:
The black oxide finish is a matte black hand-applied coating over steel.

Plastic Wastebaskets:
High impact crystal styrene.

All items are manufactured in the United States.

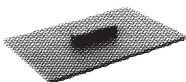
The Smokador™ Collection
 Contemporary Leather
 letter trays

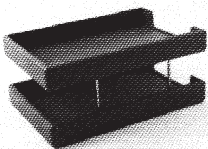
product	description	type	w	d	h	wt.
Letter Tray Cover	Legal size. Suede bottom.		10 1/2"	14 1/2"		2 lbs.
						
Single Letter Tray	Legal size. Suede bottom.		11 1/4"	15 1/4"	2"	3 lbs.
						
Double Letter Tray	Legal size. Suede bottom. Non-scuffing recessed rubber feet. Chrome posts on standard black leather. Specify chrome or brass posts on all other leather selections. Shipped fully assembled.		11 1/4"	15 1/4"	6 1/2"	6 lbs.
						

Order Code

Example:	3301-2-VP-MB-VP556
3301-2	Double letter tray
VP	Velluto Pelle
MB	Mirror brass posts
VP556	Sage

Ordering Information

Specify:

1. Pattern number
2. Leather selection
3. Hardware selection (Double Letter Tray only)

Spinneybeck leathers:
 Vicenza (VZ)
 Velluto Pelle (VP)
 Sabrina (SA)

Custom Options

There are 20 rich colors available in Vicenza and more than 100 vibrant colors available in Sabrina and Velluto Pelle. To view the complete color selection, please contact your Knoll sales representative or Spinneybeck.

Please note that 10 or more units are required on all Spinneybeck orders.

Double letter tray hardware:
 Mirror Chrome (MC)
 Mirror Brass (MB)

Customer's own leather (COL) available upon approval of sample. 10 unit minimum on all specials. Upcharges based on number of cowhides required for production. Contact your Knoll sales representative or Customer Service for complete pricing information.

pattern no.	Vicenza	Velluto Pelle	Sabrina
3333	\$245.	\$316.	\$348.
3301	342.	439.	496.
3301-2	744.	920.	999.

Construction



Spinneybeck Vicenza (VZ):
A corrected grain, aniline dyed leather. The correction process refines the surface of the leather preparing it for the reception of an embossed grain pattern prior to finishing.

Spinneybeck Sabrina (SA):
An aniline dyed, full grain, kip leather. The fine quality and lightweight material produce a supple hand and smooth, tight grain appearance. Sabrina receives a breathable, protective finish and is appropriate for high-traffic use.

Spinneybeck Velluto Pelle (VP):
An aniline dyed, enhanced full grain leather. The combination of the subtle surface enhancement and special ironing process creates the suppleness and smoothness of this leather. Velluto Pelle has a breathable, medium, protective finish.

Manufactured in the United States, using domestic and Spinneybeck Italian leathers.

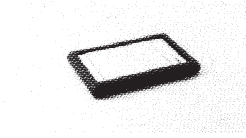
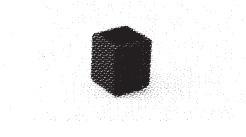
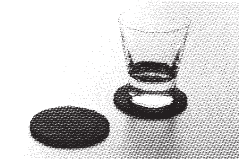
The Smokador™ Collection
Contemporary Leather
desk accessories

product	description	type	w	d	h	wt.
Memo Box	Includes 4" x 6" memo paper. Suede bottom.		5 1/4"	7 1/4"	3/4"	1 lb.
						
Pencil Cup	Suede bottom.		3 7/16"	3 7/16"	4 1/8"	1 lb.
						
Coasters	Set of four. Circular leather or black linoleum. Felt bottom.	Leather		3 1/4"		4 ozs. (set)
		Linoleum		3 1/4"		4 ozs. (set)
						
Picture Frame	Sized for 4" x 6" photographs or 5" x 7" photographs. Easel-style stand. Frame is available in Spinneybeck leathers as a special only.		5 3/4"	3/4"	7 3/4"	1 lb.
			6 3/4"	3/4"	8 3/4"	1 lb.
						

Order Code

Example: 3315-VZ BLK
3315 Pencil Cup
VZ BLK Vicenza Black

Ordering Information

Specify:
 1. Pattern number
 2. Leather selection

Spinneybeck leathers:
 Vicenza (VZ)
 Velluto Pelle (VP)
 Sabrina (SA)

There are 20 rich colors available in vicenza and more than 100 vibrant colors available in Sabrina and Velluto Pelle. To view the complete color selection, please contact your Knoll sales representative or Spinneybeck.

Please note that 10 or more units are required on all Spinneybeck orders.

pattern no.	linoleum	Vicenza	Velluto Pelle	Sabrina
3305		\$236.	\$285.	\$316.
3315		204.	269.	301.
3319-4		75.	106.	140.
3319-4-LN	32.			
3370 (4" x 6")		218.		
3371 (5" x 7")		230.		

Custom Options

Customer's own leather (COL) available upon approval of sample. 10 unit minimum on all specials. Upcharges based on number of cowhides required for production. Contact your Knoll sales representative or Customer Service for complete pricing information.

Construction



Spinneybeck Vicenza (VZ):
A corrected grain, aniline dyed leather. The correction process refines the surface of the leather preparing it for the reception of an embossed grain pattern prior to finishing.

Spinneybeck Sabrina (SA):
An aniline dyed, full grain, kip leather. The fine quality and lightweight material produce a supple hand and smooth, tight grain appearance. Sabrina receives a breathable, protective finish and is appropriate for high-traffic use.

Spinneybeck Velluto Pelle (VP):
An aniline dyed, enhanced full grain leather. The combination of the subtle surface enhancement and special ironing process creates the suppleness and smoothness of this leather. Velluto Pelle has a breathable, medium, protective finish.

Manufactured in the United States, using domestic and Spinneybeck Italian leathers.

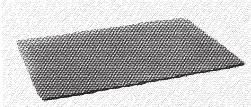
The Smokador™ Collection
*Contemporary Leather
 deskpad and wastebaskets*

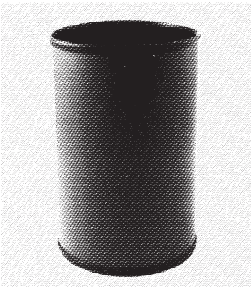
product	description	type	w	d	wgt.
Desk Pad: 4" Side Panels 	Black linoleum with black felt back. 4" wide raised side panels in specified leather.	Desk Pad: 4" Side Panels	34"	20"	6 lbs.
		Desk Pad: 4" Side Panels	38"	24"	7 lbs.12 ozs.
Rectilinear Conference Pad 	Leather or black linoleum. Black felt back.	Leather	18"	12"	3 lbs. 6 ozs.
		Linoleum	18"	12"	1 lb. 6 ozs.
Oval Conference Pad 	Leather or black linoleum. Black felt back.	Leather	18"	12"	2 lbs. 9 ozs.
		Linoleum	18"	12"	1 lb. 4 ozs.
Round Wastebasket 	Black interior. Steel covered with leather.	Round Wastebasket	10"	14 3/4"	6 lbs.

Order Code

Example:	3312-4-VZ BLK
3312-4	38" x 24" desk pad
VZ BLK	Vicenza Black

Ordering Information

Specify:

1. Pattern number
2. Leather selection

Spinneybeck leathers:
 Vicenza (VZ)
 Velluto Pelle (VP)
 Sabrina (SA)

There are 20 rich colors available in vicenza and more than 100 vibrant colors available in Sabrina and Velluto Pelle. To view the complete color selection, please contact your Knoll sales representative or Spinneybeck.

Please note that 10 or more units are required on all Spinneybeck orders.

Custom Options

Custom sized leather conference pads available in sizes up to 38"W x 24"D (rectangular) and 18"W x 12"D (oval). Customer's own leather (COL) available upon approval of sample. 10 unit minimum on all specials. Upcharges based on number of cowhides required for production. Contact your Knoll sales representative or Customer Service for complete pricing information.

pattern no.	black linoleum	Vicenza	Velluto Pelle	Sabrina
3312-3		\$253.	\$348.	\$391.
3312-4		285.	380.	422.
3313		245.	291.	326.
1912-20	58.			
3314		245.	291.	326.
512-20	58.			
3350		285.	374.	431.

Construction





Spinneybeck Vicenza (VZ):
A corrected grain, aniline dyed leather. The correction process refines the surface of the leather preparing it for the reception of an embossed grain pattern prior to finishing.

Spinneybeck Sabrina (SA):
An aniline dyed, full grain, kip leather. The fine quality and lightweight material produce a supple hand and smooth, tight grain appearance. Sabrina receives a breathable, protective finish and is appropriate for high-traffic use.

Spinneybeck Velluto Pelle (VP):
An aniline dyed, enhanced full grain leather. The combination of the subtle surface enhancement and special ironing process creates the suppleness and smoothness of this leather. Velluto Pelle has a breathable, medium, protective finish.

Manufactured in the United States, using domestic and Spinneybeck Italian leathers.

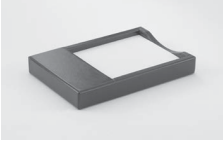
The Smokador™ Collection
Traditional Leather
desk accessories

product	description	type	w	d	h	wgt.
Single Letter Tray	Legal size. Suede bottom.		10 1/2"	15"	2 1/2"	2 lbs.
						
Book Ends	2 per set. Suede bottoms.		4"	4 3/8"	6 1/2"	6 lbs.
						
Memo Box	Includes 5" x 8" memo paper. Suede bottom.		6"	9"	1 1/4"	1 lb. 8 oz.
						
Pencil Cup	Leather wrapped. Suede bottom.		3"	3 1/2"	4"	1 lb.
						

Order Code

Example: 3601-VZ BLK	
3601	Single letter tray
VZ BLK	Vicenza Black

Ordering Information

- Specify:*
1. Pattern number
 2. Leather selection
 3. Hardware selection (Calendar set)

Spinneybeck leathers:
 Vicenza (VZ)
 Velluto Pelle (VP)
 Sabrina (SA)

There are 20 rich colors available in vicenza and more than 100 vibrant colors available in Sabrina and Velluto Pelle. To view the complete color selection, please contact your Knoll sales representative or Spinneybeck.

Please note that 10 or more units are required on all Spinneybeck orders.

Custom Options

Customer's own leather (COL) available upon approval of sample. 10 unit minimum on all specials. Upcharges based on number of cowhides required for production. Contact your Knoll sales representative or Customer Service for complete pricing information.

pattern no.	Vicenza	Velluto Pelle	Sabrina
3601	\$380.	\$511.	\$561.
3604	464.	528.	561.
3605	269.	342.	374.
3615	219.	258.	291.

Construction

Spinneybeck Vicenza (VZ):
A corrected grain, aniline dyed leather. The correction process refines the surface of the leather preparing it for the reception of an embossed grain pattern prior to finishing.



Spinneybeck Sabrina (SA):
An aniline dyed, full grain, kip leather. The fine quality and lightweight material produce a supple hand and smooth, tight grain appearance. Sabrina receives a breathable, protective finish and is appropriate for high-traffic use.

Spinneybeck Velluto Pelle (VP):
An aniline dyed, enhanced full grain leather. The combination of the subtle surface enhancement and special ironing process creates the suppleness and smoothness of this leather. Velluto Pelle has a breathable, medium, protective finish.

Spinneybeck Sabrina (SA):
A durable, immersion aniline-dyed, full grain kip leather which has received a protective surface finish. The superbly soft hand is achieved by its fine quality and light weight.

Manufactured in the United States, using domestic and Spinneybeck Italian leathers.

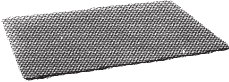
The Smokador™ Collection
Traditional Leather
desk pads and wastebaskets

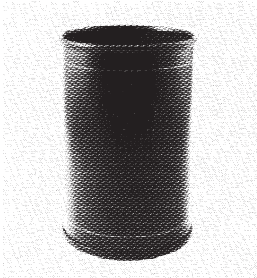
product	description	type	w	d	h	wt.
Desk Pad: 3 1/2" Side Panels 	Black linoleum with black felt back. 3 1/2" wide raised side panels.		34"	20"		6 lbs.
			38"	24"		7 lbs. 6 ozs.
Rectilinear Conference Pad 	Leather or black linoleum. Black felt back.	Leather	18"	12"		3 lbs. 6 ozs.
		Linoleum	18"	12"		1 lb. 6 ozs.
Oval Conference Pad 	Leather or black linoleum. Black felt back.	Leather	18"	12"		2 lbs. 9 ozs.
		Linoleum	18"	12"		1 lb. 4 ozs.
Round Wastebasket 	Black interior. Steel covered with leather.		10"		15"	6 lbs.

Order Code

Example:	3612-4-SA-764
3612-4	38 "x 24 "Desk pad
SA	Sabrina
764	Clay

Ordering Information

Specify:

1. Pattern number
2. Leather selection

Spinneybeck leathers:
 Vicenza (VZ)
 Velluto Pelle (VP)
 Sabrina (SA)

There are 20 rich colors available in Vicenza and more than 100 vibrant colors available in Sabrina and Velluto Pelle. To view the complete color selection, please contact your Knoll sales representative or Spinneybeck.

Please note that 10 or more units are required on all Spinneybeck orders.

Custom Options

Custom sized leather conference pads available in sizes up to 38"W x 24"D (rectangular) and 18"W x 12"D (oval). Customer's own leather (COL) available upon approval of sample. 10 unit minimum on all specials. Upcharges based on number of cowhides required for production. Contact your Knoll sales representative or Customer Service for complete pricing information.

pattern no.	black linoleum	Vicenza	Velluto Pelle	Sabrina
3612-3		\$276.	\$348.	\$391.
3612-4		310.	380.	422.
3613		253.	326.	342.
1912-20	58.			
3614		253.	326.	342.
512-20	58.			
3650		365.	445.	480.

Construction

Spinneybeck Vicenza (VZ):
A corrected grain, aniline dyed leather. The correction process refines the surface of the leather preparing it for the reception of an embossed grain pattern prior to finishing.



Spinneybeck Sabrina (SA):
An aniline dyed, full grain, kip leather. The fine quality and lightweight material produce a supple hand and smooth, tight grain appearance. Sabrina receives a breathable, protective finish and is appropriate for high-traffic use.

Spinneybeck Velluto Pelle (VP):
An aniline dyed, enhanced full grain leather. The combination of the subtle surface enhancement and special ironing process creates the suppleness and smoothness of this leather. Velluto Pelle has a breathable, medium, protective finish.

Manufactured in the United States, using domestic and Spinneybeck Italian leathers.

The Smokador™ Collection

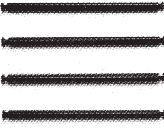
Replacement Parts

product	description	d	h
Metal Letter Tray Stacking Posts 	4 per set, with screws. For use with the Contemporary Leather and Exec Rectilinear Collections. Available in mirror chrome, mirror brass, and matte black only.	1/4"	4 1/4"
Letter Tray Stacking Post Threaded Rods 	4 per set. For use with stacking posts for the Contemporary Leather and Exec Rectilinear Collections.		

Order Code

Example: 001-214-MC
001-214 Metal letter tray stacking posts
MC Mirror chrome

Ordering Information

- Specify:*
1. Pattern number
 2. Finish (except Threaded Rods)

Metal letter tray post finishes:
 Mirror Brass (MB)
 Matte Black (BK)
 Mirror Chrome (MC)

pattern no.	list price
001-214	\$32.

001-315	8.
----------------	----

International Collection

Glassware

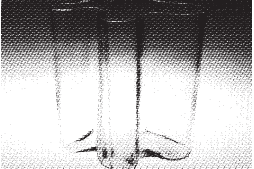
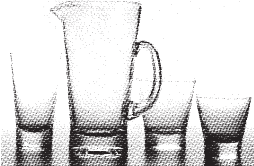
product	description	type	h	wt.
Aalto Vase 	Designed by Alvar Aalto, 1933-36. Permanent collection of the New York Museum of Modern Art. Available in clear and opal.		3 3/4" 4 3/4" 6 1/4"	
Savoy Vase 	Designed by Alvar Aalto, 1936. Larger, less convoluted versions of the Aalto Vases. Exhibited at the 1937 World Exhibition in Paris. Clear crystal.		8" 24"	
Aarne Glassware 	Designed by Goran Hongell, 1948.			11 1/2 oz. Double Old Fashioned 12 1/2 oz. Highball 3 pt. Pitcher 7 oz. Old Fashioned Pilsner

Order Code

Example: **3030-120-OP**
3030-120 4 3/4" Aalto vase
OP Opal

Ordering Information

Specify:
 1. Pattern number
 2. Color (Aalto only)

Aalto Colors:
 Opal (OP)
 Clear (CL)

Ordering note:
 All crystal pieces are priced and shipped individually.

Custom Options

Additional barware sizes available. Contact your Knoll sales representative or Customer Service for selection and pricing information.

pattern no.	opal	clear
3030-095	\$177.	\$177.
3030-120	313.	313.
3030-160	426.	426.
<hr/>		
3031-200		572.
3031-600		6,420.
<hr/>		
2020-032		74.
2020-035		74.
2020-150		251.
2020-020		62.
2020-038		74.

Construction

Lead-free crystal.
Manufactured in Finland.

Design Award

Aalto Vase:
The International Tabletop Award,
1988.

Aarne Glassware:
The International Tabletop Award,
1989.

International Collection

Stainless Boardroom Accessories

product	description	type	w	d	h	wt.
Large Stainless Carafe 	Designed by Erik Magnussen, 1977. Delivered with automatic tilt close top and screw close top options. Glass vacuum liner for serving hot or cold liquids. Matte black plastic top and handle. Available in satin stainless or black oxide finish. 1 liter capacity.		4"		12"	2 lbs. 11 ozs.
Small Stainless Carafe 	Designed by Erik Magnussen, 1977. Delivered with automatic tilt close top and screw close top options. Glass vacuum liner for serving hot or cold liquids. Matte black plastic top and handle. Available in satin stainless or black oxide finish. 1/2 liter capacity.		4"		8 1/4"	1 lb. 11 ozs.
Stainless Creamer 	Designed by Erik Magnussen, 1977. Satin stainless. Matte black plastic top. 8 oz. capacity.		3 1/4"		3 3/4"	4 ozs.
Stainless Sugar Bowl 	Designed by Erik Magnussen, 1977. Satin stainless. Matte black plastic top. 10 oz. capacity.		4 1/4"		2 1/4"	5 ozs.
Serving Tray 	Designed by Erik Magnussen. Satin stainless with black rubber liner.				15" dia. x 3/4"	

Order Code

Example: **STL-900-ST**
STL-900 Large stainless carafe
ST Satin stainless

Ordering Information

Specify:
 1. Pattern number
 2. Finish (Carafe only)

Metal finishes:
 Satin Stainless (ST)
 Black Oxide (BO)

Custom Options

Additional stainless steel accessories available. Contact your Knoll sales representative or Customer Service for selection and pricing information.

Construction

Solid, satinized stainless steel that has been lacquered for long-term finish protection. Textured, ABS plastic top and handle. Black oxide finish is painted over stainless steel.

 Manufactured in Denmark.

pattern no.	black oxide	satin stainless	stainless
STL-900	\$475.	\$376.	
<hr/>			
STL-915	410.	313.	
<hr/>			
STL-1000		138.	
<hr/>			
STL-1100		138.	
<hr/>			
STL-2004		292.	
<hr/>			

Boardroom Accessories

International Collection

Stainless Boardroom Accessories

product	description	type	w	d	h	wt.
	Stainless Coffee Pot Cylinda-line, designed by Arne Jacobsen, 1967. 1 1/2 liter capacity.		4"		8"	1 lb. 9 ozs.
	Stainless Tea Pot Cylinda-line, designed by Arne Jacobsen, 1967. 1 1/4 liter capacity.		5"		4 1/4"	1 lb. 9 ozs.
	Stainless Creamer & Sugar Bowl Cylinda-line, designed by Arne Jacobsen, 1967. Includes sugar bowl, creamer, and sugar bowl lid. Spoon not included. Creamer is 2" x 3 3/4". Sugar Bowl is 3" x 2 1/4".	Creamer Sugar Bowl				
	Stainless Serving Tray with Handles Cylinda-line, designed by Arne Jacobsen, 1967. Round tray with straight wall lip and curved handles. Brushed stainless.		13 1/8"		1"	2 lbs.
	Stainless Ice Bucket Cylinda-line, designed by Arne Jacobsen, 1967.	Small: 35 oz. capacity	5 1/8"		4 1/8"	2 lbs.
	Stainless Ice Tongs		6 3/4"		1/2"	3 ozs.
	Stainless Coaster Set Cylinda-line, designed by Arne Jacobsen, 1967. Set of 6.		3 1/4"		1/4"	10 ozs. (each)

Order Code

Example: **STL-900-ST**
STL-900 Large stainless carafe
ST Satin stainless

Ordering Information

Specify:
 1. Pattern number
 2. Finish (Carafe only)
Metal finishes:
 Satin Stainless (ST)
 Black Oxide (BO)

Custom Options

Additional stainless steel accessories available. Contact your Knoll sales representative or Customer Service for selection and pricing information.

Construction

Solid, satinized stainless steel that has been lacquered for long-term finish protection. Textured, ABS plastic top and handle. Black oxide finish is painted over stainless steel.
 Manufactured in Denmark.

pattern no.	black oxide	satin stainless	stainless
STL-01-2			\$795.
<hr/>			
STL-04-2			795.
<hr/>			
STL-06-2			172.
STL-06-3			223.
<hr/>			
STL-014-2			356.
<hr/>			
STL-05-1			610.
<hr/>			
STL-015-1			82.
<hr/>			
STL-019-1			192.
<hr/>			
<hr/>			

International Collection

Stainless Boardroom Accessories

product	description	type	w	d	h	wgt.
Napkin Holder	Designed by Peter Holmblad Stainless Steel		7 ¹⁵ / ₁₆ "	7 ¹⁵ / ₁₆ "	3 ³ / ₄ "	



Order Code	Ordering Information	Custom Options	Construction
Example: STL-900-ST	<i>Specify:</i>	Additional stainless steel accessories available. Contact your Knoll sales representative or Customer Service for selection and pricing information.	Solid, satinized stainless steel that has been lacquered for long-term finish protection. Textured, ABS plastic top and handle. Black oxide finish is painted over stainless steel. Manufactured in Denmark.
STL-900 Large stainless carafe	1. Pattern number		
ST Satin stainless	2. Finish (Carafe only)		
	<i>Metal finishes:</i> Satin Stainless (ST) Black Oxide (BO)		

pattern no.	black oxide	satin stainless	stainless
STL-486			\$173.

Boardroom Accessories

International Collection

Plastic Boardroom Accessories

product	description	w	d	h	wt.
Large Plastic Carafe 	Designed by Erik Magnussen, 1977. Automatic tilt-close top. Glass vacuum liner for serving hot or cold liquids. 1 liter capacity. Textured black top. Available in red, black, white and blue.	4"		11 3/4"	2 lbs. 6 ozs.
Small Plastic Carafe 	Designed by Erik Magnussen, 1977. Automatic tilt-close top. Glass vacuum liner for serving hot or cold liquids. 1/2 liter capacity. Textured black top. Available in black.	4"		8 3/4"	1 lb. 6 ozs.
Plastic Water Pitcher 	Designed by Erik Magnussen, 1977. Textured black top. Available in clear. 1 1/2 liter capacity.	4"		9 1/4"	1 lb. 4 ozs.
Plastic Creamer 	Designed by Erik Magnussen, 1977. Textured black top. Available in black. 8 oz. capacity.	3 1/4"		3 3/4"	4 ozs.
Plastic Sugar Bowl 	Designed by Erik Magnussen, 1977. Textured black top. Available in black. 10 oz. capacity.	4 1/4"		2 1/4"	4 ozs.

Order Code

Example: STL-9-30
STL-9 Plastic carafe
30 Black

Ordering Information

Specify:

1. Pattern number
2. Finish

Large carafe plastic finishes:
 Red (20)
 Black (30)
 White (60)
 Blue (70)

Custom Options

Small carafe plastic finish:
 Black (30)

Water pitcher plastic finish:
 Clear (10)

Creamer and sugar bowl plastic finish:
 Black (30)

Additional plastic accessories available. Contact your Knoll sales representative or Customer Service for selection and pricing information.

pattern no.	list price
STL-9	\$192.
STL-15	154.
STL-13	96.
STL-10	54.
STL-11	54.

Construction

Durable ABS plastic.

Manufactured in Denmark.

International Collection

Umbrella Stand and Clocks

product	description	w	d	h	wgt.
Ivy Umbrella Stand	Designed by Emanuela Frattini, 1990. Lightweight aluminum. Comfortably holds 9 umbrellas. Saucer-shaped base collects water.	15"	15"	20"	7 lbs.

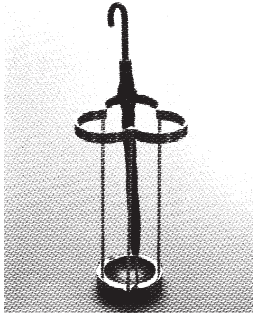

Mathiesen Wall Clock	Designed by Ole Mathiesen, 1972. Battery-operated Swiss quartz movement. Batteries included. Black finish.	8 ³ / ₄ "	1 lb.
		12 ¹ / ₄ "	2 lbs.
		17 ¹ / ₂ "	3 lbs.

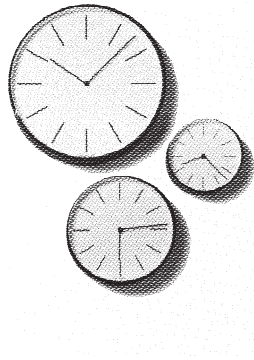

Order Code

Example: **EFM-IVYU**

EFM-IVYU Ivy umbrella stand

Ordering Information

Specify:

1. Pattern number

pattern no.	list price
EFM-IVYU	\$603.

1-2600	795.
1-2601	1,007.
1-2602	1,725.

Construction

Umbrella stand:

Cast aluminum base and top ring.
Solid aluminum rods. Polished on
top surfaces and bead blasted on
sides and center of base and top
ring.

Manufactured in the United States.

Mathiesen Wall Clock:

Hand-formed aluminum frame and
hands. Glass face cover.

Manufactured in Denmark.

International Collection

Replacement Parts

product	description
Carafe Stopper	For use with STL-900, STL-915, STL-9 and STL-15 stainless and plastic carafes.
Carafe Top	Black textured plastic. For use with STL-900, STL-915, STL-9 and STL-15 stainless and plastic carafes.
Large Carafe Thermal Liner & Gasket	For use with STL-900 and STL-915 stainless and plastic carafes.



Order Code

Example: **STL-900-1**
STL-900-1 Carafe stopper

Ordering Information

Specify:

1. Pattern number

Note:

Please consult Customer Service for additional replacement parts.

pattern no.	list price
STL-900-1	\$37.
STL-900-2	37.
STL-900-3	88.

Orchestra® Universal System Accessories
 by Bruce Hannah & Ayse Birsel
 letter trays

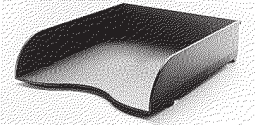
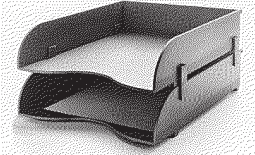
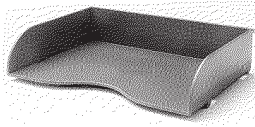
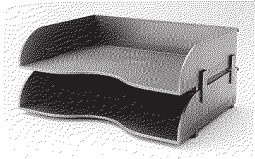
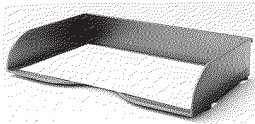
product	description	w	d	h	wgt.
Front Letter Single Tray 	Single tray. Non-scuffing rubber feet.	10 1/4"	13"	2 3/4"	1 lb. 2 ozs.
Front Letter Double Tray 	Double tray. Non-scuffing rubber feet. Removable stacking brackets included.	10 1/4"	13"	7 1/4"	2 lbs. 5 ozs.
Side Letter Single Tray 	Single tray. Non-scuffing rubber feet. *Available in Translucent Orange and Blue	13 1/4"	9 1/2"	2 3/4"	1 lb. 7 ozs.
Side Letter Double Tray 	Double tray. Non-scuffing rubber feet. Removable stacking brackets included. *Available Translucent in Orange and Blue	13 1/4"	9 1/2"	7 1/4"	2 lbs. 15 ozs.
Side Legal Single Tray 	Single tray. Non-scuffing rubber feet.	15 1/2"	9 1/2"	2 3/4"	2 lbs.

Order Code

Example: **ORCH-F-LT-BK**
ORCH-F- Front letter tray
LT
BK Black

Ordering Information

Specify:
 1. Pattern number
 2. Finish
Opaque plastic finishes:
 Black (BK)
 Medium Grey (DG)
 Soft Grey (E)
 Warm Putty (WP)

Custom Options

Translucent polycarbonate finishes:
 Clear (CL)
 *Orange (OR)
 *Blue (BL)
 *Select Products Only

Custom colors available upon sample chip approval. \$350 color match fee and 500 piece minimum per line item.

Letter trays mounted on slat wall or load bars accommodate up to max. 15lbs of weight.

pattern no.	translucent colors list price	opaque colors list price
ORCH-F-LT	\$47.	\$37.
2ORCH-F-LT	92.	80.
ORCH-S-LT	47.	37.
2ORCH-S-LT	92.	80.
ORCH-S-LGT	56.	49.

System top cap-mounted signage plate available, designed to customer specifications and system. Customer responsible for graphics. 100 unit minimum. Contact your Knoll sales representative or Customer Service for complete pricing information.

Construction

Opaque plastic finishes:
Sturdy polystyrene plastic in matte, textured finish. Fingerprint resistant.

Translucent finishes:
Sturdy polycarbonate resin.

Manufactured in the United States.

Design Awards

Permanent Collection of the Cooper-Hewitt, National Design Museum, Smithsonian Institution, 1994; ROSCOE Award, Interior Design Magazine, 1991; Outstanding Performance, Product Design Achievement Award, IBD Southern California Chapter, 1991; Bronze Award, IBD Product Design Competition, 1990.

Orchestra® Universal System Accessories
 by Bruce Hannah & Ayse Birsal
letter trays

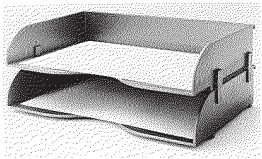
product	description	w	d	h	wgt.
Side Legal Double Tray 	Double tray. Non-scuffing rubber feet. Removable stacking brackets included.	15 1/2"	9 1/2"	7 1/4"	4 lbs. 1 oz.
Replacement Stacking Brackets	Set of four stacking brackets for all Orchestra letter trays. *Available in Translucent Orange and Blue	3/4"	1/2"	2"	1 oz. (set)

Order Code

Example: **ORCH-F-LT-BK**

ORCH-F- Front letter tray

LT

BK Black

Ordering Information

Specify:

1. Pattern number
2. Finish

Opaque plastic finishes:

- Black (BK)
- Medium Grey (DG)
- Soft Grey (E)
- Warm Putty (WP)

Translucent polycarbonate finishes:

- Clear (CL)
- *Orange (OR)
- *Blue (BL)
- *Select Products Only

Letter trays mounted on slat wall or load bars accommodate up to max. 15lbs of weight.

Custom Options

Custom colors available upon sample chip approval. \$350 color match fee and 500 piece minimum per line item.

pattern no.	translucent colors list price	opaque colors list price
2ORCH-S-LGT	\$111.	\$96.
ORCH-SB	6.	5.

System top cap-mounted signage plate available, designed to customer specifications and system. Customer responsible for graphics. 100 unit minimum. Contact your Knoll sales representative or Customer Service for complete pricing information.

Construction

Opaque plastic finishes:
Sturdy polystyrene plastic in matte, textured finish. Fingerprint resistant.

Translucent finishes:
Sturdy polycarbonate resin.

Manufactured in the United States.

Design Awards

Permanent Collection of the Cooper-Hewitt, National Design Museum, Smithsonian Institution, 1994; ROSCOE Award, Interior Design Magazine, 1991; Outstanding Performance, Product Design Achievement Award, IBD Southern California Chapter, 1991; Bronze Award, IBD Product Design Competition, 1990.

Orchestra® Universal System Accessories
 by Bruce Hannah & Ayse Birsal
 paper management

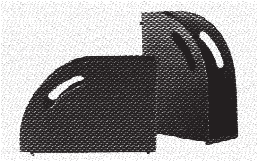
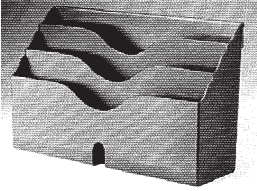
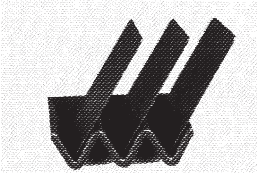
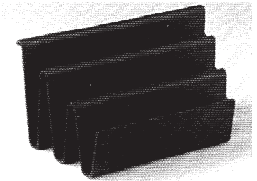
product	description	w	d	h	wgt.
2-Way Binder Bin 	Horizontal or vertical positioning. Excellent for rail-mount, desktop, and overhead storage.	4 ⁷ / ₈ "	12 ¹ / ₄ "	8 ¹ / ₄ "	1 lb. 6 ozs.
Vertical Paper Pack 	Holds memo, letter, legal and unbound EDP size material. *Available in Translucent Orange and Blue	15 ¹ / ₄ "	5"	9"	2 lbs. 1 oz.
Slanted Sorter 	Removable dividers tilt left and right. *Available in Translucent Orange and Blue	9"	11"	8 ¹ / ₂ "	2 lbs. 4 ozs.
File Sorter 	Versatile sorter holds small files, stationery, envelopes, messages and other desktop papers.	10 ¹ / ₄ "	5 ¹ / ₂ "	5 ¹ / ₂ "	1 lb. 8 ozs.



Order Code	Ordering Information	Custom Options	Construction
Example: ORCH-BDN-DG ORCH- Binder bin BDN DG Medium grey	<i>Specify:</i> 1. Pattern number 2. Finish <i>Opaque plastic finishes:</i> Black (BK) Medium Grey (DG) Soft Grey (E) Warm Putty (WP) <i>Translucent polycarbonate finishes:</i> Clear (CL) *Orange (OR) *Blue (BL) *Select Products Only	Custom colors available upon sample chip approval. \$350 color match fee and 500 piece minimum per line item. System top cap-mounted signage plate available, designed to customer specifications and system. Customer responsible for graphics. 100 unit minimum. Contact your KnollExtra representative or Customer Service for complete pricing information.	<i>Opaque plastic finishes:</i> Sturdy polystyrene plastic in matte, textured finish. Fingerprint resistant. <i>Translucent finishes:</i> Sturdy polycarbonate resin. Manufactured in the United States.

pattern no.	translucent colors list price	opaque colors list price
ORCH-BDN	\$59.	\$52.
ORCH-VPP	64.	59.
ORCH-SSD	64.	59.
ORCH-FS	45.	41.

Design Awards

Permanent Collection of the Cooper-Hewitt, National Design Museum, Smithsonian Institution, 1994; ROSCOE Award, Interior Design Magazine, 1991; Outstanding Performance, Product Design Achievement Award, IBD Southern California Chapter, 1991; Bronze Award, IBD Product Design Competition, 1990.

Orchestra® Universal System Accessories
 by Bruce Hannah & Ayse Birsal
 hanging file holders, pencil cup and utility trays

product	description	w	d	h	wgt.
Hanging File Holders 	2 per set. Attach to rail and hold legal or letter size hanging folders for easy access. Black is anodized aluminum. Medium grey is painted aluminum. Not for use on Currents slat wall.	1"	8"	1"	8 ozs. (pair)
Pencil Cup 	Three compartments for pencils, 4" x 6" memo paper, and large Post-It™ Notes. *Available in Translucent Orange and Blue	5"	3"	4"	7 ozs.
Utility Tray 	6 versatile compartments hold pencils, paper clips, and other paper management items. Largest compartment is 3" x 8 1/4".	12"	7"	1"	12 ozs.

Order Code	Ordering Information	Custom Options
Example: ORCH-PC ORCH-PC Pencil cup CL Clear	<i>Specify:</i> 1. Pattern number 2. Finish 3. Divider finish(mini-shelf only) <i>Opaque plastic finishes:</i> Black (BK) Medium Grey (DG) Soft Grey (E) Warm Putty (WP) <i>Translucent polycarbonate finishes:</i> Clear (CL) *Orange (OR) *Blue (BL) *Select Products Only	<i>Hanging file holder metal finishes:</i> Black (BK) Medium Grey (DG) For plastic accessories, custom colors available upon sample chip approval. \$350 color match fee and 500 piece minimum per line item. System top cap-mounted signage plate available, designed to customer specifications and system. Customer responsible for graphics. 100 unit minimum. Contact your Knoll sales representative or Customer Service for complete pricing information.

pattern no.	translucent colors list price	opaque colors list price
ORCH-HFH		\$44.
ORCH-PC	26.	23.
ORCH-UT	32.	30.

Construction

Hanging file holder and mini-shelf:
Medium grey painted aluminum or black anodized aluminum. Mini-shelf dividers are poly-styrene plastic.

Pencil cup and utility tray:
Sturdy polystyrene plastic in a matte, textured finish. Fingerprint resistant.

Translucent finishes:
Sturdy polycarbonate resin.

All items are manufactured in the United States.

Design Awards

Permanent Collection of the Cooper-Hewitt, National Design Museum, Smithsonian Institution, 1994; ROSCOE Award, Interior Design Magazine, 1991; Outstanding Performance, Product Design Achievement Award, IBD Southern California Chapter, 1991; Bronze Award, IBD Product Design Competition, 1990.

Orchestra® Universal System Accessories

by Bruce Hannah & Ayse Birsal

tape dispenser and memo tray

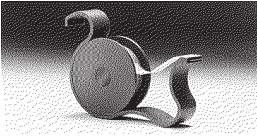
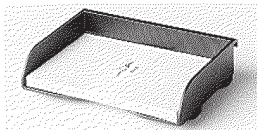
product	description	type	w	d	h	wt.
Tape Dispenser	Holds standard, clear tape (not included).		1"	4 1/2"	3 1/2"	3 ozs.
						
Memo Tray	Includes 4" x 6" memo paper. Non-scaffing rubber feet.		6"	4"	1"	9 ozs.
						
	*Available in Translucent Orange and Blue					



Order Code	Ordering Information	Custom Options	Construction
Example: ORCH-TD-E	<i>Specify:</i>	Custom colors available upon sample chip approval. \$350 color match fee and 500 piece minimum per line item.	<i>Opaque plastic finishes:</i> Sturdy polystyrene plastic in matte, textured finish. Fingerprint resistant.
ORCH-TD Tape dispenser	1. Pattern number		<i>Translucent finishes:</i> Sturdy polycarbonate resin.
E Soft grey	2. Finish	System top cap-mounted signage plate available, designed to customer specifications and system. Customer responsible for graphics. 100 unit minimum. Contact your Knoll sales representative or Customer Service for complete pricing information.	Manufactured in the United States.
	<i>Opaque plastic finishes:</i> Black (BK) Medium Grey (DG) Soft Grey (E) Warm Putty (WP)		
	<i>Translucent polycarbonate finishes:</i> Clear (CL) *Orange (OR) *Blue (BL) *Select Products Only		

pattern no.	translucent colors list price	opaque colors list price
ORCH-TD	\$22.	\$21.
ORCH-MT	26.	23.

Design Awards

Permanent Collection of the Cooper-Hewitt, National Design Museum, Smithsonian Institution, 1994; ROSCOE Award, Interior Design Magazine, 1991; Outstanding Performance, Product Design Achievement Award, IBD Southern California Chapter, 1991; Bronze Award, IBD Product Design Competition, 1990.

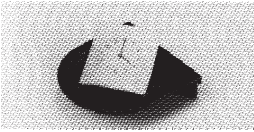
Orchestra® Universal System Accessories
 by Bruce Hannah & Ayse Birsel
clip/cup holder, bud vase and telephone shelf

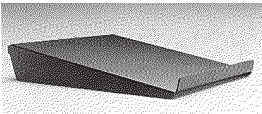
product	description	w	d	h	wgt.
Clip/Cup Holder 	Removes coffee cups, cans, paper clips, thumb tacks, etc. from the worksurface. Available in black and medium grey painted aluminum.	3 3/4"	4"	1"	4 ozs.
Bud Vase 	Available in black and clear. Rail-mounted only.	2"	2"	7"	3 ozs.
Telephone Shelf 	Holds virtually any standard office telephone. Available in black only.	12"	11 1/2"	2"	3 lbs. 12 ozs.

Order Code

Example: ORCH-CCH-BK
ORCH- Clip/ Cup Holder
CCH
BK Black

Ordering Information

- Specify:*
1. Pattern number
 2. Finish (When applicable)

Acrylic vase finishes:
 Black (BK)
 Clear (CL)

Clip/cup holder finishes:
 Black (BK)
 Medium Grey (DG)

Custom Options

For plastic accessories, custom colors available upon sample chip approval. \$350 color match fee and 500 piece minimum per line item.

System top cap-mounted signage plate available, designed to customer specifications and system. Customer responsible for graphics. 100 unit minimum. Contact your Knoll sales representative or Customer Service for complete pricing information.

pattern no.	opaque colors list price
ORCH-CCH	\$51.
ORCH-VAS	23.
ORCH-TS-UNI	90.

Construction

Translucent finishes:
Sturdy polycarbonate resin.

Clip/cup holder:
Painted, sand cast aluminum.

Bud vase:
Acrylic with black polystyrene holder.

Telephone shelf:
16-gauge painted steel.

Bud Vase is manufactured in Taiwan, Republic of China. All other items are manufactured in the United States.

Design Awards

Permanent Collection of the Cooper-Hewitt, National Design Museum, Smithsonian Institution, 1994; ROSCOE Award, Interior Design Magazine, 1991; Outstanding Performance, Product Design Achievement Award, IBD Southern California Chapter, 1991; Bronze Award, IBD Product Design Competition, 1990.

Orchestra® Universal System Accessories

by Bruce Hannah & Ayse Birsel

desk pads and wastebaskets

product	description	w	d	h	wgt.
Racetrack Desk Pad	Black linoleum with felt back.	30"	18"		5 lbs.



Wastebasket	Freestanding, 24 qt. capacity.	8 1/2"	14"	14 7/8"	4 lbs. 6 ozs.
-------------	--------------------------------	--------	-----	---------	---------------



Recycling Wastebasket	Blue recycling color for desk-side separation of waste materials. Includes recycling stickers. Freestanding. 24 qt. capacity.	8 1/2"	14"	14 7/8"	4 lbs. 6 ozs.
-----------------------	---	--------	-----	---------	---------------

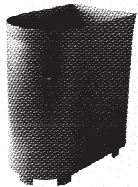

Order Code	Ordering Information	Custom Options	Construction
Example: ORCH-WBK-E	<i>Specify:</i>	Additional desk pad colors available. Special sizes available up to 34"W x 28"D. 50 piece minimum on all custom desk pads. Custom wastebasket colors available upon sample chip approval. \$350 color match fee and 750 minimum per line item. Contact your Knoll sales representative or Customer Service for complete pricing information.	<i>Desk pad:</i> Black linoleum with felt black
ORCH-WBK	1. Pattern number 2. Finish (When applicable)		<i>Wastebasket:</i> Polypropylene with matte textured finish.
E	<i>Wastebasket finishes:</i> Black (BK) Soft Grey (E) Warm putty (WP) Electric blue (EB)		All items are manufactured in the United States.

pattern no.	list price
ORCH-DP	\$87.

ORCH-WBK	99.
-----------------	-----

ORCH-WBK-R-EB	99.
----------------------	-----

Design Awards

Permanent Collection of the Cooper-Hewitt, National Design Museum, Smithsonian Institution, 1994; ROSCOE Award, Interior Design Magazine, 1991; Outstanding Performance, Product Design Achievement Award, IBD Southern California Chapter, 1991; Bronze Award, IBD Product Design Competition, 1990.

Orchestra® Universal System Accessories

by Bruce Hannah & Ayse Birsal

load bar/info rail

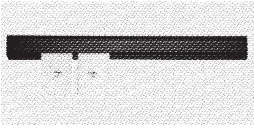
product	description	w	d	h	wgt.
Load Bar/Info Rail 	• Fits virtually every office system.	24"	1/2"	3"	1 lb. 9 ozs.
	• Mounts on panel, stanchion, wall or freestanding desk.	30"	1/2"	3"	2 lbs.
	• Info Rail underside holds memos and notes for easy access.	35"	1/2"	3"	2 lbs. 6 ozs.
	• Black plastic end caps.	36"	1/2"	3"	2 lbs. 9 ozs.
	• Wall, stanchion or panel-mounted brackets included in list price (see mounting options page).	42"	1/2"	3"	3 lbs.
		45"	1/2"	3"	3 lbs. 2 ozs.
		48"	1/2"	3"	3 lbs. 4 ozs.
		54"	1/2"	3"	4 lbs.
		60"	1/2"	3"	4 lbs. 5 ozs.
		66"	1/2"	3"	4 lbs. 8 ozs.
	72"	1/2"	3"	4 lbs. 12 ozs.	
Load Bar/Info Rail Morrison Network 2		11 5/8"	1/2"	3"	
		17 5/8"	1/2"	3"	
		23 5/8"	1/2"	3"	
		29 5/8"	1/2"	3"	
		35 5/8"	1/2"	3"	
		41 5/8"	1/2"	3"	
		47 5/8"	1/2"	3"	
Currents Work Shelf Load Bar		13 1/2"	1/2"	3"	
		17 7/8"	1/2"	3"	
		29 7/8"	1/2"	3"	
Currents Stanchion Mounted Load Bar		26 3/4"	1/2"	3"	
		38 3/4"	1/2"	3"	
Dividends and Caliber Stanchion Mounted Load Bar		31 5/8"	1/2"	3"	
		37 5/8"	1/2"	3"	
		43 5/8"	1/2"	3"	
		55 5/8"	1/2"	3"	
		67 5/8"	1/2"	3"	

Order Code	Ordering Information
Example: OR-LBI-36-111 OR-BKT-PM-R <hr/> OR-LBI-36 36" load bar 111 Black <hr/> OR-BKT-PM-R Panel-mounted bracket for Reff	<i>Specify:</i> 1. Pattern number 2. System Suffix 3. Finish 4. Mounting Option Special sizes and small quantity orders may be painted <i>Anodized aluminum finish:</i> Silver Anodized (SV)
	<i>Painted Core aluminum finishes:</i> Medium Grey (115) Soft Grey (117) Black (111) Beige Mist Metallic (611) Brown (112) Dark Grey (113) Folkstone Grey (114) Sandstone (116) Bright White (118) Medium Grey Metallic (612)
	<i>Painted Legacy aluminum finishes are still available for existing customers only:</i> Medium Metallic Grey (DG) Soft Grey (E) Warm Putty (WP) Flint (F) Black (BK)

pattern no.	list
OR-LBI-24-()()	\$88.
OR-LBI-30-()()	88.
OR-LBI-35-()()	95.
OR-LBI-36-()()	95.
OR-LBI-42-()()	106.
OR-LBI-45-()()	118.
OR-LBI-48-()()	118.
OR-LBI-54-()()	129.
OR-LBI-60-()()	136.
OR-LBI-66-()()	151.
OR-LBI-72-()()	176.
OR-LBI-24-N2-()()	78.
OR-LBI-30-N2-()()	84.
OR-LBI-36-N2-()()	88.
OR-LBI-42-N2-()()	88.
OR-LBI-48-N2-()()	95.
OR-LBI-54-N2-()()	106.
OR-LBI-60-N2-()()	118.
OR-LBI-66-N2-()()	129.
OR-LBI-72-N2-()()	136.
OR-LBI-30-C-()()	36.
OR-LBI-36-C-()()	45.
OR-LBI-48-C-()()	62.
OR-LBI-36-CS-()()	57.
OR-LBI-48-CS-()()	85.
OR-LBI-36-DV-()()	61.
OR-LBI-42-DV-()()	73.
OR-LBI-48-DV-()()	86.
OR-LBI-60-DV-()()	103.
OR-LBI-72-DV-()()	129.

Mounting Options	Custom Options	Construction	Design Awards
<p>Please note flat panel monitor arms cannot be mounted on Orchestra® load bars. Flat panel monitors can be mounted on Orchestra® slat wall only when mounted on an architectural wall. The Wishbone Test Matrix on Knoll Exchange outlines all monitor limitations. Please review before mounting. Please see p.128 for flat panel monitor tool bar options (Note: tool bars cannot hold Orchestra® organizational tools.)</p>	<p><i>Note:</i> Load Bar/Info Rails are available in custom lengths. Please note that for all lengths greater than 66", load bar will be painted, not anodized. Contact your local Knoll Customer Service representative for details.</p>	<p><i>Load bar/info rail:</i> Corrosion-resistant T-6063 painted or anodized aluminum. End caps are textured polystyrene plastic. Load Bar is filled with 1/2" Delrin plastic pellets to support papers on info rail.</p> <p>All items manufactured in the United States.</p>	<p>Permanent Collection of the Cooper-Hewitt, National Design Museum, Smithsonian Institution, 1994; ROSCOE Award, Interior Design Magazine, 1991; Outstanding Performance, Product Design Achievement Award, IBD Southern California Chapter, 1991; Bronze Award, IBD Product Design Competition, 1990.</p>

See page 70 for mounting options

Orchestra® Universal System Accessories
 by Bruce Hannah & Ayse Birsal
 load bar/info rail

product	description	w	d	h	wgt.
Equity Stanchion Load Bar		24"	1"	3"	
		30"	1"	3"	
		36"	1"	3"	
		42"	1"	3"	
		54"	1"	3"	
		66"	1"	3"	
Equity Application Load Bar		22 1/4"	1/2"	3"	
		28 1/4"	1/2"	3"	
		34 1/4"	1/2"	3"	
		40 1/4"	1/2"	3"	
		46 1/4"	1/2"	3"	
		52 1/4"	1/2"	3"	
		58 1/4"	1/2"	3"	
		64 1/4"	1/2"	3"	
		70 1/4"	1/2"	3"	

Order Code	Ordering Information
Example: OR-LBI-36-111 OR-BKT-PM-R	<i>Specify:</i>
OR-LBI-36 36" load bar	1. Pattern number
111 Black	2. System Suffix
OR-BKT-PM-R Panel-mounted bracket for Reff	3. Finish
	4. Mounting Option
	Special sizes and small quantity orders may be painted
	<i>Anodized aluminum finish:</i> Silver Anodized (SV)
	<i>Painted Core aluminum finishes:</i> Medium Grey (115) Soft Grey (117) Black (111) Beige Mist Metallic (611) Brown (112) Dark Grey (113) Folkstone Grey (114) Sandstone (116) Bright White (118) Medium Grey Metallic (612)
	<i>Painted Legacy aluminum finishes are still available for existing customers only:</i> Medium Metallic Grey (DG) Soft Grey (E) Warm Putty (WP) Flint (F) Black (BK)

pattern no.	list
OR-LBI-30-ES-()()	\$88.
OR-LBI-36-ES-()()	88.
OR-LBI-42-ES-()()	95.
OR-LBI-48-ES-()()	106.
OR-LBI-60-ES-()()	129.
OR-LBI-72-ES-()()	151.
OR-LBI-24-EY-()()	88.
OR-LBI-30-EY-()()	88.
OR-LBI-36-EY-()()	95.
OR-LBI-42-EY-()()	106.
OR-LBI-48-EY-()()	118.
OR-LBI-54-EY-()()	129.
OR-LBI-60-EY-()()	136.
OR-LBI-66-EY-()()	151.
OR-LBI-72-EY-()()	176.

Mounting Options

Please note flat panel monitor arms cannot be mounted on Orchestra® load bars. Flat panel monitors can be mounted on Orchestra® slat wall only when mounted on an architectural wall. The Wishbone Test Matrix on Knoll Exchange outlines all monitor limitations. Please review before mounting. Please see p.128 for flat panel monitor tool bar options (Note: tool bars cannot hold Orchestra® organizational tools.)

See page 70 for mounting options

Custom Options

Note:
Load Bar/Info Rails are available in custom lengths. Please note that for all lengths greater than 66", load bar will be painted, not anodized. Contact your local Knoll Customer Service representative for details.

Construction

Load bar/info rail:
Corrosion-resistant T-6063 painted or anodized aluminum. End caps are textured polystyrene plastic. Load Bar is filled with 1/2" Delrin plastic pellets to support papers on info rail.

All items manufactured in the United States.

Design Awards

Permanent Collection of the Cooper-Hewitt, National Design Museum, Smithsonian Institution, 1994; ROSCOE Award, Interior Design Magazine, 1991; Outstanding Performance, Product Design Achievement Award, IBD Southern California Chapter, 1991; Bronze Award, IBD Product Design Competition, 1990.

Orchestra® Universal System Accessories

by Bruce Hannah & Ayse Birsal

slat board 6 1/2"

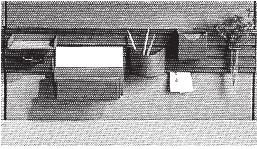
product	description	w	d	h	wgt.
Slat board-6 1/2" 	<ul style="list-style-type: none"> Fits virtually every office system. Mounts on panel, stanchion, wall or freestanding desk. 3 horizontal accessory channels. Info rail underside holds memos and notes for easy access. Wall, stanchion, or panel-mounted brackets included in list price (see mounting options page). 	24"	1"	6 1/2"	2 lbs. 9 ozs.
		30"	1"	6 1/2"	3 lbs. 3 ozs.
		35"	1"	6 1/2"	3 lbs. 13 ozs.
		36"	1"	6 1/2"	3 lbs. 13 ozs.
		42"	1"	6 1/2"	4 lbs. 8 ozs.
		45"	1"	6 1/2"	4 lbs. 8 ozs.
		48"	1"	6 1/2"	5 lbs. 2 ozs.
		54"	1"	6 1/2"	5 lbs. 12 ozs.
		60"	1"	6 1/2"	6 lbs. 6 ozs.
		66"	1"	6 1/2"	7 lbs.
		72"	1"	6 1/2"	7 lbs. 11 ozs.
Slat board Morrison Network 2		11 5/8"	1"	6 1/2"	
		17 5/8"	1"	6 1/2"	
		23 5/8"	1"	6 1/2"	
		29 5/8"	1"	6 1/2"	
		35 5/8"	1"	6 1/2"	
		41 5/8"	1"	6 1/2"	
		47 5/8"	1"	6 1/2"	
		53 5/8"	1"	6 1/2"	
	59 5/8"	1"	6 1/2"		
Slat board-Equity Stanchion		24"	1"	6 1/2"	
		30"	1"	6 1/2"	
		36"	1"	6 1/2"	
		42"	1"	6 1/2"	
		54"	1"	6 1/2"	
		66"	1"	6 3/4"	
Equity application		24"	1"	6 1/2"	2 lbs. 9 ozs.
		30"	1"	6 1/2"	3 lbs. 3 ozs.
		36"	1"	6 1/2"	3 lbs. 13 ozs.
		42"	1"	6 1/2"	4 lbs. 8 ozs.
		48"	1"	6 1/2"	5 lbs. 2 ozs.
		54"	1"	6 1/2"	5 lbs. 12 ozs.
		60"	1"	6 1/2"	6 lbs. 6 ozs.
		66"	1"	6 1/2"	7 lbs.
	72"	1"	6 1/2"	7 lbs. 11 ozs.	

Order Code

Example: OR-SL-06-42-EY-117-OR-BKT-PM-E
OR-SL-06- 42"W x 6 1/2"H slat board
42
EY Equity suffix
117 Soft grey
OR-BKT- Panel-mounted bracket
PM-E for Equity

Ordering Information

Specify:

1. Pattern number
2. System
3. Finish
4. Mounting Option

Satin anodized aluminum finish:
 Satin Anodized Aluminum (SA) includes painted matte black endcap. Special sizes and small quantity orders may be painted

Painted aluminum finishes:

Medium Grey (115)
 Soft Grey (117)
 Black (111)
 Beige Mist Metallic (611)
 Brown (112)
 Dark Grey (113)
 Folkstone Grey (114)
 Sandstone (116)
 Bright White (118)
 Medium Grey Metallic (612)

Painted Legacy aluminum finishes are still available for existing customers only:

Medium Metallic Grey (DG)
 Soft Grey (E)
 Warm Putty (WP)
 Flint (F)
 Black (BK)

Worksurface-mounted bracket:
 Metal posts attach to underside of worksurface with C-clamp, raising Load Bar 10" above worksurface. Usable on worksurfaces 1 1/8"-1 13/16" thick. Set of 2 brackets. For Slat boards wider than 66", order additional brackets.

For use with load bars and 6 1/2" slat boards only.

pattern no.	list price
OR-SL-06-24-()()	\$136.
OR-SL-06-30-()()	159.
OR-SL-06-35-()()	182.
OR-SL-06-36-()()	182.
OR-SL-06-42-()()	202.
OR-SL-06-45-()()	226.
OR-SL-06-48-()()	226.
OR-SL-06-54-()()	249.
OR-SL-06-60-()()	270.
OR-SL-06-66-()()	293.
OR-SL-06-72-()()	316.
<hr/>	
OR-SL-06-24-N2-()()	90.
OR-SL-06-30-N2-()()	112.
OR-SL-06-36-N2-()()	136.
OR-SL-06-42-N2-()()	159.
OR-SL-06-48-N2-()()	182.
OR-SL-06-54-N2-()()	202.
OR-SL-06-60-N2-()()	226.
OR-SL-06-66-N2-()()	249.
OR-SL-06-72-N2-()()	270.
<hr/>	
OR-SL-06-30-ES-()()	136.
OR-SL-06-36-ES-()()	159.
OR-SL-06-42-ES-()()	182.
OR-SL-06-48-ES-()()	202.
OR-SL-06-60-ES-()()	249.
OR-SL-06-72-ES-()()	293.
<hr/>	
OR-SL-06-24-EY-()()	136.
OR-SL-06-30-EY-()()	159.
OR-SL-06-36-EY-()()	182.
OR-SL-06-42-EY-()()	202.
OR-SL-06-48-EY-()()	226.
OR-SL-06-54-EY-()()	249.
OR-SL-06-60-EY-()()	270.
OR-SL-06-66-EY-()()	293.
OR-SL-06-72-EY-()()	316.

Mounting Options

Please note flat panel monitor arms cannot be mounted on Orchestra® load bars. Flat panel monitors can be mounted on Orchestra® slat wall only when mounted on an architectural wall. The Wishbone Test Matrix on Knoll Exchange outlines all monitor limitations. Please review before mounting. Please see p.128 for flat panel monitor tool bar options (Note: tool bars cannot hold Orchestra® organizational tools.)

Panel, stanchion and wall-mounted brackets:

Wall, stanchion, or panel-mounted brackets are included in the list price.

Note: Other brackets for other manufacturers stations are available. Contact your Customer Representative for more information.

Custom Options

Note:

Slat board is available in custom lengths of up to 96". Please note that for all lengths greater than 66", load bar will be painted, not anodized.

Brackets are currently available for virtually every major office system. Panel-mounted brackets for other systems can be developed. Minimum of 100 sets per bracket. Tooling and set-up charges may be required.

Construction

Corrosion-resistant T-6063-T5 painted or anodized aluminum. End caps are 11 gauge steel painted matte black. Bottom rail is filled with 1/2" Delrin plastic pellets to support papers on Info Rail.

Worksurface-mounted bracket:
Die-cast aluminum painted black.

All items manufactured in the United States.

Orchestra® Universal System Accessories
 by Bruce Hannah & Ayse Birsal
 slat board 14³/₄"

product	description	w	d	h	wgt.
Slat board-14 ³ / ₄ " 	<ul style="list-style-type: none"> Fits virtually every office system. Mounts on panel, stanchion, wall or freestanding desk. 8 horizontal accessory channels. Info rail underside holds memos and notes for easy access. Wall, stanchion, or panel-mounted brackets included in list price (see mounting options page). 	24"	1"	14 ³ / ₄ "	5 lbs. 2 ozs.
		30"	1"	14 ³ / ₄ "	6 lbs. 6 ozs.
		35"	1"	14 ³ / ₄ "	7 lbs. 1 oz.
		36"	1"	14 ³ / ₄ "	7 lbs. 1 oz.
		42"	1"	14 ³ / ₄ "	9 lbs.
		45"	1"	14 ³ / ₄ "	9 lbs.
		48"	1"	14 ³ / ₄ "	10 lbs. 4 ozs.
		54"	1"	14 ³ / ₄ "	11 lbs. 8 ozs.
		60"	1"	14 ³ / ₄ "	12 lbs. 12 ozs.
		66"	1"	14 ³ / ₄ "	14 lbs.
		72"	1"	14 ³ / ₄ "	15 lbs. 6 ozs.
Slat board-Equity Stanchion		24"	1"	14 ³ / ₄ "	5 lbs. 2 ozs.
		30"	1"	14 ³ / ₄ "	6 lbs. 6 ozs.
		36"	1"	14 ³ / ₄ "	7 lbs. 1 oz.
		42"	1"	14 ³ / ₄ "	9 lbs.
		54"	1"	14 ³ / ₄ "	11 lbs. 8 ozs.
		66"	1"	14 ³ / ₄ "	14 lbs.
Equity application		24"	1"	14 ³ / ₄ "	2 lbs. 9 ozs.
		30"	1"	14 ³ / ₄ "	3 lbs. 3 ozs.
		36"	1"	14 ³ / ₄ "	3 lbs. 13 ozs.
		42"	1"	14 ³ / ₄ "	4 lbs. 8 ozs.
		48"	1"	14 ³ / ₄ "	5 lbs. 2 ozs.
		54"	1"	14 ³ / ₄ "	5 lbs. 12 ozs.
		60"	1"	14 ³ / ₄ "	6 lbs. 6 ozs.
		66"	1"	14 ³ / ₄ "	7 lbs.
	72"	1"	14 ³ / ₄ "	7 lbs. 11 ozs.	

Order Code

Example: OR-SL-14-42-EY-117-OR-BKT-PM-E
OR-SL-14- 42"W x 14"H slat board
42
EY Equity suffix
117 Soft grey
OR-BKT- Panel-mounted bracket
PM-E for Equity

Ordering Information

Specify:
 1. Pattern number
 2. System
 3. Finish
 4. Mounting Option
anodized aluminum finish:
 Satin Anodized Aluminum (SA)
 Special sizes and small quantity orders may be painted

Painted aluminum finishes:
 Medium Grey (115)
 Soft Grey (117)
 Black (111)
 Beige Mist Metallic (611)
 Brown (112)
 Dark Grey (113)
 Folkstone Grey (114)
 Sandstone (116)
 Bright White (118)
 Medium Grey Metallic (612)

Painted Legacy aluminum finishes are still available for existing customers only:
 Medium Metallic Grey (DG)
 Soft Grey (E)
 Warm Putty (WP)
 Flint (F)
 Black (BK)

pattern no.	list price
OR-SL-14-24-()()	\$361.
OR-SL-14-30-()()	399.
OR-SL-14-35-()()	436.
OR-SL-14-36-()()	436.
OR-SL-14-42-()()	480.
OR-SL-14-45-()()	526.
OR-SL-14-48-()()	526.
OR-SL-14-54-()()	571.
OR-SL-14-60-()()	617.
OR-SL-14-66-()()	660.
OR-SL-14-72-()()	709.
<hr/>	
OR-SL-14-30-ES-()()	361.
OR-SL-14-36-ES-()()	399.
OR-SL-14-42-ES-()()	436.
OR-SL-14-48-ES-()()	480.
OR-SL-14-60-ES-()()	571.
OR-SL-14-72-ES-()()	660.
<hr/>	
OR-SL-14-24-EY-()()	361.
OR-SL-14-30-EY-()()	399.
OR-SL-14-36-EY-()()	436.
OR-SL-14-42-EY-()()	480.
OR-SL-14-48-EY-()()	526.
OR-SL-14-54-EY-()()	571.
OR-SL-14-60-EY-()()	617.
OR-SL-14-66-EY-()()	660.
OR-SL-14-72-EY-()()	709.

Mounting Options

Please note flat panel monitor arms cannot be mounted on Orchestra® load bars. Flat panel monitors can be mounted on Orchestra® slat wall only when mounted on an architectural wall. The Wishbone Test Matrix on Knoll Exchange outlines all monitor limitations. Please review before mounting. Please see p.128 for flat panel monitor tool bar options (Note: tool bars cannot hold Orchestra® organizational tools.)

Panel, stanchion and wall-mounted brackets:

Wall, stanchion, or panel-mounted brackets are included in the list price.

Note: Other brackets for other manufacturers stations are available. Contact your Customer Representative for more information.

Custom Options

Note:
Slat board is available in custom lengths of up to 96". Please note that for all lengths greater than 66", load bar will be painted, not anodized.

Brackets are currently available for virtually every major office system. Panel-mounted brackets for other systems can be developed. Minimum of 100 sets per bracket. Tooling and set-up charges may be required.

Panel, stanchion and wall-mounted brackets:

Wall, stanchion, or panel-mounted brackets are included in the list price and are specified when ordering pattern number. To specify appropriate panel-mounted bracket, consult the KnollExtra Bracket Chart on page 12 for appropriate suffix. For Equity panel-mounted applications, include an "EY" at end of base pattern number.

Worksurface mounted bracket is for use with load bars and 6 1/2" slat boards only.

Construction

Corrosion-resistant T-6063-T5 painted or anodized aluminum. End caps are 11 gauge steel painted matte black. Bottom rail is filled with 1/2" Delrin plastic pellets to support papers on Info Rail.

Worksurface-mounted bracket:
Die-cast aluminum painted black.

All items manufactured in the United States.

Orchestra® Universal System Accessories
 by Bruce Hannah & Ayse Birsal
 mounting options

product	description
Mounting Options  <i>Worksurface - Mounted Brackets</i>	Panel Mounted Bracket (Deep Universal only). Based on 1" centers. Set of 2.*
	Panel Mounted Bracket (Dividends Panel only). Set of 2.*
	Panel Mounted Bracket (Equity only). Set of 2.*
	Panel Mounted Bracket (Morrison only). Set of 2.*
	Panel Mounted Bracket (Reff only). Set of 2.*
	Panel Mounted Bracket (Shallow Universal only). Based on 1" centers. Set of 2.*
	Stanchion-Mounted Bracket (Calibre only). Set of 2.*
	Stanchion-Mounted Bracket (Currents workshelf and stanchion). Set of 2.*
	Stanchion-Mounted Bracket (Dividends only). Set of 2.*
	Stanchion-Mounted Bracket (Equity only). Set of 2.*
	Stanchion-Mounted Bracket (Morrison Network only). Set of 2.*
	Wall-Mounted Bracket. Set of 2.*
	Worksurface-Mounted Bracket. For load bars and 6 1/2" slat boards only. Set of 2. Black finish.

* No charge when ordered with Load Bar or Slat board, configured in load bar and slat board pattern numbers when ordered with load bars and slat boards.

Order Code	Ordering Information	Mounting Options
Example: OR-BKT-SM-A	<i>Specify:</i>	<i>Panel, stanchion and wall-mounted brackets:</i>
OR-BKT-SM-A Worksurface-mounted bracket	1. Pattern number	Wall, stanchion, or panel-mounted brackets are included in the list price and are specified when ordering pattern number.
		<i>Worksurface-mounted bracket:</i> Metal posts attach to underside of worksurface with C-clamp, raising Load Bar 10" above worksurface. Usable on worksurfaces 7/8"-1 1/2" thick. There should be at least 3/4"-1" of space between the back of the desk and the surface behind (ie. it cannot be flush). Set of 2 brackets. For Load Bars wider than 66", order additional brackets. For use with load bars and 6 1/2" slat boards only.

pattern no.	list price
OR-BKT-PM-B *	\$11.
OR-BKT-PM-DV *	11.
OR-BKT-PM-E *	15.
OR-BKT-PM-M *	11.
OR-BKT-PM-R *	11.
OR-BKT-PM-D *	11.
OR-BKT-PM-CE *	15.
OR-BKT-PM-CS *	27.
OR-BKT-PM-DS *	15.
OR-BKT-PM-ES *	15.
OR-BKT-PM-N *	15.
OR-BKT-WM *	23.
OR-BKT-SM-A	145.

Mounting Options

Note: Flat panel monitor arms cannot be mounted to Orchestra® load bars. Arms can only be mounted on Orchestra® slat wall if mounted per the Wishbone Test Matrix mounting instructions on Knoll Exchange. Please review before mounting. Flat panel monitor arm mounting options start at p. 122-123

Note: Load bars and 6 1/2" slat boards only can be mounted to worksurface using the worksurface mounted bracket. 14 3/4" slat board is too large for this application.

Custom Options

Brackets are currently available for virtually every major office system. Panel-mounted brackets for other systems can be developed. Minimum of 100 sets per bracket. Tooling and set-up charges may be required. Contact your Knoll sales representative or Customer Service for complete pricing information.

Note: Other brackets for other manufacturers stations are available. Contact your KnollExtra Representative for more information.

Construction

Worksurface-mounted bracket:
Die-cast aluminum painted black.

All items manufactured in the United States.

Design Awards

Permanent Collection of the Cooper-Hewitt, National Design Museum, Smithsonian Institution, 1994; ROSCOE Award, Interior Design Magazine, 1991; Outstanding Performance, Product Design Achievement Award, IBD Southern California Chapter, 1991; Bronze Award, IBD Product Design Competition, 1990.

Sapper™ Monitor Arm Collection

Easy Order Single Arm Kits

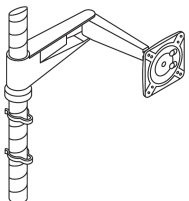
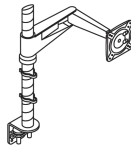
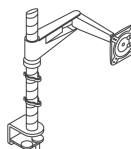
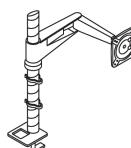
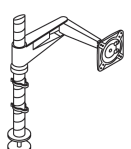
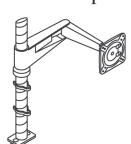
	type	description
 <p>Kit includes everything needed to mount one monitor to a worksurface, slat wall or wall: single standard arm, 16" mast, movement joint (includes fast release monitor plate), adjustment knob, cable management clips and mounting option (see right for options)</p>	 <p>Two-piece Table Clamp Mount</p>	Single monitor arm table clamp kit
	 <p>Deep Table Clamp Mount</p>	Single monitor arm deep table clamp kit
	 <p>Grommet Mount</p>	Single monitor arm grommet mount kit
	 <p>Fixed Table Mount</p>	Single monitor arm fixed table mount kit
	 <p>Crinion Open Table Mount</p>	Single monitor arm Crinion Open Table center channel mount kit

Order Code

Example: SAP-MA-S-CLMP-K
SAP-MA- Sapper single standard
S-CLMP-K arm table clamp kit
115 Medium Grey
R Red knob

Ordering Information

Specify:

1. Pattern number
2. Finish where required

Kits do not require any additional mounting specifications.

Standard Monitor Arm Finish

Options:

- Jet Black (111)
- Medium Grey (115)
- Bright White (118)

Silver Monitor Arm Finish Option:

Silver (613)

Knob Finish Option:

- Red (R)
- Black (B)

Antenna table center beam side mount finish options:

- Jet Black (111)
- Brown (112)
- Dark Grey (113)
- Folkstone (114)
- Medium Grey (115)
- Sandstone (116)
- Soft Grey (117)
- Bright White (118)
- Dark Red (130)
- Slate Blue (131)
- Beige Mist Metallic (611)
- Medium Metallic Grey (612)
- Silver Metallic (613)

Silver finish arm is made in the USA. The kits (which come with foreign components) and individual arms in this finish are made in compliance with the Trade Agreements Act (TAA).

pattern no.	silver finish list price	standard finish list price
SAP MA S CLMP K ()	\$370.	\$270.
SAP MA S CLMP DP K ()	400.	300.
SAP MA S GRMT K ()	375.	275.
SAP MA S FTM K ()	360.	260.
SAP MA S COT K ()	355.	255.

Mounting and Application Information

See pp. 100 for comprehensive mounting, application and construction information.

Sapper™ Monitor Arm Collection

Easy Order Single Arm Kits

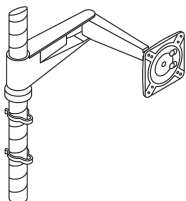
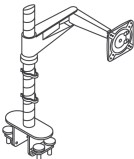
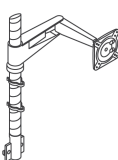
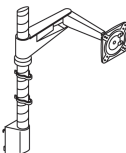
	type	description
	Dividends Horizon Benching Mount	Single monitor arm Dividends Horizon benching mount kit
<p>Kit includes everything needed to mount one monitor to a worksurface, slat wall or wall: single standard arm, 16" mast, movement joint (includes fast release monitor plate), adjustment knob, cable management clips and mounting option (see right for options)</p>		Single monitor arm Antenna table center beam center mount kit
		Single monitor arm Antenna table center beam side mount kit
		Single monitor arm slat wall 8" mast mount kit
		Single monitor arm slat wall 12" mast mount kit
		Single monitor arm slat wall 16" mast mount kit

Order Code

Example: SAP-MA-S-CLMP-K
SAP-MA- Sapper single standard
S-CLMP-K arm table clamp kit
115 Medium Grey
R Red knob

Ordering Information

Specify:

1. Pattern number
2. Finish where required

Kits do not require any additional mounting specifications.

Standard Monitor Arm Finish

Options:

- Jet Black (111)
- Medium Grey (115)
- Bright White (118)

Silver Monitor Arm Finish Option:

Silver (613)

Knob Finish Option:

- Red (R)
- Black (B)

Antenna table center beam side mount finish options:

- Jet Black (111)
- Brown (112)
- Dark Grey (113)
- Folkstone (114)
- Medium Grey (115)
- Sandstone (116)
- Soft Grey (117)
- Bright White (118)
- Dark Red (130)
- Slate Blue (131)
- Beige Mist Metallic (611)
- Medium Metallic Grey (612)
- Silver Metallic (613)

Silver finish arm is made in the USA. The kits (which come with foreign components) and individual arms in this finish are made in compliance with the Trade Agreements Act (TAA).



pattern no.	silver finish list price	standard finish list price
SAP MA S DH K ()	\$425.	\$325.
SAP MA S ANT CTR K ()	360.	260.
SAP MA S ANT SIDE K ()()	365.	265.
SAP MA S SW MST 8 K ()	380.	280.
SAP MA S SW MST 12 K ()	385.	285.
SAP MA S SW MST 16 K ()	390.	290.

Mounting and Application Information

See pp. 100 for comprehensive mounting, application and construction information.

Sapper™ Monitor Arm Collection

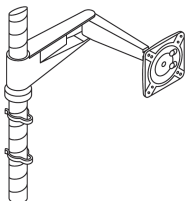
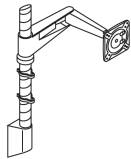
Easy Order Single Arm Kits

	type	description
	Wall Mast Mount	Single monitor arm wall 8" mast mount kit
		Single monitor arm wall 12" mast mount kit
		Single monitor arm wall 16" mast mount kit
<p>Kit includes everything needed to mount one monitor to a worksurface, slat wall or wall: single standard arm, 16" mast, movement joint (includes fast release monitor plate), adjustment knob, cable management clips and mounting option (see right for options)</p>	Compact Arm Direct Slat Wall Mount	Compact monitor arm direct slat wall mount kit
		
	Compact Arm Direct Wall Mount	Compact monitor arm direct wall mount kit
		

Order Code

Example: SAP-MA-S-CLMP-K	
SAP-MA- Sapper single standard	
S-CLMP-K arm table clamp kit	
115 Medium Grey	
R Red knob	

Ordering Information

Specify:

1. Pattern number
2. Finish where required

Kits do not require any additional mounting specifications.

Standard Monitor Arm Finish

Options:

- Jet Black (111)
- Medium Grey (115)
- Bright White (118)

Silver Monitor Arm Finish Option:

Silver (613)

Knob Finish Option:

- Red (R)
- Black (B)

Antenna table center beam side mount finish options:

- Jet Black (111)
- Brown (112)
- Dark Grey (113)
- Folkstone (114)
- Medium Grey (115)
- Sandstone (116)
- Soft Grey (117)
- Bright White (118)
- Dark Red (130)
- Slate Blue (131)
- Beige Mist Metallic (611)
- Medium Metallic Grey (612)
- Silver Metallic (613)

Silver finish arm is made in the USA. The kits (which come with foreign components) and individual arms in this finish are made in compliance with the Trade Agreements Act (TAA).

pattern no.	silver finish list price	standard finish list price
SAP MA S WL MST 8 K ()	\$375.	\$275.
SAP MA S WL MST 12 K ()	380.	280.
SAP MA S WL MST 16 K ()	385.	285.
SAP MA C SW DIR K ()	225.	175.
SAP MA C WL DIR K ()	210.	160.

Mounting and Application Information

See pp. 100 for comprehensive mounting, application and construction information.

Sapper™ Monitor Arm Collection

Easy Order Double Arm Kits

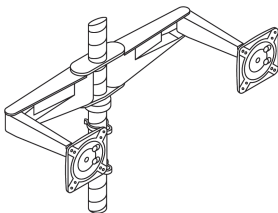
	type	description
 <p>Kit includes everything needed to mount two monitors to a worksurface, slat wall or wall: two standard arms, 16" mast, movement joints (includes fast release monitor plate), adjustment knob, cable management clips, double arm bracket and mounting option (see right for options)</p>	Two-piece Table Clamp Mount	Double monitor arm table clamp kit
	Deep Table Clamp Mount	Double monitor arm deep table clamp kit
	Grommet Mount	Double monitor arm grommet mount kit
	Fixed Table Mount	Double monitor arm fixed table mount kit
	Crinion Open Table Mount	Double monitor arm Crinion Open Table center channel mount kit

Order Code

Example:	SAP-MA-D-ANT-SIDE-K-() ()
SAP-MA-D-ANT-SIDE-K	Sapper double monitor arm Antenna side beam mount
115	Medium Grey
613	Silver
R	Red knob

Ordering Information

Specify:

1. Pattern number
2. Finish where required

Kits do not require any additional mounting specifications.

Standard Monitor Arm Finish Options:

- Jet Black (111)
- Medium Grey (115)
- Bright White (118)

Silver Monitor Arm Finish Option:

- Silver (613)

Knob Finish Option:

- Red (R)
- Black (B)

Antenna table center beam side mount finish options:

- Jet Black (111)
- Brown (112)
- Dark Grey (113)
- Folkstone (114)
- Medium Grey (115)
- Sandstone (116)
- Soft Grey (117)
- Bright White (118)
- Dark Red (130)
- Slate Blue (131)
- Beige Mist Metallic (611)
- Medium Metallic Grey (612)
- Silver Metallic (613)

Silver finish arm is made in the USA. The kits (which come with foreign components) and individual arms in this finish are made in compliance with the Trade Agreements Act (TAA).

pattern no.	silver finish list price	standard finish list price
SAP MA D CLMP K ()	\$575.	\$475.
SAP MA D CLMP DP K ()	605.	505.
SAP MA D GRMT K ()	585.	485.
SAP MA D FTM K ()	565.	465.
SAP MA D COT K ()	560.	460.

Mounting and Application Information

See pp. 100 for comprehensive mounting, application and construction information.

Sapper™ Monitor Arm Collection

Easy Order Double Arm Kits

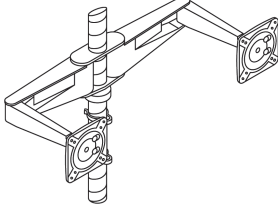
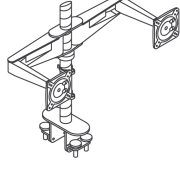
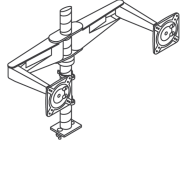
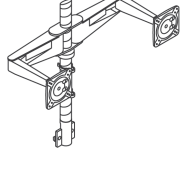
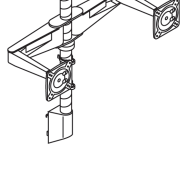
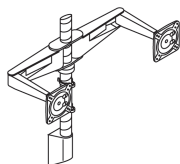
	type	description
	Dividends Horizon Benching Mount	Double monitor arm Dividends Horizon benching mount kit
<p>Kit includes everything needed to mount two monitors to a worksurface, slat wall or wall: two standard arms, 16" mast, movement joints (includes fast release monitor plate), adjustment knob, cable management clips, double arm bracket and mounting option (see right for options)</p>		Double monitor arm Antenna table center beam center mount kit
		Double monitor arm Antenna table center beam side mount kit
		Double monitor arm slat wall 8" mast mount kit Double monitor arm slat wall 12" mast mount kit Double monitor arm slat wall 16" mast mount kit
		Double monitor arm wall 8" mast mount kit Double monitor arm wall 12" mast mount kit Double monitor arm wall 16" mast mount kit
		Double monitor arm wall 8" mast mount kit Double monitor arm wall 12" mast mount kit Double monitor arm wall 16" mast mount kit

Order Code

Example:	SAP-MA-D-ANT-SIDE-K-() ()
SAP-MA-D-ANT-SIDE-K	Sapper double monitor arm Antenna side beam mount
115	Medium Grey
613	Silver
R	Red knob

Ordering Information

Specify:

1. Pattern number
2. Finish where required

Kits do not require any additional mounting specifications.

Standard Monitor Arm Finish

Options:

Jet Black (111)
Medium Grey (115)
Bright White (118)

Silver Monitor Arm Finish Option:
Silver (613)

Knob Finish Option:
Red (R)
Black (B)

Antenna table center beam side mount finish options:

Jet Black (111)
Brown (112)
Dark Grey (113)
Folkstone (114)
Medium Grey (115)
Sandstone (116)
Soft Grey (117)
Bright White (118)
Dark Red (130)
Slate Blue (131)
Beige Mist Metallic (611)
Medium Metallic Grey (612)
Silver Metallic (613)

Silver finish arm is made in the USA. The kits (which come with foreign components) and individual arms in this finish are made in compliance with the Trade Agreements Act (TAA).

pattern no.	silver finish list price	standard finish list price
SAP MA D DH K ()	\$630.	\$530.
SAP MA D ANT CTR K ()	565.	465.
SAP MA D ANT SIDE K () ()	570.	470.
SAP MA D SW MST 8 K ()	585.	485.
SAP MA D SW MST 12 K ()	590.	490.
SAP MA D SW MST 16 K ()	595.	495.
SAP MA D WL MST 8 K ()	580.	480.
SAP MA D WL MST 12 K ()	585.	485.
SAP MA D WL MST 16 K ()	590.	490.

Mounting and Application Information

See pp. 100 for comprehensive mounting, application and construction information.

Sapper™ Monitor Arm Collection

Easy Order Triple Monitor Support Kits

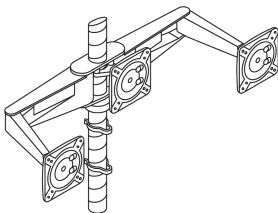
	type	description
 <p>Kit includes everything needed to mount three monitors to a worksurface, slat wall or wall: two standard arms, 16" mast, movement joints (includes fast release monitor plate), adjustment knob, cable management clips, triple monitor support bracket and mounting option (see right for options)</p>	Two piece clamp mount	Triple monitor support table clamp kit
	Deep Table Clamp Mount	Triple monitor support deep table clamp kit
	Grommet Mount	Triple monitor support grommet mount kit
	Fixed Table Mount	Triple monitor support fixed table mount kit
	Crinion Open Table Mount	Triple monitor support Crinion Open Table center channel mount kit

Order Code	Ordering Information	Ordering Note
Example: SAP-MA-T-CLMP-K-111	<i>Specify:</i>	<i>Antenna table center beam side mount finish options:</i>
SAP-MA- Sapper triple monitor	1. Pattern number	Jet Black (111)
T-CLMP-K support table clamp kit	2. Finish where required	Brown (112)
111 Jet Black	Kits do not require any additional mounting specifications.	Dark Grey (113)
B Black knob	<i>Standard Monitor Arm Finish Options:</i>	Folkstone (114)
	Jet Black (111)	Medium Grey (115)
	Medium Grey (115)	Sandstone (116)
	Bright White (118)	Soft Grey (117)
	Bright White (118)	Bright White (118)
	<i>Silver Monitor Arm Finish Option:</i>	Dark Red (130)
	Silver (613)	Slate Blue (131)
		Beige Mist Metallic (611)
		Medium Metallic Grey (612)
		Silver Metallic (613)
	<i>Knob Finish Option:</i>	
	Red (R)	
	Black (B)	
		Silver finish arm is made in the USA. The kits (which come with foreign components) and individual arms in this finish are made in compliance with the Trade Agreements Act (TAA).
		Please note a triple monitor support includes two standard arms plus one triple monitor support bracket with a movement joint. The monitor in the middle can rotate, tilt and swivel but has no depth adjustment. See page 100 for further details.

pattern no.	silver finish list price	standard finish list price
SAP MAT CLMP K ()	\$670.	\$570.
SAP MAT CLMP DP K ()	700.	600.
SAP MAT GRMT K ()	680.	580.
SAP MAT FTM K ()	660.	560.
SAP MAT COT K ()	655.	555.

Mounting and Application Information

See pp. 100 for comprehensive mounting, application and construction information.

Sapper™ Monitor Arm Collection

Easy Order Triple Monitor Support Kits

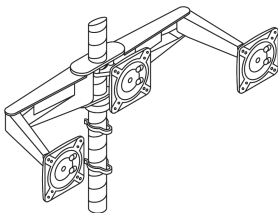
	type	description
 <p>Kit includes everything needed to mount three monitors to a worksurface, slat wall or wall: two standard arms, 16" mast, movement joints (includes fast release monitor plate), adjustment knob, cable management clips, triple monitor support bracket and mounting option (see right for options)</p>	Dividends Horizon Benching Mount	Triple monitor support Dividends Horizon benching mount kit
	Antenna Center Beam Center Mount	Triple monitor support Antenna table center beam center mount kit
	Antenna Center Beam Side Mount	Triple monitor support Antenna table center beam side mount kit
	Slat wall Mast Mount	Triple monitor support slat wall 8" mast mount kit Triple monitor support slat wall 12" mast mount kit Triple monitor support slat wall 16" mast mount kit
	Wall Mast Mount	Triple monitor support wall 8" mast mount kit Triple monitor support wall 12" mast mount kit Triple monitor support wall 16" mast mount kit

Order Code	Ordering Information	Ordering Note
Example: SAP-MA-T-CLMP-K-111	<i>Specify:</i>	<i>Antenna table center beam side mount finish options:</i>
SAP-MA- Sapper triple monitor	1. Pattern number	Jet Black (111)
T-CLMP-K support table clamp kit	2. Finish where required	Brown (112)
111 Jet Black	Kits do not require any additional mounting specifications.	Dark Grey (113)
B Black knob	<i>Standard Monitor Arm Finish</i>	Folkstone (114)
	<i>Options:</i>	Medium Grey (115)
	Jet Black (111)	Sandstone (116)
	Medium Grey (115)	Soft Grey (117)
	Bright White (118)	Bright White (118)
		Dark Red (130)
	<i>Silver Monitor Arm Finish Option:</i>	Slate Blue (131)
	Silver (613)	Beige Mist Metallic (611)
		Medium Metallic Grey (612)
	<i>Knob Finish Option:</i>	Silver Metallic (613)
	Red (R)	
	Black (B)	

Silver finish arm is made in the USA. The kits (which come with foreign components) and individual arms in this finish are made in compliance with the Trade Agreements Act (TAA).

Please note a triple monitor support includes two standard arms plus one triple monitor support bracket with a movement joint. The monitor in the middle can rotate, tilt and swivel but has no depth adjustment. See page 100 for further details.

pattern no.	silver finish list price	standard finish list price
SAP MA T DH K ()	\$725.	\$625.
SAP MA T ANT CTR K ()	660.	560.
SAP MA T ANT SIDE K () ()	665.	565.
SAP MA T SW MST 8 K ()	680.	580.
SAP MA T SW MST 12 K ()	685.	585.
SAP MA T SW MST 16 K ()	690.	590.
SAP MA T WL MST 8 K ()	675.	575.
SAP MA T WL MST 12 K ()	680.	580.
SAP MA T WL MST 16 K ()	685.	585.

Mounting and Application Information

See pp. 100 for comprehensive mounting, application and construction information.

Sapper™ Monitor Arm Collection

Easy Order Quadruple Mount Support Kits

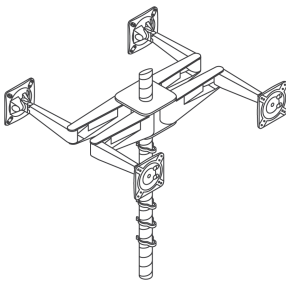
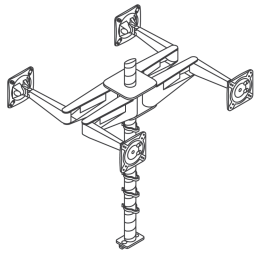
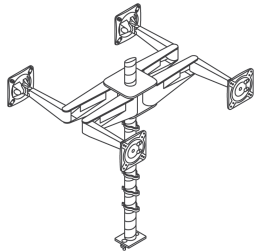
	type	description
	Crinion Open Table Mount	Quadruple monitor support Crinion Open Table center channel mount 16" mast kit
		Quadruple monitor support Crinion Open Table center channel mount 24" mast kit
	Dividends Horizon Benching Mount	Quadruple monitor support Dividends Horizon benching mount 16" mast kit
		Quadruple monitor support Dividends Horizon benching mount 24" mast kit
	Antenna Center Beam Center Mount	Quadruple monitor support Antenna table center beam center mount 16" mast kit
		Quadruple monitor support Antenna table center beam center mount 24" mast kit

Kit includes everything needed to mount four monitors back-to-back to a center table mount: four standard arms, 16" or 24" mast, movement joints (includes fast release monitor plate), adjustment knob, cable management clips, quadruple monitor support bracket and mounting option (see right for options)

Order Code	Ordering Information	Ordering Note	Mounting and Application Information
Example: SAP-MA-16-4-ANT-CTR-K	<i>Specify:</i> 1. Pattern number 2. Finish where required	Silver finish arm is made in the USA. The kits (which come with foreign components) and individual arms in this finish are made in compliance with the Trade Agreements Act (TAA).	See pp. 100 for comprehensive mounting, application and construction information.
SAP-MA-16-4-ANT-CTR-K	Sapper quadruple monitor support Antenna table center beam center mount 16" mast kit		
111	Jet Black		
R	Red knob		
	<i>Standard Monitor Arm Finish</i> <i>Options:</i> Jet Black (111) Medium Grey (115) Bright White (118)		
	<i>Silver Monitor Arm Finish Option:</i> Silver (613)		
	<i>Knob Finish Option:</i> Red (R) Black (B)		







pattern no.	silver finish list price	standard finish list price
SAP MA 16 4 COT K ()	\$1,175.	\$800.
SAP MA 24 4 COT K ()	1,215.	840.

SAP MA 16 4 DH K ()	1,240.	865.
SAP MA 24 4 DH K ()	1,280.	905.

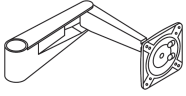
SAP MA 16 4 ANT CTR K ()	1,180.	805.
SAP MA 24 4 ANT CTR K ()	1,220.	845.

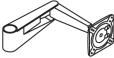
Sapper™ Monitor Arm Collection

Monitor Arms, Brackets and Movement Joints

	description
	Sleeve mount arm (arm with movement joint) 
<p>Arms and brackets can be ordered individually to easily reconfigure</p>	Single compact arm (with movement joint) 
	Single standard arm (with movement joint) 
	Double arm bracket (does not include arms, must order separately) 
	Triple support bracket (does not include arms, must order separately) 
	Quatruple monitor arm bracket (does not include arms, must order separately) 

Order Code	Ordering Information	Mounting and Application Information
Example: SAP-MA-S-115	<i>Specify:</i>	See pp. 100 for comprehensive mounting, application and construction information.
SAP-MA-S Sapper single standard monitor arm	1. Pattern number 2. Finish where required	
115 Medium Grey	Kits do not require any additional mounting specifications. <i>Standard Monitor Arm Finish</i> <i>Options:</i> Jet Black (111) Medium Grey (115) Bright White (118) <i>Silver Monitor Arm Finish Option:</i> Silver (613)	

pattern no.	silver finish list price	standard finish list price
SAP MA SL ()		\$50.
SAP MA C	175.	125.
SAP MA S ()	250.	150.
SAP D BKT		75.
SAP T BKT		125.
SAP 4 BKT		150.

Sapper™ Monitor Arm Collection

Monitor Arms, Brackets and Movement Joints

description

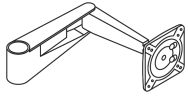

Double monitor to triple monitor support conversion kit
(Third monitor support bracket with movement joint)



Arms and brackets can be ordered individually to easily reconfigure

Movement joint (includes fast release pin)



Order Code

Example: **SAP-MA-S-115**

SAP-MA-S Sapper single standard monitor arm

115 Medium Grey

Ordering Information

Specify:

1. Pattern number
2. Finish where required

Kits do not require any additional mounting specifications.

Standard Monitor Arm Finish

Options:

- Jet Black (111)
- Medium Grey (115)
- Bright White (118)

Silver Monitor Arm Finish Option:

Silver (613)

Mounting and Application Information

See pp. 100 for comprehensive mounting, application and construction information.

pattern no.	silver finish list price	standard finish list price
SAP MA TD		\$85.

SAP MJ		46.
---------------	--	-----

Sapper™ Monitor Arm Collection

Masts

description



Masts come in various sizes to accommodate different monitor mounting solutions

8" Mast (includes adjustment knob and 1 cable management clip)



12" Mast (includes adjustment knob and 2 cable management clips)



16" Mast (includes adjustment knob and 2 cable management clips)



24" Mast (includes adjustment knob and 2 cable management clips)



32" Mast (includes 2 adjustment knobs and 4 cable management clips)



Order Code

Example: **SAP-MST-12**
SAP-MST- Sapper 12" mast
12



Mounting and Application Information

See pp. 100 for comprehensive mounting, application and construction information.

pattern no.	list price
SAP MST 8	\$70.
SAP MST 12	75.
SAP MST 16	80.
SAP MST 24	120.
SAP MST 32	180.

Sapper™ Monitor Arm Collection

Adjustment Knobs and Mast Cable Management Clips

	description
	Adjustment knob 
<i>Adjustment knobs and mast cable management clips can be ordered individually</i>	Mast cable management clips (set of 10) 

Order Code

Example: **SAP-MST-KNB**
SAP-MST- Sapper adjustment knob
KNB
B Black knob

Ordering Information

Specify:
 1. Pattern number
 2. Finish where required
Knob Finish Option:
 Red (R)
 Black (B)











Mounting and Application Information

See pp. 100 for comprehensive mounting and application information.

pattern no.	list price
SAP MST KNB ()	\$15.
SAP MST CM	20.

Sapper™ Monitor Arm Collection

Mounting Options







	description
 <p>Seven interchangeable mounting options provide ultimate flexibility</p>	Two-piece Table clamp mount 
	Deep Table Clamp 
	Heavy Duty Clamp 
	Grommet Mount 
	Fixed Table Mount 
	Crimion Open Table Center Channel Mount 
	Dividends Horizon Benching Mount 
	Antenna Table Center Beam Center Mount 
Antenna Table Center Beam Side Mount 	

Order Code	Ordering Information	Mounting and Application Information
Example: SAP-CLMP	<i>Specify:</i>	See pp. 100 for comprehensive mounting, application and construction information.
SAP-CLMP Sapper table clamp	1. Pattern number 2. Finish where required	
		<i>Antenna table center beam side mount finish options:</i> Jet Black (111) Brown (112) Dark Grey (113) Folkstone (114) Medium Grey (115) Sandstone (116) Soft Grey (117) Bright White (118) Dark Red (130) Slate Blue (131) Beige Mist Metallic (611) Medium Metallic Grey (612) Silver Metallic (613)

pattern no.	list price
SAP CLMP	\$55.
SAP CLMP DP	85.
SAP CLMP HD	80.
SAP GRMT	58.
SAP FTM	40.
SAP COT	40.
SAP DH	105.
SAP ANT CTR	45.
SAP ANT SIDE ()	50.

Sapper™ Monitor Arm Collection

Mounting Options

	description
	Slat wall Mast Mount 
<i>Seven interchangeable mounting options provide ultimate flexibility</i>	Direct Slat wall Mount 
	Wall Mast Mount 
	Direct wall mount 
	Compact Arm Direct Slat wall Mount 
	Compact Arm Direct Wall Mount 

Order Code

Example: **SAP-CLMP**
SAP-CLMP Sapper table clamp

Ordering Information

Specify:
 1. Pattern number
 2. Finish where required

Antenna table center beam side mount finish options:
 Jet Black (111)
 Brown (112)
 Dark Grey (113)
 Folkstone (114)
 Medium Grey (115)
 Sandstone (116)
 Soft Grey (117)
 Bright White (118)
 Dark Red (130)
 Slate Blue (131)
 Beige Mist Metallic (611)
 Medium Metallic Grey (612)
 Silver Metallic (613)

Mounting and Application Information

See pp. 100 for comprehensive mounting, application and construction information.

pattern no.	list price
SAP SW MST	\$70.
SAP SW DIR	75.
SAP WL MST	66.
SAP WL DIR	70.
SAP SW DIR C	70.
SAP WL DIR C	65.

Sapper™ Monitor Arm Collection

Mounting, Construction and Application Information

Mounting and Application Information:

All Sapper standard monitor arms:

- Maximum weight of 20 lbs * per arm, weight limits vary by mounting option
- Ship standard with fast release movement joint
- Offer 165 degrees of monitor tilt up and down, 180 degrees of swivel left and right and 360 degrees of rotation for portrait and landscape viewing
- Fold into themselves to be highly compact at (only 2 7/8" when fully compressed)
- Are durable and lightweight (standard arm weighs only 2.6 pounds)

*Please note this limit accommodates up to 95% of monitors on the market. There is not a specific monitor size maximum limitation for a single Sapper monitor arm. A larger size (e.g., 24" widescreen) does not necessarily equate to a higher weight monitor. It is key to understand the application to know if a certain size monitor will fit within a space and/or if there are multiple monitors. Also, it is important to note weight limitations vary by application. See details below.

Weight Limits:

Weight limitations for individual mounting options are outlined below. Taken together (both the mounting option weight limit and the individual arm limit of 20 lbs) you can best determine what mounting approach is best for your client given the number of monitors they desire to mount and the weight of those monitors. Weight limits are outlined by mounting option on the next few pages.

For example, if you want to mount two monitors on a worksurface with a grommet mount and each of those monitors weighs 18 lbs (2 monitors x 18 lbs each equals 36 lbs total), we can accommodate that with the 45 lbs weight limit for the grommet mount and the 20 lbs limitation for each arm. However, if they want to do three monitors weighing each 18 lbs (3 monitors x 18 lbs each equals 54 lbs total) with a grommet mount, we cannot do that on a single mast with this mount since the maximum weight limitation is 45 lbs.

Size Limits:

There is no specific size maximum for a single arm solution (outside the limitations of the space in which you are trying to put it). When mounting two monitors, the maximum outer horizontal width per monitor is 31.8" for a cockpit solution or 33.9" for a flat positioning flush next to each other. For three monitors, the maximum outer horizontal width per monitor is 15.2" for a cockpit solution or 16.35" for a flat positioning flush next to each other in a row. Clients can accommodate larger screen monitors in triples by turning monitor screens to a portrait position.

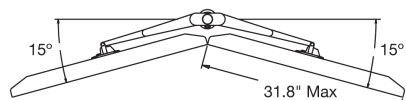

Double Cockpit

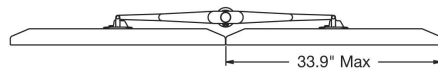

Double Flat

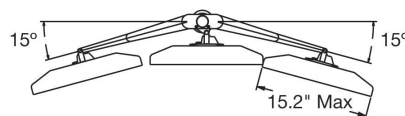

Triple Cockpit

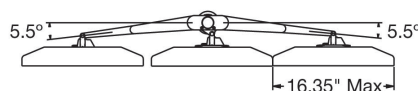

Triple Flat

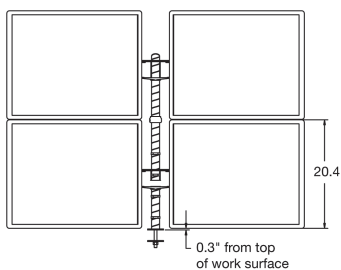

Maximum Monitor Height on a 32" Mast for Double Stacked Monitors

Please note while four monitors (two-on-two) are shown above, the height limitation apply to six monitor (three-on-three) configurations as well.

KEY NOTE: Flat panel monitor manufacturers refer to their products by diagonal screen measurements. So a 19" widescreen monitor has a 19" screen measured diagonally, but is not necessarily 19" in horizontal width (refer to manufacturers specifications for specific overall height and width).

Monitor Mounting:

All Sapper monitor arms are compatible with the international Video Electronics Standard Association (VESA) industry interface standard (75 mm x 75 mm and 100 mm x 100 mm hole patterns or 2.95" x 2.95" and 3.94" x 3.94") adopted by most panel manufacturers. VESA compliance is a requirement to mount any monitor to a monitor arm. Please note our monitor plates come standard with both 75 mm x 75 mm and 100 mm x 100 mm holes. If your customer has a recessed monitor back with only 75 mm x 75 mm holes, additional spacers will be needed to ensure proper fit. Contact Customer Service for more details including part and pricing information.

Some larger (over 22" wide) widescreen monitors now come with the home VESA standard (200 mm x 100 mm or 200 mm x 200 mm) which can be accommodated as a special through Custom Product Development.

Knoll and its dealers will not take the responsibility for mounting the monitor to the arm. The end user's IT department must confirm VESA mounting compliance and mount the monitor to the arm using customer's own screws. The most common screws are M5 x 8mm and M5 x 10mm.

Please follow installation instructions closely (available in each kit box shipped as well as on Knoll Exchange).

Apple Computer Note:

Apple iMacs are not VESA compliant. To mount a 24-inch iMac or 24-inch LED Cinema Display to a Sapper arm requires a customer to purchase a Cinema Display VESA Mount Adapter Kit from Apple. The adapter kit comes standard with a 100 mm x 100 mm hole pattern and can be purchased online at apple.com

Unbalanced Monitor Note:

Please note there are some monitors on the market that have all of their media connections on one side which makes the monitor unbalanced. In order to level the monitor, a special set screw in the VESA plate is needed. Please contact Custom Product Development for pricing and details.

Clamp Mounting:

Two-Piece Table Clamp Mounting:

The standard two-piece table clamp is easy to install or retrofit and works on most worksurfaces or desks that are a minimum of 1 1/8" thick solid core. The maximum worksurface thickness is 2 3/4". There are four settings to accommodate a range of worksurface thicknesses. For the fourth setting to accommodate the thickest worksurfaces you must invert the lower mounting plate to allow the mount to clamp the maximum 2 3/4". It is important to mock up the table clamp, particularly on competitive product to ensure a proper fit. The clamp is not compatible with Morrison Network.

Maximum weight limit is 75 lbs.

Deep Table Clamp Mounting:

This clamp is one piece and works on most surfaces. The deep table clamp mount is intended to clear most knife-edge (45 degree angle) desks or worksurfaces.

Maximum weight limit is 75 lbs.

Heavy-Duty Table Clamp Mounting:

This clamp is intended for heavier weight applications. Please note you still have a 20 lbs. limitation per monitor arm in conjunction with the mounting limit.

Maximum weight limit is 120 lbs.

Grommet Mounting:

With all systems furniture, it is important to pass monitor and peripheral plugs through grommet mount cover while it is still loose. Please note the grommet mount is compatible with Morrison, Autostrada, Reff, Propeller, Scope and Wa, but is not compatible with the Graham Collection or Dividends Horizon grommet holes. To use on Morrison Network, spacers must be requested through Customer Service. The required cutout in the worksurface is 3" x 1.77", which includes room for the threaded stud (actual hole in the grommet plate is 2" x 1.77").

Maximum weight limit is 45 lbs.

Fixed Table Mounting:

Installers will need to drill a permanent hole into the worksurface so the mast will be fixed to a dedicated location on the worksurface. Please note with this mounting, the mast will not be able to be moved without leaving a permanent hole. The worksurface must be of adequate structure and we recommend a minimum of 1 1/8" thick solid core for adequate structural integrity. Knoll cannot be held responsible for the structural integrity of non-Knoll worksurfaces.

Maximum weight limit is 85 lbs.

Crinon Open Table Center Channel Mounting:

This mount is intended to provide maximum worksurface or desk usage by mounting to the center channel. Note that when used for individuals, you will need to stagger users across the table.

Maximum weight limit is 40 lbs.

Dividends Horizon Benching Mounting:

This mount is intended to provide maximum worksurface or desk usage by mounting in between worksurfaces. It clamps to worksurfaces ranging from 3/8" to 1 3/8". Note that when used for individuals, you will need to stagger users across the table. This mount is designed for use with Dividends Horizon flat profile panel trim, and is not compatible with radius profile.

Maximum weight limit is 40 lbs.

Antenna Table Center Beam Table Mounting:

This mount is intended to provide maximum worksurface or desk usage by mounting to the center beam. Note that when used for individuals, you will need to stagger users across the table.

Maximum weight limit is 100 lbs.

Antenna Table Center Beam Side Mounting:

This mount allows you to clear the flip door while allowing for maximum worksurface usage and individual height adjustment without the need to stagger users. Please note a screen can be mounted in the center beam with a monitor arm in front of it. The fit will be snug and flush with the screen.

Maximum weight limit is 100 lbs.

Slat Wall Direct Mast Mounting:

For single monitor mounting, you can use either the slat wall mast mount or direct slat wall mount. For double or triple monitor mounting, you must use the slat wall mast mount. The direct slat wall mount cannot be used for multiple monitors.

Works with most Knoll slat board and slat wall profiles, however, load ratings vary across products and mounting approaches. Please review product breakdown on the following pages to ensure compatibility with your specific application needs.

Orchestra/KnollExtra slat board must be mounted to an architectural wall if a flat panel monitor arm is to be mounted to it. You can only use this slat board when it is wall-mounted as outlined below. Knoll cannot be held responsible for the structural integrity of a wall so please work with clients to ensure their wall is structurally sound to hold the slat board, the arm configuration and the monitor weight.

Slat Wall Direct Mounting (for both standard and compact arm):

For single monitor mounting, you can use either the slat wall mast mount or direct slat wall mount. For double or triple monitor mounting, you must use the slat wall mast mount. The direct slat wall mount cannot be used for multiple monitors.

Please note that the Compact Arm Direct Wall Mount is specific to the compact arm. You cannot use the standard mount with the compact arm or a standard arm with the compact mount.

Works with most Knoll slat board and slat wall profiles, however, load ratings vary across products and mounting approaches. Please review product breakdown on the following pages to ensure compatibility with your specific application needs.

Orchestra/KnollExtra slat board must be mounted to an architectural wall if a flat panel monitor arm is to be mounted to it. You can only use this slat board when it is wall-mounted as outlined below. Knoll cannot be held responsible for the structural integrity of a wall so please work with clients to ensure their wall is structurally sound to hold the slat board, the arm configuration and the monitor weight.

Direct Wall Mast Mounting:

For single monitor mounting, you can use either the direct wall mast mount or direct wall mount. For double or triple monitor mounting, you must use the wall mast mount. The direct wall mount cannot be used for multiple monitors.

For use on architectural walls only as outlined further on this page. Knoll cannot be held responsible for the structural integrity of a wall so please work with clients to ensure their wall is structurally sound to hold the arm configuration and the monitor weight. See above for weight limits if mounting slat wall to an architectural wall.

Direct Wall Mounting (for both standard and compact arm):

For single monitor mounting, you can use either the direct wall mast mount or direct wall mount. For double or triple monitor mounting, you must use the wall mast mount. The direct wall mount cannot be used for multiple monitors.

Please note that the Compact Arm Direct Wall Mount is specific to the compact arm. You cannot use the standard mount with the compact arm or a standard arm with the compact mount.

For use on architectural walls only as outlined further on this page. Knoll cannot be held responsible for the structural integrity of a wall so please work with clients to ensure their wall is structurally sound to hold the arm configuration and the monitor weight. See above for weight limits if mounting slat wall to an architectural wall.

Cable Management:

External cable management allows for easy installation and removal of monitors. There are gates under the the arm that will contain wires from the monitor to plastic cable management clips that go on the mast to keep wires tidy to the electrical socket.

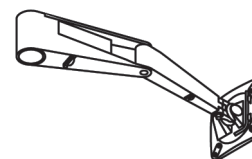
Gates**Clips**

Sapper™ Monitor Arm Collection

Mounting, Construction and Application Information

Adjustment:

The Sapper monitor arm collection offers intuitive adjustment. To adjust the height, you simply manually lift the arm and twist the adjustment knob like a screw up or down the mast to a comfortable setting. The easiest way to lift the monitor is to fold it in before making the adjustment. To adjust the depth, you can move the arm in or out. You can also rotate the monitor 360 degrees for landscape or portrait viewing and adjust the swivel back and forth 180 degrees and tilt up and down 165 degrees. The arm folds in and out from 2⁷/₈" fully compressed to approximately 17" when fully extended.

Height Adjustment

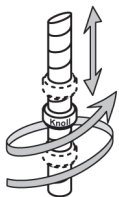

Rotation, Swivel, Tilt and Depth Adjustment

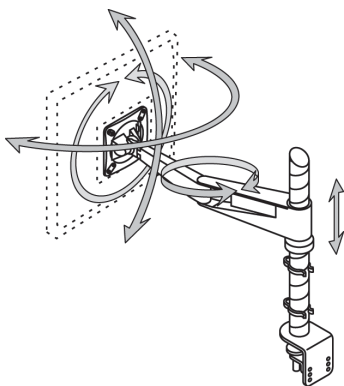

Fast Release:

Allows for swift installation and removal of flat panel monitors by merely popping the quick release pin up to remove monitor with movement joint/back plate attached.

Fast Release

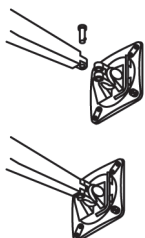

Theft Deterrence:

All movement joints come with a set screw within the fast release pin, to prevent fast release if so desired. Also there is a set screw at the top of the mast to deter removal of the entire arm and monitor from the mast.

Deactivate Fast Release with Set Screw



Set Screw to Prevent Arm Removal

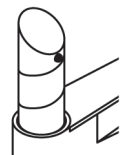

Compatibility:

The Sapper Monitor Arm Collection is not compatible with the Wishbone Flat Panel Monitor Support System (i.e., Wishbone, Zorro or Rotation arms, posts, tool bars, brackets, mounting, etc.). They have been designed independently and as such parts from one system cannot be used with the other.

Monitors cannot be mounted on KnollExtra®/Orchestra® load bars.

Installation Instructions:

Comprehensive installation instructions will be shipped with product and are also available on Knoll Exchange for easy reference.

Construction:

Arm: die cast aluminum with a cold rolled steel top plate

Mast: anodized aluminum extrusion

Adjustment knob: nylon undermold with a TPU overmold

Movement joint (includes fast release monitor plate): acetal bushings, zinc and acetal molded plastic tilt friction components and glass filled nylon VESA plate

Table clamp, grommet mount, fixed table mount, COT Center channel mount, DH Benching mount, Antenna center beam center mount: steel

Slat wall and wall mounts (both mast mount and direct both standard and compact sizes): die cast aluminum with steel back plates

Double arm bracket: die cast aluminum, steel top plate, extruded aluminum posts, acetal upper and lower bushings

Triple support arm bracket: die cast aluminum, steel top plate, extruded aluminum posts, acetal upper and lower bushings

Cable management: transparent polycarbonate clips on the mast; acetal gates under standard arms

Antenna and Quadruple support arm bracket: die cast aluminum.

Two-Piece Table Clamp, Deep Table Clamp, Heavy-Duty Table, Clamp, Grommet, Fixed Table, Crinion Open Table Center Channel, Dividends Horizon Benching and Antenna Center Beam Table Mounting: Steel

Antenna Table Center Beam Side Mounting: Die-cast Aluminum

Slat Wall and Wall Mounts both Direct Mast Mounting and Direct Mounting (for both standard and compact arms): Die-cast Aluminum with steel back plates

Quadruple arm bracket: Die-cast Aluminum

This page intentionally left blank.

Sapper™ Monitor Arm Collection

Mounting, Construction and Application Information

Sapper Monitor Arm Mounting Options by Product Line

	Two-Piece Table Clamp	Deep Table Clamp	Heavy-Duty Table Clamp	Grommet Mount	Fixed Table Mount	Crinion Open Table Center Channel	Dividends Horizon Benching Mount	Antenna Side / Center Table Mount	Slatwall Mounts* Direct Wall Mounts*
Morrison	Yes	Yes	Yes	Yes	Yes	n/a	n/a	n/a	n/a
Morrison Network	No	No	No	No needs spacer order thru CR	Yes	n/a	n/a	n/a	n/a
Currents	Yes	Yes	Yes	Yes	Yes	n/a	n/a	n/a	Yes
Autostrada AS1	Yes (non tapered edge only)	Yes	Yes	Yes	Yes	n/a	n/a	n/a	Yes
Autostrada AS2	Yes (non tapered edge only)	Yes	Yes	Yes	Yes	n/a	n/a	n/a	No
Autostrada AS3	Yes (non tapered edge only)	Yes	Yes	Yes	Yes	n/a	n/a	n/a	Yes
Crinion Open Table/ AS4	Yes (non tapered edge only)	Yes	Yes	n/a	Yes	Yes	n/a	n/a	Yes
Reff	Yes	Yes	Yes	Yes	Yes	n/a	n/a	n/a	No
Dividends Horizon	Yes	Yes	Yes	n/a	Yes	n/a	Yes	n/a	Yes
Equity	Yes	Yes	Yes	n/a	Yes	n/a	n/a	n/a	n/a
Cascade Edge Worksurfaces	Yes	Yes	Yes	Yes	Yes	n/a	n/a	n/a	n/a
Template	Yes	Yes	Yes	n/a	Yes	n/a	n/a	n/a	n/a
Graham Collection	Yes	Yes	Yes	No	Yes	n/a	n/a	n/a	n/a
Antenna	Yes	Yes	Yes	Yes	Yes	n/a	n/a	Yes	n/a
Upstart	Yes	Yes	Yes	n/a	Yes	n/a	n/a	n/a	n/a
Interaction	Yes	Yes	Yes	n/a	Yes	n/a	n/a	n/a	n/a
Magnusson	Yes	Yes	Yes	Yes	Yes	n/a	n/a	n/a	n/a
Propeller	Yes	Yes	Yes	Yes	Yes	n/a	n/a	n/a	n/a

Sapper Monitor Arm Mounting Options Weight Limits and Mounting Notes

Two-Piece Table Clamp Mount and Deep Table Clamp Mount	20 lbs. maximum per arm 75 lbs. maximum load limit per mast	Note: Quad Mount option not available
Heavy Duty Table Clamp	20 lbs. maximum per arm 120 lbs. maximum load limit per mast	Note: Quad Mount option not available
Grommet Mount	20 lbs. maximum per arm 45 lbs. maximum load limit per mast	Note: Quad Mount option not available
Fixed Table Mount	20 lbs. maximum per arm 85 lbs. maximum load limit per mast	
Crinion Open Table Center Channel Mount	20 lbs. maximum per arm 40 lbs. maximum load limit per mast	
Dividends Horizon Benching Mount	20 lbs. maximum per arm 40 lbs. maximum load limit per mast	
Antenna Center Beam Table Mount	20 lbs. maximum per arm 100 lbs. maximum load limit per mast	
Antenna Table Side Beam Mount	20 lbs. maximum per arm 100 lbs. maximum load limit per mast	Note: Quad Mount option not available

Slat Wall Mounting Weight Limits and Mounting Notes

	Currents Spine / Autostrada AS1 Spine	Reff / Autostrada AS2 P Vertical Panel	Autostrada Applied Wall / AS3	Dividends Horizon panel	KnollExtra / Orchestra® Slat	COT Center Screen
Direct	20 lbs	Not an option	20 lbs	20 lbs	20 lbs	15 lbs
Mast Mount:						
8"	60 lbs	Not an option	60 lbs	10 lbs	45 lbs	15 lbs
12"	60 lbs	Not an option	60 lbs	7.5 lbs	45 lbs	10 lbs
16"	50 lbs	Not an option	50 lbs	5 lbs	30 lbs	5 lbs
24"	30 lbs	Not an option	30 lbs	0 lbs	15 lbs	0 lbs
32"	20 lbs	Not an option	20 lbs	0 lbs	15 lbs	0 lbs
	Note: no maximum total load limit.		Note: requires special mount plate through CPD as slat wall pitch is different from other AS product; no maximum total load limit.	Note: 30 lbs maximum weight limit per slat wall.	Note: 1) can only be used when mounted on a structural architectural wall, 2) must use one Orchestra® wall mount bracket (OR-BKT-WM) per arm installed on 24" on center maximum and 3) no maximum total load limit.	Note: 1) can only be used in combination with the AutoStrada buttress (see AS price list) and 2) must be used with COT mid-span support positioned under each buttress and 3) 45 lbs maximum weight limit per screen face. All weight limits above are per face or side of screen.

Wall Mounting Weight Limits and Mounting Notes (Architectural Walls Only)

Direct	20 lbs
Mast Mount:	
8"	75 lbs
12"	75 lbs
16"	75 lbs
24"	75 lbs
32"	70 lbs

Note: No maximum total load limit

Adjustable Keyboard Supports

Romeo and Juliet Platform/Mechanism Configurations

product	description	type	w	d	h	wgt.	
Romeo and Juliet Platform and Mouse Pad 	Romeo 20" min., 28" max. x 11" x 1". 2"H with palm rest for keyboard platform <ul style="list-style-type: none"> • Rigid plastic platform with steel stiffener plate for stable keying surface. • Flexible soft textured plastic overcoat. • Thin profile for extra knee room. Juliet A teardrop shaped mouse pad that swivels under the keyboard platform for easy storage. Soft plastic overcoat and lip keep mouse from sliding off during adjustments. See Mechanism Attributes below.	Romeo and Juliet with easy lift arm	20.25"-28"	12.5"-17.25"	2.25"	13.8 lbs.	
		Romeo and Juliet with easy lift arm with pivot	20.25"-28"	12.5"-17.25"	2.25"	15.3 lbs.	
		Romeo and Juliet with short easy lift arm	20.25"-28"	12.5"-17.25"	2.25"	13.2 lbs.	
		Romeo and Juliet with short easy lift arm with pivot	20.25"-28"	12.5"-17.25"	2.25"	14.6 lbs.	
		Romeo and Juliet with sit/stand arm	20.25"-28"	12.50"-17.25"	2.25"	15.4 lbs.	
		Romeo and Juliet with sit/stand arm with pivot	20.25"-28"	12.5"-17.25"	2.25"	17 lbs.	
		<hr/>					
		Juliet	Juliet with palm rest. Mounted for right-handed use.		9 1/2"	11"	1 1/8"



Order Code	Ordering Information	Application Notes	Construction
Example: OA-K-RJ-EL2-BK (16,18,22,23,25) OA-K-RJ-EL2-BK Romeo and Juliet platform mounted on an (16,18, 22, easy lift mechanism 23,25)	<i>Specify:</i> 1. Pattern number 2. Track size (if applicable) <i>Track length:</i> Options are 16, 17.750, 21.625, 22.63 and 25 inches. Minimum clearance required is the length of the track plus 1/2". Romeo and Juliet and Act II have two width and depth measurements based on whether the mouse is open or closed. The larger measurement reflects an open mouse.	Keyboard support provides users with a more comfortable working environment by allowing them to adjust the height and pitch of the platform holding their computer keyboard. When not in use, the Adjustable Keyboard Support stores the keyboard under the worksurface to free vital worksurface space. Dimensions above are for the platform only. For full configuration depths, all component measurements and application suggestions, refer to the Keyboard Measurements tool on Knoll Exchange.	<i>Romeo and Juliet Keyboard Platform and Mouse Platform:</i> TPE (thermoplastic elastomer) and 40% mica reinforced polypropylene. Steel stiffener plate at the base of platform. <i>Palm rests:</i> Nylon upholstered palm rest of dual density polyurethane. <i>Mechanisms:</i> All arms are steel with a powdercoat finish. Tracks are steel with nylon glides.

pattern no.	list price
OAK-RJ-EL2-BK-(16,18,22,23,25)	\$522.
OAK-RJ-EL2-BK-PT-(16,18,22,23,25)	587.
OAK-RJ-SL2-BK-(16,18,22,23,25)	467.
OAK-RJ-SL2-BK-PT-(16,18,22,23,25)	532.
OAK-RJ-SS2-BK-(16,18,22,23,25)	623.
OAK-RJ-SS2-BK-PT-(16,18,22,23,25)	687.
<hr/>	
4B2-MP-WR	62.

Mechanism Attributes

Short easy lift arm:

- Spring assist adjustment
- Knobless height adjustment
- Soft touch knob adjusts tilt from 0° to (-)15°
- Variable height adjustment of 4.26" (up 1.06", down 3.20")
- Pivots side to side 360°
- Black textured metal finish

Short easy lift arm with pivot:

Same features as the Short easy lift arm plus the keyboard platform moves independently from arm, allowing it to parallel the worksurface as the arm is moved laterally.

Easy lift arm:

- Spring assist adjustment
- Knobless height adjustment
- Soft touch knob adjusts tilt from 0° to (-) 15°
- Variable height adjustment of 7.04"(up 2.83",down 4.21")
- Pivots side to side 360°
- Black textured finish with black soft touch knob
- Mounts on virtually any worksurface

Easy lift arm with pivot:

Same features as the Easy lift arm plus the keyboard platform moves independently from arm, allowing it to parallel the worksurface as the arm is moved laterally.

Sit/Stand arm:

- Spring assist adjustment
- Knobless height adjustment
- Soft touch knob adjusts tilt from 0° to (-) 15°
- Variable height adjustment of 11.57"(up 6.40", down 5.17")
- Pivots side to side 360°
- Black textured finish.
- Mounts on virtually any worksurface

Sit/Stand arm with pivot:

Same features as the Sit/Stand arm plus the keyboard platform moves independently from arm, allowing it to parallel the worksurface as the arm is moved laterally.

Antenna Mounting Note

In order to mount to Antenna Workspace tables, you will need to order a special adapter available through that price list. Pattern code is YAK.

For taller individuals, we recommend using a pivot solution mounted on the diagonal to maximize knee space.

Adjustable Keyboard Supports

Prospero Platform/Mechanism Configurations

product	description	type	w	d	h	wgt.
Prospero Platform 	Prospero <ul style="list-style-type: none"> • 26" x 11" x 1" • 2" with palm rest • Rigid plastic platform with steel stiffener plate for stable keying surface. • Flexible soft textured plastic overcoat. • Thin profile for extra knee room. • Included palm rest provides soothing support by displacement. • Sized to accommodate keyboard and mouse on the same plane. • No additional mousing surface required See Mechanism Attributes below	Prospero with easy lift arm	26.25"	11.50"	2"	14.5 lbs.
		Prospero with easy lift arm with pivot	26.25"	11.50"	2"	16 lbs.
		Prospero with short easy lift arm	26.25	11.50"	2"	13 lbs.
		Prospero with short easy lift arm with pivot	26.25"	11.50"	2"	14.4 lbs.
		Prospero with sit/stand arm	26.25"	11.50"	2"	16.3 lbs.
		Prospero with sit/stand arm with pivot	26.25"	11.50"	2"	17.9 lbs.

Order Code	Ordering Information	Application Notes	Construction
Example: OA-K-PR-EL2-BK (16,18,22,23,25) <hr/> OA-K-PR- Prospero platform EL2-BK mounted on an easy (16,18,22, lift mechanism 23,25)	<i>Specify:</i> 1. Pattern number 2. Track size (if applicable) <i>Track length:</i> Options are 16, 17.750, 21.625, 22.63 and 25 inches. Minimum clearance required is the length of the track plus 1/2".	Keyboard support provides users with a more comfortable working environment by allowing them to adjust the height and pitch of the platform holding their computer keyboard. When not in use, the Adjustable Keyboard Support stores the keyboard under the worksurface to free vital worksurface space. Dimensions above are for the platform only. For full configuration depths, all component measurements and application suggestions refer to the Keyboard Measurements tool on Knoll Exchange.	<i>Prospero:</i> TPE (thermoplastic elastomer) and 40% mica reinforced polypropylene undermold. Steel stiffener plate at the base of platform. <i>Mechanisms:</i> All arms are steel with a powdercoat finish. Tracks are steel with nylon glides.

pattern no.	list price
OA-K-PR-EL2-BK-(16,18,22,23,25)	\$486.
OA-K-PR-EL2-BK-PT-(16,18,22,23,25)	550.
OA-K-PR-SL2-BK-(16,18,22,23,25)	424.
OA-K-PR-SL2-BK-PT-(16,18,22,23,25)	488.
OA-K-PR-SS2-BK-(16,18,22,23,25)	560.
OA-K-PR-SS2-BK-PT-(16,18,22,23,25)	625.

Mechanism Attributes

Short Easy Lift Arm:

- Spring assist adjustment
- Knobless height adjustment
- Soft touch knob adjusts tilt from 0° to (-) 15°
- Variable height adjustment of 4.26" (up 1.06", down 3.20")
- Pivots side to side 360°
- Black textured metal finish

Short easy lift arm with pivot:

Same features as the short easy lift arm plus the keyboard platform moves independently from arm, allowing it to parallel the worksurface as the arm is moved laterally.

Easy lift arm:

- Spring assist adjustment
- Knobless height adjustment
- Soft touch knob adjusts tilt from 0° to (-) 15°
- Variable height adjustment of 7.04" (up 2.83", down 4.21")
- Pivots side to side 360°
- Black textured finish with black soft touch knob
- Mounts on virtually any worksurface

Easy lift arm with pivot:

Same features as the Easy lift arm plus the keyboard platform moves independently from arm, allowing it to parallel the worksurface as the arm is moved laterally.

Sit/Stand Arm:

- Spring assist adjustment
- Knobless height adjustment
- Soft touch knob adjusts tilt from 0° to (-) 15°
- Variable height adjustment of 11.57" (up 6.40", down 5.17")
- Pivots side to side 360°
- Black textured finish.
- Mounts on virtually any worksurface

Sit/Stand arm with pivot:

Same features as the sit/stand arm plus the keyboard platform moves independently from arm, allowing it to parallel the worksurface as the arm is moved laterally.

Adjustable Keyboard Supports

Caesar Platform/Mechanism Configurations

product	description	type	w	d	h	wgt.
Caesar Platform	Caesar <ul style="list-style-type: none"> • 18" x 9 1/2" x 1/4" • Sturdy metal platform attaches Microsoft® keyboard to mechanism. • Suitable for both Natural and Elite styles of Microsoft keyboards. See Mechanism Attributes below.	Caesar with easy lift arm	18"	25"	2 1/2"	
		Caesar with sit/stand arm	18"	25"	4 1/4"	
Caesar Plate to retrofit to existing mechanisms						

Order Code	Ordering Information	Application Notes	Construction
Example: OA-K-EL2-MS (16,18,22,23,25)	<i>Specify:</i> 1. Pattern number 2. Mouse size Track length options are 16, 17.750, 21.625, 22.63 and 25 inches.	Keyboard support provides users with a more comfortable working environment by allowing them to adjust the height and pitch of the platform holding their computer keyboard. When not in use, the Adjustable Keyboard Support stores the keyboard under the worksurface to free vital worksurface space.	<i>Caesar:</i> Black textured powdercoated steel plate <i>Mechanisms:</i> All arms are steel with a powdercoat finish. Tracks are steel with nylon glides. Microsoft® is a registered trademark of the Microsoft Corporation.
OA-K-EL2-MS (16,18,22,23,25)	Caesar platform mounted on an easy lift mechanism		

pattern no.	list price
OA-K-EL2-MS-(16,18,22,23,25)	\$385.
OA-K-SS2-MS-(16,18,22,23,25)	497.

OA-K-MS	87.
----------------	-----

Mechanism Attributes

Easy lift arm:

- Spring assist adjustment
- Knobless height adjustment
- Soft touch knob adjusts tilt from 0° to (-) 15°
- Variable height adjustment of 7.04" (up 2.83", down 4.21")
- Pivots side to side 360°
- Black textured finish with black soft touch knob
- Mounts on virtually any worksurface

Sit/Stand arm:

- Spring assist adjustment
- Knobless height adjustment
- Soft touch knob adjusts tilt from 0° to (-) 15°
- Variable height adjustment of 11.57" (up 6.40", down 5.17")
- Pivots side to side 360°
- Black textured finish.
- Mounts on virtually any worksurface

Adjustable Keyboard Supports

Act I

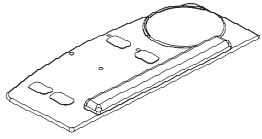
product	description	type	w	d	h	mdf	h phn	mdf wgt.	phn wgt.
	Act I keyboard platform	Act I with Easy Lift arm	26.75"	11.5"	1.44"	1.31"		10.2 lbs.	11 lbs.
	Act I keyboard platform	Act I with Easy Lift arm with Pivot	26.75"	11.5"	1.44"	1.31"		11.7 lbs.	12.5 lbs.
	Act I keyboard platform	Act I with Short Easy Lift	26.75"	11.5"	1.44"	1.31"		9.6 lbs.	10.4 lbs.
	Act I keyboard platform	Act I with Short Easy Lift and Pivot	26.75"	11.5"	1.44"	1.31"		11 lbs.	11.8 lbs.
	Act I keyboard platform	Act I with Sit/Stand arm	26.75"	11.5"	1.44"	1.31"		11.8 lbs.	12.6 lbs.
	Act I keyboard platform	Act I with Sit/Stand arm with Pivot	26.75"	11.5"	1.44"	1.31"		13.4 lbs.	14.2 lbs.

Order Code	Ordering Information	Application Notes	Construction
Example: OA-K-A1-W-EL2-BK-18	When you specify, you will be prompted to indicate either MDF (W) or phenolic (P).	<p>Keyboard support provides users with a more comfortable working environment by allowing them to adjust the height and pitch of the platform holding their computer keyboard. When not in use, the Adjustable Keyboard Support stores the keyboard under the worksurface to free vital worksurface space.</p> <p>Dimensions above are for the platform only. For full configuration depths, all component measurements and application suggestions refer to the Keyboard Measurements tool on Knoll Exchange.</p>	<p>Board is either MDF or phenolic.</p> <p>Wristrest is foam-filled vinyl on MDF board.</p> <p>Mousepad is lycra covered polyurethane.</p> <p>Mechanism: All arms are steel with a powder-coated finish. Tracks are steel with nylon glides.</p>
OAK Office automation keyboard	Track length options are 16, 17.750, 21.625, 22.63 and 25 inches.		
A1 Act I	Standard color is black.		
W Wood	Minimum clearance required is the length of the track plus 1/2".		
EL2 Easy-lift mechanism			
BK Black			
18 Track length of 18 inches			

pattern no.	list
OAK-A1-W/P-EL2-BK-(16,18,22,23,25)	\$391.
OAK-A1-W/P-EL2-BK-PT-(16,18,22,23,25)	458.
OAK-A1-W/P-SL2-BK-(16,18,22,23,25)	366.
OAK-A1-W/P-SL2-BK-PT-(16,18,22,23,25)	432.
OAK-A1-W/P-SS2-BK-(16,18,22,23,25)	491.
OAK-A1-W/P-SS2-BK-PT-(16,18,22,23,25)	557.

Mechanism Attributes

Short Easy Lift Arm:

- Spring assist adjustment
- Knobless height adjustment
- Soft touch knob adjusts tilt from 0° to (-)15°
- Variable height adjustment of 4.26"(up 1.06", down 3.20")
- Pivots side to side 360°
- Black textured metal finish

Short easy lift arm with pivot:

Same features as the short easy lift arm plus the keyboard platform moves independently from arm, allowing it to parallel the worksurface as the arm is moved laterally.

Easy Lift Arm:

- Spring assist adjustment
- Knobless height adjustment
- Soft touch knob adjusts tilt from 0° to (-) 15°
- Variable height adjustment of 7.04"(up 2.83",down 4.21")
- Pivots side to side 360°
- Black textured finish with Black Soft touch knob.
- Mounts on virtually any worksurface

Easy lift arm with pivot:

Same features as the easy lift arm plus the keyboard platform moves independently from arm, allowing it to parallel the worksurface as the arm is moved laterally.

Sit/Stand Arm:

- Spring assist adjustment
- Knobless height adjustment
- Sort touch knob adjusts tilt from 0° to (-) 15°
- Variable height adjustment of 11.57"(up 6.40", down 5.17")
- Pivots side to side 360°
- Black textured finish.
- Mounts on virtually any worksurface

Sit/Stand arm with pivot:

Same features as the sit/stand arm plus the keyboard platform moves independently from arm, allowing it to parallel the worksurface as the arm is moved laterally.

Adjustable Keyboard Supports

Act II

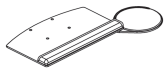
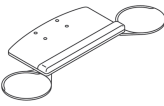
product	description	type	w	d	h	wgt.
 	Act II keyboard platform	Act II with Easy Lift arm	19"- 27.25"	11.50"- 14.75"	1.69"	10.2 lbs.
	Act II keyboard platform	Act II with Easy Lift arm with Pivot	19"- 27.25"	11.50"- 14.75"	1.69"	11.7 lbs.
	Act II keyboard platform	Act II with Easy Lift arm with two mouse pads with Pivot	19"- 35.5"	11.50"- 14.75"	1.69"	12.3 lbs.
	Act II keyboard platform	Act II with Easy Lift arm with two mouse pads	19"- 35.5"	11.50"- 14.75"	1.69"	10.8 lbs.
	Act II keyboard platform	Act II with Short Easy Lift arm	19"- 27.25"	11.50"- 14.75"	1.69"	9.6 lbs.
	Act II keyboard platform	Act II with Short Easy Lift arm with Pivot	19"- 27.25"	11.50"- 14.75"	1.69"	11 lbs.
	Act II keyboard platform	Act II with Short Easy Lift arm with two mouse pads	19"- 35.5"	11.50"- 14.75"	1.69"	10.2 lbs.
	Act II keyboard platform	Act II with Short Easy Lift arm with two mouse pads with Pivot	19"- 35.5"	11.50"- 14.75"	1.69"	11.6 lbs.
	Act II keyboard platform	Act II with Sit/Stand arm	19"- 27.25"	11.50"- 14.75"	1.69"	11.8 lbs.
	Act II keyboard platform	Act II with Sit/Stand arm with Pivot	19"- 27.25"	11.50"- 14.75"	1.69"	13.4 lbs.
	Act II keyboard platform	Act II with Sit/Stand arm with two mouse pads	19"- 35.5"	11.50"- 14.75"	1.69"	12.4 lbs.
	Act II keyboard platform	Act II with Sit/Stand arm with two mouse pads with Pivot	19"- 35.5"	11.50"- 14.75"	1.69"	14 lbs.

Order Code	Ordering Information	Application Notes	Construction
Example: OAK-A2-P-1-EL2-BK-(16,18,22,23,25)	Track length options are 16, 17.750, 21.625, 22.63 and 25 inches.	Keyboard support provides users with a more comfortable working environment by allowing them to adjust the height and pitch of the platform holding their computer keyboard. When not in use, the Adjustable Keyboard Support stores the keyboard under the worksurface to free vital worksurface space.	Board is phenolic. Wristrest is foam-filled vinyl on MDF board. Mousepad is lycra covered polyurethane. Mechanism: All arms are steel with a powder-coated finish. Tracks are steel with nylon glides.
OAK Office automation keyboard	Standard color is black.		
A2 Act II	Minimum clearance required is the length of the track plus 1/2".	Dimensions above are for the platform only. For full configuration depths, all component measurements and application suggestions refer to the Keyboard Measurements tool on Knoll Exchange.	
P phenolic (standard)			
1 Mouse pad comes standard on right side			
EL2 Easy-lift mechanism			
BK Black			
18 Track length of 18 inches			

pattern no.	list
OAK-A2-P-1-EL2-BK-(16,18,22,23,25)	\$424.
OAK-A2-P-1-EL2-BK-PT-(16,18,22,23,25)	488.
OAK-A2-P-2-EL2-BK-PT-(16,18,22,23,25)	523.
OAK-A2-P-2-EL2-BK-(16,18,22,23,25)	468.
OAK-A2-P-1-SL2-BK-(16,18,22,23,25)	398.
OAK-A2-P-1-SL2-BK-PT-(16,18,22,23,25)	463.
OAK-A2-P-2-SL2-BK-(16,18,22,23,25)	462.
OAK-A2-P-2-SL2-BK-PT-(16,18,22,23,25)	517.
OAK-A2-P-1-SS2-BK-(16,18,22,23,25)	522.
OAK-A2-P-1-SS2-BK-PT-(16,18,22,23,25)	587.
OAK-A2-P-2-SS2-BK-(16,18,22,23,25)	571.
OAK-A2-P-2-SS2-BK-PT-(16,18,22,23,25)	627.

Mechanism Attributes

Short Easy Lift Arm:

- Spring assist adjustment
- Knobless height adjustment
- Soft touch knob adjusts tilt from 0° to (-) 15°
- Variable height adjustment of 4.26"(up 1.06", down 3.20")
- Pivots side to side 360°
- Black textured metal finish

Short easy lift arm with pivot:

Same features as the Short easy lift arm plus the keyboard platform moves independently from arm, allowing it to parallel the worksurface as the arm is moved laterally.

Easy Lift Arm:

- Spring assist adjustment
- Knobless height adjustment
- Soft touch knob adjusts tilt from 0° to (-) 15°
- Variable height adjustment of 7.04"(up 2.83", down 4.21")
- Pivots side to side 360°
- Black textured finish with Black soft touch knob
- Mounts on virtually any worksurface

Easy lift arm with pivot:

Same features as the easy lift arm plus the keyboard platform moves independently from arm, allowing it to parallel the worksurface as the arm is moved laterally.

Sit/Stand Arm:



- Spring assist adjustment
- Knobless height adjustment
- Soft touch knob adjusts tilt from 0° to (-) 15°
- Variable height adjustment of 11.57"(up 6.40", down 5.17")
- Pivots side to side 360°
- Black textured finish.
- Mounts on virtually any worksurface

Sit/Stand arm with pivot:

Same features as the Sit/Stand arm plus the keyboard platform moves independently from arm, allowing it to parallel the worksurface as the arm is moved laterally.

Adjustable Keyboard Supports

Mousing Solutions

product	description	type	w	d	h	wgt.
Juliet Mouse Pad 	<ul style="list-style-type: none"> • Teardrop shaped mousing surface swivels under the keyboard platform. • Attaches to the underside of the platform. • Soft plastic overcoat keeps the mouse from sliding during adjustments. 		11"	10"	1 1/2"	1 lb. 3 oz.
		for use with Caesar platform	11"	10"	1 1/2"	1 lb. 3 oz.
Juliet Palm Rest 	<ul style="list-style-type: none"> • Palm rest to retrofit to existing mouse pad. • Palm rest provides soothing support. 		6"	2 1/4"	1/2"	1 oz.
Over ten-key mouse pad 	<ul style="list-style-type: none"> • Mouse flips over ten-keypad. • Tension fit allows users to adjust tilt • Generous size pad for easy mousing • For use with Romeo platform only (platforms manufactured from 2002 on) 	for use with Romeo only				

Order Code

Example: **4B2-MP**
4B2-MP Juliet mouse pad

Ordering Information

Specify:
 1. Pattern number
 Not all mousing solutions are appropriate with all platforms.

Construction

Worksurface mounted surf mousepad:
 Black painted steel mechanism mounted with hard surface backed surf mouse pad.



Juliet mouse pad:
 TPE (a thermoplastic elastomer) overmold with 40% mica reinforced polypropylene undermold.

Juliet palm rest:
 Nylon upholstered palm rest is dual density polyurethane. The gel beneath the fabric, nominally .65", is formulated to provide soothing support.

pattern no.	list price
4B2-MP	\$40.
4B2-MP-MS	51.
4B2-WR	23.
OAK-OTK-MP	44.

Freestanding Surf® Ergonomic Accessories

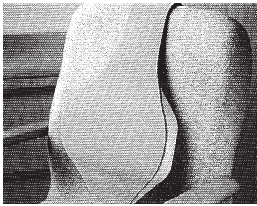
by Ross Lovegrove & Stephen Peart

product	description	type	w	d	h	wgt.									
 <p>Wrist Rest</p>	<ul style="list-style-type: none"> • Soft, biomorphic form reduces strain on wrist. • Long, radial shape with single straight edge ensures a tightfit with standard size keyboards. • Gel pad for greater use comfort. 		19"	4 1/8"	1"	7 ozs.									
 <p>Lumbar Support</p>	<ul style="list-style-type: none"> • Self-adjusts over any seat back. • Heat and pressure reactive foam responds to individual user. • Support returns to original form within 10 seconds after use. • Neoprene nylon outer skin allows body to breathe comfortably. 		12 1/2"	30 3/4"	2 3/8"	1 lbs. 10 ozs.									
 <p>Surf Board VDT Corner</p>	<ul style="list-style-type: none"> • Fits any worksurface thickness or edge profile. • Creates generous 24" wide VDT corner, 14" from worksurface corner. • Can be adjusted to any angle, or removed when not needed. • Integral non-handed mouse pad. • Felt back and rubber bumpers protect worksurface. 	<table border="1"> <tr> <td>Metallic finish</td> <td>41 1/2"</td> <td>16 1/2"</td> <td>1"</td> <td>14 lbs.</td> </tr> <tr> <td>Soft touch finish</td> <td>41 1/2"</td> <td>16 1/2"</td> <td>1"</td> <td>14 lbs.</td> </tr> </table>	Metallic finish	41 1/2"	16 1/2"	1"	14 lbs.	Soft touch finish	41 1/2"	16 1/2"	1"	14 lbs.			
Metallic finish	41 1/2"	16 1/2"	1"	14 lbs.											
Soft touch finish	41 1/2"	16 1/2"	1"	14 lbs.											

Order Code	Ordering Information	Ergonomic Value
<p>Example: SF-SB-E</p> <p>SF-SB Metallic finish Surf Board VDT corner</p> <p>E Soft grey</p>	<p><i>Specify:</i></p> <ol style="list-style-type: none"> 1. Pattern number 2. Finish <p><i>Neoprene nylon finishes:</i> Black (BK)</p> <p><i>Surf Board painted finishes:</i> Soft Grey (E) Medium Metallic Grey (J) Soft Touch Light Grey (GS) Soft Touch Black (BS)</p>	<p>The Surf Collection wrist rest, mouse pad, and lumbar support play a critical role in workplace ergonomics. Proper use of these pieces helps users maintain the body neutral position, reducing harmful strain on muscles and joints.</p> <p>The collection's design advantage is in its simplicity. These accessories are extraordinarily versatile and flexible, responding to the individual needs of the specific user, unlike over-engineered mechanical pieces.</p> <p>Each piece in the Surf Collection is a "footprint form," derived from natural ergonomic movements. No sharp edges or angles are used. As a result, the accessories can be approached by the user from any direction. The Surf soft, biomorphic shapes echo the curves and contours of the human body.</p> <p><i>Lumbar support note:</i> Back problems are the second leading cause of lost work time after the common cold. Most back rests utilize rigid, unyielding materials, ignoring the diversity of human form and movement.</p>

pattern no.	list price
SF-WR-FS-(BK)-G	\$91.
SF-LS	250.
SF-SB-(E, J)	272.
SF-SB-(GS, BS)	343.

General Notes

The Surf Lumbar Support rests loosely over the chair like a saddle bag, held in place by a counter balance weight. The piece is easily adjusted up or down, to the preference of the user.

The supports high performance patented foam molds itself to both the user and the chair back. As the user moves throughout the workday, the foam responds in kind, continuously resculpting itself around the user's body. When body pressure is removed, the lumbar support returns to its original form within 10 seconds, ready for the next user.

Construction

Surf Board:
Rigid steel plate with 1" thick rolled front detail. Black rubber bumpers and non-scuffing felt back.

Wrist rest and mouse pad:
Nylon upholstered dual-density polyurethane. Gel beneath fabric, nominally .65", is formulated to provide soothing support by displacement.

Lumbar support:
High memory, heat-reactive patented polyurethane foam developed for high performance use in military fighter pilot seats. Covered with wear-resistant, closed cell Neoprene and a bright colored, breathable nylon outer skin. Die-cast zinc counter-balance weight.

All items manufactured in the United States.

Design Awards

First place, Interior Design Product Award, ASID, 1994. High Design Quality Red Dot Award, Design Zentrum, Germany, 1994.

Lumbar support:
Honorable Mention, Furniture, *ID Magazine* Annual Design Review, 1994.

Surf Board:
Best of Category Award, Consumer Products, *ID Magazine* Annual Design Review, 1994.

Freestanding Ergonomic Accessories

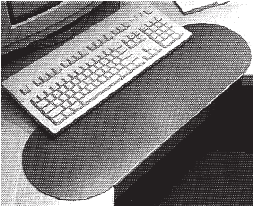
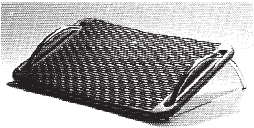
product	description	type	w	d	h	wgt.
VDT Sleeve 	<ul style="list-style-type: none"> • Racetrack-shaped sleeve slides over worksurface to create VDT corner. • Creates 17 3/8" wide VDT corner, 9" from worksurface corner. • Can be adjusted to any angle, or removed when not needed. • Heavy-gauge steel with felt backing to prevent scuffing. • 1 1/4", 1 3/4" and 2 1/2" worksurface thicknesses. • 1/4" screw holes on underside for optional attachment to worksurface. • Available in two metallic and two soft-touch finishes. 	Metallic finish	26 3/4"	9 1/8"	1 1/4"-2 1/2"	3 lbs.
		Soft touch finish	26 3/4"	9 1/8"	1 1/4"-2 1/2"	3 lbs.
Adjustable Foot Rest 	<ul style="list-style-type: none"> • Self-adjusts +30°/-30°. • Durable, ribbed rubber platform. 		17 1/8"	12"	3 7/8"	7 lbs. 14 ozs.

Order Code	Ordering Information	Custom Options	Construction
Example: OA-SLV-A-E	<i>Specify:</i>	Custom colors available upon sample chip approval. Contact your Knoll sales representative or Customer Service for complete pricing information.	<i>VDT sleeve:</i> Heavy-gauge steel in painted finish. Felt backing protects worksurface. Manufactured in the United States.
OA-SLV VDT sleeve	<ol style="list-style-type: none"> 1. Pattern number 2. Thickness (VDT sleeve only) 3. Finish 		
A 1 1/4" sleeve	<i>VDT sleeve worksurface thicknesses:</i> 1 1/4" (A): Equity, Morrison, Reff 1 3/4" (B): Morrison, Reff 2 1/2" (C): Reff		
E Soft grey finish	<i>VDT sleeve finishes:</i> Soft Grey (E) Medium Metallic Grey (J) Soft Touch Light Grey (GS) Soft Touch Black (BS)		

pattern no.	list price
OA-SLV(A,B,C)-(E, J)	\$193.
OA-SLV(A,B,C)-(GS, BS)	250.

OA-FR-BK	209.
-----------------	------

Adjustable foot rest:
Black rubber platform. Polished
chrome frame.
Manufactured in Sweden.

VDT Sleeve

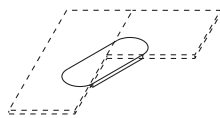

Worksurface Support

Adjustable CPU Holders

product	description	w, min	w, max	d, min	d, max	h, min	h, max	wgt.
Adjustable vertical metal CPU holder 	<ul style="list-style-type: none"> • Adjusts to hold equipment 6" to 10" wide by 14" to 24" high • Hangs vertically from worksurface to maximize knee space. • Slides on track under worksurface for easy CPU access. • Ventilation holes on sides. • Has a weight capacity of 60 pounds. • Mounts on virtually any worksurface. • Swivel is 360°. • Track length is 17 3/4". 	7"	11"	18"	18"	15"	25"	24 lbs.

Adjustable vertical sling CPU holder 	<ul style="list-style-type: none"> • Adjusts to hold equipment 6" to 10" wide by 14" to 24" high. • Sling made of woven vinyl coated polyester for flexibility and ventilation. • Hangs vertically from worksurface to maximize knee space under surface. • Slides on track under worksurface for easy CPU access. • Has a weight capacity of 60 pounds. • Swivel is 360°. • Track length is 17 3/4". 	7"	11"	18"	18"	15"	25"	13 lbs.
--	--	----	-----	-----	-----	-----	-----	---------

Order Code	Ordering Information	Installation Notes	Construction
Example: OA-CPU-SLNG-V	<i>Specify:</i>	CPU holders come standard with a 17 3/4" long track. They mount on work surfaces 18 1/2" or deeper.	<i>Metal CPU holder:</i> Rigid 16-gauge painted steel construction. Black paint finish. Black plastic pull.
OA-CPU CPU holder	1. Pattern number		
SLNG Sling style			
V Vertical mounting option			
			<i>Sling CPU holder:</i> Black painted steel mounting mechanism. Woven vinyl coated polyester sling.

pattern no.

list price

OA-CPU-MTL-V

\$502.

OA-CPU-SLNG-V

306.

Custom Options

Longer and shorter track lengths are available. Contact Customer Service for pricing information.

BackPack® Universal Storage Drawers

by Robert Reuter

suspended files

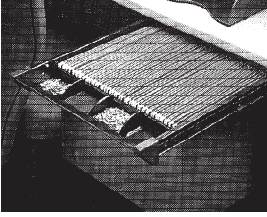
product	description	w	d	back/front h	wgt.
Standard Suspended File 	<ul style="list-style-type: none"> • Full width, 4³/₄" d 1³/₄"H pencil trough. • Two removable plastic organizing trays. • Generous 16"w 12"D filing space. • Accepts 16" side-to-side hanging letter files. • Accepts 12" front-to-back hanging legal or European A-4 and foolscap files. • Drawer contains 107% capacity of standard file drawer. • Optional lock. • Black painted steel construction with full extension ball-bearing slides. 	17"	18"	10 ¹ / ₂ "	16 lbs. 4 ozs.

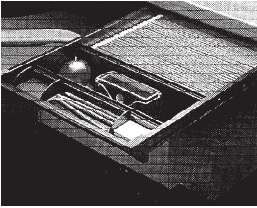
Deep Suspended File 	<ul style="list-style-type: none"> • Full width, 4³/₄" d 1³/₄"H pencil trough. • Two removable plastic organizing trays. • Full width, 5¹/₂" d 6"H intermediate compartment holds computer disks, desk supplies and personal items. • Generous 16"w 12"D filing space. • Accepts 16" side-to-side hanging letter files. • Accepts 12" front-to-back hanging legal or European A-4 and foolscap files. • Drawer contains 107% capacity of standard file drawer. • Optional lock and mouse pad. • Black painted steel construction with full extension ball-bearing slides. 	17"	24"	10 ¹ / ₂ "	18 lbs.
---	--	-----	-----	----------------------------------	---------

Order Code

Example: BP-SSF
BP-SSF Standard suspended file

Ordering Information

Specify:
 1. Pattern number
 2. Lock option
Lock option:
 Lock attaches to slides in field.
 Removable for use elsewhere.

Application Notes

BackPack drawers can be used with virtually any Knoll or other wood worksurface.

BackPack storage drawers attach to the underside of wood worksurfaces at any location. In most cases, the drawers may be mounted flush to side panels. When supporting brackets extend further than 2¹/₂" from the side panel, a slight reveal will occur. Mounting hardware and template included.

For wire management needs, the minimum depth worksurface for standard depth drawers is 24"; minimum depth for deep drawers is 30". When no wire management is necessary, the Standard Suspended File may be used on an 18" worksurface and the Deep Suspended File may be used on a 24" worksurface.

pattern no.

list price

BP-SSF

\$461.

BP-DSF

509.

Construction

Knee clearance:
In order to maximize filing capacity, the Standard and Deep Suspended Files do not provide adequate knee clearance. For center worksurface applications, specify the Keyboard or Center File Drawers.

Sturdy, 20-gauge painted steel with full-extension ball-bearing metal slides. Foam surface on mouse pad.

Die-cast zinc lock painted black.

Manufactured in the United States.

Design Awards

ROSCOE Award, *Interior Design Magazine*, 1994. Honorable Mention, Furniture, *ID Magazine* Annual Design Review, 1994.

BackPack® Universal Storage Drawers

by Robert Reuter

suspended files

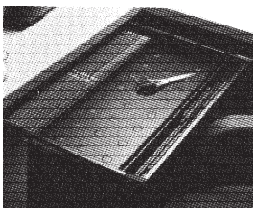
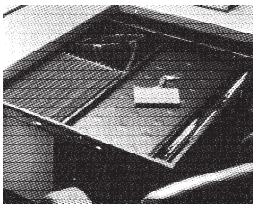
product	description	w	d	back/front h	wgt.
Standard Center File 	<ul style="list-style-type: none"> Includes 26"w 14"d 2"H storage for desk and personal items. Full width pencil trough and rear filing area. 3 1/2" deep filing area accepts 2 rows of front-to-back letter filing, or one row of front-to-back legal or European A-4/foolscap filing plus space for handbag. Drawer contains 57% capacity of standard file drawer. Optional lock. Black painted steel construction with full extension ball-bearing slides. 	27"	18"	11 1/8"/2"	16 lbs. 6 ozs.
Deep Center File 	<ul style="list-style-type: none"> Includes 26"w 14"d 2"H storage for desk and personal items Full width pencil trough and rear filing area. 9 1/2" deep filing area accepts 2 rows of front-to-back letter filing, or one row of front-to-back legal or European/foolscap filing plus space for handbag. Drawer contains 94% capacity of standard file drawer. Optional lock. Black painted steel construction with full extension ball-bearing slides. 	17" 27"	24" 24"	11 1/8"/2" 11 1/8"/2"	20 lbs. 13 ozs.
Optional Lock	<ul style="list-style-type: none"> Non-handed. 	1 1/4"	2 1/4"	1 1/4"	5 ozs.

Order Code

Example: BP-SSF
BP-SSF Standard suspended file

Ordering Information

Specify:
 1. Pattern number
 2. Lock option
Lock option:
 Lock attaches to slides in field.
 Removable for use elsewhere.

Application Notes

BackPack drawers can be used with virtually any Knoll or other wood worksurface.

BackPack storage drawers attach to the underside of wood worksurfaces at any location. In most cases, the drawers may be mounted flush to side panels. When supporting brackets extend further than 2 1/2" from the side panel, a slight reveal will occur. Mounting hardware and template included.

For wire management needs, the minimum depth worksurface for standard depth drawers is 24"; minimum depth for deep drawers is 30". When no wire management is necessary, the Standard Suspended File may be used on an 18" worksurface and the Deep Suspended File may be used on a 24" worksurface.

pattern no.	list price
BP-SCF	\$515.



BP-DCF-17	467.
BP-DCF	563.

BP-L	59.
-------------	-----

	Construction	Design Awards
<p><i>Knee clearance:</i> In order to maximize filing capacity, the Standard and Deep Suspended Files do not provide adequate knee clearance. For center worksurface applications, specify the Keyboard or Center File Drawers.</p>	<p>Sturdy, 20-gauge painted steel with full-extension ball-bearing metal slides. Foam surface on mouse pad.</p> <p>Die-cast zinc lock painted black.</p> <p>Manufactured in the United States.</p>	<p>ROSCOE Award, <i>Interior Design Magazine</i>, 1994. Honorable Mention, Furniture, <i>ID Magazine</i> Annual Design Review, 1994.</p>

BackPack® Universal Storage Drawers

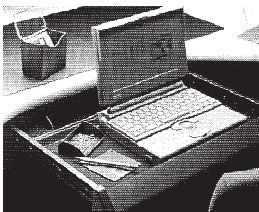
by Robert Reuter
keyboard drawers

product	description	w	d	back/front h	wgt.
 <p>Narrow Keyboard Drawer</p>	<ul style="list-style-type: none"> Accommodates virtually any standard keyboard or laptop computer. Full width, 2 3/4" d 3/4" H integral palm rest. 21 1/4" w 9 3/8" D keying/ mousing space. Full width rear pencil trough and 2 removable plastic organizing trays. Thin profile maximizes knee clearance under drawer. Optional lock. Black painted steel construction. Full extension ball-bearing slides, with click-stop in half open position for steady use. 	22 1/2"	18"	2"	8 lbs. 12 ozs.
 <p>Wide Keyboard Drawer with Mouse Pad</p>	<ul style="list-style-type: none"> Accommodates virtually any standard keyboard or laptop computer. Full width, 2 3/4" d 3/4" H integral palm rest. Non-handed mouse pad, black foam with square corners 8" x 9". 27 1/4" w 9 3/8" D keying/mousing space. Full width rear pencil trough and 4 removable plastic organizing trays. Thin profile maximizes knee clearance under drawer. Optional lock. Black painted steel construction. Full extension ball-bearing slides, with click-stop in half open position for steady use. 	25" 28 1/2"	18"	2"	10 lbs. 12 ozs.
 <p>Keyboard/Filing Drawer</p>	<ul style="list-style-type: none"> Accommodates virtually any standard keyboard or laptop computer. Full width, 2 3/4" d 3/4" H integral palm rest. Non-handed mouse pad, black foam with square corners 8" x 9". 27 1/4" w 9 3/8" D keying/mousing space. 4 removable plastic organizing trays. 26 1/16" w 8" D filing space accepts 2 rows of front-to-back letter filing, or one row of front-to-back legal or European A4/foolscap filing. Optional lock. Black painted steel construction. Full extension ball-bearing slides, with click-stop in half open position for steady use. 	27 1/4"	24"	11 1/2"/2"	20 lbs. 7 ozs.
Optional Lock	<ul style="list-style-type: none"> Non-handed. 	1 1/4"	2 1/4"	1 1/4"	5 ozs.

Order Code	Ordering Information	Application Notes
Example: BP-NKD-BK BP-NKD Narrow keyboard drawer BK Black palm rest	<i>Specify:</i> 1. Pattern number 2. Wrist rest finish 3. Lock option <i>Palm rest nylon finishes:</i> Black (BK)	Call Customer Service for availability and minimum requirement. <i>Lock option:</i> Lock attaches to slides in field. Removable for use elsewhere.

pattern no.	list price
BP-NKD	\$409.

BP-WKD-25	425.
BP-WKD	440.

BP-KFD	589.
---------------	-------------

BP-L	59.
-------------	------------



Storage

	Construction	Design Awards
<p>BackPack storage drawers attach 2³/₈" below the underside of wood worksurfaces at any location. Mounting hardware and template included.</p> <p>For wire management needs, the minimum depth worksurface for the Narrow and Wide keyboard drawers is 24", and 30" for the Keyboard/Filing Drawer. When no wire management is necessary, both the Narrow and Wide Keyboard Drawers may be used on an 18" deep worksurface and the Keyboard/Filing Drawer may be used on a 24" deep worksurface.</p>	<p>Durable 20-gauge steel painted black. Full-extension ball-bearing metal slides with click-stop in half-open position. Nylon-sheathed foam palm rest.</p> <p>Die-cast zinc lock painted black.</p> <p>Manufactured in the United States.</p>	<p>ROSCOE Award, <i>Interior Design Magazine</i>, 1994. Honorable Mention, Furniture, <i>ID Magazine Annual Design Review</i>, 1994.</p>

BackPack® Universal Storage Drawers

by Robert Reuter

pencil and top drawers

product	description	w	d	back/front h	wgt.
Pencil Drawer 	<ul style="list-style-type: none"> • 23" w 11 1/2" D paper storage. • Full width pencil trough. • Two removable plastic organizing trays. • Black painted steel construction with full extension ball-bearing slides. • Optional lock. 	24"	17 5/8"	2"	
Top Drawer 	<ul style="list-style-type: none"> • Full width, 4 3/4" d 1 3/4" H pencil trough. • Two removable plastic organizing trays. • 13" w 10" D filing space. • Black painted steel construction with full extension ball-bearing slides. • Optional lock. 	14 1/4"	18"	10 1/2"	
Optional Lock	<ul style="list-style-type: none"> • Non-handed. 	1 1/4"	2 1/4"	1 1/4"	5 ozs.

Order Code

Example: BP-PD

BP-PD Pencil drawer

BP-L Optional lock

Ordering Information

Specify:

1. Pattern number
2. Lock option

Lock option:

Lock attaches to slides in field.
Removable for use elsewhere.

Application Notes

BackPack drawers can be used with virtually any Knoll or other wood worksurface.

BackPack storage drawers attach to the underside of wood worksurfaces at any location. Mounting hardware and template included.

For wire management needs, the minimum depth worksurface for standard depth drawers is 24"; minimum depth for deep drawers is 30". When no wire management is necessary, the Standard Center File may be used on an 18" worksurface and the Deep Center File may be used on a 24" worksurface.

pattern no.	list price
BP-PD	\$198.
BP-TOP-C	419.
BP-L	59.

Construction

Sturdy 20-gauge painted steel with full extension ball-bearing metal slides.

Die-cast zinc lock painted black.

BackPack® Top Drawer
Manufactured in the United States.

BackPack® Pencil Drawer
manufactured in Canada.

Design Awards

ROSCOE Award, *Interior Design Magazine*, 1994. Honorable Mention, Furniture, *ID Magazine* Annual Design Review, 1994.

Universal Pencil Drawer

by Brooks Rorke

product	description	w	d	back/front h	wgt.
Universal Pencil Drawer 	<ul style="list-style-type: none"> • 7 roomy compartments. • Large rear compartment holds flat, legal files, ruler, etc. • Slanted card compartment holds index cards, Post-It™ Notes or business cards. • Middle compartment holds White-Out™ bottle or change. • Front middle compartment holds stapler, pens, scissors, etc. • Other compartments holds calculator, clips, pins, etc. • Available in textured matte black plastic. • Three-quarters extension, ball bearing metal slides with smooth, silent movement. 	16 1/2"	22 3/4"	1 3/4"	5 lbs. 12 ozs.

Order Code	Ordering Information	Application Notes	Construction
Example: ORCH-PD-A ORCH-PD-A Pencil drawer	<i>Specify:</i> 1. Pattern number	Universal Pencil Drawer can be used with virtually any Knoll or competitor wood worksurface. Minimum depth worksurface for drawer is 24". On freestanding Morrison Network systems, a 30" deep worksurface is required.	<i>Universal pencil drawer:</i> Durable vacuum-formed ABS plastic drawer in a matte black, textured finish. Three-quarter extension, ball bearing metal slides with smooth, silent movement. Manufactured in the United States.

pattern no.

list price



ORCH-PD-A

\$197.

Storage

Universal Marker Boards

by Bruce Hannah & Ayse Birsal

product	description	w	d	h	wt.
Marker Board 	<ul style="list-style-type: none"> • 1/2" wide anodized aluminum frame with white surface. • Marker Tray option specified separately. • Mountable on load bar, panel, wall or top cap. • Load bar-mounted brackets included in list price, but specified separately (see Mounting Options below). 	24"	5/8"	18"	5 lbs. 2 ozs.
		30"	5/8"	18"	8 lbs. 10 ozs.
		30"	5/8"	24"	11 lbs. 7 ozs.
		36"	5/8"	18"	10 lbs. 5 ozs.
		36"	5/8"	24"	13 lbs. 12 ozs.
		42"	5/8"	24"	16 lbs. 1 oz.
		42"	5/8"	30"	20 lbs. 1 oz.
		48"	5/8"	30"	22 lbs. 15 ozs.
Marker Board Equity panel-mount application 	<ul style="list-style-type: none"> • 1/2" wide anodized aluminum frame with white surface. • Marker Tray option specified separately. • Mountable on load bar, panel, wall or top cap. • Load bar-mounted brackets included in list price, but specified separately (see Mounting Options below). 	22 1/4"	5/8"	18"	5 lbs. 2 ozs.
		28 1/4"	5/8"	18"	8 lbs. 10 ozs.
		28 1/4"	5/8"	24"	11 lbs. 7 ozs.
		34 1/4"	5/8"	18"	10 lbs. 5 ozs.
		34 1/4"	5/8"	24"	13 lbs. 12 ozs.
		40 1/4"	5/8"	24"	16 lbs. 1 oz.
		40 1/4"	5/8"	30"	20 lbs. 1 oz.
		46 1/4"	5/8"	30"	22 lbs. 15 ozs.
Marker Tray 	<ul style="list-style-type: none"> • Anodized aluminum snap-fit tray for Marker Board markers and erasers. 	17"	1 1/4"		5 ozs.

Mounting Options	Load Bar-Mounted Brackets. Set of 2.
	Panel-Mounted Brackets (Generic deep)
	Panel-Mounted Brackets (Generic shallow)
	Panel-Mounted Brackets for Dividends
	Panel-Mounted Brackets for Equity
	Panel-Mounted Brackets for Morrison
	Panel-Mounted Brackets for Reff
	Top Cap-Mounted Brackets (Dividends only)
	Top Cap-Mounted Brackets (Equity only)
	Top Cap-Mounted Brackets (Reff only)
	Top Cap-Mounted Brackets. Set of 2. (Morrison only)
	Wall-Mounted Brackets. Set of 2.

* No charge when ordered with Marker or Tack Board

Order Code	Ordering Information
Example: OR-WB-24-18-BK OR-WB-PM-M OR-WB-TR-BK	<i>Specify:</i> 1. Pattern number 2. Frame finish 3. Mounting option 4. System suffix (panel and top cap-mounted only) 5. Marker Tray (optional) 6. Marker Tray finish
OR-WB-24-18 24" x 18" Marker board	<i>Mounting options:</i> Rail-Mounted: Standard option. Includes load bar clip and adhesive-backed rubber bumper to protect panel fabric and prevent deflection. <i>Panel-Mounted:</i> To ensure rigidity, specify two sets and brackets
BK Black frame	
OR-WB-PM Panel-mounted	
M Morrison Network	
OR-WB-TR Marker tray	
BK Black	
	<i>Wall-Mounted:</i> Specify pattern number. <i>Top cap-mounted:</i> Equity and Morrison Network Systems brackets available. Use bracket pattern numbers listed below: Equity E Morrison Network M
	* *Please consult Customer Service for lead times.

pattern no.	list price
OR-WB-24-18	\$196.
OR-WB-30-18	293.
OR-WB-30-24	330.
OR-WB-36-18	413.
OR-WB-36-24	459.
OR-WB-42-24	533.
OR-WB-42-30	594.
OR-WB-48-30	684.
OR-WB-22-18-E	196.
OR-WB-28-18-E	293.
OR-WB-28-24-E	330.
OR-WB-34-18-E	413.
OR-WB-34-24-E	459.
OR-WB-40-24-E	533.
OR-WB-40-30-E	594.
OR-WB-46-30-E	684.
OR-WB-TR	52.
OR-WB-LBZ *	7.
OR-WB-PM-B	21.
OR-WB-PM-D	21.
OR-WB-PM-DV	45.
OR-WB-PM-E	32.
OR-WB-PM-M	32.
OR-WB-PM-R	53.
OR-WB-TCM-DV *	7.
OR-WB-TCM-E *	7.
OR-WB-TCM-R *	7.
OR-WB-TCM-M *	7.
OR-WB-WM	35.

Equity application note:

For all Equity panel-mounted applications, add "E" to end of base pattern number.

Note:

If your system is not listed, contact your KnollExtra representative or Customer Service for appropriate panel-mounted bracket to specify.

Custom Options

Other writing surface and custom frame colors available. Custom frame sizes available up to 72"W x 48"D in size. High performance porcelain-covered steel market board also available. 25 unit minimum per line item on all customs. Contact your Knoll sales representative or Customer Service for pricing information.

Construction

Satin anodized aluminum frame (can be powder coated black). Porcelain coating on cold rolled steel laminated to corrugated and hardboard with a Mylar backing. All Universal Marker Boards are magnetized.

Manufactured in the United States.

Universal Fabric Boards

Standard Sizes

product	description	w	d	h	textile fabric yards
Fabric Boards 	<ul style="list-style-type: none"> Standard fabric board has 1/2" thick mineral board construction with squared corner. Rounded corner or radiused edge, available at upcharge. Panel or wall mounting options. 	24"	1/2"	14"	.66
		24"	1/2"	16"	.66
		24"	1/2"	18"	.66
		24"	1/2"	20"	.75
		24"	1/2"	24"	1
		30"	1/2"	14"	.66
		30"	1/2"	16"	.66
		30"	1/2"	18"	.66
		30"	1/2"	20"	.75
		30"	1/2"	24"	1
		36"	1/2"	14"	.66
		36"	1/2"	16"	.66
		36"	1/2"	18"	.66
		36"	1/2"	20"	.75
		36"	1/2"	24"	1
		42"	1/2"	14"	.66
42"	1/2"	16"	.66		

Order Code	Ordering Information	Mounting Options
Example: F-24-16-R2-A-30-W388/1 F-WM-F <hr/> F-24-16 24" x 16" Fabric board <hr/> R2 Rounded corner/radius edge detail <hr/> A Thickness <hr/> 30 Fabric grade 30 <hr/> W388/1 Freehand, Glacier <hr/> F-WM-F Wall-mounted, flush	<p><i>Specify:</i></p> <ol style="list-style-type: none"> Pattern number Corner/edge detail Thickness Fabric grade Fabric selection Mounting option pattern number System suffix (panel-mounted option only) <p><i>Equity application note:</i> For all Equity panel-mounted applications, add "E" to end of base pattern number.</p> <p><i>Corner/edge detail:</i> Squared corner/rectilinear edge (S1) Squared corner/radiused edge (S2) Rounded corner/radiused edge (R2)</p> <p>Standard fabric board has squared corner and rectilinear edge details. See page 136 for edge upcharge.</p> <p>Standard fabric board has 1/2" thick mineral board.</p>	<p><i>Panel-mounted brackets:</i> Panel-mounted brackets are included in the list price but must be specified separately. To specify appropriate panel-mounted bracket, consult the KnollExtra Bracket Chart on page 12.</p> <p>Panel mounted bracket size must match height of fabric board.</p> <p><i>Wall-mounted options:</i> Wall-mounted applications must be specified as flush (F-WM-F) or reveal (F-WM-R). Both options are appropriate for any smooth, clean surface. Flush wall-mount option utilizes velcro squares.</p> <p>Reveal wall-mount option provides 1/2" clearance for wire management behind fabric board. Fabric boards mount with 4 brackets onto 2 black painted wall rails that screw into wall to ensure rigidity. For other mounting options and pricing, contact Customer Service.</p> <p><i>Under overhead specification note:</i> For application under a system overhead, provide clearance distance between the worksurface and the bottom of the overhead or task light.</p> <p><i>Side by side fabric board specification note:</i> Please note if a panel-mounted fabric board will be used contiguous to another fabric board, drawings are required and there will be an up-charge.</p> <p><i>60" wide boards in fabric grades 50, 55 and 60:</i> Due to grades 50, 55 and 60 fabric widths being less than the width of a 60" board, contact your KnollExtra representative or Customer Service for pricing and fabric railroading information.</p>

pattern no.	10	COM 15	20	30	35	40	45/46	50	55	60
F-24-14-()-A-()()	\$264.	\$270.	\$302.	\$313.	\$316.	\$322.	\$333.	\$334.	\$352.	\$364.
F-24-16-()-A-()()	264.	270.	302.	313.	316.	322.	333.	334.	352.	364.
F-24-18-()-A-()()	283.	289.	311.	323.	325.	329.	341.	343.	361.	374.
F-24-20-()-A-()()	352.	356.	362.	376.	379.	384.	396.	399.	418.	432.
F-24-24-()-A-()()	395.	403.	445.	461.	466.	473.	490.	493.	520.	540.
F-30-14-()-A-()()	301.	306.	349.	357.	361.	365.	378.	379.	396.	409.
F-30-16-()-A-()()	309.	315.	355.	365.	368.	376.	386.	387.	407.	417.
F-30-18-()-A-()()	319.	324.	364.	377.	379.	384.	395.	396.	414.	428.
F-30-20-()-A-()()	398.	404.	434.	446.	450.	457.	468.	469.	490.	506.
F-30-24-()-A-()()	444.	453.	481.	498.	502.	511.	527.	528.	557.	575.
F-36-14-()-A-()()	309.	315.	364.	377.	379.	384.	395.	396.	414.	428.
F-36-16-()-A-()()	326.	333.	376.	384.	387.	392.	403.	404.	424.	436.
F-36-18-()-A-()()	336.	342.	383.	393.	396.	402.	413.	414.	431.	445.
F-36-20-()-A-()()	398.	404.	443.	456.	459.	463.	477.	478.	499.	513.
F-36-24-()-A-()()	468.	477.	536.	552.	556.	563.	580.	582.	610.	629.
F-42-14-()-A-()()	328.	334.	392.	403.	407.	412.	423.	424.	442.	454.
F-42-16-()-A-()()	354.	360.	399.	410.	413.	416.	428.	430.	447.	460.

Custom Options

For special sizes:
For specials contact Customer Service. Maximum fabric board size is 120"W x 24"H. Fabric must be railroaded on any panel wider than 60".

Customer's own material:
For approval, submit at least one yard of fabric for application testing. For panel-mounted applications, all COMs and textiles that are not pre-approved must be UL-tested. Please consult Knoll sales Customer Services for details.

Construction

1/2" thick mineral board for durable, highly tackable surface.
Manufactured in the United States.

Fabric Selection

<i>Grade 10</i> Annex Bailey II Broadcloth Element Foundation Growth Spurt Solid Crepe Symbolic Tailor Made Taurus Versatility	<i>Grade 20 (cont.)</i> Outback Photon Reflect Resolution Walkabout Weave Three	<i>Grade 30</i> Basket Draft Flow Harmony Interknit Match Point Micro Progression Progression Striae Relay	<i>Grade 40</i> Amplify Analogy * Clarkson Foil Rap Hard Rock Heavy Metal Metaphor * Monarch Ornament Palladium	<i>Grade 45</i> Bandwidth Backdrop† Dristi * Fast Forward†	<i>Grade 50</i> Abacus * Bankshot * Chroma *‡ Knoll Hopsack * Mariner *‡ Presto * Ricochet * Stepping Stones‡ Wide Angle	<i>Grade 55</i> Cavalier‡ Field Day * Knoll Felt * <i>Grade 60</i> Classic Boucle *‡
---	---	--	---	---	---	--

† Not available with radiused edge.
* Consult your Knoll sales representative or Customer Service for pricing on 60" wide boards.
‡ Available for wall mount only.

Note:
As a general rule, all fabrics approved for a Morrison panel application are approved for KnollExtra fabric wrapped tack boards.

Universal Fabric Boards

Standard Sizes

product	description	w	d	h	textile fabric yards
Fabric Boards 	<ul style="list-style-type: none"> Standard fabric board has 1/2" thick mineral board construction with squared corner. Rounded corner or radiused edge, available at upcharge. Panel or wall mounting options. 	42"	1/2"	18"	.66
		42"	1/2"	20"	.75
		42"	1/2"	24"	1
		48"	1/2"	14"	.66
		48"	1/2"	16"	.66
		48"	1/2"	18"	.66
		48"	1/2"	20"	.75
		48"	1/2"	24"	1
		60"	1/2"	14"	.66
		60"	1/2"	16"	.66
		60"	1/2"	18"	.66
		60"	1/2"	20"	.75
		60"	1/2"	24"	1

Order Code

Example:	F-24-16-R2-A-30-
	W388/1
	F-WM-F
F-24-16	24" x 16" Fabric board
R2	Rounded corner/radius edge detail
A	Thickness
30	Fabric grade 30
W388/1	Freehand, Glacier
F-WM-F	Wall-mounted, flush

Ordering Information

Specify:

1. Pattern number
2. Corner/edge detail
3. Thickness
4. Fabric grade
5. Fabric selection
6. Mounting option pattern number
7. System suffix (panel-mounted option only)

Equity application note:
For all Equity panel-mounted applications, add "E" to end of base pattern number.

Corner/edge detail:
Squared corner/rectilinear edge (S1)
Squared corner/radiused edge (S2)
Rounded corner/radiused edge (R2)

Standard fabric board has squared corner and rectilinear edge details. See page 136 for edge upcharge.

Standard fabric board has 1/2" thick mineral board.

Mounting Options

Panel-mounted brackets:
Panel-mounted brackets are included in the list price but must be specified separately. To specify appropriate panel-mounted bracket, consult the KnollExtra Bracket Chart on page 12.

Panel mounted bracket size must match height of fabric board.

Wall-mounted options:
Wall-mounted applications must be specified as flush (F-WM-F) or reveal (F-WM-R). Both options are appropriate for any smooth, clean surface. Flush wall-mount option utilizes velcro squares.

Reveal wall-mount option provides 1/2" clearance for wire management behind fabric board. Fabric boards mount with 4 brackets onto 2 black painted wall rails that screw into wall to ensure rigidity. For other mounting options and pricing, contact Customer Service.

Under overhead specification note:
For application under a system overhead, provide clearance distance between the worksurface and the bottom of the overhead or task light.

Side by side fabric board specification note:
Please note if a panel-mounted fabric board will be used contiguous to another fabric board, drawings are required and there will be an up-charge.

60" wide boards in fabric grades 50, 55 and 60:
Due to grades 50, 55 and 60 fabric widths being less than the width of a 60" board, contact your KnollExtra representative or Customer Service for pricing and fabric railroading information.

pattern no.	10	COM 15	20	30	35	40	45/46	50	55	60
F-42-18-()-A-() () ()	\$354.	\$360.	\$418.	\$429.	\$431.	\$437.	\$447.	\$451.	\$468.	\$480.
F-42-20-()-A-() () ()	453.	458.	497.	509.	512.	519.	531.	532.	553.	568.
F-42-24-()-A-() () ()	550.	559.	609.	625.	629.	636.	655.	656.	684.	702.
F-48-14-()-A-() () ()	336.	342.	401.	412.	414.	418.	430.	431.	451.	462.
F-48-16-()-A-() () ()	354.	360.	418.	429.	431.	437.	447.	451.	468.	480.
F-48-18-()-A-() () ()	363.	368.	418.	429.	431.	437.	447.	451.	468.	480.
F-48-20-()-A-() () ()	453.	458.	497.	509.	512.	519.	531.	532.	553.	568.
F-48-24-()-A-() () ()	560.	568.	697.	714.	717.	724.	743.	745.	772.	791.
F-60-14-()-A-() () ()	426.	431.	508.	519.	521.	527.	539.	n/a	n/a	n/a
F-60-16-()-A-() () ()	436.	441.	518.	528.	531.	537.	548.	n/a	n/a	n/a
F-60-18-()-A-() () ()	461.	467.	529.	541.	543.	549.	560.	n/a	n/a	n/a
F-60-20-()-A-() () ()	494.	501.	552.	563.	566.	572.	583.	n/a	n/a	n/a
F-60-24-()-A-() () ()	560.	568.	697.	714.	717.	724.	743.	n/a	n/a	n/a

Custom Options

For special sizes:
For specials contact Customer Service. Maximum fabric board size is 120"W x 24"H. Fabric must be railroaded on any panel wider than 60".

Customer's own material:
For approval, submit at least one yard of fabric for application testing. For panel-mounted applications, all COMs and textiles that are not pre-approved must be UL-tested. Please consult Knoll sales Customer Services for details.

Construction

1/2" thick mineral board for durable, highly tackable surface.
Manufactured in the United States.

Fabric Selection

<i>Grade 10</i> Annex Bailey II Broadcloth Element Foundation Growth Spurt Solid Crepe Symbolic Tailor Made Taurus Versatility	<i>Grade 20 (cont.)</i> Outback Photon Reflect Resolution Walkabout Weave Three	<i>Grade 30</i> Basket Draft Flow Harmony Interknit Match Point Micro Progression Progression Striae Relay	<i>Grade 40</i> Amplify Analogy * Clarkson Foil Rap Hard Rock Heavy Metal Metaphor * Monarch Ornament Palladium	<i>Grade 45</i> Bandwidth Backdrop† Dristi * Fast Forward†	<i>Grade 50</i> Abacus * Bankshot * Chroma *‡ Knoll Hopsack * Mariner *‡ Presto * Ricochet * Stepping Stones‡ Wide Angle	<i>Grade 55</i> Cavalier‡ Field Day * Knoll Felt * <i>Grade 60</i> Classic Boucle *‡
---	---	--	---	---	---	--

† Not available with radiused edge.
* Consult your Knoll sales representative or Customer Service for pricing on 60" wide boards.
‡ Available for wall mount only.

Note:
As a general rule, all fabrics approved for a Morrison panel application are approved for KnollExtra fabric wrapped tack boards.

Universal Fabric Boards

Options and Mounting Information

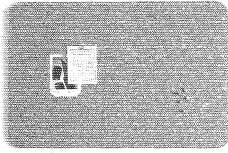
product	description	application	w	d	h
Fabric Boards	Mounting Options	1/2" Reveal Wall-Mounted			
		Flush Wall-Mounted (No charge when ordered with fabric board)			
		Panel-Mounted Dividends (No charge when ordered with fabric board)			
		Panel-Mounted Equity (No charge when ordered with fabric board)			
		Panel-Mounted Morrison (No charge when ordered with fabric board)			
		Panel-Mounted Reff (No charge when ordered with fabric board)			
		Edge Detail	Rounded corner/radiused edge (add -R2 to end of fabric board pattern number)		
		Squared corner/radiused edge (add -S2 to end of fabric board pattern number)			
		Squared corner/rectilinear edge (add -S1 to end of fabric board pattern number)			
		<ul style="list-style-type: none"> • Standard fabric board has 1/2" thick mineral board construction with squ • Rounded corner or radiused edge option available at upcharge. • Panel or wall mounting options. 			

Order Code	Ordering Information	Mounting Options
Example: F-60-14-S1-A-40-W337/4 F-PM-R-14	<i>Specify:</i>	<i>Panel-mounted brackets:</i>
F-60-14	1. Pattern number	Panel-mounted brackets are included in the list price but must be specified separately. To specify appropriate panel-mounted bracket, consult the Knoll sales bracket chart on page 12.
S1	2. Corner/edge detail	
A	3. Fabric grade	Panel mounted bracket size must match height of fabric board.
40	4. Fabric selection	<i>Wall-mounted options:</i>
W337/4	5. Mounting option pattern number	Wall-mounted applications must be specified as flush (F-WM-F) or reveal (F-WM-R). Both options are appropriate for any smooth, clean surface.
F-PM	6. System suffix (panel-mounted option only)	Flush wall-mount option utilizes velcro squares.
R	<i>Equity application note:</i>	
14	For all Equity panel-mounted applications, add "E" to end of base pattern number.	
	<i>Corner/edge detail:</i>	
	Squared corner/rectilinear edge (S1)	
	Squared corner/radiused edge (S2)	
	Rounded corner/radiused edge (R2)	

pattern no.	list price
F-WM-R-(14, 16, 18, 20 or 24)	\$106.
F-WM-F-(24, 30, 36, 42, 48, 60)- (14, 16, 18, 20 or 24)	32.
F-PM-D-(14, 16, 18, 20 or 24)	41.
F-PM-E-(14, 16, 18, 20 or 24)	41.
F-PM-M-(14, 16, 18, 20 or 24)	41.
F-PM-R-(14, 16, 18, 20 or 24)	41.
R2	32.
S2	32.
S1	n/c

Under overhead specification note:
For application under a system overhead, provide clearance distance between the worksurface and the bottom of the overhead or task light.

Side by side fabric board specification note:
Please note if a panel-mounted fabric board will be used contiguous to another fabric board drawings are required and there will be an up-charge.

Construction

1/2" thick mineral board for durable, highly tackable surface.

Custom Options

For special sizes:
Refer to the standard size scope. Locate the standard fabric board size which is equal to or greater in width and depth than the requested special. Add 10% to the standard list price. Note "special" when ordering. For specials above 60"W x 24"H, contact Customer Service. Maximum fabric board size is 120"W x 24"H. Fabric must be railroaded on any panel wider than 60".

Customer's own material:
For approval, submit at least one yard of fabric for application testing. For panel-mounted applications, all COMs and textiles that are not pre-approved must be UL-tested. Please consult Knoll sales Customer Service for details.

Corner/Edge Detail

S1. Squared corner/Rectilinear edge

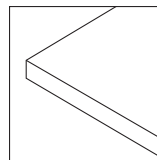

R2. Rounded corner/Radiused edge

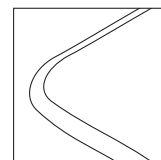

S2. Squared corner/Radiused edge

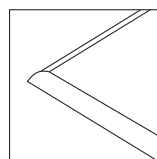

Universal Fabric Boards

Top Cap Hung Marker Board

product	description	application	w	d	h
Top Cap Hung Marker Board	<ul style="list-style-type: none"> • Incorporates erasable surface. • Includes tray for markers and erasers. 		30"	3"	36"
	Mounting Option	Wall Rail			







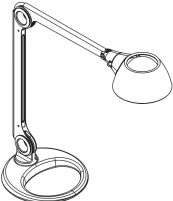

Order Code	Ordering Information	Mounting Options	Construction
Example: PR MB 3036 PR MB Top Cap Hung Marker 3036 Board	<i>Specify:</i> 1. Pattern number	<p><i>Top cap hung marker board:</i> Marker boards hang from top of systems panels between .375" and 2.5" inches wide.</p> <p>Reveal wall-mount option provides 1/2" clearance for wire management behind fabric board. Fabric boards mount with 4 brackets onto 2 black painted wall rails that screw into wall to ensure rigidity. For other mounting options and pricing, consult Customer Service.</p>	<p><i>Top cap hung marker board:</i> White laminate surface on Sintra core. Extruded aluminum trough.</p> <p>Manufactured in the United States.</p> <p><i>Wall Rail:</i> Machined aluminum powder coated light grey to match top cap hung marker board trough.</p>

pattern no.	list price
PR-MB-3036	\$714.
PR-MB-WM-Rail	32.

Copeland™ Light

by Stephan Copeland

product	description	
Standard Arm		<ul style="list-style-type: none"> Standard Arm. 13 watt ENERGY STAR rated compact fluorescent bulb (equivalent of 75 watt incandescent bulb). Mounting option must be ordered separately. 20.75" h x 21.75" w (at 90° angle) Reaches height fo 29.75" when extended up and depth of 35.75" when extended out.
<i>Shown with base</i>		
Compact Arm		<ul style="list-style-type: none"> Compact Arm. 13 watt ENERGY STAR rated compact fluorescent bulb (equivalent of 60 watt incandescent bulb). Mounting option must be ordered separately. 16.25" h x 17.75" w (at 90° angle) Reaches height of 23.5" when extended up and depth of 28.75" when extended out.
<i>Shown with base</i>		
Replacement bulb	<ul style="list-style-type: none"> ENERGY STAR 13 watt replacement compact fluorescent bulb (fits compact and standard lights) 	
Mounting Options	Standard base	<ul style="list-style-type: none"> Standard base. To be used with standard arm only 
	Compact base	<ul style="list-style-type: none"> Compact base To be used with compact arm only 
	Table clamp	<ul style="list-style-type: none"> To be used with either size arm. Works on desks of up to 1 3/4" thick. 
	Panel Mount, Morrison	<ul style="list-style-type: none"> Panel mount bracket for Morrison. To be used with either size arm 

Order Code
Example: COPE-01-SV, COPE-01-BASE-SV
COPE-01-SV Copeland light standard arm in silver
COPE-01-BASE-SV Copeland standard base in silver

Ordering Information
Specify:
1. Pattern number for arm
2. Finish for arm
3. Mounting option pattern number
4. Mounting option finish

Finish Options:
Silver (SV)
Black (111)





Light Bulb Information
Standard Light:
<ul style="list-style-type: none"> Ships with a 13 watt compact fluorescent light bulb. This is equivalent light output of a 75 watt incandescent light bulb. 13w/120v/2700K, UL listed, ENERGY STAR rated. An incandescent light bulb can also be used. 75 watt is the maximum. See above for bulb replacement.

pattern no.	list price
COPE-01-()	\$181.
COPE-02-()	169.
COPEBULB	13.
COPE-01-BASE-()	99.
COPE-02-BASE-()	92.
COPE-CLMP-()	55.
COPE-PM-M-()	82.

	Construction	Design Awards
<p>Compact Light:</p> <ul style="list-style-type: none"> • Ships with a 13 watt compact fluorescent light bulb. This is equivalent light output of a 60 watt incandescent light bulb. • 13w/120v/2700K, UL listed, ENERGY STAR rated. • A “ceiling fan” incandescent bulb can also be used. 60 watt is the maximum. 	<p>The Copeland Light has a steel arm, aluminum axles, zinc coated cast iron base and metallic-painted ABS shade.</p>	<p>Best of NeoCon 2005, Silver Award</p>

Copeland™ Light

by Stephan Copeland

product	description
Mounting Options	Panel Mount, Equity <ul style="list-style-type: none"> • Panel mount bracket for Equity. • To be used with either size arm 
	Panel Mount, Reff <ul style="list-style-type: none"> • Panel mount bracket for Reff. • To be used with either size arm 
	Panel Mount, Dividends <ul style="list-style-type: none"> • Panel mount bracket for Dividends. • To be used with either size arm 
	Grommet Mount <ul style="list-style-type: none"> • To be used with either size arm 
	<ul style="list-style-type: none"> • Slat wall mount. • To be used with either size arm • Can be used on all Knoll systems slat wall as well as Orchestra® slat boards and load bars. 

Order Code	Ordering Information	Light Bulb Information
Example: COPE-01-SV, COPE-01-BASE-SV COPE-01-SV Copeland light standard arm in silver COPE-01-BASE-SV Copeland standard base in silver	<i>Specify:</i> <ol style="list-style-type: none"> 1. Pattern number for arm 2. Finish for arm 3. Mounting option pattern number 4. Mounting option finish 	<i>Finish Options:</i> Silver (SV) Black (111)
		Standard Light: <ul style="list-style-type: none"> • Ships with a 13 watt compact fluorescent light bulb. This is equivalent light output of a 75 watt incandescent light bulb. • 13w/120v/2700K, UL listed, ENERGY STAR rated. • An incandescent light bulb can also be used. 75 watt is the maximum. • See above for bulb replacement.

pattern no.	list price
COPE-PM-E-()	\$82.
COPE-PM-R-()	82.
COPE-PM-D-()	82.
COPE-GRMT-()	99.
COPE-SLT-()	82.

	Construction	Design Awards
<p>Compact Light:</p> <ul style="list-style-type: none"> • Ships with a 13 watt compact fluorescent light bulb. This is equivalent light output of a 60 watt incandescent light bulb. • 13w/120v/2700K, UL listed, ENERGY STAR rated. • A “ceiling fan” incandescent bulb can also be used. 60 watt is the maximum. 	<p>The Copeland Light has a steel arm, aluminum axles, zinc coated cast iron base and metallic-painted ABS shade.</p>	<p>Best of NeoCon 2005, Silver Award</p>

Little Dipper and Big Dipper Lighting System

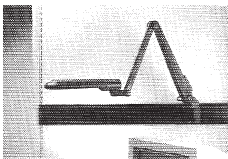
product	description	w	d	h	wgt.	bulb type	watts
Big Dipper 	<ul style="list-style-type: none"> • 34" arm reach. • 18 watt fluorescent tube that provides output equivalent to an ordinary 100 watt lamp. • Applicable on virtually all systems. • Four joints easily adjust lamp to needs of user. • Shade adjusts to minimize glare and eyestrain. • Matte black plastic. • UL-listed. 	34"	3"	2"	3 lbs. 4 ozs.	Fluorescent	PL18

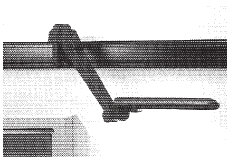
Little Dipper 	<ul style="list-style-type: none"> • 19" arm reach. • 18 watt fluorescent tube that provides output equivalent to an ordinary 100 watt lamp. • Applicable on virtually all systems. • Three joints easily adjust lamp to needs of user. • Shade adjusts to minimize glare and eyestrain. • Matte black plastic. • UL-listed. 	19"	3"	2"	2 lbs. 8 ozs.	Fluorescent	PL18
--	---	-----	----	----	---------------	-------------	------

Mounting Options	Desk-Mounted Bracket	3"	1 1/4"	3 3/4"	6 ozs.		
	Freestanding Weighted Base	8"	6 1/4"	2"	14 lbs.		
	Load bar mount						
	Load Bar-Mounted Bracket	4 1/4"	2"	3"	11 ozs.		
	Panel-Mounted Bracket - Mid-run	4"	3"	3 1/2"	10 ozs.		
	Panel-Mounted Bracket for Dividends	4"	3"	3 1/2"	10 ozs.		
	Panel-Mounted Bracket for Reff - Mid Run	4"	3"	3 1/2"	10 ozs.		
Wall-Mounted Bracket	3 1/4"	2 1/2"	2 1/2"	12 ozs.			

Order Code

Example: **ORCH-BD**
ORCH-D-PMC

ORCH-BD Big Dipper

ORCH-D- Panel-mounted bracket,
PMC corner

Ordering Information

Specify:

1. Pattern number
2. Mounting option pattern number

Mounting bracket:

To specify appropriate panel-mounting brackets consult the KnollExtra Bracket Chart on page 12.

pattern no.	list price
ORCH-BD	\$465.
ORCH-LD	433.
ORCH-D-DM	30.
ORCH-D-BASE	126.
ART-TOL-BELLA-LBZ-BK	70.
ORCH-D-LBZ	80.
ORCH-D-PMM	103.
ORCH-D-PMMD	103.
ORCH-D-PMR	129.
ORCH-D-WM	30.

Construction

Constructed of fingerprint-resistant matte black plastic. 3"W x 12"D x 2"H arched shade includes full-length reflector to distribute light evenly over work area. Compact 18-watt fluorescent tube offers light output equivalent to an ordinary 100-watt lamp, and provides approximately 10,000 hours of light. 7 foot black cord.

Manufactured in Taiwan, Republic of China.

Desktop Lamp

By John Rizzi and Brooks Rorke

product	description	watts	w	d	h	wgt.	bulb type
Desktop Lamp 	<ul style="list-style-type: none"> • Freestanding. • Available in halogen or fluorescent. • Adjustable height extends to 19 1/2". • Dual intensity switch on halogen model. • Base, shaft and shade in black only. • UL-listed. 	22 watt, T5 circular 120V, 60 HZ, 3200K	11 1/2"	11 1/2"	15 1/4"	5 lbs. 11 ozs.	F
		50 watt, G8 120V, 60HZ Dimmable to 30 watt.	11 1/2"	11 1/2"	15 1/4"	5 lbs. 11 ozs.	H
Replacement bulb	<ul style="list-style-type: none"> • Fluorescent • Halogen 						

Order Code

Example: **ORCH-DES-H-BK**

ORCH-DES Desktop lamp

H Halogen bulb

BK Black shade

Ordering Information

Lamp, specify:

1. Pattern number
2. Bulb type

Bulb type:

Halogen (H)
Fluorescent (F)

Shade:

Black (BK)

pattern no.	list price
ORCH-DES-F	\$203.
ORCH-DES-H	192.
ORCH-DESF-BULB	10.
ORCH-DESH-BULB	10.

Construction

The weighted base is constructed of molded ABS plastic. Vertical posts are durable black aluminum. Covers are heat resistant polycarbonate. Halogen models feature dual intensity switch for 30/50 watt output. UL-listed.

Design Award

Furniture/Lighting Gold Award, IDSA/IDEA, 1992; Silver Award, IBD Product Design Competition, 1990.

Alpha-Numeric Index

<i>pattern no.</i>	<i>page</i>	<i>pattern no.</i>	<i>page</i>	<i>pattern no.</i>	<i>page</i>	<i>pattern no.</i>	<i>page</i>
001-214	32	3650	30	F-60-24	138	ORCH-BD	148
001-315	32	4B2-MP	116	F-PM-D-(14, 16, 18, 20 or 24)	140	ORCH-BDN	52
012-1	18	4B2-MP-MS	116	F-PM-E-(14, 16, 18, 20 or 24)	140	ORCH-CCH	58
012-2	18	4B2-MP-WR	106	F-PM-M-(14, 16, 18, 20 or 24)	140	ORCH-D-BASE	148
012-3	18	4B2-WR	116	F-PM-R-(14, 16, 18, 20 or 24)	140	ORCH-D-DM	148
012-4	18	512-20	18, 26, 30	F-WM-F-(24, 30, 36, 42, 48, 60)- (14, 16, 18, 20 or 24)	140	ORCH-DES-F	150
050	20	ART-TOL-BELLA-LBZ-BK	148	F-WM-R-(14, 16, 18, 20 or 24)	140	ORCH-DES-F-BULB	150
055-BO	20	BP-DCF	126	OA-CPU-MTL-V	122	ORCH-DES-H	150
1-2600	44	BP-DCF-17	126	OA-CPU-SLNG-V	122	ORCH-D-BULB	150
1-2601	44	BP-DSF	124	OA-FR-BK	120	ORCH-D-LBZ	148
1-2602	44	BP-KFD	128	OAK-A1-W/P-EL2-BK-(16,18,22,23,25)	112	ORCH-DP	60
1901	14	BP-L	126, 128, 130	OAK-A1-W/P-EL2-BK-PT-(16,18,22,23,25)	112	ORCH-D-PMM	148
1901-2	14	BP-NKD	128	OAK-A1-W/P-SL2-BK-(16,18,22,23,25)	112	ORCH-D-PMMD	148
1901-3	14	BP-PD	130	OAK-A1-W/P-SL2-BK-PT-(16,18,22,23,25)	112	ORCH-D-PMR	148
1905	16	BP-SCF	126	OAK-A1-W/P-SS2-BK-(16,18,22,23,25)	112	ORCH-D-WM	148
1906	16	BP-SSF	124	OAK-A1-W/P-SS2-BK-PT-(16,18,22,23,25)	112	ORCH-F-LT	48
1912-20	18, 26, 30	BP-TOP-C	130	OAK-A1-W/P-SS2-BK-PT-(16,18,22,23,25)	112	ORCH-FS	52
1912-30	18	BP-WKD	128	OAK-A2-P-1-EL2-BK-(16,18,22,23,25)	114	ORCH-HFH	54
1912-31	18	BP-WKD-25	128	OAK-A2-P-1-EL2-BK-PT-(16,18,22,23,25)	114	ORCH-LD	148
1912-32	18	COPE-01	144	OAK-A2-P-1-SL2-BK-(16,18,22,23,25)	114	ORCH-MT	56
1912-40	18	COPE-01-BASE	144	OAK-A2-P-1-SL2-BK-PT-(16,18,22,23,25)	114	ORCH-PC	54
1912-41	18	COPE-02	144	OAK-A2-P-1-SS2-BK-(16,18,22,23,25)	114	ORCH-PD-A	132
1912-42	18	COPE-02-BASE	144	OAK-A2-P-1-SS2-BK-PT-(16,18,22,23,25)	114	ORCH-SB	50
1915	16	COPEBULB	144	OAK-A2-P-2-EL2-BK-(16,18,22,23,25)	114	ORCH-S-LGT	48
1916	16	COPE-CLMP	144	OAK-A2-P-2-EL2-BK-PT-(16,18,22,23,25)	114	ORCH-S-LT	48
2020-020	34	COPE-CRMT	146	OAK-A2-P-2-SL2-BK-(16,18,22,23,25)	114	ORCH-SSD	52
2020-032	34	COPE-PM-D	146	OAK-A2-P-2-SL2-BK-PT-(16,18,22,23,25)	114	ORCH-TD	56
2020-035	34	COPE-PM-E	146	OAK-A2-P-2-SS2-BK-(16,18,22,23,25)	114	ORCH-TS-UNI	58
2020-038	34	COPE-PM-M	144	OAK-A2-P-2-SS2-BK-PT-(16,18,22,23,25)	114	ORCH-UT	54
2020-150	34	COPE-PM-R	146	OA-K-EL2-MS-(16,18,22,23,25)	110	ORCH-VAS	58
255	20	COPE-SLT	146	OA-K-MS	110	ORCH-VPP	52
2ORCH-F-LT	48	EFM-IVYU	44	OAK-OTK-MP	116	ORCH-WBK	60
2ORCH-S-LGT	50	F-24-14	136	OA-K-PR-EL2-BK-(16,18,22,23,25)	108	ORCH-WBK-R-EB	60
2ORCH-S-LT	48	F-24-16	136	OA-K-PR-EL2-BK-PT-(16,18,22,23,25)	108	OR-LBI-24-EY-()	64
3030-095	34	F-24-18	136	OA-K-PR-SL2-BK-(16,18,22,23,25)	108	OR-LBI-24-N2-()	62
3030-120	34	F-24-20	136	OA-K-PR-SL2-BK-PT-(16,18,22,23,25)	108	OR-LBI-24-()	62
3030-160	34	F-24-24	136	OA-K-PR-SS2-BK-(16,18,22,23,25)	108	OR-LBI-30-C-()	62
3031-200	34	F-30-14	136	OA-K-PR-SS2-BK-PT-(16,18,22,23,25)	108	OR-LBI-30-ES-()	64
3031-600	34	F-30-16	136	OAK-RJ-EL2-BK-(16,18,22,23,25)	106	OR-LBI-30-EY-()	64
3301	22	F-30-18	136	OAK-RJ-EL2-BK-PT-(16,18,22,23,25)	106	OR-LBI-30-N2-()	62
3301-2	22	F-30-20	136	OAK-RJ-SL2-BK-(16,18,22,23,25)	106	OR-LBI-30-()	62
3305	24	F-30-24	136	OAK-RJ-SL2-BK-PT-(16,18,22,23,25)	106	OR-LBI-35-()	62
3312-3	26	F-36-14	136	OAK-RJ-SS2-BK-(16,18,22,23,25)	106	OR-LBI-36-CS-()	62
3312-4	26	F-36-16	136	OAK-RJ-SS2-BK-PT-(16,18,22,23,25)	106	OR-LBI-36-C-()	62
3313	26	F-36-18	136	OA-K-SS2-MS-(16,18,22,23,25)	110	OR-LBI-36-DV-()	62
3314	26	F-36-20	136	OA-SLV(A,B,C)-(E, J)	120	OR-LBI-36-ES-()	64
3315	24	F-36-24	136	OA-SLV(A,B,C)-(GS, BS)	120	OR-LBI-36-EY-()	64
3319-4	24	F-42-14	136	OR-BKT-PM-B	70	OR-LBI-36-N2-()	62
3319-4-LN	24	F-42-16	136	OR-BKT-PM-CE	70	OR-LBI-36-()	62
3333	22	F-42-18	138	OR-BKT-PM-CS	70	OR-LBI-42-DV-()	62
3350	26	F-42-20	138	OR-BKT-PM-D	70	OR-LBI-42-ES-()	64
3370 (4" x 6")	24	F-42-24	138	OR-BKT-PM-DS	70	OR-LBI-42-EY-()	64
3371 (5" x 7")	24	F-48-14	138	OR-BKT-PM-DV	70	OR-LBI-42-N2-()	62
3601	28	F-48-16	138	OR-BKT-PM-E	70	OR-LBI-42-()	62
3604	28	F-48-18	138	OR-BKT-PM-ES	70	OR-LBI-45-()	62
3605	28	F-48-20	138	OR-BKT-PM-M	70	OR-LBI-48-CS-()	62
3612-3	30	F-48-24	138	OR-BKT-PM-N	70	OR-LBI-48-C-()	62
3612-4	30	F-60-14	138	OR-BKT-PM-R	70	OR-LBI-48-DV-()	62
3613	30	F-60-16	138	OR-BKT-SM-A	70	OR-LBI-48-ES-()	64
3614	30	F-60-18	138	OR-BKT-WM	70	OR-LBI-48-EY-()	64
3615	28	F-60-20	138			OR-LBI-48-N2-()	62

<i>pattern no.</i>	<i>page</i>	<i>pattern no.</i>	<i>page</i>	<i>pattern no.</i>	<i>page</i>	<i>pattern no.</i>	<i>page</i>
OR-LBI-48-())	62	OR-SL-14-48-ES-())	68	SAP MA C SW DIR K	76	SF-WR-FS-(BK)-G	118
OR-LBI-54-EY-())	64	OR-SL-14-48-EY-())	68	SAP MA C WL DIR K	76	STL-01-2	38
OR-LBI-54-N2-())	62	OR-SL-14-48-())	68	SAP MA D ANT CTR K	80	STL-014-2	38
OR-LBI-54-())	62	OR-SL-14-54-EY-())	68	SAP MA D ANT SIDE K	80	STL-015-1	38
OR-LBI-60-DV-())	62	OR-SL-14-54-())	68	SAP MA D CLMP DP K	78	STL-019-1	38
OR-LBI-60-ES-())	64	OR-SL-14-60-ES-())	68	SAP MA D CLMP K	78	STL-04-2	38
OR-LBI-60-EY-())	64	OR-SL-14-60-EY-())	68	SAP MA D COT K	78	STL-05-1	38
OR-LBI-60-N2-())	62	OR-SL-14-60-())	68	SAP MA D DH K	80	STL-06-2	38
OR-LBI-60-())	62	OR-SL-14-66-EY-())	68	SAP MA D FTM K	78	STL-06-3	38
OR-LBI-66-EY-())	64	OR-SL-14-66-())	68	SAP MA D GRMT K	78	STL-10	42
OR-LBI-66-N2-())	62	OR-SL-14-72-ES-())	68	SAP MA D SW MST 12 K	80	STL-1000	36
OR-LBI-66-())	62	OR-SL-14-72-EY-())	68	SAP MA D SW MST 16 K	80	STL-11	42
OR-LBI-72-DV-())	62	OR-SL-14-72-())	68	SAP MA D SW MST 8 K	80	STL-1100	36
OR-LBI-72-ES-())	64	OR-WB-22-18-E	134	SAP MA D WL MST 12 K	80	STL-13	42
OR-LBI-72-EY-())	64	OR-WB-24-18	134	SAP MA D WL MST 16 K	80	STL-15	42
OR-LBI-72-N2-())	62	OR-WB-28-18-E	134	SAP MA D WL MST 8 K	80	STL-2004	36
OR-LBI-72-())	62	OR-WB-28-24-E	134	SAP MA S	88	STL-486	40
OR-SL-06-24-EY-())	66	OR-WB-30-18	134	SAP MA S ANT CTR K	74	STL-9	42
OR-SL-06-24-N2-())	66	OR-WB-30-24	134	SAP MA S ANT SIDE K	74	STL-900	36
OR-SL-06-24-())	66	OR-WB-34-18-E	134	SAP MA S CLMP DP K	72	STL-900-1	46
OR-SL-06-30-ES-())	66	OR-WB-34-24-E	134	SAP MA S CLMP K	72	STL-900-2	46
OR-SL-06-30-EY-())	66	OR-WB-36-18	134	SAP MA S COT K	72	STL-900-3	46
OR-SL-06-30-N2-())	66	OR-WB-36-24	134	SAP MA S DH K	74	STL-915	36
OR-SL-06-30-())	66	OR-WB-40-24-E	134	SAP MA S FTM K	72		
OR-SL-06-35-())	66	OR-WB-40-30-E	134	SAP MA S GRMT K	72		
OR-SL-06-36-ES-())	66	OR-WB-42-24	134	SAP MA S SW MST 12 K	74		
OR-SL-06-36-EY-())	66	OR-WB-42-30	134	SAP MA S SW MST 16 K	74		
OR-SL-06-36-N2-())	66	OR-WB-46-30-E	134	SAP MA S SW MST 8 K	74		
OR-SL-06-36-())	66	OR-WB-48-30	134	SAP MA S WL MST 12 K	76		
OR-SL-06-42-ES-())	66	OR-WB-LBZ	134	SAP MA S WL MST 16 K	76		
OR-SL-06-42-EY-())	66	OR-WB-PM-B	134	SAP MA S WL MST 8 K	76		
OR-SL-06-42-N2-())	66	OR-WB-PM-D	134	SAP MA SL	88		
OR-SL-06-42-())	66	OR-WB-PM-DV	134	SAP MA T ANT CTR K	84		
OR-SL-06-45-())	66	OR-WB-PM-E	134	SAP MA T ANT SIDE K	84		
OR-SL-06-48-ES-())	66	OR-WB-PM-M	134	SAP MA T CLMP DP K	82		
OR-SL-06-48-EY-())	66	OR-WB-PM-R	134	SAP MA T CLMP K	82		
OR-SL-06-48-N2-())	66	OR-WB-TCM-DV	134	SAP MA T COT K	82		
OR-SL-06-48-())	66	OR-WB-TCM-E	134	SAP MA T DH K	84		
OR-SL-06-54-EY-())	66	OR-WB-TCM-M	134	SAP MA T FTM K	82		
OR-SL-06-54-N2-())	66	OR-WB-TCM-R	134	SAP MA T GRMT K	82		
OR-SL-06-54-())	66	OR-WB-TR	134	SAP MA T SW MST 12 K	84		
OR-SL-06-60-ES-())	66	OR-WB-WM	134	SAP MA T SW MST 16 K	84		
OR-SL-06-60-EY-())	66	PR-MB-3036	142	SAP MA T SW MST 8 K	84		
OR-SL-06-60-N2-())	66	PR-MB-WM-Rail	142	SAP MA T WL MST 12 K	84		
OR-SL-06-60-())	66	R2	140	SAP MA T WL MST 16 K	84		
OR-SL-06-66-EY-())	66	S1	140	SAP MA T WL MST 8 K	84		
OR-SL-06-66-N2-())	66	S2	140	SAP MA TD	90		
OR-SL-06-66-())	66	SAP 4 BKT	88	SAP MJ	90		
OR-SL-06-72-ES-())	66	SAP ANT CTR	96	SAP MST 12	92		
OR-SL-06-72-EY-())	66	SAP ANT SIDE	96	SAP MST 16	92		
OR-SL-06-72-N2-())	66	SAP CLMP	96	SAP MST 24	92		
OR-SL-06-72-())	66	SAP CLMP DP	96	SAP MST 32	92		
OR-SL-14-24-EY-())	68	SAP CLMP HD	96	SAP MST 8	92		
OR-SL-14-24-())	68	SAP COT	96	SAP MST CM	94		
OR-SL-14-30-ES-())	68	SAP D BKT	88	SAP MST KNB	94		
OR-SL-14-30-EY-())	68	SAP DH	96	SAP SW DIR	98		
OR-SL-14-30-())	68	SAP FTM	96	SAP SW DIR C	98		
OR-SL-14-35-())	68	SAP GRMT	96	SAP SW MST	98		
OR-SL-14-36-ES-())	68	SAP MA 16 4 ANT CTR K	86	SAP T BKT	88		
OR-SL-14-36-EY-())	68	SAP MA 16 4 COT K	86	SAP WL DIR	98		
OR-SL-14-36-())	68	SAP MA 16 4 DH K	86	SAP WL DIR C	98		
OR-SL-14-42-ES-())	68	SAP MA 24 4 ANT CTR K	86	SAP WL MST	98		
OR-SL-14-42-EY-())	68	SAP MA 24 4 COT K	86	SF-LS	118		
OR-SL-14-42-())	68	SAP MA 24 4 DH K	86	SF-SB-(E, J)	118		
OR-SL-14-45-())	68	SAP MA C	88	SF-SB-(GS, BS)	118		

Selling Policy

	<p>This Selling Policy supercedes all previous selling policies. Prices, discounts and product offerings are subject to change without notice.</p>
Terms & Conditions of Sales	<p>Sales by Knoll, Inc. or Knoll North America Corp. ("Seller") of Knoll Product Lines (hereinafter "Products") within the United States and Canada are made only on the terms which are contained in this Selling Policy. Seller hereby gives notice of its objection to any different or additional terms and conditions. This sale is expressly conditional upon Purchaser's assent to the terms and conditions set forth below. Additional terms and conditions may apply to KnollStudio and KnollTextiles orders. These terms and conditions may be modified or supplemented only by a written document signed by an authorized representative of Seller. These terms and conditions supercede any prior and/or contemporaneous agreements or correspondence between Purchaser and Seller. Written quotations expire thirty (30) days from the date of issuance and can be withdrawn by written notice anytime during that period. Where Purchaser and Seller have entered into the Knoll Electronic Terms and Conditions, all orders, acknowledgements, invoices and other business communications placed or transmitted in accordance with the Knoll Electronic Terms and Conditions shall be deemed to be in writing and signed and shall be valid for all purposes as if they were originated and maintained in documentary form.</p>
Ordering Information	<p>All orders must be in writing. The product pattern number(s) contained on Seller's order acknowledgement shall be the final expression of the order.</p>
Order Confirmation	<p>A purchase order is not binding on Seller until Purchaser has received Seller's order confirmation or acknowledgment.</p>
Pricing Policies	<p>List prices are subject to change without notice.</p> <p>List prices shall be those prices in effect on the date of receipt of a complete purchase order unless shipment is requested more than ninety (90) days after order entry in which case prices in effect on the date of shipment apply. List prices include specified freight costs. Unless specified in writing by Seller, no other charges are included in Seller's list prices.</p>
Taxes	<p>All sales, use, excise and other taxes applicable to the sale of the Products shall be paid by Purchaser. If Purchaser claims an exemption from any tax, Purchaser shall submit to Seller the appropriate exemption certificates.</p>
Terms of Payment	<p>Payment for one hundred percent (100%) of the net order amount is due within thirty (30) days of the date of invoice, which is issued upon shipment. In case of any discrepancies, such as shortages, and Seller is notified in writing within ten (10) days of receipt of Product, only that portion may be deducted and the balance paid. For orders greater than \$100,000 net, a fifty percent (50%) deposit is due at the time of order placement, with the remainder due within thirty (30) days of the date of invoice.</p> <p>KnollStudio orders less than \$2,000 require payment for one hundred percent (100%) of the net order amount (including any applicable sales tax and charges for inside delivery, special packaging, etc.), due at time of order placement. For KnollStudio orders greater than \$2,000, a one-half (50%) deposit is due at time of order placement with the remainder (including any applicable sales tax and charges for inside delivery, special packaging, etc.) due prior to shipment.</p> <p>If, in the judgment of Seller, Purchaser's financial condition does not justify the terms of the payment, Seller may require full or partial payment in advance.</p> <p>Past due accounts shall be charged one and one-half percent (1.5%) per month, or the highest rate permitted by law, whichever is less, and will be added to the outstanding balance. In the event Purchaser defaults on payment, Purchaser shall be liable for all collection costs, including reasonable attorney's fees and costs.</p>
Changes and Cancellation	<p>Purchase orders may not be changed or cancelled, in whole or in part, without prior written consent of Seller. Changes may effect delivery dates. Expenses incurred because of changes shall be charged to Purchaser. In the event of cancellations, Purchaser will be liable for reasonable cancellation charges established by Seller. Orders for special Product, orders including "COM" (hereinafter defined) material and orders pursuant to expedited delivery programs, may not be canceled.</p>
Freight Prepaid	<p>Freight is prepaid and included in the price of all Products, except KnollTextiles, within the 48 contiguous United States for orders placed with Knoll, Inc. and within Canada, excluding the Yukon, Northwest Territories, Nunavut and Newfoundland for orders placed with Knoll North America Corp. Packing is tested for rigorous motion and transportation but is not guaranteed to protect furniture from conditions over which the Seller has no control. If special packaging is required for any reason, please consult with your sales representative or dealer. Seller shall select the method of shipment and routing. All shipments shall be tailgate deliveries. Freight for all KnollTextiles orders is prepaid and added to the invoice.</p>
Delivery/Freight Charges	<p>Shipments outside the contiguous 48 United States and Canada shall be shipped F.O.B. Origin.</p> <p>For shipments outside the contiguous United States and Canada, Purchaser is responsible for the cost of freight from point of embarkation, including any handling and transportation charges incidental to loading at the point of departure and unloading at the final destination.</p> <p>Conditions beyond the control of Seller, including weather, available facilities and traffic conditions, may affect exact time of delivery. Seller shall not be responsible for specific carrier delivery date or time unless it has made a specific delivery commitment, in writing.</p> <p>Nonstandard methods of shipment and/or additional services are available upon request. Purchaser will be billed for the differential cost of any special services in excess of standard surface carrier freight costs. Premium charges, at Purchaser's request, will be added for airfreight, exclusive use of vehicle and extra, export or special packaging. Accessorial charges will be added for inside delivery, extra labor, reassignment and redelivery.</p> <p>Partial shipments may be made and invoiced by Seller.</p>
Claims	<p>All shipments for all Knoll Products within the contiguous United States and Canada are F.O.B. Origin. Risk of loss passes to Purchaser at time of delivery to carrier. Purchaser shall inspect all Products upon receipt and notify Seller within ten (10) working days after receipt of any damage or defects which are, or should be, apparent from an inspection of the Product and its packaging. Failure of Purchaser to make a claim against carrier or notify Seller during the ten (10) working day period shall constitute acceptance of the Products and waiver of any apparent defects, errors or shortages. Seller will agree to repair or replace Product damaged in shipment if Purchaser has notified Seller of freight damage within ten (10) working days after receipt and assigns its rights against the carrier.</p>
Seller's Security Interest	<p>Until Seller receives the full payment for the Product, Seller shall have a security interest in the Product. Purchaser agrees to perform all acts, including but not limited to the execution and filing of documentation, which may be necessary to perfect and assure the security interest of Seller.</p>
Returns	<p>The return of Products without a written authorization by Seller shall not be accepted. To receive authorization for Product return, please call Customer Service. All Products that are returned pursuant to a valid authorization shall be subject to a twenty-five percent (25%) of list restocking charge. Products not currently offered for sale by Seller (including COM) shall not be authorized for return. All returned Products must be unused, in original condition and in the original Seller packing cartons. No refund or credit shall be given for damaged Products.</p>
Held Orders/Storage	<p>If Purchaser requests that an order be held or delayed, prices and terms and conditions in effect at the time of shipment shall apply. If Purchaser requests a delay after the time when Seller can defer production, Purchaser will be invoiced for the Product, payable in accordance with standard terms, when the order is ready for shipment. Seller may transfer the Product to storage, in which case all expenses incurred in connection with storage, including demurrage, preparation for storage, storage charges and handling shall be payable by Purchaser upon submission of invoices by Seller. Risk of loss to the Product shall pass to the Purchaser upon delivery of the Product into storage.</p>

Selling Policy

Customer's Own Material	<p>A Purchaser who requests a fabric or other surface material not standard to Seller's line of Products ("COM") must submit samples of the requested material to Seller prior to entry of a purchaser order. Seller shall determine if the material is suitable to its manufacturing processes and meets any requirements of Underwriters Laboratories. If the COM is acceptable, Seller will then establish a price for using the COM or the Product in question. For a description of the procedures for submitting samples and testing, contact customer resources or your sales representative. Seller shall have no responsibility for the appearance, condition, performance, durability, colorfastness or any other physical attribute of the COM. Purchaser shall indemnify and hold Seller harmless for any damages, injuries or losses arising out of or related to use of the COM on the Product.</p>
Warranty	<p>Seller warrants to the original Purchaser only that the Products Seller manufactures and sells to Purchaser are free of defects in workmanship and materials, during the applicable warranty period set forth below.</p> <p>Warranty period set forth below is for 24-hour, 7 days a week, multi shift use (includes parts and labor to repair).</p> <p>Should any failure to conform with this limited warranty appear to a Product listed below during the applicable warranty period from the date of shipment, Seller shall, upon prompt written notice, repair or replace, at its option and costs, the affected part or parts.</p> <p><i>Product and Period of Warranty</i></p> <p><i>Lifetime: Antenna Workspaces, AutoStrada, Calibre, Crinion Open Table, Currents, Dividends Horizon, Equity, Morrison, Reff Profiles laminate, Series 2 Storage, Template, Antenna Workspaces and other non-wood components (except cascade edge worksurfaces, operational parts, controls, electrical, Lighting, Series 2 Veneer Front Storage, special or custom products, see below)</i></p> <p><i>12 Years: Chadwick, Essentials Work Chairs, Generation by Knoll, Life, Moment, MultiGeneration by Knoll, RPM and Sapper seating (except seating upholstery, textiles, leathers and finishes, see below).</i></p> <p><i>10 Years: Antenna Workspaces, AutoStrada, Crinion Open Table, Reff Profiles wood components, Series 2 Veneer Front Storage, cascade edge worksurfaces, Wood Casegoods (Magnusson, The Graham Collection) (except wood casegoods upholstered surfaces, see below), Interaction tables (except height adjustment mechanisms for Counterforce, crank-adjustable, and split-top tables and worksurfaces, see below), Reuter overheads, Reuter vertical storage, KnollExtra Sapper Monitor Arm Collection, Adjustable keyboard mechanisms and platforms, Communication Boards (except fabric board textiles, see below), Smokador collection (except leathers, see below), and Orchestra Universal Systems Accessories.</i></p> <p><i>5 Years: Operational parts, controls, electrical, Lighting (except light ballasts, bulbs and power supply, see below), special or custom product, wood veneer products, Currents handcrank, Interaction Counterforce, Interaction crank-adjustable, and split-top mechanisms, KnollStudio, CPU storage and all universal storage drawers.</i></p> <p><i>3 Years: Seating upholstery, textiles, leathers and finishes. Fabric boards textiles and Smokador Collection leathers.</i></p> <p><i>2 Years: All other KnollExtra product</i></p> <p><i>1 Year: Light ballasts, bulbs and power supply, seating upholstered armpads and soft armpads, wood casegoods upholstered surfaces.</i></p> <p>This warranty does not apply to:</p> <ul style="list-style-type: none">• Damage caused by a carrier other than the Seller.• Normal wear and tear or acts or omissions of parties other than Seller (including user modification, improper use or installation of Products).• COM or other third party materials applied to Products.• Products not installed by or under the auspices of a Knoll Dealer.• Dramatic temperature variations or exposure to unusual conditions.• Changes in surface finishes, including colorfastness due to aging or exposure to light.• Except as specifically noted above, textiles and upholstery supplied by <i>KnollTextiles</i> (consult current <i>KnollTextiles</i> price list for applicable warranty). <p>Natural variations occurring in wood, marble, and leather shall not be considered defects, and the Seller does not guarantee the colorfastness or matching of the colors, grains or textures, or surface hardness of such materials. The Seller also does not guarantee the colorfastness of fiberglass panel surfaces.</p> <p>THE EXPRESS WARRANTIES CONTAINED HEREIN ARE IN LIEU OF ALL OTHER WARRANTIES, EXPRESS OR IMPLIED, INCLUDING ANY WARRANTIES OF MERCHANTABILITY AND FITNESS FOR PARTICULAR PURPOSE AND ALL OTHER WARRANTIES ARISING FROM COURSE OF DEALING OR USAGE OF TRADE.</p> <p>The remedies provided above are the Purchaser's sole remedies for any failure of Seller to comply with its obligations regarding the workmanship of its Products. Correction of any nonconformity in the manner and for the period of time provided shall constitute complete fulfillment of all liabilities of Seller, with respect to or arising out of the Product furnished hereunder.</p>
Delay/Force Majeure	<p>Seller shall not be liable for failure to perform or for delay in performance due to fire, flood, strike or other labor difficulty, act of God, act of any governmental authority or of the Purchaser, riot, embargo, fuel or energy shortage, wrecks or delay in transportation, inability to obtain necessary labor, materials or manufacturing facilities from usual sources or failure of suppliers to meet their contractual obligations, or due to any cause beyond its reasonable control. If any such event occurs, Seller may extend delivery dates by a period of time necessary to overcome the effect of such delay, allocate available Product or cancel any purchase order.</p>
Compliance with Law	<p>PURCHASER IS SOLELY RESPONSIBLE FOR COMPLIANCE WITH ALL APPLICABLE FEDERAL, STATE AND LOCAL LAWS, ORDINANCES, REGULATIONS, RULES AND STANDARDS RELATING TO THE INSTALLATION, MAINTENANCE, USE AND OPERATION OF THE PRODUCTS.</p>
Patents	<p>Subject to the following provisions, Seller shall, at its own expense, defend or, at its option, settle any claim, suit or proceeding brought against the Purchaser, and/or its vendees, mediate and immediate, so far as based on an allegation that any Product or any part thereof furnished hereunder constitutes a direct or a contributory infringement of any claim of any patent of the United States or Canada. This obligation shall be effective only if Purchaser shall have made all payments then due hereunder and if Seller is notified promptly in writing and given authority, information and assistance for the defense of said claim, suit or proceeding. Seller shall pay all damages and costs awarded in such suit or proceedings so defended.</p> <p>The foregoing indemnity does not apply to the following:</p> <ul style="list-style-type: none">• Products supplied according to a design other than that of Seller, and which is required by the Purchaser.• Combination of the Product with another product not furnished hereunder unless Seller is a contributory infringer.• Any settlements of a suit or proceeding made without Seller's written consent.
Limitations of Liability	<p>SELLER, ITS CONTRACTORS, AUTHORIZED DEALERS AND SUBCONTRACTORS OR SUPPLIERS OF ANY TIER SHALL NOT BE LIABLE TO PURCHASER FOR ANY SPECIAL, INDIRECT, INCIDENTAL OR CONSEQUENTIAL DAMAGES ARISING FROM A BREACH OF THIS AGREEMENT.</p> <p>Purchaser's remedies set forth herein are exclusive and the liability of Seller with respect to the breach of this agreement or any contract entered into between the parties pursuant hereto shall not exceed the price of the Product or part on which such liability is based.</p>

General Ordering Information

The Products

This guide encompasses all standard products for this product group.

Sizes

Dimensions listed in this guide are indicated as:

H = height

W = width

D = depth

Dia. = diameter

Rad. = radius

Pricing

All prices shown are list.

How to Order

Select pattern numbers and quantities required for your complete installation. Product questions can be addressed in the specific sections of this guide or by contacting your sales representative or customer resource representative at 1-800-343-5665.

Next, select options (if required), along with colors and finishes appropriate to each product. Reference the Finishes and Fabrics pages for color designations.

On large installations, an item's "designated area" can be specified to assist in product organization and handling.

To expedite complete / correct entry of your order, be certain all pattern numbers, quantities, colors and area identifications are completely specified. Also, include complete purchase order numbers, bill-to and ship-to addresses, a contact name and specific factory shipping dates required.

Mail all orders to:

Knoll, Inc.

1235 Water Street

East Greenville, PA 18041

Attention: Order Entry

Once your order is entered at Knoll, an acknowledgment will be mailed to you. You will be advised of your scheduled shipping date within five days of the original acknowledgment. If it is necessary to revise your order, please contact your customer resource representative.

Sustainability Statement

Sustainable design is a key component of Knoll's environmental focus. Our commitment to social responsibility and a healthy environment has prompted us to further articulate our longstanding environmental programs and, with encouragement and support from our colleagues in the industry, we have re-energized our focus on such "green" initiatives as life cycle analysis and LEED™ certification. Knoll is proud to have contributed to projects that have received LEED certification from the U.S. Green Building Council.

For the latest information on Knoll products that help our customers achieve LEED certification, log on to knoll.com, click on "About Knoll" and then "Environmental Focus."