

Table of Contents

| | | | |
|---|--|---|----|
| Introduction | Knoll and Sustainable Design | 4 | |
| | AutoStrada Basics | 5 | |
| | AutoStrada Materials and Details | 6 | |
| | AutoStrada Finishes | 7 | |
| | AutoStrada Fabric Options | 8 | |
| | AutoStrada Paint and Laminate Finishes Matrix | 9 | |
| Applied Wall | Introduction | 10 | |
| | Planning the applied wall system | 11 | |
| | Specifying the applied wall system | 12 | |
| | Applied wall frames | 13 | |
| | Horizontal channels | 14 | |
| | Wall trim and corners | 19 | |
| | Wall covers | 21 | |
| | Display shelves | 35 | |
| | Glass shelves | 36 | |
| | Bookshelves | 37 | |
| | Open overhead cabinets | 38 | |
| | Sliding door overhead cabinets with glass doors | 39 | |
| | Sliding door overhead cabinets with laminate or veneer doors | 40 | |
| | Hinged door overhead cabinets | 41 | |
| | Overhead storage mounting kits | 42 | |
| | Power and wire management | 43 | |
| | Accessories | 45 | |
| Spine and linkable screens | Service wall frames | 46 | |
| | Wall crown and base trim covers | 47 | |
| | Structural base cover kits | 50 | |
| | Access covers | 52 | |
| | Spine ends and connectors | 57 | |
| | End Starters | 66 | |
| | Panel system starters and T-ends | 70 | |
| | Power components, spine | 79 | |
| | Add up glass panels, for spine | 82 | |
| | Linkable screens and windows | 83 | |
| | Gallery Screens | 89 | |
| | Panels | Tiled/Monolithic - mono side only with base raceway | 90 |
| | | Mono/Mono - exterior hard side no raceway | 94 |
| Tiled/Monolithic - both sides with base raceway | | 98 | |
| Tiled one side/Slatwall combo other | | 102 | |
| Slatwall/Fabric combo both sides - both sides with base raceway | | 106 | |
| Frameless glass add-ups for panels | | 107 | |
| Posts, panels | | 109 | |
| Trim, panels | | 117 | |
| Power distribution components for one side raceway panels | | 121 | |
| Power distribution components | | 122 | |

| | | |
|-------------------------|---|------------------|
| Medians | 42" Medians with binder depth top shelf | 127 |
| | 42" Medians with binder depth top shelf cont'd | 128 |
| | 42" Medians with legal depth top shelf | 129 |
| | 42" Medians with legal depth top shelf cont'd | 130 |
| | 42" Medians with double end gable | 131 |
| | 42" Medians with double end gable cont'd | 132 |
| | 42" Median storage, binder depth | 133 |
| | 42" Median storage, legal depth | 134 |
| | 49" Medians with binder depth top shelf | 135 |
| | 49" Medians with binder depth top shelf cont'd | 136 |
| | 49" Medians with legal depth top shelf | 137 |
| | 49" Medians with legal depth top shelf cont'd | 138 |
| | 49" Medians with double end gable | 139 |
| | 49" Medians with double end gable cont'd | 140 |
| | 49" Median storage, binder depth | 141 |
| | 49" Median storage, legal depth | 142 |
| | Bridges | 42" Bridge units |
| 49" Bridge units | | 144 |
| Top shelves for bridges | | 145 |
| Window kits for bridges | | 147 |
| Cabinets | Storage Anchored Cabinets, w/BBF and FF configurations | 148 |
| | Storage Anchored Cabinets, with hinged door configurations | 150 |
| | Storage Anchored Cabinets, w/ Wardrobe and BBF | 152 |
| | Storage Anchored Cabinets, w/ Wardrobe and FF | 153 |
| | Storage Anchored Cabinets w/front and back access | 154 |
| | Storage Anchored Cabinets, front access | 160 |
| | Storage Anchored brackets | 163 |
| | Storage anchored cabinet trim | 164 |
| | Freestanding Cabinets for private office | 165 |
| | Freestanding Cabinets for open plan use with metal case pedestals | 169 |
| Lower Storage | Metal case | 170 |
| | Wood or laminate case | 175 |
| | Box shelf | 181 |
| Overhead Storage | Overhead storage, wood cases | 182 |
| | Reuter flat front overhead cabinet | 200 |
| | Reuter overhead cabinet mounting options | 201 |
| | T5 Task Light for Reuter Overhead Storage | 202 |
| | T5 Task Light | 203 |
| | Reuter T5 mounting kit | 204 |
| Worksurfaces | Glass Credenza Top Divider | 206 |
| | Flush, user edge tapered | 207 |
| | Cord drop, user edge tapered | 210 |
| | Rectilinear, user and approach edges tapered | 213 |
| | Wedge, user and approach edges tapered | 215 |
| | Peninsula, user and approach edges tapered | 216 |
| | Tables | 217 |
| | Table desks | 219 |
| Support Components | Spine-based support | 221 |
| | Linkable screen mounted worksurface support | 222 |
| | Panel hung worksurface support | 223 |
| | Worksurface support | 224 |
| | Stiffeners | 227 |
| Accessories | Tackboard sections for medians and bridges | 228 |
| | Slatwall sections for medians and bridges | 229 |
| | Wall hung tackboards | 230 |
| | Worksurface stand-offs and cabinet feet | 231 |

| | | |
|------------------------------|---|-----|
| Crinion Open Table | Introduction | 232 |
| | Specifications | 233 |
| | Crinion Open Table Finishes | 234 |
| | Worksurfaces with center hinged power access | 235 |
| | Worksurfaces with edge grommet | 236 |
| | Worksurfaces with cord drop | 237 |
| | End counters | 238 |
| | Extended end counters | 239 |
| | File tops | 241 |
| | Complete base assemblies fixed height 24" D dual | 242 |
| | Complete base assemblies fixed height 24" D single sided | 243 |
| | Complete base assemblies fixed height 30" D dual | 244 |
| | Complete base assemblies fixed height 30" D single sided | 245 |
| | Complete base assemblies adjustable height 30" D dual | 246 |
| | Complete base assemblies adjustable height 30" D single sided | 247 |
| | Complete base assemblies fixed height 36" D dual | 248 |
| | Complete base assemblies fixed height 36" D single sided | 249 |
| | Complete base assemblies adjustable height 36" D dual | 250 |
| | Complete base assemblies adjustable height 36" D single sided | 251 |
| | Top channels | 252 |
| | Beams for single sided or dual tables | 253 |
| | Beams for dual tables | 254 |
| | Beams for single sided tables | 255 |
| | End legs, intermediate leg sets for dual tables | 256 |
| | End legs, intermediate leg sets for single sided tables | 258 |
| | Beam trusses | 259 |
| | Worksurface support | 260 |
| | Modular Raceway | 262 |
| | Hardwire Raceway | 268 |
| | Cable tray and cable clips | 269 |
| | Beam mounted cable trays and cable baskets | 270 |
| | Center screens | 271 |
| | Shelves, adapters and buttresses for slatwall screens | 273 |
| | Side screens | 274 |
| | Return screens | 276 |
| | Dual end screens | 278 |
| | Single sided end screen | 280 |
| | Frameless glass Add up | 282 |
| | Morrison Network privacy screens | 283 |
| Alpha-Numeric Index | | 284 |
| Selling Policy | | 300 |
| KnollKey Lock Program | | 302 |
| General Ordering Information | | 303 |

Knoll and Sustainable Design

Each year Knoll sets key initiatives in our journey to sustainability. We are members of a global consortium on energy, have adopted a scientific, metrics-based approach to sustainable product design, and maintain a leadership position in establishing universal, verifiable, sustainability standards for our industry.

Knoll promotes independent third-party certification because it provides the most impartial and trustworthy foundation for industry-wide environmental compliance. Certification by established and respected third parties ensures that all manufacturers are held to the same high standards and that customers can trust a company's declaration about the environmental benefits of its products. Knoll third-party partners include: the International Standards Organization (ISO); Forest Stewardship Council (FSC); GREENGUARD® Environmental Institute; and Chicago Climate Exchange (CCX®).

In addition, Knoll is aligned with the U.S. Green Building Council and can help companies, healthcare organizations and educational institutions achieve Leadership in Energy and Environmental Design (LEED®) workplace certification.

1. Global Climate Change

- Knoll is a sponsor of the Clinton Global Initiative, which brings together a community of global leaders to devise and implement solutions to some of the world's most pressing challenges, including environmental change.
- Knoll is a member of the Chicago Climate Exchange, which promotes greenhouse gas reduction through the trading of credits earned for reducing emissions.
- Knoll has a comprehensive Energy Management Program to increase energy efficiency in products and processes.

2. Life Cycle Assessment (LCA) Tool

Life Cycle Assessment is a science-based measurement of a product's environmental impacts throughout its life cycle, from raw materials sourcing through manufacture, shipping, use, and re-use or end-of-life. LCA enables cradle-to-cradle implementation of sustainable practices.

- Knoll partners with The Green Standard.org (formerly the International Design Center for the Environment, or IDCE) to develop an affordable, universal, ISO-compliant computer-based LCA tool that can be used by the entire contract furniture industry.

An affordable universal LCA tool has enormous potential value to:

- Help stop dangerous and irreversible climate change
- Conserve natural resources and reduce waste
- Improve quality of life
- Eliminate market confusion about green products using real metrics and sound science
- Facilitate design innovation
- Advance the sustainability triple bottom line: environment, economics and social equity

3. Setting Industry Standards

- Knoll partners with MTS (The Institute for Market Transformation to Sustainability) to develop the SMaRT® Consensus Sustainable Products Standards, a set of consensus-based sustainable product standards based on the LEED® model, for all building products, fabric, apparel, flooring and carpet. MTS, the developer of SMaRT®, is an accredited American National Standards Institute (ANSI) standard developer.
- Knoll also participates in an ongoing BIFMA (Business and Institutional Furniture Manufacturers Association) initiative to establish sustainability standards for the contract furniture industry.
- Our goal is to encourage all manufacturers in the contract furniture and related industries to adopt standards that will lead to sustainable products and practices.

For more information about Knoll environmental, health and safety programs, visit knoll.com/environment.

Introduction

With a commitment to innovation and modern aesthetics, Knoll sets the standard for the environment in which people work. AutoStrada is one of the most comprehensive office concepts to be developed by Knoll. Evolving workplace needs are met with innovative design, from private offices to collaborative spaces for team interaction.

AutoStrada addresses any office combination with a consistent aesthetic of high quality materials and carefully detailed design. Whether an office requires a high-performance open plan system, refined architectural case goods, progressive private office furniture, or a collaborative “big table” concept, AutoStrada provides a solution.

AutoStrada is a planning approach that combines furniture and interior architecture for both open plan and private offices spaces.

AutoStrada is a premium, one-source design.

AutoStrada is the definition of the most advanced technology management capabilities.

AutoStrada is modern. It is absolute design with a strong, basic design premise.

The Planning Models

Four AutoStrada planning models offer one set of continuous, intelligent, solutions-oriented capabilities.

Four ways AutoStrada redefines space:

- Spine-based planning
- Storage-anchored planning
- Collaborative table-based planning
- Architectural office planning

Any one environment could include solutions provided by any mix or all of the four planning models. Diverse planning models meet cross-cultural workplace environments everywhere.

AS1 AutoStrada spine based planning

AutoStrada spine based planning provides wall-like architectural order to office interiors and offers high performance technological support. The spine supports continuous off-module attachment of workspaces, storage components, KnollExtra accessories, and perpendicular linkable screens or panels to define workstations. The spine also manages and distributes power and communications throughout clusters of workstations, enabling convenient outlets at desk height and unobstructed access to cabling.

Spines can be built to any one foot increment of length and can be freestanding with outriggers to support cantilevered workspaces and overhead storage. Spines may also be integrated with attached panels or screens for support and enclosure. T-ends enable the spine to extend to absorb the dimensional gain of attached panels.

Spine covers include veneer, laminate, dry-erase marker, tackable fabric, integral shelves, slatwall and integral cable tray surfaces. Spines are available in three horizons--39”H, 48”H and 64”H--and may be fitted with frameless glass add ups for additional privacy above any of four crown profiles.

Linkable screens are available in tackable upholstered or glazed panels and windows, with a complete range of connectors that also support workspaces and storage.

AS2 AutoStrada storage anchored planning

AutoStrada storage anchored planning redefines the open office architecture with aesthetic and functional alternatives to conventional panel-based systems. Storage anchored planning begins with the anchor cabinet to which either AutoStrada panels or wood or laminate surrounds are attached to create individual or shared work areas. Storage anchored planning combines the performance of systems furniture with elegant details more like custom millwork.

AutoStrada panels feature a laminate or veneer tiled grid to the floor, with aluminum reveals between tiles on the exterior, and fabric or fabric and slatwall surfaces on the inside of the workstation. Interior base raceway distributes power and communications throughout a cluster with outlets only on the inside of the panels. AutoStrada panel heights enable seated access (42”H), seated privacy (49”H) or standing privacy (64”H). Frameless glass add ups can be added to panels for additional privacy. Connectors support workspaces, overhead storage or shelves and KnollExtra paper management and technology support tools.

AutoStrada surrounds, in veneer or laminate surface, are ideal for raised floor environments and a visual alternative to panels. Median surrounds or median storage form the backbone to which bridges and anchor cabinets are attached. Medians include a back panel, one or two end gables, a counter surface and a workspace or shelves. Bridges include a back panel and workspace. AutoStrada surrounds typically describe workstation boundaries at a 49” horizon.

AS3 AutoStrada wall based planning

AutoStrada wall based planning integrates freestanding and wall supported storage, desks and tables to build distinctive workspaces in private offices and walled collaborative areas.

AutoStrada Applied Walls add systems performance to built walls, enabling various surface materials and off module support for shelves, overheads and workspaces. Applied wall is either 69”H or 84”H, in any 6” increment of width. Horizontal channels contain interchangeable inserts like veneer, marker surface, fabric, glass, slatwall or recessed covers, and accept brackets for a variety of accessories at any point. Wall frames transfer most of the supported load directly to the floor.

AutoStrada overheads and tackboards can also be directly attached to most built walls. Freestanding AutoStrada cabinets for private offices are available in 70” and 84” horizons.

AS4 AutoStrada collaborative planning

AutoStrada collaborative planning is based on the Crinion Open Table, which creates open shared workspaces for groups from two to ten or more at a continuous workspace “bench”. Designed to support teams of people Crinion Open Table is ideal for trading rooms, libraries and conference rooms.

Crinion Open Table offers a unique alternative to traditional workstations, with continuous cantilevered workspaces, unobstructed kneespace, convenient, capable power and communications distribution, and optional desktop privacy screens. An extremely strong structure supports workspaces up to 36”d each side and virtually unlimited in length.

Crinion Open Table may be complemented with AutoStrada metal or wood storage, or Calibre files and cabinets as parallel file banks or as returns.

Materials

AutoStrada offers a range of exceptional materials and finishes, including premium grade hardwood veneers, Techwood, laminate, clear anodized aluminum, and architectural glass.

Veneers are all hand selected to best showcase the beauty of natural grain. Every effort is made to ensure that Knoll veneers are the best that can be sourced in quality of color, consistency and size. Natural variations of wood are not considered to be defects. The natural process of color change in real wood products is part of the beauty and unique character of the material. Knoll expects wood to patina over time.

Techwood is a genuine wood veneer which has been enhanced by technology to provide color and grain consistency.

High recycled content aluminum is used in the manufacture of aluminum components.

High-pressure laminate surface materials have been selected for their durability and low maintenance.

FSC (Forest Stewardship Council) certified materials are available by request.

Construction details

All AutoStrada worksurfaces are 1 1/4" thick and are a 3 ply solid construction. Worksurfaces are available in rectilinear and wedge shapes. The distinctive 3/8" tapered edge can be specified on just the user side or also on the approach side. Worksurfaces can be specified "full depth" with or without grommets, or with a 3/8" cord drop along the back with a centered edge grommet.

Worksurfaces appear to "float" 1" above lower storage components. Pedestals and legs can support a worksurface height of 28 1/4"H (typically in open plan) or 29 5/8" (in private offices). The higher worksurface height requires wood pedestals equipped with cabinet feet.

Pedestals and overhead storage are available in either metal or wood case. Wood pedestals have full extension file drawer slides with bottom-loadable steel floor and 3/4 extension slides all wood construction box drawers.

Wood or laminate case cabinets with hinged doors and adjustable shelves require doors to be removed to adjust shelving; alternatively a special request 170° hinge package is available to retrofit cabinets in the field.

Metal pedestals and Reuter overhead storage cabinets with flat front are durable steel construction with painted, laminate or veneer drawer fronts.

Metal pedestals feature full width protruding aluminum pull. Metal pedestals have all full extension personal, data and file drawer slides.

Wood cases incorporate 3 ply construction and components are finished on all sides. Core material is 45lb density particleboard. Wood drawers feature dovetail joinery details. File drawers have steel floor and are bottom loadable. Wood drawers feature full width anodized aluminum recessed or protruding pull. File drawers include file bars to support letter or legal suspended filing in either direction.

Freestanding private office cabinets are supported by cylindrical extruded aluminum feet which match an optional worksurface standoff detail.

Spine, linkable screens, panels, legs and metal storage offer 1" or greater levelling capacity. Wood storage has 1/2" levelling.

Cable management

AutoStrada incorporates discreet and concealed wire management as well as four or six circuit power distribution in all four planning models, supporting low to very high technology requirements. Storage anchored surrounds, designed for raised floor environments, are the only planning type that does not have power distribution capability.

Leg design

AutoStrada support legs are a refined shape in clear anodized aluminum finish. Legs feature either lockable casters or a unique glide sleeve that allows leveling without exposed glide threads. A pair of straight legs or one 9" wide leg can support one end of a worksurface when the other end is spine-supported, panel-supported or joined to a perpendicular worksurface with AT2TB brackets. If distance between support spans over 48", additional support is required.

Two pairs of straight legs may also be specified to create a freestanding table in combination with an AutoStrada worksurface not to exceed 72" x 30" with a corresponding stiffener.

Locks

All pedestals and cabinets with drawers are supplied with a ganglock mechanism in place. In addition, cabinets 30" wide and over with drawers have an interlock anti-tip feature to prevent the opening of a second drawer when one is already open. Drawer fronts and door fronts where applicable are routed to receive the lock itself. Keying instructions for key alike must accompany all orders and are field installed. Products are shipped from the factory with random locks or lock plugs for key-alike orders.

Representative Dimensions

All dimensions in this price list are nominal and for representative purposes only. For specific build dimensions please consult specification planning tools or contact your Customer Service representative.

Line drawings in this price list are strictly for quick product identification.

Finishes**L - Laminate**

Matching edge band unless noted otherwise

| | |
|-----|--|
| 117 | Soft Grey |
| 118 | Bright White |
| 114 | Folkstone Grey |
| 111 | Jet Black |
| 119 | Pumice |
| 121 | Micro Grey with 114 Folkstone grey edge band |
| 122 | Brushed Sand with 119 Pumice edge band |
| 123 | Brushed Grey with 128 Fog edge band |
| 128 | Fog |
| 129 | Micro Sand with 119 Pumice edge band |
| 124 | Medium Cherry |
| 125 | Natural Maple |
| 126 | Natural Cherry |
| 127 | Walnut |

V1 - Techwood Closed Pore

| | |
|------|---------------|
| Y319 | Cherry |
| Y326 | Dark Mahogany |
| Y316 | Maple |
| Y323 | Medium Walnut |
| Y327 | Light Oak |
| Y329 | Medium Oak |
| Y851 | Black Oak |
| Y341 | Wenge |
| Y342 | Medium Teak |
| Y343 | Dark Grey Oak |
| Y344 | Espresso |

V2 – Natural veneer

| | |
|--------------------------------------|----------------------|
| V312 | Bronze Cherry |
| V316 | Maple |
| V411 | Light Walnut |
| V415 | Peacock Green Walnut |
| V417 | Old English Walnut |
| V418 | Smoked Walnut |
| V433 | Light Fawn Cherry |
| V436 | Medium Brown Cherry |
| <i>(all above V2's are flat cut)</i> | |
| V421 | Chalk Oak |
| V423 | Light Oak |
| V425 | Amber Oak |
| V427 | Brown Oak |
| V439 | Straight Anigre |
| <i>(all V2 Oaks are quarter cut)</i> | |

V3 – Exotic veneer

| | |
|----------------------------------|--------------------------|
| V512 | Quartered Figured Anigre |
| V514 | Quartered Makore |
| V515 | Quartered Sycamore |
| V513 | Quartered Graphite Oak |
| V517 | Natural Sapele |
| <i>(all V3s are quarter cut)</i> | |

Paint**P1**

| | |
|-----|----------------|
| 111 | Jet Black |
| 112 | Brown |
| 113 | Dark Grey |
| 114 | Folkstone Grey |
| 115 | Medium Grey |
| 116 | Sandstone |
| 117 | Soft Grey |

P2

| | |
|-----|----------------------|
| 611 | Beige Mist Metallic |
| 612 | Medium Metallic Grey |

P3

| | |
|-----|--------------|
| 118 | Bright White |
| 613 | Silver |

Anodized

| | |
|----|-------------------|
| AA | Anodized Aluminum |
|----|-------------------|

Plated

| | |
|----|----------------|
| PT | Brushed Pewter |
|----|----------------|

Glass

| | |
|------|----------------|
| TEMP | Clear Tempered |
|------|----------------|

Architectural Glass

| | |
|------|--------------|
| GL6 | Block Matrix |
| GL13 | Powder |

Mixed Finishes: (where applicable for work surfaces only)

To order mixed finishes, enter four digit finish code as follows:

Use 2 digit prefix to indicate surface finish (laminate)

| | |
|----|----------------|
| 11 | Jet Black |
| 14 | Folkstone Grey |
| 17 | Soft Grey |
| 18 | Bright White |
| 19 | Pumice |
| 21 | Micro Grey |
| 22 | Brushed Sand |
| 23 | Brushed Grey |
| 28 | Fog |
| 29 | Micro Sand |

Use 2 digit suffix to indicate edge finish (wood)

| | |
|----|----------------|
| 12 | for V312 |
| 16 | for V316, Y316 |
| Y9 | for Y319 |
| Y3 | for Y323 |
| 26 | for Y326 |
| 27 | for Y327 |
| 29 | for Y329 |
| 43 | for V433 |
| 45 | for V415 |
| 46 | for V436 |
| 47 | for V417 |
| 48 | for V418 |
| 52 | for V512 |
| 53 | for V513 |
| 54 | for V514 |
| 55 | for V515 |
| 57 | for V517 |
| 61 | for V411 |
| 71 | for V421 |
| 73 | for V423 |
| 75 | for V425 |
| 77 | for V427 |

Example:

For a Micro Grey laminate surface with Bronzed Cherry edge, enter finish code 2112

For a Jet Black laminate surface with Light Maple edge, enter finish code 1116

Fabric Options*Grade 10*

Bailey II (W359)
 Broadcloth (W288)
 Element (W1077) ●
 Foundation (W351)
 Growth Spurt (W692)
 Newbury (W812)
 Solid Crepe (W257)
 Symbolic Detail (W693)
 Tailor Made (W133)
 Versatility (W432)

Grade 15

Regency (W210)

Grade 20

Archaea (W1254) ●
 Banyan (W443)
 Bauhaus Block (W296A)
 Circle Line (W1146)
 Clarity (W281)
 Criss Cross (W305)
 Devon (W809)
 Melbourne (W228)
 Outback (W229)
 Photon (W1293)
 Reflect (W884)
 Resolution (W280)
 Walkabout (W230)
 Weave Three (W298)

Grade 30

Basket Draft (W249)
 Flow (W565)
 Harmony (W232)
 Interknit (W1090)
 Match Point (W1145)
 Micro (W465) *
 Progression (W403)
 Raku Cloth (W566)
 Relay (W1020) ▲

Grade 40

Amplify (W1215) ●
 Bandwidth (W1219) ●
 Clarkson (W1218)
 Hard Rock (W1007) ●
 Ornament (W1078)
 Palladium (W1030) ▲

Grade 45

Casual Elegance (W920)
 Dristi (K872) *

Grade 50

Knoll Hopsack (K1206)
 Presto (K1000) ●
 Ricochet (K498)

Grade 55

Knoll Felt (K1207) ▲
 Transition (W816)

**with backing only*

▲ Monolithic panels, linkable screens and tackboards only

● Linkable screens and add ups only

The following textiles are approved for use on panels. Consult Knoll representative for pricing:

Customers Own Material

Prices for panels that are to be manufactured with a customer supplied fabric will follow Grade 10 panel pricing. Customer's Own Material is subject to an application testing fee of \$750 per fabric and a \$2500 fee for UL testing. Panels bearing COM fabrics are subject to extended leadtimes. It is the responsibility of the customer's purchasing agent to ensure COM fabric is supplied for testing and manufacturing. Delays in receiving COM fabric for manufacturing will result in rescheduled delivery dates.

| | | All standard Paint Finishes | AA or all paints except Silver | Laminate Horizontal Surfaces | Laminate Vertical Surfaces | Anodized Aluminum Only |
|---|--|-----------------------------|--------------------------------|--|-----------------------------|------------------------------------|
| AS1 Spine Based | | standard crown covers | spine base trim covers | worksurfaces | structural base covers | |
| | | structural base covers | slatwall covers | tables | access covers | |
| | | outlet covers | integral shelves | | fronts for metal pedestals | |
| | | spine connectors | flat crown covers | | fronts for Reuter overheads | |
| | | metal pedestals and fronts | flat crown covers | | box shelves | |
| | | Reuter cases and fronts | straight legs | | | |
| | | | wide legs | | | |
| AS2 Storage Anchored | | slatwall, panel | panel top trim | worksurfaces | all laminate pedestals | top trim wider than 96" |
| | | panel raceway covers | panel reveals | | anchor cabinets | |
| | | | storage reveals | | medians | |
| | | | pulls | | bridges | |
| | | | | | tiles, panels | |
| AS3 Applied Wall & private office components | | wall covers | horizontal channels up to 96" | worksurfaces | all laminate overheads | |
| | | coat hook | slatwall covers | tables | wall covers | horizontal channels wider than 96" |
| | | picture hook | recess covers | applied wall shelves | freestanding storage | |
| | | bookends | end trim | | wall hung overheads | |
| | | | cable tray | | | |
| | | | marker tray | | | |
| | | | display shelf | | | |
| AS4 Crinion Open Table | | end legs | hinged access | worksurfaces, tapered edge and post formed | | beams |
| | | intermediate legs | top channel up to 96" | | | top channel longer than 96" |
| | | cantilevers | screen frames | | | |

| Finish code | Finish name | Paint grade | All standard Paint Finishes | AA or all paints except Silver | Laminate Horizontal Surfaces | Laminate Vertical Surfaces | Anodized Aluminum Only |
|-------------|----------------------|-------------|-----------------------------|--------------------------------|------------------------------|----------------------------|------------------------|
| 611 | Beige Mist Metallic | P2 | • | • | | | |
| 118 | Bright White | P3 | • | • | • | • | |
| 112 | Brown | P1 | • | • | | | |
| 123 | Brushed Grey | | | | ▲ | | |
| 122 | Brushed Sand | | | | ▲ | | |
| 113 | Dark Grey | P1 | • | • | | | |
| 128 | Fog | | | | • | • | |
| 114 | Folkstone Grey | P1 | • | • | • | • | |
| 111 | Jet Black | P1 | • | • | • | • | |
| 115 | Medium Grey | P1 | • | • | | | |
| 612 | Medium Metallic Grey | P2 | • | • | | | |
| 121 | Micro Grey | | | | ▲ | | |
| 129 | Micro Sand | | | | ▲ | | |
| 119 | Pumice | | | | • | • | |
| 116 | Sandstone | P1 | • | • | | | |
| 613 | Silver | P3 | • | | | | |
| 117 | Soft Grey | P1 | • | • | • | • | |
| 812 | Easy Grey* | | | | | | |
| 813 | Trim Grey* | | | | | | |
| AA | Anodized Aluminum | | | • | | | • |
| LW | Markerboard White ** | | | | | | |

Notes:

▲ All laminates have matching edge bands except:
 123 Brushed Grey has 128 Fog edge
 122 Brushed Sand has 119 Pumice edge
 121 Micro Grey has 114 Folkstone grey edge
 129 Micro Sand has 119 Pumice edge

* Easy Grey and Trim grey integral colors only available for
 Compact crown covers
 Linkable screen trim
 Linkable screen top caps
 Spine end connector top caps

** Markerboard white is available only on AS1 spine access covers, AS3 Applied Wall covers and AS4 screens.

Introduction

AutoStrada Applied Wall System is designed for systems performance in built wall environments. Applied Wall enables a variety of interchangeable wall surface materials, continuous support for worksurfaces, shelves and overhead storage, power distribution and integrated wire management. Applied Wall System supports AutoStrada components in private offices and collaborative work spaces, while transmitting much of the weight load directly to the floor.

Applied Wall System includes:

- wall mount frames which stand on leveling glides and are secured to built walls
- horizontal channels that are attached to the frames
- covers that insert between the channels
- shelves and overhead storage components that can be engaged anywhere along the channels
- cable tray, worksurface support brackets and accessories

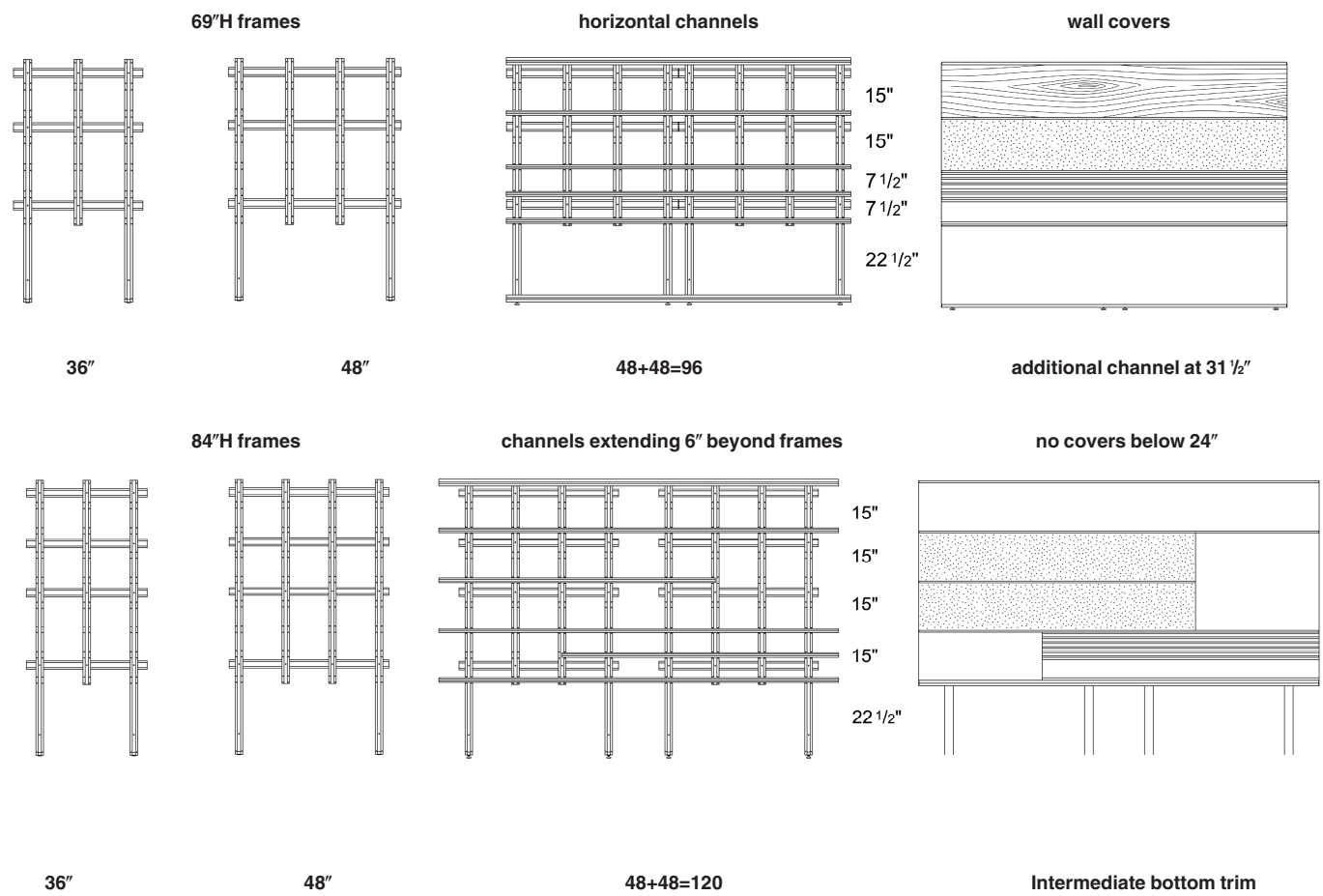

Frames

Wall mount frames are available in 69" and 84" horizons, 36" or 48" wide. Frames are steel weldments that include two or three horizontal rails through which frames are bolted to the vertical structure of the built wall. Adjacent frames can be leveled and shims enable each frame to be made plumb. At each side are vertical frame members with leveling glides. Between the side frame members are one or two intermediate studs that extend from approximately 24" above the floor to the top of the frame.

Channels

Channels are painted or natural anodized aluminum extrusions that hold covers and feature a continuous curved slot into which components and brackets are inserted. Channels are attached to the frames at each side member and stud with a bracket above and below. Channels do not need to align with frame widths and can extend up to 6" beyond the side of a frame.

Top channels, 36"-144" in width in 6" increments, attach only at the top of the frame and finish off the top of the assembly. Intermediate channels, 24"-144" in 6" increments of width, attach typically every 15" below the top channel, but may also be set at 7 1/2" or 22 1/2" increments to accommodate specific purpose covers such as slatwall or markerboards. Bottom channels, 36"-144" in 6" increments of width, attach only at the base of a wall frame to support covers below worksurface height (between 1 1/2" and 24" above the floor). If no covers are planned below 24" no bottom channel is required but intermediate bottom trim cover and vertical frame covers are recommended to enclose the structural frame.

Covers

Wall covers are designed to insert between channels and may be interchanged without removing channels. Covers are optional and not required behind overhead storage cabinets or below worksurface height, for example. The scope of wall covers includes:

- 7 1/2"H recess covers for surface-mounted plugmold and voice/data outlets, normally mounted just below worksurface height, with optional cable trays
- 7 1/2"H slatwall covers to support KnollExtra accessories
- 15" and 22 1/2"H tackable linoleum covers
- 7 1/2", 15", 22 1/2" and 30"H veneer, laminate, paint, fabric, tackable fabric covers
- 7 1/2", 15", 22 1/2", 30", 45" H marker.

All covers are available from 24"-96" in 6" increments of width except laminate and marker, 24"-72".

Components

- 5 1/2" deep display shelves in painted or clear anodized aluminum, 24"-72" wide in 6" increments
- 9" deep, 1/2" thick glass shelves and 12" deep plastic laminate or wood veneer bookshelves, 24"-72" wide, designed to align with the bottom of an adjacent cabinet,
- 9" deep glass and 12" deep plastic or veneer bookshelves to align with the top of an adjacent cabinet,
- open overhead storage units in plastic laminate or wood veneer, 18"-96" wide
- overhead storage units with solid or glass sliding doors, 42"-96" wide in 6" increments
- fully enclosed overhead storage units with hinged doors, 18"-96" wide,
- Reuter overhead storage, task lights and fascias for wood overhead storage,
- grommets for wall covers, surface mounted plugmold raceway and cable trays,
- support brackets for the back or end of a worksurface, and
- accessories such as coat hook, picture hook, marker tray, notepad, and horizontal/vertical wire manager clips.

Other cover sets

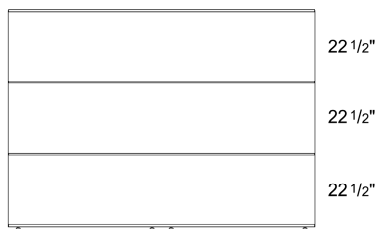

69" frames

display wall with marker surface

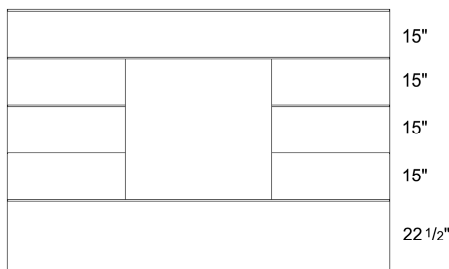

84" frames

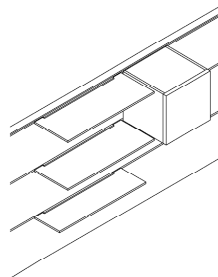

Upper shelf, lower shelf, glass shelf and overhead

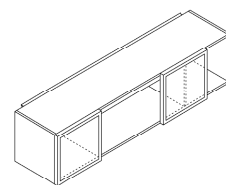

sliding doors

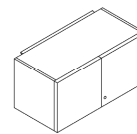

hinged doors

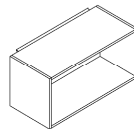

open overhead

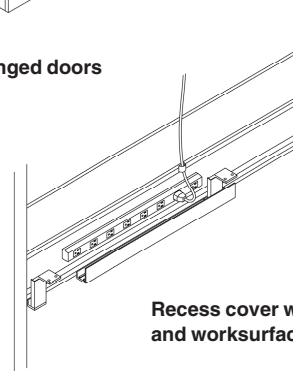

Recess cover with cable tray and worksurface brackets

How to specify Applied Wall

1. Plan frames to support the height and width of the intended overall wall system. Frames can be installed side-by-side or as much as 12" apart to provide adequate structure for horizontal channels up to 6" wider than the frame on each side. For example, a 10' length of channels and wall covers can be supported by three 36" wide frames or by two 48" wide frames.
2. Specify horizontal channels at each level required for covers and overhead storage or shelves. A top channel is always required and intermediate channels may be attached to the frame at any 7 1/2" increment above 24", 31 1/2", 39", 46 1/2", 54", 61 1/2", or 69" above the floor.
3. Typically intermediate channels are planned at 24", 39" and 54" to support 15"h covers. An additional channel at 31 1/2" will enable 7 1/2"h covers above and below worksurface height for slatwall and power/wire management. Horizontal channels can be planned the full width of the wall or may be segmented to allow taller covers such as a markerboard in specific locations. Alternatively intermediate channels may be planned at 24" and 46 1/2" on a 69"H frame to support all 22 1/2" H covers.
4. Specify bottom channel to support 22 1/2"H covers between floor and 24". Specify intermediate bottom trim and vertical frame covers if leaving the frame open below 24".
5. Specify end trim if end of wall is visible and specify corner connectors, if any.
6. Specify functional covers such as recess cover, the mounting location for surface mounted power distribution and voice/data outlets, and slatwall covers. Also specify tackable or marker surface covers. Then fill in the wall with decorative covers such as wood veneer, plastic laminate, non-tackable fabric, or backpainted glass. If planning a bookshelf the cover below the shelf cannot be glass. Covers are not required behind overhead storage cabinets.
7. Specify overhead storage: display shelves at 31 1/2" or 39", lower bookshelves at 54" and upper bookshelves at 69" to align with adjacent overhead storage cabinets. Specify open, partially open or fully enclosed overhead storage in veneer or laminate surface. Overhead storage cabinets usually hang from a channel at 69" and bear against a channel at 54" above the floor.
8. Specify power and cable trays. Power is distributed by a surface mounted plugmold raceway with ten simplex outlets, available in three configurations: one- circuit three-wire, two-circuit four wire, or two-circuit six wire. A 24" wide plugmold with eight simplex outlets is also available. Raceways are always hardwired to the building power supply by an electrical contractor. Contractor will punch a hole through the recess cover behind the plugmold to connect from the wall to the plugmold. Recess cover also accommodates voice/data outlets and cable grommets are available to line a punched hole.
9. Specify worksurface supports. Worksurface support brackets can be attached to the channel at 24" above the floor or may be attached within a cable tray at the same level.
10. Add accessories.

Customer's Responsibility:**Attachment of AutoStrada Applied Wall System to built walls**



It is the responsibility of the customer and their structural engineer/architect to verify that the permanent built wall (studs, blocks, solid masonry, or other) to which the Applied Wall System is intended to be attached is designed to support the load bearing standards set forth below. It is also the responsibility of the customer and their structural engineer/architect to specify the fasteners and method for attaching the frames to the built wall and confirm that the installers have followed these specifications. For local standards and additional requirements such as seismic the customer should consult local building and safety codes.

Design loads:

69"H Applied wall: 240#/foot of width. Assume four 60 lb. vertical loads spaced evenly between 24" and 69" above the floor, with the load centered 11" from the built wall.
 84"H Applied wall: 300#/foot of width. Assume five 60 lb. vertical loads spaced evenly between 24" and 84" above the floor, with the load centered 11" from the built wall.

Warning/Disclaimer

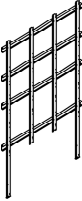
Knoll is not responsible for the attachment method of the Applied Wall System product, which is the responsibility of the customer and its structural engineer/architect. Knoll is not responsible for the cost of preparing an existing wall nor the additional cost for a new wall to make them appropriate for the installation of the Applied Wall System product. Failure to properly attach the Applied Wall System to a wall capable of supporting the loads listed above can lead to property damage and/or personal injury.

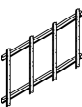
| description | h | w | d | pattern number | black |
|--|---------|-----|--------|-------------------|--------|
| 69"H frames  | 69" | 36" | 1 1/4" | AAWS F6936 | \$480. |
| | 69" | 48" | 1 1/4" | AAWS F6948 | 597. |
| 84"H frames  | 84" | 36" | 1 1/4" | AAWS F8436 | 538. |
| | 84" | 48" | 1 1/4" | AAWS F8448 | 656. |
| 22 1/2" add on frames  | 22 1/2" | 36" | 1 1/4" | AAWS F2236 | 262. |
| | 22 1/2" | 48" | 1 1/4" | AAWS F2248 | 303. |
| 30" add on frames  | 30" | 36" | 1 1/4" | AAWS F3036 | 287. |
| | 30" | 48" | 1 1/4" | AAWS F3048 | 319. |

Order Code

| | |
|----------------------------|---------------------|
| Example: AAWS F6936 | |
| A | AutoStrada |
| AWS | Applied wall system |
| F | Wall frame |
| 69 | Height |
| 36 | Width |

Specification Information

Applied wall frames are painted black

Application Notes

Wall frames attach to built walls to provide level, vertical structure for complete applied wall system assemblies. Wall frames include two leveling glides, studs on 14" centers, and horizontal beams.

Knoll does not supply or recommend specific hardware to fasten frame to built wall.

Add on frames add 22 1/2" or 30" of height to 69" or 84" frames (or other add on frames). Add on frames include stacking hardware.

Horizontal channels

Top channels

| description | h | w | d | pattern number | painted | aluminum |
|---|----|------|----|------------------------|---------|----------|
| Top channel | 1" | 36" | 1" | AAWS TC 036 () | \$65. | \$65. |
|  | 1" | 42" | 1" | AAWS TC 042 () | 76. | 76. |
| | 1" | 48" | 1" | AAWS TC 048 () | 86. | 86. |
| | 1" | 54" | 1" | AAWS TC 054 () | 104. | 104. |
| | 1" | 60" | 1" | AAWS TC 060 () | 109. | 109. |
| | 1" | 66" | 1" | AAWS TC 066 () | 114. | 114. |
| | 1" | 72" | 1" | AAWS TC 072 () | 119. | 119. |
| | 1" | 78" | 1" | AAWS TC 078 () | 131. | 131. |
| | 1" | 84" | 1" | AAWS TC 084 () | 141. | 141. |
| | 1" | 90" | 1" | AAWS TC 090 () | 152. | 152. |
| | 1" | 96" | 1" | AAWS TC 096 () | 158. | 158. |
| | 1" | 102" | 1" | AAWS TC 102 () | n/a | 163. |
| | 1" | 108" | 1" | AAWS TC 108 () | n/a | 174. |
| | 1" | 114" | 1" | AAWS TC 114 () | n/a | 180. |
| | 1" | 120" | 1" | AAWS TC 120 () | n/a | 185. |
| | 1" | 126" | 1" | AAWS TC 126 () | n/a | 190. |
| | 1" | 132" | 1" | AAWS TC 132 () | n/a | 207. |
| | 1" | 138" | 1" | AAWS TC 138 () | n/a | 212. |
| | 1" | 144" | 1" | AAWS TC 144 () | n/a | 217. |

| Order Code | Specification Information | Application Notes |
|--------------------------------|--|---|
| Example: AAWS TC 036 AA | AA- Anodized Aluminum. | <p>Top channel attaches only at the top of wall frames to provide continuous slot for component support and retention for top of wall covers. Top channel encloses top of frames to within 1/4" of the built wall for cord passage.</p> <p>Specify top channel in length to match overall length of applied wall covers, or in shorter segments. Top channel can extend past wall frame up to 6" on each end.</p> |
| A AutoStrada | <p>All standard painted finishes except 613 Silver also available for channels up to 96" wide.</p> | |
| AWS Applied wall system | | |
| TC Top channel | | |
| 036 Width | | |
| AA Finish | | |

Horizontal channels

Top Up channels

| description | h | w | d | pattern number | painted | aluminum |
|----------------|----|------|----|------------------------|---------|----------|
| Top Up channel | 1" | 36" | 1" | AAWS TU 036 () | \$157. | \$157. |
| | 1" | 42" | 1" | AAWS TU 042 () | 183. | 183. |
| | 1" | 48" | 1" | AAWS TU 048 () | 209. | 209. |
| | 1" | 54" | 1" | AAWS TU 054 () | 251. | 251. |
| | 1" | 60" | 1" | AAWS TU 060 () | 262. | 262. |
| | 1" | 66" | 1" | AAWS TU 066 () | 272. | 272. |
| | 1" | 72" | 1" | AAWS TU 072 () | 282. | 282. |
| | 1" | 78" | 1" | AAWS TU 078 () | 292. | 292. |
| | 1" | 84" | 1" | AAWS TU 084 () | 471. | 471. |
| | 1" | 90" | 1" | AAWS TU 090 () | 471. | 471. |
| | 1" | 96" | 1" | AAWS TU 096 () | 471. | 471. |
| | 1" | 102" | 1" | AAWS TU 102 () | n/a | 496. |
| | 1" | 108" | 1" | AAWS TU 108 () | n/a | 496. |
| | 1" | 114" | 1" | AAWS TU 114 () | n/a | 496. |
| | 1" | 120" | 1" | AAWS TU 120 () | n/a | 496. |
| | 1" | 126" | 1" | AAWS TU 126 () | n/a | 508. |
| | 1" | 132" | 1" | AAWS TU 132 () | n/a | 508. |
| | 1" | 138" | 1" | AAWS TU 138 () | n/a | 508. |
| | 1" | 144" | 1" | AAWS TU 144 () | n/a | 508. |

| Order Code | Specification Information | Application Notes |
|--------------------------------|---|--|
| Example: AAWS TU 073 AA | AA- Anodized Aluminum. | Top Up channels are an alternative to top channels at the top of wall frames or add on frames. |
| A AutoStrada | All standard painted finishes except Silver also available for channels up to 96" wide. | Top Up channel enables covers to be mounted above the applied wall. Specify ceiling channel separately to retain top of covers mounted above frames. |
| AWS Applied wall system | | Top Up channel provides continuous slot for component support, retains top of covers on frame and bottom of covers mounted above frame. |
| TU Top Up channel | | Top Up channel encloses top of frames to within 1/4" of the built wall for cord passage. |
| 072 Width | | Specify Top Up channel in length to match overall length of applied wall covers, or in shorter segments. Top Up channel can extend past wall frame up to 6" on each end. |
| AA Finish | | |

Horizontal channels

Ceiling channels

| description | h | w | d | pattern number | painting | aluminum |
|-----------------|----|------|----|------------------------|----------|----------|
| Ceiling channel | 1" | 36" | 1" | AAWS CC 036 () | \$131. | \$131. |
| | 1" | 42" | 1" | AAWS CC 042 () | 146. | 146. |
| | 1" | 48" | 1" | AAWS CC 048 () | 162. | 162. |
| | 1" | 54" | 1" | AAWS CC 054 () | 178. | 178. |
| | 1" | 60" | 1" | AAWS CC 060 () | 194. | 194. |
| | 1" | 66" | 1" | AAWS CC 066 () | 209. | 209. |
| | 1" | 72" | 1" | AAWS CC 072 () | 224. | 224. |
| | 1" | 78" | 1" | AAWS CC 078 () | 251. | 251. |
| | 1" | 84" | 1" | AAWS CC 084 () | 366. | 366. |
| | 1" | 90" | 1" | AAWS CC 090 () | 366. | 366. |
| | 1" | 96" | 1" | AAWS CC 096 () | 366. | 366. |
| | 1" | 102" | 1" | AAWS CC 102 () | n/a | 387. |
| | 1" | 108" | 1" | AAWS CC 108 () | n/a | 387. |
| | 1" | 114" | 1" | AAWS CC 114 () | n/a | 387. |
| | 1" | 120" | 1" | AAWS CC 120 () | n/a | 387. |
| | 1" | 126" | 1" | AAWS CC 126 () | n/a | 408. |
| | 1" | 132" | 1" | AAWS CC 132 () | n/a | 408. |
| | 1" | 138" | 1" | AAWS CC 138 () | n/a | 408. |
| | 1" | 144" | 1" | AAWS CC 144 () | n/a | 408. |

Order Code

| | |
|------------|-----------------------|
| Example: | AAWS CC 036 AA |
| A | AutoStrada |
| AWS | Applied wall system |
| CC | Ceiling channel |
| 036 | Width |
| AA | Finish |

Specification Information

AA- Anodized Aluminum.
 All standard painted finishes except Silver also available for channels up to 96" wide.

Application Notes

Ceiling channels are fastened directly to the building wall to retain the top of covers up to 30"H mounted above wall frames with Top Up channel.
 Ceiling channels do not accept brackets for applied wall storage, shelves or accessories.
 Specify ceiling channels in lengths to match overall width of covers mounted above frames or in shorter segments.

Knoll does not supply or recommend specific hardware for fastening ceiling channel to building wall.

Horizontal channels

Intermediate channels

| description | h | w | d | pattern number | painting | aluminum |
|---|------|------|------------------------|------------------------|----------|----------|
| Intermediate channel  | 1" | 24" | 1" | AAWS IC 024 () | \$55. | \$55. |
| | 1" | 30" | 1" | AAWS IC 030 () | 60. | 60. |
| | 1" | 36" | 1" | AAWS IC 036 () | 65. | 65. |
| | 1" | 42" | 1" | AAWS IC 042 () | 76. | 76. |
| | 1" | 48" | 1" | AAWS IC 048 () | 81. | 81. |
| | 1" | 54" | 1" | AAWS IC 054 () | 98. | 98. |
| | 1" | 60" | 1" | AAWS IC 060 () | 104. | 104. |
| | 1" | 66" | 1" | AAWS IC 066 () | 109. | 109. |
| | 1" | 72" | 1" | AAWS IC 072 () | 114. | 114. |
| | 1" | 78" | 1" | AAWS IC 078 () | 126. | 126. |
| | 1" | 84" | 1" | AAWS IC 084 () | 146. | 146. |
| | 1" | 90" | 1" | AAWS IC 090 () | 152. | 152. |
| | 1" | 96" | 1" | AAWS IC 096 () | 158. | 158. |
| | 1" | 102" | 1" | AAWS IC 102 () | n/a | 163. |
| | 1" | 108" | 1" | AAWS IC 108 () | n/a | 168. |
| | 1" | 114" | 1" | AAWS IC 114 () | n/a | 174. |
| | 1" | 120" | 1" | AAWS IC 120 () | n/a | 185. |
| | 1" | 126" | 1" | AAWS IC 126 () | n/a | 196. |
| | 1" | 132" | 1" | AAWS IC 132 () | n/a | 207. |
| | 1" | 138" | 1" | AAWS IC 138 () | n/a | 212. |
| 1" | 144" | 1" | AAWS IC 144 () | n/a | 217. | |

Order Code

| |
|--------------------------------|
| Example: AAWS IC 024 AA |
| A AutoStrada |
| AWS Applied wall system |
| IC Intermediate channel |
| 024 Width |
| AA Finish |

Specification Information

AA- Anodized Aluminum or any painted finish except 613 silver. Painted finish is not available on channels wider than 96".

Application Notes

Intermediate channels attach to wall frames to provide continuous slot for component support and retention for top and bottom of wall covers. Horizontal channels attach to wall frames at predetermined mounting locations depending on what height covers and overhead storage are planned on wall surface: 24", 31 1/2", 39", 46 1/2", 54", 61 1/2", 69" above the floor.

Specify channels in length to match overall length of applied wall covers, or in shorter segments. Intermediate channels can extend past wall frame up to 6" on each end. Channels include mounting hardware to attach to wall frame studs.

Horizontal channels

Bottom channels

| description | h | w | d | pattern number | painting | aluminum |
|---|----|------|----|------------------------|----------|----------|
| Bottom channel | 1" | 36" | 1" | AAWS BC 036 () | \$55. | \$55. |
|  | 1" | 42" | 1" | AAWS BC 042 () | 60. | 60. |
| | 1" | 48" | 1" | AAWS BC 048 () | 65. | 65. |
| | 1" | 54" | 1" | AAWS BC 054 () | 76. | 76. |
| | 1" | 60" | 1" | AAWS BC 060 () | 81. | 81. |
| | 1" | 66" | 1" | AAWS BC 066 () | 86. | 86. |
| | 1" | 72" | 1" | AAWS BC 072 () | 92. | 92. |
| | 1" | 78" | 1" | AAWS BC 078 () | 98. | 98. |
| | 1" | 84" | 1" | AAWS BC 084 () | 109. | 109. |
| | 1" | 90" | 1" | AAWS BC 090 () | 114. | 114. |
| | 1" | 96" | 1" | AAWS BC 096 () | 119. | 119. |
| | 1" | 102" | 1" | AAWS BC 102 () | n/a | 126. |
| | 1" | 108" | 1" | AAWS BC 108 () | n/a | 131. |
| | 1" | 114" | 1" | AAWS BC 114 () | n/a | 136. |
| | 1" | 120" | 1" | AAWS BC 120 () | n/a | 141. |
| | 1" | 126" | 1" | AAWS BC 126 () | n/a | 146. |
| | 1" | 132" | 1" | AAWS BC 132 () | n/a | 152. |
| | 1" | 138" | 1" | AAWS BC 138 () | n/a | 158. |
| | 1" | 138" | 1" | AAWS BC 144 () | n/a | 163. |

Order Code

| | |
|------------|-----------------------|
| Example: | AAWS BC 036 AA |
| A | AutoStrada |
| AWS | Applied wall system |
| BC | Bottom channel |
| 036 | Width |
| AA | Finish |

Specification Information

AA - Anodized Aluminum or any painted finish except 613 Silver.

Painted finish is not available on channels wider than 96".

Application Notes



Bottom channels attach to bottom of wall frames to retain bottom of wall covers planned below 24". Specify channels in length to match overall length of applied wall covers, or in shorter segments. Bottom channels can extend past wall frame up to 6" on each end.

Includes hardware.

Bottom channel is not required if no covers are planned below intermediate channel mounted at 24" above floor. Specify intermediate bottom trim and vertical frame covers to cover exposed studs at bottom of each wall frame.

Wall trim and corners

End trims, intermediate trim

| description | type | h | w | d | pattern no. | easy grey | painting or aluminum |
|---|--------------------------------|----------|--------|--------|------------------------|-----------|----------------------|
|  | 69"H + 22" add on | 91 1/2" | 1/8" | 2 1/4" | AAWS ET 91 () | | \$151. |
| | 69"H + 30" add on | 99" | 1/8" | 2 1/4" | AAWS ET 99 () | | 162. |
| | 69"H frame | 69" | 1/8" | 2 1/4" | AAWS ET 69 () | | 98. |
| | 84"H + 22" add on | 106 1/2" | 1/8" | 2 1/4" | AAWS ET 106 () | | 183. |
| | 84"H + 30" add on | 114" | 1/8" | 2 1/4" | AAWS ET 114 () | | 194. |
| | 84"H frame | 84" | 1/8" | 2 1/4" | AAWS ET 84 () | | 131. |
| | Field Modifiable | 144" | 1/8" | 2 1/4" | AAWS ET 144 () | | 224. |
| Wall end trim for frames open below 24" | 69"H frame, open base | 69" | 1/8" | 2 1/4" | AAWS ETO 69 () | | 76. |
| | 84"H frame, open base | 84" | 1/8" | 2 1/4" | AAWS ETO 84 () | | 92. |
| Intermediate trim cover | | 1 1/8" | 144" | 3/4" | AAWS IBT () | | 96. |
|  | Vertical frame covers (pair) | 21" | 2 1/2" | 2" | AAWS VFC () | | 43. |

Order Code

| | |
|------------|----------------------|
| Example: | AAWS ET 69 AA |
| A | AutoStrada |
| AWS | Applied wall system |
| ET | End trim |
| 69 | Width |
| AA | Finish |

Specification Information

Intermediate bottom trim and Vertical frame covers are available in Easy Grey (812) or any standard painted finish except 613 Silver.

All end trim inside and outside covers are available in AA anodized aluminum or any standard paint finish except 613 Silver.

All standard painted finishes except silver are also available for all end trims up to 91"H.

Application

Wall end trim encloses exposed end of applied wall frame and add on frames. If no wall covers are planned below 24" datum specify corresponding wall end trims for open base: 48"h for 69" h frames or 63"h for 84"h frames.

If no covers are planned below 24" datum specify optional intermediate bottom trim, which may be cut on site to overall width of applied wall, and one pair of vertical frame covers to cover exposed studs of each wall frame.

Wall trim and corners

Inside and outside corners

AutoStrada

| description | type | h | w | d | pattern no. | list | aluminum |
|---|-----------------------|----------|--------|--------|------------------------|------|----------|
| Inside corner | 69"H + 22 1/2" add on | 91 1/2" | 2 1/4" | 2 1/4" | AAWS IL 91 () | | \$230. |
| | 69"H + 30" add on | 99" | 2 1/4" | 2 1/4" | AAWS IL 99 () | | 230. |
| | 69"H frame | 69" | 2 1/4" | 2 1/4" | AAWS IL 69 () | | 131. |
| | 84"H + 22 1/2" add on | 106 1/2" | 2 1/4" | 2 1/4" | AAWS IL 106 () | | 230. |
| | 84"H + 30" add on | 114" | 2 1/4" | 2 1/4" | AAWS IL 114 () | | 230. |
| | 84"H frame | 84" | 2 1/4" | 2 1/4" | AAWS IL 84 () | | 168. |
| | Field Modifiable | 144" | 2 1/4" | 2 1/4" | AAWS IL 144 () | | 230. |
| Inside corner for frames open below 24" | 69"H frame, open base | 48" | 2 1/4" | 2 1/4" | AAWS ILO 69 () | | 104. |
| | 84"H frame, open base | 63" | 2 1/4" | 2 1/4" | AAWS ILO 84 () | | 126. |



| | | | | | | | |
|--|------------------------|----------|--------|--------|------------------------|--|------|
| Outside corner | 69"H + 22 1/2"H add on | 91 1/2" | 2 1/4" | 2 1/4" | AAWS OL 91 () | | 392. |
| | 69"H + 30"H add on | 99" | 2 1/4" | 2 1/4" | AAWS OL 99 () | | 392. |
| | 69"H frame | 69" | 2 1/4" | 2 1/4" | AAWS OL 69 () | | 207. |
| | 84"H + 22 1/2"H add on | 106 1/2" | 2 1/4" | 2 1/4" | AAWS OL 106 () | | 392. |
| | Field modifiable | 144" | 2 1/4" | 2 1/4" | AAWS OL 144 () | | 392. |
| Outside corner for frames open below 24" | 69"H frame, open base | 48" | 2 1/4" | 2 1/4" | AAWS OLO 69 () | | 152. |
| | 84"H frame, open base | 63" | 2 1/4" | 2 1/4" | AAWS OLO 84 () | | 190. |



Order Code

| | |
|------------|----------------------|
| Example: | AAWS IL 69 AA |
| A | AutoStrada |
| AWS | Applied wall system |
| IL | Inside corner |
| 69 | Width |
| AA | Finish |

Specification Information

AA - Anodized Aluminum.
All standard painted finishes except silver are also available for all end trims up to 91"H.

Application Notes

Inside corners and outside corners align and enclose the 90° junction of two wall frames or wall frames plus add on frames.

Frames must match in height.

Inside and outside corners require 2 1/4" square planning footprint.

Wall covers

Recess surface

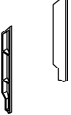
| description | h | w | d | pattern no. | easy grey | or painted aluminum |
|---|--------|------|-------------------------|-------------------------|-----------|---------------------------|
| Recess cover  | 7 1/2" | 24" | 3/4" | AAWS C0724 R () | | \$76. |
| | 7 1/2" | 30" | 3/4" | AAWS C0730 R () | | 86. |
| | 7 1/2" | 36" | 3/4" | AAWS C0736 R () | | 98. |
| | 7 1/2" | 42" | 3/4" | AAWS C0742 R () | | 109. |
| | 7 1/2" | 48" | 3/4" | AAWS C0748 R () | | 117. |
| | 7 1/2" | 54" | 3/4" | AAWS C0754 R () | | 137. |
| | 7 1/2" | 60" | 3/4" | AAWS C0760 R () | | 146. |
| | 7 1/2" | 66" | 3/4" | AAWS C0766 R () | | 157. |
| | 7 1/2" | 72" | 3/4" | AAWS C0772 R () | | 166. |
| | 7 1/2" | 78" | 3/4" | AAWS C0778 R () | | 176. |
| | 7 1/2" | 84" | 3/4" | AAWS C0784 R () | | 186. |
| | 7 1/2" | 90" | 3/4" | AAWS C0790 R () | | 206. |
| 7 1/2" | 96" | 3/4" | AAWS C0796 R () | | 215. | |
| Recess end trim (pair)  | 6 1/2" | 1/2" | 3/4" | AAWS RET () | 29. | |

Order Code

| | |
|------------|------------------------|
| Example: | AAWS C0724 R AA |
| A | AutoStrada |
| AWS | Applied wall system |
| C | Cover |
| 07 | Height |
| 24 | Width |
| R | Recess cover |
| AA | Finish |

Specification Information

Recess covers are available in AA anodized aluminum or any standard painted finish except 613 Silver.

Recess end trim is 812 Easy Grey or any standard painted finish except 613 Silver.

Application

Recess covers provide mounting location for continuous, surface-mounted plugmold strip or voice/data outlets. Recess covers are typically mounted below or just above desk height (24"-35 1/2" above floor).

Recess covers insert between intermediate channels and are secured in position with screws.

Recess covers are extruded, clear anodized aluminum surface.

Recess cover should be at least 6" wider than 60" plugmold or 24" plugstrip to be mounted.

Recess end trim encloses the ends of a recess cover where it meets any other cover type.

Recess end trim kit includes one left hand and one right hand trim.

Recess end trim is not required where recess cover meets wall end trim, corner connector or another recess cover.

Wall covers

Slatwall surface

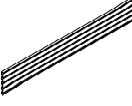
| description | h | w | d | pattern no. | price | finished |
|---|--------|-----|------|-------------------------|-------|----------|
| Slatwall cover | 7 1/2" | 24" | 1/2" | AAWS C0724 S () | \$86. | aluminum |
|  | 7 1/2" | 30" | 1/2" | AAWS C0730 S () | 98. | |
| | 7 1/2" | 36" | 1/2" | AAWS C0736 S () | 109. | |
| | 7 1/2" | 42" | 1/2" | AAWS C0742 S () | 119. | |
| | 7 1/2" | 48" | 1/2" | AAWS C0748 S () | 131. | |
| | 7 1/2" | 54" | 1/2" | AAWS C0754 S () | 152. | |
| | 7 1/2" | 60" | 1/2" | AAWS C0760 S () | 163. | |
| | 7 1/2" | 66" | 1/2" | AAWS C0766 S () | 174. | |
| | 7 1/2" | 72" | 1/2" | AAWS C0772 S () | 185. | |
| | 7 1/2" | 78" | 1/2" | AAWS C0778 S () | 196. | |
| | 7 1/2" | 84" | 1/2" | AAWS C0784 S () | 207. | |
| | 7 1/2" | 90" | 1/2" | AAWS C0790 S () | 228. | |
| | 7 1/2" | 96" | 1/2" | AAWS C0796 S () | 240. | |

| Order Code | Specification Information | Application |
|---------------------------------|---|--|
| Example: AAWS C0724 S AA | AA - Anodized Aluminum only. | Slatwall covers provide four continuous, horizontal slots to accept a variety of KnollExtra paper management accessories and flat screen monitor arms. Slatwall covers are typically installed just above desk height (31 1/2 - 39" above floor). |
| A AutoStrada | Slatwall covers are available in AA anodized aluminum or any standard painted finish except 613 Silver. | Slatwall covers insert between intermediate channels and are secured in position with screws. Slatwall covers are extruded, clear anodized aluminum surface. |
| AWS Applied wall system | | |
| C Cover | | |
| 07 Height | | |
| 24 Width | | |
| S Slatwall cover | | |
| AA Finish | | |

Wall covers

Marker surface

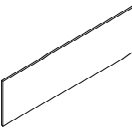
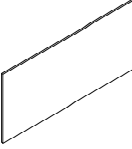
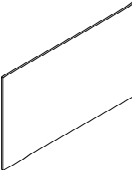
| description | h | w | d | pattern no. | list |
|--|---------|-----|------|------------------|-------|
| Marker cover, 7 1/2"H  | 7 1/2" | 24" | 1/2" | AAWS C0724 M () | \$65. |
| | 7 1/2" | 30" | 1/2" | AAWS C0730 M () | 72. |
| | 7 1/2" | 36" | 1/2" | AAWS C0736 M () | 77. |
| | 7 1/2" | 42" | 1/2" | AAWS C0742 M () | 82. |
| | 7 1/2" | 48" | 1/2" | AAWS C0748 M () | 86. |
| | 7 1/2" | 54" | 1/2" | AAWS C0754 M () | 91. |
| | 7 1/2" | 60" | 1/2" | AAWS C0760 M () | 96. |
| | 7 1/2" | 66" | 1/2" | AAWS C0766 M () | 100. |
| | 7 1/2" | 72" | 1/2" | AAWS C0772 M () | 106. |
| Marker cover, 15"H  | 15" | 24" | 1/2" | AAWS C1524 M () | 85. |
| | 15" | 30" | 1/2" | AAWS C1530 M () | 95. |
| | 15" | 36" | 1/2" | AAWS C1536 M () | 104. |
| | 15" | 42" | 1/2" | AAWS C1542 M () | 112. |
| | 15" | 48" | 1/2" | AAWS C1548 M () | 124. |
| | 15" | 54" | 1/2" | AAWS C1554 M () | 135. |
| | 15" | 60" | 1/2" | AAWS C1560 M () | 143. |
| | 15" | 66" | 1/2" | AAWS C1566 M () | 152. |
| | 15" | 72" | 1/2" | AAWS C1572 M () | 160. |
| Marker cover, 22 1/2"H  | 22 1/2" | 24" | 1/2" | AAWS C2224 M () | 106. |
| | 22 1/2" | 30" | 1/2" | AAWS C2230 M () | 118. |
| | 22 1/2" | 36" | 1/2" | AAWS C2236 M () | 139. |
| | 22 1/2" | 42" | 1/2" | AAWS C2242 M () | 151. |
| | 22 1/2" | 48" | 1/2" | AAWS C2248 M () | 164. |
| | 22 1/2" | 54" | 1/2" | AAWS C2254 M () | 177. |
| | 22 1/2" | 60" | 1/2" | AAWS C2260 M () | 206. |
| | 22 1/2" | 66" | 1/2" | AAWS C2266 M () | 211. |
| | 22 1/2" | 72" | 1/2" | AAWS C2272 M () | 215. |
| Marker cover, 30"H  | 30" | 24" | 1/2" | AAWS C3024 M () | 124. |
| | 30" | 30" | 1/2" | AAWS C3030 M () | 143. |
| | 30" | 36" | 1/2" | AAWS C3036 M () | 164. |
| | 30" | 42" | 1/2" | AAWS C3042 M () | 181. |
| | 30" | 48" | 1/2" | AAWS C3048 M () | 199. |
| | 30" | 54" | 1/2" | AAWS C3054 M () | 219. |
| | 30" | 60" | 1/2" | AAWS C3060 M () | 238. |
| | 30" | 66" | 1/2" | AAWS C3066 M () | 254. |
| | 30" | 72" | 1/2" | AAWS C3072 M () | 271. |

| Order Code | |
|---------------------------------|---------------------|
| Example: AAWS C0724 M LW | |
| A | AutoStrada |
| AWS | Applied wall system |
| C | Cover |
| 07 | Height |
| 24 | Width |
| M | Marker cover |
| LW | Finish |

Specification Information
LW - Markerboard surface

Application
Markerboard cover is a white, dry-erase surface that fits flush with adjacent wall covers. Marker covers insert between channels set at the corresponding height differences.

Wall covers

Marker surface

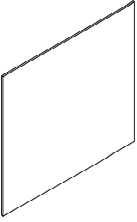
| description | h | w | d | pattern no. | list |
|---|-----|-----|------|-------------------------|--------|
| Marker cover, 45"H  | 45" | 24" | 1/2" | AAWS C4524 M () | \$165. |
| | 45" | 30" | 1/2" | AAWS C4530 M () | 189. |
| | 45" | 36" | 1/2" | AAWS C4536 M () | 230. |
| | 45" | 42" | 1/2" | AAWS C4542 M () | 255. |
| | 45" | 48" | 1/2" | AAWS C4548 M () | 280. |
| | 45" | 54" | 1/2" | AAWS C4554 M () | 307. |
| | 45" | 60" | 1/2" | AAWS C4560 M () | 330. |
| | 45" | 66" | 1/2" | AAWS C4566 M () | 356. |
| | 45" | 72" | 1/2" | AAWS C4572 M () | 382. |

Order Code

| | |
|------------|------------------------|
| Example: | AAWS C0724 M LW |
| A | AutoStrada |
| AWS | Applied wall system |
| C | Cover |
| 07 | Height |
| 24 | Width |
| M | Marker cover |
| LW | Finish |

Specification Information

LW - Markerboard surface

Application

Markerboard cover is a white, dry-erase surface that fits flush with adjacent wall covers. Marker covers insert between channels set at the corresponding height differences.

Wall covers

Tackable linoleum

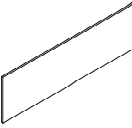
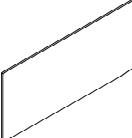
| description | h | w | d | pattern no. | list |
|---|---------|------|-------------------------|-------------------------|--------|
| Linoleum cover, 15"H  | 15" | 24" | 1/2" | AAWS C1524 L () | \$139. |
| | 15" | 30" | 1/2" | AAWS C1530 L () | 165. |
| | 15" | 36" | 1/2" | AAWS C1536 L () | 198. |
| | 15" | 42" | 1/2" | AAWS C1542 L () | 223. |
| | 15" | 48" | 1/2" | AAWS C1548 L () | 256. |
| | 15" | 54" | 1/2" | AAWS C1554 L () | 287. |
| | 15" | 60" | 1/2" | AAWS C1560 L () | 320. |
| | 15" | 66" | 1/2" | AAWS C1566 L () | 347. |
| | 15" | 72" | 1/2" | AAWS C1572 L () | 379. |
| | 15" | 78" | 1/2" | AAWS C1578 L () | 411. |
| | 15" | 84" | 1/2" | AAWS C1584 L () | 443. |
| | 15" | 90" | 1/2" | AAWS C1590 L () | 469. |
| 15" | 96" | 1/2" | AAWS C1596 L () | 500. | |
| Linoleum cover, 22 1/2"H  | 22 1/2" | 24" | 1/2" | AAWS C2224 L () | 193. |
| | 22 1/2" | 30" | 1/2" | AAWS C2230 L () | 234. |
| | 22 1/2" | 36" | 1/2" | AAWS C2236 L () | 277. |
| | 22 1/2" | 42" | 1/2" | AAWS C2242 L () | 320. |
| | 22 1/2" | 48" | 1/2" | AAWS C2248 L () | 368. |
| | 22 1/2" | 54" | 1/2" | AAWS C2254 L () | 416. |
| | 22 1/2" | 60" | 1/2" | AAWS C2260 L () | 464. |
| | 22 1/2" | 66" | 1/2" | AAWS C2266 L () | 500. |
| | 22 1/2" | 72" | 1/2" | AAWS C2272 L () | 549. |
| | 22 1/2" | 78" | 1/2" | AAWS C2278 L () | 592. |
| | 22 1/2" | 84" | 1/2" | AAWS C2284 L () | 639. |
| | 22 1/2" | 90" | 1/2" | AAWS C2290 L () | 683. |
| 22 1/2" | 96" | 1/2" | AAWS C2296 L () | 736. | |

| Order Code | Specification Information |
|----------------------------------|---------------------------|
| Example: AAWS C0724 L 851 | |
| A AutoStrada | 851 Forbo #2186 |
| AWS Applied wall system | 852 Forbo #2162 |
| C Cover | 853 Forbo #2182 |
| 07 Height | 854 Forbo #2166 |
| 24 Width | 855 Forbo #2204 |
| L Tackable linoleum | 856 Forbo #2202 |
| 851 Finish | |



| Specification Information |
|---------------------------|
| 851 Forbo #2186 |
| 852 Forbo #2162 |
| 853 Forbo #2182 |
| 854 Forbo #2166 |
| 855 Forbo #2204 |
| 856 Forbo #2202 |

Application

Linoleum covers insert between horizontal channels to provide tackable, non-upholstered surface. Linoleum covers are tackable with 1/2" pushpins. Linoleum surface is firm enough to permit open shelf brackets to bear against face of cover.

Wall covers

Tackable upholstered

| description | h | w | d | pattern no. | Grade | | | | | | | | | |
|--|--------|-----|------|-------------------------|-------|-------|-------|-------|-------|-------|-------|-------|--------|--|
| | | | | | 10 | 15 | 20 | 30 | 35 | 40 | 45 | 50 | 55 | |
| Tackable upholstered cover, 7 1/2"H  | 7 1/2" | 24" | 1/2" | AAWS C0724 A () | \$74. | \$76. | \$78. | \$83. | \$85. | \$88. | \$90. | \$96. | \$102. | |
| | 7 1/2" | 30" | 1/2" | AAWS C0730 A () | 80. | 82. | 84. | 89. | 91. | 93. | 95. | 102. | 107. | |
| | 7 1/2" | 36" | 1/2" | AAWS C0736 A () | 85. | 88. | 90. | 94. | 96. | 98. | 100. | 107. | 112. | |
| | 7 1/2" | 42" | 1/2" | AAWS C0742 A () | 98. | 100. | 102. | 103. | 105. | 108. | 109. | 112. | 117. | |
| | 7 1/2" | 48" | 1/2" | AAWS C0748 A () | 110. | 112. | 113. | 114. | 116. | 118. | 120. | 123. | 127. | |
| | 7 1/2" | 54" | 1/2" | AAWS C0754 A () | 121. | 123. | 125. | 126. | 127. | 130. | 131. | 135. | 139. | |
| | 7 1/2" | 60" | 1/2" | AAWS C0760 A () | 134. | 135. | 136. | 138. | 139. | 142. | 143. | 146. | 150. | |
| | 7 1/2" | 66" | 1/2" | AAWS C0766 A () | 144. | 146. | 147. | 148. | 150. | 152. | 154. | 157. | 161. | |
| | 7 1/2" | 72" | 1/2" | AAWS C0772 A () | 155. | 157. | 159. | 160. | 161. | 164. | 165. | 168. | 173. | |
| Tackable upholstered cover, 15"H  | 15" | 24" | 1/2" | AAWS C1524 A () | 111. | 112. | 113. | 114. | 116. | 118. | 120. | 121. | 129. | |
| | 15" | 30" | 1/2" | AAWS C1530 A () | 132. | 134. | 135. | 136. | 138. | 140. | 142. | 143. | 150. | |
| | 15" | 36" | 1/2" | AAWS C1536 A () | 153. | 154. | 155. | 157. | 159. | 161. | 163. | 164. | 172. | |
| | 15" | 42" | 1/2" | AAWS C1542 A () | 175. | 176. | 177. | 179. | 180. | 183. | 184. | 185. | 194. | |
| | 15" | 48" | 1/2" | AAWS C1548 A () | 197. | 198. | 199. | 201. | 202. | 205. | 206. | 207. | 214. | |
| | 15" | 54" | 1/2" | AAWS C1554 A () | 217. | 218. | 219. | 221. | 222. | 225. | 227. | 228. | 235. | |
| | 15" | 60" | 1/2" | AAWS C1560 A () | 239. | 241. | 242. | 244. | 245. | 248. | 249. | 251. | 257. | |
| | 15" | 66" | 1/2" | AAWS C1566 A () | 262. | 263. | 264. | 265. | 266. | 269. | 270. | 272. | 278. | |
| | 15" | 72" | 1/2" | AAWS C1572 A () | 282. | 283. | 284. | 285. | 286. | 289. | 290. | 293. | 300. | |

| Order Code | Specification Information | Application |
|------------------------------------|---|--|
| Example: AAWS C0724 A 288-6 | See finish page for Knoll textile selections. | Tackable upholstered covers insert between horizontal channels to provide tackable, fabric surface. Covers are tackable with 1/2" pushpins. Fabric is railroaded. Open shelves cannot be positioned immediately above tackable fabric covers. Tackable core is not firm enough to permit open shelf brackets to bear against face of cover. |
| A AutoStrada | | |
| AWS Applied wall system | | |
| C Cover | | |
| 07 Height | | |
| 24 Width | | |
| A Tackable upholstered | | |
| 288-6 Fabric | | |

Wall covers

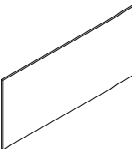
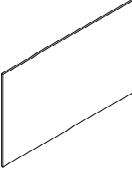

Tackable upholstered

| description | h | w | d | pattern no. | Grade | | | | | | | | |
|--|------|-----|----|-------------------------|--------|--------|--------|--------|--------|--------|--------|--------|--------|
| | | | | | 10 | 15 | 20 | 30 | 35 | 40 | 45 | 50 | 55 |
| Tackable upholstered cover, 22½"H  | 22½" | 24" | ½" | AAWS C2224 A () | \$157. | \$161. | \$164. | \$167. | \$172. | \$175. | \$179. | \$185. | \$197. |
| | 22½" | 30" | ½" | AAWS C2230 A () | 191. | 195. | 199. | 202. | 205. | 209. | 212. | 219. | 230. |
| | 22½" | 36" | ½" | AAWS C2236 A () | 223. | 228. | 231. | 234. | 239. | 243. | 246. | 253. | 264. |
| | 22½" | 42" | ½" | AAWS C2242 A () | 258. | 262. | 266. | 269. | 272. | 276. | 279. | 286. | 298. |
| | 22½" | 48" | ½" | AAWS C2248 A () | 290. | 295. | 299. | 302. | 307. | 310. | 313. | 320. | 330. |
| | 22½" | 54" | ½" | AAWS C2254 A () | 325. | 328. | 333. | 336. | 339. | 343. | 347. | 354. | 364. |
| | 22½" | 60" | ½" | AAWS C2260 A () | 358. | 362. | 366. | 369. | 374. | 377. | 380. | 387. | 397. |
| | 22½" | 66" | ½" | AAWS C2266 A () | 392. | 395. | 400. | 404. | 407. | 411. | 414. | 421. | 431. |
| | 22½" | 72" | ½" | AAWS C2272 A () | 425. | 429. | 432. | 436. | 441. | 444. | 447. | 455. | 465. |
| Tackable upholstered cover, 30"H  | 30" | 24" | ½" | AAWS C3024 A () | 286. | 290. | 293. | 297. | 302. | 307. | 311. | 315. | 333. |
| | 30" | 30" | ½" | AAWS C3030 A () | 345. | 350. | 352. | 355. | 360. | 364. | 369. | 374. | 390. |
| | 30" | 36" | ½" | AAWS C3036 A () | 405. | 409. | 411. | 414. | 419. | 423. | 427. | 431. | 449. |
| | 30" | 42" | ½" | AAWS C3042 A () | 463. | 467. | 469. | 473. | 478. | 482. | 486. | 490. | 509. |
| | 30" | 48" | ½" | AAWS C3048 A () | 522. | 525. | 527. | 531. | 536. | 541. | 545. | 549. | 566. |
| | 30" | 54" | ½" | AAWS C3054 A () | 581. | 584. | 586. | 590. | 594. | 598. | 603. | 607. | 625. |
| | 30" | 60" | ½" | AAWS C3060 A () | 638. | 641. | 644. | 649. | 653. | 657. | 662. | 665. | 684. |
| | 30" | 66" | ½" | AAWS C3066 A () | 697. | 700. | 702. | 706. | 711. | 716. | 722. | 725. | 742. |
| | 30" | 72" | ½" | AAWS C3072 A () | 756. | 759. | 761. | 765. | 769. | 774. | 780. | 783. | 801. |

| Order Code | Specification Information | Application |
|------------------------------------|---|--|
| Example: AAWS C0724 A 288-6 | See finish page for Knoll textile selections. | Tackable upholstered covers insert between horizontal channels to provide tackable, fabric surface. Covers are tackable with ½" pushpins. Fabric is railroaded. Open shelves cannot be positioned immediately above tackable fabric covers. Tackable core is not firm enough to permit open shelf brackets to bear against face of cover. |
| A AutoStrada | | |
| AWS Applied wall system | | |
| C Cover | | |
| 07 Height | | |
| 24 Width | | |
| A Tackable upholstered | | |
| 288-6 Fabric | | |

Wall covers

Non-tackable upholstered

| description | h | w | d | pattern no. | Grade | | | | | | | | | |
|--|--------|-----|------|-------------------------|-------|-------|-------|-------|-------|-------|-------|-------|--------|--|
| | | | | | 10 | 15 | 20 | 30 | 35 | 40 | 45 | 50 | 55 | |
| Non-tackable upholstered cover, 7 1/2"H  | 7 1/2" | 24" | 1/2" | AAWS C0724 F () | \$74. | \$76. | \$78. | \$83. | \$85. | \$88. | \$90. | \$96. | \$102. | |
| | 7 1/2" | 30" | 1/2" | AAWS C0730 F () | 80. | 82. | 84. | 89. | 91. | 93. | 95. | 102. | 107. | |
| | 7 1/2" | 36" | 1/2" | AAWS C0736 F () | 85. | 88. | 90. | 94. | 96. | 98. | 100. | 107. | 112. | |
| | 7 1/2" | 42" | 1/2" | AAWS C0742 F () | 91. | 93. | 95. | 99. | 102. | 104. | 106. | 112. | 117. | |
| | 7 1/2" | 48" | 1/2" | AAWS C0748 F () | 96. | 98. | 100. | 105. | 107. | 109. | 111. | 117. | 123. | |
| | 7 1/2" | 54" | 1/2" | AAWS C0754 F () | 102. | 104. | 106. | 110. | 112. | 114. | 116. | 123. | 128. | |
| | 7 1/2" | 60" | 1/2" | AAWS C0760 F () | 107. | 109. | 111. | 115. | 117. | 119. | 121. | 128. | 134. | |
| | 7 1/2" | 66" | 1/2" | AAWS C0766 F () | 112. | 114. | 116. | 120. | 123. | 125. | 127. | 134. | 139. | |
| | 7 1/2" | 72" | 1/2" | AAWS C0772 F () | 117. | 119. | 121. | 126. | 128. | 130. | 132. | 139. | 144. | |
| | 7 1/2" | 78" | 1/2" | AAWS C0778 F () | 123. | 125. | 127. | 131. | 134. | 136. | 138. | 144. | 149. | |
| | 7 1/2" | 84" | 1/2" | AAWS C0784 F () | 128. | 130. | 132. | 137. | 139. | 141. | 143. | 149. | 154. | |
| | 7 1/2" | 90" | 1/2" | AAWS C0790 F () | 134. | 136. | 138. | 142. | 144. | 146. | 148. | 154. | 160. | |
| | 7 1/2" | 96" | 1/2" | AAWS C0796 F () | 139. | 141. | 143. | 147. | 149. | 151. | 153. | 160. | 165. | |
| Non-tackable upholstered cover, 15"H  | 15" | 24" | 1/2" | AAWS C1524 F () | 93. | 96. | 98. | 105. | 107. | 109. | 112. | 114. | 119. | |
| | 15" | 30" | 1/2" | AAWS C1530 F () | 104. | 107. | 109. | 115. | 117. | 119. | 123. | 125. | 130. | |
| | 15" | 36" | 1/2" | AAWS C1536 F () | 114. | 117. | 119. | 126. | 128. | 130. | 134. | 136. | 141. | |
| | 15" | 42" | 1/2" | AAWS C1542 F () | 125. | 128. | 130. | 137. | 139. | 141. | 144. | 146. | 151. | |
| | 15" | 48" | 1/2" | AAWS C1548 F () | 136. | 139. | 141. | 147. | 149. | 151. | 154. | 157. | 162. | |
| | 15" | 54" | 1/2" | AAWS C1554 F () | 146. | 149. | 151. | 158. | 160. | 162. | 165. | 167. | 173. | |
| | 15" | 60" | 1/2" | AAWS C1560 F () | 157. | 160. | 162. | 168. | 171. | 173. | 176. | 178. | 183. | |
| | 15" | 66" | 1/2" | AAWS C1566 F () | 167. | 171. | 173. | 179. | 181. | 183. | 187. | 189. | 195. | |
| | 15" | 72" | 1/2" | AAWS C1572 F () | 178. | 181. | 183. | 190. | 193. | 195. | 198. | 200. | 205. | |
| | 15" | 78" | 1/2" | AAWS C1578 F () | 189. | 193. | 195. | 201. | 203. | 205. | 208. | 210. | 215. | |
| | 15" | 84" | 1/2" | AAWS C1584 F () | 200. | 203. | 205. | 211. | 213. | 215. | 218. | 220. | 225. | |
| | 15" | 90" | 1/2" | AAWS C1590 F () | 210. | 213. | 215. | 221. | 223. | 225. | 229. | 231. | 236. | |
| | 15" | 96" | 1/2" | AAWS C1596 F () | 220. | 223. | 225. | 232. | 234. | 236. | 241. | 243. | 248. | |

| Order Code | Specification Information | Application |
|------------------------------------|---|--|
| Example: AAWS C0724 F 288-6 | See finish page for Knoll textile selections. | Non-tackable upholstered covers insert between horizontal channels to provide fabric surface. Fabric is railroaded. Wood core is firm enough to permit open shelf brackets to bear against face of cover. |
| A AutoStrada | | |
| AWS Applied wall system | | |
| C Cover | | |
| 07 Height | | |
| 24 Width | | |
| F Non-tackable upholstered | | |
| 288-6 Fabric | | |

Wall covers

Non-tackable upholstered

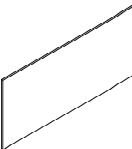
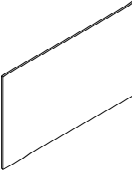
| description | h | w | d | pattern no. | Grade | | | | | | | | | |
|---|---------|-----|------|-------------------------|--------|--------|--------|--------|--------|--------|--------|--------|--------|--|
| | | | | | 10 | 15 | 20 | 30 | 35 | 40 | 45 | 50 | 55 | |
| Non-tackable upholstered cover, 22 1/2"H | 22 1/2" | 24" | 1/2" | AAWS C2224 F () | \$126. | \$131. | \$135. | \$144. | \$149. | \$154. | \$160. | \$171. | \$187. | |
|  | 22 1/2" | 30" | 1/2" | AAWS C2230 F () | 139. | 146. | 149. | 159. | 164. | 170. | 175. | 185. | 202. | |
| | 22 1/2" | 36" | 1/2" | AAWS C2236 F () | 153. | 161. | 164. | 174. | 179. | 184. | 190. | 201. | 216. | |
| | 22 1/2" | 42" | 1/2" | AAWS C2242 F () | 168. | 176. | 179. | 189. | 195. | 200. | 205. | 215. | 231. | |
| | 22 1/2" | 48" | 1/2" | AAWS C2248 F () | 183. | 191. | 195. | 204. | 209. | 214. | 219. | 230. | 247. | |
| | 22 1/2" | 54" | 1/2" | AAWS C2254 F () | 199. | 206. | 209. | 218. | 223. | 229. | 234. | 246. | 262. | |
| | 22 1/2" | 60" | 1/2" | AAWS C2260 F () | 213. | 220. | 223. | 233. | 239. | 245. | 250. | 260. | 276. | |
| | 22 1/2" | 66" | 1/2" | AAWS C2266 F () | 228. | 235. | 239. | 249. | 254. | 259. | 265. | 275. | 290. | |
| | 22 1/2" | 72" | 1/2" | AAWS C2272 F () | 244. | 251. | 254. | 264. | 269. | 274. | 279. | 289. | 307. | |
| | 22 1/2" | 78" | 1/2" | AAWS C2278 F () | 258. | 266. | 269. | 278. | 283. | 288. | 294. | 306. | 321. | |
| | 22 1/2" | 84" | 1/2" | AAWS C2284 F () | 273. | 280. | 283. | 293. | 299. | 305. | 310. | 320. | 336. | |
| | 22 1/2" | 90" | 1/2" | AAWS C2290 F () | 287. | 295. | 299. | 309. | 314. | 319. | 324. | 335. | 351. | |
| | 22 1/2" | 96" | 1/2" | AAWS C2296 F () | 303. | 311. | 314. | 323. | 328. | 334. | 339. | 350. | 366. | |
| Non-tackable upholstered cover, 30"H | 30" | 24" | 1/2" | AAWS C3024 F () | 144. | 151. | 154. | 165. | 176. | 181. | 187. | 193. | 208. | |
|  | 30" | 30" | 1/2" | AAWS C3030 F () | 163. | 171. | 174. | 184. | 196. | 201. | 206. | 211. | 227. | |
| | 30" | 36" | 1/2" | AAWS C3036 F () | 182. | 190. | 194. | 204. | 214. | 219. | 224. | 230. | 247. | |
| | 30" | 42" | 1/2" | AAWS C3042 F () | 202. | 209. | 212. | 222. | 233. | 239. | 245. | 250. | 266. | |
| | 30" | 48" | 1/2" | AAWS C3048 F () | 220. | 228. | 231. | 243. | 253. | 258. | 264. | 269. | 284. | |
| | 30" | 54" | 3/4" | AAWS C3054 F () | 241. | 248. | 251. | 262. | 272. | 277. | 282. | 287. | 305. | |
| | 30" | 60" | 1/2" | AAWS C3060 F () | 259. | 267. | 270. | 280. | 290. | 297. | 302. | 308. | 323. | |
| | 30" | 66" | 1/2" | AAWS C3066 F () | 278. | 285. | 288. | 300. | 311. | 316. | 321. | 326. | 342. | |
| | 30" | 72" | 1/2" | AAWS C3072 F () | 298. | 306. | 309. | 319. | 329. | 335. | 340. | 345. | 361. | |
| | 30" | 78" | 1/2" | AAWS C3078 F () | 317. | 324. | 327. | 338. | 349. | 354. | 359. | 364. | 381. | |
| | 30" | 84" | 1/2" | AAWS C3084 F () | 336. | 343. | 347. | 357. | 368. | 374. | 379. | 384. | 400. | |
| | 30" | 90" | 1/2" | AAWS C3090 F () | 355. | 362. | 366. | 377. | 387. | 392. | 397. | 404. | 419. | |
| | 30" | 96" | 1/2" | AAWS C3096 F () | 375. | 382. | 385. | 395. | 407. | 412. | 417. | 422. | 438. | |

Order Code

| | |
|--------------|---------------------------|
| Example: | AAWS C0724 F 288-6 |
| A | AutoStrada |
| AWS | Applied wall system |
| C | Cover |
| 07 | Height |
| 24 | Width |
| F | Non-tackable upholstered |
| 288-6 | Fabric |

Specification Information

See finish page for Knoll textile selections.

Application



Non-tackable upholstered covers insert between horizontal channels to provide fabric surface.

Fabric is railroaded.

Wood core is firm enough to permit open shelf brackets to bear against face of cover.

Wall covers

Laminate or Veneer surface

| description | h | w | d | pattern no. | L | V1 | V2 | V3 |
|--|--------|-----|------|-----------------------|-------|--------|--------|--------|
| Laminate or Veneer cover, 7 1/2"H  | 7 1/2" | 24" | 1/2" | AAWS C0724 () | \$62. | \$134. | \$166. | \$224. |
| | 7 1/2" | 30" | 1/2" | AAWS C0730 () | 69. | 141. | 170. | 235. |
| | 7 1/2" | 36" | 1/2" | AAWS C0736 () | 72. | 144. | 172. | 255. |
| | 7 1/2" | 42" | 1/2" | AAWS C0742 () | 76. | 148. | 179. | 276. |
| | 7 1/2" | 48" | 1/2" | AAWS C0748 () | 80. | 152. | 184. | 294. |
| | 7 1/2" | 54" | 1/2" | AAWS C0754 () | 84. | 157. | 191. | 314. |
| | 7 1/2" | 60" | 1/2" | AAWS C0760 () | 89. | 161. | 199. | 335. |
| | 7 1/2" | 66" | 1/2" | AAWS C0766 () | 92. | 164. | 204. | 353. |
| | 7 1/2" | 72" | 1/2" | AAWS C0772 () | 96. | 168. | 210. | 373. |
| | 7 1/2" | 78" | 1/2" | AAWS C0778 () | n/a | 173. | 216. | 393. |
| | 7 1/2" | 84" | 1/2" | AAWS C0784 () | n/a | 177. | 222. | 412. |
| | 7 1/2" | 90" | 1/2" | AAWS C0790 () | n/a | 181. | 230. | 432. |
| | 7 1/2" | 96" | 1/2" | AAWS C0796 () | n/a | 185. | 235. | 452. |
| Laminate or Veneer cover, 15"H  | 15" | 24" | 1/2" | AAWS C1524 () | 78. | 151. | 183. | 290. |
| | 15" | 30" | 1/2" | AAWS C1530 () | 86. | 159. | 197. | 330. |
| | 15" | 36" | 1/2" | AAWS C1536 () | 94. | 166. | 208. | 367. |
| | 15" | 42" | 1/2" | AAWS C1542 () | 102. | 174. | 220. | 406. |
| | 15" | 48" | 1/2" | AAWS C1548 () | 111. | 184. | 235. | 447. |
| | 15" | 54" | 1/2" | AAWS C1554 () | 120. | 195. | 254. | 485. |
| | 15" | 60" | 1/2" | AAWS C1560 () | 128. | 202. | 263. | 524. |
| | 15" | 66" | 1/2" | AAWS C1566 () | 136. | 210. | 274. | 562. |
| | 15" | 72" | 1/2" | AAWS C1572 () | 142. | 217. | 285. | 598. |
| | 15" | 78" | 1/2" | AAWS C1578 () | n/a | 224. | 299. | 636. |
| | 15" | 84" | 1/2" | AAWS C1584 () | n/a | 232. | 311. | 673. |
| | 15" | 90" | 1/2" | AAWS C1590 () | n/a | 241. | 323. | 712. |
| | 15" | 96" | 1/2" | AAWS C1596 () | n/a | 248. | 335. | 751. |

Order Code

| | |
|------------|-----------------------|
| Example: | AAWS C0724 118 |
| A | AutoStrada |
| AWS | Applied wall system |
| C | Cover |
| 07 | Height |
| 24 | Width |
| 118 | Finish |

Specification Information

See finish page for laminate and veneer finish codes.

Product on this page will accept wood grain laminate where laminate is currently an option.

List price for wood grain laminate options will be current published laminate list price plus 10%.

Application

Veneer or laminate covers insert between horizontal channels.

Techwood and natural veneer grain direction is horizontal.

Wall covers

Laminate or Veneer surface

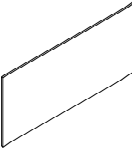
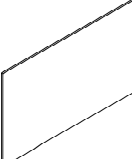
| description | h | w | d | pattern no. | L | V1 | V2 | V3 |
|---|---------|------|-----------------------|-----------------------|-------|--------|--------|--------|
| Laminate or Veneer cover, 22 1/2"H  | 22 1/2" | 24" | 1/2" | AAWS C2224 () | \$96. | \$170. | \$211. | \$371. |
| | 22 1/2" | 30" | 1/2" | AAWS C2230 () | 107. | 180. | 225. | 416. |
| | 22 1/2" | 36" | 1/2" | AAWS C2236 () | 125. | 199. | 254. | 490. |
| | 22 1/2" | 42" | 1/2" | AAWS C2242 () | 136. | 210. | 272. | 547. |
| | 22 1/2" | 48" | 1/2" | AAWS C2248 () | 145. | 220. | 289. | 600. |
| | 22 1/2" | 54" | 1/2" | AAWS C2254 () | 155. | 231. | 308. | 656. |
| | 22 1/2" | 60" | 1/2" | AAWS C2260 () | 180. | 244. | 327. | 718. |
| | 22 1/2" | 66" | 1/2" | AAWS C2266 () | 184. | 255. | 343. | 768. |
| | 22 1/2" | 72" | 1/2" | AAWS C2272 () | 188. | 266. | 361. | 824. |
| | 22 1/2" | 78" | 1/2" | AAWS C2278 () | n/a | 276. | 380. | 881. |
| | 22 1/2" | 84" | 1/2" | AAWS C2284 () | n/a | 287. | 397. | 938. |
| | 22 1/2" | 90" | 1/2" | AAWS C2290 () | n/a | 300. | 416. | 995. |
| 22 1/2" | 96" | 1/2" | AAWS C2296 () | n/a | 311. | 433. | 1,050. | |
| Laminate or Veneer cover, 30"H  | 30" | 24" | 1/2" | AAWS C3024 () | 111. | 184. | 235. | 448. |
| | 30" | 30" | 1/2" | AAWS C3030 () | 127. | 202. | 262. | 524. |
| | 30" | 36" | 1/2" | AAWS C3036 () | 146. | 220. | 289. | 601. |
| | 30" | 42" | 1/2" | AAWS C3042 () | 160. | 235. | 314. | 676. |
| | 30" | 48" | 1/2" | AAWS C3048 () | 174. | 250. | 337. | 750. |
| | 30" | 54" | 1/2" | AAWS C3054 () | 193. | 270. | 366. | 828. |
| | 30" | 60" | 1/2" | AAWS C3060 () | 206. | 284. | 390. | 904. |
| | 30" | 66" | 1/2" | AAWS C3066 () | 219. | 300. | 414. | 977. |
| | 30" | 72" | 1/2" | AAWS C3072 () | 234. | 314. | 437. | 1,052. |
| | 30" | 78" | 1/2" | AAWS C3078 () | n/a | 328. | 462. | 1,125. |
| | 30" | 84" | 1/2" | AAWS C3084 () | n/a | 343. | 485. | 1,198. |
| | 30" | 90" | 1/2" | AAWS C3090 () | n/a | 358. | 510. | 1,273. |
| 30" | 96" | 1/2" | AAWS C3096 () | n/a | 373. | 532. | 1,346. | |

Order Code

| |
|--------------------------------|
| Example: AAWS C0724 118 |
| A AutoStrada |
| AWS Applied wall system |
| C Cover |
| 07 Height |
| 24 Width |
| 118 Finish |

Specification Information

See finish page for laminate and veneer finish codes.

Product on this page will accept wood grain laminate where laminate is currently an option.

List price for wood grain laminate options will be current published laminate list price plus 10%.



Application

Veneer or laminate covers insert between horizontal channels.

Techwood and natural veneer grain direction is horizontal.

Wall covers

Painted surface

| description | h | w | d | pattern no. | paint |
|---|--------|------|-------------------------|-------------------------|--------|
| Painted cover, 7 1/2"H  | 7 1/2" | 24" | 1/2" | AAWS C0724 P () | \$114. |
| | 7 1/2" | 30" | 1/2" | AAWS C0730 P () | 115. |
| | 7 1/2" | 36" | 1/2" | AAWS C0736 P () | 116. |
| | 7 1/2" | 42" | 1/2" | AAWS C0742 P () | 144. |
| | 7 1/2" | 48" | 1/2" | AAWS C0748 P () | 146. |
| | 7 1/2" | 54" | 1/2" | AAWS C0754 P () | 147. |
| | 7 1/2" | 60" | 1/2" | AAWS C0760 P () | 175. |
| | 7 1/2" | 66" | 1/2" | AAWS C0766 P () | 177. |
| | 7 1/2" | 72" | 1/2" | AAWS C0772 P () | 178. |
| | 7 1/2" | 78" | 1/2" | AAWS C0778 P () | 180. |
| | 7 1/2" | 84" | 1/2" | AAWS C0784 P () | 209. |
| | 7 1/2" | 90" | 1/2" | AAWS C0790 P () | 211. |
| 7 1/2" | 96" | 1/2" | AAWS C0796 P () | 212. | |
| Painted cover, 15"H  | 15" | 24" | 1/2" | AAWS C1524 P () | 121. |
| | 15" | 30" | 1/2" | AAWS C1530 P () | 125. |
| | 15" | 36" | 1/2" | AAWS C1536 P () | 128. |
| | 15" | 42" | 1/2" | AAWS C1542 P () | 158. |
| | 15" | 48" | 1/2" | AAWS C1548 P () | 161. |
| | 15" | 54" | 1/2" | AAWS C1554 P () | 163. |
| | 15" | 60" | 1/2" | AAWS C1560 P () | 194. |
| | 15" | 66" | 1/2" | AAWS C1566 P () | 197. |
| | 15" | 72" | 1/2" | AAWS C1572 P () | 200. |
| | 15" | 78" | 1/2" | AAWS C1578 P () | 203. |
| | 15" | 84" | 1/2" | AAWS C1584 P () | 233. |
| | 15" | 90" | 1/2" | AAWS C1590 P () | 236. |
| 15" | 96" | 1/2" | AAWS C1596 P () | 241. | |

Order Code

| | |
|------------|-------------------------|
| Example: | AAWS C0724 P 118 |
| A | AutoStrada |
| AWS | Applied wall system |
| C | Cover |
| 07 | Height |
| 24 | Width |
| P | Painted surface |
| 118 | Finish |

Specification Information

See finish page for painted finish codes.

Application

Painted wood covers insert between horizontal channels.
 Painted covers are powder coat or wet spray on medium density fiberboard.

Wall covers

Painted surface

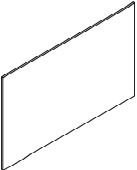
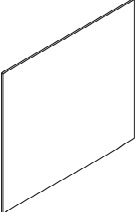
| description | h | w | d | pattern no. | paint |
|--|---------|------|-------------------------|-------------------------|--------|
| Painted cover, 22 1/2"H  | 22 1/2" | 24" | 1/2" | AAWS C2224 P () | \$128. |
| | 22 1/2" | 30" | 1/2" | AAWS C2230 P () | 134. |
| | 22 1/2" | 36" | 1/2" | AAWS C2236 P () | 138. |
| | 22 1/2" | 42" | 1/2" | AAWS C2242 P () | 168. |
| | 22 1/2" | 48" | 1/2" | AAWS C2248 P () | 173. |
| | 22 1/2" | 54" | 1/2" | AAWS C2254 P () | 178. |
| | 22 1/2" | 60" | 1/2" | AAWS C2260 P () | 209. |
| | 22 1/2" | 66" | 1/2" | AAWS C2266 P () | 213. |
| | 22 1/2" | 72" | 1/2" | AAWS C2272 P () | 218. |
| | 22 1/2" | 78" | 1/2" | AAWS C2278 P () | 222. |
| | 22 1/2" | 84" | 1/2" | AAWS C2284 P () | 256. |
| 22 1/2" | 90" | 1/2" | AAWS C2290 P () | 260. | |
| 22 1/2" | 96" | 1/2" | AAWS C2296 P () | 265. | |
| Painted cover, 30"H  | 30" | 24" | 1/2" | AAWS C3024 P () | 135. |
| | 30" | 30" | 1/2" | AAWS C3030 P () | 141. |
| | 30" | 36" | 1/2" | AAWS C3036 P () | 147. |
| | 30" | 42" | 1/2" | AAWS C3042 P () | 180. |
| | 30" | 48" | 1/2" | AAWS C3048 P () | 185. |
| | 30" | 54" | 1/2" | AAWS C3054 P () | 193. |
| | 30" | 60" | 1/2" | AAWS C3060 P () | 224. |
| | 30" | 66" | 1/2" | AAWS C3066 P () | 231. |
| | 30" | 72" | 1/2" | AAWS C3072 P () | 236. |
| | 30" | 78" | 1/2" | AAWS C3078 P () | 244. |
| | 30" | 84" | 1/2" | AAWS C3084 P () | 278. |
| 30" | 90" | 1/2" | AAWS C3090 P () | 283. | |
| 30" | 96" | 1/2" | AAWS C3096 P () | 289. | |

Order Code

| | |
|------------|-------------------------|
| Example: | AAWS C0724 P 118 |
| A | AutoStrada |
| AWS | Applied wall system |
| C | Cover |
| 07 | Height |
| 24 | Width |
| P | Painted surface |
| 118 | Finish |

Specification Information

See finish page for painted finish codes.

Application

Painted wood covers insert between horizontal channels.
 Painted covers are powder coat or wet spray on medium density fiberboard.

Wall covers

Backpainted glass surface

AutoStrada

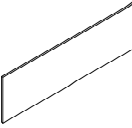
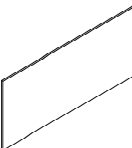
| description | h | w | pattern no. | 881 | 882 |
|--|---------|-----|-------------------------|--------|--------|
| Backpainted glass, 15"H  | 15" | 24" | AAWS C1524 G () | \$256. | \$310. |
| | 15" | 30" | AAWS C1530 G () | 299. | 352. |
| | 15" | 36" | AAWS C1536 G () | 341. | 394. |
| | 15" | 42" | AAWS C1542 G () | 384. | 437. |
| | 15" | 48" | AAWS C1548 G () | 426. | 480. |
| | 15" | 54" | AAWS C1554 G () | 469. | 523. |
| | 15" | 60" | AAWS C1560 G () | 513. | 565. |
| | 15" | 66" | AAWS C1566 G () | 554. | 607. |
| Backpainted glass, 22 1/2"H  | 22 1/2" | 24" | AAWS C2224 G () | 336. | 406. |
| | 22 1/2" | 30" | AAWS C2230 G () | 400. | 464. |
| | 22 1/2" | 36" | AAWS C2236 G () | 459. | 523. |
| | 22 1/2" | 42" | AAWS C2242 G () | 523. | 587. |
| | 22 1/2" | 48" | AAWS C2248 G () | 582. | 661. |
| | 22 1/2" | 54" | AAWS C2254 G () | 639. | 736. |
| | 22 1/2" | 60" | AAWS C2260 G () | 703. | 810. |
| | 22 1/2" | 66" | AAWS C2266 G () | 762. | 885. |
| | 22 1/2" | 72" | AAWS C2272 G () | 821. | 960. |

Order Code

| |
|----------------------------------|
| Example: AAWS C1524 G 881 |
| A AutoStrada |
| AAWS Applied wall system |
| C Cover |
| 15 Height |
| 24 Width |
| G Backpainted glass |
| 881 Finish |

Specification Information

Backpainted glass is 4mm thick.
 Specify glass surface:
 881 sea glass white
 882 star white
 Sea glass has natural glass tint.
 Star glass has low lead content for pure white appearance.

Application

Backpainted glass covers insert between horizontal channels to provide nearly opaque glass surface. Glass covers may be used as dry-erase marker surface.

Bookshelves cannot be mounted in channel directly above glass cover.

| description | h | w | d | pattern no. | price | finished |
|---|----|-----|--------|------------------------|-------|----------|
| Display shelf | 1" | 6" | 5 1/2" | AAWS DS0605 () | \$74. | aluminum |
|  | 1" | 24" | 5 1/2" | AAWS DS2405 () | 193. | aluminum |
| | 1" | 30" | 5 1/2" | AAWS DS3005 () | 203. | aluminum |
| | 1" | 36" | 5 1/2" | AAWS DS3605 () | 218. | aluminum |
| | 1" | 42" | 5 1/2" | AAWS DS4205 () | 241. | aluminum |
| | 1" | 48" | 5 1/2" | AAWS DS4805 () | 256. | aluminum |
| | 1" | 54" | 5 1/2" | AAWS DS5405 () | 277. | aluminum |
| | 1" | 60" | 5 1/2" | AAWS DS6005 () | 287. | aluminum |
| | 1" | 66" | 5 1/2" | AAWS DS6605 () | 299. | aluminum |
| | 1" | 72" | 5 1/2" | AAWS DS7205 () | 310. | aluminum |

Order Code



| | |
|------------|-----------------------|
| Example: | AAWS DS2405 AA |
| A | AutoStrada |
| AWS | Applied wall system |
| DS | Display shelf |
| 24 | Width |
| 05 | Depth |
| AA | Finish |

Specification Information

AA - Anodized Aluminum or any standard painted finish except 613 Silver.

Application

Display shelf is natural anodized aluminum extrusion with integral bracket detail that engages into horizontal channel at any point. Display shelves are typically mounted in channels at 31 1/2" or 39" above the floor. Display shelf can be mounted in channel between glass covers.

| description | h | w | d | pattern no. | list | glass |
|---|--------|-----|----|-----------------------------|------|--------|
| Powder glass lower shelf  | 1 1/2" | 24" | 9" | AAWS LS2409 G ()() | | \$448. |
| | 1 1/2" | 30" | 9" | AAWS LS3009 G ()() | | 480. |
| | 1 1/2" | 36" | 9" | AAWS LS3609 G ()() | | 518. |
| | 1 1/2" | 42" | 9" | AAWS LS4209 G ()() | | 560. |
| | 1 1/2" | 48" | 9" | AAWS LS4809 G ()() | | 602. |
| | 1 1/2" | 54" | 9" | AAWS LS5409 G ()() | | 651. |
| | 1 1/2" | 60" | 9" | AAWS LS6009 G ()() | | 693. |
| | 1 1/2" | 66" | 9" | AAWS LS6609 G ()() | | 741. |
| | 1 1/2" | 72" | 9" | AAWS LS7209 G ()() | | 790. |
| Powder glass upper shelf  | 1 1/2" | 24" | 9" | AAWS US2409 G ()() | | 448. |
| | 1 1/2" | 30" | 9" | AAWS US3009 G ()() | | 480. |
| | 1 1/2" | 36" | 9" | AAWS US3609 G ()() | | 518. |
| | 1 1/2" | 42" | 9" | AAWS US4209 G ()() | | 560. |
| | 1 1/2" | 48" | 9" | AAWS US4809 G ()() | | 602. |
| | 1 1/2" | 54" | 9" | AAWS US5409 G ()() | | 651. |
| | 1 1/2" | 60" | 9" | AAWS US6009 G ()() | | 693. |
| | 1 1/2" | 66" | 9" | AAWS US6609 G ()() | | 741. |
| | 1 1/2" | 72" | 9" | AAWS US7209 G ()() | | 790. |
| Book ends (pair) | 7" | 5" | 7" | AAWS BE () | 59. | |

| Order Code | |
|---------------------------------------|---------------------|
| Example: AAWS LS2409 G GL13 AA | |
| A | AutoStrada |
| AWS | Applied wall system |
| LS | Shelf |
| 24 | Width |
| 09 | Depth |
| G | Glass |
| GL13 | Glass finish |
| AA | Support finish |

Specification Information

GL13 - Powder glass only.

Glass platform is available in AA anodized aluminum or any standard painted finish except Silver.

Bookends are available in any standard painted finish.

Application

Glass shelves are supported by a 5 1/2" deep aluminum platform with integral bracket detail that engages into horizontal channel at any point.

Specify lower shelf for most applications to align with bottom of adjacent overhead storage cabinet. Specify upper shelf only to align with top of adjacent overhead storage cabinet.

Shelf bracket bears against surface of cover below so it cannot be positioned above glass or tackable fabric covers.



Book ends rest on glass shelf at any point to contain books or binders.

Bookshelves

laminate and veneer

AutoStrada

Applied Wall

| description | h | w | d | pattern no. | list | L | V1 | V2 | V3 |
|---|--------|-----|-----|----------------------------|------|--------|--------|--------|--------|
| Laminate or veneer lower shelf  | 1 1/2" | 24" | 12" | AAWS LS2412 () () | | \$203. | \$264. | \$303. | \$409. |
| | 1 1/2" | 30" | 12" | AAWS LS3012 () () | | 223. | 290. | 335. | 451. |
| | 1 1/2" | 36" | 12" | AAWS LS3612 () () | | 246. | 319. | 367. | 493. |
| | 1 1/2" | 42" | 12" | AAWS LS4212 () () | | 267. | 347. | 398. | 537. |
| | 1 1/2" | 48" | 12" | AAWS LS4812 () () | | 287. | 375. | 430. | 581. |
| | 1 1/2" | 54" | 12" | AAWS LS5412 () () | | 352. | 458. | 526. | 708. |
| | 1 1/2" | 60" | 12" | AAWS LS6012 () () | | 330. | 429. | 493. | 667. |
| | 1 1/2" | 66" | 12" | AAWS LS6612 () () | | 352. | 458. | 526. | 708. |
| | 1 1/2" | 72" | 12" | AAWS LS7212 () () | | 374. | 485. | 557. | 752. |
| Laminate or veneer upper shelf  | 1 1/2" | 24" | 12" | AAWS US2412 () () | | 203. | 264. | 303. | 409. |
| | 1 1/2" | 30" | 12" | AAWS US3012 () () | | 223. | 290. | 335. | 451. |
| | 1 1/2" | 36" | 12" | AAWS US3612 () () | | 246. | 319. | 367. | 493. |
| | 1 1/2" | 42" | 12" | AAWS US4212 () () | | 267. | 347. | 398. | 537. |
| | 1 1/2" | 48" | 12" | AAWS US4812 () () | | 287. | 375. | 430. | 581. |
| | 1 1/2" | 54" | 12" | AAWS US5412 () () | | 352. | 458. | 526. | 708. |
| | 1 1/2" | 60" | 12" | AAWS US6012 () () | | 330. | 429. | 493. | 667. |
| | 1 1/2" | 66" | 12" | AAWS US6612 () () | | 352. | 458. | 526. | 708. |
| | 1 1/2" | 72" | 12" | AAWS US7212 () () | | 374. | 485. | 557. | 752. |
| Book ends (pair) | 7" | 5" | 7" | AAWS BE () | 59. | | | | |

Order Code

| | |
|------------|---------------------------|
| Example: | AAWS LS2412 118 AA |
| A | Autostrada |
| AWS | Applied wall system |
| LS | Shelf |
| 24 | Width |
| 12 | Depth |
| 118 | Shelf finish |
| AA | Support finish |

Specification Information

Shelf platform is available in AA anodized aluminum or any standard painted finish except 613 Silver.

Bookends are available in any standard painted finish.

See finish page for laminate and veneer finish codes.

Product on this page will accept wood grain laminate where laminate is currently an option. List price for wood grain laminate options will be current published laminate list price plus 10%.

Application

Laminate and veneer bookshelves are supported by a 5 1/2" deep aluminum platform with integral bracket detail that engages into horizontal channel at any point. Specify lower shelf for most applications to align with bottom of adjacent overhead storage cabinet. Specify upper shelf only to align with top of adjacent overhead storage cabinet. Shelf bracket bears against surface of cover below so it cannot be positioned above glass or tackable fabric covers.

Book ends rest on bookshelf at any point to contain books or binders.

Open overhead cabinets

Laminate or wood veneer

AutoStrada

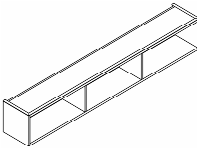
| description | h | w | d | pattern no. | L | V1 | V2 | V3 |
|---|----------------------------|-----|---------|---------------------------|---------------------------|----------|----------|----------|
| Open overhead, binder depth  96" w shown | 15" | 18" | 14 1/4" | AAWS OBO 18 ()() | \$1,427. | \$1,480. | \$1,706. | \$2,218. |
| | 15" | 24" | 14 1/4" | AAWS OBO 24 ()() | 1,466. | 1,519. | 1,749. | 2,274. |
| | 15" | 30" | 14 1/4" | AAWS OBO 30 ()() | 1,505. | 1,559. | 1,792. | 2,331. |
| | 15" | 36" | 14 1/4" | AAWS OBO 36 ()() | 1,546. | 1,601. | 1,839. | 2,389. |
| | 15" | 42" | 14 1/4" | AAWS OBO 42 ()() | 1,586. | 1,639. | 1,887. | 2,453. |
| | 15" | 48" | 14 1/4" | AAWS OBO 48 ()() | 1,630. | 1,683. | 1,937. | 2,519. |
| | 15" | 54" | 14 1/4" | AAWS OBO 54 ()() | 1,714. | 1,770. | 2,039. | 2,649. |
| | 15" | 60" | 14 1/4" | AAWS OBO 60 ()() | 1,800. | 1,857. | 2,139. | 2,780. |
| | 15" | 66" | 14 1/4" | AAWS OBO 66 ()() | 1,850. | 1,913. | 2,197. | 2,859. |
| | 15" | 72" | 14 1/4" | AAWS OBO 72 ()() | 1,900. | 1,968. | 2,258. | 2,937. |
| | 15" | 78" | 14 1/4" | AAWS OBO 78 ()() | 1,993. | 2,066. | 2,372. | 3,083. |
| | 15" | 84" | 14 1/4" | AAWS OBO 84 ()() | 2,054. | 2,127. | 2,443. | 3,176. |
| | 15" | 90" | 14 1/4" | AAWS OBO 90 ()() | 2,116. | 2,192. | 2,517. | 3,271. |
| | 15" | 96" | 14 1/4" | AAWS OBO 96 ()() | 2,179. | 2,257. | 2,592. | 3,640. |
| | Open overhead, legal depth | 15" | 18" | 17 1/4" | AAWS OGO 18 ()() | 1,541. | 1,601. | 1,840. |
| 15" | | 24" | 17 1/4" | AAWS OGO 24 ()() | 1,582. | 1,642. | 1,888. | 2,456. |
| 15" | | 30" | 17 1/4" | AAWS OGO 30 ()() | 1,627. | 1,684. | 1,936. | 2,518. |
| 15" | | 36" | 17 1/4" | AAWS OGO 36 ()() | 1,670. | 1,729. | 1,985. | 2,582. |
| 15" | | 42" | 17 1/4" | AAWS OGO 42 ()() | 1,713. | 1,770. | 2,038. | 2,649. |
| 15" | | 48" | 17 1/4" | AAWS OGO 48 ()() | 1,759. | 1,818. | 2,092. | 2,720. |
| 15" | | 54" | 17 1/4" | AAWS OGO 54 ()() | 1,851. | 1,911. | 2,202. | 2,862. |
| 15" | | 60" | 17 1/4" | AAWS OGO 60 ()() | 1,944. | 2,007. | 2,310. | 3,002. |
| 15" | | 66" | 17 1/4" | AAWS OGO 66 ()() | 1,995. | 2,066. | 2,375. | 3,089. |
| 15" | | 72" | 17 1/4" | AAWS OGO 72 ()() | 2,051. | 2,125. | 2,441. | 3,172. |
| 15" | | 78" | 17 1/4" | AAWS OGO 78 ()() | 2,155. | 2,232. | 2,563. | 3,330. |
| 15" | | 84" | 17 1/4" | AAWS OGO 84 ()() | 2,219. | 2,299. | 2,639. | 3,431. |
| 15" | | 90" | 17 1/4" | AAWS OGO 90 ()() | 2,286. | 2,366. | 2,718. | 3,533. |
| 15" | | 96" | 17 1/4" | AAWS OGO 96 ()() | 2,354. | 2,438. | 2,800. | 3,640. |

| Order Code | Specification Information | Application |
|-------------------------------------|--|---|
| Example: AAWS OBO 18 118 115 | See finish page for laminate and veneer finish codes. Product on this page will accept wood grain laminate where laminate is currently an option. List price for wood grain laminate options will be current published laminate list price plus 10%. Top trim may be specified in AA anodized aluminum or any standard painted finish except Silver. Mounting extrusions and anti dislodgement brackets match the AA trim or are black paint with any painted finish trim. | Open overhead cabinets include continuous mounting extrusion that engages into top or intermediate channel at any point. Overhead cabinets also include anti-dislodgement brackets that engage into intermediate channel below cabinet. Overhead cabinets normally mount between 54" and 69" above the floor. |
| A AutoStrada | | |
| AWS Applied wall system | | |
| OBO Open overhead cabinet | | |
| 18 Width | | |
| 118 Laminate or veneer | | |
| 115 Trim finish | Open overhead cabinets are binder height. | |

Sliding door overhead cabinets with glass doors

Laminate or wood veneer

AutoStrada

Applied Wall

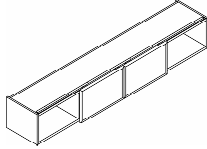
| description | h | w | d | pattern no. | L | V1 | V2 | V3 |
|--|---|-----|---------|----------------------------|----------------------------|----------|----------|----------|
|  <p>96" w shown</p> | 15" | 42" | 15 1/4" | AAWS OBR 42 () () | \$2,948. | \$3,077. | \$3,859. | \$4,630. |
| | 15" | 48" | 15 1/4" | AAWS OBR 48 () () | 3,039. | 3,177. | 3,977. | 4,775. |
| | 15" | 54" | 15 1/4" | AAWS OBR 54 () () | 3,129. | 3,279. | 4,095. | 4,914. |
| | 15" | 60" | 15 1/4" | AAWS OBR 60 () () | 3,220. | 3,380. | 4,213. | 5,056. |
| | 15" | 66" | 15 1/4" | AAWS OBR 66 () () | 3,309. | 3,482. | 4,332. | 5,199. |
| | 15" | 72" | 15 1/4" | AAWS OBR 72 () () | 3,399. | 3,581. | 4,450. | 5,341. |
| | 15" | 78" | 15 1/4" | AAWS OBR 78 () () | 3,571. | 3,762. | 4,674. | 5,609. |
| | 15" | 84" | 15 1/4" | AAWS OBR 84 () () | 3,677. | 3,875. | 4,815. | 5,776. |
| | 15" | 90" | 15 1/4" | AAWS OBR 90 () () | 3,787. | 3,990. | 4,958. | 5,950. |
| | 15" | 96" | 15 1/4" | AAWS OBR 96 () () | 3,902. | 4,109. | 5,106. | 6,130. |
| | Open/Sliding door(s) glass, legal depth | 15" | 42" | 18 1/4" | AAWS OGR 42 () () | 3,182. | 3,324. | 4,165. |
| 15" | | 48" | 18 1/4" | AAWS OGR 48 () () | 3,279. | 3,433. | 4,293. | 5,151. |
| 15" | | 54" | 18 1/4" | AAWS OGR 54 () () | 3,378. | 3,804. | 4,422. | 5,305. |
| 15" | | 60" | 18 1/4" | AAWS OGR 60 () () | 3,475. | 3,652. | 4,550. | 5,460. |
| 15" | | 66" | 18 1/4" | AAWS OGR 66 () () | 3,576. | 3,760. | 4,678. | 5,613. |
| 15" | | 72" | 18 1/4" | AAWS OGR 72 () () | 3,672. | 3,867. | 4,807. | 5,769. |
| 15" | | 78" | 18 1/4" | AAWS OGR 78 () () | 3,856. | 4,062. | 5,048. | 6,058. |
| 15" | | 84" | 18 1/4" | AAWS OGR 84 () () | 3,972. | 4,185. | 5,199. | 6,239. |
| 15" | | 90" | 18 1/4" | AAWS OGR 90 () () | 4,090. | 4,309. | 5,355. | 6,427. |
| 15" | | 96" | 18 1/4" | AAWS OGR 96 () () | 4,214. | 4,439. | 5,516. | 6,619. |

Order Code

| | |
|-------------|--|
| Example: | AAWS ORB 42 118 GL13 AA |
| A | AutoStrada |
| AWS | Applied wall system |
| ORB | Sliding glass door binder depth overhead |
| 42 | Width |
| 118 | Case finish |
| GL13 | Glass finish |
| AA | Trim finish |

Specification Information

See finish page for laminate, veneer and glass finish codes.

Product on this page will accept wood grain laminate where laminate is currently an option. List price for wood grain laminate options will be current published laminate list price plus 10%.

Trim finish is AA anodized aluminum or any standard painted finish except 613 Silver.

Mounting extrusion and anti dislodgement brackets match the AA trim or are black paint with any painted finish trim.

Application

Sliding door overhead cabinets include continuous mounting extrusion that engages into top or intermediate channel at any point. Overhead cabinets also include anti-dislodgement brackets that engage into intermediate channel below cabinet. Overhead cabinets normally mount between 54" and 69" above the floor.

Overhead cabinets are binder height.
No locks.

Sliding door overhead cabinets with laminate or veneer doors

Laminate or wood veneer

AutoStrada

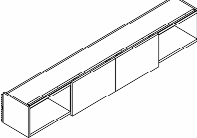
| description | h | w | d | pattern no. | L | V1 | V2 | V3 |
|---|-----|-----|---------|----------------------------|----------|----------|----------|----------|
| Open/Sliding door(s) laminate or veneer, binder depth  96" w shown | 15" | 42" | 15 1/4" | AAWS OBS 42 () () | \$2,469. | \$2,589. | \$3,290. | \$4,278. |
| | 15" | 48" | 15 1/4" | AAWS OBS 48 () () | 2,546. | 2,675. | 3,391. | 4,409. |
| | 15" | 54" | 15 1/4" | AAWS OBS 54 () () | 2,623. | 2,758. | 3,493. | 4,540. |
| | 15" | 60" | 15 1/4" | AAWS OBS 60 () () | 2,698. | 2,843. | 3,593. | 4,672. |
| | 15" | 66" | 15 1/4" | AAWS OBS 66 () () | 2,775. | 2,926. | 3,695. | 4,803. |
| | 15" | 72" | 15 1/4" | AAWS OBS 72 () () | 2,850. | 3,010. | 3,795. | 4,935. |
| | 15" | 78" | 15 1/4" | AAWS OBS 78 () () | 2,992. | 3,162. | 3,986. | 5,182. |
| | 15" | 84" | 15 1/4" | AAWS OBS 84 () () | 3,081. | 3,256. | 4,106. | 5,337. |
| | 15" | 90" | 15 1/4" | AAWS OBS 90 () () | 3,174. | 3,355. | 4,227. | 5,497. |
| | 15" | 96" | 15 1/4" | AAWS OBS 96 () () | 3,268. | 3,455. | 4,354. | 5,663. |
| Open/Sliding door(s) laminate or veneer, legal depth | 15" | 42" | 18 1/4" | AAWS OGS 42 () () | 2,668. | 2,793. | 3,563. | 4,618. |
| | 15" | 48" | 18 1/4" | AAWS OGS 48 () () | 2,752. | 2,886. | 3,668. | 4,760. |
| | 15" | 54" | 18 1/4" | AAWS OGS 54 () () | 2,832. | 2,978. | 3,774. | 4,902. |
| | 15" | 60" | 18 1/4" | AAWS OGS 60 () () | 2,912. | 3,069. | 3,880. | 5,044. |
| | 15" | 66" | 18 1/4" | AAWS OGS 66 () () | 2,996. | 3,162. | 3,990. | 5,188. |
| | 15" | 72" | 18 1/4" | AAWS OGS 72 () () | 3,077. | 3,252. | 4,101. | 5,329. |
| | 15" | 78" | 18 1/4" | AAWS OGS 78 () () | 3,232. | 3,414. | 4,306. | 5,596. |
| | 15" | 84" | 18 1/4" | AAWS OGS 84 () () | 3,327. | 3,517. | 4,434. | 5,763. |
| | 15" | 90" | 18 1/4" | AAWS OGS 90 () () | 3,428. | 3,622. | 4,566. | 5,938. |
| | 15" | 96" | 18 1/4" | AAWS OGS 96 () () | 3,531. | 3,731. | 4,704. | 6,114. |

| Order Code | Specification Information | Application |
|---|--|---|
| Example: AAWS OBS 42 118 AA A AutoStrada AWS Applied wall system OBS Sliding solid door binder depth overhead 42 Width 118 Finish AA Trim finish | See finish page for laminate and veneer finish codes. Product on this page will accept wood grain laminate where laminate is currently an option. List price for wood grain laminate options will be current published laminate list price plus 10%. Trim finish is AA anodized aluminum or any standard painted finish except 613 Silver. Mounting extrusion and anti dislodgement bracket match the AA trim or are black paint with any painted finish trim. | Sliding door overhead cabinets include continuous mounting extrusion that engages into top or intermediate channel at any point. Overhead cabinets also include anti-dislodgement brackets that engage into intermediate channel below cabinet. Overhead cabinets normally mount between 54" and 69" above the floor. Sliding door overheads are not available with locks. |

Overhead cabinets are binder height.
No locks.

Hinged door overhead cabinets

Laminate or wood veneer

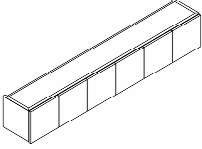
| description | h | w | d | #drs/locks | pattern no. | L | V1 | V2 | V3 |
|---|-----|-----|---------|------------|-----------------------------|----------|----------|----------|----------|
| Hinged door overhead binder depth  96" w shown | 15" | 18" | 15 1/4" | 1/1 | AAWS OBD 18L () () | \$1,961. | \$2,026. | \$2,326. | \$3,026. |
| | 15" | 18" | 15 1/4" | 1/1 | AAWS OBD 18R () () | 1,961. | 2,026. | 2,326. | 3,026. |
| | 15" | 24" | 15 1/4" | 2/1 | AAWS OBD 24 () () | 2,074. | 2,141. | 2,459. | 3,199. |
| | 15" | 30" | 15 1/4" | 2/1 | AAWS OBD 30 () () | 2,191. | 2,265. | 2,602. | 3,384. |
| | 15" | 36" | 15 1/4" | 2/1 | AAWS OBD 36 () () | 2,315. | 2,394. | 2,755. | 3,580. |
| | 15" | 42" | 15 1/4" | 3/2 | AAWS OBD 42 () () | 2,333. | 2,414. | 2,775. | 3,605. |
| | 15" | 48" | 15 1/4" | 3/2 | AAWS OBD 48 () () | 2,378. | 2,457. | 2,830. | 3,677. |
| | 15" | 54" | 15 1/4" | 3/2 | AAWS OBD 54 () () | 2,502. | 2,585. | 2,976. | 3,868. |
| | 15" | 60" | 15 1/4" | 4/2 | AAWS OBD 60 () () | 2,622. | 2,707. | 3,115. | 4,050. |
| | 15" | 66" | 15 1/4" | 4/2 | AAWS OBD 66 () () | 2,699. | 2,792. | 3,210. | 4,175. |
| | 15" | 72" | 15 1/4" | 4/2 | AAWS OBD 72 () () | 2,772. | 2,866. | 3,297. | 4,284. |
| | 15" | 78" | 15 1/4" | 5/3 | AAWS OBD 78 () () | 2,912. | 3,017. | 3,463. | 4,503. |
| | 15" | 84" | 15 1/4" | 5/3 | AAWS OBD 84 () () | 2,999. | 3,107. | 3,567. | 4,638. |
| | 15" | 90" | 15 1/4" | 6/3 | AAWS OBD 90 () () | 3,088. | 3,200. | 3,675. | 4,778. |
| | 15" | 96" | 15 1/4" | 6/3 | AAWS OBD 96 () () | 3,183. | 3,297. | 3,785. | 4,920. |
| Hinged door overhead legal depth | 15" | 18" | 18 1/4" | 1/1 | AAWS OGD 18L () () | 2,119. | 2,187. | 2,510. | 3,266. |
| | 15" | 18" | 18 1/4" | 1/1 | AAWS OGD 18R () () | 2,119. | 2,187. | 2,510. | 3,266. |
| | 15" | 24" | 18 1/4" | 2/1 | AAWS OGD 24 () () | 2,238. | 2,313. | 2,658. | 3,456. |
| | 15" | 30" | 18 1/4" | 2/1 | AAWS OGD 30 () () | 2,366. | 2,445. | 2,812. | 3,655. |
| | 15" | 36" | 18 1/4" | 2/1 | AAWS OGD 36 () () | 2,501. | 2,586. | 2,975. | 3,866. |
| | 15" | 42" | 18 1/4" | 3/2 | AAWS OGD 42 () () | 2,519. | 2,619. | 2,996. | 3,895. |
| | 15" | 48" | 18 1/4" | 3/2 | AAWS OGD 48 () () | 2,569. | 2,652. | 3,055. | 3,973. |
| | 15" | 54" | 18 1/4" | 3/2 | AAWS OGD 54 () () | 2,703. | 2,791. | 3,212. | 4,178. |
| | 15" | 60" | 18 1/4" | 4/2 | AAWS OGD 60 () () | 2,831. | 2,925. | 3,365. | 4,375. |
| | 15" | 66" | 18 1/4" | 4/2 | AAWS OGD 66 () () | 2,914. | 3,016. | 3,468. | 4,507. |
| | 15" | 72" | 18 1/4" | 4/2 | AAWS OGD 72 () () | 2,994. | 3,095. | 3,561. | 4,628. |
| | 15" | 78" | 18 1/4" | 5/3 | AAWS OGD 78 () () | 3,147. | 3,259. | 3,739. | 4,863. |
| | 15" | 84" | 18 1/4" | 5/3 | AAWS OGD 84 () () | 3,241. | 3,356. | 3,853. | 5,009. |
| | 15" | 90" | 18 1/4" | 6/3 | AAWS OGD 90 () () | 3,338. | 3,457. | 3,970. | 5,158. |
| | 15" | 96" | 18 1/4" | 6/3 | AAWS OGD 96 () () | 3,437. | 3,561. | 4,088. | 5,314. |

| Order Code | Specification Information | Application |
|---|---|--|
| Example: AAWS OBD 24 L 118 AA A AutoStrada AAWS Applied wall system OBD Hinged door binder depth overhead 24 Width L Lock 118 Case & matching door finish AA Trim finish | See finish page for laminate and veneer finish codes. Product on this page will accept wood grain laminate where laminate is currently an option. List price for wood grain laminate options will be current published laminate list price plus 10%. Trim finish is AA anodized aluminum or any standard painted finish except 613 Silver. Mounting extrusion and anti dislodgement brackets match the AA trim or are black paint with any painted finish trim. | Hinged door overhead cabinets include continuous mounting extrusion that engages into top or intermediate channel at any point. Overhead cabinets also include anti-dislodgement brackets that engage into intermediate channel below cabinet. Overhead cabinets normally mount between 54" and 69" above the floor. Overhead cabinets are binder height. |

Overhead storage mounting kits

Adapters for Reuter and wall-attached wood overheads

AutoStrada

| description | type | w | pattern no. | painting | black or AA |
|---------------------------------------|--------------|---|-----------------------|----------|-------------|
| Reuter overhead storage downmount kit | Applied Wall | | AAWS RO MK () | \$172. | |

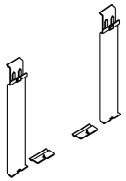

| Adapter kit for wood overhead storage | Length | Width | Pattern No. | Price |
|---------------------------------------|--------|---------|-------------------------|-------|
| | 18" | 16 1/2" | AAWS WOMK 18 () | 82. |
| | 24" | 22 1/2" | AAWS WOMK 24 () | 87. |
| | 30" | 28 1/2" | AAWS WOMK 30 () | 91. |
| | 36" | 34 1/2" | AAWS WOMK 36 () | 98. |
| | 42" | 40 1/2" | AAWS WOMK 42 () | 103. |
| | 48" | 46 1/2" | AAWS WOMK 48 () | 108. |
| | 54" | 52 1/2" | AAWS WOMK 54 () | 112. |
| | 60" | 58 1/2" | AAWS WOMK 60 () | 117. |
| | 66" | 64 1/2" | AAWS WOMK 66 () | 122. |
| | 72" | 70 1/2" | AAWS WOMK 72 () | 138. |
| | 78" | 76 1/2" | AAWS WOMK 78 () | 145. |
| | 84" | 82 1/2" | AAWS WOMK 84 () | 151. |
| | 90" | 88 1/2" | AAWS WOMK 90 () | 157. |
| | 96" | 94 1/2" | AAWS WOMK 96 () | 162. |

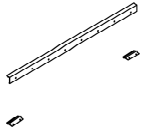



| Order Code | Specification Information | Application |
|------------------------------------|---|--|
| Example: AAWS WOMK 18 AA | | |
| A AutoStrada | For Reuter overhead downmount brackets - see finish page for painted finish code options. | Reuter overhead storage downmount kit adapts Reuter flat front or curved front cabinets to attach to top or intermediate channel. Kit includes two anti-dislodgement brackets that engage into intermediate channel below the cabinet. |
| AWS Applied wall system | Adapter kits for wood overheads are available in AA anodized aluminum or 111 black only. | |
| WOMK Wall mount bracket kit | | |
| 18 Width | | |
| AA Finish | | |

Adapter kit for wood overhead storage converts AutoStrada wall-attached single-high overhead cabinets to mount on the applied wall system.

Power and wire management

Cable trays and worksurface supports

| description | application | h | w | d | pattern no. | list | painting or aluminum |
|--|----------------------|--------|-----|--------|----------------------|------|----------------------------|
|  <p>Cable tray</p> | | 2 1/4" | 24" | 1 3/4" | AAWS CT24 () | | \$65. |
| | | 2 1/4" | 30" | 1 3/4" | AAWS CT30 () | | 71. |
| | | 2 1/4" | 36" | 1 3/4" | AAWS CT36 () | | 81. |
| | | 2 1/4" | 42" | 1 3/4" | AAWS CT42 () | | 92. |
| | | 2 1/4" | 48" | 1 3/4" | AAWS CT48 () | | 104. |
| | | 2 1/4" | 54" | 1 3/4" | AAWS CT54 () | | 119. |
| | | 2 1/4" | 60" | 1 3/4" | AAWS CT60 () | | 126. |
| | | 2 1/4" | 66" | 1 3/4" | AAWS CT66 () | | 131. |
| | | 2 1/4" | 72" | 1 3/4" | AAWS CT72 () | | 136. |
|  <p>End support bracket</p> | 28 3/8"H worksurface | 3" | 2" | | AAWS BE27 () | 109. | |
| | 29 5/8"H worksurface | 4" | 2" | | AAWS BE28 () | 109. | |

Order Code

| | |
|------------|---------------------|
| Example: | AAWS CT18 AA |
| A | AutoStrada |
| AWS | Applied Wall System |
| CT | Cable tray |
| 18 | Width |
| AA | Finish |

Specification Information

Cable trays are available in AA - Anodized Aluminum or any standard painted finish except 613 Silver.

End support brackets are available in all standard paint finishes.

Application

Cable trays mount anywhere along any intermediate channel, and are typically installed below worksurface height in the channel 24" above the floor.

End support brackets also directly engage into intermediate channel at 24" above floor to support back edge or one end of worksurface.



When combined with recess cover above cable tray is effectively expanded from 1 3/4" to 2 1/2" deep.

End support brackets include a flat base plate to engage into a slot in the base of the cable tray.

Power and wire management

Surface mounted plugmold raceway

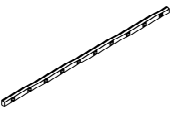
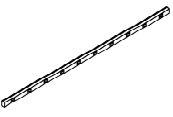
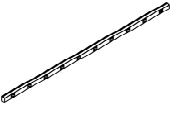
AutoStrada

| description | h | w | d | pattern no. | aluminum |
|--|--------|-----|--------|--------------------------|----------|
| Plugmold, single circuit (3 wire, grey outlets)  | 1 1/2" | 60" | 1 1/8" | AAWS RPM1 05 () | \$377. |
| Plugmold, two circuits (4 wire, grey outlets shared neutral and ground)  | 1 1/2" | 60" | 1 1/8" | AAWS RPM2 05 () | 471. |
| Plugmold, isolated (6 wire, gray + orange outlets independent neutral and ground)  | 1 1/2" | 60" | 1 1/8" | AAWS RPM2I 05 () | 471. |
| Plugstrip, two circuits (4 wire, grey + orange outlets shared neutral and ground)  | 1 1/2" | 28" | 1 1/8" | AAWS RPM2 02 () | 230. |

Order Code

| | |
|-----------------|-------------------------------|
| Example: | AAWS RPM1 03 AA |
| A | AutoStrada |
| AWS | Applied Wall System |
| RPM1 | Plugmold raceway, one circuit |
| 03 | 36" width |
| AA | Finish, Aluminum |

Specification Information

AA - Aluminum only available finish.

Plugmold is 60" wide with outlets every 6" (ten simplex outlets total).

Plugstrip is 28" wide with outlets every 3" (eight outlets total).





Application

Plugmold is surface mounted raceway for one or two circuits. Plugmold includes ten simplex outlets, anodized aluminum covers and end caps. Plugmold may be linked or trimmed to length on site.

Plugstrip includes eight simplex outlets.

Plugstrip mounts to 30" or wider recess cover.

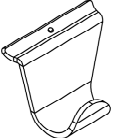
Power supply must be made by an electrical contractor, including hardwire connection from junction box in building to back side of plugmold raceway. Typically contractor punches a hole for connection through a recess cover positioned just above a junction box in the building wall.

| description | h | w | d | pattern no. | list | paint | black or AA only |
|--|--------|--------|--------|-----------------------|------|----------|------------------|
| Marker tray  | 3/4" | 24" | 2 1/2" | AAWS MT24 () | | aluminum | \$58. |
| | 3/4" | 30" | 2 1/2" | AAWS MT30 () | | aluminum | 63. |
| | 3/4" | 36" | 2 1/2" | AAWS MT36 () | | aluminum | 68. |
| | 3/4" | 42" | 2 1/2" | AAWS MT42 () | | aluminum | 73. |
| | 3/4" | 48" | 2 1/2" | AAWS MT48 () | | aluminum | 78. |
| | 3/4" | 54" | 2 1/2" | AAWS MT54 () | | aluminum | 99. |
| | 3/4" | 60" | 2 1/2" | AAWS MT60 () | | aluminum | 105. |
| | 3/4" | 66" | 2 1/2" | AAWS MT66 () | | aluminum | 110. |
| | 3/4" | 72" | 2 1/2" | AAWS MT72 () | | aluminum | 115. |
| Easel pad holder | 2" | 28" | 1 1/8" | AAWS EASEL () | | | 89. |
| Picture hook  | 1" | 1 1/4" | 1" | AAWS PH () | | | 19. |
| Coat hook  | 2" | 2 1/2" | 1 1/2" | AAWS CH () | | | 19. |
| Wire manager clips (10/pk) | 3/4" | 3/8" | 3/4" | AAWS WMC | 12. | | |
| Cable grommet (10/pk)  | 1 1/4" | | 1 1/4" | AAWS CG | 10. | | |

Order Code

| |
|--------------------------------|
| Example: AAWS MT24 AA |
| A AutoStrada |
| AWS Applied wall system |
| MT Marker tray |
| 24 Width |
| AA Finish |

Specification Information

- Markertray is available in AA anodized aluminum or any standard painted finish except 613 Silver.
- Easel pad holder is available in AA anodized aluminum or 111 black only.
- Picture hook and Coat hook are available in all standard painted finishes.
- Wire manager clips are easy grey plastic.
- Cable grommets are black plastic.

Application Notes

Applied wall system accessories include integral bracket detail that engages into top or intermediate channels at any point.

Easel pad holder includes three studs to hang standard 27"x34" easel pads on inside and outside face of bracket.

Wire manager clips may be used for horizontal or vertical wire management of lamp cords on the face of the applied wall.



Cable grommet is 1 1/4" diameter trim ring for 1" diameter hole which may be punched in recess covers to route data/communications cables from inside of applied wall to the surface.

Service wall frames

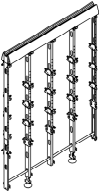
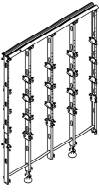
Standard and compact crown

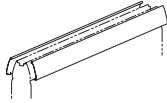
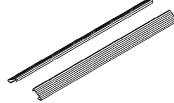

| description | type | w | d | h | pattern number | black | list |
|---|------|-----|----|-----|-------------------|--------|------|
|  | 39"H | 48" | 5" | 43" | APF1 3948 | \$468. | |
| | | 60" | 5" | 43" | APF1 3960 | 539. | |
| | | 72" | 5" | 43" | APF1 3972 | 667. | |
| | 48"H | 48" | 5" | 52" | APF1 4848 | 516. | |
| | | 60" | 5" | 52" | APF1 4860 | 590. | |
| | | 72" | 5" | 52" | APF1 4872 | 736. | |
| | 64"H | 48" | 5" | 68" | APF1 6448 | 614. | |
| | | 60" | 5" | 68" | APF1 6460 | 701. | |
| | | 72" | 5" | 68" | APF1 6472 | 879. | |
|  | 39"H | 48" | 5" | 40" | APFA1 3948 | 375. | |
| | | 60" | 5" | 40" | APFA1 3960 | 431. | |
| | | 72" | 5" | 40" | APFA1 3972 | 532. | |
| | 48"H | 48" | 5" | 49" | APFA1 4848 | 411. | |
| | | 60" | 5" | 49" | APFA1 4860 | 471. | |
| | | 72" | 5" | 49" | APFA1 4872 | 589. | |
| | 64"H | 48" | 5" | 65" | APFA1 6448 | 491. | |
| | | 60" | 5" | 65" | APFA1 6460 | 560. | |
| | | 72" | 5" | 65" | APFA1 6472 | 701. | |
| Acoustical inserts | 39"H | | 2" | 34" | APA 39 | | 27. |
| | 48"H | | 2" | 43" | APA 48 | | 32. |
| | 64"H | | 2" | 59" | APA 64 | | 44. |

| Order Code | Specification Information | Application |
|----------------------------|--|---|
| Example: APFA1 3948 | Wall frame pattern numbers begin with APF (standard crown) and APFA (compact crown) prefixes. | Service wall frames are the structural component of spine-based planning. Specify frames in any combination of widths to create the overall wall length required. |
| APF Spine frame | | Frames include vertical studs every 12" on center, with cover mounting clips and cable manager inserts on both sides. Frames also include 4"H or 1" top crown with continuous channel for add-up panels. Standard crown frames include shaped crowns for upmounting shelves and overhead storage cabinets, canopy lighting, or awnings at any point. Compact crown frames feature a slim profile crown with downmounting capability only. |
| A compact crown | | Crown is bored to accept stackable add-up panels at 3" increments. |
| 1 Generation | <i>Specify:</i> | Wall frames include two levelling feet with 2" travel, 12" from each side edge. |
| 39 Height | <i>Fifth position: height</i> | Acoustical inserts fit between studs in service wall frame to increase control of sound transmission. Inserts are bagged in heights corresponding to wall frame. Specify four inserts for 48"W frame, five for 60"W frame, and six for 72"W frame. Service walls with acoustical inserts have been tested to STC 33. Inserts do not affect the NRC rating of the wall which is .40. |
| 48 Width | 39 39"H 48 48"H 64 64"H | Specify crown covers, raceway covers, structural base covers, and wall covers for each face of frame, and specify power components separately. |
| | <i>Seventh position: width</i> | |
| | 48 48"W 60 60"W 72 72"W | |
| | All wall frames include 3" diameter, 2" levelling glides and one set of connectors to adjacent frame or wall connector. Frames are black painted finish. | |

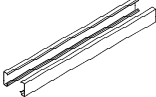
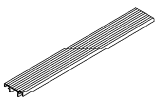

| description | type | w | d | h | pattern number | paint | list | anodized alum |
|--|---|--------------------------|--------|---------------------|-------------------|-------|-------|---------------|
| Crown covers (pair) | standard  | 48" | 5" | 4" | APT 48 () | | \$33. | |
| | | 60" | 5" | 4" | APT 60 () | | 40. | |
| | | 72" | 5" | 4" | APT 72 () | | 45. | |
| | | (specify painted finish) | | | | | | |
| compact crown, integral color  | 48" | 5" | 1" | APTA 48 () | | | 52. | |
| | 60" | 5" | 1" | APTA 60 () | | | 62. | |
| | 72" | 5" | 1" | APTA 72 () | | | 106. | |
| flat, low profile  | 48" | 5" | 1" | APTL 48 () | | 74. | | 74. |
| | 60" | 5" | 1" | APTL 60 () | | 93. | | 93. |
| | 72" | 5" | 1" | APTL 72 () | | 112. | | 112. |
| | 96" | 5" | 1" | APTL 96 () | | 149. | | 149. |
| | 120" | 5" | 1" | APTL 120 () | | n/a | | 186. |
| (finish default AA, anodized aluminum) | | | | | | | | |
| flat, high profile  | 48" | 5" | 1 1/4" | APTH 48 () | | 74. | | 74. |
| | 60" | 5" | 1 1/4" | APTH 60 () | | 93. | | 93. |
| | 72" | 5" | 1 1/4" | APTH 72 () | | 112. | | 112. |
| | 96" | 5" | 1 1/4" | APTH 96 () | | 149. | | 149. |
| | 120" | 5" | 1 1/4" | APTH 120 () | | n/a | | 186. |
| (finish default AA, anodized aluminum) | | | | | | | | |

Spine and linkable screens

| Order Code | Specification Information | Application |
|-----------------------------|--|---|
| Example: APRA 480 AA | Wall crown pattern numbers begin with APT- (standard) and APTA- (compact) prefix, then frame width. | Crown, base trim, and structural base covers are required for every wall frame in corresponding widths. Covers are specified in pairs to cover both sides of a frame. |
| APR A Base trim | Standard crown covers are available in painted finish. Please specify painted finish from paint options listed on page 7. | Crown top caps are optional fillers for the crown where no add-up panels are planned. Standard crown end caps are included with all connectors. Compact crown end caps must be ordered individually or in kits of 10. |
| 48 Width | Compact crown covers are available in Integral light grey (812 Easy grey) or dark grey (813 Trim grey) plastic. | Specify painted finish for standard crown end caps. |
| 0 Outlet openings | Flat crown covers are available in clear anodized aluminum or painted finish options listed on page 7 excluding silver. | Specify light grey (812 Easy Grey) or dark grey (813 Trim Grey) integral color for crown top cap and compact crown end cap. |
| AA Finish | Base trim covers begin with APRA- prefix, then frame width. Base trim covers are available in clear anodized aluminum or painted finish options listed on page 7 excluding silver. | Flat crown covers in high profile are designed for 48" h spine to align with attached AutoStrada 49" h panels. In all other applications, specify low profile crown covers. |
| | | Flat crown end caps in corresponding low or high profile are ordered separately as individual units. |
| | | Flat crown end caps are required for all connectors except flat ends. |

| description | type | w | d | h | pattern number | paint | list | anodized alum |
|--|-----------------------------|-----|----|--------|---------------------|--------|------|---------------|
|  | no outlets | | | 2 1/2" | APRA 480 () | \$125. | | \$125. |
| | | | | 2 1/2" | APRA 600 () | 150. | | 150. |
| | | | | 2 1/2" | APRA 720 () | 180. | | 180. |
|  | | 24" | 2" | – | APT1 C24 () | | 9. | |
| | | 36" | 2" | – | APT1 C36 () | | 15. | |
| | | 48" | 2" | – | APT1 C48 () | | 24. | |
| | | 60" | 2" | – | APT1 C60 () | | 27. | |
| | | 72" | 2" | – | APT1 C72 () | | 33. | |
| integral color only, plastic | | | | | | | | |
|  | | 24" | 2" | – | APTA C24 () | 27. | | 27. |
| | | 36" | 2" | – | APTA C36 () | 33. | | 33. |
| | | 48" | 2" | – | APTA C48 () | 40. | | 40. |
| | | 60" | 2" | – | APTA C60 () | 46. | | 46. |
| | | 72" | 2" | – | APTA C72 () | 55. | | 55. |
| default finish AA, anodized aluminum | | | | | | | | |
|  | standard (replacement part) | | | | APT () | | 5. | |
| | compact | | | | APTA CC1 () | | 13. | |
| | compact (kit of 10) | | | | APTA CC () | | 107. | |

| Order Code | Specification Information | Application |
|--|--|--|
| Example: APRA 480 AA APR A Base trim 48 Width 0 Outlet openings AA Finish | Wall crown pattern numbers begin with APT- (standard) and APTA- (compact) prefix, then frame width. Standard crown covers are available in painted finish. Please specify painted finish from paint options listed on page 7. Compact crown covers are available in Integral light grey (812 Easy grey) or dark grey (813 Trim grey) plastic. Flat crown covers are available in clear anodized aluminum or painted finish options listed on page 7 excluding silver. Base trim covers begin with APRA- prefix, then frame width. Base trim covers are available in clear anodized aluminum or painted finish options listed on page 7 excluding silver. | Crown, base trim, and structural base covers are required for every wall frame in corresponding widths. Covers are specified in pairs to cover both sides of a frame. Crown top caps are optional fillers for the crown where no add-up panels are planned. Standard crown end caps are included with all connectors. Compact crown end caps must be ordered individually or in kits of 10. Specify painted finish for standard crown end caps. Specify light grey (812 Easy Grey) or dark grey (813 Trim Grey) integral color for crown top cap and compact crown end cap. |
| | | Flat crown covers in high profile are designed for 48" h spine to align with attached AutoStrada 49" h panels. In all other applications, specify low profile crown covers. Flat crown end caps in corresponding low or high profile are ordered separately as individual units. Flat crown end caps are required for all connectors except flat ends. |

| description | type | w | d | h | pattern number | paint | list | anodized alum |
|----------------------|---|---|---|---|-----------------|------------------------|-------|---------------|
| Crown end cap, metal | flat, low profile | | | | APTL () | | \$31. | |
| |  | | | | | specify painted finish | | |
| | flat, high profile | | | | APTH () | | \$31. | |
| |  | | | | | specify painted finish | | |

Spine and linkable screens

| Order Code | Specification Information | Application |
|-----------------------------|--|---|
| Example: APRA 480 AA | | |
| APR A Base trim | Wall crown pattern numbers begin with APT- (standard) and APTA- (compact) prefix, then frame width. | Crown, base trim, and structural base covers are required for every wall frame in corresponding widths. Covers are specified in pairs to cover both sides of a frame. |
| 48 Width | Standard crown covers are available in painted finish. Please specify painted finish from paint options listed on page 7. | Crown top caps are optional fillers for the crown where no add-up panels are planned. Standard crown end caps are included with all connectors. Compact crown end caps must be ordered individually or in kits of 10. |
| 0 Outlet openings | Compact crown covers are available in Integral light grey (812 Easy grey) or dark grey (813 Trim grey) plastic. | Flat crown end caps in corresponding low or high profile are ordered separately as individual units. |
| AA Finish | Flat crown covers are available in clear anodized aluminum or painted finish options listed on page 7 excluding silver. | Flat crown end caps are required for all connectors except flat ends. |
| | Base trim covers begin with APRA- prefix, then frame width. Base trim covers are available in clear anodized aluminum or painted finish options listed on page 7 excluding silver. | Specify painted finish for standard crown end caps. Specify light grey (812 Easy Grey) or dark grey (813 Trim Grey) integral color for crown top cap and compact crown end cap. |

Structural base cover kits

Painted steel surface (pair)

AutoStrada

| description | type | width | depth | height | pattern number | paint |
|-------------------------------|---------------|-------|-------|--------|----------------------|--------|
| Structural base covers (pair) | painted steel | 48" | 1" | 16" | APCA AZ48S() | \$250. |
| | | 60" | 1" | 16" | APCA AZ60S() | 291. |
| | | 72" | 1" | 16" | APCA AZ72S() | 343. |

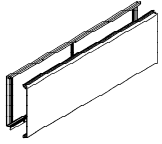

Order Code

| | |
|-------------|-----------------------|
| Example: | APCA AZ48S 118 |
| APCA | Autostrada wall cover |
| AZ | Attachment zone |
| 48 | Width |
| S | Steel |
| 118 | Finish |

Specification Information

Structural base cover kit pattern numbers begin with APCA AZ prefix, then cover width.

Starting at tenth position specify paint finish

Please specify painted finish for structural base covers from paint options listed on page 7.

Application Notes

Structural base covers are required for every wall frame in corresponding widths. Covers are specified in pairs to cover both sides of a frame.

Structural base covers bolt to each side of the wall frame up to 21"H for structure and continuous attachment capability.

Structural base cover kits

Veneer and laminate surface (pair)

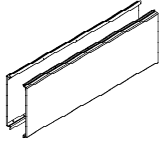

| description | type | width | depth | height | pattern number | L | V1 | V2 | V3 |
|-------------------------------|-----------------------------------|-------|-------|--------|--------------------------|--------|--------|--------|----------|
| Structural base covers (pair) | anodized aluminum or painted trim | 48" | 1" | 16" | APCA AZ48 () () | \$744. | \$798. | \$866. | \$1,179. |
| | | 60" | 1" | 16" | APCA AZ60 () () | 821. | 871. | 953. | 1,334. |
| | | 72" | 1" | 16" | APCA AZ72 () () | 855. | 892. | 1,000. | 1,451. |



| Order Code | Specification Information | Application Notes |
|--|---|--|
| <p>Example: APCA AZ48 V312 AA</p> <p>APCA AutoStrada wall cover</p> <p>AZ Attachment zone</p> <p>48 Width</p> <p>V312 Cover finish</p> <p>AA Trim finish</p> | <p>Structural base cover kit pattern numbers begin with APCA AZ prefix, then cover width.</p> <p><i>Starting at ninth position specify laminate, veneer or techwood finish</i></p> <p>Product on this page will accept wood grain laminate where laminate is currently an option. List price for wood grain laminate options will be current published laminate list price plus 10%.</p> <p>Laminate and veneer covers have an anodized aluminum or painted trim at the top and bottom of each cover. Painted finish options listed on page 7 excluding silver.</p> | <p><i>Please specify laminate, V1, V2 or V3 finish from finish options listed on page 7.</i></p> <p>Structural base covers are required for every wall frame in corresponding widths. Covers are specified in pairs to cover both sides of a frame.</p> <p>Structural base covers bolt to each side of the wall frame up to 21"H for structure and continuous attachment capability.</p> |

Access covers

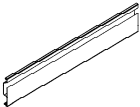
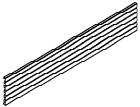
Slatwall, cable tray and outlets covers

| description | height | depth | width | pattern number | list | textured |
|--|--------|-------|-------|------------------------|-------|----------|
| 9"H cable tray covers  | 9" | 1" | 12" | APCA 0912 C () | \$71. | |
| | | 1" | 24" | APCA 0924 C () | 85. | |
| | | 1" | 36" | APCA 0936 C () | 99. | |
| | | 1" | 48" | APCA 0948 C () | 129. | |
| | | 1" | 60" | APCA 0960 C () | 165. | |
| | | 1" | 72" | APCA 0972 C () | 200. | |
| 9"H slatwall covers  | 9" | 1" | 12" | APCA 0912 S () | 62. | |
| | | 1" | 24" | APCA 0924 S () | 73. | |
| | | 1" | 36" | APCA 0936 S () | 87. | |
| | | 1" | 48" | APCA 0948 S () | 113. | |
| | | 1" | 60" | APCA 0960 S () | 143. | |
| | | 1" | 72" | APCA 0972 S () | 175. | |
| Outlets cover  | 9" | 1" | 12" | APCA OC () () | | 70. |

Order Code

| | |
|-------------|-----------------------|
| Example: | APCA 0948C AA |
| APCA | Autostrada wall cover |
| 09 | Height |
| 48 | Width |
| C | Type |
| AA | Finish |

Specification Information

Cable tray and slatwall covers are aluminum with an anodized or painted finish.

Outlets covers are painted plastic with anodized aluminum or painted extrusion on the top and bottom.

Please specify painted finish for outlets cover face from paint options listed on page 7.

Application Notes

Cable tray mounts from 21" - 30" only on any panel frame. Adjacent trays form continuous, easily accessible cable management at worksurface or table height. Shorter segments provide local cable management below outlet modules. Covers may span across a straight wall frame connection.

Bottom half of cable tray cover permits cables to be managed on surface of studs with one cable holder (55 CAT5 cables) or two clips (28 cables).

Slatwall supports KnollExtra task lights, monitor arms, paper trays, file holders and other accessories.

Locate outlets covers on wall frames before specifying other wall covers.

Outlets cover mounts between 21" and 30" (below standard desk height), 30" - 39" (above desk height) or 39" - 48" on spine wall frame.

Outlets cover is 12" wide, and mounts anywhere on wall frame between 21" and 48" above the floor. Outlets cover corresponds to power components (specified separately) mounted on wall frame.

Outlets covers have four openings for power or PDC outlets. Specify outlet fillers for unused outlet openings in cover.

Access covers

Hardwire outlets and covers

| description | height | depth | width | pattern number | list |
|------------------------|--------|-------|-------|-------------------------|-------|
| Hardwire outlets cover | 9" | 1" | 12" | APCA HOC () () | \$68. |

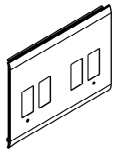

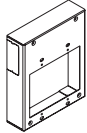

| | | | | | |
|----------------------------------|--|--|--|-----------------|------|
| Hardwire outlet box, desk height | | | | AR1 HOB | 191. |
| | | | | AR1 HOB2 | 253. |



| Order Code | Specification Information | Application Notes |
|-----------------------------------|---|--|
| Example: APCA HOC 613 AA | | |
| APCA AutoStrada wall cover | Hardwire outlets covers are painted steel with anodized aluminum or painted extrusion top and bottom. | For hardwire power applications (required in City of Chicago) specify hardwire outlets cover and hardwire outlets box, instead of standard outlets covers and modular power components. Do not specify cable tray covers at same level as hardwire power. |
| H Hardwire | | |
| OC Outlets cover | <i>Please specify painted finish for outlets cover face from paint options listed on page 7.</i> | |
| 613 Cover Finish | | |
| AA Trim Finish | Painted finish option for hardwire outlets cover trim listed on page 7 excluding silver. | Hardwire outlet box accepts two Decora-style duplex outlets, and includes mounting brackets for one face of wall between 21" and 48"H. Two quad hardwire outlet box accepts four duplex outlets on one face. Outlet boxes include openings to permit continuous lay-in wiring with Wiremold® raceway. Electrical contractor supplies infeed cable, Wiremold 2400®, and duplex outlets. Outlet boxes can be planned back to back, with distribution on one side of service wall. Wiremold will not fit behind cable tray covers. |
| | | Hardwire outlets cover mounts between 21" and 30" (below standard desk height) or 30" - 39" (above desk height) on spine frame. Outlets covers have four openings for power or PDC outlets. Specify outlet fillers for unused outlet openings in cover. |

Access covers

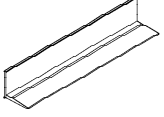
Integral shelf

| description | height | width of shelf | pattern number | list | L | V1 | V2 | V3 |
|--|--------------------------|--------------------------|--------------------------|------|--------|--------|--------|--------|
| Integral shelf covers  | 9" | 21" | APSA 0921 () () | | \$571. | \$599. | \$611. | \$652. |
| | | 24" | APSA 0924 () () | | 571. | 599. | 611. | 652. |
| | | 33" | APSA 0933 () () | | 648. | 673. | 687. | 743. |
| | | 36" | APSA 0936 () () | | 648. | 673. | 687. | 743. |
| | | 45" | APSA 0945 () () | | 695. | 722. | 739. | 810. |
| | | 48" | APSA 0948 () () | | 695. | 722. | 739. | 810. |
| | | 57" | APSA 0957 () () | | 768. | 795. | 813. | 898. |
| | | 60" | APSA 0960 () () | | 768. | 795. | 813. | 898. |
| | | 69" | APSA 0969 () () | | 826. | 853. | 872. | 973. |
| | 72" | APSA 0972 () () | | 826. | 853. | 872. | 973. | |
| | 16" | 21" | APSA 1621 () () | | 584. | 609. | 624. | 693. |
| | | 24" | APSA 1624 () () | | 584. | 609. | 624. | 693. |
| | | 33" | APSA 1633 () () | | 658. | 684. | 705. | 800. |
| | | 36" | APSA 1636 () () | | 658. | 684. | 705. | 800. |
| | | 45" | APSA 1645 () () | | 714. | 740. | 764. | 886. |
| | | 48" | APSA 1648 () () | | 714. | 740. | 764. | 886. |
| | | 57" | APSA 1657 () () | | 792. | 818. | 845. | 995. |
| | | 60" | APSA 1660 () () | | 792. | 818. | 845. | 995. |
| | | 69" | APSA 1669 () () | | 852. | 877. | 909. | 1,085. |
| 72" | APSA 1672 () () | | 852. | 877. | 909. | 1,085. | | |
| Integral shelves  | | 21" | ADS 0821 () | 319. | | | | |
| | | 24" | ADS 0824 () | 319. | | | | |
| | | 33" | ADS 0833 () | 366. | | | | |
| | | 36" | ADS 0836 () | 366. | | | | |
| | | 45" | ADS 0845 () | 404. | | | | |
| | | 48" | ADS 0848 () | 404. | | | | |
| | | 57" | ADS 0857 () | 453. | | | | |
| | | 60" | ADS 0860 () | 453. | | | | |
| | | 69" | ADS 0869 () | 493. | | | | |
| | 72" | ADS 0872 () | 493. | | | | | |

| Order Code | Specification Information | Application Notes |
|---|---|--|
| Example: APSA 0948 118 AA | | |
| APSA Autostrada integral shelf cover | Please specify laminate, V1, V2 or V3 finish for spine wall cover from finish options listed on page 7. | Service wall covers enclose frames between 21"H and the top crown. Covers may be specified in any combination of widths corresponding to the total wall length. Covers may span across a straight wall frame connection. |
| 09 Height | Product on this page will accept wood grain laminate where laminate is currently an option. | Integral shelves may be added to any laminate, marker or veneer spine cover. Holes for fasteners must be drilled through bottom extrusion and cover on site. |
| 48 Width | List price for wood grain laminate options will be current published laminate list price plus 10%. | |
| 118 Cover Ffinish | Shelf is extruded aluminum with an anodized or painted finish. | The integral shelf cover features a full width 8" deep display shelf crafted in anodized or painted aluminum. The cover is also available with a shelf that is 3" less wide than full module to accommodate a panel connected to the spine wall. |
| AA Shelf and Trim Finish | Painted finish option for integral shelf cover trim and integral shelf listed on page 7 excluding silver. | |

Access covers

Laminate, marker and veneer

| description | height | width | pattern number | L | V1 | V2 | V3 |
|--|--------|--------------------------|--------------------------|--------|--------|--------|--------|
| Access covers  | 9" | 12" | APCA 0912 () () | \$267. | \$299. | \$311. | \$344. |
| | | 24" | APCA 0924 () () | 282. | 313. | 329. | 393. |
| | | 36" | APCA 0936 () () | 312. | 341. | 363. | 449. |
| | | 48" | APCA 0948 () () | 324. | 353. | 379. | 488. |
| | | 60" | APCA 0960 () () | 349. | 379. | 411. | 544. |
| | | 72" | APCA 0972 () () | 367. | 398. | 430. | 588. |
| | 16" | 12" | APCA 1612 () () | 272. | 305. | 323. | 382. |
| | | 24" | APCA 1624 () () | 295. | 326. | 349. | 455. |
| | | 36" | APCA 1636 () () | 327. | 356. | 388. | 533. |
| | | 48" | APCA 1648 () () | 344. | 373. | 412. | 599. |
| | | 60" | APCA 1660 () () | 381. | 407. | 454. | 682. |
| | | 72" | APCA 1672 () () | 402. | 427. | 482. | 751. |
| | 18" | 12" | APCA 1812 () () | 276. | 306. | 324. | 391. |
| | | 24" | APCA 1824 () () | 300. | 328. | 354. | 472. |
| | | 36" | APCA 1836 () () | 331. | 360. | 395. | 559. |
| | | 48" | APCA 1848 () () | 354. | 381. | 424. | 633. |
| | | 60" | APCA 1860 () () | 388. | 413. | 463. | 721. |
| | | 72" | APCA 1872 () () | 412. | 440. | 498. | 801. |
| | 27" | 12" | APCA 2712 () () | 285. | 319. | 339. | 440. |
| | | 24" | APCA 2724 () () | 315. | 348. | 381. | 551. |
| | | 36" | APCA 2736 () () | 361. | 391. | 439. | 677. |
| 48" | | APCA 2748 () () | 387. | 414. | 470. | 778. | |
| 60" | | APCA 2760 () () | 431. | 457. | 525. | 903. | |
| 72" | | APCA 2772 () () | 461. | 484. | 563. | 1,013. | |

Spine and linkable screens

Order Code

| | |
|-------------|--------------------------|
| Example: | APCA 0948 V312 AA |
| APCA | Autostrada wall cover |
| 09 | Height |
| 48 | Width |
| V312 | Cover Finish |
| AA | Trim Finish |

Specification Information

Please specify laminate, V1, V2 or V3 finish for access covers from finish options listed on page 7.

Product on this page will accept wood grain laminate where laminate is currently an option.
List price for wood grain laminate options will be current published laminate list price plus 10%.

Specify finish code: LW for markerboard surface.
Painted finish option for trim listed on page 7 excluding silver.

Application Notes

Service wall covers enclose frames between 21"H and the top crown. Covers may be specified in any combination of widths corresponding to the total wall length. Covers may span across a straight wall frame connection.

For active surfaces with access to cables and power/data/communications outlets, specify 9" and 16"H segmented covers as described in Specification Information.

Access covers



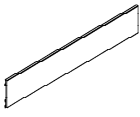

Tackable upholstered

| description | height | depth | width | pattern number | 10 | 15 | 20 | 30 | 35 | 40 | 45 | 50 | 55 |
|---|--------|-------|----------------------------|----------------------------|--------|--------|--------|--------|--------|--------|--------|--------|--------|
|  | 9" | 1" | 12" | APCA 0912 A () () | \$106. | \$108. | \$109. | \$113. | \$116. | \$120. | \$123. | \$129. | \$137. |
| | | 1" | 24" | APCA 0924 A () () | 130. | 132. | 133. | 137. | 139. | 143. | 144. | 147. | 160. |
| | | 1" | 36" | APCA 0936 A () () | 144. | 146. | 147. | 153. | 155. | 159. | 160. | 163. | 173. |
| | | 1" | 48" | APCA 0948 A () () | 162. | 166. | 167. | 169. | 173. | 175. | 176. | 181. | 191. |
| | | 1" | 60" | APCA 0960 A () () | 175. | 178. | 180. | 183. | 187. | 191. | 194. | 196. | 206. |
| | | 1" | 72" | APCA 0972 A () () | n/a | 195. | n/a | n/a | n/a | n/a | n/a | n/a | n/a |
| | 16" | 1" | 12" | APCA 1612 A () () | 114. | 119. | 121. | 129. | 134. | 138. | 143. | 150. | 169. |
| | | 1" | 24" | APCA 1624 A () () | 146. | 153. | 154. | 162. | 169. | 174. | 176. | 186. | 206. |
| | | 1" | 36" | APCA 1636 A () () | 163. | 169. | 172. | 178. | 186. | 191. | 195. | 203. | 223. |
| | | 1" | 48" | APCA 1648 A () () | 182. | 188. | 190. | 198. | 205. | 210. | 212. | 221. | 242. |
| | | 1" | 60" | APCA 1660 A () () | 200. | 205. | 206. | 214. | 220. | 228. | 231. | 239. | 259. |
| | | 1" | 72" | APCA 1672 A () () | n/a | 221. | n/a | n/a | n/a | n/a | n/a | n/a | n/a |
| | 18" | 1" | 12" | APCA 1812 A () () | 127. | 131. | 133. | 142. | 146. | 154. | 157. | 166. | 186. |
| | | 1" | 24" | APCA 1824 A () () | 148. | 154. | 157. | 166. | 172. | 176. | 180. | 188. | 209. |
| | | 1" | 36" | APCA 1836 A () () | 167. | 172. | 174. | 181. | 188. | 195. | 197. | 205. | 226. |
| | | 1" | 48" | APCA 1848 A () () | 204. | 207. | 210. | 219. | 224. | 232. | 233. | 242. | 264. |
| | | 1" | 60" | APCA 1860 A () () | 204. | 207. | 210. | 219. | 224. | 232. | 233. | 242. | 264. |
| | | 1" | 72" | APCA 1872 A () () | n/a | 226. | n/a | n/a | n/a | n/a | n/a | n/a | n/a |
| | 27" | 1" | 12" | APCA 2712 A () () | 143. | 149. | 154. | 167. | 175. | 183. | 188. | 202. | 232. |
| | | 1" | 24" | APCA 2724 A () () | 168. | 175. | 180. | 191. | 202. | 210. | 212. | 226. | 257. |
| 1" | | 36" | APCA 2736 A () () | 187. | 196. | 200. | 210. | 220. | 231. | 233. | 245. | 277. | |
| 1" | | 48" | APCA 2748 A () () | 209. | 217. | 221. | 233. | 242. | 250. | 255. | 268. | 299. | |
| 1" | | 60" | APCA 2760 A () () | 230. | 238. | 240. | 253. | 263. | 270. | 275. | 287. | 316. | |
| 1" | | 72" | APCA 2772 A () () | n/a | 255. | n/a | n/a | n/a | n/a | n/a | n/a | n/a | |

| Order Code | Specification Information | Application Notes |
|---|---|--|
| <p>Example: APCA 0948A W210 AA</p> <p>APCA Autostrada wall cover</p> <p>09 Height</p> <p>48 Width</p> <p>A Surface type</p> <p>W210 Fabric</p> <p>AA Trim Finish</p> | <p>For active face of 39"H frame, specify two 9"H covers. For passive face (along corridor or wall) specify one 18" cover.</p> <p>For active face of 48"H frame, specify three 9"H covers or one 9"H and one 18"H cover. For passive face, specify 27"H cover.</p> <p>For active face of 64"H frame, specify three 9"H covers and one 16"H cover or one 9"H, one 18"H, and one 16"H cover. For passive face, specify one 27" and one 16"H cover.</p> <p>For full fabric surface between 5" and 21", order upholstered attachment zone cover.</p> <p><i>Surface type:</i> A tackable upholstered</p> | <p>Tackable upholstered service wall covers enclose wall frames between 21" and the top crown. Covers incorporate a tackable, acoustical core in the same outward profile as other upholstered covers.</p> <p>Specify widths corresponding to wall frame width, or in any 12" increment to accommodate 12"W outlets covers or slatwall covers. Covers may span across a straight wall frame connection.</p> <p>For active surfaces with access to cables and power/data/communications outlets, specify 9" and 16"H segmented covers as described in Specification Information.</p> <p>For passive wall surfaces (corridors or conference areas) specify 18"H or 27"H covers in place of two or three 9"H covers.</p> <p>18"H covers may also be specified above 9"H covers including outlets covers below desk height on 48" or 64"H service walls.</p> <p>Service wall with upholstered tackable covers has been tested to NRC .40 and STC 22.</p> <p>When ordering 60" or wider covers, please check width of fabric specified.</p> |

Spine ends and connectors

Flat ends

| description | type | height | depth | pattern no. | price | painting |
|---|---|--------|----------------------|-------------------------|--------|----------|
| Flat end | standard crown  | 39" | 5" | AX1A F39 () () | \$102. | |
| | | 48" | 5" | AX1A F48 () () | 116. | |
| | | 64" | 5" | AX1A F64 () () | 129. | |
| | compact crown  | 39" | 5" | AX1A C39 () | 102. | |
| | | 48" | 5" | AX1A C48 () | 116. | |
| | | 64" | 5" | AX1A C64 () | 129. | |
| | low profile flat crown  | 39" | 5" | AX1A EL39 () | 102. | |
| | | 48" | 5" | AX1A EL48 () | 116. | |
| | | 64" | 5" | AX1A EL64 () | 127. | |
| high profile flat crown  | 39" | 5" | AX1A EH39 () | 102. | | |
| | 48" | 5" | AX1A EH48 () | 116. | | |
| | 64" | 5" | AX1A EH64 () | 127. | | |

Order Code

| | |
|-------------|-----------------------|
| Example: | AX1A C48 118 |
| AX1A | AutoStrada connector |
| C | Type |
| 48 | Height |
| 118 | vertical cover finish |

Specification Information

For flat ends specify:
Starting seventh position:
 painted finish for outside trim cover and raceway cover
Starting eleventh position:
 painted finish for crown end cap
 Please specify painted finishes from paint finish options listed on page 7.

Application Notes

Flat end finishes end of corresponding height spine when end of wall is supported by outriggers or perpendicular screens or panels. Flat ends include end cover for compact crown or standard crown, as specified.

High-low straight connectors join service wall of different heights in a straight line.

Straight connector is replacement hardware kit to join Currents wall frames of the same height end to end. Kit includes four barrel-shape connectors and hardware.

Spine ends and connectors

Corner, T, X, V and Y connections

AutoStrada

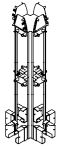
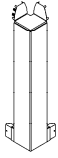
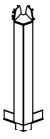
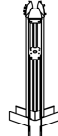
| description | type | height | width | depth | pattern number | list |
|----------------|--|--------|--------|--------|-------------------------|--------|
| 90° connector |  T connector | 39" | 6" | 7" | AX1A T39 () () | \$332. |
| | | 48" | 6" | 7" | AX1A T48 () () | 399. |
| | | 64" | 6" | 7" | AX1A T64 () () | 466. |
| |  X connector | 39" | 7" | 7" | AX1A X39 () | 332. |
| | | 48" | 7" | 7" | AX1A X48 () | 363. |
| | | 64" | 7" | 7" | AX1A X64 () | 399. |
| |  L connector | 39" | 6" | 6" | AX1A L39 () () | 332. |
| | | 48" | 6" | 6" | AX1A L48 () () | 399. |
| | | 64" | 6" | 6" | AX1A L64 () () | 466. |
| 120° connector |  V connector | 39" | 5 1/2" | 5 1/2" | AX1A V39 () () | 332. |
| | | 48" | 5 1/2" | 5 1/2" | AX1A V48 () () | 399. |
| | | 64" | 5 1/2" | 5 1/2" | AX1A V64 () () | 466. |
| |  Y connector | 39" | 6 1/2" | 5 1/2" | AX1A Y39 () () | 332. |
| | | 48" | 6 1/2" | 5 1/2" | AX1A Y48 () () | 399. |

Order Code

| | |
|-------------|-----------------------|
| Example: | AX1A L48 118 |
| AX1A | AutoStrada connector |
| L | Type |
| 48 | Height |
| 118 | vertical cover finish |

Specification Information

For L, T, V and Y connectors specify:

Seventh position:
painted finish for vertical trim cover and raceway cover

Eighth position, and X connectors:
painted finish for top cap and standard crown end caps

Please specify painted finish as applicable from paint options listed on page 7.

Application Notes

L, T, and X connectors join spine frames at 90° angles and include vertical trim covers, top cap and standard crown end caps, and one spare set of straight connectors.

When ordering connectors for the spine frame with compact crown, specify crown end caps separately.

V and Y connectors join spine frames at 120° angles and include vertical trim covers, topcap and standard crown end caps.

Spine ends and connectors

Corner, T, X, V and Y connections

| description | type | height | width | depth | pattern number | list |
|----------------|-------------|--------|--------|--------|-------------------------|--------|
| 120° connector | Y connector | 64" | 6 1/2" | 5 1/2" | AX1A Y64 () () | \$466. |

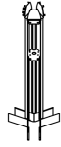

Order Code

| | |
|-------------|-----------------------|
| Example: | AX1A L48 118 |
| AX1A | AutoStrada connector |
| L | Type |
| 48 | Height |
| 118 | vertical cover finish |

Specification Information

For L, T, V and Y connectors specify:

Seventh position:
painted finish for vertical trim cover and raceway cover

Eighth position, and X connectors:
painted finish for top cap and standard crown end caps

Please specify painted finish as applicable from paint options listed on page 7.

Application Notes

L, T, and X connectors join spine frames at 90° angles and include vertical trim covers, top cap and standard crown end caps, and one spare set of straight connectors.

When ordering connectors for the spine frame with compact crown, specify crown end caps separately.

V and Y connectors join spine frames at 120° angles and include vertical trim covers, topcap and standard crown end caps.

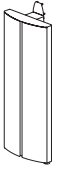

Spine ends and connectors

Stabilizer cabinet, outriggers and spine starters

| description | type | height | width | depth | pattern number | list |
|---|-----------|--------|-------|-------|---------------------------|--------|
| Outrigger  | deep | 21" | 3" | 15" | AA1ORD() | \$157. |
| | standard | 21" | 3" | 8" | AA1OR() | 114. |
| Stabilizer end cabinet  | no lock | 39" | | 19" | AX1 STC39 3 ()() | 1,415. |
| | | 48" | | 19" | AX1 STC48 3 ()() | 1,533. |
| | | 64" | | 19" | AX1 STC64 3 ()() | 1,767. |
| | with lock | 39" | | 19" | AX1 STC39 L3 ()() | 1,594. |
| | | 48" | | 19" | AX1 STC48 L3 ()() | 1,709. |
| | | 64" | | 19" | AX1 STC64 L3 ()() | 1,946. |
| Service wall starter | 39" | 39" | | 2" | AX1 SWS39 () | 102. |
| | 48" | 48" | | 2" | AX1 SWS48 () | 114. |
| | 64" | 64" | | 2" | AX1 SWS64 () | 131. |
| Straight connector kit (replacement) | | - | - | - | AX1 S | 20. |
| High low straight connector for spine with standard crown only | 48 - 39" | 48" | | 5" | AX1 HLS4839 ()() | 180. |
| | 64 - 39" | 64" | | 5" | AX1 HLS6439 ()() | 307. |
| | 64 - 48" | 64" | | 5" | AX1 HLS6448 ()() | 207. |

| Order Code | Specification Information | Application Notes |
|---|---|---|
| Example: AA1 ORD 118 AA1 Accessory ORD Outrigger deep 118 Finish | For stabilizer end specify: <i>Tenth position:</i> cabinet finish <i>Eleventh position:</i> top cap finish Please specify painted finish as applicable from finish options listed on page 7. | Outrigger connects to structural base cover at any point. Outriggers (or perpendicular systems panels) are required every 8' and adjacent to flat end for adequate support. Specify deep outriggers when cantilevering 24"D worksurfaces without adjacent perpendicular systems panels or spine wall connectors. Stabilizer end cabinet supports one end of the wall spine. Hinged cover panels in cabinet open for access to data/telecom consolidation point and cable storage. Stabilizer end cabinet with lock has recessed KnollKey lock in finger pull reveal. |
| | | Stabilizer end cabinet expands the end of the spine 3 1/2" to accommodate intermediate panel divisions between workstations. In the 3 1/2" x 5" space above this extension a ceiling infed panel may be added. Inside back corner covers may be removed for unobstructed access to cabinet and wall frame surface. Service wall starter connects service wall to building wall. |

Spine end connectors for linkable screens and Morrison panels

| description | application | h | w | d | pattern no. | list |
|--|-------------|-----|----|------|-------------------------------|--------|
|  Spine end connector | 39" h spine | 39" | 5" | 1/2" | AX1SEC3939 () () () | \$219. |
| | 48" h spine | 48" | 5" | 1/2" | AX1SEC4848 () () () | 230. |
| | 64" h spine | 64" | 5" | 1/2" | AX1SEC6464 () () () | 275. |
| Spine end connector to top of compact 1" h crown | 39" h spine | 40" | 5" | 1/2" | AX1SEC4039 L () () | 219. |
| | 48" h spine | 49" | 5" | 1/2" | AX1SEC4948 L () () | 230. |
| | 64" h spine | 65" | 5" | 1/2" | AX1SEC6564 L () () | 275. |
|  Spine end connector to top of Currents 4" h crown | 39" h spine | 43" | 5" | 1/2" | AX1SEC4339 C () () | 219. |
| | 48" h spine | 52" | 5" | 1/2" | AX1SEC5248 C () () | 230. |
| | 64" h spine | 68" | 5" | 1/2" | AX1SEC6864 C () () | 275. |
| Inside base trim cover for Currents raceway | | 4" | 5" | | AX1SECBT () | 44. |

Spine and linkable screens

| Order Code | Specification Information | Application Notes |
|--|--|---|
| Example: AX1 SEC 3939 L 613 613 812 AX1 Spine connector SEC Type 39 Connector height 39 Spine height L Crown type 613 Crown end cap finish 613 Vertical cover finish 812 Top cap finish | For spine end connectors specify: 1.Crown type C=Currents standard 4" h L=low profile flat 1" H=high profile flat 1 1/4" F=compact crown 1" 2.Crown end cap finish Standard, low and high profile flat and compact crown end caps are available in all standard paint finishes and 813 Trim Grey. Compact crown end caps are also available in 812 Easy Grey. 3.Vertical cover finish: All standard paint finishes 4.Top cap for vertical cover: 812=Easy Grey 813=Trim Grey And all standard paint finishes Spine end connectors on this page align with spine base covers ^{13/16"} above the floor. | Spine end connectors are complete vertical cover and top trim for the end of an AutoStrada or Currents spine. Side edges of end connectors accept end starters for linkable screens and other systems panels of the same height or lower. Spine end connectors include painted aluminum cover with beveled top cap and the specified flat, compact, or standard crown end cap. Spine end connectors to top of compact crown are a visual alternative that replaces the crown end cap with a taller aluminum end cover and flat top cap. Spine end connectors to top of Currents crown are recommended when attaching any end started panel that is between the nominal height of the spine and the actual height with crown, such as 42" h panel to 39" h spine with 4" h crown. Spine end connectors to top of Currents crown enclose the end of spine and standard crown and include flat top cap and inside top trim cover. |

Spine ends and connectors
*High-low spine end connectors
 for linkable screens and Morrison panels*

| description | application | h | w | d | pattern no. | list |
|--|-------------------------|-----|----|------|---------------------------|--------|
|  Spine end connector | 42" h panel/39" h spine | 39" | 5" | 1/2" | AX1SEC4239 () () | \$219. |
| | 48" h panel/39" h spine | 48" | 5" | 1/2" | AX1SEC4839 () () | 230. |
| | 56" h panel/39" h spine | 56" | 5" | 1/2" | AX1SEC5639 () () | 264. |
| | 64" h panel/39" h spine | 64" | 5" | 1/2" | AX1SEC6439 () () | 275. |
| | 56" h panel/48" h spine | 56" | 5" | 1/2" | AX1SEC5648 () () | 264. |
| | 64" h panel/48" h spine | 64" | 5" | 1/2" | AX1SEC6448 () () | 275. |
| | 80" h panel/48" h spine | 80" | 5" | 1/2" | AX1SEC8048 () () | 418. |
| | 80" h panel/64" h spine | 80" | 5" | 1/2" | AX1SEC8064 () () | 400. |
| Inside base trim cover for Currents raceway | | 4" | 5" | | AX1SECBT () | 44. |

| Order Code | Specification Information | Application Notes |
|--------------------------------------|---|--|
| Example: AX1 SEC 6448 613 812 | For spine end connectors specify: | High low spine end connectors are complete end cover and trim for an AutoStrada or Currents spine, when attached panels are taller than the spine. High low spine end connectors match the height of the attached linkable screen or Morrison panel. Side edges of spine end connectors accept end starters for linkable screens and Morrison panels of the same height or lower. |
| AX1 Spine connector | 1. Vertical cover finish: All standard paint finishes | |
| SEC Type | 2. Top cap for vertical cover 812=Easy Grey 813=Trim Grey And all standard painted finishes | <p>Note: 42" h panel/39" h spine combination (AX1SEC4239) can only be specified with compact or flat crown versions of the spine. For combination of 39" h spine with standard 4" h crown and 42" h panels specify AX1SEC4339C () ().</p> <p>High low spine end connectors include painted aluminum outside cover with flat top cap and inside cover over the end of the spine.</p> <p>Inside base trim for Currents raceway is recommended to finish inside of any spine end connector when combined with standard Currents recessed base raceway covers. Base trim is not required with AutoStrada spine base covers.</p> |
| 64 Panel height | Spine end connectors on this page align with spine base covers ¹³ / ₁₆ " above the floor. | |
| 48 Spine height | | |
| 613 Painted finish | | |
| 613 Trim finish | | |

Spine end connectors for AutoStrada and Reff panels and Gallery screens

Spine and linkable screens

| description | application | h | w | d | pattern no. | list |
|---|---|-----|------|---------------------------|-------------------------------|--------|
| Spine end connector | 34" panel or 39" screen/39"h spine | 39" | 5" | 1/2" | AX1SEA3939 () () () | \$219. |
| | 34"-42" panel or 39"-49" screen/48"h spine | 48" | 5" | 1/2" | AX1SEA4848 () () () | 230. |
| | 34"-49" panel or screen/64"h spine | 64" | 5" | 1/2" | AX1SEA4964 () () () | 275. |
| | 42" panel/39"h spine + 1 1/4" crown | 42" | 5" | 1/2" | AX1SEA4239 () () | 219. |
| | 42" panel/39"h spine + 4" crown | 43" | 5" | 1/2" | AX1SEA4339 C () () | 219. |
| | 49" panel /39" spine | 49" | 5" | 1/2" | AX1SEA4939 () () | 230. |
| | 49" panel or screen/48"h spine + 1 1/4" crown | 49" | 5" | 1/2" | AX1SEA4948 () () | 242. |
| | 49" panel or screen/48"h spine + 4" crown | 52" | 5" | 1/2" | AX1SEA5248 C () () | 230. |
| | 64" panel/39"h spine | 64" | 5" | 1/2" | AX1SEA6439 () () | 275. |
| | 64" panel/48"h spine | 64" | 5" | 1/2" | AX1SEA6448 () () | 275. |
| | 64" panel/64"h spine + 1 1/4" crown | 65" | 5" | 1/2" | AX1SEA6464 () () | 275. |
| | 64" panel/64"h spine + 4" crown | 68" | 5" | 1/2" | AX1SEA6864 C () () | 275. |
| | 79" panel/48"h spine | 79" | 5" | 1/2" | AX1SEA7948 () () | 418. |
| 79" panel/64"h spine | 79" | 5" | 1/2" | AX1SEA7964 () () | 400. | |
| Inside base trim cover for Currents raceway | | 4" | 5" | | AX1SECBT () | 44. |

| Order Code | Specification Information | Application Notes |
|--|---|---|
| Example: AX1 SEA 4239 613 613 812 | For spine end connectors when panels are lower than spine specify crown type and finish for crown end cap. 1. Crown type: C=Currents standard 4"h L=low profile flat 1"h H=high profile flat 1 1/4"h F=compact 1"h 2. All crown end caps are available in all painted finishes. For all spine end connectors specify vertical cover and top trim finish. 3. Vertical cover finish: All standard paint finishes 4. Top trim for vertical cover: 812=Easy Grey 813=Trim Grey And all standard paint finishes | Spine end connectors are complete end cover and trim for an AutoStrada or Currents spine. Side edges of spine end connectors accept end starters for AutoStrada or Reff panels or Gallery screens. In most cases spine end connectors match the height of the attached panel. When attached panel is lower than the spine, the spine end connector is as high as the nominal height of the spine and the crown requires an end cap. When attached panel is between the nominal height of the spine and the top of the Currents 4"h crown, spine end connector must cover the entire height of the spine with crown. Spine end connectors include painted outside cover with flat top cap and inside cover (where applicable) over the end of the spine. Inside base trim for Currents raceway is recommended to finish inside when combined with standard Currents recessed base raceway covers. Base trim is not required with AutoStrada spine base covers. |
| AX1 Spine connector | | |
| SEA Type | | |
| 42 Panel height | | |
| 39 Spine height | | |
| 613 Painted finish | | |
| 613 Trim finish | | |
| 812 Top trim finish | | |
| | End connectors on this page begin 1/2" above floor. | |

Spine ends and connectors

Spine end connectors for Dividends Horizon panels

| description | application | h | w | d | pattern no. | list |
|---|-----------------------------------|-----|------|---------------------------|-------------------------------|--------|
| Spine end connector | 36"h panel/39"h spine | 39" | 5" | 1/2" | AX1SED3939 () () () | \$219. |
| | 36"h-42"h panel/ 48"h spine | 48" | 5" | 1/2" | AX1SED4848 () () () | 230. |
| | 36"h-64"h panel/ 64"h spine | 64" | 5" | 1/2" | AX1SED6464 () () () | 275. |
| | 42"h panel/ 39"h spine + 1" crown | 42" | 5" | 1/2" | AX1SED4239 () () | 219. |
| | 42"h panel/ 39"h spine + 4" crown | 43" | 5" | 1/2" | AX1SED4339C () () | 219. |
| | 50"h panel/ 39"h spine | 50" | 5" | 1/2" | AX1SED5039 () () | 230. |
| | 50"h panel/ 48"h spine + 1" crown | 50" | 5" | 1/2" | AX1SED5048 () () | 242. |
| | 50"h panel/ 48"h spine + 4" crown | 52" | 5" | 1/2" | AX1SED5248C () () | 230. |
| | 57"h panel/ 39"h spine | 57" | 5" | 1/2" | AX1SED5739 () () | 264. |
| | 57"h panel/ 48"h spine | 57" | 5" | 1/2" | AX1SED5748 () () | 264. |
| | 64"h panel/ 39"h spine | 64" | 5" | 1/2" | AX1SED6439 () () | 275. |
| | 64"h panel/ 48"h spine | 64" | 5" | 1/2" | AX1SED6448 () () | 275. |
| | 78"h panel/ 48"h spine | 78" | 5" | 1/2" | AX1SED7848 () () | 418. |
| 78"h panel/ 64"h spine | 78" | 5" | 1/2" | AX1SED7864 () () | 400. | |
| Inside base trim cover for Currents raceway | | 4" | 5" | | AX1SECBT () | 44. |



| Order Code | Specification Information | Application Notes |
|--------------------------------------|---|---|
| Example: AX1 SED 6448 613 812 | <p>For spine end connectors with panel lower than spine specify crown type and finish for crown end cap.</p> <ol style="list-style-type: none"> Crown type: C=Currents standard 4"h L=low profile flat 1"h H=high profile flat 1 1/4"h F=compact 1"h All crown end caps are available in all painted finishes. <p>For all spine end connectors specify vertical cover and top trim finish:</p> <ol style="list-style-type: none"> Vertical cover finish: All standard paint finishes Top cap for vertical cover: 812=Easy Grey 813=Trim Grey And all standard painted finishes <p>End connectors on this page begin 1/2" above floor.</p> | <p>Spine end connectors are complete end cover and trim for an AutoStrada or Currents spine. Side edges of spine end connectors accept end starters for Dividends panels.</p> <p>In most cases spine end connectors match the height of the attached Dividends panel. When attached panel is lower than the spine, the spine end connector is as high as the nominal height of the spine and the crown requires an end cap.</p> |
| AX1 Spine connector | | |
| SED Type | | |
| 64 Panel height | | |
| 48 Spine height | | |
| 613 Vertical cover finish | <p>When attached panel is between the nominal height of the spine and the top of the Currents 4"h crown, spine end connector must cover the entire height of the spine with crown.</p> <p>Spine end connectors include painted aluminum outside cover with flat top cap and inside cover (where applicable) over the end of the spine.</p> <p>Inside base trim for Currents raceway is recommended to finish inside when combined with standard Currents recessed base raceway covers. Base trim is not required with AutoStrada spine base covers.</p> | |
| 812 Top cap finish | | |
| | | |
| | <p>Spine end connectors, end starters, panel starters and panel starter end trim for Dividends Horizon panels cannot be used to attach Dividends Horizon screens (open weave, glass or other screens) directly to an AutoStrada or Currents spine. In applications where Dividends Horizon open weave, glass or other screens are specified perpendicular to an AutoStrada or Currents spine, you must first connect a Dividends Horizon panel to the spine via a spine end connector and end starter or panel starter, and then connect the Dividends Horizon panel to the Dividends Horizon open weave, glass or other screen.</p> | |

3 1/2" spine extender kit for use with ceiling infeed or panels

| description | application | h | w | d | pattern no. | list |
|----------------|-------------|-----|----|----|------------------------------------|------|
| Spine extender | 39"h spine | 39" | 5" | 4" | AX1SX39 (A/C)(L/C/P)() () | n/a |
| | 48"h spine | 48" | 5" | 4" | AX1SX48 (A/C)(L/C/P)() () | n/a |
| | 64"h spine | 64" | 5" | 4" | AX1SX64 (A/C)(L/C/P)() () | n/a |

| Order Code | Specification Information | Application Notes |
|--------------------------------------|--|--|
| Example: AX1 SX 48 AL 613 613 | For all 3 1/2" spine extenders specify spine base type: | Spine extenders include brackets, side and top trim covers between the end of a spine and any spine end connector to add 3 1/2" to the length of a spine. |
| AX1 Spine connector | A AutoStrada | Spine extender dimension matches that of the Currents 3 1/2"x 5" ceiling infeed panel which may be added between nominal spine height and ceiling for connection to building power, data and communications supply. |
| SX Type | C Currents | |
| 48 Spine height | Then specify crown end type. L=Square, C=Standard and Compact, P=Power Pole. | In most cases the spine end connector matches the height of the attached Dividends panel, but the extending area is only as high as the nominal height of the spine (bottom of crown) so the crown always requires an end cap. |
| A Spine type | | |
| L Crown end type | | When attached panel is lower than the spine, the spine end connector should be the same height as the nominal height of the spine. |
| 613 Vertical finish | Then specify finish for vertical trim covers, all standard painted finishes. | |
| 613 Base trim finish | | |
| 613 Top cap finish | Then specify base cover finish. AutoStrada spine base covers are clear anodized aluminum (AA) or painted finish excluding silver. Currents spine base covers are available in any painted finish only. Then specify top cap finish (if applicable). | |

To attach linkable screens or Morrison panels to spine end connector

| description | application | h | w | d | pattern no. | 00 | 02 | 04 |
|--|---------------------|-----|----|---------------|-------------------------|--------|--------|--------|
| End starters for linkable screens  | 30" h screen | 25" | 1" | 1/2" - 4 1/2" | AX1LES30 () () | \$132. | \$143. | \$153. |
| | 39" h screen | 34" | 1" | 1/2" - 4 1/2" | AX1LES39 () () | 143. | 153. | 171. |
| | 48" h screen | 43" | 1" | 1/2" - 4 1/2" | AX1LES48 () () | 165. | 186. | 209. |
| | 64" h screen | 59" | 1" | 1/2" - 4 1/2" | AX1LES64 () () | 193. | 224. | 258. |
| End starters for Morrison panels  | 30" h screen | 30" | 1" | 1/2" - 4 1/2" | AX1MES30 () () | 138. | 143. | 153. |
| | 39" h screen | 39" | 1" | 1/2" - 4 1/2" | AX1MES39 () () | 165. | 171. | 186. |
| | 42" h screen | 42" | 1" | 1/2" - 4 1/2" | AX1MES42 () () | 165. | 171. | 193. |
| | 48" h screen | 48" | 1" | 1/2" - 4 1/2" | AX1MES48 () () | 171. | 176. | 199. |
| | 56" h screen | 56" | 1" | 1/2" - 4 1/2" | AX1MES56 () () | 199. | 219. | 248. |
| | 64" h screen | 64" | 1" | 1/2" - 4 1/2" | AX1MES64 () () | 199. | 219. | 248. |
| | 80" h screen | 80" | 1" | 1/2" - 4 1/2" | AX1MES80 () () | 285. | 329. | 395. |
| End starter top cap for Morrison panel with linkable screen trim | 00, 02 or 04 offset | | 1" | 2 1/4" | AX1LES E () | 10. | 10. | 10. |

| Order Code | Specification Information | Application Notes |
|--------------------------------------|---|---|
| Example: AX1 LES48 02 613 812 | For spine end starters specify: | End starters connect a linkable screen or panel to either side of a spine end connector of the same height or taller. |
| AX1 Spine connector | 1.Configuration | End starters for linkable screens and Morrison panels include connector track and top cap. |
| L for linkable screens | 00=Flush | For Morrison panels that have linkable screen trim also specify end starter linkable screen end cap. |
| ES End starter | 02=Offset one panel | End starters are available in three configurations: flush with end of spine or offset one or two screen/panel thickness beyond end of spine. |
| 48 Panel height | 04=Offset two panels | |
| 02 Offset | 2.Paint finish for end starter: All standard paint finishes | |
| 613 Painted finish | 3.Trim finish for top cap: 812=Easy Grey 813=Trim Grey Or all standard paint finishes for Morrison top cap. | |
| 812 Trim finish | End starters on this page align with spine base covers 13/16" above the floor. | |
| | | For full access to entire width of spine surface specify end starters offset one panel thickness (02 suffix). |
| | | For a cluster of two workstations with one screen or panel between specify one end starter offset two panel thicknesses (04 suffix) and one offset one thickness (02 suffix). |
| | | For a cluster of three workstations (two intermediate panels) specify two end starters offset two panel thicknesses (04 suffix). |
| | | For a cluster of four workstations (three intermediate panels) extend the spine 12" and specify two flush end starters (00 suffix). |
| | | When specifying an end starter top cap for a Morrison panel with linkable screen trim, note that the 02 offset top cap will also work in an 04 offset application. |

To attach AutoStrada or Reff panels to spine end connector

| description | application | h | w | d | pattern no. | 00 | 02 | 04 |
|--|-------------|-----|----|---------------|---------------------------------|--------|--------|--------|
| End starters for AutoStrada or Reff panels | 34"h panel | 34" | 1" | 1/2" - 4 1/2" | AX1AES34 () () () () | \$355. | \$355. | \$388. |
| | 42"h panel | 42" | 1" | 1/2" - 4 1/2" | AX1AES42 () () () () | 447. | 447. | 490. |
| | 49"h panel | 49" | 1" | 1/2" - 4 1/2" | AX1AES49 () () () () | 463. | 463. | 506. |
| | 64"h panel | 64" | 1" | 1/2" - 4 1/2" | AX1AES64 () () () () | 560. | 560. | 614. |
| | 79"h panel | 79" | 1" | 1/2" - 4 1/2" | AX1AES79 () () () () | 857. | 857. | 964. |

Spine and linkable screens

| Order Code | Specification Information | Application Notes |
|--|---|---|
| Example: AX1 AES49 02 24 E 812 AA | For spine end starters specify: | |
| AX1 Spine connector | 1.Configuration | End starters connect a panel to either side of a spine end connector of the same height or taller. End starters include hookstrip and top cap. Specify first adjacent panel top cap width and type. |
| A for AutoStrada panels | 00=Inset flush | |
| ES End starter | 02=Offset one panel | |
| 49 Panel height | 04=Offset two panels | |
| 02 Offset | 2.Adjoining panel width (18, 20, 24, 30, 36, 42, 48) | End starters are available in two configurations: inset flush with end of spine (00) or offset one panel thickness (02) or offset two panel thicknesses (04) beyond end of spine. |
| 24 Panel width | 3.Trim profile | |
| E Trim profile | A=Flat | |
| 812 Vertical cover finish | B=Square | |
| AA Top trim finish | C=Bullnose | |
| | E=AutoStrada | For full access to entire width of spine surface specify end starters offset one panel thickness (02 suffix). |
| | 4.Vertical cover finish | |
| | All standard paint finishes | |
| | 5.Top trim | |
| | AutoStrada: | |
| | AA Clear anodized aluminum and all core paint finishes except silver. | |
| | Reff: | |
| | All core paint finishes | |
| | | For a cluster of two workstations (one intermediate panel) specify one end starter offset two panel thicknesses (04 suffix). |
| | | For a cluster of three workstations (two intermediate panels) specify two end starters offset two panel thicknesses (04). |
| | | For a cluster of four workstations (three intermediate panels) extend the spine 12" and specify two inset end starters (00 suffix). |
| | | End starters on this page start 1/2" above the floor. |

End Starters

To attach Gallery screens to spine end connector

| description | application | height | width | depth | pattern no. | 00 | 01 | 02 |
|----------------------------------|---------------------|--------|-------|-----------|-------------------------|--------|--------|--------|
| End starters for Gallery screens | 39"h or 49"h screen | 39" | 1" | 1/2" - 3" | AX1GES39 () () | \$162. | \$135. | \$135. |
| | 49"h screen | 48" | 1" | 1/2" - 3" | AX1GES48 () () | 183. | 140. | 151. |

| Order Code | Specification Information | Application Notes |
|----------------------------------|---|--|
| Example: AX1GES 48 02 613 | For spine end starters specify: | End starters connect a 1" thick Gallery screen to either side of spine end connector of the same height or taller. |
| AX1 Spine connector | 1.Configuration | End starters are available in three configurations: flush with end of spine or offset one or two screen thicknesses beyond end of spine. |
| G Thin screens | 00=Flush | |
| ES End starter | 01=Offset one panel | Offset end starters compensate for the dimensional gain of Gallery screens attached to the spine. |
| 48 Panel height | 02=Offset two panels | |
| 02 Offset | 2.Finish: | |
| 613 Painted finish | All standard paint finishes | |
| | End starters on this page start 1/2" above the floor. | |

To attach Dividends Horizon panels to spine end connector

| description | application | h | w | d | pattern no. | list |
|-----------------------------------|-------------|-----|----|--------|-------------------------|--------|
| End starters for Dividends panels | 36" h panel | 36" | 1" | 1/2-3" | AX1DES36 () () | \$130. |
| | 42" h panel | 42" | 1" | 1/2-3" | AX1DES42 () () | 140. |
| | 50" h panel | 50" | 1" | 1/2-3" | AX1DES50 () () | 150. |
| | 57" h panel | 57" | 1" | 1/2-3" | AX1DES57 () () | 150. |
| | 64" h panel | 64" | 1" | 1/2-3" | AX1DES64 () () | 155. |
| | 78" h panel | 78" | 1" | 1/2-3" | AX1DES78 () () | 173. |

| Order Code | Specification Information | Application Notes |
|----------------------------|---|--|
| Example: AX1 DES 50 | | |
| AX1 Spine connector | 1.Top cap type 4=Metal Radius or Plastic Enhanced Smooth Radius 5=Metal Flat | End starters connect a Dividends panel to either side of a same height or taller spine end connector. End starters for Dividends panels include specified end top cap. |
| D Dividends | | |
| ES End starter | 2.Paint finish All standard paint finishes | |
| 50 Panel height | End starters on this page begin 1/2" above floor. | For a single workstation (0 intermediate panels), specify 2 spine end connectors and 2 end starters positioned offset by 1 panel thickness. |
| 5 Top cap type | Spine end connectors, end starters, panel starters and panel starter end trim for Dividends Horizon panels cannot be used to attach Dividends Horizon screens (open weave, glass or other screens) directly to an AutoStrada or Currents spine. In applications where Dividends Horizon open weave, glass or other screens are specified perpendicular to an AutoStrada or Currents spine, you must first connect a Dividends Horizon panel to the spine via a spine end connector and end starter or panel starter, and then connect the Dividends Horizon panel to the Dividends Horizon open weave, glass or other screen. | For a cluster of 2 workstations (1 intermediate panel), specify 1 panel starter, 2 spine end connectors, 1 spine extender, and 2 end starters positioned offset by 1 panel thickness. |
| 613 Painted finish | | For a cluster of 3 workstations, (2 intermediate panels), extend the spine another 12", specify 2 panel starters, 2 spine and connectors, and 2 end starters positioned inset. |
| | | For a cluster of 4 workstations (3 intermediate panels), extend the spine 12" and specify 3 panels starters, 2 spine end connectors, and 2 end starters (1 end starter inset and the other offset by 1 panel thickness). |
| | | For a cluster of 5 workstations (4 intermediate panels) extend the spine by 12" and specify 4 panel starters, 2 spine end connectors, and 2 end starters positioned offset by 1 panel thickness. |

Panel system starters and T-ends

Linkable screen panel starters

| description | type | width | depth | height | pattern number | paint | |
|---|---|------------|-------|---------------------|---------------------|--------------------|--------|
|  | Morrison and linkable screen panel starters | 30"H panel | 4" | 1" | 26" | AA1MPS30() | \$102. |
| | 39"H panel/screen | 4" | 1" | 35" | AA1MPS39() | 102. | |
| | 42"H panel | 4" | 1" | 38" | AA1MPS42() | 102. | |
| | 48"H panel/screen | 4" | 1" | 44" | AA1MPS48() | 107. | |
| | 56"H panel | 4" | 1" | 52" | AA1MPS56() | 112. | |
| | 64"H panel/screen | 4" | 1" | 60" | AA1MPS64() | 116. | |
| | 74"H panel | 4" | 1" | 70" | AA1MPS74() | 121. | |
| | 80"H panel | 4" | 1" | 76" | AA1MPS80() | 121. | |
| | Morrison raceway shroud | 2 1/4" | 3" | 4" | AA1MRS() | 44. | |
| | panel/screen top clip | | | | AA2 MTC () | 51. | |
| Linkable screen starter fillers | 39"H linkable screen | 1" | 2" | 18" | AA1CET39 () | 36. | |
| 48"H linkable screen | 1" | 2" | 27" | AA1CET48 () | 41. | | |
| 64"H linkable screen | 1" | 2" | 43" | AA1CET64 () | 64. | | |

| Order Code | Specification Information | Application Notes |
|-----------------------------|--|--|
| Example: AA1 MPS48 3 | | |
| AA1 Accessory | Please specify painted finish for panel starters, Morrison raceway shroud and end trim from paint finish options listed on page 7. | Panel starters attach perpendicular panels or linkable screens to spine wall structural base covers (5" - 21"H). |
| M Morrison | | |
| PS Panel starter | Linkable screen fillers are trim grey or easy grey integral color. | Panel starters include clamp bracket to any height spine wall and full height connector track with modified top wedge block. |
| 48 Panel height | | Top clip connects panel connector track to spine wall crown. Specify top clip for added stiffness of panels higher than 48" or whenever cantilevering components from panel. Top clip is not compatible with end trim. |
| V3 Finish | | Specify raceway shroud if connecting power from spine wall to Morrison panel. |
| | | Linkable screen fillers are optional fillers for linkable screen starters. End trims may interfere with easy access to wall covers. |

Panel system starters and T-ends

Morrison panel/linkable screen T-ends

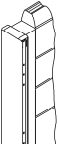
| description | type | width | depth | height | pattern number | extension, 0 or 1 1/8 | extension, 3 1/2 |
|---|----------------------|---------------|-------|--------|--------------------------|-----------------------|------------------|
|  T ends for Currents screens and linkable screens | 39" screen/39" spine | 2 1/4"-5 3/4" | 7" | 39" | AX2 C3939 () () | \$696. | \$780. |
| | 48" screen/39" spine | 2 1/4"-5 3/4" | 7" | 48" | AX2 C4839 () () | 808. | 892. |
| | 48" screen/48" spine | 2 1/4"-5 3/4" | 7" | 48" | AX2 C4848 () () | 752. | 835. |
| | 64" screen/39" spine | 2 1/4"-5 3/4" | 7" | 64" | AX2 C6439 () () | 921. | 1,003. |
| | 64" screen/48" spine | 2 1/4"-5 3/4" | 7" | 64" | AX2 C6448 () () | 864. | 947. |
| | 64" screen/64" spine | 2 1/4"-5 3/4" | 7" | 64" | AX2 C6464 () () | 864. | 947. |

| description | type | width | depth | height | pattern number | extension, 0 or 1 1/8 | extension, 3 1/2 |
|---|---------------------|-------|-------|--------|--------------------------|-----------------------|------------------|
|  T ends for Morrison panels | 39" panel/39" spine | 6" | 7" | 39" | AX1 M3939 () () | 696. | 780. |
| | 42" panel/39" spine | 6" | 7" | 42" | AX1 M4239 () () | 752. | 835. |
| | 48" panel/39" spine | 6" | 7" | 48" | AX1 M4839 () () | 808. | 892. |
| | 48" panel/48" spine | 6" | 7" | 48" | AX1 M4848 () () | 752. | 835. |
| | 56" panel/39" spine | 6" | 7" | 56" | AX1 M5639 () () | 864. | 947. |
| | 56" panel/48" spine | 6" | 7" | 56" | AX1 M5648 () () | 808. | 892. |
| | 64" panel/39" spine | 6" | 7" | 64" | AX1 M6439 () () | 921. | 1,003. |
| | 64" panel/48" spine | 6" | 7" | 64" | AX1 M6448 () () | 864. | 947. |
| | 64" panel/64" spine | 6" | 7" | 64" | AX1 M6464 () () | 864. | 947. |
| | 80" panel/39" spine | 6" | 7" | 80" | AX1 M8039 () () | 1,114. | 1,225. |
| | 80" panel/48" spine | 6" | 7" | 80" | AX1 M8048 () () | 1,114. | 1,225. |
| | 80" panel/64" spine | 6" | 7" | 80" | AX1 M8064 () () | 1,114. | 1,225. |

| description | type | extension, 0 or 1 1/8 | extension, 3 1/2 |
|---|------------------|-----------------------|------------------|
|  T-end raceway adapter kit | 1 1/8" extension | AX1 RF1 () | 45. |
| | 3 1/2" extension | AX1 RF3 () | 65. |

| description | type | extension, 0 or 1 1/8 | extension, 3 1/2 |
|--|--------------------|-----------------------|------------------|
|  T-end raceway end cover | AA1 ARE () | 25. | 25. |

| Order Code | Specification Information | Application Notes |
|--|---|---|
| Example: AX1 M6448 3 613 613 AX1 Spine connector M Morrison 64 Morrison height 48 Spine height 3 Extension 613 Top cap finish 613 Vertical trim cover | <p><i>T ends begin with AX1-prefix. Fourth position indicates attached panel system:</i></p> <p>C Linkable screen M Morrison panel</p> <p><i>Fifth position: height of panel. Seventh position: height of service wall. Ninth position: extension at end of spine.</i></p> <p>0 0" extension 1 1 1/8" extension 3 3 1/2" extension</p> <p><i>Please specify painted finish for Morrison top cap, crown end, vertical trim cover, raceway cover and T end vertical cover from from paint finish options listed on page 7.</i></p> <p>When ordering T-ends for the Spine, specify crown end caps separately.</p> | <p>T-end encloses the end of a spine wall and connects to linkable screens or panels on one or both sides. T-ends include Morrison-style top trim for the 7" wide connection to panels or screens. Currents T-end includes 5" and 6" wide trim and two end caps. Morrison T-end includes 7" wide trim. Use 5" wide trim and two end caps when connecting to Currents screens on both sides. Use 6" wide trim and one end cap when connecting to Currents screens on one side only. Specify Morrison end connector separately to finish side edge without a connected screen. Use 7" wide trim when connecting to Morrison panels. Specify Morrison end counter, top cap and raceway cover kits separately to finish side edge of Morrison T-ends without a connected panel.</p> <p>T-ends for linkable screens and Morrison panels capture the end of the wall (no extension) or extend the wall 1 1/8" or 3 1/2". This extension enables precise planning of multiple workstations and intermediate screens or panels between workstations.</p> <p>Specify two 0" T-ends for a single workstation on each side (no intermediate screens).</p> <p>Specify two 1 1/8" T-ends for one intermediate screen, one 1 1/8" and one 3 1/2" for two screens, and two 3 1/2" for three intermediate screens.</p> <p>T-ends with 3 1/2" extension have removable inside covers and accept ceiling infed panel.</p> <p>The Raceway Adapter kit finishes the bottom of a T-end with the Autostrada base trim profile. No adapter kit is necessary for 0" T-ends.</p> |

Panel system starters and T-ends

AutoStrada and Reff panel starters and T-ends

AutoStrada

| description | type | pattern number | list | extension, 0 or 1 1/8 | extension, 3 1/2 |
|--|--------------------------------|------------------------|--------|-----------------------|------------------|
|  AutoStrada or Reff panel starter | 34"H (includes AA1RTC bracket) | AA1RPS34 ()() | \$117. | | |
| | 42"H (includes AA1RTC bracket) | AA1RPS42 ()() | 204. | | |
| | 49"H (includes AA1RTC bracket) | AA1RPS49 ()() | 210. | | |
| | 64"H (includes AA1RTC bracket) | AA1RPS64 ()() | 222. | | |
| | 79"H (includes AA1RTC bracket) | AA1RPS79 ()() | 232. | | |

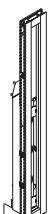
| description | type | pattern number | list | extension, 0 or 1 1/8 | extension, 3 1/2 |
|---|------------------------------|--------------------------|------|-----------------------|------------------|
|  T-end frame for AutoStrada or Reff panels | 42" panel to 39" spine frame | AX1 R34239 ()() | | 835. | 921. |
| | 49" panel to 39" spine frame | AX1 R34939 ()() | | 845. | 931. |
| | 49" panel to 48" spine frame | AX1 R34948 ()() | | 792. | 874. |
| | 64" panel to 39" spine frame | AX1 R36439 ()() | | 935. | 1,018. |
| | 64" panel to 48" spine frame | AX1 R36448 ()() | | 880. | 964. |
| | 64" panel to 64" spine frame | AX1 R36464 ()() | | 880. | 964. |
| | 79" panel to 39" spine frame | AX1 R37939 ()() | | 941. | 1,026. |
| | 79" panel to 48" spine frame | AX1 R37948 ()() | | 886. | 970. |
| | 79" panel to 64" spine frame | AX1 R37964 ()() | | 859. | 941. |

| description | type | pattern number | list | extension, 0 or 1 1/8 | extension, 3 1/2 |
|---|------------------------------|--------------------------|------|-----------------------|------------------|
| T-end frame for AutoStrada panel without base raceway | 42" panel to 39" spine frame | AX1 A34239 ()() | | 835. | 921. |
| | 49" panel to 39" spine frame | AX1 A34939 ()() | | 845. | 931. |
| | 49" panel to 48" spine frame | AX1 A34948 ()() | | 792. | 874. |
| | 64" panel to 39" spine frame | AX1 A36439 ()() | | 935. | 1,018. |

| Order Code | Specification Information | Application Notes | | | | | | | | | | | | |
|---|--|-------------------|--------------|---|------------------|---|-------------------|---|-----|-------|-----|-------|-----|--------|
| Example: AA1-RPS6448E613AA AA1 Accessory R Reff/AutoStrada PS Panel starter 64 Panel height 48 Adjoining panel width E Panel top trim profile 613 Finish, panel starter AA Panel top trim finish | <p><i>For T-end specify extension at end of spine, then paint finish. Extension at end of spine:</i></p> <table> <tr> <td>0</td> <td>0" extension</td> </tr> <tr> <td>1</td> <td>1 1/8" extension</td> </tr> <tr> <td>3</td> <td>3 1/2" extensions</td> </tr> </table> <p><i>Specify following for panel starter:</i></p> <ol style="list-style-type: none"> Adjoining panel width (<i>panel starter includes extended panel top trim for panel attached to starter</i>) Top trim profile of adjoining panel <i>E = Extruded aluminum top trim</i> Painted finish for panel starter Top trim finish <i>Anodized aluminum or painted finish</i> <p><i>Please specify painted finish for panel starters and inside covers of T-end from paint finish options listed on page 7.</i></p> | 0 | 0" extension | 1 | 1 1/8" extension | 3 | 3 1/2" extensions | <p>Panel starters attach perpendicular AutoStrada panels to spine wall. Panel starter includes clamp bracket to structural base cover, top clip, and vertical extrusion corresponding to AutoStrada panel height.</p> <p>T-end encloses the end of a spine wall and connects to perpendicular AutoStrada panels on one or both sides.</p> <p>Specify AutoStrada end connector to finish side edge without a connected wall.</p> <p>Specify T-end with 0", 1 1/8", or 3 1/2" of extension to accommodate the "creep" of panels between workstations on each side of service wall.</p> <p>Specify two 0" T-ends for a single workstation on each side (no intermediate panels).</p> <p>Specify two 1 1/8" T-ends for one intermediate panel, one 1 1/8" and one 3 1/2" for two panels, and two 3 1/2" for three intermediate panels.</p> <p>T-ends with 3 1/2" extension have removable inside covers and accept ceiling infeed panel.</p> <p>Finish options for AA1RTC() top clip:</p> <table> <tr> <td>118</td> <td>White</td> </tr> <tr> <td>111</td> <td>Black</td> </tr> <tr> <td>613</td> <td>Silver</td> </tr> </table> <p>To complete T - end solution, must specify frame, crown end cap, raceway extender and cover set.</p> | 118 | White | 111 | Black | 613 | Silver |
| 0 | 0" extension | | | | | | | | | | | | | |
| 1 | 1 1/8" extension | | | | | | | | | | | | | |
| 3 | 3 1/2" extensions | | | | | | | | | | | | | |
| 118 | White | | | | | | | | | | | | | |
| 111 | Black | | | | | | | | | | | | | |
| 613 | Silver | | | | | | | | | | | | | |

Panel system starters and T-ends

AutoStrada and Reff panel starters and T-ends

AutoStrada

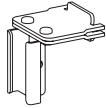

| description | type | pattern number | list | extension, 0 or 1 1/8 | extension, 3 1/2 |
|---|------------------------------|----------------------|------|-----------------------|------------------|
| T-end frame for AutoStrada panel without base raceway | 64" panel to 48" spine frame | AX1 A36448() | | \$880. | \$964. |
| | 64" panel to 64" spine frame | AX1 A36464() | | 880. | 964. |
| Top clip (replacement part) | | AA1RTC() | 83. | | |



Spine and linkable screens

| Order Code | Specification Information | Application Notes |
|-----------------------------------|--|--|
| Example: AA1-RPS6448E613AA | <i>For T-end specify extension at end of spine, then paint finish. Extension at end of spine:</i> | Panel starters attach perpendicular AutoStrada panels to spine wall. Panel starter includes clamp bracket to structural base cover, top clip, and vertical extrusion corresponding to AutoStrada panel height. |
| AA1 Accessory | | Specify two 0" T-ends for a single workstation on each side (no intermediate panels). |
| R Reff/AutoStrada | | Specify two 1 1/8" T-ends for one intermediate panel, one 1 1/8" and one 3 1/2" for two panels, and two 3 1/2" for three intermediate panels. |
| PS Panel starter | 0 0" extension | T-ends with 3 1/2" extension have removable inside covers and accept ceiling infeed panel. |
| 64 Panel height | 1 1 1/8" extension | Finish options for AA1RTC() top clip: 118 White 111 Black 613 Silver |
| 48 Adjoining panel width | 3 3 1/2" extensions | To complete T - end solution, must specify frame, crown end cap, raceway extender and cover set. |
| E Panel top trim profile | <i>Specify following for panel starter:</i> | |
| 613 Finish, panel starter | 1. Adjoining panel width (<i>panel starter includes extended panel top trim for panel attached to starter</i>) | |
| AA Panel top trim finish | 2. Top trim profile of adjoining panel <i>E = Extruded aluminum top trim</i> | |
| | 3. Painted finish for panel starter | |
| | 4. Top trim finish <i>Anodized aluminum or painted finish</i> | |
| | <i>Please specify painted finish for panel starters and inside covers of T-end from paint finish options listed on page 7.</i> | |

T-end fabric and wood cover sets (AutoStrada or Reff panels)

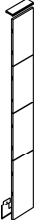
| description | type | height | pattern number | list |
|--|------------|--------|--------------------|--------|
|  Monolithic cover set | Fabric | 42" | R3B0P0F4207 | \$132. |
| | | 49" | R3B0P0F4907 | 149. |
| | | 64" | R3B0P0F6407 | 176. |
| | | 79" | R3B0P0F7907 | 202. |
| | L/V1/V2/V3 | 42" | R3B0P0H4207 | 136. |
| | | 49" | R3B0P0H4907 | 153. |
| | | 64" | R3B0P0H6407 | 180. |
| | | 79" | R3B0P0H7907 | 206. |
|  Tiled cover set | Fabric | 42" | R3B0T0F4207 | 132. |
| | | 49" | R3B0T0F4907 | 149. |
| | | 64" | R3B0T0F6407 | 176. |
| | | 79" | R3B0T0F7907 | 202. |
| | L/V1/V2/V3 | 42" | R3B0T0H4207 | 136. |
| | | 49" | R3B0T0H4907 | 153. |
| | | 64" | R3B0T0H6407 | 180. |
| | | 79" | R3B0T0H7907 | 206. |
|  Tiled cover set, no base raceway | L/V1/V2/V3 | 42" | R3R0T0H4207 | 156. |
| | | 49" | R3R0T0H4907 | 178. |
| | | 64" | R3R0T0H6407 | 208. |

Order Code

| | |
|--------------|------------------------|
| Example: | R3B0P0F4207 E 4 |
| R3B | Generation 3 |
| 0P0F | Monolithic |
| 42 | Panel height |
| 07 | Width |
| E | Top trim profile |
| 4 | 4" base height |
| W359- | Fabric |
| AA | Trim finish |
| 111 | Outside base finish |
| 111 | Inside base finish |

Specification Information

See Reff System for full selection of painted finishes, fabrics and wood veneers for T-end cover sets.

Specify:

1. Top trim profile
2. Panel finishes
3. Top trim finish
4. Base finish

Top trim profile:

E Extruded Aluminum

Base height:

4 4" base height

Application Notes

Specify covers in monolithic or tiled sets to complete T-end frames for AutoStrada or Reff panel.

Monolithic cover sets include a raceway cover and a single snap-in panel above.

Tiled sets include raceway cover and segmented tiles corresponding to adjacent AutoStrada or Reff tiled panels.

AutoStrada or Reff tiled module horizontal reveals are at nominal 19", 34", 49" and 64" above the floor and do not align with service wall cover reveals.

Please see page 7 for list of applicable finishes.

Panel system starters and T-ends

Gallery screen starters

| description | h | w | d | pattern no. | list |
|-------------------------------|-----|----|----|-------------------|--------|
| Gallery screen starter | 21" | 3" | 1" | AA1GPS () | \$118. |
| Screen-to-worksurface bracket | | | | AG1B | 28. |

Order Code

| | |
|------------|--------------------|
| Example: | AA1 GPS 613 |
| AA1 | Accessory |
| G | For thin screens |
| PS | Panel starter |
| 613 | Painted finish |

Specification Information

For intermediate gallery screen starters specify any standard painted finish.

Screen to worksurface bracket is black painted finish.

Application Notes

Gallery screen starter attaches thin screen to structural base cover of AutoStrada spine or Currents service wall. Specify Gallery screen to have through holes for starter bracket.

Screen-to-worksurface bracket is required to stabilize Gallery screens by connecting to adjacent worksurface. Specify one bracket for each screen.

Panel system starters and T-ends

Dividends Horizon panel starters

AutoStrada

| description | application | h | w | d | pattern no. | list |
|---------------------------------------|------------------|-----|----|------|-------------------|--------|
| Panel starters for Dividends panels | Any height panel | 16" | 3" | 1/2" | AA1DPS () | \$224. |
| Top clip for Dividends to lower spine | | | | | AA1DTC () | 94. |

| Order Code | Specification Information | Application Notes |
|-----------------------------|--|--|
| Example: AA1 DPS 613 | Specify paint finish for panel starter and top clip. | Panel starter includes a clamp bracket that attaches to the structural base cover of the spine to start a Dividends panel run perpendicular to the face of the spine anywhere other than at the end of the spine. For panel starters, specify trim separately (see next page). Top clip, which secures top edge of panel to underside of spine crown, is required in addition to panel starter for stability of 57" or higher panels or 50"H panels with cantilevered shelves overhead storage. |
| AA1 Accessory | | |
| D For Dividends | | |
| PS Panel starter | | |
| 613 Painted finish | | |
| | | Spine end connectors, end starters, panel starters and panel starter end trim for Dividends Horizon panels cannot be used to attach Dividends Horizon screens (open weave, glass or other screens) directly to an AutoStrada or Currents spine. In applications where Dividends Horizon open weave, glass or other screens are specified perpendicular to an AutoStrada or Currents spine, you must first connect a Dividends Horizon panel to the spine via a spine end connector and end starter or panel starter, and then connect the Dividends Horizon panel to the Dividends Horizon open weave, glass or other screen. |

Panel system starters and T-ends

End trim kits for Dividends Horizon panel starters



| description | application | h | w | d | pattern no. | list |
|---|-------------|-----|------|----|---------------------------|-------|
| End trim kit for Dividends panel above 21" to top of panel | 36"h panel | 15" | 1/2" | 3" | AX1DET36 () () | \$60. |
| | 42"h panel | 21" | 1/2" | 3" | AX1DET42 () () | 60. |
| | 50"h panel | 29" | 1/2" | 3" | AX1DET50 () () | 62. |
| | 57"h panel | 36" | 1/2" | 3" | AX1DET57 () () | 62. |
| | 64"h panel | 43" | 1/2" | 3" | AX1DET64 () () | 63. |
| End trim kit for Dividends panel between 21" and top of panel with top clip at 39"H | 50"h panel | 29" | 1/2" | 3" | AX1DET5039 () () | 72. |
| | 57"h panel | 36" | 1/2" | 3" | AX1DET5739 () () | 72. |
| | 64"h panel | 43" | 1/2" | 3" | AX1DET6439 () () | 73. |
| End trim kit for Dividends panel between 21" and top of panel with top clip at 48"H | 50"h panel | 29" | 1/2" | 3" | AX1DET5048 () () | 72. |
| | 57"h panel | 36" | 1/2" | 3" | AX1DET5748 () () | 72. |
| | 64"h panel | 43" | 1/2" | 3" | AX1DET6448 () () | 73. |
| | 78"h panel | 57" | 1/2" | 3" | AX1DET7848 () () | 76. |
| End trim kit for Dividends panel between 21" and top of panel with top clip at 64"H | 64"h panel | 64" | 1/2" | 3" | AX1DET6464 () () | 73. |
| | 78"h panel | 78" | 1/2" | 3" | AX1DET7864 () () | 76. |

| Order Code | Specification Information | Application Notes |
|----------------------------|-----------------------------|---|
| Example: AX1 DET 36 | For end trim kits specify: | End trim kits for Dividends Horizon panel starters fit the space above the panel starter clamp bracket (21" above floor) to top of panel. |
| AX1 Spine connector | 1. End trim type | End trim kits for Dividends Horizon panel starters with top clip are segmented into two pieces. One piece fits the space between clamp bracket and top clip and the other fits between top clip and top of panel. |
| D Dividends | 5= Metal Flat | |
| ET End trim kit | 2. Paint finishes | Spine end connectors, end starters, panel starters and panel starter end trim for Dividends Horizon panels cannot be used to attach Dividends Horizon screens (open weave, glass or other screens) directly to an AutoStrada or Currents spine. |
| 36 Panel height | All standard paint finishes | |
| 5 End trim type | | |
| 613 Trim finish | | In applications where Dividends Horizon open weave, glass or other screens are specified perpendicular to an AutoStrada or Currents spine, you must first connect a Dividends Horizon panel to the spine via a spine end connector and end starter or panel starter, and then connect the Dividends Horizon panel to the Dividends Horizon open weave, glass or other screen. |

Panel system starters and T-ends

Universal panel starter and T-end

AutoStrada

| description | width | depth | height | pattern number | paint |
|--|-------|-------|--------|--------------------|-------|
|  Universal T-end adapter | 2-6" | 7" | 39" | AA1UA39() | \$72. |
| | 2-6" | 7" | 48" | AA1UA48() | 87. |
| | 2-6" | 7" | 64" | AA1UA64() | 97. |
|  Universal panel starters | 3" | 1" | 39" | AA1UPS39() | 162. |
| | 3" | 1" | 48" | AA1UPS48() | 176. |
| | 3" | 1" | 64" | AA1UPS64() | 186. |
|  Universal top clip | | | | AA2 UTC () | 70. |

Order Code

| | |
|------------|----------------------|
| Example: | AA1 UPS48 111 |
| AA1 | Accessory |
| UPS | Panel starter |
| 48 | Panel height |
| 111 | Finish |

Specification Information

Please specify painted finish for universal end and panel starters from paint finish options listed on page 7.

Application Notes

Universal adapters and starters integrate other panel systems with the AutoStrada spine. Vertical surface accepts architectural wall starter of most other systems.

T-end adapters include connector to corresponding height T-end for linkable screen (specified separately).

Panel starter includes clamp bracket to structural base cover on service wall.

Top clip gives added stability to attached panels of the same height or higher than the service wall.

Power components, spine

2+2 power components

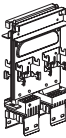
| description | type | w | d | h | pattern number | black | orange (-O) or orange triangle (-T) | no finish |
|---|-------------------|------|---|----|------------------|-------|-------------------------------------|-----------|
| Desk height outlet module | 21-48"H | 5" | - | 6" | AR1 EOM | | | \$148. |
|  | | | | | | | | |
| Central switch | 21-48"H | | | | AR1-ELS-B | | | 415. |
| Duplex outlet | Circuit A | | | | AR1 DA | 36. | | |
| | Circuit B | | | | AR1 DB | 36. | | |
| | Circuit X | | | | AR1 DX | 36. | | 41. |
| | Circuit Y | | | | AR1 DY | 36. | | 41. |
| Power infeeds, modular | Desk height power | 85" | | | AR1 EPI5 | | | 172. |
| | Ceiling infeed | 145" | | | AR1 EPIC | | | 214. |
| Hardwire base infeeds (NYC) | One connector | | | | AR1 EPH1 | | | 285. |
| | Two connectors | | | | AR1 EPH2 | | | 427. |
| Transitional connectors for Morrison or Reff | 12" | 61" | | | AR1 ET1 | | | 157. |
| | 36" | 85" | | | AR1 ET3 | | | 199. |
| | 60" | 109" | | | AR1 ET5 | | | 228. |
| | 96" | 133" | | | AR1 ET8 | | | 255. |
| Jumper cable | 12" | 37" | | | AR1 EJ1 | | | 85. |
| | 24" | 49" | | | AR1 EJ2 | | | 113. |
| | 36" | 61" | | | AR1 EJ3 | | | 129. |
| | 48" | 73" | | | AR1 EJ4 | | | 141. |
| | 60" | 85" | | | AR1 EJ5 | | | 157. |
| | 72" | 97" | | | AR1 EJ6 | | | 172. |
| | 96" | 121" | | | AR1 EJ8 | | | 199. |
| | 120" | 145" | | | AR1 EJ10 | | | 227. |
| | 144" | 169" | | | AR1 EJ12 | | | 255. |

Order Code

| | |
|------------|-----------------|
| Example: | AR1 EOM |
| AR1 | Power component |
| E | 2+2 |
| OM | Outlet module |

Application Notes

Autostrada power components distribute four 20-amp circuits at desk height: two convenience circuits and two protected circuits, with separate grounds and heavy duty #10 neutrals. Power may be distributed point-to-point between outlet modules at or below desk height. Outlet modules accept two duplex outlets on each face and four jumper cables to connect to other modules or infeed power.

Modular desk-height outlet module mounts between frame studs at any height from 21" - 48", above or below adjacent worksurfaces. Each 12"W frame bay can accept two outlet housings (up to four duplex outlets on each side) side by side.

Central switch controls three outlets inside wall frame for task or ambient lights. Switch occupies right-hand outlet opening in outlets cover on one side of wall.

Switches cannot be positioned back-to-back in combination with an outlet module. Central switch includes white rocker switch, connector to adjacent outlet module, and three simplex outlets on circuit B (2+2 or 3+3).

Outlet modules accept two duplex outlets on each face. Specify outlets with black face for convenience circuits. Specify orange face or black with orange triangle for protected circuits with separate ground and neutral in building power supply.

Desk height power infeed connects from floor box to outlets module in spine. Infeed includes 6' cable with pigtail. Ceiling infeed connects from ceiling mounted box to desk height outlet module. Specify ceiling infeed panel separately.

Hardwire base infeed is approved for installations in the City of New York. Infeed includes junction box for base raceway and connector to outlet module.

Jumper cables join power from outlet module to outlet module. Application dimension is distance between modules.

Transitional connectors connect power from AutoStrada spine to powered Morrison or Reff panels attached to the spine. Application dimension suggests distance from outlet to panel. Transitional connectors have watertight conduit between modular ends. Do not specify transitional connectors in City of New York installations.

Power components, spine

3+3 power components

AutoStrada

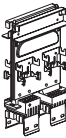
| description | type | w | d | h | pattern number | black | orange (-O) or orange triangle (-T) | no finish |
|---|-------------------|------|----|----|------------------|-------|-------------------------------------|-----------|
| Desk-height outlet module | 21"-48"H | 6" | 1" | 9" | AR1 TOM | | | \$172. |
|  | | | | | | | | |
| Central switch | 21-48"H | | | | AR1-ELS-B | | | 415. |
| Duplex outlet | Circuit A | | | | AR1 DA | 36. | | |
| | Circuit B | | | | AR1 DB | 36. | | |
| | Circuit C | | | | AR1 DC | 36. | | |
| | Circuit X | | | | AR1 DX | 36. | | 41. |
| | Circuit Y | | | | AR1 DY | 36. | | 41. |
| | Circuit Z | | | | AR1 DZ | 36. | | 41. |
| Power infeeds | Desk height power | 85" | | | AR1 TPI5 | | | 199. |
| | Ceiling infeed | 145" | | | AR1 TPIC | | | 243. |
| Hardwire base infeeds (NYC) | One connector | | | | AR1 TPH1 | | | 314. |
| | Two connectors | | | | AR1 TPH2 | | | 486. |
| Transitional connectors for Morrison or Reff | 12" | 61" | | | AR1 TT1 | | | 185. |
| | 36" | 85" | | | AR1 TT3 | | | 228. |
| | 60" | 109" | | | AR1 TT5 | | | 255. |
| | 96" | 133" | | | AR1 TT8 | | | 285. |
| Jumper cable | 120" | | | | AR1 TJ10 | | | 255. |
| | 12" | 37" | | | AR1 TJ1 | | | 99. |
| | 24" | 49" | | | AR1 TJ2 | | | 129. |
| | 36" | 61" | | | AR1 TJ3 | | | 157. |
| | 48" | 73" | | | AR1 TJ4 | | | 172. |
| | 60" | 85" | | | AR1 TJ5 | | | 185. |
| | 72" | 97" | | | AR1 TJ6 | | | 199. |
| | 96" | 121" | | | AR1 TJ8 | | | 227. |
| | 144" wall | 169" | | | AR1 TJ12 | | | 284. |

Order Code

| | |
|------------|-----------------|
| Example: | AR1 TOM |
| AR1 | Power component |
| T | 3+3 |
| OM | Outlet module |

Application Notes

AutoStrada power components distribute six 20-amp circuits at desk height or wall base: three convenience circuits and three protected circuits, with separate grounds and heavy-duty #10 neutrals.

Service wall power may be distributed point-to-point between outlet modules at desk height or in the base raceway. Outlet modules and power rails accept two duplex outlets on each face and four connector/jumper cables.

Modular desk-height outlet module mounts between frame studs at any height from 21" - 48", above or below adjacent worksurfaces. Each 12"W frame bay can accept two outlet housings (up to four duplex outlets on each side.)

Central switch controls three outlets inside wall frame for task or ambient lights. Switch occupies right-hand outlet opening in outlets cover on one side of wall.

Central switch includes white rocker switch, connector to adjacent outlet module, and three simplex outlets on circuit B (2+2 or 3+3).

Outlet modules and power rails accept two duplex outlets on each face. Specify outlets with black face for convenience circuits. Specify orange face or black with orange triangle for protected circuits with separate ground and neutral in building power supply.

| description | width | depth | height | pattern number | no finish | paint |
|----------------------------------|-------|-------|--------|--------------------|-----------|-------|
| High capacity cable holders (10) | 1" | 3/4" | 2 1/2" | AR1 HCC H10 | \$29. | |



| | | | | | | |
|----------------------------------|------|------|--------|--------------------|-----|--|
| Cable clips for wall studs (100) | 1/4" | 1/2" | 1 1/2" | AR1 PCC 100 | 71. | |
|----------------------------------|------|------|--------|--------------------|-----|--|



| | | | | |
|--|----|-----|---------------------|------|
| Ceiling infeed panel for stabilizer end cabinet or T-end with 3 1/2" extension | 5" | 48" | APX CIP4 () | 436. |
| | 5" | 72" | APX CIP6 () | 508. |
| | 5" | 96" | APX CIP8 () | 581. |

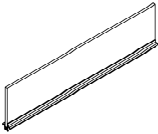
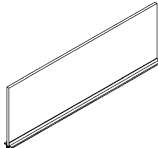
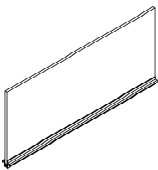

| Order Code | Specification Information | Application Notes |
|-----------------------------|---|--|
| Example: AR1 PCC 100 | Cable clips and cable managers are black plastic. | Specify cable clips, approximately 50 per wall frame to support and manage cables on the face of studs in the spine wall frame. Each clip manages up to 14 Category 5 or fiber optic cables; four clips attach between 21"-30", 30"-39", 39"-48"; six between 48"-64"H. Only two clips fit behind a cable tray cover at the 21"-30" height. |
| AR1 Raceway | Cable holders are light grey plastic. | |
| PCC Cable clip | <i>Please specify painted finish for ceiling infeed panel from paint finish options listed on page 7.</i> | |
| 100 Size/Quantity | | Specify high capacity cable holders approximately 20 per wall frame to support and manage larger bundles of cables. Each holds up to 55 Cat 5 cables; two holders attach to studs at each 9" level; three holders at the 16" level of a 64"H wall. Only one holder fits behind a cable tray cover at the 21"-30" height (upside down). |
| | | Raceway cable managers are U-shape cable supports that snap into the underside of the panel frame. Plan one per foot to contain data cables or power jumpers in the base raceway. |
| | | Ceiling infeed panel attaches to end of spine adjacent to stabilizer end cabinet or Currents, Morrison, or Ref T-end panel with 3 1/2" extension, or to power monument. Center channel, 2" x 2 1/2", accommodates one or two power infeed cables. Each side channel is 1 1/2" x 3 1/2" lay-in cable raceway, for continuous lay-in cabling from ceiling to wall surface. |
| | | Specify ceiling infeed separately. |

| description | type | width | depth | height | pattern number | clear tempered | powder |
|---------------|--|-------|-------|--------|----------------------------|----------------|--------|
| Add up panels | frameless glass, 8"h  | 24" | 1/2" | 8" | AUA1 0824 G () () | \$238. | \$290. |
| | | 36" | 1/2" | 8" | AUA1 0836 G () () | 270. | 388. |
| | | 48" | 1/2" | 8" | AUA1 0848 G () () | 350. | 485. |
| | | 60" | 1/2" | 8" | AUA1 0860 G () () | 430. | 624. |
| | | 72" | 1/2" | 8" | AUA1 0872 G () () | 485. | 754. |
| | frameless glass, 12"h  | 24" | 1/2" | 12" | AUA1 1224 G () () | 285. | 328. |
| | | 36" | 1/2" | 12" | AUA1 1236 G () () | 399. | 462. |
| | | 48" | 1/2" | 12" | AUA1 1248 G () () | 514. | 593. |
| | | 60" | 1/2" | 12" | AUA1 1260 G () () | 627. | 725. |
| | | 72" | 1/2" | 12" | AUA1 1272 G () () | 743. | 855. |
| | frameless glass, 15"h  | 24" | 1/2" | 15" | AUA1 1524 G () () | 290. | 510. |
| | | 36" | 1/2" | 15" | AUA1 1536 G () () | 404. | 565. |
| | | 48" | 1/2" | 15" | AUA1 1548 G () () | 517. | 813. |
| | | 60" | 1/2" | 15" | AUA1 1560 G () () | 635. | 916. |
| | | 72" | 1/2" | 15" | AUA1 1572 G () () | 748. | 1,072. |

| Order Code | Specification Information | Application Notes |
|-------------------------------------|---|--|
| Example: AUA1 1248 G TEMP AA | <i>Add up type:</i> | Add-up panels add acoustical privacy and light control above any height spine wall. |
| AUA1 Autostrada add up panel | G Glass | |
| 12 Height | Glass add-ups are available with the following glass options: | Anodized aluminum or painted base frame inserts in center of any spine crown and is secured by bolts within crown. |
| 48 Width | TEMP Clear tempered | |
| G Type | GL13 Powder | Frameless glass add-ups can be positioned at any 3" increment in standard or compact crown with any cover type. |
| TEMP Glass Finish | Specify wide add-up panels for use on long Service Wall and Fence runs. | |
| AA Trim Finish | | Any height add up can be used on any height AutoStrada spine or Currents service wall or fence. |

- 8"h Add ups are designed primarily for use on 39"h spine with 1"h crown to create a 48"h horizon.
- 12"h Add ups are designed for use on 48"h spine for a 61" horizon with 1"h crown or a 64" horizon with 4"h crown.
- 15"h Add ups are designed primarily for use on 48"h spine with 1"h crown for a 64" horizon.

Linkable screens and windows

Upholstered

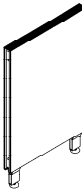
| description | type | height | depth | width | pattern number | 10 | 15 | 20 | 30 | 35 | 40 | 45 | 50 | 55 |
|---|------|--------|--------|------------------------------|------------------------------|--------|--------|--------|--------|--------|--------|--------|--------|--------|
|  | 30"H | 30" | 2 1/4" | 18" | AP1L 3018 N() () () | \$231. | \$262. | \$278. | \$324. | \$339. | \$363. | \$363. | \$406. | \$452. |
| | | 30" | 2 1/4" | 24" | AP1L 3024 N() () () | 267. | 302. | 321. | 374. | 390. | 419. | 464. | 489. | 516. |
| | | 30" | 2 1/4" | 30" | AP1L 3030 N() () () | 292. | 332. | 350. | 408. | 426. | 456. | 508. | 536. | 564. |
| | | 30" | 2 1/4" | 36" | AP1L 3036 N() () () | 334. | 378. | 397. | 461. | 481. | 515. | 571. | 603. | 635. |
| | | 30" | 2 1/4" | 42" | AP1L 3042 N() () () | 383. | 429. | 455. | 528. | 550. | 590. | 654. | 688. | 723. |
| | | 30" | 2 1/4" | 48" | AP1L 3048 N() () () | 421. | 474. | 498. | 578. | 602. | 646. | 714. | 752. | 793. |
| | | 30" | 2 1/4" | 60" | AP1L 3060 N() () () | 497. | 558. | 589. | 677. | 756. | 836. | n/a | n/a | n/a |
| | | 30" | 2 1/4" | 72" | AP1L 3072 N() () () | n/a | 696. | n/a | n/a | n/a | n/a | n/a | n/a | n/a |
| 39"H | 39" | 2 1/4" | 18" | AP1L 3918 N() () () | 279. | 310. | 325. | 373. | 388. | 410. | 454. | 475. | 498. | |
| | 39" | 2 1/4" | 24" | AP1L 3924 N() () () | 316. | 349. | 368. | 421. | 437. | 465. | 512. | 537. | 564. | |
| | 39" | 2 1/4" | 30" | AP1L 3930 N() () () | 340. | 380. | 397. | 456. | 475. | 503. | 554. | 584. | 612. | |
| | 39" | 2 1/4" | 36" | AP1L 3936 N() () () | 382. | 424. | 446. | 509. | 530. | 563. | 620. | 652. | 683. | |
| | 39" | 2 1/4" | 42" | AP1L 3942 N() () () | 429. | 478. | 502. | 573. | 598. | 636. | 702. | 735. | 770. | |
| | 39" | 2 1/4" | 48" | AP1L 3948 N() () () | 468. | 520. | 546. | 624. | 651. | 691. | 762. | 800. | 838. | |
| | 39" | 2 1/4" | 60" | AP1L 3960 N() () () | 545. | 604. | 635. | 724. | 755. | 804. | 885. | n/a | n/a | |
| | 39" | 2 1/4" | 72" | AP1L 3972 N() () () | n/a | 731. | n/a | n/a | n/a | n/a | n/a | n/a | n/a | |
| 48"H | 48" | 2 1/4" | 18" | AP1L 4818 N() () () | 327. | 363. | 381. | 434. | 454. | 482. | 532. | 558. | 587. | |
| | 48" | 2 1/4" | 24" | AP1L 4824 N() () () | 370. | 410. | 431. | 494. | 514. | 547. | 601. | 630. | 662. | |
| | 48" | 2 1/4" | 30" | AP1L 4830 N() () () | 402. | 447. | 469. | 536. | 559. | 595. | 654. | 685. | 720. | |
| | 48" | 2 1/4" | 36" | AP1L 4836 N() () () | 452. | 500. | 526. | 600. | 624. | 666. | 732. | 768. | 806. | |
| | 48" | 2 1/4" | 42" | AP1L 4842 N() () () | 506. | 562. | 591. | 675. | 705. | 748. | 824. | 864. | 907. | |
| | 48" | 2 1/4" | 48" | AP1L 4848 N() () () | 551. | 612. | 644. | 734. | 765. | 813. | 895. | 940. | 988. | |
| | 48" | 2 1/4" | 60" | AP1L 4860 N() () () | 641. | 713. | 748. | 857. | 891. | 947. | 1,043. | n/a | n/a | |
| | 48" | 2 1/4" | 72" | AP1L 4872 N() () () | n/a | 868. | n/a | n/a | n/a | n/a | n/a | n/a | n/a | |
| 64"H | 64" | 2 1/4" | 18" | AP1L 6418 A() () () | 425. | 473. | 496. | 565. | 591. | 626. | 690. | 724. | 762. | |
| | 64" | 2 1/4" | 24" | AP1L 6424 A() () () | 468. | 520. | 546. | 624. | 651. | 691. | 762. | 800. | 838. | |
| | 64" | 2 1/4" | 30" | AP1L 6430 A() () () | 526. | 585. | 613. | 703. | 731. | 775. | 857. | 896. | 941. | |
| | 64" | 2 1/4" | 36" | AP1L 6436 A() () () | 567. | 632. | 665. | 760. | 792. | 839. | 926. | 971. | 1,020. | |
| | 64" | 2 1/4" | 42" | AP1L 6442 A() () () | 626. | 696. | 732. | 836. | 872. | 928. | 1,020. | 1,073. | 1,124. | |
| | 64" | 2 1/4" | 48" | AP1L 6448 A() () () | 672. | 746. | 781. | 894. | 933. | 991. | 1,090. | 1,146. | 1,201. | |
| | 64" | 2 1/4" | 60" | AP1L 6460 A() () () | 762. | 844. | 887. | 1,014. | 1,056. | 1,122. | 1,235. | n/a | n/a | |

Spine and linkable screens

| Order Code | Specification Information | Application Notes |
|--|--|--|
| Example: AP1L 3948N 15 812 AA AP1 AutoStrada L Linkable screen 39 Height 48 Width N Core 15 Fabric Grade 812 Trim Color AA Leg Finish | Linkable screens include top cap and 4"H x 2 1/2"W extruded aluminum legs with levellers. Top cap is integral color trim grey or easy grey. Legs are available in clear anodized aluminum or painted finish options list on page 7 excluding silver. | Linkable screens divide workstations perpendicular to spine where base raceway is not required. Linkable screens connect to the wall with screen starters and to each other with screen connectors. Specify starters and connectors separately. Linkable screens with connectors can end support or cantilever worksurfaces, upmount or downmount overhead storage, with brackets designed for Morrison panel mounting. 30"H upholstered screens are primarily intended for use in combination with 18"H windows, connected to other 48"H screens with 48"H screen connectors. |

39"H screens align with the underside of either compact or standard crown on 39"H spines. 39"H screens enable seated visual access.

48"H screens align with the underside of either compact or standard crown on 48"H spines. 48"H screens provide some seated privacy.

64"H screens align with the underside of either compact or standard crown on 64"H spines. 64"H screens provide seated privacy, and include a high-acoustical core for improved sound absorption.

Linkable screens and windows

Glazed

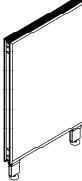
| description | type | width | depth | height | pattern number | clear tempered | architectural |
|---|------|-------|--------|--------|---------------------------|----------------|---------------|
|  | 39"H | 18" | 2 1/4" | 39" | AP1L 3918G () () | \$529. | \$650. |
| | | 24" | 2 1/4" | 39" | AP1L 3924G () () | 569. | 731. |
| | | 30" | 2 1/4" | 39" | AP1L 3930G () () | 635. | 838. |
| | | 36" | 2 1/4" | 39" | AP1L 3936G () () | 654. | 901. |
| | | 42" | 2 1/4" | 39" | AP1L 3942G () () | 704. | 994. |
| | | 48" | 2 1/4" | 39" | AP1L 3948G () () | 729. | 1,061. |
| | 48"H | 18" | 2 1/4" | 48" | AP1L 4818G () () | 573. | 726. |
| | | 24" | 2 1/4" | 48" | AP1L 4824G () () | 617. | 824. |
| | | 30" | 2 1/4" | 48" | AP1L 4830G () () | 677. | 939. |
| | | 36" | 2 1/4" | 48" | AP1L 4836G () () | 713. | 1,026. |
| | | 42" | 2 1/4" | 48" | AP1L 4842G () () | 766. | 1,136. |
| | | 48" | 2 1/4" | 48" | AP1L 4848G () () | 797. | 1,219. |
| | 64"H | 18" | 2 1/4" | 64" | AP1L 6418G () () | 659. | 869. |
| | | 24" | 2 1/4" | 64" | AP1L 6424G () () | 717. | 1,002. |
| | | 30" | 2 1/4" | 64" | AP1L 6430G () () | 785. | 1,141. |
| | | 36" | 2 1/4" | 64" | AP1L 6436G () () | 822. | 1,257. |
| | | 42" | 2 1/4" | 64" | AP1L 6442G () () | 891. | 1,400. |
| | | 48" | 2 1/4" | 64" | AP1L 6448G () () | 931. | 1,511. |

Order Code

Example: **AP1L 3948G GL6 AA 812 AA**

| | |
|------------|-----------------|
| AP1 | AutoStrada |
| L | Linkable screen |
| 39 | Height |
| 48 | Width |
| G | Glazed |
| GL6 | Glass Type |
| AA | Frame Finish |
| 812 | Trim Color |
| AA | Leg Finish |

Specification Information

Glazed linkable screens include top cap and two 4"H x 2 1/2"W extruded aluminum legs with levellers. Top cap is integral color trim grey or easy grey. Window frame is anodized aluminum or painted extrusions.

Frame and legs are available in clear anodized aluminum or painted finish options listed on page 7 excluding silver.

Glass is tempered clear. Architectural glass is available in powder or block matrix finishes.

TEMP Clear Tempered
GL6 Block Matrix
GLI3 Powder

Application Notes

Linkable screens divide workstations perpendicular to spine where base raceway is not required. Linkable screens connect to the wall with screen starters and to each other with screen connectors. Specify starters and connectors separately.

Glazed linkable screens feature nearly flush glazing on one surface and a perimeter frame of anodized or painted aluminum. Glazed linkable screens with connectors can end support or cantilever worksurfaces with brackets designed for Morrison panel mounting.

39"H screens align with the underside of either compact or standard crown on 39"H spines. 39"H screens enable seated visual access.

48"H screens align with the underside of either compact or standard crown on 48"H spines. 48"H screens provide some seated privacy.

64"H screens align with the underside of either compact or standard crown on 64"H spines.

Linkable screens and windows

Windows for linkable screens

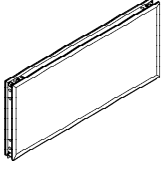
| description | type | width | height | pattern number | clear tempered | architectural |
|---|------|-------|---------------------------|---------------------------|----------------|---------------|
| Window  | 16"H | 24" | 16" | AP1W 1624G () () | \$430. | \$448. |
| | | 30" | 16" | AP1W 1630G () () | 475. | 493. |
| | | 36" | 16" | AP1W 1636G () () | 532. | 552. |
| | | 42" | 16" | AP1W 1642G () () | 572. | 597. |
| | | 48" | 16" | AP1W 1648G () () | 635. | 660. |
| | | 60" | 16" | AP1W 1660G () () | 702. | 730. |
| | | 72" | 16" | AP1W 1672G () () | 802. | 833. |
| | 18"H | 24" | 18" | AP1W 1824G () () | 447. | 464. |
| | | 30" | 18" | AP1W 1830G () () | 492. | 512. |
| | | 36" | 18" | AP1W 1836G () () | 551. | 572. |
| | | 42" | 18" | AP1W 1842G () () | 596. | 619. |
| | | 48" | 18" | AP1W 1848G () () | 657. | 683. |
| | | 60" | 18" | AP1W 1860G () () | 762. | 793. |
| | | 72" | 18" | AP1W 1872G () () | 934. | 971. |
| | 22"H | 24" | 22" | AP1W 2224G () () | 462. | 480. |
| | | 30" | 22" | AP1W 2230G () () | 509. | 529. |
| | | 36" | 22" | AP1W 2236G () () | 570. | 595. |
| | | 42" | 22" | AP1W 2242G () () | 616. | 640. |
| | | 48" | 22" | AP1W 2248G () () | 678. | 706. |
| | | 60" | 22" | AP1W 2260G () () | 787. | 818. |
| | | 72" | 22" | AP1W 2272G () () | 972. | 1,011. |
| 25"H | 24" | 25" | AP1W 2524G () () | 478. | 496. | |
| | 30" | 25" | AP1W 2530G () () | 526. | 546. | |
| | 36" | 25" | AP1W 2536G () () | 591. | 615. | |
| | 42" | 25" | AP1W 2542G () () | 637. | 662. | |
| | 48" | 25" | AP1W 2548G () () | 701. | 729. | |
| | 60" | 25" | AP1W 2560G () () | 811. | 842. | |
| | 72" | 25" | AP1W 2572G () () | 1,011. | 1,052. | |

Spine and linkable screens

| Order Code | Specification Information | Application Notes |
|--|---|--|
| Example: AP1W 1624G GL6 AA AP1 AutoStrada linkable screen W Window 16 Height 24 Width G Surface Type GL6 Glass Finish AA Frame Finish | Window frame is anodized aluminum or painted extrusions. Painted finish option listed on page 7 excluding silver. Glass is tempered clear. Architectural glass is available in powder or block matrix finishes. TEMP Clear Tempered GL6 Block Matrix GL13 Powder | Windows add on to linkable screens to build partially glazed screens. Linkable screens with windows connect to the wall with screen starters and to each other with screen connectors. Specify starters and connectors in the same height as the combination of screen and window. Windows feature nearly flush glazing on one surface and a perimeter frame of anodized or painted aluminum. |

Specify 16"H windows on 48"H linkable screens and connect with 64"H connectors.

Specify 18"H windows on 30"H linkable screens and connect with 48"H connectors.

Specify 25"H windows on 39"H linkable screens and connect with 64"H connectors.

Linkable screens and windows

Connectors and trim

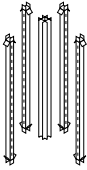
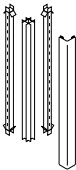
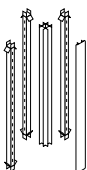
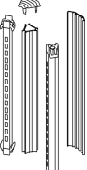
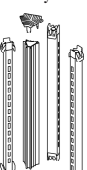
| description | type | height | depth | width | pattern number | no finish | integral color | list |
|----------------|--|--------|--------|--------|---------------------|-----------|----------------|------|
| 90° connector | 4-way X  | 39" | 2 1/4" | 2 1/4" | AC1 39X4 () | \$218. | | |
| | | 48" | 2 1/4" | 2 1/4" | AC1 48X4 () | 243. | | |
| | | 64" | 2 1/4" | 2 1/4" | AC1 64X4 () | 271. | | |
| | 2-way L  | 39" | 2" | | AC1 39L2 () | | | 146. |
| | | 48" | 2" | | AC1 48L2 () | | | 154. |
| | | 64" | 2" | | AC1 64L2 () | | | 166. |
| | 3-way T  | 39" | 2" | | AC1 39T3 () | | | 186. |
| | | 48" | 2" | | AC1 48T3 () | | | 196. |
| | | 64" | 2" | | AC1 64T3 () | | | 211. |
| 120° connector | 2-way V  | 39" | | | AC1 39V2 () | | | 163. |
| | | 48" | | | AC1 48V2 () | | | 170. |
| | | 64" | | | AC1 64V2 () | | | 185. |
| | 3-way Y  | 39" | | | AC1 39Y3 () | | | 199. |

Order Code

| |
|--------------------------------------|
| Example: AC1 39L2 812 |
| AC1 Linkable screen connector |
| 39 Height |
| L2 90° 2-way L |
| 812 Finish |

Specification Information

All top and vertical trim is easy grey (812) or trim grey (813) integral color surface.

Connector post is painted black extrusion.

Carpet grips are black integral color surface.

Linkable screen feet are anodized aluminum or painted finish option listed on page 7 excluding silver.

Application Notes

Connectors join linkable screens in straight, 90° or 120° post configurations.

Linkable screen connectors include connector tracks, universal posts and top and vertical trim (where required).

Connector tracks have cantilever slots for worksurface and storage support.

L, T and X connectors include a universal post and 2, 3 or 4 connector tracks and top cap.





End trim may be specified instead of an end connector if cantilever capability is not required.

Carpet grips snap into linkable screen glides to prevent components from sliding. Glide rotates in carpet grip to permit levelling.

Non-skid grips snap into glides to prevent sliding on hard surface floors.

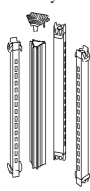
Linkable screens and windows

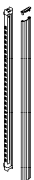
Connectors and trim

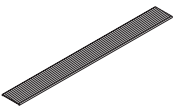
| description | type | height | depth | width | pattern number | no finish | integral color | list |
|--|--|--------|-------|--------------------|----------------------|-----------|----------------|--------|
| 120° connector | 3-way Y  | 48" | | | AC1 48Y3 () | | | \$207. |
| | | 64" | | | AC1 64Y3 () | | | 221. |
| Connector track  | No trim | 39" | – | – | MC1-39S1 | 44. | | |
| | | 48" | – | – | MC1-48S1 | 49. | | |
| | | 64" | – | – | MC1-64S1 | 53. | | |
| End connector  | with connector track | 30" | | | ACA1 30E1 () | | 62. | |
| | | 39" | | | ACA1 39E1 () | | 65. | |
| | | 48" | | | ACA1 48E1 () | | 77. | |
| | | 64" | | | ACA1 64E1 () | | 89. | |
| linkable screen end trim (no connector)  | | 30" | | | AA1 30E () | | | 39. |
| | | 39" | | | AA1 39E () | | | 41. |
| | | 48" | | | AA1 48E () | | | 43. |
| | | 64" | | | AA1 64E () | | | 44. |
| top trim, linkable screen (replacement)  | | | | 6" | AA1 T06 () | | | 9. |
| | | | | 18" | AA1 T18 () | | | 12. |
| | | | | 24" | AA1 T24 () | | | 14. |
| | | | | 30" | AA1 T30 () | | | 21. |
| | | | | 36" | AA1 T36 () | | | 23. |
| | | | | 42" | AA1 T42 () | | | 24. |
| | | | | 48" | AA1 T48 () | | | 26. |
| | | | 60" | AA1 T60 () | | | 29. | |

Order Code

| |
|--------------------------------------|
| Example: AC1 39L2 812 |
| AC1 Linkable screen connector |
| 39 Height |
| L2 90° 2-way L |
| 812 Finish |

Specification Information

All top and vertical trim is easy grey (812) or trim grey (813) integral color surface.

Connector post is painted black extrusion.

Carpet grips are black integral color surface.

Linkable screen feet are anodized aluminum or painted finish option listed on page 7 excluding silver.

Application Notes

Connectors join linkable screens in straight, 90° or 120° post configurations.

Linkable screen connectors include connector tracks, universal posts and top and vertical trim (where required).

Connector tracks have cantilever slots for worksurface and storage support.

L, T and X connectors include a universal post and 2, 3 or 4 connector tracks and top cap.



End trim may be specified instead of an end connector if cantilever capability is not required.

Carpet grips snap into linkable screen glides to prevent components from sliding. Glide rotates in carpet grip to permit levelling.

Non-skid grips snap into glides to prevent sliding on hard surface floors.

Linkable screens and windows

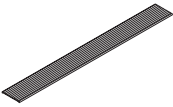
Connectors and trim

| description | type | height | depth | width | pattern number | no finish | integral color | list |
|---|------------------|--------|-------|-------|--------------------|-----------|----------------|-------|
| top trim, linkable screen (replacement) | | | | 72" | AA1 T72 () | | | \$32. |
|  | | | | | | | | |
| linkable screen feet, pair | replacement part | | | | APA1 LF () | | | 64. |
|  | | | | | | | | |
| Raceway cover for Currents end connector or end trim on Morrison panel | | | | | AA1RE() | | | 28. |
| Non-skid pads (set of 10) | | | | | AA1NSK | | | 32. |
| Carpet grips (set of 10) | | | | | MM2-CG | | | 19. |

| Order Code | Specification Information | Application Notes |
|--------------------------------------|--|---|
| Example: AC1 39L2 812 | | |
| AC1 Linkable screen connector | All top and vertical trim is easy grey (812) or trim grey (813) integral color surface. | Connectors join linkable screens in straight, 90° or 120° post configurations. |
| 39 Height | Connector post is painted black extrusion. | Linkable screen connectors include connector tracks, universal posts and top and vertical trim (where required). |
| L2 90° 2-way L | Carpet grips are black integral color surface. | Connector tracks have cantilever slots for worksurface and storage support. |
| 812 Finish | Linkable screen feet are anodized aluminum or painted finish option listed on page 7 excluding silver. | L, T and X connectors include a universal post and 2, 3 or 4 connector tracks and top cap. |
| | | End trim may be specified instead of an end connector if cantilever capability is not required. |
| | | Carpet grips snap into linkable screen glides to prevent components from sliding. Glide rotates in carpet grip to permit levelling. |
| | | Non-skid grips snap into glides to prevent sliding on hard surface floors. |

| description | application | h | w | d | pattern no. | L | V1 | V2 | V3 |
|-----------------|-------------|-----|-----|----|-------------------------|--------|--------|--------|--------|
| Gallery screens | 39" high | 39" | 20" | 1" | AG1B3920 () () | \$301. | \$378. | \$485. | \$818. |
| | 39" high | 39" | 24" | 1" | AG1B3924 () () | 339. | 411. | 541. | 947. |
| | 39" high | 39" | 30" | 1" | AG1B3930 () () | 378. | 446. | 597. | 1,092. |
| | 39" high | 39" | 36" | 1" | AG1B3936 () () | 415. | 480. | 653. | 1,239. |
| | 39" high | 39" | 42" | 1" | AG1B3942 () () | 453. | 515. | 708. | 1,384. |
| | 39" high | 39" | 48" | 1" | AG1B3948 () () | 490. | 549. | 764. | 1,530. |
| | 39" high | 39" | 54" | 1" | AG1B3954 () () | 528. | 584. | 821. | 1,675. |
| | 39" high | 39" | 60" | 1" | AG1B3960 () () | 565. | 618. | 876. | 1,820. |
| | 39" high | 39" | 66" | 1" | AG1B3966 () () | 603. | 653. | 933. | 1,965. |
| | 39" high | 39" | 72" | 1" | AG1B3972 () () | 640. | 687. | 989. | 2,111. |
| | 39" high | 39" | 78" | 1" | AG1B3978 () () | 678. | 722. | 1,044. | 2,256. |
| | 39" high | 39" | 84" | 1" | AG1B3984 () () | 717. | 756. | 1,101. | 2,401. |
| | 39" high | 39" | 90" | 1" | AG1B3990 () () | 754. | 791. | 1,156. | 2,547. |
| | 39" high | 39" | 96" | 1" | AG1B3996 () () | 792. | 825. | 1,213. | 2,692. |
| | 49" high | 49" | 20" | 1" | AG1B4920 () () | 393. | 458. | 598. | 1,007. |
| | 49" high | 49" | 24" | 1" | AG1B4924 () () | 430. | 492. | 662. | 1,137. |
| | 49" high | 49" | 30" | 1" | AG1B4930 () () | 468. | 527. | 727. | 1,314. |
| | 49" high | 49" | 36" | 1" | AG1B4936 () () | 506. | 561. | 792. | 1,492. |
| | 49" high | 49" | 42" | 1" | AG1B4942 () () | 544. | 596. | 857. | 1,670. |
| | 49" high | 49" | 48" | 1" | AG1B4948 () () | 582. | 630. | 921. | 1,846. |
| | 49" high | 49" | 54" | 1" | AG1B4954 () () | 619. | 665. | 985. | 2,024. |
| | 49" high | 49" | 60" | 1" | AG1B4960 () () | 657. | 698. | 1,050. | 2,202. |
| | 49" high | 49" | 66" | 1" | AG1B4966 () () | 694. | 733. | 1,114. | 2,379. |
| | 49" high | 49" | 72" | 1" | AG1B4972 () () | 732. | 767. | 1,179. | 2,557. |
| | 49" high | 49" | 78" | 1" | AG1B4978 () () | 769. | 802. | 1,244. | 2,734. |
| | 49" high | 49" | 84" | 1" | AG1B4984 () () | 808. | 836. | 1,308. | 2,913. |
| | 49" high | 49" | 90" | 1" | AG1B4990 () () | 845. | 871. | 1,372. | 3,091. |
| | 49" high | 49" | 96" | 1" | AG1B4996 () () | 883. | 905. | 1,437. | 3,268. |

Spine and linkable screens

| Order Code | Specification Information | Application Notes |
|-----------------------------------|--|--|
| Example: AG1 B 4948L N 115 | For Gallery screens specify: | Gallery screens attach to AutoStrada or Currents spine and adjacent worksurfaces to define workspaces. Gallery screens are 1" thick, solid wood core, self-edged in laminate, Techwood or natural veneer. 39"H screens correspond in height to 39"H spine (underside of any crown). 49"H screens correspond in height to 49"H Anchor cabinet and to 48"H spine with compact or flat crown. |
| AG1 Gallery screen | 1.Planning application, L=Screen at left end of spine (from inside face of screen) R=Screen at right end of spine S=Intermediate screen attached to face of spine | Other end of 39"H screen is always "N", no attachment. Other end of 49"H screen can have provisions for attachment to 49"H Anchor cabinet or no attachment. |
| B Back screen | 2.Then specify other end application: A=Attach to anchor cabinet (49"H screen only) N=No attachment | Gallery screens must be stabilized by screen-to-worksurface bracket or attachment to Anchor cabinet. |
| 49 Height | 3.Then specify finish, all standard laminates for vertical applications, all standard Techwoods and natural veneers. | |
| 48 Width | Gallery screens include black leveling glides with 1" range. Starting point for screens is 1/2" above floor. | |
| L End starter | | |
| N No attachment | | |
| 115 Finish | | |

Tiled/Monolithic - mono side only with base raceway
Tiled one side - Laminate/Monolithic side - fabric

| description | h | w | pattern no. | Grade | | | | | | |
|---|-----|-----|--|--|--------|--------|--------|--------|--------|--------|
| | | | | 10 | 15 | 20 | 30 | 35 | 40 | 45 |
| Tiled laminate one side, fabric monolithic other side (tiled side without base raceway) | 34" | 18" | R3R1AFL3418 () () () () () () () | \$646. | \$658. | \$689. | \$729. | \$757. | \$806. | \$830. |
| | | 24" | R3R1AFL3424 () () () () () () () | 689. | 701. | 734. | 772. | 802. | 851. | 877. |
| | | 30" | R3R1AFL3430 () () () () () () () | 739. | 752. | 785. | 822. | 852. | 900. | 927. |
| | | 36" | R3R1AFL3436 () () () () () () () | 787. | 798. | 830. | 869. | 897. | 947. | 971. |
| | | 42" | R3R1AFL3442 () () () () () () () | 903. | 917. | 948. | 987. | 1,016. | 1,064. | 1,090. |
| | | 48" | R3R1AFL3448 () () () () () () () | 935. | 948. | 980. | 1,019. | 1,047. | 1,096. | 1,121. |
| | | 42" | 18" | R3R1AFL4218 () () () () () () () | 716. | 736. | 777. | 830. | 865. | 924. |
| | | 24" | R3R1AFL4224 () () () () () () () | 766. | 787. | 828. | 881. | 916. | 973. | 1,011. |
| | | 30" | R3R1AFL4230 () () () () () () () | 821. | 842. | 883. | 936. | 970. | 1,029. | 1,066. |
| | | 36" | R3R1AFL4236 () () () () () () () | 875. | 895. | 936. | 989. | 1,024. | 1,082. | 1,119. |
| | | 42" | R3R1AFL4242 () () () () () () () | 983. | 1,003. | 1,044. | 1,097. | 1,132. | 1,191. | 1,227. |
| | | 48" | R3R1AFL4248 () () () () () () () | 1,038. | 1,060. | 1,099. | 1,152. | 1,188. | 1,245. | 1,283. |
| | 49" | 18" | R3R1AFL4918 () () () () () () () | 797. | 816. | 865. | 922. | 965. | 1,038. | 1,075. |
| | | 24" | R3R1AFL4924 () () () () () () () | 852. | 870. | 919. | 977. | 1,020. | 1,092. | 1,131. |
| | | 30" | R3R1AFL4930 () () () () () () () | 918. | 936. | 985. | 1,043. | 1,085. | 1,159. | 1,196. |
| | | 36" | R3R1AFL4936 () () () () () () () | 971. | 992. | 1,041. | 1,098. | 1,142. | 1,212. | 1,250. |
| | | 42" | R3R1AFL4942 () () () () () () () | 1,095. | 1,114. | 1,163. | 1,221. | 1,264. | 1,336. | 1,375. |
| | | 48" | R3R1AFL4948 () () () () () () () | 1,155. | 1,174. | 1,224. | 1,282. | 1,325. | 1,398. | 1,435. |
| | 64" | 18" | R3R1AFL6418 () () () () () () () | 911. | 938. | 1,003. | 1,080. | 1,140. | 1,233. | 1,284. |
| | | 24" | R3R1AFL6424 () () () () () () () | 973. | 1,001. | 1,064. | 1,142. | 1,199. | 1,294. | 1,347. |
| | | 30" | R3R1AFL6430 () () () () () () () | 1,048. | 1,075. | 1,141. | 1,217. | 1,273. | 1,370. | 1,421. |
| | | 36" | R3R1AFL6436 () () () () () () () | 1,112. | 1,141. | 1,203. | 1,281. | 1,338. | 1,434. | 1,485. |
| | | 42" | R3R1AFL6442 () () () () () () () | 1,268. | 1,293. | 1,359. | 1,434. | 1,492. | 1,587. | 1,640. |
| | | 48" | R3R1AFL6448 () () () () () () () | 1,332. | 1,359. | 1,421. | 1,499. | 1,558. | 1,652. | 1,703. |

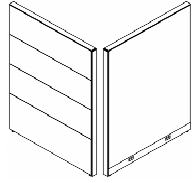

both sides 64x48 shown, 49" h with three tiles; 34" h with two tiles; 42" h 3 tiles/ top tile 7" h

| Order Code | Specification Information | Application Notes |
|--|--|--|
| Example: R3R1AFL3418EAA4K613W359-118N | To order please specify pattern number including: | Monolithic side with base raceway only. Tiled side inserts extended to the floor. Be sure to specify power rails for panels with one sided base raceways. |
| R3 AutoStrada w/generation 3 frame | 1. Height | |
| R1 Base raceway monolithic side only | 2. Width | |
| A Tiled one side, Monolithic other | 3. Extruded Aluminum Top Trim <i>E - default</i> | Tiled side includes panel reveals between laminate inserts. Aluminum vertical hookstrip cover ordered separately. |
| F Fabric, monolithic side | 4. Finish, Aluminum trim (top trim and tile dividers/reveals) <i>Anodized aluminum or painted finish options listed on page 9 excluding silver.</i> | Panels are not for use with medians, storage medians or bridges. |
| L Laminate, tiled side | 5. Base raceway height <i>4 = 4" h, default</i> | Black PVC hookstrip reveals should be ordered for monolithic side from Reff price list. |
| 34 34" high | 6. Knock-out option <i>K = with knock-outs</i> <i>N = no knock-outs</i> | Panels on this page will accept standard Reff System stacking window modules. |
| 18 18" wide | 7. Base raceway finish <i>painted or plated finish options only</i> | Product on this page will accept wood grain laminate where laminate is currently an option. Panel product is subject to 10% on the base panel price. Refer to panel product upcharge table. |
| E Extruded Aluminum top trim | 8. Fabric selection | |
| AA Top Trim anodized aluminum finish | 9. Finish, Laminate | |
| 4 4" high base raceway | 10. Milled for ported components <i>M = milled for (\$14 list upcharge applicable)</i> <i>N = not milled for</i> | |
| K Knock-outs in base raceway | See page 7 for finish options applicable. | |
| 613 Finish, base raceway | | |
| W359- Finish, fabric | | |
| 118 Finish, Bright White | | |
| N Not milled for ported components | | |

Tiled/Monolithic - mono side only with base raceway
 Tiled one side - V1 Techwood/Monolithic - fabric

| description | h | w | pattern no. | Grade | | | | | | |
|---|-----|-------------------------------------|-------------------------------------|--------|--------|--------|--------|--------|--------|--------|
| | | | | 10 | 15 | 20 | 30 | 35 | 40 | 45 |
| Tiled V1 techwood one side, fabric monolithic other side (tiled side without base raceway) | 34" | 18" | R3R1AF13418 () () () () () () | \$658. | \$670. | \$701. | \$741. | \$769. | \$817. | \$844. |
| | | 24" | R3R1AF13424 () () () () () () | 705. | 718. | 751. | 789. | 817. | 867. | 892. |
| | | 30" | R3R1AF13430 () () () () () () | 755. | 768. | 800. | 838. | 868. | 917. | 942. |
| | | 36" | R3R1AF13436 () () () () () () | 800. | 814. | 845. | 884. | 911. | 961. | 987. |
| | | 42" | R3R1AF13442 () () () () () () | 926. | 936. | 968. | 1,008. | 1,035. | 1,085. | 1,110. |
| | | 48" | R3R1AF13448 () () () () () () | 954. | 967. | 1,001. | 1,038. | 1,068. | 1,115. | 1,142. |
| | 42" | 18" | R3R1AF14218 () () () () () () | 729. | 749. | 791. | 843. | 878. | 936. | 973. |
| | | 24" | R3R1AF14224 () () () () () () | 782. | 802. | 843. | 896. | 931. | 989. | 1,026. |
| | | 30" | R3R1AF14230 () () () () () () | 840. | 861. | 901. | 954. | 989. | 1,046. | 1,084. |
| | | 36" | R3R1AF14236 () () () () () () | 892. | 912. | 952. | 1,005. | 1,041. | 1,098. | 1,136. |
| 42" | | R3R1AF14242 () () () () () () | 1,005. | 1,026. | 1,067. | 1,120. | 1,155. | 1,213. | 1,250. | |
| 48" | | R3R1AF14248 () () () () () () | 1,055. | 1,076. | 1,117. | 1,169. | 1,204. | 1,263. | 1,299. | |
| 49" | 18" | R3R1AF14918 () () () () () () | 811. | 830. | 879. | 936. | 980. | 1,052. | 1,091. | |
| | 24" | R3R1AF14924 () () () () () () | 868. | 887. | 934. | 993. | 1,034. | 1,109. | 1,147. | |
| | 30" | R3R1AF14930 () () () () () () | 933. | 952. | 1,002. | 1,060. | 1,102. | 1,173. | 1,212. | |
| | 36" | R3R1AF14936 () () () () () () | 992. | 1,010. | 1,060. | 1,115. | 1,160. | 1,231. | 1,270. | |
| | 42" | R3R1AF14942 () () () () () () | 1,120. | 1,141. | 1,187. | 1,244. | 1,288. | 1,361. | 1,400. | |
| | 48" | R3R1AF14948 () () () () () () | 1,181. | 1,200. | 1,248. | 1,306. | 1,349. | 1,421. | 1,461. | |
| 64" | 18" | R3R1AF16418 () () () () () () | 932. | 958. | 1,021. | 1,099. | 1,158. | 1,253. | 1,304. | |
| | 24" | R3R1AF16424 () () () () () () | 995. | 1,020. | 1,084. | 1,161. | 1,220. | 1,317. | 1,367. | |
| | 30" | R3R1AF16430 () () () () () () | 1,070. | 1,096. | 1,160. | 1,237. | 1,294. | 1,392. | 1,443. | |
| | 36" | R3R1AF16436 () () () () () () | 1,133. | 1,160. | 1,224. | 1,301. | 1,360. | 1,457. | 1,508. | |
| | 42" | R3R1AF16442 () () () () () () | 1,292. | 1,318. | 1,381. | 1,460. | 1,517. | 1,613. | 1,664. | |
| | 48" | R3R1AF16448 () () () () () () | 1,360. | 1,384. | 1,448. | 1,526. | 1,583. | 1,681. | 1,733. | |

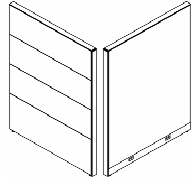

both sides 64x48 shown, 49" h with three tiles; 34" h with two tiles; 42" h 3 tiles/ top tile 7" h

Panels

| Order Code | Specification Information | Application Notes |
|--|--|---|
| Example: R3R1AF13418EAA4K 613W359-Y319N | To order please specify pattern number including: | Monolithic side with base raceway only. Tiled side inserts extended to the floor. Be sure to specify power rails for panels with one sided base raceways. |
| R3 AutoStrada w/generation 3 frame | 1. Height | |
| R1 Base raceway monolithic side only | 2. Width | |
| A Tiled one side, Monolithic other | 3. Extruded Aluminum Top Trim <i>E - default</i> | Tiled side includes panel reveals between V1 inserts. Aluminum vertical hookstrip cover ordered separately. |
| F Fabric, monolithic side | 4. Finish, Aluminum trim (top trim and tile dividers/reveals) <i>Anodized aluminum or painted finish options listed on page 9 excluding silver.</i> | Panels are not for use with medians, storage medians or bridges. |
| 1 V1 Techwood, tiled side | 5. Base raceway height <i>4 = 4" h, default</i> | Black PVC hookstrip reveals should be ordered for monolithic side from Reff price list. |
| 34 34" high | 6. Knock-out option <i>K = with knock-outs</i> <i>N = no knock-outs</i> | Panels on this page will accept standard Reff System stacking window modules. |
| 18 18" wide | 7. Base raceway finish <i>painted or plated finish options only</i> | |
| E Extruded Aluminum top trim | 8. Fabric selection | |
| AA Top Trim anodized aluminum finish | 9. Finish, V1 Techwood | |
| 4 4" high base raceway | 10. Milled for ported componenets <i>M = milled for (\$14 list upcharge applicable)</i> <i>N = not milled for</i> | |
| K Knock-outs in base raceway | | |
| 613 Finish, base raceway | | |
| W359- Finish, fabric | | |
| Y319 Finish, Cherry | | |
| N Not milled for ported components | See page 7 for finish options applicable. | |

Tiled/Monolithic - mono side only with base raceway
Tiled one side - V2 Natural/Monolithic - fabric

| description | h | w | pattern no. | Grade | | | | | | | |
|---|-----|-----|------------------------------------|------------------------------------|--------|--------|--------|--------|--------|--------|--------|
| | | | | 10 | 15 | 20 | 30 | 35 | 40 | 45 | |
| Tiled V2 natural one side, fabric monolithic other side (tiled side without base raceway) | 34" | 18" | R3R1AF23418 (X)(X)(X)(X)(X) | \$671. | \$686. | \$717. | \$755. | \$785. | \$831. | \$858. | |
| | | 24" | R3R1AF23424 (X)(X)(X)(X)(X) | 719. | 733. | 766. | 804. | 831. | 881. | 907. | |
| | | 30" | R3R1AF23430 (X)(X)(X)(X)(X) | 769. | 783. | 815. | 854. | 882. | 931. | 955. | |
| | | 36" | R3R1AF23436 (X)(X)(X)(X)(X) | 816. | 829. | 863. | 900. | 929. | 977. | 1,003. | |
| | | 42" | R3R1AF23442 (X)(X)(X)(X)(X) | 941. | 952. | 986. | 1,022. | 1,052. | 1,101. | 1,128. | |
| | | 48" | R3R1AF23448 (X)(X)(X)(X)(X) | 974. | 987. | 1,019. | 1,058. | 1,086. | 1,134. | 1,160. | |
| | | 42" | 18" | R3R1AF24218 (X)(X)(X)(X)(X) | 744. | 764. | 804. | 858. | 893. | 950. | 988. |
| | | | 24" | R3R1AF24224 (X)(X)(X)(X)(X) | 798. | 818. | 860. | 912. | 947. | 1,004. | 1,042. |
| | | | 30" | R3R1AF24230 (X)(X)(X)(X)(X) | 855. | 876. | 917. | 969. | 1,004. | 1,063. | 1,099. |
| | | | 36" | R3R1AF24236 (X)(X)(X)(X)(X) | 912. | 933. | 973. | 1,026. | 1,062. | 1,119. | 1,157. |
| | | 42" | R3R1AF24242 (X)(X)(X)(X)(X) | 1,024. | 1,044. | 1,085. | 1,138. | 1,173. | 1,231. | 1,268. | |
| | | 48" | R3R1AF24248 (X)(X)(X)(X)(X) | 1,078. | 1,098. | 1,140. | 1,193. | 1,227. | 1,285. | 1,322. | |
| | 49" | 18" | R3R1AF24918 (X)(X)(X)(X)(X) | 829. | 849. | 896. | 953. | 997. | 1,070. | 1,109. | |
| | | 24" | R3R1AF24924 (X)(X)(X)(X)(X) | 884. | 904. | 952. | 1,010. | 1,054. | 1,126. | 1,165. | |
| | | 30" | R3R1AF24930 (X)(X)(X)(X)(X) | 954. | 974. | 1,022. | 1,082. | 1,125. | 1,196. | 1,234. | |
| | | 36" | R3R1AF24936 (X)(X)(X)(X)(X) | 1,012. | 1,031. | 1,080. | 1,140. | 1,181. | 1,253. | 1,292. | |
| | | 42" | R3R1AF24942 (X)(X)(X)(X)(X) | 1,141. | 1,159. | 1,207. | 1,264. | 1,308. | 1,380. | 1,419. | |
| | | 48" | R3R1AF24948 (X)(X)(X)(X)(X) | 1,203. | 1,223. | 1,270. | 1,330. | 1,371. | 1,444. | 1,483. | |
| | 64" | 18" | R3R1AF26418 (X)(X)(X)(X)(X) | 951. | 977. | 1,042. | 1,119. | 1,178. | 1,271. | 1,324. | |
| | | 24" | R3R1AF26424 (X)(X)(X)(X)(X) | 1,014. | 1,041. | 1,103. | 1,181. | 1,240. | 1,334. | 1,386. | |
| | | 30" | R3R1AF26430 (X)(X)(X)(X)(X) | 1,090. | 1,115. | 1,180. | 1,258. | 1,312. | 1,410. | 1,462. | |
| | | 36" | R3R1AF26436 (X)(X)(X)(X)(X) | 1,159. | 1,183. | 1,248. | 1,325. | 1,382. | 1,481. | 1,531. | |
| | | 42" | R3R1AF26442 (X)(X)(X)(X)(X) | 1,320. | 1,345. | 1,409. | 1,485. | 1,544. | 1,640. | 1,693. | |
| | | 48" | R3R1AF26448 (X)(X)(X)(X)(X) | 1,384. | 1,410. | 1,475. | 1,551. | 1,610. | 1,706. | 1,759. | |

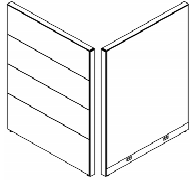

both sides 64x48 shown, 49" h with three tiles; 34" h with two tiles; 42" h 3 tiles/ top tile 7" h

| Order Code | Specification Information | Application Notes |
|---|--|---|
| Example: R3R1AF23418EAA4K613W359-V316N | To order please specify pattern number including: | Monolithic side with base raceway only. Tiled side inserts extended to the floor. Be sure to specify power rails for panels with one sided base raceways. |
| R3 AutoStrada w/generation 3 frame | 1. Height | |
| R1 Base raceway monolithic side only | 2. Width | |
| A Tiled one side, Monolithic other | 3. Extruded Aluminum Top Trim <i>E - default</i> | Tiled side includes panel reveals between V2 inserts. Aluminum vertical hookstrip cover ordered separately. |
| F Fabric, monolithic side | 4. Finish, Aluminum trim (top trim and tile dividers/reveals) <i>Anodized aluminum or painted finish options listed on page 9 excluding silver.</i> | Panels are not for use with medians, storage medians or bridges. |
| 2 V2 Natural, tiled side | 5. Base raceway height <i>4 = 4" h, default</i> | Black PVC hookstrip reveals should be ordered for monolithic side from Reff price list. |
| 34 34" high | 6. Knock-out option <i>K = with knock-outs</i> <i>N = no knock-outs</i> | Panels on this page will accept standard Reff System stacking window modules. |
| 18 18" wide | 7. Base raceway finish <i>painted or plated finish options only</i> | |
| E Extruded Aluminum top trim | 8. Fabric selection | |
| AA Top Trim anodized aluminum finish | 9. Finish, V2 Natural | |
| 4 4" high base raceway | 10. Milled for ported components <i>M = milled for (\$14 list upcharge applicable)</i> <i>N = not milled for</i> | |
| K Knock-outs in base raceway | | |
| 613 Finish, base raceway | | |
| W359- Finish, fabric | | |
| V316 Finish, Maple | | |
| N Not milled for ported components | See page 7 for finish options applicable. | |

Tiled/Monolithic - mono side only with base raceway
Tiled one side - V3 Exotic/Monolithic - fabric

| description | h | w | pattern no. | Grade | | | | | | | |
|--|-----|-----|--|--|--------|--------|----------|----------|----------|----------|--------|
| | | | | 10 | 15 | 20 | 30 | 35 | 40 | 45 | |
| Tiled V3 exotic one side, fabric monolithic other side (tiled side without base raceway) | 34" | 18" | R3R1AF33418 () () () () () () | \$893. | \$909. | \$951. | \$1,003. | \$1,041. | \$1,102. | \$1,134. | |
| | | 24" | R3R1AF33424 () () () () () () | 954. | 971. | 1,015. | 1,065. | 1,102. | 1,165. | 1,198. | |
| | | 30" | R3R1AF33430 () () () () () () | 1,020. | 1,035. | 1,079. | 1,130. | 1,167. | 1,229. | 1,263. | |
| | | 36" | R3R1AF33436 () () () () () () | 1,082. | 1,098. | 1,141. | 1,188. | 1,226. | 1,291. | 1,324. | |
| | | 42" | R3R1AF33442 () () () () () () | 1,242. | 1,259. | 1,299. | 1,349. | 1,388. | 1,449. | 1,484. | |
| | | 48" | R3R1AF33448 () () () () () () | 1,285. | 1,303. | 1,345. | 1,394. | 1,431. | 1,495. | 1,528. | |
| | | 42" | 18" | R3R1AF34218 () () () () () () | 1,015. | 1,035. | 1,077. | 1,130. | 1,165. | 1,223. | 1,261. |
| | | | 24" | R3R1AF34224 () () () () () () | 1,087. | 1,108. | 1,149. | 1,202. | 1,236. | 1,295. | 1,332. |
| | | | 30" | R3R1AF34230 () () () () () () | 1,166. | 1,187. | 1,227. | 1,280. | 1,315. | 1,373. | 1,411. |
| | | | 36" | R3R1AF34236 () () () () () () | 1,243. | 1,264. | 1,304. | 1,358. | 1,393. | 1,450. | 1,487. |
| | | 42" | R3R1AF34242 () () () () () () | 1,394. | 1,414. | 1,454. | 1,508. | 1,543. | 1,601. | 1,637. | |
| | | 48" | R3R1AF34248 () () () () () () | 1,467. | 1,487. | 1,529. | 1,581. | 1,616. | 1,675. | 1,711. | |
| | 49" | 18" | R3R1AF34918 () () () () () () | 1,105. | 1,131. | 1,194. | 1,268. | 1,325. | 1,419. | 1,469. | |
| | | 24" | R3R1AF34924 () () () () () () | 1,179. | 1,203. | 1,267. | 1,342. | 1,399. | 1,492. | 1,543. | |
| | | 30" | R3R1AF34930 () () () () () () | 1,270. | 1,296. | 1,359. | 1,432. | 1,489. | 1,583. | 1,634. | |
| | | 36" | R3R1AF34936 () () () () () () | 1,345. | 1,368. | 1,431. | 1,506. | 1,563. | 1,657. | 1,707. | |
| | | 42" | R3R1AF34942 () () () () () () | 1,509. | 1,534. | 1,597. | 1,670. | 1,727. | 1,822. | 1,873. | |
| | | 48" | R3R1AF34948 () () () () () () | 1,594. | 1,618. | 1,679. | 1,757. | 1,812. | 1,903. | 1,955. | |
| | 64" | 18" | R3R1AF36418 () () () () () () | 1,273. | 1,307. | 1,392. | 1,490. | 1,565. | 1,693. | 1,759. | |
| | | 24" | R3R1AF36424 () () () () () () | 1,357. | 1,388. | 1,473. | 1,573. | 1,647. | 1,774. | 1,840. | |
| | | 30" | R3R1AF36430 () () () () () () | 1,454. | 1,486. | 1,569. | 1,670. | 1,746. | 1,873. | 1,939. | |
| | | 36" | R3R1AF36436 () () () () () () | 1,544. | 1,577. | 1,661. | 1,761. | 1,835. | 1,960. | 2,028. | |
| | | 42" | R3R1AF36442 () () () () () () | 1,752. | 1,785. | 1,870. | 1,970. | 2,045. | 2,169. | 2,238. | |
| | | 48" | R3R1AF36448 () () () () () () | 1,839. | 1,873. | 1,955. | 2,054. | 2,130. | 2,255. | 2,322. | |

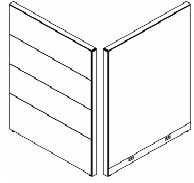

both sides 64x48 shown, 49" h with three tiles; 34" h with two tiles; 42" h 3 tiles/ top tile 7" h

Panels

| Order Code | Specification Information | Application Notes |
|--|---|---|
| Example: R3R1AF33418EAA4K 613W359-V515N | To order please specify pattern number including: | Monolithic side with base raceway only. Tiled side inserts extended to the floor. Be sure to specify power rails for panels with one sided base raceways. |
| R3 | AutoStrada w/generation 3 frame | |
| R1 | Base raceway monolithic side only | |
| A | Tiled one side, Monolithic other | Tiled side includes panel reveals between V3 inserts. Aluminum vertical hookstrip cover ordered separately. |
| F | Fabric, monolithic side | |
| 3 | V3 Exotic, tiled side | Panels are not for use with medians, storage medians or bridges. |
| 34 | 34" high | |
| 18 | 18" wide | Black PVC hookstrip reveals should be ordered for monolithic side from Reff price list. |
| E | Extruded Aluminum top trim | |
| AA | Top Trim anodized aluminum finish | Panels on this page will accept standard Reff System stacking window modules. |
| 4 | 4" high base raceway | |
| K | Knock-outs in base raceway | |
| 613 | Finish, base raceway | |
| W359- | Finish, fabric | |
| V515 | Finish, Quartered Clear Figured Sycamore | |
| N | Not milled for ported components | |

See page 7 for finish options applicable.

Mono/Mono - exterior hard side no raceway
Laminate outside / Fabric inside

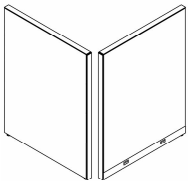
| description | h | w | pattern no. | Grade | | | | | | |
|---|-----|---|---|--------|--------|--------|--------|--------|--------|--------|
| | | | | 10 | 15 | 20 | 30 | 35 | 40 | 45 |
| Monolithic laminate exterior no raceway, interior fabric with raceway  <i>both sides 49x48 shown</i> | 42" | 18" | R3R1PFL4218 () () () () () () () () | \$452. | \$462. | \$482. | \$522. | \$553. | \$590. | \$615. |
| | | 24" | R3R1PFL4224 () () () () () () () () | 459. | 468. | 488. | 528. | 559. | 596. | 621. |
| | | 30" | R3R1PFL4230 () () () () () () () () | 550. | 558. | 580. | 620. | 652. | 688. | 715. |
| | | 36" | R3R1PFL4236 () () () () () () () () | 596. | 604. | 624. | 665. | 698. | 734. | 759. |
| | | 42" | R3R1PFL4242 () () () () () () () () | 669. | 678. | 698. | 740. | 772. | 809. | 834. |
| | | 48" | R3R1PFL4248 () () () () () () () () | 728. | 736. | 757. | 799. | 831. | 868. | 895. |
| | 49" | 18" | R3R1PFL4918 () () () () () () () () | 500. | 515. | 537. | 588. | 620. | 663. | 692. |
| | | 24" | R3R1PFL4924 () () () () () () () () | 548. | 561. | 585. | 634. | 669. | 712. | 740. |
| | | 30" | R3R1PFL4930 () () () () () () () () | 620. | 634. | 657. | 708. | 741. | 786. | 814. |
| | | 36" | R3R1PFL4936 () () () () () () () () | 670. | 684. | 707. | 757. | 792. | 835. | 863. |
| 42" | 42" | R3R1PFL4942 () () () () () () () () | 739. | 752. | 776. | 872. | 861. | 905. | 934. | |
| | 48" | R3R1PFL4948 () () () () () () () () | 832. | 845. | 870. | 922. | 955. | 1,001. | 1,029. | |

| Order Code | Specification Information | Application Notes |
|---|--|---|
| Example: R3R1PFL4218EAA4K 613W359-118N | <i>To order please specify pattern number including:</i> | Interior fabric side with base raceway, exterior monolithic laminate finish insert extended to the floor. Be sure to specify power rails for panels with one sided base raceways. |
| R3 AutoStrada w/generation 3 frame | 1. Height | Aluminum vertical hookstrip cover ordered separately. |
| R1 Base raceway monolithic side only | 2. Width | |
| P Monolithic | 3. Extruded Aluminum Top Trim <i>E - default</i> | Panels are not for use with medians, storage medians or bridges. |
| F Fabric, interior side | 4. Finish, Aluminum top trim <i>Anodized aluminum or painted finish options listed on page 9 excluding silver.</i> | |
| L Laminate, exterior side | 5. Base raceway height <i>4 = 4" h, default</i> | Black PVC hookstrip reveals should be ordered for fabric side from Reff price list. |
| 42 42" high | 6. Knock-out option <i>K = with knock-outs</i> <i>N = no knock-outs</i> | |
| 18 18" wide | 7. Base raceway finish <i>painted or plated finish options only</i> | Panels on this page will accept standard Reff System stacking window modules. |
| E Extruded Aluminum top trim | 8. Fabric selection | |
| AA Top Trim anodized aluminum finish | 9. Finish, Laminate | Product on this page will accept wood grain laminate where laminate is currently an option. Panel product is subject to 10% on the base panel price. Refer to panel product upcharge table. |
| 4 4" high base raceway | 10. Milled for ported components <i>M = milled for (\$14 list upcharge applicable)</i> <i>N = not milled for</i> | |
| K Knock-outs in base raceway | See page 7 for finish options applicable. | |
| 613 Finish, base raceway | | |
| W359- Finish, fabric | | |
| 118 Finish, Bright White | | |
| N Not milled for ported components | | |

Mono/Mono - exterior hard side no raceway V1 Techwood outside / Fabric inside

| description | h | w | pattern no. | Grade | | | | | | |
|---|-----|--|--|--------|--------|--------|--------|--------|--------|--------|
| | | | | 10 | 15 | 20 | 30 | 35 | 40 | 45 |
| Monolithic V1 techwood exterior no raceway, interior fabric with raceway | 42" | 18" | R3R1PF14218 () () () () () () () | \$532. | \$543. | \$566. | \$612. | \$650. | \$691. | \$720. |
| | | 24" | R3R1PF14224 () () () () () () () | 537. | 548. | 571. | 618. | 655. | 696. | 726. |
| | 49" | 30" | R3R1PF14230 () () () () () () () | 648. | 658. | 682. | 729. | 766. | 808. | 836. |
| | | 36" | R3R1PF14236 () () () () () () () | 700. | 711. | 735. | 782. | 819. | 862. | 892. |
| | 49" | 42" | R3R1PF14242 () () () () () () () | 788. | 798. | 824. | 870. | 908. | 950. | 980. |
| | | 48" | R3R1PF14248 () () () () () () () | 858. | 867. | 892. | 939. | 978. | 1,019. | 1,051. |
| | 49" | 18" | R3R1PF14918 () () () () () () () | 590. | 605. | 632. | 689. | 728. | 777. | 810. |
| | | 24" | R3R1PF14924 () () () () () () () | 646. | 661. | 687. | 745. | 784. | 833. | 867. |
| | | 30" | R3R1PF14930 () () () () () () () | 735. | 750. | 777. | 835. | 875. | 925. | 958. |
| | | 36" | R3R1PF14936 () () () () () () () | 787. | 803. | 830. | 888. | 928. | 977. | 1,011. |
| 42" | | R3R1PF14942 () () () () () () () | 871. | 887. | 915. | 973. | 1,013. | 1,063. | 1,096. | |
| 48" | | R3R1PF14948 () () () () () () () | 980. | 996. | 1,024. | 1,083. | 1,122. | 1,173. | 1,207. | |

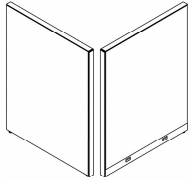

both sides 49x48 shown

| Order Code | Specification Information | Application Notes |
|--|--|--|
| Example: R3R1PF14218EAA4K 613W359-Y319N | To order please specify pattern number including: | Interior fabric side with base raceway, exterior monolithic V1 insert extended to the floor. Be sure to specify power rails for panels with one sided base raceways. |
| R3 AutoStrada w/generation 3 frame | 1. Height | |
| R1 Base raceway monolithic side only | 2. Width | |
| P Monolithic, both sides | 3. Extruded Aluminum Top Trim <i>E - default</i> | Aluminum vertical hookstrip cover ordered separately. |
| F Fabric, inside | 4. Finish, Aluminum top trim <i>Anodized aluminum or painted finish options listed on page 9 excluding silver.</i> | Panels are not for use with medians, storage medians or bridges. |
| 1 V1 Techwood, outside | 5. Base raceway height <i>4 = 4" h, default</i> | Black PVC hookstrip reveals should be ordered for fabric side from Reff price list. |
| 42 42" high | 6. Knock-out option <i>K = with knock-outs</i> <i>N = no knock-outs</i> | Panels on this page will accept standard Reff System stacking window modules. |
| 18 18" wide | 7. Base raceway finish <i>painted or plated finish options only</i> | |
| E Extruded Aluminum top trim | 8. Fabric selection | |
| AA Top Trim anodized aluminum finish | 9. Finish, V1 Techwood | |
| 4 4" high base raceway | 10. Milled for ported components <i>M = milled for (\$14 list upcharge applicable)</i> <i>N = not milled for</i> | |
| K Knock-outs in base raceway | | |
| 613 Finish, base raceway | | |
| W359- Finish, fabric | | |
| Y319 Finish, Cherry | | |
| N Not milled for ported components | See page 7 for finish options applicable. | |

Mono/Mono - exterior hard side no raceway
V2 Natural veneer outside / Fabric inside

| description | h | w | pattern no. | Grade | | | | | | |
|--|-----|-------------------------------------|-------------------------------------|--------|--------|--------|--------|--------|--------|--------|
| | | | | 10 | 15 | 20 | 30 | 35 | 40 | 45 |
| Monolithic V2 natural veneer exterior no raceway, interior fabric with raceway | 42" | 18" | R3R1PF24218 () () () () () () | \$542. | \$552. | \$577. | \$621. | \$660. | \$700. | \$730. |
| | | 24" | R3R1PF24224 () () () () () () | 549. | 560. | 584. | 630. | 667. | 708. | 737. |
| | 30" | R3R1PF24230 () () () () () () | 661. | 670. | 695. | 742. | 780. | 820. | 851. | |
| | 36" | R3R1PF24236 () () () () () () | 714. | 725. | 749. | 796. | 833. | 875. | 904. | |
| | 42" | R3R1PF24242 () () () () () () | 804. | 814. | 838. | 886. | 925. | 965. | 996. | |
| | 48" | R3R1PF24248 () () () () () () | 876. | 886. | 911. | 959. | 997. | 1,038. | 1,069. | |
| | 49" | 18" | R3R1PF24918 () () () () () () | 601. | 616. | 644. | 700. | 739. | 788. | 821. |
| | | 24" | R3R1PF24924 () () () () () () | 658. | 672. | 699. | 758. | 797. | 845. | 879. |
| | | 30" | R3R1PF24930 () () () () () () | 746. | 762. | 789. | 847. | 886. | 935. | 968. |
| | | 36" | R3R1PF24936 () () () () () () | 803. | 818. | 845. | 903. | 943. | 993. | 1,027. |
| 42" | | R3R1PF24942 () () () () () () | 888. | 903. | 932. | 991. | 1,029. | 1,079. | 1,113. | |
| 48" | | R3R1PF24948 () () () () () () | 1,002. | 1,017. | 1,045. | 1,103. | 1,144. | 1,195. | 1,228. | |

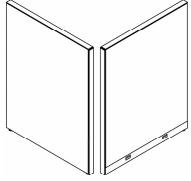

both sides 49x48 shown

| Order Code | Specification Information | Application Notes |
|--|--|---|
| Example: R3R1PF24218EAA4K 613W359-V316N | To order please specify pattern number including: | Interior fabric side with base raceway, exterior monolithic V2 finish insert extended to the floor. Be sure to specify power rails for panels with one sided base raceways. |
| R3 AutoStrada w/generation 3 frame | 1. Height | Aluminum vertical hookstrip cover ordered separately. Panels are not for use with medians, storage medians or bridges. Black PVC hookstrip reveals should be ordered for fabric side from Reff price list. Panels on this page will accept standard Reff System stacking window modules. |
| R1 Base raceway monolithic side only | 2. Width | |
| P Monolithic | 3. Extruded Aluminum Top Trim <i>E - default</i> | |
| F Fabric, monolithic interior | 4. Finish, Aluminum top trim <i>Anodized aluminum or painted finish options listed on page 9 excluding silver.</i> | |
| 2 V2 Natural, monolithic exterior | 5. Base raceway height <i>4 = 4" h, default</i> | |
| 42 42" high | 6. Knock-out option <i>K = with knock-outs N = no knock-outs</i> | |
| 18 18" wide | 7. Base raceway finish <i>painted or plated finish options only</i> | |
| E Extruded Aluminum top trim | 8. Fabric selection | |
| AA Top Trim anodized aluminum finish | 9. Finish, V2 Natural | |
| 4 4" high base raceway | 10. Milled for ported components <i>M = milled for (\$14 list upcharge applicable) N = not milled for</i> | |
| K Knock-outs in base raceway | | |
| 613 Finish, base raceway | See page 7 for finish options applicable. | |
| W359- Finish, fabric | | |
| V316 Finish, Maple | | |
| N Not milled for ported components | | |

Mono/Mono - exterior hard side no raceway

V3 Exotic veneer outside / Fabric inside

| description | h | w | pattern no. | Grade | | | | | | |
|---|-----|-----|--|--------|--------|--------|--------|--------|--------|--------|
| | | | | 10 | 15 | 20 | 30 | 35 | 40 | 45 |
| Monolithic V3 exotic veneer exterior no raceway, interior fabric with raceway | 42" | 18" | R3R1PF34218 () () () () () () () | \$731. | \$742. | \$765. | \$812. | \$850. | \$889. | \$920. |
| | | 24" | R3R1PF34224 () () () () () () () | 743. | 752. | 777. | 822. | 861. | 901. | 931. |
| | | 30" | R3R1PF34230 () () () () () () () | 894. | 904. | 929. | 975. | 1,013. | 1,054. | 1,084. |
| | | 36" | R3R1PF34236 () () () () () () () | 967. | 978. | 1,003. | 1,050. | 1,087. | 1,129. | 1,159. |
| | | 42" | R3R1PF34242 () () () () () () () | 1,093. | 1,102. | 1,128. | 1,175. | 1,213. | 1,254. | 1,284. |
| | | 48" | R3R1PF34248 () () () () () () () | 1,193. | 1,203. | 1,228. | 1,275. | 1,313. | 1,354. | 1,385. |
| both sides 49x48 shown | 49" | 18" | R3R1PF34918 () () () () () () () | 811. | 826. | 853. | 910. | 949. | 999. | 1,032. |
| | | 24" | R3R1PF34924 () () () () () () () | 888. | 904. | 931. | 989. | 1,028. | 1,078. | 1,111. |
| | | 30" | R3R1PF34930 () () () () () () () | 1,011. | 1,027. | 1,054. | 1,112. | 1,151. | 1,201. | 1,234. |
| | | 36" | R3R1PF34936 () () () () () () () | 1,090. | 1,104. | 1,132. | 1,191. | 1,230. | 1,280. | 1,313. |
| | | 42" | R3R1PF34942 () () () () () () () | 1,208. | 1,223. | 1,250. | 1,309. | 1,349. | 1,399. | 1,432. |
| | | 48" | R3R1PF34948 () () () () () () () | 1,362. | 1,378. | 1,407. | 1,465. | 1,504. | 1,554. | 1,589. |

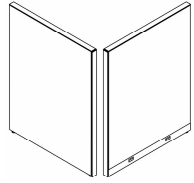

both sides 49x48 shown

| Order Code | Specification Information | Application Notes |
|--|---|---|
| Example: R3R1PF34218EAA4K 613W359-V515N | <i>To order please specify pattern number including:</i> | Interior fabric side with base raceway, exterior monolithic V3 finish insert extended to the floor. Be sure to specify power rails for panels with one sided base raceways. |
| R3 AutoStrada w/generation 3 frame | 1. Height | |
| R1 Base raceway monolithic side only | 2. Width | |
| P Monolithic | 3. Extruded Aluminum Top Trim <i>E - default</i> | Aluminum vertical hookstrip cover ordered separately. |
| F Fabric, interior side | 4. Finish, Aluminum top trim <i>Anodized aluminum or painted finish options listed on page 9 excluding silver.</i> | |
| 3 V3 Exotic, exterior side | 5. Base raceway height <i>4 = 4" h, default</i> | Panels are not for use with medians, storage medians or bridges. |
| 42 42" high | 6. Knock-out option <i>K = with knock-outs</i> <i>N = no knock-outs</i> | Black PVC hookstrip reveals should be ordered for fabric side from Reff price list. |
| 18 18" wide | 7. Base raceway finish <i>painted or plated finish options only</i> | |
| E Extruded Aluminum top trim | 8. Fabric selection | Panels on this page will accept standard Reff System stacking window modules. |
| AA Top Trim anodized aluminum finish | 9. Finish, V3 Exotic | |
| 4 4" high base raceway | 10. Milled for ported componenets <i>M = milled for (\$14 list upcharge applicable)</i> <i>N = not milled for</i> | |
| K Knock-outs in base raceway | | |
| 613 Finish, base raceway | | |
| W359- Finish, fabric | | |
| V515 Finish, Quartered Clear Figured Sycamore | See page 7 for finish options applicable. | |
| N Not milled for ported components | | |

Tiled/Monolithic - both sides with base raceway
 Tiled one side - Laminate/Monolithic side - fabric

| description | h | w | pattern no. | Grade | | | | | | | |
|--|-----|-----|--|--|--------|--------|--------|--------|--------|--------|--------|
| | | | | 10 | 15 | 20 | 30 | 35 | 40 | 45 | |
| Tiled laminate one side, fabric monolithic other side (both sides w/ base raceway) | 34" | 18" | R3R2AFL3418 () () () () () () () | \$646. | \$658. | \$689. | \$729. | \$757. | \$806. | \$830. | |
| | | 24" | R3R2AFL3424 () () () () () () () | 689. | 701. | 734. | 772. | 802. | 851. | 877. | |
| | | 30" | R3R2AFL3430 () () () () () () () | 739. | 752. | 785. | 822. | 852. | 900. | 927. | |
| | | 36" | R3R2AFL3436 () () () () () () () | 787. | 798. | 830. | 869. | 897. | 947. | 971. | |
| | | 42" | R3R2AFL3442 () () () () () () () | 903. | 917. | 948. | 987. | 1,016. | 1,064. | 1,090. | |
| | | 48" | R3R2AFL3448 () () () () () () () | 935. | 948. | 980. | 1,019. | 1,047. | 1,096. | 1,121. | |
| | | 49" | 18" | R3R2AFL4918 () () () () () () () | 797. | 816. | 865. | 922. | 965. | 1,038. | 1,075. |
| | | | 24" | R3R2AFL4924 () () () () () () () | 852. | 870. | 919. | 977. | 1,020. | 1,092. | 1,131. |
| | | | 30" | R3R2AFL4930 () () () () () () () | 918. | 936. | 985. | 1,043. | 1,085. | 1,159. | 1,196. |
| | | | 36" | R3R2AFL4936 () () () () () () () | 971. | 992. | 1,041. | 1,098. | 1,142. | 1,212. | 1,250. |
| | | | 42" | R3R2AFL4942 () () () () () () () | 1,095. | 1,114. | 1,163. | 1,221. | 1,264. | 1,336. | 1,375. |
| | | | 48" | R3R2AFL4948 () () () () () () () | 1,155. | 1,174. | 1,224. | 1,282. | 1,325. | 1,398. | 1,435. |
| | 64" | 18" | R3R2AFL6418 () () () () () () () | 911. | 938. | 1,003. | 1,080. | 1,140. | 1,233. | 1,284. | |
| | | 24" | R3R2AFL6424 () () () () () () () | 973. | 1,001. | 1,064. | 1,142. | 1,199. | 1,294. | 1,347. | |
| | | 30" | R3R2AFL6430 () () () () () () () | 1,048. | 1,075. | 1,141. | 1,217. | 1,273. | 1,370. | 1,421. | |
| | | 36" | R3R2AFL6436 () () () () () () () | 1,112. | 1,141. | 1,203. | 1,281. | 1,338. | 1,434. | 1,485. | |
| | | 42" | R3R2AFL6442 () () () () () () () | 1,268. | 1,293. | 1,359. | 1,434. | 1,492. | 1,587. | 1,640. | |
| | | 48" | R3R2AFL6448 () () () () () () () | 1,332. | 1,359. | 1,421. | 1,499. | 1,558. | 1,652. | 1,703. | |

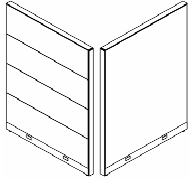

both sides 64x48 shown, 49" h with three tiles; 34" h with two tiles

| Order Code | Specification Information | Application Notes |
|---|--|---|
| Example: R3R2AFL3418EAA4K 613W359-118N | To order please specify pattern number including: | Tiled side includes aluminum panel reveals between laminate inserts. Aluminum vertical hookstrip cover ordered separately. |
| R3 AutoStrada w/generation 3 frame | 1. Height | |
| R2 Base raceway both sides | 2. Width | |
| A Tiled one side, Monolithic other | 3. Extruded Aluminum Top Trim <i>E - default</i> | Panels are not for use with medians, storage medians or bridges. |
| F Fabric, monolithic side | 4. Finish, Aluminum trim (top trim and tile dividers/reveals) <i>Anodized aluminum or painted finish options listed on page 9 excluding silver.</i> | Black PVC hookstrip reveals should be ordered for monolithic side from Reff price list. |
| L Laminate, tiled side | 5. Base raceway height <i>4 = 4" h, default</i> | Panels on this page will accept standard Reff System stacking window modules. |
| 34 34" high | 6. Knock-out option <i>K = with knock-outs</i> <i>N = no knock-outs</i> | Product on this page will accept wood grain laminate where laminate is currently an option. Panel product is subject to 10% on the base panel price. Refer to panel product upcharge table. |
| 18 18" wide | 7. Base raceway finish <i>painted or plated finish options only</i> | |
| E Extruded Aluminum top trim | 8. Fabric selection | |
| AA Top Trim anodized aluminum finish | 9. Finish, Laminate | |
| 4 4" high base raceway | 10. Milled for ported components <i>M = milled for (\$14 list upcharge applicable)</i> <i>N = not milled for</i> | |
| K Knock-outs in base raceway | | |
| 613 Finish, base raceway | | |
| W359- Finish, fabric | | |
| 118 Finish, laminate tile side | | |
| N Not milled for ported components | See page 7 for finish options applicable. | |

Tiled/Monolithic - both sides with base raceway
Tiled one side - V1 Techwood/Monolithic - fabric

| description | h | w | pattern no. | Grade | | | | | | |
|--|-----|--|--|--------|--------|--------|--------|--------|--------|--------|
| | | | | 10 | 15 | 20 | 30 | 35 | 40 | 45 |
| Tiled V1 techwood one side, fabric monolithic other side (both sides w/ base raceway) | 34" | 18" | R3R2AF13418 () () () () () () () | \$658. | \$670. | \$701. | \$741. | \$769. | \$817. | \$844. |
| | | 24" | R3R2AF13424 () () () () () () () | 705. | 718. | 751. | 789. | 817. | 867. | 892. |
| | | 30" | R3R2AF13430 () () () () () () () | 755. | 768. | 800. | 838. | 868. | 917. | 942. |
| | | 36" | R3R2AF13436 () () () () () () () | 800. | 814. | 845. | 884. | 911. | 961. | 987. |
| | | 42" | R3R2AF13442 () () () () () () () | 926. | 936. | 968. | 1,008. | 1,035. | 1,085. | 1,110. |
| | | 48" | R3R2AF13448 () () () () () () () | 954. | 967. | 1,001. | 1,038. | 1,068. | 1,115. | 1,142. |
| | 49" | 18" | R3R2AF14918 () () () () () () () | 811. | 830. | 879. | 936. | 980. | 1,052. | 1,091. |
| | | 24" | R3R2AF14924 () () () () () () () | 868. | 887. | 934. | 993. | 1,034. | 1,109. | 1,147. |
| | | 30" | R3R2AF14930 () () () () () () () | 933. | 952. | 1,002. | 1,060. | 1,102. | 1,173. | 1,212. |
| | | 36" | R3R2AF14936 () () () () () () () | 992. | 1,010. | 1,060. | 1,115. | 1,160. | 1,231. | 1,270. |
| | | 42" | R3R2AF14942 () () () () () () () | 1,120. | 1,141. | 1,187. | 1,244. | 1,288. | 1,361. | 1,400. |
| | | 48" | R3R2AF14948 () () () () () () () | 1,181. | 1,200. | 1,248. | 1,306. | 1,349. | 1,421. | 1,461. |
| 64" | 18" | R3R2AF16418 () () () () () () () | 932. | 958. | 1,021. | 1,099. | 1,158. | 1,253. | 1,304. | |
| | 24" | R3R2AF16424 () () () () () () () | 995. | 1,020. | 1,084. | 1,161. | 1,220. | 1,317. | 1,367. | |
| | 30" | R3R2AF16430 () () () () () () () | 1,070. | 1,096. | 1,160. | 1,237. | 1,294. | 1,392. | 1,443. | |
| | 36" | R3R2AF16436 () () () () () () () | 1,133. | 1,160. | 1,224. | 1,301. | 1,360. | 1,457. | 1,508. | |
| | 42" | R3R2AF16442 () () () () () () () | 1,292. | 1,318. | 1,381. | 1,460. | 1,517. | 1,613. | 1,664. | |
| | 48" | R3R2AF16448 () () () () () () () | 1,360. | 1,384. | 1,448. | 1,526. | 1,583. | 1,681. | 1,733. | |

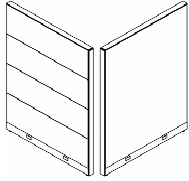

both sides 64x48 shown, 49" h with three tiles; 34" h with two tiles

Panels

| Order Code | Specification Information | Application Notes |
|--|---|---|
| Example: R3R2AF13418EAA4K 613W359-Y319N | To order please specify pattern number including: | Tiled side includes panel reveals between V1 inserts. Aluminum vertical hookstrip cover ordered separately. |
| R3 AutoStrada w/generation 3 frame | 1. Height | |
| R2 Base raceway both sides | 2. Width | |
| A Tiled one side, Monolithic other | 3. Extruded Aluminum Top Trim <i>E - default</i> | Panels are not for use with medians, storage medians or bridges. |
| F Fabric, monolithic side | 4. Finish, Aluminum trim (top trim and tile dividers/reveals) | Black PVC hookstrip reveals should be ordered for monolithic side from Reff price list. |
| 1 V1 Techwood, tiled side | <i>Anodized aluminum or painted finish options listed on page 9 excluding silver.</i> | |
| 34 34" high | 5. Base raceway height <i>4 = 4" h, default</i> | Panels on this page will accept standard Reff System stacking window modules. |
| 18 18" wide | 6. Knock-out option <i>K = with knock-outs</i> <i>N = no knock-outs</i> | |
| E Extruded Aluminum top trim | 7. Base raceway finish <i>painted or plated finish options only</i> | |
| AA Top Trim anodized aluminum finish | 8. Fabric selection | |
| 4 4" high base raceway | 9. Finish, V1 Techwood | |
| K Knock-outs in base raceway | 10. Milled for ported componenets <i>M = milled for (\$14 list upcharge applicable)</i> <i>N = not milled for</i> | |
| 613 Finish, base raceway | | |
| W359- Finish, fabric | | |
| Y319 Finish, Cherry | | |
| N Not milled for ported components | See page 7 for finish options applicable. | |

Tiled/Monolithic - both sides with base raceway
 Tiled one side - V2 Natural/Monolithic - fabric

| description | h | w | pattern no. | Grade | | | | | | | |
|--|-----|-----|------------------------------------|------------------------------------|--------|--------|--------|--------|--------|--------|--------|
| | | | | 10 | 15 | 20 | 30 | 35 | 40 | 45 | |
| Tiled V2 natural one side, fabric monolithic other side (both sides w/ base raceway) | 34" | 18" | R3R2AF23418 (X)(X)(X)(X)(X) | \$671. | \$686. | \$717. | \$755. | \$785. | \$831. | \$858. | |
| | | 24" | R3R2AF23424 (X)(X)(X)(X)(X) | 719. | 733. | 766. | 804. | 831. | 881. | 907. | |
| | | 30" | R3R2AF23430 (X)(X)(X)(X)(X) | 769. | 783. | 815. | 854. | 882. | 931. | 955. | |
| | | 36" | R3R2AF23436 (X)(X)(X)(X)(X) | 816. | 829. | 863. | 900. | 929. | 977. | 1,003. | |
| | | 42" | R3R2AF23442 (X)(X)(X)(X)(X) | 941. | 952. | 986. | 1,022. | 1,052. | 1,101. | 1,128. | |
| | | 48" | R3R2AF23448 (X)(X)(X)(X)(X) | 974. | 987. | 1,019. | 1,058. | 1,086. | 1,134. | 1,160. | |
| | | 49" | 18" | R3R2AF24918 (X)(X)(X)(X)(X) | 829. | 849. | 896. | 953. | 997. | 1,070. | 1,109. |
| | | | 24" | R3R2AF24924 (X)(X)(X)(X)(X) | 884. | 904. | 952. | 1,010. | 1,054. | 1,126. | 1,165. |
| | | | 30" | R3R2AF24930 (X)(X)(X)(X)(X) | 954. | 974. | 1,022. | 1,082. | 1,125. | 1,196. | 1,234. |
| | | | 36" | R3R2AF24936 (X)(X)(X)(X)(X) | 1,012. | 1,031. | 1,080. | 1,140. | 1,181. | 1,253. | 1,292. |
| | | 42" | R3R2AF24942 (X)(X)(X)(X)(X) | 1,141. | 1,159. | 1,207. | 1,264. | 1,308. | 1,380. | 1,419. | |
| | | 48" | R3R2AF24948 (X)(X)(X)(X)(X) | 1,203. | 1,223. | 1,270. | 1,330. | 1,371. | 1,444. | 1,483. | |
| | 64" | 18" | R3R2AF26418 (X)(X)(X)(X)(X) | 951. | 977. | 1,042. | 1,119. | 1,178. | 1,271. | 1,324. | |
| | | 24" | R3R2AF26424 (X)(X)(X)(X)(X) | 1,014. | 1,041. | 1,103. | 1,181. | 1,240. | 1,334. | 1,386. | |
| | | 30" | R3R2AF26430 (X)(X)(X)(X)(X) | 1,090. | 1,115. | 1,180. | 1,258. | 1,312. | 1,410. | 1,462. | |
| | | 36" | R3R2AF26436 (X)(X)(X)(X)(X) | 1,159. | 1,183. | 1,248. | 1,325. | 1,382. | 1,481. | 1,531. | |
| | | 42" | R3R2AF26442 (X)(X)(X)(X)(X) | 1,320. | 1,345. | 1,409. | 1,485. | 1,544. | 1,640. | 1,693. | |
| | | 48" | R3R2AF26448 (X)(X)(X)(X)(X) | 1,384. | 1,410. | 1,475. | 1,551. | 1,610. | 1,706. | 1,759. | |

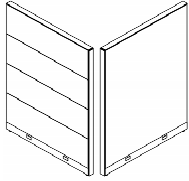

both sides 64x48 shown, 49" h with three tiles; 34" h with two tiles

| Order Code | Specification Information | Application Notes |
|--|--|---|
| Example: R3R2AF23418EAA4K 613W359-V316N | To order please specify pattern number including: | Tiled side includes panel reveals between V2 inserts. Aluminum vertical hookstrip cover ordered separately. |
| R3 AutoStrada w/generation 3 frame | 1. Height | |
| R2 Base raceway both sides | 2. Width | |
| A Tiled one side, Monolithic other | 3. Extruded Aluminum Top Trim <i>E - default</i> | Panels are not for use with medians, storage medians or bridges. |
| F Fabric, monolithic side | 4. Finish, Aluminum trim (top trim and tile dividers/reveals) <i>Anodized aluminum or painted finish options listed on page 9 excluding silver.</i> | Black PVC hookstrip reveals should be ordered for monolithic side from Reff price list. |
| 2 V2 Natural, tiled side | 5. Base raceway height <i>4 = 4" h, default</i> | Panels on this page will accept standard Reff System stacking window modules. |
| 34 34" high | 6. Knock-out option <i>K = with knock-outs</i> <i>N = no knock-outs</i> | |
| 18 18" wide | 7. Base raceway finish <i>painted or plated finish options only</i> | |
| E Extruded Aluminum top trim | 8. Fabric selection | |
| AA Top Trim anodized aluminum finish | 9. Finish, V2 Natural | |
| 4 4" high base raceway | 10. Milled for ported components <i>M = milled for (\$14 list upcharge applicable)</i> <i>N = not milled for</i> | |
| K Knock-outs in base raceway | | |
| 613 Finish, base raceway | | |
| W359- Finish, fabric | | |
| V316 Finish, Maple | | |
| N Not milled for ported components | See page 7 for finish options applicable. | |

Tiled/Monolithic - both sides with base raceway
 Tiled one side - V3 Exotic/Monolithic - fabric

| description | h | w | pattern no. | Grade | | | | | | | |
|---|-----|-----|--|--|--------|--------|----------|----------|----------|----------|--------|
| | | | | 10 | 15 | 20 | 30 | 35 | 40 | 45 | |
| Tiled V3 exotic one side, fabric monolithic other side (both sides w/ base raceway) | 34" | 18" | R3R2AF33418 () () () () () () () | \$893. | \$909. | \$951. | \$1,003. | \$1,041. | \$1,102. | \$1,134. | |
| | | 24" | R3R2AF33424 () () () () () () () | 954. | 971. | 1,015. | 1,065. | 1,102. | 1,165. | 1,198. | |
| | | 30" | R3R2AF33430 () () () () () () () | 1,020. | 1,035. | 1,079. | 1,130. | 1,167. | 1,229. | 1,263. | |
| | | 36" | R3R2AF33436 () () () () () () () | 1,082. | 1,098. | 1,141. | 1,188. | 1,226. | 1,291. | 1,324. | |
| | | 42" | R3R2AF33442 () () () () () () () | 1,242. | 1,259. | 1,299. | 1,349. | 1,388. | 1,449. | 1,484. | |
| | | 48" | R3R2AF33448 () () () () () () () | 1,285. | 1,303. | 1,345. | 1,394. | 1,431. | 1,495. | 1,528. | |
| | | 49" | 18" | R3R2AF34918 () () () () () () () | 1,105. | 1,131. | 1,194. | 1,268. | 1,325. | 1,419. | 1,469. |
| | | | 24" | R3R2AF34924 () () () () () () () | 1,179. | 1,203. | 1,267. | 1,342. | 1,399. | 1,492. | 1,543. |
| | | | 30" | R3R2AF34930 () () () () () () () | 1,270. | 1,296. | 1,359. | 1,432. | 1,489. | 1,583. | 1,634. |
| | | | 36" | R3R2AF34936 () () () () () () () | 1,345. | 1,368. | 1,431. | 1,506. | 1,563. | 1,657. | 1,707. |
| | | 42" | R3R2AF34942 () () () () () () () | 1,509. | 1,534. | 1,597. | 1,670. | 1,727. | 1,822. | 1,873. | |
| | | 48" | R3R2AF34948 () () () () () () () | 1,594. | 1,618. | 1,679. | 1,757. | 1,812. | 1,903. | 1,955. | |
| | 64" | 18" | R3R2AF36418 () () () () () () () | 1,273. | 1,307. | 1,392. | 1,490. | 1,565. | 1,693. | 1,759. | |
| | | 24" | R3R2AF36424 () () () () () () () | 1,357. | 1,388. | 1,473. | 1,573. | 1,647. | 1,774. | 1,840. | |
| | | 30" | R3R2AF36430 () () () () () () () | 1,454. | 1,486. | 1,569. | 1,670. | 1,746. | 1,873. | 1,939. | |
| | | 36" | R3R2AF36436 () () () () () () () | 1,544. | 1,577. | 1,661. | 1,761. | 1,835. | 1,960. | 2,028. | |
| | | 42" | R3R2AF36442 () () () () () () () | 1,752. | 1,785. | 1,870. | 1,970. | 2,045. | 2,169. | 2,238. | |
| | | 48" | R3R2AF36448 () () () () () () () | 1,839. | 1,873. | 1,955. | 2,054. | 2,130. | 2,255. | 2,322. | |

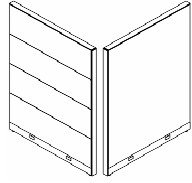

both sides 64x48 shown, 49" h with three tiles; 34" h with two tiles

Panels

| Order Code | Specification Information | Application Notes |
|--|--|---|
| Example: R3R2AF33418EAA4K 613W359-V515N | To order please specify pattern number including: | Tiled side includes panel reveals between V3 inserts. Aluminum vertical hookstrip cover ordered separately. |
| R3 AutoStrada w/generation 3 frame | 1. Height | |
| R2 Base raceway both sides | 2. Width | |
| A Tiled one side, Monolithic other | 3. Extruded Aluminum Top Trim <i>E - default</i> | Panels are not for use with medians, storage medians or bridges. |
| F Fabric, monolithic side | 4. Finish, Aluminum trim (top trim and tile dividers/reveals) <i>Anodized aluminum or painted finish options listed on page 9 excluding silver.</i> | Black PVC hookstrip reveals should be ordered for monolithic side from Reff price list. |
| 3 V3 Exotic, tiled side | 5. Base raceway height <i>4 = 4" h, default</i> | Panels on this page will accept standard Reff System stacking window modules. |
| 34 34" high | 6. Knock-out option <i>K = with knock-outs</i> | |
| 18 18" wide | 7. Base raceway finish <i>N = no knock-outs</i> | |
| E Extruded Aluminum top trim | 8. Fabric selection | |
| AA Top Trim anodized aluminum finish | 9. Finish, V3 Exotic | |
| 4 4" high base raceway | 10. Milled for ported components <i>M = milled for (\$14 list upcharge applicable)</i> | |
| K Knock-outs in base raceway | <i>N = not milled for</i> | |
| 613 Finish, base raceway | | |
| W359- Finish, fabric | | |
| V515 Finish, Quartered Clear Figured Sycamore | | |
| N Not milled for ported components | See page 7 for finish options applicable. | |

Tiled one side/Slatwall combo other
Tiled one side - Laminate/Slatwall and Fabric other side

| description | h | w | pattern no. | Grade | | | | | | |
|--|-----|--|--|--------|--------|----------|----------|----------|----------|----------|
| | | | | 10 | 15 | 20 | 30 | 35 | 40 | 45 |
| Tiled laminate one side, slatwall/fabric other side (tiled side without base raceway) | 42" | 18" | R3R1CXL4218 () () () () () () () | \$966. | \$980. | \$1,015. | \$1,064. | \$1,095. | \$1,146. | \$1,174. |
| | | 24" | R3R1CXL4224 () () () () () () () | 1,069. | 1,083. | 1,117. | 1,166. | 1,198. | 1,248. | 1,279. |
| | | 30" | R3R1CXL4230 () () () () () () () | 1,170. | 1,185. | 1,220. | 1,268. | 1,299. | 1,350. | 1,380. |
| | | 36" | R3R1CXL4236 () () () () () () () | 1,273. | 1,287. | 1,322. | 1,370. | 1,402. | 1,454. | 1,483. |
| | | 42" | R3R1CXL4242 () () () () () () () | 1,376. | 1,390. | 1,424. | 1,473. | 1,504. | 1,557. | 1,584. |
| | | 48" | R3R1CXL4248 () () () () () () () | 1,481. | 1,495. | 1,528. | 1,577. | 1,609. | 1,661. | 1,689. |
| | | 49" | 18" R3R1CXL4918 () () () () () () () | 1,107. | 1,125. | 1,166. | 1,215. | 1,253. | 1,316. | 1,348. |
| | | | 24" R3R1CXL4924 () () () () () () () | 1,226. | 1,243. | 1,284. | 1,334. | 1,371. | 1,434. | 1,468. |
| | | | 30" R3R1CXL4930 () () () () () () () | 1,346. | 1,362. | 1,404. | 1,454. | 1,490. | 1,554. | 1,585. |
| | | | 36" R3R1CXL4936 () () () () () () () | 1,464. | 1,482. | 1,524. | 1,573. | 1,610. | 1,674. | 1,706. |
| | | 42" R3R1CXL4942 () () () () () () () | 1,583. | 1,600. | 1,641. | 1,693. | 1,729. | 1,791. | 1,825. | |
| | | 48" R3R1CXL4948 () () () () () () () | 1,703. | 1,720. | 1,762. | 1,813. | 1,849. | 1,912. | 1,945. | |
| | 64" | 18" R3R1CXL6418 () () () () () () () | 1,225. | 1,247. | 1,303. | 1,368. | 1,419. | 1,501. | 1,546. | |
| | | 24" R3R1CXL6424 () () () () () () () | 1,385. | 1,408. | 1,463. | 1,530. | 1,580. | 1,663. | 1,707. | |
| | | 30" R3R1CXL6430 () () () () () () () | 1,546. | 1,568. | 1,624. | 1,690. | 1,740. | 1,823. | 1,867. | |
| | | 36" R3R1CXL6436 () () () () () () () | 1,707. | 1,729. | 1,784. | 1,851. | 1,900. | 1,983. | 2,028. | |
| | | 42" R3R1CXL6442 () () () () () () () | 1,867. | 1,890. | 1,945. | 2,012. | 2,061. | 2,144. | 2,189. | |
| | | 48" R3R1CXL6448 () () () () () () () | 2,028. | 2,050. | 2,105. | 2,173. | 2,222. | 2,306. | 2,350. | |

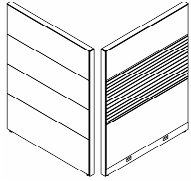

both sides 64x48 shown, 42" & 49" h do not have insert above slatwall section

| Order Code | Specification Information | Application Notes |
|--|--|---|
| Example: R3R1CXL4218EAA4K 613W359-118AA | <i>To order please specify pattern number including:</i> | Tiled side includes panel reveals between laminate inserts. |
| R3 AutoStrada w/generation 3 frame | 1. Height | Aluminum vertical hookstrip cover ordered separately. Tiled side inserts extend to the floor, there is no base raceway on this panel side. Be sure to specify power rails for panels with one sided base raceways. |
| R1 Base raceway slatwall combo side only | 2. Width | |
| C Tiled one side, Slatwall combo other | 3. Extruded Aluminum Top Trim <i>E - default</i> | Product on this page will accept wood grain laminate where laminate is currently an option. Panel product is subject to 10% on the base panel price. Refer to panel product upcharge table. |
| X Fabric/Slatwall combo side | 4. Finish, Aluminum trim (top trim and tile dividers/reveals) <i>Anodized aluminum or painted finish options listed on page 9 excluding silver.</i> | Slatwall/fabric side combination: Slatwall above worksurface is nominally 15" h for 42" high panels, and 22 1/2" h for both 49" and 64" high panels. Fabric insert begins at just below worksurface height to the base raceway. (64" high panels also have a fabric insert above the slatwall section). |
| L Laminate, tiled side | 5. Base raceway height <i>4 = 4" h, default</i> | |
| 42 42" high | 6. Knock-out option <i>K = with knock-outs N = no knock-outs</i> | |
| 18 18" wide | 7. Base raceway finish <i>painted or plated finish options only</i> | |
| E Extruded Aluminum top trim | 8. Fabric selection | |
| AA Top Trim anodized aluminum finish | 9. Finish, Laminate | |
| 4 4" high base raceway | 10. Finish, Slatwall <i>Anodized aluminum or painted finish options listed on page 9 excluding silver</i> | |
| K Knock-outs in base raceway | | |
| 613 Finish, base raceway | | |
| W359- Finish, Fabric (combo side) | | |
| 118 Finish, Bright white (tiled side) | See page 7 for finish options applicable. | |
| AA Finish, Slatwall | | |

Tiled one side - V1 Techwood/Slatwall and Fabric other side

| description | h | w | pattern no. | Grade | | | | | | | |
|--|-----|-----|---------------------------------------|---------------------------------------|----------|----------|----------|----------|----------|----------|--------|
| | | | | 10 | 15 | 20 | 30 | 35 | 40 | 45 | |
| Tiled V1 techwood one side, slatwall/fabric other side (tiled side without base raceway) | 42" | 18" | R3R1CX14218 (X)(X)(X)(X)(X)(X) | \$1,362. | \$1,376. | \$1,410. | \$1,460. | \$1,490. | \$1,543. | \$1,570. | |
| | | 24" | R3R1CX14224 (X)(X)(X)(X)(X)(X) | 1,468. | 1,482. | 1,516. | 1,564. | 1,597. | 1,647. | 1,677. | |
| | | 30" | R3R1CX14230 (X)(X)(X)(X)(X)(X) | 1,573. | 1,585. | 1,622. | 1,669. | 1,701. | 1,752. | 1,781. | |
| | | 36" | R3R1CX14236 (X)(X)(X)(X)(X)(X) | 1,678. | 1,693. | 1,726. | 1,775. | 1,807. | 1,858. | 1,886. | |
| | | 42" | R3R1CX14242 (X)(X)(X)(X)(X)(X) | 1,783. | 1,798. | 1,832. | 1,880. | 1,912. | 1,963. | 1,992. | |
| | | 48" | R3R1CX14248 (X)(X)(X)(X)(X)(X) | 1,885. | 1,899. | 1,935. | 1,982. | 2,014. | 2,065. | 2,094. | |
| | | 49" | 18" | R3R1CX14918 (X)(X)(X)(X)(X)(X) | 1,504. | 1,523. | 1,563. | 1,613. | 1,649. | 1,712. | 1,746. |
| | | | 24" | R3R1CX14924 (X)(X)(X)(X)(X)(X) | 1,626. | 1,643. | 1,684. | 1,735. | 1,773. | 1,834. | 1,867. |
| | | | 30" | R3R1CX14930 (X)(X)(X)(X)(X)(X) | 1,748. | 1,764. | 1,807. | 1,857. | 1,895. | 1,956. | 1,990. |
| | | | 36" | R3R1CX14936 (X)(X)(X)(X)(X)(X) | 1,872. | 1,886. | 1,929. | 1,978. | 2,015. | 2,078. | 2,111. |
| | | 42" | R3R1CX14942 (X)(X)(X)(X)(X)(X) | 1,992. | 2,010. | 2,050. | 2,100. | 2,138. | 2,200. | 2,232. | |
| | | 48" | R3R1CX14948 (X)(X)(X)(X)(X)(X) | 2,115. | 2,132. | 2,174. | 2,223. | 2,260. | 2,323. | 2,356. | |
| | 64" | 18" | R3R1CX16418 (X)(X)(X)(X)(X)(X) | 1,723. | 1,746. | 1,801. | 1,867. | 1,916. | 2,000. | 2,045. | |
| | | 24" | R3R1CX16424 (X)(X)(X)(X)(X)(X) | 1,895. | 1,915. | 1,972. | 2,038. | 2,089. | 2,172. | 2,215. | |
| | | 30" | R3R1CX16430 (X)(X)(X)(X)(X)(X) | 2,063. | 2,086. | 2,142. | 2,208. | 2,257. | 2,341. | 2,385. | |
| | | 36" | R3R1CX16436 (X)(X)(X)(X)(X)(X) | 2,234. | 2,256. | 2,312. | 2,378. | 2,428. | 2,511. | 2,556. | |
| | | 42" | R3R1CX16442 (X)(X)(X)(X)(X)(X) | 2,406. | 2,427. | 2,482. | 2,549. | 2,598. | 2,682. | 2,726. | |
| | | 48" | R3R1CX16448 (X)(X)(X)(X)(X)(X) | 2,575. | 2,596. | 2,653. | 2,717. | 2,768. | 2,851. | 2,895. | |

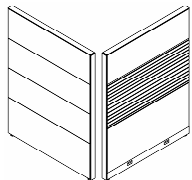

both sides 64x48 shown, 42" & 49" h do not have insert above slatwall section

Panels

| Order Code | Specification Information | Application Notes |
|---|--|---|
| Example: R3R1CX14218EAA4K 613W359-Y319AA | <i>To order please specify pattern number including:</i> | Tiled side includes panel reveals between V1 inserts. Aluminum vertical hookstrip cover ordered separately. Tiled side inserts extend to the floor, there is no base raceway on this panel side. Be sure to specify power rails for panels with one sided base raceways. |
| R3 | 1. Height | Slatwall/fabric side combination: Slatwall above worksurface is nominally 15" h for 42" high panels, and 22 1/2" h for both 49" and 64" high panels. Fabric insert begins at just below worksurface height to the base raceway. (64" high panels also have a fabric insert above the slatwall section). |
| R1 | 2. Width | |
| C | 3. Extruded Aluminum Top Trim | |
| X | 4. Finish, Aluminum trim (top trim and tile dividers/reveals) | |
| 1 | 5. Base raceway height | |
| 42 | 6. Knock-out option | |
| 18 | 7. Base raceway finish | |
| E | 8. Fabric selection | |
| AA | 9. Finish, V1 Techwood | |
| 4 | 10. Finish, Slatwall | |
| K | <i>Anodized aluminum or painted finish options listed on page 9 excluding silver</i> | Black PVC hookstrip reveals should be ordered for panel side with slatwall. |
| 613 | <i>Anodized aluminum or painted finish options listed on page 9 excluding silver</i> | Panels on this page will accept standard Reff System stacking window modules. |
| W359- | <i>Anodized aluminum or painted finish options listed on page 9 excluding silver</i> | |
| Y319 | <i>Anodized aluminum or painted finish options listed on page 9 excluding silver</i> | |
| AA | See page 7 for finish options applicable. | Panels with slatwall one or both sides do not accommodate ported power or data modules 42" and 49" h panels on this page will not accept frameless glass add-ups. Slatwall stiffener bracket recommended when installing multiple Wishbone monitor arms. See page 106. |

Tiled one side - V2 Natural/Slatwall and Fabric other side

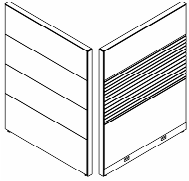
| description | h | w | pattern no. | Grade | | | | | | | | |
|---|---|---------------------------------|---------------------------------|---------------------------------|---------------------------------|----------|----------|----------|----------|----------|----------|--------|
| | | | | 10 | 15 | 20 | 30 | 35 | 40 | 45 | | |
| Tiled V2 natural one side, slatwall/fabric other side (tiled side without base raceway) |  | 18" | R3R1CX24218 | () () () () () () () () | \$1,418. | \$1,431. | \$1,467. | \$1,514. | \$1,546. | \$1,598. | \$1,626. | |
| | | 24" | R3R1CX24224 | () () () () () () () () | 1,537. | 1,550. | 1,584. | 1,634. | 1,665. | 1,716. | 1,746. | |
| | | 30" | R3R1CX24230 | () () () () () () () () | 1,656. | 1,669. | 1,703. | 1,752. | 1,784. | 1,835. | 1,864. | |
| | | 36" | R3R1CX24236 | () () () () () () () () | 1,775. | 1,788. | 1,823. | 1,873. | 1,902. | 1,955. | 1,983. | |
| | | 42" | R3R1CX24242 | () () () () () () () () | 1,895. | 1,908. | 1,942. | 1,991. | 2,023. | 2,075. | 2,102. | |
| | | 48" | R3R1CX24248 | () () () () () () () () | 2,013. | 2,026. | 2,061. | 2,110. | 2,142. | 2,192. | 2,222. | |
| | | 49" | 18" | R3R1CX24918 | () () () () () () () () | 1,568. | 1,584. | 1,626. | 1,677. | 1,714. | 1,776. | 1,809. |
| | | 24" | R3R1CX24924 | () () () () () () () () | 1,707. | 1,723. | 1,764. | 1,815. | 1,852. | 1,914. | 1,947. | |
| | | 30" | R3R1CX24930 | () () () () () () () () | 1,845. | 1,862. | 1,902. | 1,953. | 1,991. | 2,052. | 2,086. | |
| | | 36" | R3R1CX24936 | () () () () () () () () | 1,984. | 2,001. | 2,042. | 2,093. | 2,130. | 2,192. | 2,227. | |
| 42" | R3R1CX24942 | () () () () () () () () | 2,123. | 2,140. | 2,180. | 2,231. | 2,269. | 2,330. | 2,365. | | | |
| 48" | R3R1CX24948 | () () () () () () () () | 2,262. | 2,280. | 2,322. | 2,371. | 2,409. | 2,472. | 2,505. | | | |
| 64" | 18" | R3R1CX26418 | () () () () () () () () | 1,809. | 1,832. | 1,886. | 1,953. | 2,003. | 2,086. | 2,130. | | |
| 24" | R3R1CX26424 | () () () () () () () () | 2,001. | 2,024. | 2,079. | 2,147. | 2,196. | 2,279. | 2,323. | | | |
| 30" | R3R1CX26430 | () () () () () () () () | 2,193. | 2,216. | 2,273. | 2,339. | 2,389. | 2,472. | 2,515. | | | |
| 36" | R3R1CX26436 | () () () () () () () () | 2,387. | 2,409. | 2,464. | 2,530. | 2,579. | 2,664. | 2,708. | | | |
| 42" | R3R1CX26442 | () () () () () () () () | 2,578. | 2,601. | 2,656. | 2,723. | 2,772. | 2,855. | 2,901. | | | |
| 48" | R3R1CX26448 | () () () () () () () () | 2,771. | 2,793. | 2,848. | 2,915. | 2,965. | 3,047. | 3,093. | | | |

both sides 64x48 shown, 42" & 49" h do not have insert above slatwall section

| Order Code | Specification Information | Application Notes |
|---|---|--|
| Example: R3R1CX24218EAA4K 613W359-V316AA | <i>To order please specify pattern number including:</i> | Tiled side includes panel reveals between V2 inserts. Aluminum vertical hookstrip cover ordered separately. Tiled side inserts extend to the floor, there is no base raceway on this panel side. Be sure to specify power rails for panels with one sided base raceways. |
| R3 AutoStrada w/generation 3 frame | 1. Height | Panels with slatwall one or both sides do not accommodate ported power or data modules 42" and 49" h panels on this page will not accept frameless glass add-ups. Slatwall stiffener bracket recommended when installing multiple Wishbone monitor arms. See page 106. |
| R1 Base raceway slatwall combo side only | 2. Width | |
| C Tiled one side, Slatwall combo other | 3. Extruded Aluminum Top Trim | |
| X Fabric/Slatwall combo side | <i>E - default</i> | |
| 2 V2 Natural, tiled side | 4. Finish, Aluminum trim (top trim and tile dividers/reveals) | |
| 42 42" high | <i>Anodized aluminum or painted finish options listed on page 9 excluding silver.</i> | |
| 18 18" wide | 5. Base raceway height | |
| E Extruded Aluminum top trim | <i>4 = 4" h, default</i> | |
| AA Top Trim anodized aluminum finish | 6. Knock-out option | |
| 4 4" high base raceway | <i>K = with knock-outs</i> | |
| K Knock-outs in base raceway | <i>N = no knock-outs</i> | |
| 613 Finish, base raceway | 7. Base raceway finish | Panels on this page will accept standard Reff System stacking window modules. |
| W359- Finish, Fabric (combo side) | <i>Painted or plated finish options only</i> | |
| V316 Finish, Maple (tiled side) | 8. Fabric selection | |
| AA Finish, Slatwall | 9. Finish, V2 Natural | |
| | 10. Finish, Slatwall | |
| | <i>Anodized aluminum or painted finish options listed on page 9 excluding silver</i> | |
| | See page 7 for finish options applicable. | |
| | | |
| | | |
| | | |

Tiled one side/Slatwall combo other
 Tiled one side - V3 Exotic/Slatwall and Fabric other side

| description | h | w | pattern no. | Grade | | | | | | | |
|--|-----|-----|--|--|----------|----------|----------|----------|----------|----------|--------|
| | | | | 10 | 15 | 20 | 30 | 35 | 40 | 45 | |
| Tiled V3 exotic one side, slatwall/fabric other side (tiled side without base raceway) | 42" | 18" | R3R1CX34218 () () () () () () () () | \$1,867. | \$1,885. | \$1,930. | \$1,993. | \$2,035. | \$2,101. | \$2,139. | |
| | | 24" | R3R1CX34224 () () () () () () () () | 2,022. | 2,039. | 2,084. | 2,148. | 2,189. | 2,255. | 2,294. | |
| | | 30" | R3R1CX34230 () () () () () () () () | 2,176. | 2,193. | 2,240. | 2,301. | 2,344. | 2,411. | 2,449. | |
| | | 36" | R3R1CX34236 () () () () () () () () | 2,330. | 2,350. | 2,394. | 2,457. | 2,499. | 2,565. | 2,603. | |
| | | 42" | R3R1CX34242 () () () () () () () () | 2,488. | 2,505. | 2,549. | 2,613. | 2,654. | 2,721. | 2,757. | |
| | | 48" | R3R1CX34248 () () () () () () () () | 2,642. | 2,658. | 2,704. | 2,767. | 2,809. | 2,875. | 2,913. | |
| | | 49" | 18" | R3R1CX34918 () () () () () () () () | 2,067. | 2,090. | 2,143. | 2,207. | 2,256. | 2,338. | 2,379. |
| | | | 24" | R3R1CX34924 () () () () () () () () | 2,247. | 2,269. | 2,323. | 2,387. | 2,437. | 2,516. | 2,559. |
| | | | 30" | R3R1CX34930 () () () () () () () () | 2,427. | 2,449. | 2,504. | 2,566. | 2,616. | 2,696. | 2,741. |
| | | | 36" | R3R1CX34936 () () () () () () () () | 2,609. | 2,630. | 2,684. | 2,750. | 2,796. | 2,879. | 2,922. |
| | | 42" | R3R1CX34942 () () () () () () () () | 2,789. | 2,810. | 2,864. | 2,929. | 2,978. | 3,058. | 3,103. | |
| | | 48" | R3R1CX34948 () () () () () () () () | 2,971. | 2,991. | 3,045. | 3,110. | 3,160. | 3,241. | 3,284. | |
| | 64" | 18" | R3R1CX36418 () () () () () () () () | 2,390. | 2,418. | 2,491. | 2,576. | 2,642. | 2,750. | 2,807. | |
| | | 24" | R3R1CX36424 () () () () () () () () | 2,640. | 2,668. | 2,742. | 2,827. | 2,892. | 2,999. | 3,057. | |
| | | 30" | R3R1CX36430 () () () () () () () () | 2,891. | 2,919. | 2,990. | 3,078. | 3,142. | 3,249. | 3,307. | |
| | | 36" | R3R1CX36436 () () () () () () () () | 3,140. | 3,169. | 3,241. | 3,326. | 3,392. | 3,499. | 3,559. | |
| | | 42" | R3R1CX36442 () () () () () () () () | 3,389. | 3,420. | 3,493. | 3,577. | 3,643. | 3,751. | 3,809. | |
| | | 48" | R3R1CX36448 () () () () () () () () | 3,641. | 3,670. | 3,740. | 3,828. | 3,893. | 4,001. | 4,058. | |

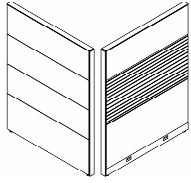

both sides 64x48 shown, 42" & 49" h do not have insert above slatwall section

| Order Code | Specification Information | Application Notes |
|---|---|---|
| Example: R3R1CX34218EAA4K 613W359-V515AA | To order please specify pattern number including: | Tiled side includes panel reveals between V3 inserts. |
| R3 AutoStrada w/generation 3 frame | 1. Height | Aluminum vertical hookstrip cover ordered separately. Tiled side inserts extend to the floor, there is no base raceway on this panel side. |
| R1 Base raceway slatwall combo side only | 2. Width | Be sure to specify power rails for panels with one sided base raceways. |
| C Tiled one side, Slatwall combo other | 3. Extruded Aluminum Top Trim <i>E - default</i> | Slatwall/fabric side combination: Slatwall above worksurface is nominally 15" h for 42" high panels, and 22 1/2" h for both 49" and 64" high panels. Fabric insert begins at just below worksurface height to the base raceway. (64" high panels also have a fabric insert above the slatwall section). |
| X Fabric/Slatwall combo side | 4. Finish, Aluminum trim (top trim and tile dividers/reveals) | Black PVC hookstrip reveals should be ordered for panel side with slatwall. |
| 3 V3 Exotic, tiled side | <i>Anodized aluminum or painted finish options listed on page 9 excluding silver.</i> | Panels on this page will accept standard Reff System stacking window modules. |
| 42 42" high | 5. Base raceway height <i>4 = 4" h, default</i> | |
| 18 18" wide | 6. Knock-out option <i>K = with knock-outs N = no knock-outs</i> | |
| E Extruded Aluminum top trim | 7. Base raceway finish <i>painted or plated finish options only</i> | |
| AA Top Trim anodized aluminum finish | 8. Fabric selection | |
| 4 4" high base raceway | 9. Finish, V3 Exotic | |
| K Knock-outs in base raceway | 10. Finish, Slatwall <i>Anodized aluminum or painted finish options listed on page 9 excluding silver</i> | |
| 613 Finish, base raceway | | |
| W359- Finish, Fabric (combo side) | See page 7 for finish options applicable. | |
| V515 Finish, Quartered Clear Figured Sycamore (tiled side) | | |
| AA Finish, Slatwall | | |

Slatwall/Fabric combo both sides - both sides with base raceway

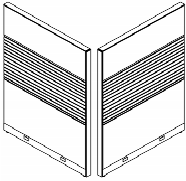
| description | h | w | pattern no. | Grade | | | | | | list |
|--|-----|--|--|----------|----------|----------|----------|----------|----------|----------|
| | | | | 10 | 15 | 20 | 30 | 35 | 40 | |
| Slatwall/Fabric both sides (base raceway both sides)  <i>both sides 64x48 shown, 42"h and 49"h do not have inserts above slatwall sections</i> | 42" | 18" | R3R2SXX4218 () () () () () () () () | \$1,079. | \$1,105. | \$1,174. | \$1,271. | \$1,336. | \$1,439. | \$1,497. |
| | 24" | | R3R2SXX4224 () () () () () () () () | 1,179. | 1,207. | 1,275. | 1,371. | 1,435. | 1,538. | 1,597. |
| | 30" | | R3R2SXX4230 () () () () () () () () | 1,279. | 1,306. | 1,375. | 1,471. | 1,536. | 1,637. | 1,696. |
| | 36" | | R3R2SXX4236 () () () () () () () () | 1,378. | 1,406. | 1,475. | 1,570. | 1,635. | 1,737. | 1,796. |
| | 42" | | R3R2SXX4242 () () () () () () () () | 1,477. | 1,504. | 1,574. | 1,670. | 1,735. | 1,836. | 1,896. |
| | 48" | | R3R2SXX4248 () () () () () () () () | 1,580. | 1,608. | 1,677. | 1,774. | 1,836. | 1,940. | 1,998. |
| | 49" | 18" | R3R2SXX4918 () () () () () () () () | 1,332. | 1,364. | 1,447. | 1,547. | 1,623. | 1,747. | 1,814. |
| | 24" | | R3R2SXX4924 () () () () () () () () | 1,457. | 1,487. | 1,570. | 1,670. | 1,746. | 1,872. | 1,937. |
| | 30" | | R3R2SXX4930 () () () () () () () () | 1,578. | 1,611. | 1,695. | 1,795. | 1,870. | 1,993. | 2,060. |
| | 36" | | R3R2SXX4936 () () () () () () () () | 1,701. | 1,735. | 1,817. | 1,916. | 1,992. | 2,116. | 2,183. |
| | 42" | | R3R2SXX4942 () () () () () () () () | 1,825. | 1,858. | 1,941. | 2,040. | 2,115. | 2,240. | 2,307. |
| | 48" | | R3R2SXX4948 () () () () () () () () | 1,947. | 1,980. | 2,063. | 2,163. | 2,239. | 2,363. | 2,430. |
| | 64" | 18" | R3R2SXX6418 () () () () () () () () | 1,367. | 1,412. | 1,524. | 1,656. | 1,757. | 1,922. | 2,011. |
| | 24" | | R3R2SXX6424 () () () () () () () () | 1,497. | 1,541. | 1,651. | 1,784. | 1,884. | 2,050. | 2,139. |
| 30" | | R3R2SXX6430 () () () () () () () () | 1,625. | 1,669. | 1,779. | 1,913. | 2,013. | 2,178. | 2,268. | |
| 36" | | R3R2SXX6436 () () () () () () () () | 1,753. | 1,799. | 1,910. | 2,041. | 2,142. | 2,308. | 2,395. | |
| 42" | | R3R2SXX6442 () () () () () () () () | 1,883. | 1,926. | 2,038. | 2,172. | 2,271. | 2,437. | 2,525. | |
| 48" | | R3R2SXX6448 () () () () () () () () | 2,011. | 2,054. | 2,164. | 2,298. | 2,397. | 2,564. | 2,653. | |
| Slatwall Stiffener Bracket | 42" | | ASWRB42 | | | | | | | 319. |
| | 49" | | ASWRB49 | | | | | | | 404. |
| | 64" | | ASWRB64 | | | | | | | 427. |
| | 79" | | ASWRB79 | | | | | | | 449. |

| Order Code | Specification Information | Application Notes |
|---|--|---|
| Example: R3R2SXX4218EAA4K613W359-W359-AA | <i>To order please specify pattern number including:</i> | Slatwall/fabric combination: Panels with slatwall one or both sides do not accommodate ported power or data modules. |
| R3 AutoStrada w/generation 3 frame | 1. Height | 42" and 49" panels on this page will not accept frameless glass add-ups. |
| R2 Base raceway both sides | 2. Width | Slatwall stiffener bracket recommended when installing multiple wishbone monitor arms. |
| S Slatwall/Fabric combo both sides | 3. Extruded Aluminum Top Trim <i>E - default</i> | Two recommended for panel widths 42" and 48" w, one for 36" w panels, none for 24" w or 30" w panels. Specify stiffener bracket height to corresponding panel height. |
| X Fabric/Slatwall combo side 1 | 4. Finish, Aluminum trim (top trim and tile dividers/reveals) <i>Anodized aluminum or painted finish options listed on page 9 excluding silver.</i> | |
| X Fabric/Slatwall combo side 2 | 5. Base raceway height <i>4 = 4" h, default</i> | |
| 42 42" high | 6. Knock-out option <i>K = with knock-outs N = no knock-outs</i> | Black PVC hookstrip reveals should be ordered for both panel sides with slatwall. |
| 18 18" wide | 7. Base raceway finish <i>painted or plated finish options only</i> | Panels on this page will accept standard Ref System stacking window modules. |
| E Extruded Aluminum top trim | 8. Fabric selection (side 1) | |
| AA Top Trim anodized aluminum finish | 9. Fabric selection (side 2) | |
| 4 4" high base raceway | 10. Finish, Slatwall <i>Anodized aluminum or painted finish options listed on page 9 excluding silver</i> | |
| K Knock-outs in base raceway | | |
| 613 Finish, base raceway | | |
| W359- Finish, Fabric (side 1) | | |
| W359- Finish, Fabric (side 2) | | |
| AA Finish, Slatwall | See page 7 for finish options applicable. | |

| description | w | d | pattern no. | clear temp | GL13 | list |
|---|-----|---|----------------------------|------------|--------|------|
| Frameless glass add-up 8"h, for panels | 18" | | R3GAU0818 () () | \$263. | \$329. | |
| | 20" | | R3GAU0820 () () | 280. | 355. | |
| | 24" | | R3GAU0824 () () | 298. | 385. | |
| | 30" | | R3GAU0830 () () | 330. | 437. | |
| | 36" | | R3GAU0836 () () | 361. | 491. | |
| | 42" | | R3GAU0842 () () | 417. | 567. | |
| | 48" | | R3GAU0848 () () | 431. | 605. | |
| Frameless glass add-up 12"h, for panels | 18" | | R3GAU1218 () () | 288. | 394. | |
| | 20" | | R3GAU1220 () () | 311. | 432. | |
| | 24" | | R3GAU1224 () () | 331. | 473. | |
| | 30" | | R3GAU1230 () () | 371. | 546. | |
| | 36" | | R3GAU1236 () () | 411. | 620. | |
| | 42" | | R3GAU1242 () () | 476. | 720. | |
| | 48" | | R3GAU1248 () () | 499. | 780. | |
| Frameless glass add-up 15"h, for panels | 18" | | R3GAU1518 () () | 298. | 419. | |
| | 20" | | R3GAU1520 () () | 322. | 464. | |
| | 24" | | R3GAU1524 () () | 345. | 506. | |
| | 30" | | R3GAU1530 () () | 387. | 590. | |
| | 36" | | R3GAU1536 () () | 430. | 672. | |
| | 42" | | R3GAU1542 () () | 498. | 782. | |
| | 48" | | R3GAU1548 () () | 527. | 849. | |
| Frameless glass add-up 8"h, for panels for hi/lo condition no post involved | 18" | | R3GAUHL0818 () () | 263. | 329. | |
| | 20" | | R3GAUHL0820 () () | 280. | 355. | |
| | 24" | | R3GAUHL0824 () () | 298. | 385. | |
| | 30" | | R3GAUHL0830 () () | 330. | 437. | |
| | 36" | | R3GAUHL0836 () () | 361. | 491. | |
| | 42" | | R3GAUHL0842 () () | 417. | 567. | |
| | 48" | | R3GAUHL0848 () () | 431. | 605. | |

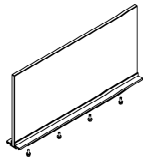

Panels

| Order Code | Specification Information | Application Notes |
|---|--|---|
| Example: R3GAU0818GL13AA | <i>To order please specify pattern number including:</i> | Frameless glass add-ups only for use with non-progressive tile construction panels with at least one side fabric tiles. |
| R3 AutoStrada w/generation 3 frame | 1. Height | It is necessary to order replacement post caps and end trim caps to work specifically with frameless glass add-up modules. |
| GAU Glass add-up | 08 = 42"h panel with add-up will align with top of 49"h panel | <i>To order please specify pattern number including configuration condition:</i> |
| 08 height | 12 = 49"h panel with add-up will align with 48"h spine with spine add-up (overall height 61" nominal) | 1 = add-up on one side of post |
| 18 width | 15 = add-up will align with tile segments of 34"h, 49"h or 64"h panels (ie: 34"h panel with add-up align to 49"h panel) | 2 = add-ups on two sides of post |
| GL13 glass finish, powder | 2. Width | 3 = add-ups on three sides of post (applicable T and X post caps) |
| AA finish, capture/trim | 3. Glass Finish | 4 = add-ups on four sides of post (applicable X post caps only) |
| | <i>TEMP = clear tempered glass</i> | |
| | <i>GL13 = powder</i> | |
| | 4. Finish, capture/trim | Finish: Anodized aluminum or painted finish options as listed on page 7 excluding silver |
| | <i>Anodized aluminum or painted finish options listed on page 7 excluding silver</i> | |

| description | w | d | pattern no. | clear temp | GL13 | list |
|--|-----|---|----------------------------|------------|--------|------|
| Frameless glass add-up 12”h, for panels for hi/lo condition no post involved | 18” | | R3GAUHL1218 () () | \$288. | \$394. | |
| | 20” | | R3GAUHL1220 () () | 311. | 432. | |
| | 24” | | R3GAUHL1224 () () | 331. | 473. | |
| | 30” | | R3GAUHL1230 () () | 371. | 546. | |
| | 36” | | R3GAUHL1236 () () | 411. | 620. | |
| | 42” | | R3GAUHL1242 () () | 476. | 720. | |
| | 48” | | R3GAUHL1248 () () | 499. | 780. | |
| Frameless glass add-up 15”h, for panels for hi/lo condition no post involved | 18” | | R3GAUHL1518 () () | 298. | 419. | |
| | 20” | | R3GAUHL1520 () () | 322. | 464. | |
| | 24” | | R3GAUHL1524 () () | 345. | 506. | |
| | 30” | | R3GAUHL1530 () () | 387. | 590. | |
| | 36” | | R3GAUHL1536 () () | 430. | 672. | |
| | 42” | | R3GAUHL1542 () () | 498. | 782. | |
| | 48” | | R3GAUHL1548 () () | 527. | 849. | |
| Add-up Alignment Clip, pack of 10 | | | R3AUAC10 | | | 27. |

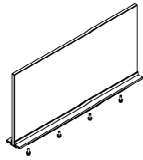

Alignment clips recommended to ensure glass alignment of add-up modules in side by side applications

| Order Code | Specification Information | Application Notes |
|---|--|---|
| Example: R3GAU0818GL13AA | <i>To order please specify pattern number including:</i> | Frameless glass add-ups only for use with non-progressive tile construction panels with at least one side fabric tiles. |
| R3 AutoStrada w/generation 3 frame | 1. Height | It is necessary to order replacement post caps and end trim caps to work specifically with frameless glass add-up modules. |
| GAU Glass add-up | 08 = 42”h panel with add-up will align with top of 49”h panel | <i>To order please specify pattern number including configuration condition:</i> |
| 08 height | 12 = 49”h panel with add-up will align with 48”h spine with spine add-up (overall height 61” nominal) | 1 = add-up on one side of post |
| 18 width | 15 = add-up will align with tile segments of 34”h, 49”h or 64”h panels (ie: 34”h panel with add-up align to 49”h panel) | 2 = add-ups on two sides of post |
| GL13 glass finish, powder | 2. Width | 3 = add-ups on three sides of post (applicable T and X post caps) |
| AA finish, capture/trim | 3. Glass Finish | 4 = add-ups on four sides of post (applicable X post caps only) |
| | <i>TEMP = clear tempered glass</i> | |
| | <i>GL13 = powder</i> | |
| | 4. Finish, capture/trim | Finish: Anodized aluminum or painted finish options as listed on page 7 excluding silver |
| | <i>Anodized aluminum or painted finish options listed on page 7 excluding silver</i> | |

Posts, panels

T post

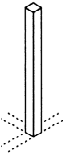
| description | h | pattern no. | list |
|--|-----|------------------------------|--------|
|  T post, tiled laminate (no base plate) | 34" | R3R0TTL34 () () () | \$208. |
| | 42" | R3R0TTL42 () () () | 228. |
| | 49" | R3R0TTL49 () () () | 259. |
| | 64" | R3R0TTL64 () () () | 286. |
| T post, tiled V1 techwood (no base plate) | 34" | R3R0TT134 () () () | 219. |
| | 42" | R3R0TT142 () () () | 240. |
| | 49" | R3R0TT149 () () () | 271. |
| | 64" | R3R0TT164 () () () | 300. |
| T post, tiled V2 natural (no base plate) | 34" | R3R0TT234 () () () | 241. |
| | 42" | R3R0TT242 () () () | 263. |
| | 49" | R3R0TT249 () () () | 297. |
| | 64" | R3R0TT264 () () () | 329. |
| T post, tiled V3 exotic (no base plate) | 34" | R3R0TT334 () () () | 313. |
| | 42" | R3R0TT342 () () () | 342. |
| | 49" | R3R0TT349 () () () | 388. |
| | 64" | R3R0TT364 () () () | 429. |
| T post, monolithic V1 techwood (no base plate) | 42" | R3R0TP142 () () () | 240. |
| | 49" | R3R0TP149 () () () | 271. |

| Order Code | Specification Information | Application Notes |
|--|---|--|
| Example: R3R0TTL34E2AA118 | <i>To order please specify pattern number including:</i> | 5. Finish, Aluminum trim (top cap and reveals) <i>Anodized aluminum or painted finish options listed on page 9 excluding silver</i> |
| R3 AutoStrada w/generation 3 post | 1. Surface <i>L = Painted to match laminate</i> | * Painted to match laminate. |
| R0 No base raceway exposed | <i>V1 = V1 Techwood</i> | |
| T T post | <i>V2 = V2 Natural</i> | |
| T Tiled | <i>V3 = V3 Exotic</i> | |
| L Laminate match | 2. Height | 6. Finish, Tiles <i>Laminate *, V1, V2 or V3 finish</i> |
| 34 34" high | 3. Extruded aluminum top cap <i>E = default</i> | See page 7 for finish options applicable. |
| E Extruded aluminum top cap | 4. Top Cap Configuration <i>1 = Regular L, finished 2 adjacent sides</i> | |
| 2 Regular T cap configuration | <i>2 = Regular T, finished one side</i> | |
| AA Finish, top cap and reveal | <i>3 = Regular X, no sides finished</i> | |
| 118 Finish, tiles | <i>4 = Hi/Lo cap at direction change, finished 3 sides</i> | |
| | <i>5 = Hi/Lo cap in line, finished 2 opposite sides</i> | |

Posts, panels

T post

| description | h | pattern no. | list |
|--|-----|------------------------------|--------|
| T post, monolithic V2 natural (no base plate) | 42" | R3R0TP242 () () () | \$263. |
| | 49" | R3R0TP249 () () () | 297. |
| T post, monolithic laminate (no base plate) | 42" | R3R0TPL42 () () () | 228. |
| | 49" | R3R0TPL49 () () () | 259. |
| T post, monolithic V3 exotic (no base plate) | 42" | R3R0TP342 () () () | 342. |
| | 49" | R3R0TP349 () () () | 388. |

| Order Code | Specification Information | Application Notes |
|--|---|--|
| Example: R3R0TTL34E2AA118 | <i>To order please specify pattern number including:</i> | |
| R3 AutoStrada w/generation 3 post | 1. Surface <i>L = Painted to match laminate</i> | 5. Finish, Aluminum trim (top cap and reveals) <i>Anodized aluminum or painted finish options listed on page 9 excluding silver</i> |
| R0 No base raceway exposed | <i>V1 = V1 Techwood</i> | 6. Finish, Tiles <i>Laminate *, V1, V2 or V3 finish</i> |
| T T post | <i>V2 = V2 Natural</i> | |
| T Tiled | <i>V3 = V3 Exotic</i> | See page 7 for finish options applicable. |
| L Laminate match | 2. Height | |
| 34 34" high | 3. Extruded aluminum top cap <i>E = default</i> | |
| E Extruded aluminum top cap | 4. Top Cap Configuration <i>1 = Regular L, finished 2 adjacent sides</i> | |
| 2 Regular T cap configuration | <i>2 = Regular T, finished one side</i> | |
| AA Finish, top cap and reveal | <i>3 = Regular X, no sides finished</i> | |
| 118 Finish, tiles | <i>4 = Hi/Lo cap at direction change, finished 3 sides</i> | |
| | <i>5 = Hi/Lo cap in line, finished 2 opposite sides</i> | |

Posts, panels

L post, no base plates

| description | h | pattern no. | list |
|---|---------------------------|----------------------------------|--------|
|  L post, tiled (to match) laminate (no base plate) | 34" | R3R0LTL34 () () () () | \$173. |
| | 42" | R3R0LTL42 () () () () | 259. |
| | 49" | R3R0LTL49 () () () () | 286. |
| | 64" | R3R0LTL64 () () () () | 317. |
| | Tiled laminate both sides | | |
| L post, tiled V1 techwood (no base plate) | 34" | R3R0LT134 () () () () | 181. |
| | 42" | R3R0LT142 () () () () | 271. |
| | 49" | R3R0LT149 () () () () | 300. |
| | 64" | R3R0LT164 () () () () | 333. |
| | Tiled V1 both sides | | |
| L post, tiled V2 natural (no base plate) | 34" | R3R0LT234 () () () () | 199. |
| | 42" | R3R0LT242 () () () () | 297. |
| | 49" | R3R0LT249 () () () () | 329. |
| | 64" | R3R0LT264 () () () () | 365. |
| | Tiled V2 both sides | | |
| L post, tiled V3 exotic (no base plate) | 34" | R3R0LT334 () () () () | 258. |
| | 42" | R3R0LT342 () () () () | 388. |
| | 49" | R3R0LT349 () () () () | 429. |
| | 64" | R3R0LT364 () () () () | 474. |
| | Tiled V3 both sides | | |
| L post, monolithic (to match) laminate (no base plate) | 42" | R3R0LPL42 () () () () | 259. |
| | 49" | R3R0LPL49 () () () () | 286. |

Panels

| Order Code | Specification Information | Application Notes |
|--|---|--|
| Example: R3R0LTL34E1AA118 | <i>To order please specify pattern number including:</i> | 5. Post cover configuration |
| R3 AutoStrada w/generation 3 post | 1. Finish type tiles <i>L = Painted to match laminate</i> | 1 = 1 piece (same finish both sides) |
| R0 No base raceway exposed | <i>V1 = V1 Techwood</i> | 2 = 2 piece (same or different finish per side) |
| L L post | <i>V2 = V2 Natural</i> | 6. Finish, Aluminum trim (top cap and reveals) |
| T Tiled (both faces) | <i>V3 = V3 Exotic</i> | <i>Anodized aluminum or painted finish options listed on page 9 excluding silver</i> |
| L Laminate match | 2. Height | 7. Finish, Side 1 |
| 34 34" high | 3. Extruded aluminum top cap <i>E = default</i> | <i>Laminate *, V1, V2 or V3 finish</i> |
| E Extruded aluminum top cap | 4. Top Cap Configuration <i>1 = Regular L, finished 2 adjacent sides</i> | 8. Finish, Side 2 (side 2 finish applicable only when 2 piece post cover configuration selected) |
| 1 Regular L cap configuration | <i>2 = Regular T, finished one side</i> | <i>Laminate *, V1, V2, or V3 finish</i> |
| AA Finish, top cap and reveal | <i>3 = Regular X, no sides finished</i> | |
| 118 Finish, tiles | <i>4 = Hi/Lo cap at direction change, finished 3 sides</i> | |
| | <i>5 = Hi/Lo cap in line, finished 2 opposite sides</i> | |
| | | See page 7 for finish options applicable. |

Posts, panels
L post, no base plates

| description | h | pattern no. | list |
|---|-----|--------------------------------------|--------|
| L post, monolithic V1 techwood (no base plate) | 42" | R3R0LP142 () () () () () | \$271. |
| | 49" | R3R0LP149 () () () () () | 300. |
| L post, monolithic V2 natural (no base plate) | 42" | R3R0LP242 () () () () () | 297. |
| | 49" | R3R0LP249 () () () () () | 329. |
| L post, monolithic V3 exotic (no base plate) | 42" | R3R0LP342 () () () () () | 388. |
| | 49" | R3R0LP349 () () () () () | 429. |

| Order Code | Specification Information | Application Notes |
|--|---|---|
| Example: R3R0LTL34E1AA118 | <i>To order please specify pattern number including:</i> | |
| R3 AutoStrada w/generation 3 post | 1. Finish type tiles <i>L = Painted to match laminate</i> | 5. Post cover configuration 1 = 1 piece (same finish both sides) 2 = 2 piece (same or different finish per side) |
| R0 No base raceway exposed | <i>V1 = V1 Techwood</i> | 6. Finish, Aluminum trim (top cap and reveals) <i>Anodized aluminum or painted finish options listed on page 9 excluding silver</i> |
| L L post | <i>V2 = V2 Natural</i> | 7. Finish, Side 1 <i>Laminate *, V1, V2 or V3 finish</i> |
| T Tiled (both faces) | <i>V3 = V3 Exotic</i> | 8. Finish, Side 2 (side 2 finish applicable only when 2 piece post cover configuration selected) <i>Laminate *, V1, V2, or V3 finish</i> |
| L Laminate match | 2. Height | |
| 34 34" high | 3. Extruded aluminum top cap <i>E = default</i> | |
| E Extruded aluminum top cap | 4. Top Cap Configuration <i>1 = Regular L, finished 2 adjacent sides</i> | |
| 1 Regular L cap configuration | <i>2 = Regular T, finished one side</i> | |
| AA Finish, top cap and reveal | <i>3 = Regular X, no sides finished</i> | |
| 118 Finish, tiles | <i>4 = Hi/Lo cap at direction change, finished 3 sides</i> | |
| | <i>5 = Hi/Lo cap in line, finished 2 opposite sides</i> | |

See page 7 for finish options applicable.

Posts, panels

L post, one face only w/base plate

| description | h | pattern no. | list |
|--|-----|---|--------|
| L post, tiled laminate left face w/o base, fabric/mono right face w/base | 34" | R3R1LALL34 () () () () () () | \$173. |
| | 42" | R3R1LALL42 () () () () () () | 259. |
| | 49" | R3R1LALL49 () () () () () () | 286. |
| | 64" | R3R1LALL64 () () () () () () | 317. |

Laminate side 1, fabric side 2

| | | | |
|--|-----|---|------|
| L post, tiled laminate right face w/o base, fabric/mono left face w/base | 34" | R3R1LARL34 () () () () () () | 173. |
| | 42" | R3R1LARL42 () () () () () () | 259. |
| | 49" | R3R1LARL49 () () () () () () | 286. |
| | 64" | R3R1LARL64 () () () () () () | 317. |



Fabric side 1, laminate side 2

| | | | |
|---|-----|---|------|
| L post, tiled V1 techwood left face w/o base, fabric/mono right face w/base | 34" | R3R1LAL134 () () () () () () | 181. |
| | 42" | R3R1LAL142 () () () () () () | 271. |
| | 49" | R3R1LAL149 () () () () () () | 300. |
| | 64" | R3R1LAL164 () () () () () () | 333. |

V1 side 1, fabric side 2

| | | | |
|---|-----|---|------|
| L post, tiled V1 techwood right face w/o base, fabric/mono left face w/base | 34" | R3R1LAR134 () () () () () () | 181. |
| | 42" | R3R1LAR142 () () () () () () | 271. |
| | 49" | R3R1LAR149 () () () () () () | 300. |
| | 64" | R3R1LAR164 () () () () () () | 333. |



Fabric side 1, V1 side 2

| Order Code | Specification Information | Application Notes |
|---|---|---|
| Example: R3R1LALL34E1AA4N613118W359- | To order please specify pattern number including: | Aluminum vertical hookstrip cover ordered separately. |
| R3 AutoStrada w/generation 3 post | 1. Tiled side L = Tiled left face, monolithic right face R = Tiled right face, monolithic left face | * Painted to match laminate. |
| R1 Base raceway, mono side | 2. Finish type tiled side L = Painted to match laminate V1 = V1 Techwood V2 = V2 Natural V3 = V3 Exotic | See page 7 for finish options applicable. |
| L L post | 3. Height | |
| A Tiled one side/Mono other | 4. Extruded aluminum top cap E = default | |
| L Left face tiled | 5. Top Cap Configuration 1 = Regular L, finished 2 adjacent sides 2 = Regular T, finished one side 3 = Regular X, no sides finished 4 = Hi/Lo cap at direction change, finished 3 sides 5 = Hi/Lo cap in line, finished 2 opposite sides | |
| L Laminate match | 6. Finish, Aluminum trim (top cap and reveals) Anodized aluminum or painted finish options listed on page 9 excluding silver | |
| 34 34" high | 7. Base height 4 = 4" h, default | |
| E Extruded aluminum top cap | 8. Base infeed - applicable for face with base plate only N = None F = Base infeed fabric face side | |
| 1 Regular L cap configuration | 9. Finish, base raceway | |
| AA Finish, top cap and reveal | 10. Finish, Side 1 If side 1 tiled specify laminate *, V1, V2 or V3 finish; If side 1 monolithic specify fabric | |
| 4 4" high base | 11. Finish, Side 2 If side 2 tiled specify laminate *, V1, V2 or V3 finish; If side 2 monolithic specify fabric | |
| N No base infeed | | |
| 613 Finish, base plate | | |
| 118 Finish, tiles | | |
| W359- Finish, fabric (mono side) | | |

Posts, panels

L post, one face only w/base plate

| description | h | pattern no. | list |
|--|-----|---|--------|
| L post, tiled V2 natural left face w/o base, fabric/mono right face w/base | 34" | R3R1LAL234 () () () () () () | \$199. |
| | 42" | R3R1LAL242 () () () () () () | 297. |
| | 49" | R3R1LAL249 () () () () () () | 329. |
| | 64" | R3R1LAL264 () () () () () () | 365. |

V2 side 1, fabric side 2

| | | | |
|--|-----|---|------|
| L post, tiled V2 natural right face w/o base, fabric/mono left face w/base | 34" | R3R1LAR234 () () () () () () | 199. |
| | 42" | R3R1LAR242 () () () () () () | 297. |
| | 49" | R3R1LAR249 () () () () () () | 329. |
| | 64" | R3R1LAR264 () () () () () () | 365. |



Fabric side 1, V2 side 2

| | | | |
|---|-----|---|------|
| L post, tiled V3 exotic left face w/o base, fabric/mono right face w/base | 34" | R3R1LAL334 () () () () () () | 258. |
| | 42" | R3R1LAL342 () () () () () () | 388. |
| | 49" | R3R1LAL349 () () () () () () | 429. |
| | 64" | R3R1LAL364 () () () () () () | 474. |

V3 side 1, fabric side 2



| | | | |
|---|-----|---|------|
| L post, tiled V3 exotic right face w/o base, fabric/mono left face w/base | 34" | R3R1LAR334 () () () () () () | 258. |
| | 42" | R3R1LAR342 () () () () () () | 388. |
| | 49" | R3R1LAR349 () () () () () () | 429. |
| | 64" | R3R1LAR364 () () () () () () | 474. |



Fabric side 1, V3 side 2

| Order Code | Specification Information | Application Notes |
|--|--|--|
| Example: R3R1LALL34E1AA4N 613118W359- | <i>To order please specify pattern number including:</i> | 6. Finish, Aluminum trim (top cap and reveals) <i>Anodized aluminum or painted finish options listed on page 9 excluding silver</i> |
| R3 AutoStrada w/generation 3 post | 1. Tiled side <i>L = Tiled left face, monolithic right face</i> <i>R = Tiled right face, monolithic left face</i> | 7. Base height <i>4 = 4" h, default</i> |
| R1 Base raceway, mono side | 2. Finish type tiled side <i>L = Painted to match laminate</i> <i>V1 = V1 Techwood</i> <i>V2 = V2 Natural</i> <i>V3 = V3 Exotic</i> | 8. Base infeed - applicable for face with base plate only <i>N = None</i> <i>F = Base infeed fabric face side</i> |
| L L post | 3. Height | 9. Finish, base raceway |
| A Tiled one side/Mono other | 4. Extruded aluminum top cap <i>E = default</i> | 10. Finish, Side 1 <i>If side 1 tiled specify laminate *, V1, V2 or V3 finish;</i> <i>If side 1 monolithic specify fabric</i> |
| L Left face tiled | 5. Top Cap Configuration <i>1 = Regular L, finished 2 adjacent sides</i> <i>2 = Regular T, finished one side</i> <i>3 = Regular X, no sides finished</i> <i>4 = Hi/Lo cap at direction change, finished 3 sides</i> <i>5 = Hi/Lo cap in line, finished 2 opposite sides</i> | 11. Finish, Side 2 <i>If side 2 tiled specify laminate *, V1, V2 or V3 finish;</i> <i>If side 2 monolithic specify fabric</i> |
| L Laminate match | | |
| 34 34" high | | |
| E Extruded aluminum top cap | | |
| 1 Regular L cap configuration | | |
| AA Finish, top cap and reveal | | |
| 4 4" high base | | |
| N No base infeed | | |
| 613 Finish, base plate | | |
| 118 Finish, tiles | | |
| W359- Finish, fabric (mono side) | | |

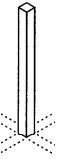
Posts, panels x and straight posts

| description | h | pattern no. | list |
|---|-----|--------------------------------------|--------|
|  X post, universal aluminum top cap | 34" | R3X34E () | \$197. |
| | 42" | R3X42E () | 211. |
| | 49" | R3X49E () | 227. |
| | 64" | R3X64E () | 254. |
|  Straight post, tiled laminate face w/o base, fabric/mono face w/base | 34" | R3R1SAL34 () () () () () | 173. |
| | 42" | R3R1SAL42 () () () () () | 259. |
| | 49" | R3R1SAL49 () () () () () | 286. |
| | 64" | R3R1SAL64 () () () () () | 317. |
| Straight post, tiled V1 techwood face w/o base, fabric/mono face w/base | 34" | R3R1SA134 () () () () () | 181. |
| | 42" | R3R1SA142 () () () () () | 271. |
| | 49" | R3R1SA149 () () () () () | 300. |
| | 64" | R3R1SA164 () () () () () | 333. |
| Straight post, tiled V2 natural face w/o base, fabric/mono face w/base | 34" | R3R1SA234 () () () () () | 199. |
| | 42" | R3R1SA242 () () () () () | 297. |
| | 49" | R3R1SA249 () () () () () | 329. |
| | 64" | R3R1SA264 () () () () () | 365. |

Panels

| Order Code | Order Code | Specification Information |
|--|--|--|
| Example: R3X34E3AA R3 AutoStrada w/generation 3 Post X X post 34 34" high E Extruded aluminum top cap 3 Regular X cap configuration AA Finish, aluminum top cap | Example: R3R1SAL34E1AA4 N613118W359- R3 AutoStrada w/generation 3 Post R1 Base raceway, fabric mono side S Straight post A Tiled one face/mono other L Tiled face, Laminate match 34 34" high E Extruded aluminum top cap 1 Reg L cap config AA Finish, aluminum top cap & reveal 4 4" high base N No base infeed 613 Finish, base raceway 118 Finish, tiled side W359- Finish, mono side | To order please specify pattern number including: 1. Post type <i>X = X post</i> <i>S = Straight post</i> 2. Tiled surface type (applicable straight posts only, embedded in pattern number) <i>L = Painted to match laminate</i> <i>1 = V1 Techwood</i> <i>2 = V2 Natural</i> <i>3 = V3 Exotic</i> 3. Height <i>E = default</i> 4. Extruded aluminum top cap <i>E = default</i> 5. Top Cap Configuration <i>1 = Regular L, finished 2 adjacent sides</i> <i>2 = Regular T, finished one side</i> <i>3 = Regular X, no sides finished</i> <i>4 = Hi/Lo cap at direction change, finished 3 sides</i> <i>5 = Hi/Lo cap in line, finished 2 opposite sides</i> 6. Finish, Aluminum top cap and reveals <i>Anodized aluminum or painted finish options listed on page 9 excluding silver</i> 7. Base height <i>4 = 4" h, default</i> 8. Base infeed (applicable straight posts only) <i>N = None</i> <i>F = Base infeed fabric face side</i> 9. Finish, base raceway (applicable straight posts only) 10. Finish, Tiled side <i>Laminate *, V1, V2 or V3 finish</i> 11. Finish, mono side <i>Fabric selection</i> See page 7 for finish options applicable. Aluminum vertical hookstrip cover ordered separately. * Painted to match laminate. |

Posts, panels *x and straight posts*

| description | h | pattern no. | list |
|--|-----|--------------------------------------|--------|
| Straight post, tiled V3 exotic face w/o base, fabric/mono face w/base | 34" | R3R1SA334 () () () () () | \$258. |
| | 42" | R3R1SA342 () () () () () | 388. |
| | 49" | R3R1SA349 () () () () () | 429. |
| | 64" | R3R1SA364 () () () () () | 474. |
| Straight post, monolithic (to match) laminated (no base plate) | 42" | R3R0SPL42 () () () | 259. |
| | 49" | R3R0SPL49 () () () | 286. |
| Straight post, monolithic V1 techwood (no base plate) | 42" | R3R0SP142 () () () | 271. |
| | 49" | R3R0SP149 () () () | 300. |
| Straight post, monolithic V2 natural (no base plate) | 42" | R3R0SP242 () () () | 297. |
| | 49" | R3R0SP249 () () () | 329. |
| Straight post, monolithic V3 exotic (no base plate) | 42" | R3R0SP342 () () () | 388. |
| | 49" | R3R0SP349 () () () | 429. |

| Order Code | Order Code | Specification Information |
|--|---|--|
| Example: R3X34E3AA | Example: R3R1SAL34E1AA4 N613118W359- | <i>To order please specify pattern number including:</i> |
| R3 AutoStrada w/generation 3 Post | R3 AutoStrada w/generation 3 Post | 6. Finish, Aluminum top cap and reveals <i>Anodized aluminum or painted finish options listed on page 9 excluding silver</i> |
| X X post | R1 Base raceway, fabric mono side | 7. Base height <i>4 = 4" h, default</i> |
| 34 34" high | S Straight post | 8. Base infeed (applicable straight posts only) <i>N = None</i> |
| E Extruded aluminum top cap | A Tiled one face/mono other | 9. Finish, tiled side <i>Laminate *, V1, V2 or V3 finish</i> |
| 3 Regular X cap configuration | L Tiled face, Laminate match | 11. Finish, mono side <i>Fabric selection</i> |
| AA Finish, aluminum top cap | 34 34" high | See page 7 for finish options applicable. |
| | E Extruded aluminum top cap | Aluminum vertical hookstrip cover ordered separately. |
| | 1 Reg L cap config | * Painted to match laminate. |
| | AA Finish, aluminum top cap & reveal | |
| | 4 4" high base | |
| | N No base infeed | |
| | 613 Finish, base raceway | |
| | 118 Finish, tiled side | |
| | W359- Finish, mono side | |
| | | 1. Post type <i>X = X post</i> <i>S = Straight post</i> |
| | | 2. Tiled surface type (applicable straight posts only, embedded in pattern number) <i>L = Painted to match laminate</i> <i>1 = V1 Techwood</i> <i>2 = V2 Natural</i> <i>3 = V3 Exotic</i> |
| | | 3. Height |
| | | 4. Extruded aluminum top cap <i>E = default</i> |
| | | 5. Top Cap Configuration <i>1 = Regular L, finished 2 adjacent sides</i> <i>2 = Regular T, finished one side</i> <i>3 = Regular X, no sides finished</i> <i>4 = Hi/Lo cap at direction change, finished 3 sides</i> <i>5 = Hi/Lo cap in line, finished 2 opposite sides</i> |

Trim, panels aluminum reveals

| description | h | w | pattern no. | AA or paint |
|--|-------|---------------------|---------------------|-------------|
| Aluminum hookstrip cover condition including stacking modules without exposed 4" raceway | 33.5" | | R2AHCN34 () | \$61. |
| | 41.5" | | R2AHCN42 () | 75. |
| | 48.5" | | R2AHCN49 () | 87. |
| | 63.5" | | R2AHCN64 () | 116. |
| | 78.5" | | R2AHCN79 () | 147. |
| Aluminum hookstrip cover condition including stacking modules with 4"h base raceway. | 30" | | R2AHCR34 () | 61. |
| | 38" | | R2AHCR42 () | 75. |
| | 45" | | R2AHCR49 () | 87. |
| | 60" | | R2AHCR64 () | 116. |
| | 75" | | R2AHCR79 () | 145. |
| Alum horizontal reveal for between base panel and stacking window module | | 18" | R2AHWR18 () | 36. |
| | | 20" | R2AHWR20 () | 36. |
| | | 24" | R2AHWR24 () | 38. |
| | | 30" | R2AHWR30 () | 39. |
| | | 36" | R2AHWR36 () | 43. |
| | | 42" | R2AHWR42 () | 45. |
| Alum horizontal reveal for between two stacking window modules or between stacking and window modules or between two stacking modules | | 18" | R2AHBW18 () | 36. |
| | | 20" | R2AHBW20 () | 36. |
| | | 24" | R2AHBW24 () | 38. |
| | | 30" | R2AHBW30 () | 39. |
| | | 36" | R2AHBW36 () | 43. |
| | | 42" | R2AHBW42 () | 45. |
| Alum horizontal reveal for between base panel and stacking module (FL/F1/F2) | | 18" | R2AHSR18 () | 36. |
| | | 20" | R2AHSR20 () | 36. |
| | | 24" | R2AHSR24 () | 38. |
| | | 30" | R2AHSR30 () | 39. |
| | | 36" | R2AHSR36 () | 43. |
| | | 42" | R2AHSR42 () | 45. |
| | 48" | R2AHSR48 () | 50. | |

Panels

| Order Code | Specification Information | Application Notes |
|-------------------------------------|---|---|
| Example: R2AHCN34 AA | <i>To order please specify pattern number including:</i> 1. Height or 2. Width 3. Finish <i>Anodized aluminum or painted finish options listed on page 7 excluding silver</i> | Aluminum hookstrip covers best suited for hard side (laminare, V1, V2 or V3) of panels only. Not recommended for fabric tiled side of panels. Recommend use on outside of stations/clusters only. When and where aluminum vertical hookstrip cover installed, forfeit panel hung capability. |
| R2 AutoStrada/Reff | | |
| A Aluminum | | |
| HC Hookstrip cover | | |
| N No exposed raceway | | |
| 34 for 34"h | | |
| AA Finish, anodized aluminum | | |

Trim, panels end trim and post trim

| description | height | to height | width | pattern no. | list |
|--|--------|-----------|-------|----------------------|--------|
|  Aluminum end trim (full height), w/hookstrip | 34" | | | A1FHETE34 () | \$125. |
| | 42" | | | A1FHETE42 () | 146. |
| | 49" | | | A1FHETE49 () | 167. |
| | 64" | | | A1FHETE64 () | 188. |

| | | | | | |
|--|-----|-----|--|------------------------|------|
|  Aluminum end trim for Hi/Lo w/hookstrip (no post involved) | 34" | 42" | | A1HLETE3442 () | 110. |
| | 34" | 49" | | A1HLETE3449 () | 112. |
| | 34" | 64" | | A1HLETE3464 () | 115. |
| | 42" | 49" | | A1HLETE4249 () | 110. |
| | 42" | 64" | | A1HLETE4264 () | 112. |
| | 49" | 64" | | A1HLETE4964 () | 115. |

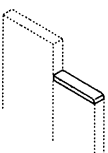

| | | | | | |
|---|-----|-----|--|---------------------------------|-----|
|  Post cover trim for Hi/Lo (post involved) | 34" | 42" | | A1HLPTE3442 () | 29. |
| | 34" | 49" | | A1HLPTE3449 () | 43. |
| | 34" | 64" | | A1HLPTE3464 (F/T)() () | 86. |
| | 42" | 49" | | A1HLPTE4249 () | 29. |
| | 42" | 64" | | A1HLPTE4264 (F/T)() () | 72. |
| | 49" | 64" | | A1HLPTE4964 () | 43. |

Finish options fabric, V1, V2, V3 or painted to match laminate only, not available in AA anodized aluminum.

| | | | | | |
|---|--|-----|---------------------|---------------------|-----|
|  Alum Top Trim for Hi/Lo condition, no post involved | | | 18" | AHLTTE18 () | 21. |
| | | | 20" | AHLTTE20 () | 23. |
| | | | 24" | AHLTTE24 () | 26. |
| | | | 30" | AHLTTE30 () | 31. |
| | | | 36" | AHLTTE36 () | 41. |
| | | | 42" | AHLTTE42 () | 42. |
| | | 48" | AHLTTE48 () | 57. | |

| Order Code | Specification Information | Application Notes |
|-------------------------------------|---|--|
| Example: A1HLETE3442AA | <i>To order please specify pattern number including:</i> | |
| A AutoStrada | | 3. If (T) for tiled cover set, specify tile divider finish B - Black reveal E - painted silver to match AA extruded aluminum panel reveal or painted finish options listed on page 7 |
| 1 Generation 1 | 1. Hi/Lo Condition <i>ETE = End trim, no post w/hookstrip, height changes does not involve a post</i> <i>PTE = Post end trim, height change involves post</i> | Aluminum end trim (full height), with hookstrip does not have base plate detail. |
| HL Hi/Lo | | Post cover trim for hi/lo conditions are available in choice of fabric, V1, V2, V3 or painted to match laminate finishes only. |
| ET End Trim | | |
| E Extruded Aluminum Profile | | |
| 3442 34"h to 42"h | 2. Hi/Lo Height 3442 = 34"h to 42"h 3449 = 34"h to 49"h 3464 = 34"h to 64"h * 4249 = 42"h to 49"h 4264 = 42"h to 64"h * 4964 = 49"h to 64"h | 4. Finish <i>If end trim: Anodized aluminum or painted finish options listed on page 9 excluding silver</i> <i>If post cover trim: () fabric, V1,V2,V3 or painted to match laminate</i> |
| AA Finish, anodized aluminum | | See page 7 for finish options applicable. |
| | *Applicable for post cover trim: Specify (F) for full monolithic cover or (T) for tiled cover set. | |

Trim, panels
full length top trim

| description | width | pattern no. | paint | AA |
|---|-------|-----------------------|-------|-------|
| Continuous run top trim  | 60" | A1CRTT60 () | \$79. | \$79. |
| | 66" | A1CRTT66 () | 79. | 79. |
| | 72" | A1CRTT72 () | 85. | 85. |
| | 78" | A1CRTT78 () | 85. | 85. |
| | 84" | A1CRTT84 () | 97. | 97. |
| | 90" | A1CRTT90 () | 128. | 128. |
| | 96" | A1CRTT96 () | 128. | 128. |
| | 102" | A1CRTT102 () | n/a | 139. |
| | 108" | A1CRTT108 () | n/a | 139. |
| | 114" | A1CRTT114 () | n/a | 139. |
| | 120" | A1CRTT120 () | n/a | 139. |
| | 126" | A1CRTT126 () | n/a | 146. |
| | 132" | A1CRTT132 () | n/a | 146. |
| | 138" | A1CRTT138 () | n/a | 152. |
| | 144" | A1CRTT144 () | n/a | 152. |
| Continuous run top trim for Hi/Lo conditions  | 60" | A1CHLTT60 () | 79. | 79. |
| | 66" | A1CHLTT66 () | 79. | 79. |
| | 72" | A1CHLTT72 () | 85. | 85. |
| | 78" | A1CHLTT78 () | 85. | 85. |
| | 84" | A1CHLTT84 () | 97. | 97. |
| | 90" | A1CHLTT90 () | 128. | 128. |
| | 96" | A1CHLTT96 () | 128. | 128. |
| | 102" | A1CHLTT102 () | n/a | 139. |
| | 108" | A1CHLTT108 () | n/a | 139. |
| | 114" | A1CHLTT114 () | n/a | 139. |
| | 120" | A1CHLTT120 () | n/a | 139. |
| | 126" | A1CHLTT126 () | n/a | 146. |
| | 132" | A1CHLTT132 () | n/a | 146. |
| | 138" | A1CHLTT138 () | n/a | 152. |
| | 144" | A1CHLTT144 () | n/a | 152. |

Order Code

| | |
|-----------|---------------------------|
| Example: | A1CRTT60AA |
| A | AutoStrada |
| 1 | Generation 1 |
| CR | Continuous Run |
| TT | Top Trim |
| 60 | 60" wide |
| AA | Finish, anodized aluminum |

Specification Information

To order please specify pattern number including:

1. Width
2. Finish, where applicable
Up to and including 96" w AA anodized aluminum or painted finish options listed on page 7 excluding silver

Only available in AA-anodized aluminum over 96" w

Application Notes

Continuous run top trim for spanning multiple panels with one piece of trim. Continuous run top trim ships with "W" clips which secures trim to panel frame.

Trim, panels

panel trim and install aids

| description | type | h | pattern no. | list |
|---|------------------------------------|-----|-----------------|------|
| Hookstrip cover strips, black flexible PVC | 15 pcs/pack | 79" | RHSC15 | \$0. |
| | 70 pcs/pack | 79" | RHSC70 | 0. |
| | 250 pcs/pack | 79" | RHSC250 | 0. |
| cut to size to fit during installation recommended use interior of station or where aluminum vertical reveals not installed | | | | |
| Panel alignment kits | panel-to-panel | | RSPABPP | 6. |
| | window-to-panel | | RSPABPW | 6. |
| | window-to-window | | RSPABWW | 6. |
| | stacking module-to-panel | | R3SPABPT | 6. |
| | stacking module-to-stacking module | | R3SPABTT | 6. |
| | window-to-stacking module | | R3SPABTW | 6. |
| Panel leveling plates | 10 pcs/pack | | APLP10 | 37. |
| | 25 pcs/pack | | APLP25 | 83. |
| Carpet grippers | 10 pcs/pack | | R2CG | 20. |

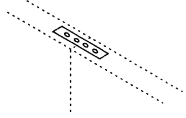

| Order Code | Specification Information | Application Notes |
|------------------------|--|--|
| Example: APLP10 | <i>To order please specify pattern number including:</i> 1. Pack quantity required | Panel leveling plates are for installation aid only. The plate fits on top of the hookstrip connecting two panels and spans the joint between the panels. Simply drop the plate in the cavity between the two panels, tighten top wedges as you would normally during installation. The dimension and shape will force panel alignment. Remove the plate and proceed onto the next connection. |
| A AutoStrada | | |
| P Panel | | |
| L Leveling | | |
| P Plates | | |
| 10 Pack of 10 | Panel alignment kits are required for stacking modules and long panel runs. Panel alignment kits are required at the highest point of each panel and stacking module connection. They are recommended when panels are supporting overhead storage. One alignment bracket required for every two panels. Please refer to Reff planning guide, page 45 for additional information. | |

| description | type | h | w | d | pattern no. | list |
|---|-----------|----|-----|----|-----------------|--------|
| Power rail for panel with one side only base raceway (8 wire) | 24" panel | 2" | 6" | 2" | RR3-E24S | \$139. |
| | 30" panel | 2" | 12" | 2" | RR3-E30S | 160. |
| | 36" panel | 2" | 18" | 2" | RR3-E36S | 175. |
| | 42" panel | 2" | 24" | 2" | RR3-E42S | 189. |
| | 48" panel | 2" | 30" | 2" | RR3-E48S | 194. |

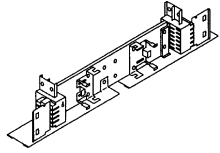

| | | | | | | |
|--|-----------|----|-----|----|-----------------|------|
| Power rail for panel with one side only base raceway (10 wire) | 24" panel | 2" | 6" | 2" | RR3-T24S | 167. |
| | 30" panel | 2" | 12" | 2" | RR3-T30S | 182. |
| | 36" panel | 2" | 18" | 2" | RR3-T36S | 194. |
| | 42" panel | 2" | 24" | 2" | RR3-T42S | 211. |
| | 48" panel | 2" | 30" | 2" | RR3-T48S | 216. |

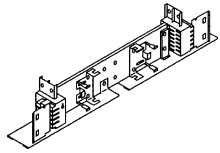

Order Code

| |
|-------------------------------------|
| Example: RR3-T24S |
| RR3 Reff panel frame raceway |
| T Ten wire, 3+3 |
| 24 for 24" w panel |
| S Single sided raceway |

Specification Information

Power rails are the primary power distribution component. Each rail provides provides outlet mounting position on one side and receptacles for branching power connectors at each end.



Power rail for 24" wide panel accepts one duplex outlet or one power infeed. Power rails for 30" to 48" wide panels accept two outlets.

Application Notes

Power rails on this page are for use with panels with one side raceway only.

Power connections and duplexes as required to be specified from following pages for 8 or 10 wire as required for panels with either one sided base raceway or both sides with base raceway.

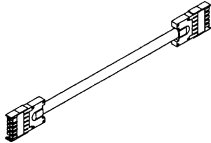
Power distribution components
 2+2 Base Raceway
 four circuit, eight-wire raceway for panels
 power rails and connector

| description | type | w | d | h | pattern no. | list price | |
|---|---|-----------|----|----|-------------------|---------------|-----|
|  | 24" panel | 6" | 2" | 2" | RR3-E24 | \$132. | |
| | 30" panel | 12" | 2" | 2" | RR3-E30NS | 146. | |
| | 36" panel | 18" | 2" | 2" | RR3-E36NS | 160. | |
| | 42" panel | 24" | 2" | 2" | RR3-E42NS | 167. | |
| | 48" panel | 30" | 2" | 2" | RR3-E48NS | 175. | |
| | 60" panel | 42" | 2" | 2" | RR3-E60-4 | 265. | |
| | 66" panel | 48" | 2" | 2" | RR3-E66-4 | 279. | |
| | 72" panel | 54" | 2" | 2" | RR3-E72-4 | 299. | |
|  | Straight | 16 1/2" | 2" | 2" | RR3-EPC24 | 77. | |
| | | 18 1/2" | 2" | 2" | RR3-EPCS | 77. | |
| | | 20 1/4" | 2" | 2" | RR3-EPC | 77. | |
| | Use RR3-EPC24 for straight 24" to 24" wide panel. Use RR3-EPCS for straight 24" to any other width panel and for 30" to 30" wide panels. Use RR3-EPC for all other straight power connection configurations. | | | | | | |
| | Through post | 19" | 2" | 2" | RR3-EPCP24 | 77. | |
| | | 21" | 2" | 2" | RR3-EPCPS | 77. | |
| | | 22 3/4" | 2" | 2" | RR3-EPCP | 77. | |
| | Use RR3-EPCP24 for through post 24" to 24" wide panels. Use RR3-EPCPS for through post 24" to any other width panel and for 30" to 30" wide panels. Use RR3-EPCP for all other through post power connection configurations. | | | | | | |
| |  | Circuit A | | | | RR3-DA | 36. |
| | | Circuit B | | | | RR3-DB | 36. |
| Circuit X | | | | | RR3-DX | 36. | |
| Circuit Y | | | | | RR3-DY | 36. | |
|  | Circuit X | | | | RR3-DXO | 41. | |
| | Circuit Y | | | | RR3-DYO | 41. | |
| Data Shield | 1 pair | | | | RR3-DATSHD | 25. | |

Order Code

| | |
|--------------------------|----------------|
| Example: RR3-E-24 | |
| RR3 | Reff raceway |
| E | Eight wire 2+2 |
| 24 | for 24" panel |

Specification Information

Reff 2+2 Raceway is a four-circuit, eight-wire modular power distribution system for use in Reff panels. 2+2 Raceway components distribute two 20-amp convenience circuits (A and B) with neutral and ground, and two protected 20-amp circuits (X and Y) with separate neutral and ground. In Canada circuits carry 15 amp load resting.

Specify the suffix "RF" after the power rail pattern number for panels manufactured before June 1996.

Application Notes

Power rails are the primary power distribution component of the Reff 2+2 Raceway. Each rail provides outlet mounting positions on both sides and receptacles for two branching power connectors at each end. Center supports permit lay-in cabling from either side of the raceway.

Rail for 24" wide panel accepts one duplex outlet or power infeed centered on each side. Rails for 30" to 48" panels accept two outlets (or one outlet and one infeed) on each side. 60", 66" and 72"W panels accept four duplex outlets per side. Duplex outlets are preconfigured to access one of the four circuits, A, B, X, Y, and snap into any standard outlet location. Duplexes on circuits X and Y may be specified in orange to signify protected circuits for electronic equipment.

Power connectors transmit power between adjacent powered panels. Specify straight power connector for straight connections and through-post power connector when passing in a 90° or straight through a T, X or L post connection.

Power connectors are enclosed in steel flexible conduit.

*Power connectors must be specified according to the panel widths in the specified orientation.

If separation of cabling and electrical wires is required, a data shield can be attached below the power rail. Data Shields are field installed.

Power distribution components

2+2 Base Raceway

four circuit, eight-wire raceway for panels

jumpers and infeed

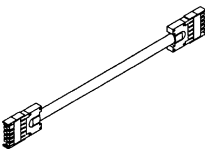
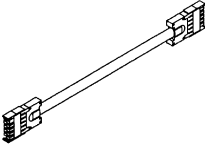
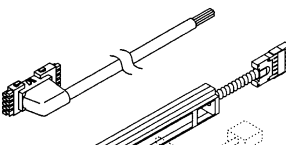
| description | type | w | d | h | pattern no. | list price |
|---|--------------------------------------|----------|----|------------------|-------------------------|------------|
|  | 18" panel | 38" | 2" | 2" | RR3-EJ18 | \$96. |
| | 20" panel | 40" | 2" | 2" | RR3-EJ20 | 96. |
| | 24" panel | 44" | 2" | 2" | RR3-EJ24 | 104. |
| | 30" panel | 50" | 2" | 2" | RR3-EJ30 | 111. |
| | 36" panel | 56" | 2" | 2" | RR3-EJ36 | 120. |
| | 42" panel | 62" | 2" | 2" | RR3-EJ42 | 126. |
| | 48" panel | 68" | 2" | 2" | RR3-EJ48 | 132. |
| | 54" panel run | 76 1/2" | 2" | 2" | RR3-EJ54P | 139. |
| | 60" panel run | 82 1/2" | 2" | 2" | RR3-EJ60P | 146. |
| | 66" panel run | 88 1/2" | 2" | 2" | RR3-EJ66P | 154. |
| | 72" panel run | 94 1/2" | 2" | 2" | RR3-EJ72P | 160. |
| | 78" panel run | 100 1/2" | 2" | 2" | RR3-EJ78P | 167. |
| | 84" panel run | 106 1/2" | 2" | 2" | RR3-EJ84P | 175. |
| 90" panel run | 112 1/2" | 2" | 2" | RR3-EJ90P | 182. | |
| 96" panel run | 118 1/2" | 2" | 2" | RR3-EJ96P | 189. | |
|  | 18" + post | 40 1/2" | 2" | 2" | RR3-EJ18P | 96. |
| | 20" + post | 42 1/2" | 2" | 2" | RR3-EJ20P | 96. |
| | 24" + post | 46 1/2" | 2" | 2" | RR3-EJ24P | 104. |
| | 30" + post | 52 1/2" | 2" | 2" | RR3-EJ30P | 111. |
| | 36" + post | 58 1/2" | 2" | 2" | RR3-EJ36P | 120. |
| | 42" + post | 64 1/2" | 2" | 2" | RR3-EJ42P | 126. |
| | 48" + post | 70 1/2" | 2" | 2" | RR3-EJ48P | 132. |
|  | Ceiling power cable infeed | | | | RR3-EPVR | 258. |
| | Hardwire infeed (NYC) one direction | | | | RR3-EPNY1 | 194. |
| | Hardwire infeed (NYC) two directions | | | | RR3-EPNY2 | 291. |
| | Panel base end feed | | | | RR3-REPI | 230. |
| | Panel base side infeed | | | | RR3-EPI | 230. |
| | Surge suppressors | | | | RR3-SP-(A,B,X,Y) | 167. |

Panels

| Order Code | Specification Information | Application Notes |
|--------------------------|---------------------------|-------------------|
| Example: RR3-EPVR | | |
| RR3 | Reff raceway | |
| E | Eight wire 2+2 | |
| P | power infeed | |
| VR | for vertical raceway | |

Reff 2+2 Raceway is a four-circuit, eight-wire modular power distribution system for use in Reff panels. 2+2 Raceway components distribute two 20-amp convenience circuits (A and B) with neutral and ground, and two 20-amp circuits (X and Y) with separate neutral and ground.

For use in Canada, all circuits are CGA rated 15 amp capacity.

Note:
For NYC hardwire infeeds specify bracket height: 4", 5", or 6"H.

Beltway panels can use jumpers at the panel base in a straight run or around a corner.

Jumpers pass power through the raceway of panels that do not require power access to the next available power rail. Jumpers only connect to power rails. Jumpers 18" to 48" are available standard or extended. Extended jumpers should be specified when passing through a panel and a post. Jumpers 54" to 96" wide can be used with or without a post application. Extended jumpers and jumpers 54" to 96" wide can only pass through panels and one post.

Power infeeds connect building power supply to a cluster of interconnected power rails. Panel base infeed snaps into any outlet position in rail, and includes 6 foot liquid-tight conduit and pigtail for connection to floor or wall electrical box. Ceiling infeeds include up to 13' pigtail for connection

into panel base through power pole adjacent to panel with power rail. Power pole and post must be ordered separately.

Hardwire infeed, used in all New York City installations, includes junction box that mounts within non-powered panel base (any width 30" or greater). Electrical contractor supplies watertight conduit from building power supply to panel and trims power connectors to length. **RR3-EPNY2** includes two power connectors to power panels on both sides of infeed panel; **RR3-EPNY1** includes only one power connector.



Cable sizes are nominal. Use the "type" column to specify the required cable for your panel.

Power distribution components

3+3 Base Raceway

six circuit, ten-wire raceway for panels

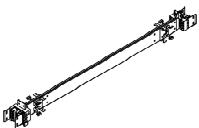
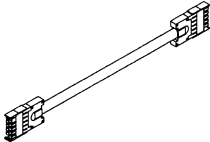
power rails and connectors

| description | type | w | d | h | pattern no. | list price | |
|---|--|---------|----|----|-------------------|------------|--|
|  | 24" panel | 6" | 2" | 2" | RR3-T24 | \$154. | |
| | 30" panel | 12" | 2" | 2" | RR3-T30NS | 167. | |
| | 36" panel | 18" | 2" | 2" | RR3-T36NS | 182. | |
| | 42" panel | 24" | 2" | 2" | RR3-T42NS | 194. | |
| | 48" panel | 30" | 2" | 2" | RR3-T48NS | 202. | |
| | 60" panel | 42" | 2" | 2" | RR3-T60-4 | 314. | |
| | 66" panel | 48" | 2" | 2" | RR3-T66-4 | 327. | |
| | 72" panel | 54" | 2" | 2" | RR3-T72-4 | 349. | |
|  | Straight | 16 1/2" | 2" | 2" | RR3-TPC24 | 96. | |
| | | 18 1/2" | 2" | 2" | RR3-TPCS | 96. | |
| | | 20 1/4" | 2" | 2" | RR3-TPC | 96. | |
| | Use RR3-TPC24 for through post 24" to 24" wide panels. Use RR3-TPCS for through post 24" to any other width panel and for 30" to 30" wide panels. Use RR3-TPC for all other through post power connection configurations. | | | | | | |
| | Through post | 19" | 2" | 2" | RR3-TPCP24 | 96. | |
| | | 21" | 2" | 2" | RR3-TPCPS | 96. | |
| | | 22 3/4" | 2" | 2" | RR3-TPCP | 96. | |
| Use RR3-TPCP24 for through post 24" to 24" wide panels. Use RR3-TPCPS for through post 24" to any other width panel and for 30" to 30" wide panels. Use RR3-TPCP for all other through post power connection configurations. | | | | | | | |
|  | Circuit A | | | | RR3-DA | 36. | |
| | Circuit B | | | | RR3-DB | 36. | |
| | Circuit C | | | | RR3-DC | 36. | |
| | Circuit X | | | | RR3-DX | 36. | |
| | Circuit Y | | | | RR3-DY | 36. | |
| | Circuit Z | | | | RR3-DZ | 36. | |
|  | Circuit X | | | | RR3-DXO | 41. | |
| | Circuit Y | | | | RR3-DYO | 41. | |
| | Circuit Z | | | | RR3-DZO | 41. | |
| Data Shield | 1 pair | | | | RR3-DATSHD | 25. | |

Order Code

| |
|--------------------------|
| Example: RR3-T-24 |
| RR3 Reff raceway |
| T Ten wire 3+3 |
| 24 for 24" panel |

Specification Information

Reff 3+3 Raceway is a six-circuit, ten-wire modular power distribution system for use in Reff panels. 3+3 Raceway components distribute three 20-amp convenience circuits (A,B and C) with neutral and ground, and three 20-amp circuits (X, Y and Z) with separate neutral and ground.

A, B, X, Y outlets are identical to eight wire, 2+2 components.

Duplex outlet circuits are designated by white letters on black background.

In Canada, circuits carry a 15 amp load rating.

Note:

Specify the suffix "RF" after the power rail pattern number for panels manufactured before June 1996.

Application Notes

Power rails are the primary power distribution component of the Reff 3+3 Raceway. Each rail provides outlet mounting positions on both sides and receptacles for branching power connectors at each end. Center supports permit lay-in cabling from either side of the raceway.

Rail for 24"W panel accepts one duplex outlet or power infeed one either side. Rails for 30" to 48" panels accept two outlets each side, 60", 66" and 72" rails accept four duplex outlets per side.

*Power connectors must be specified according to the panel widths in the specified orientation.

Power connectors transmit power between adjacent powered panels. Specify straight power connector for straight connections and through-post power connector when passing in a 90° or straight through a T or X or L post connection.

Duplex outlets are preconfigured to access one of the four circuits, A, B, X, Y, and snap into any standard outlet location. Duplexes on circuits X and Y may be specified in orange to signify protected circuits for electronic equipment; all duplexes are black.

If separation of cabling and electrical wires is required, a data shield can be attached below the power rail. Data Shields are field installed.

Power distribution components

3+3 Base Raceway

six circuit, ten-wire raceway for panels

jumpers and infeed

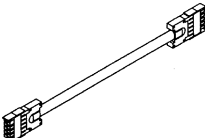
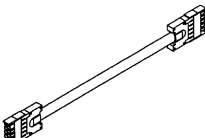
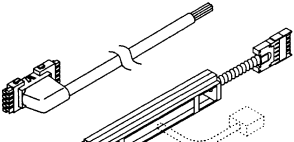
| description | type | w | d | h | pattern no. | list price |
|---|---|----------|----|------------------|----------------------------------|------------|
|  | 18" panel | 38" | 2" | 2" | RR3-TJ18 | \$111. |
| | 20" panel | 40" | 2" | 2" | RR3-TJ20 | 111. |
| | 24" panel | 44" | 2" | 2" | RR3-TJ24 | 120. |
| | 30" panel | 50" | 2" | 2" | RR3-TJ30 | 126. |
| | 36" panel | 56" | 2" | 2" | RR3-TJ36 | 132. |
| | 42" panel | 62" | 2" | 2" | RR3-TJ42 | 146. |
| | 48" panel | 68" | 2" | 2" | RR3-TJ48 | 160. |
| | 54" panel run | 76 1/2" | 2" | 2" | RR3-TJ54P | 167. |
| | 60" panel | 82 1/2" | 2" | 2" | RR3-TJ60P | 175. |
| | 66" panel run | 86 1/2" | 2" | 2" | RR3-TJ66P | 182. |
| | 72" panel run | 94 1/2" | 2" | 2" | RR3-TJ72P | 189. |
| | 78" panel run | 100 1/2" | 2" | 2" | RR3-TJ78P | 194. |
| | 84" panel run | 106 1/2" | 2" | 2" | RR3-TJ84P | 211. |
| 90" panel run | 112 1/2" | 2" | 2" | RR3-TJ90P | 216. | |
| 96" panel run | 118 1/2" | 2" | 2" | RR3-TJ96P | 222. | |
|  | 18" + post | 40 1/2" | 2" | 2" | RR3-TJ18P | 111. |
| | 20" + post | 46 1/2" | 2" | 2" | RR3-TJ20P | 111. |
| | 24" + post | 46 1/2" | 2" | 2" | RR3-TJ24P | 120. |
| | 30" + post | 52 1/2" | 2" | 2" | RR3-TJ30P | 126. |
| | 36" + post | 58 1/2" | 2" | 2" | RR3-TJ36P | 132. |
| | 42" + post | 64 1/2" | 2" | 2" | RR3-TJ42P | 146. |
| | 48" + post | 70 1/2" | 2" | 2" | RR3-TJ48P | 160. |
|  | Ceiling power cable infeed | | | | RR3-TPVR | 312. |
| | Hardwire infeed (NYC) one direction ** | | | | RR3-TPNY1 | 222. |
| | Hardwire infeed (NYC) two directions ** | | | | RR3-TPNY2 | 321. |
| | Panel base end feed | | | | RR3-RTPI | 265. |
| | Panel base side infeed | | | | RR3-TPI | 265. |
| | Surge suppressors * | | | | RR3-SP-(A, B, C, X, Y, Z) | 167. |

* Select which circuit needs protecting and order the specified surge processor.
 ** For RR3-TPNY1 and RR3-TPNY2 specify base height of panel for NYC.

| Order Code | Specification Information | Application Notes |
|---|--|--|
| Example: RR3-TPVR RR3 Reff raceway T Ten wire 3+3 P power infeed VR for vertical raceway | <p>Reff 3+3 Raceway is a six-circuit, ten-wire modular power distribution system for use in Reff panels. 3+3 Raceway components distribute three 20-amp convenience circuits (A, B and C) with neutral and ground, and three 20-amp circuits (X, Y and Z) with separate neutral and ground.</p> <p>In Canada, circuits carry a 15 amp load rating.</p> <p>Power infeeds connect building power supply to a cluster of interconnected power rails. Panel base infeed snaps into any outlet position in rail, and includes 6 foot liquid-tight conduit and pigtail for connection to floor or wall electrical box. Ceiling infeeds include up to 13' pigtail for connection into panel base through standard power pole. Power pole and post must be ordered separately.</p> | <p>Jumpers pass power through the raceway of panels that do not require power access to the next available power rail. Jumpers only connect to power rails. Jumpers 18" to 48" are available standard or extended. Extended jumpers should be specified when passing through a panel and a post. Jumpers 54" to 96" wide can be used with or without a post application. Extended jumpers and jumpers 54" to 96" wide can only pass through panels and one post.</p> <p>Cable sizes are nominal. Use the "type" column to specify the required cable for your panel.</p> <p>Beltway panels can use jumpers at the panel base in a straight run or around a corner.</p> |

Panels

Power distribution components

Hardwire box

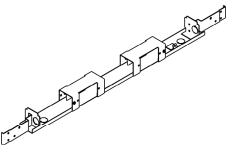
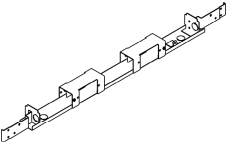
| description | type | pattern no. | list |
|--|-----------|------------------|--------|
| Chicago Hardwire Box 1 Sided  | 24" panel | RR3CHI241 | \$207. |
| | 30" panel | RR3CHI301 | 240. |
| | 36" panel | RR3CHI361 | 259. |
| | 42" panel | RR3CHI421 | 262. |
| | 48" panel | RR3CHI481 | 280. |
| Chicago Hardwire Box 2 Sided  | 24" panel | RR3CHI242 | 214. |
| | 30" panel | RR3CHI302 | 256. |
| | 36" panel | RR3CHI362 | 263. |
| | 42" panel | RR3CHI422 | 267. |
| | 48" panel | RR3CHI482 | 298. |

Order Code

| | |
|--------------------------|----------------------------|
| Example: RR3CHI24 | |
| RR3 | Reff/AutoStrada raceway G3 |
| CHI | Chicago Hardwire Box |
| 24 | For 24" wide panel |
| 1 | One sided raceway |

Specification Information

Hardwire box is dedicated for panels with raceway either one or two sided, be sure to match to panel specification.

Application Notes

Certified electrician to install.
Reff Hardwire Box
Installation instruction sheet available. Part number 6TR45715.

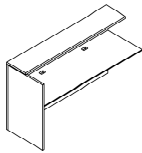
| description | type | h* | w* | d | pattern no. | L | M/V1 or V1 | M/V2 or V2 | M/V3 or V3 |
|---|------------|-----|-----|---------|-----------------------------------|----------|---------------|---------------|---------------|
|  <p>left hand shown, worksurface height fixed 27" h to underside</p> | left hand | 42" | 42" | 26 1/2" | AMB42L424 () () () () () () | \$1,381. | \$1,722. | \$1,980. | \$2,574. |
| | | 42" | 48" | 26 1/2" | AMB42L484 () () () () () () | 1,438. | 1,792. | 2,060. | 2,679. |
| | | 42" | 54" | 26 1/2" | AMB42L544 () () () () () () | 1,495. | 1,862. | 2,143. | 2,783. |
| | | 42" | 60" | 26 1/2" | AMB42L604 () () () () () () | 1,551. | 1,932. | 2,223. | 2,891. |
| | | 42" | 66" | 26 1/2" | AMB42L664 () () () () () () | 1,608. | 2,003. | 2,304. | 2,995. |
| | | 42" | 72" | 26 1/2" | AMB42L724 () () () () () () | 1,665. | 2,073. | 2,383. | 3,099. |
| | | 42" | 78" | 26 1/2" | AMB42L784 () () () () () () | 1,720. | 2,144. | 2,465. | 3,204. |
| | | 42" | 84" | 26 1/2" | AMB42L844 () () () () () () | 1,776. | 2,214. | 2,546. | 3,310. |
| | | 42" | 90" | 26 1/2" | AMB42L904 () () () () () () | 1,834. | 2,283. | 2,627. | 3,416. |
| | | 42" | 96" | 26 1/2" | AMB42L964 () () () () () () | 1,889. | 2,354. | 2,708. | 3,522. |
| | right hand | 42" | 42" | 26 1/2" | AMB42R424 () () () () () () | 1,381. | 1,722. | 1,980. | 2,574. |
| | | 42" | 48" | 26 1/2" | AMB42R484 () () () () () () | 1,438. | 1,792. | 2,060. | 2,679. |
| | | 42" | 54" | 26 1/2" | AMB42R544 () () () () () () | 1,495. | 1,862. | 2,143. | 2,783. |
| | | 42" | 60" | 26 1/2" | AMB42R604 () () () () () () | 1,551. | 1,932. | 2,223. | 2,891. |
| | | 42" | 66" | 26 1/2" | AMB42R664 () () () () () () | 1,608. | 2,003. | 2,304. | 2,995. |
| | | 42" | 72" | 26 1/2" | AMB42R724 () () () () () () | 1,665. | 2,073. | 2,383. | 3,099. |
| | | 42" | 78" | 26 1/2" | AMB42R784 () () () () () () | 1,720. | 2,144. | 2,465. | 3,204. |
| | | 42" | 84" | 26 1/2" | AMB42R844 () () () () () () | 1,776. | 2,214. | 2,546. | 3,310. |
| | | 42" | 90" | 26 1/2" | AMB42R904 () () () () () () | 1,834. | 2,283. | 2,627. | 3,416. |
| | | 42" | 96" | 26 1/2" | AMB42R964 () () () () () () | 1,889. | 2,354. | 2,708. | 3,522. |

| Order Code | Specification Information | Application Notes |
|--|--|--|
| Example: AMB42L424GFEV316 V316613AA | To order please specify pattern number including: | |
| A AutoStrada | 1. Hand <i>L = Left hand</i> <i>R = Right hand</i> | 7. Finish, surround, top shelf and worksurface front edge <i>Laminate, V1, V2 or V3 finish</i> |
| M Median | 2. Width | 8. Finish, worksurface <i>Laminate, V1, V2 or V3 finish</i> |
| B Binder depth top shelf | 3. Depth <i>4 = 26.5" d nominal</i> <i>5 = 32.5" d nominal</i> | 9. Finish, Grommet(s) <i>specify painted or plated finish</i> |
| 42 42" high | 4. Grommet option <i>G = Grommet(s)</i> <i>N = No grommet(s)</i> | 10. Finish, Aluminum trim <i>AA - Anodized aluminum or painted finish option from page 7 excluding silver</i> |
| L Left hand | 5. Face drill option <i>F = face drill for attachment to next unit</i> <i>N = no drill, last unit in run</i> | Order worksurface stiffener for unsupported spans exceeding 48". |
| 42 42" wide | 6. End drill option <i>E = end drill gable to attach to bridge</i> <i>N = no drill</i> | *42" h to top of gable; with aluminum trim and top shelf 43.2" h. |
| 4 26.5" d | | *Width noted is interior nominal dimension, overall footprint additional 1" nominal. |
| G Grommet | | See page 7 for finish options applicable. |
| F Face drill gable | | Product on this page will accept wood grain laminate where laminate is currently an option. |
| E End drill gable | | List price for wood grain laminate options will be current published laminate list price plus 10%. |
| V316 Finish, surround, top shelf & worksurface edge | | |
| V316 Finish, worksurface | | |
| 613 Finish, grommet | | |
| AA Trim, anodized aluminum | | |

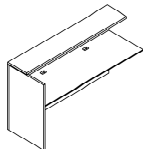
| description | type | h* | w* | d | pattern no. | L | M/V1 or V1 | M/V2 or V2 | M/V3 or V3 |
|--|------------|-----|-----|---------|--------------------------------------|----------|---------------|---------------|---------------|
|  <p>left hand shown, worksurface height fixed 27" h to underside</p> | left hand | 42" | 42" | 32 1/2" | AMB42L425 () () () () () | \$1,462. | \$1,804. | \$2,076. | \$2,698. |
| | | 42" | 48" | 32 1/2" | AMB42L485 () () () () () | 1,517. | 1,874. | 2,155. | 2,800. |
| | | 42" | 54" | 32 1/2" | AMB42L545 () () () () () | 1,574. | 1,943. | 2,234. | 2,905. |
| | | 42" | 60" | 32 1/2" | AMB42L605 () () () () () | 1,629. | 2,011. | 2,314. | 3,008. |
| | | 42" | 66" | 32 1/2" | AMB42L665 () () () () () | 1,685. | 2,081. | 2,393. | 3,111. |
| | | 42" | 72" | 32 1/2" | AMB42L725 () () () () () | 1,742. | 2,149. | 2,475. | 3,215. |
| | | 42" | 78" | 32 1/2" | AMB42L785 () () () () () | 1,798. | 2,219. | 2,555. | 3,319. |
| | | 42" | 84" | 32 1/2" | AMB42L845 () () () () () | 1,854. | 2,289. | 2,632. | 3,422. |
| | | 42" | 90" | 32 1/2" | AMB42L905 () () () () () | 1,909. | 2,357. | 2,712. | 3,526. |
| | | 42" | 96" | 32 1/2" | AMB42L965 () () () () () | 1,965. | 2,426. | 2,793. | 3,630. |
| | right hand | 42" | 42" | 32 1/2" | AMB42R425 () () () () () | 1,462. | 1,804. | 2,076. | 2,698. |
| | | 42" | 48" | 32 1/2" | AMB42R485 () () () () () | 1,517. | 1,874. | 2,155. | 2,800. |
| | | 42" | 54" | 32 1/2" | AMB42R545 () () () () () | 1,574. | 1,943. | 2,234. | 2,905. |
| | | 42" | 60" | 32 1/2" | AMB42R605 () () () () () | 1,629. | 2,011. | 2,314. | 3,008. |
| | | 42" | 66" | 32 1/2" | AMB42R665 () () () () () | 1,685. | 2,081. | 2,393. | 3,111. |
| | | 42" | 72" | 32 1/2" | AMB42R725 () () () () () | 1,742. | 2,149. | 2,475. | 3,215. |
| | | 42" | 78" | 32 1/2" | AMB42R785 () () () () () | 1,798. | 2,219. | 2,555. | 3,319. |
| | | 42" | 84" | 32 1/2" | AMB42R845 () () () () () | 1,854. | 2,289. | 2,632. | 3,422. |
| | | 42" | 90" | 32 1/2" | AMB42R905 () () () () () | 1,909. | 2,357. | 2,712. | 3,526. |
| | | 42" | 96" | 32 1/2" | AMB42R965 () () () () () | 1,965. | 2,426. | 2,793. | 3,630. |

| Order Code | Specification Information | Application Notes |
|--|--|--|
| Example: AMB42L425GFEV316 V316613AA | To order please specify pattern number including: | |
| A AutoStrada | 1. Hand <i>L = Left hand</i> <i>R = Right hand</i> | 7. Finish, surround, top shelf and worksurface front edge <i>Laminate, V1, V2 or V3 finish</i> |
| M Median | 2. Width | 8. Finish, worksurface <i>Laminate, V1, V2 or V3 finish</i> |
| B Binder depth top shelf | 3. Depth <i>4 = 26.5" d nominal</i> <i>5 = 32.5" d nominal</i> | 9. Finish, Grommet(s) <i>specify painted or plated finish</i> |
| 42 42" high | 4. Grommet option <i>G = Grommet(s)</i> <i>N = No grommet(s)</i> | 10. Finish, Aluminum trim <i>AA - Anodized aluminum or painted finish option from page 7 excluding silver</i> |
| L Left hand | 5. Face drill option <i>F = face drill for attachment to next unit</i> <i>N = no drill, last unit in run</i> | Order worksurface stiffener for unsupported spans exceeding 48". |
| 42 42" wide | 6. End drill option <i>E = end drill gable to attach to bridge</i> <i>N = no drill</i> | *42" h to top of gable; with aluminum trim and top shelf 43.2" h. |
| 5 32.5" d | | *Width noted is interior nominal dimension, overall footprint additional 1" nominal. |
| G Grommet | | See page 7 for finish options applicable. |
| F Face drill gable | | Product on this page will accept wood grain laminate where laminate is currently an option. List price for wood grain laminate options will be current published laminate list price plus 10%. |
| E End drill gable | | |
| V316 Finish, surround, top shelf & worksurface edge | | Median end without gable to be attached to a storage anchored cabinet. Optional face drill option is to drill outside face of gable to attach to next median in line, if last unit in run specify no drill. Optional end drill gable option is for attachment to bridge units on page 144, specify no drill if configuration does not include bridge unit. |
| V316 Finish, worksurface | | Mixed finish options applicable with V1, V2 or V3 finish surround, top shelf and worksurface front edge with laminate finish worksurface. |
| 613 Finish, grommet | | Products on this page shipped knocked-down. |
| AA Trim, anodized aluminum | | |

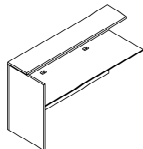
| description | type | h* | w* | d | pattern no. | L | M/V1 or V1 | M/V2 or V2 | M/V3 or V3 |
|--|------------|-----|-----|---------|--------------------------------------|----------|---------------|---------------|---------------|
|  <p>left hand shown, worksurface height fixed 27" h to underside</p> | left hand | 42" | 42" | 26 1/2" | AMG42L424 () () () () () | \$1,411. | \$1,757. | \$2,020. | \$2,625. |
| | | 42" | 48" | 26 1/2" | AMG42L484 () () () () () | 1,468. | 1,828. | 2,102. | 2,732. |
| | | 42" | 54" | 26 1/2" | AMG42L544 () () () () () | 1,526. | 1,900. | 2,184. | 2,841. |
| | | 42" | 60" | 26 1/2" | AMG42L604 () () () () () | 1,582. | 1,970. | 2,268. | 2,948. |
| | | 42" | 66" | 26 1/2" | AMG42L664 () () () () () | 1,640. | 2,043. | 2,350. | 3,055. |
| | | 42" | 72" | 26 1/2" | AMG42L724 () () () () () | 1,698. | 2,115. | 2,433. | 3,162. |
| | | 42" | 78" | 26 1/2" | AMG42L784 () () () () () | 1,755. | 2,185. | 2,515. | 3,270. |
| | | 42" | 84" | 26 1/2" | AMG42L844 () () () () () | 1,813. | 2,257. | 2,597. | 3,376. |
| | | 42" | 90" | 26 1/2" | AMG42L904 () () () () () | 1,870. | 2,328. | 2,680. | 3,482. |
| | | 42" | 96" | 26 1/2" | AMG42L964 () () () () () | 1,927. | 2,400. | 2,762. | 3,592. |
| | right hand | 42" | 42" | 26 1/2" | AMG42R424 () () () () () | 1,411. | 1,757. | 2,020. | 2,625. |
| | | 42" | 48" | 26 1/2" | AMG42R484 () () () () () | 1,468. | 1,828. | 2,102. | 2,732. |
| | | 42" | 54" | 26 1/2" | AMG42R544 () () () () () | 1,526. | 1,900. | 2,184. | 2,841. |
| | | 42" | 60" | 26 1/2" | AMG42R604 () () () () () | 1,582. | 1,970. | 2,268. | 2,948. |
| | | 42" | 66" | 26 1/2" | AMG42R664 () () () () () | 1,640. | 2,043. | 2,350. | 3,055. |
| | | 42" | 72" | 26 1/2" | AMG42R724 () () () () () | 1,698. | 2,115. | 2,433. | 3,162. |
| | | 42" | 78" | 26 1/2" | AMG42R784 () () () () () | 1,755. | 2,185. | 2,515. | 3,270. |
| | | 42" | 84" | 26 1/2" | AMG42R844 () () () () () | 1,813. | 2,257. | 2,597. | 3,376. |
| | | 42" | 90" | 26 1/2" | AMG42R904 () () () () () | 1,870. | 2,328. | 2,680. | 3,482. |
| | | 42" | 96" | 26 1/2" | AMG42R964 () () () () () | 1,927. | 2,400. | 2,762. | 3,592. |

| Order Code | Specification Information | Application Notes |
|--|--|---|
| Example: AMG42L424GFEV316 V316613AA | To order please specify pattern number including: | |
| A AutoStrada | 1. Left or Right hand <i>L = Left hand</i> <i>R = Right hand</i> | 7. Finish, surround, top shelf & worksurface edge <i>Laminate, V1, V2 or V3 finish</i> |
| M Median | 2. Width | 8. Finish, worksurface <i>Laminate, V1, V2 or V3</i> |
| G Legal depth top shelf | 3. Depth <i>4 = 26.5" d nominal</i> <i>5 = 32.5" d nominal</i> | 9. Finish, Grommet(s) <i>specify painted or plated finish</i> |
| 42 42" high | 4. Grommet option <i>G = Grommet(s)</i> <i>N = No grommet(s)</i> | 10. Finish, Aluminum trim <i>AA - Anodized aluminum or painted finish option from page 7 excluding silver</i> |
| L Left hand | 5. Face drill option <i>F = face drill for attachment to next unit</i> <i>N = no drill, last unit in run</i> | Order worksurface stiffener for unsupported spans exceeding 48". |
| 42 42" wide | 6. End drill option <i>E = end drill gable to attach to bridge</i> <i>N = no drill</i> | *42" h to top of gable; with aluminum trim and top shelf 43.2" h. |
| 4 26.5" d | | *Width noted is interior nominal dimension, overall footprint additional 1" nominal. |
| G Grommet | | See page 7 for finish options applicable. |
| F Face drill gable | | Product on this page will accept wood grain laminate where laminate is currently an option. |
| E End drill gable | | List price for wood grain laminate options will be current published laminate list price plus 10%. |
| V316 Finish, surround, top shelf & worksurface edge | | Mixed finish options applicable with V1, V2 or V3 finish surround, top shelf and worksurface front edge with laminate finish worksurface. |
| V316 Finish, worksurface | | Product on this page shipped knocked-down. |
| 613 Finish, grommet | | |
| AA Trim, anodized aluminum | | |

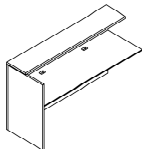
| description | type | h* | w* | d | pattern no | L | M/V1 or V1 | M/V2 or V2 | M/V3 or V3 |
|---|------------|-----|-----|---------|--------------------------------------|----------|---------------|---------------|---------------|
|  <p>left hand shown, worksurface height fixed 27" h to underside</p> | left hand | 42" | 42" | 32 1/2" | AMG42L425 () () () () () | \$1,492. | \$1,841. | \$2,116. | \$2,751. |
| | | 42" | 48" | 32 1/2" | AMG42L485 () () () () () | 1,548. | 1,910. | 2,197. | 2,856. |
| | | 42" | 54" | 32 1/2" | AMG42L545 () () () () () | 1,606. | 1,982. | 2,279. | 2,962. |
| | | 42" | 60" | 32 1/2" | AMG42L605 () () () () () | 1,663. | 2,051. | 2,359. | 3,070. |
| | | 42" | 66" | 32 1/2" | AMG42L665 () () () () () | 1,719. | 2,123. | 2,441. | 3,174. |
| | | 42" | 72" | 32 1/2" | AMG42L725 () () () () () | 1,776. | 2,191. | 2,522. | 3,278. |
| | | 42" | 78" | 32 1/2" | AMG42L785 () () () () () | 1,834. | 2,263. | 2,604. | 3,385. |
| | | 42" | 84" | 32 1/2" | AMG42L845 () () () () () | 1,890. | 2,332. | 2,685. | 3,492. |
| | | 42" | 90" | 32 1/2" | AMG42L905 () () () () () | 1,948. | 2,403. | 2,767. | 3,596. |
| | | 42" | 96" | 32 1/2" | AMG42L965 () () () () () | 2,004. | 2,476. | 2,848. | 3,704. |
| | right hand | 42" | 42" | 32 1/2" | AMG42R425 () () () () () | 1,492. | 1,841. | 2,116. | 2,751. |
| | | 42" | 48" | 32 1/2" | AMG42R485 () () () () () | 1,548. | 1,910. | 2,197. | 2,856. |
| | | 42" | 54" | 32 1/2" | AMG42R545 () () () () () | 1,606. | 1,982. | 2,279. | 2,962. |
| | | 42" | 60" | 32 1/2" | AMG42R605 () () () () () | 1,663. | 2,051. | 2,359. | 3,070. |
| | | 42" | 66" | 32 1/2" | AMG42R665 () () () () () | 1,719. | 2,123. | 2,441. | 3,174. |
| | | 42" | 72" | 32 1/2" | AMG42R725 () () () () () | 1,776. | 2,191. | 2,522. | 3,278. |
| | | 42" | 78" | 32 1/2" | AMG42R785 () () () () () | 1,834. | 2,263. | 2,604. | 3,385. |
| | | 42" | 84" | 32 1/2" | AMG42R845 () () () () () | 1,890. | 2,332. | 2,685. | 3,492. |
| | | 42" | 90" | 32 1/2" | AMG42R905 () () () () () | 1,948. | 2,403. | 2,767. | 3,596. |
| | | 42" | 96" | 32 1/2" | AMG42R965 () () () () () | 2,004. | 2,476. | 2,848. | 3,704. |

| Order Code | Specification Information | Application Notes |
|--|--|---|
| Example: AMG42L425GF316V316613AA | To order please specify pattern number including: | |
| A AutoStrada | 1. Left or Right hand <i>L = Left hand</i> <i>R = Right hand</i> | 7. Finish, surround, top shelf & worksurface edge <i>Laminate, V1, V2 or V3 finish</i> |
| M Median | 2. Width | 8. Finish, worksurface <i>Laminate, V1, V2 or V3</i> |
| G Legal depth top shelf | 3. Depth <i>4 = 26.5" d nominal</i> <i>5 = 32.5" d nominal</i> | 9. Finish, Grommet(s) <i>specify painted or plated finish</i> |
| 42 42" high | 4. Grommet option <i>G = Grommet(s)</i> <i>N = No grommet(s)</i> | 10. Finish, Aluminum trim <i>AA - Anodized aluminum or painted finish option from page 7 excluding silver</i> |
| L Left hand | 5. Face drill option <i>F = face drill for attachment to next unit</i> <i>N = no drill, last unit in run</i> | Order worksurface stiffener for unsupported spans exceeding 48". *42" h to top of gable; with aluminum trim and top shelf 43.2" h. |
| 42 42" wide | 6. End drill option <i>E = end drill gable to attach to bridge</i> <i>N = no drill</i> | *Width noted is interior nominal dimension, overall footprint additional 1" nominal. |
| 5 32.5" d | | See page 7 for finish options applicable. |
| G Grommet | | Product on this page will accept wood grain laminate where laminate is currently an option. List price for wood grain laminate options will be current published laminate list price plus 10%. |
| F Face drill gable | | |
| E End drill gable | | |
| V316 Finish, surround, top shelf & worksurface edge | | Mixed finish options applicable with V1, V2 or V3 finish surround, top shelf and worksurface front edge with laminate finish worksurface. |
| V316 Finish, worksurface | | Product on this page shipped knocked-down. |
| 613 Finish, grommet | | |
| AA Trim, anodized aluminum | | |

| description | h* | w* | d | pattern no. | L | M/V1 or V1 | M/V2 or V2 | M/V3 or V3 |
|--|-----|-----|-------|------------------------------|----------|---------------|---------------|---------------|
| Medians with double end gable 42"h x 26.5"d with binder depth top shelf | 42" | 60" | 26.5" | AMB42E604() () () () () | \$1,907. | \$2,411. | \$2,783. | \$3,621. |
| | 42" | 66" | 26.5" | AMB42E664() () () () () | 1,963. | 2,481. | 2,865. | 3,726. |
| | 42" | 72" | 26.5" | AMB42E724() () () () () | 2,019. | 2,554. | 2,946. | 3,830. |
| | 42" | 78" | 26.5" | AMB42E784() () () () () | 2,076. | 2,622. | 3,028. | 3,934. |
| | 42" | 84" | 26.5" | AMB42E844() () () () () | 2,133. | 2,693. | 3,108. | 4,041. |
| | 42" | 90" | 26.5" | AMB42E904() () () () () | 2,188. | 2,762. | 3,190. | 4,146. |
| | 42" | 96" | 26.5" | AMB42E964() () () () () | 2,246. | 2,832. | 3,271. | 4,252. |

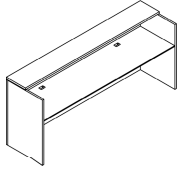

| | | | | | | | | |
|--|-----|-----|-------|------------------------------|--------|--------|--------|--------|
| Medians with double end gable 42"h x 32.5"d with binder depth top shelf | 42" | 60" | 32.5" | AMB42E605() () () () () | 2,008. | 2,518. | 2,919. | 3,793. |
| | 42" | 66" | 32.5" | AMB42E665() () () () () | 2,062. | 2,585. | 2,998. | 3,897. |
| | 42" | 72" | 32.5" | AMB42E725() () () () () | 2,119. | 2,656. | 3,078. | 4,002. |
| | 42" | 78" | 32.5" | AMB42E785() () () () () | 2,173. | 2,724. | 3,158. | 4,105. |
| | 42" | 84" | 32.5" | AMB42E845() () () () () | 2,231. | 2,795. | 3,237. | 4,208. |
| | 42" | 90" | 32.5" | AMB42E905() () () () () | 2,286. | 2,864. | 3,317. | 4,312. |
| | 42" | 96" | 32.5" | AMB42E965() () () () () | 2,343. | 2,931. | 3,397. | 4,418. |

| Order Code | Specification Information | Application Notes |
|---|---|--|
| Example: AMB42E604GFNEBV316 V316613AA <hr/> A AutoStrada <hr/> M Median <hr/> B Binder depth top shelf <hr/> 42 42" high <hr/> E End gables, both sides <hr/> 60 60" wide <hr/> 4 26.5" d <hr/> G Grommet <hr/> FN Face drill gable, none <hr/> EB End drill gable, both <hr/> V316 Finish, surround, top shelf & worksurface edge <hr/> V316 Finish, worksurface <hr/> 613 Finish, grommet <hr/> AA Trim, anodized aluminum | To order please specify pattern number including: 1. Width 2. Depth <i>4 = 26.5" d nominal</i> <i>5 = 32.5" d nominal</i> 3. Grommet option <i>G = Grommet(s)</i> <i>N = No grommet(s)</i> 4. Face drill option <i>FL = face drill left gable for ganging</i> <i>FR = face drill right gable for ganging</i> <i>FN = face drill none</i> 5. End drill option <i>EL = end drill left gable to attach to bridge</i> <i>ER = end drill right gable to attach to bridge</i> <i>EB = end drill both gables to attach to bridges (applicable 84"w, 90"w and 96"w only)</i> <i>EN = no drill (for freestanding applications)</i> | 6. Finish, surround, top shelf and worksurface front edge <i>Laminate, V1, V2 or V3 finish</i> 7. Finish, worksurface <i>Laminate, V1, V2 or V3 finish</i> 8. Finish, Grommet(s) <i>specify painted or plated finish</i> 9. Finish, Aluminum trim <i>AA - Anodized aluminum or painted finish option from page 7 excluding silver</i> Order worksurface stiffener for unsupported spans exceeding 48". *42"h to top of gable; with aluminum trim and top shelf 43.2"h. *Width noted is interior nominal dimension, overall footprint additional 2" nominal. See page 7 for finish options applicable. Product on this page will accept wood grain laminate where laminate is currently an option. List price for wood grain laminate options will be current published laminate list price plus 10%. |

| description | h* | w* | d | pattern no. | L | M/V1 or V1 | M/V2 or V2 | M/V3 or V3 |
|---|-----|-----|-------|--------------------------------------|----------|---------------|---------------|---------------|
| Medians with double end gable 42"h x 26.5"d with legal depth top shelf | 42" | 60" | 26.5" | AMG42E604 () () () () () | \$1,939. | \$2,449. | \$2,829. | \$3,677. |
| | 42" | 66" | 26.5" | AMG42E664 () () () () () | 1,995. | 2,521. | 2,911. | 3,786. |
| | 42" | 72" | 26.5" | AMG42E724 () () () () () | 2,053. | 2,594. | 2,994. | 3,893. |
| | 42" | 78" | 26.5" | AMG42E784 () () () () () | 2,111. | 2,664. | 3,075. | 3,998. |
| | 42" | 84" | 26.5" | AMG42E844 () () () () () | 2,168. | 2,736. | 3,158. | 4,107. |
| | 42" | 90" | 26.5" | AMG42E904 () () () () () | 2,226. | 2,806. | 3,241. | 4,214. |
| | 42" | 96" | 26.5" | AMG42E964 () () () () () | 2,283. | 2,880. | 3,323. | 4,323. |

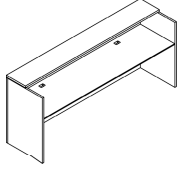

| | | | | | | | | |
|---|-----|-----|-------|--------------------------------------|--------|--------|--------|--------|
| Medians with double end gable 42"h x 32.5"d with legal depth top shelf | 42" | 60" | 32.5" | AMG42E605 () () () () () | 2,039. | 2,558. | 2,965. | 3,855. |
| | 42" | 66" | 32.5" | AMG42E665 () () () () () | 2,096. | 2,628. | 3,046. | 3,960. |
| | 42" | 72" | 32.5" | AMG42E725 () () () () () | 2,153. | 2,699. | 3,128. | 4,067. |
| | 42" | 78" | 32.5" | AMG42E785 () () () () () | 2,211. | 2,771. | 3,210. | 4,172. |
| | 42" | 84" | 32.5" | AMG42E845 () () () () () | 2,269. | 2,841. | 3,292. | 4,278. |
| | 42" | 90" | 32.5" | AMG42E905 () () () () () | 2,325. | 2,909. | 3,373. | 4,384. |
| | 42" | 96" | 32.5" | AMG42E965 () () () () () | 2,381. | 2,980. | 3,454. | 4,489. |

| Order Code | Specification Information | Application Notes |
|--|--|---|
| Example: AMB42E604GFNEBV316 V316613AA | <i>To order please specify pattern number including:</i> | |
| A AutoStrada | 1. Width | 6. Finish, surround, top shelf and worksurface front edge <i>Laminate, V1, V2 or V3 finish</i> |
| M Median | 2. Depth <i>4 = 26.5" d nominal</i> <i>5 = 32.5" d nominal</i> | 7. Finish, worksurface <i>Laminate, V1, V2 or V3 finish</i> |
| B Binder depth top shelf | 3. Grommet option <i>G = Grommet(s)</i> <i>N = No grommet(s)</i> | 8. Finish, Grommet(s) <i>specify painted or plated finish</i> |
| 42 42" high | 4. Face drill option <i>FL = face drill left gable for ganging</i> <i>FR = face drill right gable for ganging</i> <i>FN = face drill none</i> | 9. Finish, Aluminum trim <i>AA - Anodized aluminum or painted finish option from page 7 excluding silver</i> |
| E End gables, both sides | 5. End drill option <i>EL = end drill left gable to attach to bridge</i> <i>ER = end drill right gable to attach to bridge</i> <i>EB = end drill both gables to attach to bridges (applicable 84"w, 90"w and 96"w only)</i> <i>EN = no drill (for freestanding applications)</i> | Order worksurface stiffener for unsupported spans exceeding 48". |
| 60 60" wide | | *42"h to top of gable; with aluminum trim and top shelf 43.2"h. |
| 4 26.5" d | | *Width noted is interior nominal dimension, overall footprint additional 2" nominal. |
| G Grommet | | See page 7 for finish options applicable. |
| FN Face drill gable, none | | Product on this page will accept wood grain laminate where laminate is currently an option. List price for wood grain laminate options will be current published laminate list price plus 10%. |
| EB End drill gable, both | | |
| V316 Finish, surround, top shelf & worksurface edge | | |
| V316 Finish, worksurface | | |
| 613 Finish, grommet | | |
| AA Trim, anodized aluminum | | |

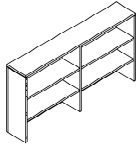
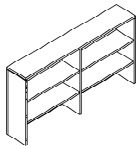
| description | type | h* | w* | d | pattern no. | L | V1 | V2 | V3 |
|--|--------------|-----|-----|-----|------------------------------|----------|----------|----------|----------|
|  <p>Storage Median, 42" h w/ wood shelves</p> <p>center gable only in units 54" w and over</p> | binder depth | 42" | 42" | 14" | ASM42WB42 () () () | \$1,587. | \$1,981. | \$2,276. | \$2,960. |
| | | 42" | 48" | 14" | ASM42WB48 () () () | 1,653. | 2,060. | 2,369. | 3,080. |
| | | 42" | 54" | 14" | ASM42WB54 () () () | 1,809. | 2,440. | 2,932. | 3,813. |
| | | 42" | 60" | 14" | ASM42WB60 () () () | 1,878. | 2,531. | 3,045. | 3,956. |
| | | 42" | 66" | 14" | ASM42WB66 () () () | 1,945. | 2,623. | 3,156. | 4,103. |
| | | 42" | 72" | 14" | ASM42WB72 () () () | 2,014. | 2,715. | 3,266. | 4,246. |
| | | 42" | 78" | 14" | ASM42WB78 () () () | 2,081. | 2,806. | 3,378. | 4,391. |
| | | 42" | 84" | 14" | ASM42WB84 () () () | 2,150. | 2,899. | 3,490. | 4,534. |
| | | 42" | 90" | 14" | ASM42WB90 () () () | 2,218. | 2,991. | 3,599. | 4,679. |
| | | 42" | 96" | 14" | ASM42WB96 () () () | 2,286. | 3,082. | 3,709. | 4,824. |
|  <p>Storage Median, 42" h w/ metal shelves</p> <p>center gable only in units 54" w and over</p> | binder depth | 42" | 42" | 14" | ASM42MB42 () () () | 2,190. | 2,653. | 2,697. | 3,236. |
| | | 42" | 48" | 14" | ASM42MB48 () () () | 2,280. | 2,761. | 2,806. | 3,369. |
| | | 42" | 54" | 14" | ASM42MB54 () () () | 2,494. | 3,020. | 3,475. | 4,171. |
| | | 42" | 60" | 14" | ASM42MB60 () () () | 2,587. | 3,133. | 3,607. | 4,325. |
| | | 42" | 66" | 14" | ASM42MB66 () () () | 2,681. | 3,247. | 3,736. | 4,486. |
| | | 42" | 72" | 14" | ASM42MB72 () () () | 2,774. | 3,363. | 3,869. | 4,644. |
| | | 42" | 78" | 14" | ASM42MB78 () () () | 2,868. | 3,475. | 4,001. | 4,801. |
| | | 42" | 84" | 14" | ASM42MB84 () () () | 2,964. | 3,589. | 4,132. | 4,958. |
| | | 42" | 90" | 14" | ASM42MB90 () () () | 3,057. | 3,703. | 4,262. | 5,116. |
| | | 42" | 96" | 14" | ASM42MB96 () () () | 3,151. | 3,818. | 4,394. | 5,274. |

| Order Code | Specification Information | Application Notes | | | | | | | | | | | | | | | | | | | | |
|---|---------------------------|-------------------|-----------|----------------|-----------|----------|----------|--------------|----------|--------------|-----------|----------|-----------|----------------------|-----------|----------------------|-------------|---------------|-----------|-------------------------|--|---|
| <p>Example: ASM42WB42FNELV316AA</p> <table border="1"> <tr> <td>A</td> <td>AutoStrada</td> </tr> <tr> <td>SM</td> <td>Storage Median</td> </tr> <tr> <td>42</td> <td>42" high</td> </tr> <tr> <td>W</td> <td>Wood shelves</td> </tr> <tr> <td>B</td> <td>Binder depth</td> </tr> <tr> <td>42</td> <td>42" wide</td> </tr> <tr> <td>FN</td> <td>Face drill gable, no</td> </tr> <tr> <td>EL</td> <td>End drill left gable</td> </tr> <tr> <td>V316</td> <td>Finish, Maple</td> </tr> <tr> <td>AA</td> <td>Trim, anodized aluminum</td> </tr> </table> | A | AutoStrada | SM | Storage Median | 42 | 42" high | W | Wood shelves | B | Binder depth | 42 | 42" wide | FN | Face drill gable, no | EL | End drill left gable | V316 | Finish, Maple | AA | Trim, anodized aluminum | <p>To order please specify pattern number including:</p> <ol style="list-style-type: none"> 1. Wood or Metal shelves Embedded in pattern number W = wood shelves M = metal shelves (Two piece extruded assembly) <i>Note: shelf at worksurface height always wood</i> 2. Depth Embedded in pattern number B = Binder depth G = Legal depth 3. Width 4. Face drill option FL = face drill left gable for ganging FR = face drill right gable for ganging FB = face drill both gables for ganging FN = face drill none 5. End drill option EL = end drill left gable to attach to bridge ER = end drill right gable to attach to bridge EB = end drill both gables to attach to bridges (applicable 84" w, 90" w and 96" w only) EN = no drill (for freestanding applications) 6. Finish Laminate, V1, V2 or V3 finish 7. Finish, metal shelves AA - anodized aluminum or painted finish option from page 7 excluding silver 8. Finish, Aluminum trim AA - Anodized aluminum or painted finish option from page 7 excluding silver <p>*42" h to top of gables, with aluminum trim and top shelf 43.2" h. Inside width above, overall footprint additional 2" nominal.</p> <p>See page 7 for finish options applicable.</p> <p>Product on this page will accept wood grain laminate where laminate is currently an option. List price for wood grain laminate options will be current published laminate list price plus 10%.</p> | <p>Storage medians may be used in free-standing applications alone or multiple units side by side. When specifying side by side applications, be sure to select appropriate face drilling option (see specification option #4) and EN for no end drilling in gables. Storage medians may also be used with bridges on page 144 for creating L shaped work area configurations. When specifying for use with bridges, be sure to specify appropriate end drill option (see specification option #5).</p> <p>Center shelf fixed at 27" h to underside to align with bridge worksurface height and always same material as case (wood or laminate).</p> <p>Bridge units include hardware kit with washers to accommodate connection of 1" thick fixed storage median shelf to 1 1/4" thick bridge worksurface.</p> <p>Product on this page shipped knocked-down.</p> |
| A | AutoStrada | | | | | | | | | | | | | | | | | | | | | |
| SM | Storage Median | | | | | | | | | | | | | | | | | | | | | |
| 42 | 42" high | | | | | | | | | | | | | | | | | | | | | |
| W | Wood shelves | | | | | | | | | | | | | | | | | | | | | |
| B | Binder depth | | | | | | | | | | | | | | | | | | | | | |
| 42 | 42" wide | | | | | | | | | | | | | | | | | | | | | |
| FN | Face drill gable, no | | | | | | | | | | | | | | | | | | | | | |
| EL | End drill left gable | | | | | | | | | | | | | | | | | | | | | |
| V316 | Finish, Maple | | | | | | | | | | | | | | | | | | | | | |
| AA | Trim, anodized aluminum | | | | | | | | | | | | | | | | | | | | | |

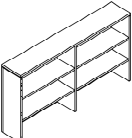
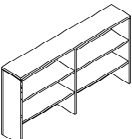
| description | type | h* | w* | d | pattern no. | L | V1 | V2 | V3 |
|---|-------------|-----|-----|-----|------------------------------|----------|----------|----------|----------|
|  <p>Storage Median, 42" h w/ wood shelves</p> <p><i>center gable only in units 54" w and over</i></p> | legal depth | 42" | 42" | 17" | ASM42WG42 () () () | \$1,669. | \$2,080. | \$2,390. | \$3,108. |
| | | 42" | 48" | 17" | ASM42WG48 () () () | 1,737. | 2,164. | 2,489. | 3,236. |
| | | 42" | 54" | 17" | ASM42WG54 () () () | 1,900. | 2,560. | 3,081. | 4,005. |
| | | 42" | 60" | 17" | ASM42WG60 () () () | 1,971. | 2,658. | 3,197. | 4,156. |
| | | 42" | 66" | 17" | ASM42WG66 () () () | 2,042. | 2,755. | 3,314. | 4,307. |
| | | 42" | 72" | 17" | ASM42WG72 () () () | 2,114. | 2,851. | 3,430. | 4,459. |
| | | 42" | 78" | 17" | ASM42WG78 () () () | 2,185. | 2,948. | 3,546. | 4,610. |
| | | 42" | 84" | 17" | ASM42WG84 () () () | 2,256. | 3,044. | 3,662. | 4,760. |
| | | 42" | 90" | 17" | ASM42WG90 () () () | 2,328. | 3,141. | 3,779. | 4,913. |
| | | 42" | 96" | 17" | ASM42WG96 () () () | 2,400. | 3,237. | 3,896. | 5,066. |
|  <p>Storage Median, 42" h w/ metal shelves</p> <p><i>center gable only in units 54" w and over</i></p> | legal depth | 42" | 42" | 17" | ASM42MG42 () () () | 2,300. | 2,784. | 2,831. | 3,397. |
| | | 42" | 48" | 17" | ASM42MG48 () () () | 2,393. | 2,900. | 2,946. | 3,538. |
| | | 42" | 54" | 17" | ASM42MG54 () () () | 2,618. | 3,170. | 3,649. | 4,378. |
| | | 42" | 60" | 17" | ASM42MG60 () () () | 2,717. | 3,291. | 3,787. | 4,543. |
| | | 42" | 66" | 17" | ASM42MG66 () () () | 2,815. | 3,409. | 3,926. | 4,709. |
| | | 42" | 72" | 17" | ASM42MG72 () () () | 2,914. | 3,528. | 4,062. | 4,876. |
| | | 42" | 78" | 17" | ASM42MG78 () () () | 3,012. | 3,649. | 4,201. | 5,040. |
| | | 42" | 84" | 17" | ASM42MG84 () () () | 3,111. | 3,770. | 4,339. | 5,207. |
| | | 42" | 90" | 17" | ASM42MG90 () () () | 3,209. | 3,888. | 4,476. | 5,370. |
| | | 42" | 96" | 17" | ASM42MG96 () () () | 3,309. | 4,007. | 4,614. | 5,538. |

| Order Code | Specification Information | Application Notes |
|--|--|--|
| <p>Example: ASM42WG42FNELV316AA</p> <p>A AutoStrada</p> <p>SM Storage Median</p> <p>42 42" high</p> <p>W Wood shelves</p> <p>G Legal depth</p> <p>42 42" wide</p> <p>FN Face drill gable, no</p> <p>EL End drill left gable</p> <p>V316 Finish, Maple</p> <p>AA Trim, anodized aluminum</p> | <p>To order please specify pattern number including:</p> <p>1. Wood or Metal shelves <i>Embedded in pattern number</i> <i>W = wood shelves</i> <i>M = metal shelves (Two piece extruded assembly)</i> <i>Note: shelf at worksurface height always wood</i></p> <p>2. Depth <i>Embedded in pattern number</i> <i>B = Binder depth</i> <i>G = Legal depth</i></p> <p>3. Width</p> <p>4. Face drill option <i>FL = face drill left gable for ganging</i> <i>FR = face drill right gable for ganging</i> <i>FB = face drill both gables for ganging</i> <i>FN = face drill none</i></p> | <p>5. End drill option <i>EL = end drill left gable to attach to bridge</i> <i>ER = end drill right gable to attach to bridge</i> <i>EB = end drill both gables to attach to bridges (applicable 84" w, 90" w and 96" w only)</i> <i>EN = no drill (for freestanding applications)</i></p> <p>6. Finish <i>Laminate, V1, V2 or V3 finish</i></p> <p>7. Finish, metal shelves <i>AA - Anodized aluminum or painted finish option from page 7 excluding silver</i></p> <p>8. Finish, Aluminum trim <i>AA - Anodized aluminum or painted finish option from page 7 excluding silver</i></p> <p>See page 7 for finish options applicable.</p> <p>*42" h to top of gables, with aluminum trim and top shelf 43.2" h. Inside width above, overall footprint additional 2" nominal.</p> <p>See page 7 for finish options applicable.</p> <p>Product on this page will accept wood grain laminate where laminate is currently an option. List price for wood grain laminate options will be current published laminate list price plus 10%.</p> |
| | | <p>Storage medians may be used in free-standing applications alone or multiple units side by side. When specifying side by side applications, be sure to select appropriate face drilling option (see specification option #4) and EN for no end drilling in gables. Storage medians may also be used with bridges on page 144 for creating L shaped work area configurations. When specifying for use with bridges, be sure to specify appropriate end drill option (see specification option #5).</p> <p>Center shelf fixed at 27" h to underside to align with bridge worksurface height and always same material as case (wood or laminate).</p> <p>Bridge units include hardware kit with washers to accommodate connection of 1" thick fixed storage median shelf to 1 1/4" thick bridge worksurface.</p> <p>Products on this page shipped knocked-down.</p> |

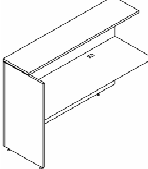
| description | type | h* | w* | d | pattern no. | L | M/V1 or V1 | M/V2 or V2 | M/V3 or V3 |
|---|------------|-----|-----|---------|--|----------|---------------|---------------|---------------|
|  <p>left hand shown, worksurface height fixed 27" h to underside</p> | left hand | 49" | 42" | 26 1/2" | AMBL424 () () () () () () | \$1,454. | \$1,813. | \$2,084. | \$2,709. |
| | | 49" | 48" | 26 1/2" | AMBL484 () () () () () () | 1,514. | 1,886. | 2,168. | 2,820. |
| | | 49" | 54" | 26 1/2" | AMBL544 () () () () () () | 1,573. | 1,960. | 2,255. | 2,929. |
| | | 49" | 60" | 26 1/2" | AMBL604 () () () () () () | 1,633. | 2,033. | 2,340. | 3,043. |
| | | 49" | 66" | 26 1/2" | AMBL664 () () () () () () | 1,692. | 2,108. | 2,425. | 3,154. |
| | | 49" | 72" | 26 1/2" | AMBL724 () () () () () () | 1,752. | 2,181. | 2,509. | 3,262. |
| | | 49" | 78" | 26 1/2" | AMBL784 () () () () () () | 1,811. | 2,256. | 2,595. | 3,373. |
| | | 49" | 84" | 26 1/2" | AMBL844 () () () () () () | 1,870. | 2,330. | 2,680. | 3,483. |
| | | 49" | 90" | 26 1/2" | AMBL904 () () () () () () | 1,931. | 2,403. | 2,765. | 3,596. |
| | | 49" | 96" | 26 1/2" | AMBL964 () () () () () () | 1,988. | 2,478. | 2,850. | 3,707. |
| | right hand | 49" | 42" | 26 1/2" | AMBR424 () () () () () () | 1,454. | 1,813. | 2,084. | 2,709. |
| | | 49" | 48" | 26 1/2" | AMBR484 () () () () () () | 1,514. | 1,886. | 2,168. | 2,820. |
| | | 49" | 54" | 26 1/2" | AMBR544 () () () () () () | 1,573. | 1,960. | 2,255. | 2,929. |
| | | 49" | 60" | 26 1/2" | AMBR604 () () () () () () | 1,633. | 2,033. | 2,340. | 3,043. |
| | | 49" | 66" | 26 1/2" | AMBR664 () () () () () () | 1,692. | 2,108. | 2,425. | 3,154. |
| | | 49" | 72" | 26 1/2" | AMBR724 () () () () () () | 1,752. | 2,181. | 2,509. | 3,262. |
| | | 49" | 78" | 26 1/2" | AMBR784 () () () () () () | 1,811. | 2,256. | 2,595. | 3,373. |
| | | 49" | 84" | 26 1/2" | AMBR844 () () () () () () | 1,870. | 2,330. | 2,680. | 3,483. |
| | | 49" | 90" | 26 1/2" | AMBR904 () () () () () () | 1,931. | 2,403. | 2,765. | 3,596. |
| | | 49" | 96" | 26 1/2" | AMBR964 () () () () () () | 1,988. | 2,478. | 2,850. | 3,707. |

| Order Code | Specification Information | Application Notes |
|--|--|--|
| Example: AMBL424GFEV316 V316613AA | To order please specify pattern number including: | Median end without gable to be attached to a storage anchored cabinet. Optional face drill option is to drill outside face of gable to attach to next median in line, if last unit in run specify no drill. Optional end drill gable option is for attachment to bridge units on page 144, specify no drill if configuration does not include bridge unit. |
| A AutoStrada | 1. Hand <i>L = Left hand</i> <i>R = Right hand</i> | 7. Finish, surround, top shelf and worksurface front edge <i>Laminate, V1, V2 or V3 finish</i> |
| M Median | 2. Width | 8. Finish, worksurface <i>Laminate, V1, V2 or V3 finish</i> |
| B Binder depth top shelf | 3. Depth <i>4 = 26.5" d nominal</i> <i>5 = 32.5" d nominal</i> | 9. Finish, Grommet(s) <i>specify painted or plated finish</i> |
| L Left hand | 4. Grommet option <i>G = Grommet(s)</i> <i>N = No grommet(s)</i> | 10. Finish, Aluminum trim <i>AA - Anodized aluminum or painted finish option from page 7 excluding silver</i> |
| 42 42" wide | 5. Face drill option <i>F = face drill for attachment to next unit</i> <i>N = no drill, last unit in run</i> | Order worksurface stiffener for unsupported spans exceeding 48". |
| 4 26.5" d | 6. End drill option <i>E = end drill gable to attach to bridge</i> <i>N = no drill</i> | *49" h to top of gable; with aluminum trim and top shelf 50.2" h. |
| G Grommet | | *Width noted is interior nominal dimension, overall footprint additional 1" nominal. |
| F Face drill gable | | See page 7 for finish options applicable. |
| E End drill gable | | Product on this page will accept wood grain laminate where laminate is currently an option. List price for wood grain laminate options will be current published laminate list price plus 10%. |
| V316 Finish, surround, top shelf & worksurface edge | | |
| V316 Finish, worksurface | | |
| 613 Finish, grommet | | |
| AA Trim, anodized aluminum | | |

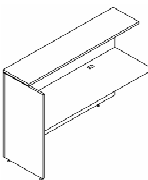
| description | type | h* | w* | d | pattern no. | L | M/V1 or V1 | M/V2 or V2 | M/V3 or V3 |
|---|------------|-----|-----|---------|--|----------|---------------|---------------|---------------|
|  <p>left hand shown, worksurface height fixed 27" h to underside</p> | left hand | 49" | 42" | 32 1/2" | AMBL425 () () () () () () | \$1,539. | \$1,899. | \$2,184. | \$2,840. |
| | | 49" | 48" | 32 1/2" | AMBL485 () () () () () () | 1,598. | 1,972. | 2,268. | 2,948. |
| | | 49" | 54" | 32 1/2" | AMBL545 () () () () () () | 1,657. | 2,045. | 2,352. | 3,057. |
| | | 49" | 60" | 32 1/2" | AMBL605 () () () () () () | 1,715. | 2,116. | 2,437. | 3,166. |
| | | 49" | 66" | 32 1/2" | AMBL665 () () () () () () | 1,774. | 2,190. | 2,520. | 3,274. |
| | | 49" | 72" | 32 1/2" | AMBL725 () () () () () () | 1,833. | 2,262. | 2,604. | 3,385. |
| | | 49" | 78" | 32 1/2" | AMBL785 () () () () () () | 1,891. | 2,336. | 2,689. | 3,494. |
| | | 49" | 84" | 32 1/2" | AMBL845 () () () () () () | 1,952. | 2,409. | 2,771. | 3,602. |
| | | 49" | 90" | 32 1/2" | AMBL905 () () () () () () | 2,010. | 2,481. | 2,855. | 3,712. |
| | | 49" | 96" | 32 1/2" | AMBL965 () () () () () () | 2,069. | 2,554. | 2,940. | 3,821. |
| | right hand | 49" | 42" | 32 1/2" | AMBR425 () () () () () () | 1,539. | 1,899. | 2,184. | 2,840. |
| | | 49" | 48" | 32 1/2" | AMBR485 () () () () () () | 1,598. | 1,972. | 2,268. | 2,948. |
| | | 49" | 54" | 32 1/2" | AMBR545 () () () () () () | 1,657. | 2,045. | 2,352. | 3,057. |
| | | 49" | 60" | 32 1/2" | AMBR605 () () () () () () | 1,715. | 2,116. | 2,437. | 3,166. |
| | | 49" | 66" | 32 1/2" | AMBR665 () () () () () () | 1,774. | 2,190. | 2,520. | 3,274. |
| | | 49" | 72" | 32 1/2" | AMBR725 () () () () () () | 1,833. | 2,262. | 2,604. | 3,385. |
| | | 49" | 78" | 32 1/2" | AMBR785 () () () () () () | 1,891. | 2,336. | 2,689. | 3,494. |
| | | 49" | 84" | 32 1/2" | AMBR845 () () () () () () | 1,952. | 2,409. | 2,771. | 3,602. |
| | | 49" | 90" | 32 1/2" | AMBR905 () () () () () () | 2,010. | 2,481. | 2,855. | 3,712. |
| | | 49" | 96" | 32 1/2" | AMBR965 () () () () () () | 2,069. | 2,554. | 2,940. | 3,821. |

| Order Code | Specification Information | Application Notes |
|--|--|---|
| Example: AMBR425GF316V316613AA | To order please specify pattern number including: | 7. Finish, surround, top shelf and worksurface front edge <i>Laminate, V1, V2 or V3 finish</i> |
| A AutoStrada | 1. Hand <i>L = Left hand R = Right hand</i> | 8. Finish, worksurface <i>Laminate, V1, V2 or V3 finish</i> |
| M Median | 2. Width | 9. Finish, Grommet(s) <i>specify painted or plated finish</i> |
| B Binder depth top shelf | 3. Depth <i>4 = 26.5" d nominal 5 = 32.5" d nominal</i> | 10. Finish, Aluminum trim <i>AA - Anodized aluminum or painted finish option from page 7 excluding silver</i> |
| R Right hand | 4. Grommet option <i>G = Grommet(s) N = No grommet(s)</i> | Order worksurface stiffener for unsupported spans exceeding 48". *49"h to top of gable; with aluminum trim and top shelf 50.2"h. |
| 42 42" wide | 5. Face drill option <i>F = face drill for attachment to next unit N = no drill, last unit in run</i> | *Width noted is interior nominal dimension, overall footprint additional 1" nominal. |
| 5 32.5" d | 6. End drill option <i>E = end drill gable to attach to bridge N = no drill</i> | See page 7 for finish options applicable. |
| G Grommet | | Product on this page will accept wood grain laminate where laminate is currently an option. List price for wood grain laminate options will be current published laminate list price plus 10%. |
| F Face drill gable | | |
| E End drill gable | | |
| V316 Finish, surround, top shelf & worksurface edge | | |
| V316 Finish, worksurface | | |
| 613 Finish, grommet | | |
| AA Trim, anodized aluminum | | |

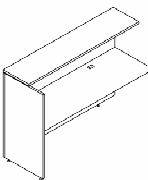
| description | type | h* | w* | d | pattern no. | L | M/V1 or V1 | M/V2 or V2 | M/V3 or V3 |
|---|------------|-----|-----|---------|--|----------|---------------|---------------|---------------|
|  <p>left hand shown, worksurface height fixed 27" h to underside</p> | left hand | 49" | 42" | 26 1/2" | AMGL424 () () () () () () | \$1,484. | \$1,849. | \$2,126. | \$2,763. |
| | | 49" | 48" | 26 1/2" | AMGL484 () () () () () () | 1,545. | 1,924. | 2,213. | 2,877. |
| | | 49" | 54" | 26 1/2" | AMGL544 () () () () () () | 1,606. | 2,000. | 2,299. | 2,990. |
| | | 49" | 60" | 26 1/2" | AMGL604 () () () () () () | 1,666. | 2,075. | 2,387. | 3,104. |
| | | 49" | 66" | 26 1/2" | AMGL664 () () () () () () | 1,727. | 2,150. | 2,474. | 3,216. |
| | | 49" | 72" | 26 1/2" | AMGL724 () () () () () () | 1,786. | 2,227. | 2,561. | 3,328. |
| | | 49" | 78" | 26 1/2" | AMGL784 () () () () () () | 1,847. | 2,300. | 2,647. | 3,442. |
| | | 49" | 84" | 26 1/2" | AMGL844 () () () () () () | 1,908. | 2,376. | 2,733. | 3,554. |
| | | 49" | 90" | 26 1/2" | AMGL904 () () () () () () | 1,968. | 2,450. | 2,821. | 3,666. |
| | | 49" | 96" | 26 1/2" | AMGL964 () () () () () () | 2,029. | 2,527. | 2,907. | 3,781. |
| | right hand | 49" | 42" | 26 1/2" | AMGR424 () () () () () () | 1,484. | 1,849. | 2,126. | 2,763. |
| | | 49" | 48" | 26 1/2" | AMGR484 () () () () () () | 1,545. | 1,924. | 2,213. | 2,877. |
| | | 49" | 54" | 26 1/2" | AMGR544 () () () () () () | 1,606. | 2,000. | 2,299. | 2,990. |
| | | 49" | 60" | 26 1/2" | AMGR604 () () () () () () | 1,666. | 2,075. | 2,387. | 3,104. |
| | | 49" | 66" | 26 1/2" | AMGR664 () () () () () () | 1,727. | 2,150. | 2,474. | 3,216. |
| | | 49" | 72" | 26 1/2" | AMGR724 () () () () () () | 1,786. | 2,227. | 2,561. | 3,328. |
| | | 49" | 78" | 26 1/2" | AMGR784 () () () () () () | 1,847. | 2,300. | 2,647. | 3,442. |
| | | 49" | 84" | 26 1/2" | AMGR844 () () () () () () | 1,908. | 2,376. | 2,733. | 3,554. |
| | | 49" | 90" | 26 1/2" | AMGR904 () () () () () () | 1,968. | 2,450. | 2,821. | 3,666. |
| | | 49" | 96" | 26 1/2" | AMGR964 () () () () () () | 2,029. | 2,527. | 2,907. | 3,781. |

| Order Code | Specification Information | Application Notes |
|--|--|--|
| Example: AMGL424GFEV316 V316613AA | <i>To order please specify pattern number including:</i> | |
| A AutoStrada | 1. Left or Right hand <i>L = Left hand</i> <i>R = Right hand</i> | 7. Finish, surround, top shelf & worksurface edge <i>Laminate, V1, V2 or V3 finish</i> |
| M Median | 2. Width | 8. Finish, worksurface <i>Laminate, V1, V2 or V3</i> |
| G Legal depth top shelf | 3. Depth <i>4 = 26.5" d nominal</i> <i>5 = 32.5" d nominal</i> | 9. Finish, Grommet(s) <i>specify painted or plated finish</i> |
| L Left hand | 4. Grommet option <i>G = Grommet(s)</i> <i>N = No grommet(s)</i> | 10. Finish, Aluminum trim <i>AA - Anodized aluminum or painted finish option from page 7 excluding silver</i> |
| 42 42" wide | 5. Face drill option <i>F = face drill for attachment to next unit</i> <i>N = no drill, last unit in run</i> | Order worksurface stiffener for unsupported spans exceeding 48". *49"h to top of gable; with aluminum trim and top shelf 50.2"h. |
| 4 26.5" d | 6. End drill option <i>E = end drill gable to attach to bridge</i> <i>N = no drill</i> | *Width noted is interior nominal dimension, overall footprint additional 1" nominal. |
| G Grommet | | See page 7 for finish options applicable. |
| F Face drill gable | | Product on this page will accept wood grain laminate where laminate is currently an option. List price for wood grain laminate options will be current published laminate list price plus 10%. |
| E End drill gable | | |
| V316 Finish, surround, top shelf & worksurface edge | | Median end without gable to be attached to a storage anchored cabinet. Optional face drill option is to drill outside face of gable to attach to next median in line, if last unit in run specify no drill. Optional end drill gable option is for attachment to bridge units on page 144, specify no drill if configuration does not include bridge unit. |
| V316 Finish, worksurface | | Mixed finish options applicable with V1, V2 or V3 finish surround, top shelf and worksurface front edge with laminate finish worksurface. |
| 613 Finish, grommet | | Product on this page shipped knocked-down. |
| AA Trim, anodized aluminum | | |

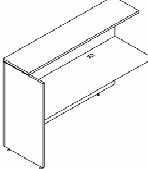
| description | type | h* | w* | d | pattern no. | L | M/V1 or V1 | M/V2 or V2 | M/V3 or V3 |
|---|------------|-----|-----|---------|--|----------|---------------|---------------|---------------|
|  <p>left hand shown, worksurface height fixed 27" h to underside</p> | left hand | 49" | 42" | 32 1/2" | AMGL425 () () () () () () | \$1,570. | \$1,939. | \$2,228. | \$2,896. |
| | | 49" | 48" | 32 1/2" | AMGL485 () () () () () () | 1,629. | 2,011. | 2,313. | 3,006. |
| | | 49" | 54" | 32 1/2" | AMGL545 () () () () () () | 1,689. | 2,086. | 2,398. | 3,117. |
| | | 49" | 60" | 32 1/2" | AMGL605 () () () () () () | 1,750. | 2,160. | 2,483. | 3,231. |
| | | 49" | 66" | 32 1/2" | AMGL665 () () () () () () | 1,810. | 2,234. | 2,570. | 3,341. |
| | | 49" | 72" | 32 1/2" | AMGL725 () () () () () () | 1,870. | 2,307. | 2,655. | 3,452. |
| | | 49" | 78" | 32 1/2" | AMGL785 () () () () () () | 1,931. | 2,382. | 2,742. | 3,563. |
| | | 49" | 84" | 32 1/2" | AMGL845 () () () () () () | 1,989. | 2,456. | 2,827. | 3,675. |
| | | 49" | 90" | 32 1/2" | AMGL905 () () () () () () | 2,050. | 2,529. | 2,913. | 3,786. |
| | | 49" | 96" | 32 1/2" | AMGL965 () () () () () () | 2,109. | 2,606. | 2,998. | 3,898. |
| | right hand | 49" | 42" | 32 1/2" | AMGR425 () () () () () () | 1,570. | 1,939. | 2,228. | 2,896. |
| | | 49" | 48" | 32 1/2" | AMGR485 () () () () () () | 1,629. | 2,011. | 2,313. | 3,006. |
| | | 49" | 54" | 32 1/2" | AMGR545 () () () () () () | 1,689. | 2,086. | 2,398. | 3,117. |
| | | 49" | 60" | 32 1/2" | AMGR605 () () () () () () | 1,750. | 2,160. | 2,483. | 3,231. |
| | | 49" | 66" | 32 1/2" | AMGR665 () () () () () () | 1,810. | 2,234. | 2,570. | 3,341. |
| | | 49" | 72" | 32 1/2" | AMGR725 () () () () () () | 1,870. | 2,307. | 2,655. | 3,452. |
| | | 49" | 78" | 32 1/2" | AMGR785 () () () () () () | 1,931. | 2,382. | 2,742. | 3,563. |
| | | 49" | 84" | 32 1/2" | AMGR845 () () () () () () | 1,989. | 2,456. | 2,827. | 3,675. |
| | | 49" | 90" | 32 1/2" | AMGR905 () () () () () () | 2,050. | 2,529. | 2,913. | 3,786. |
| | | 49" | 96" | 32 1/2" | AMGR965 () () () () () () | 2,109. | 2,606. | 2,998. | 3,898. |

| Order Code | Specification Information | Application Notes |
|--|--|--|
| Example: AMGR425GFEV316 V316613AA | <i>To order please specify pattern number including:</i> | |
| A AutoStrada | 1. Left or Right hand <i>L = Left hand</i> <i>R = Right hand</i> | 7. Finish, surround, top shelf & worksurface edge <i>Laminate, V1, V2 or V3 finish</i> |
| M Median | 2. Width | 8. Finish, worksurface <i>Laminate, V1, V2 or V3</i> |
| G Legal depth top shelf | 3. Depth <i>4 = 26.5" d nominal</i> <i>5 = 32.5" d nominal</i> | 9. Finish, Grommet(s) <i>specify painted or plated finish</i> |
| R Right hand | 4. Grommet option <i>G = Grommet(s)</i> <i>N = No grommet(s)</i> | 10. Finish, Aluminum trim <i>AA - Anodized aluminum or painted finish option from page 7 excluding silver</i> |
| 42 42" wide | 5. Face drill option <i>F = face drill for attachment to next unit</i> <i>N = no drill, last unit in run</i> | Order worksurface stiffener for unsupported spans exceeding 48". *49" h to top of gable; with aluminum trim and top shelf 50.2" h. |
| 5 32.5" d | 6. End drill option <i>E = end drill gable to attach to bridge</i> <i>N = no drill</i> | *Width noted is interior nominal dimension, overall footprint additional 1" nominal. |
| G Grommet | | See page 7 for finish options applicable. |
| F Face drill gable | | Product on this page will accept wood grain laminate where laminate is currently an option. List price for wood grain laminate options will be current published laminate list price plus 10%. |
| E End drill gable | | |
| V316 Finish, surround, top shelf & worksurface edge | | Median end without gable to be attached to a storage anchored cabinet. Optional face drill option is to drill outside face of gable to attach to next median in line, if last unit in run specify no drill. Optional end drill gable option is for attachment to bridge units on page 144, specify no drill if configuration does not include bridge unit. |
| V316 Finish, worksurface | | Mixed finish options applicable with V1, V2 or V3 finish surround, top shelf and worksurface front edge with laminate finish worksurface. |
| 613 Finish, grommet | | Product on this page shipped knocked-down. |
| AA Trim, anodized aluminum | | |

| description | h* | w* | d | pattern no. | L | M/V1 or V1 | M/V2 or V2 | M/V3 or V3 |
|---|-----|-----|-------|-------------|----------|---------------|---------------|---------------|
| Medians with double end gable | 49" | 60" | 26.5" | AMBE604() | \$2,008. | \$2,538. | \$2,929. | \$3,810. |
| 49"h x 26.5"d with binder depth top shelf | 49" | 66" | 26.5" | AMBE664() | 2,067. | 2,612. | 3,016. | 3,922. |
| | 49" | 72" | 26.5" | AMBE724() | 2,125. | 2,688. | 3,100. | 4,031. |
| | 49" | 78" | 26.5" | AMBE784() | 2,185. | 2,760. | 3,187. | 4,141. |
| | 49" | 84" | 26.5" | AMBE844() | 2,244. | 2,834. | 3,271. | 4,254. |
| | 49" | 90" | 26.5" | AMBE904() | 2,303. | 2,907. | 3,358. | 4,365. |
| | 49" | 96" | 26.5" | AMBE964() | 2,364. | 2,981. | 3,443. | 4,475. |

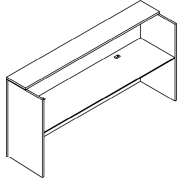

| | | | | | | | | |
|---|-----|-----|-------|-----------|--------|--------|--------|--------|
| Medians with double end gable | 49" | 60" | 32.5" | AMBE605() | 2,113. | 2,651. | 3,072. | 3,993. |
| 49"h x 32.5"d with binder depth top shelf | 49" | 66" | 32.5" | AMBE665() | 2,171. | 2,722. | 3,157. | 4,103. |
| | 49" | 72" | 32.5" | AMBE725() | 2,231. | 2,795. | 3,241. | 4,212. |
| | 49" | 78" | 32.5" | AMBE785() | 2,288. | 2,867. | 3,324. | 4,321. |
| | 49" | 84" | 32.5" | AMBE845() | 2,349. | 2,942. | 3,407. | 4,429. |
| | 49" | 90" | 32.5" | AMBE905() | 2,406. | 3,015. | 3,493. | 4,539. |
| | 49" | 96" | 32.5" | AMBE965() | 2,465. | 3,087. | 3,576. | 4,651. |

Medians

| Order Code | Specification Information | Application Notes |
|--|--|--|
| Example: AMBE604GFNEBV316 V316613AA | <i>To order please specify pattern number including:</i> | |
| A AutoStrada | 1. Width | |
| M Median | 2. Depth | |
| B Binder depth top shelf | 4 = 26.5" d nominal | |
| E End gables, both sides | 5 = 32.5" d nominal | |
| 60 60" wide | 3. Grommet option | |
| 4 26.5" d | G = Grommet(s) | |
| G Grommet | N = No grommet(s) | |
| FN Face drill gable, none | 4. Face drill option | |
| EB End drill gable, both | FL = face drill left gable for ganging | |
| V316 Finish, surround, top shelf & worksurface edge | FR = face drill right gable for ganging | |
| | FN = face drill none | |
| V316 Finish, worksurface | 5. End drill option | |
| 613 Finish, grommet | EL = end drill left gable to attach to bridge | |
| AA Trim, anodized aluminum | ER = end drill right gable to attach to bridge | |
| | EB = end drill both gables to attach to bridges (applicable 84"w, 90"w and 96"w only) | |
| | EN = no drill (for freestanding applications) | |
| | 6. Finish, surround, top shelf and worksurface front edge | Median with double end gables to be specified for single work station or end of run unit without storage anchored cabinet terminating work space. Optional end drill gable option is for attachment to bridge units on page 144, specify no drill if configuration does not include bridge unit. |
| | 7. Finish, worksurface | Mixed finish options applicable with V1, V2 or V3 finish surround, top shelf and worksurface front edge with laminate finish worksurface. |
| | 8. Finish, Grommet(s) | Product on this page shipped knocked-down. |
| | 9. Finish, Aluminum trim | |
| | AA - Anodized aluminum or painted finish option from page 7 excluding silver | |
| | Order worksurface stiffener for unsupported spans exceeding 48". | |
| | *49"h to top of gable; with aluminum trim and top shelf 50.2"h. | |
| | *Width noted is interior nominal dimension, overall footprint additional 2" nominal. | |
| | See page 7 for finish options applicable. | |
| | Product on this page will accept wood grain laminate where laminate is currently an option. | |
| | List price for wood grain laminate options will be current published laminate list price plus 10%. | |

| description | h* | w* | d | pattern no. | L | M/V1 or V1 | M/V2 or V2 | M/V3 or V3 |
|--|-----|-----|-------|----------------------------|----------|---------------|---------------|---------------|
| Medians with double end gable | 49" | 60" | 26.5" | AMGE604() () () () () | \$2,040. | \$2,578. | \$2,978. | \$3,871. |
| 49"h x 26.5"d with legal depth top shelf | 49" | 66" | 26.5" | AMGE664() () () () () | 2,100. | 2,654. | 3,064. | 3,985. |
| | 49" | 72" | 26.5" | AMGE724() () () () () | 2,161. | 2,730. | 3,153. | 4,098. |
| | 49" | 78" | 26.5" | AMGE784() () () () () | 2,222. | 2,805. | 3,238. | 4,209. |
| | 49" | 84" | 26.5" | AMGE844() () () () () | 2,282. | 2,880. | 3,324. | 4,323. |
| | 49" | 90" | 26.5" | AMGE904() () () () () | 2,343. | 2,955. | 3,411. | 4,437. |
| | 49" | 96" | 26.5" | AMGE964() () () () () | 2,403. | 3,031. | 3,498. | 4,550. |

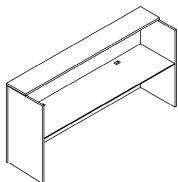

| | | | | | | | | |
|--|-----|-----|-------|----------------------------|--------|--------|--------|--------|
| Medians with double end gable | 49" | 60" | 32.5" | AMGE605() () () () () | 2,147. | 2,693. | 3,121. | 4,058. |
| 49"h x 32.5"d with legal depth top shelf | 49" | 66" | 32.5" | AMGE665() () () () () | 2,208. | 2,766. | 3,206. | 4,169. |
| | 49" | 72" | 32.5" | AMGE725() () () () () | 2,266. | 2,841. | 3,293. | 4,280. |
| | 49" | 78" | 32.5" | AMGE785() () () () () | 2,326. | 2,916. | 3,379. | 4,391. |
| | 49" | 84" | 32.5" | AMGE845() () () () () | 2,387. | 2,990. | 3,464. | 4,504. |
| | 49" | 90" | 32.5" | AMGE905() () () () () | 2,447. | 3,062. | 3,549. | 4,613. |
| | 49" | 96" | 32.5" | AMGE965() () () () () | 2,506. | 3,137. | 3,636. | 4,726. |

| Order Code | Specification Information | Application Notes |
|--|--|--|
| Example: AMBE604GFNEBV316 V316613AA | <i>To order please specify pattern number including:</i> | |
| A AutoStrada | 1. Width | 6. Finish, surround, top shelf and worksurface front edge <i>Laminate, V1, V2 or V3 finish</i> |
| M Median | 2. Depth <i>4 = 26.5" d nominal</i> <i>5 = 32.5" d nominal</i> | 7. Finish, worksurface <i>Laminate, V1, V2 or V3 finish</i> |
| B Binder depth top shelf | 3. Grommet option <i>G = Grommet(s)</i> <i>N = No grommet(s)</i> | 8. Finish, Grommet(s) <i>specify painted or plated finish</i> |
| E End gables, both sides | 4. Face drill option <i>FL = face drill left gable for ganging</i> <i>FR = face drill right gable for ganging</i> <i>FN = face drill none</i> | 9. Finish, Aluminum trim <i>AA - Anodized aluminum or painted finish option from page 7 excluding silver</i> |
| 60 60" wide | 5. End drill option <i>EL = end drill left gable to attach to bridge</i> <i>ER = end drill right gable to attach to bridge</i> <i>EB = end drill both gables to attach to bridges (applicable 84"w, 90"w and 96"w only)</i> <i>EN = no drill (for freestanding applications)</i> | Order worksurface stiffener for unsupported spans exceeding 48". *49"h to top of gable; with aluminum trim and top shelf 50.2"h. *Width noted is interior nominal dimension, overall footprint additional 2" nominal. See page 7 for finish options applicable. |
| 4 26.5" d | | Product on this page shipped knocked-down. |
| G Grommet | | |
| FN Face drill gable, none | | |
| EB End drill gable, both | | |
| V316 Finish, surround, top shelf & worksurface edge | | |
| V316 Finish, worksurface | | |
| 613 Finish, grommet | | |
| AA Trim, anodized aluminum | | |

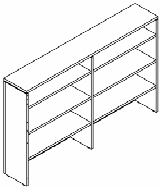
| description | type | h* | w* | d | pattern no. | L | V1 | V2 | V3 |
|--|--------------|-----|-----|-----|----------------------------|----------|----------|----------|----------|
|  <p>center gable only in units 54" w and over</p> | binder depth | 49" | 42" | 14" | ASMWB42 () () () | \$1,672. | \$2,085. | \$2,395. | \$3,115. |
| | | 49" | 48" | 14" | ASMWB48 () () () | 1,741. | 2,168. | 2,494. | 3,242. |
| | | 49" | 54" | 14" | ASMWB54 () () () | 1,904. | 2,568. | 3,088. | 4,014. |
| | | 49" | 60" | 14" | ASMWB60 () () () | 1,976. | 2,664. | 3,205. | 4,165. |
| | | 49" | 66" | 14" | ASMWB66 () () () | 2,047. | 2,761. | 3,322. | 4,319. |
| | | 49" | 72" | 14" | ASMWB72 () () () | 2,119. | 2,858. | 3,439. | 4,470. |
| | | 49" | 78" | 14" | ASMWB78 () () () | 2,190. | 2,955. | 3,556. | 4,622. |
| | | 49" | 84" | 14" | ASMWB84 () () () | 2,262. | 3,051. | 3,673. | 4,773. |
| | | 49" | 90" | 14" | ASMWB90 () () () | 2,335. | 3,149. | 3,789. | 4,926. |
| | | 49" | 96" | 14" | ASMWB96 () () () | 2,406. | 3,244. | 3,905. | 5,078. |

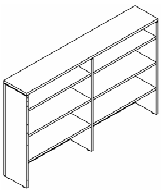
| | | | | | | | | | |
|--|--------------|-----|-----|-----|----------------------------|--------|--------|--------|--------|
|  <p>center gable only in units 54" w and over</p> | binder depth | 49" | 42" | 14" | ASMMB42 () () () | 2,258. | 2,734. | 2,780. | 3,336. |
| | | 49" | 48" | 14" | ASMMB48 () () () | 2,351. | 2,846. | 2,893. | 3,472. |
| | | 49" | 54" | 14" | ASMMB54 () () () | 2,571. | 3,112. | 3,582. | 4,300. |
| | | 49" | 60" | 14" | ASMMB60 () () () | 2,667. | 3,231. | 3,719. | 4,459. |
| | | 49" | 66" | 14" | ASMMB66 () () () | 2,764. | 3,347. | 3,852. | 4,624. |
| | | 49" | 72" | 14" | ASMMB72 () () () | 2,860. | 3,466. | 3,989. | 4,788. |
| | | 49" | 78" | 14" | ASMMB78 () () () | 2,958. | 3,582. | 4,124. | 4,949. |
| | | 49" | 84" | 14" | ASMMB84 () () () | 3,055. | 3,700. | 4,260. | 5,112. |
| | | 49" | 90" | 14" | ASMMB90 () () () | 3,152. | 3,817. | 4,394. | 5,273. |
| | | 49" | 96" | 14" | ASMMB96 () () () | 3,248. | 3,936. | 4,530. | 5,437. |

| Order Code | Specification Information | Application Notes |
|---|---|--|
| <p>Example: ASMWB42FNELV316AA</p> <p>A AutoStrada</p> <p>SM Storage Median</p> <p>W Wood shelves</p> <p>B Binder depth</p> <p>42 42" wide</p> <p>FN Face drill gable, no</p> <p>EL End drill left gable</p> <p>V316 Finish, Maple</p> <p>AA Trim, anodized aluminum</p> | <p>To order please specify pattern number including:</p> <p>1. Wood or Metal shelves <i>Embedded in pattern number</i> <i>W = wood shelves</i> <i>M = metal shelves (Two piece extruded assembly)</i> <i>Note: shelf at worksurface height always wood</i></p> <p>2. Depth <i>Embedded in pattern number</i> <i>B = Binder depth</i> <i>G = Legal depth</i></p> <p>3. Width</p> <p>4. Face drill option <i>FL = face drill left gable for ganging</i> <i>FR = face drill right gable for ganging</i> <i>FB = face drill both gables for ganging</i> <i>FN = face drill none</i></p> <p>5. End drill option <i>EL = end drill left gable to attach to bridge</i> <i>ER = end drill right gable to attach to bridge</i> <i>EB = end drill both gables to attach to bridges (applicable 84" w, 90" w and 96" w only)</i> <i>EN = no drill (for freestanding applications)</i></p> <p>6. Finish <i>Laminate, V1, V2 or V3 finish</i></p> <p>7. Finish, metal shelves <i>AA - anodized aluminum or painted finish option from page 7 excluding silver</i></p> <p>8. Finish, Aluminum trim <i>AA - Anodized aluminum or painted finish option from page 7 excluding silver</i></p> <p>See page 7 for finish options applicable.</p> <p>*49" h to top of gables, with aluminum trim and top shelf 50.2" h. Inside width above, overall footprint additional 2" nominal.</p> <p>See page 7 for finish options applicable.</p> <p>Product on this page will accept wood grain laminate where laminate is currently an option. List price for wood grain laminate options will be current published laminate list price plus 10%.</p> | <p>Storage medians may be used in free-standing applications alone or multiple units side by side. When specifying side by side applications, be sure to select appropriate face drilling option (see specification option #4) and EN for no end drilling in gables. Storage medians may also be used with bridges on page 144 for creating L shaped work area configurations. When specifying for use with bridges, be sure to specify appropriate end drill option (see specification option #5).</p> <p>Center shelf fixed at 27" h to underside to align with bridge worksurface height and always same material as case (wood or laminate). Nominally top shelf 7 1/2" h, other two 13" h.</p> <p>Bridge units include hardware kit with washers to accommodate connection of 1" thick fixed storage median shelf to 1 1/4" thick bridge worksurface.</p> <p>Product on this page shipped knocked-down.</p> |

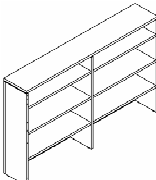
| description | type | h* | w* | d | pattern no. | L | V1 | V2 | V3 | |
|--|-------------------------------------|-------------|-----|-----|-------------|----------------------------|----------|----------|----------|----------|
|  <p>center gable only in units 54" w and over</p> | Storage Median, 49"h w/wood shelves | legal depth | 49" | 42" | 17" | ASMWG42 () () () | \$1,757. | \$2,189. | \$2,515. | \$3,271. |
| | | | 49" | 48" | 17" | ASMWG48 () () () | 1,828. | 2,278. | 2,619. | 3,405. |
| | | | 49" | 54" | 17" | ASMWG54 () () () | 2,000. | 2,695. | 3,243. | 4,216. |
| | | | 49" | 60" | 17" | ASMWG60 () () () | 2,075. | 2,797. | 3,366. | 4,375. |
| | | | 49" | 66" | 17" | ASMWG66 () () () | 2,150. | 2,899. | 3,489. | 4,534. |
| | | | 49" | 72" | 17" | ASMWG72 () () () | 2,226. | 3,002. | 3,610. | 4,693. |
| | | | 49" | 78" | 17" | ASMWG78 () () () | 2,300. | 3,104. | 3,734. | 4,853. |
| | | | 49" | 84" | 17" | ASMWG84 () () () | 2,375. | 3,204. | 3,855. | 5,011. |
| | | | 49" | 90" | 17" | ASMWG90 () () () | 2,450. | 3,307. | 3,978. | 5,171. |
| | | | 49" | 96" | 17" | ASMWG96 () () () | 2,527. | 3,407. | 4,102. | 5,333. |

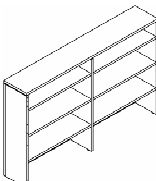
| | | | | | | | | | | |
|--|---------------------------------------|-------------|-----|-----|-----|----------------------------|--------|--------|--------|--------|
|  <p>center gable only in units 54" w and over</p> | Storage Median, 49"h w/ metal shelves | legal depth | 49" | 42" | 17" | ASMMG42 () () () | 2,371. | 2,871. | 2,919. | 3,503. |
| | | | 49" | 48" | 17" | ASMMG48 () () () | 2,467. | 2,990. | 3,037. | 3,647. |
| | | | 49" | 54" | 17" | ASMMG54 () () () | 2,698. | 3,267. | 3,762. | 4,513. |
| | | | 49" | 60" | 17" | ASMMG60 () () () | 2,800. | 3,392. | 3,904. | 4,684. |
| | | | 49" | 66" | 17" | ASMMG66 () () () | 2,902. | 3,515. | 4,047. | 4,855. |
| | | | 49" | 72" | 17" | ASMMG72 () () () | 3,004. | 3,638. | 4,188. | 5,026. |
| | | | 49" | 78" | 17" | ASMMG78 () () () | 3,105. | 3,762. | 4,330. | 5,196. |
| | | | 49" | 84" | 17" | ASMMG84 () () () | 3,207. | 3,886. | 4,473. | 5,368. |
| | | | 49" | 90" | 17" | ASMMG90 () () () | 3,309. | 4,008. | 4,614. | 5,537. |
| | | | 49" | 96" | 17" | ASMMG96 () () () | 3,411. | 4,131. | 4,757. | 5,708. |

| Order Code | Specification Information | Application Notes |
|---|---|---|
| Example: ASMWG42FNELV316AA A AutoStrada SM Storage Median W Wood shelves G Legal depth 42 42" wide FN Face drill gable, no EL End drill left gable V316 Finish, Maple AA Trim, anodized aluminum | To order please specify pattern number including: 1. Wood or Metal shelves <i>Embedded in pattern number</i> <i>W = wood shelves</i> <i>M = metal shelves</i> (Two piece extruded assembly) <i>Note: shelf at worksurface height always wood</i> 2. Depth <i>Embedded in pattern number</i> <i>B = Binder depth</i> <i>G = Legal depth</i> 3. Width 4. Face drill option <i>FL = face drill left gable for ganging</i> <i>FR = face drill right gable for ganging</i> <i>FB = face drill both gables for ganging</i> <i>FN = face drill none</i> | 5. End drill option <i>EL = end drill left gable to attach to bridge</i> <i>ER = end drill right gable to attach to bridge</i> <i>EB = end drill both gables to attach to bridges (applicable 84" w, 90" w and 96" w only)</i> <i>EN = no drill (for freestanding applications)</i> 6. Finish <i>Laminate, V1, V2 or V3 finish</i> 7. Finish, metal shelves <i>AA - Anodized aluminum or painted finish option from page 7 excluding silver</i> 8. Finish, Aluminum trim <i>AA - Anodized aluminum or painted finish option from page 7 excluding silver</i> See page 7 for finish options applicable. *49" h to top of gables, with aluminum trim and top shelf 50.2" h. Inside width above, overall footprint additional 2" nominal. See page 7 for finish options applicable. Product on this page will accept wood grain laminate where laminate is currently an option. List price for wood grain laminate options will be current published laminate list price plus 10%. |
| | | Storage medians may be used in free-standing applications alone or multiple units side by side. When specifying side by side applications, be sure to select appropriate face drilling option (see specification option #4) and EN for no end drilling in gables. Storage medians may also be used with bridges on page 144 for creating L shaped work area configurations. When specifying for use with bridges, be sure to specify appropriate end drill option (see specification option #5). Center shelf fixed at 27" h to underside to align with bridge worksurface height and always same material as case (wood or laminate). Nominally top shelf 7 1/2" h, other two 13" h. Bridge units include hardware kit with washers to accommodate connection of 1" thick fixed storage median shelf to 1 1/4" thick bridge worksurface. Products on this page shipped knocked-down. |

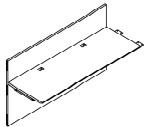
| description | h | w | d | pattern no. | L | M/V1 or V1 | M/V2 or V2 | M/V3 or V3 |
|--|-----|-----|---------|--------------------------------|--------|---------------|---------------|---------------|
|  <p>worksurface height fixed 27" h to underside</p> | 42" | 42" | 26 1/2" | AOB4242 () () () () | \$916. | \$1,143. | \$1,313. | \$1,707. |
| | 42" | 48" | 26 1/2" | AOB4248 () () () () | 953. | 1,188. | 1,366. | 1,777. |
| | 42" | 54" | 26 1/2" | AOB4254 () () () () | 992. | 1,233. | 1,421. | 1,847. |
| | 42" | 60" | 26 1/2" | AOB4260 () () () () | 1,028. | 1,282. | 1,474. | 1,916. |
| | 42" | 66" | 26 1/2" | AOB4266 () () () () | 1,065. | 1,328. | 1,529. | 1,984. |
| | 42" | 72" | 26 1/2" | AOB4272 () () () () | 1,103. | 1,374. | 1,581. | 2,056. |
| | 42" | 78" | 26 1/2" | AOB4278 () () () () | 1,140. | 1,421. | 1,633. | 2,126. |

| Order Code | Specification Information | Application Notes |
|---|--|--|
| Example: AOB4242GDV316V316613 | <i>To order please specify pattern number including:</i> | Overall depth is 26.5" nominal |
| A AutoStrada | 1. Width | Bridge units attach one side to gable end of medians or storage medians, and other end to 26.5" deep storage anchored cabinets. Attachment method is universal, bridge units are not handed. |
| OB Open Bridge | 2. Grommet option <i>G = Grommet(s)</i> <i>N = No grommet(s)</i> | |
| 42 42" high | 3. Drill for top shelf option <i>Note: not applicable for window bridges</i> <i>D = drill for top shelf attachment</i> <i>N = no drill for top shelf attachment</i> | |
| 42 42" wide | 4. Finish, back and worksurface edge <i>Laminate, V1, V2 or V3 finish</i> | Mixed finish options must only be combination of laminate surface with V1 or V2 or V3 back and edge. |
| G Grommet | 5. Finish, worksurface <i>Laminate, V1, V2 or V3 finish</i> | Optional top shelf for bridge assembly specified separately, refer to page 145. Be sure to specify drill for top shelf if required. |
| D Drill for top shelf attachment | 6. Finish, Grommet(s) <i>specify painted or plated finish</i> | |
| V316 Finish, back panel & edge | | |
| V316 Finish, worksurface | | |
| 613 Finish, grommet | | |

Order worksurface stiffener for unsupported spans exceeding 48".

See page 7 for finish options applicable.

Product on this page will accept wood grain laminate where laminate is currently an option. List price for wood grain laminate options will be current published laminate list price plus 10%.

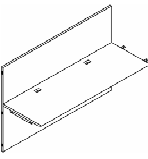
| description | h | w | d | pattern no. | L | M/V1 or V1 | M/V2 or V2 | M/V3 or V3 |
|---|-----|-----|---------|-------------------------------|--------|---------------|---------------|---------------|
|  <p>Bridge assembly, 49"h includes worksurface</p> | 49" | 42" | 26 1/2" | AOBS42 () () () () | \$963. | \$1,203. | \$1,382. | \$1,797. |
| | 49" | 48" | 26 1/2" | AOBS48 () () () () | 1,004. | 1,250. | 1,439. | 1,872. |
| | 49" | 54" | 26 1/2" | AOBS54 () () () () | 1,043. | 1,298. | 1,496. | 1,945. |
| | 49" | 60" | 26 1/2" | AOBS60 () () () () | 1,083. | 1,349. | 1,551. | 2,017. |
| | 49" | 66" | 26 1/2" | AOBS66 () () () () | 1,122. | 1,398. | 1,609. | 2,090. |
| | 49" | 72" | 26 1/2" | AOBS72 () () () () | 1,161. | 1,446. | 1,665. | 2,164. |
| | 49" | 78" | 26 1/2" | AOBS78 () () () () | 1,201. | 1,496. | 1,719. | 2,238. |

worksurface height fixed 27" h to underside

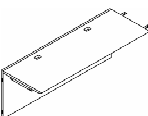
| | | | | | | | | |
|--|-----|-----|---------|-------------------------------|--------|--------|--------|--------|
|  <p>Bridge assembly, includes worksurface</p> | 28" | 42" | 26 1/2" | AWBS42 () () () () | 902. | 1,124. | 1,292. | 1,679. |
| | 28" | 48" | 26 1/2" | AWBS48 () () () () | 938. | 1,168. | 1,344. | 1,748. |
| | 28" | 54" | 26 1/2" | AWBS54 () () () () | 975. | 1,215. | 1,398. | 1,816. |
| | 28" | 60" | 26 1/2" | AWBS60 () () () () | 1,012. | 1,261. | 1,449. | 1,885. |
| | 28" | 66" | 26 1/2" | AWBS66 () () () () | 1,048. | 1,307. | 1,502. | 1,952. |
| | 28" | 72" | 26 1/2" | AWBS72 () () () () | 1,086. | 1,351. | 1,556. | 2,023. |
| | 28" | 78" | 26 1/2" | AWBS78 () () () () | 1,122. | 1,398. | 1,609. | 2,090. |
| | 28" | 84" | 26 1/2" | AWBS84 () () () () | 1,158. | 1,444. | 1,662. | 2,159. |
| | 28" | 90" | 26 1/2" | AWBS90 () () () () | 1,195. | 1,490. | 1,713. | 2,228. |
| | 28" | 96" | 26 1/2" | AWBS96 () () () () | 1,231. | 1,536. | 1,766. | 2,295. |

worksurface height fixed 27" h to underside

Specify with window bridge kits to achieve 49" h

| Order Code | Specification Information | Application Notes |
|---|--|---|
| Example: AOBS42GDV316V316613 <hr/> A AutoStrada <hr/> OB Open Bridge <hr/> S Single <hr/> 42 42" wide <hr/> G Grommet <hr/> D Drill for top shelf attachment <hr/> V316 Finish, back panel & edge <hr/> V316 Finish, worksurface <hr/> 613 Finish, grommet | To order please specify pattern number including: 1. Width 2. Grommet option <i>G = Grommet(s)</i> <i>N = No grommet(s)</i> 3. Drill for top shelf option <i>Note: not applicable for window bridges</i> <i>D = drill for top shelf attachment</i> <i>N = no drill for top shelf attachment</i> 4. Finish, back and worksurface edge <i>Laminate, V1, V2 or V3 finish</i> 5. Finish, worksurface <i>Laminate, V1, V2 or V3 finish</i> 6. Finish, Grommet(s) <i>specify painted or plated finish</i> Order worksurface stiffener for unsupported spans exceeding 48". See page 7 for finish options applicable. | Overall depth is 26.5" nominal Bridge units attach one side to gable end of medians or storage medians, and other end to 26.5" deep storage anchored cabinets. Attachment method is universal, bridge units are not handed. Mixed finish options must only be combination of laminate surface with V1 or V2 or V3 back and edge. Window kit and window trim kit for window bridge assembly specified separately, refer to page 147. Optional top shelf for bridge assembly specified separately, refer to page 145. Be sure to specify drill for top shelf if required. |

Product on this page shipped knocked-down.

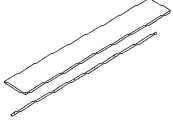

Product on this page will accept wood grain laminate where laminate is currently an option. List price for wood grain laminate options will be current published laminate list price plus 10%.

| description | thickness | w | d | pattern no. | L | V1 | V2 | V3 |
|---|-----------|----------|-----|------------------------|--------|--------|--------|--------|
| Top shelf for bridge assy to median w/26.5" gable & binder depth top  | 1 1/4" | 54 7/16" | 14" | ATSBA42 () () | \$274. | \$340. | \$392. | \$511. |
| | 1 1/4" | 60 7/16" | 14" | ATSBA48 () () | 284. | 353. | 406. | 529. |
| | 1 1/4" | 66 7/16" | 14" | ATSBA54 () () | 295. | 367. | 423. | 550. |
| | 1 1/4" | 72 7/16" | 14" | ATSBA60 () () | 307. | 381. | 439. | 570. |
| | 1 1/4" | 78 7/16" | 14" | ATSBA66 () () | 318. | 396. | 454. | 592. |
| | 1 1/4" | 84 7/16" | 14" | ATSBA72 () () | 328. | 411. | 470. | 613. |
| | 1 1/4" | 90 7/16" | 14" | ATSBA78 () () | 340. | 423. | 487. | 633. |
| Top shelf for bridge assy to median w/26.5" gable & legal depth top | 1 1/4" | 51 7/16" | 14" | ATSBB42 () () | 274. | 340. | 392. | 511. |
| | 1 1/4" | 57 7/16" | 14" | ATSBB48 () () | 284. | 353. | 406. | 529. |
| | 1 1/4" | 63 7/16" | 14" | ATSBB54 () () | 295. | 367. | 423. | 550. |
| | 1 1/4" | 69 7/16" | 14" | ATSBB60 () () | 307. | 381. | 439. | 570. |
| | 1 1/4" | 75 7/16" | 14" | ATSBB66 () () | 318. | 396. | 454. | 592. |
| | 1 1/4" | 81 7/16" | 14" | ATSBB72 () () | 328. | 411. | 470. | 613. |
| | 1 1/4" | 87 7/16" | 14" | ATSBB78 () () | 340. | 423. | 487. | 633. |
| Top shelf for bridge assy to median w/32.5" gable & binder depth top | 1 1/4" | 60 7/16" | 14" | ATSBC42 () () | 339. | 422. | 486. | 630. |
| | 1 1/4" | 66 7/16" | 14" | ATSBC48 () () | 351. | 438. | 504. | 656. |
| | 1 1/4" | 72 7/16" | 14" | ATSBC54 () () | 366. | 455. | 526. | 681. |
| | 1 1/4" | 78 7/16" | 14" | ATSBC60 () () | 381. | 473. | 544. | 708. |
| | 1 1/4" | 84 7/16" | 14" | ATSBC66 () () | 394. | 491. | 564. | 734. |
| | 1 1/4" | 90 7/16" | 14" | ATSBC72 () () | 408. | 506. | 584. | 760. |
| | 1 1/4" | 96 7/16" | 14" | ATSBC78 () () | 421. | 526. | 603. | 785. |
| Top shelf for bridge assy to median w/32.5" gable & legal depth top | 1 1/4" | 57 7/16" | 14" | ATSBD42 () () | 339. | 422. | 486. | 630. |
| | 1 1/4" | 63 7/16" | 14" | ATSBD48 () () | 351. | 438. | 504. | 656. |
| | 1 1/4" | 69 7/16" | 14" | ATSBD54 () () | 366. | 455. | 526. | 681. |
| | 1 1/4" | 75 7/16" | 14" | ATSBD60 () () | 381. | 473. | 544. | 708. |
| | 1 1/4" | 81 7/16" | 14" | ATSBD66 () () | 394. | 491. | 564. | 734. |
| | 1 1/4" | 87 7/16" | 14" | ATSBD72 () () | 408. | 506. | 584. | 760. |
| | 1 1/4" | 93 7/16" | 14" | ATSBD78 () () | 421. | 526. | 603. | 785. |
| Top shelf for bridge assy to storage median | 1 1/4" | 42" | 14" | ATSBE42 () () | 274. | 340. | 392. | 511. |
| | 1 1/4" | 48" | 14" | ATSBE48 () () | 284. | 353. | 406. | 529. |
| | 1 1/4" | 54" | 14" | ATSBE54 () () | 295. | 367. | 423. | 550. |

| Order Code | Specification Information | Application Notes |
|--|---|---|
| Example: ATSBA42V316AA A AutoStrada TS Top Shelf B Bridge A for bridge to median condition A 42 42" wide plus condition A V316 Finish, Maple AA Trim, anodized aluminum | To order please specify pattern number including: 1. Bridge to Median condition <i>A = to 26.5" d median w/binder depth top shelf</i> <i>B = to 26.5" d median w/legal depth top shelf</i> <i>C = to 32.5" d median w/binder depth top shelf</i> <i>D = to 32.5" d median w/legal depth top shelf</i> <i>E = to storage median binder or legal depth</i> 2. Width <i>specify same as corresponding bridge assembly</i> 3. Finish, Shelf <i>Laminate, V1, V2 or V3 finish</i> 4. Finish, Aluminum trim <i>AA - Anodized aluminum or painted finish option from page 7 excluding silver</i> | See page 7 for finish options applicable. Product on this page will accept wood grain laminate where laminate is currently an option. List price for wood grain laminate options will be current published laminate list price plus 10%. Top shelf extends width of bridge assembly plus exposed portion of the median gable where the median gable extends beyond median's top shelf. Top shelf assembly includes aluminum trim to install between bridge assembly and underside of top shelf; and aligns with aluminum trim detail of median or storage median. |

| description | thickness | w | d | pattern no. | L | V1 | V2 | V3 |
|---|-----------|-----|-----|----------------------|--------|--------|--------|--------|
| Top shelf for bridge assy to storage median | 1 1/4" | 60" | 14" | ATSBE60 ()() | \$307. | \$381. | \$439. | \$570. |
| | 1 1/4" | 66" | 14" | ATSBE66 ()() | 318. | 396. | 454. | 592. |
| | 1 1/4" | 72" | 14" | ATSBE72 ()() | 328. | 411. | 470. | 613. |
| | 1 1/4" | 78" | 14" | ATSBE78 ()() | 340. | 423. | 487. | 633. |

| Order Code | Specification Information | Application Notes |
|---|--|--|
| Example: ATSBA42V316AA | <i>To order please specify pattern number including:</i> | See page 7 for finish options applicable. |
| A AutoStrada | | |
| TS Top Shelf | | |
| B Bridge | | |
| A for bridge to median condition A | | |
| 42 42" wide plus condition A | | |
| V316 Finish, Maple | | |
| AA Trim, anodized aluminum | | |
| | <ol style="list-style-type: none"> Bridge to Median condition <i>A = to 26.5" d median w/binder depth top shelf</i> <i>B = to 26.5" d median w/legal depth top shelf</i> <i>C = to 32.5" d median w/binder depth top shelf</i> <i>D = to 32.5" d median w/legal depth top shelf</i> <i>E = to storage median binder or legal depth</i> Width <i>specify same as corresponding bridge assembly</i> Finish, Shelf <i>Laminate, V1, V2 or V3 finish</i> Finish, Aluminum trim <i>AA - Anodized aluminum or painted finish option from page 7 excluding silver</i> | <p>Product on this page will accept wood grain laminate where laminate is currently an option. List price for wood grain laminate options will be current published laminate list price plus 10%.</p> |
| | | <p>Top shelf extends width of bridge assembly plus exposed portion of the median gable where the median gable extends beyond median's top shelf.</p> <p>Top shelf assembly includes aluminum trim to install between bridge assembly and underside of top shelf; and aligns with aluminum trim detail of median or storage median.</p> |

| description | h | w | pattern no. | clear | architectural | list |
|--|--|---------------------------|---------------------------|--------|---------------|------|
| Window Bridge Kit  | 21" | 42" | AWBK42 () () () | \$689. | \$829. | |
| | 21" | 48" | AWBK48 () () () | 744. | 893. | |
| | 21" | 54" | AWBK54 () () () | 797. | 958. | |
| | 21" | 60" | AWBK60 () () () | 852. | 1,021. | |
| | 21" | 66" | AWBK66 () () () | 904. | 1,085. | |
| | 21" | 72" | AWBK72 () () () | 959. | 1,150. | |
| | 21" | 78" | AWBK78 () () () | 1,012. | 1,215. | |
| | 21" | 84" | AWBK84 () () () | 1,066. | 1,280. | |
| | 21" | 90" | AWBK90 () () () | 1,119. | 1,344. | |
| 21" | 96" | AWBK96 () () () | 1,173. | 1,409. | | |
| Median gable top trim for window to median w/26.5" gable&binder depth top | | 12" | AMGTTA () | | | 94. |
|  | | 9" | AMGTTB () | | | 79. |
| | Median gable top trim for window to median w/26.5" gable&legal depth top | | | | | |
| Median gable top trim for window to median w/32.5" gable&binder depth top | | 18" | AMGTTC () | | | 115. |
| Median gable top trim for window to median w/32.5" gable&legal depth top | | 15" | AMGTTD () | | | 103. |

| Order Code | Specification Information | Application Notes |
|--|---|--|
| Example: AWBK42EAAGL13AA A AutoStrada W Window BK Bridge kit 42 42" wide E Extruded Aluminum Top Trim AA Finish, window frame GL13 Finish, glass AA Finish, aluminum top trim | To order please specify pattern number including: Window bridge kit: 1. Width <i>Note: Be sure to specify window bridge kit to correspond with width of window bridge assembly</i> 2. Extruded Aluminum Top Trim profile <i>E = default</i> 3. Finish, window frame <i>Paint or Anodized Aluminum</i> 4. Finish, glass <i>TEMP - Clear, tempered</i> <i>GL6 - Block Matrix</i> <i>GL13 - Powder</i> 5. Finish, Aluminum top trim <i>AA - anodized aluminum or painted finish option from page 7 excluding silver</i> | Window bridge kits are for use with window bridge assemblies on page 144. Be sure to include median gable top trim when attaching window bridge assembly and window bridge kit to medians for the appropriate condition of median gable and top shelf. The median gable top trim is an aluminum extrusion which finishes the exposed portion of the median gable and continues a consistent aluminum trim detail from one unit to the next. |

| description | hand | h | w | d | pattern no. | L | V1 | V2 | V3 |
|--|------|--|-------|-------|-------------------------------------|----------|---------------------------------|----------|----------|
| Storage anchored cabinet, BBF front, open interior side | left | 42" | 19" | 24" | ACAL4224 () () () () | \$2,918. | \$4,037. | \$4,471. | \$5,810. |
| | | 42" | 19" | 30" | ACAL4230 () () () () | 3,142. | 4,268. | 4,776. | 6,211. |
| | | 42" | 19" | 26.5" | ACAL4226 () () () () | 3,031. | 4,153. | 4,624. | 6,013. |
| | | 42" | 19" | 32.5" | ACAL4232 () () () () | 3,254. | 4,384. | 4,930. | 6,409. |
| | | 49" | 19" | 24" | ACAL4924 () () () () () | 2,978. | 4,119. | 4,561. | 5,930. |
| | | 49" | 19" | 30" | ACAL4930 () () () () () | 3,206. | 4,355. | 4,873. | 6,338. |
| | | 49" | 19" | 26.5" | ACAL4926 () () () () () | 3,092. | 4,238. | 4,719. | 6,135. |
| | | 49" | 19" | 32.5" | ACAL4932 () () () () () | 3,320. | 4,473. | 5,031. | 6,540. |
| | | left hand shown, shelf aligns with worksurface at 28 1/4" overall, or 27" to underside | right | 42" | 19" | 24" | ACAR4224 () () () () | 2,918. | 4,037. |
| 42" | 19" | | | 30" | ACAR4230 () () () () | 3,142. | 4,268. | 4,776. | 6,211. |
| 42" | 19" | | | 26.5" | ACAR4226 () () () () | 3,031. | 4,153. | 4,624. | 6,013. |
| 42" | 19" | | | 32.5" | ACAR4232 () () () () | 3,254. | 4,384. | 4,930. | 6,409. |
| 49" | 19" | | | 24" | ACAR4924 () () () () () | 2,978. | 4,119. | 4,561. | 5,930. |
| 49" | 19" | | | 30" | ACAR4930 () () () () () | 3,206. | 4,355. | 4,873. | 6,338. |
| 49" | 19" | | | 26.5" | ACAR4926 () () () () () | 3,092. | 4,238. | 4,719. | 6,135. |
| 49" | 19" | | | 32.5" | ACAR4932 () () () () () | 3,320. | 4,473. | 5,031. | 6,540. |

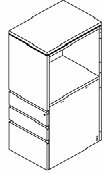

| Order Code | Specification Information | Application Notes |
|--|---|---|
| Example: ACAL4924NEDWV316AA | To order please specify pattern number including: | *Upcharge applicable as follows for ACA(L/R)49 and ACB(L/R)49 cabinets: Option S upcharge for L/V1/V2 or V3 to correspond to shelf to match case; Option M upcharge under AA or paint for aluminum metal shelf |
| A AutoStrada | 1. Hand L = User's Left R = User's Right | When planning with panels, single station or cluster groups where all workstations within the group are the same direction/hand, then specify 26.5" or 32.5" deep storage anchor cabinet units. When planning multi-station clusters mirroring left hand/right hand or with stations back to back with panel run perpendicular to two cabinets, you then need to specify one 24"d with one 26.5"d or 30"d with one 32.5" d cabinet to go side by side or back to back as the case may be. Brackets to secure cabinets to panel are required, specified separately - see page 163. |
| C Cabinet | 2. Height | |
| A BBF front, Open interior side | 3. Depth 24 = 24" deep 26 = 26.5" deep 30 = 30" deep 32 = 32.5" deep | depth L V1 V3 24" \$ 93 210 26.5" \$ 98 216 30" \$102 227 32.5" \$108 232 |
| L Left Hand | 4. Shelf option for open interior side, 49"h only N = No shelf S = Shelf to match case * M = Two piece extruded aluminum metal shelf assembly * (*upcharge applicable) | depth V2 V3 24" \$233 301 26.5" \$241 312 30" \$252 329 32.5" \$260 339 |
| 49 49" high | 5. Pull E = extruded aluminum pull P = extruded aluminum protruding pull | depth AA or paint 24" \$288 26.5" \$308 30" \$338 32.5" \$357 |
| 24 24" deep | 6. Drill option, applicable only for 24" and 30" deep units D = drilled to anchor to panel or median F = no drill, freestanding | 42"h - 42"h to below trim, 43.2"h overall 49"h - 49"h to below trim, 50.2"h overall |
| N No Shelf | 7. Interior W = wood drawer interior M = metal drawer interior, deduct \$100 list | Product on this page will accept wood grain laminate where laminate is currently an option. List price for wood grain laminate options will be current published laminate list price plus 10%. |
| E Extruded Aluminum Pull | 8. Finish Laminate, V1, V2 or V3 finish | 24" and 30" deep storage anchored cabinets may be specified for freestanding applications, specify drill option F for freestanding, otherwise connection detail will be exposed. |
| D Drilled to anchor | 9. Finish, Aluminum trim (trim, M shelf option & pull) AA - Anodized aluminum or painted finish option from page 7 excluding silver | Cabinets include angle bracket to side support worksurfaces except when drill option "F" for freestanding selected. Cabinets drilled for locks, keying instructions must accompany order. See page 7 for finish options applicable. |
| W Wood interior | | |
| V316 Finish, Maple | | |
| AA Finish, trim & pull, anodized aluminum | | |

3rd digit in pattern number indicates storage configuration, see individual pattern groups above for description.

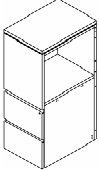
| description | hand | h | w | d | pattern no. | L | V1 | V2 | V3 |
|--|-------|-----|-----|-------|-------------------------------------|----------|----------|----------|----------|
| Storage anchored cabinet, FF front, open interior side  | left | 42" | 19" | 24" | ACBL4224 () () () () | \$2,501. | \$3,486. | \$3,945. | \$5,128. |
| | | 42" | 19" | 30" | ACBL4230 () () () () | 2,692. | 3,684. | 4,216. | 5,479. |
| | | 42" | 19" | 26.5" | ACBL4226 () () () () | 2,596. | 3,585. | 4,080. | 5,303. |
| | | 42" | 19" | 32.5" | ACBL4232 () () () () | 2,789. | 3,785. | 4,350. | 5,657. |
| | | 49" | 19" | 24" | ACBL4924 () () () () () | 2,553. | 3,557. | 4,025. | 5,233. |
| | | 49" | 19" | 30" | ACBL4930 () () () () () | 2,748. | 3,760. | 4,303. | 5,591. |
| | | 49" | 19" | 26.5" | ACBL4926 () () () () () | 2,650. | 3,658. | 4,164. | 5,411. |
| | | 49" | 19" | 32.5" | ACBL4932 () () () () () | 2,847. | 3,861. | 4,439. | 5,772. |
| left hand shown, shelf aligns with worksurface at 28 1/2" h overall, or 27" h to underside | right | 42" | 19" | 24" | ACBR4224 () () () () | 2,501. | 3,486. | 3,945. | 5,128. |
| | | 42" | 19" | 30" | ACBR4230 () () () () | 2,692. | 3,684. | 4,216. | 5,479. |
| | | 42" | 19" | 26.5" | ACBR4226 () () () () | 2,596. | 3,585. | 4,080. | 5,303. |
| | | 42" | 19" | 32.5" | ACBR4232 () () () () | 2,789. | 3,785. | 4,350. | 5,657. |
| | | 49" | 19" | 24" | ACBR4924 () () () () () | 2,553. | 3,557. | 4,025. | 5,233. |
| | | 49" | 19" | 30" | ACBR4930 () () () () () | 2,748. | 3,760. | 4,303. | 5,591. |
| | | 49" | 19" | 26.5" | ACBR4926 () () () () () | 2,650. | 3,658. | 4,164. | 5,411. |
| | | 49" | 19" | 32.5" | ACBR4932 () () () () () | 2,847. | 3,861. | 4,439. | 5,772. |

| Order Code | Specification Information | Application Notes |
|--|---|---|
| Example: ACAL4924NEDWV316AA | To order please specify pattern number including: | *Upcharge applicable as follows for ACA(L/R)49 and ACB(L/R)49 cabinets: Option S upcharge for L/V1/V2 or V3 to correspond to shelf to match case; Option M upcharge under AA or paint for aluminum metal shelf |
| A AutoStrada | 1. Hand L = User's Left R = User's Right | When planning with panels, single station or cluster groups where all workstations within the group are the same direction/hand, then specify 26.5" or 32.5" deep storage anchor cabinet units. When planning multi-station clusters mirroring left hand/right hand or with stations back to back with panel run perpendicular to two cabinets, you then need to specify one 24"d with one 26.5"d or 30"d with one 32.5" d cabinet to go side by side or back to back as the case may be. Brackets to secure cabinets to panel are required, specified separately - see page 163. |
| C Cabinet | 2. Height | |
| A BBF front, Open interior side | 3. Depth 24 = 24" deep 26 = 26.5" deep 30 = 30" deep 32 = 32.5" deep | depth L V1 V3 24" \$ 93 210 26.5" \$ 98 216 30" \$102 227 32.5" \$108 232 |
| L Left Hand | 4. Shelf option for open interior side, 49"h only N = No shelf S = Shelf to match case * M = Two piece extruded aluminum metal shelf assembly * (*upcharge applicable) | depth V2 V3 24" \$233 301 26.5" \$241 312 30" \$252 329 32.5" \$260 339 |
| 49 49" high | 5. Pull E = extruded aluminum pull P = extruded aluminum protruding pull | depth AA or paint 24" \$288 26.5" \$308 30" \$338 32.5" \$357 |
| 24 24" deep | 6. Drill option, applicable only for 24" and 30" deep units D = drilled to anchor to panel or median F = no drill, freestanding | 42"h - 42"h to below trim, 43.2"h overall 49"h - 49"h to below trim, 50.2"h overall |
| N No Shelf | 7. Interior W = wood drawer interior M = metal drawer interior, deduct \$100 list | Product on this page will accept wood grain laminate where laminate is currently an option. List price for wood grain laminate options will be current published laminate list price plus 10%. |
| E Extruded Aluminum Pull | 8. Finish Laminate, V1, V2 or V3 finish | 24" and 30" deep storage anchored cabinets may be specified for freestanding applications, specify drill option F for freestanding, otherwise connection detail will be exposed. |
| D Drilled to anchor | 9. Finish, Aluminum trim (trim, M shelf option & pull) AA - Anodized aluminum or painted finish option from page 7 excluding silver | Cabinets include angle bracket to side support worksurfaces except when drill option "F" for freestanding selected. Cabinets drilled for locks, keying instructions must accompany order. See page 7 for finish options applicable. |
| W Wood interior | | |
| V316 Finish, Maple | | |
| AA Finish, trim & pull, anodized aluminum | | |

3rd digit in pattern number indicates storage configuration, see individual pattern groups above for description.

| description | hand | h | w | d | pattern no. | L | V1 | V2 | V3 |
|--|------|-------|-------|---------------------------------|---------------------------------|---------------------------------|----------|----------|----------|
| Storage anchored cabinet, Hinged Door front, open interior side | left | 42" | 19" | 24" | ACCL4224 () () () () | \$2,085. | \$2,905. | \$3,289. | \$4,271. |
| | | 42" | 19" | 30" | ACCL4230 () () () () | 2,244. | 3,071. | 3,513. | 4,568. |
| | | 42" | 19" | 26.5" | ACCL4226 () () () () | 2,164. | 2,987. | 3,400. | 4,421. |
| | | 42" | 19" | 32.5" | ACCL4232 () () () () | 2,324. | 3,154. | 3,626. | 4,712. |
| | | 49" | 19" | 24" | ACCL4924 () () () () | 2,127. | 2,964. | 3,356. | 4,358. |
| | | 49" | 19" | 30" | ACCL4930 () () () () | 2,290. | 3,133. | 3,585. | 4,660. |
| | | 49" | 19" | 26.5" | ACCL4926 () () () () | 2,209. | 3,047. | 3,470. | 4,511. |
| | | 49" | 19" | 32.5" | ACCL4932 () () () () | 2,371. | 3,219. | 3,699. | 4,808. |
| | | right | 42" | 19" | 24" | ACCR4224 () () () () | 2,085. | 2,905. | 3,289. |
| 42" | 19" | | 30" | ACCR4230 () () () () | 2,244. | 3,071. | 3,513. | 4,568. | |
| 42" | 19" | | 26.5" | ACCR4226 () () () () | 2,164. | 2,987. | 3,400. | 4,421. | |
| 42" | 19" | | 32.5" | ACCR4232 () () () () | 2,324. | 3,154. | 3,626. | 4,712. | |
| 49" | 19" | | 24" | ACCR4924 () () () () | 2,127. | 2,964. | 3,356. | 4,358. | |
| 49" | 19" | | 30" | ACCR4930 () () () () | 2,290. | 3,133. | 3,585. | 4,660. | |
| 49" | 19" | | 26.5" | ACCR4926 () () () () | 2,209. | 3,047. | 3,470. | 4,511. | |
| 49" | 19" | | 32.5" | ACCR4932 () () () () | 2,371. | 3,219. | 3,699. | 4,808. | |

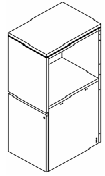

left hand shown, shelf aligns with work surface at 28 1/2" h overall, or 27" h to underside

| Order Code | Specification Information | Application Notes |
|--|--|--|
| Example: ACCL4924NEDV316AA | To order please specify pattern number including: | *Upcharge applicable as follows for ACC(L/R)49 units on this page: For option S upcharge for L/V1/V2 or V3 to correspond to shelf to match case; option M upcharge under AA or paint for aluminum metal shelf |
| A AutoStrada | 1. Hand L = User's Left R = User's Right | When planning with panels, single station or cluster groups where all workstations within the group are the same direction/hand, then specify 26.5" or 32.5" deep storage anchor cabinet units. When planning multi-station clusters mirroring left hand/right hand or with stations back to back with panel run perpendicular to two cabinets, you then need to specify one 24" d with one 26.5" d or 30" d with one 32.5" d cabinet to go side by side or back to back as the case may be. Brackets to secure cabinets to panel are required, specified separately - see page 163. |
| C Cabinet | 2. Height | |
| C HD front, Open interior side | 3. Depth 24 = 24" deep 30 = 30" deep 26 = 26.5" deep 32 = 32.5" deep | depth L V1 V2 V3 24" \$ 93 210 26.5" \$ 98 216 30" \$102 227 32.5" \$108 232 |
| L Left Hand | 4. Shelf option for open interior side, 49" h only applicable for ACC(L/R) cabinets only N = No shelf S = Shelf to match case * M = Two piece aluminum metal shelf assembly * (*upcharge applicable) | depth V2 V3 24" \$233 301 26.5" \$241 312 30" \$252 329 32.5" \$260 339 |
| 49 49" high | 5. Pull E = extruded aluminum pull P = extruded aluminum protruding pull | depth AA or paint 24" \$288 26.5" \$308 30" \$338 32.5" \$357 |
| 24 24" deep | 6. Drill option applicable only for 24" and 30" deep units D = drilled to anchor to panel or median F = no drill, freestanding | 42" h - 42" h to below trim, 43.2" h overall 49" h - 49" h to below trim, 50.2" h overall |
| N No Shelf | 7. Finish Laminate, V1, V2 or V3 finish | Product on this page will accept wood grain laminate where laminate is currently an option. List price for wood grain laminate options will be current published laminate list price plus 10%. |
| E Extruded Aluminum Pull | 8. Finish, Aluminum trim (trim M shelf option & pull) AA - Anodized aluminum or painted finish option from page 7 excluding silver | When planning with medians and bridges (single station or clusters of stations) specify either 26.5" or 32.5" deep storage anchored cabinets for anchoring the median or bridge unit of the same depth. Connection method to medians, median storage or bridges incorporated into product design, no additional hardware required. |
| D Drilled to anchor | | Cabinets include angle bracket to side support work surfaces except when drill option "F" for freestanding selected. |
| V316 Finish, Maple | | Cabinets drilled for locks, keying instructions must accompany order. |
| AA Finish, trim & pull, anodized aluminum | | See page 7 for finish options applicable. |

3rd digit in pattern number indicates storage configuration, see individual pattern groups above for description.

| description | hand | h | w | d | pattern no. | L | V1 | V2 | V3 |
|---|-------|-----|-----|-------|---------------------------------|----------|----------|----------|----------|
| Storage anchored cabinet, Hinged Door front, open side | left | 49" | 19" | 24" | ACDL4924 () () () () | \$2,403. | \$3,348. | \$3,790. | \$4,927. |
| | | 49" | 19" | 30" | ACDL4930 () () () () | 2,587. | 3,540. | 4,052. | 5,265. |
| | | 49" | 19" | 26.5" | ACDL4926 () () () () | 2,495. | 3,444. | 3,921. | 5,096. |
| | | 49" | 19" | 32.5" | ACDL4932 () () () () | 2,680. | 3,637. | 4,179. | 5,435. |
| | right | 49" | 19" | 24" | ACDR4924 () () () () | 2,403. | 3,348. | 3,790. | 4,927. |
| | | 49" | 19" | 30" | ACDR4930 () () () () | 2,587. | 3,540. | 4,052. | 5,265. |
| | | 49" | 19" | 26.5" | ACDR4926 () () () () | 2,495. | 3,444. | 3,921. | 5,096. |
| | | 49" | 19" | 32.5" | ACDR4932 () () () () | 2,680. | 3,637. | 4,179. | 5,435. |

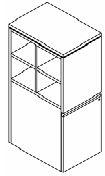

left hand shown, shelf aligns with work surface at 28 1/4" h overall, or 27" h to underside

| Order Code | Specification Information | Application Notes |
|--|--|--|
| Example: ACCL4924NEDV316AA | To order please specify pattern number including: | *Upcharge applicable as follows for ACC(L/R)49 units on this page: For option S upcharge for L/V1/V2 or V3 to correspond to shelf to match case; option M upcharge under AA or paint for aluminum metal shelf |
| A AutoStrada | 1. Hand L = User's Left R = User's Right | |
| C Cabinet | 2. Height | |
| C HD front, Open interior side | 3. Depth 24 = 24" deep 30 = 30" deep 26 = 26.5" deep 32 = 32.5" deep | depth L V1 24" \$ 93 210 26.5" \$ 98 216 30" \$102 227 32.5" \$108 232 |
| L Left Hand | 4. Shelf option for open interior side, 49" h only applicable for ACC(L/R) cabinets only N = No shelf S = Shelf to match case * M = Two piece aluminum metal shelf assembly * (*upcharge applicable) | depth V2 V3 24" \$233 301 26.5" \$241 312 30" \$252 329 32.5" \$260 339 |
| 49 49" high | 5. Pull E = extruded aluminum pull P = extruded aluminum protruding pull | depth AA or paint 24" \$288 26.5" \$308 30" \$338 32.5" \$357 |
| 24 24" deep | 6. Drill option applicable only for 24" and 30" deep units D = drilled to anchor to panel or median F = no drill, freestanding | 42" h - 42" h to below trim, 43.2" h overall 49" h - 49" h to below trim, 50.2" h overall |
| N No Shelf | 7. Finish Laminate, V1, V2 or V3 finish | Product on this page will accept wood grain laminate where laminate is currently an option. List price for wood grain laminate options will be current published laminate list price plus 10%. |
| E Extruded Aluminum Pull | 8. Finish, Aluminum trim (trim M shelf option & pull) AA - Anodized aluminum or painted finish option from page 7 excluding silver | When planning with medians and bridges (single station or clusters of stations) specify either 26.5" or 32.5" deep storage anchored cabinets for anchoring the median or bridge unit of the same depth. Connection method to medians, median storage or bridges incorporated into product design, no additional hardware required. |
| D Drilled to anchor | | When planning with panels, single station or cluster groups where all workstations within the group are the same direction/hand, then specify 26.5" or 32.5" deep storage anchor cabinet units. When planning multi-station clusters mirroring left hand/right hand or with stations back to back with panel run perpendicular to two cabinets, you then need to specify one 24" d with one 26.5" d or 30" d with one 32.5" d cabinet to go side by side or back to back as the case may be. Brackets to secure cabinets to panel are required, specified separately - see page 163. |
| V316 Finish, Maple | | 24" and 30" deep storage anchored cabinets may be specified for freestanding applications, specify drill option F for freestanding, otherwise connection detail will be exposed. |
| AA Finish, trim & pull, anodized aluminum | | Cabinets include angle bracket to side support work surfaces except when drill option "F" for freestanding selected. Cabinets drilled for locks, keying instructions must accompany order. See page 7 for finish options applicable. |

3rd digit in pattern number indicates storage configuration, see individual pattern groups above for description.

| description | h | w | d | pattern no. | L | V1 | V2 | V3 |
|--|-----|-----|-------|----------------------------------|----------|----------|----------|----------|
| Storage anchored cabinet, wardrobe and BBF front, open interior side | 42" | 24" | 24" | ACWJ(L/R)4224() () () () | \$3,742. | \$5,231. | \$5,689. | \$7,397. |
| | 42" | 24" | 30" | ACWJ(L/R)4230() () () () | 4,030. | 5,532. | 6,077. | 7,910. |
| | 42" | 24" | 26.5" | ACWJ(L/R)4226() () () () | 3,884. | 5,382. | 5,885. | 7,655. |
| | 42" | 24" | 32.5" | ACWJ(L/R)4232() () () () | 4,172. | 5,682. | 6,275. | 8,160. |
| | 49" | 24" | 24" | ACWJ(L/R)4924() () () () () | 3,809. | 5,326. | 5,795. | 7,534. |
| | 49" | 24" | 30" | ACWJ(L/R)4930() () () () () | 4,103. | 5,633. | 6,189. | 8,055. |
| | 49" | 24" | 26.5" | ACWJ(L/R)4926() () () () () | 3,955. | 5,479. | 5,994. | 7,797. |
| | 49" | 24" | 32.5" | ACWJ(L/R)4932() () () () () | 4,247. | 5,786. | 6,390. | 8,311. |
| | 64" | 24" | 24" | ACWJ(L/R)6424() () () () () | 3,881. | 5,420. | 5,960. | 7,787. |
| | 64" | 24" | 30" | ACWJ(L/R)6430() () () () () | 4,180. | 5,732. | 6,367. | 8,327. |
| | 64" | 24" | 26.5" | ACWJ(L/R)6426() () () () () | 4,030. | 5,575. | 6,165. | 8,060. |
| | 64" | 24" | 32.5" | ACWJ(L/R)6432() () () () () | 4,327. | 5,887. | 6,573. | 8,591. |

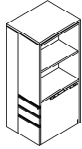

64" h left hand shown, shelf aligns with work surface at 28 1/4" overall, or 27" h to underside

| Order Code | Specification Information | Application Notes |
|--|---|--|
| Example: ACWJL4924NEDWV316AA | To order please specify pattern number including: | *Upcharge applicable as follows |
| A AutoStrada | 1. Hand | 49" h only: Option S upcharge for L/V1/V2 or V3 to correspond to shelf to match case |
| C Cabinet | L = User's Left | 49" and 64" h: Option M upcharge under AA or paint for aluminum metal shelf |
| WJ Wardrobe/ BBF Front, Side Open | R = User's Right | |
| L Left Hand | 2. Height | |
| 49 49" high | 3. Depth | depth L V1 |
| 24 24" deep | 24 = 24" deep | 24" \$ 93 210 |
| N No Shelf | 26 = 26.5" deep | 26.5" \$ 98 216 |
| E Extruded Aluminum Pull | 30 = 30" deep | 30" \$102 227 |
| D Drilled to anchor | 32 = 32.5" deep | 32.5" \$108 232 |
| W Wood interior | 4. Shelf option for open interior side | depth V2 V3 |
| V316 Finish, Maple | 42" h do not have shelf options | 24" \$233 301 |
| AA Finish, trim & pull, anodized aluminum | 64" h do not have "no" shelf option | 26.5" \$241 312 |
| | N = No shelf | 30" \$252 329 |
| | S = Shelf to match case * | 32.5" \$260 339 |
| | M = Two piece extruded aluminum metal shelf assembly * (*upcharge applicable) | depth AA or paint |
| | 5. Pull | 24" \$288 |
| | E = extruded aluminum pull | 26.5" \$308 |
| | P = extruded aluminum protruding pull | 30" \$338 |
| | 6. Drill option, applicable only for 24" and 30" deep units | 32.5" \$357 |
| | D = drilled to anchor to panel or median | Product on this page will accept wood grain laminate where laminate is currently an option. |
| | F = no drill, freestanding | List price for wood grain laminate options will be current published laminate list price plus 10%. |
| | 7. Interior | Specify either 26.5" or 32.5" deep storage anchored cabinets for anchoring median or bridge units of the same depth. Connection method to medians, median storage or bridges incorporated into product design, no additional hardware required. |
| | W = wood drawer interior | |
| | M = metal drawer interior, deduct \$100 list | |
| | 8. Finish | |
| | Laminate, V1, V2 or V3 finish | |
| | 9. Finish, Aluminum trim (trim, M shelf option & pull) | |
| | AA - Anodized aluminum or painted finish option from page 7 excluding silver | |
| | | When planning with panels, single station or cluster groups where all workstations within the group are the same direction/hand, then specify 26.5" or 32.5" deep storage anchor cabinet units. When planning multi-station clusters mirroring left hand/right hand or with stations back to back with panel run perpendicular to two cabinets, you then need to specify one 24" d with one 26.5" d or 30" d with one 32.5" d cabinet to go side by side or back to back as the case may be. Brackets to secure cabinets to panel are required, specified separately - see page 163. |
| | | 24" and 30" deep storage anchored cabinets may be specified for freestanding applications, specify drill option F for freestanding, otherwise connection detail will be exposed. |
| | | Cabinets include angle bracket to side support work surfaces except when drill option "F" for freestanding selected. |
| | | Cabinets drilled for locks, keying instructions must accompany order. |
| | | See page 7 for finish options applicable. |

3rd and 4th digit in pattern number indicates storage configuration, see individual pattern groups above for description.

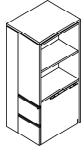
| description | h | w | d | pattern no. | L | V1 | V2 | V3 |
|--|-----|-----|-------|------------------------------|----------|----------|----------|----------|
|  <p>64" h left hand shown, shelf aligns with work surface at 28 1/4" overall, or 27" h to underside</p> | 42" | 24" | 24" | ACWK(L/R)4224() () () () | \$3,324. | \$4,679. | \$5,164. | \$6,715. |
| | 42" | 24" | 30" | ACWK(L/R)4230() () () () | 3,580. | 4,948. | 5,518. | 7,177. |
| | 42" | 24" | 26.5" | ACWK(L/R)4226() () () () | 3,452. | 4,813. | 5,341. | 6,948. |
| | 42" | 24" | 32.5" | ACWK(L/R)4232() () () () | 3,707. | 5,082. | 5,694. | 7,406. |
| | 49" | 24" | 24" | ACWK(L/R)4924() () () () | 3,392. | 4,776. | 5,270. | 6,852. |
| | 49" | 24" | 30" | ACWK(L/R)4930() () () () | 3,653. | 5,050. | 5,630. | 7,323. |
| | 49" | 24" | 26.5" | ACWK(L/R)4926() () () () | 3,522. | 4,912. | 5,451. | 7,089. |
| | 49" | 24" | 32.5" | ACWK(L/R)4932() () () () | 3,783. | 5,186. | 5,810. | 7,558. |
| | 64" | 24" | 24" | ACWK(L/R)6424() () () () | 3,464. | 4,869. | 5,435. | 7,105. |
| | 64" | 24" | 30" | ACWK(L/R)6430() () () () | 3,729. | 5,148. | 5,807. | 7,595. |
| | 64" | 24" | 26.5" | ACWK(L/R)6426() () () () | 3,596. | 5,008. | 5,621. | 7,352. |
| | 64" | 24" | 32.5" | ACWK(L/R)6432() () () () | 3,863. | 5,287. | 5,993. | 7,838. |

| Order Code | Specification Information | Application Notes |
|--|---|--|
| Example: ACWKL4924NEDWV316AA | To order please specify pattern number including: | *Upcharge applicable as follows |
| A AutoStrada | 1. Hand | 49" h only: Option S upcharge for L/V1/V2 or V3 to correspond to shelf to match case |
| C Cabinet | L = User's Left | 49" and 64" h: Option M upcharge under AA or paint for aluminum metal shelf |
| WK Wardrobe/FF front, side open | R = User's Right | |
| L Left Hand | 2. Height | |
| 49 49" high | 3. Depth | depth L V1 V2 V3 |
| 24 24" deep | 24 = 24" deep | 24" \$ 93 210 |
| N No Shelf | 26 = 26.5" deep | 26.5" \$ 98 216 |
| E Extruded Aluminum Pull | 30 = 30" deep | 30" \$102 227 |
| D Drilled to anchor | 32 = 32.5" deep | 32.5" \$108 232 |
| W Wood interior | 4. Shelf option for open interior side | depth V2 V3 |
| V316 Finish, Maple | 42" h do not have shelf options | 24" \$233 301 |
| AA Finish, trim & pull, anodized aluminum | 64" h do not have "no" shelf option | 26.5" \$241 312 |
| | N = No shelf | 30" \$252 329 |
| | S = Shelf to match case * | 32.5" \$260 339 |
| | M = Two piece extruded aluminum metal shelf assembly * (*upcharge applicable) | depth AA or paint |
| | 5. Pull | 24" \$288 |
| | E = extruded aluminum pull | 26.5" \$308 |
| | P = extruded aluminum protruding pull | 30" \$338 |
| | 6. Drill option, applicable only for 24" and 30" deep units | 32.5" \$357 |
| | D = drilled to anchor to panel or median | Specify either 26.5" or 32.5" deep storage anchored cabinets for anchoring median or bridge units of the same depth. Connection method to medians, median storage or bridges incorporated into product design, no additional hardware required. |
| | F = no drill, freestanding | |
| | 7. Interior | Product on this page will accept wood grain laminate where laminate is currently an option. List price for wood grain laminate options will be current published laminate list price plus 10%. |
| | W = wood drawer interior | |
| | M = metal drawer interior, deduct \$100 list | |
| | 8. Finish | |
| | Laminate, V1, V2 or V3 finish | |
| | 9. Finish, Aluminum trim (trim, M shelf option & pull) | |
| | AA - Anodized aluminum or painted finish option from page 7 excluding silver | |
| | | When planning with panels, single station or cluster groups where all workstations within the group are the same direction/hand, then specify 26.5" or 32.5" deep storage anchor cabinet units. When planning multi-station clusters mirroring left hand/right hand or with stations back to back with panel run perpendicular to two cabinets, you then need to specify one 24" d with one 26.5" d or 30" d with one 32.5" d cabinet to go side by side or back to back as the case may be. Brackets to secure cabinets to panel are required, specified separately - see page 163. |
| | | 24" and 30" deep storage anchored cabinets may be specified for freestanding applications, specify drill option F for freestanding, otherwise connection detail will be exposed. |
| | | Cabinets include angle bracket to side support work surfaces except when drill option "F" for freestanding selected. |
| | | Cabinets drilled for locks, keying instructions must accompany order. |
| | | See page 7 for finish options applicable. |

3rd and 4th digit in pattern number indicates storage configuration, see individual pattern groups above for description.

| description | hand | h | w | d | pattern no. | L | V1 | V2 | V3 |
|---|------------|-----|-------|-----|---------------------------------|----------|----------|----------|----------|
| Storage anchored cabinet, FF lower front, open interior back | 49"h left | 49" | 24" | 19" | ACEL4924 () () () () | \$2,620. | \$3,649. | \$4,058. | \$5,276. |
| | | 49" | 30" | 19" | ACEL4930 () () () () | 2,822. | 3,859. | 4,337. | 5,637. |
| | | 49" | 26.5" | 19" | ACEL4926 () () () () | 2,721. | 3,754. | 4,197. | 5,458. |
| | | 49" | 32.5" | 19" | ACEL4932 () () () () | 2,920. | 3,964. | 4,476. | 5,818. |
| | 49"h right | 49" | 24" | 19" | ACER4924 () () () () | 2,620. | 3,649. | 4,058. | 5,276. |
| | | 49" | 30" | 19" | ACER4930 () () () () | 2,822. | 3,859. | 4,337. | 5,637. |
| | | 49" | 26.5" | 19" | ACER4926 () () () () | 2,721. | 3,754. | 4,197. | 5,458. |
| | | 49" | 32.5" | 19" | ACER4932 () () () () | 2,920. | 3,964. | 4,476. | 5,818. |
| | 64"h left | 64" | 24" | 19" | ACEL6424 () () () () | 2,882. | 4,014. | 4,464. | 5,803. |
| | | 64" | 30" | 19" | ACEL6430 () () () () | 3,103. | 4,244. | 4,769. | 6,201. |
| | | 64" | 26.5" | 19" | ACEL6426 () () () () | 2,992. | 4,130. | 4,617. | 6,002. |
| | | 64" | 32.5" | 19" | ACEL6432 () () () () | 3,212. | 4,358. | 4,924. | 6,402. |
| | 64"h right | 64" | 24" | 19" | ACER6424 () () () () | 2,882. | 4,014. | 4,464. | 5,803. |
| | | 64" | 30" | 19" | ACER6430 () () () () | 3,103. | 4,244. | 4,769. | 6,201. |

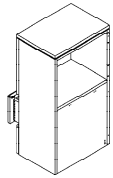

left hand shown, shelf aligns with worksurface at 28 1/4" h overall, or 27" h to underside

Order Code

| | |
|-------------|---|
| Example: | ACEL4924SEWV316AA |
| A | AutoStrada |
| C | Cabinet |
| E | File/File lower front, Interior back open shelf |
| L | Left Hand |
| 49 | 49" high |
| 24 | 24" deep |
| S | w/shelf to match cabinet case |
| E | Extruded Aluminum Pull |
| W | Wood interior |
| V316 | Finish, Maple |
| AA | Finish, trim & pull, anodized aluminum |

3rd digit in pattern number indicates storage configuration, see individual pattern groups above for description.

Specification Information

To order please specify pattern number including:

- Hand
L = User's Left
R = User's Right
- Height
49 = 49" h (for use with medians, bridges or panels, 49" h to below trim, 50.2" h overall)
64 = 64" h (for use with panels 64" h to below trim, 65.2" h overall)
- Depth
24 = 24" deep (use with 26.5" d unit for side by side cabinet application with panels)
30 = 30" deep (use with 32.5" d unit for side by side cabinet application with panels)
26 = 26.5" deep (use with medians, bridges & panels)
32 = 32.5" deep (use with medians, bridges & panels)
- Shelf option for open interior side
N = No shelf, optional for 49" h units only
S = Shelf to match case * (optional 49" and 64" h)
M = Two piece aluminum metal shelf assembly * (optional 49" and 64" h) (*upcharge applicable)
- Pull
E = extruded aluminum pull
P = extruded aluminum protruding pull

- Drawer Interior applicable ACE(L/R) and ACI(L/R) only
W = wood interior
M = metal drawer interior, deduct \$100 list
- Finish
Laminate, V1, V2 or V3 finish
- Finish, Aluminum trim (trim, M shelf option & pull)
AA - Anodized aluminum or painted finish option from page 7 excluding silver

Connection method to medians, median storage or bridges incorporated into product design, no additional hardware required.

64" h cabinets include shelf to match case in price list above. Upcharge below applicable as follows for 49" h shelf to match case for L/V1/V2/V3 or AA or paint for aluminum metal shelf for M option for both 49" h and 64" h cabinets.

| depth | L | V1 |
|-------|--------|-----|
| 24" | \$ 93 | 210 |
| 26.5" | \$ 98 | 216 |
| 30" | \$ 102 | 227 |
| 32.5" | \$ 108 | 232 |

| depth | V2 | V3 |
|-------|-------|-----|
| 24" | \$233 | 301 |
| 26.5" | \$241 | 312 |
| 30" | \$252 | 329 |
| 32.5" | \$260 | 339 |

| depth | AA or paint |
|-------|-------------|
| 24" | \$288 |
| 26.5" | \$308 |
| 30" | \$338 |
| 32.5" | \$357 |

Application Notes

- See page 7 for finish options applicable.
- Product on this page will accept wood grain laminate where laminate is currently an option. List price for wood grain laminate options will be current published laminate list price plus 10%.
- When planning with medians and bridges (single station or clusters of stations) specify 49" h cabinets in either 26.5" or 32.5" deep storage anchored cabinets for anchoring the median or bridge unit of the same depth.
- When planning with panels, single station or cluster groups where all workstations within the group are the same direction/hand, then specify 26.5" or 32.5" deep storage anchor cabinet units. When planning multi-station clusters mirroring left hand/right hand or back to back stations with panel run perpendicular to two cabinets, you then need to specify one 24" d with one 26.5" d or 30" d with one 32.5" d cabinet to go side by side or back to back as the case may be.
- Cabinets with front and back access not to be used in freestanding applications.
- Cabinet to panel attachment brackets required, see page 163.
- Cabinets include angle bracket to side support worksurfaces. Cabinets drilled for locks, keying instructions must accompany order.
- File drawers in cabinet styles prefixed ACIL and ACIR do not accommodate legal filing side to side.

| description | hand | h | w | d | pattern no. | L | V1 | V2 | V3 |
|---|------------|-----|-------|-----|------------------------------|----------|----------|----------|----------|
| Storage anchored cabinet, FF lower front, open interior back | 64"h right | 64" | 26.5" | 19" | ACER6426 (X)(X)(X)(X) | \$2,992. | \$4,130. | \$4,617. | \$6,002. |
| | | 64" | 32.5" | 19" | ACER6432 (X)(X)(X)(X) | 3,212. | 4,358. | 4,924. | 6,402. |

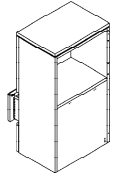

left hand shown, shelf aligns with worksurface at 28 1/4" h overall, or 27" h to underside

| Order Code | Specification Information | Application Notes |
|--|--|---|
| Example: ACEL4924SEWV316AA | To order please specify pattern number including: | See page 7 for finish options applicable. |
| A AutoStrada | | |
| C Cabinet | | |
| E File/File lower front, Interior back open shelf | | Product on this page will accept wood grain laminate where laminate is currently an option. List price for wood grain laminate options will be current published laminate list price plus 10%. |
| L Left Hand | | |
| 49 49" high | 1. Hand <i>L = User's Left</i> <i>R = User's Right</i> | |
| 24 24" deep | 2. Height <i>49 = 49" h (for use with medians, bridges or panels, 49" h to below trim, 50.2" h overall)</i> <i>64 = 64" h (for use with panels 64" h to below trim, 65.2" h overall)</i> | |
| S w/shelf to match cabinet case | 3. Depth <i>24 = 24" deep (use with 26.5" d unit for side by side cabinet application with panels)</i> <i>30 = 30" deep (use with 32.5" d unit for side by side cabinet application with panels)</i> <i>26 = 26.5" deep (use with medians, bridges & panels)</i> <i>32 = 32.5" deep (use with medians, bridges & panels)</i> | When planning with medians and bridges (single station or clusters of stations) specify 49" h cabinets in either 26.5" or 32.5" deep storage anchored cabinets for anchoring the median or bridge unit of the same depth. |
| E Extruded Aluminum Pull | 4. Shelf option for open interior side <i>N = No shelf, optional for 49" h units only</i> <i>S = Shelf to match case * (optional 49" and 64" h)</i> <i>M = Two piece aluminum metal shelf assembly * (optional 49" and 64" h)</i> <i>(*upcharge applicable)</i> | When planning with panels, single station or cluster groups where all workstations within the group are the same direction/hand, then specify 26.5" or 32.5" deep storage anchor cabinet units. When planning multi-station clusters mirroring left hand/right hand or back to back stations with panel run perpendicular to two cabinets, you then need to specify one 24" d with one 26.5" d or 30" d with one 32.5" d cabinet to go side by side or back to back as the case may be. |
| W Wood interior | 5. Pull <i>E = extruded aluminum pull</i> <i>P = extruded aluminum protruding pull</i> | |
| V316 Finish, Maple | 6. Drawer Interior applicable ACE(L/R) and ACI(L/R) only <i>W = wood interior</i> <i>M = metal drawer interior, deduct \$100 list</i> | Connection method to medians, median storage or bridges incorporated into product design, no additional hardware required. |
| AA Finish, trim & pull, anodized aluminum | 7. Finish <i>Laminate, V1, V2 or V3 finish</i> | |
| | 8. Finish, Aluminum trim (trim, M shelf option & pull) <i>AA - Anodized aluminum or painted finish option from page 7 excluding silver</i> | |
| | 64" h cabinets include shelf to match case in price list above. Upcharge below applicable as follows for 49" h shelf to match case for L/V1/V2/V3 or AA or paint for aluminum metal shelf for M option for both 49" h and 64" h cabinets. | |
| | depth L V1 | |
| | 24" \$ 93 210 | |
| | 26.5" \$ 98 216 | |
| | 30" \$ 102 227 | |
| | 32.5" \$ 108 232 | |
| | depth V2 V3 | |
| | 24" \$233 301 | |
| | 26.5" \$241 312 | |
| | 30" \$252 329 | |
| | 32.5" \$260 339 | |
| | depth AA or paint | |
| | 24" \$288 | |
| | 26.5" \$308 | |
| | 30" \$338 | |
| | 32.5" \$357 | |
| | | Cabinets with front and back access not to be used in freestanding applications. |
| | | Cabinet to panel attachment brackets required, see page 163. |
| | | Cabinets include angle bracket to side support worksurfaces. Cabinets drilled for locks, keying instructions must accompany order. |
| | | File drawers in cabinet styles prefixed ACIL and ACIR do not accommodate legal filing side to side. |

3rd digit in pattern number indicates storage configuration, see individual pattern groups above for description.

| description | hand | h | w | d | pattern no. | L | V1 | V2 | V3 |
|---|-------------|-----|-------|-----------------------------|-----------------------------|----------|----------|----------|----------|
| Storage anchored cabinet, HD lower front, open interior back | 49" h left | 49" | 24" | 19" | ACFL4924 () () () | \$2,319. | \$3,231. | \$3,656. | \$4,753. |
| | | 49" | 30" | 19" | ACFL4930 () () () | 2,496. | 3,414. | 3,908. | 5,079. |
| | | 49" | 26.5" | 19" | ACFL4926 () () () | 2,408. | 3,322. | 3,781. | 4,916. |
| | | 49" | 32.5" | 19" | ACFL4932 () () () | 2,585. | 3,508. | 4,034. | 5,242. |
| | 49" h right | 49" | 24" | 19" | ACFR4924 () () () | 2,319. | 3,231. | 3,656. | 4,753. |
| | | 49" | 30" | 19" | ACFR4930 () () () | 2,496. | 3,414. | 3,908. | 5,079. |
| | | 49" | 26.5" | 19" | ACFR4926 () () () | 2,408. | 3,322. | 3,781. | 4,916. |
| | | 49" | 32.5" | 19" | ACFR4932 () () () | 2,585. | 3,508. | 4,034. | 5,242. |
| | 64" h left | 64" | 24" | 19" | ACFL6424 () () () | 2,551. | 3,554. | 4,021. | 5,226. |
| | | 64" | 30" | 19" | ACFL6430 () () () | 2,746. | 3,757. | 4,296. | 5,588. |
| | | 64" | 26.5" | 19" | ACFL6426 () () () | 2,648. | 3,654. | 4,159. | 5,407. |
| | | 64" | 32.5" | 19" | ACFL6432 () () () | 2,843. | 3,858. | 4,437. | 5,766. |
| 64" h right | 64" | 24" | 19" | ACFR6424 () () () | 2,551. | 3,554. | 4,021. | 5,226. | |
| | 64" | 30" | 19" | ACFR6430 () () () | 2,746. | 3,757. | 4,296. | 5,588. | |

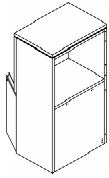

left hand shown, shelf aligns with worksurface at 28 1/4" h overall, or 27" h to underside

| Order Code | Specification Information |
|--|--|
| Example: ACEL4924SEWV316AA | To order please specify pattern number including: |
| A AutoStrada | 1. Hand |
| C Cabinet | L = User's Left |
| E File/File lower front, Interior back open shelf | R = User's Right |
| L Left Hand | 2. Height |
| 49 49" high | 49 = 49" h (for use with medians, bridges or panels, 49" h to below trim, 50.2" h overall) |
| 24 24" deep | 64 = 64" h (for use with panels 64" h to below trim, 65.2" h overall) |
| S w/shelf to match cabinet case | 3. Depth |
| E Extruded Aluminum Pull | 24 = 24" deep (use with 26.5" d unit for side by side cabinet application with panels) |
| W Wood interior | 30 = 30" deep (use with 32.5" d unit for side by side cabinet application with panels) |
| V316 Finish, Maple | 26 = 26.5" deep (use with medians, bridges & panels) |
| AA Finish, trim & pull, anodized aluminum | 32 = 32.5" deep (use with medians, bridges & panels) |

3rd digit in pattern number indicates storage configuration, see individual pattern groups above for description.

Specification Information

- Hand
L = User's Left
R = User's Right
- Height
49 = 49" h (for use with medians, bridges or panels, 49" h to below trim, 50.2" h overall)
64 = 64" h (for use with panels 64" h to below trim, 65.2" h overall)
- Depth
24 = 24" deep (use with 26.5" d unit for side by side cabinet application with panels)
30 = 30" deep (use with 32.5" d unit for side by side cabinet application with panels)
26 = 26.5" deep (use with medians, bridges & panels)
32 = 32.5" deep (use with medians, bridges & panels)
- Shelf option for open interior side
N = No shelf, optional for 49" h units only
S = Shelf to match case * (optional 49" and 64" h)
M = Two piece aluminum metal shelf assembly * (optional 49" and 64" h) (*upcharge applicable)
- Pull
E = extruded aluminum pull
P = extruded aluminum protruding pull

- Drawer Interior applicable ACE(L/R) and ACI(L/R) only
W = wood interior
M = metal drawer interior, deduct \$100 list
- Finish
Laminate, V1, V2 or V3 finish
- Finish, Aluminum trim (trim, M shelf option & pull)
AA - Anodized aluminum or painted finish option from page 7 excluding silver

Connection method to medians, median storage or bridges incorporated into product design, no additional hardware required.

64" h cabinets include shelf to match case in price list above. Upcharge below applicable as follows for 49" h shelf to match case for L/V1/V2/V3 or AA or paint for aluminum metal shelf for M option for both 49" h and 64" h cabinets.

| depth | L | V1 |
|-------|-------------|-----|
| 24" | \$ 93 | 210 |
| 26.5" | \$ 98 | 216 |
| 30" | \$ 102 | 227 |
| 32.5" | \$ 108 | 232 |
| depth | V2 | V3 |
| 24" | \$233 | 301 |
| 26.5" | \$241 | 312 |
| 30" | \$252 | 329 |
| 32.5" | \$260 | 339 |
| depth | AA or paint | |
| 24" | \$288 | |
| 26.5" | \$308 | |
| 30" | \$338 | |
| 32.5" | \$357 | |

Application Notes

- See page 7 for finish options applicable.
- Product on this page will accept wood grain laminate where laminate is currently an option. List price for wood grain laminate options will be current published laminate list price plus 10%.
- When planning with medians and bridges (single station or clusters of stations) specify 49" h cabinets in either 26.5" or 32.5" deep storage anchored cabinets for anchoring the median or bridge unit of the same depth.
- When planning with panels, single station or cluster groups where all workstations within the group are the same direction/hand, then specify 26.5" or 32.5" deep storage anchor cabinet units. When planning multi-station clusters mirroring left hand/right hand or back to back stations with panel run perpendicular to two cabinets, you then need to specify one 24" d with one 26.5" d or 30" d with one 32.5" d cabinet to go side by side or back to back as the case may be.
- Cabinets with front and back access not to be used in freestanding applications.
- Cabinet to panel attachment brackets required, see page 163.
- Cabinets include angle bracket to side support worksurfaces. Cabinets drilled for locks, keying instructions must accompany order.
- File drawers in cabinet styles prefixed ACIL and ACIR do not accommodate legal filing side to side.

| description | hand | h | w | d | pattern no. | L | V1 | V2 | V3 |
|---|-------------|-----|-------|-----|-----------------------------|----------|----------|----------|----------|
| Storage anchored cabinet, HD lower front, open interior back | 64" h right | 64" | 26.5" | 19" | ACFR6426 () () () | \$2,648. | \$3,654. | \$4,159. | \$5,407. |
| | | 64" | 32.5" | 19" | ACFR6432 () () () | 2,843. | 3,858. | 4,437. | 5,766. |

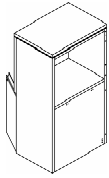

left hand shown, shelf aligns with worksurface at 28 1/4" h overall, or 27" h to underside

| Order Code | Specification Information | Application Notes | | | | | | | | | | | | | | | | | | | | | | | | | | | | | | | | | | | | | | | | | | | | | |
|--|--|--|---|----|-----|-------|-----|-------|-------|-----|-----|--------|-----|-------|--------|-----|-------|----|----|-----|-------|-----|-------|-------|-----|-----|-------|-----|-------|-------|-----|-------|-------------|--|-----|-------|--|-------|-------|--|-----|-------|--|-------|-------|--|--|
| Example: ACEL4924SEWV316AA | To order please specify pattern number including: | See page 7 for finish options applicable. | | | | | | | | | | | | | | | | | | | | | | | | | | | | | | | | | | | | | | | | | | | | | |
| A AutoStrada | | | | | | | | | | | | | | | | | | | | | | | | | | | | | | | | | | | | | | | | | | | | | | | |
| C Cabinet | | | | | | | | | | | | | | | | | | | | | | | | | | | | | | | | | | | | | | | | | | | | | | | |
| E File/File lower front, Interior back open shelf | | Product on this page will accept wood grain laminate where laminate is currently an option. List price for wood grain laminate options will be current published laminate list price plus 10%. | | | | | | | | | | | | | | | | | | | | | | | | | | | | | | | | | | | | | | | | | | | | | |
| L Left Hand | | | | | | | | | | | | | | | | | | | | | | | | | | | | | | | | | | | | | | | | | | | | | | | |
| 49 49" high | | | | | | | | | | | | | | | | | | | | | | | | | | | | | | | | | | | | | | | | | | | | | | | |
| 24 24" deep | | | | | | | | | | | | | | | | | | | | | | | | | | | | | | | | | | | | | | | | | | | | | | | |
| S w/shelf to match cabinet case | | | | | | | | | | | | | | | | | | | | | | | | | | | | | | | | | | | | | | | | | | | | | | | |
| E Extruded Aluminum Pull | | | | | | | | | | | | | | | | | | | | | | | | | | | | | | | | | | | | | | | | | | | | | | | |
| W Wood interior | | | | | | | | | | | | | | | | | | | | | | | | | | | | | | | | | | | | | | | | | | | | | | | |
| V316 Finish, Maple | | | | | | | | | | | | | | | | | | | | | | | | | | | | | | | | | | | | | | | | | | | | | | | |
| AA Finish, trim & pull, anodized aluminum | | | | | | | | | | | | | | | | | | | | | | | | | | | | | | | | | | | | | | | | | | | | | | | |
| | <p>1. Hand L = User's Left R = User's Right</p> <p>2. Height 49 = 49" h (for use with medians, bridges or panels, 49" h to below trim, 50.2" h overall) 64 = 64" h (for use with panels 64" h to below trim, 65.2" h overall)</p> <p>3. Depth 24 = 24" deep (use with 26.5" d unit for side by side cabinet application with panels) 30 = 30" deep (use with 32.5" d unit for side by side cabinet application with panels) 26 = 26.5" deep (use with medians, bridges & panels) 32 = 32.5" deep (use with medians, bridges & panels)</p> <p>4. Shelf option for open interior side N = No shelf, optional for 49" h units only S = Shelf to match case * (optional 49" and 64" h) M = Two piece aluminum metal shelf assembly * (optional 49" and 64" h) (*upcharge applicable)</p> <p>5. Pull E = extruded aluminum pull P = extruded aluminum protruding pull</p> <p>6. Drawer Interior applicable ACE(L/R) and ACI(L/R) only W = wood interior M = metal drawer interior, deduct \$100 list</p> <p>7. Finish Laminate, V1, V2 or V3 finish</p> <p>8. Finish, Aluminum trim (trim, M shelf option & pull) AA - Anodized aluminum or painted finish option from page 7 excluding silver</p> <p>Connection method to medians, median storage or bridges incorporated into product design, no additional hardware required.</p> <p>64" h cabinets include shelf to match case in price list above. Upcharge below applicable as follows for 49" h shelf to match case for L/V1/V2/V3 or AA or paint for aluminum metal shelf for M option for both 49" h and 64" h cabinets.</p> <table border="1"> <tr> <td>depth</td> <td>L</td> <td>V1</td> </tr> <tr> <td>24"</td> <td>\$ 93</td> <td>210</td> </tr> <tr> <td>26.5"</td> <td>\$ 98</td> <td>216</td> </tr> <tr> <td>30"</td> <td>\$ 102</td> <td>227</td> </tr> <tr> <td>32.5"</td> <td>\$ 108</td> <td>232</td> </tr> <tr> <td>depth</td> <td>V2</td> <td>V3</td> </tr> <tr> <td>24"</td> <td>\$233</td> <td>301</td> </tr> <tr> <td>26.5"</td> <td>\$241</td> <td>312</td> </tr> <tr> <td>30"</td> <td>\$252</td> <td>329</td> </tr> <tr> <td>32.5"</td> <td>\$260</td> <td>339</td> </tr> <tr> <td>depth</td> <td>AA or paint</td> <td></td> </tr> <tr> <td>24"</td> <td>\$288</td> <td></td> </tr> <tr> <td>26.5"</td> <td>\$308</td> <td></td> </tr> <tr> <td>30"</td> <td>\$338</td> <td></td> </tr> <tr> <td>32.5"</td> <td>\$357</td> <td></td> </tr> </table> | depth | L | V1 | 24" | \$ 93 | 210 | 26.5" | \$ 98 | 216 | 30" | \$ 102 | 227 | 32.5" | \$ 108 | 232 | depth | V2 | V3 | 24" | \$233 | 301 | 26.5" | \$241 | 312 | 30" | \$252 | 329 | 32.5" | \$260 | 339 | depth | AA or paint | | 24" | \$288 | | 26.5" | \$308 | | 30" | \$338 | | 32.5" | \$357 | | <p>When planning with medians and bridges (single station or clusters of stations) specify 49" h cabinets in either 26.5" or 32.5" deep storage anchored cabinets for anchoring the median or bridge unit of the same depth.</p> <p>When planning with panels, single station or cluster groups where all workstations within the group are the same direction/hand, then specify 26.5" or 32.5" deep storage anchor cabinet units. When planning multi-station clusters mirroring left hand/right hand or back to back stations with panel run perpendicular to two cabinets, you then need to specify one 24" d with one 26.5" d or 30" d with one 32.5" d cabinet to go side by side or back to back as the case may be.</p> <p>Cabinets with front and back access not to be used in freestanding applications.</p> <p>Cabinet to panel attachment brackets required, see page 163.</p> <p>Cabinets include angle bracket to side support worksurfaces. Cabinets drilled for locks, keying instructions must accompany order.</p> <p>File drawers in cabinet styles prefixed ACIL and ACIR do not accommodate legal filing side to side.</p> |
| depth | L | V1 | | | | | | | | | | | | | | | | | | | | | | | | | | | | | | | | | | | | | | | | | | | | | |
| 24" | \$ 93 | 210 | | | | | | | | | | | | | | | | | | | | | | | | | | | | | | | | | | | | | | | | | | | | | |
| 26.5" | \$ 98 | 216 | | | | | | | | | | | | | | | | | | | | | | | | | | | | | | | | | | | | | | | | | | | | | |
| 30" | \$ 102 | 227 | | | | | | | | | | | | | | | | | | | | | | | | | | | | | | | | | | | | | | | | | | | | | |
| 32.5" | \$ 108 | 232 | | | | | | | | | | | | | | | | | | | | | | | | | | | | | | | | | | | | | | | | | | | | | |
| depth | V2 | V3 | | | | | | | | | | | | | | | | | | | | | | | | | | | | | | | | | | | | | | | | | | | | | |
| 24" | \$233 | 301 | | | | | | | | | | | | | | | | | | | | | | | | | | | | | | | | | | | | | | | | | | | | | |
| 26.5" | \$241 | 312 | | | | | | | | | | | | | | | | | | | | | | | | | | | | | | | | | | | | | | | | | | | | | |
| 30" | \$252 | 329 | | | | | | | | | | | | | | | | | | | | | | | | | | | | | | | | | | | | | | | | | | | | | |
| 32.5" | \$260 | 339 | | | | | | | | | | | | | | | | | | | | | | | | | | | | | | | | | | | | | | | | | | | | | |
| depth | AA or paint | | | | | | | | | | | | | | | | | | | | | | | | | | | | | | | | | | | | | | | | | | | | | | |
| 24" | \$288 | | | | | | | | | | | | | | | | | | | | | | | | | | | | | | | | | | | | | | | | | | | | | | |
| 26.5" | \$308 | | | | | | | | | | | | | | | | | | | | | | | | | | | | | | | | | | | | | | | | | | | | | | |
| 30" | \$338 | | | | | | | | | | | | | | | | | | | | | | | | | | | | | | | | | | | | | | | | | | | | | | |
| 32.5" | \$357 | | | | | | | | | | | | | | | | | | | | | | | | | | | | | | | | | | | | | | | | | | | | | | |

3rd digit in pattern number indicates storage configuration, see individual pattern groups above for description.

| description | hand | h | w | d | pattern no. | L | V1 | V2 | V3 |
|---|-------|-----|-------|-----|-----------------------------|----------|----------|----------|----------|
| Storage anchored cabinet, 49"h Personal wardrobe and storage | left | 49" | 30" | 19" | ACIL4930 () () () | \$3,726. | \$5,121. | \$5,683. | \$7,337. |
| | | 49" | 32.5" | 19" | ACIL4932 () () () | 3,936. | 5,348. | 5,972. | 7,720. |
| | right | 49" | 30" | 19" | ACIR4930 () () () | 3,726. | 5,121. | 5,683. | 7,337. |
| | | 49" | 32.5" | 19" | ACIR4932 () () () | 3,936. | 5,348. | 5,972. | 7,720. |

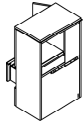

left hand shown, attach perpendicular to panel at back right side

Left hand = wardrobe on left front side
 Right hand = wardrobe on right front side
 wardrobe includes coat rod
 supports worksurface on back side at 28 1/4" overall or 27"h to underside of worksurface
 49"h I style cabinets do not have shelf above box drawer on back side access
 File drawers (front side) do not accommodate side to side legal filing

| Order Code | Specification Information | Application Notes | | | | | | | | | | | | | | | | | | | | | | | | | | | | | | | | | | | | | | | | | | | | | |
|---|--|--|---|----|-----|-------|-----|-------|-------|-----|-----|--------|-----|-------|--------|-----|-------|----|----|-----|-------|-----|-------|-------|-----|-----|-------|-----|-------|-------|-----|-------|-------------|--|-----|-------|--|-------|-------|--|-----|-------|--|-------|-------|--|--|
| Example: ACEL4924SEWV316AA | To order please specify pattern number including: | See page 7 for finish options applicable. | | | | | | | | | | | | | | | | | | | | | | | | | | | | | | | | | | | | | | | | | | | | | |
| A AutoStrada | | | | | | | | | | | | | | | | | | | | | | | | | | | | | | | | | | | | | | | | | | | | | | | |
| C Cabinet | | | | | | | | | | | | | | | | | | | | | | | | | | | | | | | | | | | | | | | | | | | | | | | |
| E File/File lower front, Interior back open shelf | | Product on this page will accept wood grain laminate where laminate is currently an option. List price for wood grain laminate options will be current published laminate list price plus 10%. | | | | | | | | | | | | | | | | | | | | | | | | | | | | | | | | | | | | | | | | | | | | | |
| L Left Hand | | | | | | | | | | | | | | | | | | | | | | | | | | | | | | | | | | | | | | | | | | | | | | | |
| 49 49" high | | | | | | | | | | | | | | | | | | | | | | | | | | | | | | | | | | | | | | | | | | | | | | | |
| 24 24" deep | | | | | | | | | | | | | | | | | | | | | | | | | | | | | | | | | | | | | | | | | | | | | | | |
| S w/shelf to match cabinet case | | | | | | | | | | | | | | | | | | | | | | | | | | | | | | | | | | | | | | | | | | | | | | | |
| E Extruded Aluminum Pull | | | | | | | | | | | | | | | | | | | | | | | | | | | | | | | | | | | | | | | | | | | | | | | |
| W Wood interior | | | | | | | | | | | | | | | | | | | | | | | | | | | | | | | | | | | | | | | | | | | | | | | |
| V316 Finish, Maple | | | | | | | | | | | | | | | | | | | | | | | | | | | | | | | | | | | | | | | | | | | | | | | |
| AA Finish, trim & pull, anodized aluminum | | | | | | | | | | | | | | | | | | | | | | | | | | | | | | | | | | | | | | | | | | | | | | | |
| 3rd digit in pattern number indicates storage configuration, see individual pattern groups above for description. | <p>1. Hand <i>L = User's Left</i> <i>R = User's Right</i></p> <p>2. Height <i>49 = 49"h (for use with medians, bridges or panels, 49"h to below trim, 50.2"h overall)</i> <i>64 = 64"h (for use with panels 64"h to below trim, 65.2"h overall)</i></p> <p>3. Depth <i>24 = 24" deep (use with 26.5"d unit for side by side cabinet application with panels)</i> <i>30 = 30" deep (use with 32.5"d unit for side by side cabinet application with panels)</i> <i>26 = 26.5" deep (use with medians, bridges & panels)</i> <i>32 = 32.5" deep (use with medians, bridges & panels)</i></p> <p>4. Shelf option for open interior side <i>N = No shelf, optional for 49"h units only</i> <i>S = Shelf to match case * (optional 49" and 64"h)</i> <i>M = Two piece aluminum metal shelf assembly * (optional 49" and 64"h)</i> (*upcharge applicable)</p> <p>5. Pull <i>E = extruded aluminum pull</i> <i>P = extruded aluminum protruding pull</i></p> <p>6. Drawer Interior applicable ACE(L/R) and ACI(L/R) only <i>W = wood interior</i> <i>M = metal drawer interior, deduct \$100 list</i></p> <p>7. Finish <i>Laminate, V1, V2 or V3 finish</i></p> <p>8. Finish, Aluminum trim (trim, M shelf option & pull) <i>AA - Anodized aluminum or painted finish option from page 7 excluding silver</i></p> <p>Connection method to medians, median storage or bridges incorporated into product design, no additional hardware required.</p> <p>64"h cabinets include shelf to match case in price list above. Upcharge below applicable as follows for 49"h shelf to match case for L/V1/V2/V3 or AA or paint for aluminum metal shelf for M option for both 49"h and 64"h cabinets.</p> <table border="1"> <tr> <td>depth</td> <td>L</td> <td>V1</td> </tr> <tr> <td>24"</td> <td>\$ 93</td> <td>210</td> </tr> <tr> <td>26.5"</td> <td>\$ 98</td> <td>216</td> </tr> <tr> <td>30"</td> <td>\$ 102</td> <td>227</td> </tr> <tr> <td>32.5"</td> <td>\$ 108</td> <td>232</td> </tr> <tr> <td>depth</td> <td>V2</td> <td>V3</td> </tr> <tr> <td>24"</td> <td>\$233</td> <td>301</td> </tr> <tr> <td>26.5"</td> <td>\$241</td> <td>312</td> </tr> <tr> <td>30"</td> <td>\$252</td> <td>329</td> </tr> <tr> <td>32.5"</td> <td>\$260</td> <td>339</td> </tr> <tr> <td>depth</td> <td>AA or paint</td> <td></td> </tr> <tr> <td>24"</td> <td>\$288</td> <td></td> </tr> <tr> <td>26.5"</td> <td>\$308</td> <td></td> </tr> <tr> <td>30"</td> <td>\$338</td> <td></td> </tr> <tr> <td>32.5"</td> <td>\$357</td> <td></td> </tr> </table> | depth | L | V1 | 24" | \$ 93 | 210 | 26.5" | \$ 98 | 216 | 30" | \$ 102 | 227 | 32.5" | \$ 108 | 232 | depth | V2 | V3 | 24" | \$233 | 301 | 26.5" | \$241 | 312 | 30" | \$252 | 329 | 32.5" | \$260 | 339 | depth | AA or paint | | 24" | \$288 | | 26.5" | \$308 | | 30" | \$338 | | 32.5" | \$357 | | <p>When planning with medians and bridges (single station or clusters of stations) specify 49"h cabinets in either 26.5" or 32.5" deep storage anchored cabinets for anchoring the median or bridge unit of the same depth.</p> <p>When planning with panels, single station or cluster groups where all workstations within the group are the same direction/hand, then specify 26.5" or 32.5" deep storage anchor cabinet units. When planning multi-station clusters mirroring left hand/right hand or back to back stations with panel run perpendicular to two cabinets, you then need to specify one 24"d with one 26.5"d or 30"d with one 32.5" d cabinet to go side by side or back to back as the case may be.</p> <p>Cabinets with front and back access not to be used in freestanding applications.</p> <p>Cabinet to panel attachment brackets required, see page 163.</p> <p>Cabinets include angle bracket to side support worksurfaces. Cabinets drilled for locks, keying instructions must accompany order.</p> <p>File drawers in cabinet styles prefixed ACIL and ACIR do not accommodate legal filing side to side.</p> |
| depth | L | V1 | | | | | | | | | | | | | | | | | | | | | | | | | | | | | | | | | | | | | | | | | | | | | |
| 24" | \$ 93 | 210 | | | | | | | | | | | | | | | | | | | | | | | | | | | | | | | | | | | | | | | | | | | | | |
| 26.5" | \$ 98 | 216 | | | | | | | | | | | | | | | | | | | | | | | | | | | | | | | | | | | | | | | | | | | | | |
| 30" | \$ 102 | 227 | | | | | | | | | | | | | | | | | | | | | | | | | | | | | | | | | | | | | | | | | | | | | |
| 32.5" | \$ 108 | 232 | | | | | | | | | | | | | | | | | | | | | | | | | | | | | | | | | | | | | | | | | | | | | |
| depth | V2 | V3 | | | | | | | | | | | | | | | | | | | | | | | | | | | | | | | | | | | | | | | | | | | | | |
| 24" | \$233 | 301 | | | | | | | | | | | | | | | | | | | | | | | | | | | | | | | | | | | | | | | | | | | | | |
| 26.5" | \$241 | 312 | | | | | | | | | | | | | | | | | | | | | | | | | | | | | | | | | | | | | | | | | | | | | |
| 30" | \$252 | 329 | | | | | | | | | | | | | | | | | | | | | | | | | | | | | | | | | | | | | | | | | | | | | |
| 32.5" | \$260 | 339 | | | | | | | | | | | | | | | | | | | | | | | | | | | | | | | | | | | | | | | | | | | | | |
| depth | AA or paint | | | | | | | | | | | | | | | | | | | | | | | | | | | | | | | | | | | | | | | | | | | | | | |
| 24" | \$288 | | | | | | | | | | | | | | | | | | | | | | | | | | | | | | | | | | | | | | | | | | | | | | |
| 26.5" | \$308 | | | | | | | | | | | | | | | | | | | | | | | | | | | | | | | | | | | | | | | | | | | | | | |
| 30" | \$338 | | | | | | | | | | | | | | | | | | | | | | | | | | | | | | | | | | | | | | | | | | | | | | |
| 32.5" | \$357 | | | | | | | | | | | | | | | | | | | | | | | | | | | | | | | | | | | | | | | | | | | | | | |

| description | hand | h | w | d | pattern no. | L | V1 | V2 | V3 |
|---|-------|-----|-------|-----|---------------------------------|----------|----------|----------|----------|
| Storage anchored cabinet, 64"h Personal wardrobe and storage | left | 64" | 30" | 19" | ACIL6430 () () () () | \$3,740. | \$5,161. | \$5,772. | \$7,503. |
| | | 64" | 32.5" | 19" | ACIL6432 () () () () | 4,016. | 5,450. | 6,155. | 8,000. |
| | right | 64" | 30" | 19" | ACIR6430 () () () () | 3,740. | 5,161. | 5,772. | 7,503. |
| | | 64" | 32.5" | 19" | ACIR6432 () () () () | 4,016. | 5,450. | 6,155. | 8,000. |

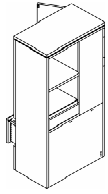

left hand shown, attach perpendicular to panel at back right side

Left hand = wardrobe on left front side
 Right hand = wardrobe on right front side
 supports worksurface on back side at 28 1/4" overall, 27"h to underside of worksurface
 wardrobe includes coat rod
 File drawers (front side) do not accommodate side to side legal filing

| Order Code | Specification Information |
|--|---|
| Example: ACEL4924SEWV316AA | To order please specify pattern number including: |
| A AutoStrada | 1. Hand |
| C Cabinet | L = User's Left |
| E File/File lower front, Interior back open shelf | R = User's Right |
| L Left Hand | 2. Height |
| 49 49" high | 49 = 49"h (for use with medians, bridges or panels, 49"h to below trim, 50.2"h overall) |
| 24 24" deep | 64 = 64"h (for use with panels 64"h to below trim, 65.2"h overall) |
| S w/shelf to match cabinet case | 3. Depth |
| E Extruded Aluminum Pull | 24 = 24" deep (use with 26.5"d unit for side by side cabinet application with panels) |
| W Wood interior | 30 = 30" deep (use with 32.5"d unit for side by side cabinet application with panels) |
| V316 Finish, Maple | 26 = 26.5" deep (use with medians, bridges & panels) |
| AA Finish, trim & pull, anodized aluminum | 32 = 32.5" deep (use with medians, bridges & panels) |

3rd digit in pattern number indicates storage configuration, see individual pattern groups above for description.

| Specification Information | Application Notes |
|---|--|
| 6. Drawer Interior applicable ACE(L/R) and ACI(L/R) only W = wood interior M = metal drawer interior, deduct \$100 list | See page 7 for finish options applicable. Product on this page will accept wood grain laminate where laminate is currently an option. List price for wood grain laminate options will be current published laminate list price plus 10%. |
| 7. Finish Laminate, V1, V2 or V3 finish | When planning with medians and bridges (single station or clusters of stations) specify 49"h cabinets in either 26.5" or 32.5" deep storage anchored cabinets for anchoring the median or bridge unit of the same depth. |
| 8. Finish, Aluminum trim (trim, M shelf option & pull) AA - Anodized aluminum or painted finish option from page 7 excluding silver | When planning with panels, single station or cluster groups where all workstations within the group are the same direction/hand, then specify 26.5" or 32.5" deep storage anchor cabinet units. When planning multi-station clusters mirroring left hand/right hand or back to back stations with panel run perpendicular to two cabinets, you then need to specify one 24"d with one 26.5"d or 30"d with one 32.5" d cabinet to go side by side or back to back as the case may be. |
| Connection method to medians, median storage or bridges incorporated into product design, no additional hardware required. | Cabinets with front and back access not to be used in freestanding applications. Cabinet to panel attachment brackets required, see page 163. |
| 64"h cabinets include shelf to match case in price list above. Upcharge below applicable as follows for 49"h shelf to match case for L/V1/V2/V3 or AA or paint for aluminum metal shelf for M option for both 49"h and 64"h cabinets. | Cabinets include angle bracket to side support worksurfaces. Cabinets drilled for locks, keying instructions must accompany order. |
| depth L V1 | File drawers in cabinet styles prefixed ACIL and ACIR do not accommodate legal filing side to side. |
| 24" \$ 93 210 | |
| 26.5" \$ 98 216 | |
| 30" \$ 102 227 | |
| 32.5" \$ 108 232 | |
| depth V2 V3 | |
| 24" \$233 301 | |
| 26.5" \$241 312 | |
| 30" \$252 329 | |
| 32.5" \$260 339 | |
| depth AA or paint | |
| 24" \$288 | |
| 26.5" \$308 | |
| 30" \$338 | |
| 32.5" \$357 | |

| description | hand | h | w | d | pattern no. | L | V1 | V2 | V3 |
|---|-------|-----|-------|-----|---------------------------------|----------|----------|----------|----------|
| Storage anchored cabinet, FFF and HD above (49"h) | left | 49" | 24" | 19" | ACGL4924 () () () () | \$2,972. | \$3,897. | \$4,477. | \$5,821. |
| | | 49" | 30" | 19" | ACGL4930 () () () () | 3,073. | 4,011. | 4,708. | 6,119. |
| | | 49" | 26.5" | 19" | ACGL4926 () () () () | 3,023. | 3,953. | 4,593. | 5,971. |
| | | 49" | 32.5" | 19" | ACGL4932 () () () () | 3,124. | 4,068. | 4,822. | 6,270. |
| | right | 49" | 24" | 19" | ACGR4924 () () () () | 2,972. | 3,897. | 4,477. | 5,821. |
| | | 49" | 30" | 19" | ACGR4930 () () () () | 3,073. | 4,011. | 4,708. | 6,119. |
| | | 49" | 26.5" | 19" | ACGR4926 () () () () | 3,023. | 3,953. | 4,593. | 5,971. |
| | | 49" | 32.5" | 19" | ACGR4932 () () () () | 3,124. | 4,068. | 4,822. | 6,270. |

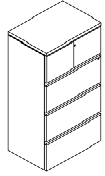

inside clearance behind hinged doors approx 9 1/4" h

| | | | | | | | | | |
|---|-------|-----|-------|-----|---------------------------------|--------|--------|--------|--------|
| Storage anchored cabinet, FFF and HD above (64"h) | left | 64" | 24" | 19" | ACGL6424 () () () () | 3,119. | 4,091. | 4,702. | 6,113. |
| | | 64" | 30" | 19" | ACGL6430 () () () () | 3,228. | 4,211. | 4,944. | 6,425. |
| | | 64" | 26.5" | 19" | ACGL6426 () () () () | 3,174. | 4,151. | 4,822. | 6,270. |
| | | 64" | 32.5" | 19" | ACGL6432 () () () () | 3,281. | 4,270. | 5,065. | 6,582. |
| | right | 64" | 24" | 19" | ACGR6424 () () () () | 3,119. | 4,091. | 4,702. | 6,113. |
| | | 64" | 30" | 19" | ACGR6430 () () () () | 3,228. | 4,211. | 4,944. | 6,425. |
| | | 64" | 26.5" | 19" | ACGR6426 () () () () | 3,174. | 4,151. | 4,822. | 6,270. |
| | | 64" | 32.5" | 19" | ACGR6432 () () () () | 3,281. | 4,270. | 5,065. | 6,582. |

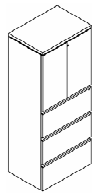

64" h includes adjustable shelf behind hinged doors, doors must be removed to adjust shelf

| Order Code | Specification Information | Application Notes |
|---|---|---|
| Example: ACGL4924EDWV316AA | To order please specify pattern number including: | <p>Products listed on this page are for use with panel based stations or freestanding applications. Not to be used with median based storage anchored planning model.</p> <p>Product on this page will accept wood grain laminate where laminate is currently an option. List price for wood grain laminate options will be current published laminate list price plus 10%.</p> <p>When planning with panels, single station or cluster groups where all workstations within the group are the same direction/hand, then specify 26.5" or 32.5" deep storage anchor cabinet units. When planning multi-station clusters mirroring left hand/right hand with stations back to back with panel run perpendicular to two cabinets you then need to specify one 24" d with one 26.5" d or 30" d with one 32.5" d cabinet to go side by side or back to back as the case may be.</p> <p>Cabinet to panel attachment brackets required, see page 163</p> |
| A AutoStrada | | |
| C Cabinet | | |
| G File drawers w/Hinged doors above | | |
| L Left Hand | | |
| 49 49" high | | |
| 24 24" deep | | |
| E Extruded Aluminum Pull | | |
| D Drilled to anchor | | |
| W Wood interior | | |
| V316 Finish, Maple | | |
| AA Finish, trim & pull, anodized aluminum | | |
| 3rd digit in pattern number indicates storage configuration, see individual pattern groups above for description. | <p>1. Hand (applicable for personal wardrobe & storage units only) L = wardrobe on left R = wardrobe on right</p> <p>2. Height 49 = 49" h (where applicable). 49" h to below trim, 50.2" h overall) 64 = 64" h (64" h to below trim, 65.2" h overall)</p> <p>3. Depth 24 = 24" deep (use with one 26.5" d for side by side or freestanding) 30 = 30" deep (use with one 32.5" d for side by side or freestanding) 26 = 26.5" deep (use with panels) 32 = 32.5" deep (use with panels)</p> <p>4. Pull (where applicable) E = Extruded aluminum pull P = Extruded aluminum protruding pull</p> <p>5. Drill option, applicable only for 24" and 30" deep units D = drilled to anchor to panel F = no drill, freestanding</p> <p>6. Interior option W = wood drawer interior M = metal drawer interior, deduct \$200 list</p> <p>7. Finish Laminate, V1, V2 or V3 finish</p> <p>8. Finish, Metal Shelves (if applicable) (paint finish or anodized aluminum two piece assembly)</p> <p>9. Finish, Aluminum trim (trim & pull) AA - Anodized aluminum or painted finish option from page 7 excluding silver</p> <p>Hinged doors above feature touch latches and do not lock.</p> <p>File drawers are drilled for locks, keying instructions must accompany order.</p> <p>Cabinets include angle brackets to side support worksurfaces perpendicular to cabinet except when drill option "F" for freestanding selected.</p> | |

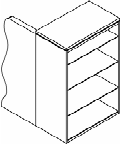
| description | hand | h | w | d | pattern no. | L | V1 | V2 | V3 |
|--|-------|-----|-------|-----|------------------------------|----------|----------|----------|----------|
| Storage anchored cabinet, 49"h bookcase w/metal shelves  | left | 49" | 24" | 19" | ACHL4924M () () () | \$1,854. | \$2,431. | \$2,795. | \$3,357. |
| | | 49" | 30" | 19" | ACHL4930M () () () | 2,007. | 2,629. | 3,024. | 3,631. |
| | | 49" | 26.5" | 19" | ACHL4926M () () () | 1,931. | 2,530. | 2,911. | 3,493. |
| | | 49" | 32.5" | 19" | ACHL4932M () () () | 2,082. | 2,728. | 3,138. | 3,768. |
| | right | 49" | 24" | 19" | ACHR4924M () () () | 1,854. | 2,431. | 2,795. | 3,357. |
| | | 49" | 30" | 19" | ACHR4930M () () () | 2,007. | 2,629. | 3,024. | 3,631. |
| | | 49" | 26.5" | 19" | ACHR4926M () () () | 1,931. | 2,530. | 2,911. | 3,493. |
| | | 49" | 32.5" | 19" | ACHR4932M () () () | 2,082. | 2,728. | 3,138. | 3,768. |

left hand shown

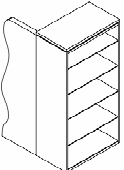
| | | | | | | | | | |
|--|-------|-----|-------|-----|------------------------------|--------|--------|--------|--------|
| Storage anchored cabinet, 64"h bookcase w/metal shelves  | left | 64" | 24" | 19" | ACHL6424M () () () | 1,948. | 2,555. | 2,936. | 3,522. |
| | | 64" | 30" | 19" | ACHL6430M () () () | 2,107. | 2,760. | 3,176. | 3,810. |
| | | 64" | 26.5" | 19" | ACHL6426M () () () | 2,027. | 2,657. | 3,056. | 3,666. |
| | | 64" | 32.5" | 19" | ACHL6432M () () () | 2,186. | 2,864. | 3,296. | 3,954. |
| | right | 64" | 24" | 19" | ACHR6424M () () () | 1,948. | 2,555. | 2,936. | 3,522. |
| | | 64" | 30" | 19" | ACHR6430M () () () | 2,107. | 2,760. | 3,176. | 3,810. |
| | | 64" | 26.5" | 19" | ACHR6426M () () () | 2,027. | 2,657. | 3,056. | 3,666. |
| | | 64" | 32.5" | 19" | ACHR6432M () () () | 2,186. | 2,864. | 3,296. | 3,954. |

left hand shown

| Order Code | Specification Information |
|--|---------------------------|
| Example: ACGL4924EDWV316AA | |
| A AutoStrada | |
| C Cabinet | |
| G File drawers w/Hinged doors above | |
| L Left Hand | |
| 49 49" high | |
| 24 24" deep | |
| E Extruded Aluminum Pull | |
| D Drilled to anchor | |
| W Wood interior | |
| V316 Finish, Maple | |
| AA Finish, trim & pull, anodized aluminum | |

3rd digit in pattern number indicates storage configuration, see individual pattern groups above for description.

Specification Information

To order please specify pattern number including:

1. Hand
(applicable for personal wardrobe & storage units only)
L = wardrobe on left
R = wardrobe on right
2. Height
49 = 49"h (where applicable).
49"h to below trim, 50.2"h overall)
64 = 64"h (64"h to below trim, 65.2"h overall)
3. Depth
24 = 24" deep (use with one 26.5"d for side by side or freestanding)
30 = 30" deep (use with one 32.5"d for side by side or freestanding)
26 = 26.5" deep (use with panels)
32 = 32.5" deep (use with panels)
4. Pull (where applicable)
E = Extruded aluminum pull
P = Extruded aluminum protruding pull
5. Drill option, applicable only for 24" and 30" deep units
D = drilled to anchor to panel
F = no drill, freestanding

6. Interior option
W = wood drawer interior
M = metal drawer interior, deduct \$200 list
7. Finish
Laminate, V1, V2 or V3 finish
8. Finish, Metal Shelves (if applicable)
(paint finish or anodized aluminum two piece assembly)
9. Finish, Aluminum trim (trim & pull)
AA - Anodized aluminum or painted finish option from page 7 excluding silver

Hinged doors above feature touch latches and do not lock.

File drawers are drilled for locks, keying instructions must accompany order.

Cabinets include angle brackets to side support worksurfaces perpendicular to cabinet except when drill option "F" for freestanding selected.

Application Notes

Products listed on this page are for use with panel based stations or freestanding applications. Not to be used with median based storage anchored planning model.

Product on this page will accept wood grain laminate where laminate is currently an option. List price for wood grain laminate options will be current published laminate list price plus 10%.

When planning with panels, single station or cluster groups where all workstations within the group are the same direction/hand, then specify 26.5" or 32.5" deep storage anchor cabinet units. When planning multi-station clusters mirroring left hand/right hand with stations back to back with panel run perpendicular to two cabinets you then need to specify one 24" d with one 26.5" d or 30" d with one 32.5" d cabinet to go side by side or back to back as the case may be.

Cabinet to panel attachment brackets required, see page 163

| description | hand | h | w | d | pattern no. | L | V1 | V2 | V3 |
|--|-------|-----|-------|-----|--------------------------|----------|----------|----------|----------|
| Storage anchored cabinet, 49" h bookcase w/shelves | left | 49" | 24" | 19" | ACHL4924W () () | \$2,211. | \$3,047. | \$3,469. | \$4,511. |
| | | 49" | 30" | 19" | ACHL4930W () () | 2,302. | 3,175. | 3,612. | 4,696. |
| | | 49" | 26.5" | 19" | ACHL4926W () () | 2,250. | 3,103. | 3,531. | 4,591. |
| | | 49" | 32.5" | 19" | ACHL4932W () () | 2,336. | 3,222. | 3,665. | 4,766. |
| | right | 49" | 24" | 19" | ACHR4924W () () | 2,211. | 3,047. | 3,469. | 4,511. |
| | | 49" | 30" | 19" | ACHR4930W () () | 2,302. | 3,175. | 3,612. | 4,696. |
| | | 49" | 26.5" | 19" | ACHR4926W () () | 2,250. | 3,103. | 3,531. | 4,591. |
| | | 49" | 32.5" | 19" | ACHR4932W () () | 2,336. | 3,222. | 3,665. | 4,766. |

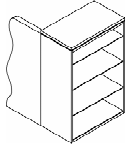

left hand shown

shelves same as case finish

| | | | | | | | | | |
|--|-------|-----|-------|-----|--------------------------|--------|--------|--------|--------|
| Storage anchored cabinet, 64" h bookcase w/shelves | left | 64" | 24" | 19" | ACHL6424W () () | 2,439. | 3,363. | 3,828. | 4,975. |
| | | 64" | 30" | 19" | ACHL6430W () () | 2,546. | 3,513. | 3,996. | 5,198. |
| | | 64" | 26.5" | 19" | ACHL6426W () () | 2,485. | 3,429. | 3,901. | 5,070. |
| | | 64" | 32.5" | 19" | ACHL6432W () () | 2,590. | 3,574. | 4,068. | 5,287. |
| | right | 64" | 24" | 19" | ACHR6424W () () | 2,439. | 3,363. | 3,828. | 4,975. |
| | | 64" | 30" | 19" | ACHR6430W () () | 2,546. | 3,513. | 3,996. | 5,198. |
| | | 64" | 26.5" | 19" | ACHR6426W () () | 2,485. | 3,429. | 3,901. | 5,070. |
| | | 64" | 32.5" | 19" | ACHR6432W () () | 2,590. | 3,574. | 4,068. | 5,287. |

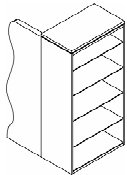

left hand shown

shelves same as case finish

| Order Code | Specification Information | Application Notes |
|--|--|---|
| Example: ACGL4924EDWV316AA | To order please specify pattern number including: | <p>Products listed on this page are for use with panel based stations or freestanding applications. Not to be used with median based storage anchored planning model.</p> <p>Product on this page will accept wood grain laminate where laminate is currently an option. List price for wood grain laminate options will be current published laminate list price plus 10%.</p> <p>When planning with panels, single station or cluster groups where all workstations within the group are the same direction/hand, then specify 26.5" or 32.5" deep storage anchor cabinet units. When planning multi-station clusters mirroring left hand/right hand with stations back to back with panel run perpendicular to two cabinets you then need to specify one 24" d with one 26.5" d or 30" d with one 32.5" d cabinet to go side by side or back to back as the case may be.</p> <p>Cabinet to panel attachment brackets required, see page 163</p> |
| A AutoStrada | 1. Hand (applicable for personal wardrobe & storage units only) L = wardrobe on left R = wardrobe on right | |
| C Cabinet | 2. Height 49 = 49" h (where applicable). 49" h to below trim, 50.2" h overall) 64 = 64" h (64" h to below trim, 65.2" h overall) | |
| G File drawers w/Hinged doors above | 3. Depth 24 = 24" deep (use with one 26.5" d for side by side or freestanding) 30 = 30" deep (use with one 32.5" d for side by side or freestanding) 26 = 26.5" deep (use with panels) 32 = 32.5" deep (use with panels) | |
| L Left Hand | 4. Pull (where applicable) E = Extruded aluminum pull P = Extruded aluminum protruding pull | |
| 49 49" high | 5. Drill option, applicable only for 24" and 30" deep units D = drilled to anchor to panel F = no drill, freestanding | |
| 24 24" deep | 6. Interior option W = wood drawer interior M = metal drawer interior, deduct \$200 list | |
| E Extruded Aluminum Pull | 7. Finish Laminate, V1, V2 or V3 finish | |
| D Drilled to anchor | 8. Finish, Metal Shelves (if applicable) (paint finish or anodized aluminum two piece assembly) | |
| W Wood interior | 9. Finish, Aluminum trim (trim & pull) AA - Anodized aluminum or painted finish option from page 7 excluding silver | |
| V316 Finish, Maple | Hinged doors above feature touch latches and do not lock. | |
| AA Finish, trim & pull, anodized aluminum | File drawers are drilled for locks, keying instructions must accompany order. | |

3rd digit in pattern number indicates storage configuration, see individual pattern groups above for description.

| description | type | pattern no. | 49" h | 64" h | list |
|-------------|------|-------------|-------|-------|------|
|-------------|------|-------------|-------|-------|------|

Bracket kit, cabinet to panel attachment
top and bottom connection for single cabinet
attachment to panel run

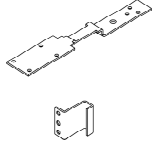

kit includes hookstrip connector (not shown)

Bracket kit, cabinet to panel attachment
top and bottom connection for use with two
cabinets side by side or back to back attached
perpendicular to panel run

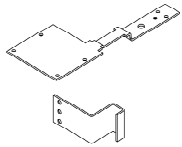

Left hand shown, (kit includes hookstrip
connector not shown)

| | | | |
|-------|------------------------|------|------|
| left | A3CPBDL () () | 209. | 219. |
| right | A3CPBDR () () | 209. | 219. |

Note - one of the two cabinets should be 2.5" wider or deeper (width or depth dimension depending on style of cabinet) than the other

| Order Code | Specification Information | Application Notes |
|---|---|---|
| Example: A3CPBS4 () | <i>To order please specify pattern number including:</i> | Bracket kits for use when attaching storage anchored cabinets to panels; kit includes top and bottom bracket as shown and ships with hookstrip connector. Please be sure to specify height to correspond with cabinet and panel height. When one cabinet perpendicular to panel run, use S bracket; when two cabinets are side by side and perpendicular to panel run, use D bracket. |
| A3 AutoStrada, generation3 | 1. Hand (if applicable) <i>L = left hand attachment</i> <i>R = right hand attachment</i> | |
| CPB Cabinet to Panel bracket | 2. Hookstrip connector height <i>2 = for 42" h cabinet to panel connection</i> <i>4 = for 49" h cabinet to panel connection</i> <i>6 = for 64" h cabinet to panel connection</i> | Brackets are NOT to be used with Reff stacking modules. Only use for cabinet to panel attachment (panel and cabinet at same height) or with cabinet to panel plus window modules (overall at same height). Painted finish 613 used when AA trim finish specified. |
| S Single | 3. Finish <i>Painted finish options only from page 7</i> | |
| 4 With 49" h hookstrip connector | | |
| () Finish | | |

| description | type | d | pattern no. | list |
|---|---------------|-----|--------------------|-------|
| Worksurface to cabinet trim | | 24" | AWTCT24 () | \$94. |
| | | 30" | AWTCT30 () | 105. |
| Slatwall end trim, use w/SA "D" cabinets | 2 pc trim kit | | ATSCD19 () | 123. |

Note: for use with ACD style storage anchored cabinets when slatwall adjacent to cabinet

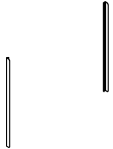

Order Code

| | |
|-----------|---------------------------|
| Example: | AWTCT24AA |
| A | AutoStrada |
| W | Worksurface |
| TC | to Cabinet |
| T | Trim |
| 24 | 24" d worksurface |
| AA | Finish, anodized aluminum |

Specification Information

To order please specify pattern number including:

1. Depth of worksurface
 24 = 24" d worksurface
 30 = 30" d worksurface
2. Finish
 AA = anodized aluminum or painted finish option from page 7 excluding silver

Application Notes

Aluminum spacer optional to fill 1/8" gap at worksurface and storage anchored cabinet connection in AS-2 storage anchored panel based planning. Trim piece installed at worksurface level and rests on side support bracket to cabinet.

| description | type | h | w | d | pattern no. | L | V1 | V2 | V3 |
|---|------|-----|-----|-----|-----------------------------|----------|----------|----------|----------|
| File drawers (2) with open wood shelves above | | 70" | 30" | 24" | ACJ722WE () () () | \$3,123. | \$4,067. | \$4,820. | \$6,266. |
| | | 70" | 36" | 24" | ACJ723WE () () () | 3,217. | 4,188. | 4,965. | 6,454. |

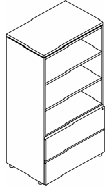

| | | | | | | | | | |
|---|--|-----|-----|-----|-----------------------------|--------|--------|--------|--------|
| File drawers (3) with open wood shelves above | | 84" | 30" | 24" | ACJ822WE () () () | 3,655. | 4,756. | 5,639. | 7,331. |
| | | 84" | 36" | 24" | ACJ823WE () () () | 3,765. | 4,899. | 5,808. | 7,551. |

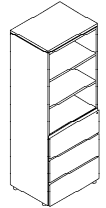

| Order Code | Specification Information | Application Notes |
|--|---|-------------------|
| Example: ACKL722WEV316AAAA | <i>To order please specify pattern number including:</i> | |
| A AutoStrada | 1. Hand <i>(applicable for units with wardrobes only)</i> <i>L = wardrobe on left</i> <i>R = wardrobe on right</i> | |
| C Cabinet | 2. Height <i>7 = 70" h</i> <i>8 = 84" h</i> | |
| K Wardrobe/Open bookcase | 3. Width <i>2 = 30" wide</i> <i>3 = 36" wide</i> | |
| L Left Hand | 4. Interior & shelf <i>W = wood drawer interior and wood shelves</i> <i>M = wood drawer interior and metal shelves</i> | |
| 7 70" high | 5. Extruded aluminum pull <i>E = extruded aluminum pull (default)</i> | |
| 2 24" deep | 6. Finish <i>Laminate, V1, V2 or V3 finish</i> | |
| 2 30" wide | 7. Finish, Metal Shelves (if applicable) <i>(paint finish or anodized aluminum three piece assembly)</i> | |
| W Wood interior | 8. Finish, Aluminum trim (trim & if pull) <i>AA - Anodized aluminum or painted finish option from page 7 excluding silver</i> | |
| E Extruded Aluminum Pull | 9. Finish, cabinet feet <i>AA - Anodized aluminum or painted finish option from page 7 excluding silver</i> | |
| V316 Finish, Maple | See page 7 for finish options applicable. | |
| AA Finish, trim & pull, anodized aluminum | Product on this page will accept wood grain laminate where laminate is currently an option. List price for wood grain laminate options will be current published laminate list price plus 10%. | |
| AA Finish, cabinet feet, anodized alum | | |

Application Notes

Cabinets on this page are styled for the private office and include aluminum feet detail which is optional addition to lower storage beginning on page 175. Specify 70" h cabinets for use with single high overhead storage and 84" h cabinets for use with double high overhead storage.

Hinged doors feature touch latches and do not lock. Sliding doors do not lock. File drawers drilled for locks, keying instructions must accompany order.

Coat rod included in wardrobes.

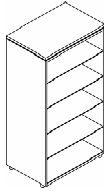
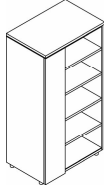
| description | type | h | w | d | pattern no. | L | V1 | V2 | V3 | |
|---|--|-----|-----|-----|------------------------------|----------|----------|----------|----------|--|
|  <p>Open bookcase</p> | metal shelves | 70" | 30" | 24" | ACL722M () () () | \$2,683. | \$3,494. | \$3,669. | \$4,768. | |
| | | 70" | 36" | 24" | ACL723M () () () | 2,836. | 3,677. | 3,861. | 5,022. | |
| | | 84" | 30" | 24" | ACL822M () () () | 2,987. | 3,862. | 4,056. | 5,273. | |
| | | 84" | 36" | 24" | ACL823M () () () | 3,139. | 4,048. | 4,252. | 5,526. | |
| | wood shelves | 70" | 30" | 24" | ACL722W () () () | 2,147. | 2,814. | 3,237. | 4,206. | |
| | | 70" | 36" | 24" | ACL723W () () () | 2,269. | 2,959. | 3,430. | 4,458. | |
| | | 84" | 30" | 24" | ACL822W () () () | 2,390. | 3,106. | 3,623. | 4,709. | |
| | | 84" | 36" | 24" | ACL823W () () () | 2,512. | 3,254. | 3,815. | 4,960. | |
|  <p>Wardrobe with hinged door open bookcase w/wood shelves</p> | left hand | 70" | 30" | 24" | ACKL722WE () () () | 2,903. | 4,006. | 4,478. | 5,822. | |
| | | 70" | 36" | 24" | ACKL723WE () () () | 3,049. | 4,207. | 4,702. | 6,113. | |
| | | 84" | 30" | 24" | ACKL822WE () () () | 3,049. | 4,207. | 4,702. | 6,113. | |
| | | 84" | 36" | 24" | ACKL823WE () () () | 3,154. | 4,351. | 4,865. | 6,323. | |
| | <i>left hand = wardrobe on left side facing cabinet (1/3rd of width)</i> | | | | | | | | | |
| | right hand | 70" | 30" | 24" | ACKR722WE () () () | 2,903. | 4,006. | 4,478. | 5,822. | |
| | | 70" | 36" | 24" | ACKR723WE () () () | 3,049. | 4,207. | 4,702. | 6,113. | |
| | | 84" | 30" | 24" | ACKR822WE () () () | 3,049. | 4,207. | 4,702. | 6,113. | |
| | | 84" | 36" | 24" | ACKR823WE () () () | 3,154. | 4,351. | 4,865. | 6,323. | |
| | <i>right hand = wardrobe on right side facing cabinet (1/3rd of width)</i> | | | | | | | | | |

left hand shown

| Order Code | Specification Information | Application Notes |
|--|---|--|
| Example: ACKL722WEV316AAAA | To order please specify pattern number including: | <p>Cabinets on this page are styled for the private office and include aluminum feet detail which is optional addition to lower storage beginning on page 175. Specify 70" h cabinets for use with single high overhead storage and 84" h cabinets for use with double high overhead storage.</p> <p>Hinged doors feature touch latches and do not lock. Sliding doors do not lock. File drawers drilled for locks, keying instructions must accompany order.</p> <p>Coat rod included in wardrobes.</p> |
| A AutoStrada | 1. Hand (applicable for units with wardrobes only) <i>L = wardrobe on left</i> <i>R = wardrobe on right</i> | |
| C Cabinet | 2. Height <i>7 = 70" h</i> <i>8 = 84" h</i> | |
| K Wardrobe/Open bookcase | 3. Width <i>2 = 30" wide</i> <i>3 = 36" wide</i> | |
| L Left Hand | 4. Interior & shelf <i>W = wood drawer interior and wood shelves</i> <i>M = wood drawer interior and metal shelves</i> | |
| 7 70" high | 5. Extruded aluminum pull <i>E = extruded aluminum pull (default)</i> | |
| 2 24" deep | 6. Finish <i>Laminate, V1, V2 or V3 finish</i> | |
| 2 30" wide | 7. Finish, Metal Shelves (if applicable) (paint finish or anodized aluminum three piece assembly) | |
| W Wood interior | 8. Finish, Aluminum trim (trim & if pull) <i>AA - Anodized aluminum or painted finish option from page 7 excluding silver</i> | |
| E Extruded Aluminum Pull | 9. Finish, cabinet feet <i>AA - Anodized aluminum or painted finish option from page 7 excluding silver</i> | |
| V316 Finish, Maple | See page 7 for finish options applicable. | |
| AA Finish, trim & pull, anodized aluminum | Product on this page will accept wood grain laminate where laminate is currently an option. List price for wood grain laminate options will be current published laminate list price plus 10%. | |
| AA Finish, cabinet feet, anodized alum | | |

| description | type | h | w | d | pattern no. | L | V1 | V2 | V3 |
|---|------------|-----|-----|-----|-----------------------------|----------|----------|----------|----------|
| Wardrobe w/sliding door open bookcase w/wood shelves | left hand | 70" | 30" | 24" | ACMWL722 () () () | \$3,085. | \$4,044. | \$4,653. | \$6,048. |
| | | 70" | 36" | 24" | ACMWL723 () () () | 3,239. | 4,246. | 4,885. | 6,351. |
| | | 84" | 30" | 24" | ACMWL822 () () () | 3,336. | 4,351. | 5,045. | 6,558. |
| | | 84" | 36" | 24" | ACMWL823 () () () | 3,495. | 4,543. | 5,297. | 6,886. |
| | right hand | 70" | 30" | 24" | ACMWR722 () () () | 3,085. | 4,044. | 4,653. | 6,048. |
| | | 70" | 36" | 24" | ACMWR723 () () () | 3,239. | 4,246. | 4,885. | 6,351. |
| | | 84" | 30" | 24" | ACMWR822 () () () | 3,336. | 4,351. | 5,045. | 6,558. |
| | | 84" | 36" | 24" | ACMWR823 () () () | 3,495. | 4,543. | 5,297. | 6,886. |

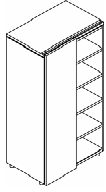

left hand shown

| | | | | | | | | | |
|--|------------|-----|-----|-----|-----------------------------|--------|--------|--------|--------|
| Wardrobe w/sliding door open bookcase w/metal shelves | left hand | 70" | 30" | 24" | ACMML722 () () () | 3,290. | 4,260. | 4,869. | 6,265. |
| | | 70" | 36" | 24" | ACMML723 () () () | 3,469. | 4,489. | 5,128. | 6,594. |
| | | 84" | 30" | 24" | ACMML822 () () () | 3,592. | 4,621. | 5,316. | 6,829. |
| | | 84" | 36" | 24" | ACMML823 () () () | 3,777. | 4,841. | 5,594. | 7,183. |
| | right hand | 70" | 30" | 24" | ACMMR722 () () () | 3,290. | 4,260. | 4,869. | 6,265. |
| | | 70" | 36" | 24" | ACMMR723 () () () | 3,469. | 4,489. | 5,128. | 6,594. |
| | | 84" | 30" | 24" | ACMMR822 () () () | 3,592. | 4,621. | 5,316. | 6,829. |
| | | 84" | 36" | 24" | ACMMR823 () () () | 3,777. | 4,841. | 5,594. | 7,183. |

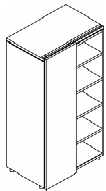

left hand shown

| Order Code | Specification Information | Application Notes |
|--|---|---|
| Example: ACKL722WEV316AAAA | To order please specify pattern number including: | <p>Cabinets on this page are styled for the private office and include aluminum feet detail which is optional addition to lower storage beginning on page 175. Specify 70" h cabinets for use with single high overhead storage and 84" h cabinets for use with double high overhead storage.</p> <p>Hinged doors feature touch latches and do not lock. Sliding doors do not lock. File drawers dilled for locks, keying instructions must accompany order.</p> <p>Coat rod included in wardrobes.</p> |
| A AutoStrada | 1. Hand (applicable for units with wardrobes only) L = wardrobe on left R = wardrobe on right | |
| C Cabinet | 2. Height 7 = 70" h 8 = 84" h | |
| K Wardrobe/Open bookcase | 3. Width 2 = 30" wide 3 = 36" wide | |
| L Left Hand | 4. Interior & shelf W = wood drawer interior and wood shelves M = wood drawer interior and metal shelves | |
| 7 70" high | 5. Extruded aluminum pull E = extruded aluminum pull (default) | |
| 2 24" deep | 6. Finish Laminate, V1, V2 or V3 finish | |
| 2 30" wide | 7. Finish, Metal Shelves (if applicable) (paint finish or anodized aluminum three piece assembly) | |
| W Wood interior | 8. Finish, Aluminum trim (trim & if pull) AA - Anodized aluminum or painted finish option from page 7 excluding silver | |
| E Extruded Aluminum Pull | 9. Finish, cabinet feet AA - Anodized aluminum or painted finish option from page 7 excluding silver | |
| V316 Finish, Maple | See page 7 for finish options applicable. | |
| AA Finish, trim & pull, anodized aluminum | Product on this page will accept wood grain laminate where laminate is currently an option. List price for wood grain laminate options will be current published laminate list price plus 10%. | |
| AA Finish, cabinet feet, anodized alum | | |

| description | type | h | w | d | pattern no. | L | V1 | V2 | V3 |
|---------------|------|-----|-----|-----|-----------------------|----------|----------|----------|----------|
| Full wardrobe | | 70" | 30" | 24" | ACW722 () () | \$2,890. | \$3,912. | \$4,464. | \$5,805. |
| | | 70" | 36" | 24" | ACW723 () () | 3,036. | 4,109. | 4,687. | 6,094. |
| | | 84" | 30" | 24" | ACW822 () () | 3,036. | 4,109. | 4,687. | 6,094. |
| | | 84" | 36" | 24" | ACW823 () () | 3,139. | 4,250. | 4,850. | 6,304. |

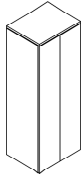

Touch latch only, no pulls/no lock; includes coat rod.

| Order Code | Specification Information | Application Notes |
|--|---|---|
| Example: ACKL722WEV316AAAA | <i>To order please specify pattern number including:</i> | |
| A AutoStrada | 1. Hand <i>(applicable for units with wardrobes only)</i> <i>L = wardrobe on left</i> <i>R = wardrobe on right</i> | |
| C Cabinet | 2. Height <i>7 = 70" h</i> <i>8 = 84" h</i> | |
| K Wardrobe/Open bookcase | 3. Width <i>2 = 30" wide</i> <i>3 = 36" wide</i> | |
| L Left Hand | 4. Interior & shelf <i>W = wood drawer interior and wood shelves</i> <i>M = wood drawer interior and metal shelves</i> | |
| 7 70" high | 5. Extruded aluminum pull <i>E = extruded aluminum pull (default)</i> | |
| 2 24" deep | 6. Finish <i>Laminate, V1, V2 or V3 finish</i> | |
| 2 30" wide | 7. Finish, Metal Shelves <i>(if applicable)</i> <i>(paint finish or anodized aluminum three piece assembly)</i> | |
| W Wood interior | 8. Finish, Aluminum trim (trim & if pull) <i>AA - Anodized aluminum or painted finish option from page 7 excluding silver</i> | |
| E Extruded Aluminum Pull | 9. Finish, cabinet feet <i>AA - Anodized aluminum or painted finish option from page 7 excluding silver</i> | |
| V316 Finish, Maple | See page 7 for finish options applicable. | |
| AA Finish, trim & pull, anodized aluminum | Product on this page will accept wood grain laminate where laminate is currently an option. List price for wood grain laminate options will be current published laminate list price plus 10%. | |
| AA Finish, cabinet feet, anodized alum | | Cabinets on this page are styled for the private office and include aluminum feet detail which is optional addition to lower storage beginning on page 175. Specify 70" h cabinets for use with single high overhead storage and 84" h cabinets for use with double high overhead storage. Hinged doors feature touch latches and do not lock. Sliding doors do not lock. File drawers drilled for locks, keying instructions must accompany order. Coat rod included in wardrobes. |

Freestanding Cabinets for open plan use with metal case pedestals

AutoStrada

| description | h | w | d | pattern no. | lam. case | lam. case | lam. case | lam. case | lam. case | ven. case | ven. case | ven. case |
|-----------------------------|-----|-----|-----|--|----------------|-----------|-----------|-----------|-----------|-----------|-----------|-----------|
| | | | | | P1/P2/P3 front | lam front | V1 front | V2 front | V3 front | V1 front | V2 front | V3 front |
| Freestanding cabinet, 48" h | 48" | 24" | 24" | AAV1 4824 S2D1F () () () () | \$2,587. | \$2,511. | \$2,746. | \$2,880. | \$3,390. | \$3,330. | \$3,960. | \$5,359. |
| | 48" | 30" | 24" | AAV1 4830 S2D1F () () () () | 2,709. | 2,627. | 2,855. | 3,012. | 3,603. | 3,421. | 4,142. | 5,813. |

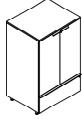

| | | | | | | | | | | | | |
|-----------------------------|-----|-----|-----|--|--------|--------|--------|--------|--------|--------|--------|--------|
| Freestanding cabinet, 64" h | 64" | 24" | 24" | AAV1 6424 S2D2F () () () () | 2,801. | 2,707. | 2,972. | 3,073. | 3,739. | 3,775. | 4,447. | 6,153. |
| | 64" | 30" | 24" | AAV1 6430 S2D2F () () () () | 2,956. | 2,846. | 3,101. | 3,234. | 4,007. | 3,855. | 4,702. | 6,717. |

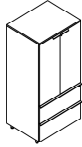

| Order Code | Specification Information | Application Notes |
|--|--|---|
| Example: AAV1 4824 S2D1F L 118 P 613 AA | <i>To order please specify pattern number including:</i> | Freestanding cabinets for open plan are designed to match drawer fronts of AutoStrada metal pedestals in heights and thickness. Doors have 5 1/2" wide protruding pull and drawers have full width pulls. Cabinets are wood construction with 1 1/2" telescoping glides to match pedestals. |
| AAV1 Freestanding cabinet | L Lock | 48"H cabinets have 2 doors over 1 file. |
| 48 Height | N No lock | 64"H cabinets have 2 doors over 2 files. |
| 24 Width | Case finish (laminate or veneer only) | Files are full extension steel drawers that accept suspended legal file folders side to side. File bars are included to also support suspended letter or A4 side to side or front to back. File drawers are not bottom loadable. |
| S Depth | Front type | Cabinets are laminate case and top with painted, laminate or veneer fronts, or all veneer case and fronts. |
| 2D Two door | L Laminate | |
| 1F One file | P Paint | |
| L With lock | V Veneer | |
| 118 Case finish | Front finish code | |
| P Front type | Pull finish (AA only) | |
| 613 Front finish | | |
| AA Pull finish | | |

Metal case
Pedestals
Floorstanding

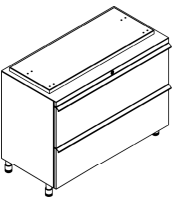
| description | type | width | depth | height | pattern number | P1/P2 front | P3 front | L front | V1 front | V2 front | V3 front |
|---|--------------------|-------|-------|--------|--------------------------------|----------------|-------------|------------|-------------|-------------|-------------|
|  | personal/data/file | 15" | 17" | 27" | ASFS1PDF18 () () () | \$1,107. | \$1,161. | \$1,071. | \$1,288. | \$1,353. | \$1,470. |
| | | 15" | 23" | 27" | ASFS1PDF24 () () () | 1,199. | 1,259. | 1,174. | 1,344. | 1,410. | 1,532. |
| | file/file | 15" | 17" | 27" | ASFS1FF18 () () () | 945. | 994. | 944. | 1,119. | 1,206. | 1,323. |
| | | 15" | 23" | 27" | ASFS1FF24 () () () | 1,026. | 1,077. | 1,029. | 1,170. | 1,261. | 1,380. |
|  | personal/data/file | 30" | 17" | 27" | ASFS1WPDF30 () () () | 1,577. | 1,657. | 1,577. | 1,705. | 1,956. | 2,543. |
| | | 36" | 17" | 27" | ASFS1WPDF36 () () () | 1,927. | 2,025. | 1,927. | 2,092. | 2,404. | 3,123. |
| | file/file | 30" | 17" | 27" | ASFS1WFF30 () () () | 1,371. | 1,440. | 1,371. | 1,484. | 1,701. | 2,211. |
| | | 36" | 17" | 27" | ASFS1WFF36 () () () | 1,677. | 1,761. | 1,677. | 1,820. | 2,090. | 2,716. |
| | data/file | 30" | 17" | 23" | ASFS1WDF30 () () () | 1,303. | 1,368. | 1,303. | 1,409. | 1,615. | 2,100. |
| | | 36" | 17" | 23" | ASFS1WDF36 () () () | 1,594. | 1,673. | 1,594. | 1,730. | 1,986. | 2,580. |
| | 2 door | 30" | 17" | 27" | ASFS1WDD30 () () () | 1,371. | 1,440. | 1,371. | 1,484. | 1,701. | 2,211. |
| | | 36" | 17" | 27" | ASFS1WDD36 () () () | 1,677. | 1,761. | 1,677. | 1,820. | 2,090. | 2,716. |

Order Code

| | |
|--------------|-----------------------------------|
| Example: | ASFS1 FF18 111 P 114 AA |
| ASFS1 | Autostrada floorstanding pedestal |
| FF | Configuration |
| 18 | Depth |
| 111 | Finish for case |
| P | Finish type for fronts |
| 114 | Finish for fronts |
| AA | Finish for pulls |

Specification Information

All pedestals include front lock with KnollKey lock system. Personal drawer is 4"h. Data drawer is 7"h. File drawers are 11"h. Deep file drawers include file support for letter (width) or legal (depth) suspended file folders. All drawers have full extension, ball bearing drawer slides.

Please specify painted finish for case or fronts from paint finish options; front finish also optional from laminate, V1, V2 or V3 finish options listed on page 7.

Pulls are available in anodized aluminum or painted finish options listed on page 7 excluding silver.

Application Notes

Floorstanding pedestals include levelling glides and closed top with 1" spacer to support one end of a worksurface at 27"h to underside of worksurface. 18"d pedestals fit under any worksurface with standard stiffener. Deep floorstanding pedestals fit under worksurfaces with worksurface stiffener 18" less than nominal width.

The metal case pedestals come with a 1"h board spacer that installs between the case and the worksurface it is supporting. The tops of the pedestals are drilled to accept the attachment screws.

Pedestals may not be used in freestanding applications.

Metal case
Pedestals
Mobile

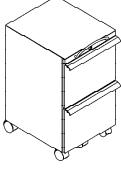
| description | type | width | depth | height | pattern number | P1/P2 front | P3 front | L front | V1 front | V2 front | V3 front | |
|---|-------------------------------|----------------------|-------|--------------------------------|--------------------------------|-------------------------------|-------------|------------|-------------|-------------|-------------|----------|
|  | Mobile pedestal | Standard - data/file | 15" | 17" | 22" | ASMS1 DF18 () () () | \$934. | \$979. | \$944. | \$1,134. | \$1,234. | \$1,285. |
| | Deep - data/file | 15" | 23" | 22" | ASMS1 DF24 () () () | 1,056. | 1,110. | 1,066. | 1,300. | 1,409. | 1,462. | |
| | Standard - personal/data/file | 15" | 17" | 26 1/2" | ASMS1 PDF18 () () () | 1,089. | 1,144. | 1,066. | 1,290. | 1,353. | 1,464. | |
| | Deep - personal/data/file | 15" | 23" | 26 1/2" | ASMS1 PDF24 () () () | 1,212. | 1,273. | 1,186. | 1,464. | 1,534. | 1,659. | |
| | Standard - file/file | 15" | 17" | 26 1/2" | ASMS1 FF18 () () () | 985. | 1,034. | 986. | 1,188. | 1,277. | 1,285. | |
| | Deep - file/file | 15" | 23" | 26 1/2" | ASMS1 FF24 () () () | 1,109. | 1,163. | 1,113. | 1,300. | 1,394. | 1,518. | |
| Mobile pedestal, open top | Standard - data/file | 15" | 17" | 22" | ASMS1 DFO18 () () () | 883. | 928. | 890. | 1,101. | 1,204. | 1,251. | |
| Deep - data/file | 15" | 23" | 22" | ASMS1 DFO24 () () () | 996. | 1,045. | 999. | 1,261. | 1,367. | 1,422. | | |

Order Code

Specification Information

Application Notes

Example: **ASMS1 FF18 111 P 114 AA**

| | |
|--------------|----------------------------|
| ASMS1 | Autostrada mobile pedestal |
| FF | Configuration |
| 18 | Depth |
| 111 | Finish for case |
| P | Finish type for fronts |
| 114 | Finish for fronts |
| AA | Finish for pulls |

All pedestals include front lock with KnollKey lock system. Personal drawer is 4"H. Data drawer is 7"H. File drawers are 11"H. Deep file drawers include file support for letter (width) or legal (depth) suspended file folders. All drawers have full extension, ball bearing drawer slides.

Please specify painted finish for case or fronts from paint finish options: front finish also optional from laminate, V1, V2 or V3 finish options listed on page 7.

Pulls are available in anodized aluminum or painted finish options listed on page 7 excluding silver.

Mobile pedestals are independent storage components with locking casters and pull. Standard mobile pedestals roll under worksurfaces set at 28" or higher. Deep mobile pedestals with two files or personal/data/file will not fit under stiffener of universal worksurface or desk set at 29" or lower. Specify data/file mobile pedestal under worksurfaces adjusted lower than 28"H.

Metal case
Pedestals
Accessories
cushion - fabric

| description | type | width | depth | pattern number | A | com B | C | D | E | F | G | H | I |
|-------------|----------|-------|-------|---------------------|---------|----------|------|------|---------------------|--------|--------|--------|--------|
| | | | | | Cushion | Deep | 15" | 23" | AS1 DPAD () | \$214. | \$240. | \$280. | \$294. |
| | Standard | 15" | 17" | AS1 SPAD () | 174. | 200. | 227. | 240. | 254. | 280. | 307. | 348. | 361. |

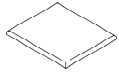

Order Code

Example: **AS1 SPAD**

AS1 Pedestal

S Depth

PAD Cushion

Specification Information

There is a \$75 upcharge on CAL133 backing on the cushion.

Consult the Currents price list for fabric information and grades

Application Notes

Pedestal cushions are for use on open top mobile pedestals.

For Customers Own Material (COM) applications, specify .75 yards of fabric for 17 inch deep mobile pedestal seat cushions, and .90 yards for 23 inch deep seat cushion.

Metal case
Pedestals
Accessories
cushion - leather

| description | type | width | depth | pattern number | COL U | V | W | X | Y |
|-------------|----------|-------|-------|---------------------|----------|--------|--------|--------|--------|
| Cushion | Deep | 15" | 23" | AS1 DPAD () | \$427. | \$508. | \$627. | \$656. | \$694. |
| | Standard | 15" | 17" | AS1 SPAD () | 335. | 400. | 493. | 508. | 534. |

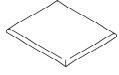

Order Code

| |
|--------------------------|
| Example: AS1 SPAD |
| AS1 Pedestal |
| S Depth |
| PAD Cushion |

Specification Information

There is a \$99 upcharge for perforated leather.

Consult the Currents price list for leather information and grades.

Application Notes

Pedestal cushions are for use on open top mobile pedestals.

For Customers Own Leather (COL) applications, specify 11.5 sq. feet of leather for 17 inch deep mobile pedestal seat cushions, and 14.5 sq. feet for 23 inch deep seat cushion.

Metal case
Pedestals
Accessories
various

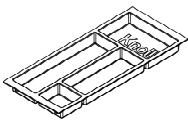
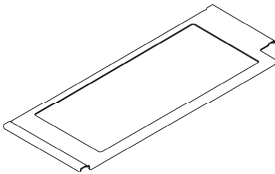
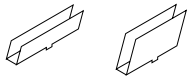
| description | type | width | depth | height | pattern number | list |
|--|-------------------------|-------|-------|--------|----------------|-------|
| Pencil tray  | Personal or data drawer | | | | AS2 PT | \$35. |
| Pencil tray adapter  | Legal width peds | | | | RPETAD | 75. |
| Drawer divider  | Personal or data drawer | | | | MD6-BD | 30. |
| File support rail | File drawer, set of 2 | | | | MD6-FS | 11. |
| Bumper kits for mobile pedestal | 21"H pedestal | | | 21" | AS1 BKL | 43. |
| | 26"H pedestal | | | 26" | AS1 BKH | 51. |

Order Code

| |
|------------------------|
| Example: AS2 PT |
| AS2 Pedestal |
| PT Pencil tray |

Specification Information

Pencil tray is black molded plastic.
Drawer divider is black painted steel.
Replacement worksurface stiffeners are black painted steel.
Bumper kit is trim grey plastic.

Application Notes

Pencil tray sets in top of personal or data drawer. Moveable dividers organize pencils, pens, and paper clips in separate compartments.
Drawer divider mounts in slots in bottom of personal or data drawer. U-shaped divider supports two rows of four CDs with titles visible in data drawer.
File support spans width of file drawer to support side-to-side letter or legal width suspended files.

Wood or laminate case

Pedestals, wood drawer interiors

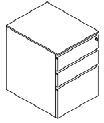
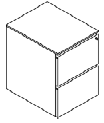
| description | type | h | w | d | pattern no. | L | V1 | V2 | V3 |
|---|----------|-----|-----|-----|------------------------------|----------|----------|----------|----------|
|  Pedestal, BBF | 19" deep | 26" | 16" | 19" | AFPB10(E/P)(W)() () | \$1,290. | \$1,386. | \$1,594. | \$2,072. |
| | | 26" | 19" | 19" | AFPB11(E/P)(W)() () | 1,290. | 1,386. | 1,594. | 2,072. |
| | 23" deep | 26" | 16" | 23" | AFPB20(E/P)(W)() () | 1,418. | 1,524. | 1,753. | 2,279. |
| | | 26" | 19" | 23" | AFPB21(E/P)(W)() () | 1,418. | 1,524. | 1,753. | 2,279. |
| | 29" deep | 26" | 16" | 29" | AFPB30(E/P)(W)() () | 1,632. | 1,752. | 2,016. | 2,621. |
| | | 26" | 19" | 29" | AFPB31(E/P)(W)() () | 1,632. | 1,752. | 2,016. | 2,621. |
|  Pedestal, FF | 19" deep | 26" | 16" | 19" | AFPF10(E/P)(W)() () | 1,219. | 1,305. | 1,501. | 1,950. |
| | | 26" | 19" | 19" | AFPF11(E/P)(W)() () | 1,219. | 1,305. | 1,501. | 1,950. |
| | | 26" | 30" | 19" | AFPF12(E/P)(W)() () | 1,573. | 1,684. | 1,931. | 2,510. |
| | | 26" | 36" | 19" | AFPF13(E/P)(W)() () | 1,924. | 2,066. | 2,373. | 3,083. |
| | | 26" | 42" | 19" | AFPF14(E/P)(W)() () | 2,359. | 2,534. | 2,915. | 3,791. |
| | 23" deep | 26" | 16" | 23" | AFPF20(E/P)(W)() () | 1,400. | 1,502. | 1,726. | 2,243. |
| | | 26" | 19" | 23" | AFPF21(E/P)(W)() () | 1,400. | 1,502. | 1,726. | 2,243. |
| | | 26" | 30" | 23" | AFPF22(E/P)(W)() () | 1,805. | 1,935. | 2,223. | 2,887. |
| | | 26" | 36" | 23" | AFPF23(E/P)(W)() () | 2,214. | 2,376. | 2,731. | 3,547. |
| | | 26" | 42" | 23" | AFPF24(E/P)(W)() () | 2,713. | 2,913. | 3,353. | 4,359. |
| | 29" deep | 26" | 16" | 29" | AFPF30(E/P)(W)() () | 1,611. | 1,727. | 1,984. | 2,578. |
| | | 26" | 19" | 29" | AFPF31(E/P)(W)() () | 1,611. | 1,727. | 1,984. | 2,578. |

Order Code

| | |
|-------------|----------------------------------|
| Example: | AFPB21EWV316AA |
| A | AutoStrada |
| F | Floor standing |
| P | Pedestal |
| B | Box/Box/File configuration |
| 2 | 23" deep (nominal) |
| 1 | 19" wide (nominal) |
| E | Extruded aluminum pull |
| W | Wood interior |
| V316 | Finish, Maple |
| AA | Finish, pull (anodized aluminum) |

Specification Information

- To order please specify pattern number including:
- Pedestal type (embedded in pattern number)
F = Floor standing
M = Mobile
 - Pedestal configuration
B = BBF (floorstanding) or BF (mobile)
F = File/File
 - Depth (nominal)
1 = 19" deep
2 = 23" deep
3 = 29" deep *
(*available only in 16" or 19" widths)
 - Width
0 = 16" wide (nominal)
1 = 19" wide (nominal)
2 = 30" wide (nominal)
3 = 36" wide (nominal)
4 = 42" wide (nominal)

- Pull
E = extruded aluminum pull
P = extruded aluminum protruding pull
- Interior
W = wood drawer interior
- Finish
Laminate, V1, V2 or V3 finish
- Finish, pull
Anodized aluminum or painted finish options listed on page 9 excluding silver.

See page 7 for finish options applicable.

Product on this page will accept wood grain laminate where laminate is currently an option. List price for wood grain laminate options will be current published laminate list price plus 10%.

Note: Optional cabinet feet are recommended when pedestals used in free-standing applications to achieve overall desk height of 29⁵/₈" (see page 231).

Primary finished top required in freestanding applications, ordered separately when item stands alone.

Wood pencil tray included with BBF pedestals.

Application Notes

Actual depth nominal plus 3/8", finished back adds 1/2" (see page 180 for backs). Mobile pedestal includes finished back. All pedestals on this page include a finished sub-top and anti-tip spacer. Height to underside of worksurface including anti-tip spacer is 27"h. Optional work surface stand-offs (to use in place of anti-tip spacer) are specified separately from page 231.

19" wide (nominal) units accommodate legal filing front to back. File bars included to accommodate letter filing front to back. 30", 36" and 42" wide units include file bars to accommodate legal and letter filing front to back and side to side.

File drawers are bottom loadable.

Pedestals drilled for locks, keying instructions must accompany order.

Wood or laminate case

Pedestals, wood drawer interiors

AutoStrada

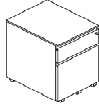
| description | type | h | w | d | pattern no. | L | V1 | V2 | V3 |
|---|----------|---------|-----|-----|------------------------------|--------|--------|--------|--------|
| Counterweight (for file/file configurations when used in single use freestanding applications) | | | | | RCOUNTWT | \$93. | | | |
| Mobile ped, BF  | 19" deep | 21 3/4" | 16" | 19" | AMPB10(E/P)(W)() () | 1,768. | 1,895. | 2,178. | 2,831. |
| | | 21 3/4" | 19" | 19" | AMPB11(E/P)(W)() () | 1,768. | 1,895. | 2,178. | 2,831. |
| | 23" deep | 21 3/4" | 16" | 23" | AMPB20(E/P)(W)() () | 2,033. | 2,178. | 2,507. | 3,257. |
| | | 21 3/4" | 19" | 23" | AMPB21(E/P)(W)() () | 2,033. | 2,178. | 2,507. | 3,257. |

| Order Code | Specification Information | Application Notes |
|--|---|---|
| Example: AFPB21EWV316AA | <i>To order please specify pattern number including:</i> | |
| A AutoStrada | 1. Pedestal type (<i>embedded in pattern number</i>) <i>F = Floor standing</i> <i>M = Mobile</i> | 5. Pull <i>E = extruded aluminum pull</i> <i>P = extruded aluminum protruding pull</i> |
| F Floor standing | 2. Pedestal configuration <i>B = BBF (floorstanding) or BF (mobile)</i> <i>F = File/File</i> | 6. Interior <i>W = wood drawer interior</i> |
| P Pedestal | 3. Depth (<i>nominal</i>) <i>1 = 19" deep</i> <i>2 = 23" deep</i> <i>3 = 29" deep *</i> <i>(*available only in 16" or 19" widths)</i> | 7. Finish <i>Laminate, V1, V2 or V3 finish</i> |
| B Box/Box/File configuration | 4. Width <i>0 = 16" wide (nominal)</i> <i>1 = 19" wide (nominal)</i> <i>2 = 30" wide (nominal)</i> <i>3 = 36" wide (nominal)</i> <i>4 = 42" wide (nominal)</i> | 8. Finish, pull <i>Anodized aluminum or painted finish options listed on page 9 excluding silver.</i> |
| 2 23" deep (<i>nominal</i>) | | See page 7 for finish options applicable. |
| 1 19" wide (<i>nominal</i>) | | Product on this page will accept wood grain laminate where laminate is currently an option. List price for wood grain laminate options will be current published laminate list price plus 10%. |
| E Extruded aluminum pull | | Note: Optional cabinet feet are recommended when pedestals used in free-standing applications to achieve overall desk height of 29 5/8" (see page 231). |
| W Wood interior | | Primary finished top required in freestanding applications, ordered separately when item stands alone. |
| V316 Finish, Maple | | Wood pencil tray included with BBF pedestals. |
| AA Finish, pull (anodized aluminum) | | |

Wood or laminate case

Pedestals, metal drawer interiors

AutoStrada

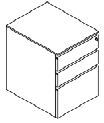
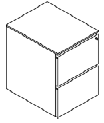
| description | type | h | w | d | pattern no. | L | V1 | V2 | V3 | |
|---|--|----------|-----|-----|------------------------------|------------------------------|----------|----------|----------|--------|
|  Pedestal, BBF | 19" deep | 26" | 16" | 19" | AFPB10(E/P)(M)() () | \$1,167. | \$1,262. | \$1,467. | \$1,941. | |
| | | 26" | 19" | 19" | AFPB11(E/P)(M)() () | 1,167. | 1,262. | 1,467. | 1,941. | |
| | 23" deep | 26" | 16" | 23" | AFPB20(E/P)(M)() () | 1,294. | 1,399. | 1,625. | 2,145. | |
| | | 26" | 19" | 23" | AFPB21(E/P)(M)() () | 1,294. | 1,399. | 1,625. | 2,145. | |
| | 29" deep | 26" | 16" | 29" | AFPB30(E/P)(M)() () | 1,504. | 1,624. | 1,884. | 2,482. | |
| | | 26" | 19" | 29" | AFPB31(E/P)(M)() () | 1,504. | 1,624. | 1,884. | 2,482. | |
| |  Pedestal, FF | 19" deep | 26" | 16" | 19" | AFPF10(E/P)(M)() () | 1,096. | 1,182. | 1,375. | 1,819. |
| | | | 26" | 19" | 19" | AFPF11(E/P)(M)() () | 1,096. | 1,182. | 1,375. | 1,819. |
| 26" | | | 30" | 19" | AFPF12(E/P)(M)() () | 1,340. | 1,448. | 1,693. | 2,264. | |
| 26" | | | 36" | 19" | AFPF13(E/P)(M)() () | 1,685. | 1,826. | 2,129. | 2,831. | |
| 23" deep | | 26" | 16" | 23" | AFPF20(E/P)(M)() () | 1,276. | 1,376. | 1,598. | 2,109. | |
| | | 26" | 19" | 23" | AFPF21(E/P)(M)() () | 1,276. | 1,376. | 1,598. | 2,109. | |
| | | 26" | 30" | 23" | AFPF22(E/P)(M)() () | 1,568. | 1,697. | 1,980. | 2,638. | |
| | | 26" | 36" | 23" | AFPF23(E/P)(M)() () | 1,972. | 2,132. | 2,483. | 3,290. | |
| 29" deep | | 26" | 16" | 29" | AFPF30(E/P)(M)() () | 1,484. | 1,599. | 1,852. | 2,441. | |
| | | 26" | 19" | 29" | AFPF31(E/P)(M)() () | 1,484. | 1,599. | 1,852. | 2,441. | |
| Counterweight (for file/file configurations when used in single use freestanding applications) | | | | | RCOUNTWT | 93. | | | | |

| Order Code | Specification Information | Application Notes | |
|---|---|--|---|
| Example: AFPB21EMV316AA A AutoStrada F Floor standing P Pedestal B Box/Box/File configuration 2 23" deep (nominal) 1 19" wide (nominal) E Extruded aluminum pull M Metal interior V316 Finish, Maple AA Finish, pull (anodized aluminum) | To order please specify pattern number including: 1. Pedestal type (embedded in pattern number) <i>F = Floor standing</i> <i>M = Mobile</i> 2. Pedestal configuration <i>B = BBF (floorstanding) or BF (mobile)</i> <i>F = File/File</i> 3. Depth (nominal) <i>1 = 19" deep</i> <i>2 = 23" deep</i> <i>3 = 29" deep *</i> (*available only in 16" or 19" widths) 4. Width <i>0 = 16" wide (nominal)</i> <i>1 = 19" wide (nominal)</i> <i>2 = 30" wide (nominal)</i> <i>3 = 36" wide (nominal)</i> | 5. Pull <i>E = extruded aluminum pull</i> <i>P = extruded aluminum protruding pull</i> 6. Interior <i>M = metal drawer interior</i> 7. Finish <i>Laminate, V1, V2 or V3 finish</i> 8. Finish, pull <i>Anodized aluminum or painted finish options listed on page 9 excluding silver.</i> See page 7 for finish options applicable. Product on this page will accept wood grain laminate where laminate is currently an option. List price for wood grain laminate options will be current published laminate list price plus 10%. Note: Optional cabinet feet are recommended when pedestals used in free-standing applications to achieve overall desk height of 29 ⁵ / ₈ " (see page 231). Primary finished top required in freestanding applications, ordered separately when item stands alone. Pencil tray included with BBF pedestals. | Actual depth nominal plus 3/8", finished back adds 1/2" (see page 180 for backs). Mobile pedestal includes finished back. All pedestals on this page include a finished sub-top and anti-tip spacer. Height to underside of worksurface including anti-tip spacer is 27"h. Optional work surface stand-offs (to use in place of anti-tip spacer) are specified separately from page 231. 19" wide (nominal) units accommodate legal filing front to back. File bars included to accommodate letter filing front to back. 30", 36" and 42" wide units include file bars to accommodate legal and letter filing front to back and side to side. File drawers are bottom loadable. Pedestals drilled for locks, keying instructions must accompany order. |

Wood or laminate case
Pedestals, metal drawer interiors

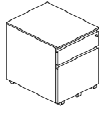
| description | type | h | w | d | pattern no. | L | V1 | V2 | V3 |
|---|----------|----------------------------------|-----|-----|------------------------------|----------|----------|----------|----------|
|  | 19" deep | 21 ³ / ₄ " | 16" | 19" | AMPB10(E/P)(M)() () | \$1,667. | \$1,792. | \$2,073. | \$2,717. |
| | | 21 ³ / ₄ " | 19" | 19" | AMPB11(E/P)(M)() () | 1,667. | 1,792. | 2,073. | 2,717. |
| | 23" deep | 21 ³ / ₄ " | 16" | 23" | AMPB20(E/P)(M)() () | 1,929. | 2,073. | 2,396. | 3,138. |
| | | 21 ³ / ₄ " | 19" | 23" | AMPB21(E/P)(M)() () | 1,929. | 2,073. | 2,396. | 3,138. |

Order Code

| | |
|-------------|----------------------------------|
| Example: | AFPB21EMV316AA |
| A | AutoStrada |
| F | Floor standing |
| P | Pedestal |
| B | Box/Box/File configuration |
| 2 | 23" deep (nominal) |
| 1 | 19" wide (nominal) |
| E | Extruded aluminum pull |
| M | Metal interior |
| V316 | Finish, Maple |
| AA | Finish, pull (anodized aluminum) |

Specification Information

To order please specify pattern number including:

- Pedestal type (embedded in pattern number)
F = Floor standing
M = Mobile
- Pedestal configuration
B = BBF (floorstanding) or BF (mobile)
F = File/File
- Depth (nominal)
1 = 19" deep
2 = 23" deep
3 = 29" deep *
(*available only in 16" or 19" widths)
- Width
0 = 16" wide (nominal)
1 = 19" wide (nominal)
2 = 30" wide (nominal)
3 = 36" wide (nominal)

Application Notes

- Pull
E = extruded aluminum pull
P = extruded aluminum protruding pull
- Interior
M = metal drawer interior
- Finish
Laminate, V1, V2 or V3 finish
- Finish, pull
Anodized aluminum or painted finish options listed on page 9 excluding silver.

See page 7 for finish options applicable.

Product on this page will accept wood grain laminate where laminate is currently an option.
List price for wood grain laminate options will be current published laminate list price plus 10%.

Note: Optional cabinet feet are recommended when pedestals used in free-standing applications to achieve overall desk height of 29⁵/₈" (see page 231).

Primary finished top required in freestanding applications, ordered separately when item stands alone.

Pencil tray included with BBF pedestals.

Actual depth nominal plus 3/8", finished back adds 1/2" (see page 180 for backs). Mobile pedestal includes finished back. All pedestals on this page include a finished sub-top and anti-tip spacer. Height to underside of worksurface including anti-tip spacer is 27"h. Optional work surface stand-offs (to use in place of anti-tip spacer) are specified separately from page 231.

19" wide (nominal) units accommodate legal filing front to back. File bars included to accommodate letter filing front to back. 30", 36" and 42" wide units include file bars to accommodate legal and letter filing front to back and side to side.

File drawers are bottom loadable.

Pedestals drilled for locks, keying instructions must accompany order.

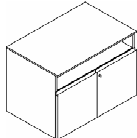

Wood or laminate case

Lower storage

| description | type | h | w | d | pattern no. | L | V1 | V2 | V3 |
|--|----------|-----|-----|-----|------------------------------------|--------|--------|----------|----------|
|  <p>36" w shown</p> | 19" deep | 26" | 16" | 19" | AFPHL10(E/P)(L/N)(W)() () | \$834. | \$894. | \$1,029. | \$1,338. |
| | | 26" | 16" | 19" | AFPHR10(E/P)(L/N)(W)() () | 834. | 894. | 1,029. | 1,338. |
| | | 26" | 19" | 19" | AFPHL11(E/P)(L/N)(W)() () | 834. | 894. | 1,029. | 1,338. |
| | | 26" | 19" | 19" | AFPHR11(E/P)(L/N)(W)() () | 834. | 894. | 1,029. | 1,338. |
| | | 26" | 30" | 19" | AFPH12(E/P)(L/N)(W)() () | 991. | 1,061. | 1,219. | 1,586. |
| | | 26" | 36" | 19" | AFPH13(E/P)(L/N)(W)() () | 1,237. | 1,325. | 1,526. | 1,982. |
| | | 26" | 42" | 19" | AFPH14(E/P)(L/N)(W)() () | 1,548. | 1,651. | 1,905. | 2,478. |
| | 23" deep | 26" | 16" | 23" | AFPHL20(E/P)(L/N)(W)() () | 959. | 1,029. | 1,183. | 1,538. |
| | | 26" | 16" | 23" | AFPHR20(E/P)(L/N)(W)() () | 959. | 1,029. | 1,183. | 1,538. |
| | | 26" | 19" | 23" | AFPHL21(E/P)(L/N)(W)() () | 959. | 1,029. | 1,183. | 1,538. |
| | | 26" | 19" | 23" | AFPHR21(E/P)(L/N)(W)() () | 959. | 1,029. | 1,183. | 1,538. |
| | | 26" | 30" | 23" | AFPH22(E/P)(L/N)(W)() () | 1,137. | 1,220. | 1,404. | 1,825. |
| | | 26" | 36" | 23" | AFPH23(E/P)(L/N)(W)() () | 1,423. | 1,524. | 1,753. | 2,280. |
| | | 26" | 42" | 23" | AFPH24(E/P)(L/N)(W)() () | 1,779. | 1,900. | 2,190. | 2,847. |

| Order Code | Specification Information | Application Notes |
|--|--|---|
| Example: AFPHL21ELWV316AA | To order please specify pattern number including: | Units on this page include a finished sub-top and anti-tip spacer. Height to underside of worksurface including anti-tip spacer is 27" h. Optional work surface stand-offs (to use in place of anti-tip spacer) are specified separately from page 231. |
| A AutoStrada | 1. Hand (applicable 16" and 19" wide units) <i>L = hinges on left</i> <i>R = hinges on right</i> | Primary finished top required in freestanding applications, ordered separately when item stands alone. |
| F Floor standing | 2. Depth <i>1 = 20" deep</i> <i>2 = 24" deep</i> | Note: Optional cabinet feet are recommended when units used in free-standing applications to achieve overall desk height of 29 ⁵ / ₈ " (see page 231). |
| P Pedestal | 3. Width <i>0 = 16" wide</i> <i>1 = 19" wide</i> <i>2 = 30" wide</i> <i>3 = 36" wide</i> <i>4 = 42" wide</i> | |
| H Hinged door/open shelf above | 4. Pull <i>E = Extruded aluminum pull</i> <i>P = Extruded aluminum protruding pull</i> | |
| L Left hand | 5. Lock option <i>L = drilled for locks</i> <i>N = not drilled for locks</i> | |
| 2 24" deep | 6. Interior <i>W = wood interior (only)</i> | |
| 1 19" wide | 7. Finish <i>Laminate, V1, V2 or V3 finish</i> | |
| E Extruded aluminum pull | 8. Finish, pull <i>Anodized aluminum or painted finish options listed on page 9 excluding silver.</i> | |
| L Drilled for lock | Optional lock drilled to be specified. If drilled for locks selected, keying instructions must accompany order. | |
| W Wood interior | See page 7 for finish options applicable. | |
| V316 Finish, Maple | Product on this page will accept wood grain laminate where laminate is currently an option. List price for wood grain laminate options will be current published laminate list price plus 10%. | |
| AA Finish, pull (anodized aluminum) | | |

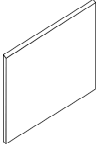
Wood or laminate case
Finished backs for lower storage

| description | h | w | thickness | pattern no. | L | V1 | V2 | V3 |
|---|---------|-----|-----------|-------------------|--------|--------|--------|--------|
|  Finished back | 25 1/2" | 16" | 1/2" | AFB16 () | \$115. | \$118. | \$138. | \$180. |
| | 25 1/2" | 19" | 1/2" | AFB19 () | 115. | 118. | 138. | 180. |
| | 25 1/2" | 30" | 1/2" | AFB30 () | 230. | 236. | 271. | 351. |
| | 25 1/2" | 36" | 1/2" | AFB36 () | 272. | 282. | 323. | 419. |
| | 25 1/2" | 42" | 1/2" | AFB42 () | 379. | 419. | 485. | 630. |
| | 25 1/2" | 60" | 1/2" | AFB60 () | 459. | 513. | 589. | 765. |
| | 25 1/2" | 72" | 1/2" | AFB72 () | 529. | 589. | 679. | 881. |
| | 25 1/2" | 84" | 1/2" | AFB84 () | 596. | 666. | 764. | 994. |
| | 25 1/2" | 96" | 1/2" | AFB96 () | 649. | 721. | 829. | 1,079. |
|  Pedestal filler strip | 25 1/2" | 5" | 1/2" | AWCPFS () | 89. | 117. | 118. | 124. |

Order Code

| |
|---------------------------|
| Example: AFB19V316 |
| A AutoStrada |
| FB Finished back |
| 19 19" wide |
| V316 Finish, Maple |

Specification Information

To order please specify pattern number including:

- Width
 16 = for 16" wide units
 19 = for 19" wide units
 30 = for 30" wide units
 36 = for 36" wide units
 42 = for 42" wide units
 60 = for two 30" w side by side
 72 = for two 36" w side by side
 84 = for two 42" w side by side
 90 = for three 30" w side by side
 96 = for two 30" w & one 36" w side by side
- Finish
 Laminate, V1, V2 or V3 finish

Application Notes

Finished backs are used with lower storage in free-standing applications where the back is exposed. Backs are 1/2" thick. Finished backs also recommended for "ganging" units together when creating build-to-spec credenza units.

Pedestal filler strip used in lieu of finished back when full back not exposed to finish gap to wall.

See page 7 for finish options applicable.

Product on this page will accept wood grain laminate where laminate is currently an option. List price for wood grain laminate options will be current published laminate list price plus 10%.

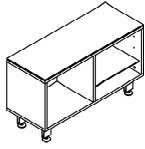
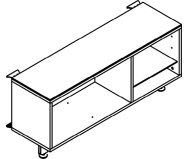
| description | w | d | h | pattern no. | L | V1 | V2 | V3 | list |
|---|-----|-----|-----|----------------------|--------|----------|----------|----------|------|
| Box shelf, freestanding  | 36" | 15" | 21" | ASBF1 36()() | \$918. | \$1,260. | \$1,454. | \$1,803. | |
| | 42" | 15" | 21" | ASBF1 42()() | 949. | 1,291. | 1,486. | 1,879. | |
| | 48" | 15" | 21" | ASBF1 48()() | 980. | 1,322. | 1,518. | 1,955. | |
| Box shelf, spine support  | 36" | 15" | 21" | ASBS1 36()() | 918. | 1,260. | 1,454. | 1,803. | |
| | 42" | 15" | 21" | ASBS1 42()() | 949. | 1,291. | 1,486. | 1,879. | |
| | 48" | 15" | 21" | ASBS1 48()() | 980. | 1,322. | 1,518. | 1,955. | |
| Box top | 36" | 15" | | ASBT1 36() | | | | | 179. |
| | 42" | 15" | | ASBT1 42() | | | | | 190. |
| | 48" | 15" | | ASBT1 48() | | | | | 203. |

| Order Code | Specification Information | Application Notes |
|--|--|--|
| Example: ASBF1 48 114 AA AS AutoStrada storage B Box shelf F1 freestanding 48 width 114 case finish AA leg finish | <p><i>To order please specify pattern number including:</i></p> <p>Box shelf freestanding</p> <ol style="list-style-type: none"> 1. Finish, Case <i>Laminate, V1, V2 or V3</i> 2. Finish, Legs <i>Clear anodized aluminum or painted finish option</i> <p>Box shelf spine support</p> <ol style="list-style-type: none"> 1. Finish, Case <i>Laminate, V1, V2 or V3</i> 2. Finish, Legs <i>Clear anodized aluminum or painted finish options listed on page 9 excluding silver.</i> 3. Finish, Bracket <i>All standard paint finishes</i> <p>Painted finish options listed on page 7 excluding silver.</p> | <p>Box top</p> <ol style="list-style-type: none"> 1. Finish, surface <i>TEMP Clear tempered glass</i> <p>Product on this page will accept wood grain laminate where laminate is currently an option. List price for wood grain laminate options will be current published laminate list price plus 10%.</p> <p>Box shelf is an open storage unit for binders or other material. Box shelf has full back, sides and partition which support one 16" wide, adjustable height glass shelf.</p> <p>Freestanding box shelf includes four clear anodized aluminum or painted legs with leveling glides.</p> <p>Spine support version includes two legs and two brackets that clamp on to the structural base cover of AutoStrada spine or Currents service wall.</p> <p>Box shelf also serves as spine support in place of outrigger. Fixed height end support bracket can be attached behind spine-attached Box shelf.</p> <p>Optional Box top is 1/4" clear tempered glass.</p> |

Overhead storage, wood cases

Stack-on Overheads (for use with Medians)

open

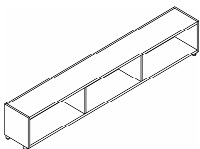
| description | type | sections | h | w | d | pattern no. | L | V1 | V2 | V3 | | |
|---|--------------|-------------|---------|------------------------|---------|------------------------|----------|------------------------|----------|----------|--------|--------|
| Stack-on Overhead, Open  96" w shown | binder depth | 2 | 15" | 42" | 14 1/4" | ASOBO42 () () | \$1,664. | \$1,719. | \$1,978. | \$2,571. | | |
| | | 2 | 15" | 48" | 14 1/4" | ASOBO48 () () | 1,723. | 1,782. | 2,048. | 2,663. | | |
| | | 2 | 15" | 54" | 14 1/4" | ASOBO54 () () | 1,744. | 1,801. | 2,073. | 2,695. | | |
| | | 2 | 15" | 60" | 14 1/4" | ASOBO60 () () | 1,762. | 1,823. | 2,098. | 2,726. | | |
| | | 2 | 15" | 66" | 14 1/4" | ASOBO66 () () | 1,961. | 2,026. | 2,331. | 3,032. | | |
| | | 2 | 15" | 72" | 14 1/4" | ASOBO72 () () | 2,161. | 2,230. | 2,567. | 3,336. | | |
| | | 3 | 15" | 78" | 14 1/4" | ASOBO78 () () | 2,231. | 2,306. | 2,651. | 3,448. | | |
| | | 3 | 15" | 84" | 14 1/4" | ASOBO84 () () | 2,305. | 2,380. | 2,739. | 3,559. | | |
| | | 3 | 15" | 90" | 14 1/4" | ASOBO90 () () | 2,377. | 2,456. | 2,823. | 3,672. | | |
| | | 3 | 15" | 96" | 14 1/4" | ASOBO96 () () | 2,462. | 2,546. | 2,926. | 3,803. | | |
| | | legal depth | | 2 | 15" | 42" | 17 1/4" | ASOGO42 () () | 1,796. | 1,853. | 2,138. | 2,778. |
| | | | | 2 | 15" | 48" | 17 1/4" | ASOGO48 () () | 1,862. | 1,924. | 2,212. | 2,877. |
| | | | | 2 | 15" | 54" | 17 1/4" | ASOGO54 () () | 1,882. | 1,946. | 2,240. | 2,911. |
| | | | | 2 | 15" | 60" | 17 1/4" | ASOGO60 () () | 1,902. | 1,967. | 2,263. | 2,944. |
| | | | | 2 | 15" | 66" | 17 1/4" | ASOGO66 () () | 2,117. | 2,188. | 2,518. | 3,273. |
| | | | | 2 | 15" | 72" | 17 1/4" | ASOGO72 () () | 2,331. | 2,408. | 2,772. | 3,602. |
| 3 | 15" | | | 78" | 17 1/4" | ASOGO78 () () | 2,411. | 2,490. | 2,864. | 3,724. | | |
| 3 | 15" | | | 84" | 17 1/4" | ASOGO84 () () | 2,488. | 2,571. | 2,957. | 3,844. | | |
| 3 | 15" | 90" | 17 1/4" | ASOGO90 () () | 2,565. | 2,651. | 3,049. | 3,965. | | | | |
| 3 | 15" | 96" | 17 1/4" | ASOGO96 () () | 2,659. | 2,748. | 3,160. | 4,109. | | | | |

| Order Code | Specification Information | Application Notes |
|--------------------------------|--|--|
| Example: ASOBO42V316AA | <i>To order please specify pattern number including:</i> | Stack-on overheads, as the description implies "stack-on" median top shelf, please make sure median top shelf depth and overhead depth correspond. |
| A AutoStrada | 1. Depth <i>B = Binder depth</i> <i>G = Legal depth</i> | Stack-on overheads correspond to interior width of medians and median storage. |
| S Stack-on | 2. Width | |
| O Overhead | 3. Finish <i>Laminate, V1, V2 or V3</i> | |
| B Binder depth | 4. Finish, support feet <i>Anodized aluminum or painted finish options listed on page 9 excluding silver.</i> | |
| O Open | | |
| 42 42" wide | | |
| V316 Finish, Maple | | |
| AA Finish, Support feet | | |

See page 7 for finish options applicable.

Product on this page will accept wood grain laminate where laminate is currently an option.

List price for wood grain laminate options will be current published laminate list price plus 10%.

Overhead storage, wood cases

Stack-on Overheads (for use with Medians)

hinged door

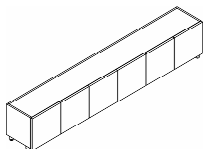
| description | type | # drs/locks | h | w | d | pattern no. | L | V1 | V2 | V3 | |
|--|--------------|-------------|---------|----------------------------|----------------------------|----------------------------|----------------------------|----------|----------|----------|--------|
|  <p>96" w shown</p> | binder depth | 3/2 | 15" | 42" | 15 1/4" | ASOBD42 () () () | \$1,846. | \$1,907. | \$2,196. | \$2,854. | |
| | | 3/2 | 15" | 48" | 15 1/4" | ASOBD48 () () () | 1,912. | 1,978. | 2,274. | 2,957. | |
| | | 3/2 | 15" | 54" | 15 1/4" | ASOBD54 () () () | 1,934. | 2,000. | 2,300. | 2,992. | |
| | | 4/2 | 15" | 60" | 15 1/4" | ASOBD60 () () () | 1,956. | 2,024. | 2,326. | 3,024. | |
| | | 4/2 | 15" | 66" | 15 1/4" | ASOBD66 () () () | 2,177. | 2,248. | 2,588. | 3,363. | |
| | | 4/2 | 15" | 72" | 15 1/4" | ASOBD72 () () () | 2,399. | 2,482. | 2,856. | 3,712. | |
| | | 5/3 | 15" | 78" | 15 1/4" | ASOBD78 () () () | 2,478. | 2,559. | 2,944. | 3,828. | |
| | | 5/3 | 15" | 84" | 15 1/4" | ASOBD84 () () () | 2,558. | 2,642. | 3,038. | 3,951. | |
| | | 6/3 | 15" | 90" | 15 1/4" | ASOBD90 () () () | 2,641. | 2,727. | 3,136. | 4,077. | |
| | | 6/3 | 15" | 96" | 15 1/4" | ASOBD96 () () () | 2,733. | 2,827. | 3,253. | 4,227. | |
| | | legal depth | 3/2 | 15" | 42" | 18 1/4" | ASOGD42 () () () | 1,992. | 2,060. | 2,371. | 3,083. |
| | | | 3/2 | 15" | 48" | 18 1/4" | ASOGD48 () () () | 2,065. | 2,138. | 2,456. | 3,193. |
| | | | 3/2 | 15" | 54" | 18 1/4" | ASOGD54 () () () | 2,089. | 2,161. | 2,484. | 3,231. |
| | | | 4/2 | 15" | 60" | 18 1/4" | ASOGD60 () () () | 2,113. | 2,184. | 2,512. | 3,266. |
| 4/2 | 15" | | 66" | 18 1/4" | ASOGD66 () () () | 2,350. | 2,429. | 2,795. | 3,635. | | |
| 4/2 | 15" | | 72" | 18 1/4" | ASOGD72 () () () | 2,590. | 2,681. | 3,083. | 4,009. | | |
| 5/3 | 15" | | 78" | 18 1/4" | ASOGD78 () () () | 2,677. | 2,763. | 3,179. | 4,134. | | |
| 5/3 | 15" | | 84" | 18 1/4" | ASOGD84 () () () | 2,761. | 2,854. | 3,281. | 4,267. | | |
| 6/3 | 15" | 90" | 18 1/4" | ASOGD90 () () () | 2,853. | 2,945. | 3,386. | 4,403. | | | |
| 6/3 | 15" | 96" | 18 1/4" | ASOGD96 () () () | 2,954. | 3,054. | 3,511. | 4,566. | | | |

| Order Code | Specification Information | Application Notes |
|---|--|--|
| Example: ASOBD42LV316AA A AutoStrada S Stack-on O Overhead B Binder depth D Hinged Door 42 42" wide L Locking V316 Finish, Maple AA Finish, support feet | To order please specify pattern number including: 1. Depth <i>B = Binder depth</i> <i>G = Legal depth</i> 2. Width 3. Lock option <i>L = Lock hole drilled</i> <i>N = Not drilled for locks</i> 4. Finish <i>Laminate, V1, V2 or V3</i> 5. Finish, support feet <i>Anodized aluminum or painted finish options listed on page 9 excluding silver.</i> | Stack-on overheads, as the description implies "stack-on" median top shelf, please make sure median top shelf depth and overhead depth correspond. Hinged doors extend slightly beyond case construction to allow for easy finger pull access along the bottom. No pulls available. Optional lock drilling to be specified. If drilled for locks selected, keying instructions must accompany order. Stack-on overheads correspond to interior width of medians and median storage. |

See page 7 for finish options applicable.

Product on this page will accept wood grain laminate where laminate is currently an option. List price for wood grain laminate options will be current published laminate list price plus 10%.

Overhead storage, wood cases

Stack-on Overheads (for use with Medians)

open / hinged door / open

| description | type | locks | h | w | d | pattern no. | L | V1 | V2 | V3 |
|--|--------------|-------|-----|---------|------------------------|------------------------|----------|----------|----------|----------|
| Stack-on Overhead, Open/Wood hinged doors/Open | binder depth | 1 | 15" | 60" | 15 1/4" | ASOBT60 () () | \$1,849. | \$1,913. | \$2,202. | \$2,861. |
| | | 1 | 15" | 66" | 15 1/4" | ASOBT66 () () | 2,059. | 2,127. | 2,449. | 3,182. |
| | | 1 | 15" | 72" | 15 1/4" | ASOBT72 () () | 2,268. | 2,342. | 2,695. | 3,503. |
| | | 1 | 15" | 78" | 15 1/4" | ASOBT78 () () | 2,343. | 2,421. | 2,784. | 3,621. |
| | | 1 | 15" | 84" | 15 1/4" | ASOBT84 () () | 2,419. | 2,499. | 2,875. | 3,737. |
| | | 1 | 15" | 90" | 15 1/4" | ASOBT90 () () | 2,495. | 2,578. | 2,965. | 3,854. |
| | 1 | 15" | 96" | 15 1/4" | ASOBT96 () () | 2,584. | 2,675. | 3,072. | 3,993. | |
| | legal depth | 1 | 15" | 60" | 18 1/4" | ASOGT60 () () | 1,999. | 2,066. | 2,378. | 3,093. |
| | | 1 | 15" | 66" | 18 1/4" | ASOGT66 () () | 2,224. | 2,298. | 2,643. | 3,438. |
| | | 1 | 15" | 72" | 18 1/4" | ASOGT72 () () | 2,449. | 2,529. | 2,911. | 3,784. |
| | | 1 | 15" | 78" | 18 1/4" | ASOGT78 () () | 2,530. | 2,615. | 3,007. | 3,911. |
| | | 1 | 15" | 84" | 18 1/4" | ASOGT84 () () | 2,614. | 2,700. | 3,106. | 4,036. |
| | | 1 | 15" | 90" | 18 1/4" | ASOGT90 () () | 2,695. | 2,783. | 3,200. | 4,163. |
| 1 | | 15" | 96" | 18 1/4" | ASOGT96 () () | 2,791. | 2,887. | 3,319. | 4,312. | |

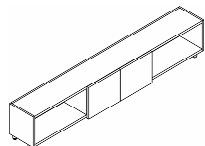

96" w shown

| Order Code | Specification Information | Application Notes |
|--------------------------------|--|--|
| Example: ASOBT60LV316AA | <i>To order please specify pattern number including:</i> | Stack-on overheads, as the description implies "stack-on" median top shelf, please make sure median top shelf depth and overhead depth correspond. |
| A AutoStrada | 1. Depth <i>B = Binder depth</i> <i>G = Legal depth</i> | Optional lock drilling to be specified. If drilled for locks selected, keying instructions must accompany order. |
| S Stack-on | 2. Width | Stack-on overheads correspond to interior width of medians and median storage. |
| O Overhead | 3. Lock option <i>L = Lock hole drilled</i> <i>N = Not drilled for locks</i> | |
| B Binder depth | 4. Finish <i>Laminate, V1, V2 or V3</i> | |
| T Open/Hinged Door/Open | 5. Finish, support feet <i>Anodized aluminum or painted finish options listed on page 9 excluding silver.</i> | |
| 60 60" wide | | |
| L Locking | | |
| V316 Finish, Maple | | |
| AA Finish, support feet | | |

To order please specify pattern number including:

- Depth
B = Binder depth
G = Legal depth
- Width
- Lock option
L = Lock hole drilled
N = Not drilled for locks
- Finish
Laminate, V1, V2 or V3
- Finish, support feet
Anodized aluminum or painted finish options listed on page 9 excluding silver.

See page 7 for finish options applicable.

Product on this page will accept wood grain laminate where laminate is currently an option. List price for wood grain laminate options will be current published laminate list price plus 10%.

Stack-on overheads, as the description implies "stack-on" median top shelf, please make sure median top shelf depth and overhead depth correspond.

Hinged doors extend slightly beyond case construction to allow for easy finger pull access along the bottom. No pulls available.

Optional lock drilling to be specified. If drilled for locks selected, keying instructions must accompany order.

Stack-on overheads correspond to interior width of medians and median storage.

Overhead storage, wood cases

Stack-on Overheads (for use with Medians) with sliding wood door(s)

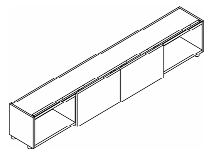
| description | type | h | w | d | pattern no. | L | V1 | V2 | V3 | | | | |
|---|---|--------------|-------------|-----|-------------|-----------------------|----------|----------|-----------------------|----------|--------|--------|--------|
|  96" w shown | Stack-on Overhead, Wood Sliding Door(s) | binder depth | 15" | 42" | 15 1/4" | ASOBS42 ()() | \$2,494. | \$2,628. | \$3,323. | \$4,319. | | | |
| | | | 15" | 48" | 15 1/4" | ASOBS48 ()() | 2,583. | 2,726. | 3,442. | 4,474. | | | |
| | | | 15" | 54" | 15 1/4" | ASOBS54 ()() | 2,614. | 2,757. | 3,481. | 4,527. | | | |
| | | | 15" | 60" | 15 1/4" | ASOBS60 ()() | 2,642. | 2,786. | 3,522. | 4,580. | | | |
| | | | 15" | 66" | 15 1/4" | ASOBS66 ()() | 2,941. | 3,099. | 3,916. | 5,092. | | | |
| | | | 15" | 72" | 15 1/4" | ASOBS72 ()() | 3,241. | 3,412. | 4,312. | 5,606. | | | |
| | | | 15" | 78" | 15 1/4" | ASOBS78 ()() | 3,346. | 3,527. | 4,455. | 5,792. | | | |
| | | | 15" | 84" | 15 1/4" | ASOBS84 ()() | 3,456. | 3,641. | 4,601. | 5,979. | | | |
| | | | 15" | 90" | 15 1/4" | ASOBS90 ()() | 3,563. | 3,758. | 4,743. | 6,166. | | | |
| | | | 15" | 96" | 15 1/4" | ASOBS96 ()() | 3,692. | 3,896. | 4,914. | 6,390. | | | |
| | | | legal depth | | | 15" | 42" | 18 1/4" | ASOGS42 ()() | 2,694. | 2,840. | 3,589. | 4,666. |
| | | | | | | 15" | 48" | 18 1/4" | ASOGS48 ()() | 2,791. | 2,944. | 3,716. | 4,832. |
| | | | | | | 15" | 54" | 18 1/4" | ASOGS54 ()() | 2,823. | 2,978. | 3,760. | 4,888. |
| | | | | | | 15" | 60" | 18 1/4" | ASOGS60 ()() | 2,854. | 3,010. | 3,805. | 4,945. |
| | | | | | | 15" | 66" | 18 1/4" | ASOGS66 ()() | 3,176. | 3,346. | 4,230. | 5,500. |
| | | | | | | 15" | 72" | 18 1/4" | ASOGS72 ()() | 3,499. | 3,686. | 4,657. | 6,054. |
| | | | | | | 15" | 78" | 18 1/4" | ASOGS78 ()() | 3,614. | 3,809. | 4,813. | 6,256. |
| 15" | 84" | 18 1/4" | | | | ASOGS84 ()() | 3,732. | 3,935. | 4,967. | 6,457. | | | |
| 15" | 90" | 18 1/4" | | | | ASOGS90 ()() | 3,849. | 4,058. | 5,123. | 6,658. | | | |
| 15" | 96" | 18 1/4" | | | | ASOGS96 ()() | 3,989. | 4,206. | 5,307. | 6,900. | | | |

| Order Code | Specification Information | Application Notes |
|-----------------------------------|---|--|
| Example: ASOBS42V316AA | <i>To order please specify pattern number including:</i> | Sliding doors are not available with locks. |
| A AutoStrada | 1. Depth <i>B = Binder depth</i> <i>G = Legal depth</i> | Stack-on overheads, as the description implies "stack-on" median top shelf, please make sure median top shelf depth and overhead depth correspond. |
| S Stack-on | 2. Sliding door material <i>S = wood, same as case</i> <i>R = glass</i> | |
| O Overhead | 3. Width | Sliding door pulls included, not visible on image. When AA finish specified pull is complimentary painted match to AA, pull not anodized. |
| B Binder depth | 4. Finish <i>Laminate, V1, V2 or V3</i> | |
| S Open/Sliding (wood) Door | 5. Finish, support feet and pull <i>Anodized aluminum or painted finish options listed on page 9 excluding silver.</i> | |
| 42 42" wide | | |
| V316 Finish, Maple | | |
| AA Finish, support feet | | |

See page 7 for finish options applicable.

Product on this page will accept wood grain laminate where laminate is currently an option.

List price for wood grain laminate options will be current published laminate list price plus 10%.

Overhead storage, wood cases

Stack-on Overheads (for use with Medians)

with sliding glass door(s)

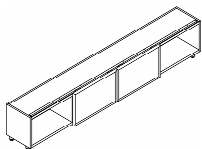
| description | type | h | w | d | pattern no. | L | V1 | V2 | V3 | | |
|--|--|--------------|-----|-----|-------------|----------------------------|----------------------------|----------|----------|----------|--------|
|  <p>96" w shown</p> | Stack-on Overhead, Glass Sliding Door(s) | binder depth | 15" | 42" | 15 1/4" | ASOBR42 () () () | \$2,977. | \$3,127. | \$3,897. | \$5,067. | |
| | | | 15" | 48" | 15 1/4" | ASOBR48 () () () | 3,083. | 3,242. | 4,036. | 5,248. | |
| | | | 15" | 54" | 15 1/4" | ASOBR54 () () () | 3,120. | 3,279. | 4,084. | 5,307. | |
| | | | 15" | 60" | 15 1/4" | ASOBR60 () () () | 3,155. | 3,316. | 4,130. | 5,369. | |
| | | | 15" | 66" | 15 1/4" | ASOBR66 () () () | 3,510. | 3,689. | 4,593. | 5,972. | |
| | | | 15" | 72" | 15 1/4" | ASOBR72 () () () | 3,867. | 4,059. | 5,057. | 6,574. | |
| | | | 15" | 78" | 15 1/4" | ASOBR78 () () () | 3,995. | 4,196. | 5,224. | 6,792. | |
| | | | 15" | 84" | 15 1/4" | ASOBR84 () () () | 4,125. | 4,331. | 5,395. | 7,012. | |
| | | | 15" | 90" | 15 1/4" | ASOBR90 () () () | 4,253. | 4,469. | 5,562. | 7,232. | |
| | | | 15" | 96" | 15 1/4" | ASOBR96 () () () | 4,407. | 4,633. | 5,764. | 7,494. | |
| | legal depth | | | 15" | 42" | 18 1/4" | ASOGR42 () () () | 3,213. | 3,377. | 4,209. | 5,471. |
| | | | | 15" | 48" | 18 1/4" | ASOGR48 () () () | 3,331. | 3,502. | 4,357. | 5,666. |
| | | | | 15" | 54" | 18 1/4" | ASOGR54 () () () | 3,370. | 3,540. | 4,410. | 5,734. |
| | | | | 15" | 60" | 18 1/4" | ASOGR60 () () () | 3,405. | 3,581. | 4,462. | 5,800. |
| | | | | 15" | 66" | 18 1/4" | ASOGR66 () () () | 3,791. | 3,981. | 4,960. | 6,450. |
| | | | | 15" | 72" | 18 1/4" | ASOGR72 () () () | 4,175. | 4,384. | 5,461. | 7,099. |
| | | | | 15" | 78" | 18 1/4" | ASOGR78 () () () | 4,315. | 4,531. | 5,643. | 7,335. |
| | | | | 15" | 84" | 18 1/4" | ASOGR84 () () () | 4,454. | 4,679. | 5,825. | 7,573. |
| | | | | 15" | 90" | 18 1/4" | ASOGR90 () () () | 4,593. | 4,827. | 6,008. | 7,810. |
| 15" | | | | 96" | 18 1/4" | ASOGR96 () () () | 4,759. | 5,004. | 6,224. | 8,092. | |

| Order Code | Specification Information | Application Notes |
|---|---|---|
| Example: ASOBR42V316GL6AA AA | To order please specify pattern number including: | Sliding doors are not available with locks. |
| A AutoStrada | 1. Depth <i>B = Binder depth</i> | Stack-on overheads, as the description implies "stack-on" median top shelf, please make sure median top shelf depth and overhead depth correspond. |
| S Stack-on | <i>G = Legal depth</i> | |
| O Overhead | 2. Sliding door material <i>S = wood, same as case</i> <i>R = glass</i> | Sliding door pulls included, not visible on image. When AA finish specified pull is complimentary painted match, pull not anodized. |
| B Binder depth | 3. Width | |
| R Open/Sliding (glass) Door | 4. Finish <i>Laminate, V1, V2 or V3</i> | See page 7 for finish options applicable. |
| 42 42" wide | 5. Finish, Glass sliding door <i>TEMP - Clear, tempered</i> <i>GL6 - Block Matrix</i> <i>GL13 - Powder</i> | |
| V316 Finish, Maple | 6. Finish, Glass sliding door frame and pull <i>Anodized aluminum or painted finish options listed on page 9 excluding silver.</i> | Product on this page will accept wood grain laminate where laminate is currently an option. List price for wood grain laminate options will be current published laminate list price plus 10%. |
| GL6 Glass, Block Matrix | 7. Finish, support feet <i>Anodized aluminum or painted finish options listed on page 7 excluding silver.</i> | |
| AA Frame, anodized aluminum | | |
| AA Finish, support feet | | |

Overhead storage, wood cases

Panel hung overheads

open

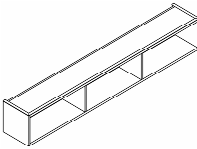
| description | type | sections | h | w | d | pattern no. | L | V1 | V2 | V3 | |
|--|--------------|-------------|-----|---------|---------------------|---------------------|---------------------|----------|----------|----------|--------|
|  <p>96" w shown</p> | binder depth | 2 | 15" | 42" | 14 1/4" | APHOBO42 () | \$1,664. | \$1,719. | \$1,978. | \$2,571. | |
| | | 2 | 15" | 48" | 14 1/4" | APHOBO48 () | 1,723. | 1,782. | 2,048. | 2,663. | |
| | | 2 | 15" | 54" | 14 1/4" | APHOBO54 () | 1,744. | 1,801. | 2,073. | 2,695. | |
| | | 2 | 15" | 60" | 14 1/4" | APHOBO60 () | 1,762. | 1,823. | 2,098. | 2,726. | |
| | | 2 | 15" | 66" | 14 1/4" | APHOBO66 () | 1,961. | 2,026. | 2,331. | 3,032. | |
| | | 2 | 15" | 72" | 14 1/4" | APHOBO72 () | 2,161. | 2,230. | 2,567. | 3,336. | |
| | | 3 | 15" | 78" | 14 1/4" | APHOBO78 () | 2,231. | 2,306. | 2,651. | 3,448. | |
| | | 3 | 15" | 84" | 14 1/4" | APHOBO84 () | 2,305. | 2,380. | 2,739. | 3,559. | |
| | | 3 | 15" | 90" | 14 1/4" | APHOBO90 () | 2,377. | 2,456. | 2,823. | 3,672. | |
| | | 3 | 15" | 96" | 14 1/4" | APHOBO96 () | 2,462. | 2,546. | 2,926. | 3,803. | |
| | | legal depth | 2 | 15" | 42" | 17 1/4" | APHOGO42 () | 1,796. | 1,853. | 2,138. | 2,778. |
| | | | 2 | 15" | 48" | 17 1/4" | APHOGO48 () | 1,862. | 1,924. | 2,212. | 2,877. |
| | | | 2 | 15" | 54" | 17 1/4" | APHOGO54 () | 1,882. | 1,946. | 2,240. | 2,911. |
| | | | 2 | 15" | 60" | 17 1/4" | APHOGO60 () | 1,902. | 1,967. | 2,263. | 2,944. |
| | | | 2 | 15" | 66" | 17 1/4" | APHOGO66 () | 2,117. | 2,188. | 2,518. | 3,273. |
| | | | 2 | 15" | 72" | 17 1/4" | APHOGO72 () | 2,331. | 2,408. | 2,772. | 3,602. |
| 3 | 15" | | 78" | 17 1/4" | APHOGO78 () | 2,411. | 2,490. | 2,864. | 3,724. | | |
| 3 | 15" | | 84" | 17 1/4" | APHOGO84 () | 2,488. | 2,571. | 2,957. | 3,844. | | |
| 3 | 15" | | 90" | 17 1/4" | APHOGO90 () | 2,565. | 2,651. | 3,049. | 3,965. | | |
| 3 | 15" | | 96" | 17 1/4" | APHOGO96 () | 2,659. | 2,748. | 3,160. | 4,109. | | |

Order Code

| | |
|-------------|---------------------|
| Example: | APHOBO42V316 |
| A | AutoStrada |
| PH | Panel hung |
| O | Overhead |
| B | Binder depth |
| O | Open |
| 42 | 42" wide |
| V316 | Finish, Maple |

Specification Information

To order please specify pattern number including:

- Depth
B = Binder depth
G = Legal depth
- Width
- Finish
Laminate, V1, V2 or V3

See page 7 for finish options applicable.

Application Notes

Panel hung overhead storage units include hardware to hang unit on panels.

Product on this page will accept wood grain laminate where laminate is currently an option. List price for wood grain laminate options will be current published laminate list price plus 10%.

*Panel hung overheads
hinged door*

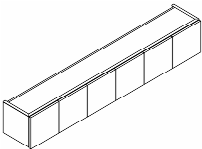
| description | type | # drs/locks | h | w | d | pattern no. | L | V1 | V2 | V3 | | | | |
|--|--|--------------|-------------|------------------------|--------|-------------|------------------------|----------|----------|------------------------|----------|--------|--------|--------|
|  <p>96" w shown</p> | Panel hung Overhead, Wood Hinged Doors | binder depth | 3/2 | 15" | 42" | 15 1/4" | APHOBD42 ()() | \$1,846. | \$1,907. | \$2,196. | \$2,854. | | | |
| | | | 3/2 | 15" | 48" | 15 1/4" | APHOBD48 ()() | 1,912. | 1,978. | 2,274. | 2,957. | | | |
| | | | 3/2 | 15" | 54" | 15 1/4" | APHOBD54 ()() | 1,934. | 2,000. | 2,300. | 2,992. | | | |
| | | | 4/2 | 15" | 60" | 15 1/4" | APHOBD60 ()() | 1,956. | 2,024. | 2,326. | 3,024. | | | |
| | | | 4/2 | 15" | 66" | 15 1/4" | APHOBD66 ()() | 2,177. | 2,248. | 2,588. | 3,363. | | | |
| | | | 4/2 | 15" | 72" | 15 1/4" | APHOBD72 ()() | 2,399. | 2,482. | 2,856. | 3,712. | | | |
| | | | 5/3 | 15" | 78" | 15 1/4" | APHOBD78 ()() | 2,478. | 2,559. | 2,944. | 3,828. | | | |
| | | | 5/3 | 15" | 84" | 15 1/4" | APHOBD84 ()() | 2,558. | 2,642. | 3,038. | 3,951. | | | |
| | | | 6/3 | 15" | 90" | 15 1/4" | APHOBD90 ()() | 2,641. | 2,727. | 3,136. | 4,077. | | | |
| | | | 6/3 | 15" | 96" | 15 1/4" | APHOBD96 ()() | 2,733. | 2,827. | 3,253. | 4,227. | | | |
| | | | legal depth | | | 3/2 | 15" | 42" | 18 1/4" | APHOGD42 ()() | 1,992. | 2,060. | 2,371. | 3,083. |
| | | | | | | 3/2 | 15" | 48" | 18 1/4" | APHOGD48 ()() | 2,065. | 2,138. | 2,456. | 3,193. |
| | | | | | | 3/2 | 15" | 54" | 18 1/4" | APHOGD54 ()() | 2,089. | 2,161. | 2,484. | 3,231. |
| | | | | | | 4/2 | 15" | 60" | 18 1/4" | APHOGD60 ()() | 2,113. | 2,184. | 2,512. | 3,266. |
| | | | | | | 4/2 | 15" | 66" | 18 1/4" | APHOGD66 ()() | 2,350. | 2,429. | 2,795. | 3,635. |
| | | | | | | 4/2 | 15" | 72" | 18 1/4" | APHOGD72 ()() | 2,590. | 2,681. | 3,083. | 4,009. |
| 5/3 | 15" | 78" | | | | 18 1/4" | APHOGD78 ()() | 2,677. | 2,763. | 3,179. | 4,134. | | | |
| 5/3 | 15" | 84" | | | | 18 1/4" | APHOGD84 ()() | 2,761. | 2,854. | 3,281. | 4,267. | | | |
| 6/3 | 15" | 90" | | | | 18 1/4" | APHOGD90 ()() | 2,853. | 2,945. | 3,386. | 4,403. | | | |
| 6/3 | 15" | 96" | 18 1/4" | APHOGD96 ()() | 2,954. | 3,054. | 3,511. | 4,566. | | | | | | |

Order Code

| |
|-------------------------------|
| Example: APHOBD42LV316 |
| A AutoStrada |
| PH Panel hung |
| O Overhead |
| B Binder depth |
| D Hinged Door |
| 42 42" wide |
| L Locking |
| V316 Finish, Maple |

Specification Information

To order please specify pattern number including:

1. Depth
B = Binder depth
G = Legal depth
2. Width
3. Lock option
L = Lock hole drilled
N = Not drilled for locks
4. Finish
Laminate, V1, V2 or V3

See page 7 for finish options applicable.

Product on this page will accept wood grain laminate where laminate is currently an option. List price for wood grain laminate options will be current published laminate list price plus 10%.

Application Notes

Panel hung overhead storage units include hardware to hang unit on panels.

Hinged doors extend slightly beyond case construction to allow for easy finger pull access along the bottom. No pulls available.

Optional lock drilling to be specified. If drilled for locks selected, keying instructions must accompany order.

Overhead storage, wood cases
Panel hung overheads
open / hinged door / open

| description | type | locks | h | w | d | pattern no. | L | V1 | V2 | V3 |
|--|--------------|-------|-----|-----|---------|-------------------------|----------|----------|----------|----------|
| Panel hung Overhead, Open/Wood hinged doors/Open | binder depth | 1 | 15" | 60" | 15 1/4" | APHOBT60 () () | \$1,849. | \$1,913. | \$2,202. | \$2,861. |
| | | 1 | 15" | 66" | 15 1/4" | APHOBT66 () () | 2,059. | 2,127. | 2,449. | 3,182. |
| | | 1 | 15" | 72" | 15 1/4" | APHOBT72 () () | 2,268. | 2,342. | 2,695. | 3,503. |
| | | 1 | 15" | 78" | 15 1/4" | APHOBT78 () () | 2,343. | 2,421. | 2,784. | 3,621. |
| | | 1 | 15" | 84" | 15 1/4" | APHOBT84 () () | 2,419. | 2,499. | 2,875. | 3,737. |
| | | 1 | 15" | 90" | 15 1/4" | APHOBT90 () () | 2,495. | 2,578. | 2,965. | 3,854. |
| | | 1 | 15" | 96" | 15 1/4" | APHOBT96 () () | 2,584. | 2,675. | 3,072. | 3,993. |
| 96" w shown | legal depth | 1 | 15" | 60" | 18 1/4" | APHOGT60 () () | 1,999. | 2,066. | 2,378. | 3,093. |
| | | 1 | 15" | 66" | 18 1/4" | APHOGT66 () () | 2,224. | 2,298. | 2,643. | 3,438. |
| | | 1 | 15" | 72" | 18 1/4" | APHOGT72 () () | 2,449. | 2,529. | 2,911. | 3,784. |
| | | 1 | 15" | 78" | 18 1/4" | APHOGT78 () () | 2,530. | 2,615. | 3,007. | 3,911. |
| | | 1 | 15" | 84" | 18 1/4" | APHOGT84 () () | 2,614. | 2,700. | 3,106. | 4,036. |
| | | 1 | 15" | 90" | 18 1/4" | APHOGT90 () () | 2,695. | 2,783. | 3,200. | 4,163. |
| | | 1 | 15" | 96" | 18 1/4" | APHOGT96 () () | 2,791. | 2,887. | 3,319. | 4,312. |

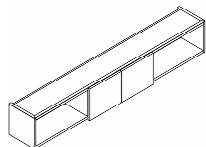

96" w shown

| Order Code | Specification Information | Application Notes |
|--------------------------------|---|--|
| Example: APHOBT60LV316 | <p>To order please specify pattern number including:</p> <ol style="list-style-type: none"> Depth <i>B = Binder depth</i> <i>G = Legal depth</i> Width Lock option <i>L = Lock hole drilled</i> <i>N = Not drilled for locks</i> Finish <i>Laminate, V1, V2 or V3</i> <p>See page 7 for finish options applicable.</p> <p>Product on this page will accept wood grain laminate where laminate is currently an option. List price for wood grain laminate options will be current published laminate list price plus 10%.</p> | <p>Panel hung overhead storage units include hardware to hang unit on panels.</p> <p>Hinged doors extend slightly beyond case construction to allow for easy finger pull access along the bottom. No pulls available</p> <p>Optional lock drilling to be specified. If drilled for locks selected, keying instructions must accompany order.</p> |
| A AutoStrada | | |
| PH Panel hung | | |
| O Overhead | | |
| B Binder depth | | |
| T Open/Hinged Door/Open | | |
| 60 60" wide | | |
| L Locking | | |
| V316 Finish, Maple | | |

Overhead storage, wood cases

Panel hung overheads

with sliding wood door(s)

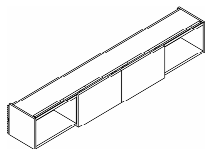
| description | type | sections | h | w | d | pattern no. | L | V1 | V2 | V3 | | |
|---|--------------|-------------|-----|-----|---------|-------------------------|----------|-------------------------|----------|----------|--------|--------|
|  <p>96" w shown</p> | binder depth | 1/1 | 15" | 42" | 15 1/4" | APHOBS42 () () | \$2,494. | \$2,628. | \$3,323. | \$4,319. | | |
| | | 1/1 | 15" | 48" | 15 1/4" | APHOBS48 () () | 2,583. | 2,726. | 3,442. | 4,474. | | |
| | | 1/1 | 15" | 54" | 15 1/4" | APHOBS54 () () | 2,614. | 2,757. | 3,481. | 4,527. | | |
| | | 2/2 | 15" | 60" | 15 1/4" | APHOBS60 () () | 2,642. | 2,786. | 3,522. | 4,580. | | |
| | | 2/2 | 15" | 66" | 15 1/4" | APHOBS66 () () | 2,941. | 3,099. | 3,916. | 5,092. | | |
| | | 2/2 | 15" | 72" | 15 1/4" | APHOBS72 () () | 3,241. | 3,412. | 4,312. | 5,606. | | |
| | | 2/2 | 15" | 78" | 15 1/4" | APHOBS78 () () | 3,346. | 3,527. | 4,455. | 5,792. | | |
| | | 2/2 | 15" | 84" | 15 1/4" | APHOBS84 () () | 3,456. | 3,641. | 4,601. | 5,979. | | |
| | | 2/2 | 15" | 90" | 15 1/4" | APHOBS90 () () | 3,563. | 3,758. | 4,743. | 6,166. | | |
| | | 2/2 | 15" | 96" | 15 1/4" | APHOBS96 () () | 3,692. | 3,896. | 4,914. | 6,390. | | |
| | | legal depth | | 1/1 | 15" | 42" | 18 1/4" | APHOGS42 () () | 2,694. | 2,840. | 3,589. | 4,666. |
| | | | | 1/1 | 15" | 48" | 18 1/4" | APHOGS48 () () | 2,791. | 2,944. | 3,716. | 4,832. |
| 1/1 | 15" | | | 54" | 18 1/4" | APHOGS54 () () | 2,823. | 2,978. | 3,760. | 4,888. | | |
| 2/2 | 15" | | | 60" | 18 1/4" | APHOGS60 () () | 2,854. | 3,010. | 3,805. | 4,945. | | |
| 2/2 | 15" | | | 66" | 18 1/4" | APHOGS66 () () | 3,176. | 3,346. | 4,230. | 5,500. | | |
| 2/2 | 15" | | | 72" | 18 1/4" | APHOGS72 () () | 3,499. | 3,686. | 4,657. | 6,054. | | |
| 2/2 | 15" | | | 78" | 18 1/4" | APHOGS78 () () | 3,614. | 3,809. | 4,813. | 6,256. | | |
| 2/2 | 15" | | | 84" | 18 1/4" | APHOGS84 () () | 3,732. | 3,935. | 4,967. | 6,457. | | |
| 2/2 | 15" | | | 90" | 18 1/4" | APHOGS90 () () | 3,849. | 4,058. | 5,123. | 6,658. | | |
| 2/2 | 15" | | | 96" | 18 1/4" | APHOGS96 () () | 3,989. | 4,206. | 5,307. | 6,900. | | |

| Order Code | Specification Information | Application Notes |
|-----------------------------------|--|--|
| Example: APHOBS42V316 | <p>To order please specify pattern number including:</p> <ol style="list-style-type: none"> Depth <i>B = Binder depth</i> <i>G = Legal depth</i> Sliding door material <i>S = wood, same as case</i> Width Finish <i>Laminate, V1, V2 or V3</i> Finish, pull <i>AA-complimentary painted match to anodized aluminum or painted finish options listed on page 7 excluding silver.</i> <p>See page 7 for finish options applicable.</p> <p>Product on this page will accept wood grain laminate where laminate is currently an option. List price for wood grain laminate options will be current published laminate list price plus 10%.</p> | <p>Sliding doors are not available with locks.</p> <p>Panel hung overhead storage units include hardware to hang unit on panels.</p> <p>Sliding door pulls included, not visible on image.</p> |
| A AutoStrada | | |
| PH Panel hung | | |
| O Overhead | | |
| B Binder depth | | |
| S Open/Sliding (wood) Door | | |
| 42 42" wide | | |
| V316 Finish, Maple | | |
| 118 Pull Finish | | |

To order please specify pattern number including:

- Depth
B = Binder depth
G = Legal depth
- Sliding door material
S = wood, same as case
- Width
- Finish
Laminate, V1, V2 or V3
- Finish, pull
AA-complimentary painted match to anodized aluminum or painted finish options listed on page 7 excluding silver.

See page 7 for finish options applicable.

Product on this page will accept wood grain laminate where laminate is currently an option.
 List price for wood grain laminate options will be current published laminate list price plus 10%.

Overhead storage, wood cases

Panel hung overheads

with sliding glass door(s)

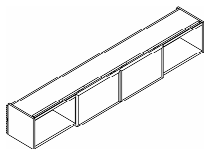
| description | type | sections | h | w | d | pattern no. | L | V1 | V2 | V3 | | |
|---|--------------|----------|-------------|-----|---------|-------------------------|----------|-------------------------|----------|----------|--------|--------|
|  <p>96" w shown</p> | binder depth | 1/1 | 15" | 42" | 15 1/4" | APHOBR42 () () | \$2,977. | \$3,127. | \$3,897. | \$5,067. | | |
| | | 1/1 | 15" | 48" | 15 1/4" | APHOBR48 () () | 3,083. | 3,242. | 4,036. | 5,248. | | |
| | | 1/1 | 15" | 54" | 15 1/4" | APHOBR54 () () | 3,120. | 3,279. | 4,084. | 5,307. | | |
| | | 2/2 | 15" | 60" | 15 1/4" | APHOBR60 () () | 3,155. | 3,316. | 4,130. | 5,369. | | |
| | | 2/2 | 15" | 66" | 15 1/4" | APHOBR66 () () | 3,510. | 3,689. | 4,593. | 5,972. | | |
| | | 2/2 | 15" | 72" | 15 1/4" | APHOBR72 () () | 3,867. | 4,059. | 5,057. | 6,574. | | |
| | | 2/2 | 15" | 78" | 15 1/4" | APHOBR78 () () | 3,995. | 4,196. | 5,224. | 6,792. | | |
| | | 2/2 | 15" | 84" | 15 1/4" | APHOBR84 () () | 4,125. | 4,331. | 5,395. | 7,012. | | |
| | | 2/2 | 15" | 90" | 15 1/4" | APHOBR90 () () | 4,253. | 4,469. | 5,562. | 7,232. | | |
| | | 2/2 | 15" | 96" | 15 1/4" | APHOBR96 () () | 4,407. | 4,633. | 5,764. | 7,494. | | |
| | | | legal depth | 1/1 | 15" | 42" | 18 1/4" | APHOGR42 () () | 3,213. | 3,377. | 4,209. | 5,471. |
| | | | | 1/1 | 15" | 48" | 18 1/4" | APHOGR48 () () | 3,331. | 3,502. | 4,357. | 5,666. |
| | | | | 1/1 | 15" | 54" | 18 1/4" | APHOGR54 () () | 3,370. | 3,540. | 4,410. | 5,734. |
| | | | | 2/2 | 15" | 60" | 18 1/4" | APHOGR60 () () | 3,405. | 3,581. | 4,462. | 5,800. |
| 2/2 | 15" | | | 66" | 18 1/4" | APHOGR66 () () | 3,791. | 3,981. | 4,960. | 6,450. | | |
| 2/2 | 15" | | | 72" | 18 1/4" | APHOGR72 () () | 4,175. | 4,384. | 5,461. | 7,099. | | |
| 2/2 | 15" | | | 78" | 18 1/4" | APHOGR78 () () | 4,315. | 4,531. | 5,643. | 7,335. | | |
| 2/2 | 15" | | | 84" | 18 1/4" | APHOGR84 () () | 4,454. | 4,679. | 5,825. | 7,573. | | |
| 2/2 | 15" | | | 90" | 18 1/4" | APHOGR90 () () | 4,593. | 4,827. | 6,008. | 7,810. | | |
| 2/2 | 15" | | | 96" | 18 1/4" | APHOGR96 () () | 4,759. | 5,004. | 6,224. | 8,092. | | |

| Order Code | Specification Information | Application Notes |
|------------------------------------|---|---|
| Example: APHOBR42V316GL6AA | To order please specify pattern number including: | Sliding doors are not available with locks. |
| A AutoStrada | 1. Depth <i>B = Binder depth</i> <i>G = Legal depth</i> | Panel hung overhead storage units include hardware to hang unit on panels. |
| PH Panel hung | 2. Sliding door material <i>S = wood, same as case</i> | |
| O Overhead | 3. Width | Sliding door pulls included, not visible on image. When AA finish specified pull is complimentary painted match, pull is not anodized. |
| B Binder depth | 4. Finish <i>Laminate, V1, V2 or V3</i> | |
| R Open/Sliding (glass) Door | 5. Finish, Glass sliding door <i>TEMP - Clear, tempered</i> <i>GL6 - Block Matrix</i> <i>GL13 - Powder</i> | See page 7 for finish options applicable. |
| 42 42" wide | 6. Finish, Glass sliding door frame and pull <i>Anodized aluminum or painted finish options listed on page 7 excluding silver.</i> | |
| V316 Finish, Maple | | Product on this page will accept wood grain laminate where laminate is currently an option. List price for wood grain laminate options will be current published laminate list price plus 10%. |
| GL6 Glass, Block Matrix | | |
| AA Frame, anodized aluminum | | |

Overhead storage, wood cases

Wall-attached overheads for private office

open, single high

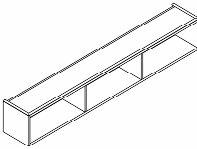
| description | type | h | w | d | pattern no. | L | V1 | V2 | V3 |
|--|-----------------------|-----|-----|---------|--------------------------|----------|----------|----------|----------|
|  <p>96" w shown</p> | binder height & depth | 15" | 30" | 14 1/4" | AWHOBSO30 () () | \$1,595. | \$1,651. | \$1,900. | \$2,468. |
| | | 15" | 36" | 14 1/4" | AWHOBSO36 () () | 1,637. | 1,695. | 1,948. | 2,531. |
| | | 15" | 42" | 14 1/4" | AWHOBSO42 () () | 1,681. | 1,736. | 1,999. | 2,598. |
| | | 15" | 48" | 14 1/4" | AWHOBSO48 () () | 1,726. | 1,783. | 2,051. | 2,667. |
| | | 15" | 54" | 14 1/4" | AWHOBSO54 () () | 1,815. | 1,876. | 2,161. | 2,806. |
| | | 15" | 60" | 14 1/4" | AWHOBSO60 () () | 1,905. | 1,967. | 2,265. | 2,945. |
| | | 15" | 66" | 14 1/4" | AWHOBSO66 () () | 1,960. | 2,026. | 2,328. | 3,029. |
| | | 15" | 72" | 14 1/4" | AWHOBSO72 () () | 2,012. | 2,085. | 2,392. | 3,111. |
| | | 15" | 78" | 14 1/4" | AWHOBSO78 () () | 2,112. | 2,189. | 2,512. | 3,266. |
| | | 15" | 84" | 14 1/4" | AWHOBSO84 () () | 2,177. | 2,254. | 2,588. | 3,364. |
| | | 15" | 90" | 14 1/4" | AWHOBSO90 () () | 2,242. | 2,323. | 2,665. | 3,464. |
| | | 15" | 96" | 14 1/4" | AWHOBSO96 () () | 2,308. | 2,391. | 2,746. | 3,855. |

Units up to 36" w have one section, units 42" w up to 72" wide have two sections, over 72" w have three sections

| description | type | h | w | d | pattern no. | L | V1 | V2 | V3 |
|-------------|-----------------------------|-----|-----|---------|--------------------------|--------|--------|--------|--------|
| | binder height & legal depth | 15" | 30" | 17 1/4" | AWHOGSO30 () () | 1,723. | 1,784. | 2,050. | 2,666. |
| | | 15" | 36" | 17 1/4" | AWHOGSO36 () () | 1,769. | 1,831. | 2,103. | 2,734. |
| | | 15" | 42" | 17 1/4" | AWHOGSO42 () () | 1,814. | 1,876. | 2,159. | 2,806. |
| | | 15" | 48" | 17 1/4" | AWHOGSO48 () () | 1,864. | 1,926. | 2,217. | 2,881. |
| | | 15" | 54" | 17 1/4" | AWHOGSO54 () () | 1,961. | 2,025. | 2,331. | 3,032. |
| | | 15" | 60" | 17 1/4" | AWHOGSO60 () () | 2,059. | 2,125. | 2,445. | 3,180. |
| | | 15" | 66" | 17 1/4" | AWHOGSO66 () () | 2,114. | 2,189. | 2,516. | 3,271. |
| | | 15" | 72" | 17 1/4" | AWHOGSO72 () () | 2,174. | 2,250. | 2,584. | 3,360. |
| | | 15" | 78" | 17 1/4" | AWHOGSO78 () () | 2,282. | 2,364. | 2,715. | 3,528. |
| | | 15" | 84" | 17 1/4" | AWHOGSO84 () () | 2,350. | 2,437. | 2,795. | 3,635. |
| | | 15" | 90" | 17 1/4" | AWHOGSO90 () () | 2,421. | 2,507. | 2,879. | 3,743. |
| | | 15" | 96" | 17 1/4" | AWHOGSO96 () () | 2,494. | 2,582. | 2,966. | 3,855. |

Units up to 36" w have one section, units 42" w up to 72" w have two sections, over 72" wide have three sections

| Order Code | Specification Information | Application Notes |
|---------------------------------|---|--|
| Example: AWHOBSO30V316AA | <p>To order please specify pattern number including:</p> <ol style="list-style-type: none"> Depth B = Binder depth G = Legal depth Width Finish Laminate, V1, V2 or V3 Finish, aluminum trim Anodized aluminum or painted finish options listed on page 7 excluding silver. | <p>Manufacturer assumes no responsibility for the installation, attachment or the securing of wall hung units to the wall. A qualified local building contractor should be consulted to advise securing method and to determine if and what blocking requirements are necessary.</p> <p>Wood cleat included for wall mounting. Two piece cleat, full width of overhead. Each piece nominally 3 3/8" h. Bottom piece attached to wall.</p> |
| A AutoStrada | | |
| WH Wall hung | | |
| O Overhead | | |
| B Binder depth | | |
| S Single high | | |
| O Open | | |
| 30 30" wide | | |
| V316 Finish, Maple | | |
| AA Finish, Aluminum trim | | |

See page 7 for finish options applicable.

Product on this page will accept wood grain laminate where laminate is currently an option. List price for wood grain laminate options will be current published laminate list price plus 10%.

Overhead storage, wood cases

Wall-attached overheads for private office

hinged door, single high

| description | type | # drs/locks | h | w | d | pattern no. | L | V1 | V2 | V3 | | |
|--|----------------------------|-------------|----------------------------------|-----|---------|------------------------------|----------|------------------------------|----------|----------|--------|--------|
| Wall hung overhead Hinged doors (wood) single high | binder height and depth | 2/1 | 15" | 30" | 15 1/4" | AWHOBSD30 () () () | \$2,322. | \$2,399. | \$2,758. | \$3,585. | | |
| | | 2/1 | 15" | 36" | 15 1/4" | AWHOBSD36 () () () | 2,452. | 2,538. | 2,917. | 3,792. | | |
| | | 3/2 | 15" | 42" | 15 1/4" | AWHOBSD42 () () () | 2,471. | 2,557. | 2,939. | 3,820. | | |
| | | 3/2 | 15" | 48" | 15 1/4" | AWHOBSD48 () () () | 2,520. | 2,603. | 2,996. | 3,896. | | |
| | | 3/2 | 15" | 54" | 15 1/4" | AWHOBSD54 () () () | 2,650. | 2,739. | 3,154. | 4,098. | | |
| | | 4/2 | 15" | 60" | 15 1/4" | AWHOBSD60 () () () | 2,776. | 2,867. | 3,299. | 4,290. | | |
| | | 4/2 | 15" | 66" | 15 1/4" | AWHOBSD66 () () () | 2,859. | 2,958. | 3,400. | 4,421. | | |
| | | 4/2 | 15" | 72" | 15 1/4" | AWHOBSD72 () () () | 2,937. | 3,036. | 3,493. | 4,539. | | |
| | | 5/3 | 15" | 78" | 15 1/4" | AWHOBSD78 () () () | 3,086. | 3,195. | 3,669. | 4,769. | | |
| | | 5/3 | 15" | 84" | 15 1/4" | AWHOBSD84 () () () | 3,178. | 3,293. | 3,778. | 4,912. | | |
| | | 6/3 | 15" | 90" | 15 1/4" | AWHOBSD90 () () () | 3,273. | 3,390. | 3,893. | 5,061. | | |
| | | 6/3 | 15" | 96" | 15 1/4" | AWHOBSD96 () () () | 3,372. | 3,493. | 4,009. | 5,211. | | |
| | | | binder height and legal depth | 2/1 | 15" | 30" | 18 1/4" | AWHOGSD30 () () () | 2,507. | 2,590. | 2,979. | 3,872. |
| | | | | 2/1 | 15" | 36" | 18 1/4" | AWHOGSD36 () () () | 2,649. | 2,741. | 3,153. | 4,096. |
| | | | | 3/2 | 15" | 42" | 18 1/4" | AWHOGSD42 () () () | 2,667. | 2,760. | 3,174. | 4,126. |
| | | | | 3/2 | 15" | 48" | 18 1/4" | AWHOGSD48 () () () | 2,721. | 2,810. | 3,237. | 4,209. |
| 3/2 | 15" | | | 54" | 18 1/4" | AWHOGSD54 () () () | 2,863. | 2,957. | 3,404. | 4,425. | | |
| 4/2 | 15" | | | 60" | 18 1/4" | AWHOGSD60 () () () | 2,997. | 3,098. | 3,563. | 4,633. | | |
| 4/2 | 15" | | | 66" | 18 1/4" | AWHOGSD66 () () () | 3,088. | 3,194. | 3,673. | 4,774. | | |
| 4/2 | 15" | | | 72" | 18 1/4" | AWHOGSD72 () () () | 3,173. | 3,279. | 3,772. | 4,902. | | |
| 5/3 | 15" | | | 78" | 18 1/4" | AWHOGSD78 () () () | 3,332. | 3,452. | 3,962. | 5,150. | | |
| 5/3 | 15" | | | 84" | 18 1/4" | AWHOGSD84 () () () | 3,432. | 3,556. | 4,080. | 5,305. | | |
| 6/3 | 15" | | | 90" | 18 1/4" | AWHOGSD90 () () () | 3,535. | 3,661. | 4,204. | 5,465. | | |
| 6/3 | 15" | | | 96" | 18 1/4" | AWHOGSD96 () () () | 3,640. | 3,772. | 4,330. | 5,628. | | |

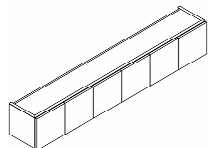

96" w shown

| Order Code | Specification Information |
|----------------------------------|---------------------------|
| Example: AWHOBSD30LV316AA | |
| A | AutoStrada |
| WH | Wall hung |
| O | Overhead |
| B | Binder depth |
| S | Single high |
| D | Hinged doors, wood |
| 30 | 30" wide |
| L | Lock holes drilled |
| V316 | Finish, Maple |
| AA | Finish, Aluminum trim |

Specification Information

To order please specify pattern number including:

- Depth
B = Binder depth
G = Legal depth
- Width
- Lock
L = lock hole drilled
N = not drilled for locks
- Finish
Laminate, V1, V2 or V3
- Finish, aluminum trim
Anodized aluminum or painted finish options listed on page 7 excluding silver.

See page 7 for finish options applicable.

Product on this page will accept wood grain laminate where laminate is currently an option. List price for wood grain laminate options will be current published laminate list price plus 10%.

Application Notes

Manufacturer assumes no responsibility for the installation, attachment or the securing of wall hung units to the wall. A qualified local building contractor should be consulted to advise securing method and to determine if and what blocking requirements are necessary.

Single high overhead storage to be mounted at 68 1/2" from floor to top of overhead unit. Dimension is to top of wood side gable of corresponding 70" h floor standing cabinet not including aluminum and wood top trim.

Hinged doors extend slightly beyond case construction to allow for easy finger pull access along the bottom. No pulls available.

Optional lock drilling to be specified. If drilled for locks selected, keying instructions must accompany order.

Wood cleat included for wall mounting. Two piece cleat, full width of overhead. Each piece nominally 3 3/8" h. Bottom piece attached to wall.

Overhead storage, wood cases

Wall-attached overheads for private office

open / hinged door / open, single high

| description | type | h | w | d | pattern no. | L | V1 | V2 | V3 |
|---|-----------------------------|-----|-----|---------|--------------------------|----------|----------|----------|----------|
| Wall hung overhead Open/Hinged doors (wood) single high | binder height & depth | 15" | 60" | 15 1/4" | AWHOBST60 () () | \$2,001. | \$2,066. | \$2,378. | \$3,094. |
| | | 15" | 66" | 15 1/4" | AWHOBST66 () () | 2,058. | 2,127. | 2,445. | 3,179. |
| | | 15" | 72" | 15 1/4" | AWHOBST72 () () | 2,112. | 2,189. | 2,512. | 3,266. |
| | | 15" | 78" | 15 1/4" | AWHOBST78 () () | 2,218. | 2,299. | 2,639. | 3,431. |
| | | 15" | 84" | 15 1/4" | AWHOBST84 () () | 2,285. | 2,366. | 2,717. | 3,533. |
| | | 15" | 90" | 15 1/4" | AWHOBST90 () () | 2,352. | 2,439. | 2,798. | 3,639. |
| | | 15" | 96" | 15 1/4" | AWHOBST96 () () | 2,425. | 2,511. | 2,883. | 3,748. |
| 96" w shown | binder height & legal depth | 15" | 60" | 18 1/4" | AWHOGST60 () () | 2,162. | 2,231. | 2,568. | 3,338. |
| | | 15" | 66" | 18 1/4" | AWHOGST66 () () | 2,222. | 2,298. | 2,641. | 3,435. |
| | | 15" | 72" | 18 1/4" | AWHOGST72 () () | 2,282. | 2,364. | 2,715. | 3,528. |
| | | 15" | 78" | 18 1/4" | AWHOGST78 () () | 2,397. | 2,482. | 2,848. | 3,704. |
| | | 15" | 84" | 18 1/4" | AWHOGST84 () () | 2,467. | 2,557. | 2,936. | 3,815. |
| | | 15" | 90" | 18 1/4" | AWHOGST90 () () | 2,543. | 2,634. | 3,023. | 3,929. |
| | | 15" | 96" | 18 1/4" | AWHOGST96 () () | 2,618. | 2,713. | 3,114. | 4,048. |

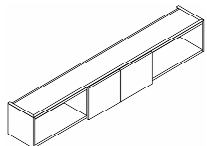

| Order Code | Specification Information | Application Notes |
|----------------------------------|---|--|
| Example: AWHOBST60LV316AA | <i>To order please specify pattern number including:</i> | Manufacturer assumes no responsibility for the installation, attachment or the securing of wall hung units to the wall. A qualified local building contractor should be consulted to advise securing method and to determine if and what blocking requirements are necessary. |
| A AutoStrada | 1. Depth <i>B = Binder depth G = Legal depth</i> | Hinged doors extend slightly beyond case construction to allow for easy finger pull access along the bottom. No pulls available. |
| WH Wall hung | 2. Width | Optional lock drilling to be specified. If drilled for locks selected, keying instructions must accompany order. |
| O Overhead | 3. Lock <i>L = lock hole drilled N = not drilled for locks</i> | Wood cleat included for wall mounting. Two piece cleat, full width of overhead. Each piece nominally 3 3/8" h. Bottom piece attached to wall. |
| B Binder depth | 4. Finish <i>Laminate, V1, V2 or V3</i> | |
| S Single high | 5. Finish, aluminum trim <i>Anodized aluminum or painted finish options listed on page 7 excluding silver.</i> | |
| T Open/Hinged doors/Open | | |
| 60 60" wide | | |
| L Lock holes drilled | | |
| V316 Finish, Maple | | |
| AA Finish, Aluminum trim | | |

See page 7 for finish options applicable.

Product on this page will accept wood grain laminate where laminate is currently an option. List price for wood grain laminate options will be current published laminate list price plus 10%.

Overhead storage, wood cases

Wall-attached overheads for private office with sliding door(s), single high

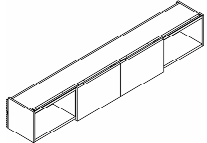
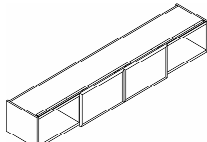
| description | type | h | w | d | pattern no. | L | V1 | V2 | V3 |
|---|-------------------------------|---------|--------------------------|---------|--------------------------|----------|----------|----------|----------|
| Wall hung overhead Open/Sliding door(s) wood single high  96" w shown | binder height and depth | 15" | 60" | 15 1/4" | AWHOBSS60 () () | \$2,858. | \$3,010. | \$3,807. | \$4,948. |
| | | 15" | 66" | 15 1/4" | AWHOBSS66 () () | 2,939. | 3,099. | 3,913. | 5,086. |
| | | 15" | 72" | 15 1/4" | AWHOBSS72 () () | 3,020. | 3,190. | 4,020. | 5,226. |
| | | 15" | 78" | 15 1/4" | AWHOBSS78 () () | 3,170. | 3,348. | 4,223. | 5,488. |
| | | 15" | 84" | 15 1/4" | AWHOBSS84 () () | 3,263. | 3,449. | 4,348. | 5,654. |
| | | 15" | 90" | 15 1/4" | AWHOBSS90 () () | 3,362. | 3,554. | 4,478. | 5,823. |
| | binder height and legal depth | 15" | 60" | 18 1/4" | AWHOGSS60 () () | 3,086. | 3,253. | 4,111. | 5,343. |
| | | 15" | 66" | 18 1/4" | AWHOGSS66 () () | 3,174. | 3,348. | 4,226. | 5,495. |
| | | 15" | 72" | 18 1/4" | AWHOGSS72 () () | 3,259. | 3,444. | 4,343. | 5,644. |
| | | 15" | 78" | 18 1/4" | AWHOGSS78 () () | 3,423. | 3,618. | 4,559. | 5,926. |
| | | 15" | 84" | 18 1/4" | AWHOGSS84 () () | 3,524. | 3,726. | 4,695. | 6,104. |
| | | 15" | 90" | 18 1/4" | AWHOGSS90 () () | 3,632. | 3,837. | 4,835. | 6,289. |
| Wall hung overhead Open/Sliding door(s) glass single high  96" w shown | binder height and depth | 15" | 60" | 15 1/4" | AWHOBSR60 () () | 3,410. | 3,581. | 4,463. | 5,356. |
| | | 15" | 66" | 15 1/4" | AWHOBSR66 () () | 3,506. | 3,689. | 4,590. | 5,506. |
| | | 15" | 72" | 15 1/4" | AWHOBSR72 () () | 3,601. | 3,794. | 4,714. | 5,658. |
| | | 15" | 78" | 15 1/4" | AWHOBSR78 () () | 3,782. | 3,986. | 4,950. | 5,941. |
| | | 15" | 84" | 15 1/4" | AWHOBSR84 () () | 3,896. | 4,105. | 5,099. | 6,118. |
| | | 15" | 90" | 15 1/4" | AWHOBSR90 () () | 4,012. | 4,226. | 5,252. | 6,302. |
| | binder height and legal depth | 15" | 60" | 18 1/4" | AWHOGSR60 () () | 3,681. | 3,868. | 4,820. | 5,784. |
| | | 15" | 66" | 18 1/4" | AWHOGSR66 () () | 3,787. | 3,981. | 4,955. | 5,947. |
| | | 15" | 72" | 18 1/4" | AWHOGSR72 () () | 3,889. | 4,097. | 5,092. | 6,110. |
| | | 15" | 78" | 18 1/4" | AWHOGSR78 () () | 4,085. | 4,304. | 5,346. | 6,417. |
| | | 15" | 84" | 18 1/4" | AWHOGSR84 () () | 4,206. | 4,433. | 5,506. | 6,608. |
| | | 15" | 90" | 18 1/4" | AWHOGSR90 () () | 4,333. | 4,564. | 5,673. | 6,808. |
| 15" | 96" | 18 1/4" | AWHOGSR96 () () | 4,464. | 4,702. | 5,841. | 7,011. | | |

| Order Code | Specification Information | Application Notes |
|------------------------------------|---|---|
| Example: AWHOBSS60V316AA | <i>To order please specify pattern number including:</i> | <p>Manufacturer assumes no responsibility for the installation, attachment or the securing of wall hung units to the wall. A qualified local building contractor should be consulted to advise securing method and to determine if and what blocking requirements are necessary.</p> <p>Single high overhead storage to be mounted at 68 1/2" from floor to top of overhead unit. Dimension is to top of wood side gable of corresponding 70" h floor standing cabinet not including aluminum and wood top trim.</p> <p>Sliding door pulls included, not visible on image.</p> |
| A AutoStrada | 1. Depth <i>B = Binder depth G = Legal depth</i> | |
| WH Wall hung | 2. Sliding door material <i>S = wood, same as case R = glass</i> | |
| O Overhead | 3. Width | |
| B Binder depth | 4. Finish <i>Laminate, V1, V2 or V3</i> | |
| S Single high | 5. Finish, Glass sliding door (as applicable) <i>TEMP - Clear, tempered GL6 - Block Matrix GL13 - Powder</i> | |
| S Open/Sliding door(s)/wood | 6. Finish, Glass sliding door frame and pull (as applicable) <i>Anodized aluminum or painted finish options listed on page 7 excluding silver.</i> | <p>Wood cleat included for wall mounting. Two piece cleat, full width of overhead. Each piece nominally 3 3/8" h. Bottom piece attached to wall.</p> <p>Sliding doors are not available with locks. When AA finish specified pull is complimentary painted match, pull is not anodized.</p> |
| 60 60" wide | | See page 7 for finish options applicable. |
| V316 Finish, Maple | | Product on this page will accept wood grain laminate where laminate is currently an option. |
| AA Finish, Aluminum trim | | List price for wood grain laminate options will be current published laminate list price plus 10%. |

Overhead storage, wood cases

Wall-attached overheads for private office

open, double high

| description | type | h | w | d | pattern no. | L | V1 | V2 | V3 |
|--------------------------------------|-----------------------|-----|-----|---------|--------------------------|----------|----------|----------|----------|
| Wall hung overhead open, double high | binder height & depth | 29" | 30" | 14 1/4" | AWHOBDO30 () () | \$2,152. | \$2,230. | \$2,564. | \$3,333. |
| | | 29" | 36" | 14 1/4" | AWHOBDO36 () () | 2,211. | 2,289. | 2,629. | 3,420. |
| | | 29" | 42" | 14 1/4" | AWHOBDO42 () () | 2,268. | 2,345. | 2,699. | 3,508. |
| | | 29" | 48" | 14 1/4" | AWHOBDO48 () () | 2,328. | 2,407. | 2,772. | 3,601. |
| | | 29" | 54" | 14 1/4" | AWHOBDO54 () () | 2,450. | 2,530. | 2,915. | 3,790. |
| | | 29" | 60" | 14 1/4" | AWHOBDO60 () () | 2,574. | 2,656. | 3,058. | 3,976. |
| | | 29" | 66" | 14 1/4" | AWHOBDO66 () () | 2,643. | 2,734. | 3,143. | 4,088. |
| | | 29" | 72" | 14 1/4" | AWHOBDO72 () () | 2,716. | 2,815. | 3,231. | 4,200. |
| | | 29" | 78" | 14 1/4" | AWHOBDO78 () () | 2,853. | 2,956. | 3,393. | 4,410. |
| | | 29" | 84" | 14 1/4" | AWHOBDO84 () () | 2,939. | 3,044. | 3,495. | 4,543. |
| | | 29" | 90" | 14 1/4" | AWHOBDO90 () () | 3,025. | 3,135. | 3,598. | 4,679. |
| | | 29" | 96" | 14 1/4" | AWHOBDO96 () () | 3,116. | 3,230. | 3,708. | 5,205. |

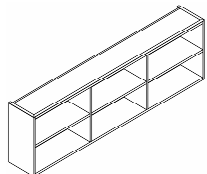

96" w shown

units up to 36" w have one section, 42" w up to 72" w have two sections, over 72" w have three sections

| description | type | h | w | d | pattern no. | L | V1 | V2 | V3 |
|-----------------------------|-----------------------------|-----|-----|---------|--------------------------|--------|--------|--------|--------|
| binder height & legal depth | binder height & legal depth | 29" | 30" | 17 1/4" | AWHOGDO30 () () | 2,325. | 2,408. | 2,770. | 3,599. |
| | | 29" | 36" | 17 1/4" | AWHOGDO36 () () | 2,389. | 2,471. | 2,841. | 3,692. |
| | | 29" | 42" | 17 1/4" | AWHOGDO42 () () | 2,449. | 2,531. | 2,914. | 3,789. |
| | | 29" | 48" | 17 1/4" | AWHOGDO48 () () | 2,516. | 2,599. | 2,993. | 3,890. |
| | | 29" | 54" | 17 1/4" | AWHOGDO54 () () | 2,646. | 2,733. | 3,148. | 4,092. |
| | | 29" | 60" | 17 1/4" | AWHOGDO60 () () | 2,778. | 2,867. | 3,304. | 4,293. |
| | | 29" | 66" | 17 1/4" | AWHOGDO66 () () | 2,857. | 2,955. | 3,396. | 4,414. |
| | | 29" | 72" | 17 1/4" | AWHOGDO72 () () | 2,934. | 3,041. | 3,490. | 4,537. |
| | | 29" | 78" | 17 1/4" | AWHOGDO78 () () | 3,081. | 3,192. | 3,663. | 4,763. |
| | | 29" | 84" | 17 1/4" | AWHOGDO84 () () | 3,174. | 3,287. | 3,774. | 4,907. |
| | | 29" | 90" | 17 1/4" | AWHOGDO90 () () | 3,269. | 3,386. | 3,887. | 5,054. |
| | | 29" | 96" | 17 1/4" | AWHOGDO96 () () | 3,366. | 3,489. | 4,004. | 5,205. |

units up to 36" w have one section, 42" w up to 72" w have two sections, over 72" w have three sections

| Order Code | Specification Information | Application Notes |
|---------------------------------|---|---|
| Example: AWHOBDO30V316AA | <i>To order please specify pattern number including:</i> | <p>Manufacturer assumes no responsibility for the installation, attachment or the securing of wall hung units to the wall. A qualified local building contractor should be consulted to advise securing method and to determine if and what blocking requirements are necessary.</p> |
| A AutoStrada | 1. Depth <i>B = Binder depth</i> <i>G = Legal depth</i> | |
| WH Wall hung | 2. Width | <p>Double high overhead storage to be mounted at 82-5/16" from floor to top of overhead unit. Dimension is to top of wood side gable of corresponding 84" h floor standing cabinet not including aluminum and wood top trim.</p> |
| O Overhead | 3. Finish <i>Laminate, V1, V2 or V3</i> | |
| B Binder depth | 4. Finish, aluminum trim <i>Anodized aluminum or painted finish options listed on page 7 excluding silver.</i> | <p>Wood cleat included for wall mounting. Two piece cleat, full width of overhead. Each piece nominally 3 3/8" h. Bottom piece attached to wall.</p> |
| D Double high | | |
| O Open | | |
| 30 30" wide | | |
| V316 Finish, Maple | | |
| AA Finish, Aluminum trim | | |

See page 7 for finish options applicable.

Product on this page will accept wood grain laminate where laminate is currently an option. List price for wood grain laminate options will be current published laminate list price plus 10%.

Overhead storage, wood cases

Wall-attached overheads for private office

hinged door, double high

| description | type | # drs/locks | h | w | d | pattern no. | L | V1 | V2 | V3 | |
|--|----------------------------|----------------------------------|-----|---------|--------------------------|--------------------------|--------------------------|----------|----------|----------|--------|
| Wall hung overhead Hinged doors (wood) double high | binder height and depth | 2/1 | 29" | 30" | 15 1/4" | AWHOBDD30 () () | \$3,133. | \$3,239. | \$3,723. | \$4,841. | |
| | | 2/1 | 29" | 36" | 15 1/4" | AWHOBDD36 () () | 3,311. | 3,424. | 3,938. | 5,120. | |
| | | 3/2 | 29" | 42" | 15 1/4" | AWHOBDD42 () () | 3,336. | 3,450. | 3,968. | 5,157. | |
| | | 3/2 | 29" | 48" | 15 1/4" | AWHOBDD48 () () | 3,400. | 3,514. | 4,046. | 5,260. | |
| | | 3/2 | 29" | 54" | 15 1/4" | AWHOBDD54 () () | 3,578. | 3,697. | 4,255. | 5,532. | |
| | | 4/2 | 29" | 60" | 15 1/4" | AWHOBDD60 () () | 3,748. | 3,873. | 4,455. | 5,792. | |
| | | 4/2 | 29" | 66" | 15 1/4" | AWHOBDD66 () () | 3,860. | 3,993. | 4,591. | 5,968. | |
| | | 4/2 | 29" | 72" | 15 1/4" | AWHOBDD72 () () | 3,965. | 4,098. | 4,714. | 6,128. | |
| | | 5/3 | 29" | 78" | 15 1/4" | AWHOBDD78 () () | 4,165. | 4,314. | 4,953. | 6,438. | |
| | | 5/3 | 29" | 84" | 15 1/4" | AWHOBDD84 () () | 4,289. | 4,443. | 5,103. | 6,632. | |
| | | 6/3 | 29" | 90" | 15 1/4" | AWHOBDD90 () () | 4,418. | 4,577. | 5,256. | 6,831. | |
| | | 6/3 | 29" | 96" | 15 1/4" | AWHOBDD96 () () | 4,551. | 4,714. | 5,411. | 7,036. | |
| | | binder height and legal depth | 2/1 | 29" | 30" | 18 1/4" | AWHOGDD30 () () | 3,383. | 3,497. | 4,020. | 5,226. |
| | | | 2/1 | 29" | 36" | 18 1/4" | AWHOGDD36 () () | 3,575. | 3,698. | 4,254. | 5,528. |
| 3/2 | 29" | | 42" | 18 1/4" | AWHOGDD42 () () | 3,602. | 3,727. | 4,285. | 5,569. | | |
| 3/2 | 29" | | 48" | 18 1/4" | AWHOGDD48 () () | 3,674. | 3,795. | 4,370. | 5,682. | | |
| 3/2 | 29" | | 54" | 18 1/4" | AWHOGDD54 () () | 3,864. | 3,992. | 4,595. | 5,974. | | |
| 4/2 | 29" | | 60" | 18 1/4" | AWHOGDD60 () () | 4,047. | 4,185. | 4,810. | 6,254. | | |
| 4/2 | 29" | | 66" | 18 1/4" | AWHOGDD66 () () | 4,170. | 4,312. | 4,959. | 6,445. | | |
| 4/2 | 29" | | 72" | 18 1/4" | AWHOGDD72 () () | 4,281. | 4,426. | 5,091. | 6,618. | | |
| 5/3 | 29" | | 78" | 18 1/4" | AWHOGDD78 () () | 4,496. | 4,659. | 5,349. | 6,955. | | |
| 5/3 | 29" | | 84" | 18 1/4" | AWHOGDD84 () () | 4,632. | 4,801. | 5,509. | 7,164. | | |
| 6/3 | 29" | | 90" | 18 1/4" | AWHOGDD90 () () | 4,771. | 4,942. | 5,675. | 7,377. | | |
| 6/3 | 29" | | 96" | 18 1/4" | AWHOGDD96 () () | 4,914. | 5,091. | 5,844. | 7,598. | | |

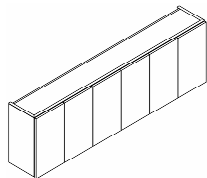

96" w shown

| Order Code | Specification Information |
|----------------------------------|---------------------------|
| Example: AWHOBDD30LV316AA | |
| A | AutoStrada |
| WH | Wall hung |
| O | Overhead |
| B | Binder depth |
| D | Double high |
| D | Hinged doors, wood |
| 30 | 30" wide |
| L | Lock holes drilled |
| V316 | Finish, Maple |
| AA | Finish, Aluminum trim |

Specification Information

To order please specify pattern number including:

- Depth
B = Binder depth
G = Legal depth
- Width
- Lock
L = lock hole drilled
N = not drilled for locks
- Finish
Laminate, V1, V2 or V3
- Finish, aluminum trim
Anodized aluminum or painted finish options listed on page 7 excluding silver.

See page 7 for finish options applicable.

Product on this page will accept wood grain laminate where laminate is currently an option. List price for wood grain laminate options will be current published laminate list price plus 10%.

Application Notes

Manufacturer assumes no responsibility for the installation, attachment or the securing of wall hung units to the wall. A qualified local building contractor should be consulted to advise securing method and to determine if and what blocking requirements are necessary.

Double high overhead storage to be mounted at 82-5/16" from floor to top of overhead unit. Dimension is to top of wood side gable of corresponding 84" h floor standing cabinet not including aluminum and wood top trim.

Hinged doors extend slightly beyond case construction to allow for easy finger pull access along the bottom. No pulls available.

Optional lock drilling to be specified. If drilled for locks selected, keying instructions must accompany order.

Wood cleat included for wall mounting. Two piece cleat, full width of overhead. Each piece nominally 3 3/8" h. Bottom piece attached to wall.

Overhead storage, wood cases

Wall-attached overheads for private office

open / hinged door / open, double high

| description | type | h | w | d | pattern no. | L | V1 | V2 | V3 |
|---|-----------------------------|-----|-----|---------|--------------------------|----------|----------|----------|----------|
| Wall hung overhead Open/Hinged doors (wood) double high | binder height & depth | 29" | 60" | 15 1/4" | AWHOBTD60 () () | \$2,701. | \$2,789. | \$3,211. | \$4,175. |
| | | 29" | 66" | 15 1/4" | AWHOBTD66 () () | 2,778. | 2,872. | 3,300. | 4,292. |
| | | 29" | 72" | 15 1/4" | AWHOBTD72 () () | 2,853. | 2,956. | 3,393. | 4,410. |
| | | 29" | 78" | 15 1/4" | AWHOBTD78 () () | 2,995. | 3,103. | 3,561. | 4,630. |
| | | 29" | 84" | 15 1/4" | AWHOBTD84 () () | 3,084. | 3,195. | 3,669. | 4,769. |
| | | 29" | 90" | 15 1/4" | AWHOBTD90 () () | 3,178. | 3,293. | 3,778. | 4,912. |
| | | 29" | 96" | 15 1/4" | AWHOBTD96 () () | 3,272. | 3,390. | 3,893. | 5,061. |
| | binder height & legal depth | 29" | 60" | 18 1/4" | AWHOGDT60 () () | 2,916. | 3,012. | 3,469. | 4,508. |
| | | 29" | 66" | 18 1/4" | AWHOGDT66 () () | 2,997. | 3,103. | 3,565. | 4,636. |
| | | 29" | 72" | 18 1/4" | AWHOGDT72 () () | 3,081. | 3,192. | 3,663. | 4,763. |
| | | 29" | 78" | 18 1/4" | AWHOGDT78 () () | 3,234. | 3,352. | 3,847. | 5,002. |
| | | 29" | 84" | 18 1/4" | AWHOGDT84 () () | 3,332. | 3,452. | 3,962. | 5,150. |
| | | 29" | 90" | 18 1/4" | AWHOGDT90 () () | 3,432. | 3,556. | 4,080. | 5,305. |
| | | 29" | 96" | 18 1/4" | AWHOGDT96 () () | 3,535. | 3,661. | 4,204. | 5,465. |

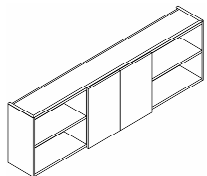

| Order Code | Specification Information | Application Notes |
|----------------------------------|---|--|
| Example: AWHOBTD60LV316AA | <i>To order please specify pattern number including:</i> | Manufacturer assumes no responsibility for the installation, attachment or the securing of wall hung units to the wall. A qualified local building contractor should be consulted to advise securing method and to determine if and what blocking requirements are necessary. |
| A AutoStrada | 1. Depth <i>B = Binder depth G = Legal depth</i> | Overhead configuration for all widths of open/hinged door/open units is two hinged doors in the center and two open ends. Hinged doors extend slightly beyond case construction to allow for easy finger pull access along the bottom. No pulls available. |
| WH Wall hung | 2. Width | |
| O Overhead | 3. Lock <i>L = lock hole drilled N = not drilled for locks</i> | Optional lock drilling to be specified. If drilled for locks selected, keying instructions must accompany order. |
| B Binder depth | 4. Finish <i>Laminate, V1, V2 or V3</i> | |
| D Double high | 5. Finish, aluminum trim <i>Anodized aluminum or painted finish options listed on page 7 excluding silver.</i> | Wood cleat included for wall mounting. Two piece cleat, full width of overhead. Each piece nominally 3 3/8" h. Bottom piece attached to wall. |
| T Open/Hinged doors/Open | See page 7 for finish options applicable. | |
| 60 60" wide | Product on this page will accept wood grain laminate where laminate is currently an option. | |
| L Lock holes drilled | List price for wood grain laminate options will be current published laminate list price plus 10%. | |
| V316 Finish, Maple | | |
| AA Finish, Aluminum trim | | |

Overhead storage, wood cases

Wall-attached overheads for private office with sliding door(s), double high

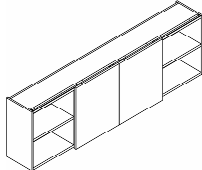
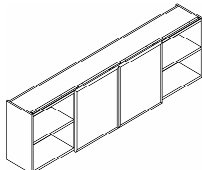
| description | type | h | w | d | pattern no. | L | V1 | V2 | V3 |
|--|-------------------------------|-----|-----|---------|--------------------------|----------|----------|----------|----------|
| Wall hung overhead Open/Sliding door(s) wood double high  96" w shown | binder height and depth | 29" | 60" | 15 1/4" | AWHOBDS60 () () | \$3,858. | \$4,065. | \$5,138. | \$6,680. |
| | | 29" | 66" | 15 1/4" | AWHOBDS66 () () | 3,966. | 4,186. | 5,283. | 6,869. |
| | | 29" | 72" | 15 1/4" | AWHOBDS72 () () | 4,074. | 4,306. | 5,426. | 7,055. |
| | | 29" | 78" | 15 1/4" | AWHOBDS78 () () | 4,278. | 4,521. | 5,699. | 7,410. |
| | | 29" | 84" | 15 1/4" | AWHOBDS84 () () | 4,407. | 4,657. | 5,870. | 7,632. |
| | | 29" | 90" | 15 1/4" | AWHOBDS90 () () | 4,539. | 4,795. | 6,047. | 7,861. |
| | | 29" | 96" | 15 1/4" | AWHOBDS96 () () | 4,675. | 4,940. | 6,226. | 8,098. |
| | binder height and legal depth | 29" | 60" | 18 1/4" | AWHOGDS60 () () | 4,167. | 4,389. | 5,549. | 7,213. |
| | | 29" | 66" | 18 1/4" | AWHOGDS66 () () | 4,283. | 4,520. | 5,706. | 7,418. |
| | | 29" | 72" | 18 1/4" | AWHOGDS72 () () | 4,402. | 4,651. | 5,861. | 7,622. |
| | | 29" | 78" | 18 1/4" | AWHOGDS78 () () | 4,621. | 4,883. | 6,155. | 8,002. |
| | | 29" | 84" | 18 1/4" | AWHOGDS84 () () | 4,760. | 5,028. | 6,340. | 8,243. |
| | | 29" | 90" | 18 1/4" | AWHOGDS90 () () | 4,902. | 5,182. | 6,531. | 8,490. |
| | | 29" | 96" | 18 1/4" | AWHOGDS96 () () | 5,050. | 5,336. | 6,726. | 8,744. |
| Wall hung overhead Open/Sliding door(s) glass double high  96" w shown | binder height and depth | 29" | 60" | 15 1/4" | AWHOBDR60 () () | 4,605. | 4,834. | 6,024. | 7,231. |
| | | 29" | 66" | 15 1/4" | AWHOBDR66 () () | 4,734. | 4,979. | 6,196. | 7,434. |
| | | 29" | 72" | 15 1/4" | AWHOBDR72 () () | 4,863. | 5,122. | 6,365. | 7,637. |
| | | 29" | 78" | 15 1/4" | AWHOBDR78 () () | 5,106. | 5,378. | 6,683. | 8,021. |
| | | 29" | 84" | 15 1/4" | AWHOBDR84 () () | 5,260. | 5,539. | 6,884. | 8,261. |
| | | 29" | 90" | 15 1/4" | AWHOBDR90 () () | 5,418. | 5,706. | 7,091. | 8,508. |
| | | 29" | 96" | 15 1/4" | AWHOBDR96 () () | 5,578. | 5,877. | 7,302. | 8,765. |
| | binder height and legal depth | 29" | 60" | 18 1/4" | AWHOGDR60 () () | 4,971. | 5,222. | 6,507. | 7,809. |
| | | 29" | 66" | 18 1/4" | AWHOGDR66 () () | 5,111. | 5,376. | 6,691. | 8,029. |
| | | 29" | 72" | 18 1/4" | AWHOGDR72 () () | 5,251. | 5,532. | 6,874. | 8,249. |
| | | 29" | 78" | 18 1/4" | AWHOGDR78 () () | 5,514. | 5,808. | 7,218. | 8,661. |
| | | 29" | 84" | 18 1/4" | AWHOGDR84 () () | 5,680. | 5,983. | 7,434. | 8,921. |
| | | 29" | 90" | 18 1/4" | AWHOGDR90 () () | 5,850. | 6,162. | 7,656. | 9,190. |
| | | 29" | 96" | 18 1/4" | AWHOGDR96 () () | 6,025. | 6,346. | 7,888. | 9,464. |

| Order Code | Specification Information | Application Notes |
|------------------------------------|---|--|
| Example: AWHOBDS60V316AA | <i>To order please specify pattern number including:</i> | Manufacturer assumes no responsibility for the installation, attachment or the securing of wall hung units to the wall. A qualified local building contractor should be consulted to advise securing method and to determine if and what blocking requirements are necessary. |
| A AutoStrada | 1. Depth <i>B = Binder depth G = Legal depth</i> | |
| WH Wall hung | 2. Sliding door material <i>S = wood, same as case R = glass</i> | Double high overhead storage to be mounted at 82-5/16" from floor to top of overhead unit. Dimension is to top of wood side gable of corresponding 84" h floor standing cabinet not including aluminum and wood top trim. Sliding door pulls included, not visible on image. |
| O Overhead | 3. Width | |
| B Binder depth | 4. Finish <i>Laminate, V1, V2 or V3</i> | Wood cleat included for wall mounting. Two piece cleat, full width of overhead. Each piece nominally 3 3/8" h. Bottom piece attached to wall. |
| D Double high | 5. Finish, Glass sliding door (as applicable) <i>TEMP - Clear, tempered GL6 - Block Matrix GL13 - Powder</i> | |
| S Open/Sliding door(s)/wood | 6. Finish, Glass sliding door frame and pull (as applicable) <i>Anodized aluminum or painted finish options listed on page 7 excluding silver.</i> | Sliding doors are not available with locks. When AA finish specified pull is complimentary painted match, pull is not anodized. |
| 60 60" wide | | See page 7 for finish options applicable. |
| V316 Finish, Maple | | Product on this page will accept wood grain laminate where laminate is currently an option. List price for wood grain laminate options will be current published laminate list price plus 10%. |
| AA Finish, Aluminum trim | | |

Reuter flat front overhead cabinet
flat front
Designed by Robert Reuter

| description | w | d | h | pattern no. | P3 | L | V1 | V2 | V3 |
|---|-----|---------|---------|------------------------------|--------|--------|----------|----------|----------|
| Enclosed cabinet (no mounting hardware) - One door, no pull, no lock | 30" | 14 1/4" | 14 3/4" | RO3-A30NN () () () | \$898. | \$961. | \$1,047. | \$1,092. | \$1,322. |
| | 36" | 14 1/4" | 14 3/4" | RO3-A36NN () () () | 1,012. | 1,091. | 1,214. | 1,278. | 1,629. |
| | 42" | 14 1/4" | 14 3/4" | RO3-A42NN () () () | 1,132. | 1,240. | 1,407. | 1,502. | 2,013. |
| | 48" | 14 1/4" | 14 3/4" | RO3-A48NN () () () | 1,326. | 1,399. | 1,523. | 1,636. | 2,335. |
| Enclosed cabinet (no mounting hardware) - Two doors, no pull, no lock | 60" | 14 1/4" | 14 3/4" | RO3-A60NN () () () | 1,722. | 1,865. | 1,946. | 2,048. | 2,536. |
| | 72" | 14 1/4" | 14 3/4" | RO3-A72NN () () () | 1,964. | 2,106. | 2,259. | 2,396. | 3,143. |
| Enclosed cabinet (no mounting hardware) - One door, no pull, with lock | 30" | 14 1/4" | 14 3/4" | RO3-A30NL () () () | 960. | 1,023. | 1,108. | 1,154. | 1,382. |
| | 36" | 14 1/4" | 14 3/4" | RO3-A36NL () () () | 1,075. | 1,153. | 1,275. | 1,340. | 1,691. |
| | 42" | 14 1/4" | 14 3/4" | RO3-A42NL () () () | 1,193. | 1,302. | 1,472. | 1,563. | 2,076. |
| | 48" | 14 1/4" | 14 3/4" | RO3-A48NL () () () | 1,390. | 1,460. | 1,585. | 1,697. | 2,396. |
| Enclosed cabinet (no mounting hardware) - Two doors, no pull, with lock | 60" | 14 1/4" | 14 3/4" | RO3-A60NL () () () | 1,846. | 1,987. | 2,068. | 2,170. | 2,661. |
| | 72" | 14 1/4" | 14 3/4" | RO3-A72NL () () () | 2,087. | 2,228. | 2,382. | 2,519. | 3,266. |
| Enclosed cabinet (no mounting hardware) - One door, with pull, no lock | 30" | 14 1/4" | 14 3/4" | RO3-A30PN () () () | 1,077. | 1,140. | 1,225. | 1,271. | 1,501. |
| | 36" | 14 1/4" | 14 3/4" | RO3-A36PN () () () | 1,193. | 1,272. | 1,395. | 1,458. | 1,810. |
| | 42" | 14 1/4" | 14 3/4" | RO3-A42PN () () () | 1,314. | 1,424. | 1,592. | 1,684. | 2,195. |
| | 48" | 14 1/4" | 14 3/4" | RO3-A48PN () () () | 1,513. | 1,586. | 1,711. | 1,823. | 2,522. |
| Enclosed cabinet (no mounting hardware) - Two doors, with pull, no lock | 60" | 14 1/4" | 14 3/4" | RO3-A60PN () () () | 2,079. | 2,221. | 2,302. | 2,404. | 2,893. |
| | 72" | 14 1/4" | 14 3/4" | RO3-A72PN () () () | 2,322. | 2,464. | 2,619. | 2,755. | 3,503. |
| Enclosed cabinet (no mounting hardware) - One door, with pull, with lock | 30" | 14 1/4" | 14 3/4" | RO3-A30PL () () () | 1,138. | 1,202. | 1,287. | 1,334. | 1,562. |
| | 36" | 14 1/4" | 14 3/4" | RO3-A36PL () () () | 1,256. | 1,335. | 1,456. | 1,519. | 1,872. |
| | 42" | 14 1/4" | 14 3/4" | RO3-A42PL () () () | 1,375. | 1,485. | 1,653. | 1,746. | 2,257. |
| | 48" | 14 1/4" | 14 3/4" | RO3-A48PL () () () | 1,575. | 1,648. | 1,773. | 1,886. | 2,584. |
| Enclosed cabinet (no mounting hardware) - Two doors, with pull, with lock | 60" | 14 1/4" | 14 3/4" | RO3-A60PL () () () | 2,201. | 2,344. | 2,425. | 2,527. | 3,018. |
| | 60" | 14 1/4" | 14 3/4" | RO3-A72PL () () () | 2,446. | 2,588. | 2,743. | 2,879. | 3,625. |

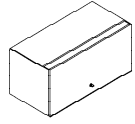

| Order Code | Specification Information | Application Notes |
|--|---|--|
| Example: RO3-A30PL-117-L-117 AA | Specify mounting hardware separately. | Reuter storage is a universal product applicable Knoll systems. |
| RO3 Reuter overhead | Optional anodized aluminum or painted front pull trims the entire width of cabinet door. | Grain direction on overhead fronts is standard horizontal. |
| A flat front | <i>Specify paint finishes for case. Finish types for front:</i> | Cabinet door rotates above cabinet on side pivots, counterbalanced by two pneumatic cylinders. Two-door cabinets have center divider and four pneumatic cylinders. Vertical interior partitions may be positioned on 1 1/2" increments of width anywhere across shelf, 1 1/2" in from each side. Vertical partitions contain cutouts for mounting up to five horizontal partitions at 2" increments on either or both sides. |
| 30 width | L laminate | Horizontals are suspended between two verticals, and may be positioned end-to-end in any combination up to 3" less than cabinet width. Available in sets of 10; 6", 9", 12", 15" widths. |
| P with pull | P paint | Order locks for overheads with a KnollKey order form. Please note that Reuter overhead cabinets 60"W or wider require two lock cores. |
| L with lock | V veneer or techwood | |
| 117 case finish | Please refer to the AutoStrada price list for finishes available on Reuter Flat Front overhead cabinets fronts. | |
| L front finish type | | |
| 117 front color | | |
| AA pull finish | | |

| description | type | width | depth | height | pattern number | black | paint |
|---|------------------------------------|-------|-------|--------|--------------------|-------|--------|
| Reuter overhead downmount brackets | For 64"H spine | | | | AA1ARODN() | | \$205. |
| Reuter overhead upmount brackets | For 48"H spine with standard crown | | | | AA1ROUP() | | 205. |
| Reuter overhead extended upmount brackets | For 39"H spine with standard crown | | | | AA1ROXUP() | | 408. |
| Upmount brackets | For AutoStrada panels | | | | RO1-RCB() | | 91. |
| | For Morrison panels | | | | RO1-CB() | | 91. |
| Panel mount brackets, pair | For AutoStrada panels | | | | RO1-RPB | | 43. |
| | For Morrison panels | | | | RO1-MPB | | 43. |
| Wall mount frames, overhead cabinet | 30"W overheads | 23" | 1/2" | 13" | RO1-WMF2 | | 80. |
| | 36" or 42"W overheads | 35" | 1/2" | 13" | RO1-WMF3 | | 86. |
| | 48" or 60"W overheads | 47" | 1/2" | 13" | RO1-WMF4 | | 91. |
| Wall mount wire manager, set of 10 | | | | | MWM-J | | 141. |

Order Code

| |
|-----------------------------|
| Example: AA1RODN 613 |
| AA1 Spine accessory |
| RO Reuter overhead |
| DN Configuration |
| 613 Finish |

Specification Information

Please specify painted finish for overhead upmount or downmount kit. Paint options are listed on page 7.

Application Notes

Reuter upmount brackets attach overhead cabinet anywhere along standard spine crown, lifting 1" above nominal wall height. Extended upmount brackets lift overhead to 10" above nominal wall height.

Downmount brackets attach overheads within the upper 16" of 64"H walls with either compact or standard crown. The AutoStrada version of the downmount brackets extends to the bottom of the access cover, making contact with the bottom trim extrusion.

Specify an extra bracket (one-half pair) for center support of overhead cabinets wider than 60".

Upmount or downmount brackets may be inset to permit overhead to extend 1" or 3" beyond the end of the spine at T-ends.

Wall mount frames secure Reuter overhead cabinets to wall (frame/wall mounting hardware is not included). Frame is concealed behind storage. Use 2 RO1-WMF2 to wall mount 66" and 72" wide Reuter overheads.

Wall mount wire manager is two-part wire concealment kit, 22"H (medium grey only).

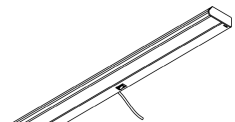
| description | type | w | d | h | pattern no. | standard | advanced |
|--|---------------------------------|-----|----|--------|---------------------|----------|----------|
| Task Light  | Use with 24" and wider overhead | 19" | 4" | 1 1/2" | RTAT5E19 () | \$213. | n/a |
| | Use with 30" and wider overhead | 25" | 4" | 1 1/2" | RTAT5E25 () | 229. | 395. |
| | Use with 42" and wider overhead | 37" | 4" | 1 1/2" | RTAT5E37 () | 247. | 416. |
| | Use with 60" and wider overhead | 49" | 4" | 1 1/2" | RTAT5E49 () | 268. | 432. |
| | Use with 66" and wider overhead | 61" | 4" | 1 1/2" | RTAT5E61 () | 285. | 450. |

| Order Code | Specification Information | Application Notes |
|--|---|---|
| Example: RTAT5E19S <hr/> RTA Task Light <hr/> T5 T5 lamp <hr/> E Electronic ballast <hr/> 19 Width <hr/> S Standard | Specify: Width - Task Lights mount in cabinets and shelves at least 5" wider than light width. Type: S Standard A Advanced Specify suffix -CH and add \$45 list for City of Chicago installations. Example: RTAT5E19S-CH All housings are black. | Task lights mount into the recess in the underside of overhead cabinets and shelves at least 5" wider than task light width. Task lights include T5 cool white (4100K) fluorescent lamp, electronic ballast, 9' grounded cordset, prismatic lens, rocker switch, one cord exit management clip and mounting hardware. Task light cordset is center exit. On smaller units cort exit is off-center, but still not handed. Task lights are TCLP compliant and meet requirements of California Title 24. Advanced task lights are fitted with ballast and lamp compliant with LEED requirements. |

T5 Task Light

for wood and laminate overhead storage

| description | type | w | d | h | pattern no. | standard | advanced |
|--|---------------------------------|-----|----|--------|---------------------|----------|----------|
| Task Light  | Use with 24" and wider overhead | 19" | 4" | 1 1/2" | AL1T5E19 () | \$259. | n/a |
| | Use with 30" and wider overhead | 25" | 4" | 1 1/2" | AL1T5E25 () | 264. | 380. |
| | Use with 42" and wider overhead | 37" | 4" | 1 1/2" | AL1T5E37 () | 269. | 400. |
| | Use with 60" and wider overhead | 49" | 4" | 1 1/2" | AL1T5E49 () | 274. | 416. |
| | Use with 72" and wider overhead | 61" | 4" | 1 1/2" | AL1T5E61 () | 290. | 432. |
| | Use with 84" and wider overhead | 73" | 4" | 1 1/2" | AL1T5E73 () | 316. | 449. |
| | Use with 96" and wider overhead | 85" | 4" | 1 1/2" | AL1T5E85 () | 395. | 465. |

| Order Code | Specification Information | Application Notes |
|--|---|--|
| Example: AL1T5E19S <hr/> LL2 Task Light <hr/> T5 T5 lamp <hr/> E Electronic ballast <hr/> 19 Width <hr/> S Standard | <p><i>Specify:</i></p> <p>Width - Task Lights mount in cabinets and shelves at least 5" wider than light width.</p> <p>Type:</p> <p>S Standard A Advanced</p> <p>Specify suffix -CH and add \$45 list for City of Chicago installations. Example: AL1T5E19S-CH</p> <p>All housings are black.</p> | <p>Task lights mount into the recess in the underside of overhead cabinets and shelves at least 5" wider than task light width.</p> <p>Task lights include T5 cool white (4100K) fluorescent lamp, electronic ballast, 9' grounded cordset, prismatic lens, rocker switch, one cord exit management clip and mounting hardware.</p> <p>Task light cordset is center exit. On smaller units cord exit is off-center, but still not handed.</p> <p>Task lights are TCLP compliant and meet requirements of California Title 24.</p> <p>Advanced task lights are fitted with ballast and lamp compliant with LEED requirements.</p> |
| | | <p>Task Light fit to overhead cabinets without the use of filler panels.</p> <p>All lights feature two screw-mounting keyholes.</p> |

Reuter T5 mounting kit for binder depth wood overhead storage

AutoStrada

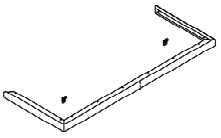
| description | type | h | w | d | pattern no. | list |
|---|-----------------------------|-----|---------|-------------------------|-------------------------|--------|
|  | binder depth | 1" | 18" | 13 1/8" | RT1 SMK 1813 () | \$132. |
| | | 1" | 24" | 13 1/8" | RT1 SMK 2413 () | 134. |
| | | 1" | 30" | 13 1/8" | RT1 SMK 3013 () | 136. |
| | | 1" | 36" | 13 1/8" | RT1 SMK 3613 () | 138. |
| | | 1" | 42" | 13 1/8" | RT1 SMK 4213 () | 140. |
| | | 1" | 48" | 13 1/8" | RT1 SMK 4813 () | 142. |
| | | 1" | 54" | 13 1/8" | RT1 SMK 5413 () | 144. |
| | | 1" | 60" | 13 1/8" | RT1 SMK 6013 () | 147. |
| | | 1" | 66" | 13 1/8" | RT1 SMK 6613 () | 154. |
| | | 1" | 72" | 13 1/8" | RT1 SMK 7213 () | 156. |
| | | 1" | 78" | 13 1/8" | RT1 SMK 7813 () | 159. |
| | | 1" | 84" | 13 1/8" | RT1 SMK 8413 () | 161. |
| | | 1" | 90" | 13 1/8" | RT1 SMK 9013 () | 163. |
| | | 1" | 96" | 13 1/8" | RT1 SMK 9613 () | 165. |
| | binder depth with tackboard | 1" | 18" | 12 3/8" | RT1 SMK 1812 () | 132. |
| | | 1" | 24" | 12 3/8" | RT1 SMK 2412 () | 134. |
| | | 1" | 30" | 12 3/8" | RT1 SMK 3012 () | 136. |
| | | 1" | 36" | 12 3/8" | RT1 SMK 3612 () | 138. |
| | | 1" | 42" | 12 3/8" | RT1 SMK 4212 () | 140. |
| | | 1" | 48" | 12 3/8" | RT1 SMK 4812 () | 142. |
| | | 1" | 54" | 12 3/8" | RT1 SMK 5412 () | 144. |
| | | 1" | 60" | 12 3/8" | RT1 SMK 6012 () | 146. |
| 1" | | 66" | 12 3/8" | RT1 SMK 6612 () | 154. | |
| 1" | | 72" | 12 3/8" | RT1 SMK 7212 () | 156. | |
| 1" | | 78" | 12 3/8" | RT1 SMK 7812 () | 159. | |
| 1" | | 84" | 12 3/8" | RT1 SMK 8412 () | 161. | |
| 1" | | 90" | 12 3/8" | RT1 SMK 9012 () | 163. | |
| 1" | | 96" | 12 3/8" | RT1 SMK 9612 () | 164. | |
| Additional T5 mounting brackets | | | | RT1 SMK B | 21. | |

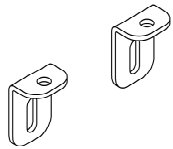

Order Code

| | |
|------------|------------------------|
| Example: | RT1 SMK 2413 AA |
| RT1 | Reuter task lamp |
| SMK | Mounting kit |
| 24 | Width |
| 13 | Depth |
| AA | Finish |

Specification Information

Mounting kit finish choice:
Anodized Aluminum or painted finish options listed on page 9 excluding silver.

12" deep: binder depth wood overhead, wall mounted with tackboard below.

13" deep: binder depth wood overhead on Applied Wall System or wall mounted without tackboard.

Application

Reuter T5 task lamp mounting kit enables task lamp to be mounted under veneer or laminate overhead storage cabinets (with or without doors). Mounting kit includes anodized aluminum fascia to conceal lamp and manage power cord along front and side of cabinet. Specify mounting kit in width corresponding to overhead cabinet. Mounting kit also includes back supports for one task lamp.

To mount a second task lamp within one longer mounting kit specify one additional pair of back supports. Back supports are L brackets into which the pins at the back of the Reuter are inserted. Sliding brackets on sides of the lamp slide over the inside lip of the fascia at any point to support the front of the lamp.

Reuter T5 mounting kit for legal depth wood overhead storage

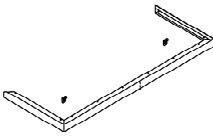
| description | type | h | w | d | pattern no. | list | | |
|---|-------------|----------------------------|-----|---------|-------------------------|---------|-------------------------|------|
|  | legal depth | 1" | 18" | 16 1/8" | RT1 SMK 1816 () | \$134. | | |
| | | 1" | 24" | 16 1/8" | RT1 SMK 2416 () | 136. | | |
| | | 1" | 30" | 16 1/8" | RT1 SMK 3016 () | 137. | | |
| | | 1" | 36" | 16 1/8" | RT1 SMK 3616 () | 140. | | |
| | | 1" | 42" | 16 1/8" | RT1 SMK 4216 () | 141. | | |
| | | 1" | 48" | 16 1/8" | RT1 SMK 4816 () | 143. | | |
| | | 1" | 54" | 16 1/8" | RT1 SMK 5416 () | 146. | | |
| | | 1" | 60" | 16 1/8" | RT1 SMK 6016 () | 148. | | |
| | | 1" | 66" | 16 1/8" | RT1 SMK 6616 () | 156. | | |
| | | 1" | 72" | 16 1/8" | RT1 SMK 7216 () | 158. | | |
| | | 1" | 78" | 16 1/8" | RT1 SMK 7816 () | 160. | | |
| | | 1" | 84" | 16 1/8" | RT1 SMK 8416 () | 162. | | |
| | | 1" | 90" | 16 1/8" | RT1 SMK 9016 () | 164. | | |
| | | 1" | 96" | 16 1/8" | RT1 SMK 9616 () | 166. | | |
| | | legal depth with tackboard | | 1" | 18" | 15 3/8" | RT1 SMK 1815 () | 134. |
| | | | | 1" | 24" | 15 3/8" | RT1 SMK 2415 () | 135. |
| | | | | 1" | 30" | 15 3/8" | RT1 SMK 3015 () | 137. |
| | | | | 1" | 36" | 15 3/8" | RT1 SMK 3615 () | 139. |
| | | | | 1" | 42" | 15 3/8" | RT1 SMK 4215 () | 141. |
| | | | | 1" | 48" | 15 3/8" | RT1 SMK 4815 () | 143. |
| | | | | 1" | 54" | 15 3/8" | RT1 SMK 5415 () | 146. |
| | | 1" | 60" | 15 3/8" | RT1 SMK 6015 () | 148. | | |
| | | 1" | 66" | 15 3/8" | RT1 SMK 6615 () | 155. | | |
| | | 1" | 72" | 15 3/8" | RT1 SMK 7215 () | 158. | | |
| | | 1" | 78" | 15 3/8" | RT1 SMK 7815 () | 160. | | |
| | | 1" | 84" | 15 3/8" | RT1 SMK 8415 () | 162. | | |
| | | 1" | 90" | 15 3/8" | RT1 SMK 9015 () | 164. | | |
| | | 1" | 96" | 15 3/8" | RT1 SMK 9615 () | 166. | | |
| Additional T5 mounting brackets | | | | | RT1 SMK B | 21. | | |

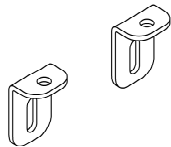

Order Code

| | |
|------------|------------------------|
| Example: | RT1 SMK 2416 AA |
| RT1 | Reuter task lamp |
| SMK | Mounting kit |
| 24 | Width |
| 16 | depth |
| AA | Finish |

Specification Information

Mounting kit finish choice:
Anodized Aluminum or painted finish options listed on page 9 excluding silver.

15" deep: legal depth wood overhead, wall mounted with tackboard below.

16" deep: legal depth wood overhead on Applied Wall System or wall mounted without tackboard.

Application

Reuter T5 task lamp mounting kit enables task lamp to be mounted under veneer or laminate overhead storage cabinets (with or without doors). Mounting kit includes anodized aluminum fascia to conceal lamp and manage power cord along front and side of cabinet. Specify mounting kit in width corresponding to overhead cabinet. Mounting kit also includes back supports for one task lamp.

To mount a second task lamp within one longer mounting kit specify one additional pair of back supports. Back supports are L brackets into which the pins at the back of the Reuter are inserted. Sliding brackets on sides of the lamp slide over the inside lip of the fascia at any point to support the front of the lamp.

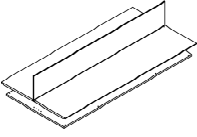
| description | h | w | d | pattern no. | L | V1/M | V2 | V3 |
|---|-----|-----|-----|---------------------------------------|----------|----------|----------|----------|
| Glass credenza top divider  | 15" | 60 | 40 | A1GCTDK60141(L/V/M)() () () | \$2,164. | \$2,434. | \$2,539. | \$3,047. |
| | 15" | 60" | 48" | A1GCTDK60142(L/V/M)() () () | 2,217. | 2,488. | 2,611. | 3,133. |
| | 15" | 72" | 40" | A1GCTDK72141(L/V/M)() () () | 2,351. | 2,621. | 2,745. | 3,294. |
| | 15" | 72" | 48" | A1GCTDK72142(L/V/M)() () () | 2,413. | 2,686. | 2,830. | 3,396. |
| | 15" | 90" | 40" | A1GCTDK90141(L/V/M)() () () | 2,565. | 2,837. | 2,988. | 3,586. |
| | 15" | 90" | 48" | A1GCTDK90142(L/V/M)() () () | 2,646. | 2,921. | 3,094. | 3,713. |
| | 15" | 96" | 40" | A1GCTDK96141(L/V/M)() () () | 2,627. | 2,898. | 3,057. | 3,668. |
| | 15" | 96" | 48" | A1GCTDK96142(L/V/M)() () () | 2,707. | 2,982. | 3,169. | 3,803. |

| Order Code | Specifications | Application Notes |
|---|--|---|
| Example: A1GCTDK60141L | <i>To order please specify pattern number including:</i> | Glass credenza top divider kit to include glass divider, pair of worksurfaces under one product code per size. |
| A AutoStrada | 1. Surface type <i>L = Laminate</i> | Applications to be restricted for use with common depth of storage either 19" deep or 23" deep on both sides. Will not offer 19" deep on one side and 23" deep on other side. |
| 1 Generation 1 | <i>M = Mixed, Laminate surface/V1, V2 or V3 edge</i> | Upcharges |
| G Glass | <i>V = V1, V2 or V3</i> | <i>width</i> GL13 GL25/GL35 |
| CT Credenza top | 2. Finish, Surface <i>Laminate, V1, V2 or V3 finish</i> | 60" \$117 \$380 |
| DK Divider kit | 3. Finish, Edge <i>Must be same as surface finish</i> | 72" \$140 \$455 |
| 60 60" wide | 4. Finish, Glass <i>TEMP = clear tempered glass</i> | 90" \$175 \$570 |
| 14 Nominal glass height | <i>GL13 = powder</i> | 96" \$187 \$610 |
| 1 | <i>GL25 = bronze</i> | |
| L Laminate | <i>GL35 = grey</i> | |
| V316 Finish, primary worksurface | 5. Finish, capture/ divider Anodized aluminum or painted finish options, listed on page 7 excluding 613 Silver. | Hardware included. |
| 111 Subtop spacer | | Assembly required. |
| TEMP Finish, glass | | Standoff / subtop only available in 111. |
| AA Finish, divider capture | | |

Flush, user edge tapered Rectilinear, 20" and 24" deep

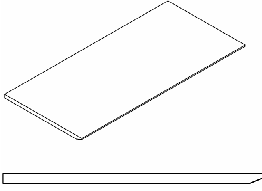
| description | d | w | pattern no. | L | M | V1 | V2 | V3 | |
|--|-----|-----|------------------------------|------------------------------|--------|--------|--------|--------|------|
| Straight rectangular, (full depth) front edge tapered  | 20" | 18" | AW1T1RF1820 (X)(X)(X) | \$324. | \$396. | \$396. | \$452. | \$589. | |
| | | 20" | AW1T1RF2020 (X)(X)(X) | 338. | 405. | 405. | 464. | 604. | |
| | | 24" | AW1T1RF2420 (X)(X)(X) | 345. | 416. | 416. | 475. | 618. | |
| | | 30" | AW1T1RF3020 (X)(X)(X) | 373. | 458. | 458. | 524. | 681. | |
| | | 36" | AW1T1RF3620 (X)(X)(X) | 377. | 481. | 481. | 554. | 720. | |
| | | 42" | AW1T1RF4220 (X)(X)(X) | 386. | 502. | 502. | 579. | 752. | |
| | | 48" | AW1T1RF4820 (X)(X)(X) | 396. | 523. | 523. | 599. | 780. | |
| | | 54" | AW1T1RF5420 (X)(X)(X) | 408. | 544. | 544. | 630. | 819. | |
| | | 60" | AW1T1RF6020 (X)(X)(X) | 432. | 589. | 589. | 676. | 878. | |
| | | 66" | AW1T1RF6620 (X)(X)(X) | 463. | 606. | 606. | 699. | 908. | |
| | | 72" | AW1T1RF7220 (X)(X)(X) | 467. | 637. | 637. | 732. | 950. | |
| | | 78" | AW1T1RF7820 (X)(X)(X) | 482. | 645. | 645. | 742. | 964. | |
| | | 84" | AW1T1RF8420 (X)(X)(X) | 508. | 686. | 686. | 789. | 1,027. | |
| | | 90" | AW1T1RF9020 (X)(X)(X) | 521. | 716. | 716. | 822. | 1,069. | |
| | | 96" | AW1T1RF9620 (X)(X)(X) | 556. | 742. | 742. | 853. | 1,109. | |
| | | 24" | 18" | AW1T1RF1824 (X)(X)(X) | 346. | 417. | 417. | 478. | 622. |
| | | | 20" | AW1T1RF2024 (X)(X)(X) | 361. | 426. | 426. | 490. | 637. |
| | | | 24" | AW1T1RF2424 (X)(X)(X) | 369. | 436. | 436. | 502. | 654. |
| | | 30" | AW1T1RF3024 (X)(X)(X) | 385. | 495. | 495. | 568. | 738. | |
| | | 36" | AW1T1RF3624 (X)(X)(X) | 397. | 514. | 514. | 591. | 769. | |
| | | 42" | AW1T1RF4224 (X)(X)(X) | 411. | 530. | 530. | 608. | 791. | |
| | | 48" | AW1T1RF4824 (X)(X)(X) | 455. | 568. | 568. | 652. | 847. | |
| | | 54" | AW1T1RF5424 (X)(X)(X) | 459. | 606. | 606. | 699. | 908. | |
| | | 60" | AW1T1RF6024 (X)(X)(X) | 482. | 650. | 650. | 745. | 969. | |
| | | 66" | AW1T1RF6624 (X)(X)(X) | 522. | 673. | 673. | 771. | 1,003. | |
| | | 72" | AW1T1RF7224 (X)(X)(X) | 535. | 701. | 701. | 809. | 1,052. | |
| | | 78" | AW1T1RF7824 (X)(X)(X) | 553. | 734. | 734. | 847. | 1,101. | |
| | | 84" | AW1T1RF8424 (X)(X)(X) | 576. | 766. | 766. | 878. | 1,143. | |
| | | 90" | AW1T1RF9024 (X)(X)(X) | 615. | 797. | 797. | 920. | 1,195. | |
| | | 96" | AW1T1RF9624 (X)(X)(X) | 629. | 828. | 828. | 956. | 1,243. | |

Worksurfaces

| Order Code | Specification Information | Application Notes |
|--|---|--|
| Example: AW1T1RF1820MG118 V316613 | To order please specify pattern number including: | 7. Finish, Grommet(s) <i>specify painted or plated finish</i> |
| A AutoStrada | 1. Width | Hardware to attach to vertical support to be specified separately. |
| W Worksurface | 2. Depth | 1 1/4" tops require additional support when distance spans over 48". |
| 1 Generation 1 | 3. Surface type | Actual widths are 1/16" less than nominal dimension noted and depths are 1/8" less than nominal dimension noted. |
| T1 Tapered one side, user | <i>L = Laminate</i> | When grommets specified up to 48" w tops have one grommet, over 48" w tops have two grommets. |
| R Rectilinear | <i>M = Mixed, Laminate surface/V1, V2 or V3 edge</i> | |
| F Full depth, flush | <i>V = V1, V2 or V3</i> | |
| 18 18" wide | 4. Grommet option | |
| 20 20" deep | <i>N = No grommets</i> | |
| M Surface type, Mixed | <i>G = Grommet(s), flush</i> | |
| G Grommet | 5. Finish, Surface | |
| 118 Finish surface, Bright white | <i>Laminate, V1, V2 or V3 finish</i> | |
| V316 Finish edge, Maple | 6. Finish, Edge | |
| 613 Finish, grommet | <i>Must be same as surface finish unless M surface type specified, then must be V1, V2 or V3 finish</i> | |

Flush, user edge tapered
Rectilinear, 30" and 36" deep

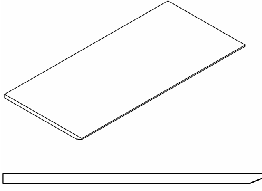
| description | d | w | pattern no. | L | M | V1 | V2 | V3 | |
|--|-----|-----|------------------------------------|------------------------------------|--------|--------|--------|--------|------|
| Straight rectangular, (full depth) front edge tapered  | 30" | 18" | AW1T1RF1830 () () () () | \$354. | \$451. | \$451. | \$521. | \$676. | |
| | | 20" | AW1T1RF2030 () () () () | 360. | 463. | 463. | 534. | 692. | |
| | | 24" | AW1T1RF2430 () () () () | 368. | 474. | 474. | 546. | 711. | |
| | | 30" | AW1T1RF3030 () () () () | 386. | 536. | 536. | 614. | 799. | |
| | | 36" | AW1T1RF3630 () () () () | 400. | 578. | 578. | 661. | 861. | |
| | | 42" | AW1T1RF4230 () () () () | 419. | 598. | 598. | 688. | 894. | |
| | | 48" | AW1T1RF4830 () () () () | 466. | 639. | 639. | 737. | 959. | |
| | | 54" | AW1T1RF5430 () () () () | 478. | 692. | 692. | 795. | 1,034. | |
| | | 60" | AW1T1RF6030 () () () () | 506. | 717. | 717. | 823. | 1,070. | |
| | | 66" | AW1T1RF6630 () () () () | 545. | 733. | 733. | 843. | 1,097. | |
| | | 72" | AW1T1RF7230 () () () () | 563. | 752. | 752. | 864. | 1,123. | |
| | | 78" | AW1T1RF7830 () () () () | 583. | 786. | 786. | 907. | 1,178. | |
| | | 84" | AW1T1RF8430 () () () () | 606. | 819. | 819. | 942. | 1,226. | |
| | | 90" | AW1T1RF9030 () () () () | 660. | 855. | 855. | 987. | 1,282. | |
| | | 96" | AW1T1RF9630 () () () () | 662. | 887. | 887. | 1,021. | 1,326. | |
| | | 36" | 18" | AW1T1RF1836 () () () () | 363. | 489. | 489. | 565. | 734. |
| | | | 20" | AW1T1RF2036 () () () () | 367. | 501. | 501. | 580. | 754. |
| | | | 24" | AW1T1RF2436 () () () () | 382. | 514. | 514. | 593. | 772. |
| | | | 30" | AW1T1RF3036 () () () () | 398. | 580. | 580. | 665. | 865. |
| | | 36" | AW1T1RF3636 () () () () | 423. | 646. | 646. | 739. | 961. | |
| | | 42" | AW1T1RF4236 () () () () | 457. | 676. | 676. | 780. | 1,014. | |
| | | 48" | AW1T1RF4836 () () () () | 502. | 722. | 722. | 834. | 1,085. | |
| | | 54" | AW1T1RF5436 () () () () | 519. | 793. | 793. | 904. | 1,177. | |
| | | 60" | AW1T1RF6036 () () () () | 525. | 796. | 796. | 910. | 1,181. | |
| | | 66" | AW1T1RF6636 () () () () | 580. | 800. | 800. | 923. | 1,200. | |
| | | 72" | AW1T1RF7236 () () () () | 600. | 822. | 822. | 947. | 1,231. | |
| | | 78" | AW1T1RF7836 () () () () | 629. | 841. | 841. | 971. | 1,262. | |
| | | 84" | AW1T1RF8436 () () () () | 652. | 875. | 875. | 1,012. | 1,314. | |
| | | 90" | AW1T1RF9036 () () () () | 703. | 917. | 917. | 1,057. | 1,375. | |
| | | 96" | AW1T1RF9636 () () () () | 723. | 947. | 947. | 1,089. | 1,415. | |

| Order Code | Specification Information | Application Notes |
|--|---|--|
| Example: AW1T1RF1830MG118 V316613 | To order please specify pattern number including: | Hardware to attach to vertical support to be specified separately. |
| A AutoStrada | 1. Width | 1 1/4" tops require additional support when distance spans over 48". |
| W Worksurface | 2. Depth | |
| 1 Generation 1 | 3. Surface type | Actual widths are 1/16" less than nominal dimension noted and depths are 1/8" less than nominal dimension noted. |
| T1 Tapered 1 side, user | <i>L = Laminate</i> | |
| R Rectilinear | <i>M = Mixed, Laminate surface/V1, V2 or V3 edge</i> | When grommets specified up to 48" w tops have one grommet, over 48" w have two grommets. |
| F Full depth, flush | <i>V = V1, V2 or V3</i> | |
| 18 18" wide | 4. Grommet option | |
| 30 30" deep | <i>N = No grommets</i> | |
| M Surface type, Mixed | <i>G = Grommet(s), flush</i> | |
| G Grommet | <i>R = Grommet(s), recessed</i> | |
| 118 Finish surface, Bright white | 5. Finish, Surface | |
| V316 Finish edge, Maple | <i>Laminate, V1, V2 or V3 finish</i> | |
| 613 Finish, grommet | 6. Finish, Edge | |
| | <i>Must be same as surface finish unless M surface type specified, then must be V1, V2 or V3 finish</i> | |
| | 7. Finish, Grommet(s) | |
| | <i>specify painted or plated finish</i> | |
| | See page 7 for finish options applicable. | |
| | Product on this page will accept wood grain laminate where laminate is currently an option. | |
| | List price for wood grain laminate options will be current published laminate list price plus 10%. | |

Flush, user edge tapered Wedge

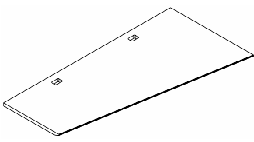
| description | d, left | w | d, right | pattern no. | L | M | V1 | V2 | V3 |
|---|---------|-----|----------|------------------------------------|--------|--------|--------|--------|--------|
| Wedge, (full depth) front edge tapered  | 24" | 48" | 30" | AW1T1WF4823 () () () () | \$538. | \$639. | \$639. | \$737. | \$959. |
| | 24" | 60" | 30" | AW1T1WF6023 () () () () | 571. | 717. | 717. | 823. | 1,070. |
| | 24" | 72" | 36" | AW1T1WF7226 () () () () | 705. | 806. | 806. | 922. | 1,198. |
| | 30" | 48" | 24" | AW1T1WF4832 () () () () | 538. | 639. | 639. | 737. | 959. |
| | 30" | 60" | 24" | AW1T1WF6032 () () () () | 571. | 717. | 717. | 823. | 1,070. |
| | 36" | 72" | 24" | AW1T1WF7262 () () () () | 705. | 806. | 806. | 922. | 1,198. |
| Presentation wood sample (with tapered edge detail) | 16" | 16" | 16" | ASAMP1616 () | 106. | 155. | 155. | 207. | 244. |

| Order Code | Specification Information | Application Notes |
|--|--|--|
| Example: AW1T1WF4823MG118 V316613 | <i>To order please specify pattern number including:</i> | |
| A AutoStrada | 1. Width | |
| W Worksurface | 2. Depth | |
| 1 Generation 1 | 23 = 24" deep left, 30" deep right | |
| T1 Tapered 1 side, user | 32 = 30" deep left, 24" deep right | |
| W Wedge | 26 = 24" deep left, 36" deep right | |
| F Full depth, flush | 62 = 36" deep left, 24" deep right | |
| 48 48" wide | 3. Surface type | |
| 2 24" deep, left | L = Laminate | |
| 3 30" deep, right | M = Mixed, Laminate surface/V1, V2 or V3 edge | |
| M Surface type, Mixed | V = V1, V2 or V3 | |
| G Grommet | 4. Grommet option | |
| 118 Finish surface, Bright white | N = No grommets | |
| V316 Finish edge, Maple | G = Grommet(s), flush | |
| 613 Finish, grommet | R = Grommet(s), recessed | |
| | 5. Finish, Surface | |
| | Laminate, V1, V2 or V3 finish | |
| | 6. Finish, Edge | |
| | Must be same as surface finish unless M surface type specified, then must be V1, V2 or V3 finish | Hardware to attach to vertical support to be specified separately. |
| | 7. Finish, Grommet(s) | 1 1/4" tops require additional support when distance spans over 48". |
| | specify painted or plated finish | Actual widths are 1/16" less than nominal dimension noted and depths are 1/8" less than nominal dimension noted. |
| | See page 7 for finish options applicable. | When grommets specified up to 48" w tops have one grommet, over 48" w have two grommets. |
| | Product on this page will accept wood grain laminate where laminate is currently an option. | |
| | List price for wood grain laminate options will be current published laminate list price plus 10%. | |

Cord drop, user edge tapered

Rectilinear

AutoStrada

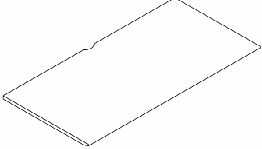
| description | d | w | pattern no. | L | M | V1 | V2 | V3 |
|---|-----|-----|--------------------------------|--------------------------------|--------|--------|--------|--------|
| Straight rectangular, (cord drop) front edge tapered  | 20" | 18" | AW1T1RU1820 () () () | \$335. | \$396. | \$396. | \$452. | \$589. |
| | | 20" | AW1T1RU2020 () () () | 338. | 405. | 405. | 464. | 604. |
| | | 24" | AW1T1RU2420 () () () | 345. | 416. | 416. | 475. | 618. |
| | | 30" | AW1T1RU3020 () () () | 387. | 458. | 458. | 524. | 681. |
| | | 36" | AW1T1RU3620 () () () | 390. | 481. | 481. | 554. | 720. |
| | | 42" | AW1T1RU4220 () () () | 395. | 502. | 502. | 579. | 752. |
| | | 48" | AW1T1RU4820 () () () | 407. | 523. | 523. | 599. | 780. |
| | | 54" | AW1T1RU5420 () () () | 419. | 544. | 544. | 630. | 819. |
| | | 60" | AW1T1RU6020 () () () | 442. | 589. | 589. | 676. | 878. |
| | | 66" | AW1T1RU6620 () () () | 472. | 606. | 606. | 699. | 908. |
| | | 72" | AW1T1RU7220 () () () | 476. | 637. | 637. | 732. | 950. |
| | | 78" | AW1T1RU7820 () () () | 494. | 645. | 645. | 742. | 964. |
| | | 84" | AW1T1RU8420 () () () | 518. | 686. | 686. | 789. | 1,027. |
| | | 90" | AW1T1RU9020 () () () | 530. | 716. | 716. | 822. | 1,069. |
| | | 96" | AW1T1RU9620 () () () | 566. | 742. | 742. | 853. | 1,109. |
| | | 24" | 18" | AW1T1RU1824 () () () | 357. | 417. | 417. | 478. |
| | | 20" | AW1T1RU2024 () () () | 362. | 426. | 426. | 490. | 637. |
| | | 24" | AW1T1RU2424 () () () | 365. | 436. | 436. | 502. | 654. |
| | | 30" | AW1T1RU3024 () () () | 367. | 495. | 495. | 568. | 738. |
| | | 36" | AW1T1RU3624 () () () | 373. | 514. | 514. | 591. | 769. |
| | | 42" | AW1T1RU4224 () () () | 388. | 530. | 530. | 608. | 791. |
| | | 48" | AW1T1RU4824 () () () | 400. | 568. | 568. | 652. | 847. |
| | | 54" | AW1T1RU5424 () () () | 470. | 606. | 606. | 699. | 908. |
| | | 60" | AW1T1RU6024 () () () | 517. | 650. | 650. | 745. | 969. |
| | | 66" | AW1T1RU6624 () () () | 532. | 673. | 673. | 771. | 1,003. |
| | | 72" | AW1T1RU7224 () () () | 545. | 701. | 701. | 809. | 1,052. |
| | | 78" | AW1T1RU7824 () () () | 564. | 734. | 734. | 847. | 1,101. |
| | | 84" | AW1T1RU8424 () () () | 586. | 766. | 766. | 878. | 1,143. |
| | | 90" | AW1T1RU9024 () () () | 624. | 797. | 797. | 920. | 1,195. |
| | | 96" | AW1T1RU9624 () () () | 639. | 828. | 828. | 956. | 1,243. |
| | 30" | 18" | AW1T1RU1830 () () () | 364. | 451. | 451. | 521. | 676. |
| | | 20" | AW1T1RU2030 () () () | 369. | 463. | 463. | 534. | 692. |
| | | 24" | AW1T1RU2430 () () () | 381. | 474. | 474. | 546. | 711. |

| Order Code | Specification Information | Application Notes |
|--|--|--|
| Example: AW1T1RC1820M118 V316 812 | To order please specify pattern number including: | Worksurfaces with cord drop are not recommended for freestanding applications. |
| A AutoStrada | 1. Width | Hardware to attach to vertical support to be specified separately. |
| W Worksurface | 2. Depth | |
| 1 Generation 1 | 3. Surface type <i>L = Laminate</i> | 1 1/4" tops require additional support when distance spans over 48". |
| T1 Tapered 1 side, user | <i>M = Mixed, Laminate surface/V1, V2 or V3 edge</i> | |
| R Rectilinear | <i>V = V1, V2 or V3</i> | Actual widths are 1/16" less than nominal dimension noted and depths are 3/8" less than nominal dimension noted. |
| C Cord drop | 4. Finish, Surface <i>Laminate, V1, V2 or V3 finish</i> | |
| 18 18" wide | 5. Finish, Edge <i>Must be same as surface finish unless M surface type specified, then must be V1, V2 or V3 finish</i> | See page 7 for finish options applicable. Product on this page will accept wood grain laminate where laminate is currently an option. List price for wood grain laminate options will be current published laminate list price plus 10%. |
| 20 20" deep | 6. Finish, Grommet | |
| M Surface type, Mixed | 111 Jet black | |
| 118 Finish surface, Bright white | 812 Easy grey | |
| V316 Finish edge, Maple | | |
| 812 Finish grommet, Easy grey | | |

Cord drop, user edge tapered

Rectilinear

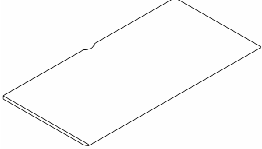
| description | d | w | pattern no. | L | M | V1 | V2 | V3 |
|---|-----|-----|--------------------------------|--------|--------|--------|--------|--------|
| Straight rectangular, (cord drop) front edge tapered  | 30" | 30" | AW1T1RU3030 () () () | \$395. | \$536. | \$536. | \$614. | \$799. |
| | | 36" | AW1T1RU3630 () () () | 411. | 578. | 578. | 661. | 861. |
| | | 42" | AW1T1RU4230 () () () | 429. | 598. | 598. | 688. | 894. |
| | | 48" | AW1T1RU4830 () () () | 475. | 639. | 639. | 737. | 959. |
| | | 54" | AW1T1RU5430 () () () | 487. | 692. | 692. | 795. | 1,034. |
| | | 60" | AW1T1RU6030 () () () | 542. | 717. | 717. | 823. | 1,070. |
| | | 66" | AW1T1RU6630 () () () | 555. | 733. | 733. | 843. | 1,097. |
| | | 72" | AW1T1RU7230 () () () | 573. | 752. | 752. | 864. | 1,123. |
| | | 78" | AW1T1RU7830 () () () | 591. | 786. | 786. | 907. | 1,178. |
| | | 84" | AW1T1RU8430 () () () | 615. | 819. | 819. | 942. | 1,226. |
| | | 90" | AW1T1RU9030 () () () | 671. | 855. | 855. | 987. | 1,282. |
| | | 96" | AW1T1RU9630 () () () | 672. | 887. | 887. | 1,021. | 1,326. |

Worksurfaces

| Order Code | Specification Information | Application Notes |
|--|---|--|
| Example: AW1T1RC1820M118 V316 812 | To order please specify pattern number including: | Worksurfaces with cord drop are not recommended for freestanding applications. |
| A AutoStrada | 1. Width | See page 7 for finish options applicable. |
| W Worksurface | 2. Depth | |
| 1 Generation 1 | 3. Surface type | Product on this page will accept wood grain laminate where laminate is currently an option. |
| T1 Tapered 1 side, user | <i>L = Laminate</i> | |
| R Rectilinear | <i>M = Mixed, Laminate surface/V1, V2 or V3 edge</i> | List price for wood grain laminate options will be current published laminate list price plus 10%. |
| C Cord drop | <i>V = V1, V2 or V3</i> | |
| 18 18" wide | 4. Finish, Surface | Hardware to attach to vertical support to be specified separately. |
| 20 20" deep | <i>Laminate, V1, V2 or V3 finish</i> | |
| M Surface type, Mixed | 5. Finish, Edge | 1 1/4" tops require additional support when distance spans over 48". |
| 118 Finish surface, Bright white | <i>Must be same as surface finish unless M surface type specified, then must be V1, V2 or V3 finish</i> | |
| V316 Finish edge, Maple | 6. Finish, Grommet | Actual widths are 1/16" less than nominal dimension noted and depths are 3/8" less than nominal dimension noted. |
| 812 Finish grommet, Easy grey | 111 Jet black 812 Easy grey | |

Cord drop, user edge tapered

Wedge

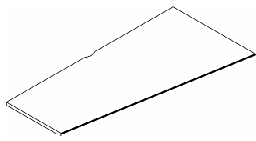
| description | d, left | w | d, right | pattern no. | L | M | V1 | V2 | V3 |
|--|---------|-----|----------|--------------------------------|--------|--------|--------|--------|--------|
| Wedge, (cord drop) front edge tapered  | 24" | 48" | 30" | AW1T1WU4823 () () () | \$542. | \$639. | \$639. | \$737. | \$959. |
| | 24" | 60" | 30" | AW1T1WU6023 () () () | 574. | 717. | 717. | 823. | 1,070. |
| | 24" | 72" | 36" | AW1T1WU7226 () () () | 712. | 806. | 806. | 922. | 1,198. |
| | 30" | 48" | 24" | AW1T1WU4832 () () () | 542. | 639. | 639. | 737. | 959. |
| | 30" | 60" | 24" | AW1T1WU6032 () () () | 574. | 717. | 717. | 823. | 1,070. |
| | 36" | 72" | 24" | AW1T1WU7262 () () () | 712. | 806. | 806. | 922. | 1,198. |

| Order Code | Specification Information | Application Notes |
|--|---|--|
| Example: AW1T1WC4823M118 V316 812 | <i>To order please specify pattern number including:</i> | <p>Worksurfaces with cord drop are not recommended for freestanding applications.</p> <p>Hardware to attach to vertical support to be specified separately.</p> <p>1 1/4" tops require additional support when distance spans over 48".</p> <p>Actual widths are 1/16" less than nominal dimension noted and depths are 3/8" less than nominal dimension noted.</p> |
| A AutoStrada | 1. Width | |
| W Worksurface | 2. Depth | |
| 1 Generation 1 | 23 = 24" deep left, 30" deep right | |
| T1 Tapered 1 side, user | 32 = 30" deep left, 24" deep right | |
| W Wedge | 26 = 24" deep left, 36" deep right | |
| C Cord drop | 62 = 36" deep left, 24" deep right | |
| 48 48" wide | 3. Surface type | |
| 2 24" deep, left | L = Laminate | |
| 3 30" deep, right | M = Mixed, Laminate surface/V1, V2 or V3 edge | |
| M Surface type, Mixed | V = V1, V2 or V3 | |
| 118 Finish surface, Bright white | 4. Finish, Surface Laminate, V1, V2 or V3 finish | |
| V316 Finish edge, Maple | 5. Finish, Edge Must be same as surface finish unless M surface type specified, then must be V1, V2 or V3 finish | |
| 812 Finish grommet, Easy grey | 6. Finish, Grommet 111 Jet black 812 Easy grey | |

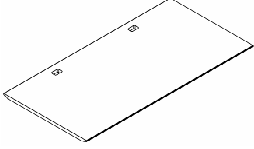
| description | d | w | pattern no. | L | M | V1 | V2 | V3 |
|--|-----|-----|-----------------------------------|-----------------------------------|--------|--------|--------|--------|
| Straight rectangular, (full depth) front& back edge tapered  | 30" | 30" | AW1T2R3030 () () () () | \$441. | \$654. | \$654. | \$732. | \$918. |
| | | 36" | AW1T2R3630 () () () () | 455. | 694. | 694. | 779. | 977. |
| | | 42" | AW1T2R4230 () () () () | 473. | 716. | 716. | 807. | 1,013. |
| | | 48" | AW1T2R4830 () () () () | 495. | 758. | 758. | 855. | 1,077. |
| | | 54" | AW1T2R5430 () () () () | 560. | 811. | 811. | 914. | 1,151. |
| | | 60" | AW1T2R6030 () () () () | 578. | 834. | 834. | 941. | 1,188. |
| | | 66" | AW1T2R6630 () () () () | 596. | 851. | 851. | 962. | 1,215. |
| | | 72" | AW1T2R7230 () () () () | 614. | 869. | 869. | 982. | 1,240. |
| | | 78" | AW1T2R7830 () () () () | 636. | 903. | 903. | 1,025. | 1,296. |
| | | 84" | AW1T2R8430 () () () () | 655. | 936. | 936. | 1,059. | 1,343. |
| | | 90" | AW1T2R9030 () () () () | 702. | 972. | 972. | 1,104. | 1,400. |
| | | 96" | AW1T2R9630 () () () () | 722. | 1,004. | 1,004. | 1,138. | 1,443. |
| | | 36" | 30" | AW1T2R3036 () () () () | 456. | 697. | 697. | 783. |
| | | 36" | AW1T2R3636 () () () () | 475. | 764. | 764. | 857. | 1,079. |
| | | 42" | AW1T2R4236 () () () () | 497. | 794. | 794. | 896. | 1,132. |
| | | 48" | AW1T2R4836 () () () () | 521. | 839. | 839. | 951. | 1,203. |
| | | 54" | AW1T2R5436 () () () () | 590. | 915. | 915. | 1,023. | 1,295. |
| | | 60" | AW1T2R6036 () () () () | 611. | 910. | 910. | 1,028. | 1,299. |
| | | 66" | AW1T2R6636 () () () () | 645. | 919. | 919. | 1,040. | 1,317. |
| | | 72" | AW1T2R7236 () () () () | 653. | 940. | 940. | 1,066. | 1,349. |
| | | 78" | AW1T2R7836 () () () () | 681. | 960. | 960. | 1,089. | 1,380. |
| | | 84" | AW1T2R8436 () () () () | 698. | 992. | 992. | 1,130. | 1,433. |
| | | 90" | AW1T2R9036 () () () () | 748. | 1,034. | 1,034. | 1,175. | 1,492. |
| | | 96" | AW1T2R9636 () () () () | 771. | 1,066. | 1,066. | 1,206. | 1,533. |
| | 42" | 30" | AW1T2R3042 () () () () | 474. | 755. | 755. | 847. | 1,101. |
| | | 36" | AW1T2R3642 () () () () | 497. | 858. | 858. | 958. | 1,244. |
| | | 42" | AW1T2R4242 () () () () | 518. | 894. | 894. | 1,016. | 1,322. |
| | | 48" | AW1T2R4842 () () () () | 544. | 946. | 946. | 1,079. | 1,403. |
| | | 54" | AW1T2R5442 () () () () | 617. | 976. | 976. | 1,106. | 1,438. |
| | | 60" | AW1T2R6042 () () () () | 640. | 1,005. | 1,005. | 1,135. | 1,476. |
| | | 66" | AW1T2R6642 () () () () | 663. | 1,012. | 1,012. | 1,144. | 1,487. |
| | | 72" | AW1T2R7242 () () () () | 686. | 1,016. | 1,016. | 1,152. | 1,498. |
| | | 78" | AW1T2R7842 () () () () | 730. | 1,028. | 1,028. | 1,167. | 1,515. |

Worksurfaces

| Order Code | Specification Information | Application Notes |
|--|---|--|
| Example: AW1T2R3030MG118 V316613 | To order please specify pattern number including: | 7. Finish, Grommet(s) specify painted or plated finish |
| A AutoStrada | 1. Width | Hardware to attach to vertical support to be specified separately. |
| W Worksurface | 2. Depth | 1 1/4" tops require additional support when distance spans over 48". |
| 1 Generation 1 | 3. Surface type L = Laminate M = Mixed, Laminate surface/V1, V2 or V3 edge V = V1, V2 or V3 | When grommets specified up to 48" w tops have one grommet, over 48" w have two grommets. |
| T2 Tapered 2 sides, user & approach | 4. Grommet option N = No grommets G = Grommet(s), flush R = Grommet(s), recessed | |
| R Rectilinear | 5. Finish, Surface Laminate, V1, V2 or V3 finish | |
| 30 30" wide | 6. Finish, Edge Must be same as surface finish unless M surface type specified, then must be V1, V2 or V3 finish | |
| 30 30" deep | | |
| M Surface type, Mixed | | |
| G Grommet | | |
| 118 Finish surface, Bright white | | |
| V316 Finish edge, Maple | | |
| 613 Finish, grommet | | |

| description | d | w | pattern no. | L | M | V1 | V2 | V3 |
|---|-----|-----|-----------------------------------|--------|----------|----------|----------|----------|
| Straight rectangular, (full depth) front& back edge tapered | 42" | 84" | AW1T2R8442 () () () () | \$738. | \$1,063. | \$1,063. | \$1,211. | \$1,575. |
| | | 90" | AW1T2R9042 () () () () | 792. | 1,108. | 1,108. | 1,261. | 1,640. |
| | | 96" | AW1T2R9642 () () () () | 818. | 1,139. | 1,139. | 1,288. | 1,674. |

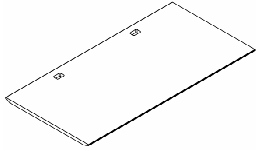

| Order Code | Specification Information | Application Notes |
|---|--|---|
| Example: AW1T2R3030MG118 V316613 | <i>To order please specify pattern number including:</i> | 7. Finish, Grommet(s) <i>specify painted or plated finish</i> |
| A AutoStrada | 1. Width | See page 7 for finish options applicable. |
| W Worksurface | 2. Depth | |
| 1 Generation 1 | 3. Surface type <i>L = Laminate</i> | Product on this page will accept wood grain laminate where laminate is currently an option. List price for wood grain laminate options will be current published laminate list price plus 10%. |
| T2 Tapered 2 sides, user & approach | <i>M = Mixed, Laminate surface/V1, V2 or V3 edge</i> | |
| R Rectilinear | <i>V = V1, V2 or V3</i> | When grommets specified up to 48" w tops have one grommet, over 48" w have two grommets. |
| 30 30" wide | 4. Grommet option <i>N = No grommets</i> | |
| 30 30" deep | <i>G = Grommet(s), flush</i> | |
| M Surface type, Mixed | <i>R = Grommet(s), recessed</i> | |
| G Grommet | 5. Finish, Surface <i>Laminate, V1, V2 or V3 finish</i> | |
| 118 Finish surface, Bright white | 6. Finish, Edge <i>Must be same as surface finish unless M surface type specified, then must be V1, V2 or V3 finish</i> | |
| V316 Finish edge, Maple | | |
| 613 Finish, grommet | | |

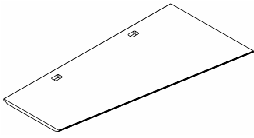
| description | d, left | w | d, right | pattern no. | L | M | V1 | V2 | V3 |
|---|---------|-----|----------|-----------------------------------|--------|--------|--------|--------|----------|
| Wedge, front and back edge tapered  | 24" | 48" | 30" | AW1T2W4823 () () () () | \$580. | \$758. | \$758. | \$855. | \$1,077. |
| | 24" | 60" | 30" | AW1T2W6023 () () () () | 642. | 834. | 834. | 941. | 1,188. |
| | 24" | 72" | 36" | AW1T2W7226 () () () () | 748. | 923. | 923. | 1,039. | 1,314. |
| | 30" | 48" | 24" | AW1T2W4832 () () () () | 580. | 758. | 758. | 855. | 1,077. |
| | 30" | 60" | 24" | AW1T2W6032 () () () () | 642. | 834. | 834. | 941. | 1,188. |
| | 36" | 72" | 24" | AW1T2W7262 () () () () | 748. | 923. | 923. | 1,039. | 1,314. |

| Order Code | Specification Information | Application Notes |
|---|--|--|
| Example: AW1T2W4823MG118 V316613 | <i>To order please specify pattern number including:</i> | |
| A AutoStrada | 1. Width | 6. Finish, Edge |
| W Worksurface | 2. Depth | <i>Must be same as surface finish unless M surface type specified, then must be V1, V2 or V3 finish</i> |
| 1 Generation 1 | 23 = 24" deep left, 30" deep right | 7. Finish, Grommet(s) |
| T2 Tapered 2 sides, user & approach | 32 = 30" deep left, 24" deep right | <i>specify painted or plated finish</i> |
| W Wedge | 26 = 24" deep left, 36" deep right | See page 7 for finish options applicable. |
| 48 48" wide | 62 = 36" deep left, 24" deep right | Product on this page will accept wood grain laminate where laminate is currently an option. |
| 2 24" deep, left | 3. Surface type | List price for wood grain laminate options will be current published laminate list price plus 10%. |
| 3 30" deep, right | <i>L = Laminate</i> | |
| M Surface type, Mixed | <i>M = Mixed, Laminate surface/V1, V2 or V3 edge</i> | |
| G Grommet | 4. Grommet option | |
| 118 Finish surface, Bright white | <i>N = No grommets</i> | |
| V316 Finish edge, Maple | <i>G = Grommet(s), flush</i> | |
| 613 Finish, grommet | <i>R = Grommet(s), recessed</i> | |
| | 5. Finish, Surface | |
| | <i>Laminate, V1, V2 or V3 finish</i> | |
| | | Hardware to attach to vertical support to be specified separately. |
| | | 1 1/4" tops require additional support when distance spans over 48". |
| | | Important: Please note placement of grommet(s) when specified assumes user edge is wedge side. If application requires user side to be straight edge and wedge edge as approach side, then specify no grommets. |
| | | When grommets specified up to 48" w tops have one grommet, over 48" w have two grommets. |

| description | d, left | w | d, right | pattern no. | L | M | V1 | V2 | V3 |
|---|---------|-----|----------|------------------------------------|--------|--------|--------|--------|----------|
| Double wedge, front and back edge tapered | 24" | 48" | 36" | AW1T2DW4826 () () () () | \$606. | \$839. | \$839. | \$951. | \$1,203. |
| | 24" | 60" | 36" | AW1T2DW6026 () () () () | 675. | 910. | 910. | 1,028. | 1,299. |
| | 24" | 72" | 36" | AW1T2DW7226 () () () () | 748. | 960. | 960. | 1,089. | 1,380. |

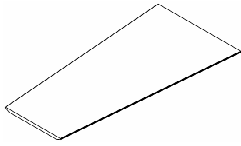

| Order Code | Specification Information | Application Notes |
|--|--|--|
| Example: AW1T2DW4826MG118V316613 | <i>To order please specify pattern number including:</i> | 5. Finish, Grommet <i>specify painted or plated finish</i> |
| A AutoStrada | 1. Surface type <i>L = Laminate</i> | See page 7 for finish options applicable. |
| W Worksurface | <i>M = Mixed, Laminate surface/V1, V2 or V3 edge</i> | Product on this page will accept wood grain laminate where laminate is currently an option. |
| 1 Generation 1 | <i>V = V1, V2 or V3</i> | List price for wood grain laminate options will be current published laminate list price plus 10%. |
| T2 Tapered 2 sides, user & approach | 2. Grommet option <i>N = No grommet</i> | |
| DW Double Wedge | <i>G = Grommet</i> | |
| 48 48" wide | 3. Finish, Surface <i>Laminate, V1, V2 or V3 finish</i> | |
| 2 24" deep | 4. Finish, Edge <i>Must be same as surface finish unless M surface type specified, then must be V1, V2 or V3 finish</i> | |
| 6 36" deep | | |
| M Surface type, Mixed | | |
| G Grommet | | |
| 118 Finish surface, Bright white | | Hardware to attach to vertical support to be specified separately. |
| V316 Finish edge, Maple | | 1 1/4" tops require additional support when distance spans over 48". |
| 613 Finish, grommet | | Grommet when specified, centered 36" w end. |

Tables with straight legs

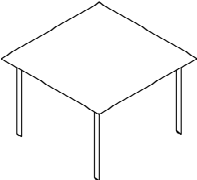
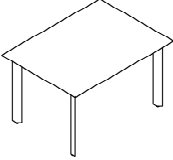
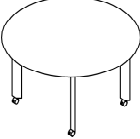
| description | h | w | d | dia. | pattern no. | L | M | V1 | V2 | V3 |
|---|---------|-----|-----|------|-----------------------------------|----------|----------|----------|----------|----------|
| Square table, tapered 4 sides  | 28 1/4" | 42" | 42" | | ATA1T44242 () () () () | \$1,479. | \$1,640. | \$1,640. | \$1,672. | \$1,937. |
| | 28 1/4" | 48" | 48" | | ATA1T44848 () () () () | 1,601. | 1,680. | 1,680. | 1,726. | 2,058. |
| Rectangular table, tapered 4 sides  | 28 1/4" | 48" | 30" | | ATA1T44830 () () () () | 1,509. | 1,626. | 1,626. | 1,649. | 1,878. |
| | 28 1/4" | 60" | 30" | | ATA1T46030 () () () () | 1,591. | 1,715. | 1,715. | 1,750. | 2,026. |
| | 28 1/4" | 72" | 30" | | ATA1T47230 () () () () | 1,671. | 1,749. | 1,749. | 1,791. | 2,115. |
| | 28 1/4" | 72" | 36" | | ATA1T47236 () () () () | 1,710. | 1,779. | 1,779. | 1,833. | 2,212. |
| Round table, tapered edge  | 28 1/4" | | 36" | | ATA1R36 () () () () | 1,534. | 1,759. | 1,591. | 1,642. | 1,863. |
| | 28 1/4" | | 42" | | ATA1R42 () () () () | 1,606. | 1,792. | 1,628. | 1,692. | 1,980. |
| | 28 1/4" | | 48" | | ATA1R48 () () () () | 1,736. | 1,833. | 1,673. | 1,749. | 2,112. |

Worksurfaces

| Order Code | Specification Information | Application Notes |
|---------------------------------------|--|--|
| Example: ATA1T44242V27C V316AA | <i>To order please specify pattern number including:</i> | |
| A AutoStrada | 1. Width | 7. Finish, Edge <i>Must be same as surface finish unless M surface type specified, then must be V1, V2 or V3 finish</i> |
| TA Table | 2. Depth | 8. Finish, Leg <i>Anodized aluminum finish or painted finish option excluding silver.</i> |
| 1 Generation 1 | 3. Surface type <i>L = Laminate M = Mixed, Laminate surface/V1, V2 or V3 edge V = V1, V2 or V3</i> | AutoStrada tables include four straight legs with glides or casters. Tables can be specified to surface height of: 28 3/8" : specify 27" leg. 29 3/8" : specify 28" leg. 31 1/2" : specify 30" leg. |
| T4 Tapered edge 4 sides | 4. Leg height (to underside of surface) <i>27 = 27" h 28 = 28 3/8" h (add \$30 for this option) 30 = 30 1/8" h (add \$66 for this option)</i> | See page 7 for finish options applicable. Product on this page will accept wood grain laminate where laminate is currently an option. List price for wood grain laminate options will be current published laminate list price plus 10%. |
| 42 42" wide | 5. Leg type <i>C = with Caster G = with Glide</i> | Grommets are not optional for tables. |
| 42 42" deep | 6. Finish, Surface <i>Laminate, Mixed, V1, V2 or V3 finish</i> | Stiffener included with rectangular tables 60" w and over. |
| V Surface type, veneer | | |
| 27 27" leg height | | |
| C Caster | | |
| V316 Finish top, Maple | | |
| AA Finish, leg | | |

Tables with L-legs

| description | h | w | d | dia. | leg height | pattern no. | L | M | V1 | V2 | V3 |
|---|----------------------------------|-----|-----|------|----------------------------------|-----------------------------|----------|----------|----------|----------|----------|
| Square table, tapered 4 sides with L-legs | 28 ³ / ₈ " | 42" | 42" | | 27" | ATAT4LL424227(L/M/V)() () | \$2,145. | \$2,383. | \$2,383. | \$2,432. | \$2,797. |
| | 28 ³ / ₈ " | 48" | 48" | | 27" | ATAT4LL484827(L/M/V)() () | 2,158. | 2,398. | 2,398. | 2,447. | 2,814. |
| | 29 ³ / ₄ " | 42" | 42" | | 28 ³ / ₈ " | ATAT4LL424228(L/M/V)() () | 2,149. | 2,388. | 2,388. | 2,437. | 2,803. |
| | 29 ³ / ₄ " | 48" | 48" | | 28 ³ / ₈ " | ATAT4LL484828(L/M/V)() () | 2,185. | 2,427. | 2,427. | 2,477. | 2,849. |

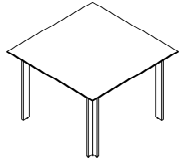

| | | | | | | | | | | | |
|---------------------------------------|----------------------------------|--|-----|----------------------------------|--|--------------------------|--------|--------|--------|--------|--------|
| Round table, tapered edge with L-legs | 28 ³ / ₈ " | | 36" | 27" | | ATARLL3627(L/M/V)() () | 2,088. | 2,320. | 2,320. | 2,367. | 2,722. |
| | 28 ³ / ₈ " | | 42" | 27" | | ATARLL4227(L/M/V)() () | 2,094. | 2,327. | 2,327. | 2,374. | 2,730. |
| | 28 ³ / ₈ " | | 48" | 27" | | ATARLL4827(L/M/V)() () | 2,105. | 2,339. | 2,339. | 2,387. | 2,745. |
| | 29 ³ / ₄ " | | 36" | 28 ³ / ₈ " | | ATARLL3628(L/M/V)() () | 2,123. | 2,359. | 2,359. | 2,407. | 2,768. |
| | 29 ³ / ₄ " | | 42" | 28 ³ / ₈ " | | ATARLL4228(L/M/V)() () | 2,129. | 2,366. | 2,366. | 2,414. | 2,776. |
| | 29 ³ / ₄ " | | 48" | 28 ³ / ₈ " | | ATARLL4828(L/M/V)() () | 2,141. | 2,378. | 2,378. | 2,427. | 2,791. |

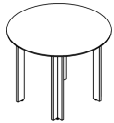

| | | | | | | | | | | | |
|---|----------------------------------|-----|-----|--|----------------------------------|-----------------------------|--------|--------|--------|--------|--------|
| Rectangular table desk, tapered 4 sides with L-legs | 28 ³ / ₈ " | 48" | 30" | | 27" | ATDT4LL483027(L/M/V)() () | 1,959. | 2,177. | 2,177. | 2,221. | 2,554. |
| | 28 ³ / ₈ " | 60" | 30" | | 27" | ATDT4LL603027(L/M/V)() () | 1,994. | 2,216. | 2,216. | 2,261. | 2,600. |
| | 28 ³ / ₈ " | 72" | 30" | | 27" | ATDT4LL723027(L/M/V)() () | 2,012. | 2,235. | 2,235. | 2,281. | 2,623. |
| | 28 ³ / ₈ " | 72" | 36" | | 27" | ATDT4LL723627(L/M/V)() () | 2,029. | 2,255. | 2,255. | 2,301. | 2,646. |
| | 29 ³ / ₄ " | 48" | 30" | | 28 ³ / ₈ " | ATDT4LL483028(L/M/V)() () | 2,038. | 2,265. | 2,265. | 2,311. | 2,658. |
| | 29 ³ / ₄ " | 60" | 30" | | 28 ³ / ₈ " | ATDT4LL603028(L/M/V)() () | 2,091. | 2,324. | 2,324. | 2,371. | 2,727. |
| | 29 ³ / ₄ " | 72" | 30" | | 28 ³ / ₈ " | ATDT4LL723028(L/M/V)() () | 2,135. | 2,373. | 2,373. | 2,421. | 2,784. |
| | 29 ³ / ₄ " | 72" | 36" | | 28 ³ / ₈ " | ATDT4LL723628(L/M/V)() () | 2,171. | 2,412. | 2,412. | 2,461. | 2,830. |

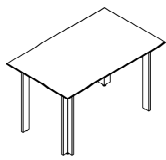

| Order Code | Specification Information | Application Notes |
|--|--|---|
| Example: ATAT4LL424227 V316AA | To order please specify pattern number including: | AutoStrada table desks include four L-legs with glides. |
| A AutoStrada | 1. Width | Tables can be specified to overall surface height of: |
| TA Table | 2. Depth | 28 ³ / ₈ " : specify 27" leg. |
| T4 Top tapered 4 sides | 3. Leg height (to underside of surface) 27 = 27"h 28 = 28 ³ / ₈ "h | 29 ³ / ₄ " : specify 28" leg. |
| LL L-Leg | 4. Surface type L = Laminate M = Mixed, Laminate surface/V1, V2 or V3 edge V = V1, V2 or V3 | |
| 42 42" wide | 5. Finish, Surface Laminate, Mixed, V1, V2 or V3 finish | |
| 42 42" deep | | |
| 27 Leg height | | |
| V Surface type, veneer | | |
| V316 Finish top, Maple | | |
| AA Finish, leg | | |

6. Finish, Edge (if applicable)
Must be same as surface finish unless M surface type specified, then must be V1, V2 or V3 finish
7. Finish, Leg
Anodized aluminum finish or painted finish option excluding silver.

See page 7 for finish options applicable.

Product on this page will accept wood grain laminate where laminate is currently an option.
List price for wood grain laminate options will be current published laminate list price plus 10%.

Grommets are not optional for tables.

Worksurface stiffener included with rectangular table desks 60" w and over.

Table desks with L-legs

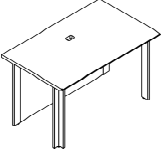
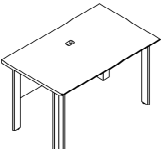
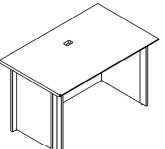
| description | h | w | d | leg height | pattern no. | L | M | V1 | V2 | V3 |
|--|----------------------------------|-----|----------------------------------|--------------------------------------|--------------------------------------|----------|----------|----------|----------|----------|
| Rectangular table desk with L-legs and full front modesty  | 28 ³ / ₈ " | 48" | 30" | 27" | ATDT1LFM483027(L/M/V)() () () () | \$2,412. | \$2,680. | \$2,680. | \$2,735. | \$3,145. |
| | 28 ³ / ₈ " | 60" | 30" | 27" | ATDT1LFM603027(L/M/V)() () () () | 2,448. | 2,720. | 2,720. | 2,775. | 3,191. |
| | 28 ³ / ₈ " | 72" | 30" | 27" | ATDT1LFM723027(L/M/V)() () () () | 2,477. | 2,752. | 2,752. | 2,808. | 3,229. |
| | 28 ³ / ₈ " | 72" | 36" | 27" | ATDT1LFM723627(L/M/V)() () () () | 2,494. | 2,771. | 2,771. | 2,828. | 3,252. |
| | 29 ³ / ₄ " | 48" | 30" | 28 ³ / ₈ " | ATDT1LFM483028(L/M/V)() () () () | 2,543. | 2,825. | 2,825. | 2,883. | 3,315. |
| | 29 ³ / ₄ " | 60" | 30" | 28 ³ / ₈ " | ATDT1LFM603028(L/M/V)() () () () | 2,547. | 2,830. | 2,830. | 2,888. | 3,321. |
| | 29 ³ / ₄ " | 72" | 30" | 28 ³ / ₈ " | ATDT1LFM723028(L/M/V)() () () () | 2,556. | 2,840. | 2,840. | 2,898. | 3,333. |
| 29 ³ / ₄ " | 72" | 36" | 28 ³ / ₈ " | ATDT1LFM723628(L/M/V)() () () () | 2,582. | 2,869. | 2,869. | 2,928. | 3,367. | |
| Rectangular table desk with L-legs and partial front modesty  | 28 ³ / ₈ " | 48" | 30" | 27" | ATDT1LPM483027(L/M/V)() () () () | 2,313. | 2,571. | 2,571. | 2,623. | 3,016. |
| | 28 ³ / ₈ " | 60" | 30" | 27" | ATDT1LPM603027(L/M/V)() () () () | 2,318. | 2,575. | 2,575. | 2,628. | 3,022. |
| | 28 ³ / ₈ " | 72" | 30" | 27" | ATDT1LPM723027(L/M/V)() () () () | 2,327. | 2,585. | 2,585. | 2,638. | 3,034. |
| | 28 ³ / ₈ " | 72" | 36" | 27" | ATDT1LPM723627(L/M/V)() () () () | 2,353. | 2,615. | 2,615. | 2,668. | 3,068. |
| | 29 ³ / ₄ " | 48" | 30" | 28 ³ / ₈ " | ATDT1LPM483028(L/M/V)() () () () | 2,411. | 2,678. | 2,678. | 2,733. | 3,143. |
| | 29 ³ / ₄ " | 60" | 30" | 28 ³ / ₈ " | ATDT1LPM603028(L/M/V)() () () () | 2,415. | 2,683. | 2,683. | 2,738. | 3,149. |
| | 29 ³ / ₄ " | 72" | 30" | 28 ³ / ₈ " | ATDT1LPM723028(L/M/V)() () () () | 2,424. | 2,693. | 2,693. | 2,748. | 3,160. |
| 29 ³ / ₄ " | 72" | 36" | 28 ³ / ₈ " | ATDT1LPM723628(L/M/V)() () () () | 2,450. | 2,722. | 2,722. | 2,778. | 3,195. | |
| Rectangular table desk with L-legs and full front&side modesties  | 28 ³ / ₈ " | 48" | 30" | 27" | ATDT1LFS483027(L/M/V)() () () () | 2,987. | 3,319. | 3,319. | 3,387. | 3,895. |
| | 28 ³ / ₈ " | 60" | 30" | 27" | ATDT1LFS603027(L/M/V)() () () () | 3,027. | 3,363. | 3,363. | 3,432. | 3,947. |
| | 28 ³ / ₈ " | 72" | 30" | 27" | ATDT1LFS723027(L/M/V)() () () () | 3,062. | 3,403. | 3,403. | 3,472. | 3,993. |
| | 28 ³ / ₈ " | 72" | 36" | 27" | ATDT1LFS723627(L/M/V)() () () () | 3,089. | 3,432. | 3,432. | 3,502. | 4,027. |
| | 29 ³ / ₄ " | 48" | 30" | 28 ³ / ₈ " | ATDT1LFS483028(L/M/V)() () () () | 3,076. | 3,417. | 3,417. | 3,487. | 4,010. |
| | 29 ³ / ₄ " | 60" | 30" | 28 ³ / ₈ " | ATDT1LFS603028(L/M/V)() () () () | 3,115. | 3,461. | 3,461. | 3,532. | 4,062. |
| | 29 ³ / ₄ " | 72" | 30" | 28 ³ / ₈ " | ATDT1LFS723028(L/M/V)() () () () | 3,151. | 3,501. | 3,501. | 3,572. | 4,108. |
| 29 ³ / ₄ " | 72" | 36" | 28 ³ / ₈ " | ATDT1LFS723628(L/M/V)() () () () | 3,177. | 3,530. | 3,530. | 3,602. | 4,142. | |

Worksurfaces

| Order Code | Specification Information | Application Notes |
|--|---|--|
| Example: ATDT1LPS483027VG V316AA111 | <i>To order please specify pattern number including:</i> | |
| A AutoStrada | 1. Full or partial modesty (and end panels when applicable) | 8. Finish, Edge <i>Must be same as surface finish unless M surface type specified, then must be V1, V2 or V3 finish</i> |
| TD Table desk | 2. Width | 9. Finish, Leg <i>Anodized aluminum finish or painted finish option excluding silver.</i> |
| T1 Top tapered 1 side (user only) | 3. Depth | 10. Finish, Grommet |
| L L-Leg | 4. Leg height (to underside of surface) 27 = 27"h 28 = 28 ³ / ₈ "h | See page 7 for finish options applicable. |
| FM Full front modesty | 5. Surface type <i>L = Laminate M = Mixed, Laminate surface/V1, V2 or V3 edge V = V1, V2 or V3</i> | Product on this page will accept wood grain laminate where laminate is currently an option. List price for wood grain laminate options will be current published laminate list price plus 10%. |
| 48 48" wide | 6. Grommet <i>G=Grommet N=No Grommet</i> | Worksurface stiffener included with rectangular tables 60"w and over. |
| 30 30" deep | 7. Finish, Surface <i>Laminate, Mixed, V1, V2 or V3 finish</i> | |
| 27 Leg height | | |
| V Surface type, veneer | | |
| G Grommet | | |
| V316 Finish top, Maple | | |
| AA Finish, leg | | |
| 111 Grommet finish | | |



AutoStrada tables include four L-legs with glides and full or partial height modesty (and optional end panels).
Tables can be specified to overall surface height of:
28³/₈" : specify 27" leg.
29³/₄" : specify 28" leg.

Partial height option for 27" leg is nominally 13" and 14"h nominally with 28³/₈"h legs; and may be mounted flush to underside of worksurface or with 1" gap below worksurface.

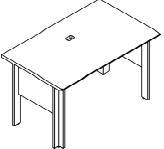
Table desks with L-legs

| description | h | w | d | leg height | pattern no. | L | M | V1 | V2 | V3 |
|--|----------------------------------|-----|-----|----------------------------------|--------------------------------------|----------|----------|----------|----------|----------|
| Rectangular table desk with L-legs and partial front and side modesties  | 28 ³ / ₈ " | 48" | 30" | 27" | ATDT1LPS483027(L/M/V)() () () () | \$2,836. | \$3,151. | \$3,151. | \$3,215. | \$3,697. |
| | 28 ³ / ₈ " | 60" | 30" | 27" | ATDT1LPS603027(L/M/V)() () () () | 2,875. | 3,195. | 3,195. | 3,260. | 3,749. |
| | 28 ³ / ₈ " | 72" | 30" | 27" | ATDT1LPS723027(L/M/V)() () () () | 2,911. | 3,234. | 3,234. | 3,300. | 3,795. |
| | 28 ³ / ₈ " | 72" | 36" | 27" | ATDT1LPS723627(L/M/V)() () () () | 2,937. | 3,263. | 3,263. | 3,330. | 3,830. |
| | 29 ³ / ₄ " | 48" | 30" | 28 ³ / ₈ " | ATDT1LPS483028(L/M/V)() () () () | 2,924. | 3,249. | 3,249. | 3,315. | 3,812. |
| | 29 ³ / ₄ " | 60" | 30" | 28 ³ / ₈ " | ATDT1LPS603028(L/M/V)() () () () | 2,964. | 3,293. | 3,293. | 3,360. | 3,864. |
| | 29 ³ / ₄ " | 72" | 30" | 28 ³ / ₈ " | ATDT1LPS723028(L/M/V)() () () () | 2,999. | 3,332. | 3,332. | 3,400. | 3,910. |
| | 29 ³ / ₄ " | 72" | 36" | 28 ³ / ₈ " | ATDT1LPS723628(L/M/V)() () () () | 3,025. | 3,361. | 3,361. | 3,430. | 3,945. |

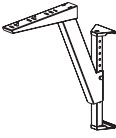
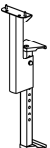
| Order Code | Specification Information | Application Notes |
|--|--|--|
| Example: ATDT1LPS483027VG V316AA111 | To order please specify pattern number including: | |
| A AutoStrada | 1. Full or partial modesty (and end panels when applicable) | 8. Finish, Edge Must be same as surface finish unless M surface type specified, then must be V1, V2 or V3 finish |
| TD Table desk | 2. Width | 9. Finish, Leg Anodized aluminum finish or painted finish option excluding silver. |
| T1 Top tapered 1 side (user only) | 3. Depth | 10. Finish, Grommet |
| L L-Leg | 4. Leg height (to underside of surface) 27 = 27" h 28 = 28 ³ / ₈ " h | See page 7 for finish options applicable. |
| FM Full front modesty | 5. Surface type L = Laminated M = Mixed, Laminated surface/V1, V2 or V3 edge V = V1, V2 or V3 | Product on this page will accept wood grain laminate where laminate is currently an option. List price for wood grain laminate options will be current published laminate list price plus 10%. |
| 48 48" wide | 6. Grommet G=Grommet N=No Grommet | Worksurface stiffener included with rectangular tables 60" w and over. |
| 30 30" deep | 7. Finish, Surface Laminated, Mixed, V1, V2 or V3 finish | |
| 27 Leg height | | AutoStrada tables include four L-legs with glides and full or partial height modesty (and optional end panels). Tables can be specified to overall surface height of: 28 ³ / ₈ " : specify 27" leg. 29 ³ / ₄ " : specify 28" leg. |
| V Surface type, veneer | | Partial height option for 27" leg is nominally 13" and 14" h nominally with 28 ³ / ₈ " h legs; and may be mounted flush to underside of worksurface or with 1" gap below worksurface. |
| G Grommet | | |
| V316 Finish top, Maple | | |
| AA Finish, leg | | |
| 111 Grommet finish | | |

| description | type | width | depth | height | pattern no. | painting | list |
|---|---|-------|-------|--------|----------------------|----------|------|
| Adjustable cantilever bracket (up to 24"D) | | 3" | 20" | 23-33" | AB1 AC24 () | \$184. | |
|  <p>Maximum of 24" deep worksurfaces may be cantilevered from Spine.</p> | | | | | | | |
| Adjustable end support bracket | | | 6" | 23-33" | AB2 AE () | | 148. |
|  | | | | | | | |
| Compact fixed height end support bracket | for 28"h worksurface | | 6" | 27" | AB2 FE27 () | | 125. |
| | for 29 ⁵ / ₈ "h worksurface | | 6" | 28" | AB2 FE28 () | | 125. |
|  | | | | | | | |
| Adjustable cantilever bridging bracket | | 3" | 20" | 23-33" | AB1-ABC24 () | | 239. |
| <p>Maximum of 24" deep worksurfaces may be cantilevered from Spine.</p> | | | | | | | |
| spacers (20 per pack) use with spine worksurface support brackets | | | | | AA1 BS | | 12. |

Order Code

| |
|-----------------------------|
| Example: AB1 AC24118 |
| AB1 Bracket |
| AC Type |
| 24 Depth |
| 118 Finish |

Specification Information

Please specify painted finish from paint options listed on page 7.

Specify worksurface cantilever and end support brackets to attach worksurfaces to spine walls.

Specify two cantilever brackets to support any 24"D worksurface up to 84" wide, or one back edge of corner worksurface. Specify three cantilever brackets to support any 24"D worksurface greater than 84" wide. Specify two end support brackets to support one end of straight, conference, or arc-shape surface.

Application Notes





Adjustable height cantilever and bridging cantilever brackets support underside of worksurface in 1" increments from 23" to 33"H (24" to 34" top height).

Spacers (AA1 BS) to be used with adjustable cantilever or end support brackets to accommodate wood case AutoStrada pedestals and lower storage with optional cabinet feet. Resulting overall worksurface height achieved 29⁵/₈"h.

Adjustable bridging cantilever supports adjacent 48"W straight or corner worksurfaces.

End support brackets adjust 23"-33"H (24" to 34" top height). Fixed height brackets support worksurface at 28"H and 29⁵/₈"H.

Cannot exceed maximum of 24" deep worksurfaces cantilevered from Spine.

| description | type | w | d | h | pattern no. | paint | list |
|--|---------------------------|-------|-----|---------|---------------------------|-------|------|
| End support brackets - E with wood screws  | 18"d straight worksurface | | 18" | 1 1/4" | MB3-E18W-() | \$38. | |
| | 24"d straight worksurface | | 24" | 1 1/4" | MB3-E24W-() | 41. | |
| | 30"d straight worksurface | | 30" | 1 1/4" | MB3-E30W-() | 46. | |
| | 36"d straight worksurface | | 36" | 1 1/4" | MB3-E36W-() | 52. | |
| End support brackets - E with wood screws End support for 30"h linkable screen  | 18"d straight worksurface | | 18" | 1 1/4" | MB3-EC18W-() * | 38. | |
| | 24"d straight worksurface | | 24" | 1 1/4" | MB3-EC24W-() * | 41. | |
| | 30"d straight worksurface | | 30" | 1 1/4" | MB3-EC30W-() * | 46. | |
| Cantilever brackets - C with wood screws  | 18"d worksurface | 1/2" | 15" | 8 1/2" | MB2-C18W-(L/R)-() | | 50. |
| | 24"d worksurface | 1/2" | 21" | 11 1/2" | MB2-C24W-(L/R)-() | | 58. |
| | 30"d worksurface | 1/2" | 24" | 13 1/2" | MB2-C30W-(L/R)-() | | 68. |
| Cantilever tie-clips - AUX-C (10) | | | | | MB1-AUX-C | | 12. |
| Worksurface/vertical panel spacer Y with wood screws  | | 1/16" | 15" | 8 1/2" | MB2-YW-(L/R)-() | | 43. |

| Order Code | Specification Information | Application Notes |
|---|--|---|
| Example: MB3-E30W-613 MB3 Bracket E Bracket type 30 Bracket depth W with wood screws 613 Finish, paint | Bracket type: E End Support C Cantilever Y Worksurface/vertical panel spacer <i>Please specify painted finish from paint options listed on page 7.</i> | E-type end support brackets support 1 1/4" or 1 3/4" worksurface from connector tracks at both back and front. C-type cantilever brackets support worksurfaces from connector track at the back. Specify left or right hand. AUX-C cantilever tie-clips tie together two adjacent cantilever brackets for added stability. Y-type spacer brackets secure the end of pedestal-supported worksurfaces to a connector track. Y brackets maintain the 3/8" wire drop and allow pedestal fronts to align with the end of the worksurface. * MB3-EC18W-(), MB3-EC24W-() and MB3-EC30W-() end support brackets should be specified when supporting worksurfaces from 30" high linkable screens. |

| description | d | pattern no. | P1 | P2 | P3 |
|--------------------------------|-----|-------------------------|-------|-------|-------|
| Cantilever bracket, panel hung | 18" | ASBC18 (L/R) () | \$88. | \$93. | \$97. |
| | 24" | ASBC24 (L/R) () | 97. | 104. | 109. |

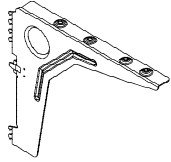

18" for 20" and 24" deep tops
 24" for 30" and 36" deep tops
 specify paint finish

| | | | | | |
|---------------------------------|--|------------------|-----|-----|-----|
| Side hung support bracket, pair | | RBCCP () | 38. | 41. | 42. |
|---------------------------------|--|------------------|-----|-----|-----|

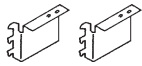

specify paint finish

| | | | | | |
|--|---------|------------|----|--|--|
| top to top brackets (pair) for use when top to top condition is without tapered edges | 6" x 1" | RBF | 6. | | |
|--|---------|------------|----|--|--|



| | | | | | |
|--|---------|---------------------|-----|--|--|
| Top to top bracket for use with tapered edge worksurface conditions ('tapered to tapered' or 'tapered to straight') | 4" x 7" | AT2TB (pair) | 94. | | |
|--|---------|---------------------|-----|--|--|

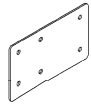

| Order Code | Specification Information | Application Notes |
|------------------------------|--|--|
| Example: RBC18L111 | <i>To order please specify pattern number including:</i> | <i>Flat edge to flat edge:</i> |
| R from Reff | 1. Left or right hand where applicable | RBF top to top brackets are for end to end worksurface connection, no tapered edges. |
| B Bracket | 2. Paint finish where applicable | A cantilever bracket should be used to join two adjacent straight worksurfaces along with pair of RBF top to top brackets. RBF brackets install between screw ports on cantilever bracket to underside of worksurface. |
| C Cantilever | <i>Specify painted finish from paint options listed on page 7.</i> | Tapered edges: AT2TB top to top brackets are for connection of worksurfaces at right angle, with one or both edges tapered. |
| 18 18" deep | | A cantilever bracket should be used to join two worksurfaces along with pair of AT2TB top to top brackets. Install one AT2TB bracket behind cantilever and one in front of cantilever. |
| L Left hand | | Midspan support required every 48" for all worksurfaces. |
| 111 Finish, Jet black | | Side hung support brackets provide primary connection of a worksurface to a panel, not recommended for midspan support. |

Worksurface support

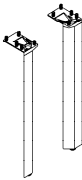
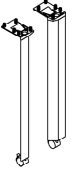
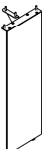
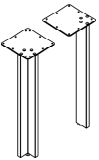

Straight legs, wide legs and L-legs

AutoStrada

| description | type | height | pattern number | list |
|--|--------------|----------------------------------|---------------------|--------|
|  Straight leg (pair) | Fixed height | 27" | AB1AS27 () | \$336. |
| | | 28 ³ / ₈ " | AB1AS28 () | 353. |
| | | 30 ¹ / ₈ " | AB1AS30 () | 363. |
|  Straight leg with casters (pair) | Fixed height | 27" | AB1ASC27 () | 336. |
| | | 28 ³ / ₈ " | AB1ASC28 () | 353. |
| | | 30 ¹ / ₈ " | AB1ASC30 () | 363. |
|  Wide leg | Fixed height | 27" | AB1AW27 () | 309. |
| | | 28 ³ / ₈ " | AB1AW28 () | 329. |
|  L-legs (pair) | Fixed height | 26 ¹ / ₂ " | APTLL26 () | 594. |
| | | 27" | APTLL27 () | 611. |
| | | 28 ³ / ₈ " | APTLL28 () | 621. |

| Order Code | Specification Information | Application Notes |
|----------------------------|---|---|
| Example: AB1AS28 AA | AutoStrada straight legs, wide legs and L-legs are available in anodized aluminum or painted finish option listed on page 7 excluding silver. | A pair of straight legs or a pair of L-legs or one wide leg can support one end of a worksurface when the other end is spine-supported, panel-supported or joined to a perpendicular worksurface with AT2TB brackets. If distance between support spans over 48", additional support is required. |
| AB1A AutoStrada leg | | |
| S Straight | To order specify pattern number including height 1. Specify finish | 27" from floor to underside of worksurface (28 ³ / ₈ " desk height) |
| 28 Height | | 28 ³ / ₈ " from floor to underside of worksurface (29 ³ / ₄ " desk height) |
| AA Finish | | 30 ¹ / ₈ " from floor to underside of worksurface (31 ¹ / ₂ " desk height) |
| | | AutoStrada wide legs are only available on glides, 27" or 28 ³ / ₈ " to underside of worksurface. |
| | | AutoStrada L-legs are available in three heights, glide only (no caster option) 26 ¹ / ₂ "h, 27"h and 28 ³ / ₈ "h. |
| | | Two pairs of straight legs or L-legs may also be specified to create a freestanding table in combination with an AutoStrada worksurface not to exceed 72" x 30" with a corresponding worksurface stiffener. |
| | | AutoStrada straight legs are available in three heights with or without casters: |

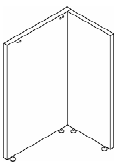
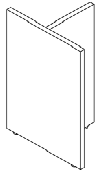
Worksurface support T and L bases

| description | type | h | w | d | pattern no. | L | V1 | V2 | V3 |
|---|--------------------------------|----------------------------------|-----|-----|--------------------|--------|--------|--------|--------|
|  | right hand | 28 ³ / ₈ " | 24" | | ALBR24 () | \$443. | \$453. | \$520. | \$676. |
| | | 28 ³ / ₈ " | 30" | | ALBR30 () | 511. | 525. | 607. | 790. |
| | | 28 ³ / ₈ " | 36" | | ALBR36 () | 581. | 602. | 691. | 898. |
| | left hand | 28 ³ / ₈ " | 24" | | ALBL24 () | 443. | 453. | 520. | 676. |
| | | 28 ³ / ₈ " | 30" | | ALBL30 () | 511. | 525. | 607. | 790. |
| | | 28 ³ / ₈ " | 36" | | ALBL36 () | 581. | 602. | 691. | 898. |
| <i>left hand shown</i> | | | | | | | | | |
|  | T Base for tapered 1 edge tops | 28 ³ / ₈ " | 18" | 12" | ATBT120 () | 406. | 421. | 490. | 637. |
| | | 28 ³ / ₈ " | 22" | 12" | ATBT124 () | 435. | 453. | 520. | 676. |
| | | 28 ³ / ₈ " | 28" | 12" | ATBT130 () | 511. | 525. | 607. | 790. |
| | | 28 ³ / ₈ " | 34" | 12" | ATBT136 () | 581. | 602. | 691. | 898. |
|  | T Base for tapered 2 edge tops | 28 ³ / ₈ " | 20" | 12" | ATBT224 () | 435. | 453. | 520. | 676. |
| | | 28 ³ / ₈ " | 26" | 12" | ATBT230 () | 511. | 525. | 607. | 790. |
| | | 28 ³ / ₈ " | 32" | 12" | ATBT236 () | 581. | 602. | 691. | 898. |
| | | 28 ³ / ₈ " | 38" | 12" | ATBT242 () | 718. | 740. | 855. | 1,109. |

| Order Code | Specification Information | Application Notes |
|---------------------------|---|---|
| Example: ATB24V316 | <i>To order please specify pattern number including:</i> | T and L bases are 28 ³ / ₈ "h to underside of worksurface. If used with wood case pedestals or lower storage as support, must specify cabinet feet (see page 231) for pedestals/lower storage to achieve required height. |
| A Autostrada | 1. Hand (applicable for L bases only) <i>L = left hand</i> <i>R = right hand</i> | |
| TB T-base | 2. Width | |
| 24 24" w x 12" d | 3. Finish <i>Laminate, V1, V2 or V3 finish</i> | |
| V316 Finish, Maple | See page 7 for finish options applicable. | |
| | Product on this page will accept wood grain laminate where laminate is currently an option. List price for wood grain laminate options will be current published laminate list price plus 10%. | |

Worksurface support

Modesty panels

AutoStrada

| description | h | w | pattern no. | L | V1 | V2 | V3 |
|---|-----|---------|--------------------|--------|--------|--------|--------|
|  Half height suspended modesty | 13" | 33 1/2" | AHHSM36 () | \$318. | \$377. | \$409. | \$532. |
| | 13" | 39 1/2" | AHHSM42 () | 328. | 384. | 420. | 547. |
| | 13" | 45 1/2" | AHHSM48 () | 337. | 393. | 430. | 560. |
| | 13" | 51 1/2" | AHHSM54 () | 347. | 400. | 443. | 574. |
| | 13" | 57 1/2" | AHHSM60 () | 355. | 408. | 454. | 589. |
| | 13" | 63 1/2" | AHHSM66 () | 365. | 415. | 465. | 604. |
| | 13" | 69 1/2" | AHHSM72 () | 375. | 423. | 476. | 618. |
| | 13" | 75 1/2" | AHHSM78 () | 384. | 430. | 487. | 633. |
| | 13" | 81 1/2" | AHHSM84 () | 394. | 438. | 499. | 649. |
| | 13" | 87 1/2" | AHHSM90 () | 403. | 447. | 510. | 663. |
| | 13" | 93 1/2" | AHHSM96 () | 412. | 455. | 521. | 677. |

Order Code

| | |
|-------------|------------------------|
| Example: | AHHSM30V316 |
| A | AutoStrada |
| HH | Half height |
| S | Suspended |
| M | Modesty |
| 30 | for 30" w work surface |
| V316 | Finish, Maple |

Specification Information

To order please specify pattern number including:

1. Finish
Laminate, V1, V2 or V3 finish

See page 7 for finish options applicable.

Product on this page will accept wood grain laminate where laminate is currently an option.
List price for wood grain laminate options will be current published laminate list price plus 10%.

Application Notes

To be used for free-standing private office applications.

Half height suspended modesty intended for optional use with work surfaces when creating configurations including a peninsula top supported at one end by a pair of legs (legs on page 224) or "freestanding" table desk by set of legs and would install just behind the legs by angle bracket that ships with modesty. Attachment hardware included.

If installing below worksurface with grommets, be sure to specify recessed grommet location.

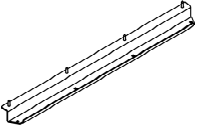
| description | type | width | depth | height | pattern number | list |
|---|------|-------|--------|--------|-----------------|-------|
| Stiffener for worksurface, full depths  | 36" | 20" | 1 1/2" | 1" | AWM1 S36 | \$52. |
| | 42" | 26" | 1 1/2" | 1" | AWM1 S42 | 55. |
| | 48" | 32" | 1 1/2" | 1" | AWM1 S48 | 57. |
| | 60" | 44" | 1 1/2" | 1" | AWM1 S60 | 59. |
| | 66" | 50" | 1 1/2" | 1" | AWM1 S66 | 61. |
| | 72" | 56" | 1 1/2" | 1" | AWM1 S72 | 63. |
| | 78" | 62" | 1 1/2" | 1" | AWM1 S78 | 66. |
| | 84" | 68" | 1 1/2" | 1" | AWM1 S84 | 68. |

Order CodeExample: **AWM1 S36****AWM1** Stiffener**S** Straight**36** Application**Specification Information**

Stiffeners are black painted finish.

Application Notes

AutoStrada worksurfaces require stiffeners when the span between structural supports exceeds 48". Stiffener also serves as horizontal cable manager.

Stiffener corresponds in width to straight or corner worksurface back edge. Specify 12" less wide stiffener to mount adjacent to floor standing pedestal.

For 90" application span, use AWM1-S84 stiffener.

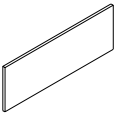
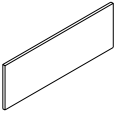
| description | h | w | pattern no. | list |
|---|-----|--------------------|--------------------|--------|
| Tackboard for 49" h Median  | 21" | 26 1/2" | ATBM26 () | \$142. |
| | 21" | 32 1/2" | ATBM32 () | 174. |
| | 21" | 42" | ATBM42 () | 228. |
| | 21" | 48" | ATBM48 () | 261. |
| | 21" | 54" | ATBM54 () | 294. |
| | 21" | 60" | ATBM60 () | 326. |
| | 21" | 66" | ATBM66 () | 359. |
| | 21" | 72" | ATBM72 () | 392. |
| | 21" | 78" | ATBM78 () | 424. |
| | 21" | 84" | ATBM84 () | 457. |
| | 21" | 90" | ATBM90 () | 489. |
| 21" | 96" | ATBM96 () | 522. | |
| Tackboard for 49" h Bridge  | 21" | 42" | ATBB42 () | 228. |
| | 21" | 48" | ATBB48 () | 261. |
| | 21" | 54" | ATBB54 () | 294. |
| | 21" | 60" | ATBB60 () | 326. |
| | 21" | 66" | ATBB66 () | 359. |
| | 21" | 72" | ATBB72 () | 392. |
| | 21" | 78" | ATBB78 () | 424. |
| 14" h Tackboard for use with 42" h medians or bridges | 14" | 26 1/2" | ATB1426 () | 138. |
| | 14" | 32 1/2" | ATB1432 () | 168. |
| | 14" | 42" | ATB1442 () | 221. |
| | 14" | 48" | ATB1448 () | 253. |
| | 14" | 54" | ATB1454 () | 285. |
| | 14" | 60" | ATB1460 () | 317. |
| | 14" | 66" | ATB1466 () | 349. |
| | 14" | 72" | ATB1472 () | 380. |
| | 14" | 78" | ATB1478 () | 412. |
| | 14" | 84" | ATB1484 () | 444. |
| | 14" | 90" | ATB1490 () | 475. |
| 14" | 96" | ATB1496 () | 506. | |

| Order Code | Specification Information | Application Notes |
|--|---|---|
| Example: ATBM26W359- A AutoStrada TB Tackboard M for median 26 for 26.5" d gable W359- Fabric selection | To order please specify pattern number including: 1. For median or bridge <i>M = for medians</i> <i>B = for bridges</i> 2. Width <i>26 = for 26.5 d median gable</i> <i>32 = for 32.5 d median gable</i> <i>All others specify to match width of corresponding median or bridge</i> 3. Fabric selection | Velcro included to attach tackboard to median or bridge as required. Fabric orientation is applied "railroaded". Fabric choices listed on page 8. |

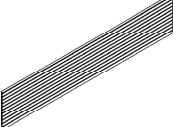
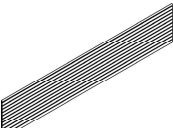
| description | h | w | pattern no. | AA or paint |
|--|-----|-------------------|-------------------|-------------|
| Slatwall for Median  | 19" | 26 1/2" | ASWM26 () | \$225. |
| | 19" | 32 1/2" | ASWM32 () | 282. |
| | 19" | 42" | ASWM42 () | 337. |
| | 19" | 48" | ASWM48 () | 378. |
| | 19" | 54" | ASWM54 () | 420. |
| | 19" | 60" | ASWM60 () | 461. |
| | 19" | 66" | ASWM66 () | 501. |
| | 19" | 72" | ASWM72 () | 542. |
| | 19" | 78" | ASWM78 () | 582. |
| | 19" | 84" | ASWM84 () | 612. |
| | 19" | 90" | ASWM90 () | 641. |
| 19" | 96" | ASWM96 () | 670. | |
| Slatwall for Bridge  | 19" | 42" | ASWB42 () | 337. |
| | 19" | 48" | ASWB48 () | 378. |
| | 19" | 54" | ASWB54 () | 420. |
| | 19" | 60" | ASWB60 () | 461. |
| | 19" | 66" | ASWB66 () | 501. |
| | 19" | 72" | ASWB72 () | 542. |
| | 19" | 78" | ASWB78 () | 582. |

| Order Code | Specification Information | Application Notes |
|-------------------------------------|--|--|
| Example: ASWM26AA | <i>To order please specify pattern number including:</i> | Slatwall attaches to median or bridge assembly with brackets (supplied with slatwall) which are then screwed onto modesty of median or bridge assembly. Modesties are not predrilled for attachment, field drill required during installation. |
| A AutoStrada | 1. For median or bridge <i>M = for medians</i> <i>B = for bridges</i> | |
| SW Slatwall | 2. Width <i>26 = for 26.5 d median gable</i> <i>32 = for 32.5 d median gable</i> <i>All others specify to match width of corresponding median or bridge</i> | |
| M for median | 3. Finish <i>AA - anodized aluminum or painted finish option from page 7 excluding silver</i> | |
| 26 for 26.5" d gable | | |
| AA Finish, anodized aluminum | | |

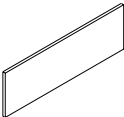
| description | height | width | pattern no. | list |
|--|--------|-------|--------------------|--------|
| Wall hung tackboard  | 24" | 30" | AWHTB30 () | \$194. |
| | 24" | 36" | AWHTB36 () | 232. |
| | 24" | 42" | AWHTB42 () | 272. |
| | 24" | 48" | AWHTB48 () | 310. |
| | 24" | 54" | AWHTB54 () | 348. |
| | 24" | 60" | AWHTB60 () | 388. |
| | 24" | 66" | AWHTB66 () | 426. |
| | 24" | 72" | AWHTB72 () | 466. |
| | 24" | 78" | AWHTB78 () | 503. |
| | 24" | 84" | AWHTB84 () | 542. |
| | 24" | 90" | AWHTB90 () | 582. |
| | 24" | 96" | AWHTB96 () | 620. |

Order Code

| |
|-------------------------------|
| Example: AWHTB30W359- |
| A AutoStrada |
| WH Wall hung |
| TB Tackboard |
| 30 30" wide |
| W359- Fabric selection |

Specification Information

To order please specify pattern number including:

1. Width
2. Fabric selection

Application Notes

Fabric orientation is applied railroaded.

Velcro supplied for attaching to wall.

Fabric choices listed on page 8.

$\frac{3}{4}$ " wide x $\frac{3}{8}$ " deep vertical channel 3" from right hand edge of tackboard routed for task light cord.

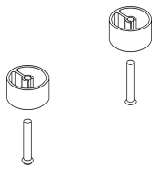
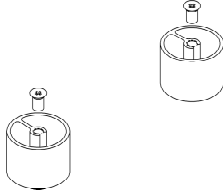
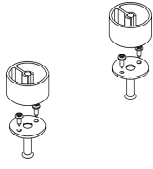
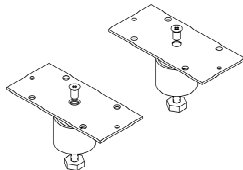
| description | height | dia. | pattern no. | list |
|--|--------|--------|------------------|-------|
| Worksurface stand-off (pair)  | 1" | 1 3/4" | AWSO () | \$30. |
| Cabinet feet (pair)  | 1 7/8" | 1 3/4" | ACF () | 152. |
| Worksurface stand-off (pair), for "ganging"  | 1" | 1 3/4" | AWSOG () | 30. |
| Cabinet feet (pair) for "ganging"  | 1 7/8" | 1 3/4" | ACFG () | 152. |

| Order Code | Specification Information | Application Notes |
|---|---|--|
| Example: AWSOAA A AutoStrada WSO Work surface stand-off AA Finish, anodized aluminum | To order please specify pattern number including: 1. Finish <i>AA - anodized aluminum or painted finish option from page 7 excluding silver</i> | <p>Worksurface stand-offs are for use primarily in the private office between work surfaces and wood case pedestals or lower storage. Worksurface stand-offs may also be installed in place of anti-tip wood spacer between work surfaces and wood case pedestals or lower storage in storage anchored planning. Anti-tip wood spacer and stand-offs are both 1" h.</p> <p>Cabinet feet are for use with lower storage units in private office planning to achieve overall worksurface height of 29 3/8".</p> <p>Note: Free-standing cabinets on page 165 include cabinet feet.</p> <p>If you are planning to create an open knee space credenza with one storage unit on either end of the credenza, you would require 2 pairs of work surface stand-offs and 2 pairs of cabinet feet for each lower storage unit.</p> <p>When "ganging" units together to create "build-to-spec" credenzas, one pair of work surface stand-offs and one pair of cabinet feet are required to span side-by-side units. For instance, if creating a credenza with 3 lower storage units, specify 4 pairs of stand-offs and 4 pairs of cabinet feet.</p> <p>Cabinet feet should not be used in spine-based or storage anchored planning models. Use only with wood case pedestals and laterals to achieve overall worksurface height of 29 3/8" (or 28 3/8" to underside of worksurface). Spine based and Storage Anchored planning model components are engineered at 27" from floor to underside of worksurface.</p> <p>To install cabinet feet, first remove leveller from pedestal or lower storage, then reinstall with feet.</p> |

This Order Guide provides basic planning, specifications and pricing information for Crinion Open Tables.

Refer to KnollExtra price list for compatible accessories such as flat screen monitor supports, task lights, paper management accessories, keyboard and storage drawers.

Refer to Calibre, Reff or Currents price lists for shared and individual storage options. Additional information can be found at www.knoll.com.

Crinion Open Table is the straightforward alternative for open, collaborative work environments. The table accommodates a group of four to eight or more at a continuous work surface.

Crinion Open Table typically consists of deep worksurfaces end-to-end and back-to-back, cantilever supported by parallel beams between end legs. The beams form a technology corridor for flat screen monitor supports, outlets and power/data distribution. Also available is a single-sided configuration, with a single main beam and a smaller back beam, and a single beam configuration for tables with shallower (24" deep) worksurface.

The center of dual tables or back of single-sided tables features a top channel which supports privacy screens above the table and modular power distribution below the worksurface.

Crinion Open Table is appropriate for libraries and education environments, laboratories, finance and trading desks, teaming areas and design offices.

Crinion Open Table is unique in offering individual height-adjustability and extraordinarily deep worksurfaces. Overall dual table depth is 48", 60" or 72".

The table structure is strong enough to span 16 feet between end legs or intermediate supports to build tables of any length.

The continuous worksurfaces and clear kneespace enable varying numbers of workers to sit on each side. Storage is typically separated from the table in parallel, shared file-and-storage islands, perpendicular files and filetops as returns or mobile pedestals.

Crinion is distinguished by a minimalist, modern design, and details like square or tapered edge worksurfaces, plastic laminate, Techwood or natural veneers, and aluminum fittings.

Crinion Open Table simplifies the planning and specifications of an open office, and it can make a dramatic visual and functional statement of collaboration.

The quality and classic design of Crinion work well in virtually any interior.

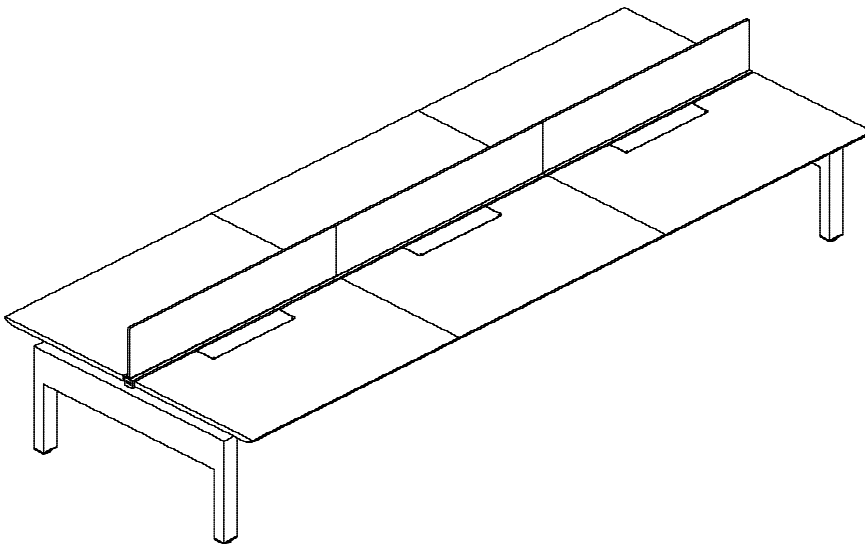

Crinion Open Tables are comprised of worksurfaces, table base assemblies, power components and screens.

Worksurfaces

Individual worksurfaces are available in four standard widths (48", 60", 72", 96") and three depths (nominal 24", 30", 36"), which may be combined to form single-sided or dual-sided groups of two to ten or more positions.

Worksurface edge options

Worksurfaces are 1 1/4" thick, with three front edge options: Tapered edge, laminate, veneer or mixed.

Square edge, veneer

Postformed edge, laminate only

Power and accessory options

Worksurfaces may be specified with hinged power access door and continuous 1/2" cord drop, or edge grommet and continuous cord drop, or just cord drop.

Hinged power access door is 24"W and 5"D, centered on worksurface width. Door hinges toward user for continuity between access opening and cord drop.

Any worksurface (except end counters) accepts clamp on KnollExtra accessories such as flat screen monitor arm or task light.

Other worksurface types

End counters have front edge detail on side edges as well and are designed to extend dual tables 24" or 30" beyond the endleg. End counters also include 3" wide center grommet. Extended end counters are 36"D surfaces with center grommet or hinged power access door. Base of the table must be extended 12" under the back of each extended end counter (although top channels should be specified only as wide as the worksurfaces on each side of the table).

All end counters must be supported by end counter cantilevers and endlegs for end counters.

Worksurface heights

Fixed height cantilevers support worksurfaces at 28 1/2"H, with 27" clear below the top (except directly below cantilevers).

Adjustable height cantilevers enable worksurfaces to be independently set at 27", 27 3/4", 28 1/2", 29 1/4", or 30"H.

Open Table base assemblies

Complete base assemblies simplify specifications for most common configurations of dual or single-sided open tables. Base assemblies include top channels and end caps, beams, end legs and intermediate legs (where required), trusses and top channel supports, cantilever brackets (specify fixed or adjustable height) and midspan supports. Specify worksurfaces, screens, power components, cable trays and accessories separately.

Complete base assemblies are available for the following typical tables, combinations of 60" or 72" worksurfaces.

Single-sided or dual, 24"D, 30"D, or 36"D, with continuous beam span between end legs

10' W two/four positions 60"W

12' W two/four positions 72"W

15' W three/six positions 60"W

Single sided or dual 24"D, 30"D, or 36"D, with intermediate leg

18' W three/six positions 72"W

20' W four/eight positions 60"W

24' W four/eight positions 72"W

25' W five/ten positions 60"W

Open Table base components

Base assemblies may also be specified by individual components to create configurations other than those listed above, or to create tables with end counters or frameless glass add ups.

In addition to worksurfaces Open tables require top channel, starter beams for spans up to 15', extension beams for additional spans of 4' to 15', intermediate legs every 16' or less, two end legs, trusses at every worksurface junction and at each end leg. Adjustable tables require two cantilevers per worksurface (or three for 96"W). Fixed height tables may be supported by a fixed height cantilever at each end, shared cantilevers at each worksurface joint, and a midspan support bracket at the center of each worksurface greater than 48" wide. For 96"W worksurfaces the midspan support should be a 24"D cantilever. Power components, cable trays and screens are optional.

Power distribution

Optional modular raceway distributes 2+2 four circuit or 3+3 six circuit configuration from a single point of supply. Bundles of cables can be managed from the floor in a cable infeed shroud located at any intermediate leg. Raceway provides power outlets and data/communications outlet openings on one or both sides, accessed through hinged access doors in worksurfaces or from under table. Specify 30" raceway for two duplex outlets each side or 42" raceway for four duplex outlets each side. Duplex outlets, power infeed and jumpers between raceways must be specified separately.

Specify compact power module for outlets under extended end counters.

Privacy screens

There are four screen options for Crinion Open Table.

The standard screens are 14"H (42" horizon) or 21"H (49" horizon) in acrylic, slatwall or combination surfaces. Center screens include mounting hardware to attach to the standard top channel. Center screens are available full width, 48", 60" or 72", or shorter by 1" to leave space at either end of the table for a dual end screen. Side screens attach to the front and back of a worksurface at any point other than at a hinged access door. Mounting brackets are specified separately to correspond to each worksurface edge detail. Dual end screens span across the end of a table (or above an end counter) from worksurface front edges.

Frameless glass add ups are available in 12" height only, 48", 60", and 72"W. Add ups can only mount to a top channel for frameless glass add ups, which may be at the center of a dual table or back of a single-sided table specified by components.

Original Crinion privacy screens are 12"H or 19"H (41" or 48" horizons) and mount to a standard top channel only.

Morrison Network fabric screens (15"H or 22"H) can also be mounted to the standard top channel with Crinion Open Table mast kit.

Accessories and storage

All Crinion worksurfaces accept clamp base KnollExtra flat screen monitor arms and task lights at any point except behind the hinged power access door. Worksurfaces also accept suspended accessories like adjustable keyboard supports, BackPack center file or keyboard drawers, or CPU holders. Beam location under most tables prevents pedestals deeper than 20" underneath. However 36"D tops can be planned on 30"D table bases to create additional kneespace depth and room for 24"D pedestals.

Crinion Open Table file tops are available for 27"H Calibre files positioned perpendicular to the table to act as returns. Tapered front and back edges assure consistent detail with tapered worksurface edges. File tops are also available for pairs of files and back to back files.

Finishes

L - Laminate

Matching edge band unless noted otherwise

- 117 Soft Grey
- 118 Bright White
- 114 Folkstone Grey
- 111 Jet Black
- 119 Pumice
- 121 Micro Grey with 114 Folkstone grey edge band
- 122 Brushed Sand with 119 Pumice edge band
- 123 Brushed Grey with 128 Fog edge band
- 128 Fog
- 129 Micro Sand with 119 Pumice edge band

Additional wood grain laminates for application on postformed laminate tops only.

(not available on end counters or tapered edge tops):

- 125 Natural Maple
- 126 Natural Cherry
- 124 Medium Cherry
- 127 Walnut

V1 - Techwood Closed Pore

- Y319 Cherry
- Y326 Dark Mahogany
- Y316 Maple
- Y323 Medium Walnut
- Y327 Light Oak
- Y329 Medium Oak
- Y851 Black Oak
- Y341 Wenge
- Y342 Medium Teak
- Y343 Dark Grey Oak
- Y344 Espresso

V2 - Natural veneer

- V312 Bronze Cherry
 - V316 Maple
 - V411 Light Walnut
 - V415 Peacock Green Walnut
 - V417 Old English Walnut
 - V418 Smoked Walnut
 - V433 Light Fawn Cherry
 - V436 Medium Brown Cherry
- (all above V2's are flat cut)*
- V421 Chalk Oak
 - V423 Light Oak
 - V425 Amber Oak
 - V427 Brown Oak
 - V439 Straight Anigre
- (all V2 Oaks are quarter cut)*

V3 - Exotic veneer

- V512 Quartered Figured Anigre
 - V514 Quartered Makore
 - V515 Quartered Sycamore
 - V513 Quartered Graphite Oak
 - V517 Natural Sapele
- (all V3s are quarter cut)*

Paint

P1

- 111 Jet Black
- 112 Brown
- 113 Dark Grey
- 114 Folkstone Grey
- 115 Medium Grey
- 116 Sandstone
- 117 Soft Grey

P2

- 611 Beige Mist Metallic
- 612 Medium Metallic Grey

P3

- 118 Bright White
- 613 Silver

Anodized

- AA Anodized Aluminum

Glass

- TEMP Clear Tempered
- GL13 Powder

Acrylic

- O Opal
- T Translucent

Architectural

- GL13 Powder

Fabric Options

Grade 10

- Bailey II (W359)
- Broadcloth (W288)
- Element (W1077)
- Foundation (W351)
- Growth Spurt (W692)
- Newbury (W812)
- Solid Crepe (W257)
- Symbolic Detail (W693)
- Tailor Made (W133)
- Versatility (W432)

Grade 15

- Regency (W210)

Grade 20

- Archaea (W1254)
- Banyan (W443)
- Bauhaus Block (W296A)
- Circle Line (W1146)
- Clarity (W281)
- Criss Cross (W305)
- Devon (W809)

Fabric Options

Grade 20 (continued)

- Melbourne (W228)
- Outback (W229)
- Photon (W1293)
- Reflect (W884)
- Resolution (W280)
- Walkabout (W230)
- Weave Three (W298)

Grade 30

- Basket Draft (W249)
- Flow (W565)
- Harmony (W232)
- Interknit (W1090)
- Match Point (W1145)
- Micro (W465)
- Progression (W403)
- Progression Striae (W463)
- Raku Cloth (W566)
- Relay (W1020)

Grade 40

- Amplify (W1215)
- Bandwidth (W1219)
- Clarkson (W1219)
- Monarch (K1149)
- Ornament (W1078)

Grade 45

- Casual Elegance (W920)
- Dristi (K872)
- Macro (W544)
- Mezzo (W543)

Grade 50

- Knoll Hopsack (K1206)
- Presto (K1000)

Grade 55

- Transition (W816)

Customers Own Material

Prices for panels that are to be manufactured with a customer supplied fabric will follow Grade 10 panel pricing. COM fabrics are subject to a testing charge prior to acceptance for use on panels. Panels bearing COM fabrics are subject to extended leadtimes. It is the responsibility of the customer's purchasing agent to ensure COM fabric is supplied for testing and manufacturing. Delays in receiving COM fabric for manufacturing will result in rescheduled delivery dates.

Mixed Finish work surfaces:

To order mixed finishes, enter four digit finish code as follows:

Use 2 digit prefix to indicate surface finish (laminate)

- 11 Jet Black
- 14 Folkstone Grey
- 17 Soft Grey
- 18 Bright White
- 19 Pumice
- 21 Micro Grey
- 22 Brushed Sand
- 23 Brushed Grey
- 28 Fog
- 29 Micro Sand

Use 2 digit suffix to indicate edge finish (wood)

- 11 for Y311
- 12 for V312
- 16 for V316, Y316
- Y9 for Y319
- Y3 for Y323
- 24 for Y324
- 25 for Y325
- 26 for Y326
- 27 for Y327
- 28 for Y328
- 29 for Y329
- 41 for V431
- 43 for V433
- 45 for V415
- 46 for V436
- 47 for V417
- 48 for V418
- 52 for V512
- 53 for V513
- 54 for V514
- 55 for V515
- 57 for V517
- 61 for V411
- 71 for V421
- 73 for V423
- 75 for V425
- 77 for V427

Example:

For a Micro Grey laminate surface with Bronzed Cherry edge, enter finish code 2112

For a Jet Black laminate surface with Light Maple edge, enter finish code 1116

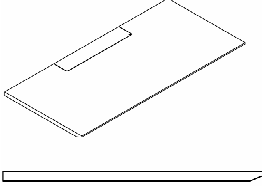
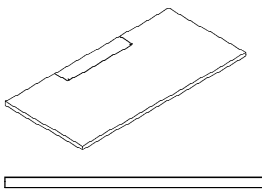
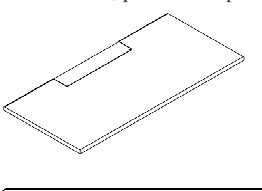
| description | nominal depth | w | d | h | pattern number | L | M | V1 | V2 | V3 |
|--|--|-----|-----|--------|-------------------------------|---------------------------|--------|--------|--------|----------|
| Worksurface, tapered edge  | 24" | 48" | 22" | 1 1/4" | XTTK4824A (L/M/1/2/3) () () | \$755. | \$880. | \$880. | \$964. | \$1,164. |
| | 24" | 60" | 22" | 1 1/4" | XTTK6024A (L/M/1/2/3) () () | 782. | 962. | 962. | 1,060. | 1,288. |
| | 24" | 72" | 22" | 1 1/4" | XTTK7224A (L/M/1/2/3) () () | 835. | 1,015. | 1,015. | 1,124. | 1,373. |
| | 24" | 96" | 22" | 1 1/4" | XTTK9624A (L/M/1/2/3) () () | 929. | 1,144. | 1,144. | 1,275. | 1,568. |
| | 30" | 48" | 28" | 1 1/4" | XTTK4830A (L/M/1/2/3) () () | 766. | 953. | 953. | 1,051. | 1,277. |
| | 30" | 60" | 28" | 1 1/4" | XTTK6030A (L/M/1/2/3) () () | 806. | 1,031. | 1,031. | 1,139. | 1,390. |
| | 30" | 72" | 28" | 1 1/4" | XTTK7230A (L/M/1/2/3) () () | 863. | 1,066. | 1,066. | 1,180. | 1,444. |
| | 30" | 96" | 28" | 1 1/4" | XTTK9630A (L/M/1/2/3) () () | 962. | 1,204. | 1,204. | 1,340. | 1,651. |
| | 36" | 48" | 34" | 1 1/4" | XTTK4836A (L/M/1/2/3) () () | 802. | 1,036. | 1,036. | 1,151. | 1,406. |
| | 36" | 60" | 34" | 1 1/4" | XTTK6036A (L/M/1/2/3) () () | 825. | 1,109. | 1,109. | 1,228. | 1,505. |
| | 36" | 72" | 34" | 1 1/4" | XTTK7236A (L/M/1/2/3) () () | 900. | 1,121. | 1,121. | 1,240. | 1,521. |
| | 36" | 96" | 34" | 1 1/4" | XTTK9636A (L/M/1/2/3) () () | 1,023. | 1,266. | 1,266. | 1,410. | 1,743. |
| | Worksurface, veneer square edge  | 24" | 48" | 22" | 1 1/4" | XTTS4824A (1/2/3) () () | n/a | n/a | 721. | 793. |
| 24" | | 60" | 22" | 1 1/4" | XTTS6024A (1/2/3) () () | n/a | n/a | 756. | 828. | 936. |
| 24" | | 72" | 22" | 1 1/4" | XTTS7224A (1/2/3) () () | n/a | n/a | 793. | 864. | 985. |
| 24" | | 96" | 22" | 1 1/4" | XTTS9624A (1/2/3) () () | n/a | n/a | 852. | 924. | 1,068. |
| 30" | | 48" | 28" | 1 1/4" | XTTA4830A (1/2/3) () () | n/a | n/a | 828. | 901. | 1,020. |
| 30" | | 60" | 28" | 1 1/4" | XTTA6030A (1/2/3) () () | n/a | n/a | 852. | 930. | 1,069. |
| 30" | | 72" | 28" | 1 1/4" | XTTA7230A (1/2/3) () () | n/a | n/a | 877. | 961. | 1,163. |
| 30" | | 96" | 28" | 1 1/4" | XTTA9630A (1/2/3) () () | n/a | n/a | 924. | 1,020. | 1,321. |
| 36" | | 48" | 34" | 1 1/4" | XTTA4836A (1/2/3) () () | n/a | n/a | 901. | 990. | 1,140. |
| 36" | | 60" | 34" | 1 1/4" | XTTA6036A (1/2/3) () () | n/a | n/a | 936. | 1,027. | 1,168. |
| 36" | | 72" | 34" | 1 1/4" | XTTA7236A (1/2/3) () () | n/a | n/a | 972. | 1,082. | 1,278. |
| 36" | | 96" | 34" | 1 1/4" | XTTA9636A (1/2/3) () () | n/a | n/a | 1,044. | 1,188. | 1,476. |
| Worksurface, postformed plastic  | | 24" | 48" | 22" | 1 1/4" | XTPP4824A (L) () () | 556. | n/a | n/a | n/a |
| | 24" | 60" | 22" | 1 1/4" | XTPP6024A (L) () () | 633. | n/a | n/a | n/a | n/a |
| | 24" | 72" | 22" | 1 1/4" | XTPP7224A (L) () () | 692. | n/a | n/a | n/a | n/a |
| | 24" | 96" | 22" | 1 1/4" | XTPP9624A (L) () () | 757. | n/a | n/a | n/a | n/a |
| | 30" | 48" | 28" | 1 1/4" | XTPP4830A (L) () () | 579. | n/a | n/a | n/a | n/a |
| | 30" | 60" | 28" | 1 1/4" | XTPP6030A (L) () () | 662. | n/a | n/a | n/a | n/a |
| | 30" | 72" | 28" | 1 1/4" | XTPP7230A (L) () () | 727. | n/a | n/a | n/a | n/a |
| | 30" | 96" | 28" | 1 1/4" | XTPP9630A (L) () () | 804. | n/a | n/a | n/a | n/a |
| | 36" | 48" | 34" | 1 1/4" | XTPP4836A (L) () () | 610. | n/a | n/a | n/a | n/a |
| | 36" | 60" | 34" | 1 1/4" | XTPP6036A (L) () () | 727. | n/a | n/a | n/a | n/a |
| | 36" | 72" | 34" | 1 1/4" | XTPP7236A (L) () () | 785. | n/a | n/a | n/a | n/a |
| | 36" | 96" | 34" | 1 1/4" | XTPP9636A (L) () () | 870. | n/a | n/a | n/a | n/a |

| Order Code | Specifications | Application Notes |
|--|--|---|
| Example: XTPP6030AL 118 118 | Worksurfaces are 1 1/4" thick with square edge or tapered edge option tapering to 1/2" thick front edge. | Crinon 30"D worksurfaces correspond in width to table bases, which are specified separately. |
| XT Crinon Open Table | | 48"W worksurfaces plan on 12' wide or 20' wide bases. 60"W worksurfaces plan on 5', 10', 15' and 20' wide bases. 72" W worksurfaces plan on 6', 12' and 18' wide bases. |
| T Worksurface | | |
| P Postformed plastic | | |
| 60 Width | 1. Specify finish group: L - Laminate M - Laminate/veneer edge | |
| 30 Depth | 1 - Veneer group 1 2 - Veneer group 2 3 - Veneer group 3 | |
| A With center hinged power access | 2. Specify worksurface finish. | Power access door is 24" wide, 5" deep, centered at back edge of worksurface. |
| L Finish Type | 3. Specify hinged access cover finish. | Continous 1/2" wire drop accommodates clamp-on flat screen monitor arm or most power cords plugs. |
| 118 Work Surface finish | | Actual worksurface depth is 22.35", 28.35" or 34.35". |
| 118 Access door finish | AA anodized aluminum and all P1,P2 and P3 paint finishes are available except 613 Silver. | Worksurfaces with hinged power access enable access to suspended modular raceway. |

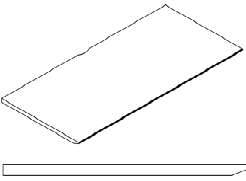
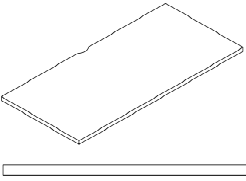
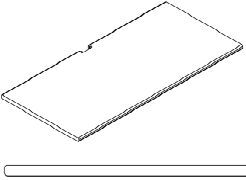
| description | nominal depth | w | d | h | pattern number | L | M | V1 | V2 | V3 |
|--|--|-----|-----|--------|--------------------------------------|----------------------------------|--------|--------|--------|--------|
| Worksurface, tapered edge  | 24" | 48" | 22" | 1 1/4" | XTTK4824U (L/M/1/2/3) () () | \$495. | \$620. | \$620. | \$704. | \$904. |
| | 24" | 60" | 22" | 1 1/4" | XTTK6024U (L/M/1/2/3) () () | 522. | 702. | 702. | 800. | 1,028. |
| | 24" | 72" | 22" | 1 1/4" | XTTK7224U (L/M/1/2/3) () () | 575. | 755. | 755. | 864. | 1,113. |
| | 24" | 96" | 22" | 1 1/4" | XTTK9624U (L/M/1/2/3) () () | 669. | 884. | 884. | 1,015. | 1,308. |
| | 30" | 48" | 28" | 1 1/4" | XTTK4830U (L/M/1/2/3) () () | 506. | 693. | 693. | 791. | 1,017. |
| | 30" | 60" | 28" | 1 1/4" | XTTK6030U (L/M/1/2/3) () () | 546. | 771. | 771. | 879. | 1,130. |
| | 30" | 72" | 28" | 1 1/4" | XTTK7230U (L/M/1/2/3) () () | 603. | 806. | 806. | 920. | 1,184. |
| | 30" | 96" | 28" | 1 1/4" | XTTK9630U (L/M/1/2/3) () () | 702. | 944. | 944. | 1,080. | 1,391. |
| | 36" | 48" | 34" | 1 1/4" | XTTK4836U (L/M/1/2/3) () () | 542. | 776. | 776. | 891. | 1,146. |
| | 36" | 60" | 34" | 1 1/4" | XTTK6036U (L/M/1/2/3) () () | 565. | 849. | 849. | 968. | 1,245. |
| | 36" | 72" | 34" | 1 1/4" | XTTK7236U (L/M/1/2/3) () () | 640. | 861. | 861. | 980. | 1,261. |
| | 36" | 96" | 34" | 1 1/4" | XTTK9636U (L/M/1/2/3) () () | 763. | 1,006. | 1,006. | 1,150. | 1,483. |
| | Worksurface, veneer square edge  | 24" | 48" | 22" | 1 1/4" | XTTS4824U (1/2/3) () () | n/a | n/a | 461. | 533. |
| 24" | | 60" | 22" | 1 1/4" | XTTS6024U (1/2/3) () () | n/a | n/a | 496. | 568. | 676. |
| 24" | | 72" | 22" | 1 1/4" | XTTS7224U (1/2/3) () () | n/a | n/a | 533. | 604. | 725. |
| 24" | | 96" | 22" | 1 1/4" | XTTS9624U (1/2/3) () () | n/a | n/a | 592. | 664. | 808. |
| 30" | | 48" | 28" | 1 1/4" | XTTS4830U (1/2/3) () () | n/a | n/a | 568. | 641. | 760. |
| 30" | | 60" | 28" | 1 1/4" | XTTS6030U (1/2/3) () () | n/a | n/a | 592. | 670. | 809. |
| 30" | | 72" | 28" | 1 1/4" | XTTS7230U (1/2/3) () () | n/a | n/a | 617. | 701. | 903. |
| 30" | | 96" | 28" | 1 1/4" | XTTS9630U (1/2/3) () () | n/a | n/a | 664. | 760. | 1,061. |
| 36" | | 48" | 34" | 1 1/4" | XTTS4836U (1/2/3) () () | n/a | n/a | 641. | 730. | 880. |
| 36" | | 60" | 34" | 1 1/4" | XTTS6036U (1/2/3) () () | n/a | n/a | 676. | 767. | 908. |
| 36" | | 72" | 34" | 1 1/4" | XTTS7236U (1/2/3) () () | n/a | n/a | 712. | 822. | 1,018. |
| 36" | | 96" | 34" | 1 1/4" | XTTS9636U (1/2/3) () () | n/a | n/a | 784. | 928. | 1,216. |
| Worksurface, postformed plastic  | | 24" | 48" | 22" | 1 1/4" | XTPP4824B (L) () () | 296. | n/a | n/a | n/a |
| | 24" | 60" | 22" | 1 1/4" | XTPP6024B (L) () () | 373. | n/a | n/a | n/a | n/a |
| | 24" | 72" | 22" | 1 1/4" | XTPP7224B (L) () () | 432. | n/a | n/a | n/a | n/a |
| | 24" | 96" | 22" | 1 1/4" | XTPP9624B (L) () () | 497. | n/a | n/a | n/a | n/a |
| | 30" | 48" | 28" | 1 1/4" | XTPP4830B (L) () () | 319. | n/a | n/a | n/a | n/a |
| | 30" | 60" | 28" | 1 1/4" | XTPP6030B (L) () () | 402. | n/a | n/a | n/a | n/a |
| | 30" | 72" | 28" | 1 1/4" | XTPP7230B (L) () () | 467. | n/a | n/a | n/a | n/a |
| | 30" | 96" | 28" | 1 1/4" | XTPP9630B (L) () () | 544. | n/a | n/a | n/a | n/a |
| | 36" | 48" | 34" | 1 1/4" | XTPP4836B (L) () () | 350. | n/a | n/a | n/a | n/a |
| | 36" | 60" | 34" | 1 1/4" | XTPP6036B (L) () () | 467. | n/a | n/a | n/a | n/a |
| | 36" | 72" | 34" | 1 1/4" | XTPP7236B (L) () () | 525. | n/a | n/a | n/a | n/a |
| | 36" | 96" | 34" | 1 1/4" | XTPP9636B (L) () () | 610. | n/a | n/a | n/a | n/a |

| Order Code | Specifications | Application Notes |
|------------------------------------|--|---|
| Example: XTPP6030BL 118 812 | | |
| XT Crinion Open Table | Worksurfaces are 1 1/4" thick with square edge or tapered edge option tapering to 1/2" thick front edge. | Crinion 30"D worksurfaces correspond in width to table bases, which are specified separately. |
| T Worksurface | 1. Specify finish group: L - Laminate M - Laminate/veneer edge | 48"W worksurfaces plan on 12" wide or 20" wide bases. 60"W worksurfaces plan on 5', 10', 15' and 20' wide bases. 72" W worksurfaces plan on 6', 12' and 18' wide bases. |
| P Postformed plastic | 1 - Veneer group 1 2 - Veneer group 2 3 - Veneer group 3 | |
| 60 Width | 2. Specify worksurface finish. | |
| 30 Depth | 3. Specify grommet color: 812 - Easy grey 111 - Black | Edge grommet accommodates most power cord plugs up to 1" deep. |
| B With edge grommet | | |
| L Finish type | | |
| 118 Surface finish | | |
| 812 Grommet finish | | Actual worksurface depth is 21.85", 27.85" or 33.85". |

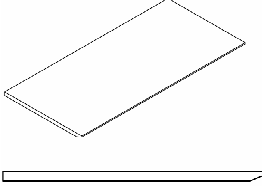
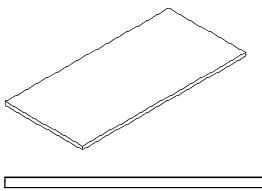
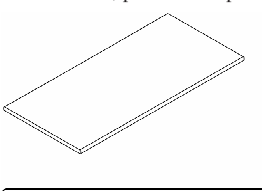
| description | nominal depth | w | d | h | pattern number | L | M | V1 | V2 | V3 | |
|--|--|-----|-----|--------|----------------------------------|------------------------------|--------|--------|--------|--------|------|
| Worksurface, tapered edge  | 24" | 48" | 22" | 1 1/4" | XTTK4824C (L/M/1/2/3) () | \$455. | \$580. | \$580. | \$664. | \$864. | |
| | 24" | 60" | 22" | 1 1/4" | XTTK6024C (L/M/1/2/3) () | 482. | 662. | 662. | 760. | 988. | |
| | 24" | 72" | 22" | 1 1/4" | XTTK7224C (L/M/1/2/3) () | 535. | 715. | 715. | 824. | 1,073. | |
| | 24" | 96" | 22" | 1 1/4" | XTTK9624C (L/M/1/2/3) () | 629. | 844. | 844. | 975. | 1,268. | |
| | 30" | 48" | 28" | 1 1/4" | XTTK4830C (L/M/1/2/3) () | 466. | 653. | 653. | 751. | 977. | |
| | 30" | 60" | 28" | 1 1/4" | XTTK6030C (L/M/1/2/3) () | 506. | 731. | 731. | 839. | 1,090. | |
| | 30" | 72" | 28" | 1 1/4" | XTTK7230C (L/M/1/2/3) () | 563. | 766. | 766. | 880. | 1,144. | |
| | 30" | 96" | 28" | 1 1/4" | XTTK9630C (L/M/1/2/3) () | 662. | 904. | 904. | 1,040. | 1,351. | |
| | 36" | 48" | 34" | 1 1/4" | XTTK4836C (L/M/1/2/3) () | 502. | 736. | 736. | 851. | 1,106. | |
| | 36" | 60" | 34" | 1 1/4" | XTTK6036C (L/M/1/2/3) () | 525. | 809. | 809. | 928. | 1,205. | |
| | 36" | 72" | 34" | 1 1/4" | XTTK7236C (L/M/1/2/3) () | 600. | 821. | 821. | 940. | 1,221. | |
| | 36" | 96" | 34" | 1 1/4" | XTTK9636C (L/M/1/2/3) () | 723. | 966. | 966. | 1,110. | 1,443. | |
| | Worksurface, veneer square edge  | 24" | 48" | 22" | 1 1/4" | XTTS4824C (1/2/3) () | n/a | n/a | 421. | 493. | 589. |
| | | 24" | 60" | 22" | 1 1/4" | XTTS6024C (1/2/3) () | n/a | n/a | 456. | 528. | 636. |
| 24" | | 72" | 22" | 1 1/4" | XTTS7224C (1/2/3) () | n/a | n/a | 493. | 564. | 685. | |
| 24" | | 96" | 22" | 1 1/4" | XTTS9624C (1/2/3) () | n/a | n/a | 552. | 624. | 768. | |
| 30" | | 48" | 28" | 1 1/4" | XTTS4830C (1/2/3) () | n/a | n/a | 528. | 601. | 720. | |
| 30" | | 60" | 28" | 1 1/4" | XTTS6030C (1/2/3) () | n/a | n/a | 552. | 630. | 769. | |
| 30" | | 72" | 28" | 1 1/4" | XTTS7230C (1/2/3) () | n/a | n/a | 577. | 661. | 863. | |
| 30" | | 96" | 28" | 1 1/4" | XTTS9630C (1/2/3) () | n/a | n/a | 624. | 720. | 1,021. | |
| 36" | | 48" | 34" | 1 1/4" | XTTS4836C (1/2/3) () | n/a | n/a | 601. | 690. | 840. | |
| 36" | | 60" | 34" | 1 1/4" | XTTS6036C (1/2/3) () | n/a | n/a | 636. | 727. | 868. | |
| 36" | | 72" | 34" | 1 1/4" | XTTS7236C (1/2/3) () | n/a | n/a | 672. | 782. | 978. | |
| 36" | | 96" | 34" | 1 1/4" | XTTS9636C (1/2/3) () | n/a | n/a | 744. | 888. | 1,176. | |
| Worksurface, postformed plastic  | | 24" | 48" | 22" | 1 1/4" | XTTP4824C (L) () | 256. | n/a | n/a | n/a | n/a |
| | | 24" | 60" | 22" | 1 1/4" | XTTP6024C (L) () | 333. | n/a | n/a | n/a | n/a |
| | 24" | 72" | 22" | 1 1/4" | XTTP7224C (L) () | 392. | n/a | n/a | n/a | n/a | |
| | 24" | 96" | 22" | 1 1/4" | XTTP9624C (L) () | 457. | n/a | n/a | n/a | n/a | |
| | 30" | 48" | 28" | 1 1/4" | XTTP4830C (L) () | 279. | n/a | n/a | n/a | n/a | |
| | 30" | 60" | 28" | 1 1/4" | XTTP6030C (L) () | 362. | n/a | n/a | n/a | n/a | |
| | 30" | 72" | 28" | 1 1/4" | XTTP7230C (L) () | 427. | n/a | n/a | n/a | n/a | |
| | 30" | 96" | 28" | 1 1/4" | XTTP9630C (L) () | 504. | n/a | n/a | n/a | n/a | |
| | 36" | 48" | 34" | 1 1/4" | XTTP4836C (L) () | 310. | n/a | n/a | n/a | n/a | |
| | 36" | 60" | 34" | 1 1/4" | XTTP6036C (L) () | 427. | n/a | n/a | n/a | n/a | |
| | 36" | 72" | 34" | 1 1/4" | XTTP7236C (L) () | 485. | n/a | n/a | n/a | n/a | |
| | 36" | 96" | 34" | 1 1/4" | XTTP9636C (L) () | 570. | n/a | n/a | n/a | n/a | |

Crinion Open Table

| Order Code | Specifications | Application Notes |
|--------------------------------|--|---|
| Example: XTTP6030CL 118 | Worksurfaces are 1 1/4" thick with square edge or tapered edge option tapering to 1/2" thick front edge. | Crinion 30"D worksurfaces correspond in width to table bases, which are specified separately. 48"W worksurfaces plan on 12' wide or 20' wide bases. 60"W worksurfaces plan on 5', 10', 15' and 20' wide bases. 72" W worksurfaces plan on 6', 12' and 18' wide bases. |
| XT Crinion Open Table | Specify finishes: L - Laminate M- Laminate/veneer edge | Actual work surface depth is 21.85", 27.85" or 33.85". |
| T Worksurface | 1 - Veneer group 1 2 - Veneer group 2 3 - Veneer group 3 | |
| P Postformed plastic | | |
| 60 Width | | |
| 30 Depth | | |
| C With cord drop | | |
| L Finish type | | |
| 118 Surface | | Continuous 1/2" cord drop accommodates clamp-on flat screen monitor arm or most power cords. |

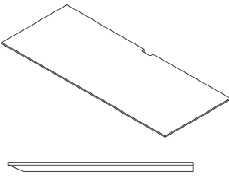
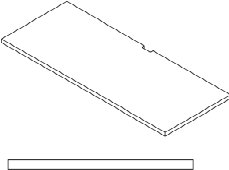
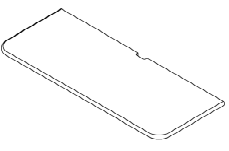
| description | nominal depth | w | l | h | pattern number | L | M | V1 | V2 | V3 |
|---|---------------|-----|-----|--------|----------------------------------|--------|--------|--------|--------|----------|
| End counter, tapered edge  | 24" | 48" | 24" | 1 1/4" | XTTK4824E (L/M/1/2/3) () | \$637. | \$820. | \$820. | \$904. | \$1,103. |
| | 24" | 60" | 24" | 1 1/4" | XTTK6024E (L/M/1/2/3) () | 754. | 901. | 901. | 1,001. | 1,228. |
| | 24" | 72" | 24" | 1 1/4" | XTTK7224E (L/M/1/2/3) () | 783. | 954. | 954. | 1,064. | 1,312. |
| | 30" | 48" | 30" | 1 1/4" | XTTK4830E (L/M/1/2/3) () | 713. | 893. | 893. | 992. | 1,217. |
| | 30" | 60" | 30" | 1 1/4" | XTTK6030E (L/M/1/2/3) () | 777. | 970. | 970. | 1,079. | 1,331. |
| | 30" | 72" | 30" | 1 1/4" | XTTK7230E (L/M/1/2/3) () | 811. | 1,006. | 1,006. | 1,120. | 1,384. |
| End counter, veneer square edge  | 24" | 48" | 24" | 1 1/4" | XTTS4824E (1/2/3) () | n/a | n/a | 421. | 493. | 589. |
| | 24" | 60" | 24" | 1 1/4" | XTTS6024E (1/2/3) () | n/a | n/a | 456. | 528. | 636. |
| | 24" | 72" | 24" | 1 1/4" | XTTS7224E (1/2/3) () | n/a | n/a | 493. | 564. | 685. |
| | 30" | 48" | 30" | 1 1/4" | XTTS4830E (1/2/3) () | n/a | n/a | 528. | 601. | 720. |
| | 30" | 60" | 30" | 1 1/4" | XTTS6030E (1/2/3) () | n/a | n/a | 552. | 630. | 769. |
| | 30" | 72" | 30" | 1 1/4" | XTTS7230E (1/2/3) () | n/a | n/a | 577. | 661. | 863. |
| End counter for postformed plastic  | 24" | 48" | 24" | 1 1/4" | XTTP4824E (L) () | 475. | n/a | n/a | n/a | n/a |
| | 24" | 60" | 24" | 1 1/4" | XTTP6024E (L) () | 564. | n/a | n/a | n/a | n/a |
| | 24" | 72" | 24" | 1 1/4" | XTTP7224E (L) () | 635. | n/a | n/a | n/a | n/a |
| | 30" | 48" | 30" | 1 1/4" | XTTP4830E (L) () | 534. | n/a | n/a | n/a | n/a |
| | 30" | 60" | 30" | 1 1/4" | XTTP6030E (L) () | 635. | n/a | n/a | n/a | n/a |
| | 30" | 72" | 30" | 1 1/4" | XTTP7230E (L) () | 760. | n/a | n/a | n/a | n/a |

* Note

Order Code

| |
|--------------------------------|
| Example: XTTP6024EL 118 |
| XT Crinion Open Table |
| T Worksurface |
| P Postformed plastic |
| 60 Width |
| 24 Length |
| E End counter |
| L Finish Type |
| 118 Surface |

Specifications

End counters are 1 1/4" thick with square edge or tapered edge option tapering to 1/2" thick front edge. End counters are tapered front and side edges only.

Specify finishes:
 L - Laminate
 M- Laminate/veneer edge
 1 - Veneer group 1
 2 - Veneer group 2
 3 - Veneer group 3

Application Notes

End counters mount at the ends of dual tables with two end counter cantilever brackets. Specify dual end legs for end counters instead of standard dual end legs (tables with end counters must be specified from components, not assemblies).

Specify 48" W for dual 24" tables, 60" W for dual 30" tables and 72" W for dual 36" tables.

Specify added length of 24" or 30" beyond end leg for end counters.

* Note - End counters for postformed plastic are not available in these finishes:
 121 Micro grey
 129 Micro sand
 122 Brushed sand
 123 Brushed grey

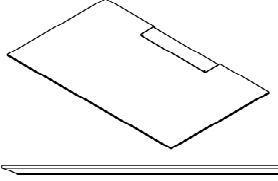
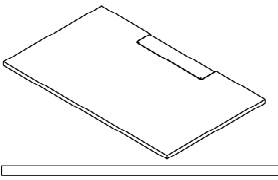
| description | nominal depth | w | l | h | pattern no. | L | M | V1 | V2 | V3 |
|--|---------------|-----|-----|--------|--------------------------------------|----------|----------|----------|----------|----------|
| Extended end counter, tapered edge with hinged power access  | 36" | 48" | 36" | 1 1/4" | XTTK4836D (L/M/1/2/3) () () | \$1,058. | \$1,229. | \$1,229. | \$1,339. | \$1,587. |
| | 36" | 60" | 36" | 1 1/4" | XTTK6036D (L/M/1/2/3) () () | 1,086. | 1,281. | 1,281. | 1,395. | 1,659. |
| | 36" | 72" | 36" | 1 1/4" | XTTK7236D (L/M/1/2/3) () () | 1,166. | 1,379. | 1,379. | 1,499. | 1,793. |
| Extended end counter, tapered edge with grommet | 36" | 48" | 36" | 1 1/4" | XTTK4836E (L/M/1/2/3) () | 783. | 954. | 954. | 1,064. | 1,312. |
| | 36" | 60" | 36" | 1 1/4" | XTTK6036E (L/M/1/2/3) () | 811. | 1,006. | 1,006. | 1,120. | 1,384. |
| | 36" | 72" | 36" | 1 1/4" | XTTK7236E (L/M/1/2/3) () | 891. | 1,104. | 1,104. | 1,224. | 1,518. |
| Extended end counter, veneer square edge with hinged power access  | 36" | 48" | 36" | 1 1/4" | XTTS4836D (1/2/3) () () | n/a | n/a | 744. | 812. | 927. |
| | 36" | 60" | 36" | 1 1/4" | XTTS6036D (1/2/3) () () | n/a | n/a | 852. | 936. | 1,138. |
| | 36" | 72" | 36" | 1 1/4" | XTTS7236D (1/2/3) () () | n/a | n/a | 936. | 1,024. | 1,266. |
| Extended end counter, veneer square edge with grommet | 36" | 48" | 36" | 1 1/4" | XTTS4836E (1/2/3) () | n/a | n/a | 469. | 537. | 652. |
| | 36" | 60" | 36" | 1 1/4" | XTTS6036E (1/2/3) () | n/a | n/a | 577. | 661. | 863. |
| | 36" | 72" | 36" | 1 1/4" | XTTS7236E (1/2/3) () | n/a | n/a | 661. | 749. | 991. |

| Order Code | Specifications | Application Notes | |
|--|--|---|--|
| Example: XTTP6036DL 118 AA | | | |
| XT Crinion Open Table | End counters are 1 1/4" thick with square edge or tapered edge option tapering to 1/2" thick front edge. End counters are tapered front and side edges only. 1. Specify finish group: L - Laminate M - Laminate/veneer edge 1 - Veneer group 1 2 - Veneer group 2 3 - Veneer group 3 2. Specify worksurface finish. 3. Specify hinged access cover finish. | End counters mount at the ends of dual tables with two end counter cantilever brackets. Specify dual end legs for end counters instead of standard dual end legs (tables with end counters must be specified from components, not assemblies). Specify 48" W for dual 24" tables, 60" W for dual 30" tables and 72" W for dual 36" tables. | |
| T Worksurface | | | Each extended end counter requires base assembly 12" longer than worksurfaces on each side. * Note - End counters for postformed plastic are not available in these finishes: 121 Micro grey 129 Micro sand 122 Brushed sand 123 Brushed grey |
| P Postformed plastic | | | |
| 60 Width | | | |
| 36 Length | | | |
| D End counter, center hinged power access | | | |
| L Finish Type | | | |
| 118 Surface finish | | | |
| AA Access door finish | | | |

Hinged access covers are available in AA anodized aluminum and all standard paint finishes except 613 Silver.

| description | nominal depth | w | l | h | pattern no. | L | M | V1 | V2 | V3 |
|---|---------------|-----|-----|--------|------------------------------|--------|-----|-----|-----|-----|
| Extended end counter, postformed plastic with hinged power access | 36" | 48" | 36" | 1 1/4" | XTTP4836D (L) () () | \$910. | n/a | n/a | n/a | n/a |
| | 36" | 60" | 36" | 1 1/4" | XTTP6036D (L) () () | 1,035. | n/a | n/a | n/a | n/a |
| | 36" | 72" | 36" | 1 1/4" | XTTP7236D (L) () () | 1,125. | n/a | n/a | n/a | n/a |

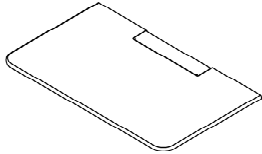

* Note

| | | | | | | | | | | |
|---|-----|-----|-----|--------|--------------------------|------|-----|-----|-----|-----|
| Extended end counter, postformed plastic with grommet | 36" | 48" | 36" | 1 1/4" | XTTP4836E (L) () | 635. | n/a | n/a | n/a | n/a |
| | 36" | 60" | 36" | 1 1/4" | XTTP6036E (L) () | 760. | n/a | n/a | n/a | n/a |
| | 36" | 72" | 36" | 1 1/4" | XTTP7236E (L) () | 850. | n/a | n/a | n/a | n/a |

* Note

| Order Code | Specifications | Application Notes |
|--|--|---|
| Example: XTTP6036DL 118 AA | | |
| XT Crinion Open Table | End counters are 1 1/4" thick with square edge or tapered edge option tapering to 1/2" thick front edge. End counters are tapered front and side edges only. 1. Specify finish group: L - Laminate M - Laminate/veneer edge 1 - Veneer group 1 2 - Veneer group 2 3 - Veneer group 3 2. Specify worksurface finish. 3. Specify hinged access cover finish. | End counters mount at the ends of dual tables with two end counter cantilever brackets. Specify dual end legs for end counters instead of standard dual end legs (tables with end counters must be specified from components, not assemblies). Specify 48" W for dual 24" tables, 60" W for dual 30" tables and 72" W for dual 36" tables. |
| T Worksurface | | |
| P Postformed plastic | | |
| 60 Width | | |
| 36 Length | | |
| D End counter, center hinged power access | | |
| L Finish Type | | |
| 118 Surface finish | | |
| AA Access door finish | | |
| | | |

Hinged access covers are available in AA anodized aluminum and all standard paint finishes except 613 Silver.

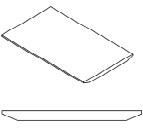
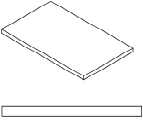
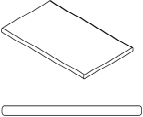
| description | w | d | h | pattern number | L | M | V1 | V2 | V3 |
|--|-----|--------|----------------------------------|----------------------------------|--------|--------|--------|--------|--------|
| File top, tapered edge  | 30" | 18" | 1 1/4" | XTTK3018F (L/M/1/2/3) () | \$333. | \$564. | \$552. | \$589. | \$853. |
| | 30" | 36" | 1 1/4" | XTTK3036F (L/M/1/2/3) () | 456. | 712. | 712. | 798. | 1,002. |
| | 36" | 18" | 1 1/4" | XTTK3618F (L/M/1/2/3) () | 345. | 577. | 564. | 595. | 908. |
| | 36" | 36" | 1 1/4" | XTTK3636F (L/M/1/2/3) () | 475. | 780. | 780. | 873. | 1,100. |
| | 42" | 18" | 1 1/4" | XTTK4218F (L/M/1/2/3) () | 357. | 589. | 577. | 606. | 964. |
| | 42" | 36" | 1 1/4" | XTTK4236F (L/M/1/2/3) () | 497. | 810. | 810. | 915. | 1,154. |
| | 60" | 18" | 1 1/4" | XTTK6018F (L/M/1/2/3) () | 564. | 870. | 870. | 960. | 1,200. |
| | 60" | 36" | 1 1/4" | XTTK6036F (L/M/1/2/3) () | 611. | 928. | 928. | 1,048. | 1,325. |
| | 72" | 18" | 1 1/4" | XTTK7218F (L/M/1/2/3) () | 593. | 900. | 900. | 1,008. | 1,262. |
| | 72" | 36" | 1 1/4" | XTTK7236F (L/M/1/2/3) () | 653. | 941. | 941. | 1,060. | 1,341. |
| 84" | 18" | 1 1/4" | XTTK8418F (L/M/1/2/3) () | 641. | 960. | 960. | 1,080. | 1,321. | |
| 84" | 36" | 1 1/4" | XTTK8436F (L/M/1/2/3) () | 698. | 1,011. | 1,011. | 1,152. | 1,461. | |
| File top, veneer square edge  | 30" | 18" | 1 1/4" | XTTS3018F (1/2/3) () | n/a | n/a | 246. | 270. | 449. |
| | 36" | 18" | 1 1/4" | XTTS3618F (1/2/3) () | n/a | n/a | 253. | 276. | 484. |
| | 42" | 18" | 1 1/4" | XTTS4218F (1/2/3) () | n/a | n/a | 259. | 283. | 523. |
| File top, postformed plastic  | 30" | 18" | 1 1/4" | XTTP3018F (L) () | 226. | n/a | n/a | n/a | n/a |
| | 36" | 18" | 1 1/4" | XTTP3618F (L) () | 238. | n/a | n/a | n/a | n/a |
| | 42" | 18" | 1 1/4" | XTTP4218F (L) () | 249. | n/a | n/a | n/a | n/a |

Order Code

| |
|--------------------------------|
| Example: XTTP4218FL 118 |
| XT Crinion Open Table |
| T Worksurface |
| P Postformed |
| 42 Width |
| 18 Depth |
| F File top |
| L Finish type |
| 118 Surface |

Specifications

File tops are 1 1/4" thick with square edge or tapered edge option tapering to 1/2" thick front edge. Tapered edge file tops are tapered front and back edges only.

Specify finishes:
 L - Laminate
 M - Laminate/veneer edge
 1 - Veneer group 1
 2 - Veneer group 2
 3 - Veneer group 3

Application Notes

File tops correspond to 30", 36" or 42"W lateral files. File tops on 2 high Calibre files positioned perpendicular to the Crinion Open Table serve as a worksurface return.

Complete base assemblies fixed height 24" D dual

AutoStrada

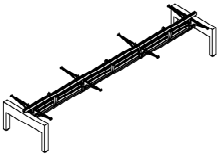
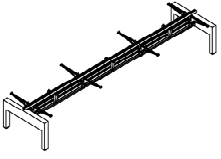
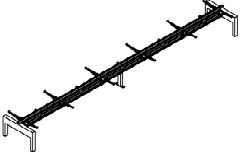
| description | nominal | w | d | h | pattern number | P1/P2 | P3 |
|--|----------------|------|-----|---------|---------------------------------|----------|----------|
|  Base assembly, continuous | 10' dual | 120" | 44" | 28 1/2" | XTB1 BAS 24D10CF () () | \$8,531. | \$8,756. |
| | 12' dual | 144" | 44" | 28 1/2" | XTB1 BAS 24D12CF () () | 8,888. | 9,115. |
| | 15' dual | 180" | 44" | 28 1/2" | XTB1 BAS 24D15CF () () | 10,285. | 10,519. |
|  Base assembly, segmented | 10' + 5' dual | 180" | 44" | 28 1/2" | XTB1 BAS 24D15SF () () | 11,033. | 11,269. |
|  Base assembly, with intermediate leg | 12' + 6' dual | 216" | 44" | 28 1/2" | XTB1 BAS 24D18SF () () | 12,174. | 12,409. |
| | 10' + 10' dual | 240" | 44" | 28 1/2" | XTB1 BAS 24D20SF () () | 13,306. | 13,549. |
| | 12' + 12' dual | 288" | 44" | 28 1/2" | XTB1 BAS 24D24SF () () | 14,020. | 14,264. |
| | 15' + 10' dual | 300" | 44" | 28 1/2" | XTB1 BAS 24D25SF () () | 15,060. | 15,312. |

Order Code

| | |
|------------|------------------------------|
| Example: | XTB1BAS24D10CF 613 AA |
| XT | Crinion Open Table |
| B1 | Base components |
| BAS | Assembly |
| 24 | Depth |
| D | Dual |
| 10 | Width |
| C | Continuous |
| F | Fixed height |
| 613 | Base finish |
| AA | Top channel finish |

Specifications

Base assemblies include end legs, beams, trusses, cantilever brackets, channels and end caps.

Fixed height base assemblies have shared cantilever brackets for adjacent worksurfaces and midspan support brackets for every worksurface.

- Specify painted finish for base assembly.
For leg and cantilever brackets specify one paint finish for all.
- Specify finish for top channel.
AA anodized aluminum and all paint finishes are available except 613 Silver.
Beams are anodized aluminum only.

Application Notes



Complete base assemblies include all base components necessary to support worksurfaces. Specify screens, power components and cable trays separately. Base assemblies include end legs, intermediate leg (where required), beams, trusses, cantilever brackets, mid span support brackets, top channel and end caps.

No table on this page has beams longer than 15'.

Base assemblies correspond to:
 10': four 60"x24"D worksurfaces
 12': four 72"x24"D worksurfaces
 15': six 60"x24"D worksurfaces
 18': six 72"x24"D worksurfaces
 20': eight 60"x24"D worksurfaces
 24': eight 72"x24"D worksurfaces
 25': ten 60"x24"D worksurfaces

Complete base assemblies fixed height 24" D single sided

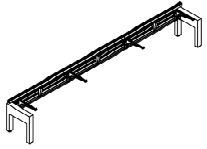
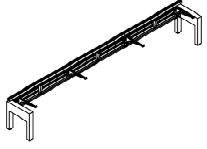
AutoStrada

| description | nominal | w | d | h | pattern number | P1/P2 | P3 |
|--|------------------------|------|-----|---------|---------------------------------|----------|----------|
|  Base assembly, continuous | 10' single sided | 120" | 24" | 28 1/2" | XTB1 BAS 24S10CF () () | \$7,675. | \$7,894. |
| | 12' single sided | 144" | 24" | 28 1/2" | XTB1 BAS 24S12CF () () | 8,034. | 8,250. |
| | 15' single sided | 180" | 24" | 28 1/2" | XTB1 BAS 24S15CF () () | 9,112. | 9,333. |
|  Base assembly, segmented | 10' + 5' single sided | 180" | 24" | 28 1/2" | XTB1 BAS 24S15SF () () | 9,861. | 10,082. |
|  Base assembly, with intermediate leg | 12' + 6' single sided | 216" | 24" | 28 1/2" | XTB1 BAS 24S18SF () () | 11,001. | 11,223. |
| | 10' + 10' single sided | 240" | 24" | 28 1/2" | XTB1 BAS 24S20SF () () | 11,815. | 12,041. |
| | 12' + 12' single sided | 288" | 24" | 28 1/2" | XTB1 BAS 24S24SF () () | 12,529. | 12,754. |
| | 15' + 10' single sided | 300" | 24" | 28 1/2" | XTB1 BAS 24S25SF () () | 13,250. | 13,481. |

Order Code

| | |
|------------|-------------------------------|
| Example: | XTB1BAS24S10CF 613 118 |
| XT | Crinion Open Table |
| B1 | Base components |
| BAS | Assembly |
| 24 | Depth |
| S | Single |
| 10 | Width |
| C | Continuous |
| F | Fixed height |
| 613 | Base finish |
| 118 | Top channel finish |

Specifications

Base assemblies include end legs, beams, trusses, cantilever brackets, channels and end caps.

Fixed height base assemblies have shared cantilever brackets for adjacent worksurfaces and midspan support brackets for every worksurface.

- Specify base finish for base assembly.
For legs and cantilever brackets specify one paint finish for all.
- Specify top channel finish.
AA anodized aluminum and all paint finishes are available except 613 Silver.
Beams are anodized aluminum only.

Application Notes

Complete base assemblies include all base components necessary to support worksurfaces. Specify screens, power components and cable trays separately. Base assemblies include end legs, intermediate leg (where required), beams, trusses, cantilever brackets, mid span support brackets, top channel and end caps.

No table on this page has beams longer than 15'.

Base assemblies correspond to:
 10': two 60"x24"D worksurfaces
 12': two 72"x24"D worksurfaces
 15': three 60"x24"D worksurfaces
 18': three 72"x24"D worksurfaces
 20': four 60"x24"D worksurfaces
 24': four 72"x24"D worksurfaces
 25': five 60"x24"D worksurfaces

Complete base assemblies fixed height 30" D dual

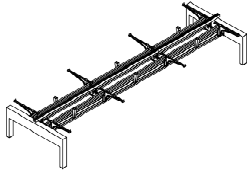
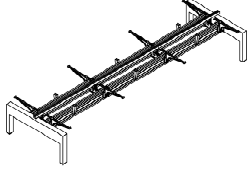
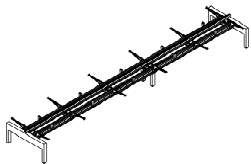
| description | nominal | w | d | h | pattern number | P1/P2 | P3 |
|---|----------------|------|-----|------|---------------------------------|-----------|-----------|
|  | 10' dual | 120" | 54" | 28½" | XTB1 BAS 30D10CF () () | \$10,151. | \$10,439. |
| | 12' dual | 144" | 54" | 28½" | XTB1 BAS 30D12CF () () | 10,565. | 10,852. |
| | 15' dual | 180" | 54" | 28½" | XTB1 BAS 30D15CF () () | 12,299. | 12,617. |
|  | 10' + 5' dual | 180" | 54" | 28½" | XTB1 BAS 30D15SF () () | 13,336. | 13,654. |
|  | 12' + 6' dual | 216" | 54" | 28½" | XTB1 BAS 30D18SF () () | 14,776. | 15,140. |
| | 10' + 10' dual | 240" | 54" | 28½" | XTB1 BAS 30D20SF () () | 16,474. | 16,868. |
| | 12' + 12' dual | 288" | 54" | 28½" | XTB1 BAS 30D24CF () () | 17,304. | 17,698. |
| | 15' + 10' dual | 300" | 54" | 28½" | XTB1 BAS 30D25CF () () | 18,621. | 19,046. |

Order Code

| | |
|------------|-------------------------------|
| Example: | XTB1BAS30D18SF 613 111 |
| XT | Crinion Open Table |
| B1 | Base components |
| BAS | Assembly |
| 30 | Depth |
| D | Dual |
| 18 | Width |
| S | Segmented |
| F | Fixed height |
| 613 | Base finish |
| 111 | Top channel finish |

Specifications

Base assemblies include end legs, beams, trusses, cantilever brackets, channels and end caps.

Fixed height base assemblies have shared cantilever brackets for adjacent worksurfaces and midspan support brackets for every worksurface.

- Specify base finish for base assembly.
For legs and cantilever brackets specify one paint finish for all.
- Specify top channel finish.
AA anodized aluminum and all paint finishes are available except 613 Silver.
Beams are anodized aluminum only.

Application Notes

Complete base assemblies include all base components necessary to support worksurfaces. Specify screens, power components and cable trays separately. Base assemblies include end legs, intermediate leg (where required), beams, trusses, cantilever brackets, mid span support brackets, top channel and end caps.

No table on this page has beams longer than 15'.

Base assemblies correspond to:
 10': four 60"x30"D worksurfaces
 12': four 72"x30"D worksurfaces
 15': six 60"x30"D worksurfaces
 18': six 72"x30"D worksurfaces
 20': eight 60"x30"D worksurfaces
 24': eight 72"x30"D worksurfaces
 25': ten 60"x30"D worksurfaces

Complete base assemblies fixed height 30" D single sided

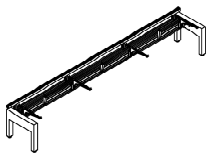
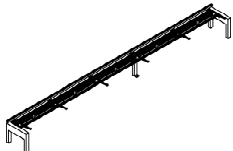
| description | nominal | w | d | h | pattern number | P1/P2 | P3 |
|---|------------------------|------|----------------------------------|----------------------------------|---------------------------------|----------|----------|
|  | 10' single sided | 120" | 28 ³ / ₄ " | 28 ¹ / ₂ " | XTB1 BAS 30S10CF () () | \$8,935. | \$9,184. |
| | 12' single sided | 144" | 28 ³ / ₄ " | 28 ¹ / ₂ " | XTB1 BAS 30S12CF () () | 9,349. | 9,597. |
| | 15' single sided | 180" | 28 ³ / ₄ " | 28 ¹ / ₂ " | XTB1 BAS 30S15CF () () | 10,636. | 10,900. |
| Base assembly, segmented | 10' + 5' single sided | 180" | 28 ³ / ₄ " | 28 ¹ / ₂ " | XTB1 BAS 30S15SF () () | 9,945. | 10,208. |
|  | 12' + 6' single sided | 216" | 28 ³ / ₄ " | 28 ¹ / ₂ " | XTB1 BAS 30S18SF () () | 10,799. | 11,060. |
| | 10' + 10' single sided | 240" | 28 ³ / ₄ " | 28 ¹ / ₂ " | XTB1 BAS 30S20SF () () | 12,280. | 12,559. |
| | 12' + 12' single sided | 288" | 28 ³ / ₄ " | 28 ¹ / ₂ " | XTB1 BAS 30S24SF () () | 14,839. | 15,116. |
| | 15' + 10' single sided | 300" | 28 ³ / ₄ " | 28 ¹ / ₂ " | XTB1 BAS 30S25SF () () | 15,712. | 16,004. |

Order Code

Example: **XTB1BAS30S15CF 613 115**

| | |
|------------|--------------------|
| XT | Crinion Open Table |
| B1 | Base components |
| BAS | Assembly |
| 30 | Depth |
| S | Single |
| 15 | Width |
| C | Continuous |
| F | Fixed height |
| 613 | Base finish |
| 115 | Top channel finish |

Specifications

Base assemblies include end legs, beams, trusses, cantilever brackets, channels and end caps.

Fixed height base assemblies have shared cantilever brackets for adjacent worksurfaces and midspan support brackets for every worksurface.

- Specify base finish for base assembly.
For legs and cantilever brackets specify one paint finish for all.
- Specify top channel finish.
AA anodized aluminum and all paint finishes are available except 613 Silver.
Beams are anodized aluminum only.

Application Notes

Complete base assemblies include all base components necessary to support worksurfaces. Specify screens, power components and cable trays separately. Base assemblies include end legs, intermediate leg (where required), beams, trusses, cantilever brackets, mid span support brackets, top channel and end caps.

Base assemblies correspond to:
 10': two 60"x30"D worksurfaces
 12': two 72"x30"D worksurfaces
 15': three 60"x30"D worksurfaces
 18': three 72"x30"D worksurfaces
 20': four 60"x30"D worksurfaces
 24': four 72"x30"D worksurfaces
 25': five 60"x30"D worksurfaces

No table on this page has beams longer than 15'.

Complete base assemblies adjustable height 30" D dual

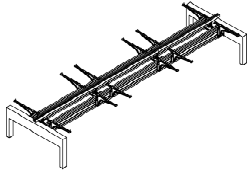
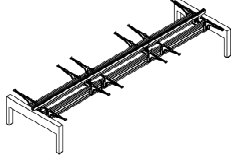
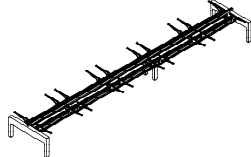
| description | nominal | w | d | h | pattern number | P1/P2 | P3 |
|--|----------------|------|-----|---------|---------------------------------|-----------|-----------|
|  Base assembly, continuous | 10' dual | 120" | 54" | 28 1/2" | XTB1 BAS 30D10CA () () | \$10,301. | \$10,600. |
| | 12' dual | 144" | 54" | 28 1/2" | XTB1 BAS 30D12CA () () | 10,716. | 11,015. |
| | 15' dual | 180" | 54" | 28 1/2" | XTB1 BAS 30D15CA () () | 12,732. | 13,077. |
|  Base assembly, segmented | 10' + 5' dual | 180" | 54" | 28 1/2" | XTB1 BAS 30D15SA () () | 13,769. | 14,115. |
|  Base assembly, with intermediate leg | 12' + 6' dual | 216" | 54" | 28 1/2" | XTB1 BAS 30D18SA () () | 15,209. | 15,602. |
| | 10' + 10' dual | 240" | 54" | 28 1/2" | XTB1 BAS 30D20SA () () | 17,190. | 17,629. |
| | 12' + 12' dual | 288" | 54" | 28 1/2" | XTB1 BAS 30D24CA () () | 18,020. | 18,458. |
| | 15' + 10' dual | 300" | 54" | 28 1/2" | XTB1 BAS 30D25CA () () | 19,622. | 20,106. |

| Order Code | Specifications | Application Notes |
|--|---|---|
| Example: XTB1BAS30D18SA 613 118 | Base assemblies include end legs, beams, trusses, cantilever brackets, channels and end caps. | Complete base assemblies include all base components necessary to support worksurfaces. Specify screens, power components and cable trays separately. Base assemblies include end legs, intermediate leg (where required), beams, trusses, cantilever brackets, top channel and end caps. |
| XT Crinion Open Table | 1. Specify base finish for base assembly. | Base assemblies correspond to: 10': four 60"x30"D worksurfaces 12': four 72"x30"D worksurfaces 15': six 60"x30"D worksurfaces 18': six 72"x30"D worksurfaces 20': eight 60"x30"D worksurfaces 24': eight 72"x30"D worksurfaces 25': ten 60"x30"D worksurfaces |
| B1 Base components | For legs and cantilever brackets specify one paint finish for all. | No table on this page has beams longer than 15'. |
| BAS Assembly | 2. Specify top channel finish. | |
| 30 Depth | AA anodized aluminum and all paint finishes are available except 613 Silver. | |
| D Dual | Beams are anodized aluminum only. | |
| 18 Width | | |
| S Segmented | | |
| A Adjustable height | | |
| 613 Base finish | | |
| 118 Top channel finish | | |

Complete base assemblies adjustable height 30" D single sided

AutoStrada

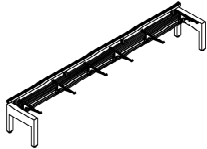
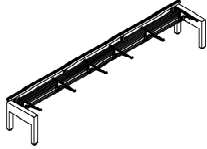
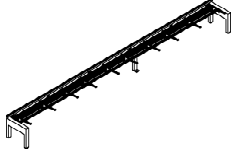
| description | nominal | w | d | h | pattern number | P1/P2 | P3 |
|--|------------------------|------|----------------------------------|----------------------------------|---------------------------------|----------|----------|
|  Base assembly, continuous | 10' single sided | 120" | 28 ³ / ₄ " | 28 ¹ / ₂ " | XTB1 BAS 30S10CA () () | \$9,034. | \$9,286. |
| | 12' single sided | 144" | 28 ³ / ₄ " | 28 ¹ / ₂ " | XTB1 BAS 30S12CA () () | 9,448. | 9,700. |
| | 15' single sided | 180" | 28 ³ / ₄ " | 28 ¹ / ₂ " | XTB1 BAS 30S15CA () () | 10,888. | 11,164. |
|  Base assembly, segmented | 10' +5' single sided | 180" | 28 ³ / ₄ " | 28 ¹ / ₂ " | XTB1 BAS 30S15SA () () | 10,198. | 10,474. |
|  Base assembly, with intermediate leg | 12' + 6' single sided | 216" | 28 ³ / ₄ " | 28 ¹ / ₂ " | XTB1 BAS 30S18SA () () | 11,280. | 11,557. |
| | 10' + 10' single sided | 240" | 28 ³ / ₄ " | 28 ¹ / ₂ " | XTB1 BAS 30S20SA () () | 12,685. | 12,986. |
| | 12' + 12' single sided | 288" | 28 ³ / ₄ " | 28 ¹ / ₂ " | XTB1 BAS 30S24SA () () | 15,243. | 15,543. |
| | 15' + 10' single sided | 300" | 28 ³ / ₄ " | 28 ¹ / ₂ " | XTB1 BAS 30S25SA () () | 16,268. | 16,591. |

Crinion Open Table

| Order Code | Specifications | Application Notes | |
|---------------------------------------|---|---|---|
| Example: XTB1BAS30S18SA 613 AA | Base assemblies include end legs, beams, trusses, cantilever brackets, channels and end caps. <ol style="list-style-type: none"> Specify base finish for base assembly. For legs and cantilever brackets specify one paint finish for all. Specify top channel finish. AA anodized aluminum and all paint finishes are available except 613 Silver. Beams are anodized aluminum only. | Complete base assemblies include all base components necessary to support worksurfaces. Specify screens, power components and cable trays separately. Base assemblies include end legs, intermediate leg (where required), beams, trusses, cantilever brackets, top channel and end caps. No table on this page has beams longer than 15'. | |
| XT Crinion Open Table | | | |
| B1 Base components | | | |
| BAS Assembly | | | |
| 30 Depth | | | |
| S Single | | | |
| 18 Width | | | |
| S Segmented | | | |
| A Adjustable height | | | |
| 613 Base finish | | | |
| AA Top channel finish | | | |
| | | | Base assemblies correspond to: 10': two 60"x30"D worksurfaces 12': two 72"x30"D worksurfaces 15': three 60"x30"D worksurfaces 18': three 72"x30"D worksurfaces 20': four 60"x30"D worksurfaces 24': four 72"x30"D worksurfaces 25': five 60"x30"D worksurfaces |

Complete base assemblies fixed height 36" D dual

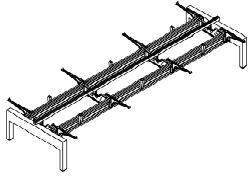
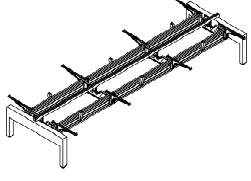
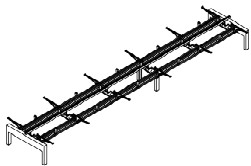
| description | nominal | w | h | d | pattern number | P1/P2 | P3 |
|---|----------------|------|---------|-----|---------------------------------|-----------|-----------|
|  | 10' dual | 120" | 28 1/2" | 54" | XTB1 BAS 36D10CF () () | \$10,289. | \$10,578. |
| | 12' dual | 144" | 28 1/2" | 54" | XTB1 BAS 36D12CF () () | 10,703. | 10,991. |
| | 15' dual | 180" | 28 1/2" | 54" | XTB1 BAS 36D15CF () () | 12,482. | 12,801. |
|  | 10' + 5' dual | 180" | 28 1/2" | 54" | XTB1 BAS 36D15SF () () | 13,520. | 13,839. |
|  | 12' + 6' dual | 216" | 28 1/2" | 54" | XTB1 BAS 36D18SF () () | 14,960. | 15,324. |
| | 10' + 10' dual | 240" | 28 1/2" | 54" | XTB1 BAS 36D20SF () () | 16,704. | 17,099. |
| | 12' + 12' dual | 288" | 28 1/2" | 54" | XTB1 BAS 36D24CF () () | 17,533. | 17,927. |
| | 15' + 10' dual | 300" | 28 1/2" | 54" | XTB1 BAS 36D25CF () () | 18,898. | 19,322. |

Order Code

| | |
|------------|-------------------------------|
| Example: | XTB1BAS36D18SF 613 111 |
| XT | Crinion Open Table |
| B1 | Base components |
| BAS | Assembly |
| 36 | Depth |
| D | Dual |
| 18 | Width |
| S | Segmented |
| F | Fixed height |
| 613 | Base finish |
| 111 | Top channel finish |

Specifications

Base assemblies include end legs, beams, trusses, cantilever brackets, channels and end caps.

Fixed height base assemblies have shared cantilever brackets for adjacent worksurfaces and midspan support brackets for every worksurface.

- Specify base finish for base assembly.
For legs and cantilever brackets specify one paint finish for all.
- Specify top channel finish.
AA anodized aluminum and all paint finishes are available except 613 Silver.
Beams are anodized aluminum only.

Application Notes

Complete base assemblies include all base components necessary to support worksurfaces. Specify screens, power components and cable trays separately. Base assemblies include end legs, intermediate leg (where required), beams, trusses, cantilever brackets, mid span support brackets, top channel and end caps.

No table on this page has beams longer than 15'.

Base assemblies correspond to:
10': four 60"x36"D worksurfaces
12': four 72"x36"D worksurfaces
15': six 60"x36"D worksurfaces
18': six 72"x36"D worksurfaces
20': eight 60"x36"D worksurfaces
24': eight 72"x36"D worksurfaces
25': ten 60"x36"D worksurfaces

Complete base assemblies fixed height 36" D single sided

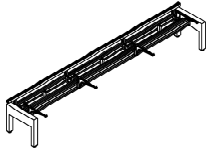
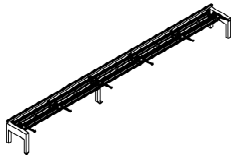
| description | nominal | w | d | h | pattern number | P1/P2 | P3 |
|---|------------------------|------|----------------------------------|----------------------------------|---------------------------------|----------|----------|
|  | 10' single sided | 120" | 28 ³ / ₄ " | 28 ¹ / ₂ " | XTB1 BAS 36S10CF () () | \$9,073. | \$9,321. |
| | 12' single sided | 144" | 28 ³ / ₄ " | 28 ¹ / ₂ " | XTB1 BAS 36S12CF () () | 9,487. | 9,736. |
| | 15' single sided | 180" | 28 ³ / ₄ " | 28 ¹ / ₂ " | XTB1 BAS 36S15CF () () | 10,821. | 11,084. |
| Base assembly, segmented | 10' + 5' single sided | 180" | 28 ³ / ₄ " | 28 ¹ / ₂ " | XTB1 BAS 36S15SF () () | 10,130. | 10,393. |
|  | 12' + 6' single sided | 216" | 28 ³ / ₄ " | 28 ¹ / ₂ " | XTB1 BAS 36S18SF () () | 11,213. | 11,476. |
| | 10' + 10' single sided | 240" | 28 ³ / ₄ " | 28 ¹ / ₂ " | XTB1 BAS 36S20SF () () | 12,512. | 12,789. |
| | 12' + 12' single sided | 288" | 28 ³ / ₄ " | 28 ¹ / ₂ " | XTB1 BAS 36S24SF () () | 15,070. | 15,347. |
| | 15' + 10' single sided | 300" | 28 ³ / ₄ " | 28 ¹ / ₂ " | XTB1 BAS 36S25SF () () | 15,987. | 16,281. |

Order Code

| | |
|------------|------------------------------|
| Example: | XTB1BAS36S18SF 613 AA |
| XT | Crinion Open Table |
| B1 | Base components |
| BAS | Assembly |
| 36 | Depth |
| S | Single |
| 18 | Width |
| S | Segmented |
| F | Fixed height |
| 613 | Base finish |
| AA | Top channel finish |

Specifications

Base assemblies include end legs, beams, trusses, cantilever brackets, channels and end caps.

Fixed height base assemblies have shared cantilever brackets for adjacent worksurfaces and midspan support brackets for every worksurface.

- Specify base finish for base assembly.
For legs and cantilever brackets specify one paint finish for all.
- Specify top channel finish.
AA anodized aluminum and all paint finishes are available except 613 Silver.
Beams are anodized aluminum only.

Application Notes



Complete base assemblies include all base components necessary to support worksurfaces. Specify screens, power components and cable trays separately. Base assemblies include end legs, intermediate leg (where required), beams, trusses, cantilever brackets, mid span support brackets, top channel and end caps.

No table on this page has beams longer than 15'.

Base assemblies correspond to:
 10': two 60"x36"D worksurfaces
 12': two 72"x36"D worksurfaces
 15': three 60"x36"D worksurfaces
 18': three 72"x36"D worksurfaces
 20': four 60"x36"D worksurfaces
 24': four 72"x36"D worksurfaces
 25': five 60"x36"D worksurfaces

Complete base assemblies adjustable height 36" D dual

AutoStrada

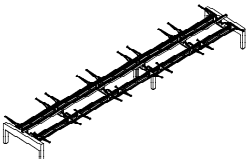
| description | nominal | w | d | h | pattern number | P1/P2 | P3 |
|--|----------------|------|-----|---------|---------------------------------|-----------|-----------|
|  Base assembly, continuous | 10' dual | 120" | 54" | 28 1/2" | XTB1 BAS 36D10CA () () | \$10,439. | \$10,738. |
| | 12' dual | 144" | 54" | 28 1/2" | XTB1 BAS 36D12CA () () | 10,852. | 11,154. |
| | 15' dual | 180" | 54" | 28 1/2" | XTB1 BAS 36D15CA () () | 12,917. | 13,262. |
|  Base assembly, segmented | 10' + 5' dual | 180" | 54" | 28 1/2" | XTB1 BAS 36D15SA () () | 13,953. | 14,298. |
|  Base assembly, with intermediate leg | 12' + 6' dual | 216" | 54" | 28 1/2" | XTB1 BAS 36D18SA () () | 15,393. | 15,785. |
| | 10' + 10' dual | 240" | 54" | 28 1/2" | XTB1 BAS 36D20SA () () | 17,420. | 17,859. |
| | 12' + 12' dual | 288" | 54" | 28 1/2" | XTB1 BAS 36D24CA () () | 18,251. | 18,688. |
| | 15' + 10' dual | 300" | 54" | 28 1/2" | XTB1 BAS 36D25CA () () | 19,898. | 20,382. |

| Order Code | Specifications | Application Notes |
|--|---|---|
| Example: XTB1BAS36D18SA 613 115 | Base assemblies include end legs, beams, trusses, cantilever brackets, channels and end caps. | Complete base assemblies include all base components necessary to support worksurfaces. Specify screens, power components and cable trays separately. Base assemblies include end legs, intermediate leg (where required), beams, trusses, cantilever brackets, top channel and end caps. |
| XT Crinion Open Table | | Base assemblies correspond to: 10': four 60"x36"D worksurfaces 12': four 72"x36"D worksurfaces 15': six 60"x36"D worksurfaces 18': six 72"x36"D worksurfaces 20': eight 60"x36"D worksurfaces 24': eight 72"x36"D worksurfaces 25': ten 60"x36"D worksurfaces |
| B1 Base components | 1. Specify base finish for base assembly. | No table on this page has beams longer than 15'. |
| BAS Assembly | For legs and cantilever brackets specify one paint finish for all. | |
| 36 Depth | 2. Specify top channel finish. | |
| D Dual | AA anodized aluminum and all paint finishes are available except 613 Silver. | |
| 18 Width | Beams are anodized aluminum only. | |
| S Segmented | | |
| A Adjustable height | | |
| 613 Base finish | | |
| 115 Top channel finish | | |

Complete base assemblies adjustable height 36" D single sided

AutoStrada

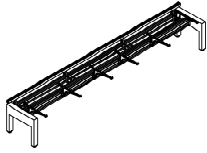
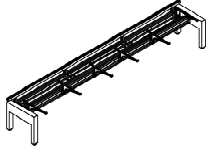
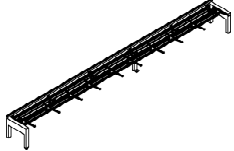
| description | nominal | w | d | h | pattern number | P1/P2 | P3 |
|--|------------------------|------|----------------------------------|----------------------------------|---------------------------------|----------|----------|
|  Base assembly, continuous | 10' single sided | 120" | 28 ³ / ₄ " | 28 ¹ / ₂ " | XTB1 BAS 36S10CA () () | \$9,172. | \$9,425. |
| | 12' single sided | 144" | 28 ³ / ₄ " | 28 ¹ / ₂ " | XTB1 BAS 36S12CA () () | 9,586. | 9,839. |
| | 15' single sided | 180" | 28 ³ / ₄ " | 28 ¹ / ₂ " | XTB1 BAS 36S15CA () () | 11,073. | 11,350. |
|  Base assembly, segmented | 10' + 5' single sided | 180" | 28 ³ / ₄ " | 28 ¹ / ₂ " | XTB1 BAS 36S15SA () () | 10,381. | 10,659. |
|  Base assembly, with intermediate leg | 12' + 6' single sided | 216" | 28 ³ / ₄ " | 28 ¹ / ₂ " | XTB1 BAS 36S18SA () () | 11,464. | 11,741. |
| | 10' + 10' single sided | 240" | 28 ³ / ₄ " | 28 ¹ / ₂ " | XTB1 BAS 36S20SA () () | 12,917. | 13,215. |
| | 12' + 12' single sided | 288" | 28 ³ / ₄ " | 28 ¹ / ₂ " | XTB1 BAS 36S24SA () () | 15,474. | 15,773. |
| | 15' + 10' single sided | 300" | 28 ³ / ₄ " | 28 ¹ / ₂ " | XTB1 BAS 36S25SA () () | 16,546. | 16,868. |

Crinion Open Table

| Order Code | Specifications | Application Notes | |
|---------------------------------------|---|---|---|
| Example: XTB1BAS36S18SA 613 AA | Base assemblies include end legs, beams, trusses, cantilever brackets, channels and end caps. 1. Specify base finish for base assembly. For legs and cantilever brackets specify one paint finish for all. 2. Specify top channel finish. AA anodized aluminum and all paint finishes are available except 613 Silver. Beams are anodized aluminum only. | Complete base assemblies include all base components necessary to support worksurfaces. Specify screens, power components and cable trays separately. Base assemblies include end legs, intermediate leg (where required), beams, trusses, cantilever brackets, top channel and end caps. No table on this page has beams longer than 15'. | |
| XT Crinion Open Table | | | |
| B1 Base components | | | |
| BAS Assembly | | | |
| 36 Depth | | | |
| S Single | | | |
| 18 Width | | | |
| S Segmented | | | |
| A Adjustable height | | | |
| 613 Base finish | | | |
| AA Top channel finish | | | |
| | | | Base assemblies correspond to: 10': two 60"x36"D worksurfaces 12': two 72"x36"D worksurfaces 15': three 60"x36"D worksurfaces 18': three 72"x36"D worksurfaces 20': four 60"x36"D worksurfaces 24': four 72"x36"D worksurfaces 25': five 60"x36"D worksurfaces |

| description | nominal | w | d | h | pattern number | list price |
|---|---------|------|--------|----|---------------------|------------|
|  | 4' | 48" | 2 1/2" | 2" | XTC1 48 () | \$154. |
| | 5' | 60" | 2 1/2" | 2" | XTC1 60 () | 196. |
| | 6' | 72" | 2 1/2" | 2" | XTC1 72 () | 230. |
| | 8' | 96" | 2 1/2" | 2" | XTC1 96 () | 312. |
| | 10' | 120" | 2 1/2" | 2" | XTC1 120 AA | 392. |
| | 12' | 144" | 2 1/2" | 2" | XTC1 144 AA | 461. |
| Top channel end cap | | | 2 1/2" | 2" | XTC1 END () | 35. |

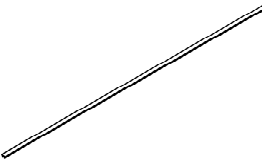

| | | | | | | |
|---|-----|------|--------|----|---------------------|------|
|  | 4' | 48" | 2 1/2" | 2" | XTCA1 48 () | 230. |
| | 5' | 60" | 2 1/2" | 2" | XTCA1 60 () | 277. |
| | 6' | 72" | 2 1/2" | 2" | XTCA1 72 () | 328. |
| | 8' | 96" | 2 1/2" | 2" | XTCA1 96 () | 426. |
| | 10' | 120" | 2 1/2" | 2" | XTCA1 120 AA | 519. |
| | 12' | 144" | 2 1/2" | 2" | XTCA1 144 AA | 646. |

| | | | | | | |
|--|--|-----|--|--|--------------------|-----|
|  | | 48" | | | XTCF 48 () | 29. |
| | | 60" | | | XTCF 60 () | 40. |
| | | 72" | | | XTCF 72 () | 40. |

Order Code

| | |
|------------|--------------------|
| Example: | XTC1120AA |
| XT | Crinion open table |
| C1 | Top channel |
| 120 | Width |
| AA | Finish |

Specifications

Top channels are extruded aluminum with natural anodized finish AA or any standard painted finish except 613 Silver.

Top channel end caps are die cast aluminum AA or any standard painted finish except 613 Silver.

Top channel filler is 812 Easy Grey or 111 Black.

Application Notes

Crinion Open Table top channel supports privacy screens and suspended raceway components at any point. Top channel is required at the center of dual tables.

Top channels and end caps are included in complete base assemblies.

Top channels correspond in width to one or two worksurface widths.

Beams for single sided or dual tables 24" D

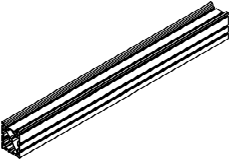
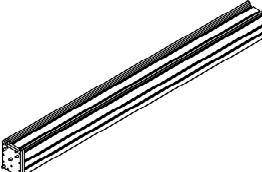
| description | nominal | w | d | h | pattern number | list price |
|---|---------|------|----|----|------------------|------------|
|  Starter beam set for 24" D | 5' | 52" | 3" | 8" | XTB1TB5C | \$1,037. |
| | 6' | 64" | 3" | 8" | XTB1TB6C | 1,152. |
| | 8' | 88" | 3" | 8" | XTB1TB8C | 1,383. |
| | 10' | 112" | 3" | 8" | XTB1TB10C | 1,672. |
| | 12' | 136" | 3" | 8" | XTB1TB12C | 1,959. |
| | 15' | 172" | 3" | 8" | XTB1TB15C | 2,419. |
|  Extension beam set for 24" D tables | 4' | 48" | 3" | 8" | XTB1TB4E | 1,383. |
| | 5' | 60" | 3" | 8" | XTB1TB5E | 1,498. |
| | 6' | 72" | 3" | 8" | XTB1TB6E | 1,613. |
| | 8' | 96" | 3" | 8" | XTB1TB8E | 1,843. |
| | 10' | 120" | 3" | 8" | XTB1TB10E | 2,132. |
| | 12' | 144" | 3" | 8" | XTB1TB12E | 2,419. |
| | 15' | 180" | 3" | 8" | XTB1TB15E | 2,881. |

Order Code

| | |
|---------------------------|--------------------|
| Example: XTB1TB15C | |
| XT | Crinion Open Table |
| B1 | Base components |
| TB | Dual beam set |
| 15 | Width |
| C | Starter |

Specifications

Beams are extruded aluminum with natural anodized finish.

Application Notes

Crinion Open Table bases are assembled from beams, end legs, intermediate legs and trusses.

Beam sets can be used with either dual or single sided tables. Table bases require one starter beam and extension beam adding up to the length as the sum of the worksurface widths on one side.

Extension beam sets are specified only to add on to starter sets or other extension beams.

Beam sets must be supported by intermediate legs at least every 16'. Intermediate leg must be positioned at beam truss location, where two worksurfaces meet.

Beams for dual tables

30" and 36" D

| description | nominal | w | | h | pattern number | list price |
|---|---------|------|----|----|------------------|------------|
| Starter beam set for dual table 30" or 36" (pair of beams) | 5' | 52" | 3" | 8" | XTB1DB5C | \$1,383. |
| | 6' | 64" | 3" | 8" | XTB1DB6C | 1,498. |
| | 8' | 88" | 3" | 8" | XTB1DB8C | 1,959. |
| | 10' | 112" | 3" | 8" | XTB1DB10C | 2,304. |
| | 12' | 136" | 3" | 8" | XTB1DB12C | 2,650. |
| | 15' | 172" | 3" | 8" | XTB1DB15C | 3,111. |

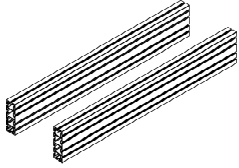

| | | | | | | |
|---|-----|------|----|----|------------------|--------|
| Extension beam set for dual table 30" or 36" (pair of beams) | 4' | 48" | 3" | 8" | XTB1DB4E | 1,843. |
| | 5' | 60" | 3" | 8" | XTB1DB5E | 1,843. |
| | 6' | 72" | 3" | 8" | XTB1DB6E | 1,959. |
| | 8' | 96" | 3" | 8" | XTB1DB8E | 2,419. |
| | 10' | 120" | 3" | 8" | XTB1DB10E | 2,765. |
| | 12' | 144" | 3" | 8" | XTB1DB12E | 3,111. |
| | 15' | 180" | 3" | 8" | XTB1DB15E | 3,573. |

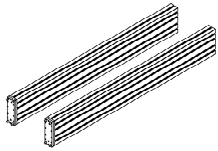

Order Code

| | |
|---------------------------|--------------------|
| Example: XTB1DB15C | |
| XT | Crinion Open Table |
| B1 | Base components |
| DB | Dual beam set |
| 15 | Width |
| C | Starter |

Specifications

Beams are extruded aluminum with natural anodized finish.

Beam sets are starter or extension.

Extension beam sets are specified only to add on to starter sets or other extension beams.

Application Notes

Crinion Open Table bases are assembled from beams, end legs, intermediate legs and trusses. Beam sets may be used with either worksurface depth. Dual tables require one pair of main beams of the same nominal width as the sum of the worksurfaces on each side.

Beam sets must be supported by intermediate legs at least every 16'. Intermediate leg must be positioned at beam truss location, where two worksurfaces meet.

Beams for single sided tables 30" and 36" D

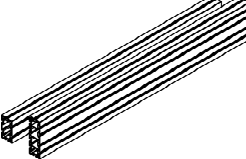
| description | nominal | w | d | h | pattern number | list price |
|--|---------|------|---|----|------------------|------------|
| Starter beam set for single sided table 30" or 36" (main and back beam)  | 5' | 52" | | 8" | XTB1SB5C | \$1,211. |
| | 6' | 64" | | 8" | XTB1SB6C | 1,267. |
| | 8' | 88" | | 8" | XTB1SB8C | 1,672. |
| | 10' | 112" | | 8" | XTB1SB10C | 1,959. |
| | 12' | 136" | | 8" | XTB1SB12C | 2,304. |
| | 15' | 172" | | 8" | XTB1SB15C | 2,650. |

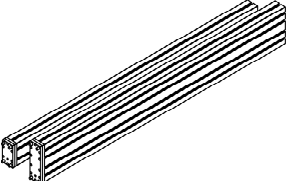
| | | | | | | |
|--|-----|------|--|----|------------------|--------|
| Extension beam set for single sided table 30" or 36" (main and back beam)  | 4' | 48" | | 8" | XTB1SB4E | 1,613. |
| | 5' | 60" | | 8" | XTB1SB5E | 1,672. |
| | 6' | 72" | | 8" | XTB1SB6E | 1,729. |
| | 8' | 96" | | 8" | XTB1SB8E | 2,132. |
| | 10' | 120" | | 8" | XTB1SB10E | 2,419. |
| | 12' | 144" | | 8" | XTB1SB12E | 2,765. |
| | 15' | 180" | | 8" | XTB1SB15E | 3,111. |

Order Code

| | |
|---------------------------|--------------------|
| Example: XTB1DB15C | |
| XT | Crinion Open Table |
| B1 | Base components |
| DB | Dual beam set |
| 15 | Width |
| C | Starter |

Specifications

Beams are extruded aluminum with natural anodized finish.

Beam sets are starter or extension.

Extension beam sets are specified only to add on to starter sets or other extension beams.

Application Notes

Crinion Open Table bases are assembled from beams, end legs, intermediate legs and trusses. Beam sets may be used with either worksurface depth. Single sided tables require one pair of main beams of the same nominal width as the sum of the worksurfaces on each side.

Beam sets must be supported by intermediate legs at least every 16'. Intermediate leg must be positioned at beam truss location, where two worksurfaces meet.

| description | application | w | d | h | pattern number | P1/P2 | P3 |
|---|-------------------|----|-----|-----|----------------------|----------|----------|
| End leg for dual tables (pair of legs) | 24" D worksurface | 4" | | 24" | XTB1EDD24 () | \$4,171. | \$4,379. |
| | 30" D worksurface | 4" | 54" | 24" | XTB1EDD30 () | 4,171. | 4,379. |
| | 36" D worksurface | 4" | 54" | 24" | XTB1EDD36 () | 4,171. | 4,379. |

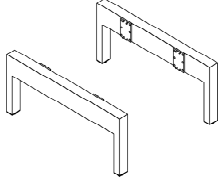

| | | | | | | | |
|--|------------------------|----|--------|-----|----------------------|------|------|
| Intermediate leg for dual table (pair of legs for 30" and 36"D) | 24" D worksurfaces | 4" | 2 1/8" | 16" | XTB1LDD24 () | 605. | 634. |
| | 30"&36" D worksurfaces | 4" | 2 1/8" | 16" | XTB1LDD () | 875. | 922. |

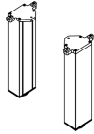

| | | | | | | | |
|--|-----------------------|--------|--------|-----|------------------------|------|------|
| Shroud for intermediate leg infeed kit | 24" D or single sided | 3 3/4" | 2 1/2" | 15" | XTB1 SLIK () | 157. | 165. |
| | 30" D | 11" | 4" | 15" | XTB1 SLIK30 () | 198. | 208. |
| | 36" D | 23" | 4" | 15" | XTB1 SLIK36 () | 232. | 245. |

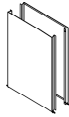

| | | | | | | | |
|--|-------------------|---|----|----|----------------------|--------|--------|
| End leg for end counters both ends (pair of legs) | 48" W end counter | 4 | 44 | 24 | XTB1XDD24 () | 4,459. | 4,667. |
| | 60" W end counter | 4 | 54 | 24 | XTB1XDD30 () | 4,459. | 4,667. |
| | 72" W end counter | 4 | 54 | 24 | XTB1XDD36 () | 4,459. | 4,667. |

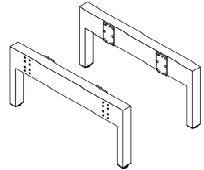

| Order Code | Specifications | Application Notes |
|-------------------------------|--|---|
| Example: XTB1EDD30 118 | Specify paint finish code after pattern number. | <p>Crinion Open Table bases are assembled from main beams, end legs, intermediate legs and trusses. After selecting starter or segmented beam sets, specify legs to support each end of beams. End legs support main beams at each end of a table.</p> <p>Dual end legs for end counters have threaded metal inserts on the outside of the leg to accept two fixed height or adjustable cantilevers for end counters.</p> <p>Intermediate legs must be specified to provide support under beam sets spanning longer than 12' for 24"D tables or 16' for 30"D or 36"D tables. Intermediate legs may be positioned under beams at any beam truss location. End legs include beam end plates and hardware.</p> |
| XT Crinion Open Table | | |
| B1 Base components | | |
| E End leg | | |
| D Dual | | |
| D Desk height | | |
| 30 Depth of tops | | |
| 118 Finish | | |
| | Shroud for intermediate leg kit encloses the space between legs to protect power, data and communication cables between floor and table base. Side covers may be removed for access. | |
| | Shroud for 24"d intermediate leg is U-shaped cover that attaches to side of intermediate leg for 24"d or any single sided intermediate leg. | |
| | End legs for 24"D worksurfaces and end legs for 48"W end counters have only one end plate for attaching centered beam sets for 24"D tables. | |

| description | application | w | d | h | pattern number | P1/P2 | P3 |
|--|-------------------|---|----|----|----------------------|----------|----------|
| End leg for end counters one end only (pair of legs) | 48" W end counter | 4 | 44 | 24 | XTB1YDD24 () | \$4,315. | \$4,523. |
| | 60" W end counter | 4 | 54 | 24 | XTB1YDD30 () | 4,315. | 4,523. |
| | 72" W end counter | 4 | 54 | 24 | XTB1YDD36 () | 4,315. | 4,523. |

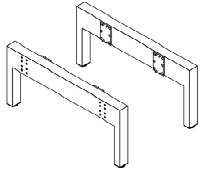

| Order Code | Specifications | Application Notes |
|-------------------------------|---|---|
| Example: XTB1EDD30 118 | Specify paint finish code after pattern number. | <p>Crinion Open Table bases are assembled from main beams, end legs, intermediate legs and trusses. After selecting starter or segmented beam sets, specify legs to support each end of beams. End legs support main beams at each end of a table.</p> <p>Dual end legs for end counters have threaded metal inserts on the outside of the leg to accept two fixed height or adjustable cantilevers for end counters.</p> <p>Intermediate legs must be specified to provide support under beam sets spanning longer than 12' for 24"D tables or 16' for 30"D or 36"D tables. Intermediate legs may be positioned under beams at any beam truss location. End legs include beam end plates and hardware.</p> |
| XT Crinion Open Table | | |
| B1 Base components | | |
| E End leg | | |
| D Dual | | |
| D Desk height | | |
| 30 Depth of tops | | |
| 118 Finish | <p>Shroud for intermediate leg kit encloses the space between legs to protect power, data and communication cables between floor and table base. Side covers may be removed for access.</p> <p>Shroud for 24"d intermediate leg is U-shaped cover that attaches to side of intermediate leg for 24"d or any single sided intermediate leg.</p> <p>End legs for 24"D worksurfaces and end legs for 48"W end counters have only one end plate for attaching centered beam sets for 24"D tables.</p> | |

| description | application | width | depth | height | pattern number | P1/P2 | P3 |
|---|-------------------|-------|----------------------------------|--------|----------------------|----------|----------|
| End leg for single sided tables (pair of legs) | 24" D worksurface | 4" | 24" | 24" | XTB1ESD24 () | \$4,171. | \$4,379. |
| | 30" D worksurface | 4" | 28 ³ / ₄ " | 24" | XTB1ESD30 () | 4,171. | 4,379. |
| | 36" D worksurface | 4" | 28 ³ / ₄ " | 24" | XTB1ESD36 () | 4,171. | 4,379. |

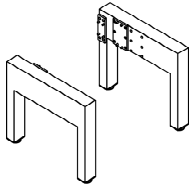

| | | | | | | | |
|---|------------------------|----|--------|-----|----------------------|------|------|
| Intermediate leg for single sided table | 24" D worksurfaces | 4" | 2 1/8" | 16" | XTB1LSD24 () | 605. | 634. |
| | 30"&36" D worksurfaces | 4" | 2 1/8" | 16" | XTB1LSD () | 605. | 634. |

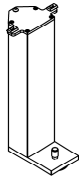

Order Code

| | |
|------------|----------------------|
| Example: | XTB1ESD30 118 |
| XT | Crinion Open Table |
| B1 | Base components |
| E | End leg |
| S | Single |
| D | Desk height |
| 30 | Depth of tops |
| 118 | Finish |

Specifications

Specify paint finish code after pattern number.



Application Notes

Crinion Open Table bases are assembled from main beams, end legs, intermediate legs and trusses. After selecting starter or segmented beam sets, specify legs to support each end of beams. End legs support main beams at each end of a table.

Dual end legs for end counters have threaded metal inserts on the outside of the leg to accept two fixed height or adjustable cantilevers for end counters.

Intermediate legs must be specified to provide support under beam sets spanning longer than 12'. Intermediate legs may be positioned under beams at any beam truss location. End legs include beam end plates and hardware.

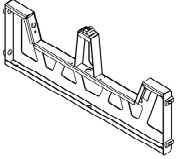
Shroud for intermediate leg kit encloses the space between legs to protect power, data and communication cables between floor and table base. Side covers may be removed for access.

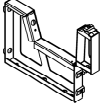
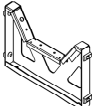
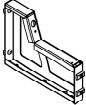
| description | application | w | d | h | pattern number | P1/P2/P3 |
|--|-------------------|----|-----|-----|----------------------|----------|
|  Beam truss for dual tables | 30" D worksurface | 3" | 11" | 10" | XTB1XD30 () | \$508. |
| | 36" D worksurface | 3" | 23" | 10" | XTB1XD36 () | 553. |
|  Top channel support | 24" D worksurface | | | | XTB1T24 () | 183. |
|  Beam truss for single sided tables | 30" D worksurface | 3" | | | XTB1XS30 () | 508. |
| | 36" D worksurface | 3" | | | XTB1XS36 () | 553. |
|  Beam truss for dual tables no top channel support | 30" D worksurface | 3" | 11" | 8" | XTB1XD30N () | 393. |
| | 36" D worksurface | 3" | 23" | 8" | XTB1XD36N () | 451. |
|  Beam truss for single sided tables no top channel support | 30" D worksurface | 3" | | | XTB1XS30N () | 393. |
| | 36" D worksurface | 3" | | | XTB1XS36N () | 451. |

Order Code

| |
|-------------------------------------|
| Example: XTB1XD30 613 |
| XT Crinion Open Table |
| B1 Base components |
| XD Beam truss for dual table |
| 30 Depth |
| 613 Finish |

Specifications

Beam trusses are available in all standard painted finishes.

Application Notes



Crinion Open Table bases are assembled from beams, end legs, intermediate legs and trusses. After selecting beams and leg kits, specify trusses between beams.

Specify beam trusses adjacent to each end leg and at each worksurface junction.

For 24"D tables specify top channel support instead of truss.

Beam trusses with no top channel support must be specified in combination with intermediate legs planned other than at worksurface junctions (as for cable infeed shrouds).

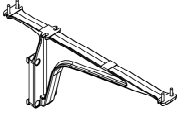
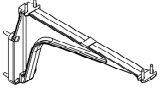
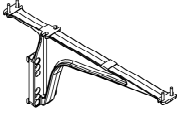
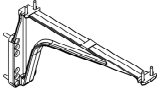
Worksurface support cantilever and mid span support

| description | w | d | h | pattern number | P1/P2 | P3 |
|---|----|-----|----------|---------------------|--------|--------|
| Cantilever, fixed height 30" or 36" D  | 3" | 24" | 9" | XTB1FC () | \$209. | \$218. |
| Cantilever, fixed height 24" D  | 3" | 19" | 9" | XTB1FC24 () | 209. | 218. |
| Cantilever, adjustable height 30" or 36" D  | 3" | 24" | 9" - 12" | XTB1AC () | 230. | 243. |
| Cantilever, adjustable height 24" D  | 3" | 24" | 9" - 12" | XTB1AC24 () | 230. | 243. |
| Mid span support  | 2 | 2 | 8 | XTB1MB () | 99. | 104. |

| Order Code | Specifications | Application Notes |
|-----------------------------------|--|--|
| Example: XTB1FC 118 | Specify paint finish code after pattern number. | Cantilever brackets are required to support each end of worksurfaces. |
| XT Crinion Open Table | | |
| B1 Base components | | Brackets can be positioned at ends of worksurface, or inset at legs or floorstanding pedestal locations. |
| FC Fixed height cantilever | 48" worksurfaces: shared cantilevers each end or two adjustable per worksurface. | Fixed height cantilevers can be shared between adjacent worksurfaces. Mid span support bracket must be specified for worksurface spans exceeding 4'. |
| 118 Finish | 60" and 72" worksurfaces: shared cantilevers each end plus mid span support or two adjustable cantilevers inset 8". | Fixed height cantilever supports worksurface at 28 1/2" H. |
| | 96" worksurfaces: shared cantilevers at ends plus one in center or three adjustable cantilevers. | Adjustable cantilevers enable worksurfaces to be set at 27", 27 3/4", 28 1/2", 29 1/4" or 30" H. |
| | 96"x 24" with hinged door: shared cantilever each end plus two mid span supports. | |
| | 96"x 30" with hinged door: shared cantilever each end plus 24"d cantilever as center support. | |
| | 96"x 36" with hinged door: shared cantilever each end plus 24", 30" or 36"d cantilever as center support. | |

Worksurface support

linking plate and cantilever for end counters

AutoStrada

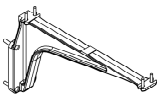
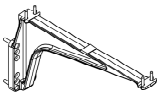
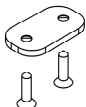
| description | w | d | h | pattern no. | P1/P2 | P3 |
|---|----|-----|----------|----------------------|--------|--------|
| Cantilever for end counters, fixed height | 3" | 19" | 9" | XTB1FCEND () | \$209. | \$218. |
|  | | | | | | |
| Cantilever for end counters, adjustable height | 3" | 19" | 9" - 12" | XTB1ACEND () | 230. | 243. |
|  | | | | | | |
| Worksurface linking plate | | | | XTB1LP | | 28. |
|  | | | | | | |

Crinion Open Table

| Order Code | Specification | Application Notes |
|-----------------------------------|---|---|
| Example: XTB1FCEND 613 | Specify paint finish code after pattern number. | Cantilever brackets are required to support each end of worksurface. |
| XT Crinion Open Table | | Brackets attach to inserts on the outside face of end legs for end counters. |
| B1 Base components | | Fixed height cantilever supports for end counter at 28 1/2" H. |
| FC Fixed height cantilever | | Adjustable cantilevers for end counter enables end counter to be set at 28 1/2", 29 1/4" or 30" H. |
| END for end counter | | A linking plate is recommended to join adjacent worksurfaces that are independently supported at the same height. Specify two linking plates at the junction of two worksurfaces, or four total for each end counter to two worksurfaces. A linking plate is not required where adjacent tops are supported by a shared fixed height cantilever bracket, as with complete fixed height base assemblies. Linking plates are recommended for complete adjustable height base assemblies in which tops are set at the same height. |
| 613 Finish | | |

Modular Raceway

2 + 2 eight-wire Raceway with covers

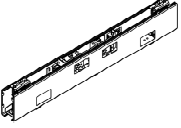
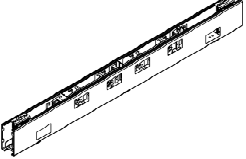
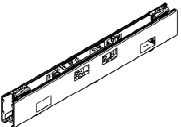
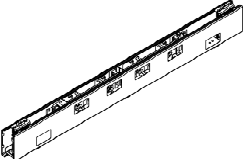

AutoStrada

| description | type | h | w | d | pattern number | list price |
|---|------|----|-----|----|----------------------|------------|
| Dual raceway, two power + two data outlets each side | | 4" | 30" | 2" | XTR1E30D () | \$273. |
|  | | | | | | |
| Dual raceway, four power + two data outlets each side | | 4" | 42" | 2" | XTR1E424D () | 392. |
|  | | | | | | |
| Flat end cover | | | | | XTR1FE () | 23. |
| Extended end cover | | | | | XTR1EE () | 23. |
| Single sided raceway two power + two data outlets one side | | 4" | 30" | 2" | XTR1E30S () | 273. |
|  | | | | | | |
| Single sided raceway four power + two data outlets one side | | 4" | 42" | 2" | XTR1E424S () | 392. |
|  | | | | | | |

| Order Code | Specifications | Applications notes |
|-------------------------------|---|--|
| Example: XTR1E424D 613 | | |
| XT Crinion Open Table | Eight wire 2+2 has two sets of circuits, each set with a separate ground and neutral. | Raceway for Crinion Open Table is suspended from the top channel. For ideal access, worksurfaces should be specified with hinged power access. |
| R1 Raceway | Specify paint finish code after pattern number. | Each raceway requires four or eight duplex outlets, on any of four circuits. |
| E Eight wire system | Covers have two openings for data/com outlet modules (Decora-size, specified separately). | Jumpers connect power from one raceway to another. |
| 42 Width | | To join power between 30" raceways: specify 30" jumper for 60" desks and specify 42" jumper for 72" desks. |
| 4 Extra outlets | | Flat end covers enclose the end of a raceway at the end of a table. |
| D Dual Raceway | | Extended end covers enclose the end of a raceway at the end of a table where power infeed is located. |
| 613 Finish | | Specify outlet fillers separately for unused outlet openings. |

Modular Raceway

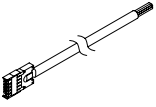
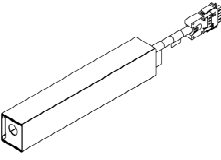
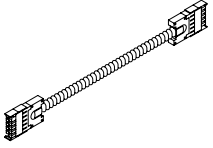
2 + 2 eight-wire Raceway components

| description | type | h | w | d | pattern number | list price |
|---|-------------------|---|-----|---|---------------------|------------|
| Modular infeed | | | | | XTR1EPI | \$206. |
|  | | | | | | |
| NYC infeed kit | | | | | XTR1EPH | 471. |
|  | | | | | | |
| Jumper | | | 18" | | XTR1EJ18 | 95. |
|  | | | 30" | | XTR1EJ30 | 108. |
| | | | 42" | | XTR1EJ42 | 124. |
| Duplex outlet | Circuit A | | | | XTR1DA | 35. |
|  | Circuit B | | | | XTR1DB | 35. |
| | Circuit X, orange | | | | XTR1DXO | 40. |
| | Circuit Y, orange | | | | XTR1DYO | 40. |
| Outlet filler | Set of 10 | | | | XTR1OF | 29. |
| PDC module extension kit | Set of 10 | | | | XTR1PDCX | 120. |
| Compact Power Module | | | | | XTR1ECPM () | 508. |
|  | | | | | | |

| Order Code | Specifications | Application Notes |
|------------------------------|---|--|
| Example: XTR1EJ18 | | |
| XT Crinion Open Table | Eight wire 2+2 has two sets of circuits, each set with a separate ground and neutral. | Raceway for Crinion Open Table is suspended from the top channel. For ideal access, worksurfaces should be specified with hinged power access. |
| R1 Raceway | | |
| E Eight wire | | |
| J Jumper | | |
| 18 Width | | Each raceway requires four or eight duplex outlets, on any of four circuits. |
| | | Power infeed includes pigtail for connection to building power supply and connector to either end of any raceway. |
| | | NYC infeed kit includes junction box that mounts to inside face of beams in table base. |
| | | Jumper length is difference between worksurface width and specified raceway width. |
| | | Compact power module is designed to supply power outlets under extended end counter worksurfaces, or additional outlets under desks. |
| | | Compact power module can be suspended from top channel or attached to inside face of beams. |
| | | Each face of compact power module accepts two duplex outlets. |

Modular Raceway

3 + 3 ten-wire Raceway with covers

AutoStrada

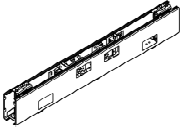
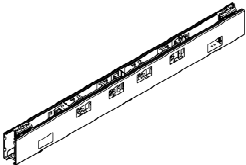
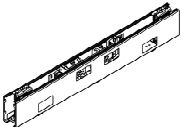
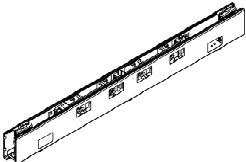
| description | type | h | w | d | pattern number | list price |
|---|------|----|-----|----|----------------------|------------|
| Dual raceway, two power + two data outlets each side | | 4" | 30" | 2" | XTR1T30D () | \$286. |
|  | | | | | | |
| Dual raceway, four power + two data outlets each side | | 4" | 42" | 2" | XTR1T424D () | 405. |
|  | | | | | | |
| Flat end cover | | | | | XTR1FE () | 23. |
| Extended end cover | | | | | XTR1EE () | 23. |
| Single sided raceway two power + two data outlets one side | | 4" | 30" | 2" | XTR1T30S () | 286. |
|  | | | | | | |
| Single sided raceway four power + two data outlets one side | | 4" | 42" | 2" | XTR1T424S () | 405. |
|  | | | | | | |

Order Code

| | |
|-------------------------------|--|
| Example: XTR1T424D 613 | |
| XT Crinion Open Table | |
| R1 Raceway | |
| T Ten wire system | |
| 42 Width | |
| 4 Extra outlets | |
| D Dual Raceway | |
| 613 Finish | |

Specifications

Ten wire 3+3 has two sets of three circuits, each set with a separate ground and neutral.

Specify paint finish code after pattern number.

Covers have two openings for data/com outlet modules (Decora-size, specified separately).

Application Notes

Raceway for Crinion Open Table is suspended from the top channel. For ideal access, worksurfaces should be specified with hinged power access.

Each raceway requires four or eight duplex outlets, on any of six circuits.

Jumpers connect power from one raceway to another.

To join power between 30" raceways: specify 30" jumper for 60" desks and specify 42" jumper for 72" desks.

To join power between 42" raceways: specify 18" jumper for 60" desks and 30" jumper for 72" desks.



Flat end covers enclose the end of a raceway at the end of a table.

Extended end covers enclose the end of a raceway at the end of a table where power infeed is located.

Specify outlet fillers separately for unused outlet openings.

Modular Raceway

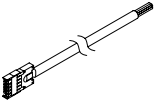
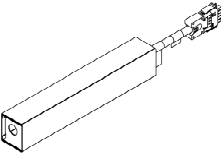
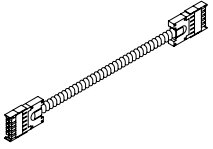
3 + 3 ten-wire Raceway components

| description | type | h | w | d | pattern number | list pricing |
|---|-------------------|---|-----|---|---------------------|--------------|
| Modular infeed | | | | | XTR1TPI | \$231. |
|  | | | | | | |
| NYC infeed kit | | | | | XTR1TPH | 471. |
|  | | | | | | |
| Jumper | | | 18" | | XTR1TJ18 | 108. |
|  | | | 30" | | XTR1TJ30 | 124. |
| | | | 42" | | XTR1TJ42 | 143. |
| Duplex outlet | Circuit A | | | | XTR1DA | 35. |
|  | Circuit B | | | | XTR1DB | 35. |
| | Circuit C | | | | XTR1DC | 35. |
| | Circuit X, orange | | | | XTR1DXO | 40. |
| | Circuit Y, orange | | | | XTR1DYO | 40. |
| | Circuit Z, orange | | | | XTR1DZO | 40. |
| Outlet filler | Set of 10 | | | | XTR1OF | 29. |
| PDC module extension kit | Set of 10 | | | | XTR1PDCX | 120. |
| Compact Power Module | | | | | XTR1TCPM () | 523. |
|  | | | | | | |

| Order Code | Specifications | Application Notes |
|------------------------------|---|--|
| Example: XTR1TJ18 | | |
| XT Crinion Open Table | Ten wire 3+3 has two sets of three circuits, each set with a separate ground and neutral. | Raceway for Crinion Open Table is suspended from the top channel. For ideal access, worksurfaces should be specified with hinged power access. |
| R1 Raceway | | Each raceway requires four or eight duplex outlets, on any of six circuits. |
| T Ten wire | | Power infeed includes pigtail for connection to building power supply and connector to either end of any raceway. |
| J Jumper | | NYC infeed kit includes junction box that mounts to inside face of beams in table base. |
| 18 Width | | Jumper length is difference between worksurface width and specified raceway width. Compact power module is designed to supply power outlets under extended end counter worksurfaces, or additional outlets under desks. Compact power module can be suspended from top channel or attached to inside face of beams. Each face of compact power module accepts two duplex outlets. |

Modular Raceway

4-4-2 ten-wire Raceway with covers

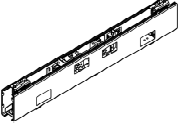
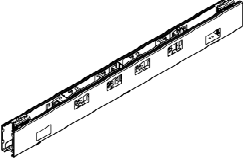
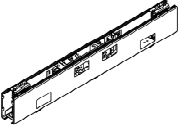
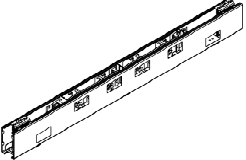

AutoStrada

| description | type | h | w | d | pattern number | list price |
|---|------|----|-----|----|----------------------|------------|
| Dual raceway, two power + two data outlets each side  | | 4" | 30" | 2" | XTR1X30D () | \$301. |
| Dual raceway, four power + two data outlets each side  | | 4" | 42" | 2" | XTR1X424D () | 425. |
| Single sided raceway two power + two data outlets one side  | | 4" | 30" | 2" | XTR1X30S () | 301. |
| Single sided raceway four power + two data outlets one side  | | 4" | 42" | 2" | XTR1X424S () | 425. |

| Order Code | Specifications | Application Notes |
|-------------------------------|---|---|
| Example: XTR1X424D 613 | | |
| XT Crinion Open Table | Ten wire 4-4-2 has four circuits each with a separate neutral, plus a ground wire for circuit 1 and 2 and another ground for circuit 3 and 4. | Raceway for Crinion Open Table is suspended from the top channel. For ideal access, worksurfaces should be specified with hinged power access. |
| R1 Raceway | | |
| X Ten wire 4-4-2 | Specify paint finish code after pattern number. | Each raceway requires four or eight duplex outlets, on any of six circuits. |
| 42 Width | | |
| 4 Extra outlets | Covers have two openings for data/com outlet modules (Decora-size, specified separately). | Jumpers connect power from one raceway to another. |
| D Dual Raceway | | |
| 613 Finish | | |
| | | To join power between 42" raceways: specify 18" jumper for 60" desks and 30" jumper for 72" desks. Flat end covers enclose the end of a raceway at the end of a table. Extended end covers enclose the end of a raceway at the end of a table where power infeed is located. Specify outlet fillers separately for unused outlet openings. |
| | | To join power between 30" raceways: specify 30" jumper for 60" desks and specify 42" jumper for 72" desks. |

Modular Raceway

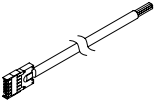
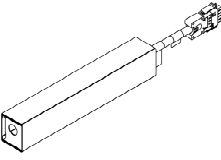
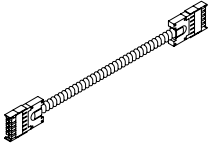
4-4-2 ten-wire Raceway components

| description | type | h | w | d | pattern number | list price |
|---|-----------|---|-----|---|---------------------|------------|
| Modular infeed | | | | | XTR1XPI | \$243. |
|  | | | | | | |
| NYC infeed kit | | | | | XTR1XPH | 494. |
|  | | | | | | |
| Jumper | | | 18" | | XTR1XJ18 | 113. |
|  | | | 30" | | XTR1XJ30 | 130. |
| | | | 42" | | XTR1XJ42 | 148. |
| Duplex outlet | Circuit 1 | | | | XTR1D1 | 37. |
|  | Circuit 2 | | | | XTR1D2 | 37. |
| | Circuit 3 | | | | XTR1D3 | 37. |
| | Circuit 4 | | | | XTR1D4 | 37. |
| Compact Power Module | | | | | XTR1XCPM () | 523. |
|  | | | | | | |

Order Code

| | |
|-----------|--------------------|
| Example: | XTR1XJ18 |
| XT | Crinion Open Table |
| R1 | Raceway |
| X | Ten wire 4-4-2 |
| J | Jumper |
| 18 | Width |

Specifications

Ten wire 4-4-2 has four circuits each with a separate neutral, plus a ground wire for circuit 1 and 2 and another ground for circuit 3 and 4.

All duplex outlets are black.

Application Notes

Raceway for Crinion Open Table is suspended from the top channel. For ideal access, worksurfaces should be specified with hinged power access.

Each raceway requires four or eight duplex outlets, on any of six circuits.

Power infeed includes pigtail for connection to building power supply and connector to either end of any raceway.

NYC infeed kit includes junction box that mounts to inside face of beams in table base.

Jumper length is difference between worksurface width and specified raceway width.

Compact power module is designed to supply power outlets under extended end counter worksurfaces, or additional outlets under desks.

Compact power module can be suspended from top channel or attached to inside face of beams.

Each face of compact power module accepts two duplex outlets.

| description | type | h | w | d | pattern number | list price |
|--|-----------|----|-----|----|---------------------|------------|
| Dual raceway, two power + two data outlets each side | | 4" | 30" | 2" | XTR1H30D () | \$595. |
| Flat end cover | | | | | XTR1FE () | 23. |
| Extended end cover | | | | | XTR1EE () | 23. |
| Outlet filler | Set of 10 | | | | XTR1OF | 29. |

Order Code

| |
|------------------------------|
| Example: XTR1H30D 613 |
| XT Crinion Open Table |
| R1 Raceway |
| H Hard wire system |
| 30 Width |
| D Dual Raceway |
| 613 Finish |

Specifications

Specify paint finish code after pattern number.

Hardwired raceway components are designed for use in City of Chicago installations.

Covers have two openings for data/com outlet modules (Decora-size, by others).



Application Notes

Raceway for Crinion Open Table is suspended from the top channel. For ideal access, worksurfaces should be specified with hinged power access.



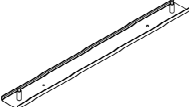

Dual raceways are code-approved boxed with openings for two or four duplex outlets on each face, plus two additional openings for data/communications faceplates on each face. A continuous horizontal metal septum divides power wires and connections from data and communications cables. Each raceway requires Decora-type architectural power outlets, internal wiring and connecting cables, supplied by electrical contractor.

Flat end covers enclose the raceway at the end of a table. Extended end covers provide an opening on the underside to permit cables to enter the raceway.

Specify outlet filler plates for unused outlet openings. Specify PDC extenders to create space behind data/com for cable distribution inside dual raceway.

| description | table size | w | d | pattern number | list price |
|---|------------|-----|----|-----------------------|------------|
|  Cable trays, leg position, pair | 5', 30"D | 53" | 1" | XTCT6030LD () | \$247. |
| | 5', 36"D | 53" | 4" | XTCT6036LD () | 337. |
| | 6', 30"D | 65" | 1" | XTCT7230LD () | 268. |
| | 6', 36"D | 65" | 4" | XTCT7236LD () | 391. |
|  Cable trays, full width, pair | 5', 30"D | 60" | 1" | XTCT6030D () | 247. |
| | 5', 36"D | 60" | 4" | XTCT6036D () | 337. |
| | 6', 30"D | 72" | 1" | XTCT7230D () | 268. |
| | 6', 36"D | 72" | 4" | XTCT7236D () | 391. |
| Data tray kit | | 42" | | XTDT42 () | 174. |
|  Data + excess cable tray kit | | 42" | | XTDTX42 () | 288. |
| Truss cable clips, set of 25 | | | | XTR1TCC25 | 15. |
| Beam cable clips, set of 50 | | | | XTR1BCC50 | 230. |
| Random attachment kit, set of 10 | | | | XTB1RAK | 80. |

| Order Code | Specifications | Applications notes |
|-------------------------------|---|--|
| Example: XTCT7230D 613 | Cable trays and Data tray kits are available in all standard paint finishes. | Cable trays are optional kits to manage cables on each side of dual table bases. Specify cable trays for leg position at each end of the table. Specify cable trays, full width for other positions. Data tray kit provides 3" wide horizontal open cable tray directly below either 30" or 42"W raceway module (at center of 60" or 72" desks). Data + excess tray kit provides two open trays below either raceway module, one 3"W and one 5"W. |
| XT Crinion Open Table | | |
| CT Cable tray | | |
| 72 Width | | |
| 30 Depth | | |
| D Dual table | | |
| 613 Finish | Truss cable clips manage cables between raceway. Specify 2 clips per truss (one set of 10 for each five trusses). Beam cable clips manage cables along the inside faces of each beam set. Random attachment kit is a set of ten M8 slot nuts for attaching various products to the Crinion Open Table beams or top channel. Specify appropriate M8 screws separately. | |

| description | application | w | d | h | pattern no. | list |
|---|---|------|----|------|----------------------|-------|
|  | 24"D tables | 18" | 2" | 3/4" | XTBT18 () | \$79. |
| | 24"D tables | 24" | 2" | 3/4" | XTBT24 () | 88. |
| | 24"D tables | 36" | 2" | 3/4" | XTBT36 () | 96. |
| | 24"D tables | 48" | 2" | 3/4" | XTBT48 () | 105. |
| | 24"D tables | 60" | 2" | 3/4" | XTBT60 () | 113. |
| Cable basket, 10' | | 120" | 8" | 1" | XTWB120 | 428. |
| Cable basket hangers | From truss 30/36D only | | | | XTWTX () | 68. |
| |  | | | | | |
| | From truss at infeed shroud | | | | XTWTBSLIK () | 209. |
| |  | | | | | |
| | From main beam, 24D only | | | | XTWTB () | 68. |
|  | | | | | | |
| | From top channel, 30/36D only | | | | XTWTC () | 89. |

| Order Code | Specifications | Application Notes |
|-----------------------------------|--|---|
| Example: XTBT36 118 | | |
| XT Crinion Open Table | Beam mounted cable trays are available in any standard painted finish. | Beam mounted cable trays may be inserted in slots on either face of Crinion Open Table main beams. On 24"D dual or single sided tables beam mounted cable trays are the only option for cable management other than the shallow channel on top of the beam or a cable basket. On 30"D and 36"D tables beam mounted trays may complement other cable tray options. |
| BT Beam mounted cable tray | Cable basket is zinc metal finish only. | For 96"W worksurfaces specify 36"W trays between supports. Specify 48"W trays for additional cable management between trusses on the inside face of beams on dual 30"D and 36"D tables with 60" worksurfaces. Specify 60"W trays on the inside face of beams on dual 30"D and 36"D tables with 72"W worksurfaces. |
| 36 Width | Basket hangers can be specified in any standard painted finish. | Beam mounted cable trays must be segmented to fit between cantilever and midspan support brackets. Cable basket offers the most flexibility for managing large bundles of cables and for entering or exiting the tray at any point. Cable basket ships in 10' lengths and is cut to size in field. Specify cable basket hangers separately. Each hanger can suspend one end of a tray or two adjacent trays. Hanger from trusses is for 30" or 36"D dual or single sided tables. Hanger from main beam is for 24"D dual tables only. Hangers from top channel are for 30" or 36"D dual tables only. |
| 118 Paint finish | | For 48"W worksurfaces with shared cantilevers specify 36"W trays. For 60"W worksurfaces with shared cantilevers and midspan supports specify 24"W trays adjacent to end legs specify 18"W trays. For 72"W worksurfaces with shared cantilevers and midspan supports specify 24"W trays. |

Center screens

Acrylic, slatwall, combination, marker or veneer surface

| description | appl. | w | d | h | pattern no. | Opal acrylic | Trans. acrylic / Marker | slatwall | Comb. acrylic / slatwall | V1 | V2 | V3 |
|---|-------|-----|--------|-----|-------------------------------|--------------|-------------------------|----------|--------------------------|----------|----------|----------|
|  <p>Center screen to 43" H</p> | 48" | 48" | 1 1/4" | 14" | XTCS1 4814 () () () | \$835. | \$863. | \$1,326. | n/a | \$1,152. | \$1,262. | \$1,478. |
| | 60" | 60" | 1 1/4" | 14" | XTCS1 6014 () () () | 1,095. | 1,149. | 1,440. | n/a | 1,246. | 1,375. | 1,648. |
| | 72" | 72" | 1 1/4" | 14" | XTCS1 7214 () () () | 1,152. | 1,207. | 1,556. | n/a | 1,309. | 1,459. | 1,784. |

acrylic shown

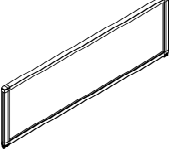
| | | | | | | | | | | | | |
|--|-----|-----|--------|-----|-------------------------------|--------|--------|--------|-----|--------|--------|--------|
|  <p>Center screen to 43" H adjacent to end screen</p> | 48" | 47" | 1 1/4" | 14" | XTCS1 4714 () () () | 835. | 863. | 1,326. | n/a | 1,152. | 1,262. | 1,478. |
| | 60" | 59" | 1 1/4" | 14" | XTCS1 5914 () () () | 1,095. | 1,149. | 1,440. | n/a | 1,246. | 1,375. | 1,648. |
| | 72" | 71" | 1 1/4" | 14" | XTCS1 7114 () () () | 1,152. | 1,207. | 1,556. | n/a | 1,309. | 1,459. | 1,784. |

acrylic shown

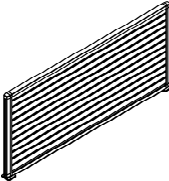
| | | | | | | | | | | | | |
|--|-----|-----|--------|-----|-------------------------------|--------|--------|--------|--------|--------|--------|--------|
|  <p>Center screen to 50" H</p> | 48" | 48" | 1 1/4" | 21" | XTCS1 4821 () () () | 979. | 1,023. | 1,556. | 1,440. | 1,263. | 1,407. | 1,718. |
| | 60" | 60" | 1 1/4" | 21" | XTCS1 6021 () () () | 1,267. | 1,349. | 1,729. | 1,672. | 1,359. | 1,533. | 1,922. |
| | 72" | 72" | 1 1/4" | 21" | XTCS1 7221 () () () | 1,326. | 1,406. | 1,902. | 1,786. | 1,408. | 1,610. | 2,081. |

slatwall shown

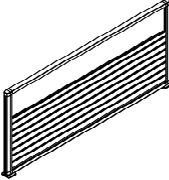
| | | | | | | | | | | | | |
|--|-----|-----|--------|-----|-------------------------------|--------|--------|--------|--------|--------|--------|--------|
|  <p>Center screen to 50" H adjacent to end screen</p> | 48" | 47" | 1 1/4" | 21" | XTCS1 4721 () () () | 979. | 1,023. | 1,556. | 1,440. | 1,263. | 1,407. | 1,718. |
| | 60" | 59" | 1 1/4" | 21" | XTCS1 5921 () () () | 1,267. | 1,349. | 1,729. | 1,672. | 1,359. | 1,533. | 1,922. |
| | 72" | 71" | 1 1/4" | 21" | XTCS1 7121 () () () | 1,326. | 1,406. | 1,902. | 1,786. | 1,408. | 1,610. | 2,081. |

combination shown

| Order Code | Specifications | Application Notes |
|----------------------------------|---|---|
| Example: XTCS16014A O 111 | | |
| XT Crinion Open Table | Acrylic surface is AO opal or AT translucent. | Center screens mount to continuous channel at center of tables. Specify 14" H screens for a 42" horizon. |
| CS1 Center screen | For Marker surface both sides specify suffix M. | Specify 21" H screens for a 49" horizon. Horizons are maintained regardless of worksurface height. |
| 60 Width | For Slatwall screens specify slatwall and frame finish. | Combination screens include 14" high slatwall with acrylic above. |
| 14 Height | For combination acrylic/slatwall screens specify suffixes CO (opal) or CT (translucent), slatwall and frame finish. | Center screens include mounting hardware for standard top channel only. |
| A Surface | Slatwall surface is available in (AA) or any standard painted finish except 613 Silver. | Center screens adjacent to end screens allow space for dual or single sided end screens. |
| O Opal | For veneer surface specify suffix V and finish code from list on Crinion Open Table. | Slatwall screens require buttresses to support Knoll Extra flat screen monitor arm. Specify one buttress per monitor arm, up to four buttresses per screen. |
| 111 Frame finish | Frame is clear anodized aluminum or any standard paint finish except 613 Silver. | Veneer grain direction is horizontal. Marker surface has wood core. |

Crinion Open Table

Center screens
Tackable fabric surface

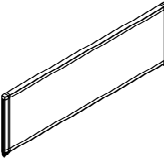
| description | application | w | d | h | pattern no. | 10 | 15 | 20 | 30 | 35 | 40 | 45 |
|---|-------------|-----|--------|-----|----------------------------|--------|--------|--------|--------|--------|--------|--------|
|  | 48" | 48" | 1 1/4" | 14" | XTCS1 4814F () () | \$882. | \$899. | \$902. | \$922. | \$936. | \$936. | \$968. |
| | 60" | 60" | 1 1/4" | 14" | XTCS1 6014F () () | 963. | 984. | 988. | 1,011. | 1,029. | 1,029. | 1,069. |
| | 72" | 72" | 1 1/4" | 14" | XTCS1 7214F () () | 986. | 1,012. | 1,016. | 1,045. | 1,067. | 1,067. | 1,114. |

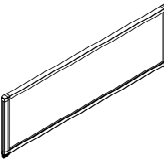
| | | | | | | | | | | | | |
|---|-----|-----|--------|-----|----------------------------|------|--------|--------|--------|--------|--------|--------|
|  | 48" | 47" | 1 1/4" | 14" | XTCS1 4714F () () | 873. | 891. | 894. | 911. | 927. | 927. | 959. |
| | 60" | 59" | 1 1/4" | 14" | XTCS1 5914F () () | 963. | 984. | 988. | 1,011. | 1,029. | 1,029. | 1,069. |
| | 72" | 71" | 1 1/4" | 14" | XTCS1 7114F () () | 986. | 1,012. | 1,016. | 1,045. | 1,067. | 1,067. | 1,114. |

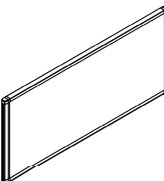

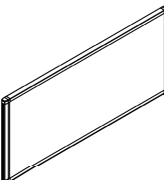

| | | | | | | | | | | | | |
|---|-----|-----|--------|-----|----------------------------|--------|--------|--------|--------|--------|--------|--------|
|  | 48" | 48" | 1 1/4" | 21" | XTCS1 4821F () () | 935. | 952. | 955. | 973. | 988. | 988. | 1,019. |
| | 60" | 60" | 1 1/4" | 21" | XTCS1 6021F () () | 1,043. | 1,066. | 1,069. | 1,091. | 1,110. | 1,110. | 1,150. |
| | 72" | 72" | 1 1/4" | 21" | XTCS1 7221F () () | 1,054. | 1,080. | 1,085. | 1,113. | 1,136. | 1,136. | 1,182. |

| | | | | | | | | | | | | |
|---|-----|-----|--------|-----|----------------------------|--------|--------|--------|--------|--------|--------|--------|
|  | 48" | 47" | 1 1/4" | 21" | XTCS1 4721F () () | 935. | 952. | 955. | 973. | 988. | 988. | 1,019. |
| | 60" | 59" | 1 1/4" | 21" | XTCS1 5921F () () | 1,043. | 1,066. | 1,069. | 1,091. | 1,110. | 1,110. | 1,150. |
| | 72" | 71" | 1 1/4" | 21" | XTCS1 7121F () () | 1,054. | 1,080. | 1,085. | 1,113. | 1,136. | 1,136. | 1,182. |

| Order Code | |
|---|--------------------|
| Example: XTCS16014F20 (W2801) AA | |
| XT | Crinion Open Table |
| CS1 | Center screen |
| 60 | Width |
| 14 | Height |
| F | Surface |
| 20 | Fabric grade |
| W2801 | Fabric |
| AA | Frame finish |

| Specifications |
|--|
| 1. Tackable fabric surface is suffix F. |
| 2. Select fabric surface finish code from list on page Crinion Open Table. |
| Frame is clear anodized aluminum or any standard paint finish except 613 Silver. |
| Fabric is railroaded. |

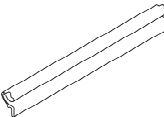
| Application Notes |
|--|
| Fabric center screens mount to continuous channel at center of tables. Specify 14" H screens for a 43" horizon. Specify 21" H screens for a 50" horizon. Horizons are maintained regardless of worksurface height. |
| Center screens adjacent to end screens allow space for dual or single sided end screens. |
| Center screens include mounting hardware for standard top channel only. |

| description | application | w | d | h | pattern no. | list | AA/paint | L | V1 | V2 | V3 |
|--|--------------|-----|-----|----|-------------------------|--------------------|----------|------|------|------|------|
| Display shelf 5"D aluminum only  | 48" slatwall | 45" | 5" | 1" | XT1DS4505 () | | \$256. | | | | |
| | 60" slatwall | 57" | 5" | 1" | XT1DS5705 () | | 287. | | | | |
| | 72" slatwall | 69" | 5" | 1" | XT1DS6905 () | | 310. | | | | |
| Open shelf 9"D laminate or veneer only  | 48" slatwall | 45" | 9" | 1" | XT1LS4509 ()() | | | 287. | 375. | 430. | 581. |
| | 60" slatwall | 57" | 9" | 1" | XT1LS5709 ()() | | | 330. | 429. | 493. | 667. |
| | 72" slatwall | 69" | 9" | 1" | XT1LS6909 ()() | | | 374. | 485. | 557. | 752. |
| Slatwall adapters for applied wall accessories  | | 24" | | | XT1SA24 () | | | 26. | | | |
| | | | 30" | | | XT1SA30 () | | 31. | | | |
| | | | 36" | | | XT1SA36 () | | 37. | | | |
| | | | 42" | | | XT1SA42 () | | 42. | | | |
| | | | 48" | | | XT1SA48 () | | 47. | | | |
| | | | 54" | | | XT1SA54 () | | 53. | | | |
| | | | 60" | | | XT1SA60 () | | 58. | | | |
| | | | 66" | | | XT1SA66 () | | 63. | | | |
| | | 72" | | | XT1SA72 () | | 68. | | | | |
| Buttress for slatwall screen  | | | | | XTCS1 SBA () | | | 230. | | | |

| Order Code | Specifications | Application Notes |
|----------------------------------|--|---|
| Example: XT1LS5709 118 AA | | |
| XT1 Crinion Open Table | Display shelves are anodized aluminum (AA) or any standard painted finish except silver. | Open shelves and display shelves for slatwall are designed for use on Crinion Open Table center screens with slatwall inserts. |
| LS Open shelf | | |
| 57 Width | For open shelves specify any standard laminate or veneer finish, then platform finish. | Shelves include adapter that snaps into horizontal channels in slatwall, approximately every 2" vertically. |
| 09 Depth | Shelf platform may be AA or any standard paint finish except silver. | Shelf width fits either full width center screens or screens adjacent to end screens. |
| 118 Shelf finish | | |
| AA Platform finish | Slatwall adapters are integral color 812 Easy grey or 111 Black only. | Slatwall adapters enable other Applied Wall System shelves and accessories to be mounted to Crinion Open Table slatwall. Adapter will also fit other Knoll system slatwalls, such as AutoStrada spine or panels, but use of shelves in these applications may not comply with ANSI/BIFMA safety standards for anti-dislodgment. |

Side screens

Acrylic, Marker or veneer surface

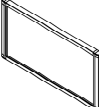
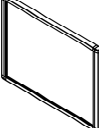
| description | application | w | d | h | pattern no. | list | Opal acrylic | Trans. acrylic / Marker | V1 | V2 | V3 | |
|--|-------------------|-----|--------|-----|-------------------------------|-------------------|--------------|-------------------------|--------|--------|----------|--|
|  Side screen to 43" H | 24" D worksurface | 22" | 1 1/4" | 14" | XTSS1 2414 () () () | | \$605. | \$621. | \$911. | \$978. | \$1,077. | |
| | 30" D worksurface | 28" | 1 1/4" | 14" | XTSS1 3014 () () () | | 634. | 656. | 940. | 1,016. | 1,143. | |
| | 36" D worksurface | 34" | 1 1/4" | 14" | XTSS1 3614 () () () | | 691. | 719. | 965. | 1,051. | 1,206. | |
| | acrylic shown | | | | | | | | | | | |
|  Side screen to 50" H | 24" D worksurface | 22" | 1 1/4" | 21" | XTSS1 2421 () () () | | 691. | 719. | 976. | 1,058. | 1,200. | |
| | 30" D worksurface | 28" | 1 1/4" | 21" | XTSS1 3021 () () () | | 721. | 753. | 1,007. | 1,103. | 1,284. | |
| | 36" D worksurface | 34" | 1 1/4" | 21" | XTSS1 3621 () () () | | 777. | 815. | 1,035. | 1,147. | 1,368. | |
| | acrylic shown | | | | | | | | | | | |
| Side screen brackets (pair) | postformed edge | | | | | XTSM1P () | 243. | | | | | |
| | squared edge | | | | | XTSM1S () | 173. | | | | | |
| | tapered edge | | | | | XTSM1K () | 173. | | | | | |

Order Code

| | |
|------------|------------------------|
| Example: | XTSS13014A O AA |
| XT | Crinion Open Table |
| SS1 | Side screen |
| 30 | Width |
| 14 | Height |
| A | Surface |
| O | Opal |
| AA | Frame finish |

Specifications

- Specify surface
A = Acrylic
V = Veneer
M = Marker
- For Acrylic surface specify
O = Opal
T = Translucent
 Veneer surfaces may be any standard AutoStrada V1, V2 or V3 veneer.
 Specify veneer finish code from Crinion Open Table.

Frame is clear anodized aluminum or any standard paint finish except 613 Silver.

Brackets are available in all paint finishes

Application Notes

Side screens clamp to front and back edge of worksurface at any point (except at hinged access door). Specify side screen brackets separately. Specify 14" H screens for a 42" horizon. Specify 21" H screens for a 49" horizon. Side screens align in height with center screens when worksurfaces are set at 28 3/8" H.

Veneer grain direction is horizontal.

Side screens

Tackable fabric surface

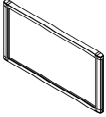
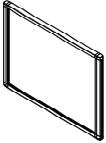
| description | application | w | d | h | pattern no. | list | 10 | 15 | 20 | 30 | 35 | 40 | 45 |
|---|-------------------|-----|--------|-----|----------------------------|--------|--------|--------|--------|--------|--------|--------|----|
|  | 24" D worksurface | 22" | 1 1/4" | 14" | XTSS1 2414F () () | \$687. | \$695. | \$697. | \$707. | \$714. | \$714. | \$730. | |
| | 30" D worksurface | 28" | 1 1/4" | 14" | XTSS1 3014F () () | 707. | 719. | 721. | 732. | 741. | 741. | 760. | |
| | 36" D worksurface | 34" | 1 1/4" | 14" | XTSS1 3614F () () | 728. | 741. | 757. | 767. | 767. | 767. | 792. | |
|  | 24" D worksurface | 22" | 1 1/4" | 21" | XTSS1 2421F () () | 718. | 726. | 727. | 737. | 744. | 744. | 760. | |
| | 30" D worksurface | 28" | 1 1/4" | 21" | XTSS1 3021F () () | 748. | 758. | 760. | 772. | 781. | 781. | 801. | |
| | 36" D worksurface | 34" | 1 1/4" | 21" | XTSS1 3621F () () | 762. | 775. | 777. | 792. | 802. | 802. | 826. | |
| Side screen brackets (pair) | postformed edge | | | | XTSM1P () | 243. | | | | | | | |
| | squared edge | | | | XTSM1S () | 173. | | | | | | | |
| | tapered edge | | | | XTSM1K () | 173. | | | | | | | |

| Order Code | Specifications | Application Notes |
|--|--|---|
| Example: XTSS13014F20 (W2801) 115 | | |
| XT Crinion Open Table | 1. Tackable fabric surface is suffix F. | Side screens clamp to front and back edge of worksurface at any point (except at hinged access door). Specify side screen brackets separately. Specify 14" H screens for a 43" horizon. Specify 21" H screens for a 50" horizon. Side screens align in height with center screens when worksurfaces are set at 28 3/8" H. |
| SS1 Side screen | 2. Select fabric surface finish code from list on page Crinion Open Table. | |
| 30 Width | 3. Specify frame finish. | |
| 14 Height | Frame is clear anodized aluminum or any standard paint finish except 613 Silver. | |
| F Surface | Fabric is railroaded. | |
| 20 Fabric grade | Brackets are available in all paint finishes. | |
| W2801 Fabric | | |
| 115 Frame finish | | |

Return screens

Acrylic, Marker or veneer surface

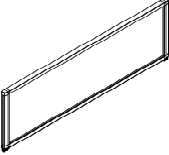
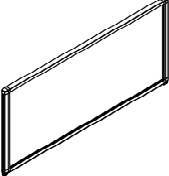
| description | application | w | d | h | pattern no. | list | Opal acrylic | Trans. acrylic / Marker | V1 | V2 | V3 |
|---|------------------------|-----|-----|--------|-------------------|-------------------------------|--------------|-------------------------|----------|----------|----------|
|  | Return screen to 43" H | 54" | 52" | 1 1/4" | 14" | XTRS1 5414 () () () | \$1,008. | \$1,062. | \$1,099. | \$1,215. | \$1,449. |
| | | 60" | 58" | 1 1/4" | 14" | XTRS1 6014 () () () | 1,008. | 1,062. | 1,113. | 1,240. | 1,502. |
| | | 66" | 64" | 1 1/4" | 14" | XTRS1 6614 () () () | 1,008. | 1,062. | 1,137. | 1,271. | 1,564. |
| | | 72" | 70" | 1 1/4" | 14" | XTRS1 7214 () () () | 1,008. | 1,062. | 1,151. | 1,296. | 1,616. |
| | | 78" | 76" | 1 1/4" | 14" | XTRS1 7814 () () () | 1,123. | 1,177. | 1,363. | 1,486. | 1,833. |
|  | Return screen to 50" H | 54" | 52" | 1 1/4" | 21" | XTRS1 5421 () () () | 1,181. | 1,262. | 1,205. | 1,358. | 1,698. |
| | | 60" | 58" | 1 1/4" | 21" | XTRS1 6021 () () () | 1,181. | 1,262. | 1,225. | 1,395. | 1,775. |
| | | 66" | 64" | 1 1/4" | 21" | XTRS1 6621 () () () | 1,181. | 1,262. | 1,246. | 1,429. | 1,849. |
| | | 72" | 70" | 1 1/4" | 21" | XTRS1 7221 () () () | 1,181. | 1,262. | 1,266. | 1,464. | 1,923. |
| | | 78" | 76" | 1 1/4" | 21" | XTRS1 7821 () () () | 1,326. | 1,406. | 1,484. | 1,664. | 2,161. |
| Side screen brackets (pair) | postformed edge | | | | XTSM1P () | 243. | | | | | |
| | squared edge | | | | XTSM1S () | 173. | | | | | |

| Order Code | |
|----------------------------------|--------------------|
| Example: XTRS16014A O 118 | |
| XT | Crinion Open Table |
| RS1 | Return screen |
| 60 | Width |
| 14 | Height |
| A | Acrylic |
| O | Opal |
| 118 | Frame finish |

- Specifications**
- Specify surface
A = Acrylic
V = Veneer
M = Marker
 - For Acrylic surface specify
O = Opal
T = Translucent
 Veneer surfaces may be any standard AutoStrada V1, V2 or V3 veneer.
 Specify veneer finish code from Crinion Open Table.
 - Specify frame finish.
- Frame is clear anodized aluminum (AA) or any standard paint finish except 613 Silver.
- Brackets are available in all paint finishes.

- Application Notes**
- Return screens span the depth of Crinion Open Table worksurfaces and the width of a 30", 36" or 42" worksurface planned as perpendicular return. Specify 14" H screens for 42" horizon. Specify 21" H screens for a 49" horizon. Returns (file tops or AutoStrada worksurfaces) must be at the same height as worksurface.
- Specify side brackets separately.
- Veneer grain direction is horizontal.

Return screens

Tackable fabric surface

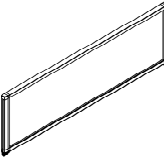
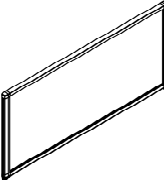
| description | application | w | d | h | pattern no. | list | 10 | 15 | 20 | 30 | 35 | 40 | 45 |
|--|-----------------|-----|--------|-----|--------------------------------|--------|--------|--------|--------|--------|--------|--------|----|
|  Return screen to 43" H | 54" | 52" | 1 1/4" | 14" | XTRS1 5414F () () () | \$838. | \$859. | \$863. | \$883. | \$899. | \$899. | \$936. | |
| | 60" | 58" | 1 1/4" | 14" | XTRS1 6014F () () () | 845. | 866. | 870. | 894. | 911. | 911. | 952. | |
| | 66" | 64" | 1 1/4" | 14" | XTRS1 6614F () () () | 862. | 885. | 890. | 916. | 935. | 935. | 978. | |
| | 72" | 70" | 1 1/4" | 14" | XTRS1 7214F () () () | 867. | 893. | 898. | 928. | 946. | 946. | 996. | |
| | 78" | 76" | 1 1/4" | 14" | XTRS1 7814F () () () | 998. | 1,025. | 1,031. | 1,061. | 1,083. | 1,083. | 1,136. | |
|  Return screen to 50" H | 54" | 52" | 1 1/4" | 21" | XTRS1 5421F () () () | 820. | 838. | 842. | 865. | 881. | 881. | 917. | |
| | 60" | 58" | 1 1/4" | 21" | XTRS1 6021F () () () | 851. | 872. | 875. | 900. | 918. | 918. | 957. | |
| | 66" | 64" | 1 1/4" | 21" | XTRS1 6621F () () () | 857. | 880. | 884. | 909. | 930. | 930. | 973. | |
| | 72" | 70" | 1 1/4" | 21" | XTRS1 7221F () () () | 862. | 887. | 893. | 921. | 942. | 942. | 990. | |
| | 78" | 76" | 1 1/4" | 21" | XTRS1 7821F () () () | 1,017. | 1,045. | 1,051. | 1,081. | 1,104. | 1,104. | 1,155. | |
| Side screen brackets (pair) | postformed edge | | | | XTSM1P () | 243. | | | | | | | |
| | squared edge | | | | XTSM1S () | 173. | | | | | | | |

| Order Code | Specifications | Application Notes |
|--|--|--|
| Example: XTRS16014F20 (W2801) 611 | | |
| XT Crinion Open Table | 1. Tackable fabric surface is suffix F. | Fabric return screens span the depth of Crinion Open Table worksurfaces and the width of a 30", 36" or 42" worksurface planned as perpendicular return. Specify 14" H screens for 43" horizon. Specify 21" H screens for a 50" horizon. Returns must be at the same height as worksurface. |
| RS1 Return screen | 2. Select fabric surface finish code from list on page Crinion Open Table. | |
| 60 Width | 3. Specify frame finish. | |
| 14 Height | Frame is clear anodized aluminum or any standard paint finish except 613 Silver. | Specify mounting brackets separately. |
| F Surface | Fabric is railroaded. | |
| 20 Fabric grade | Brackets are available in all paint finishes. | |
| W2801 Fabric | | |
| 611 Frame finish | | |

Dual end screens

Acrylic, Marker or veneer surface

AutoStrada

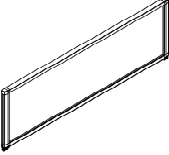
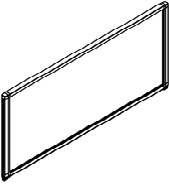
| description | application | w | d | h | pattern no. | list | Opal acrylic | Trans. acrylic / Marker | V1 | V2 | V3 | |
|---|---------------------------|------------|-----|--------|-------------|-------------------------------|--------------|-------------------------|----------|----------|----------|--|
|  | Dual end screens to 43" H | 24" D dual | 48" | 1 1/4" | 14" | XTES1 4814 () () () | \$750. | \$776. | \$1,054. | \$1,163. | \$1,380. | |
| | | 30" D dual | 60" | 1 1/4" | 14" | XTES1 6014 () () () | 979. | 1,034. | 1,148. | 1,279. | 1,550. | |
| | | 36" D dual | 72" | 1 1/4" | 14" | XTES1 7214 () () () | 1,008. | 1,062. | 1,212. | 1,360. | 1,686. | |
| | acrylic shown | | | | | | | | | | | |
|  | Dual end screens to 50" H | 24" D dual | 48" | 1 1/4" | 21" | XTES1 4821 () () () | 893. | 936. | 1,164. | 1,309. | 1,621. | |
| | | 30" D dual | 60" | 1 1/4" | 21" | XTES1 6021 () () () | 1,152. | 1,232. | 1,261. | 1,434. | 1,824. | |
| | | 36" D dual | 72" | 1 1/4" | 21" | XTES1 7221 () () () | 1,181. | 1,369. | 1,311. | 1,511. | 1,982. | |
| | acrylic shown | | | | | | | | | | | |
| Replacement mast Kit | acrylic center screen | | | | | XTSM1C () | 98. | | | | | |
| | slatwall center screen | | | | | XTSM1SLAT () | 259. | | | | | |
| End screen brackets (pair) | tapered edge worksurface | | | | | XTSM1KK () | 173. | | | | | |
| Side screen brackets (pair) | postformed edge | | | | | XTSM1P () | 243. | | | | | |
| | squared edge | | | | | XTSM1S () | 173. | | | | | |

| Order Code | Specifications | Application Notes |
|---------------------------------|---|---|
| Example: XTES16014A O AA | | |
| XT Crinion Open Table | 1. Specify surface <i>A = Acrylic</i> <i>V = Veneer</i> <i>M = Marker</i> | Dual end screens clamp to front edge of worksurface on either side of table. Specify 14" H screens for a 42" horizon. Specify 21" H screens for a 49" horizon. Side screens align with center screens when worksurfaces are set at 28 3/8" H. |
| ES1 End screen | 2. For Acrylic surface specify <i>O = Opal</i> <i>T = Translucent</i> Veneer surfaces may be any standard AutoStrada V1, V2 or V3 veneer. Specify veneer finish code from Crinion Open Table. | |
| 60 Width | 3. Specify frame finish. | |
| 14 Height | Frame is clear anodized aluminum or any standard paint finish except 613 Silver. | Specify end screen brackets separately for each screen. |
| A Surface | Brackets are available in all paint finishes. | Veneer grain direction is horizontal. |
| O Opal | Replacement mast kit for acrylic center screen is 812 Easy Grey or 111 Black. | |
| AA Frame finish | | |

Dual end screens

Tackable fabric surface

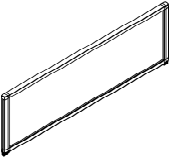
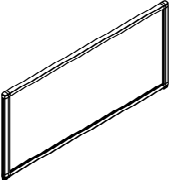
| description | application | w | d | h | pattern no. | list | 10 | 15 | 20 | 30 | 35 | 40 | 45 |
|---|------------------------|-----|--------|-----|----------------------------|--------|--------|--------|--------|--------|--------|--------|----|
|  Dual end screens to 43" H | 24" D dual | 48" | 1 1/4" | 14" | XTES1 4814F () () | \$772. | \$791. | \$794. | \$813. | \$827. | \$827. | \$860. | |
| | 30" D dual | 60" | 1 1/4" | 14" | XTES1 6014F () () | 845. | 866. | 870. | 894. | 911. | 911. | 952. | |
| | 36" D dual | 72" | 1 1/4" | 14" | XTES1 7214F () () | 867. | 893. | 898. | 927. | 946. | 946. | 996. | |
|  Dual end screens to 50" H | 24" D dual | 48" | 1 1/4" | 21" | XTES1 4821F () () | 834. | 852. | 857. | 874. | 890. | 890. | 922. | |
| | 30" D dual | 60" | 1 1/4" | 21" | XTES1 6021F () () | 906. | 929. | 933. | 956. | 974. | 974. | 1,014. | |
| | 36" D dual | 72" | 1 1/4" | 21" | XTES1 7221F () () | 919. | 944. | 948. | 977. | 999. | 999. | 1,045. | |
| Replacement mast Kit | acrylic center screen | | | | XTSM1C () | 98. | | | | | | | |
| | slatwall center screen | | | | XTSM1SLAT () | 259. | | | | | | | |
| End screen brackets (pair) | tapered edge | | | | XTSM1KK () | 173. | | | | | | | |
| | worksurface | | | | | | | | | | | | |
| Side screen brackets (pair) | postformed edge | | | | XTSM1P () | 243. | | | | | | | |
| | squared edge | | | | XTSM1S () | 173. | | | | | | | |

| Order Code | Specifications | Application Notes |
|--|--|---|
| Example: XTES16014F20 (W2801) 112 | 1. Tackable fabric surface is suffix F. | Dual end screens clamp to front edge of worksurface on either side of table. Specify 14" H screens for a 43" horizon. Specify 21" H screens for a 50" horizon. Side screens align with center screens when worksurfaces are set at 28 3/8" H. |
| XT Crinion Open Table | 2. Select fabric surface finish code from list on page Crinion Open Table. | |
| ES1 End screen | 3. Specify frame finish. | |
| 60 Width | Frame is clear anodized aluminum or any standard paint finish except 613 Silver. | Specify end screen brackets separately for each screen. |
| 14 Height | Fabric is railroaded. | |
| F Surface | Brackets are available in all paint finishes. | |
| 20 Fabric grade | Replacement mast kit is 812 Easy Grey or 111 Black. | |
| W2801 Fabric | | |
| 112 Frame finish | | |

Single sided end screen

Acrylic, Marker or veneer surface

AutoStrada

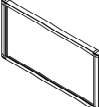
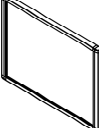
| description | application | w | d | h | pattern no. | list | Opal | Trans. | V1 | V2 | V3 | |
|---|--------------------|---------|--------|-----|-------------------------------|--------------------|---------|------------------|--------|--------|----------|--|
| | | | | | | | acrylic | acrylic / Marker | | | | |
|  Single sided end screens to 43" H | 24" D Single sided | 24 1/2" | 1 1/4" | 14" | XTES1 2414 () () () | | \$605. | \$621. | \$911. | \$978. | \$1,077. | |
| | 30" D Single sided | 30 1/2" | 1 1/4" | 14" | XTES1 3014 () () () | | 634. | 656. | 940. | 1,016. | 1,143. | |
| | 36" D Single sided | 36 1/2" | 1 1/4" | 14" | XTES1 3614 () () () | | 691. | 719. | 965. | 1,051. | 1,206. | |
| acrylic shown | | | | | | | | | | | | |
|  Single sided end screen to 50" H | 24" D single sided | 24 1/2" | 1 1/4" | 21" | XTES1 2421 () () () | | 691. | 719. | 976. | 1,058. | 1,200. | |
| | 30" D single sided | 30 1/2" | 1 1/4" | 21" | XTES1 3021 () () () | | 721. | 753. | 1,007. | 1,103. | 1,284. | |
| | 36" D single sided | 36 1/2" | 1 1/4" | 21" | XTES1 3621 () () () | | 777. | 815. | 1,035. | 1,147. | 1,368. | |
| acrylic shown | | | | | | | | | | | | |
| Single sided end screen brackets (set) | postformed edge | | | | | XTSM1PC () | | 174. | | | | |
| | square edge | | | | | XTSM1SC () | | 128. | | | | |
| | tapered edge | | | | | XTSM1KC () | | 128. | | | | |

| Order Code | Specifications | Application Notes |
|----------------------------------|---|--|
| Example: XTES13614A O 114 | | |
| XT Crinion Open Table | 1. Specify surface <i>A = Acrylic</i> <i>V = Veneer</i> <i>M = Marker</i> | Single sided end screens clamp to front edge of worksurface and attach to top of channel. Specify 14" H screens for a 42" horizon. Specify 21" H screens for a 49" horizon. Side screens align with center screens when worksurfaces are set at 28 3/8" H. |
| ES1 End screen | 2. For Acrylic surface specify <i>O = Opal</i> <i>T = Translucent</i> Veneer surfaces may be any standard AutoStrada V1, V2 or V3 veneer. Specify veneer finish code from Crinion Open Table. | |
| 36 Width | 3. Specify frame finish. Frame is clear anodized aluminum or any standard paint finish except 613 Silver. Brackets are available in all paint finishes. | |
| 14 Height | | Specify end screen brackets separately for each screen. Veneer grain direction is horizontal. |
| A Surface | | |
| O Opal | | |
| 114 Frame finish | | |

Single sided end screen

Tackable fabric surface

AutoStrada

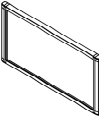
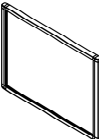
| description | application | w | d | h | pattern no. | list | 10 | 15 | 20 | 30 | 35 | 40 | 45 |
|---|--------------------|---------|--------|-----|--------------------------------|--------|--------|--------|--------|--------|--------|--------|----|
|  | 24" D Single sided | 24 1/2" | 1 1/4" | 14" | XTES1 2414F () () () | \$687. | \$695. | \$697. | \$707. | \$714. | \$714. | \$730. | |
| | 30" D Single sided | 30 1/2" | 1 1/4" | 14" | XTES1 3014F () () () | 707. | 719. | 721. | 732. | 741. | 741. | 760. | |
| | 36" D Single sided | 36 1/2" | 1 1/4" | 14" | XTES1 3614F () () () | 728. | 741. | 757. | 767. | 767. | 767. | 792. | |
|  | 24" D single sided | 24 1/2" | 1 1/4" | 21" | XTES1 2421F () () () | 718. | 726. | 727. | 737. | 744. | 744. | 760. | |
| | 30" D single sided | 30 1/2" | 1 1/4" | 21" | XTES1 3021F () () () | 748. | 758. | 760. | 772. | 781. | 781. | 801. | |
| | 36" D single sided | 36 1/2" | 1 1/4" | 21" | XTES1 3621F () () () | 762. | 775. | 777. | 792. | 802. | 802. | 826. | |
| Single sided end screen brackets (set) | postformed edge | | | | XTSM1PC () | 174. | | | | | | | |
| | square edge | | | | XTSM1SC () | 128. | | | | | | | |
| | tapered edge | | | | XTSM1KC () | 128. | | | | | | | |

Crinion Open Table

| Order Code | Specifications | Application Notes |
|--|--|--|
| Example: XTES13614F20 (W2801) 111 | | |
| XT Crinion Open Table | 1. Tackable fabric surface is suffix F. | Single sided end screens clamp to front edge of worksurface and attach to top of channel. Specify 14" H screens for a 43" horizon. Specify 21" H screens for a 50" horizon. Side screens align with center screens when worksurfaces are set at 28 3/8" H. |
| ES1 End screen | 2. Select fabric surface finish code from list on page Crinion Open Table. | |
| 36 Width | 3. Specify frame finish. | |
| 14 Height | Frame is clear anodized aluminum or any paint finish except 613 Silver. | Specify end screen brackets separately for each screen. |
| F Surface | Fabric is railroaded. | |
| 20 Fabric grade | Brackets are available in all paint finishes. | |
| W2801 Fabric | | |
| 111 Frame finish | | |

Frameless glass Add up for *Crinion Open Table*

AutoStrada

| description | w | d | h | pattern number | clear tempered | powder |
|-------------------------|-----|------|-----|---------------------------|----------------|--------|
| Frameless glass Add ups | 48" | 1/2" | 12" | XAUA 1248G () () | \$514. | \$534. |
| | 60" | 1/2" | 12" | XAUA 1260G () () | 628. | 654. |
| | 72" | 1/2" | 12" | XAUA 1272G () () | 742. | 771. |

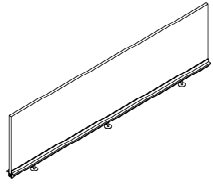

| Order Code | Specifications | Application Notes |
|------------------------------------|---|--|
| Example: XAUA 1248G TEMP AA | <i>Add up type:</i> | Frameless glass addups for Crinion Open Table match those available for the AutoStrada spine. |
| X Crinion Open Table | G Glass | |
| AUA Frameless addup screen | Glass add-ups are available with the following glass options: | Tempered glass in clear or powered finish is 1/2" thick. Base frame is secured with bolts to top channel for frameless glass addups. |
| 48 Width | | |
| 12 Height | | |
| G Glass | TEMP Clear tempered | Frameless addups cannot be mounted to standard top channel included with base assemblies. |
| TEMP Finish | GL13 Powder | |
| AA Base finish | Specify base finish: AA anodized aluminum and all standard painted finishes except 613 Silver. | |

Morrison Network privacy screens mounting kit for Crinion Open Table

AutoStrada

| description | w | d | h | pattern number | list price |
|----------------------------|---|---|---|-------------------|------------|
| Fabric screen mounting kit | | | | XTPS1MZKIT | \$117. |



Crinion Open Table

| Order Code | Specifications | Applications notes |
|----------------------------|--------------------|--|
| Example: XTPS1MZKIT | | |
| XT | Crinion Open Table | <p>Crinion Open Tables are designed to accept Morrison Network privacy screens with fabric screen mounting kit. Screens are tackable fabric, $\frac{3}{4}$" thick, in widths corresponding to Crinion worksurfaces 48", 60" or 72" wide. Specify screens MZ1-B4815F, MZ1B6015F or MZ1B7215F.</p> <p>Specify one mounting kit for each screen. Fabric screen mounting kits include two uprights that fasten to the top channel at any point. Uprights slide into internal channels in screens. Fabric screens do not align in height with acrylic privacy screens.</p> |
| PS1 | Privacy Screen | |
| MZ | Fabric | |
| KIT | Kit | |

Alpha-Numeric Index

| <i>pattern no.</i> | <i>page</i> | <i>pattern no.</i> | <i>page</i> | <i>pattern no.</i> | <i>page</i> | <i>pattern no.</i> | <i>page</i> |
|---------------------|-------------|--------------------|-------------|--------------------|-------------|--------------------|-------------|
| A1CHLTT102 | 119 | AA1 ARE | 71 | AAWS BC 096 | 18 | AAWS C0766 | 30 |
| A1CHLTT108 | 119 | AA1 BS | 221 | AAWS BC 102 | 18 | AAWS C0766 A | 26 |
| A1CHLTT114 | 119 | AA1 T06 | 87 | AAWS BC 108 | 18 | AAWS C0766 F | 28 |
| A1CHLTT120 | 119 | AA1 T18 | 87 | AAWS BC 114 | 18 | AAWS C0766 M | 23 |
| A1CHLTT126 | 119 | AA1 T24 | 87 | AAWS BC 120 | 18 | AAWS C0766 P | 32 |
| A1CHLTT132 | 119 | AA1 T30 | 87 | AAWS BC 126 | 18 | AAWS C0766 R | 21 |
| A1CHLTT138 | 119 | AA1 T36 | 87 | AAWS BC 132 | 18 | AAWS C0766 S | 22 |
| A1CHLTT144 | 119 | AA1 T42 | 87 | AAWS BC 138 | 18 | AAWS C0772 | 30 |
| A1CHLTT60 | 119 | AA1 T48 | 87 | AAWS BC 144 | 18 | AAWS C0772 A | 26 |
| A1CHLTT66 | 119 | AA1 T60 | 87 | AAWS BE | 36, 37 | AAWS C0772 F | 28 |
| A1CHLTT72 | 119 | AA1 T72 | 88 | AAWS BE27 | 43 | AAWS C0772 M | 23 |
| A1CHLTT78 | 119 | AA1ARODN | 201 | AAWS BE28 | 43 | AAWS C0772 P | 32 |
| A1CHLTT84 | 119 | AA1CET39 | 70 | AAWS C0724 | 30 | AAWS C0772 R | 21 |
| A1CHLTT90 | 119 | AA1CET48 | 70 | AAWS C0724 A | 26 | AAWS C0772 S | 22 |
| A1CHLTT96 | 119 | AA1CET64 | 70 | AAWS C0724 F | 28 | AAWS C0778 | 30 |
| A1CRTT102 | 119 | AA1DPS | 76 | AAWS C0724 M | 23 | AAWS C0778 F | 28 |
| A1CRTT108 | 119 | AA1DTC | 76 | AAWS C0724 P | 32 | AAWS C0778 P | 32 |
| A1CRTT114 | 119 | AA1GPS | 75 | AAWS C0724 R | 21 | AAWS C0778 R | 21 |
| A1CRTT120 | 119 | AA1MPS30 | 70 | AAWS C0724 S | 22 | AAWS C0778 S | 22 |
| A1CRTT126 | 119 | AA1MPS39 | 70 | AAWS C0730 | 30 | AAWS C0784 | 30 |
| A1CRTT132 | 119 | AA1MPS42 | 70 | AAWS C0730 A | 26 | AAWS C0784 F | 28 |
| A1CRTT138 | 119 | AA1MPS48 | 70 | AAWS C0730 F | 28 | AAWS C0784 P | 32 |
| A1CRTT144 | 119 | AA1MPS56 | 70 | AAWS C0730 M | 23 | AAWS C0784 R | 21 |
| A1CRTT60 | 119 | AA1MPS64 | 70 | AAWS C0730 P | 32 | AAWS C0784 S | 22 |
| A1CRTT66 | 119 | AA1MPS74 | 70 | AAWS C0730 R | 21 | AAWS C0790 | 30 |
| A1CRTT72 | 119 | AA1MPS80 | 70 | AAWS C0730 S | 22 | AAWS C0790 F | 28 |
| A1CRTT78 | 119 | AA1MRS | 70 | AAWS C0736 | 30 | AAWS C0790 P | 32 |
| A1CRTT84 | 119 | AA1NSK | 88 | AAWS C0736 A | 26 | AAWS C0790 R | 21 |
| A1CRTT90 | 119 | AA1OR | 60 | AAWS C0736 F | 28 | AAWS C0790 S | 22 |
| A1CRTT96 | 119 | AA1ORD | 60 | AAWS C0736 M | 23 | AAWS C0796 | 30 |
| A1FHETE34 | 118 | AA1RE | 88 | AAWS C0736 P | 32 | AAWS C0796 F | 28 |
| A1FHETE42 | 118 | AA1ROUP | 201 | AAWS C0736 R | 21 | AAWS C0796 P | 32 |
| A1FHETE49 | 118 | AA1ROXUP | 201 | AAWS C0736 S | 22 | AAWS C0796 R | 21 |
| A1FHETE64 | 118 | AA1RPS34 | 72 | AAWS C0742 | 30 | AAWS C0796 S | 22 |
| A1GCTDK60141(L/V/M) | 206 | AA1RPS42 | 72 | AAWS C0742 A | 26 | AAWS C1524 | 30 |
| A1GCTDK60142(L/V/M) | 206 | AA1RPS49 | 72 | AAWS C0742 F | 28 | AAWS C1524 A | 26 |
| A1GCTDK72141(L/V/M) | 206 | AA1RPS64 | 72 | AAWS C0742 M | 23 | AAWS C1524 F | 28 |
| A1GCTDK72142(L/V/M) | 206 | AA1RPS79 | 72 | AAWS C0742 P | 32 | AAWS C1524 G | 34 |
| A1GCTDK90141(L/V/M) | 206 | AA1RTC | 73 | AAWS C0742 R | 21 | AAWS C1524 L | 25 |
| A1GCTDK90142(L/V/M) | 206 | AA1UA39 | 78 | AAWS C0742 S | 22 | AAWS C1524 M | 23 |
| A1GCTDK96141(L/V/M) | 206 | AA1UA48 | 78 | AAWS C0748 | 30 | AAWS C1524 P | 32 |
| A1GCTDK96142(L/V/M) | 206 | AA1UA64 | 78 | AAWS C0748 A | 26 | AAWS C1530 | 30 |
| A1HLETE3442 | 118 | AA1UPS39 | 78 | AAWS C0748 F | 28 | AAWS C1530 A | 26 |
| A1HLETE3449 | 118 | AA1UPS48 | 78 | AAWS C0748 M | 23 | AAWS C1530 F | 28 |
| A1HLETE3464 | 118 | AA1UPS64 | 78 | AAWS C0748 P | 32 | AAWS C1530 G | 34 |
| A1HLETE4249 | 118 | AA2 MTC | 70 | AAWS C0748 R | 21 | AAWS C1530 L | 25 |
| A1HLETE4264 | 118 | AA2 UTC | 78 | AAWS C0748 S | 22 | AAWS C1530 M | 23 |
| A1HLETE4964 | 118 | AAV1 4824 S2D1F | 169 | AAWS C0754 | 30 | AAWS C1530 P | 32 |
| A1HLPTE3442 | 118 | AAV1 4830 S2D1F | 169 | AAWS C0754 A | 26 | AAWS C1536 | 30 |
| A1HLPTE3449 | 118 | AAV1 6424 S2D2F | 169 | AAWS C0754 F | 28 | AAWS C1536 A | 26 |
| A1HLPTE3464 (F/T) | 118 | AAV1 6430 S2D2F | 169 | AAWS C0754 M | 23 | AAWS C1536 F | 28 |
| A1HLPTE4249 | 118 | AAWS BC 036 | 18 | AAWS C0754 P | 32 | AAWS C1536 G | 34 |
| A1HLPTE4264 (F/T) | 118 | AAWS BC 042 | 18 | AAWS C0754 R | 21 | AAWS C1536 L | 25 |
| A1HLPTE4964 | 118 | AAWS BC 048 | 18 | AAWS C0754 S | 22 | AAWS C1536 M | 23 |
| A3CPBDL | 163 | AAWS BC 054 | 18 | AAWS C0760 | 30 | AAWS C1536 P | 32 |
| A3CPBDR | 163 | AAWS BC 060 | 18 | AAWS C0760 A | 26 | AAWS C1542 | 30 |
| A3CPBS | 163 | AAWS BC 066 | 18 | AAWS C0760 F | 28 | AAWS C1542 A | 26 |
| AA1 30E | 87 | AAWS BC 072 | 18 | AAWS C0760 M | 23 | AAWS C1542 F | 28 |
| AA1 39E | 87 | AAWS BC 078 | 18 | AAWS C0760 P | 32 | AAWS C1542 G | 34 |
| AA1 48E | 87 | AAWS BC 084 | 18 | AAWS C0760 R | 21 | AAWS C1542 L | 25 |
| AA1 64E | 87 | AAWS BC 090 | 18 | AAWS C0760 S | 22 | AAWS C1542 M | 23 |

| <i>pattern no.</i> | <i>page</i> | <i>pattern no.</i> | <i>page</i> | <i>pattern no.</i> | <i>page</i> | <i>pattern no.</i> | <i>page</i> |
|--------------------|-------------|--------------------|-------------|--------------------|-------------|--------------------|-------------|
| AAWS C1542 P | 32 | AAWS C2230 P | 33 | AAWS C2296 P | 33 | AAWS C4566 M | 24 |
| AAWS C1548 | 30 | AAWS C2236 | 31 | AAWS C3024 | 31 | AAWS C4572 M | 24 |
| AAWS C1548 A | 26 | AAWS C2236 A | 27 | AAWS C3024 A | 27 | AAWS CC 036 | 16 |
| AAWS C1548 F | 28 | AAWS C2236 F | 29 | AAWS C3024 F | 29 | AAWS CC 042 | 16 |
| AAWS C1548 G | 34 | AAWS C2236 G | 34 | AAWS C3024 M | 23 | AAWS CC 048 | 16 |
| AAWS C1548 L | 25 | AAWS C2236 L | 25 | AAWS C3024 P | 33 | AAWS CC 054 | 16 |
| AAWS C1548 M | 23 | AAWS C2236 M | 23 | AAWS C3030 | 31 | AAWS CC 060 | 16 |
| AAWS C1548 P | 32 | AAWS C2236 P | 33 | AAWS C3030 A | 27 | AAWS CC 066 | 16 |
| AAWS C1554 | 30 | AAWS C2242 | 31 | AAWS C3030 F | 29 | AAWS CC 072 | 16 |
| AAWS C1554 A | 26 | AAWS C2242 A | 27 | AAWS C3030 M | 23 | AAWS CC 078 | 16 |
| AAWS C1554 F | 28 | AAWS C2242 F | 29 | AAWS C3030 P | 33 | AAWS CC 084 | 16 |
| AAWS C1554 G | 34 | AAWS C2242 G | 34 | AAWS C3036 | 31 | AAWS CC 090 | 16 |
| AAWS C1554 L | 25 | AAWS C2242 L | 25 | AAWS C3036 A | 27 | AAWS CC 096 | 16 |
| AAWS C1554 M | 23 | AAWS C2242 M | 23 | AAWS C3036 F | 29 | AAWS CC 102 | 16 |
| AAWS C1554 P | 32 | AAWS C2242 P | 33 | AAWS C3036 M | 23 | AAWS CC 108 | 16 |
| AAWS C1560 | 30 | AAWS C2248 | 31 | AAWS C3036 P | 33 | AAWS CC 114 | 16 |
| AAWS C1560 A | 26 | AAWS C2248 A | 27 | AAWS C3042 | 31 | AAWS CC 120 | 16 |
| AAWS C1560 F | 28 | AAWS C2248 F | 29 | AAWS C3042 A | 27 | AAWS CC 126 | 16 |
| AAWS C1560 G | 34 | AAWS C2248 G | 34 | AAWS C3042 F | 29 | AAWS CC 132 | 16 |
| AAWS C1560 L | 25 | AAWS C2248 L | 25 | AAWS C3042 M | 23 | AAWS CC 138 | 16 |
| AAWS C1560 M | 23 | AAWS C2248 M | 23 | AAWS C3042 P | 33 | AAWS CC 144 | 16 |
| AAWS C1560 P | 32 | AAWS C2248 P | 33 | AAWS C3048 | 31 | AAWS CG | 45 |
| AAWS C1566 | 30 | AAWS C2254 | 31 | AAWS C3048 A | 27 | AAWS CH | 45 |
| AAWS C1566 A | 26 | AAWS C2254 A | 27 | AAWS C3048 F | 29 | AAWS CT24 | 43 |
| AAWS C1566 F | 28 | AAWS C2254 F | 29 | AAWS C3048 M | 23 | AAWS CT30 | 43 |
| AAWS C1566 G | 34 | AAWS C2254 G | 34 | AAWS C3048 P | 33 | AAWS CT36 | 43 |
| AAWS C1566 L | 25 | AAWS C2254 L | 25 | AAWS C3054 | 31 | AAWS CT42 | 43 |
| AAWS C1566 M | 23 | AAWS C2254 M | 23 | AAWS C3054 A | 27 | AAWS CT48 | 43 |
| AAWS C1566 P | 32 | AAWS C2254 P | 33 | AAWS C3054 F | 29 | AAWS CT54 | 43 |
| AAWS C1572 | 30 | AAWS C2260 | 31 | AAWS C3054 M | 23 | AAWS CT60 | 43 |
| AAWS C1572 A | 26 | AAWS C2260 A | 27 | AAWS C3054 P | 33 | AAWS CT66 | 43 |
| AAWS C1572 F | 28 | AAWS C2260 F | 29 | AAWS C3060 | 31 | AAWS CT72 | 43 |
| AAWS C1572 G | 34 | AAWS C2260 G | 34 | AAWS C3060 A | 27 | AAWS DS0605 | 35 |
| AAWS C1572 L | 25 | AAWS C2260 L | 25 | AAWS C3060 F | 29 | AAWS DS2405 | 35 |
| AAWS C1572 M | 23 | AAWS C2260 M | 23 | AAWS C3060 M | 23 | AAWS DS3005 | 35 |
| AAWS C1572 P | 32 | AAWS C2260 P | 33 | AAWS C3060 P | 33 | AAWS DS3605 | 35 |
| AAWS C1578 | 30 | AAWS C2266 | 31 | AAWS C3066 | 31 | AAWS DS4205 | 35 |
| AAWS C1578 F | 28 | AAWS C2266 A | 27 | AAWS C3066 A | 27 | AAWS DS4805 | 35 |
| AAWS C1578 L | 25 | AAWS C2266 F | 29 | AAWS C3066 F | 29 | AAWS DS5405 | 35 |
| AAWS C1578 P | 32 | AAWS C2266 G | 34 | AAWS C3066 M | 23 | AAWS DS6005 | 35 |
| AAWS C1584 | 30 | AAWS C2266 L | 25 | AAWS C3066 P | 33 | AAWS DS6605 | 35 |
| AAWS C1584 F | 28 | AAWS C2266 M | 23 | AAWS C3072 | 31 | AAWS DS7205 | 35 |
| AAWS C1584 L | 25 | AAWS C2266 P | 33 | AAWS C3072 A | 27 | AAWS EASEL | 45 |
| AAWS C1584 P | 32 | AAWS C2272 | 31 | AAWS C3072 F | 29 | AAWS ET 106 | 19 |
| AAWS C1590 | 30 | AAWS C2272 A | 27 | AAWS C3072 M | 23 | AAWS ET 114 | 19 |
| AAWS C1590 F | 28 | AAWS C2272 F | 29 | AAWS C3072 P | 33 | AAWS ET 144 | 19 |
| AAWS C1590 L | 25 | AAWS C2272 G | 34 | AAWS C3078 | 31 | AAWS ET 69 | 19 |
| AAWS C1590 P | 32 | AAWS C2272 L | 25 | AAWS C3078 F | 29 | AAWS ET 84 | 19 |
| AAWS C1596 | 30 | AAWS C2272 M | 23 | AAWS C3078 P | 33 | AAWS ET 91 | 19 |
| AAWS C1596 F | 28 | AAWS C2272 P | 33 | AAWS C3084 | 31 | AAWS ET 99 | 19 |
| AAWS C1596 L | 25 | AAWS C2278 | 31 | AAWS C3084 F | 29 | AAWS ETO 69 | 19 |
| AAWS C1596 P | 32 | AAWS C2278 F | 29 | AAWS C3084 P | 33 | AAWS ETO 84 | 19 |
| AAWS C2224 | 31 | AAWS C2278 L | 25 | AAWS C3090 | 31 | AAWS F2236 | 13 |
| AAWS C2224 A | 27 | AAWS C2278 P | 33 | AAWS C3090 F | 29 | AAWS F2248 | 13 |
| AAWS C2224 F | 29 | AAWS C2284 | 31 | AAWS C3090 P | 33 | AAWS F3036 | 13 |
| AAWS C2224 G | 34 | AAWS C2284 F | 29 | AAWS C3096 | 31 | AAWS F3048 | 13 |
| AAWS C2224 L | 25 | AAWS C2284 L | 25 | AAWS C3096 F | 29 | AAWS F6936 | 13 |
| AAWS C2224 M | 23 | AAWS C2284 P | 33 | AAWS C3096 P | 33 | AAWS F6948 | 13 |
| AAWS C2224 P | 33 | AAWS C2290 | 31 | AAWS C4524 M | 24 | AAWS F8436 | 13 |
| AAWS C2230 | 31 | AAWS C2290 F | 29 | AAWS C4530 M | 24 | AAWS F8448 | 13 |
| AAWS C2230 A | 27 | AAWS C2290 L | 25 | AAWS C4536 M | 24 | AAWS IBT | 19 |
| AAWS C2230 F | 29 | AAWS C2290 P | 33 | AAWS C4542 M | 24 | AAWS IC 024 | 17 |
| AAWS C2230 G | 34 | AAWS C2296 | 31 | AAWS C4548 M | 24 | AAWS IC 030 | 17 |
| AAWS C2230 L | 25 | AAWS C2296 F | 29 | AAWS C4554 M | 24 | AAWS IC 036 | 17 |
| AAWS C2230 M | 23 | AAWS C2296 L | 25 | AAWS C4560 M | 24 | AAWS IC 042 | 17 |

| <i>pattern no.</i> | <i>page</i> | <i>pattern no.</i> | <i>page</i> | <i>pattern no.</i> | <i>page</i> | <i>pattern no.</i> | <i>page</i> |
|--------------------|-------------|--------------------|-------------|--------------------|-------------|--------------------|-------------|
| AAWS IC 048 | 17 | AAWS OBD 84 | 41 | AAWS OGO 96 | 38 | AAWS TU 102 | 15 |
| AAWS IC 054 | 17 | AAWS OBD 90 | 41 | AAWS OGR 42 | 39 | AAWS TU 108 | 15 |
| AAWS IC 060 | 17 | AAWS OBD 96 | 41 | AAWS OGR 48 | 39 | AAWS TU 114 | 15 |
| AAWS IC 066 | 17 | AAWS OBO 18 | 38 | AAWS OGR 54 | 39 | AAWS TU 120 | 15 |
| AAWS IC 072 | 17 | AAWS OBO 24 | 38 | AAWS OGR 60 | 39 | AAWS TU 126 | 15 |
| AAWS IC 078 | 17 | AAWS OBO 30 | 38 | AAWS OGR 66 | 39 | AAWS TU 132 | 15 |
| AAWS IC 084 | 17 | AAWS OBO 36 | 38 | AAWS OGR 72 | 39 | AAWS TU 138 | 15 |
| AAWS IC 090 | 17 | AAWS OBO 42 | 38 | AAWS OGR 78 | 39 | AAWS TU 144 | 15 |
| AAWS IC 096 | 17 | AAWS OBO 48 | 38 | AAWS OGR 84 | 39 | AAWS US2409 G | 36 |
| AAWS IC 102 | 17 | AAWS OBO 54 | 38 | AAWS OGR 90 | 39 | AAWS US2412 | 37 |
| AAWS IC 108 | 17 | AAWS OBO 60 | 38 | AAWS OGR 96 | 39 | AAWS US3009 G | 36 |
| AAWS IC 114 | 17 | AAWS OBO 66 | 38 | AAWS OGS 42 | 40 | AAWS US3012 | 37 |
| AAWS IC 120 | 17 | AAWS OBO 72 | 38 | AAWS OGS 48 | 40 | AAWS US3609 G | 36 |
| AAWS IC 126 | 17 | AAWS OBO 78 | 38 | AAWS OGS 54 | 40 | AAWS US3612 | 37 |
| AAWS IC 132 | 17 | AAWS OBO 84 | 38 | AAWS OGS 60 | 40 | AAWS US4209 G | 36 |
| AAWS IC 138 | 17 | AAWS OBO 90 | 38 | AAWS OGS 66 | 40 | AAWS US4212 | 37 |
| AAWS IC 144 | 17 | AAWS OBO 96 | 38 | AAWS OGS 72 | 40 | AAWS US4809 G | 36 |
| AAWS IL 106 | 20 | AAWS OBR 42 | 39 | AAWS OGS 78 | 40 | AAWS US4812 | 37 |
| AAWS IL 114 | 20 | AAWS OBR 48 | 39 | AAWS OGS 84 | 40 | AAWS US5409 G | 36 |
| AAWS IL 144 | 20 | AAWS OBR 54 | 39 | AAWS OGS 90 | 40 | AAWS US5412 | 37 |
| AAWS IL 69 | 20 | AAWS OBR 60 | 39 | AAWS OGS 96 | 40 | AAWS US6009 G | 36 |
| AAWS IL 84 | 20 | AAWS OBR 66 | 39 | AAWS OL 106 | 20 | AAWS US6012 | 37 |
| AAWS IL 91 | 20 | AAWS OBR 72 | 39 | AAWS OL 144 | 20 | AAWS US6609 G | 36 |
| AAWS IL 99 | 20 | AAWS OBR 78 | 39 | AAWS OL 69 | 20 | AAWS US6612 | 37 |
| AAWS ILO 69 | 20 | AAWS OBR 84 | 39 | AAWS OL 91 | 20 | AAWS US7209 G | 36 |
| AAWS ILO 84 | 20 | AAWS OBR 90 | 39 | AAWS OL 99 | 20 | AAWS US7212 | 37 |
| AAWS LS2409 G | 36 | AAWS OBR 96 | 39 | AAWS OLO 69 | 20 | AAWS VFC | 19 |
| AAWS LS2412 | 37 | AAWS OBS 42 | 40 | AAWS OLO 84 | 20 | AAWS WMC | 45 |
| AAWS LS3009 G | 36 | AAWS OBS 48 | 40 | AAWS PH | 45 | AAWS WOMK 18 | 42 |
| AAWS LS3012 | 37 | AAWS OBS 54 | 40 | AAWS RET | 21 | AAWS WOMK 24 | 42 |
| AAWS LS3609 G | 36 | AAWS OBS 60 | 40 | AAWS RO MK | 42 | AAWS WOMK 30 | 42 |
| AAWS LS3612 | 37 | AAWS OBS 66 | 40 | AAWS RPM1 05 | 44 | AAWS WOMK 36 | 42 |
| AAWS LS4209 G | 36 | AAWS OBS 72 | 40 | AAWS RPM2 02 | 44 | AAWS WOMK 42 | 42 |
| AAWS LS4212 | 37 | AAWS OBS 78 | 40 | AAWS RPM2 05 | 44 | AAWS WOMK 48 | 42 |
| AAWS LS4809 G | 36 | AAWS OBS 84 | 40 | AAWS RPM2I 05 | 44 | AAWS WOMK 54 | 42 |
| AAWS LS4812 | 37 | AAWS OBS 90 | 40 | AAWS TC 036 | 14 | AAWS WOMK 60 | 42 |
| AAWS LS5409 G | 36 | AAWS OBS 96 | 40 | AAWS TC 042 | 14 | AAWS WOMK 66 | 42 |
| AAWS LS5412 | 37 | AAWS OGD 18L | 41 | AAWS TC 048 | 14 | AAWS WOMK 72 | 42 |
| AAWS LS6009 G | 36 | AAWS OGD 18R | 41 | AAWS TC 054 | 14 | AAWS WOMK 78 | 42 |
| AAWS LS6012 | 37 | AAWS OGD 24 | 41 | AAWS TC 060 | 14 | AAWS WOMK 84 | 42 |
| AAWS LS6609 G | 36 | AAWS OGD 30 | 41 | AAWS TC 066 | 14 | AAWS WOMK 90 | 42 |
| AAWS LS6612 | 37 | AAWS OGD 36 | 41 | AAWS TC 072 | 14 | AAWS WOMK 96 | 42 |
| AAWS LS7209 G | 36 | AAWS OGD 42 | 41 | AAWS TC 078 | 14 | AB1 AC24 | 221 |
| AAWS LS7212 | 37 | AAWS OGD 48 | 41 | AAWS TC 084 | 14 | AB1-ABC24 | 221 |
| AAWS MT24 | 45 | AAWS OGD 54 | 41 | AAWS TC 090 | 14 | AB1AS27 | 224 |
| AAWS MT30 | 45 | AAWS OGD 60 | 41 | AAWS TC 096 | 14 | AB1AS28 | 224 |
| AAWS MT36 | 45 | AAWS OGD 66 | 41 | AAWS TC 102 | 14 | AB1AS30 | 224 |
| AAWS MT42 | 45 | AAWS OGD 72 | 41 | AAWS TC 108 | 14 | AB1ASC27 | 224 |
| AAWS MT48 | 45 | AAWS OGD 78 | 41 | AAWS TC 114 | 14 | AB1ASC28 | 224 |
| AAWS MT54 | 45 | AAWS OGD 84 | 41 | AAWS TC 120 | 14 | AB1ASC30 | 224 |
| AAWS MT60 | 45 | AAWS OGD 90 | 41 | AAWS TC 126 | 14 | AB1AW27 | 224 |
| AAWS MT66 | 45 | AAWS OGD 96 | 41 | AAWS TC 132 | 14 | AB1AW28 | 224 |
| AAWS MT72 | 45 | AAWS OGO 18 | 38 | AAWS TC 138 | 14 | AB2 AE | 221 |
| AAWS OBD 18L | 41 | AAWS OGO 24 | 38 | AAWS TC 144 | 14 | AB2 FE27 | 221 |
| AAWS OBD 18R | 41 | AAWS OGO 30 | 38 | AAWS TU 036 | 15 | AB2 FE28 | 221 |
| AAWS OBD 24 | 41 | AAWS OGO 36 | 38 | AAWS TU 042 | 15 | AC1 39L2 | 86 |
| AAWS OBD 30 | 41 | AAWS OGO 42 | 38 | AAWS TU 048 | 15 | AC1 39T3 | 86 |
| AAWS OBD 36 | 41 | AAWS OGO 48 | 38 | AAWS TU 054 | 15 | AC1 39V2 | 86 |
| AAWS OBD 42 | 41 | AAWS OGO 54 | 38 | AAWS TU 060 | 15 | AC1 39X4 | 86 |
| AAWS OBD 48 | 41 | AAWS OGO 60 | 38 | AAWS TU 066 | 15 | AC1 39Y3 | 86 |
| AAWS OBD 54 | 41 | AAWS OGO 66 | 38 | AAWS TU 072 | 15 | AC1 48L2 | 86 |
| AAWS OBD 60 | 41 | AAWS OGO 72 | 38 | AAWS TU 078 | 15 | AC1 48T3 | 86 |
| AAWS OBD 66 | 41 | AAWS OGO 78 | 38 | AAWS TU 084 | 15 | AC1 48V2 | 86 |
| AAWS OBD 72 | 41 | AAWS OGO 84 | 38 | AAWS TU 090 | 15 | AC1 48X4 | 86 |
| AAWS OBD 78 | 41 | AAWS OGO 90 | 38 | AAWS TU 096 | 15 | AC1 48Y3 | 87 |

| <i>pattern no.</i> | <i>page</i> | <i>pattern no.</i> | <i>page</i> | <i>pattern no.</i> | <i>page</i> | <i>pattern no.</i> | <i>page</i> |
|--------------------|-------------|--------------------|-------------|--------------------|-------------|--------------------|-------------|
| ACI 64L2 | 86 | ACELA924 | 154 | ACHL6432W | 162 | ACWJ(L/R)4224 | 152 |
| ACI 64T3 | 86 | ACELA926 | 154 | ACHR4924M | 161 | ACWJ(L/R)4226 | 152 |
| ACI 64V2 | 86 | ACELA930 | 154 | ACHR4924W | 162 | ACWJ(L/R)4230 | 152 |
| ACI 64X4 | 86 | ACELA932 | 154 | ACHR4926M | 161 | ACWJ(L/R)4232 | 152 |
| ACI 64Y3 | 87 | ACELA6424 | 154 | ACHR4926W | 162 | ACWJ(L/R)4924 | 152 |
| ACA1 30E1 | 87 | ACELA6426 | 154 | ACHR4930M | 161 | ACWJ(L/R)4926 | 152 |
| ACA1 39E1 | 87 | ACELA6430 | 154 | ACHR4930W | 162 | ACWJ(L/R)4930 | 152 |
| ACA1 48E1 | 87 | ACELA6432 | 154 | ACHR4932M | 161 | ACWJ(L/R)4932 | 152 |
| ACA1 64E1 | 87 | ACER4924 | 154 | ACHR4932W | 162 | ACWJ(L/R)6424 | 152 |
| ACAL4224 | 148 | ACER4926 | 154 | ACHR6424M | 161 | ACWJ(L/R)6426 | 152 |
| ACAL4226 | 148 | ACER4930 | 154 | ACHR6424W | 162 | ACWJ(L/R)6430 | 152 |
| ACAL4230 | 148 | ACER4932 | 154 | ACHR6426M | 161 | ACWJ(L/R)6432 | 152 |
| ACAL4232 | 148 | ACER6424 | 154 | ACHR6426W | 162 | ACWK(L/R)4224 | 153 |
| ACAL4924 | 148 | ACER6426 | 155 | ACHR6430M | 161 | ACWK(L/R)4226 | 153 |
| ACAL4926 | 148 | ACER6430 | 154 | ACHR6430W | 162 | ACWK(L/R)4230 | 153 |
| ACAL4930 | 148 | ACER6432 | 155 | ACHR6432M | 161 | ACWK(L/R)4232 | 153 |
| ACAL4932 | 148 | ACF | 231 | ACHR6432W | 162 | ACWK(L/R)4924 | 153 |
| ACAR4224 | 148 | ACFG | 231 | ACHL4930 | 158 | ACWK(L/R)4926 | 153 |
| ACAR4226 | 148 | ACFL4924 | 156 | ACHL4932 | 158 | ACWK(L/R)4930 | 153 |
| ACAR4230 | 148 | ACFL4926 | 156 | ACHL6430 | 159 | ACWK(L/R)4932 | 153 |
| ACAR4232 | 148 | ACFL4930 | 156 | ACHL6432 | 159 | ACWK(L/R)6424 | 153 |
| ACAR4924 | 148 | ACFL4932 | 156 | ACHR4930 | 158 | ACWK(L/R)6426 | 153 |
| ACAR4926 | 148 | ACFL6424 | 156 | ACHR4932 | 158 | ACWK(L/R)6430 | 153 |
| ACAR4930 | 148 | ACFL6426 | 156 | ACHR6430 | 159 | ACWK(L/R)6432 | 153 |
| ACAR4932 | 148 | ACFL6430 | 156 | ACHR6432 | 159 | ADS 0821 | 54 |
| ACBL4224 | 149 | ACFL6432 | 156 | ACJ722WE | 165 | ADS 0824 | 54 |
| ACBL4226 | 149 | ACFR4924 | 156 | ACJ723WE | 165 | ADS 0833 | 54 |
| ACBL4230 | 149 | ACFR4926 | 156 | ACJ822WE | 165 | ADS 0836 | 54 |
| ACBL4232 | 149 | ACFR4930 | 156 | ACJ823WE | 165 | ADS 0845 | 54 |
| ACBL4924 | 149 | ACFR4932 | 156 | ACKL722WE | 166 | ADS 0848 | 54 |
| ACBL4926 | 149 | ACFR6424 | 156 | ACKL723WE | 166 | ADS 0857 | 54 |
| ACBL4930 | 149 | ACFR6426 | 157 | ACKL822WE | 166 | ADS 0860 | 54 |
| ACBL4932 | 149 | ACFR6430 | 156 | ACKL823WE | 166 | ADS 0869 | 54 |
| ACBR4224 | 149 | ACFR6432 | 157 | ACKR722WE | 166 | ADS 0872 | 54 |
| ACBR4226 | 149 | ACGL4924 | 160 | ACKR723WE | 166 | AFB16 | 180 |
| ACBR4230 | 149 | ACGL4926 | 160 | ACKR822WE | 166 | AFB19 | 180 |
| ACBR4232 | 149 | ACGL4930 | 160 | ACKR823WE | 166 | AFB30 | 180 |
| ACBR4924 | 149 | ACGL4932 | 160 | ACL722M | 166 | AFB36 | 180 |
| ACBR4926 | 149 | ACGL6424 | 160 | ACL722W | 166 | AFB42 | 180 |
| ACBR4930 | 149 | ACGL6426 | 160 | ACL723M | 166 | AFB60 | 180 |
| ACBR4932 | 149 | ACGL6430 | 160 | ACL723W | 166 | AFB72 | 180 |
| ACCL4224 | 150 | ACGL6432 | 160 | ACL822M | 166 | AFB72 | 180 |
| ACCL4226 | 150 | ACGR4924 | 160 | ACL822W | 166 | AFB84 | 180 |
| ACCL4230 | 150 | ACGR4926 | 160 | ACL823M | 166 | AFB90 | 180 |
| ACCL4232 | 150 | ACGR4930 | 160 | ACL823W | 166 | AFB96 | 180 |
| ACCL4924 | 150 | ACGR4932 | 160 | ACMML722 | 167 | AFPB10(E/P)(M) | 177 |
| ACCL4926 | 150 | ACGR6424 | 160 | ACMML723 | 167 | AFPB10(E/P)(W) | 175 |
| ACCL4930 | 150 | ACGR6426 | 160 | ACMML822 | 167 | AFPB11(E/P)(M) | 177 |
| ACCL4932 | 150 | ACGR6430 | 160 | ACMML823 | 167 | AFPB11(E/P)(W) | 175 |
| ACCR4224 | 150 | ACGR6432 | 160 | ACMMR722 | 167 | AFPB20(E/P)(M) | 177 |
| ACCR4226 | 150 | ACHL4924M | 161 | ACMMR723 | 167 | AFPB20(E/P)(W) | 175 |
| ACCR4230 | 150 | ACHL4924W | 162 | ACMMR822 | 167 | AFPB21(E/P)(M) | 177 |
| ACCR4232 | 150 | ACHL4926M | 161 | ACMMR823 | 167 | AFPB21(E/P)(W) | 175 |
| ACCR4924 | 150 | ACHL4926W | 162 | ACMWL722 | 167 | AFPB30(E/P)(M) | 177 |
| ACCR4926 | 150 | ACHL4930M | 161 | ACMWL723 | 167 | AFPB30(E/P)(W) | 175 |
| ACCR4930 | 150 | ACHL4930W | 162 | ACMWL822 | 167 | AFPB31(E/P)(M) | 177 |
| ACCR4932 | 150 | ACHL4932M | 161 | ACMWL823 | 167 | AFPB31(E/P)(W) | 175 |
| ACDL4924 | 151 | ACHL4932W | 162 | ACMWR722 | 167 | AFFP10(E/P)(M) | 177 |
| ACDL4926 | 151 | ACHL6424M | 161 | ACMWR723 | 167 | AFFP10(E/P)(W) | 175 |
| ACDL4930 | 151 | ACHL6424W | 162 | ACMWR822 | 167 | AFFP11(E/P)(M) | 177 |
| ACDL4932 | 151 | ACHL6426M | 161 | ACMWR823 | 167 | AFFP11(E/P)(W) | 175 |
| ACDR4924 | 151 | ACHL6426W | 162 | ACW722 | 168 | AFFP12(E/P)(M) | 177 |
| ACDR4926 | 151 | ACHL6430M | 161 | ACW723 | 168 | AFFP12(E/P)(W) | 175 |
| ACDR4930 | 151 | ACHL6430W | 162 | ACW822 | 168 | AFFP13(E/P)(M) | 177 |
| ACDR4932 | 151 | ACHL6432M | 161 | ACW823 | 168 | AFFP13(E/P)(W) | 175 |
| | | | | | | AFFP14(E/P)(W) | 175 |

| <i>pattern no.</i> | <i>page</i> | <i>pattern no.</i> | <i>page</i> | <i>pattern no.</i> | <i>page</i> | <i>pattern no.</i> | <i>page</i> |
|----------------------|-------------|--------------------|-------------|--------------------|-------------|--------------------|-------------|
| AFPF20(E/P)(M) | 177 | AHHSM90 | 226 | AMB42R665 | 128 | AMG42E604 | 132 |
| AFPF20(E/P)(W) | 175 | AHHSM96 | 226 | AMB42R724 | 127 | AMG42E605 | 132 |
| AFPF21(E/P)(M) | 177 | AHLTTE18 | 118 | AMB42R725 | 128 | AMG42E664 | 132 |
| AFPF21(E/P)(W) | 175 | AHLTTE20 | 118 | AMB42R784 | 127 | AMG42E665 | 132 |
| AFPF22(E/P)(M) | 177 | AHLTTE24 | 118 | AMB42R785 | 128 | AMG42E724 | 132 |
| AFPF22(E/P)(W) | 175 | AHLTTE30 | 118 | AMB42R844 | 127 | AMG42E725 | 132 |
| AFPF23(E/P)(M) | 177 | AHLTTE36 | 118 | AMB42R845 | 128 | AMG42E784 | 132 |
| AFPF23(E/P)(W) | 175 | AHLTTE42 | 118 | AMB42R904 | 127 | AMG42E785 | 132 |
| AFPF24(E/P)(W) | 175 | AHLTTE48 | 118 | AMB42R905 | 128 | AMG42E844 | 132 |
| AFPF30(E/P)(M) | 177 | ALIT5E19 | 203 | AMB42R964 | 127 | AMG42E845 | 132 |
| AFPF30(E/P)(W) | 175 | ALIT5E25 | 203 | AMB42R965 | 128 | AMG42E904 | 132 |
| AFPF31(E/P)(M) | 177 | ALIT5E37 | 203 | AMBE604 | 139 | AMG42E905 | 132 |
| AFPF31(E/P)(W) | 175 | ALIT5E49 | 203 | AMBE605 | 139 | AMG42E964 | 132 |
| AFPH12(E/P)(L/N)(W) | 179 | ALIT5E61 | 203 | AMBE664 | 139 | AMG42E965 | 132 |
| AFPH13(E/P)(L/N)(W) | 179 | ALIT5E73 | 203 | AMBE665 | 139 | AMG42L424 | 129 |
| AFPH14(E/P)(L/N)(W) | 179 | ALIT5E85 | 203 | AMBE724 | 139 | AMG42L425 | 130 |
| AFPH22(E/P)(L/N)(W) | 179 | ALBL24 | 225 | AMBE725 | 139 | AMG42L484 | 129 |
| AFPH23(E/P)(L/N)(W) | 179 | ALBL30 | 225 | AMBE784 | 139 | AMG42L485 | 130 |
| AFPH24(E/P)(L/N)(W) | 179 | ALBL36 | 225 | AMBE785 | 139 | AMG42L544 | 129 |
| AFPHL10(E/P)(L/N)(W) | 179 | ALBR24 | 225 | AMBE844 | 139 | AMG42L545 | 130 |
| AFPHL11(E/P)(L/N)(W) | 179 | ALBR30 | 225 | AMBE845 | 139 | AMG42L604 | 129 |
| AFPHL20(E/P)(L/N)(W) | 179 | ALBR36 | 225 | AMBE904 | 139 | AMG42L605 | 130 |
| AFPHL21(E/P)(L/N)(W) | 179 | AMB42E604 | 131 | AMBE905 | 139 | AMG42L664 | 129 |
| AFPHR10(E/P)(L/N)(W) | 179 | AMB42E605 | 131 | AMBE964 | 139 | AMG42L665 | 130 |
| AFPHR11(E/P)(L/N)(W) | 179 | AMB42E664 | 131 | AMBE965 | 139 | AMG42L724 | 129 |
| AFPHR20(E/P)(L/N)(W) | 179 | AMB42E665 | 131 | AMBL424 | 135 | AMG42L725 | 130 |
| AFPHR21(E/P)(L/N)(W) | 179 | AMB42E724 | 131 | AMBL425 | 136 | AMG42L784 | 129 |
| AG1B | 75 | AMB42E725 | 131 | AMBL484 | 135 | AMG42L785 | 130 |
| AG1B3920 | 89 | AMB42E784 | 131 | AMBL485 | 136 | AMG42L844 | 129 |
| AG1B3924 | 89 | AMB42E785 | 131 | AMBL544 | 135 | AMG42L845 | 130 |
| AG1B3930 | 89 | AMB42E844 | 131 | AMBL545 | 136 | AMG42L904 | 129 |
| AG1B3936 | 89 | AMB42E845 | 131 | AMBL604 | 135 | AMG42L905 | 130 |
| AG1B3942 | 89 | AMB42E904 | 131 | AMBL605 | 136 | AMG42L964 | 129 |
| AG1B3948 | 89 | AMB42E905 | 131 | AMBL664 | 135 | AMG42L965 | 130 |
| AG1B3954 | 89 | AMB42E964 | 131 | AMBL665 | 136 | AMG42R424 | 129 |
| AG1B3960 | 89 | AMB42E965 | 131 | AMBL724 | 135 | AMG42R425 | 130 |
| AG1B3966 | 89 | AMB42L424 | 127 | AMBL725 | 136 | AMG42R484 | 129 |
| AG1B3972 | 89 | AMB42L425 | 128 | AMBL784 | 135 | AMG42R485 | 130 |
| AG1B3978 | 89 | AMB42L484 | 127 | AMBL785 | 136 | AMG42R544 | 129 |
| AG1B3984 | 89 | AMB42L485 | 128 | AMBL844 | 135 | AMG42R545 | 130 |
| AG1B3990 | 89 | AMB42L544 | 127 | AMBL845 | 136 | AMG42R604 | 129 |
| AG1B3996 | 89 | AMB42L545 | 128 | AMBL904 | 135 | AMG42R605 | 130 |
| AG1B4920 | 89 | AMB42L604 | 127 | AMBL905 | 136 | AMG42R664 | 129 |
| AG1B4924 | 89 | AMB42L605 | 128 | AMBL964 | 135 | AMG42R665 | 130 |
| AG1B4930 | 89 | AMB42L664 | 127 | AMBL965 | 136 | AMG42R724 | 129 |
| AG1B4936 | 89 | AMB42L665 | 128 | AMBR424 | 135 | AMG42R725 | 130 |
| AG1B4942 | 89 | AMB42L724 | 127 | AMBR425 | 136 | AMG42R784 | 129 |
| AG1B4948 | 89 | AMB42L725 | 128 | AMBR484 | 135 | AMG42R785 | 130 |
| AG1B4954 | 89 | AMB42L784 | 127 | AMBR485 | 136 | AMG42R844 | 129 |
| AG1B4960 | 89 | AMB42L785 | 128 | AMBR544 | 135 | AMG42R845 | 130 |
| AG1B4966 | 89 | AMB42L844 | 127 | AMBR545 | 136 | AMG42R904 | 129 |
| AG1B4972 | 89 | AMB42L845 | 128 | AMBR604 | 135 | AMG42R905 | 130 |
| AG1B4978 | 89 | AMB42L904 | 127 | AMBR605 | 136 | AMG42R964 | 129 |
| AG1B4984 | 89 | AMB42L905 | 128 | AMBR664 | 135 | AMG42R965 | 130 |
| AG1B4990 | 89 | AMB42L964 | 127 | AMBR665 | 136 | AMGE604 | 140 |
| AG1B4996 | 89 | AMB42L965 | 128 | AMBR724 | 135 | AMGE605 | 140 |
| AHHSM36 | 226 | AMB42R424 | 127 | AMBR725 | 136 | AMGE664 | 140 |
| AHHSM42 | 226 | AMB42R425 | 128 | AMBR784 | 135 | AMGE665 | 140 |
| AHHSM48 | 226 | AMB42R484 | 127 | AMBR785 | 136 | AMGE724 | 140 |
| AHHSM54 | 226 | AMB42R485 | 128 | AMBR844 | 135 | AMGE725 | 140 |
| AHHSM60 | 226 | AMB42R544 | 127 | AMBR845 | 136 | AMGE784 | 140 |
| AHHSM66 | 226 | AMB42R545 | 128 | AMBR904 | 135 | AMGE785 | 140 |
| AHHSM72 | 226 | AMB42R604 | 127 | AMBR905 | 136 | AMGE844 | 140 |
| AHHSM78 | 226 | AMB42R605 | 128 | AMBR964 | 135 | AMGE845 | 140 |
| AHHSM84 | 226 | AMB42R664 | 127 | AMBR965 | 136 | AMGE904 | 140 |

| <i>pattern no.</i> | <i>page</i> | <i>pattern no.</i> | <i>page</i> | <i>pattern no.</i> | <i>page</i> | <i>pattern no.</i> | <i>page</i> |
|--------------------|-------------|--------------------|-------------|--------------------|-------------|--------------------|-------------|
| AMGE905 | 140 | AOBS60 | 144 | APIW 1860G | 85 | APCA 1860 A | 56 |
| AMGE964 | 140 | AOBS66 | 144 | APIW 1872G | 85 | APCA 1872 | 55 |
| AMGE965 | 140 | AOBS72 | 144 | APIW 2224G | 85 | APCA 1872 A | 56 |
| AMGL424 | 137 | AOBS78 | 144 | APIW 2230G | 85 | APCA 2712 | 55 |
| AMGL425 | 138 | APIL 3018 N | 83 | APIW 2236G | 85 | APCA 2712 A | 56 |
| AMGL484 | 137 | APIL 3024 N | 83 | APIW 2242G | 85 | APCA 2724 | 55 |
| AMGL485 | 138 | APIL 3030 N | 83 | APIW 2248G | 85 | APCA 2724 A | 56 |
| AMGL544 | 137 | APIL 3036 N | 83 | APIW 2260G | 85 | APCA 2736 | 55 |
| AMGL545 | 138 | APIL 3042 N | 83 | APIW 2272G | 85 | APCA 2736 A | 56 |
| AMGL604 | 137 | APIL 3048 N | 83 | APIW 2524G | 85 | APCA 2748 | 55 |
| AMGL605 | 138 | APIL 3060 N | 83 | APIW 2530G | 85 | APCA 2748 A | 56 |
| AMGL664 | 137 | APIL 3072 N | 83 | APIW 2536G | 85 | APCA 2760 | 55 |
| AMGL665 | 138 | APIL 3918 N | 83 | APIW 2542G | 85 | APCA 2760 A | 56 |
| AMGL724 | 137 | APIL 3918G | 84 | APIW 2548G | 85 | APCA 2772 | 55 |
| AMGL725 | 138 | APIL 3924 N | 83 | APIW 2560G | 85 | APCA 2772 A | 56 |
| AMGL784 | 137 | APIL 3924G | 84 | APIW 2572G | 85 | APCA AZ48 | 51 |
| AMGL785 | 138 | APIL 3930 N | 83 | APA 39 | 46 | APCA AZ48S | 50 |
| AMGL844 | 137 | APIL 3930G | 84 | APA 48 | 46 | APCA AZ60 | 51 |
| AMGL845 | 138 | APIL 3936 N | 83 | APA 64 | 46 | APCA AZ60S | 50 |
| AMCL904 | 137 | APIL 3936G | 84 | APA1 LF | 88 | APCA AZ72 | 51 |
| AMGL905 | 138 | APIL 3942 N | 83 | APCA 0912 | 55 | APCA AZ72S | 50 |
| AMGL964 | 137 | APIL 3942G | 84 | APCA 0912 A | 56 | APCA HOC | 53 |
| AMGL965 | 138 | APIL 3948 N | 83 | APCA 0912 C | 52 | APCA OC | 52 |
| AMCR424 | 137 | APIL 3948G | 84 | APCA 0912 S | 52 | APF1 3948 | 46 |
| AMGR425 | 138 | APIL 3960 N | 83 | APCA 0924 | 55 | APF1 3960 | 46 |
| AMGR484 | 137 | APIL 3972 N | 83 | APCA 0924 A | 56 | APF1 3972 | 46 |
| AMGR485 | 138 | APIL 4818 N | 83 | APCA 0924 C | 52 | APF1 4848 | 46 |
| AMCR544 | 137 | APIL 4818G | 84 | APCA 0924 S | 52 | APF1 4860 | 46 |
| AMGR545 | 138 | APIL 4824 N | 83 | APCA 0936 | 55 | APF1 4872 | 46 |
| AMGR604 | 137 | APIL 4824G | 84 | APCA 0936 A | 56 | APF1 6448 | 46 |
| AMGR605 | 138 | APIL 4830 N | 83 | APCA 0936 C | 52 | APF1 6460 | 46 |
| AMCR664 | 137 | APIL 4830G | 84 | APCA 0936 S | 52 | APF1 6472 | 46 |
| AMGR665 | 138 | APIL 4836 N | 83 | APCA 0948 | 55 | APFA1 3948 | 46 |
| AMGR724 | 137 | APIL 4836G | 84 | APCA 0948 A | 56 | APFA1 3960 | 46 |
| AMGR725 | 138 | APIL 4842 N | 83 | APCA 0948 C | 52 | APFA1 3972 | 46 |
| AMGR784 | 137 | APIL 4842G | 84 | APCA 0948 S | 52 | APFA1 4848 | 46 |
| AMGR785 | 138 | APIL 4848 N | 83 | APCA 0960 | 55 | APFA1 4860 | 46 |
| AMGR844 | 137 | APIL 4848G | 84 | APCA 0960 A | 56 | APFA1 4872 | 46 |
| AMCR845 | 138 | APIL 4860 N | 83 | APCA 0960 C | 52 | APFA1 6448 | 46 |
| AMCR904 | 137 | APIL 4872 N | 83 | APCA 0960 S | 52 | APFA1 6460 | 46 |
| AMGR905 | 138 | APIL 6418 A | 83 | APCA 0972 | 55 | APFA1 6472 | 46 |
| AMGR964 | 137 | APIL 6418G | 84 | APCA 0972 A | 56 | APHOBD42 | 188 |
| AMGR965 | 138 | APIL 6424 A | 83 | APCA 0972 C | 52 | APHOBD48 | 188 |
| AMCTTA | 147 | APIL 6424G | 84 | APCA 0972 S | 52 | APHOBD54 | 188 |
| AMGTTB | 147 | APIL 6430 A | 83 | APCA 1612 | 55 | APHOBD60 | 188 |
| AMG TTC | 147 | APIL 6430G | 84 | APCA 1612 A | 56 | APHOBD66 | 188 |
| AMGTTD | 147 | APIL 6436 A | 83 | APCA 1624 | 55 | APHOBD72 | 188 |
| AMPB10(E/P)(M) | 178 | APIL 6436G | 84 | APCA 1624 A | 56 | APHOBD78 | 188 |
| AMPB10(E/P)(W) | 176 | APIL 6442 A | 83 | APCA 1636 | 55 | APHOBD84 | 188 |
| AMPB11(E/P)(M) | 178 | APIL 6442G | 84 | APCA 1636 A | 56 | APHOBD90 | 188 |
| AMPB11(E/P)(W) | 176 | APIL 6448 A | 83 | APCA 1648 | 55 | APHOBD96 | 188 |
| AMPB20(E/P)(M) | 178 | APIL 6448G | 84 | APCA 1648 A | 56 | APHOBO42 | 187 |
| AMPB20(E/P)(W) | 176 | APIL 6460 A | 83 | APCA 1660 | 55 | APHOBO48 | 187 |
| AMPB21(E/P)(M) | 178 | APIW 1624G | 85 | APCA 1660 A | 56 | APHOBO54 | 187 |
| AMPB21(E/P)(W) | 176 | APIW 1630G | 85 | APCA 1672 | 55 | APHOBO60 | 187 |
| AOB4242 | 143 | APIW 1636G | 85 | APCA 1672 A | 56 | APHOBO66 | 187 |
| AOB4248 | 143 | APIW 1642G | 85 | APCA 1812 | 55 | APHOBO72 | 187 |
| AOB4254 | 143 | APIW 1648G | 85 | APCA 1812 A | 56 | APHOBO78 | 187 |
| AOB4260 | 143 | APIW 1660G | 85 | APCA 1824 | 55 | APHOBO84 | 187 |
| AOB4266 | 143 | APIW 1672G | 85 | APCA 1824 A | 56 | APHOBO90 | 187 |
| AOB4272 | 143 | APIW 1824G | 85 | APCA 1836 | 55 | APHOBO96 | 187 |
| AOB4278 | 143 | APIW 1830G | 85 | APCA 1836 A | 56 | APHOBR42 | 191 |
| AOBS42 | 144 | APIW 1836G | 85 | APCA 1848 | 55 | APHOBR48 | 191 |
| AOBS48 | 144 | APIW 1842G | 85 | APCA 1848 A | 56 | APHOBR54 | 191 |
| AOBS54 | 144 | APIW 1848G | 85 | APCA 1860 | 55 | APHOBR60 | 191 |

| <i>pattern no.</i> | <i>page</i> | <i>pattern no.</i> | <i>page</i> | <i>pattern no.</i> | <i>page</i> | <i>pattern no.</i> | <i>page</i> |
|--------------------|-------------|--------------------|-------------|--------------------|-------------|--------------------|-------------|
| APHOBR66 | 191 | APHOCT72 | 189 | APX CIP6 | 81 | ASBT1 48 | 181 |
| APHOBR72 | 191 | APHOCT78 | 189 | APX CIP8 | 81 | ASFS1FF18 | 170 |
| APHOBR78 | 191 | APHOCT84 | 189 | AR1 DA | 79, 80 | ASFS1FF24 | 170 |
| APHOBR84 | 191 | APHOCT90 | 189 | AR1 DB | 79, 80 | ASFS1PDF18 | 170 |
| APHOBR90 | 191 | APHOCT96 | 189 | AR1 DC | 80 | ASFS1PDF24 | 170 |
| APHOBR96 | 191 | APLP10 | 120 | AR1 DX | 79, 80 | ASFS1WDD30 | 170 |
| APHOBS42 | 190 | APLP25 | 120 | AR1 DY | 79, 80 | ASFS1WDD36 | 170 |
| APHOBS48 | 190 | APRA 480 | 48 | AR1 DZ | 80 | ASFS1WDF30 | 170 |
| APHOBS54 | 190 | APRA 600 | 48 | AR1 EJ1 | 79 | ASFS1WDF36 | 170 |
| APHOBS60 | 190 | APRA 720 | 48 | AR1 EJ10 | 79 | ASFS1WFF30 | 170 |
| APHOBS66 | 190 | APSA 0921 | 54 | AR1 EJ12 | 79 | ASFS1WFF36 | 170 |
| APHOBS72 | 190 | APSA 0924 | 54 | AR1 EJ2 | 79 | ASFS1WPDF30 | 170 |
| APHOBS78 | 190 | APSA 0933 | 54 | AR1 EJ3 | 79 | ASFS1WPDF36 | 170 |
| APHOBS84 | 190 | APSA 0936 | 54 | AR1 EJ4 | 79 | ASM42MB42 | 133 |
| APHOBS90 | 190 | APSA 0945 | 54 | AR1 EJ5 | 79 | ASM42MB48 | 133 |
| APHOBS96 | 190 | APSA 0948 | 54 | AR1 EJ6 | 79 | ASM42MB54 | 133 |
| APHOBT60 | 189 | APSA 0957 | 54 | AR1 EJ8 | 79 | ASM42MB60 | 133 |
| APHOBT66 | 189 | APSA 0960 | 54 | AR1 EOM | 79 | ASM42MB66 | 133 |
| APHOBT72 | 189 | APSA 0969 | 54 | AR1 EPH1 | 79 | ASM42MB72 | 133 |
| APHOBT78 | 189 | APSA 0972 | 54 | AR1 EPH2 | 79 | ASM42MB78 | 133 |
| APHOBT84 | 189 | APSA 1621 | 54 | AR1 EPI5 | 79 | ASM42MB84 | 133 |
| APHOBT90 | 189 | APSA 1624 | 54 | AR1 EPIC | 79 | ASM42MB90 | 133 |
| APHOBT96 | 189 | APSA 1633 | 54 | AR1 ET1 | 79 | ASM42MB96 | 133 |
| APHOGD42 | 188 | APSA 1636 | 54 | AR1 ET3 | 79 | ASM42MG42 | 134 |
| APHOGD48 | 188 | APSA 1645 | 54 | AR1 ET5 | 79 | ASM42MG48 | 134 |
| APHOGD54 | 188 | APSA 1648 | 54 | AR1 ET8 | 79 | ASM42MG54 | 134 |
| APHOGD60 | 188 | APSA 1657 | 54 | AR1 HCC H10 | 81 | ASM42MG60 | 134 |
| APHOGD66 | 188 | APSA 1660 | 54 | AR1 HOB | 53 | ASM42MG66 | 134 |
| APHOGD72 | 188 | APSA 1669 | 54 | AR1 HOB2 | 53 | ASM42MG72 | 134 |
| APHOGD78 | 188 | APSA 1672 | 54 | AR1 PCC 100 | 81 | ASM42MG78 | 134 |
| APHOGD84 | 188 | APT | 48 | AR1 TJ1 | 80 | ASM42MG84 | 134 |
| APHOGD90 | 188 | APT 48 | 47 | AR1 TJ10 | 80 | ASM42MG90 | 134 |
| APHOGD96 | 188 | APT 60 | 47 | AR1 TJ12 | 80 | ASM42MG96 | 134 |
| APHOGO42 | 187 | APT 72 | 47 | AR1 TJ2 | 80 | ASM42WB42 | 133 |
| APHOGO48 | 187 | APT1 C24 | 48 | AR1 TJ3 | 80 | ASM42WB48 | 133 |
| APHOGO54 | 187 | APT1 C36 | 48 | AR1 TJ4 | 80 | ASM42WB54 | 133 |
| APHOGO60 | 187 | APT1 C48 | 48 | AR1 TJ5 | 80 | ASM42WB60 | 133 |
| APHOGO66 | 187 | APT1 C60 | 48 | AR1 TJ6 | 80 | ASM42WB66 | 133 |
| APHOGO72 | 187 | APT1 C72 | 48 | AR1 TJ8 | 80 | ASM42WB72 | 133 |
| APHOGO78 | 187 | APTA 48 | 47 | AR1 TOM | 80 | ASM42WB78 | 133 |
| APHOGO84 | 187 | APTA 60 | 47 | AR1 TPH1 | 80 | ASM42WB84 | 133 |
| APHOGO90 | 187 | APTA 72 | 47 | AR1 TPH2 | 80 | ASM42WB90 | 133 |
| APHOGO96 | 187 | APTA C24 | 48 | AR1 TPI5 | 80 | ASM42WB96 | 133 |
| APHOGR42 | 191 | APTA C36 | 48 | AR1 TPIC | 80 | ASM42WG42 | 134 |
| APHOGR48 | 191 | APTA C48 | 48 | AR1 TT1 | 80 | ASM42WG48 | 134 |
| APHOGR54 | 191 | APTA C60 | 48 | AR1 TT3 | 80 | ASM42WG54 | 134 |
| APHOGR60 | 191 | APTA C72 | 48 | AR1 TT5 | 80 | ASM42WG60 | 134 |
| APHOGR66 | 191 | APTA CC | 48 | AR1 TT8 | 80 | ASM42WG66 | 134 |
| APHOGR72 | 191 | APTA CC1 | 48 | AR1-ELS-B | 79, 80 | ASM42WG72 | 134 |
| APHOGR78 | 191 | APTH | 49 | AS1 BKH | 174 | ASM42WG78 | 134 |
| APHOGR84 | 191 | APTH 120 | 47 | AS1 BKL | 174 | ASM42WG84 | 134 |
| APHOGR90 | 191 | APTH 48 | 47 | AS1 DPAD | 172, 173 | ASM42WG90 | 134 |
| APHOGR96 | 191 | APTH 60 | 47 | AS1 SPAD | 172, 173 | ASM42WG96 | 134 |
| APHOGS42 | 190 | APTH 72 | 47 | AS2 PT | 174 | ASMMB42 | 141 |
| APHOGS48 | 190 | APTH 96 | 47 | ASAMP1616 | 209 | ASMMB48 | 141 |
| APHOGS54 | 190 | APTL | 49 | ASBC18 (L/R) | 223 | ASMMB54 | 141 |
| APHOGS60 | 190 | APTL 120 | 47 | ASBC24 (L/R) | 223 | ASMMB60 | 141 |
| APHOGS66 | 190 | APTL 48 | 47 | ASBF1 36 | 181 | ASMMB66 | 141 |
| APHOGS72 | 190 | APTL 60 | 47 | ASBF1 42 | 181 | ASMMB72 | 141 |
| APHOGS78 | 190 | APTL 72 | 47 | ASBF1 48 | 181 | ASMMB78 | 141 |
| APHOGS84 | 190 | APTL 96 | 47 | ASBS1 36 | 181 | ASMMB84 | 141 |
| APHOGS90 | 190 | APTL26 | 224 | ASBS1 42 | 181 | ASMMB90 | 141 |
| APHOGS96 | 190 | APTL27 | 224 | ASBS1 48 | 181 | ASMMB96 | 141 |
| APHOCT60 | 189 | APTL28 | 224 | ASBT1 36 | 181 | ASMMG42 | 142 |
| APHOCT66 | 189 | APX CIP4 | 81 | ASBT1 42 | 181 | ASMMG48 | 142 |

| <i>pattern no.</i> | <i>page</i> | <i>pattern no.</i> | <i>page</i> | <i>pattern no.</i> | <i>page</i> | <i>pattern no.</i> | <i>page</i> |
|--------------------|-------------|--------------------|-------------|----------------------|-------------|-----------------------|-------------|
| ASMMG54 | 142 | ASOBR96 | 186 | ASWB42 | 229 | ATBM48 | 228 |
| ASMMG60 | 142 | ASOBS42 | 185 | ASWB48 | 229 | ATBM54 | 228 |
| ASMMG66 | 142 | ASOBS48 | 185 | ASWB54 | 229 | ATBM60 | 228 |
| ASMMG72 | 142 | ASOBS54 | 185 | ASWB60 | 229 | ATBM66 | 228 |
| ASMMG78 | 142 | ASOBS60 | 185 | ASWB66 | 229 | ATBM72 | 228 |
| ASMMG84 | 142 | ASOBS66 | 185 | ASWB72 | 229 | ATBM78 | 228 |
| ASMMG90 | 142 | ASOBS72 | 185 | ASWB78 | 229 | ATBM84 | 228 |
| ASMMG96 | 142 | ASOBS78 | 185 | ASWM26 | 229 | ATBM90 | 228 |
| ASMS1 DF18 | 171 | ASOBS84 | 185 | ASWM32 | 229 | ATBM96 | 228 |
| ASMS1 DF24 | 171 | ASOBS90 | 185 | ASWM42 | 229 | ATBT120 | 225 |
| ASMS1 DFO18 | 171 | ASOBS96 | 185 | ASWM48 | 229 | ATBT124 | 225 |
| ASMS1 DFO24 | 171 | ASOBT60 | 184 | ASWM54 | 229 | ATBT130 | 225 |
| ASMS1 FF18 | 171 | ASOBT66 | 184 | ASWM60 | 229 | ATBT136 | 225 |
| ASMS1 FF24 | 171 | ASOBT72 | 184 | ASWM66 | 229 | ATBT224 | 225 |
| ASMS1 PDF18 | 171 | ASOBT78 | 184 | ASWM72 | 229 | ATBT230 | 225 |
| ASMS1 PDF24 | 171 | ASOBT84 | 184 | ASWM78 | 229 | ATBT236 | 225 |
| ASMWB42 | 141 | ASOBT90 | 184 | ASWM84 | 229 | ATBT242 | 225 |
| ASMWB48 | 141 | ASOBT96 | 184 | ASWM90 | 229 | ATDT1LFM483027(L/M/V) | 219 |
| ASMWB54 | 141 | ASOCD42 | 183 | ASWM96 | 229 | ATDT1LFM483028(L/M/V) | 219 |
| ASMWB60 | 141 | ASOCD48 | 183 | ASWRB42 | 106 | ATDT1LFM603027(L/M/V) | 219 |
| ASMWB66 | 141 | ASOCD54 | 183 | ASWRB49 | 106 | ATDT1LFM603028(L/M/V) | 219 |
| ASMWB72 | 141 | ASOCD60 | 183 | ASWRB64 | 106 | ATDT1LFM723027(L/M/V) | 219 |
| ASMWB78 | 141 | ASOCD66 | 183 | ASWRB79 | 106 | ATDT1LFM723028(L/M/V) | 219 |
| ASMWB84 | 141 | ASOCD72 | 183 | AT2TB (pair) | 223 | ATDT1LFM723627(L/M/V) | 219 |
| ASMWB90 | 141 | ASOCD78 | 183 | ATA1R36 | 217 | ATDT1LFM723628(L/M/V) | 219 |
| ASMWB96 | 141 | ASOCD84 | 183 | ATA1R42 | 217 | ATDT1LFS483027(L/M/V) | 219 |
| ASMWG42 | 142 | ASOCD90 | 183 | ATA1R48 | 217 | ATDT1LFS483028(L/M/V) | 219 |
| ASMWG48 | 142 | ASOCD96 | 183 | ATA1T44242 | 217 | ATDT1LFS603027(L/M/V) | 219 |
| ASMWG54 | 142 | ASOGO42 | 182 | ATA1T44830 | 217 | ATDT1LFS603028(L/M/V) | 219 |
| ASMWG60 | 142 | ASOGO48 | 182 | ATA1T44848 | 217 | ATDT1LFS723027(L/M/V) | 219 |
| ASMWG66 | 142 | ASOGO54 | 182 | ATA1T46030 | 217 | ATDT1LFS723028(L/M/V) | 219 |
| ASMWG72 | 142 | ASOGO60 | 182 | ATA1T47230 | 217 | ATDT1LFS723627(L/M/V) | 219 |
| ASMWG78 | 142 | ASOGO66 | 182 | ATA1T47236 | 217 | ATDT1LFS723628(L/M/V) | 219 |
| ASMWG84 | 142 | ASOGO72 | 182 | ATARLL3627(L/M/V) | 218 | ATDT1LPM483027(L/M/V) | 219 |
| ASMWG90 | 142 | ASOGO78 | 182 | ATARLL3628(L/M/V) | 218 | ATDT1LPM483028(L/M/V) | 219 |
| ASMWG96 | 142 | ASOGO84 | 182 | ATARLL4227(L/M/V) | 218 | ATDT1LPM603027(L/M/V) | 219 |
| ASOBD42 | 183 | ASOGO90 | 182 | ATARLL4228(L/M/V) | 218 | ATDT1LPM603028(L/M/V) | 219 |
| ASOBD48 | 183 | ASOGO96 | 182 | ATARLL4827(L/M/V) | 218 | ATDT1LPM723027(L/M/V) | 219 |
| ASOBD54 | 183 | ASOGR42 | 186 | ATARLL4828(L/M/V) | 218 | ATDT1LPM723028(L/M/V) | 219 |
| ASOBD60 | 183 | ASOGR48 | 186 | ATAT4LL424227(L/M/V) | 218 | ATDT1LPM723627(L/M/V) | 219 |
| ASOBD66 | 183 | ASOGR54 | 186 | ATAT4LL424228(L/M/V) | 218 | ATDT1LPM723628(L/M/V) | 219 |
| ASOBD72 | 183 | ASOGR60 | 186 | ATAT4LL484827(L/M/V) | 218 | ATDT1LPS483027(L/M/V) | 220 |
| ASOBD78 | 183 | ASOGR66 | 186 | ATAT4LL484828(L/M/V) | 218 | ATDT1LPS483028(L/M/V) | 220 |
| ASOBD84 | 183 | ASOGR72 | 186 | ATB1426 | 228 | ATDT1LPS603027(L/M/V) | 220 |
| ASOBD90 | 183 | ASOGR78 | 186 | ATB1432 | 228 | ATDT1LPS603028(L/M/V) | 220 |
| ASOBD96 | 183 | ASOGR84 | 186 | ATB1442 | 228 | ATDT1LPS723027(L/M/V) | 220 |
| ASOBO42 | 182 | ASOGR90 | 186 | ATB1448 | 228 | ATDT1LPS723028(L/M/V) | 220 |
| ASOBO48 | 182 | ASOGR96 | 186 | ATB1454 | 228 | ATDT1LPS723627(L/M/V) | 220 |
| ASOBO54 | 182 | ASOCS42 | 185 | ATB1460 | 228 | ATDT1LPS723628(L/M/V) | 220 |
| ASOBO60 | 182 | ASOCS48 | 185 | ATB1466 | 228 | ATDT4LL483027(L/M/V) | 218 |
| ASOBO66 | 182 | ASOCS54 | 185 | ATB1472 | 228 | ATDT4LL483028(L/M/V) | 218 |
| ASOBO72 | 182 | ASOCS60 | 185 | ATB1478 | 228 | ATDT4LL603027(L/M/V) | 218 |
| ASOBO78 | 182 | ASOCS66 | 185 | ATB1484 | 228 | ATDT4LL603028(L/M/V) | 218 |
| ASOBO84 | 182 | ASOCS72 | 185 | ATB1490 | 228 | ATDT4LL723027(L/M/V) | 218 |
| ASOBO90 | 182 | ASOCS78 | 185 | ATB1496 | 228 | ATDT4LL723028(L/M/V) | 218 |
| ASOBO96 | 182 | ASOCS84 | 185 | ATBB42 | 228 | ATDT4LL723627(L/M/V) | 218 |
| ASOBR42 | 186 | ASOCS90 | 185 | ATBB48 | 228 | ATDT4LL723628(L/M/V) | 218 |
| ASOBR48 | 186 | ASOCS96 | 185 | ATBB54 | 228 | ATSB442 | 145 |
| ASOBR54 | 186 | ASOCT60 | 184 | ATBB60 | 228 | ATSB448 | 145 |
| ASOBR60 | 186 | ASOCT66 | 184 | ATBB66 | 228 | ATSB454 | 145 |
| ASOBR66 | 186 | ASOCT72 | 184 | ATBB72 | 228 | ATSB460 | 145 |
| ASOBR72 | 186 | ASOCT78 | 184 | ATBB78 | 228 | ATSB466 | 145 |
| ASOBR78 | 186 | ASOCT84 | 184 | ATBM26 | 228 | ATSB472 | 145 |
| ASOBR84 | 186 | ASOCT90 | 184 | ATBM32 | 228 | ATSB478 | 145 |
| ASOBR90 | 186 | ASOCT96 | 184 | ATBM42 | 228 | ATSB482 | 145 |

| <i>pattern no.</i> | <i>page</i> | <i>pattern no.</i> | <i>page</i> | <i>pattern no.</i> | <i>page</i> | <i>pattern no.</i> | <i>page</i> |
|--------------------|-------------|--------------------|-------------|--------------------|-------------|--------------------|-------------|
| ATSB48 | 145 | AW1T1RF4230 | 208 | AW1T1RU6620 | 210 | AW1T2R9042 | 214 |
| ATSB54 | 145 | AW1T1RF4236 | 208 | AW1T1RU6624 | 210 | AW1T2R9630 | 213 |
| ATSB60 | 145 | AW1T1RF4820 | 207 | AW1T1RU6630 | 211 | AW1T2R9636 | 213 |
| ATSB66 | 145 | AW1T1RF4824 | 207 | AW1T1RU7220 | 210 | AW1T2R9642 | 214 |
| ATSB72 | 145 | AW1T1RF4830 | 208 | AW1T1RU7224 | 210 | AW1T2W4823 | 215 |
| ATSB78 | 145 | AW1T1RF4836 | 208 | AW1T1RU7230 | 211 | AW1T2W4832 | 215 |
| ATSB42 | 145 | AW1T1RF5420 | 207 | AW1T1RU7820 | 210 | AW1T2W6023 | 215 |
| ATSB48 | 145 | AW1T1RF5424 | 207 | AW1T1RU7824 | 210 | AW1T2W6032 | 215 |
| ATSB54 | 145 | AW1T1RF5430 | 208 | AW1T1RU7830 | 211 | AW1T2W7226 | 215 |
| ATSB60 | 145 | AW1T1RF5436 | 208 | AW1T1RU8420 | 210 | AW1T2W7262 | 215 |
| ATSB66 | 145 | AW1T1RF6020 | 207 | AW1T1RU8424 | 210 | AWBK42 | 147 |
| ATSB72 | 145 | AW1T1RF6024 | 207 | AW1T1RU8430 | 211 | AWBK48 | 147 |
| ATSB78 | 145 | AW1T1RF6030 | 208 | AW1T1RU9020 | 210 | AWBK54 | 147 |
| ATSD42 | 145 | AW1T1RF6036 | 208 | AW1T1RU9024 | 210 | AWBK60 | 147 |
| ATSD48 | 145 | AW1T1RF6620 | 207 | AW1T1RU9030 | 211 | AWBK66 | 147 |
| ATSD54 | 145 | AW1T1RF6624 | 207 | AW1T1RU9620 | 210 | AWBK72 | 147 |
| ATSD60 | 145 | AW1T1RF6630 | 208 | AW1T1RU9624 | 210 | AWBK78 | 147 |
| ATSD66 | 145 | AW1T1RF6636 | 208 | AW1T1RU9630 | 211 | AWBK84 | 147 |
| ATSD72 | 145 | AW1T1RF7220 | 207 | AW1T1WF4823 | 209 | AWBK90 | 147 |
| ATSD78 | 145 | AW1T1RF7224 | 207 | AW1T1WF4832 | 209 | AWBK96 | 147 |
| ATSE42 | 145 | AW1T1RF7230 | 208 | AW1T1WF6023 | 209 | AWBS42 | 144 |
| ATSE48 | 145 | AW1T1RF7236 | 208 | AW1T1WF6032 | 209 | AWBS48 | 144 |
| ATSE54 | 145 | AW1T1RF7820 | 207 | AW1T1WF7226 | 209 | AWBS54 | 144 |
| ATSE60 | 146 | AW1T1RF7824 | 207 | AW1T1WF7262 | 209 | AWBS60 | 144 |
| ATSE66 | 146 | AW1T1RF7830 | 208 | AW1T1WU4823 | 212 | AWBS66 | 144 |
| ATSE72 | 146 | AW1T1RF7836 | 208 | AW1T1WU4832 | 212 | AWBS72 | 144 |
| ATSE78 | 146 | AW1T1RF8420 | 207 | AW1T1WU6023 | 212 | AWBS78 | 144 |
| ATSCD19 | 164 | AW1T1RF8424 | 207 | AW1T1WU6032 | 212 | AWBS84 | 144 |
| AUA1 0824 G | 82 | AW1T1RF8430 | 208 | AW1T1WU7226 | 212 | AWBS90 | 144 |
| AUA1 0836 G | 82 | AW1T1RF8436 | 208 | AW1T1WU7262 | 212 | AWBS96 | 144 |
| AUA1 0848 G | 82 | AW1T1RF9020 | 207 | AW1T2DW4826 | 216 | AWCPFS | 180 |
| AUA1 0860 G | 82 | AW1T1RF9024 | 207 | AW1T2DW6026 | 216 | AWHOBDD30 | 197 |
| AUA1 0872 G | 82 | AW1T1RF9030 | 208 | AW1T2DW7226 | 216 | AWHOBDD36 | 197 |
| AUA1 1224 G | 82 | AW1T1RF9036 | 208 | AW1T2R3030 | 213 | AWHOBDD42 | 197 |
| AUA1 1236 G | 82 | AW1T1RF9620 | 207 | AW1T2R3036 | 213 | AWHOBDD48 | 197 |
| AUA1 1248 G | 82 | AW1T1RF9624 | 207 | AW1T2R3042 | 213 | AWHOBDD54 | 197 |
| AUA1 1260 G | 82 | AW1T1RF9630 | 208 | AW1T2R3630 | 213 | AWHOBDD60 | 197 |
| AUA1 1272 G | 82 | AW1T1RF9636 | 208 | AW1T2R3636 | 213 | AWHOBDD66 | 197 |
| AUA1 1524 G | 82 | AW1T1RU1820 | 210 | AW1T2R3642 | 213 | AWHOBDD72 | 197 |
| AUA1 1536 G | 82 | AW1T1RU1824 | 210 | AW1T2R4230 | 213 | AWHOBDD78 | 197 |
| AUA1 1548 G | 82 | AW1T1RU1830 | 210 | AW1T2R4236 | 213 | AWHOBDD84 | 197 |
| AUA1 1560 G | 82 | AW1T1RU2020 | 210 | AW1T2R4242 | 213 | AWHOBDD90 | 197 |
| AUA1 1572 G | 82 | AW1T1RU2024 | 210 | AW1T2R4830 | 213 | AWHOBDD96 | 197 |
| AW1T1RF1820 | 207 | AW1T1RU2030 | 210 | AW1T2R4836 | 213 | AWHOBDO30 | 196 |
| AW1T1RF1824 | 207 | AW1T1RU2420 | 210 | AW1T2R4842 | 213 | AWHOBDO36 | 196 |
| AW1T1RF1830 | 208 | AW1T1RU2424 | 210 | AW1T2R5430 | 213 | AWHOBDO42 | 196 |
| AW1T1RF1836 | 208 | AW1T1RU2430 | 210 | AW1T2R5436 | 213 | AWHOBDO48 | 196 |
| AW1T1RF2020 | 207 | AW1T1RU3020 | 210 | AW1T2R5442 | 213 | AWHOBDO54 | 196 |
| AW1T1RF2024 | 207 | AW1T1RU3024 | 210 | AW1T2R6030 | 213 | AWHOBDO60 | 196 |
| AW1T1RF2030 | 208 | AW1T1RU3030 | 211 | AW1T2R6036 | 213 | AWHOBDO66 | 196 |
| AW1T1RF2036 | 208 | AW1T1RU3620 | 210 | AW1T2R6042 | 213 | AWHOBDO72 | 196 |
| AW1T1RF2420 | 207 | AW1T1RU3624 | 210 | AW1T2R6630 | 213 | AWHOBDO78 | 196 |
| AW1T1RF2424 | 207 | AW1T1RU3630 | 211 | AW1T2R6636 | 213 | AWHOBDO84 | 196 |
| AW1T1RF2430 | 208 | AW1T1RU4220 | 210 | AW1T2R6642 | 213 | AWHOBDO90 | 196 |
| AW1T1RF2436 | 208 | AW1T1RU4224 | 210 | AW1T2R7230 | 213 | AWHOBDO96 | 196 |
| AW1T1RF3020 | 207 | AW1T1RU4230 | 211 | AW1T2R7236 | 213 | AWHOBDR60 | 199 |
| AW1T1RF3024 | 207 | AW1T1RU4820 | 210 | AW1T2R7242 | 213 | AWHOBDR66 | 199 |
| AW1T1RF3030 | 208 | AW1T1RU4824 | 210 | AW1T2R7830 | 213 | AWHOBDR72 | 199 |
| AW1T1RF3036 | 208 | AW1T1RU4830 | 211 | AW1T2R7836 | 213 | AWHOBDR78 | 199 |
| AW1T1RF3620 | 207 | AW1T1RU5420 | 210 | AW1T2R7842 | 213 | AWHOBDR84 | 199 |
| AW1T1RF3624 | 207 | AW1T1RU5424 | 210 | AW1T2R8430 | 213 | AWHOBDR90 | 199 |
| AW1T1RF3630 | 208 | AW1T1RU5430 | 211 | AW1T2R8436 | 213 | AWHOBDR96 | 199 |
| AW1T1RF3636 | 208 | AW1T1RU6020 | 210 | AW1T2R8442 | 214 | AWHOBDS60 | 199 |
| AW1T1RF4220 | 207 | AW1T1RU6024 | 210 | AW1T2R9030 | 213 | AWHOBDS66 | 199 |
| AW1T1RF4224 | 207 | AW1T1RU6030 | 211 | AW1T2R9036 | 213 | AWHOBDS72 | 199 |

| <i>pattern no.</i> | <i>page</i> | <i>pattern no.</i> | <i>page</i> | <i>pattern no.</i> | <i>page</i> | <i>pattern no.</i> | <i>page</i> |
|--------------------|-------------|--------------------|-------------|--------------------|-------------|--------------------|-------------|
| AWHOBDS78 | 199 | AWHOGDD84 | 197 | AWHOGSR90 | 195 | AX1 R36448 | 72 |
| AWHOBDS84 | 199 | AWHOGDD90 | 197 | AWHOGSR96 | 195 | AX1 R36464 | 72 |
| AWHOBDS90 | 199 | AWHOGDD96 | 197 | AWHOGSS60 | 195 | AX1 R37939 | 72 |
| AWHOBDS96 | 199 | AWHOGDO30 | 196 | AWHOGSS66 | 195 | AX1 R37948 | 72 |
| AWHOBST60 | 198 | AWHOGDO36 | 196 | AWHOGSS72 | 195 | AX1 R37964 | 72 |
| AWHOBST66 | 198 | AWHOGDO42 | 196 | AWHOGSS78 | 195 | AX1 RF1 | 71 |
| AWHOBST72 | 198 | AWHOGDO48 | 196 | AWHOGSS84 | 195 | AX1 RF3 | 71 |
| AWHOBST78 | 198 | AWHOGDO54 | 196 | AWHOGSS90 | 195 | AX1 S | 60 |
| AWHOBST84 | 198 | AWHOGDO60 | 196 | AWHOGSS96 | 195 | AX1 STC39 3 | 60 |
| AWHOBST90 | 198 | AWHOGDO66 | 196 | AWHOGST60 | 194 | AX1 STC39 L3 | 60 |
| AWHOBST96 | 198 | AWHOGDO72 | 196 | AWHOGST66 | 194 | AX1 STC48 3 | 60 |
| AWHOBSD30 | 193 | AWHOGDO78 | 196 | AWHOGST72 | 194 | AX1 STC48 L3 | 60 |
| AWHOBSD36 | 193 | AWHOGDO84 | 196 | AWHOGST78 | 194 | AX1 STC64 3 | 60 |
| AWHOBSD42 | 193 | AWHOGDO90 | 196 | AWHOGST84 | 194 | AX1 STC64 L3 | 60 |
| AWHOBSD48 | 193 | AWHOGDO96 | 196 | AWHOGST90 | 194 | AX1 SWS39 | 60 |
| AWHOBSD54 | 193 | AWHOGDR60 | 199 | AWHOGST96 | 194 | AX1 SWS48 | 60 |
| AWHOBSD60 | 193 | AWHOGDR66 | 199 | AWHTB30 | 230 | AX1 SWS64 | 60 |
| AWHOBSD66 | 193 | AWHOGDR72 | 199 | AWHTB36 | 230 | AX1A C39 | 57 |
| AWHOBSD72 | 193 | AWHOGDR78 | 199 | AWHTB42 | 230 | AX1A C48 | 57 |
| AWHOBSD78 | 193 | AWHOGDR84 | 199 | AWHTB48 | 230 | AX1A C64 | 57 |
| AWHOBSD84 | 193 | AWHOGDR90 | 199 | AWHTB54 | 230 | AX1A EH39 | 57 |
| AWHOBSD90 | 193 | AWHOGDR96 | 199 | AWHTB60 | 230 | AX1A EH48 | 57 |
| AWHOBSD96 | 193 | AWHOGDS60 | 199 | AWHTB66 | 230 | AX1A EH64 | 57 |
| AWHOBSD96 | 193 | AWHOGDS66 | 199 | AWHTB72 | 230 | AX1A EL39 | 57 |
| AWHOBSD96 | 193 | AWHOGDS72 | 199 | AWHTB78 | 230 | AX1A EL48 | 57 |
| AWHOBSD96 | 193 | AWHOGDS78 | 199 | AWHTB84 | 230 | AX1A EL64 | 57 |
| AWHOBSD96 | 193 | AWHOGDS84 | 199 | AWHTB90 | 230 | AX1A F39 | 57 |
| AWHOBSD96 | 193 | AWHOGDS90 | 199 | AWHTB96 | 230 | AX1A F48 | 57 |
| AWHOBSD96 | 193 | AWHOGDS96 | 199 | AWM1 S36 | 227 | AX1A F64 | 57 |
| AWHOBSD96 | 193 | AWHOGDT60 | 198 | AWM1 S42 | 227 | AX1A L39 | 58 |
| AWHOBSD96 | 193 | AWHOGDT66 | 198 | AWM1 S48 | 227 | AX1A L48 | 58 |
| AWHOBSD96 | 193 | AWHOGDT72 | 198 | AWM1 S60 | 227 | AX1A L64 | 58 |
| AWHOBSD96 | 193 | AWHOGDT78 | 198 | AWM1 S66 | 227 | AX1A T39 | 58 |
| AWHOBSD96 | 193 | AWHOGDT84 | 198 | AWM1 S72 | 227 | AX1A T48 | 58 |
| AWHOBSD96 | 193 | AWHOGDT90 | 198 | AWM1 S78 | 227 | AX1A T64 | 58 |
| AWHOBSD96 | 193 | AWHOGDT96 | 198 | AWM1 S84 | 227 | AX1A V39 | 58 |
| AWHOBSD96 | 193 | AWHOGSD30 | 193 | AWM1 S84 | 227 | AX1A V48 | 58 |
| AWHOBSD96 | 193 | AWHOGSD36 | 193 | AWM1 S84 | 227 | AX1A V64 | 58 |
| AWHOBSD96 | 193 | AWHOGSD42 | 193 | AWM1 S84 | 227 | AX1A X39 | 58 |
| AWHOBSD96 | 193 | AWHOGSD48 | 193 | AWM1 S84 | 227 | AX1A X48 | 58 |
| AWHOBSD96 | 193 | AWHOGSD54 | 193 | AWM1 S84 | 227 | AX1A X64 | 58 |
| AWHOBSD96 | 193 | AWHOGSD60 | 193 | AWM1 S84 | 227 | AX1A Y39 | 58 |
| AWHOBSD96 | 193 | AWHOGSD66 | 193 | AWM1 S84 | 227 | AX1A Y48 | 58 |
| AWHOBSD96 | 193 | AWHOGSD72 | 193 | AWM1 S84 | 227 | AX1A Y64 | 59 |
| AWHOBSD96 | 193 | AWHOGSD78 | 193 | AWM1 S84 | 227 | AX1AES34 | 67 |
| AWHOBSD96 | 193 | AWHOGSD84 | 193 | AWM1 S84 | 227 | AX1AES42 | 67 |
| AWHOBSD96 | 193 | AWHOGSD90 | 193 | AWM1 S84 | 227 | AX1AES49 | 67 |
| AWHOBSD96 | 193 | AWHOGSD96 | 193 | AWM1 S84 | 227 | AX1AES64 | 67 |
| AWHOBSD96 | 193 | AWHOGSO30 | 192 | AWM1 S84 | 227 | AX1AES79 | 67 |
| AWHOBSD96 | 193 | AWHOGSO36 | 192 | AWM1 S84 | 227 | AX1DES36 | 69 |
| AWHOBSD96 | 193 | AWHOGSO42 | 192 | AWM1 S84 | 227 | AX1DES42 | 69 |
| AWHOBSD96 | 193 | AWHOGSO48 | 192 | AWM1 S84 | 227 | AX1DES50 | 69 |
| AWHOBSD96 | 193 | AWHOGSO54 | 192 | AWM1 S84 | 227 | AX1DES57 | 69 |
| AWHOBSD96 | 193 | AWHOGSO60 | 192 | AWM1 S84 | 227 | AX1DES64 | 69 |
| AWHOBSD96 | 193 | AWHOGSO66 | 192 | AWM1 S84 | 227 | AX1DES78 | 69 |
| AWHOBSD96 | 193 | AWHOGSO72 | 192 | AWM1 S84 | 227 | AX1DET36 | 77 |
| AWHOBSD96 | 193 | AWHOGSO78 | 192 | AWM1 S84 | 227 | AX1DET42 | 77 |
| AWHOBSD96 | 193 | AWHOGSO84 | 192 | AWM1 S84 | 227 | AX1DET50 | 77 |
| AWHOBSD96 | 193 | AWHOGSO90 | 192 | AWM1 S84 | 227 | AX1DET5039 | 77 |
| AWHOBSD96 | 193 | AWHOGSO96 | 192 | AWM1 S84 | 227 | AX1DET5048 | 77 |
| AWHOBSD96 | 193 | AWHOGSR60 | 195 | AWM1 S84 | 227 | AX1DET57 | 77 |
| AWHOBSD96 | 193 | AWHOGSR66 | 195 | AWM1 S84 | 227 | AX1DET5739 | 77 |
| AWHOBSD96 | 193 | AWHOGSR72 | 195 | AWM1 S84 | 227 | AX1DET5748 | 77 |
| AWHOBSD96 | 193 | AWHOGSR78 | 195 | AWM1 S84 | 227 | AX1DET64 | 77 |
| AWHOBSD96 | 193 | AWHOGSR84 | 195 | AWM1 S84 | 227 | AX1DET6439 | 77 |

| <i>pattern no.</i> | <i>page</i> | <i>pattern no.</i> | <i>page</i> | <i>pattern no.</i> | <i>page</i> | <i>pattern no.</i> | <i>page</i> |
|----------------------|----------------|----------------------|-------------|--------------------|-------------|--------------------|-------------|
| AX1DET6448 | 77 | AX1SX48 (A/C)(L/C/P) | 65 | R3B0P0H4907 | 74 | R3R0LT234 | 111 |
| AX1DET6464 | 77 | AX1SX64 (A/C)(L/C/P) | 65 | R3B0P0H6407 | 74 | R3R0LT242 | 111 |
| AX1DET7848 | 77 | AX2 C3939 | 71 | R3B0P0H7907 | 74 | R3R0LT249 | 111 |
| AX1DET7864 | 77 | AX2 C4839 | 71 | R3B0T0F4207 | 74 | R3R0LT264 | 111 |
| AX1GES39 | 68 | AX2 C4848 | 71 | R3B0T0F4907 | 74 | R3R0LT334 | 111 |
| AX1GES48 | 68 | AX2 C6439 | 71 | R3B0T0F6407 | 74 | R3R0LT342 | 111 |
| AX1LES E | 66 | AX2 C6448 | 71 | R3B0T0F7907 | 74 | R3R0LT349 | 111 |
| AX1LES30 | 66 | AX2 C6464 | 71 | R3B0T0H4207 | 74 | R3R0LT364 | 111 |
| AX1LES39 | 66 | MB1-AUX-C | 222 | R3B0T0H4907 | 74 | R3R0LTL34 | 111 |
| AX1LES48 | 66 | MB2-C18W-(L/R) | 222 | R3B0T0H6407 | 74 | R3R0LTL42 | 111 |
| AX1LES64 | 66 | MB2-C24W-(L/R) | 222 | R3B0T0H7907 | 74 | R3R0LTL49 | 111 |
| AX1MES30 | 66 | MB2-C30W-(L/R) | 222 | R3CAU0818 | 107 | R3R0LTL64 | 111 |
| AX1MES39 | 66 | MB2-YW-(L/R) | 222 | R3CAU0820 | 107 | R3R0SP142 | 116 |
| AX1MES42 | 66 | MB3-E18W | 222 | R3CAU0824 | 107 | R3R0SP149 | 116 |
| AX1MES48 | 66 | MB3-E24W | 222 | R3CAU0830 | 107 | R3R0SP242 | 116 |
| AX1MES56 | 66 | MB3-E30W | 222 | R3CAU0836 | 107 | R3R0SP249 | 116 |
| AX1MES64 | 66 | MB3-E36W | 222 | R3CAU0842 | 107 | R3R0SP342 | 116 |
| AX1MES80 | 66 | MB3-EC18W | 222 | R3CAU0848 | 107 | R3R0SP349 | 116 |
| AX1SEA3939 | 63 | MB3-EC24W | 222 | R3CAU1218 | 107 | R3R0SP142 | 116 |
| AX1SEA4239 | 63 | MB3-EC30W | 222 | R3CAU1220 | 107 | R3R0SP149 | 116 |
| AX1SEA4339 C | 63 | MCI-39S1 | 87 | R3CAU1224 | 107 | R3R0TOH4207 | 74 |
| AX1SEA4848 | 63 | MCI-48S1 | 87 | R3CAU1230 | 107 | R3R0TOH4907 | 74 |
| AX1SEA4939 | 63 | MCI-64S1 | 87 | R3CAU1236 | 107 | R3R0TOH6407 | 74 |
| AX1SEA4948 | 63 | MD6-BD | 174 | R3CAU1242 | 107 | R3R0TP142 | 109 |
| AX1SEA4964 | 63 | MD6-FS | 174 | R3CAU1248 | 107 | R3R0TP149 | 109 |
| AX1SEA5248 C | 63 | MM2-CG | 88 | R3CAU1518 | 107 | R3R0TP242 | 110 |
| AX1SEA6439 | 63 | MWM-J | 201 | R3CAU1520 | 107 | R3R0TP249 | 110 |
| AX1SEA6448 | 63 | R2AHBW18 | 117 | R3CAU1524 | 107 | R3R0TP342 | 110 |
| AX1SEA6464 | 63 | R2AHBW20 | 117 | R3CAU1530 | 107 | R3R0TP349 | 110 |
| AX1SEA6864 C | 63 | R2AHBW24 | 117 | R3CAU1536 | 107 | R3R0TPL42 | 110 |
| AX1SEA7948 | 63 | R2AHBW30 | 117 | R3CAU1542 | 107 | R3R0TPL49 | 110 |
| AX1SEA7964 | 63 | R2AHBW36 | 117 | R3CAU1548 | 107 | R3R0TT134 | 109 |
| AX1SEC3939 | 61 | R2AHBW42 | 117 | R3CAUHL0818 | 107 | R3R0TT142 | 109 |
| AX1SEC4039 L | 61 | R2AHBW48 | 117 | R3CAUHL0820 | 107 | R3R0TT149 | 109 |
| AX1SEC4239 | 62 | R2AHCN34 | 117 | R3CAUHL0824 | 107 | R3R0TT164 | 109 |
| AX1SEC4339 C | 61 | R2AHCN42 | 117 | R3CAUHL0830 | 107 | R3R0TT234 | 109 |
| AX1SEC4839 | 62 | R2AHCN49 | 117 | R3CAUHL0836 | 107 | R3R0TT242 | 109 |
| AX1SEC4848 | 61 | R2AHCN64 | 117 | R3CAUHL0842 | 107 | R3R0TT249 | 109 |
| AX1SEC4948 L | 61 | R2AHCN79 | 117 | R3CAUHL0848 | 107 | R3R0TT264 | 109 |
| AX1SEC5248 C | 61 | R2AHCR34 | 117 | R3CAUHL1218 | 108 | R3R0TT334 | 109 |
| AX1SEC5639 | 62 | R2AHCR42 | 117 | R3CAUHL1220 | 108 | R3R0TT342 | 109 |
| AX1SEC5648 | 62 | R2AHCR49 | 117 | R3CAUHL1224 | 108 | R3R0TT349 | 109 |
| AX1SEC6439 | 62 | R2AHCR64 | 117 | R3CAUHL1230 | 108 | R3R0TT364 | 109 |
| AX1SEC6448 | 62 | R2AHCR79 | 117 | R3CAUHL1236 | 108 | R3R0TTL34 | 109 |
| AX1SEC6464 | 61 | R2AHSR18 | 117 | R3CAUHL1242 | 108 | R3R0TTL42 | 109 |
| AX1SEC6564 L | 61 | R2AHSR20 | 117 | R3CAUHL1248 | 108 | R3R0TTL49 | 109 |
| AX1SEC6864 C | 61 | R2AHSR24 | 117 | R3CAUHL1518 | 108 | R3R0TTL64 | 109 |
| AX1SEC8048 | 62 | R2AHSR30 | 117 | R3CAUHL1520 | 108 | R3R1AF13418 | 91 |
| AX1SEC8064 | 62 | R2AHSR36 | 117 | R3CAUHL1524 | 108 | R3R1AF13424 | 91 |
| AX1SECBT | 61, 62, 63, 64 | R2AHSR42 | 117 | R3CAUHL1530 | 108 | R3R1AF13430 | 91 |
| AX1SED3939 | 64 | R2AHSR48 | 117 | R3CAUHL1536 | 108 | R3R1AF13436 | 91 |
| AX1SED4239 | 64 | R2AHWR18 | 117 | R3CAUHL1542 | 108 | R3R1AF13442 | 91 |
| AX1SED4339C | 64 | R2AHWR20 | 117 | R3CAUHL1548 | 108 | R3R1AF13448 | 91 |
| AX1SED4848 | 64 | R2AHWR24 | 117 | R3ROLP142 | 112 | R3R1AF14218 | 91 |
| AX1SED5039 | 64 | R2AHWR30 | 117 | R3ROLP149 | 112 | R3R1AF14224 | 91 |
| AX1SED5048 | 64 | R2AHWR36 | 117 | R3ROLP242 | 112 | R3R1AF14230 | 91 |
| AX1SED5248C | 64 | R2AHWR42 | 117 | R3ROLP249 | 112 | R3R1AF14236 | 91 |
| AX1SED5739 | 64 | R2AHWR48 | 117 | R3ROLP342 | 112 | R3R1AF14242 | 91 |
| AX1SED5748 | 64 | R2CG | 120 | R3ROLP349 | 112 | R3R1AF14248 | 91 |
| AX1SED6439 | 64 | R3AUAC10 | 108 | R3ROLPL42 | 111 | R3R1AF14918 | 91 |
| AX1SED6448 | 64 | R3B0P0F4207 | 74 | R3ROLPL49 | 111 | R3R1AF14924 | 91 |
| AX1SED6464 | 64 | R3B0P0F4907 | 74 | R3ROLT134 | 111 | R3R1AF14930 | 91 |
| AX1SED7848 | 64 | R3B0P0F6407 | 74 | R3ROLT142 | 111 | R3R1AF14936 | 91 |
| AX1SED7864 | 64 | R3B0P0F7907 | 74 | R3ROLT149 | 111 | R3R1AF14942 | 91 |
| AX1SX39 (A/C)(L/C/P) | 65 | R3B0P0H4207 | 74 | R3ROLT164 | 111 | R3R1AF14948 | 91 |

| <i>pattern no.</i> | <i>page</i> | <i>pattern no.</i> | <i>page</i> | <i>pattern no.</i> | <i>page</i> | <i>pattern no.</i> | <i>page</i> |
|--------------------|-------------|--------------------|-------------|--------------------|-------------|--------------------|-------------|
| R3R1AF16418 | 91 | R3R1AFL4248 | 90 | R3R1CX36442 | 105 | R3R1PF24224 | 96 |
| R3R1AF16424 | 91 | R3R1AFL4918 | 90 | R3R1CX36448 | 105 | R3R1PF24230 | 96 |
| R3R1AF16430 | 91 | R3R1AFL4924 | 90 | R3R1CXL4218 | 102 | R3R1PF24236 | 96 |
| R3R1AF16436 | 91 | R3R1AFL4930 | 90 | R3R1CXL4224 | 102 | R3R1PF24242 | 96 |
| R3R1AF16442 | 91 | R3R1AFL4936 | 90 | R3R1CXL4230 | 102 | R3R1PF24248 | 96 |
| R3R1AF16448 | 91 | R3R1AFL4942 | 90 | R3R1CXL4236 | 102 | R3R1PF24918 | 96 |
| R3R1AF23418 | 92 | R3R1AFL4948 | 90 | R3R1CXL4242 | 102 | R3R1PF24924 | 96 |
| R3R1AF23424 | 92 | R3R1AFL6418 | 90 | R3R1CXL4248 | 102 | R3R1PF24930 | 96 |
| R3R1AF23430 | 92 | R3R1AFL6424 | 90 | R3R1CXL4918 | 102 | R3R1PF24936 | 96 |
| R3R1AF23436 | 92 | R3R1AFL6430 | 90 | R3R1CXL4924 | 102 | R3R1PF24942 | 96 |
| R3R1AF23442 | 92 | R3R1AFL6436 | 90 | R3R1CXL4930 | 102 | R3R1PF24948 | 96 |
| R3R1AF23448 | 92 | R3R1AFL6442 | 90 | R3R1CXL4936 | 102 | R3R1PF34218 | 97 |
| R3R1AF24218 | 92 | R3R1AFL6448 | 90 | R3R1CXL4942 | 102 | R3R1PF34224 | 97 |
| R3R1AF24224 | 92 | R3R1CX14218 | 103 | R3R1CXL4948 | 102 | R3R1PF34230 | 97 |
| R3R1AF24230 | 92 | R3R1CX14224 | 103 | R3R1CXL6418 | 102 | R3R1PF34236 | 97 |
| R3R1AF24236 | 92 | R3R1CX14230 | 103 | R3R1CXL6424 | 102 | R3R1PF34242 | 97 |
| R3R1AF24242 | 92 | R3R1CX14236 | 103 | R3R1CXL6430 | 102 | R3R1PF34248 | 97 |
| R3R1AF24248 | 92 | R3R1CX14242 | 103 | R3R1CXL6436 | 102 | R3R1PF34918 | 97 |
| R3R1AF24918 | 92 | R3R1CX14248 | 103 | R3R1CXL6442 | 102 | R3R1PF34924 | 97 |
| R3R1AF24924 | 92 | R3R1CX14918 | 103 | R3R1CXL6448 | 102 | R3R1PF34930 | 97 |
| R3R1AF24930 | 92 | R3R1CX14924 | 103 | R3R1LAL134 | 113 | R3R1PF34936 | 97 |
| R3R1AF24936 | 92 | R3R1CX14930 | 103 | R3R1LAL142 | 113 | R3R1PF34942 | 97 |
| R3R1AF24942 | 92 | R3R1CX14936 | 103 | R3R1LAL149 | 113 | R3R1PF34948 | 97 |
| R3R1AF24948 | 92 | R3R1CX14942 | 103 | R3R1LAL164 | 113 | R3R1PFL4218 | 94 |
| R3R1AF26418 | 92 | R3R1CX14948 | 103 | R3R1LAL234 | 114 | R3R1PFL4224 | 94 |
| R3R1AF26424 | 92 | R3R1CX16418 | 103 | R3R1LAL242 | 114 | R3R1PFL4230 | 94 |
| R3R1AF26430 | 92 | R3R1CX16424 | 103 | R3R1LAL249 | 114 | R3R1PFL4236 | 94 |
| R3R1AF26436 | 92 | R3R1CX16430 | 103 | R3R1LAL264 | 114 | R3R1PFL4242 | 94 |
| R3R1AF26442 | 92 | R3R1CX16436 | 103 | R3R1LAL334 | 114 | R3R1PFL4248 | 94 |
| R3R1AF26448 | 92 | R3R1CX16442 | 103 | R3R1LAL342 | 114 | R3R1PFL4918 | 94 |
| R3R1AF33418 | 93 | R3R1CX16448 | 103 | R3R1LAL349 | 114 | R3R1PFL4924 | 94 |
| R3R1AF33424 | 93 | R3R1CX24218 | 104 | R3R1LAL364 | 114 | R3R1PFL4930 | 94 |
| R3R1AF33430 | 93 | R3R1CX24224 | 104 | R3R1LALL34 | 113 | R3R1PFL4936 | 94 |
| R3R1AF33436 | 93 | R3R1CX24230 | 104 | R3R1LALL42 | 113 | R3R1PFL4942 | 94 |
| R3R1AF33442 | 93 | R3R1CX24236 | 104 | R3R1LALL49 | 113 | R3R1PFL4948 | 94 |
| R3R1AF33448 | 93 | R3R1CX24242 | 104 | R3R1LALL64 | 113 | R3R1SA134 | 115 |
| R3R1AF34218 | 93 | R3R1CX24248 | 104 | R3R1LAR134 | 113 | R3R1SA142 | 115 |
| R3R1AF34224 | 93 | R3R1CX24918 | 104 | R3R1LAR142 | 113 | R3R1SA149 | 115 |
| R3R1AF34230 | 93 | R3R1CX24924 | 104 | R3R1LAR149 | 113 | R3R1SA164 | 115 |
| R3R1AF34236 | 93 | R3R1CX24930 | 104 | R3R1LAR164 | 113 | R3R1SA234 | 115 |
| R3R1AF34242 | 93 | R3R1CX24936 | 104 | R3R1LAR234 | 114 | R3R1SA242 | 115 |
| R3R1AF34248 | 93 | R3R1CX24942 | 104 | R3R1LAR242 | 114 | R3R1SA249 | 115 |
| R3R1AF34918 | 93 | R3R1CX24948 | 104 | R3R1LAR249 | 114 | R3R1SA264 | 115 |
| R3R1AF34924 | 93 | R3R1CX26418 | 104 | R3R1LAR264 | 114 | R3R1SA334 | 116 |
| R3R1AF34930 | 93 | R3R1CX26424 | 104 | R3R1LAR334 | 114 | R3R1SA342 | 116 |
| R3R1AF34936 | 93 | R3R1CX26430 | 104 | R3R1LAR342 | 114 | R3R1SA349 | 116 |
| R3R1AF34942 | 93 | R3R1CX26436 | 104 | R3R1LAR349 | 114 | R3R1SA364 | 116 |
| R3R1AF34948 | 93 | R3R1CX26442 | 104 | R3R1LAR364 | 114 | R3R1SAL34 | 115 |
| R3R1AF36418 | 93 | R3R1CX26448 | 104 | R3R1LARL34 | 113 | R3R1SAL42 | 115 |
| R3R1AF36424 | 93 | R3R1CX34218 | 105 | R3R1LARL42 | 113 | R3R1SAL49 | 115 |
| R3R1AF36430 | 93 | R3R1CX34224 | 105 | R3R1LARL49 | 113 | R3R1SAL64 | 115 |
| R3R1AF36436 | 93 | R3R1CX34230 | 105 | R3R1LARL64 | 113 | R3R2AF13418 | 99 |
| R3R1AF36442 | 93 | R3R1CX34236 | 105 | R3R1PF14218 | 95 | R3R2AF13424 | 99 |
| R3R1AF36448 | 93 | R3R1CX34242 | 105 | R3R1PF14224 | 95 | R3R2AF13430 | 99 |
| R3R1AFL3418 | 90 | R3R1CX34248 | 105 | R3R1PF14230 | 95 | R3R2AF13436 | 99 |
| R3R1AFL3424 | 90 | R3R1CX34918 | 105 | R3R1PF14236 | 95 | R3R2AF13442 | 99 |
| R3R1AFL3430 | 90 | R3R1CX34924 | 105 | R3R1PF14242 | 95 | R3R2AF13448 | 99 |
| R3R1AFL3436 | 90 | R3R1CX34930 | 105 | R3R1PF14248 | 95 | R3R2AF14918 | 99 |
| R3R1AFL3442 | 90 | R3R1CX34936 | 105 | R3R1PF14918 | 95 | R3R2AF14924 | 99 |
| R3R1AFL3448 | 90 | R3R1CX34942 | 105 | R3R1PF14924 | 95 | R3R2AF14930 | 99 |
| R3R1AFL4218 | 90 | R3R1CX34948 | 105 | R3R1PF14930 | 95 | R3R2AF14936 | 99 |
| R3R1AFL4224 | 90 | R3R1CX36418 | 105 | R3R1PF14936 | 95 | R3R2AF14942 | 99 |
| R3R1AFL4230 | 90 | R3R1CX36424 | 105 | R3R1PF14942 | 95 | R3R2AF14948 | 99 |
| R3R1AFL4236 | 90 | R3R1CX36430 | 105 | R3R1PF14948 | 95 | R3R2AF16418 | 99 |
| R3R1AFL4242 | 90 | R3R1CX36436 | 105 | R3R1PF24218 | 96 | R3R2AF16424 | 99 |

| <i>pattern no.</i> | <i>page</i> | <i>pattern no.</i> | <i>page</i> | <i>pattern no.</i> | <i>page</i> | <i>pattern no.</i> | <i>page</i> |
|--------------------|-------------|--------------------|-------------|---------------------------|-------------|--------------------|-------------|
| R3R2AF16430 | 99 | R3R2SXX4924 | 106 | RR3CHI482 | 126 | RR3-T36S | 121 |
| R3R2AF16436 | 99 | R3R2SXX4930 | 106 | RR3-DA | 122, 124 | RR3-T42NS | 124 |
| R3R2AF16442 | 99 | R3R2SXX4936 | 106 | RR3-DATSHD | 122, 124 | RR3-T42S | 121 |
| R3R2AF16448 | 99 | R3R2SXX4942 | 106 | RR3-DB | 122, 124 | RR3-T48NS | 124 |
| R3R2AF23418 | 100 | R3R2SXX4948 | 106 | RR3-DC | 124 | RR3-T48S | 121 |
| R3R2AF23424 | 100 | R3R2SXX6418 | 106 | RR3-DX | 122, 124 | RR3-T60-4 | 124 |
| R3R2AF23430 | 100 | R3R2SXX6424 | 106 | RR3-DXO | 122, 124 | RR3-T66-4 | 124 |
| R3R2AF23436 | 100 | R3R2SXX6430 | 106 | RR3-DY | 122, 124 | RR3-T72-4 | 124 |
| R3R2AF23442 | 100 | R3R2SXX6436 | 106 | RR3-DYO | 122, 124 | RR3-TJ18 | 125 |
| R3R2AF23448 | 100 | R3R2SXX6442 | 106 | RR3-DZ | 124 | RR3-TJ18P | 125 |
| R3R2AF24918 | 100 | R3R2SXX6448 | 106 | RR3-DZO | 124 | RR3-TJ20 | 125 |
| R3R2AF24924 | 100 | R3SPABPT | 120 | RR3-E24 | 122 | RR3-TJ20P | 125 |
| R3R2AF24930 | 100 | R3SPABTT | 120 | RR3-E24S | 121 | RR3-TJ24 | 125 |
| R3R2AF24936 | 100 | R3SPABTW | 120 | RR3-E30NS | 122 | RR3-TJ24P | 125 |
| R3R2AF24942 | 100 | R3X34E | 115 | RR3-E30S | 121 | RR3-TJ30 | 125 |
| R3R2AF24948 | 100 | R3X42E | 115 | RR3-E36NS | 122 | RR3-TJ30P | 125 |
| R3R2AF26418 | 100 | R3X49E | 115 | RR3-E36S | 121 | RR3-TJ36 | 125 |
| R3R2AF26424 | 100 | R3X64E | 115 | RR3-E42NS | 122 | RR3-TJ36P | 125 |
| R3R2AF26430 | 100 | RBCCP | 223 | RR3-E42S | 121 | RR3-TJ42 | 125 |
| R3R2AF26436 | 100 | RBF | 223 | RR3-E48NS | 122 | RR3-TJ42P | 125 |
| R3R2AF26442 | 100 | RCOUNTWT | 176, 177 | RR3-E48S | 121 | RR3-TJ48 | 125 |
| R3R2AF26448 | 100 | RHSC15 | 120 | RR3-E60-4 | 122 | RR3-TJ48P | 125 |
| R3R2AF33418 | 101 | RHSC250 | 120 | RR3-E66-4 | 122 | RR3-TJ54P | 125 |
| R3R2AF33424 | 101 | RHSC70 | 120 | RR3-E72-4 | 122 | RR3-TJ60P | 125 |
| R3R2AF33430 | 101 | RO1-CB | 201 | RR3-EJ18 | 123 | RR3-TJ66P | 125 |
| R3R2AF33436 | 101 | RO1-MPB | 201 | RR3-EJ18P | 123 | RR3-TJ72P | 125 |
| R3R2AF33442 | 101 | RO1-RCB | 201 | RR3-EJ20 | 123 | RR3-TJ78P | 125 |
| R3R2AF33448 | 101 | RO1-RPB | 201 | RR3-EJ20P | 123 | RR3-TJ84P | 125 |
| R3R2AF34918 | 101 | RO1-WMF2 | 201 | RR3-EJ24 | 123 | RR3-TJ90P | 125 |
| R3R2AF34924 | 101 | RO1-WMF3 | 201 | RR3-EJ24P | 123 | RR3-TJ96P | 125 |
| R3R2AF34930 | 101 | RO1-WMF4 | 201 | RR3-EJ30 | 123 | RR3-TPC | 124 |
| R3R2AF34936 | 101 | RO3-A30NL | 200 | RR3-EJ30P | 123 | RR3-TPC24 | 124 |
| R3R2AF34942 | 101 | RO3-A30NN | 200 | RR3-EJ36 | 123 | RR3-TPCP | 124 |
| R3R2AF34948 | 101 | RO3-A30PL | 200 | RR3-EJ36P | 123 | RR3-TPCP24 | 124 |
| R3R2AF36418 | 101 | RO3-A30PN | 200 | RR3-EJ42 | 123 | RR3-TPCPS | 124 |
| R3R2AF36424 | 101 | RO3-A36NL | 200 | RR3-EJ42P | 123 | RR3-TPCS | 124 |
| R3R2AF36430 | 101 | RO3-A36NN | 200 | RR3-EJ48 | 123 | RR3-TPI | 125 |
| R3R2AF36436 | 101 | RO3-A36PL | 200 | RR3-EJ48P | 123 | RR3-TPNY1 | 125 |
| R3R2AF36442 | 101 | RO3-A36PN | 200 | RR3-EJ54P | 123 | RR3-TPNY2 | 125 |
| R3R2AF36448 | 101 | RO3-A42NL | 200 | RR3-EJ60P | 123 | RR3-TPVR | 125 |
| R3R2AFL3418 | 98 | RO3-A42NN | 200 | RR3-EJ66P | 123 | RSPABPP | 120 |
| R3R2AFL3424 | 98 | RO3-A42PL | 200 | RR3-EJ72P | 123 | RSPABPW | 120 |
| R3R2AFL3430 | 98 | RO3-A42PN | 200 | RR3-EJ78P | 123 | RSPABWW | 120 |
| R3R2AFL3436 | 98 | RO3-A48NL | 200 | RR3-EJ84P | 123 | RT1 SMK 1812 | 204 |
| R3R2AFL3442 | 98 | RO3-A48NN | 200 | RR3-EJ90P | 123 | RT1 SMK 1813 | 204 |
| R3R2AFL3448 | 98 | RO3-A48PL | 200 | RR3-EJ96P | 123 | RT1 SMK 1815 | 205 |
| R3R2AFL4918 | 98 | RO3-A48PN | 200 | RR3-EPC | 122 | RT1 SMK 1816 | 205 |
| R3R2AFL4924 | 98 | RO3-A60NL | 200 | RR3-EPC24 | 122 | RT1 SMK 2412 | 204 |
| R3R2AFL4930 | 98 | RO3-A60NN | 200 | RR3-EPCP | 122 | RT1 SMK 2413 | 204 |
| R3R2AFL4936 | 98 | RO3-A60PL | 200 | RR3-EPCP24 | 122 | RT1 SMK 2415 | 205 |
| R3R2AFL4942 | 98 | RO3-A60PN | 200 | RR3-EPCPS | 122 | RT1 SMK 2416 | 205 |
| R3R2AFL4948 | 98 | RO3-A72NL | 200 | RR3-EPCS | 122 | RT1 SMK 3012 | 204 |
| R3R2AFL6418 | 98 | RO3-A72NN | 200 | RR3-EPI | 123 | RT1 SMK 3013 | 204 |
| R3R2AFL6424 | 98 | RO3-A72PL | 200 | RR3-EPNY1 | 123 | RT1 SMK 3015 | 205 |
| R3R2AFL6430 | 98 | RO3-A72PN | 200 | RR3-EPNY2 | 123 | RT1 SMK 3016 | 205 |
| R3R2AFL6436 | 98 | RPETAD | 174 | RR3-EPVR | 123 | RT1 SMK 3612 | 204 |
| R3R2AFL6442 | 98 | RR3CHI241 | 126 | RR3-REPI | 123 | RT1 SMK 3613 | 204 |
| R3R2AFL6448 | 98 | RR3CHI242 | 126 | RR3-RTPI | 125 | RT1 SMK 3615 | 205 |
| R3R2SXX4218 | 106 | RR3CHI301 | 126 | RR3-SP-(A, B, C, X, Y, Z) | 125 | RT1 SMK 3616 | 205 |
| R3R2SXX4224 | 106 | RR3CHI302 | 126 | RR3-SP-(A,B,X,Y) | 123 | RT1 SMK 4212 | 204 |
| R3R2SXX4230 | 106 | RR3CHI361 | 126 | RR3-T24 | 124 | RT1 SMK 4213 | 204 |
| R3R2SXX4236 | 106 | RR3CHI362 | 126 | RR3-T24S | 121 | RT1 SMK 4215 | 205 |
| R3R2SXX4242 | 106 | RR3CHI421 | 126 | RR3-T30NS | 124 | RT1 SMK 4216 | 205 |
| R3R2SXX4248 | 106 | RR3CHI422 | 126 | RR3-T30S | 121 | RT1 SMK 4812 | 204 |
| R3R2SXX4918 | 106 | RR3CHI481 | 126 | RR3-T36NS | 124 | RT1 SMK 4813 | 204 |

| <i>pattern no.</i> | <i>page</i> | <i>pattern no.</i> | <i>page</i> | <i>pattern no.</i> | <i>page</i> | <i>pattern no.</i> | <i>page</i> |
|--------------------|-------------|--------------------|-------------|--------------------|-------------|--------------------|-------------|
| RT1 SMK 4815 | 205 | XTB1 BAS 24D25SF | 242 | XTB1 BAS 36S18SA | 251 | XTB1TB5E | 253 |
| RT1 SMK 4816 | 205 | XTB1 BAS 24S10CF | 243 | XTB1 BAS 36S18SF | 249 | XTB1TB6C | 253 |
| RT1 SMK 5412 | 204 | XTB1 BAS 24S12CF | 243 | XTB1 BAS 36S20SA | 251 | XTB1TB6E | 253 |
| RT1 SMK 5413 | 204 | XTB1 BAS 24S15CF | 243 | XTB1 BAS 36S20SF | 249 | XTB1TB8C | 253 |
| RT1 SMK 5415 | 205 | XTB1 BAS 24S15SF | 243 | XTB1 BAS 36S24SA | 251 | XTB1TB8E | 253 |
| RT1 SMK 5416 | 205 | XTB1 BAS 24S18SF | 243 | XTB1 BAS 36S24SF | 249 | XTB1XD30 | 259 |
| RT1 SMK 6012 | 204 | XTB1 BAS 24S20SF | 243 | XTB1 BAS 36S25SA | 251 | XTB1XD30N | 259 |
| RT1 SMK 6013 | 204 | XTB1 BAS 24S24SF | 243 | XTB1 BAS 36S25SF | 249 | XTB1XD36 | 259 |
| RT1 SMK 6015 | 205 | XTB1 BAS 24S25SF | 243 | XTB1 SLIK | 256 | XTB1XD36N | 259 |
| RT1 SMK 6016 | 205 | XTB1 BAS 30D10CA | 246 | XTB1 SLIK30 | 256 | XTB1XDD24 | 256 |
| RT1 SMK 6612 | 204 | XTB1 BAS 30D10CF | 244 | XTB1 SLIK36 | 256 | XTB1XDD30 | 256 |
| RT1 SMK 6613 | 204 | XTB1 BAS 30D12CA | 246 | XTB1AC | 260 | XTB1XDD36 | 256 |
| RT1 SMK 6615 | 205 | XTB1 BAS 30D12CF | 244 | XTB1AC24 | 260 | XTB1XS30 | 259 |
| RT1 SMK 6616 | 205 | XTB1 BAS 30D15CA | 246 | XTB1ACEND | 261 | XTB1XS30N | 259 |
| RT1 SMK 7212 | 204 | XTB1 BAS 30D15CF | 244 | XTB1DB10C | 254 | XTB1XS36 | 259 |
| RT1 SMK 7213 | 204 | XTB1 BAS 30D15SA | 246 | XTB1DB10E | 254 | XTB1XS36N | 259 |
| RT1 SMK 7215 | 205 | XTB1 BAS 30D15SF | 244 | XTB1DB12C | 254 | XTB1YDD24 | 257 |
| RT1 SMK 7216 | 205 | XTB1 BAS 30D18SA | 246 | XTB1DB12E | 254 | XTB1YDD30 | 257 |
| RT1 SMK 7812 | 204 | XTB1 BAS 30D18SF | 244 | XTB1DB15C | 254 | XTB1YDD36 | 257 |
| RT1 SMK 7813 | 204 | XTB1 BAS 30D20SA | 246 | XTB1DB15E | 254 | XTBT18 | 270 |
| RT1 SMK 7815 | 205 | XTB1 BAS 30D20SF | 244 | XTB1DB4E | 254 | XTBT24 | 270 |
| RT1 SMK 7816 | 205 | XTB1 BAS 30D24CA | 246 | XTB1DB5C | 254 | XTBT36 | 270 |
| RT1 SMK 8412 | 204 | XTB1 BAS 30D24CF | 244 | XTB1DB5E | 254 | XTBT48 | 270 |
| RT1 SMK 8413 | 204 | XTB1 BAS 30D25CA | 246 | XTB1DB6C | 254 | XTBT60 | 270 |
| RT1 SMK 8415 | 205 | XTB1 BAS 30D25CF | 244 | XTB1DB6E | 254 | XTC1 120 AA | 252 |
| RT1 SMK 8416 | 205 | XTB1 BAS 30S10CA | 247 | XTB1DB8C | 254 | XTC1 144 AA | 252 |
| RT1 SMK 9012 | 204 | XTB1 BAS 30S10CF | 245 | XTB1DB8E | 254 | XTC1 48 | 252 |
| RT1 SMK 9013 | 204 | XTB1 BAS 30S12CA | 247 | XTB1EDD24 | 256 | XTC1 60 | 252 |
| RT1 SMK 9015 | 205 | XTB1 BAS 30S12CF | 245 | XTB1EDD30 | 256 | XTC1 72 | 252 |
| RT1 SMK 9016 | 205 | XTB1 BAS 30S15CA | 247 | XTB1EDD36 | 256 | XTC1 96 | 252 |
| RT1 SMK 9612 | 204 | XTB1 BAS 30S15CF | 245 | XTB1ESD24 | 258 | XTC1 END | 252 |
| RT1 SMK 9613 | 204 | XTB1 BAS 30S15SA | 247 | XTB1ESD30 | 258 | XTCA1 120 AA | 252 |
| RT1 SMK 9615 | 205 | XTB1 BAS 30S15SF | 245 | XTB1ESD36 | 258 | XTCA1 144 AA | 252 |
| RT1 SMK 9616 | 205 | XTB1 BAS 30S18SA | 247 | XTB1FC | 260 | XTCA1 48 | 252 |
| RT1 SMK B | 204, 205 | XTB1 BAS 30S18SF | 245 | XTB1FC24 | 260 | XTCA1 60 | 252 |
| RTAT5E19 | 202 | XTB1 BAS 30S20SA | 247 | XTB1FCEND | 261 | XTCA1 72 | 252 |
| RTAT5E25 | 202 | XTB1 BAS 30S20SF | 245 | XTB1LDD | 256 | XTCA1 96 | 252 |
| RTAT5E37 | 202 | XTB1 BAS 30S24SA | 247 | XTB1LDD24 | 256 | XTCF 48 | 252 |
| RTAT5E49 | 202 | XTB1 BAS 30S24SF | 245 | XTB1LP | 261 | XTCF 60 | 252 |
| RTAT5E61 | 202 | XTB1 BAS 30S25SA | 247 | XTB1LSD | 258 | XTCF 72 | 252 |
| XAUA 1248C | 282 | XTB1 BAS 30S25SF | 245 | XTB1LSD24 | 258 | XTCS1 4714 | 271 |
| XAUA 1260G | 282 | XTB1 BAS 36D10CA | 250 | XTB1MB | 260 | XTCS1 4714F | 272 |
| XAUA 1272G | 282 | XTB1 BAS 36D10CF | 248 | XTB1RAK | 269 | XTCS1 4721 | 271 |
| XT1DS4505 | 273 | XTB1 BAS 36D12CA | 250 | XTB1SB10C | 255 | XTCS1 4721F | 272 |
| XT1DS5705 | 273 | XTB1 BAS 36D12CF | 248 | XTB1SB10E | 255 | XTCS1 4814 | 271 |
| XT1DS6905 | 273 | XTB1 BAS 36D15CA | 250 | XTB1SB12C | 255 | XTCS1 4814F | 272 |
| XT1LS4509 | 273 | XTB1 BAS 36D15CF | 248 | XTB1SB12E | 255 | XTCS1 4821 | 271 |
| XT1LS5709 | 273 | XTB1 BAS 36D15SA | 250 | XTB1SB15C | 255 | XTCS1 4821F | 272 |
| XT1LS6909 | 273 | XTB1 BAS 36D15SF | 248 | XTB1SB15E | 255 | XTCS1 5914 | 271 |
| XT1SA24 | 273 | XTB1 BAS 36D18SA | 250 | XTB1SB4E | 255 | XTCS1 5914F | 272 |
| XT1SA30 | 273 | XTB1 BAS 36D18SF | 248 | XTB1SB5C | 255 | XTCS1 5921 | 271 |
| XT1SA36 | 273 | XTB1 BAS 36D20SA | 250 | XTB1SB5E | 255 | XTCS1 5921F | 272 |
| XT1SA42 | 273 | XTB1 BAS 36D20SF | 248 | XTB1SB6C | 255 | XTCS1 6014 | 271 |
| XT1SA48 | 273 | XTB1 BAS 36D24CA | 250 | XTB1SB6E | 255 | XTCS1 6014F | 272 |
| XT1SA54 | 273 | XTB1 BAS 36D24CF | 248 | XTB1SB8C | 255 | XTCS1 6021 | 271 |
| XT1SA60 | 273 | XTB1 BAS 36D25CA | 250 | XTB1SB8E | 255 | XTCS1 6021F | 272 |
| XT1SA66 | 273 | XTB1 BAS 36D25CF | 248 | XTB1T24 | 259 | XTCS1 7114 | 271 |
| XT1SA72 | 273 | XTB1 BAS 36S10CA | 251 | XTB1TB10C | 253 | XTCS1 7114F | 272 |
| XTB1 BAS 24D10CF | 242 | XTB1 BAS 36S10CF | 249 | XTB1TB10E | 253 | XTCS1 7121 | 271 |
| XTB1 BAS 24D12CF | 242 | XTB1 BAS 36S12CA | 251 | XTB1TB12C | 253 | XTCS1 7121F | 272 |
| XTB1 BAS 24D15CF | 242 | XTB1 BAS 36S12CF | 249 | XTB1TB12E | 253 | XTCS1 7214 | 271 |
| XTB1 BAS 24D15SF | 242 | XTB1 BAS 36S15CA | 251 | XTB1TB15C | 253 | XTCS1 7214F | 272 |
| XTB1 BAS 24D18SF | 242 | XTB1 BAS 36S15CF | 249 | XTB1TB15E | 253 | XTCS1 7221 | 271 |
| XTB1 BAS 24D20SF | 242 | XTB1 BAS 36S15SA | 251 | XTB1TB4E | 253 | XTCS1 7221F | 272 |
| XTB1 BAS 24D24SF | 242 | XTB1 BAS 36S15SF | 249 | XTB1TB5C | 253 | XTCS1 SBA | 273 |

| <i>pattern no.</i> | <i>page</i> | <i>pattern no.</i> | <i>page</i> | <i>pattern no.</i> | <i>page</i> | <i>pattern no.</i> | <i>page</i> |
|--------------------|---------------|-----------------------|------------------------------|-----------------------|-------------|--------------------|-------------|
| XTCT6030D | 269 | XTR1TCC25 | 269 | XTTK4824C (L/M/1/2/3) | 237 | XTPP4836B (L) | 236 |
| XTCT6030LD | 269 | XTR1TCPM | 265 | XTTK4824E (L/M/1/2/3) | 238 | XTPP4836C (L) | 237 |
| XTCT6036D | 269 | XTR1TJ18 | 265 | XTTK4824U (L/M/1/2/3) | 236 | XTPP4836D (L) | 240 |
| XTCT6036LD | 269 | XTR1TJ30 | 265 | XTTK4830A (L/M/1/2/3) | 235 | XTPP4836E (L) | 240 |
| XTCT7230D | 269 | XTR1TJ42 | 265 | XTTK4830C (L/M/1/2/3) | 237 | XTPP6024A (L) | 235 |
| XTCT7230LD | 269 | XTR1TPH | 265 | XTTK4830E (L/M/1/2/3) | 238 | XTPP6024B (L) | 236 |
| XTCT7236D | 269 | XTR1TPI | 265 | XTTK4830U (L/M/1/2/3) | 236 | XTPP6024C (L) | 237 |
| XTCT7236LD | 269 | XTR1X30D | 266 | XTTK4836A (L/M/1/2/3) | 235 | XTPP6024E (L) | 238 |
| XTD42 | 269 | XTR1X30S | 266 | XTTK4836C (L/M/1/2/3) | 237 | XTPP6030A (L) | 235 |
| XTD42 | 269 | XTR1X424D | 266 | XTTK4836D (L/M/1/2/3) | 239 | XTPP6030B (L) | 236 |
| XTES1 2414 | 280 | XTR1X424S | 266 | XTTK4836E (L/M/1/2/3) | 239 | XTPP6030C (L) | 237 |
| XTES1 2414F | 281 | XTR1XCPM | 267 | XTTK4836U (L/M/1/2/3) | 236 | XTPP6030E (L) | 238 |
| XTES1 2421 | 280 | XTR1XJ18 | 267 | XTTK6018F (L/M/1/2/3) | 241 | XTPP6036A (L) | 235 |
| XTES1 2421F | 281 | XTR1XJ30 | 267 | XTTK6024A (L/M/1/2/3) | 235 | XTPP6036B (L) | 236 |
| XTES1 3014 | 280 | XTR1XJ42 | 267 | XTTK6024C (L/M/1/2/3) | 237 | XTPP6036C (L) | 237 |
| XTES1 3014F | 281 | XTR1XPH | 267 | XTTK6024E (L/M/1/2/3) | 238 | XTPP6036D (L) | 240 |
| XTES1 3021 | 280 | XTR1XPI | 267 | XTTK6024U (L/M/1/2/3) | 236 | XTPP6036E (L) | 240 |
| XTES1 3021F | 281 | XTRS1 5414 | 276 | XTTK6030A (L/M/1/2/3) | 235 | XTPP7224A (L) | 235 |
| XTES1 3614 | 280 | XTRS1 5414F | 277 | XTTK6030C (L/M/1/2/3) | 237 | XTPP7224B (L) | 236 |
| XTES1 3614F | 281 | XTRS1 5421 | 276 | XTTK6030E (L/M/1/2/3) | 238 | XTPP7224C (L) | 237 |
| XTES1 3621 | 280 | XTRS1 5421F | 277 | XTTK6030U (L/M/1/2/3) | 236 | XTPP7224E (L) | 238 |
| XTES1 3621F | 281 | XTRS1 6014 | 276 | XTTK6036A (L/M/1/2/3) | 235 | XTPP7230A (L) | 235 |
| XTES1 4814 | 278 | XTRS1 6014F | 277 | XTTK6036C (L/M/1/2/3) | 237 | XTPP7230B (L) | 236 |
| XTES1 4814F | 279 | XTRS1 6021 | 276 | XTTK6036D (L/M/1/2/3) | 239 | XTPP7230C (L) | 237 |
| XTES1 4821 | 278 | XTRS1 6021F | 277 | XTTK6036E (L/M/1/2/3) | 239 | XTPP7230E (L) | 238 |
| XTES1 4821F | 279 | XTRS1 6614 | 276 | XTTK6036F (L/M/1/2/3) | 241 | XTPP7236A (L) | 235 |
| XTES1 6014 | 278 | XTRS1 6614F | 277 | XTTK6036U (L/M/1/2/3) | 236 | XTPP7236B (L) | 236 |
| XTES1 6014F | 279 | XTRS1 6621 | 276 | XTTK7218F (L/M/1/2/3) | 241 | XTPP7236C (L) | 237 |
| XTES1 6021 | 278 | XTRS1 6621F | 277 | XTTK7224A (L/M/1/2/3) | 235 | XTPP7236D (L) | 240 |
| XTES1 6021F | 279 | XTRS1 7214 | 276 | XTTK7224C (L/M/1/2/3) | 237 | XTPP7236E (L) | 240 |
| XTES1 7214 | 278 | XTRS1 7214F | 277 | XTTK7224E (L/M/1/2/3) | 238 | XTPP9624A (L) | 235 |
| XTES1 7214F | 279 | XTRS1 7221 | 276 | XTTK7224U (L/M/1/2/3) | 236 | XTPP9624B (L) | 236 |
| XTES1 7221 | 278 | XTRS1 7221F | 277 | XTTK7230A (L/M/1/2/3) | 235 | XTPP9624C (L) | 237 |
| XTES1 7221F | 279 | XTRS1 7814 | 276 | XTTK7230C (L/M/1/2/3) | 237 | XTPP9630A (L) | 235 |
| XTPS1MZKIT | 283 | XTRS1 7814F | 277 | XTTK7230E (L/M/1/2/3) | 238 | XTPP9630B (L) | 236 |
| XTR1BCC50 | 269 | XTRS1 7821 | 276 | XTTK7230U (L/M/1/2/3) | 236 | XTPP9630C (L) | 237 |
| XTR1D1 | 267 | XTRS1 7821F | 277 | XTTK7236A (L/M/1/2/3) | 235 | XTPP9636A (L) | 235 |
| XTR1D2 | 267 | XTSM1C | 278, 279 | XTTK7236C (L/M/1/2/3) | 237 | XTPP9636B (L) | 236 |
| XTR1D3 | 267 | XTSM1K | 274, 275 | XTTK7236D (L/M/1/2/3) | 239 | XTPP9636C (L) | 237 |
| XTR1D4 | 267 | XTSM1KC | 280, 281 | XTTK7236E (L/M/1/2/3) | 239 | XTTS3018F (1/2/3) | 241 |
| XTR1DA | 263, 265 | XTSM1KK | 278, 279 | XTTK7236F (L/M/1/2/3) | 241 | XTTS3618F (1/2/3) | 241 |
| XTR1DB | 263, 265 | XTSM1P | 274, 275, 276, 277, 278, 279 | XTTK7236U (L/M/1/2/3) | 236 | XTTS4218F (1/2/3) | 241 |
| XTR1DC | 265 | XTSM1PC | 280, 281 | XTTK8418F (L/M/1/2/3) | 241 | XTTS4824A (1/2/3) | 235 |
| XTR1DXO | 263, 265 | XTSM1S | 274, 275, 276, 277, 278, 279 | XTTK8436F (L/M/1/2/3) | 241 | XTTS4824C (1/2/3) | 237 |
| XTR1DYO | 263, 265 | XTSM1SC | 280, 281 | XTTK9624A (L/M/1/2/3) | 235 | XTTS4824E (1/2/3) | 238 |
| XTR1DZO | 265 | XTSM1SLAT | 278, 279 | XTTK9624C (L/M/1/2/3) | 237 | XTTS4824U (1/2/3) | 236 |
| XTR1E30D | 262 | XTSS1 2414 | 274 | XTTK9624U (L/M/1/2/3) | 236 | XTTS4830A (1/2/3) | 235 |
| XTR1E30S | 262 | XTSS1 2414F | 275 | XTTK9630A (L/M/1/2/3) | 235 | XTTS4830C (1/2/3) | 237 |
| XTR1E424D | 262 | XTSS1 2421 | 274 | XTTK9630C (L/M/1/2/3) | 237 | XTTS4830E (1/2/3) | 238 |
| XTR1E424S | 262 | XTSS1 2421F | 275 | XTTK9630U (L/M/1/2/3) | 236 | XTTS4830U (1/2/3) | 236 |
| XTR1ECPM | 263 | XTSS1 3014 | 274 | XTTK9636A (L/M/1/2/3) | 235 | XTTS4836A (1/2/3) | 235 |
| XTR1EE | 262, 264, 268 | XTSS1 3014F | 275 | XTTK9636C (L/M/1/2/3) | 237 | XTTS4836C (1/2/3) | 237 |
| XTR1EJ18 | 263 | XTSS1 3021 | 274 | XTTK9636U (L/M/1/2/3) | 236 | XTTS4836D (1/2/3) | 239 |
| XTR1EJ30 | 263 | XTSS1 3021F | 275 | XTPP3018F (L) | 241 | XTTS4836E (1/2/3) | 239 |
| XTR1EJ42 | 263 | XTSS1 3614 | 274 | XTPP3618F (L) | 241 | XTTS4836U (1/2/3) | 236 |
| XTR1EPH | 263 | XTSS1 3614F | 275 | XTPP4218F (L) | 241 | XTTS6024A (1/2/3) | 235 |
| XTR1EPI | 263 | XTSS1 3621 | 274 | XTPP4824A (L) | 235 | XTTS6024C (1/2/3) | 237 |
| XTR1FE | 262, 264, 268 | XTSS1 3621F | 275 | XTPP4824B (L) | 236 | XTTS6024E (1/2/3) | 238 |
| XTR1H30D | 268 | XTTK3018F (L/M/1/2/3) | 241 | XTPP4824C (L) | 237 | XTTS6024U (1/2/3) | 236 |
| XTR1OF | 263, 265, 268 | XTTK3036F (L/M/1/2/3) | 241 | XTPP4824E (L) | 238 | XTTS6030A (1/2/3) | 235 |
| XTR1PDCX | 263, 265 | XTTK3618F (L/M/1/2/3) | 241 | XTPP4830A (L) | 235 | XTTS6030C (1/2/3) | 237 |
| XTR1T30D | 264 | XTTK3636F (L/M/1/2/3) | 241 | XTPP4830B (L) | 236 | XTTS6030E (1/2/3) | 238 |
| XTR1T30S | 264 | XTTK4218F (L/M/1/2/3) | 241 | XTPP4830C (L) | 237 | XTTS6030U (1/2/3) | 236 |
| XTR1T424D | 264 | XTTK4236F (L/M/1/2/3) | 241 | XTPP4830E (L) | 238 | XTTS6036A (1/2/3) | 235 |
| XTR1T424S | 264 | XTTK4824A (L/M/1/2/3) | 235 | XTPP4836A (L) | 235 | XTTS6036C (1/2/3) | 237 |

| <i>pattern no.</i> | <i>page</i> |
|--------------------|-------------|
| XTTS6036D (1/2/3) | 239 |
| XTTS6036E (1/2/3) | 239 |
| XTTS6036U (1/2/3) | 236 |
| XTTS7224A (1/2/3) | 235 |
| XTTS7224C (1/2/3) | 237 |
| XTTS7224E (1/2/3) | 238 |
| XTTS7224U (1/2/3) | 236 |
| XTTS7230A (1/2/3) | 235 |
| XTTS7230C (1/2/3) | 237 |
| XTTS7230E (1/2/3) | 238 |
| XTTS7230U (1/2/3) | 236 |
| XTTS7236A (1/2/3) | 235 |
| XTTS7236C (1/2/3) | 237 |
| XTTS7236D (1/2/3) | 239 |
| XTTS7236E (1/2/3) | 239 |
| XTTS7236U (1/2/3) | 236 |
| XTTS9624A (1/2/3) | 235 |
| XTTS9624C (1/2/3) | 237 |
| XTTS9624U (1/2/3) | 236 |
| XTTS9630A (1/2/3) | 235 |
| XTTS9630C (1/2/3) | 237 |
| XTTS9630U (1/2/3) | 236 |
| XTTS9636A (1/2/3) | 235 |
| XTTS9636C (1/2/3) | 237 |
| XTTS9636U (1/2/3) | 236 |
| XTWB120 | 270 |
| XTWTB | 270 |
| XTWTBSLIK | 270 |
| XTWTC | 270 |
| XTWTX | 270 |

Selling Policy

| | |
|--|---|
| | <p>This Selling Policy supercedes all previous selling policies. Prices, discounts and product offerings are subject to change without notice.</p> |
| Terms & Conditions of Sales | <p>Sales by Knoll, Inc. or Knoll North America Corp. ("Seller") of Knoll Product Lines (hereinafter "Products") within the United States and Canada are made only on the terms which are contained in this Selling Policy. Seller hereby gives notice of its objection to any different or additional terms and conditions. This sale is expressly conditional upon Purchaser's assent to the terms and conditions set forth below. Additional terms and conditions may apply to KnollStudio and KnollTextiles orders. These terms and conditions may be modified or supplemented only by a written document signed by an authorized representative of Seller. These terms and conditions supercede any prior and/or contemporaneous agreements or correspondence between Purchaser and Seller. Written quotations expire thirty (30) days from the date of issuance and can be withdrawn by written notice anytime during that period. Where Purchaser and Seller have entered into the Knoll Electronic Terms and Conditions, all orders, acknowledgements, invoices and other business communications placed or transmitted in accordance with the Knoll Electronic Terms and Conditions shall be deemed to be in writing and signed and shall be valid for all purposes as if they were originated and maintained in documentary form.</p> |
| Ordering Information | <p>All orders must be in writing. The product pattern number(s) contained on Seller's order acknowledgement shall be the final expression of the order.</p> |
| Order Confirmation | <p>A purchase order is not binding on Seller until Purchaser has received Seller's order confirmation or acknowledgment.</p> |
| Pricing Policies | <p>List prices are subject to change without notice.</p> <p>List prices shall be those prices in effect on the date of receipt of a complete purchase order unless shipment is requested more than ninety (90) days after order entry in which case prices in effect on the date of shipment apply. List prices include specified freight costs. Unless specified in writing by Seller, no other charges are included in Seller's list prices.</p> |
| Taxes | <p>All sales, use, excise and other taxes applicable to the sale of the Products shall be paid by Purchaser. If Purchaser claims an exemption from any tax, Purchaser shall submit to Seller the appropriate exemption certificates.</p> |
| Terms of Payment | <p>Payment for one hundred percent (100%) of the net order amount is due within thirty (30) days of the date of invoice, which is issued upon shipment. In case of any discrepancies, such as shortages, and Seller is notified in writing within ten (10) days of receipt of Product, only that portion may be deducted and the balance paid. For orders greater than \$100,000 net, a fifty percent (50%) deposit is due at the time of order placement, with the remainder due within thirty (30) days of the date of invoice.</p> <p>KnollStudio orders less than \$2,000 require payment for one hundred percent (100%) of the net order amount (including any applicable sales tax and charges for inside delivery, special packaging, etc.), due at time of order placement. For KnollStudio orders greater than \$2,000, a one-half (50%) deposit is due at time of order placement with the remainder (including any applicable sales tax and charges for inside delivery, special packaging, etc.) due prior to shipment.</p> <p>If, in the judgment of Seller, Purchaser's financial condition does not justify the terms of the payment, Seller may require full or partial payment in advance.</p> <p>Past due accounts shall be charged one and one-half percent (1.5%) per month, or the highest rate permitted by law, whichever is less, and will be added to the outstanding balance. In the event Purchaser defaults on payment, Purchaser shall be liable for all collection costs, including reasonable attorney's fees and costs.</p> |
| Changes and Cancellation | <p>Purchase orders may not be changed or cancelled, in whole or in part, without prior written consent of Seller. Changes may effect delivery dates. Expenses incurred because of changes shall be charged to Purchaser. In the event of cancellations, Purchaser will be liable for reasonable cancellation charges established by Seller. Orders for special Product, orders including "COM" (hereinafter defined) material and orders pursuant to expedited delivery programs, may not be canceled.</p> |
| Freight Prepaid | <p>Freight is prepaid and included in the price of all Products, except KnollTextiles, within the 48 contiguous United States for orders placed with Knoll, Inc. and within Canada, excluding the Yukon, Northwest Territories, Nunavut and Newfoundland for orders placed with Knoll North America Corp. Packing is tested for rigorous motion and transportation but is not guaranteed to protect furniture from conditions over which the Seller has no control. If special packaging is required for any reason, please consult with your sales representative or dealer. Seller shall select the method of shipment and routing. All shipments shall be tailgate deliveries. Freight for all KnollTextiles orders is prepaid and added to the invoice.</p> |
| Delivery/Freight Charges | <p>Shipments outside the contiguous 48 United States and Canada shall be shipped F.O.B. Origin.</p> <p>For shipments outside the contiguous United States and Canada, Purchaser is responsible for the cost of freight from point of embarkation, including any handling and transportation charges incidental to loading at the point of departure and unloading at the final destination.</p> <p>Conditions beyond the control of Seller, including weather, available facilities and traffic conditions, may affect exact time of delivery. Seller shall not be responsible for specific carrier delivery date or time unless it has made a specific delivery commitment, in writing.</p> <p>Nonstandard methods of shipment and/or additional services are available upon request. Purchaser will be billed for the differential cost of any special services in excess of standard surface carrier freight costs. Premium charges, at Purchaser's request, will be added for airfreight, exclusive use of vehicle and extra, export or special packaging. Accessorial charges will be added for inside delivery, extra labor, reassignment and redelivery.</p> <p>Partial shipments may be made and invoiced by Seller.</p> |
| Claims | <p>All shipments for all Knoll Products within the contiguous United States and Canada are F.O.B. Origin. Risk of loss passes to Purchaser at time of delivery to carrier. Purchaser shall inspect all Products upon receipt and notify Seller within ten (10) working days after receipt of any damage or defects which are, or should be, apparent from an inspection of the Product and its packaging. Failure of Purchaser to make a claim against carrier or notify Seller during the ten (10) working day period shall constitute acceptance of the Products and waiver of any apparent defects, errors or shortages. Seller will agree to repair or replace Product damaged in shipment if Purchaser has notified Seller of freight damage within ten (10) working days after receipt and assigns its rights against the carrier.</p> |
| Seller's Security Interest | <p>Until Seller receives the full payment for the Product, Seller shall have a security interest in the Product. Purchaser agrees to perform all acts, including but not limited to the execution and filing of documentation, which may be necessary to perfect and assure the security interest of Seller.</p> |
| Returns | <p>The return of Products without a written authorization by Seller shall not be accepted. To receive authorization for Product return, please call Customer Service. All Products that are returned pursuant to a valid authorization shall be subject to a twenty-five percent (25%) of list restocking charge. Products not currently offered for sale by Seller (including COM) shall not be authorized for return. All returned Products must be unused, in original condition and in the original Seller packing cartons. No refund or credit shall be given for damaged Products.</p> |
| Held Orders/Storage | <p>If Purchaser requests that an order be held or delayed, prices and terms and conditions in effect at the time of shipment shall apply. If Purchaser requests a delay after the time when Seller can defer production, Purchaser will be invoiced for the Product, payable in accordance with standard terms, when the order is ready for shipment. Seller may transfer the Product to storage, in which case all expenses incurred in connection with storage, including demurrage, preparation for storage, storage charges and handling shall be payable by Purchaser upon submission of invoices by Seller. Risk of loss to the Product shall pass to the Purchaser upon delivery of the Product into storage.</p> |

Selling Policy

| | |
|---------------------------------|--|
| Customer's Own Material | A Purchaser who requests a fabric or other surface material not standard to Seller's line of Products ("COM") must submit samples of the requested material to Seller prior to entry of a purchaser order. Seller shall determine if the material is suitable to its manufacturing processes and meets any requirements of Underwriters Laboratories. If the COM is acceptable, Seller will then establish a price for using the COM or the Product in question. For a description of the procedures for submitting samples and testing, contact customer resources or your sales representative. Seller shall have no responsibility for the appearance, condition, performance, durability, colorfastness or any other physical attribute of the COM. Purchaser shall indemnify and hold Seller harmless for any damages, injuries or losses arising out of or related to use of the COM on the Product. |
| Warranty | Seller warrants to the original Purchaser only that the Products Seller manufactures and sells to Purchaser are free of defects in workmanship and materials, during the applicable warranty period set forth below. Warranty period set forth below for <i>Bulldog, Chadwick, Essentials Work Chairs, Life, Moment, Open Up, RPM, Sapper</i> and <i>SoHo</i> seating is for 24-hour, 7 days a week, multi shift use. Should any failure to conform with this limited warranty appear to a Product listed below during the applicable warranty period from the date of shipment, Seller shall, upon prompt written notice, repair or replace, at its option and costs, the affected part or parts. <i>Product and Period of Warranty</i> <i>Lifetime: AutoStrada, Calibre, Crinion Open Table, Currents, Dividends Horizon, Equity, Morrison, Reff</i> laminate, <i>Series 2 Storage</i> and other non-wood components (except cascade edge worksurfaces, operational parts, controls, electrical, <i>Series 2 Veneer Front Storage</i> , special or custom products, see below) <i>10 Years: AutoStrada, Crinion Open Table, Reff</i> wood components, <i>Series 2 Veneer Front Storage, Wood Casegoods (Magnusson, The Graham Collection), Interaction</i> tables (except height adjustment mechanisms for <i>Counterforce</i> , crank-adjustable, and split-top tables and worksurfaces, see below), <i>Reuter</i> overheads, <i>Reuter</i> vertical storage, <i>Bulldog, Chadwick, Essentials Work Chairs, Life, Moment, RPM</i> and <i>Sapper</i> seating structural and operational parts, controls, casters, pneumatic cylinders, seat and back mesh (except seating upholstery, finishes and labor, wood casegoods upholstered surfaces, see below) <i>5 Years: Operational parts, controls, electrical (except light ballasts and bulbs, see below), cascade edge worksurfaces, special or custom product, wood veneer products, Currents</i> handcrank, <i>Interaction Counterforce, Interaction</i> crank-adjustable, and split-top mechanisms, <i>KnollStudio, KnollExtra</i> adjustable keyboard supports, VDT carousel, monitor platform, equipment storage drawers and all universal storage drawers, <i>Open Up and SoHo</i> seating structural and operational parts, controls, pneumatic cylinders (except seating upholstery, finishes and labor, see below) <i>3 Years: Upholstery, finishes and labor to repair the following chairs: Bulldog, Chadwick, Essentials Work Chairs, Life, Moment, Open Up, RPM, Sapper and SoHo.</i> <i>2 Years: All other KnollExtra</i> product <i>1 Year: Light ballasts and bulbs, seating upholstered armpads and soft armpads, wood casegoods upholstered surfaces.</i> This warranty does not apply to: <ul style="list-style-type: none">• Damage caused by a carrier other than the Seller.• Normal wear and tear or acts or omissions of parties other than Seller (including user modification).• COM or other third party materials applied to Products.• Products not installed by or under the auspices of a certified dealer of Seller.• Dramatic temperature variations or exposure to unusual conditions.• Except as specifically noted above, textiles and upholstery supplied by <i>KnollTextiles</i> (consult current <i>KnollTextiles</i> price list for applicable warranty). Natural variations occurring in wood, marble, and leather shall not be considered defects, and the Seller does not guarantee the colorfastness or matching of the colors, grains or textures, or surface hardness of such materials. The Seller also does not guarantee the colorfastness of fiberglass panel surfaces. THE EXPRESS WARRANTIES CONTAINED HEREIN ARE IN LIEU OF ALL OTHER WARRANTIES, EXPRESS OR IMPLIED, INCLUDING ANY WARRANTIES OF MERCHANTABILITY AND FITNESS FOR PARTICULAR PURPOSE AND ALL OTHER WARRANTIES ARISING FROM COURSE OF DEALING OR USAGE OF TRADE. The remedies provided above are the Purchaser's sole remedies for any failure of Seller to comply with its obligations regarding the workmanship of its Products. Correction of any nonconformity in the manner and for the period of time provided shall constitute complete fulfillment of all liabilities of Seller, with respect to or arising out of the Product furnished hereunder. |
| Delay/Force Majeure | Seller shall not be liable for failure to perform or for delay in performance due to fire, flood, strike or other labor difficulty, act of God, act of any governmental authority or of the Purchaser, riot, embargo, fuel or energy shortage, wrecks or delay in transportation, inability to obtain necessary labor, materials or manufacturing facilities from usual sources or failure of suppliers to meet their contractual obligations, or due to any cause beyond its reasonable control. If any such event occurs, Seller may extend delivery dates by a period of time necessary to overcome the effect of such delay, allocate available Product or cancel any purchase order. |
| Compliance with Law | PURCHASER IS SOLELY RESPONSIBLE FOR COMPLIANCE WITH ALL APPLICABLE FEDERAL, STATE AND LOCAL LAWS, ORDINANCES, REGULATIONS, RULES AND STANDARDS RELATING TO THE INSTALLATION, MAINTENANCE, USE AND OPERATION OF THE PRODUCTS. |
| Patents | Subject to the following provisions, Seller shall, at its own expense, defend or, at its option, settle any claim, suit or proceeding brought against the Purchaser, and/or its vendees, mediate and immediate, so far as based on an allegation that any Product or any part thereof furnished hereunder constitutes a direct or a contributory infringement of any claim of any patent of the United States or Canada. This obligation shall be effective only if Purchaser shall have made all payments then due hereunder and if Seller is notified promptly in writing and given authority, information and assistance for the defense of said claim, suit or proceeding. Seller shall pay all damages and costs awarded in such suit or proceedings so defended. The foregoing indemnity does not apply to the following: <ul style="list-style-type: none">• Products supplied according to a design other than that of Seller, and which is required by the Purchaser.• Combination of the Product with another product not furnished hereunder unless Seller is a contributory infringer.• Any settlements of a suit or proceeding made without Seller's written consent. |
| Limitations of Liability | SELLER, ITS CONTRACTORS, AUTHORIZED DEALERS AND SUBCONTRACTORS OR SUPPLIERS OF ANY TIER SHALL NOT BE LIABLE TO PURCHASER FOR ANY SPECIAL, INDIRECT, INCIDENTAL OR CONSEQUENTIAL DAMAGES ARISING FROM A BREACH OF THIS AGREEMENT. Purchaser's remedies set forth herein are exclusive and the liability of Seller with respect to the breach of this agreement or any contract entered into between the parties pursuant hereto shall not exceed the price of the Product or part on which such liability is based. |

KnollKey Lock Program

KnollKey Lock Program General Information

Following is the KnollKey lock policy, applicable to all products.

Knoll furniture can be ordered keyed-alike or random keyed. Key-alike and random keying instructions cannot be mixed on any single order. Only one of the two instructions can be used on an individual order. When an order is submitted with mixed (key-alike and random) instructions, Knoll will release the order as key-alike only and lock cores will have to be specified separately.

Key-alike

For the convenience of the user, furniture may be keyed alike at no charge. Write "Key-alike" in the description of your purchase order for any pedestal, overhead, file or other item you wish to have keyed alike.

Using the key-alike instructions, order cores and keys as line items on your purchase order. Do NOT submit a key-alike form. The Knoll East Greenville Lock Center will select key numbers from the standard range of K 001 - K 250. Key numbers will not be repeated unless over 250 sets are ordered. Lock cores keyed-alike will ship separately from the product, ready for field installation.

There is no charge for key-alike orders if placed with the furniture order.

IF THE KEY-ALIKE ORDER IS NOT PLACED AT LEAST TWO WEEKS PRIOR TO THE FURNITURE SHIP DATE, A \$50 HANDLING CHARGE AND AIR FREIGHT CHARGES WILL APPLY.

If product is ordered and shipped random-keyed, additional lock cores for key-alike are billable.

Random-Keying

To specify product keyed-random, write "key-random" in the product description. Random-keyed product is shipped with the lock core factory installed. A shrouded key is included. Random means no effort has been made to match key numbers, or to make them different.

Keys

A Knoll shrouded key is shipped with every lock core. 250 Key numbers are available. For numbers above 250, contact Custom Product Development. Additional keys and key blanks are available. See service parts for more information.

Master Keying

Knoll locks can be controlled by means of a master key. There is no additional per-lock charge for master keying. A letter of approval from the client must accompany orders for master keys.

Installing Lock Cores

Lock cores can be installed or removed in the field by using a change key. Cores must be in the unlocked position to be removed. See service parts for change key pattern number and pricing.

Lock Distribution

All orders for key-alike lock cores/keys are packaged and shipped from the East Greenville Lock Center, regardless of where the pedestals, overhead, or other units are produced. Random keyed product will have cores factory-installed.

How to Specify Key-Alike

Following is an example of how to specify key-alike for a cluster of 10 workstations.

Step 1 - Using the project floorplan, count the number of locks in each workstation.

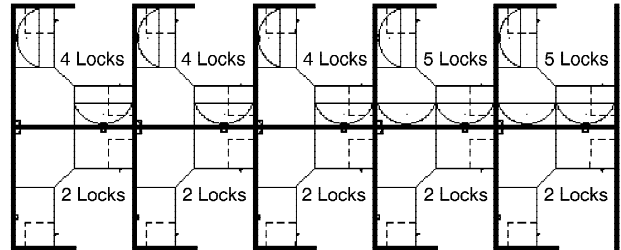

Step 2 - Count the number of workstations with the same quantity of locks. Group together the workstations with a like number of locks.

5 workstations with 2 locks per station
3 workstations with 4 locks per station
2 workstations with 5 locks per station

Step 3 - For the first group (5 sets of 2 locks), enter the number of workstations in the quantity column.

| Qty | Pattern # | Description | Unit List | Ext. List |
|-----|-----------|-------------|-----------|-----------|
| 5 | | | | |

Step 4 - Then enter the pattern number "KSPEC_ _" and add a suffix for the number of locks for that group (i.e., for 2 locks per station, add the suffix "2"). Up to 30 lock cores are available in a set (i.e., KSPEC 30).

| Qty | Pattern # | Description | Unit List | Ext. List |
|-----|-----------|---------------------|-----------|-----------|
| 5 | KSPEC 2 | Set of 2 cores/keys | N / C | N / C |

Step 5 - Repeat for other groups.

| Qty | Pattern # | Description | Unit List | Ext. List |
|-----|-----------|---------------------|-----------|-----------|
| 5 | KSPEC 2 | Set of 2 cores/keys | N / C | N / C |
| 3 | KSPEC 4 | Set of 4 cores/keys | N / C | N / C |
| 2 | KSPEC 5 | Set of 5 cores/keys | N / C | N / C |

Your Key instructions are complete.

Knoll will select key numbers for each set from 250 available numbers. Additional key numbers are available through Custom Product Development. **For additions to existing installations, specify desired key numbers in the description.**

Service Parts

| Pattern # | Description | List Price |
|-------------|---|------------|
| KKEY_ _ _ | Shrouded Key Specify key number desired | \$5 |
| KBLANK | Shrouded Key Blank | \$5 |
| KSPECB_ _ _ | Retrofit Universal Core/Key Specify key number desired | \$18 |
| KCHANGE | Change Key | \$5 |
| KMASTER* | Master Key | \$5 |

*Note: A letter of approval on company letterhead from the client must accompany all orders for master keys.

General Ordering Information

The Products

This guide encompasses all standard products for this product group.

Sizes

Dimensions listed in this guide are indicated as:

H = height

W = width

D = depth

Dia. = diameter

Rad. = radius

Pricing

All prices shown are list.

How to Order

Select pattern numbers and quantities required for your complete installation. Product questions can be addressed in the specific sections of this guide or by contacting your sales representative or customer resource representative at 1-800-343-5665.

Next, select options (if required), along with colors and finishes appropriate to each product. Reference the Finishes and Fabrics pages for color designations.

On large installations, an item's "designated area" can be specified to assist in product organization and handling.

To expedite complete / correct entry of your order, be certain all pattern numbers, quantities, colors and area identifications are completely specified. Also, include complete purchase order numbers, bill-to and ship-to addresses, a contact name and specific factory shipping dates required.

Mail all orders to:

Knoll, Inc.

1235 Water Street

P.O. Box 157

East Greenville, PA 18041

Attention: Order Entry

Once your order is entered at Knoll, an acknowledgment will be mailed to you. You will be advised of your scheduled shipping date within five days of the original acknowledgment. If it is necessary to revise your order, please contact your customer resource representative.

Sustainability Statement

Sustainable design is a key component of Knoll's environmental focus. Our commitment to social responsibility and a healthy environment has prompted us to further articulate our longstanding environmental programs and, with encouragement and support from our colleagues in the industry, we have re-energized our focus on such "green" initiatives as life cycle analysis and LEED™ certification. Knoll is proud to have contributed to projects that have received LEED certification from the U.S. Green Building Council.

For the latest information on Knoll products that help our customers achieve LEED certification, log on to knoll.com, click on "About Knoll" and then "Environmental Focus."