

Reff Profiles

28 3/8" PLANNING
VOLUME TWO

Price List
February 2016



Knoll

Introduction	Knoll and Sustainable Design	3	
	General Specifications	4	
	Reff Profiles finish options	5	
	Reff Profiles Master Features	8	
	Introduction - Planning Guidelines	12	
Horizons Planning	Horizons - 28 ³ / ₈ " Planning	13	
	Side Elevations - 28 ³ / ₈ " Planning	16	
Worksurfaces & Peninsulas	Worksurfaces - Planning Guidelines and Specifications	18	
	Worksurface 1 1/2"	21	
	Worksurface Credenza	25	
	Peninsula 1 1/2" - Planning Guidelines and Specifications	28	
	Peninsula 1 1/2"	35	
Tables	Tables - Planning Guidelines and Specifications	62	
	Tables with Open Frame Leg	74	
	Open Frames legs Infill Options	75	
	Tables with L-Legs	76	
	Tables with Reverse L-Legs	77	
	Tables with Soft Rectangular Legs	78	
	Tables with Column Legs	79	
	Tables - Mobile	80	
	Tables with 2 x 4 Legs - 28 ³ / ₈ "h	81	
	Tables with 4 x 4 Legs - 28 ³ / ₈ "h	83	
	Meeting Tables - Planning Guidelines and Specifications	85	
	Meeting Tables Electrical - Planning Guidelines and Specifications	93	
	Meeting Tables with 4 x 4 Legs - Single Depth - 28 ³ / ₈ "h	96	
	Meeting Tables with 4 x 4 Legs - Double Depth - 28 ³ / ₈ "h	98	
	Meeting Tables with 4 x 4 Legs - Single Depth - 34 ³ / ₈ "h	100	
	Meeting Tables - Center Support Covers	101	
	Meeting Tables - Power	103	
	Media Enclave Tables with 4 x 4 Leg	106	
	Center Column Tables - Planning Guidelines and Specifications	108	
	Center Column Tables - Sliding	111	
	Center Column Tables - Fixed Height with Column Base Leg	114	
	Center Column Tables - Height Adjustable Sliding	116	
	Center Column Tables - Height Adjustable	119	
	Support components	Top support components	121
		Stiffeners	131
		Modesty	132
	Cabinetry	Pedestals, 28 ³ / ₈ " planning	139
Pedestals, 34 ³ / ₈ " high		158	
Pedestals		159	
Progressive Credenzas, 28 ³ / ₈ " planning		160	
Credenza Cushions		165	
Wall Storage Units - Planning Guidelines & Specifications		166	
Wall Storage Units, 28 ³ / ₈ " planning		174	
Cabinets, 28 ³ / ₈ " planning		195	
Cabinets Progressive, 28 3/8 planning		227	
Desktop towers		Desktop Towers, 28 ³ / ₈ " planning	243
Overhead storage	Overhead, 28 ³ / ₈ " planning	250	
	Hutches, 28 ³ / ₈ " planning	278	
	Progressive Overheads, 28 ³ / ₈ " Planning	289	
	Cubbies	298	
Classic Desks	Classic Desks, 28 ³ / ₈ " planning	299	
Classic Credenza	Classic Credenza, 28 ³ / ₈ " h	301	
	Classic Credenza, 34 ³ / ₈ " h	313	
	Glass Accent Tops	333	

Task panels	Task Panels - Planning Guidelines and Specifications	334
	Task Panels	340
	Tackboards	378
	Desk Screens	383
Accessories	Accessories - Planning Guidelines and Specification	388
	Accessories	399
Administrative / Reception	Single Wide Desk	430
	Double Wide Desk	432
	Bridge	434
	Return	436
	Shared Return One Sided	438
	Shared Return Two Sided	440
	Technology Island Peninsula	442
	Infill Panel	444
	Transaction Tops	449
	Accent Tops	452
	Cabinets	454
	Supports	458
	Accessories	459
Wall Mounting of Knoll Products		463
Alpha-Numeric Index		465
Selling Policy		480
KnollKey Lock Program		482
General Ordering Information		483

Knoll and Sustainable Design

Each year Knoll sets key initiatives in our journey to sustainability. We are members of a global consortium on energy, have adopted a scientific, metrics-based approach to sustainable product design, and maintain a leadership position in establishing universal, verifiable, sustainability standards for our industry.

Knoll promotes independent third-party certification because it provides the most impartial and trustworthy foundation for industry-wide environmental compliance. Certification by established and respected third parties ensures that all manufacturers are held to the same high standards and that customers can trust a company's declaration about the environmental benefits of its products. Knoll third-party partners include: the International Standards Organization (ISO); Forest Stewardship Council (FSC®); Rainforest Alliance; GREENGUARD® Environmental Institute; and The Business and Institutional Furniture Manufacturer's Association (BIFMA) level® certification from Scientific Certification Systems (SCS).

In addition, Knoll is aligned with the U.S. Green Building Council and can help companies, healthcare organizations and educational institutions achieve Leadership in Energy and Environmental Design (LEED®) workplace certification.

Global Climate Change

- Knoll is a sponsor of the Clinton Global Initiative, which brings together a community of global leaders to devise and implement solutions to some of the world's most pressing challenges, including environmental change.
- Knoll has a comprehensive Energy Management Program to increase energy efficiency in products and processes.

Life Cycle Assessment (LCA) Tool

- Life Cycle Assessment is a science-based measurement of a product's environmental impacts throughout its life cycle, from raw materials sourcing through manufacture, shipping, use and re-use or end-of-life. LCA enables cradle-to-cradle implementation of sustainable practices.
- Knoll has partnered with The Green Standard.org to develop an affordable, universal ISO-compliant computer-based LCA tool that can be used by the entire contract furniture industry and is partnering on the development of an Environmental Product Declaration System (EPDs) for Knoll products. EPDs are verified documents containing LCA results and additional environmental performance information about a product.

Setting Industry Standards

- Knoll partners with MTS (The Institute for Market Transformation to Sustainability) to develop the SMaRT® Consensus Sustainable Products Standards, a set of consensus-based sustainable product standards based on the LEED® model, for all building products, fabric, apparel, flooring and carpet. MTS, the developer of SMaRT®, is an accredited American National Standards Institute (ANSI) standard developer.
- Knoll also partners with BIFMA (Business and Institutional Furniture Manufacturers Association) to promote level® sustainability standards for the contract furniture industry.
- Knoll has established FSC® (Forest Stewardship Council) certified wood as the standard for general office open plan office systems, casegoods and tables.
- Knoll has launched Full Circle, a resource recovery program developed with ANEW, to help customers extend the life cycle of surplus furniture, fixtures and equipment (FF&E) in an economically, socially and environmentally responsible manner.
- Our goal is to encourage all manufacturers in the contract furniture industry and related industries to adopt standards that will lead to sustainable products and practices.

For more information about Knoll and sustainable design, visit knoll.com/environment.

Note:

Line drawings in this price list are purely for quick product identification without any form of detail. One must not use the price list line drawings to satisfy production dimensions, shape or support options. Refer to Planning Guide for detailed product information.

Wood and Laminate Components

Tops are 1 1/2" or 1 1/4" thick.

Flush and cantilever top assemblies have 1 1/16" or 2 1/16" thick endpanels, and 15/16" thick backpanels. Recessed top assemblies have 1 1/16" or 2 1/16" thick endpanels and a 15/16" thick backpanel.

Pedestals are supplied with metal channels on the top to attach the pedestal to the underside of a worksurface.

Drawer boxes can be specified in either metal or wood with dovetailed joinery. Hinge doors use concealed, adjustable hinges.

Components are finished on all sides unless otherwise specified. Edges are banded with treated paper on hidden surfaces and .6 or 2.0 mm ABS or wood on visible surfaces.

Locks

All pedestals and cabinets with drawers are supplied with a ganglock mechanism in place. In addition, cabinets with drawers have a drawer interlock anti-tip device designed to prevent the opening of a second drawer when one is already open. Locks for drawers in pedestals and cabinets can be retro-fitted. Door locks are not pre-routed and therefore, locks cannot be retro-fitted.

Reff lockcores must be specified separately. Reff lock mechanisms are optionally black or silver and feature a removable core for easy replacement.

Orders with 50 or fewer locks required with no specific keying requests will be sent randomly keyed by the factory without warning.

Levellers

All endpanels, backpanels (except recessed), floor pedestals and cabinets are equipped with levellers.

Lighting

Task lights are available as fluorescent or LED solutions.

Task Lights

Task lights are TCLP compliant and meet requirements of California Title 20 and Title 24. T5 advanced task lights are fitted with ballasts and lamps compliant with LEED requirements. All task lights are approved for New York City installations.

T5 Task Lights

All T5 task lights include mounting hardware for attachment to overhead cabinets, shelves, up mounted cabinets and freestanding overdesks.

Specify task lights one size or less than the overall cabinet or overdesk width. T5 task lights have adjustable mounting brackets that lock into integral channels in the underside of the cabinet's lower shelf. The spring steel adjustable mounting brackets flex to install without requiring tools and allow the light to be positioned at any position side-to-side and front-to-back.

LED Task Lights

LED task lights mount into the recess in the underside of overhead cabinets and shelves at least 5" wider than the task light width.

Grommets

Grommets are optional (except where noted). Tops up to 48 wide have one grommet. Tops wider than 48 include two grommets. See Planning Guide for locations.

All dimensions in this price list are for representative purposes only. For accurate build dimensions or factory drawings, please call Customer Services.

Finishing

All Reff natural wood veneer and Techwood components are stained and sealed using a state of the art custom blended polyurethane finishing process.

This finish provides superior resistance to solvents, stains, abrasion and heat.

Each component is coated and then cured with ultraviolet light for a durable, lasting wood surface.

Natural veneers are all hand selected to best showcase the beauty of natural grain and to Knoll's meticulous color and grain standards.

Every effort is made to ensure that Knoll Reff Profiles veneers are the best that can be sourced in quality of color, consistency and size. Natural variations of wood are held in high regard and are not considered to be defects. Natural variations are not subject to warranty. The natural process of color change in real wood products is part of the unique character and beauty of this material.

Knoll expects wood to patina over time and does not warranty color change.

Techwood is real wood, enhanced by technology to provide added color and grain consistency.

Wood Finishes

V1 Techwood

Natural Edge	Synthetic Edge	Finish
Y316	S316	Maple
Y319	S319	Cherry
Y323	S323	Medium Walnut
Y326	S326	Dark Mahogany
Y329	S329	Medium Oak
Y342	S342	Medium Teak *
Y344	S344	Espresso
Y811	S811	Natural
Y821	S821	Blond Maple
Y831	S831	Light Cherry
Y851	S851	Black Oak
Y881	S881	Light Walnut
Y882	S882	Dove Grey *
Y883	S883	Pangar Wenge

V2 Natural Veneers / Premium Techwood

Natural Edge	Synthetic Edge	Finish
V312	R312	Bronze Cherry
V316	R316	Maple
V319	R319	Medium Cherry
V411	R411	Light Walnut
V412	R412	Natural Cherry
V413	R413	Sand Oak (Open pore)
V414	R414	Natural Oak
V415	R415	Peacock Green Walnut
V417	R417	Old English Walnut
V421	R421	Chalk Oak
V423	R423	Light Oak
V433	R433	Light Fawn Cherry
V436	R436	Medium Brown Cherry
V439	R439	Straight Anigre

V2 Natural Veneers / Premium Techwood (cont.)

Natural Edge	Synthetic Edge	Finish
V440	R440	Natural Hemlock (QC)
Y841	S841	Ebony (Open pore)*
Y861	S861	Grigio (Open pore)*
Y884	S884	White Pine (Open pore)*

V3 Premium Veneer

Natural Edge	Synthetic Edge	Finish
V512	R512	Figured Anigre
V514	R514	Makore
V515	R515	Figured Sycamore
V517	R517	Natural Sapele
V518	R518	Natural Chestnut

***Note:**

- Finishes with * are NOT available on Reff Optional Edges.
- All finishes shift in color over time, this natural aging process varies by material.
- Synthetic Edge option is available on worksurfaces, only.

Laminates

Core Laminate

Surface / Edge

111	Jet Black
114	Folkstone Grey
115	Medium Grey
117	Soft Grey
118	Bright White
119	Pumice
121	Micro Grey *
122	Brushed Sand *
123	Brushed Grey *
128	Fog
129	Micro Sand *

*121, 122, 123, 129 Not available with matching edge option, and only available on worksurfaces.

*121, 122, 123, 129 Not available for Panel post covers, post caps, top trims, end trims.

LW Marker Board - Available for panels, Task panels and sliding display boards.

Note: All core Laminate worksurfaces are available with optional edge finish. (unless otherwise noted)
ie; A worksurface in 118, can have 139 edge finish.

Wood Grain Laminates

Surface / Edge

124	Medium Chery
125	Natural Maple
126	Natural Cherry
127	Walnut
139	Light Ash
140	Warm Ash
141	Whitened Ash
142	Grey Ash
143	Classic Oak
144	Graphite Pear
145	Zebra

Wood Grain Laminates are NOT available on the following components:

- Storage with J Pull option
- Administrative and Reception products
- Worksurfaces with optional edge profiles
- Panel post covers, post caps, top trims, end trims and panels with beltway options

Impact Resistant Laminate

Core & Wood Grain Laminates

Surface / Edge

911	Jet Black
914	Folkstone Grey
917	Soft Grey
918	Bright White
919	Pumice
924	Medium Cherry
925	Natural Maple
926	Natural Cherry
927	Walnut
928	Fog

Note: *The Rules of Core and Wood grain Laminates, applies to the Impact Resistant Laminates.*

**25% Upcharge applies to the laminate pricing for the Impact Resistant Laminates.*

Important Note:

Laminate wood grain direction depends on the width of the product.

For any vertical surface, ie; modesty panels, overheads and hutches, **up to 60"** wide, the laminate wood grain direction will be **vertical**. For any vertical surface **greater than 60"** wide, the laminate wood grain direction is **horizontal**.

up to 60" (vertical)



60" greater (horizontal)



Note: Pedestals and Cabinets with metal interior, when specified in "Wood Grain Laminate" or "Veneer", the shelves are painted black.

Mixed Finishes: For Laminate worksurfaces with Laminate or Veneer Edge Options, specify mixed finish worksurfaces using separate top finish & edge finish.

For Example:

Top finish: 114 Folkstone Grey Laminate

Edge finish: 115 Medium Grey Laminate, or Y882 Dove Grey Techwood

Forbo

- 851 Biscuit
- 852 Sky Blue
- 853 Stone
- 854 Cinnamon
- 855 Heather Blue

Solid Surface

- AW Artic White

Glass

- G1**
TEMP Clear Tempered

G2
Architectural Glass Options

- GL13 Powder
- GL8 Wafer
- GL6 Block Matrix

G3
Back Painted Glass 5mm

- GL11 Back Painted Black
- GL14 Folkstone Grey
- GL15 Back Painted Medium Grey
- GL17 Back Painted Soft Grey
- GL18 Back Painted White

Colored Glass

- GL25 Bronze
- GL35 Grey
- GL85 Star Clear

Note:

All Glass options are Tempered.

Paint

- P1**
- 111 Jet Black
 - 112 Brown
 - 113 Dark Grey
 - 114 Folkstone Grey
 - 115 Medium Grey
 - 116 Sandstone
 - 117 Soft Grey
 - 118 Bright White
- P2**
- 611 Beige Mist Metallic
 - 612 Medium Metallic Grey
 - AA Anodized Aluminum
- P3**
- 613 Silver
- P4**
- PD Polish Chrome
 - PU Satin Nickel
 - PT Brushed Pewter
 - AP Anodized Polished
 - AU Anodized Satin

Plated

- PD Polish Chrome
- PU Satin Nickel
- PT Brushed Pewter

Anodized

- AP Anodized Polished
- AU Anodized Satin
- AA Anodized Aluminum

Locks

- B Black
- S Matte Silver

Complementary Colors:

- AP (anodized polished) compliments PD (polished chrome)
- AU (anodized satin) compliments PU (satin nickel)

Fabric Options For Panels

Grade 10
 Broadcloth II (W1619)
 Circuit (W1754)
 Element (W1077)
 Foundation (W351)
 Growth Spurt (W692)
 Pivot (W1926)
 Skylark (W1718)
 Symbolic Detail (W693)
 Tailor Made II (W1610/6)
 Twister (W1923)
 Versatility (W432)

Grade 20
 Bauhaus Block (W296A)
 Circle Line (W1146)
 Criss Cross (W305)
 Delite (K2026)
 Logic (W1318)
 Nematic II (W1620)
 Photon II (W1620)
 Reflect (W884) ◊
 Resolution (W280)
 Weave Three (W298)

Grade 30
 Basket Draft (W249)
 Flow (W565)
 Harmony (W232)
 Match Point (W1145)
 Micro (W465)*
 Relay (W1020) ▲

Grade 40
 Ornament (W1078)
 Palladium (W1030)

Grade 45
 Monarch (K1149)

*with backing only

▲ Monolithic panels and tackboards only

◊ May not be available in all colors.

★ Non-merchandized available for purchase but samples not available.

The following textiles are approved for use on Reff panels. Consult Knoll representative for pricing:

Grade 50
 Versa (K1698)

Grade 55
 Knoll Felt (K1207)
 Knoll Hopsack (K1206)
 Ransom (K1298)
 Transition (W816)

Customers Own Material

Prices for panels and tackboards that are to be manufactured with a customer supplied fabric will follow Grade 10 panel pricing.

COM fabrics are subject to a testing charge prior to acceptance for use on Reff panels. Panels bearing COM fabrics are subject to extended leadtimes. It is the responsibility of the customer's purchasing agent to ensure COM fabric is supplied for testing and manufacturing. Delays in receiving COM fabric for manufacturing will result in rescheduled delivery dates.

When specifying panel/fabrics use the following format to denote location on a tiled panel.

Side 1		Side 2
1E	Top of Panel	2E
1D		2D
1C		2C
1B		2B
1A	Bottom of Panel	2A

(Side 1 is always the inside of the workstation.)

Panels with beltway one side: assume the beltway is on SIDE 1 of the panel.

Fabric Options For Cushions

A
 Alignment (K349) ♣
 Basket Draft (W249)
 Beacon (W1597)
 Bocce (K1255) ♣
 Cats Cradle (K1290) ♣
 Chance (K1552)
 Common Ground (K448) ♣
 Delite (K2026)
 Distri (K872)
 Hourglass (K1523)
 Mariner (K642)
 Monarch (K1149) ♣
 Prep (K1076) ♣
 Presto (K1000) ♣
 Reflect (W884)
 Soliloquy (K1458)
 Sonnet (K1460) ♣
 Stacks (K528)
 Trophy (K1709) ♣

B
 Abacus (K715) ♣
 Argyle (K1938)
 Bank Shot (K134) ♣
 Belize (K1165)
 Boundary (K1828)
 Cameo (K1443)
 Chroma (K345) ♣
 Chronicle (K1525) ♣
 Close Knit (K201)

B cont.
 Dovetail (K1150) ♣
 Ferry (K1697)
 Framework (K1447) ♣
 Keaton (K1596)
 Gala II (K1520) ♣
 Grande (K180)
 Grandview (K1463)
 Holbrook (K1928)
 Journey (K1806) ♣
 Knoll Felt (K1207) ♣
 Knoll Hopsack (K1206) ♣
 Ludlow (K1998)
 Lyric (K698)
 Mini Stitch (K1130) ♣
 Night Life (K181)
 Nonchalant CR (HC198)
 Paradigm (K1101)
 Pogo (K1100) ♣
 Prairie (K1925)
 Prim (K1884)
 Radiance (K1921)
 Ransom (K1298) ♣
 Ricochet (K498) ♣
 Roam (K1657)
 Rush Hour (K1824)
 Spark (K1075) ♣
 Spotlight (K772)
 Spree (K1600)
 Sutton (K1750) ♣

B cont.
 Utmost (K1325)
 Tabloid (K2022) ♣
 Venue (K1558)
 Westwood (K1949)
 Wide Angle (K244) ♣
 Zipline (K1448) ♣

C
 Atlas (K1236)
 Baxter (K1557)
 Biota (K1297) ♣
 Cairo (K2034)
 Charm (K1049)
 Circa (K1054)
 Classic Boucle (K162) ♣
 Durand (K1885)
 Earthwork (K1238) ♣
 Empire Stripe (K1025)
 Entourage (K1389)
 Fable CR (HC1122)
 Fibra (K1105)
 Fox Trot CR (HC777)
 Greenwich (K1753)
 Hudson (K1765)
 Hula Hoop (K753)
 Kora CR (HC1010)
 Lagos (K2038)
 Legend CR (W432)
 Lore CR (HC1123)
 Magnolia (K1999)

C cont.
 Metro (K1018)
 Milestone (K1886)
 Moto CR (HC1002)
 Noble (K1556)
 Palisade (K2030)
 Panache CR (HC1047)
 Pony Up (K1323) ♣
 Quark (K781)
 Regard CR (HC1063)
 Roundtrip (K1430) ♣
 Sahara (HC1269)
 Sandpiper CR (HC1258)
 Sequin CR (HC1009)
 Sinclair (K1555)
 Smart (K1268)
 Soiree (K1616)
 Spectator (K1391) ♣
 Spot On (K1324)
 Star Struck (K1048)
 Stepping Stones (K346)
 Swing (K479)
 Tight Rope (K1798)
 Tilden (K1779)
 Tower Grid (K1887)
 Treble CR (HC1062)
 Vibe (K1029)
 Zari CR (HC1008)

D
 Cavalier (K217)
 Compass CR (HC1183)
 Eclat Weave (K1104)
 Harrison (K1084)
 Hologram (K500)
 Masquerade (K806)
 Menagerie (K1322)
 Zoom (K113)

E
 Cross Stitch (K1026) ♣
 Highland (K2010)
 Kampala (K2032)
 Katazome (K1459)
 Kimono (K1174)
 Mamba (K549)
 Marquee (K1608)
 Meroe (K2043)
 Sherman (K1789)
 Tryst (K1522)
 Whip (K1386)

F
 Atelier (K1607)
 Biscayne (K1771)
 Century (K1051)
 Coco (K1024)
 Cornaro (K1320)
 Glider (K1717)
 Groove Line (K488)

♣ = Cal 133 Pre-approved

F cont.
 Icon (K1028)
 Intrigue (K1551)
 Jubilee (K1445)
 Kinship (K1465) ♣
 Liberty (K1888)
 Mod Plaid (K1630)
 Rivington (K1080)
 Soon (K1787)
 Topography (K1052)
 Totem (K1561)
 Tweed Frieze (K754)

G
 Djenne (K2029)
 Gibson (K1086)
 Haze (K109)
 Kinabalu (K1800)
 Kingston (K1826)
 Melange (K1882)
 Serendipity (K1528)
 Striae Stripe (K1827)
 Ultrasuede® (K1021) ♣
 Utrillo (K1807)

H
 Arno (K128) ♣
 Haiku (K1479)

I
 Aswan (K2046)
 Dynamic (K1617)

Worksurface Profiles



1 1/2", 1 1/4" and 1" Thick Standard

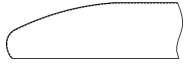

1 1/4" Thick Cascade

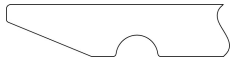

1" Thick Sliding Table

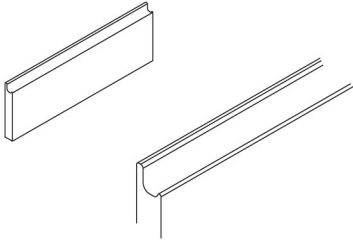

Integral Wood J-Pull

Does not protrude
Matches the case finish

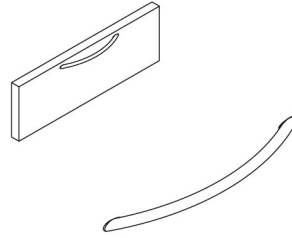

C-Pull

(Nickle Plated Finish Only)
7 3/8" wide x 1 5/32" deep

Protrudes 1" from the drawer front
Available in Nickle Plated Finish only
1 pull per drawer front
Position: center, 1/2" down from the top of drawer

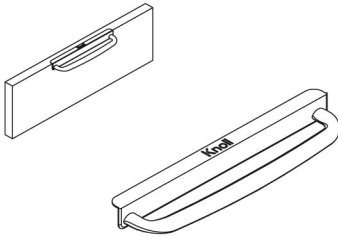

D-Pull

7 3/4" wide x 1 13/32" deep

Protrudes 1 13/32" from the drawer front
Available in all core paint finishes,
Brushed Pewter (PT) and Satin Brass (PZ)
1 pull per drawer front
Position: Assembled to plate, center line,
1/2" down from the top of drawer

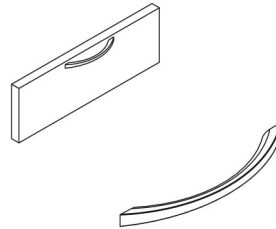

S-Pull

(Stainless Steel Finish Only)
6 5/32" wide x 1 1/16" deep

Protrudes 1 3/64" from the drawer front
Available in Stainless Steel only
1 pull per drawer front
Position : Center, 1/2" down from the top of drawer

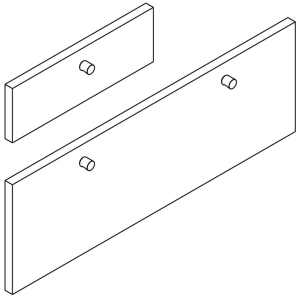

R-Cylinder
 1" diameter
 Protrudes 1" from the drawer front
 Available in painted and plated finishes
 1 pull per 16" & 19" wide pedestal drawer
 Position: center position for 16" & 19" drawers
 2 pulls per 30" & 36" lateral drawers
 Position: 6" in from end, 1 1/2" down from top of drawers

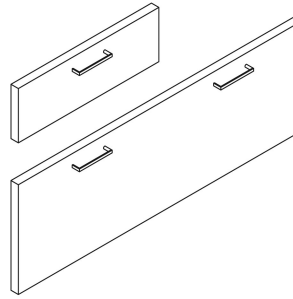

H-Out Line
 4" wide x 1" deep
 Protrudes 1" from the drawer front
 Available in painted and plated finishes
 1 pull per 16" & 19" wide pedestal drawer
 Position: center, 1 1/2" down from the top of drawer
 2 pulls per 30" & 36" lateral drawers
 Position: 6" in from left/right, 1 1/2" down from top of drawers

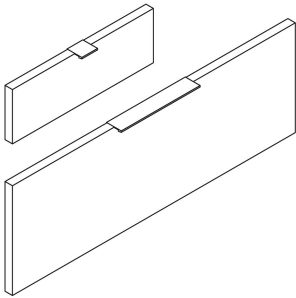

T-Tab
 Short Tab: 2" wide x 1 3/4" deep
 Long Tab: 10" wide x 1 3/4" deep
 Protrudes 3/4" from drawer front
 Available in painted or plated finishes
 Position: Center line position on drawers

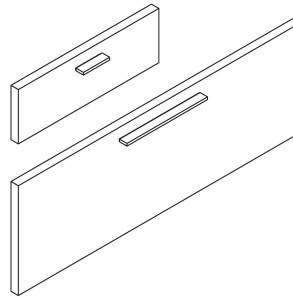

F-Bar Pull
 Short bar pull: 3 3/8" wide x .3" thick
 Long bar pull: 10 1/2" wide x .3" thick
 Protrudes 1" from drawer front
 Available in painted and plated finishes

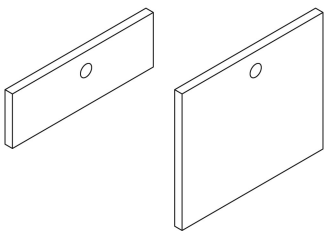

G-Grommet Pull
 1 7/32" diameter
 Flush with the drawer front
 Available in painted and plated finishes
 1 pull per 60" & 72" sliding doors
 Position: 1.656" from left or right, center line vertical
 2 pulls per 90" & 108" sliding doors
 Position: 1.656" from left and right, center line vertical
 Position: Center line position on drawers

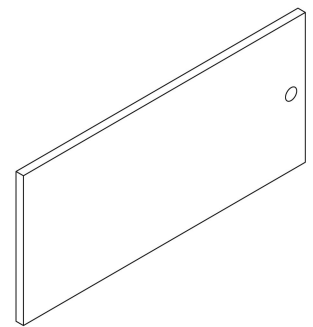
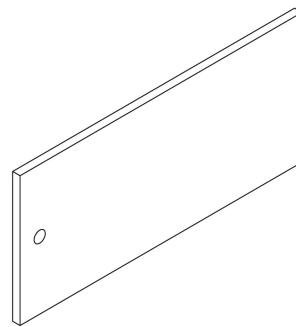
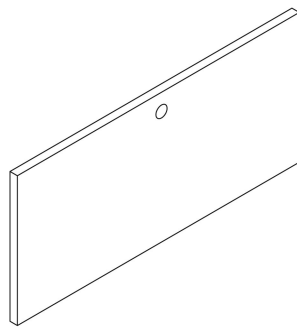

Legs and End Supports

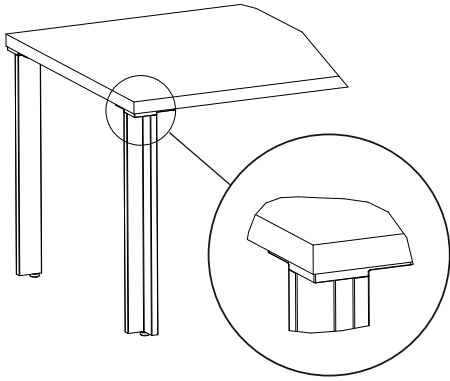

L-Leg
 Leg: 3" x 3"
 Top plates: 5 1/2" x 5 1/2"
 Flush with worksurface edges
 Finishes: painted or anodized
 Available on rectilinear peninsulas;
 square and rectangular 1 1/2" tables
 Available in pairs

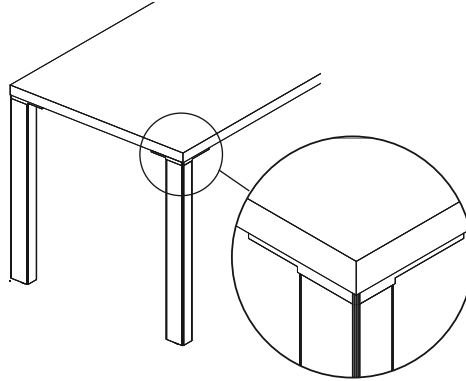

Soft Rectangular Leg
 Leg: 2" x 3"
 Top plates: 5 1/2" x 5 1/2"
 Flush with worksurface edges
 Finishes: painted or anodized
 Available on rectilinear peninsulas;
 square and rectangular 1 1/2" tables
 Available in pairs

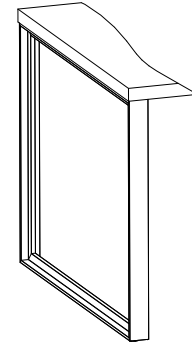

Open Frame Leg
 Leg: 2 1/4" thick
 Top plates (2): 6" x 6"
 Flush with worksurface edges
 Finishes: painted or anodized
 Available on rectilinear peninsulas;
 rectangular 1 1/2" tables
 Available with laminate or wood
 veneer infill panels

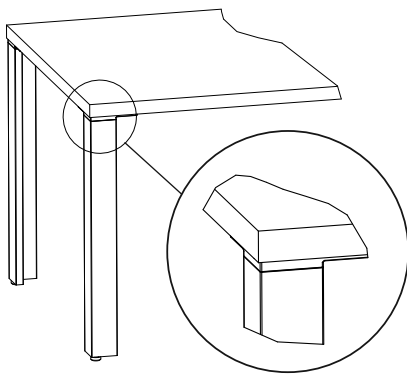

Reverse L-leg
 Leg: 3" x 3"
 Top plates: 5 1/2" x 5 1/2"
 Flush with worksurface edges
 Finishes: painted or anodized
 Available on rectilinear peninsulas;
 square and rectangular 1 1/2" tables
 Available in pairs

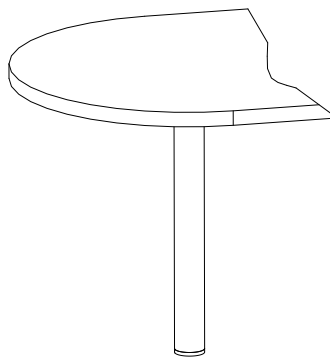

Column Leg
 Leg: 3" diameter
 Top plate: 10" x 10" (peninsulas)
 Top plate: 7 5/8" x 7 5/8"
 triangular (tables)
 Flush with worksurface edges
 Finishes: painted or plated
 Available on bullet, D, P and 9
 peninsulas; 2 1/2" and 4" diameter
 available on 1 1/2" tables

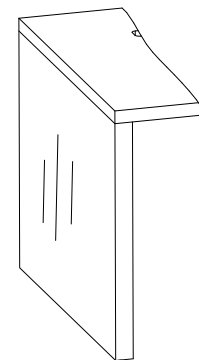

Thick End Panel
 Leg: 2 1/16" thick
 Top bracket: extends 1 5/8" inboard x
 2 5/16" from front and back edges
 Flush with worksurface edges
 Finishes: laminate or wood veneer
 Veneer direction is vertical
 Available on rectilinear peninsulas
 Not sold separately

What is Reff Profiles?

Reff Profiles is finely detailed office furniture that combines versatility with image by providing unparalleled attention to quality from dovetailed joinery to a patented finishing process. Users can choose from a broad range of natural woods, fine veneers and durable laminates to create private offices, freestanding work areas and panel-based environments that fit the individual's requirements. A variety of stacking panel styles, including monolithic, tiled and floor-to-ceiling, will support any design criteria.

Worksurfaces are available in traditional rectilinear or innovative curvilinear shapes for a choice of aesthetic approaches and ergonomic solutions. Cabinetry can be specified in numerous sizes and configurations with either wood or metal interiors with a choice of hardware options to support any storage requirement. Innovative desk-height storage, cabinets and office towers combine aesthetics with functionality.

The result is a comprehensive product offering that will satisfy a wide spectrum of users. Let your imagination take hold.

For private offices consider a variety of desk options including flush, cantilevered, recessed or bow fronts and storage solutions including innovative workwalls.

In freestanding furniture, Reff Profiles offers a full selection of components to support any requirement from managerial to administrative. Options include numerous worksurfaces and meeting tops with a variety of freestanding supports. Administrative and Gallery desk surrounds, stationary and mobile storage components and storage towers provide exceptional planning alternatives.

Panel systems provide high-density power, data and communications capacity along with acoustic control and design flexibility. Panels can be specified with smooth monolithic surfaces, tiled faces or stacking modules. Additionally, panel surfaces are available with fabric on both sides or with fabric on one side and wood on the other.

Who should consider Reff Profiles?

Reff Profiles is well suited to organizations who want to project a high image while supporting any work environment from private offices to panel-based workstations. Companies will appreciate the fine quality and breathtaking aesthetics of Reff Profiles and, for those rapidly changing firms who require interchangeable components to support long term use, Reff Profiles is truly the design choice for inspired offices.

Desk Height Planning vs. Standard Height Planning

Reff Profiles offers two support height planning models: "standard" height (26 1/2") and "desk" height (28 3/8").

"Standard height" support components provide an underdesk clearance of 26 1/2". This yields a worksurface height of 27 3/4" with 1 1/4" thick worksurfaces and 28" with 1 1/2" worksurfaces.

Standard height planning (26 1/2") may be utilized in panel-based open planning, freestanding open planning (including Reff Profiles Gallery), and in private office planning.

"Desk height" support components provide an underdesk clearance of 28 3/8". This yields a worksurface height of 29 5/8" with 1 1/4" thick worksurfaces and 29 7/8" with 1 1/2" thick worksurfaces.

"Low Credenza" and "3/4 high" storage options may be incorporated into desk height planning models. Progressive Low Credenza storage incorporates a 1 1/16" top shelf for a finished height of 23 3/8". 3/4 high storage is 22 3/8" high and requires a 1" thick applied worksurface top which yields a low worksurface height of 23 3/8".

Desk height planning (28 3/8") may be utilized in freestanding open planning (including Administrative and Reception desk units) and in private office planning.

Storage Relationships

Care should be taken to make sure storage cabinets are specified in the type that corresponds to the planning height model being used.

Classic Cabinets, Overheads, Workwalls, and Overdesk Units are available for both standard and desk height planning and must be specified accordingly.

Progressive Cabinets, Progressive Overheads, and Desktop Towers are only available for desk height planning.

Task panels are intended to be used with desk height planning. They are not recommended for use with standard height planning.

Price List / Planning Guide Organization

The Reff Profiles price list is divided into two volumes. Volume 1 contains pricing related to panels and "standard" height (26 1/2") planning. Planning guidelines for 26 1/2" height planning are available in the Reff Planning Guide, on Exchange. The Reff Profiles price list Volume 2 contains pricing and planning information for "desk" height (28 3/8") elements.

It is not advised to mix 28 3/8" desk height products with 26 1/2" components.

Nominal
Planning Horizons

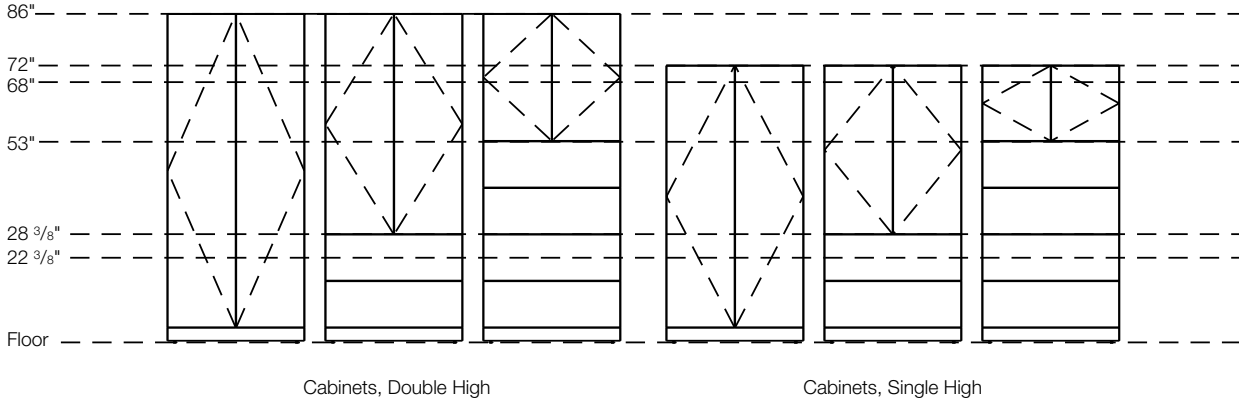

Nominal
Planning Horizons

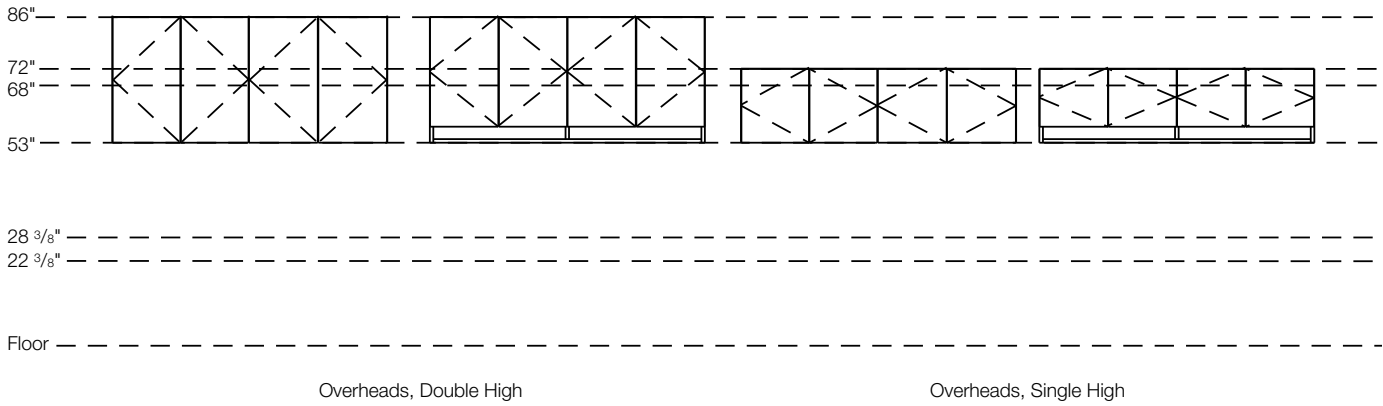

Notes

- Planning horizons are nominal. Dimensions are actual.
- Images displayed are examples only and do not represent the complete scope of products available.

Nominal
Planning Horizons

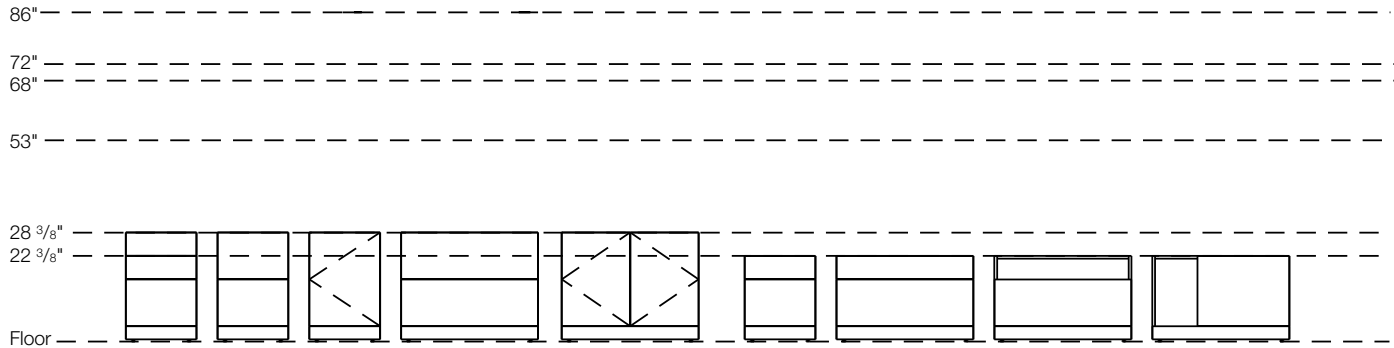

Lower Storage, Full Height

Lower Storage, 3/4 Height

Nominal
Planning Horizons

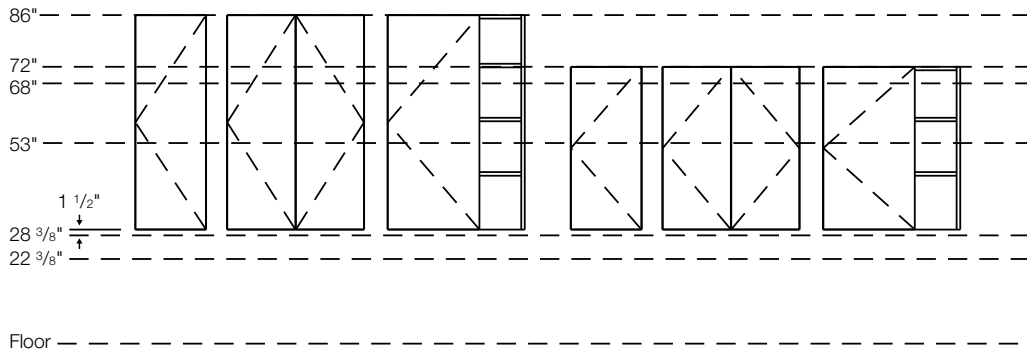

Desktop Towers, Double High

Desktop Towers, Single High

Notes

- Planning horizons are nominal. Dimensions are actual.
- Images displayed are examples only and do not represent the complete scope of products available.

Horizons - 28³/₈" Planning

Planning Guidelines and Specifications

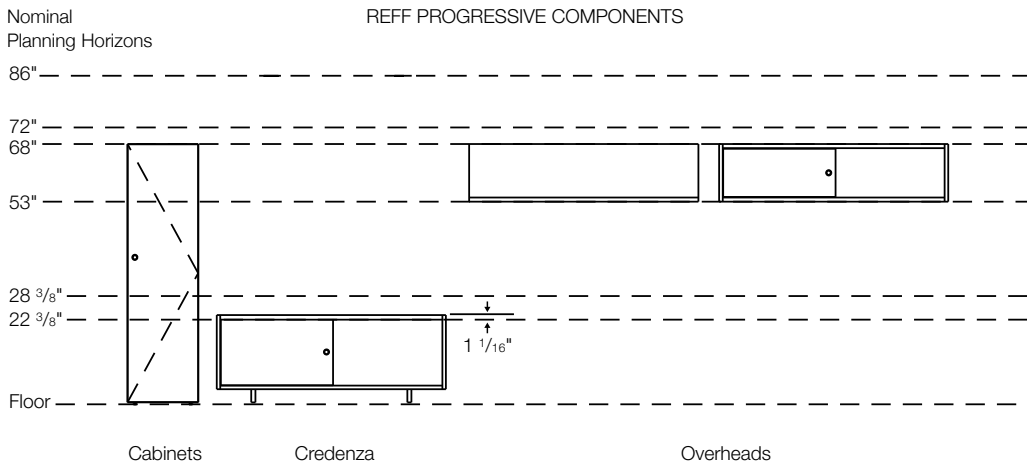

Notes

- Planning horizons are nominal. Dimensions are actual.
- Images displayed are examples only and do not represent the complete scope of products available.

Side Elevations - 28³/₈" Planning
 Planning Guidelines and Specifications
 Classic

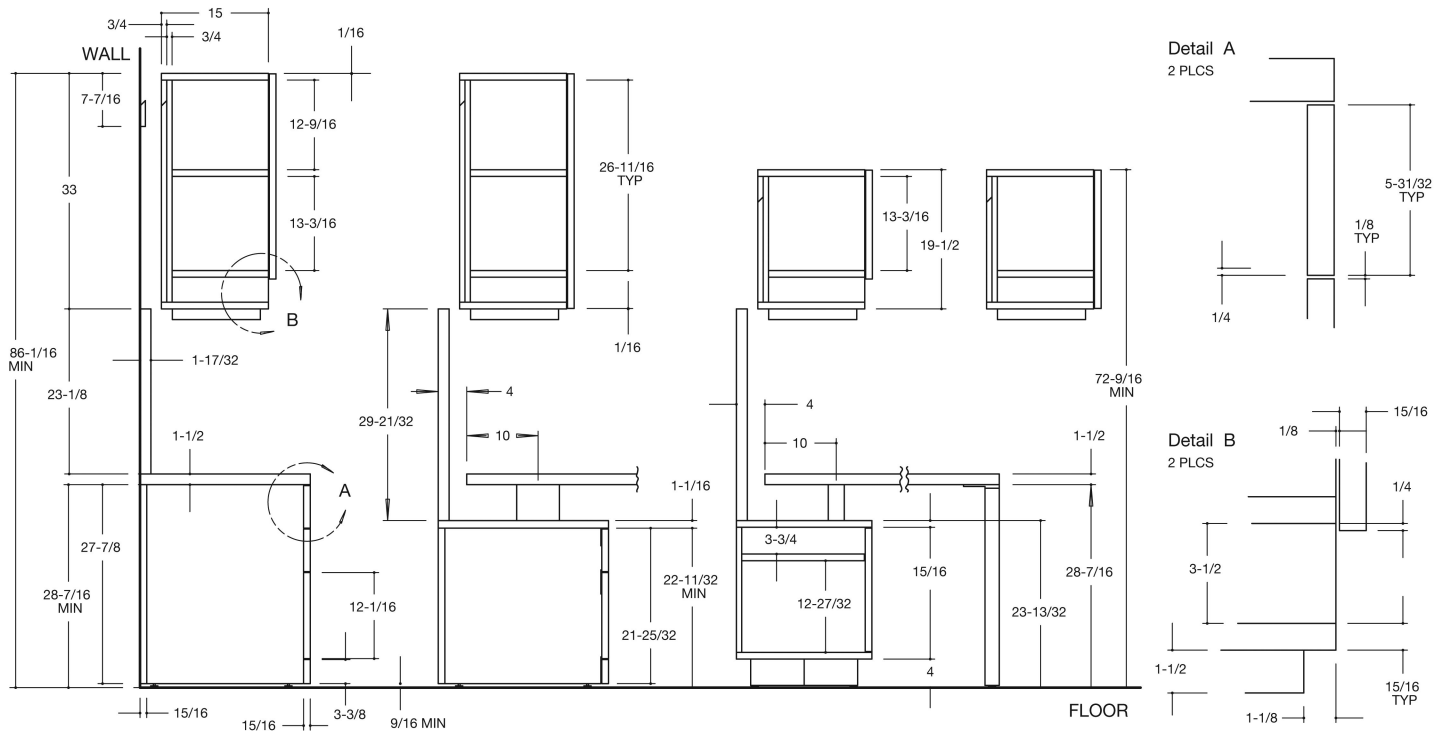

Note: Planning Side Elevations are nominal. Dimensions are actual.

Side Elevations - 28^{3/8}" Planning
Planning Guidelines and Specifications
Progressive

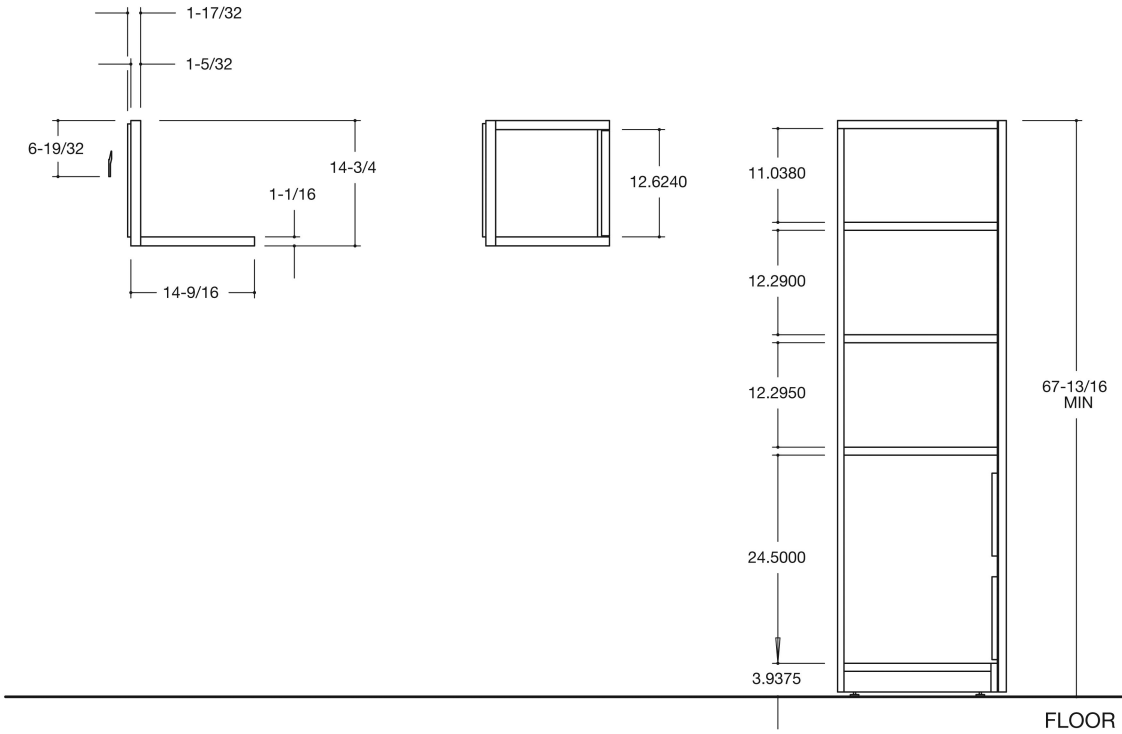

Note: Planning Side Elevations are nominal. Dimensions are actual.

Worksurfaces

The selection of worksurface sizes and their relationship to each other are primary considerations when planning a Reff Profiles office. Refer to the illustrations in the Introduction to Desk Height Planning to see how the various heights of storage and worksurface supports relate to the choice of worksurface thickness. Reff worksurfaces are available in three thicknesses: 1", 1 ¼" and 1 ½". Construction details specific to the 1 ¼" thick surfaces, including Cascade and Edge Detail surfaces, can be found in the Reff Planning Guide on Exchange.

When selecting top sizes consider whether storage components can be used to support the surfaces and what other worksurface supports will be required.

NOTE: Additional support is required when using 1" thick credenza tops for unsupported spans over 36". 1 ¼" thick worksurfaces require additional support for an unsupported span of more than 48". When using 1 ½" thick worksurfaces the maximum unsupported span is 54".

NOTE: All dimensions shown in these descriptions and on the Worksurface price pages are nominal dimensions. Actual widths are 1/16" less than nominal. Actual depths are 1/8" less than nominal.

Construction

All worksurfaces feature 3-ply construction (see figure below) and can be specified in laminate, veneer or laminate tops with veneer edges. Laminate tops have a laminate top surface with an FSC-certified, 45-pound density particle board core and neutral tone backer sheet for balanced construction. Edges match the top in 2.0mm ABS with 2.0mm radius top and bottom edges. Ends overlap the front and back edges (see figure below).

Techwood and natural veneer tops have a veneer top surface, an FSC-certified, 45-pound density particle board core and a neutral tone backer sheet for balanced construction. Veneer tops have matching finish 2.0mm thick solid veneer edges on all sides. Edges have a 2.0mm radius on the top and bottom.

All worksurfaces except Bridge Rectilinear worksurfaces are pre-drilled with pilot holes for use with wood screws.

Application Notes

1 ¼" Straight Rectilinear worksurfaces are available in 20", 24", 30" and 36" depths for regular worksurface applications. Widths available range from 24" to 96" in 6" increments.

1 ½" Straight Rectilinear worksurfaces are available in 20", 24", 30" and 36" depths for regular worksurface applications. Widths available range from 24" to 108" in 6" increments.

Bridge Rectilinear worksurfaces are 1 ½" thick and available from 36"W to 54" wide in 6 inch increments in either 20" or 24" depths. They can be ordered with the grain specified to run either vertically (across the depth of the surface) or horizontally (along the length of the surface) when specified in wood grain laminate or veneer finish.

Credenza Tops are available in both 1" and in 1 ½" thicknesses and in widths from 60" to 108" in 6" increments.

Rectilinear worksurfaces can be specified in non-standard dimensions. For information, contact Knoll Custom Product Development

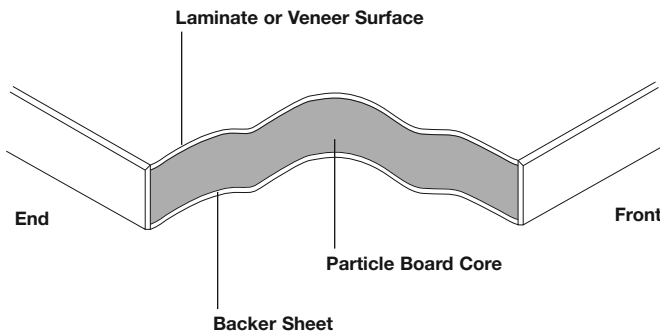

Top Construction

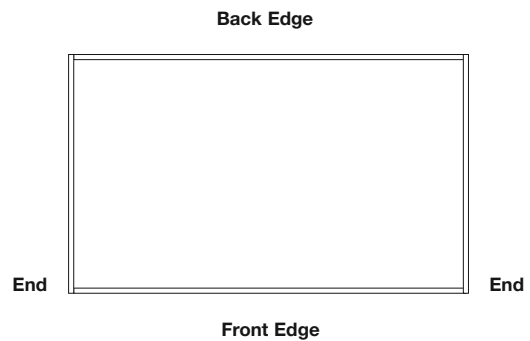

Edge Banding

1 ¼" Worksurface Straight Rectilinear

Size Availability & Grain Direction

	20"D	24"D	30"D	36"D
24"W				
30"W				
36"W				
42"W				
48"W				
54"W				
60"W				
66"W				
72"W				
78"W				
84"W				
90"W				
96"W				

1 ½" Worksurface Straight Rectilinear

Size Availability & Grain Direction

	20"D	24"D	30"D	36"D
24"W				
30"W				
36"W				
42"W				
48"W				
54"W				
60"W				
66"W				
72"W				
78"W				
84"W				
90"W				
96"W				
108"W				

1 ½" Bridge Rectilinear

Size Availability & Grain Direction

	20"D	24"D
36"W		
42"W		
48"W		
54"W		

Horizontal Grain Direction

	20"D	24"D
36"W		
42"W		
48"W		
54"W		

Vertical Grain Direction

1 ½" Worksurface Credenza

Size Availability & Grain Direction

60"W		
66"W		
72"W		
78"W		
84"W		
90"W		
96"W		
108"W		

1" Worksurface Credenza

Size Availability & Grain Direction

60"W		
66"W		
72"W		
78"W		
84"W		
90"W		
96"W		
108"W		

Grommets

Grommets are optional and must be specified by adding the appropriate designation to the pattern number. Designations are:

- N = No grommet
- F = Flush grommet location
- R = Recessed grommet location

Rectilinear worksurfaces 24" to 48" wide receive one grommet centered on the back edge of the worksurface. Rectilinear worksurfaces over 48" wide receive two grommets along the back edge.

1 ¼" and 1 ½" thick rectilinear tops are available with no grommet, flush grommet or recessed grommets locations.

1 ¼" thick tops are available with additional grommet options; **Classic type** and **Profile type**.

Classic type grommets sit even with top of the worksurface.

Profiles type grommets have a 1/16" thick flange which rests above the worksurface.

These 2 types of grommets, provides additional grommet options for 1 ¼" thick tops (only);

- CF = Classic grommet in flush location
- PF = Profiles grommet in flush location
- CR = Classic grommet in Recessed location
- PR = Profiles grommet in Recessed location
- CA = Classic grommet in Alternative location
- PA = Profiles grommet in Alternative location

* CA & PA are available on 36" deep tops only.

1 ½" thick credenza tops come standard with a 1 3/8" deep edge grommet which runs along the rear of the worksurface to within 6" of each end (see figure below).

The 1" credenza tops are available with or without an edge grommet.

Refer to the Reff Planning Guide, posted on Exchange, for 2" x 3" grommet locations.

For non-standard grommet locations contact Knoll Custom Product Development.

Planning for Worksurface Thicknesses

Critical to the correct specification of Reff Profiles is an understanding of worksurface thicknesses, support component heights and their relationship to each other. Worksurfaces and support components can be combined to create the following overall finish heights:

23 ¾" – Intended as a credenza height in 28 ¾"H planning scenarios; this height is achieved using 1" thick worksurfaces with 22 ¾"H (¾ height) storage components.

27 ¾" – Intended as the overall worksurface height in a panel supported workstation scenario; this height is achieved by combining "Standard height" 26 ½" storage or support components with 1 ¼" thick worksurfaces.

29 7/8" – Intended as the overall worksurface height in freestanding office scenarios; this height is achieved by combining "Desk height" 28 ¾" storage or support components with 1 ½" thick worksurfaces.

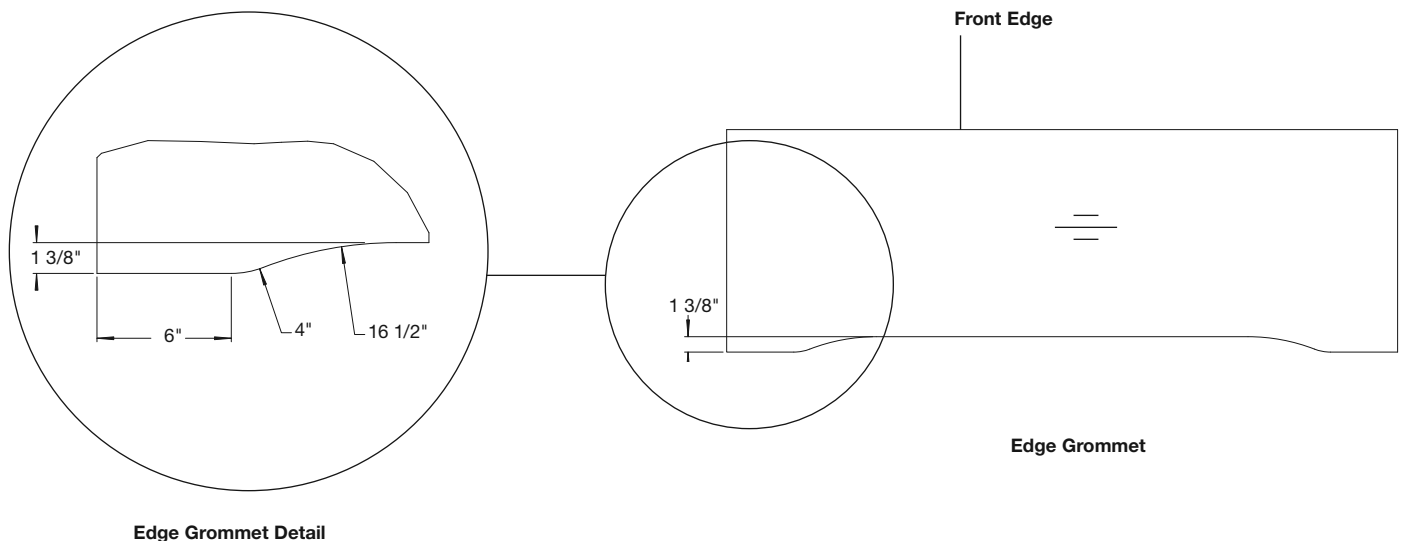

Worksurface 1 1/2"
 rectilinear
 20" and 24" deep

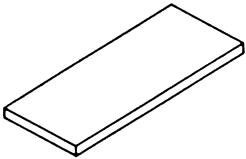
description	d	w	pattern no.	L	M/V1	V2	V3
Straight rectangular work tops 	20"	24"	RSD241-()()()	\$369.	\$410.	\$473.	\$636.
	20"	30"	RSD301-()()()	403.	450.	517.	698.
	20"	36"	RSD361-()()()	427.	476.	545.	739.
	20"	42"	RSD421-()()()	443.	497.	571.	771.
	20"	48"	RSD481-()()()	465.	515.	592.	798.
	20"	54"	RSD541-()()()	484.	535.	619.	836.
	20"	60"	RSD601-()()()	547.	581.	667.	903.
	20"	66"	RSD661-()()()	535.	597.	689.	929.
	20"	72"	RSD721-()()()	565.	630.	721.	975.
	20"	78"	RSD781-()()()	574.	636.	732.	990.
	20"	84"	RSD841-()()()	608.	681.	779.	1,051.
	20"	90"	RSD901-()()()	636.	707.	810.	1,096.
	20"	96"	RSD961-()()()	659.	732.	842.	1,136.
	20"	102"	RSD1021-()()()	725.	807.	927.	1,248.
	20"	108"	RSD1081-()()()	797.	887.	1,018.	1,374.
	24"	24"	RSD242-()()()	388.	431.	497.	670.
	24"	30"	RSD302-()()()	438.	486.	562.	756.
	24"	36"	RSD362-()()()	452.	508.	583.	785.
	24"	42"	RSD422-()()()	472.	524.	602.	810.
	24"	48"	RSD482-()()()	500.	562.	645.	869.
	24"	54"	RSD542-()()()	535.	597.	689.	929.
	24"	60"	RSD602-()()()	577.	643.	738.	994.
	24"	66"	RSD662-()()()	591.	672.	763.	1,030.
	24"	72"	RSD722-()()()	621.	692.	797.	1,077.
	24"	78"	RSD782-()()()	652.	723.	835.	1,128.
	24"	84"	RSD842-()()()	675.	753.	867.	1,171.
	24"	90"	RSD902-()()()	709.	787.	905.	1,220.
	24"	96"	RSD962-()()()	735.	818.	941.	1,271.
	24"	102"	RSD1022-()()()	808.	900.	1,036.	1,397.
	24"	108"	RSD1082-()()()	888.	988.	1,140.	1,538.

Order Code	Specification Information
Example: RSD241RL	
R	Reff
S	Straight top
D	1 1/2" thick
24	24" wide
1	20" deep
R	Recessed grommet location
111	Jet Black (grommet)
V316	Top finish
()	Edge finish

To order please specify pattern number including:

- Grommet option:
 F=Flush front grommet location
 N=No grommet
 R=Recessed front (not recommended for 20"D and 24"D tops)
- Grommet finish:
 Painted, Plated
- Top finish:
 L, V1, V2, V3
- Edge finish: L, V1, V2, V3
 (Edge options are available on laminate tops only.)

Knoll accepts no responsibility for special grommet locations which interfere with support or other hardware. All requests for special grommet locations must be approved through custom product development .

Product on this page will accept woodgrain laminate where laminate is currently an option.

Worksurfaces stiffeners recommended to provide additional support for open spans greater than 54"w.

Application Notes

Products on this page are shipped without hardware which must be ordered separately from the support components section.

Actual widths of worksurfaces are 1/16" less than nominal dimension. Actual depth is 1/8" less.

These worksurfaces are predrilled with pilot holes for use with wood screws.

Worksurface 1 1/2"
 rectilinear
 30" and 36" deep

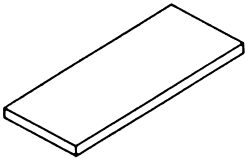
description	d	w	pattern no.	L	M/V1	V2	V3
Straight rectangular work tops 	30"	24"	RSD243-()()	\$423.	\$469.	\$536.	\$724.
	30"	30"	RSD303-()()	476.	528.	607.	821.
	30"	36"	RSD363-()()	509.	569.	652.	880.
	30"	42"	RSD423-()()	532.	591.	682.	921.
	30"	48"	RSD483-()()	569.	632.	724.	980.
	30"	54"	RSD543-()()	614.	684.	782.	1,057.
	30"	60"	RSD603-()()	637.	708.	812.	1,098.
	30"	66"	RSD663-()()	648.	722.	834.	1,126.
	30"	72"	RSD723-()()	666.	741.	852.	1,149.
	30"	78"	RSD783-()()	696.	776.	892.	1,203.
	30"	84"	RSD843-()()	724.	807.	928.	1,254.
	30"	90"	RSD903-()()	757.	845.	972.	1,312.
	30"	96"	RSD963-()()	783.	874.	1,007.	1,357.
	30"	102"	RSD1023-()()	863.	962.	1,107.	1,493.
	30"	108"	RSD1083-()()	949.	1,058.	1,218.	1,643.
	36"	60"	RSD604-()()	734.	817.	936.	1,254.
36"	66"	RSD664-()()	757.	846.	974.	1,313.	
36"	72"	RSD724-()()	782.	873.	1,005.	1,356.	

Order Code

Example: RSD243RL	
R	Reff
S	Straight top
D	1 1/2" thick
24	24" wide
3	30" deep
R	Recessed grommet location
111	Jet Black (grommet)
V316	Top finish
()	Edge finish

Specification Information

To order please specify pattern number including:

- Grommet options:
 N = No grommets
 F = Flush front grommet location
 R = Recessed front (not recommended for 20"D and 24"D tops)
 A = Alternate location (for 36"D tops only)
- Grommet finish:
 Painted, Plated
- Finish:
 L, V1, V2, V3
- Edge finish: L, V1, V2, V3
 (Edge options are available on laminate tops only.)

Knoll accepts no responsibility for special grommet locations which interfere with support or other hardware. All requests for special grommet locations must be approved through custom product development .

Product on this page will accept woodgrain laminate where laminate is currently an option.

Worksurfaces stiffeners recommended to provide additional support for open spans greater than 54"w.

Application Notes

Products on this page are shipped without hardware which must be ordered separately from the support components section.

Actual widths of worksurfaces are 1/16" less than nominal dimension. Actual depth is 1/8" less.

These worksurfaces are predrilled with pilot holes for use with wood screws.

Worksurface 1 1/2"
 Bridge rectilinear
 Horizontal or vertical grain direction

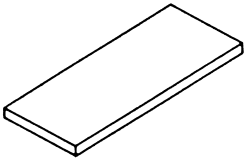
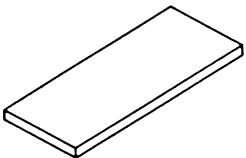
description	d	w	pattern no.	L	M/V1	V2	V3		
Worksurface, bridge rectilinear	20"		36" RBD361H () () ()	\$427.	\$476.	\$545.	\$739.		
			36" RBD361V () () ()	427.	476.	545.	739.		
			42" RBD421H () () ()	443.	497.	571.	771.		
			42" RBD421V () () ()	443.	497.	571.	771.		
			48" RBD481H () () ()	465.	515.	592.	798.		
			48" RBD481V () () ()	465.	515.	592.	798.		
			54" RBD541H () () ()	484.	535.	619.	836.		
			54" RBD541V () () ()	484.	535.	619.	836.		
			24"		36" RBD362H () () ()	452.	508.	583.	785.
					36" RBD362V () () ()	452.	508.	583.	785.
42" RBD422H () () ()	472.	524.			602.	810.			
42" RBD422V () () ()	472.	524.			602.	810.			
48" RBD482H () () ()	500.	562.			645.	869.			
48" RBD482V () () ()	500.	562.			645.	869.			
54" RBD542H () () ()	535.	597.			689.	929.			
54" RBD542V () () ()	535.	597.			689.	929.			

Order Code	Specification Information	Application Notes
Example: RBD361H	<i>To order please specify pattern number including:</i>	Product on this page will accept woodgrain laminate where laminate is currently an option.
R Reff	1. Options for grain direction H = Horizontal grain direction V = Vertical grain direction	Worksurface stiffeners recommended to provide additional support for open spans greater than 54" w.
B Bridge	2. Grommet type: N = No grommet F = Flush front grommet location	Stiffener sold separately.
D 1 1/2"	3. Grommet finish: Painted or Plated	J=Bracket sold separately.
36 36" wide	4. Worksurface finish: L, V1, V2, V3	Modesty sold separately
H/V Horizontal or Vertical grain	5. Edge finish: L, V1, V2, V3 (Edge options are available on laminate tops only.)	
F Grommet type		
115 Grommet finish		
114 Laminate		
() Edge finish		

Actual widths of worksurfaces are 1/16" less than nominal dimensions. Actual depth is 1/8" less.

Products on this page are shipped including bridge hardware only.

Assembly required.

Note: For "L" and "U" configurations, please refer to page 24.

Worksurface 1 1/2"
 Return and Bridge rectilinear
 Horizontal or vertical grain direction

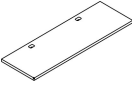
description	d	w	pattern no.	L	M/V1	V2	V3
Return / Bridge 1 1/2" thick 	20"	36"	RSDR361(H/V)()()	\$427.	\$476.	\$545.	\$739.
	20"	42"	RSDR421(H/V)()()	443.	497.	571.	771.
	20"	48"	RSDR481(H/V)()()	465.	515.	592.	798.
	20"	54"	RSDR541(H/V)()()	484.	535.	619.	836.
	20"	60"	RSDR601(H/V)()()	547.	581.	667.	903.
	20"	66"	RSDR661(H/V)()()	535.	597.	689.	929.
	20"	72"	RSDR721(H/V)()()	565.	630.	721.	975.
	24"	36"	RSDR362(H/V)()()	452.	508.	583.	785.
	24"	42"	RSDR422(H/V)()()	472.	524.	602.	810.
	24"	48"	RSDR482(H/V)()()	500.	562.	645.	869.
	24"	54"	RSDR542(H/V)()()	535.	597.	689.	929.
	24"	60"	RSDR602(H/V)()()	577.	643.	738.	994.
	24"	66"	RSDR662(H/V)()()	591.	672.	763.	1,030.
	24"	72"	RSDR722(H/V)()()	621.	692.	797.	1,077.

Order Code

Example: RSDR361(H/V)()()	
R	Reff
S	Straight top
D	1 1/2" top
R	Return
36	36" wide
1	20" deep
H/V	Horizontal or Vertical grain
()	Grommet type
()	Grommet finish
()	Worksurface finish
()	Edge finish

Specification Information

To order please specify pattern number including:

- Grommet type:
F = Flush
N = No Grommet
- Grommet finish:
Painted or Plated
- Worksurface finish:
L, V1, V2, V3
- Edge finish: L, V1, V2, V3
(Edge options are available on laminate tops only.)

Product on this page will accept woodgrain laminate where laminate is currently an option.

Products on this page are shipped including bridge hardware only.

Application Notes

The above pattern codes must be used in any 'L' and 'U' configurations as shown below.

L-shaped / Double: Spanning 2 worksurfaces

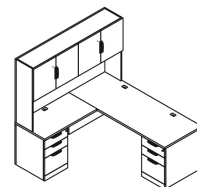

U-shaped / Triple: Spanning 3 worksurfaces

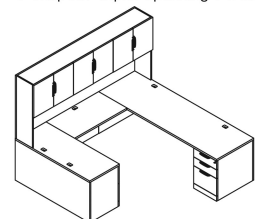

Worksurface Credenza

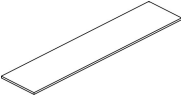

1" No grommet

description	d	w	pattern no.	L	M/V1	V2	V3
Credenza tops 	20"	30"	RCE301()	\$383.	\$414.	\$428.	\$555.
	20"	36"	RCE361()	404.	427.	446.	591.
	20"	60"	RCE601()	503.	513.	590.	798.
	20"	66"	RCE661()	518.	529.	609.	822.
	20"	72"	RCE721()	545.	557.	639.	862.
	20"	78"	RCE781()	551.	562.	648.	875.
	20"	84"	RCE841()	589.	602.	690.	931.
	20"	90"	RCE901()	613.	625.	716.	970.
	20"	96"	RCE961()	636.	648.	745.	1,005.
	20"	102"	RCE1021()	699.	713.	820.	1,105.
	20"	108"	RCE1081()	770.	784.	902.	1,216.
	24"	30"	RCE302()	402.	434.	451.	595.
	24"	36"	RCE362()	419.	455.	476.	641.
	24"	60"	RCE602()	558.	568.	651.	880.
	24"	66"	RCE662()	575.	586.	674.	910.
	24"	72"	RCE722()	599.	611.	705.	954.
	24"	78"	RCE782()	628.	641.	741.	997.
	24"	84"	RCE842()	655.	667.	768.	1,036.
	24"	90"	RCE902()	684.	697.	801.	1,080.
	24"	96"	RCE962()	709.	723.	832.	1,124.
	24"	102"	RCE1022()	780.	796.	916.	1,236.
	24"	108"	RCE1082()	858.	875.	1,009.	1,360.

Order Code	Specification Information	Application Notes
Example: RCE601	<i>To order please specify pattern number including:</i> 1. Finish L, V1, V2, V3 2. Edge finish: L, V1, V2, V3 (Edge options are available on laminate tops only.)	No grommet options Product on this page will accept woodgrain laminate where laminate is currently an option. Hardware are NOT included.
R Reff		
C Credenza Top		
E 1"		
60 width		
1 20"		
V316 Finish		
() Edge finish	Credenza tops are drilled to accept pedestals and end panels. Credenza tops are predrilled with pilot holes for use with wood screws. 1" Credenza tops are recommended to work with the Task Panel application. Credenza tops are intended to be supported by full lower storage.	

Worksurface Credenza

1" and 1 1/4" with edge grommet

description	d	w	pattern no.	L	M/V1	V2	V3
Credenza tops, 1" thick with grommet 	20"	60"	RCEEG601()	\$703.	\$718.	\$826.	\$1,118.
		66"	RCEEG661()	726.	741.	854.	1,151.
		72"	RCEEG721()	765.	779.	894.	1,206.
		78"	RCEEG781()	772.	787.	908.	1,227.
		84"	RCEEG841()	826.	844.	966.	1,303.
		90"	RCEEG901()	857.	874.	1,003.	1,357.
		96"	RCEEG961()	890.	908.	1,042.	1,407.
		102"	RCEEG1021()	980.	998.	1,147.	1,546.
		108"	RCEEG1081()	1,076.	1,098.	1,262.	1,703.
		24"	60"	RCEEG602()	780.	796.	912.
	66"		RCEEG662()	804.	820.	944.	1,274.
	72"		RCEEG722()	838.	856.	987.	1,335.
	78"		RCEEG782()	879.	898.	1,036.	1,396.
	84"		RCEEG842()	915.	934.	1,074.	1,450.
	90"		RCEEG902()	956.	976.	1,121.	1,513.
	96"		RCEEG962()	992.	1,013.	1,166.	1,574.
	102"		RCEEG1022()	1,093.	1,115.	1,283.	1,731.
	108"	RCEEG1082()	1,201.	1,226.	1,411.	1,904.	
Credenza tops, 1 1/4" thick 	20"	60"	RCA601()	736.	750.	863.	1,169.
		66"	RCA661()	759.	774.	891.	1,202.
		72"	RCA721()	798.	815.	934.	1,262.
		78"	RCA781()	806.	822.	949.	1,281.
		84"	RCA841()	862.	880.	1,010.	1,361.
		90"	RCA901()	897.	914.	1,049.	1,419.
		96"	RCA961()	931.	949.	1,090.	1,469.
		102"	RCA1021()	1,023.	1,043.	1,199.	1,617.
		108"	RCA1081()	1,124.	1,147.	1,318.	1,777.
		24"	60"	RCA602()	816.	831.	953.
	66"		RCA662()	841.	857.	988.	1,333.
	72"		RCA722()	877.	895.	1,032.	1,394.
	78"		RCA782()	918.	937.	1,084.	1,460.
	84"		RCA842()	958.	978.	1,123.	1,516.
	90"		RCA902()	1,000.	1,020.	1,172.	1,581.
	96"		RCA962()	1,038.	1,060.	1,220.	1,645.
	102"		RCA1022()	1,142.	1,165.	1,341.	1,810.
	108"	RCA1082()	1,256.	1,281.	1,475.	1,992.	

Order Code	Specification Information	Application Notes
Example: RCEEG601	<i>To order please specify pattern number including:</i>	These tops will always come with a cut out (notch) at the back of top.
R Reff	1. Top finish L, V1, V2, V3	Edge grommet: 35mm deep, 6" in from back corner.
C Credenza Top	2. Edge finish: L, V1, V2, V3 (Edge options are available on laminate tops only.)	No other grommet option.
E 1"		Product on this page will accept woodgrain laminate where laminate is currently an option.
EG Edge Grommet		
60 Width		
1 20" deep 2 = 24" deep		
V316 Finish		
() Edge finish		

1" Credenza tops are recommended to work with the Task Panel application.

The 1 1/4" thick tops are recommended to be used with Hutches.

These tops are recommended to be used with Hutches.

Credenza tops are intended to be supported by full lower storage.

Credenza tops are drilled to accept pedestals.

Credenza tops are predrilled with pilot holes for use with wood screws.

Worksurface Credenza

1 1/2" with edge grommet

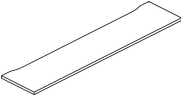
description	d	w	pattern no.	L	M/V1	V2	V3
Credenza tops, 1 1/2" thick 	20"	60"	RCD601()	\$774.	\$790.	\$909.	\$1,230.
	20"	66"	RCD661()	798.	815.	938.	1,265.
	20"	72"	RCD721()	841.	855.	983.	1,328.
	20"	78"	RCD781()	849.	865.	998.	1,349.
	20"	84"	RCD841()	908.	927.	1,063.	1,433.
	20"	90"	RCD901()	943.	962.	1,104.	1,493.
	20"	96"	RCD961()	980.	998.	1,147.	1,546.
	20"	102"	RCD1021()	1,076.	1,098.	1,262.	1,703.
	20"	108"	RCD1081()	1,184.	1,207.	1,388.	1,871.
	24"	60"	RCD602()	858.	875.	1,003.	1,355.
	24"	66"	RCD662()	884.	902.	1,040.	1,403.
	24"	72"	RCD722()	924.	941.	1,087.	1,468.
	24"	78"	RCD782()	967.	986.	1,141.	1,536.
	24"	84"	RCD842()	1,009.	1,029.	1,182.	1,596.
	24"	90"	RCD902()	1,052.	1,073.	1,233.	1,664.
	24"	96"	RCD962()	1,093.	1,115.	1,283.	1,731.
	24"	102"	RCD1022()	1,201.	1,226.	1,411.	1,904.
	24"	108"	RCD1082()	1,322.	1,349.	1,553.	2,096.

Order Code	Specification Information	Application Notes
Example: RCD601	<i>To order please specify pattern number including:</i>	These tops will always come with a cut out (notch) at the back of top.
R Reff	1. Finish	Edge grommet: 35mm deep, 6" in from back corner.
C Credenza	L, V1, V2, V3	
D 1 1/2" top	2. Edge finish: L, V1, V2, V3	No other grommet options.
60 Width	(Edge options are available on laminate tops only.)	
1 20" 2 = 24" deep		Product on this page will accept woodgrain laminate where laminate is currently an option.
V316 Finish		Credenza tops are predrilled with pilot holes for use with wood screws.
() Edge finish		

Peninsulas

Peninsulas for Reff Profiles are a central element in private office planning. Peninsulas are available in two styles; flush mounted and over-sailing. The flush mounted style is intended to connect tops which use full height pedestals for support, creating a flush transition

between the peninsula and the adjoining top. The over-sailing style of peninsula is designed to overlap low storage made up of 3/4 height cabinets with 1" credenza tops or Progressive low credenzas by using a stand-off to support the peninsula top and create a space between the top and the low storage element.

See diagrams below and page following for descriptions. Peninsulas are offered as complete assemblies including worksurface, leg(s), credenza support, and grommet options.

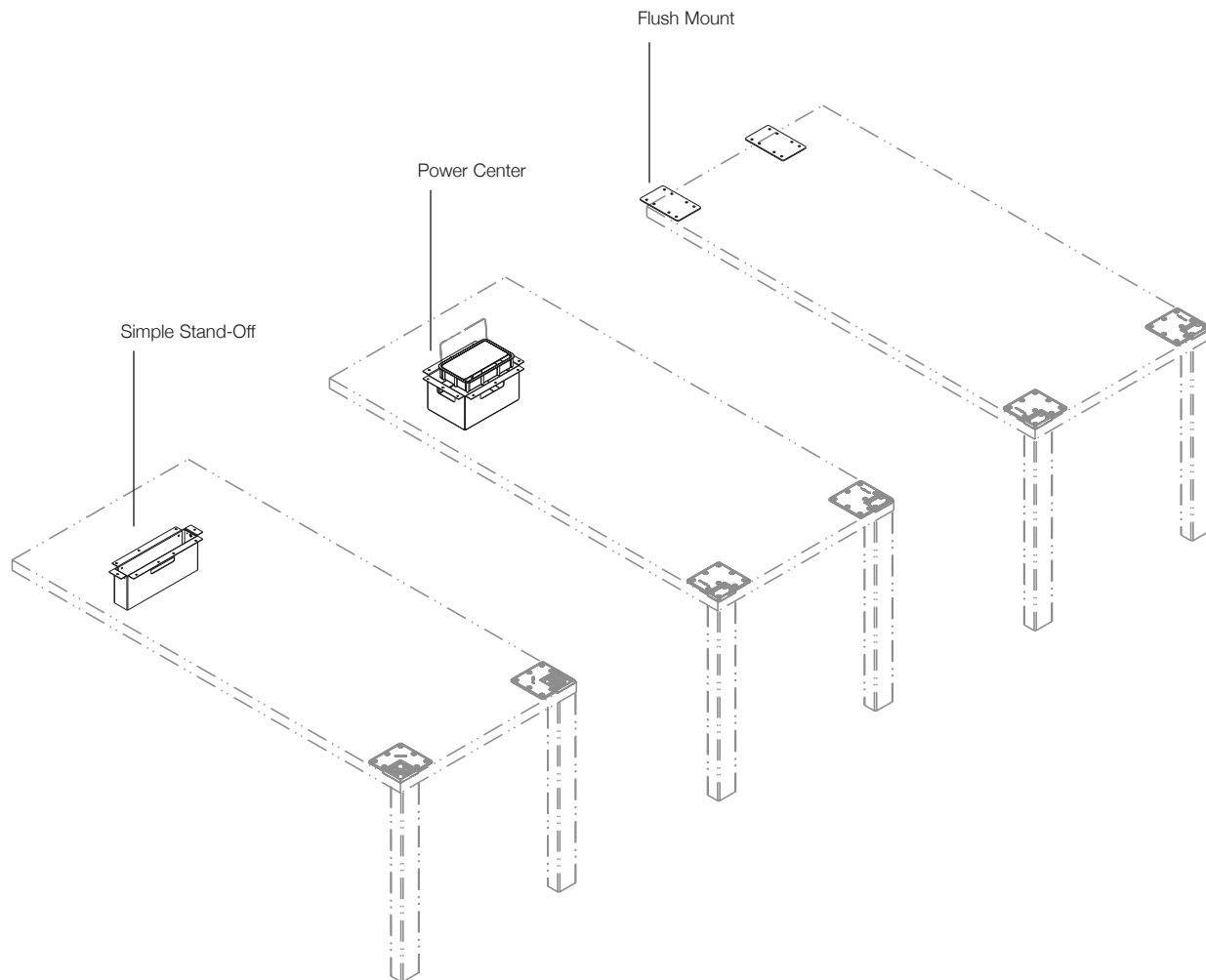

Specification Options

Peninsulas are available with a variety of worksurface shapes including rectilinear, asymmetrical and symmetrical bullet, P, 9 and D shapes.

Peninsula tops are available in any Reff Profiles core laminate or veneer finish; see Reff Profiles finish options pages for further information.

Laminate tops are offered with color-matched edges or wood veneer edges as a mixed finish option. Edge material for veneer tops is wood.

Flush mounted peninsulas, previous page below right, come with Flush Mounting kit including two flush plates and connection hardware.

Over-sailing peninsulas are offered with two stand-off options; Power Center, previous page middle, and Simple stand-off, previous page left.

Electrical components are not supplied with peninsulas but are orderable separately. Refer to Planning Guidelines for Accessories.

The Power Center kit is supplied with power center grommet, stand-off, round cable grommet and connection hardware.

When specified with a Power Center, the peninsula top is pre-drilled to accept the Power Center grommet. The Power Center stand-off is field installed to the peninsula top and lower storage. Refer to PN #6TP00081 for Power Center Stand-Off installation instructions.

In the recommended mounting location, the peninsula top will be 2 1/2" from the wall or the back edge of the 1" credenza top (over 3/4 height pedestals). Refer to elevation diagrams below for details.

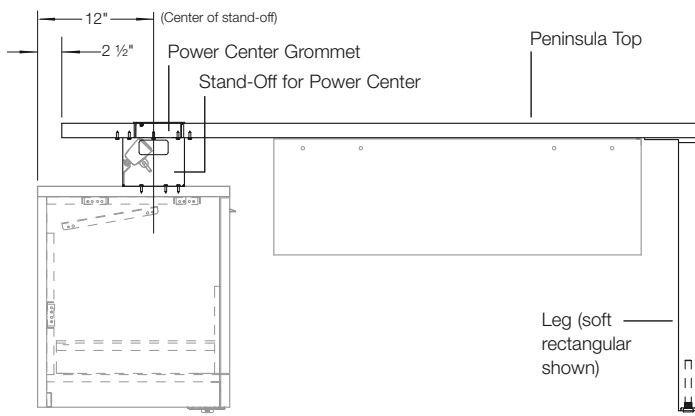

Over-Sailing Style
Peninsula with Power Center

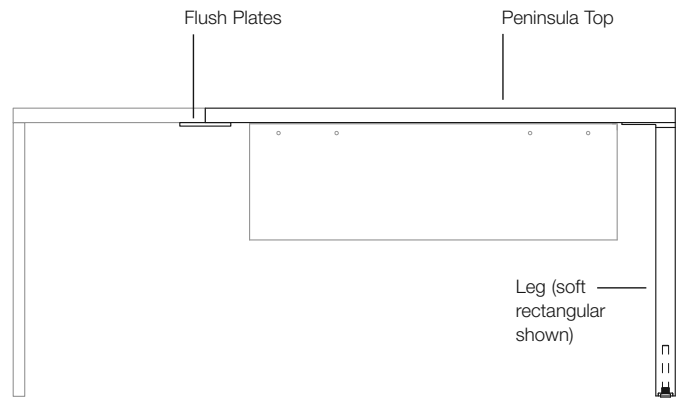

Flush Mounted Style
Peninsula with Flush Mount

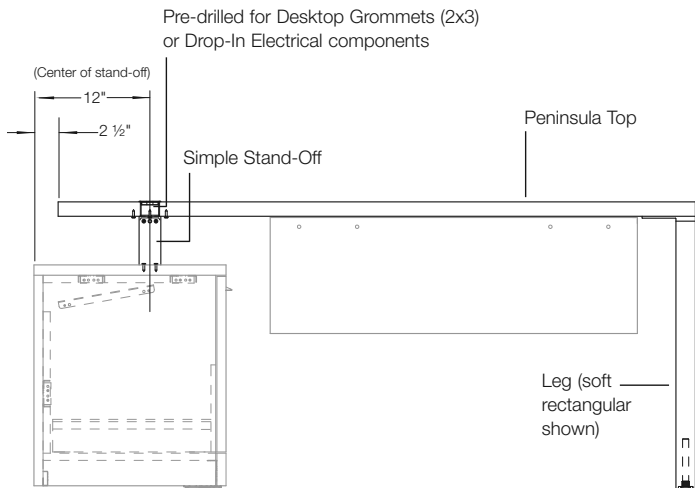

Over-Sailing Style
Peninsula with Simple Stand-Off

The Simple Stand-Off kit is supplied with a simple stand-off, stand-off mount, round cable grommet and connection hardware. When specified, the peninsula top is pre-drilled to accept the 2 x 3 grommet or drop-in electrical components. Refer to Planning Guideline for Accessories. The Simple Stand-Off is field installed to the peninsula top and lower storage. Refer to PN #6TP00081 for Power Center Stand-Off installation instructions.

Power center and 2 x 3 grommets are offered in two plated finishes; Polished Chrome (PD) and Satin Nickel (PU) and all core paint finishes.

Stand-Off's are offered in all Reff Profiles core paint finishes.

Rectilinear Tops
Right Hand Shown

Simple Stand-Off

Power Center

Flush Mount

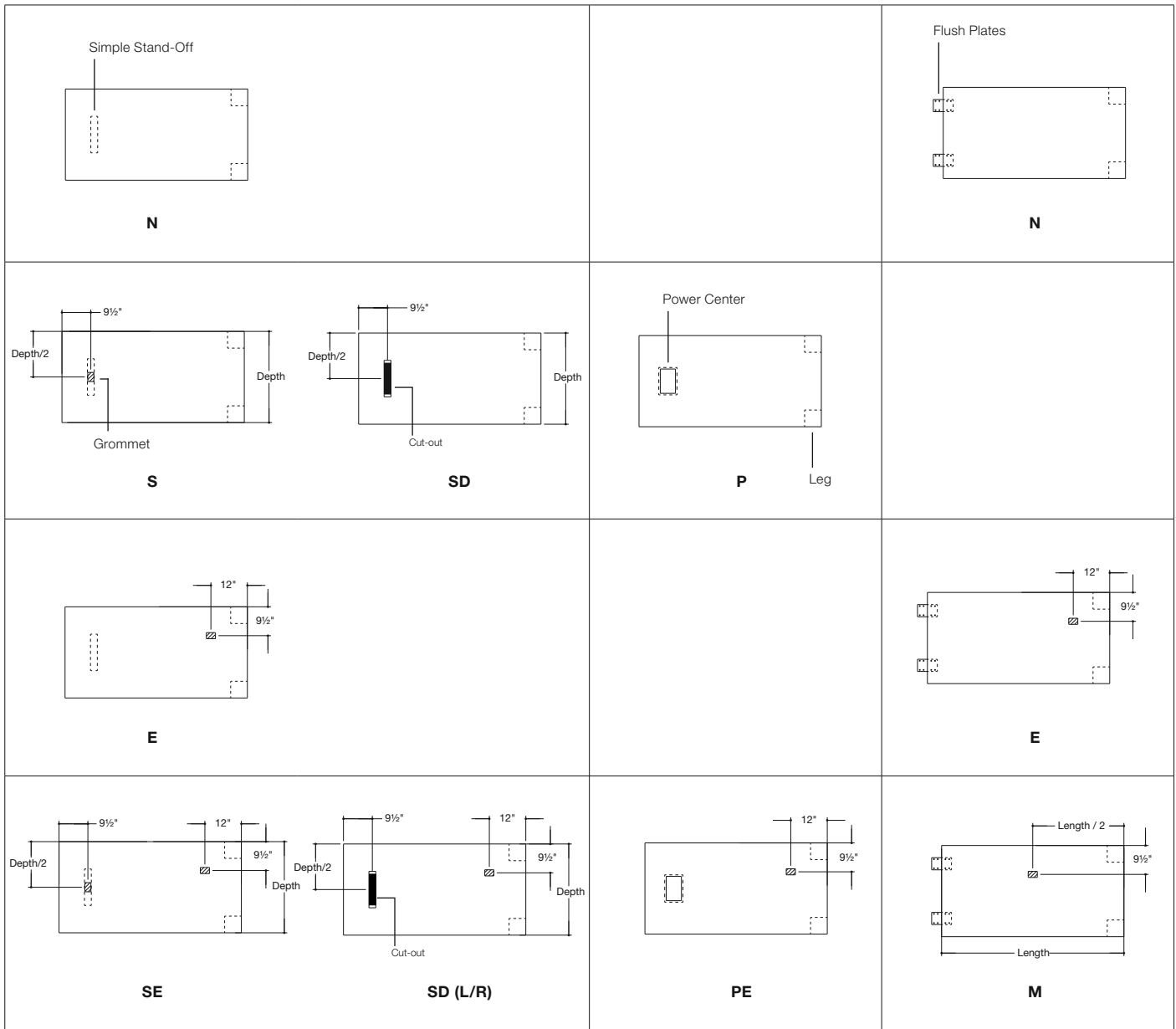

Leg options for Peninsulas include L-leg, reverse L-leg, soft rectangular leg, open frame leg and cylindrical column leg. L, reverse L, soft rectangular and open frame legs are offered with anodized finishes: Polished (AP) and Satin (AU).

Cylindrical column leg is offered with plated finishes: Polished Chrome (PD) and Satin Nickel (PU).

All legs are available in all Reff Profiles core paint finishes.

Rectilinear peninsula tops are offered with L, reverse L, soft rectangular, and open frame leg options. All other peninsula tops are offered with cylindrical column leg.

Refer to figures on previous page and following for grommet locations and order codes.

Asymmetrical Bullet Tops
Right Hand Shown

Simple Stand-Off

Power Center

Flush Mount

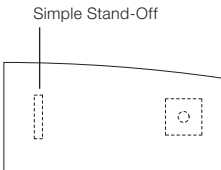
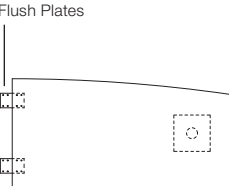
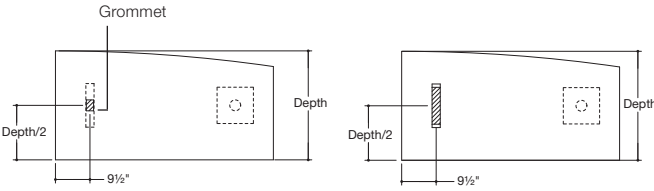
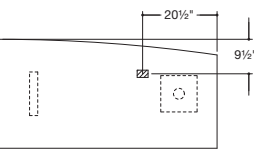
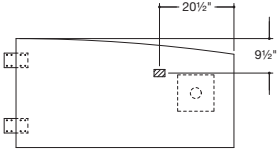
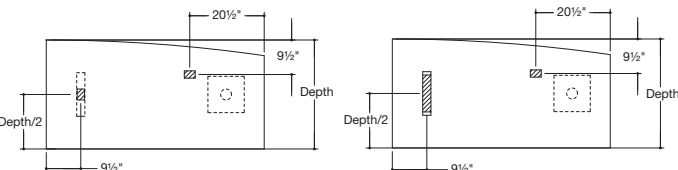
 <p>Simple Stand-Off</p> <p>N</p>		 <p>Flush Plates</p> <p>N</p>
 <p>Grommet</p> <p>Depth</p> <p>Depth/2</p> <p>9 1/2"</p> <p>S</p> <p>SD</p> <p>Power Center</p> <p>Leg</p> <p>P</p>		
 <p>20 1/2"</p> <p>9 1/2"</p> <p>E</p>		 <p>20 1/2"</p> <p>9 1/2"</p> <p>E</p>
 <p>20 1/2"</p> <p>9 1/2"</p> <p>Depth</p> <p>Depth/2</p> <p>9 1/2"</p> <p>SE</p> <p>SD (L/R)</p>		

Construction

Reff Profiles peninsula tops are nominal 1 1/2" thick, consisting of 1 7/16" thick substrate with a laminate or veneer surface finish.

Laminate tops have a laminate top surface with an FSC-certified particle board core and a neutral tone backer sheet for balanced construction. Edges can match the top or are available in a selection

of veneers. Matching edges are in 2.0mm ABS with 2.0mm radius top and bottom edges. End edges overlap the front and back edges with the outside corners minimally radiused.

Edges on veneer tops are 2.4mm thick wood with 2.4mm radius top and bottom edges. Ends overlap front and back edges

with 2.4mm radius on outside corners.

All tops are supplied with pilot holes for hardware inserts for attachment of specified leg options.

Legs are shipped separately, fully assembled with connection hardware included.

Symmetrical Bullet Tops
Right Hand Shown

Simple Stand-Off

Power Center

Flush Mount

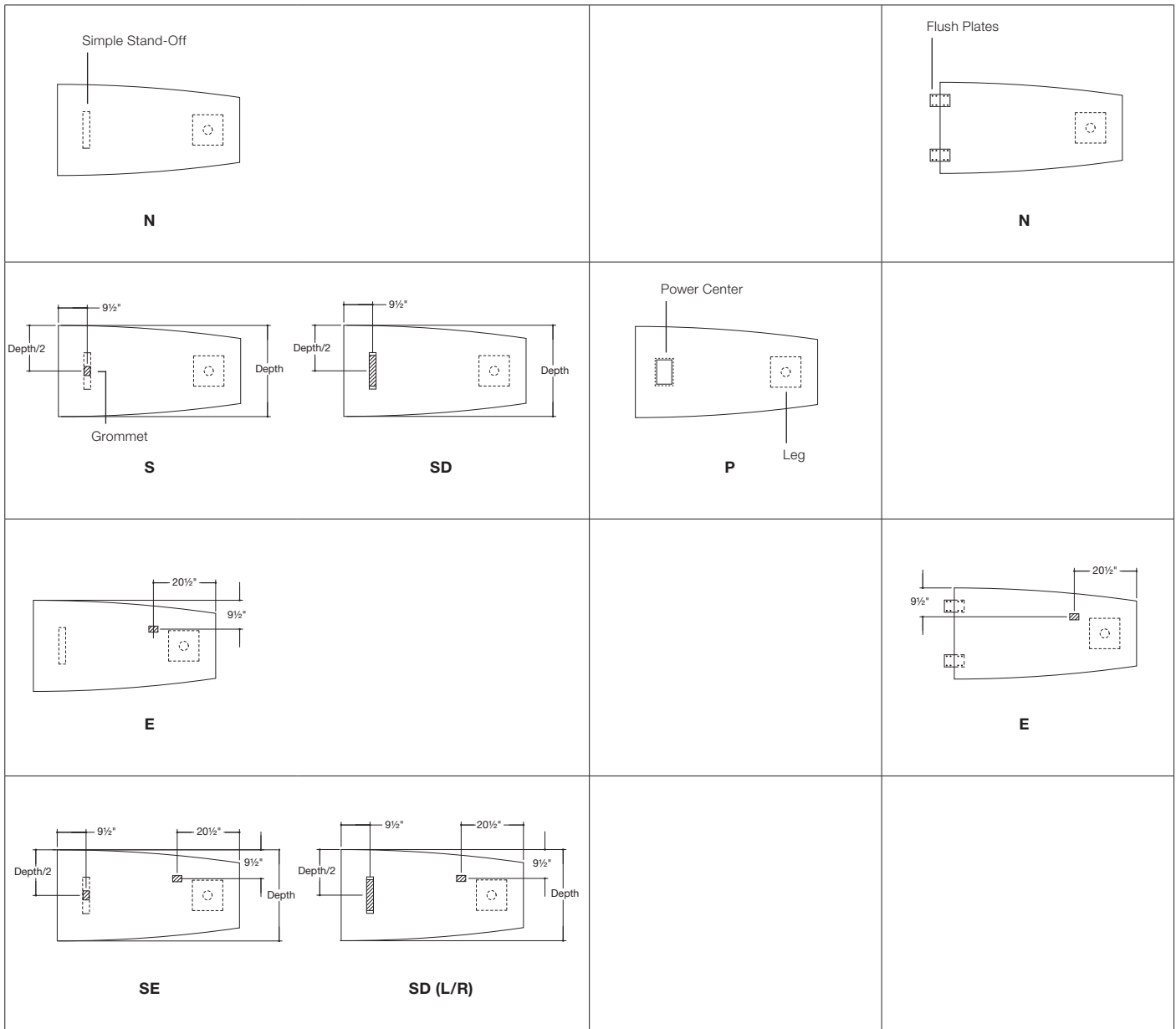

Planning Notes

1. Partial height modesty is available, sold separately and field installed.
2. J-wire manager is available, sold separately and field installed.
3. Peninsula tops require additional stiffening for spans greater than 54".
4. Peninsula top is right handed when the leg is on the right hand side (from the users perspective) and vice versa.
5. Power center electrical components are not included with the Peninsula and are ordered separately.

P and 9 Tops

Flush Mount Options:

P-Shaped

9-Shaped



<p>No Grommet</p>		
<p>Single Grommet</p>		
<p>Double Grommet</p>		

D-Tops
Right Hand Shown

Simple Stand-Off

Power Center

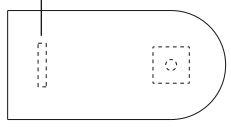
Flush Mount

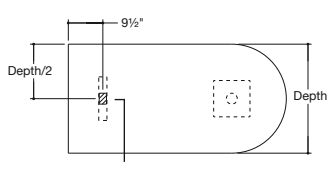
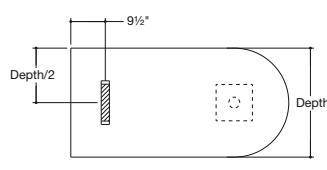
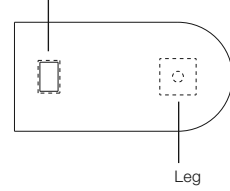
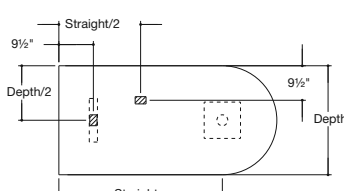
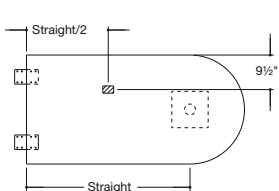
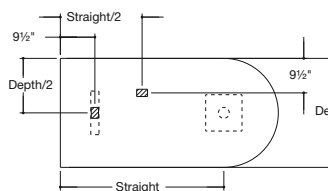
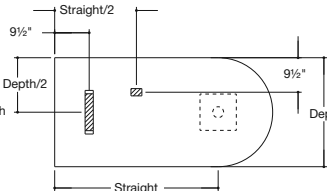
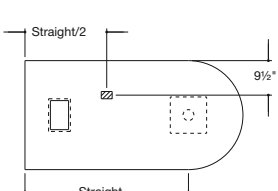
<p>Simple Stand-Off</p>  <p>N</p>		<p>Flush Plates</p>  <p>N</p>
 <p>Grommet</p> <p>S</p>  <p>SD</p>	<p>Power Center</p>  <p>Leg</p> <p>P</p>	
 <p>M</p>		 <p>M</p>
 <p>SM</p>  <p>SDR</p>	 <p>PM</p>	

Worksurface with L-leg

Stand-Off with Power Center, Rectilinear top, Square Edge

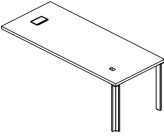
description	d	w	th	pattern no.	L	M/V1	V2	V3
 <p>Left hand shown</p>	20"	60"	1 1/2"	RPTDLPC(L/R)6020() () ()	\$1,270.	\$1,434.	\$1,612.	\$1,892.
	20"	66"	1 1/2"	RPTDLPC(L/R)6620() () ()	1,281.	1,453.	1,636.	1,940.
	20"	72"	1 1/2"	RPTDLPC(L/R)7220() () ()	1,293.	1,484.	1,671.	2,000.
	20"	78"	1 1/2"	RPTDLPC(L/R)7820() () ()	1,304.	1,503.	1,694.	2,048.
	20"	84"	1 1/2"	RPTDLPC(L/R)8420() () ()	1,316.	1,523.	1,718.	2,093.
	24"	60"	1 1/2"	RPTDLPC(L/R)6024() () ()	1,286.	1,452.	1,636.	1,953.
	24"	66"	1 1/2"	RPTDLPC(L/R)6624() () ()	1,300.	1,509.	1,702.	2,045.
	24"	72"	1 1/2"	RPTDLPC(L/R)7224() () ()	1,344.	1,530.	1,728.	2,099.
	24"	78"	1 1/2"	RPTDLPC(L/R)7824() () ()	1,357.	1,563.	1,767.	2,167.
	24"	84"	1 1/2"	RPTDLPC(L/R)8424() () ()	1,369.	1,586.	1,794.	2,220.
	30"	60"	1 1/2"	RPTDLPC(L/R)6030() () ()	1,411.	1,545.	1,747.	2,120.
	30"	66"	1 1/2"	RPTDLPC(L/R)6630() () ()	1,428.	1,571.	1,779.	2,184.
	30"	72"	1 1/2"	RPTDLPC(L/R)7230() () ()	1,443.	1,608.	1,825.	2,262.
	30"	78"	1 1/2"	RPTDLPC(L/R)7830() () ()	1,480.	1,636.	1,858.	2,327.
	30"	84"	1 1/2"	RPTDLPC(L/R)8430() () ()	1,497.	1,672.	1,901.	2,403.
	36"	60"	1 1/2"	RPTDLPC(L/R)6036() () ()	1,393.	1,603.	1,818.	2,247.
	36"	66"	1 1/2"	RPTDLPC(L/R)6636() () ()	1,460.	1,635.	1,858.	2,325.
	36"	72"	1 1/2"	RPTDLPC(L/R)7236() () ()	1,478.	1,676.	1,908.	2,410.
	36"	78"	1 1/2"	RPTDLPC(L/R)7836() () ()	1,497.	1,708.	1,873.	2,391.
	36"	84"	1 1/2"	RPTDLPC(L/R)8436() () ()	1,516.	1,738.	1,985.	2,561.

Order Code	Specification Information	Application Notes
Example: RPTDLPC(L/R)6030() () ()	<i>To order please specify pattern number including:</i>	It is not advisable to mix 28 3/8" h desk height product with 26 1/2" h standard height products.
R Reff	1. Left or Right hand	Products on this page work with 28 3/8" height planning.
PT Peninsula	2. Grommet option P=Power Center, PE= Power center grommet	
D 1 1/2" Thick Square Edge	3. Grommet option Painted or plated	Products on this page will accept woodgrain laminate where laminate is currently an option.
L L-leg	4. Worksurface finish L, V1, V2, V3	
PC Power Center	5. Edge finish: L, V1, V2, V3 (Edge options are available on laminate tops only.)	Worksurface stiffeners, recommended to provide additional support for open spans greater than 48" w.
L Left hand/ Right hand	6. Leg finish Painted or Anodized	
60 Width	7. Stand-off finish Painted	Upcharges apply to legs with P2, P3 and P4 finishes. Additional upcharges;
30 Depth		
P Grommet option		Leg Finish Add P2 \$50 P3 \$80 P4 \$200
115 Grommet Finish		
114 Worksurface Finish		Peninsula worksurfaces with power center do not come with Electrical Components. For electrical components please refer to page 399. Modesty sold separately and can be field installed. Wire chase sold separately. Refer to grommet page for location option. From users perspective, if the leg is on the right side, the peninsula is classified a "Right Hand" peninsula.
() Edge finish		
115 Leg Finish		
115 Stand-Off Finish		

Worksurface with L-leg

Simple Stand-Off, Rectilinear top, Square Edge

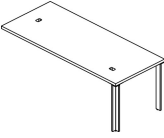
description	d	w	th	pattern no.	L	M/V1	V2	V3
 <p>Left hand shown</p>	20"	60"	1 1/2"	RPTDLST(L/R)6020() () ()	\$1,130.	\$1,253.	\$1,411.	\$1,691.
	20"	66"	1 1/2"	RPTDLST(L/R)6620() () ()	1,141.	1,271.	1,435.	1,739.
	20"	72"	1 1/2"	RPTDLST(L/R)7220() () ()	1,152.	1,302.	1,472.	1,800.
	20"	78"	1 1/2"	RPTDLST(L/R)7820() () ()	1,163.	1,321.	1,495.	1,848.
	20"	84"	1 1/2"	RPTDLST(L/R)8420() () ()	1,175.	1,341.	1,519.	1,894.
	24"	60"	1 1/2"	RPTDLST(L/R)6024() () ()	1,147.	1,304.	1,473.	1,790.
	24"	66"	1 1/2"	RPTDLST(L/R)6624() () ()	1,159.	1,326.	1,501.	1,846.
	24"	72"	1 1/2"	RPTDLST(L/R)7224() () ()	1,204.	1,349.	1,528.	1,898.
	24"	78"	1 1/2"	RPTDLST(L/R)7824() () ()	1,217.	1,382.	1,566.	1,966.
	24"	84"	1 1/2"	RPTDLST(L/R)8424() () ()	1,230.	1,403.	1,594.	2,019.
	30"	60"	1 1/2"	RPTDLST(L/R)6030() () ()	1,272.	1,363.	1,546.	1,919.
	30"	66"	1 1/2"	RPTDLST(L/R)6630() () ()	1,287.	1,389.	1,579.	1,984.
	30"	72"	1 1/2"	RPTDLST(L/R)7230() () ()	1,303.	1,427.	1,624.	2,061.
	30"	78"	1 1/2"	RPTDLST(L/R)7830() () ()	1,341.	1,454.	1,657.	2,128.
	30"	84"	1 1/2"	RPTDLST(L/R)8430() () ()	1,356.	1,490.	1,702.	2,203.
	36"	60"	1 1/2"	RPTDLST(L/R)6036() () ()	1,254.	1,422.	1,620.	2,047.
	36"	66"	1 1/2"	RPTDLST(L/R)6636() () ()	1,320.	1,453.	1,658.	2,124.
	36"	72"	1 1/2"	RPTDLST(L/R)7236() () ()	1,339.	1,493.	1,709.	2,210.
	36"	78"	1 1/2"	RPTDLST(L/R)7836() () ()	1,357.	1,525.	1,748.	2,287.
	36"	84"	1 1/2"	RPTDLST(L/R)8436() () ()	1,376.	1,556.	1,786.	2,363.

Order Code	Specification Information	Application Notes
Example: RPTDLST(L/R)6030() () ()	<i>To order please specify pattern number including:</i>	It is not advisable to mix 28 3/8" h desk height product with 26 1/2" h standard height products.
R Reff	1. Left or Right hand	Peninsula worksurfaces with power center do not come with Electrical Components.
PT Peninsula	2. Grommet option N=No grommet E=End location grommet S=Stand-off location grommet SE=Stand-off grommet with end grommet SD=Drop in electrical cut out-no grommet SDR=Drop in electrical cutout-end grommet RH SDL=Drop in electrical cutout-end grommet LH	Products on this page work with 28 3/8" height planning. Products on this page will accept woodgrain laminate where laminate is currently an option. Worksurface stiffeners, recommended to provide additional support for open spans greater than 48" w.
D 1 1/2" Thick Square Edge	Note: Please order electrical for the following options; SD, SDR and SDL.	For electrical components please refer to page 399.
L L-Leg	3. Grommet Finish: Painted or plated where applicable, N & SD have no finish option.	Modesty sold separately and can be field installed.
ST Stand-Off	4. Worksurface finish L, V1, V2, V3	Wire chase sold separately.
L Left hand/ Right hand	5. Edge finish: L, V1, V2, V3 (Edge options are available on laminate tops only.)	Refer to Peninsula Planning Guidelines for location option.
60 Width	6. Leg finish Painted or Anodized	From users perspective, if the leg is on the right side, the peninsula is classified a "Right Hand" peninsula.
30 Depth	7. Stand-off finish Painted	
E Grommet Type		
115 Grommet Finish		
114 Worksurface Finish		
() Edge finish		
115 Leg Finish		
115 Stand-Off Finish		

Worksurface with L-leg

Flush Mount Attachment, Rectilinear top, Square Edge

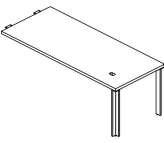
description	d	w	th	pattern no.	L	M/V1	V2	V3
 <p>Left hand shown</p>	20"	36"	1 1/2"	RPTDLFM(L/R)3620() () () ()	\$852.	\$947.	\$1,068.	\$1,251.
	20"	42"	1 1/2"	RPTDLFM(L/R)4220() () () ()	867.	973.	1,098.	1,298.
	20"	48"	1 1/2"	RPTDLFM(L/R)4820() () () ()	927.	1,008.	1,139.	1,371.
	20"	54"	1 1/2"	RPTDLFM(L/R)5420() () () ()	974.	1,027.	1,162.	1,420.
	20"	60"	1 1/2"	RPTDLFM(L/R)6020() () () ()	1,021.	1,122.	1,270.	1,549.
	20"	66"	1 1/2"	RPTDLFM(L/R)6620() () () ()	1,032.	1,142.	1,294.	1,597.
	20"	72"	1 1/2"	RPTDLFM(L/R)7220() () () ()	1,043.	1,172.	1,328.	1,657.
	20"	78"	1 1/2"	RPTDLFM(L/R)7820() () () ()	1,055.	1,191.	1,352.	1,705.
	20"	84"	1 1/2"	RPTDLFM(L/R)8420() () () ()	1,066.	1,212.	1,376.	1,751.
	24"	36"	1 1/2"	RPTDLFM(L/R)3624() () () ()	866.	983.	1,108.	1,317.
	24"	42"	1 1/2"	RPTDLFM(L/R)4224() () () ()	890.	1,010.	1,141.	1,376.
	24"	48"	1 1/2"	RPTDLFM(L/R)4824() () () ()	955.	1,042.	1,180.	1,441.
	24"	54"	1 1/2"	RPTDLFM(L/R)5424() () () ()	982.	1,066.	1,208.	1,499.
	24"	60"	1 1/2"	RPTDLFM(L/R)6024() () () ()	1,038.	1,174.	1,330.	1,646.
	24"	66"	1 1/2"	RPTDLFM(L/R)6624() () () ()	1,051.	1,197.	1,357.	1,703.
	24"	72"	1 1/2"	RPTDLFM(L/R)7224() () () ()	1,095.	1,219.	1,385.	1,757.
	24"	78"	1 1/2"	RPTDLFM(L/R)7824() () () ()	1,108.	1,252.	1,424.	1,823.
	24"	84"	1 1/2"	RPTDLFM(L/R)8424() () () ()	1,121.	1,274.	1,451.	1,878.

Order Code	Specification Information	Application Notes
Example: RPTDLFM(L/R)3620() () () ()	<i>To order please specify pattern number including:</i>	It is not advisable to mix 28 3/8" h desk height product with 26 1/2" h standard height products.
R Reff	1. Left or Right hand	Products on this page work with 28 3/8" height planning.
PT Peninsula	2. Grommet option E=End, N=No grommet, M=Middle grommet	
D 1 1/2" Thick Square Edge	3. Grommet finish Painted or plated	Products on this page will accept woodgrain laminate where laminate is currently an option.
IL L-leg	4. Worksurface finish L, V1, V2, V3	Worksurface stiffeners, recommended to provide additional support for open spans greater than 48" w.
FM Flush Mount Attachment Plate	5. Edge finish: L, V1, V2, V3 (Edge options are available on laminate tops only.)	Modesty sold separately and can be field installed.
L Left hand/ Right hand	6. Leg finish Painted or Anodized	Wire chase sold separately.
36 Width	Upcharges apply to legs with P2, P3 and P4 finishes.	Refer to grommet page for location option.
20 Depth	Additional upcharges;	From users perspective, if the leg is on the right side, the peninsula is classified a "Right Hand" peninsula.
M Grommet Option	Leg Finish Add	
115 Grommet Finish	P2 \$50	
114 Worksurface Finish	P3 \$80	
() Edge finish	P4 \$200	
115 Leg Finish		

Worksurface with L-leg

Flush Mount Attachment, Rectilinear top, Square Edge

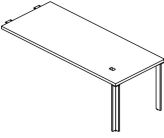
description	d	w	th	pattern no.	L	M/V1	V2	V3
 <p>Left hand shown</p>	30"	36"	1 1/2"	RPTDLFM(L/R)3630() () ()	\$907.	\$1,019.	\$1,152.	\$1,397.
	30"	42"	1 1/2"	RPTDLFM(L/R)4230() () ()	924.	1,047.	1,186.	1,464.
	30"	48"	1 1/2"	RPTDLFM(L/R)4830() () ()	987.	1,136.	1,288.	1,598.
	30"	54"	1 1/2"	RPTDLFM(L/R)5430() () ()	1,030.	1,162.	1,321.	1,664.
	30"	60"	1 1/2"	RPTDLFM(L/R)6030() () ()	1,163.	1,233.	1,404.	1,777.
	30"	66"	1 1/2"	RPTDLFM(L/R)6630() () ()	1,179.	1,260.	1,436.	1,841.
	30"	72"	1 1/2"	RPTDLFM(L/R)7230() () ()	1,194.	1,297.	1,480.	1,918.
	30"	78"	1 1/2"	RPTDLFM(L/R)7830() () ()	1,232.	1,324.	1,515.	1,984.
	30"	84"	1 1/2"	RPTDLFM(L/R)8430() () ()	1,247.	1,360.	1,558.	2,060.
	36"	36"	1 1/2"	RPTDLFM(L/R)3636() () ()	945.	1,050.	1,191.	1,472.
	36"	42"	1 1/2"	RPTDLFM(L/R)4236() () ()	966.	1,093.	1,242.	1,562.
	36"	48"	1 1/2"	RPTDLFM(L/R)4836() () ()	1,027.	1,186.	1,350.	1,704.
	36"	54"	1 1/2"	RPTDLFM(L/R)5436() () ()	1,069.	1,217.	1,389.	1,781.
	36"	60"	1 1/2"	RPTDLFM(L/R)6036() () ()	1,145.	1,292.	1,476.	1,904.
	36"	66"	1 1/2"	RPTDLFM(L/R)6636() () ()	1,212.	1,323.	1,515.	1,981.
	36"	72"	1 1/2"	RPTDLFM(L/R)7236() () ()	1,230.	1,364.	1,565.	2,066.
	36"	78"	1 1/2"	RPTDLFM(L/R)7836() () ()	1,248.	1,396.	1,604.	2,144.
	36"	84"	1 1/2"	RPTDLFM(L/R)8436() () ()	1,267.	1,427.	1,643.	2,219.

Order Code	Specification Information	Application Notes
Example: RPTDLFM(L/R)3620() () ()	<i>To order please specify pattern number including:</i>	It is not advisable to mix 28 3/8" h desk height product with 26 1/2" h standard height products.
R	Reff	Products on this page work with 28 3/8" height planning.
PT	Peninsula	
D	1 1/2" Thick Square Edge	Products on this page will accept woodgrain laminate where laminate is currently an option.
IL	L-leg	Worksurface stiffeners, recommended to provide additional support for open spans greater than 48" w.
FM	Flush Mount Attachment Plate	Peninsula worksurfaces with power center do not come with Electrical Components.
L	Left hand/ Right hand	
36	Width	For electrical components please refer to page 399.
20	Depth	Modesty sold separately and can be field installed.
M	Grommet Option	Wire chase sold separately.
115	Grommet Finish	Refer to grommet page for location option.
114	Worksurface Finish	From users perspective, if the leg is on the right side, the peninsula is classified a "Right Hand" peninsula.
()	Edge finish	
115	Leg Finish	

Upcharges apply to legs with P2, P3 and P4 finishes.
 Additional upcharges;
 Leg Finish Add
 P2 \$50
 P3 \$80
 P4 \$200

Worksurface with Reverse L-leg

Stand Off with Power Center, Rectilinear top, Square Edge

description	d	w	th	pattern no.	L	M/V1	V2	V3
Peninsula Rectilinear Top	20"	60"	1 1/2"	RPTDRPC(L/R)6020() () () ()	\$1,270.	\$1,434.	\$1,612.	\$1,892.
	20"	66"	1 1/2"	RPTDRPC(L/R)6620() () () ()	1,281.	1,453.	1,636.	1,940.
	20"	72"	1 1/2"	RPTDRPC(L/R)7220() () () ()	1,293.	1,484.	1,671.	2,000.
	20"	78"	1 1/2"	RPTDRPC(L/R)7820() () () ()	1,304.	1,503.	1,694.	2,048.
	20"	84"	1 1/2"	RPTDRPC(L/R)8420() () () ()	1,316.	1,523.	1,718.	2,093.
	24"	60"	1 1/2"	RPTDRPC(L/R)6024() () () ()	1,286.	1,452.	1,636.	1,953.
	24"	66"	1 1/2"	RPTDRPC(L/R)6624() () () ()	1,300.	1,509.	1,702.	2,045.
	24"	72"	1 1/2"	RPTDRPC(L/R)7224() () () ()	1,344.	1,530.	1,728.	2,099.
	24"	78"	1 1/2"	RPTDRPC(L/R)7824() () () ()	1,357.	1,563.	1,767.	2,167.
	24"	84"	1 1/2"	RPTDRPC(L/R)8424() () () ()	1,369.	1,586.	1,794.	2,220.
	30"	60"	1 1/2"	RPTDRPC(L/R)6030() () () ()	1,411.	1,545.	1,747.	2,120.
	30"	66"	1 1/2"	RPTDRPC(L/R)6630() () () ()	1,428.	1,571.	1,779.	2,184.
	30"	72"	1 1/2"	RPTDRPC(L/R)7230() () () ()	1,443.	1,608.	1,825.	2,262.
	30"	78"	1 1/2"	RPTDRPC(L/R)7830() () () ()	1,480.	1,636.	1,858.	2,327.
	30"	84"	1 1/2"	RPTDRPC(L/R)8430() () () ()	1,497.	1,672.	1,901.	2,403.
	36"	60"	1 1/2"	RPTDRPC(L/R)6036() () () ()	1,393.	1,603.	1,818.	2,247.
	36"	66"	1 1/2"	RPTDRPC(L/R)6636() () () ()	1,460.	1,635.	1,858.	2,325.
	36"	72"	1 1/2"	RPTDRPC(L/R)7236() () () ()	1,478.	1,676.	1,908.	2,410.
	36"	78"	1 1/2"	RPTDRPC(L/R)7836() () () ()	1,497.	1,708.	1,873.	2,391.
	36"	84"	1 1/2"	RPTDRPC(L/R)8436() () () ()	1,516.	1,738.	1,985.	2,561.

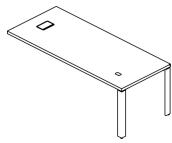

Left hand shown

Order Code

Example:	RPTDRPC(L/R)6030() () () ()
R	Reff
PT	Peninsula
D	1 1/2" Thick Square Edge
R	Reverse L-leg
PC	Power Center
L	Left hand/ Right hand
30	Depth
40	Width
P	Grommet Option
115	Grommet Finish
114	Worksurface Finish
()	Edge finish
115	Leg Finish
115	Stand-off finish

Specification Information

To order please specify pattern number including:

1. Left or Right hand
2. Grommet option
P=Power Center, PE=Power center plus end grommet
3. Grommet finish
Painted or plated
4. Worksurface finish
L, V1, V2, V3
5. Edge finish: L, V1, V2, V3
(Edge options are available on laminate tops only.)
6. Leg finish
Painted or Anodized
7. Stand-off finish
Painted

Upcharges apply to legs with P2, P3 and P4 finishes.
Additional upcharges;

Leg Finish	Add
P2	\$50
P3	\$80
P4	\$200

Application Notes

It is not advisable to mix 28 3/8" h desk height product with 26 1/2" h standard height products.

Products on this page work with 28 3/8" height planning.

Products on this page will accept woodgrain laminate where laminate is currently an option.

Worksurface stiffeners, recommended to provide additional support for open spans greater than 48" w.

Peninsula worksurfaces with power center do not come with Electrical Components.

For electrical components please refer to page 399.

Modesty sold separately and can be field installed.

Wire chase sold separately.

Refer to grommet page for location option.

From users perspective, if the leg is on the right side, the peninsula is classified a "Right Hand" peninsula.

*Worksurface with Reverse L-leg
Simple Stand Off, Rectilinear top, Square Edge*

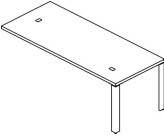
description	d	w	th	pattern no.	L	M/V1	V2	V3
 <p>Left hand shown</p>	20"	60"	1 1/2"	RPTDRST(L/R)6020() () () ()	\$1,130.	\$1,253.	\$1,411.	\$1,691.
	20"	66"	1 1/2"	RPTDRST(L/R)6620() () () ()	1,141.	1,271.	1,435.	1,739.
	20"	72"	1 1/2"	RPTDRST(L/R)7220() () () ()	1,152.	1,302.	1,472.	1,800.
	20"	78"	1 1/2"	RPTDRST(L/R)7820() () () ()	1,163.	1,321.	1,495.	1,848.
	20"	84"	1 1/2"	RPTDRST(L/R)8420() () () ()	1,175.	1,341.	1,519.	1,894.
	24"	60"	1 1/2"	RPTDRST(L/R)6024() () () ()	1,147.	1,304.	1,473.	1,790.
	24"	66"	1 1/2"	RPTDRST(L/R)6624() () () ()	1,159.	1,326.	1,501.	1,846.
	24"	72"	1 1/2"	RPTDRST(L/R)7224() () () ()	1,204.	1,349.	1,528.	1,898.
	24"	78"	1 1/2"	RPTDRST(L/R)7824() () () ()	1,217.	1,382.	1,566.	1,966.
	24"	84"	1 1/2"	RPTDRST(L/R)8424() () () ()	1,230.	1,403.	1,594.	2,019.
	30"	60"	1 1/2"	RPTDRST(L/R)6030() () () ()	1,272.	1,363.	1,546.	1,919.
	30"	66"	1 1/2"	RPTDRST(L/R)6630() () () ()	1,287.	1,389.	1,579.	1,984.
	30"	72"	1 1/2"	RPTDRST(L/R)7230() () () ()	1,303.	1,427.	1,624.	2,061.
	30"	78"	1 1/2"	RPTDRST(L/R)7830() () () ()	1,341.	1,454.	1,657.	2,128.
	30"	84"	1 1/2"	RPTDRST(L/R)8430() () () ()	1,356.	1,490.	1,702.	2,203.
	36"	60"	1 1/2"	RPTDRST(L/R)6036() () () ()	1,254.	1,422.	1,620.	2,047.
	36"	66"	1 1/2"	RPTDRST(L/R)6636() () () ()	1,339.	1,493.	1,709.	2,210.
	36"	72"	1 1/2"	RPTDRST(L/R)7236() () () ()	1,357.	1,525.	1,748.	2,287.
	36"	78"	1 1/2"	RPTDRST(L/R)7836() () () ()	1,376.	1,556.	1,786.	2,363.
	36"	84"	1 1/2"	RPTDRST(L/R)8436() () () ()	1,376.	1,556.	1,786.	2,363.

Order Code	Specification Information	Application Notes
Example: RPTDRST(L/R)6030() () () ()	<i>To order please specify pattern number including:</i>	It is not advisable to mix 28 3/8" h desk height product with 26 1/2" h standard height products.
R Reff	1. Left or Right hand	Products on this page work with 28 3/8" height planning.
PT Peninsula	2. Grommet option N=No grommet E=End location grommet SE=Stand-off and end grommet S=Stand-off location grommet SD=Drop in electrical cut out & no grommet SDR=Drop in electrical cutout & end grommet, RH SDL=Drop in electrical cutout & end grommet, LH	Products on this page will accept woodgrain laminate where laminate is currently an option.
D 1 1/2" Thick Square Edge	Note: Please order electrical for the following options; SD, SDR and SDL.	Worksurface stiffeners, recommended to provide additional support for open spans greater than 48" w.
R Reverse L-leg	3. Grommet finish Painted or plated where applicable, N & SD have no finish option	Upcharges apply to legs with P2, P3 and P4 finishes. Additional upcharges; Leg Finish Add P2 \$50 P3 \$80 P4 \$200
ST Stand off	4. Worksurface finish L, V1, V2, V3	Peninsula worksurfaces with power center do not come with Electrical Components.
L Left hand/ Right hand	5. Edge finish: L, V1, V2, V3 (Edge options are available on laminate tops only.)	For electrical components please refer to page 399.
60 Width	6. Leg finish Painted or Anodized	Modesty sold separately and can be field installed.
30 Depth	7. Stand-off finish Painted	Wire chase sold separately.
SE Grommet Option		Refer to Peninsula planning guidelines for location option.
115 Grommet Finish		From users perspective, if the leg is on the right side, the peninsula is classified a "Right Hand" peninsula.
114 Worksurface Finish		
() Edge Finish		
115 Leg Finish		
115 Stand-Off Finish		

Worksurface with Reverse L-leg

Flush Mount Attachment, Rectilinear top, Square Edge

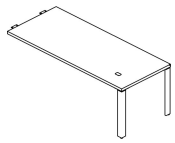
description	d	w	th	pattern no.	L	M/V1	V2	V3
 <p>Left hand shown</p>	20"	36"	1 1/2"	RPTDRFM(L/R)3620() () () ()	\$852.	\$947.	\$1,068.	\$1,251.
	20"	42"	1 1/2"	RPTDRFM(L/R)4220() () () ()	867.	973.	1,098.	1,298.
	20"	48"	1 1/2"	RPTDRFM(L/R)4820() () () ()	927.	1,008.	1,139.	1,371.
	20"	54"	1 1/2"	RPTDRFM(L/R)5420() () () ()	974.	1,027.	1,162.	1,420.
	20"	60"	1 1/2"	RPTDRFM(L/R)6020() () () ()	1,021.	1,122.	1,270.	1,549.
	20"	66"	1 1/2"	RPTDRFM(L/R)6620() () () ()	1,032.	1,142.	1,294.	1,597.
	20"	72"	1 1/2"	RPTDRFM(L/R)7220() () () ()	1,043.	1,172.	1,328.	1,657.
	20"	78"	1 1/2"	RPTDRFM(L/R)7820() () () ()	1,055.	1,191.	1,352.	1,705.
	20"	84"	1 1/2"	RPTDRFM(L/R)8420() () () ()	1,066.	1,212.	1,376.	1,751.
	24"	36"	1 1/2"	RPTDRFM(L/R)3624() () () ()	866.	983.	1,108.	1,317.
	24"	42"	1 1/2"	RPTDRFM(L/R)4224() () () ()	890.	1,010.	1,141.	1,376.
	24"	48"	1 1/2"	RPTDRFM(L/R)4824() () () ()	955.	1,042.	1,180.	1,441.
	24"	54"	1 1/2"	RPTDRFM(L/R)5424() () () ()	982.	1,066.	1,208.	1,499.
	24"	60"	1 1/2"	RPTDRFM(L/R)6024() () () ()	1,038.	1,174.	1,330.	1,646.
	24"	66"	1 1/2"	RPTDRFM(L/R)6624() () () ()	1,051.	1,197.	1,357.	1,703.
	24"	72"	1 1/2"	RPTDRFM(L/R)7224() () () ()	1,095.	1,219.	1,385.	1,757.
	24"	78"	1 1/2"	RPTDRFM(L/R)7824() () () ()	1,108.	1,252.	1,424.	1,823.
	24"	84"	1 1/2"	RPTDRFM(L/R)8424() () () ()	1,121.	1,274.	1,451.	1,878.

Order Code	Specification Information	Application Notes
Example: RPTDRFM(L/R)3620() () () ()	<i>To order please specify pattern number including:</i>	It is not advisable to mix 28 3/8" h desk height product with 26 1/2" h standard height products.
R	Reff	
PT	Peninsula	
D	1 1/2" Thick Square Edge	Products on this page work with 28 3/8" height planning.
R	Reverse L-leg	Products on this page will accept woodgrain laminate where laminate is currently an option.
FM	Flush Mount Attachment Leg	Worksurface stiffeners, recommended to provide additional support for open spans greater than 48" w.
L	Left hand/ Right hand	
36	Width	
20	Depth	
M	Grommet Option	
115	Grommet Finish	
114	Worksurface Finish	
()	Edge finish	
115	Leg Finish	
	1. Left or Right hand 2. Grommet option E=End, N=No grommet, M=Mid. grommet 3. Grommet finish Painted or plated 4. Worksurface finish L, V1, V2, V3 5. Edge finish: L, V1, V2, V3 (Edge options are available on laminate tops only.) 6. Leg finish Painted or Anodized Upcharges apply to legs with P2, P3 and P4 finishes. Additional upcharges: Leg Finish Add P2 \$50 P3 \$80 P4 \$200	Peninsula worksurfaces with power center do not come with Electrical Components. For electrical components please refer to page 399. Modesty sold separately and can be field installed. Wire chase sold separately. Refer to grommet page for location option. From users perspective, if the leg is on the right side, the peninsula is classified a "Right Hand" peninsula.

Worksurface with Reverse L-leg

Flush Mount Attachment, Rectilinear top, Square Edge

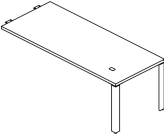
description	d	w	th	pattern no.	L	M/V1	V2	V3
 <p>Left hand shown</p>	30"	36"	1 1/2"	RPTDRFM(L/R)3630() () ()	\$907.	\$1,019.	\$1,152.	\$1,397.
	30"	42"	1 1/2"	RPTDRFM(L/R)4230() () ()	924.	1,047.	1,186.	1,464.
	30"	48"	1 1/2"	RPTDRFM(L/R)4830() () ()	987.	1,136.	1,288.	1,598.
	30"	54"	1 1/2"	RPTDRFM(L/R)5430() () ()	1,030.	1,162.	1,321.	1,664.
	30"	60"	1 1/2"	RPTDRFM(L/R)6030() () ()	1,163.	1,233.	1,404.	1,777.
	30"	66"	1 1/2"	RPTDRFM(L/R)6630() () ()	1,179.	1,260.	1,436.	1,841.
	30"	72"	1 1/2"	RPTDRFM(L/R)7230() () ()	1,194.	1,297.	1,480.	1,918.
	30"	78"	1 1/2"	RPTDRFM(L/R)7830() () ()	1,232.	1,324.	1,515.	1,984.
	30"	84"	1 1/2"	RPTDRFM(L/R)8430() () ()	1,247.	1,360.	1,558.	2,060.
	36"	36"	1 1/2"	RPTDRFM(L/R)3636() () ()	945.	1,050.	1,191.	1,472.
	36"	42"	1 1/2"	RPTDRFM(L/R)4236() () ()	966.	1,093.	1,242.	1,562.
	36"	48"	1 1/2"	RPTDRFM(L/R)4836() () ()	1,027.	1,186.	1,350.	1,704.
	36"	54"	1 1/2"	RPTDRFM(L/R)5436() () ()	1,069.	1,217.	1,389.	1,781.
	36"	54"	1 1/2"	RPTDRFM(L/R)6036() () ()	1,145.	1,292.	1,476.	1,904.
	36"	66"	1 1/2"	RPTDRFM(L/R)6636() () ()	1,212.	1,323.	1,515.	1,981.
	36"	72"	1 1/2"	RPTDRFM(L/R)7236() () ()	1,230.	1,364.	1,565.	2,066.
	36"	78"	1 1/2"	RPTDRFM(L/R)7836() () ()	1,248.	1,396.	1,604.	2,144.
	36"	84"	1 1/2"	RPTDRFM(L/R)8436() () ()	1,267.	1,427.	1,643.	2,219.

Order Code	Specification Information	Application Notes
Example: RPTDRFM(L/R)3620() () ()	<i>To order please specify pattern number including:</i>	It is not advisable to mix 28 3/8" h desk height product with 26 1/2" h standard height products.
R	Reff	Products on this page work with 28 3/8" height planning.
PT	Peninsula	
D	1 1/2" Thick Square Edge	Products on this page will accept woodgrain laminate where laminate is currently an option.
R	Reverse L-leg	Worksurface stiffeners, recommended to provide additional support for open spans greater than 48" w.
FM	Flush Mount Attachment Leg	Modesty sold separately and can be field installed.
L	Left hand/ Right hand	
36	Width	Wire chase sold separately.
20	Depth	Refer to grommet page for location option.
M	Grommet Option	From users perspective, if the leg is on the right side, the peninsula is classified a "Right Hand" peninsula.
115	Grommet Finish	
114	Worksurface Finish	
()	Edge finish	
115	Leg Finish	

Upcharges apply to legs with P2, P3 and P4 finishes.
 Additional upcharges;
 Leg Finish Add
 P2 \$50
 P3 \$80
 P4 \$200

*Worksurface with Soft Rectangular Leg
Stand Off with Power Center, Rectilinear top, Square Edge*

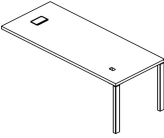
description	d	w	th	pattern number	L	M/V1	V2	V3
 <p>Left hand shown</p>	20"	60"	1 1/2"	RPTDSPC(L/R)6020() () () ()	\$1,390.	\$1,554.	\$1,745.	\$2,024.
	20"	66"	1 1/2"	RPTDSPC(L/R)6620() () () ()	1,401.	1,573.	1,767.	2,072.
	20"	72"	1 1/2"	RPTDSPC(L/R)7220() () () ()	1,411.	1,603.	1,803.	2,132.
	20"	78"	1 1/2"	RPTDSPC(L/R)7820() () () ()	1,423.	1,623.	1,827.	2,179.
	20"	84"	1 1/2"	RPTDSPC(L/R)8420() () () ()	1,434.	1,643.	1,850.	2,225.
	24"	60"	1 1/2"	RPTDSPC(L/R)6024() () () ()	1,406.	1,572.	1,768.	2,084.
	24"	66"	1 1/2"	RPTDSPC(L/R)6624() () () ()	1,420.	1,629.	1,833.	2,177.
	24"	72"	1 1/2"	RPTDSPC(L/R)7224() () () ()	1,464.	1,650.	1,859.	2,231.
	24"	78"	1 1/2"	RPTDSPC(L/R)7824() () () ()	1,477.	1,683.	1,898.	2,298.
	24"	84"	1 1/2"	RPTDSPC(L/R)8424() () () ()	1,489.	1,706.	1,926.	2,352.
	30"	60"	1 1/2"	RPTDSPC(L/R)6030() () () ()	1,560.	1,693.	1,910.	2,428.
	30"	66"	1 1/2"	RPTDSPC(L/R)6630() () () ()	1,576.	1,720.	1,942.	2,347.
	30"	72"	1 1/2"	RPTDSPC(L/R)7230() () () ()	1,592.	1,757.	1,986.	2,424.
	30"	78"	1 1/2"	RPTDSPC(L/R)7830() () () ()	1,629.	1,785.	2,021.	2,491.
	30"	84"	1 1/2"	RPTDSPC(L/R)8430() () () ()	1,645.	1,820.	2,064.	2,567.
	36"	60"	1 1/2"	RPTDSPC(L/R)6036() () () ()	1,513.	1,723.	1,951.	2,379.
	36"	66"	1 1/2"	RPTDSPC(L/R)6636() () () ()	1,580.	1,755.	1,991.	2,456.
	36"	72"	1 1/2"	RPTDSPC(L/R)7236() () () ()	1,598.	1,796.	2,040.	2,541.
	36"	78"	1 1/2"	RPTDSPC(L/R)7836() () () ()	1,616.	1,828.	2,079.	2,619.
	36"	84"	1 1/2"	RPTDSPC(L/R)8436() () () ()	1,635.	1,858.	2,118.	2,694.

Order Code	Specification Information	Application Notes
Example: RPTDSPC(L/R)6030() () () ()	<i>To order please specify pattern number including:</i>	It is not advisable to mix 28 3/8" desk height product with 26 1/2" standard height products.
R Reff	1. Left or Right hand	Peninsula worksurfaces with power center do not come with Electrical Components.
PT Peninsula	2. Grommet option P=Power Center PE=Power center and end grommet	Products on this page work with 28 3/8" height planning. For electrical components please refer to page 399.
D 1 1/2" Thick Square Edge	3. Grommet finish Painted or plated	Products on this page will accept woodgrain laminate where laminate is currently an option. Modesty sold separately and can be field installed.
S Soft Rectangular Leg	4. Worksurface finish L, V1, V2, V3	Wire chase sold separately.
PC Power Center	5. Edge finish: L, V1, V2, V3 (Edge options are available on laminate tops only.)	Refer to grommet page for location option.
L Left hand/ Right hand	6. Leg finish Painted or Anodized	From users perspective, if the leg is on the right side, the peninsula is classified a "Right Hand" peninsula.
60 Width	7. Stand-off finish Painted	
30 Depth	Upcharges apply to legs with P2, P3 and P4 finishes.	
P Grommet Option	Additional upcharges;	
115 Grommet Finish	Leg Finish Add	
114 Worksurface Finish	P2 \$50	
() Edge finish	P3 \$80	
115 Leg Finish	P4 \$200	
115 Stand-Off Finish		

*Worksurface with Soft Rectangular Leg
Simple Stand Off, Rectilinear top, Square Edge*

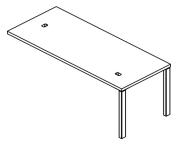
description	d	w	th	pattern no.	L	M/V1	V2	V3
 <p>Left hand shown</p>	20"	60"	1 1/2"	RPTDSST(L/R)6020() () () ()	\$1,278.	\$1,400.	\$1,575.	\$1,855.
	20"	66"	1 1/2"	RPTDSST(L/R)6620() () () ()	1,289.	1,420.	1,599.	1,903.
	20"	72"	1 1/2"	RPTDSST(L/R)7220() () () ()	1,301.	1,450.	1,634.	1,963.
	20"	78"	1 1/2"	RPTDSST(L/R)7820() () () ()	1,312.	1,470.	1,657.	2,011.
	20"	84"	1 1/2"	RPTDSST(L/R)8420() () () ()	1,323.	1,489.	1,681.	2,058.
	24"	60"	1 1/2"	RPTDSST(L/R)6024() () () ()	1,295.	1,452.	1,636.	1,952.
	24"	66"	1 1/2"	RPTDSST(L/R)6624() () () ()	1,308.	1,475.	1,665.	2,009.
	24"	72"	1 1/2"	RPTDSST(L/R)7224() () () ()	1,352.	1,498.	1,691.	2,062.
	24"	78"	1 1/2"	RPTDSST(L/R)7824() () () ()	1,365.	1,530.	1,729.	2,130.
	24"	84"	1 1/2"	RPTDSST(L/R)8424() () () ()	1,379.	1,552.	1,757.	2,183.
	30"	60"	1 1/2"	RPTDSST(L/R)6030() () () ()	1,421.	1,511.	1,710.	2,083.
	30"	66"	1 1/2"	RPTDSST(L/R)6630() () () ()	1,436.	1,538.	1,743.	2,148.
	30"	72"	1 1/2"	RPTDSST(L/R)7230() () () ()	1,451.	1,574.	1,788.	2,224.
	30"	78"	1 1/2"	RPTDSST(L/R)7830() () () ()	1,489.	1,602.	1,821.	2,291.
	30"	84"	1 1/2"	RPTDSST(L/R)8430() () () ()	1,505.	1,639.	1,864.	2,367.
	36"	60"	1 1/2"	RPTDSST(L/R)6036() () () ()	1,401.	1,569.	1,781.	2,210.
	36"	66"	1 1/2"	RPTDSST(L/R)6636() () () ()	1,468.	1,601.	1,822.	2,282.
	36"	72"	1 1/2"	RPTDSST(L/R)7236() () () ()	1,487.	1,642.	1,871.	2,374.
	36"	78"	1 1/2"	RPTDSST(L/R)7836() () () ()	1,506.	1,674.	1,910.	2,450.
	36"	84"	1 1/2"	RPTDSST(L/R)8436() () () ()	1,524.	1,705.	1,950.	2,525.

Order Code	Specification Information	Application Notes
Example: RPTDSST(L/R)6030() () () ()	<i>To order please specify pattern number including:</i>	It is not advisable to mix 28 3/8" h desk height product with 26 1/2" h standard height products.
R Reff	1. Left or Right hand	Products on this page work with 28 3/8" height planning.
PT Peninsula	2. Grommet option N=No grommet E=End location grommet SE=Stand-off and end grommet S=Stand-off location grommet SD=Drop in electrical cutout & no grommet SDR=Drop in electrical cutout & end grommet, RH SDL=Drop in electrical cutout & end grommet, LH Note: Please order electrical for the following options; SD, SDR and SDL.	
D 1 1/2" Thick Square Edge	3. Grommet finish Painted or plated where applicable. N & SD have no finish option.	Products on this page will accept woodgrain laminate where laminate is currently an option.
S Soft Rectangular Leg	4. Worksurface finish L, V1, V2, V3	Worksurface stiffeners, recommended to provide additional support for open spans greater than 48" w.
ST Stand Off	5. Edge finish: L, V1, V2, V3 (Edge options are available on laminate tops only.)	Upcharges apply to legs with P2, P3 and P4 finishes. Additional upcharges;
L Left hand/ Right hand	6. Leg finish Painted or Anodized	Leg Finish Add P2 \$50 P3 \$80 P4 \$200
60 Width	7. Stand-off finish Painted	
30 Depth		
E Grommet Option		
115 Grommet Finish		
114 Worksurface Finish		
() Edge finish		
115 Leg Finish		
115 Stand-Off Finish		

*Worksurface with Soft Rectangular Leg
Flush Mount Attachment, Rectilinear top, Square Edge*

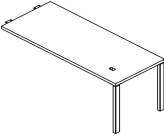
description	d	w	th	pattern no.	L	M/V1	V2	V3
 <p>Left hand shown</p>	20"	36"	1 1/2"	RPTDSFM(L/R)3620() () () ()	\$1,000.	\$1,095.	\$1,231.	\$1,413.
	20"	42"	1 1/2"	RPTDSFM(L/R)4220() () () ()	1,016.	1,121.	1,262.	1,469.
	20"	48"	1 1/2"	RPTDSFM(L/R)4820() () () ()	1,075.	1,156.	1,303.	1,534.
	20"	54"	1 1/2"	RPTDSFM(L/R)5420() () () ()	1,122.	1,176.	1,326.	1,583.
	20"	60"	1 1/2"	RPTDSFM(L/R)6020() () () ()	1,170.	1,271.	1,433.	1,712.
	20"	66"	1 1/2"	RPTDSFM(L/R)6620() () () ()	1,181.	1,290.	1,456.	1,760.
	20"	72"	1 1/2"	RPTDSFM(L/R)7220() () () ()	1,192.	1,320.	1,491.	1,819.
	20"	78"	1 1/2"	RPTDSFM(L/R)7820() () () ()	1,203.	1,340.	1,515.	1,869.
	20"	84"	1 1/2"	RPTDSFM(L/R)8420() () () ()	1,215.	1,359.	1,540.	1,915.
	24"	36"	1 1/2"	RPTDSFM(L/R)3624() () () ()	1,015.	1,131.	1,272.	1,480.
	24"	42"	1 1/2"	RPTDSFM(L/R)4224() () () ()	1,038.	1,158.	1,305.	1,540.
	24"	48"	1 1/2"	RPTDSFM(L/R)4824() () () ()	1,104.	1,191.	1,343.	1,604.
	24"	54"	1 1/2"	RPTDSFM(L/R)5424() () () ()	1,131.	1,215.	1,372.	1,662.
	24"	60"	1 1/2"	RPTDSFM(L/R)6024() () () ()	1,186.	1,322.	1,492.	1,810.
	24"	66"	1 1/2"	RPTDSFM(L/R)6624() () () ()	1,199.	1,345.	1,521.	1,867.
	24"	72"	1 1/2"	RPTDSFM(L/R)7224() () () ()	1,243.	1,367.	1,548.	1,919.
	24"	78"	1 1/2"	RPTDSFM(L/R)7824() () () ()	1,257.	1,400.	1,588.	1,986.
	24"	84"	1 1/2"	RPTDSFM(L/R)8424() () () ()	1,270.	1,423.	1,614.	2,041.

Order Code	Specification Information	Application Notes
Example: RPTDSFM(L/R)4830() () () ()	<i>To order please specify pattern number including:</i>	It is not advisable to mix 28 3/8" h desk height product with 26 1/2" h standard height products.
R Reff	1. Left or Right hand	Products on this page work with 28 3/8" height planning.
PT Peninsula	2. Grommet option E=End N=No grommet M=Mid. grommet	
D 1 1/2" Thick Square Edge	3. Grommet finish Painted or plated	Products on this page will accept woodgrain laminate where laminate is currently an option.
S Soft Rectangular Leg	4. Worksurface finish L, V1, V2, V3	Worksurface stiffeners, recommended to provide additional support for open spans greater than 48" w.
FM Flush Mount Attachment Platef	5. Edge finish: L, V1, V2, V3 (Edge options are available on laminate tops only.)	Upcharges apply to legs with P2, P3 and P4 finishes. Additional upcharges;
L Left hand/ Right hand	6. Leg finish Painted or Anodized	Leg Finish Add P2 \$50 P3 \$80 P4 \$200
48 Width		Peninsula worksurfaces with power center do not come with Electrical Components.
30 Depth		For electrical components please refer to page 399.
E Grommet Option		Modesty sold separately and can be field installed.
115 Grommet Finish		Wire chase sold separately.
114 Worksurface Finish		Refer to grommet page for location option.
() Edge finish		From users perspective, if the leg is on the right side, the peninsula is classified a "Right Hand" peninsula.
115 Leg Finish		

*Worksurface with Soft Rectangular Leg
Flush Mount Attachment, Rectilinear top, Square Edge*

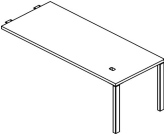
description	d	w	th	pattern no.	L	M/V1	V2	V3
 <p>Left hand shown</p>	30"	36"	1 1/2"	RPTDSFM(L/R)3630() () () ()	\$1,055.	\$1,166.	\$1,316.	\$1,560.
	30"	42"	1 1/2"	RPTDSFM(L/R)4230() () () ()	1,072.	1,194.	1,350.	1,626.
	30"	48"	1 1/2"	RPTDSFM(L/R)4830() () () ()	1,135.	1,284.	1,452.	1,761.
	30"	54"	1 1/2"	RPTDSFM(L/R)5430() () () ()	1,178.	1,311.	1,485.	1,826.
	30"	60"	1 1/2"	RPTDSFM(L/R)6030() () () ()	1,311.	1,382.	1,566.	1,939.
	30"	66"	1 1/2"	RPTDSFM(L/R)6630() () () ()	1,327.	1,407.	1,599.	2,005.
	30"	72"	1 1/2"	RPTDSFM(L/R)7230() () () ()	1,343.	1,445.	1,644.	2,082.
	30"	78"	1 1/2"	RPTDSFM(L/R)7830() () () ()	1,380.	1,473.	1,678.	2,148.
	30"	84"	1 1/2"	RPTDSFM(L/R)8430() () () ()	1,396.	1,509.	1,722.	2,223.
	36"	36"	1 1/2"	RPTDSFM(L/R)3636() () () ()	1,094.	1,198.	1,354.	1,635.
	36"	42"	1 1/2"	RPTDSFM(L/R)4236() () () ()	1,114.	1,240.	1,421.	1,724.
	36"	48"	1 1/2"	RPTDSFM(L/R)4836() () () ()	1,176.	1,334.	1,513.	1,868.
	36"	54"	1 1/2"	RPTDSFM(L/R)5436() () () ()	1,218.	1,365.	1,553.	1,945.
	36"	60"	1 1/2"	RPTDSFM(L/R)6036() () () ()	1,293.	1,440.	1,639.	2,066.
	36"	66"	1 1/2"	RPTDSFM(L/R)6636() () () ()	1,359.	1,472.	1,679.	2,144.
	36"	72"	1 1/2"	RPTDSFM(L/R)7236() () () ()	1,378.	1,513.	1,728.	2,230.
	36"	78"	1 1/2"	RPTDSFM(L/R)7836() () () ()	1,396.	1,544.	1,768.	2,308.
	36"	84"	1 1/2"	RPTDSFM(L/R)8436() () () ()	1,416.	1,575.	1,806.	2,382.

Order Code	Specification Information	Application Notes
Example: RPTDSFM(L/R)4830() () () ()	<i>To order please specify pattern number including:</i>	It is not advisable to mix 28 3/8" h desk height product with 26 1/2" h standard height products.
R Reff	1. Left or Right hand	Products on this page work with 28 3/8" height planning.
PT Peninsula	2. Grommet option E=End N=No grommet M=Mid. grommet	
D 1 1/2" Thick Square Edge	3. Grommet finish Painted or plated	Products on this page will accept woodgrain laminate where laminate is currently an option.
S Soft Rectangular Leg	4. Worksurface finish L, V1, V2, V3	Worksurface stiffeners, recommended to provide additional support for open spans greater than 48" w.
FM Flush Mount Attachment Platef	5. Edge finish: L, V1, V2, V3 (Edge options are available on laminate tops only.)	Upcharges apply to legs with P2, P3 and P4 finishes. Additional upcharges;
L Left hand/ Right hand	6. Leg finish Painted or Anodized	Leg Finish Add P2 \$50 P3 \$80 P4 \$200
48 Width		Peninsula worksurfaces with power center do not come with Electrical Components.
30 Depth		For electrical components please refer to page 399.
E Grommet Option		Modesty sold separately and can be field installed.
115 Grommet Finish		Wire chase sold separately.
114 Worksurface Finish		Refer to grommet page for location option.
() Edge finish		From users perspective, if the leg is on the right side, the peninsula is classified a "Right Hand" peninsula.
115 Leg Finish		

*Worksurface with Open Frame Leg
Stand-Off with Power Center, Rectilinear top, Square Edge*

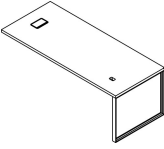
description	d	w	th	pattern no.	L	M/V1	V2	V3
 Peninsula, Rectilinear Top Left hand shown	20"	60"	1 1/2"	RPTDOPC(L/R)6020() () ()	\$1,438.	\$1,560.	\$1,751.	\$2,031.
	20"	66"	1 1/2"	RPTDOPC(L/R)6620() () ()	1,449.	1,580.	1,774.	2,078.
	20"	72"	1 1/2"	RPTDOPC(L/R)7220() () ()	1,461.	1,609.	1,810.	2,139.
	20"	78"	1 1/2"	RPTDOPC(L/R)7820() () ()	1,471.	1,629.	1,834.	2,186.
	20"	84"	1 1/2"	RPTDOPC(L/R)8420() () ()	1,482.	1,649.	1,857.	2,233.
	24"	60"	1 1/2"	RPTDOPC(L/R)6024() () ()	1,454.	1,611.	1,812.	2,128.
	24"	66"	1 1/2"	RPTDOPC(L/R)6624() () ()	1,468.	1,635.	1,839.	2,184.
	24"	72"	1 1/2"	RPTDOPC(L/R)7224() () ()	1,512.	1,656.	1,867.	2,239.
	24"	78"	1 1/2"	RPTDOPC(L/R)7824() () ()	1,525.	1,689.	1,881.	2,304.
	24"	84"	1 1/2"	RPTDOPC(L/R)8424() () ()	1,538.	1,712.	1,932.	2,359.
	30"	60"	1 1/2"	RPTDOPC(L/R)6030() () ()	1,586.	1,709.	1,926.	2,299.
	30"	66"	1 1/2"	RPTDOPC(L/R)6630() () ()	1,601.	1,734.	1,959.	2,359.
	30"	72"	1 1/2"	RPTDOPC(L/R)7230() () ()	1,632.	1,772.	2,004.	2,442.
	30"	78"	1 1/2"	RPTDOPC(L/R)7830() () ()	1,654.	1,800.	2,038.	2,507.
	30"	84"	1 1/2"	RPTDOPC(L/R)8430() () ()	1,670.	1,836.	2,082.	2,583.
	36"	60"	1 1/2"	RPTDOPC(L/R)6036() () ()	1,576.	1,776.	2,009.	2,437.
	36"	66"	1 1/2"	RPTDOPC(L/R)6636() () ()	1,644.	1,808.	2,049.	2,515.
	36"	72"	1 1/2"	RPTDOPC(L/R)7236() () ()	1,663.	1,849.	2,098.	2,600.
	36"	78"	1 1/2"	RPTDOPC(L/R)7836() () ()	1,681.	1,881.	2,138.	2,678.
	36"	84"	1 1/2"	RPTDOPC(L/R)8436() () ()	1,699.	1,912.	2,176.	2,752.

Order Code	Specification Information	Application Notes
Example: RPTDOPC(L/R)6030() () ()	<i>To order please specify pattern number including:</i>	It is not advisable to mix 28 3/8" h desk height product with 26 1/2" h standard height products.
R Reff	1. Left or Right hand	Products on this page work with 28 3/8" height planning.
PT Peninsula	2. Grommet option P=Power Center PE=Power center and end grommet	
D 1 1/2" Thick Square Edge	3. Grommet finish Painted or plated	Products on this page will accept woodgrain laminate where laminate is currently an option.
O Open Frame Leg	4. Worksurface finish L, V1, V2, V3	Worksurface stiffeners, recommended to provide additional support for open spans greater than 48" w.
PC Power Center	5. Edge finish: L, V1, V2, V3 (Edge options are available on laminate tops only.)	Upcharges apply to legs with P2, P3 and P4 finishes. Additional upcharges: LegFinish Add P2 \$60 P3 \$90 P4 - for 20" & 24" d legs; \$350 - for 30" & 36" d legs; \$450
L Left hand/ Right hand	6. Leg finish Painted or Anodized	
60 Width	7. Stand-off finish Painted	Peninsula worksurfaces with power center do not come with Electrical Components.
30 Depth		For electrical components please refer to page 399.
P Grommet Option		Modesty sold separately and can be field installed.
115 Grommet Finish		Wire chase sold separately.
114 Worksurface Finish		For infill options please refer to page 75.
() Edge finish		Refer to grommet page for location option.
115 Leg Finish		From users perspective, if the leg is on the right side, the peninsula is classified a "Right Hand" peninsula.
115 Stand-Off Finish		

*Worksurface with Open Frame Leg
Simple Stand-Off, Rectilinear top, Square Edge*

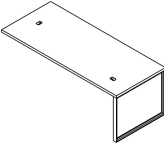
description	d	w	th	pattern no.	L	M/V1	V2	V3
 Peninsula, Rectilinear Top Left hand shown	20"	60"	1 1/2"	RPTDOST(L/R)6020() () () ()	\$1,298.	\$1,420.	\$1,597.	\$1,876.
	20"	66"	1 1/2"	RPTDOST(L/R)6620() () () ()	1,309.	1,439.	1,621.	1,925.
	20"	72"	1 1/2"	RPTDOST(L/R)7220() () () ()	1,320.	1,470.	1,656.	1,984.
	20"	78"	1 1/2"	RPTDOST(L/R)7820() () () ()	1,331.	1,489.	1,679.	2,033.
	20"	84"	1 1/2"	RPTDOST(L/R)8420() () () ()	1,343.	1,509.	1,703.	2,079.
	24"	60"	1 1/2"	RPTDOST(L/R)6024() () () ()	1,314.	1,472.	1,655.	1,973.
	24"	66"	1 1/2"	RPTDOST(L/R)6624() () () ()	1,327.	1,494.	1,686.	2,031.
	24"	72"	1 1/2"	RPTDOST(L/R)7224() () () ()	1,371.	1,550.	1,756.	2,123.
	24"	78"	1 1/2"	RPTDOST(L/R)7824() () () ()	1,385.	1,550.	1,751.	2,151.
	24"	84"	1 1/2"	RPTDOST(L/R)8424() () () ()	1,398.	1,571.	1,778.	2,205.
	30"	60"	1 1/2"	RPTDOST(L/R)6030() () () ()	1,445.	1,536.	1,737.	2,110.
	30"	66"	1 1/2"	RPTDOST(L/R)6630() () () ()	1,462.	1,563.	1,770.	2,175.
	30"	72"	1 1/2"	RPTDOST(L/R)7230() () () ()	1,477.	1,600.	1,812.	2,244.
	30"	78"	1 1/2"	RPTDOST(L/R)7830() () () ()	1,514.	1,628.	1,849.	2,319.
	30"	84"	1 1/2"	RPTDOST(L/R)8430() () () ()	1,550.	1,664.	1,892.	2,393.
	36"	60"	1 1/2"	RPTDOST(L/R)6036() () () ()	1,445.	1,536.	1,737.	2,110.
	36"	66"	1 1/2"	RPTDOST(L/R)6636() () () ()	1,504.	1,636.	1,860.	2,326.
	36"	72"	1 1/2"	RPTDOST(L/R)7236() () () ()	1,522.	1,678.	1,910.	2,412.
	36"	78"	1 1/2"	RPTDOST(L/R)7836() () () ()	1,541.	1,709.	1,950.	2,490.
	36"	84"	1 1/2"	RPTDOST(L/R)8436() () () ()	1,559.	1,740.	1,987.	2,564.

Order Code	Specification Information	Application Notes
Example: RPTDOST(L/R)6030() () () ()	<i>To order please specify pattern number including:</i>	It is not advisable to mix 28 3/8" h desk height product with 26 1/2" h standard height products.
R Reff	1. Left or Right hand	Products on this page work with 28 3/8" height planning.
PT Peninsula	2. Grommet option N=No grommet E=End location grommet SE=Stand-off and end grommet S=Stand-off location grommet SD=Drop in electrical cutout & no grommet SDR=Drop in electrical cutout & end grommet, RH SDL=Drop in electrical cutout & end grommet, LH	Products on this page will accept woodgrain laminate where laminate is currently an option.
D 1 1/2" Thick Square Edge	Note: Please order electric for the following options; SD, SDR and SDL.	Worksurface stiffeners, recommended to provide additional support for open spans greater than 48" w.
O Open Frame Leg	3. Grommet finish Painted or plated where applicable. N & SD have no finish option.	Upcharges apply to legs with P2, P3 and P4 finishes. Additional upcharges; LegFinish Add P2 \$60 P3 \$90 P4 -for 20" & 24" d legs; \$350 -for 30" & 36" d legs; \$450
ST Stand-Off	4. Worksurface finish L, V1, V2, V3	Peninsula worksurfaces with power center do not come with Electrical Components.
L Left hand/ Right hand	5. Edge finish: L, V1, V2, V3 (Edge options are available on laminate tops only.)	For electrical components please refer to page 399.
60 Width	6. Leg finish Painted or Anodized	Modesty sold separately and can be field installed.
30 Depth	7. Stand-off finish Painted	Wire chase sold separately.
S Grommet Option		For infill options please refer to page 75.
115 Grommet Finish		Refer Peninsula Planning Guidelines for location option.
114 Worksurface Finish		From users perspective, if the leg is on the right side, the peninsula is classified a "Right Hand" peninsula.
() Edge finish		
115 Leg Finish		
115 Stand-Off Finish		

Worksurface with Open Frame Leg

Flush Mount Attachment, Rectilinear top, Square Edge

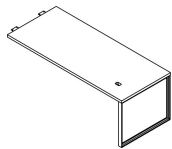
description	d	w	th	pattern no.	L	M/V1	V2	V3
 <p>Left hand shown</p>	20"	36"	1 1/2"	RPTDOFM(L/R)3620() () () ()	\$1,020.	\$1,114.	\$1,253.	\$1,435.
	20"	42"	1 1/2"	RPTDOFM(L/R)4220() () () ()	1,035.	1,141.	1,283.	1,490.
	20"	48"	1 1/2"	RPTDOFM(L/R)4820() () () ()	1,095.	1,176.	1,323.	1,556.
	20"	54"	1 1/2"	RPTDOFM(L/R)5420() () () ()	1,142.	1,195.	1,348.	1,604.
	20"	60"	1 1/2"	RPTDOFM(L/R)6020() () () ()	1,189.	1,280.	1,442.	1,722.
	20"	66"	1 1/2"	RPTDOFM(L/R)6620() () () ()	1,200.	1,299.	1,466.	1,770.
	20"	72"	1 1/2"	RPTDOFM(L/R)7220() () () ()	1,212.	1,329.	1,502.	1,830.
	20"	78"	1 1/2"	RPTDOFM(L/R)7820() () () ()	1,223.	1,349.	1,524.	1,879.
	20"	84"	1 1/2"	RPTDOFM(L/R)8420() () () ()	1,234.	1,368.	1,549.	1,925.
	24"	36"	1 1/2"	RPTDOFM(L/R)3624() () () ()	1,034.	1,150.	1,294.	1,502.
	24"	42"	1 1/2"	RPTDOFM(L/R)4224() () () ()	1,058.	1,178.	1,326.	1,560.
	24"	48"	1 1/2"	RPTDOFM(L/R)4824() () () ()	1,123.	1,211.	1,364.	1,626.
	24"	54"	1 1/2"	RPTDOFM(L/R)5424() () () ()	1,150.	1,234.	1,394.	1,683.
	24"	60"	1 1/2"	RPTDOFM(L/R)6024() () () ()	1,205.	1,331.	1,503.	1,819.
	24"	66"	1 1/2"	RPTDOFM(L/R)6624() () () ()	1,219.	1,354.	1,531.	1,876.
	24"	72"	1 1/2"	RPTDOFM(L/R)7224() () () ()	1,263.	1,377.	1,558.	1,929.
	24"	78"	1 1/2"	RPTDOFM(L/R)7824() () () ()	1,276.	1,409.	1,597.	1,997.
	24"	84"	1 1/2"	RPTDOFM(L/R)8424() () () ()	1,289.	1,431.	1,624.	2,050.

Order Code	Specification Information	Application Notes
Example: RPTDOFM(L/R)3620() () () ()	<i>To order please specify pattern number including:</i>	It is not advisable to mix 28 3/8" h desk height product with 26 1/2" h standard height products.
R Reff	1. Left or Right hand	Peninsula worksurfaces with power center do not come with Electrical Components.
PT Peninsula	2. Grommet option E=End M=Mid, grommet N=No grommet	Products on this page work with 28 3/8" height planning.
D 1 1/2" Thick Square Edge	3. Grogmet finish Painted or plated	Products on this page will accept woodgrain laminate where laminate is currently an option.
O Open Frame Leg	4. Worksurface finish L, V1, V2, V3	Worksurface stiffeners, recommended to provide additional support for open spans greater than 48" w.
FM Flush Mount Attachment Plate	5. Edge finish: L, V1, V2, V3 (Edge options are available on laminate tops only.)	Modesty sold separately and can be field installed.
L Left hand/ Right hand	6. Leg finish Painted or Anodized	Wire chase sold separately.
36 Width		For infill options please refer to page 75.
20 Depth		Refer to grommet page for location option.
E Grommet Option		From users perspective, if the leg is on the right side, the peninsula is classified a "Right Hand" peninsula.
115 Grommet Finish		
114 Worksurface Finish		
() Edge finish		
115 Leg Finish		
		Upcharges apply to legs with P2, P3 and P4 finishes. Additional upcharges: LegFinish Add P2 \$60 P3 \$90 P4 - for 20" & 24" d legs; \$350 - for 30" & 36" d legs; \$450

Worksurface with Open Frame Leg

Flush Mount Attachment, Rectilinear top, Square Edge

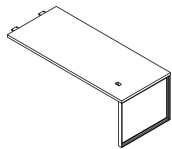
description	d	w	th	pattern no.	L	M/V1	V2	V3
 <p>Left hand shown</p>	30"	36"	1 1/2"	RPTDOFM(L/R)3630() () () ()	\$1,080.	\$1,192.	\$1,310.	\$1,589.
	30"	42"	1 1/2"	RPTDOFM(L/R)4230() () () ()	1,097.	1,220.	1,378.	1,654.
	30"	48"	1 1/2"	RPTDOFM(L/R)4830() () () ()	1,160.	1,299.	1,469.	1,777.
	30"	54"	1 1/2"	RPTDOFM(L/R)5430() () () ()	1,203.	1,325.	1,502.	1,842.
	30"	60"	1 1/2"	RPTDOFM(L/R)6030() () () ()	1,337.	1,396.	1,583.	1,957.
	30"	66"	1 1/2"	RPTDOFM(L/R)6630() () () ()	1,353.	1,423.	1,615.	2,020.
	30"	72"	1 1/2"	RPTDOFM(L/R)7230() () () ()	1,368.	1,460.	1,657.	2,089.
	30"	78"	1 1/2"	RPTDOFM(L/R)7830() () () ()	1,405.	1,487.	1,694.	2,164.
	30"	84"	1 1/2"	RPTDOFM(L/R)8430() () () ()	1,422.	1,524.	1,737.	2,241.
	36"	36"	1 1/2"	RPTDOFM(L/R)3636() () () ()	1,129.	1,233.	1,394.	1,673.
	36"	42"	1 1/2"	RPTDOFM(L/R)4236() () () ()	1,149.	1,276.	1,444.	1,758.
	36"	48"	1 1/2"	RPTDOFM(L/R)4836() () () ()	1,212.	1,359.	1,541.	1,894.
	36"	54"	1 1/2"	RPTDOFM(L/R)5436() () () ()	1,254.	1,390.	1,580.	1,972.
	36"	60"	1 1/2"	RPTDOFM(L/R)6036() () () ()	1,328.	1,465.	1,667.	2,095.
	36"	66"	1 1/2"	RPTDOFM(L/R)6636() () () ()	1,395.	1,496.	1,706.	2,172.
	36"	72"	1 1/2"	RPTDOFM(L/R)7236() () () ()	1,413.	1,538.	1,756.	2,257.
	36"	78"	1 1/2"	RPTDOFM(L/R)7836() () () ()	1,432.	1,569.	1,795.	2,335.
	36"	84"	1 1/2"	RPTDOFM(L/R)8436() () () ()	1,450.	1,600.	1,834.	2,410.

Order Code	Specification Information	Application Notes
Example: RPTDOFM(L/R)3620() () () ()	<i>To order please specify pattern number including:</i>	It is not advisable to mix 28 3/8" h desk height product with 26 1/2" h standard height products.
R Reff	1. Left or Right hand	Products on this page work with 28 3/8" height planning.
PT Peninsula	2. Grommet option E=End M=Mid, grommet N=No grommet	Products on this page will accept woodgrain laminate where laminate is currently an option.
D 1 1/2" Thick Square Edge	3. Grommet finish Painted or plated	Worksurface stiffeners, recommended to provide additional support for open spans greater than 48" w.
O Open Frame Leg	4. Worksurface finish L, V1, V2, V3	Upcharges apply to legs with P2, P3 and P4 finishes. Additional upcharges;
FM Flush Mount Attachment Plate	5. Edge finish: L, V1, V2, V3 (Edge options are available on laminate tops only.)	LegFinish Add P2 \$60 P3 \$90 P4 - for 20" & 24" d legs; \$350 - for 30" & 36" d legs; \$450
L Left hand/ Right hand	6. Leg finish Painted or Anodized	Peninsula worksurfaces with power center do not come with Electrical Components. For electrical components please refer to page 399. Modesty sold separately and can be field installed. Wire chase sold separately. For infill options please refer to page 75. Refer to grommet page for location option. From users perspective, if the leg is on the right side, the peninsula is classified a "Right Hand" peninsula.
36 Width		
20 Depth		
E Grommet Option		
115 Grommet Finish		
114 Worksurface Finish		
() Edge finish		
115 Leg Finish		

Worksurface with Thick End Panel

Stand-Off with Power Center, Rectilinear top, Square Edge

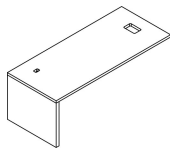
description	d	w	th	pattern no.	L/L	V1/V1	V2/V2	V3/V3	L/V1	L/V2	L/V3
 Peninsula, Rectilinear Top Left hand shown	20"	60"	1 1/2"	RPTDEPC(L/R)6020() () () ()	\$1,460.	\$1,963.	\$2,258.	\$2,934.	\$2,395.	\$2,488.	\$2,595.
	20"	66"	1 1/2"	RPTDEPC(L/R)6620() () () ()	1,470.	1,981.	2,280.	2,963.	2,411.	2,504.	2,612.
	20"	72"	1 1/2"	RPTDEPC(L/R)7220() () () ()	1,481.	2,011.	2,314.	3,007.	2,440.	2,533.	2,639.
	20"	78"	1 1/2"	RPTDEPC(L/R)7820() () () ()	1,492.	2,031.	2,336.	3,037.	2,455.	2,548.	2,656.
	20"	84"	1 1/2"	RPTDEPC(L/R)8420() () () ()	1,503.	2,069.	2,380.	3,093.	2,494.	2,587.	2,695.
	24"	60"	1 1/2"	RPTDEPC(L/R)6024() () () ()	1,495.	2,013.	2,315.	3,009.	2,440.	2,532.	2,639.
	24"	66"	1 1/2"	RPTDEPC(L/R)6624() () () ()	1,509.	2,036.	2,342.	3,044.	2,458.	2,551.	2,659.
	24"	72"	1 1/2"	RPTDEPC(L/R)7224() () () ()	1,551.	2,059.	2,369.	3,079.	2,477.	2,570.	2,676.
	24"	78"	1 1/2"	RPTDEPC(L/R)7824() () () ()	1,564.	2,091.	2,405.	3,127.	2,506.	2,600.	2,707.
	24"	84"	1 1/2"	RPTDEPC(L/R)8424() () () ()	1,576.	2,132.	2,452.	3,189.	2,547.	2,640.	2,747.
	30"	60"	1 1/2"	RPTDEPC(L/R)6030() () () ()	1,673.	2,075.	2,386.	3,101.	2,491.	2,585.	2,693.
	30"	66"	1 1/2"	RPTDEPC(L/R)6630() () () ()	1,686.	2,102.	2,417.	3,143.	2,513.	2,607.	2,714.
	30"	72"	1 1/2"	RPTDEPC(L/R)7230() () () ()	1,703.	2,138.	2,460.	3,198.	2,548.	2,641.	2,748.
	30"	78"	1 1/2"	RPTDEPC(L/R)7830() () () ()	1,717.	2,168.	2,494.	3,242.	2,571.	2,665.	2,772.
	30"	84"	1 1/2"	RPTDEPC(L/R)8430() () () ()	1,732.	2,222.	2,555.	3,323.	2,624.	2,718.	2,826.
	36"	60"	1 1/2"	RPTDEPC(L/R)6036() () () ()	1,741.	2,135.	2,455.	3,193.	2,544.	2,637.	2,744.
	36"	66"	1 1/2"	RPTDEPC(L/R)6636() () () ()	1,759.	2,168.	2,494.	3,243.	2,571.	2,664.	2,772.
	36"	72"	1 1/2"	RPTDEPC(L/R)7236() () () ()	1,777.	2,210.	2,541.	3,304.	2,609.	2,701.	2,809.
	36"	78"	1 1/2"	RPTDEPC(L/R)7836() () () ()	1,797.	2,243.	2,579.	3,354.	2,635.	2,728.	2,835.
	36"	84"	1 1/2"	RPTDEPC(L/R)8436() () () ()	1,813.	2,293.	2,638.	3,430.	2,683.	2,776.	2,883.

Order Code	Specification Information	Application Notes
Example: RPTDEPC(L/R)6030() () () ()	<i>To order please specify pattern number including:</i>	It is not advisable to mix 28 3/8" h desk height product with 26 1/2" h standard height products.
R Reff	1. <i>Left or Right hand</i>	Products on this page work with 28 3/8" height planning.
PT Peninsula	2. <i>Grommet option:</i> P=Power Center PE=Power center and end grommet	
D 1 1/2" Thick Square Edge	3. <i>Grommet finish:</i> Painted or plated	Products on this page will accept woodgrain laminate where laminate is currently an option.
E Thick End Panel Leg	4. <i>Worksurface finish:</i> L, V1, V2, V3	Worksurface stiffeners, recommended to provide additional support for open spans greater than 48" w.
PC Power Center	5. <i>Edge finish:</i> L, V1, V2, V3 (Edge options are available on laminate tops only.)	Modesty sold separately and can be field installed.
L Left hand/ Right hand	6. <i>Leg finish:</i> Wood or Laminate	
60 Width	7. <i>Stand-off finish:</i> Painted	Wire chase sold separately.
20 Depth		Refer to grommet page for location option.
P Grommet Option		From users perspective, if the leg is on the right side, the peninsula is classified a "Right Hand" peninsula.
115 Grommet Finish		
V316 Worksurface Finish		
() Edge finish		
V316 Leg Finish		
115 Stand-Off Finish		

*Worksurface with Thick End Panel
Simple Stand-Off, Rectilinear top, Square Edge*

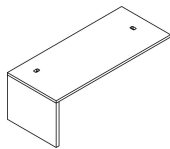
description	d	w	th	pattern no.	L/L	V1/V1	V2/V2	V3/V3	L/V1	L/V2	L/V3
 <p>Left hand shown</p>	20"	60"	1 1/2"	RPTDEST(L/R)6020() () () ()	\$1,294.	\$1,804.	\$2,075.	\$2,697.	\$2,213.	\$2,304.	\$2,413.
	20"	66"	1 1/2"	RPTDEST(L/R)6620() () () ()	1,304.	1,823.	2,097.	2,725.	2,229.	2,322.	2,429.
	20"	72"	1 1/2"	RPTDEST(L/R)7220() () () ()	1,314.	1,853.	2,131.	2,770.	2,257.	2,349.	2,456.
	20"	78"	1 1/2"	RPTDEST(L/R)7820() () () ()	1,325.	1,872.	2,154.	2,800.	2,272.	2,366.	2,472.
	20"	84"	1 1/2"	RPTDEST(L/R)8420() () () ()	1,336.	1,912.	2,198.	2,858.	2,311.	2,404.	2,511.
	24"	60"	1 1/2"	RPTDEST(L/R)6024() () () ()	1,329.	1,854.	2,132.	2,772.	2,257.	2,348.	2,456.
	24"	66"	1 1/2"	RPTDEST(L/R)6624() () () ()	1,342.	1,878.	2,160.	2,807.	2,276.	2,369.	2,476.
	24"	72"	1 1/2"	RPTDEST(L/R)7224() () () ()	1,385.	1,900.	2,185.	2,841.	2,294.	2,388.	2,495.
	24"	78"	1 1/2"	RPTDEST(L/R)7824() () () ()	1,397.	1,934.	2,222.	2,888.	2,324.	2,417.	2,524.
	24"	84"	1 1/2"	RPTDEST(L/R)8424() () () ()	1,410.	1,973.	2,269.	2,951.	2,364.	2,457.	2,564.
	30"	60"	1 1/2"	RPTDEST(L/R)6030() () () ()	1,505.	1,916.	2,204.	2,864.	2,308.	2,402.	2,509.
	30"	66"	1 1/2"	RPTDEST(L/R)6630() () () ()	1,520.	1,943.	2,235.	2,905.	2,331.	2,424.	2,532.
	30"	72"	1 1/2"	RPTDEST(L/R)7230() () () ()	1,536.	1,979.	2,278.	2,960.	2,366.	2,458.	2,565.
	30"	78"	1 1/2"	RPTDEST(L/R)7830() () () ()	1,551.	2,009.	2,311.	2,992.	2,389.	2,483.	2,589.
	30"	84"	1 1/2"	RPTDEST(L/R)8430() () () ()	1,566.	2,063.	2,373.	3,085.	2,443.	2,536.	2,643.
	36"	60"	1 1/2"	RPTDEST(L/R)6036() () () ()	1,574.	1,976.	2,272.	2,954.	2,362.	2,454.	2,561.
	36"	66"	1 1/2"	RPTDEST(L/R)6636() () () ()	1,593.	2,009.	2,311.	3,004.	2,389.	2,807.	2,589.
	36"	72"	1 1/2"	RPTDEST(L/R)7236() () () ()	1,610.	2,051.	2,358.	3,066.	2,426.	2,517.	2,626.
	36"	78"	1 1/2"	RPTDEST(L/R)7836() () () ()	1,630.	2,084.	2,396.	3,116.	2,453.	2,546.	2,654.
	36"	84"	1 1/2"	RPTDEST(L/R)8436() () () ()	1,646.	2,134.	2,455.	3,192.	2,501.	2,593.	2,701.

Order Code	Specification Information	Application Notes
Example: RPTDEST(L/R)6030() () () ()	<i>To order please specify pattern number including:</i>	It is not advisable to mix 28 3/8" h desk height product with 26 1/2" h standard height products.
R Reff	1. <i>Left or Right hand</i>	Products on this page work with 28 3/8" height planning.
PT Peninsula	2. <i>Grommet option:</i>	Products on this page will accept woodgrain laminate where laminate is currently an option.
D 1 1/2" Thick Square Edge	N=No grommet	Worksurface stiffeners, recommended to provide additional support for open spans greater than 48" w.
E Thick End Panel Leg	E = End location grommet	
ST Stand-Off	SE=Stand-off and end grommet	
L Left hand/ Right hand	S = Stand-off location grommet	
60 Width	SD = Drop in electrical cutout & no grommet	
20 Depth	SDR = Drop in electrical cutout & end grommet, RH	
S Grommet Option	SDL = Drop in electrical cutout & end grommet, LH	
115 Grommet Finish	Note: Please order electric for the following options; SD, SDR and SDL.	
V316 Worksurface Finish	3. <i>Grommet finish:</i>	
() Edge finish	Painted or plated where applicable.	
V316 Leg Finish	N & SD have not finish options.	
115 Stand-Off Finish	4. <i>Worksurface finish:</i>	
	L, V1, V2, V3	
	5. Edge finish: L, V1, V2, V3 (Edge options are available on laminate tops only.)	
	6. <i>Leg finish:</i>	
	Wood or Laminate	
	7. <i>Stand-off finish:</i>	
	Painted	

Worksurface with Thick End Panel

Flush Mount Attachment, Rectilinear top, Square Edge

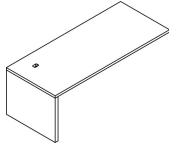
description	d	w	th	pattern no.	L/L	V1/V1	V2/V2	V3/V3	L/V1	L/V2	L/V3
 <p>Left hand shown</p>	20"	36"	1 1/2"	RPTDEFM(L/R)3620() () () ()	\$1,054.	\$1,499.	\$1,724.	\$2,240.	\$1,886.	\$1,978.	\$2,086.
	20"	42"	1 1/2"	RPTDEFM(L/R)4220() () () ()	1,068.	1,524.	1,754.	2,280.	1,911.	2,003.	2,110.
	20"	48"	1 1/2"	RPTDEFM(L/R)4820() () () ()	1,093.	1,550.	1,781.	2,317.	1,931.	2,024.	2,131.
	20"	54"	1 1/2"	RPTDEFM(L/R)5420() () () ()	1,096.	1,569.	1,804.	2,345.	1,948.	2,041.	2,148.
	20"	60"	1 1/2"	RPTDEFM(L/R)6020() () () ()	1,156.	1,673.	1,922.	2,500.	2,060.	2,155.	2,262.
	20"	66"	1 1/2"	RPTDEFM(L/R)6620() () () ()	1,169.	1,691.	1,945.	2,530.	2,077.	2,170.	2,277.
	20"	72"	1 1/2"	RPTDEFM(L/R)7220() () () ()	1,179.	1,722.	1,978.	2,573.	2,105.	2,197.	2,304.
	20"	78"	1 1/2"	RPTDEFM(L/R)7820() () () ()	1,190.	1,740.	2,002.	2,602.	2,122.	2,214.	2,322.
	20"	84"	1 1/2"	RPTDEFM(L/R)8420() () () ()	1,200.	1,779.	2,046.	2,660.	2,160.	2,253.	2,360.
	24"	36"	1 1/2"	RPTDEFM(L/R)3624() () () ()	1,088.	1,533.	1,763.	2,292.	1,915.	2,008.	2,115.
	24"	42"	1 1/2"	RPTDEFM(L/R)4224() () () ()	1,111.	1,561.	1,794.	2,333.	1,940.	2,032.	2,139.
	24"	48"	1 1/2"	RPTDEFM(L/R)4824() () () ()	1,135.	1,583.	1,819.	2,367.	1,958.	2,052.	2,159.
	24"	54"	1 1/2"	RPTDEFM(L/R)5424() () () ()	1,147.	1,607.	1,848.	2,403.	1,978.	2,073.	2,180.
	24"	60"	1 1/2"	RPTDEFM(L/R)6024() () () ()	1,194.	1,723.	1,980.	2,575.	2,105.	2,197.	2,304.
	24"	66"	1 1/2"	RPTDEFM(L/R)6624() () () ()	1,206.	1,747.	2,008.	2,611.	2,124.	2,217.	2,324.
	24"	72"	1 1/2"	RPTDEFM(L/R)7224() () () ()	1,249.	1,769.	2,034.	2,645.	2,142.	2,237.	2,343.
	24"	78"	1 1/2"	RPTDEFM(L/R)7824() () () ()	1,261.	1,801.	2,072.	2,693.	2,173.	2,265.	2,373.
	24"	84"	1 1/2"	RPTDEFM(L/R)8424() () () ()	1,274.	1,842.	2,118.	2,754.	2,213.	2,306.	2,413.

Order Code	Specification Information	Application Notes
Example: RPTDEFM(L/R)4830() () ()	To order please specify pattern number including:	It is not advisable to mix 28 3/8" h desk height product with 26 1/2" h standard height products.
R	1. Left or Right hand:	Products on this page work with 28 3/8" height planning.
PT	2. Grommet option: E = End M = Mid. grommet N = No grommet	
D	3. Grommet finish: Painted or plated	Products on this page will accept woodgrain laminate where laminate is currently an option.
E	4. Worksurface finish: L, V1, V2, V3	
FM	5. Edge finish: L, V1, V2, V3 (Edge options are available on laminate tops only.)	Worksurface stiffeners, recommended to provide additional support for open spans greater than 48" w.
L	6. Leg finish: Wood or Laminate	
60	7. Stand Off finish: Painted	Peninsula worksurfaces with power center do not come with Electrical Components.
20		For electrical components please refer to page 399.
E		Modesty sold separately and can be field installed.
115		Wire chase sold separately.
V316		Refer to grommet page for location option.
()		From users perspective, if the leg is on the right side, the peninsula is classified a "Right Hand" peninsula.
V316		
115		

Worksurface with Thick End Panel

Flush Mount Attachment, Rectilinear top, Square Edge

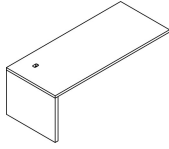
description	d	w	th	pattern no.	L/L	V1/V1	V2/V2	V3/V3	L/V1	L/V2	L/V3
 <p>Left hand shown</p>	30"	36"	1 1/2"	RPTDEFM(L/R)3630() () () ()	\$1,173.	\$1,570.	\$1,806.	\$2,347.	\$1,948.	\$2,041.	\$2,148.
	30"	42"	1 1/2"	RPTDEFM(L/R)4230() () () ()	1,188.	1,598.	1,839.	2,390.	1,971.	2,063.	2,171.
	30"	48"	1 1/2"	RPTDEFM(L/R)4830() () () ()	1,221.	1,635.	1,882.	2,446.	2,005.	2,098.	2,206.
	30"	54"	1 1/2"	RPTDEFM(L/R)5430() () () ()	1,235.	1,664.	1,913.	2,487.	2,026.	2,121.	2,228.
	30"	60"	1 1/2"	RPTDEFM(L/R)6030() () () ()	1,368.	1,785.	2,052.	2,667.	2,158.	2,250.	2,356.
	30"	66"	1 1/2"	RPTDEFM(L/R)6630() () () ()	1,385.	1,811.	2,083.	2,709.	2,180.	2,272.	2,380.
	30"	72"	1 1/2"	RPTDEFM(L/R)7230() () () ()	1,400.	1,848.	2,126.	2,764.	2,214.	2,306.	2,414.
	30"	78"	1 1/2"	RPTDEFM(L/R)7830() () () ()	1,415.	1,877.	2,159.	2,806.	2,238.	2,330.	2,437.
	30"	84"	1 1/2"	RPTDEFM(L/R)8430() () () ()	1,431.	1,933.	2,221.	2,887.	2,291.	2,384.	2,491.
	36"	36"	1 1/2"	RPTDEFM(L/R)3636() () () ()	1,247.	1,604.	1,845.	2,399.	1,975.	2,069.	2,176.
	36"	42"	1 1/2"	RPTDEFM(L/R)4236() () () ()	1,283.	1,645.	1,892.	2,459.	2,013.	2,106.	2,213.
	36"	48"	1 1/2"	RPTDEFM(L/R)4836() () () ()	1,285.	1,686.	1,940.	2,522.	2,050.	2,142.	2,249.
	36"	54"	1 1/2"	RPTDEFM(L/R)5436() () () ()	1,303.	1,721.	1,977.	2,571.	2,077.	2,170.	2,277.
	36"	60"	1 1/2"	RPTDEFM(L/R)6036() () () ()	1,439.	1,844.	2,122.	2,757.	2,211.	2,302.	2,410.
	36"	66"	1 1/2"	RPTDEFM(L/R)6636() () () ()	1,458.	1,878.	2,160.	2,807.	2,237.	2,330.	2,437.
	36"	72"	1 1/2"	RPTDEFM(L/R)7236() () () ()	1,474.	1,919.	2,208.	2,870.	2,274.	2,368.	2,475.
	36"	78"	1 1/2"	RPTDEFM(L/R)7836() () () ()	1,494.	1,953.	2,245.	2,919.	2,300.	2,394.	2,502.
	36"	84"	1 1/2"	RPTDEFM(L/R)8436() () () ()	1,511.	2,003.	2,303.	2,994.	2,349.	2,443.	2,550.

Order Code	Specification Information	Application Notes
Example: RPTDEFM(L/R)4830() () () ()	To order please specify pattern number including:	It is not advisable to mix 28 3/8" h desk height product with 26 1/2" h standard height products.
R	1. Left or Right hand:	Products on this page work with 28 3/8" height planning.
PT	2. Grommet option: E = End M = Mid. grommet N = No grommet	
D	3. Grommet finish: Painted or plated	Products on this page will accept woodgrain laminate where laminate is currently an option.
E	4. Worksurface finish: L, V1, V2, V3	
FM	5. Edge finish: L, V1, V2, V3 (Edge options are available on laminate tops only.)	Worksurface stiffeners, recommended to provide additional support for open spans greater than 48" w.
L	6. Leg finish: Wood or Laminate	
60	7. Stand Off finish: Painted	Peninsula worksurfaces with power center do not come with Electrical Components.
20		For electrical components please refer to page 399.
E		Modesty sold separately and can be field installed.
115		Wire chase sold separately.
V316		Refer to grommet page for location option.
()		From users perspective, if the leg is on the right side, the peninsula is classified a "Right Hand" peninsula.
V316		
115		

Worksurface with Column Leg

Stand-Off with Power Center, Asymmetrical and Symmetrical Bullet top, Square Edge

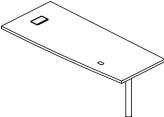
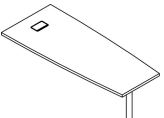
description	d	w	th	pattern no.	L	M/V1	V2	V3
 Peninsula, Asymmetrical Bullet Top <i>Left handed peninsula shown</i>	30"	60"	1 1/2"	RATDCPC(L/R)6030() () () ()	\$1,581.	\$1,862.	\$2,096.	\$2,523.
	30"	66"	1 1/2"	RATDCPC(L/R)6630() () () ()	1,599.	1,889.	2,129.	2,534.
	30"	66"	1 1/2"	RATDCPC(L/R)7230() () () ()	1,615.	1,926.	2,174.	2,612.
	30"	78"	1 1/2"	RATDCPC(L/R)7830() () () ()	1,633.	1,954.	2,208.	2,678.
	30"	84"	1 1/2"	RATDCPC(L/R)8430() () () ()	1,650.	1,991.	2,251.	2,753.
	36"	60"	1 1/2"	RATDCPC(L/R)6036() () () ()	1,613.	1,915.	2,168.	2,596.
	36"	66"	1 1/2"	RATDCPC(L/R)6636() () () ()	1,634.	1,953.	2,208.	2,674.
	36"	72"	1 1/2"	RATDCPC(L/R)7236() () () ()	1,654.	1,994.	2,257.	2,759.
	36"	78"	1 1/2"	RATDCPC(L/R)7836() () () ()	1,675.	2,025.	2,297.	2,837.
	36"	84"	1 1/2"	RATDCPC(L/R)8436() () () ()	1,695.	2,056.	2,336.	2,911.
 Peninsula, Symmetrical Bullet Top <i>Left hand shown</i>	30"	60"	1 1/2"	RSTDCPC(L/R)6030() () () ()	1,724.	2,190.	2,457.	2,830.
	30"	66"	1 1/2"	RSTDCPC(L/R)6630() () () ()	1,742.	2,227.	2,501.	2,901.
	30"	72"	1 1/2"	RSTDCPC(L/R)7230() () () ()	1,761.	2,255.	2,535.	2,973.
	30"	78"	1 1/2"	RSTDCPC(L/R)7830() () () ()	1,781.	2,282.	2,569.	3,039.
	30"	84"	1 1/2"	RSTDCPC(L/R)8430() () () ()	1,797.	2,319.	2,613.	3,114.
	36"	60"	1 1/2"	RSTDCPC(L/R)6036() () () ()	1,759.	2,250.	2,529.	2,957.
	36"	66"	1 1/2"	RSTDCPC(L/R)6636() () () ()	1,782.	2,281.	2,570.	3,035.
	36"	72"	1 1/2"	RSTDCPC(L/R)7236() () () ()	1,804.	2,322.	2,618.	3,121.
	36"	78"	1 1/2"	RSTDCPC(L/R)7836() () () ()	1,827.	2,353.	2,659.	3,198.
	36"	84"	1 1/2"	RSTDCPC(L/R)8436() () () ()	1,849.	2,384.	2,697.	3,272.

Order Code	Specification Information	Application Notes
Example: RATDCPC(L/R)6030() () () ()	<i>To order please specify pattern number including:</i>	It is not advisable to mix 28 3/8" desk height product with 26 1/2" standard height products.
R Reff	1. Grommet finish: Painted or Plated	Peninsula worksurfaces with power center do not come with Electrical Components.
AT Asymmetrical Top	2. Top finish: L, V1, V2, V3	Products on this page work with 28 3/8" height planning.
D 1 1/2" Thick Square Edge	3. Edge finish: L, V1, V2, V3 (Edge options are available on laminate tops only.)	For electrical components please refer to page 399.
C Column Leg	4. Leg finish: Painted or Plated	Products on this page will accept woodgrain laminate where laminate is currently an option.
PC Power Center	5. Stand-off finish: Painted	Modesty sold separately and can be field installed.
L Left hand/ Right hand	Grommet type: P only	Wire chase sold separately.
60 Width		Refer to grommet page for location option.
30 Depth		Worksurface stiffeners, recommended to provide additional support for open spans greater than 48" w.
115 Grommet Finish		Upcharges apply to legs with P2, P3 and P4 finishes.
114 Worksurface Finish		Additional upcharges;
() Edge finish		Leg Finish Add
115 Leg Finish		P2 \$35
115 Stand-off Finish		P3 \$50
		P4 \$150

Worksurface with Column Leg

Simple Stand-Off, Asymmetrical and Symmetrical Bullet top, Square Edge

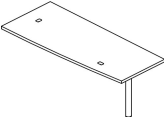
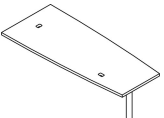
description	d	w	th	pattern no.	L	M/V1	V2	V3
 Peninsula, Asymmetrical Bullet Top Left handed peninsula shown	30"	60"	1 1/2"	RATDCST(L/R)6030() () () ()	\$1,428.	\$1,644.	\$1,856.	\$2,228.
	30"	66"	1 1/2"	RATDCST(L/R)6630() () () ()	1,444.	1,671.	1,889.	2,293.
	30"	72"	1 1/2"	RATDCST(L/R)7230() () () ()	1,463.	1,708.	1,932.	2,370.
	30"	78"	1 1/2"	RATDCST(L/R)7830() () () ()	1,479.	1,735.	1,966.	2,436.
	30"	84"	1 1/2"	RATDCST(L/R)8430() () () ()	1,497.	1,771.	2,010.	2,512.
	36"	60"	1 1/2"	RATDCST(L/R)6036() () () ()	1,461.	1,703.	1,928.	2,356.
	36"	66"	1 1/2"	RATDCST(L/R)6636() () () ()	1,480.	1,734.	1,968.	2,433.
	36"	72"	1 1/2"	RATDCST(L/R)7236() () () ()	1,501.	1,775.	2,017.	2,518.
	36"	78"	1 1/2"	RATDCST(L/R)7836() () () ()	1,521.	1,806.	2,056.	2,596.
	36"	84"	1 1/2"	RATDCST(L/R)8436() () () ()	1,542.	1,838.	2,095.	2,671.
 Peninsula, Symmetrical Bullet Top Left hand shown	30"	60"	1 1/2"	RSTDCST(L/R)6030() () () ()	1,556.	1,994.	2,240.	2,613.
	30"	66"	1 1/2"	RSTDCST(L/R)6630() () () ()	1,574.	2,019.	2,272.	2,678.
	30"	72"	1 1/2"	RSTDCST(L/R)7230() () () ()	1,594.	2,057.	2,318.	2,754.
	30"	78"	1 1/2"	RSTDCST(L/R)7830() () () ()	1,612.	2,084.	2,351.	2,821.
	30"	84"	1 1/2"	RSTDCST(L/R)8430() () () ()	1,630.	2,121.	2,394.	2,897.
	36"	60"	1 1/2"	RSTDCST(L/R)6036() () () ()	1,592.	2,052.	2,312.	2,740.
	36"	66"	1 1/2"	RSTDCST(L/R)6636() () () ()	1,613.	2,083.	2,352.	2,818.
	36"	72"	1 1/2"	RSTDCST(L/R)7236() () () ()	1,636.	2,124.	2,401.	2,904.
	36"	78"	1 1/2"	RSTDCST(L/R)7836() () () ()	1,658.	2,156.	2,442.	2,980.
	36"	84"	1 1/2"	RSTDCST(L/R)8436() () () ()	1,680.	2,186.	2,479.	3,056.

Order Code	Specification Information	Application Notes
Example: RATDCST (L/R)6030	<i>To order please specify pattern number including:</i>	It is not advisable to mix 28 3/8" h desk height product with 26 1/2" h standard height products.
R Reff		
AT Asymmetrical Top	1. Grommet option: N=No grommet E=End location grommet SE=Stand-off and end grommet S=Stand-off location grommet SD=Drop in electrical cutout & no grommet SDR=Drop in electrical cutout & end grommet, RH SDL=Drop in electrical cutout & end grommet, LH	Products on this page work with 28 3/8" height planning.
D 1 1/2" Thick Square Edge		Products on this page will accept woodgrain laminate where laminate is currently an option.
C Column Leg		Worksurface stiffeners, recommended to provide additional support for open spans greater than 48" w.
ST Stand-Off	Note: Please order electric for the following options; SD, SDR and SDL.	Upcharges apply to legs with P2, P3 and P4 finishes.
L/R Left/Right Hand		Additional upcharges;
60 Width		Leg Finish Add
30 Depth		P2 \$35
N Grommet Option		P3 \$50
115 Grommet Finish		P4 \$150
V316 Worksurface Finish		
() Edge finish		
115 Leg Finish		
115 Stand-Off Finish		
	2. Grommet finish: Painted or Plated where applicable. N & SD have no finish option.	
	3. Top finish: L, V1, V2, V3	
	4. Edge finish: L, V1, V2, V3 (Edge options are available on laminate tops only.)	
	5. Leg finish: Painted or Plated	
	6. Stand-off finish: Painted	
		Peninsula worksurfaces with power center do not come with Electrical Components.
		For electrical components please refer to page 399.
		Modesty sold separately and can be field installed.
		Wire chase sold separately.
		Refer to Peninsula Planning Guidelines for location option.
		From users perspective, if the leg is on the right side, the peninsula is classified a "Right Hand" peninsula.

Worksurface with Column Leg

Flush Mount Attachment, Asymmetrical and Symmetrical Bullet top, Square Edge

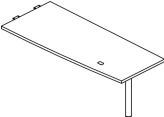
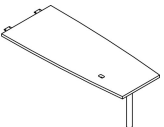
description	d	w	th	pattern no.	L	M/V1	V2	V3
 <p>Left handed peninsula shown</p>	30"	48"	1 1/2"	RATDCFM(L/R)4830() () ()	\$1,138.	\$1,438.	\$1,622.	\$1,930.
		54"	1 1/2"	RATDCFM(L/R)5430() () ()	1,228.	1,465.	1,654.	1,995.
		60"	1 1/2"	RATDCFM(L/R)6030() () ()	1,308.	1,535.	1,735.	2,108.
		66"	1 1/2"	RATDCFM(L/R)6630() () ()	1,325.	1,561.	1,768.	2,174.
		72"	1 1/2"	RATDCFM(L/R)7230() () ()	1,353.	1,599.	1,813.	2,251.
		78"	1 1/2"	RATDCFM(L/R)7830() () ()	1,376.	1,627.	1,847.	2,318.
		84"	1 1/2"	RATDCFM(L/R)8430() () ()	1,406.	1,663.	1,891.	2,392.
			36"	48"	1 1/2"	RATDCFM(L/R)4836() () ()	1,182.	1,487.
54"	1 1/2"			RATDCFM(L/R)5436() () ()	1,258.	1,519.	1,722.	2,115.
60"	1 1/2"			RATDCFM(L/R)6036() () ()	1,341.	1,594.	1,808.	2,236.
66"	1 1/2"			RATDCFM(L/R)6636() () ()	1,361.	1,626.	1,848.	2,313.
72"	1 1/2"			RATDCFM(L/R)7236() () ()	1,382.	1,667.	1,897.	2,400.
78"	1 1/2"			RATDCFM(L/R)7836() () ()	1,401.	1,697.	1,937.	2,477.
84"	1 1/2"			RATDCFM(L/R)8436() () ()	1,422.	1,729.	1,975.	2,551.
 <p>Left hand shown</p>	30"			48"	1 1/2"	RSTDCFM(L/R)4830() () ()	1,240.	1,788.
		54"	1 1/2"	RSTDCFM(L/R)5430() () ()	1,266.	1,813.	2,039.	2,379.
		60"	1 1/2"	RSTDCFM(L/R)6030() () ()	1,426.	1,884.	2,120.	2,493.
		66"	1 1/2"	RSTDCFM(L/R)6630() () ()	1,444.	1,911.	2,153.	2,557.
		72"	1 1/2"	RSTDCFM(L/R)7230() () ()	1,464.	1,948.	2,198.	2,635.
		78"	1 1/2"	RSTDCFM(L/R)7830() () ()	1,482.	1,975.	2,231.	2,702.
		84"	1 1/2"	RSTDCFM(L/R)8430() () ()	1,500.	2,012.	2,274.	2,777.
			36"	48"	1 1/2"	RSTDCFM(L/R)4836() () ()	1,289.	1,837.
54"	1 1/2"			RSTDCFM(L/R)5436() () ()	1,314.	1,869.	2,106.	2,499.
60"	1 1/2"			RSTDCFM(L/R)6036() () ()	1,462.	1,942.	2,191.	2,620.
66"	1 1/2"			RSTDCFM(L/R)6636() () ()	1,483.	1,974.	2,231.	2,698.
72"	1 1/2"			RSTDCFM(L/R)7236() () ()	1,506.	2,015.	2,281.	2,784.
78"	1 1/2"			RSTDCFM(L/R)7836() () ()	1,527.	2,047.	2,321.	2,861.
84"	1 1/2"			RSTDCFM(L/R)8436() () ()	1,550.	2,078.	2,360.	2,935.

Order Code

Example:	RATDCFM (L/R)4830
R	Reff
AT	Asymmetrical Top
D	1 1/2" Thick Square Edge
C	Column Leg
FM	Flush Mount Plate
L/R	Left/Right Hand
48	Width
30	Depth
N	Grommet Option
115	Grommet Finish
V316	Worksurface Finish
()	Edge finish
115	Leg Finish

Specification Information

- To order please specify pattern number including:
- Grommet option:
E=End grommet
N=No grommet
 - Grommet finish:
Painted or Plated
 - Top finish:
L, V1, V2, V3
 - Edge finish: L, V1, V2, V3
(Edge options are available on laminate tops only.)
 - Leg finish:
Painted or Plated

Application Notes

- It is not advisable to mix 28 3/8" h desk height product with 26 1/2" h standard height products.
- Products on this page work with 28 3/8" height planning.
- Products on this page will accept woodgrain laminate where laminate is currently an option.
- Worksurface stiffeners, recommended to provide additional support for open spans greater than 48" w.
- Upcharges apply to legs with P2, P3 and P4 finishes.
Additional upcharges;
- | | |
|------------|-------|
| Leg Finish | Add |
| P2 | \$35 |
| P3 | \$50 |
| P4 | \$150 |
- Peninsula worksurfaces with power center do not come with Electrical Components.
- For electrical components please refer to page 399.
- Modesty sold separately and can be field installed.
- Wire chase sold separately.
- Refer to grommet page for location option.
- From users perspective, if the leg is on the right side, the peninsula is classified a "Right Hand" peninsula.

Worksurface with Column Leg

Flush Mount Attachment, P and 9 tops, Square Edge

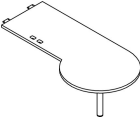
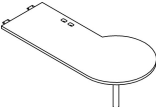
description	d	w	th	pattern no.	L	M/V1	V2	V3
Peninsula, P Shaped Top 	30"	84"	1 1/2"	RPTDCFM8430 () () () ()	\$2,246.	\$2,407.	\$2,733.	\$3,385.
	30"	96"	1 1/2"	RPTDCFM9630 () () () ()	2,326.	2,477.	2,822.	3,555.
Peninsula, 9 Shaped Top 	30"	84"	1 1/2"	R9TDCFM8430 () () () ()	2,246.	2,407.	2,733.	3,385.
	30"	96"	1 1/2"	R9TDCFM9630 () () () ()	2,326.	2,477.	2,822.	3,555.

Order Code	Specification Information	Application Notes
Example: RPTDCFM8430 () () ()	<i>To order please specify pattern number including:</i>	It is not advisable to mix 28 3/8" h desk height product with 26 1/2" h standard height products.
R Reff	1. Grommet option: F=Flush M=Mid. Grommet N=No grommet	For electrical components please refer to page 399.
PT P-Shaped top	2. Grommet finish: Painted or Plated	Modesty sold separately and can be field installed.
D 1 1/2" Thick Square Edge	3. Top finish: L, V1, V2, V3	Wire chase sold separately.
C Column Leg	4. Edge finish: L, V1, V2, V3 (Edge options are available on laminate tops only.)	Refer to grommet page for location option.
FM Flush Mount Attachment Plate	5. Leg finish: Painted or Plated	From users perspective, if the leg is on the right side, the peninsula is classified a "Right Hand" peninsula.
84 Width		Worksurface stiffeners, recommended to provide additional support for open spans greater than 48" w.
30 Depth		Upcharges apply to legs with P2, P3 and P4 finishes.
N Grommet Option		Additional upcharges:
115 Grommet Finish		Leg Finish Add
114 Worksurface Finish		P2 \$35
() Edge finish		P3 \$50
115 Leg Finish		P4 \$150

*Worksurface with Column Leg
Stand-Off with Power Center, D top, Square Edge*

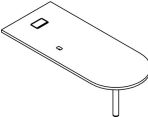
description	d	w	th	pattern no.	L	M/V1	V2	V3
 <p>Left hand shown</p>	30"	66"	1 1/2"	RDTDCPC(L/R)6630() () () ()	\$1,800.	\$2,041.	\$2,129.	\$2,482.
	30"	72"	1 1/2"	RDTDCPC(L/R)7230() () () ()	1,825.	2,068.	2,166.	2,547.
	30"	78"	1 1/2"	RDTDCPC(L/R)7830() () () ()	1,844.	2,090.	2,195.	2,605.
	30"	84"	1 1/2"	RDTDCPC(L/R)8430() () () ()	1,870.	2,120.	2,230.	2,667.
	30"	90"	1 1/2"	RDTDCPC(L/R)9030() () () ()	1,890.	2,140.	2,260.	2,723.
	36"	66"	1 1/2"	RDTDCPC(L/R)6636() () () ()	1,843.	2,089.	2,195.	2,601.
	36"	72"	1 1/2"	RDTDCPC(L/R)7236() () () ()	1,873.	2,123.	2,236.	2,672.
	36"	78"	1 1/2"	RDTDCPC(L/R)7836() () () ()	1,894.	2,148.	2,269.	2,739.
	36"	84"	1 1/2"	RDTDCPC(L/R)8436() () () ()	1,916.	2,171.	2,302.	2,803.
	36"	90"	1 1/2"	RDTDCPC(L/R)9036() () () ()	1,939.	2,197.	2,337.	2,869.
	36"	96"	1 1/2"	RDTDCPC(L/R)9636() () () ()	1,963.	2,223.	2,370.	2,935.

Order Code	Specification Information	Application Notes
Example: RDTDCPCL6630 () () ()	<i>To order please specify pattern number including:</i>	It is not advisable to mix 28 3/8" h desk height product with 26 1/2" h standard height products.
R Reff	1. Grommet option: P=Power center PM=Power center and middle grommet	Products on this page work with 28 3/8" height planning.
DT P-Shaped top	2. Grommet finish: Painted or Plated	Products on this page will accept woodgrain laminate where laminate is currently an option.
D 1 1/2" Thick Square Edge	3. Top finish: L, V1, V2, V3	Worksurface stiffeners, recommended to provide additional support for open spans greater than 48" w.
C Column Leg	4. Edge finish: L, V1, V2, V3 (Edge options are available on laminate tops only.)	Upcharges apply to legs with P2, P3 and P4 finishes. Additional upcharges:
PC Power Center	5. Leg finish: Painted or Plated	Leg Finish Add P2 \$35 P3 \$50 P4 \$150
L	6. Stand-off finish: Painted	
66 Width		Peninsula worksurfaces with power center do not come with Electrical Components.
30 Depth		For electrical components please refer to page 399.
P Grommet option		Modesty sold separately and can be field installed.
115 Grommet finish		Wire chase sold separately.
V316 Top finish		Refer to grommet page for location option.
() Edge finish		From users perspective, if the leg is on the right side, the peninsula is classified a "Right Hand" peninsula.
115 Leg Finish		
115 Stand-Off Finish		

Peninsula 1 1/2"
 Worksurface with Column Leg
 Simple Stand-Off, D top, Square Edge

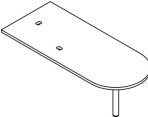
description	d	w	th	pattern no.	L	M/V1	V2	V3
 Peninsula, D-Shaped Top Left hand shown	30"	66"	1 1/2"	RDTDCST(L/R)6630() () () ()	\$1,646.	\$1,864.	\$1,954.	\$2,307.
	30"	72"	1 1/2"	RDTDCST(L/R)7230() () () ()	1,672.	1,894.	1,992.	2,373.
	30"	78"	1 1/2"	RDTDCST(L/R)7830() () () ()	1,690.	1,916.	2,020.	2,429.
	30"	84"	1 1/2"	RDTDCST(L/R)8430() () () ()	1,715.	1,944.	2,055.	2,494.
	30"	90"	1 1/2"	RDTDCST(L/R)9030() () () ()	1,734.	1,967.	2,084.	2,549.
	30"	96"	1 1/2"	RDTDCST(L/R)9630() () () ()	1,754.	1,987.	2,112.	2,604.
	36"	66"	1 1/2"	RDTDCST(L/R)6636() () () ()	1,689.	1,915.	2,020.	2,426.
	36"	72"	1 1/2"	RDTDCST(L/R)7236() () () ()	1,718.	1,948.	2,060.	2,498.
	36"	78"	1 1/2"	RDTDCST(L/R)7836() () () ()	1,740.	1,972.	2,095.	2,565.
	36"	84"	1 1/2"	RDTDCST(L/R)8436() () () ()	1,762.	1,997.	2,128.	2,628.
	36"	90"	1 1/2"	RDTDCST(L/R)9036() () () ()	1,785.	2,022.	2,162.	2,694.
	36"	96"	1 1/2"	RDTDCST(L/R)9636() () () ()	1,807.	2,049.	2,195.	2,760.

Order Code	Specification Information	Application Notes
Example: RDTDCST6630 () () ()	<i>To order please specify pattern number including:</i>	It is not advisable to mix 28 3/8" desk height product with 26 1/2" standard height products.
R Reff	1. Left or Right hand	Products on this page work with 28 3/8" height planning.
DT D-Shaped top	2. Grommet option: M=Mid. grommet location N=No grommet S=Stand-off location SM=Stand-off plus grommet SD=Drop in electrical cutout & no grommet SDR=Drop in electrical cutout & end grommet, RH SDL=Drop in electrical cutout & end grommet, LH	Products on this page will accept woodgrain laminate where laminate is currently an option.
D 1 1/2" Thick Square Edge	Note: Please order electric for the following options; SD, SDR and SDL.	Worksurface stiffeners, recommended to provide additional support for open spans greater than 48" w.
C Column Leg	3. Grommet finish: Painted or Plated where applicable. N & SD have no finish option.	Upcharges apply to legs with P2, P3 and P4 finishes. Additional upcharges: Leg Finish Add P2 \$35 P3 \$50 P4 \$150
ST Stand-Off	4. Top finish: L, V1, V2, V3	Peninsula worksurfaces with power center do not come with Electrical Components.
66 Width	5. Edge finish: L, V1, V2, V3 (Edge options are available on laminate tops only.)	For electrical components please refer to page 399.
30 Depth	6. Leg finish: Painted or Plated	Modesty sold separately and can be field installed.
N Grommet Option	7. Stand-off finish: Painted	Wire chase sold separately.
115 Grommet Finish		Refer to Peninsula Planning Guidelines for location option.
V316 Worksurface Finish		From users perspective, if the leg is on the right side, the peninsula is classified a "Right Hand" peninsula.
() Edge finish		
115 Leg Finish		
115 Stand-Off Finish		

*Worksurface with Column Leg
Flush Mount Attachment, D top, Square Edge*

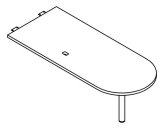
description	d	w	th	pattern no.	L	M/V1	V2	V3
 <p>Left hand shown</p>	30"	54"	1 1/2"	RDTDCFM(L/R)5430 () () ()	\$1,460.	\$1,653.	\$1,730.	\$2,026.
	30"	60"	1 1/2"	RDTDCFM(L/R)6030 () () ()	1,517.	1,720.	1,802.	2,128.
	30"	66"	1 1/2"	RDTDCFM(L/R)6630 () () ()	1,536.	1,740.	1,831.	2,184.
	30"	72"	1 1/2"	RDTDCFM(L/R)7230 () () ()	1,562.	1,769.	1,867.	2,247.
	30"	78"	1 1/2"	RDTDCFM(L/R)7830 () () ()	1,581.	1,792.	1,896.	2,304.
	30"	84"	1 1/2"	RDTDCFM(L/R)8430 () () ()	1,606.	1,819.	1,933.	2,369.
	36"	54"	1 1/2"	RDTDCFM(L/R)5436 () () ()	1,498.	1,697.	1,787.	2,128.
	36"	60"	1 1/2"	RDTDCFM(L/R)6036 () () ()	1,558.	1,765.	1,862.	2,236.
	36"	66"	1 1/2"	RDTDCFM(L/R)6636 () () ()	1,580.	1,791.	1,896.	2,301.
	36"	72"	1 1/2"	RDTDCFM(L/R)7236 () () ()	1,608.	1,823.	1,937.	2,374.
	36"	78"	1 1/2"	RDTDCFM(L/R)7836 () () ()	1,632.	1,849.	1,971.	2,441.
	36"	84"	1 1/2"	RDTDCFM(L/R)8436 () () ()	1,653.	1,873.	2,004.	2,504.

Order Code	Specification Information	Application Notes
Example: RDTDCFM5430 () () ()	<i>To order please specify pattern number including:</i>	It is not advisable to mix 28 3/8" h desk height product with 26 1/2" h standard height products.
R Reff	1. Grommet option: N=None M=Middle	Products on this page work with 28 3/8" height planning.
DT P-Shapped top	2. Grommet finish: Painted or Plated	Products on this page will accept woodgrain laminate where laminate is currently an option.
D 1 1/2" Thick Square Edge	3. Worksurface finish: L, V1, V2, V3	Worksurface stiffeners, recommended to provide additional support for open spans greater than 48" w.
C Column Leg	4. Edge finish: L, V1, V2, V3 (Edge options are available on laminate tops only.)	Upcharges apply to legs with P2, P3 and P4 finishes. Additional upcharges;
FM Flush Mount Attachment Plate	5. Leg finish: Painted or Plated	Leg Finish Add P2 \$35 P3 \$50 P4 \$150
54 Width		Peninsula worksurfaces with power center do not come with Electrical Components.
30 Depth		For electrical components please refer to page 399.
M Grommet Option		Modesty sold separately and can be field installed.
115 Grommet Finish		Wire chase sold separately.
V316 Worksurface Finish		Refer to grommet page for location option.
() Edge finish		From users perspective, if the leg is on the right side, the peninsula is classified a "Right Hand" peninsula.
115 Leg Finish		

Reff Profiles Tables are freestanding worksurface solutions for private and open office planning as well as meeting and activity spaces. Reff Profiles offers a variety of types of tables which have differing aesthetics and functionality. All of the tables in this section plan with desk height products and all are 28 $\frac{3}{8}$ " high measured to the underside of the worksurface.

Due to interference conditions, desk height storage which is 28 $\frac{3}{8}$ " high may not be placed under any tables.

Except where otherwise noted, worksurface stiffeners are required for support of 1 $\frac{1}{2}$ " thick table tops with spans greater than 54". The recommended stiffener is AWM1S.

Tables are divided into two basic types; four legged versions and center column versions.

The four legged versions are:

- Tables with Open Frame Legs*
- Tables with L-Legs
- Tables with Reverse L-Legs
- Tables with Soft Rectangular Legs
- Tables with Column Legs
- Mobile Tables
- Tables with 2x4 Legs
- Tables with 4x4 Legs

*Two open frame legs are used per table but are connected to the underside of worksurfaces in each of the four corners.

The center column versions are:

- Sliding Tables
- Height Adjustable Sliding Tables
- Column Base Tables
- Height Adjustable Column Base Tables

General Construction features – Four Legged Tables

All four legged tables have 1 $\frac{1}{2}$ " thick tops and square profile edges. Refer to Worksurface planning guide pages for tops construction details.

Hardware is supplied with the legs for field assembly to the worksurfaces. Unless otherwise indicated, legs are attached to the tops using wood screws. Tops and legs are shipped in separate packages.

Tables with Open Frame Legs

These tables are available in Rectangular top shapes.

Scope of nominal sizes:

Depths: 24", 30", 36"

Widths: 60", 66", 72", 78", 84"

Construction Details

Tables with open frame legs have two open frame supports which are positioned flush to the edge at both ends of the table. See **Figure 1**. Tables are supplied with required stiffener beams which connect with the top plates of the legs. Worksurfaces are supplied with pilot holes pre-drilled for threaded metal inserts. Legs are attached to the table top using machine screws supplied. Grommets are not available for these tables. Refer to installation instruction 6TP00441 available on Knoll Exchange.

The legs consist of four extruded aluminum frame members with mitered corners connected to two top plates of cast zinc alloy. See **Figure 2**. The frame members have a "T" shape which enables infill panels to be inserted flush to the face of the frame. Infill panels are available separately and installed in pairs.

The required stiffener beams are steel "hat" shapes which attach at each end to the top plates of the open frame legs and are also affixed to the under-side of the table top at regular intervals along the length of each stiffener.

Finish Details

Worksurface tops are available in all core laminates, wood grain laminates, mixed finish (laminated top with wood edges), and all core veneer finishes including synthetic edge options.

Open frame legs are available in all core paint finishes and anodized finishes. Leg top plates are painted to match the leg finish when core paint is selected. Leg top plates are plated to compliment the leg finish when anodized is selected.

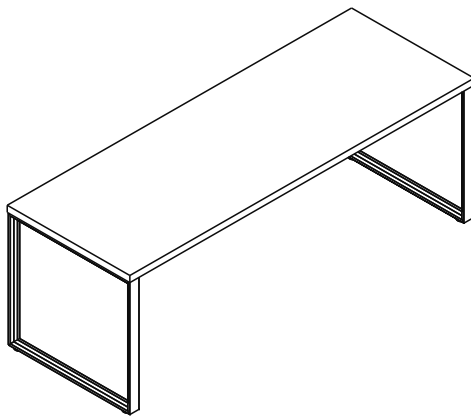

Figure 1: Open Frame Leg table

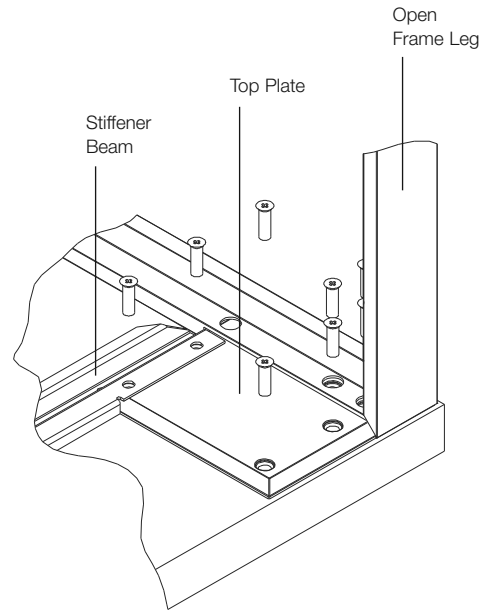

Figure 2: Detail of table corner with top plate

Tables with L-legs, Reverse L-legs and Soft Rectangular legs

These tables are available in Rectangular and Square top shapes.

Scope of Nominal Sizes

Rectangular sizes:

- 30"D x 48"W
- 30"D x 60"W
- 30"D x 72"W
- 36"D x 72"W

Square sizes:

- 42"D x 48"W
- 48"D x 48"W

Grommet Options

These tables are offered with four grommet options for use with three types of electrical power and data outlets.

Grommet types are:

NG – No grommet

PE – Power center; cast grommet sleeve and hinged lid included with the table; suitable for use with under-mounted electrical outlets*

2E – Table drop-in electrical unit; a cutout is provided for a 4 position table drop-in electrical outlet*

3E – Table drop-in electrical unit; a cutout is provided for a 6 position table drop-in electrical outlet*

*All electrical outlets are offered separately. Refer to the Accessories – Power & Data section for available options.

Ex. 2E = Cutout for 4 position table drop-in electrical outlet located at one end of the table

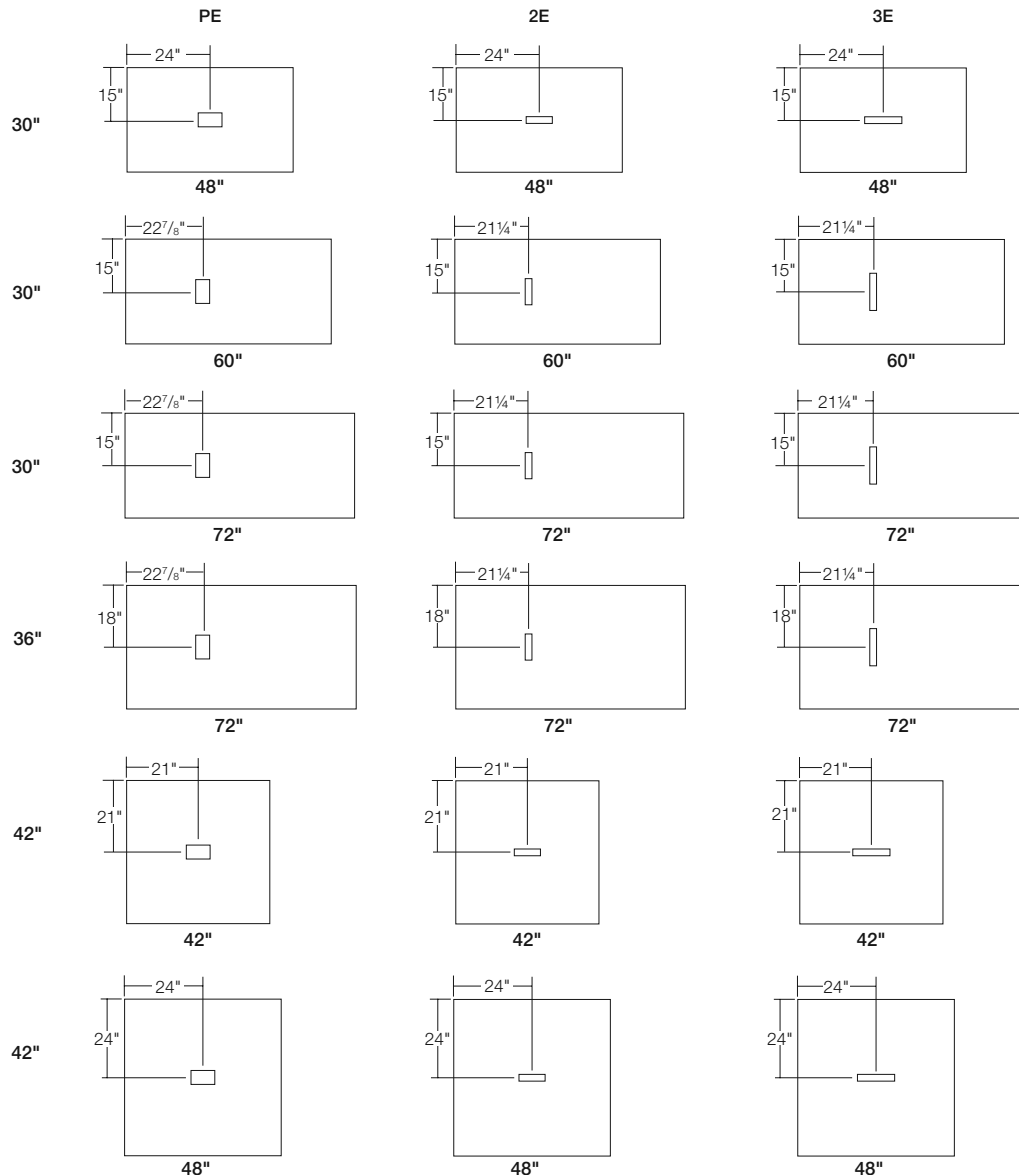

Figure 1: Grommet Locations

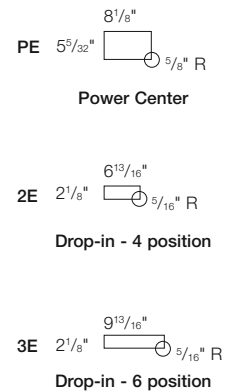

Figure 2: Cut-out Sizes

Tables with L-legs, Reverse L-legs and Soft Rectangular legs, cont'd.

Construction Details

Tables with L, Reverse-L and Soft Rectangular legs have four legs which are positioned flush to the edge of the four corners of the table.

See **Figure 2**. L and Reverse-L legs are not handed. The Soft Rectangular legs are handed; 2-LH and 2-RH. Worksurfaces are supplied with pilot holes pre-drilled to help center the legs in their design positions. Legs are attached to the table top using wood screws supplied.

Each leg consists of an extruded aluminum vertical support, factory connected to a cast zinc alloy top plate assembly. See **Figure 3**. The L-leg and Reverse-L leg are 3" x 3" x 7/8" thick. The Soft rectangular leg is 2" x 3". The top plate assembly is 5 1/2" x 5 1/2" x 3/16" thick.

Each leg is supplied with a black 1 1/8" diameter glide which provides 3/4" of height adjustability.

Finish Details

Worksurface tops are available in all core laminates, wood grain laminates, mixed finish (laminated top with wood edges), and all core veneer finishes including synthetic edge options.

L, Reverse-L and Soft Rectangular legs are available in all core paint finishes and anodized finishes. Leg top plates are painted to match the leg finish when core paint is selected. Leg top plates are plated to compliment the leg finish when anodized is selected.

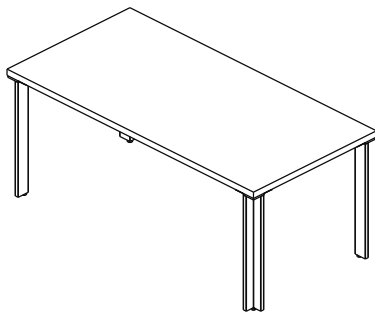

L-Leg Table

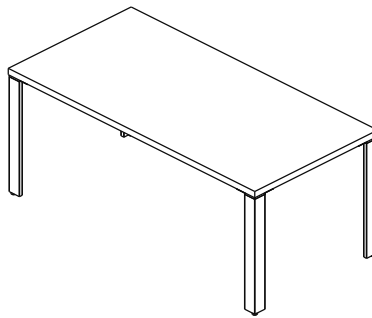

Reverse L-Leg Table

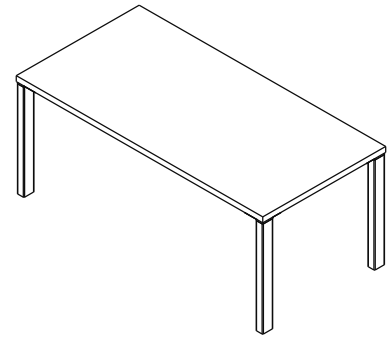

Soft Rectangular Leg Table

Figure 2: Table Styles

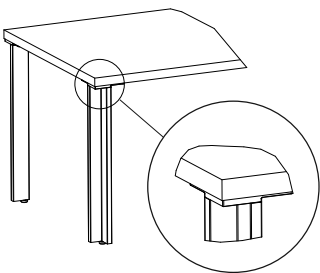

L-Leg

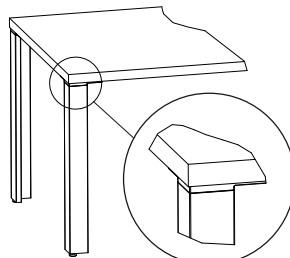

Reverse L-Leg

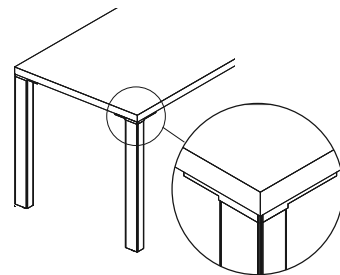

Soft Rectangular Leg

Figure 3: Detail of Table Corners with Top Plate

Tables with Column Legs

These tables are available in Round, Square, Rectangular and Racetrack top shapes. See **Figure 1**.

Scope of nominal sizes

Round sizes:

- 42" Diameter
- 48" Diameter

Square sizes:

- 36"D x 36"W
- 42"D x 48"W
- 48"D x 48"W

Rectangular sizes:

- 36"D x 72"W
- 42"D x 84"W
- 48"D x 96"W

Racetrack sizes:

- 36"D x 72"W
- 42"D x 84"W
- 48"D x 96"W

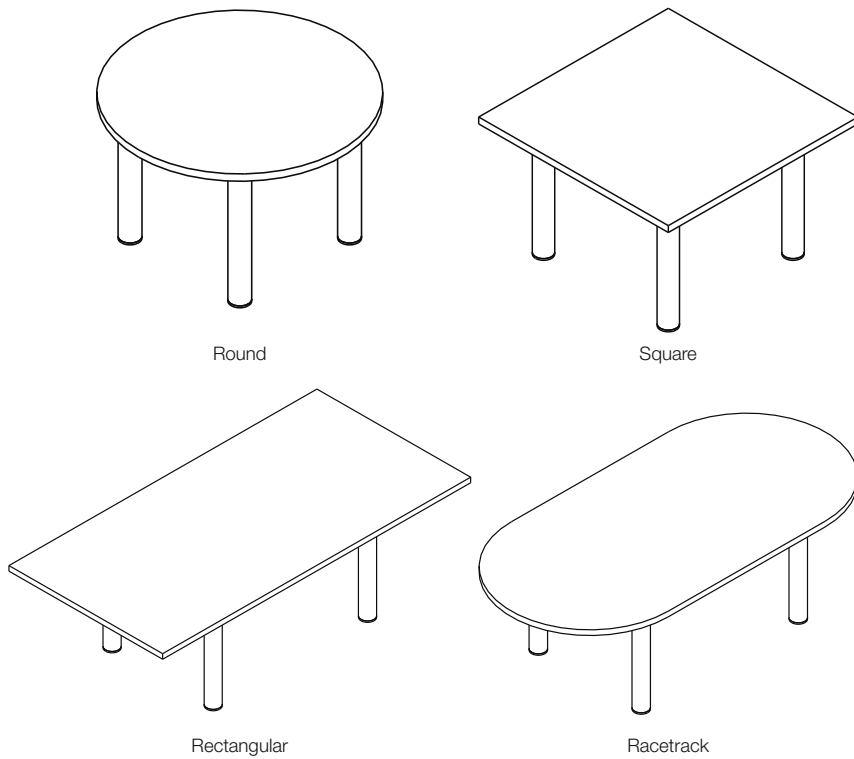

Figure 1: Column Leg Tables

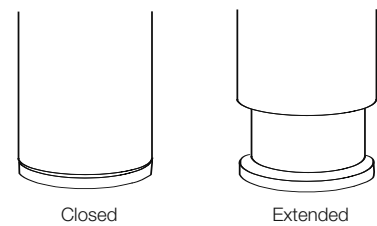

Figure 2: Column Leg glide detail

Tables with Column Legs, cont'd.

Construction Details

Tables with Column legs have four legs which are positioned inset from the edges of the table. See **Figure 3**. Column legs are not handed. Grommets are not available for these tables. Contact Custom Product Development if grommets are required.

Worksurfaces are supplied with pilot holes pre-drilled to help center the legs in their design positions. Legs are attached to the table top using wood screws supplied.

Each leg consists of round steel vertical support, factory connected to a steel top plate assembly. The diameter of the leg is dependent upon the top size selected:

- 36" diameter and 36" deep tops come with 2 1/2" diameter legs.
- 42" diameter and 42" deep tops come with 3" diameter legs.
- 48" diameter and 48" deep tops come with 4" diameter legs.

The top plate assembly is 7 1/2" x 7 1/2" x 3/16" thick.

Each leg is supplied with a cast glide that is the same diameter as the leg. See **Figure 2** (previous page). The glide provides 2 1/4" of height adjustability.

Finish Details

Worksurface tops are available in all core laminates, wood grain laminates, mixed finish (laminated top with wood edges), and all core veneer finishes including synthetic edge options.

Column legs are available in all core paint finishes and plated finishes. Leg top plates are painted black. The leg glides are finished the same color as the leg.

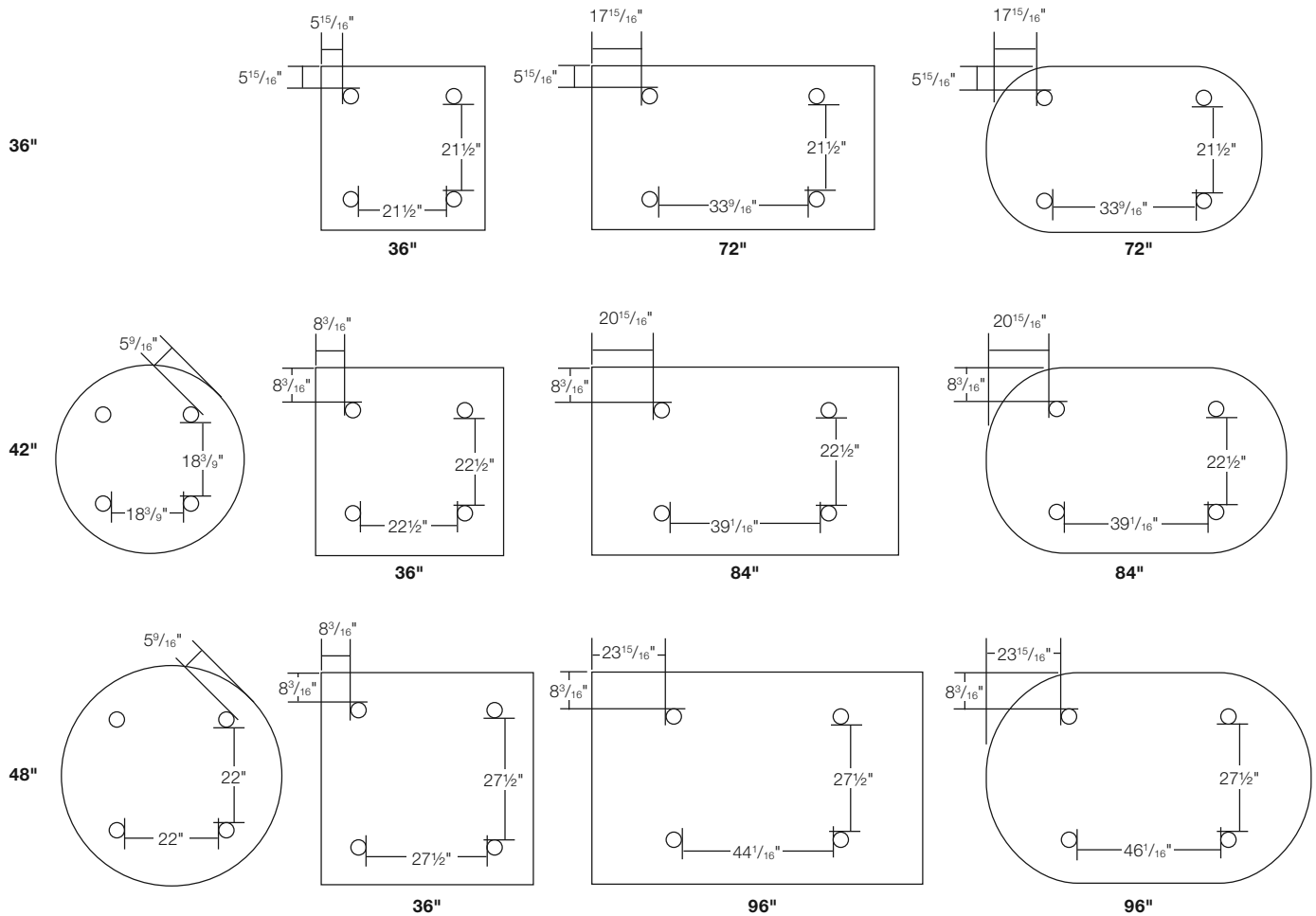

Figure 3: Leg Locations for Column Leg Tables

Mobile Tables

These tables are available in Round, Square, and Rectangular top shapes. **See Figure 1.**

Scope of nominal sizes:

Round sizes:

- 36" Diameter
- 42" Diameter
- 48" Diameter

Square sizes:

- 42"D x 48"W
- 48"D x 48"W

Rectangular sizes:

- 30"D x 48"W
- 30"D x 60"W
- 30"D x 72"W
- 36"D x 72"W

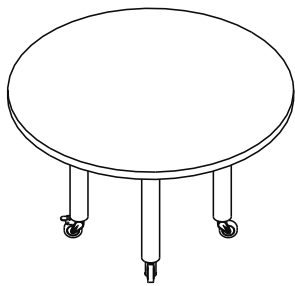

Round

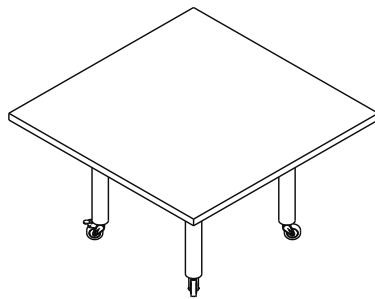

Square

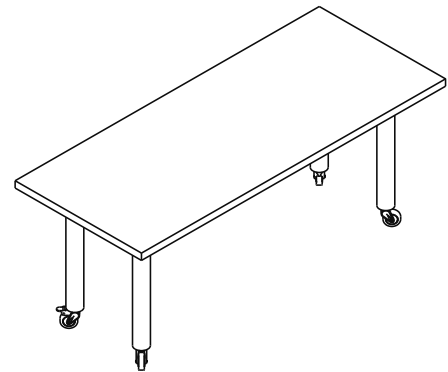

Rectangular

Figure 1: Mobile Tables

Mobile Tables, cont'd.

Construction Details

Mobile Tables have four round Column legs with casters, which are positioned inset from the edges of the table. See **Figure 2**. The castors are swivel type; two are provided with wheel brakes. Grommets are not available for these tables. Contact Custom Product Development if grommets are required. Worksurfaces are supplied with pilot holes pre-drilled to help center the legs in their design positions. Legs are attached to the table top using wood screws supplied.

Each leg consists of a round steel vertical support, factory connected to a steel top plate assembly. The legs are 3" diameter. The top plate assembly is 7 1/2" x 7 1/2" x 3/16" thick.

Castors have polyurethane wheels with thread guards. Each castor is rated for 120 lbs.

The table height is 28 3/8" to the underside of the 1 1/2" thick top. There is no height adjustability on Mobile Tables.

Finish Details

Worksurface tops are available in all core laminates, wood grain laminates, mixed finish (laminated top with wood edges), and all core veneer finishes including synthetic edge options.

Column legs are available in all core paint finishes and plated finishes. Leg top plates are painted black. The castors are black.

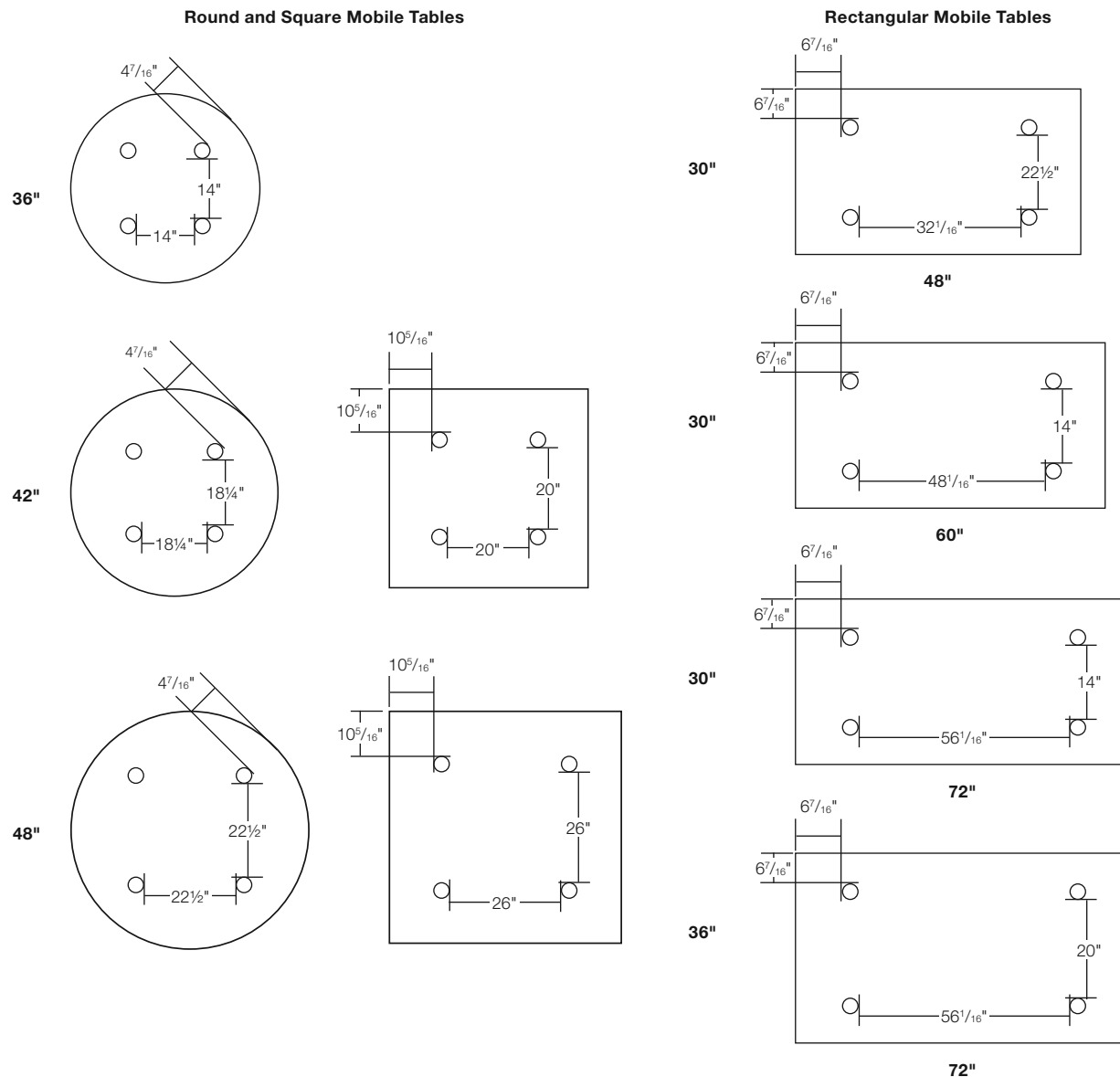

Figure 2: Leg Locations

Tables with 2x4 Legs

Tables with 2x4 Legs are versatile meeting tables offering a vast selection of power and communications functionality and aesthetic diversity. Options for power and communications include several configurations; power center grommets which elegantly conceal the outlets below the table surface or drop-in table outlets which provide outlets flush with the table top. All electrical outlets and cable management accessories are ordered separately. Table tops and legs may be specified in different finishes creating nearly unlimited aesthetic possibilities.

These tables are available with Rectangular top shapes.

Scope of nominal sizes:

Depths: 36", 42", 48"
Widths: 72", 78", 84", 90", 96"

Grommet Options

Tables with 2x4 Legs are offered with four grommet types in three location configurations. Grommet option code is made up of the combination of the grommet type and the grommet location.

Grommet types are:

NG – No grommet

P – Power center; cast grommet sleeve and hinged lid included with the table; suitable for use with under-mounted electrical outlets*

2 – Table drop-in electrical unit; a cutout is provided for a 4 position table drop-in electrical outlet*

3 – Table drop-in electrical unit; a cutout is provided for a 6 position table drop-in electrical outlet*

*All electrical outlets are offered separately. Refer to the Accessories – Power & Data section for available options.

Grommet locations are:

B – Both ends

C – Centered

E – One end

Ex. 2E = Cutout for 4 position table drop-in electrical outlet located at one end of the table, see **Figure 1**. Refer to Tables with L-legs, **Figure 2**, for cut-out sizes.





No Grommet	 <p style="text-align: center;">NG</p>		
Power Center	 <p style="text-align: center;">PC</p>	 <p style="text-align: center;">22 7/8" PE</p>	 <p style="text-align: center;">22 7/8" PB</p>
2+2 Drop-In	 <p style="text-align: center;">2C</p>	 <p style="text-align: center;">21 1/4" 2E</p>	 <p style="text-align: center;">21 1/4" 2B</p>
3+3 Drop-In	 <p style="text-align: center;">3C</p>	 <p style="text-align: center;">21 1/4" 3E</p>	 <p style="text-align: center;">21 1/4" 3B</p>

Figure 1: Grommet Options Matrix

Tables with 2x4 Legs, cont'd.

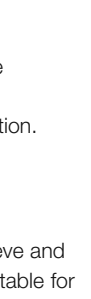
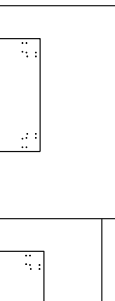
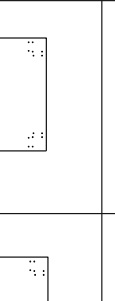
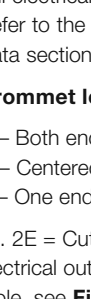
Construction Details

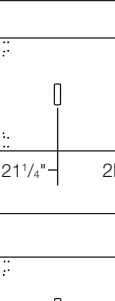
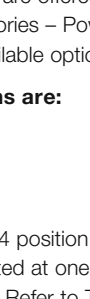
Tables with 2 x 4 legs have four legs which are positioned flush to the edges at the corners of the table. The legs are connected to a substructure which is integral to the table. The substructure consists of four peripheral rails which form the table skirt. The legs are field connected to the table skirt with a cast top plate at each corner. Triangular corner brackets provide further reinforcement and a connection point for the substructure to the table top.

L-brackets provide further connection points between the substructure and the table top. See **Figure 2**. No auxiliary stiffeners are required to reinforce the worksurface. Worksurfaces are supplied with pilot holes pre-drilled to locate the wood screws used to attach the worksurface to the substructure. Refer to installation instruction 6TP00385 available on Knoll Exchange.

The table skirt is an extruded aluminum profile; inset 2" from the long edge and 3" from the short edge. The skirt rails are 2" high x 1" deep.

The legs are constructed of a 2" x 4 1/2" extruded aluminum profile, factory connected to top plates of cast zinc alloy. The leg top plate creates a 1/8" thick reveal between the top of the leg and the bottom of the worksurface. A glide at the base of each leg provides 1 1/2" of height adjustability.

Corner brackets and L-brackets are formed steel.

Finish Details

Worksurface tops are available in all core laminates, wood grain laminates, mixed finish (laminated top with wood edges), and all core veneer finishes including synthetic edge options.

Legs may be specified in all core paint finishes or in wood veneer finishes. When specified with a wood veneer finish, the leg finish must match the worksurface finish. Contact Custom Product Development if the wood veneer finish of the legs is desired to be a different wood veneer finish than the top.

The skirt finish defaults to the leg finish.

The leg reveal may be any core paint finish.

Corner brackets and L-brackets are supplied black.

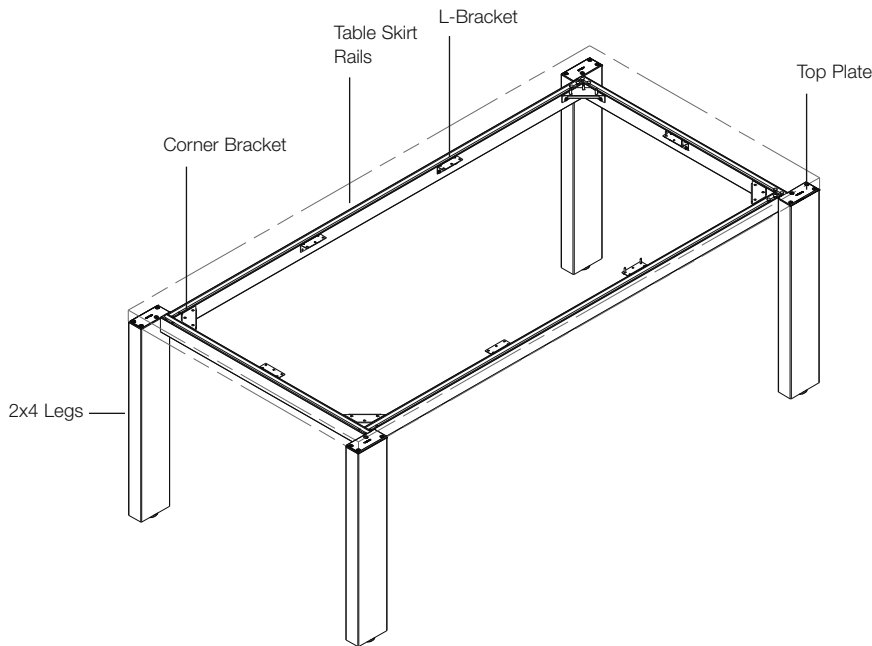

Figure 2: Table Elements

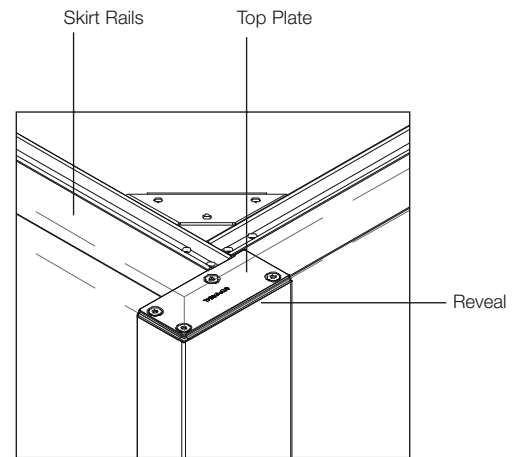

Figure 3: Table Corner

Tables with 4x4 Legs

Tables with 4x4 Legs are versatile meeting tables offering a vast selection of power and communications functionality and aesthetic diversity. Options for power and communications include several configurations; power center grommets which elegantly conceal the outlets below the table surface or drop-in table outlets which provide outlets flush with the table top. All electrical outlets and cable management accessories are ordered separately. Table tops and legs may be specified in different finishes creating nearly unlimited aesthetic possibilities.

These tables are available with Rectangular top shapes.

Scope of nominal sizes:

Depths: 36", 42", 48"

Widths: 72", 78", 84", 90", 96"

Grommet Options

Tables with 4x4 Legs are offered with four grommet types in three location configurations. Grommet option code is made up of the combination of the grommet type and the grommet location.

Grommet types are:

NG – No grommet

P – Power center; cast grommet sleeve and hinged lid included with the table; suitable for use with under-mounted electrical outlets*

2 – Table drop-in electrical unit; a cutout is provided for a 4 position table drop-in electrical outlet*

3 – Table drop-in electrical unit; a cutout is provided for a 6 position table drop-in electrical outlet*

*All electrical outlets are offered separately. Refer to the Accessories – Power & Data section for available options.

Grommet locations are:

B – Both ends

C – Centered

E – One end

Ex. 2E = Cutout for 4 position table drop-in electrical outlet located at one end of the table.

See **Figure 1**, Tables with 2x4 Legs, for grommet options matrix.

See **Figure 2**, Tables with L-legs, for grommet cut-out sizes.

Tables with 4x4 Legs, cont'd.

Construction Details

Tables with 4 x 4 legs have four legs which are positioned flush to the edges at the corners of the table. The legs are connected to a substructure which is integral to the table. The substructure consists of four diagonal rails which join four interior rails using cast Y-connectors. See **Figure 2**. The legs are field connected to the table substructure with a cast top plate at each corner. No auxiliary stiffeners are required to reinforce the worksurface. Worksurfaces are supplied with pilot holes pre-drilled to locate the wood screws used to attach the worksurface to the substructure. Refer to installation instruction 6TP00384 available on Knoll Exchange.

The table substructure rails are an extruded aluminum profile; 2" high x 1" deep. There is a 1/8" gap between the top of the rails and the underside of the worksurface.

The legs are constructed of a 4" x 4" extruded aluminum profile, factory connected to top plates of cast zinc alloy. The leg top plate creates a 1/8" thick reveal between the top of the leg and the bottom of the worksurface. A glide at the base of each leg provides 1 1/2" of height adjustability.

Finish Details

Worksurface tops are available in all core laminates, wood grain laminates, mixed finish (laminated top with wood edges), and all core veneer finishes including synthetic edge options.

Legs may be specified in all core paint finishes or in wood veneer finishes. When specified with a wood veneer finish, the leg finish must match the worksurface finish. Contact Custom Product Development if the wood veneer finish of the legs is desired to be a different wood veneer finish than the top.

The substructure is painted and defaults to the leg reveal color.

The leg reveal may be any core paint finish.

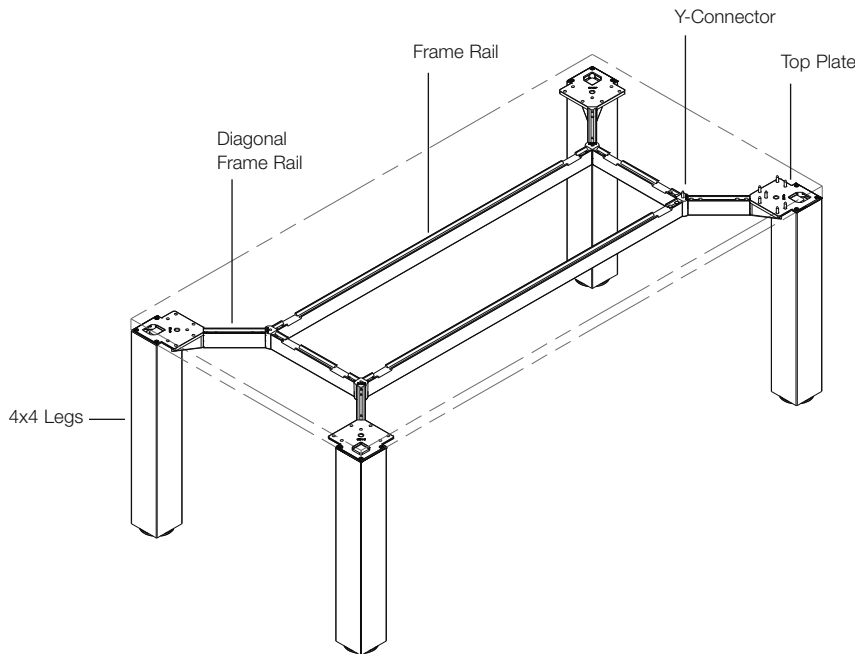

Figure 2: Table Elements

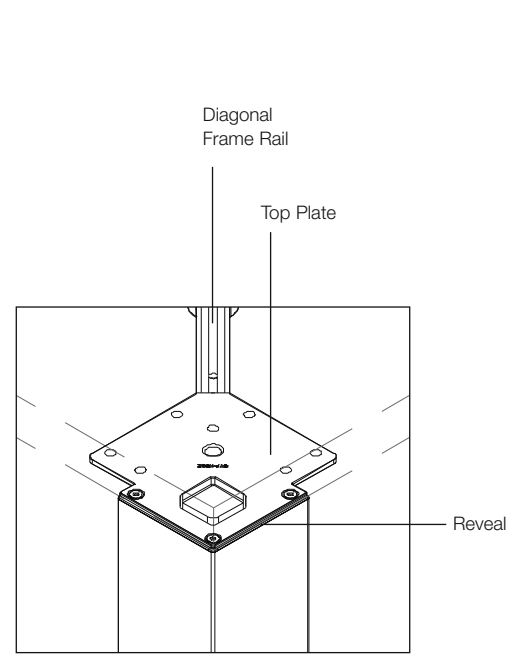

Figure 3: Table Corner

Tables with Open Frame Leg

Rectangular, 1 1/2" thick

description	d	w	th	pattern no.	L	M/V1	V2	V3
Table Top Rectangle 24" Deep with 28 3/8" height leg	24"	60"	1 1/2"	RTRDOF60242() ()	\$1,731.	\$1,842.	\$2,064.	\$2,380.
	24"	66"	1 1/2"	RTRDOF66242() ()	1,716.	1,889.	2,120.	2,464.
	24"	72"	1 1/2"	RTRDOF72242() ()	1,786.	1,902.	1,805.	2,492.
	24"	78"	1 1/2"	RTRDOF78242() ()	1,812.	1,959.	2,202.	2,601.
	24"	84"	1 1/2"	RTRDOF84242() ()	1,829.	2,005.	2,255.	2,681.

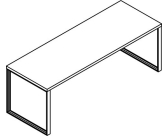

Table Top Rectangle 30" Deep with 28 3/8" height leg	30"	60"	1 1/2"	RTRDOF60302() ()	1,823.	1,921.	2,160.	2,533.
	30"	66"	1 1/2"	RTRDOF66302() ()	1,864.	1,971.	2,219.	2,625.
	30"	72"	1 1/2"	RTRDOF72302() ()	1,884.	1,986.	2,266.	2,704.
	30"	78"	1 1/2"	RTRDOF78302() ()	1,913.	2,051.	2,314.	2,784.
	30"	84"	1 1/2"	RTRDOF84302() ()	1,932.	2,112.	2,385.	2,886.

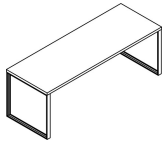
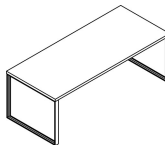



Table Top Rectangle 36" Deep with 28 3/8" height leg	36"	60"	1 1/2"	RTRDOF60362() ()	1,854.	1,979.	2,232.	2,660.
	36"	66"	1 1/2"	RTRDOF66362() ()	1,897.	2,035.	2,299.	2,764.
	36"	72"	1 1/2"	RTRDOF72362() ()	1,920.	2,079.	2,351.	2,853.
	36"	78"	1 1/2"	RTRDOF78362() ()	1,952.	2,123.	2,404.	2,944.
	36"	84"	1 1/2"	RTRDOF84362() ()	1,974.	2,177.	2,469.	3,044.



Order Code	Specification Information	Application Notes
Example: RTRDOF60242	<i>To order please specify pattern number including:</i>	It is not advisable to mix 28 3/8" h desk height product with 26 1/2" h standard height products.
R Reff	1. Worksurface finish L, V1, V2, V3	
TR Table Rectangular	2. Edge finish: L, V1, V2, V3 (Edge options are available on laminate tops only.)	Table height = 28 3/8" h to the underside of worksurface.
D 1 1/2"	3. Open Frame Leg finish Painted and Anodized	Product on this page will accept woodgrain laminate where laminate is currently an option.
OF Open Frame Leg	Upcharges apply to legs with P2, P3 and P4 finishes.	Grommets are NOT optional for these tables.
60 Width	Additional upcharges;	
24 Depth	LegFinish Add	The tables on this page, will come with appropriate stiffener support.
2 28 3/8" height leg	P2 \$120	Modesty sold separately.
V316 Finish	P3 \$180	For infill options please refer to page 75.
() Edge finish	P4 for 20" & 24" d legs; \$700	Assembly required, ships knock down.
111 Leg Finish	for 30" & 36" d legs; \$900	

Open Frames legs Infill Options for Tables and Peninsulas, 28³/₈" High

description	h	d	pattern no.	L	V1	V2	V3	glass
*Inside Infill Options for Open Frame Legs For Tables and Peninsulas, 28 ³ / ₈ " h 	26"	20"	RIPI202()	\$316.	\$409.	\$472.	\$612.	
	26"	24"	RIPI242()	324.	420.	483.	629.	
	26"	30"	RIPI302()	341.	442.	507.	661.	
	26"	36"	RIPI362()	362.	469.	538.	700.	

*Outside Infill Options for Open Frame Legs For Tables and Peninsulas, 28 ³ / ₈ " h 	27"	20"	RIPO202()	317.	411.	473.	614.	
	27"	24"	RIPO242()	325.	422.	485.	630.	
	27"	30"	RIPO302()	343.	445.	510.	664.	
	27"	36"	RIPO362()	363.	470.	540.	702.	

*Outside Glass Infill Options for Open Frame Legs For Tables and Peninsulas, 28 ³ / ₈ " h 	27"	20"	RIPOG202()					816.
	27"	24"	RIPOG242()					920.
	27"	30"	RIPOG302()					1,082.
	27"	36"	RIPOG362()					1,248.

Order Code	Specification Information	Application Notes
Example: RIPI242 ()	<i>To order please specify pattern number including:</i>	It is not advisable to mix 28 ³ / ₈ "h desk height product with 26 ¹ / ₂ "h standard height products.
R Reff Profiles	1. Finish: L, V1,V2,V3, Glass	Product on this page will accept woodgrain laminate where laminate is currently an option.
IP Infill Panel	I=Inside	All noted dimensions are nominal.
I Inside Infill	O=Outside	Both Inside and Outside infill panels are required and must be ordered separately.
24 Width	OG=Outside Glass	Installation instruction sheets available on Knoll Exchange. Reference number 6TP00307.
2 28 ³ / ₈ "h: Desk Height	Glass options: GL11, GL14, GL15, GL17, GL18	* Note: the infills for the open frame leg Peninsula and Tables are interchangeable, as of July 17, 2012.
() Finish		For replacement infills, prior July 17th, contact your account manager.
		Infills; fill entire opening of open frame legs.
		Infills connect to each other. Can be removed without any damage to the frame legs.
		Glass Option is only available for outside infill.
		Inside infill options are wood or laminate.

Tables with L-Legs

Rectangular and Square

description	d	w	th	pattern no.	L	M/V1	V2	V3
Table Top Rectangle 30" Deep with 28 ³ / ₈ " height leg	30"	48"	1 1/2"	RTRDL48302 () () ()	\$1,449.	\$1,695.	\$1,904.	\$1,964.
	30"	60"	1 1/2"	RTRDL60302 () () ()	1,514.	1,792.	2,018.	2,082.
	30"	72"	1 1/2"	RTRDL72302 () () ()	1,580.	1,855.	2,096.	2,218.

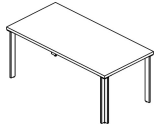

Table Top Rectangle 36" Deep with 28 ³ / ₈ " height leg	36"	72"	1 1/2"	RTRDL72362 () () ()	1,654.	1,923.	2,179.	2,364.
--	-----	-----	--------	-------------------------------	--------	--------	--------	--------

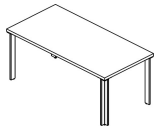
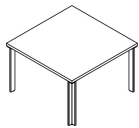

Table Top Square with 28 ³ / ₈ " height legs	42"	42"	1 1/2"	RTSDL42422 () () ()	1,507.	1,749.	1,971.	2,025.
	48"	48"	1 1/2"	RTSDL48482 () () ()	1,602.	1,835.	2,210.	2,527.



Order Code	Specification Information	Application Notes								
Example: RTRDL48301 () ()	<p><i>To order please specify pattern number including:</i></p> <ol style="list-style-type: none"> Grommet option: PE = Power center plus end grommet 2E = 2 + 2 Drop in electrical unit end 3E = 3 + 3 Drop in electrical unit end Grommet finish: PE = Painted or plated 2E, 3E = Drilled location only, finish not applicable Worksurface finish L, V1, V2, V3 Edge finish: L, V1, V2, V3 (Edge options are available on laminate tops only.) Leg finish Painted / Anodized 	<p>It is not advisable to mix 28³/₈"h desk height product with 26¹/₂"h standard height products.</p> <p>Table height = 28³/₈"h to the underside of worksurface.</p> <p>Product on this page will accept woodgrain laminate where laminate is currently an option.</p> <p>Assembly required, ships knock down.</p> <p>Worksurface stiffeners, recommended to provide additional support for open spans greater than 48" w.</p> <p>Upcharges apply to legs with P2, P3 and P4 finishes. Additional upcharges:</p> <table border="0"> <tr> <td>Leg Finish</td> <td>Add</td> </tr> <tr> <td>P2</td> <td>\$100</td> </tr> <tr> <td>P3</td> <td>\$160</td> </tr> <tr> <td>P4</td> <td>\$400</td> </tr> </table>	Leg Finish	Add	P2	\$100	P3	\$160	P4	\$400
Leg Finish			Add							
P2			\$100							
P3			\$160							
P4			\$400							
R Reff				When ordering: Power center grommets (PE), upcharges apply for: - lids and sleeves = \$144. - undermount wire basket kit = \$93						
TR Table Rectangular TS = Table Square				Grommet options; 2E and 3E are drilled options only.						
D 1 1/2"				Products on this page do not include electrical components. For electrical components, see page 403.						
L L-Leg				Modesty sold separately.						
48 Width				Installation instruction sheets available on Knoll Exchange. Refer to reference number 6TP00388, for drop in electrical.						
30 Depth										
2 28 ³ / ₈ " height										
PE Grommet option										
111 Grommet finish										
V316 Finish										
() Edge finish										
111 Leg Finish										

Tables with Reverse L-Legs Rectangular and Square

description	d	w	th	pattern no.	L	M/V1	V2	V3
Table Top Rectangle 30" Deep with 28 ³ / ₈ " height leg	30"	48"	1 1/2"	RTRDRL48302 () () ()	\$1,449.	\$1,695.	\$1,904.	\$1,964.
	30"	60"	1 1/2"	RTRDRL60302 () () ()	1,514.	1,792.	2,018.	2,082.
	30"	72"	1 1/2"	RTRDRL72302 () () ()	1,580.	1,855.	2,096.	2,218.

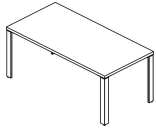

Table Top Rectangle 36" Deep with 28 ³ / ₈ " height leg	36"	72"	1 1/2"	RTRDRL72362 () () ()	1,654.	1,923.	2,179.	2,364.
--	-----	-----	--------	--------------------------------	--------	--------	--------	--------

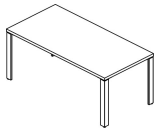
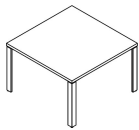

Table Top Square with 28 ³ / ₈ " height legs	42"	42"	1 1/2"	RTSDRL42422 () () ()	1,507.	1,749.	1,971.	2,025.
	48"	48"	1 1/2"	RTSDRL48482 () () ()	1,602.	1,835.	2,210.	2,527.



Order Code	Specification Information	Application Notes								
Example: RTRDRL48301 () () ()	<p><i>To order please specify pattern number including:</i></p> <ol style="list-style-type: none"> Grommet option: PE = Power center plus end grommet 2E = 2 + 2 Drop in electrical unit end 3E = 3 + 3 Drop in electrical unit end Worksurface finish: PE = Painted or plated 2E, 3E = Drilled location only, finish not applicable Worksurface finish L, V1, V2, V3 Edge finish: L, V1, V2, V3 (Edge options are available on laminate tops only.) Leg finish Painted / Anodized 	<p>It is not advisable to mix 28³/₈"h desk height product with 26 1/2"h standard height products.</p> <p>Table height = 28³/₈"h to the underside of worksurface.</p> <p>Product on this page will accept woodgrain laminate where laminate is currently an option.</p> <p>Assembly required, ships knock down.</p> <p>Worksurface stiffeners, recommended to provide additional support for open spans greater than 54"w.</p> <p>Upcharges apply to legs with P2, P3 and P4 finishes. Additional upcharges:</p> <table border="1"> <tr> <td>Leg Finish</td> <td>Add</td> </tr> <tr> <td>P2</td> <td>\$100</td> </tr> <tr> <td>P3</td> <td>\$160</td> </tr> <tr> <td>P4</td> <td>\$400</td> </tr> </table>	Leg Finish	Add	P2	\$100	P3	\$160	P4	\$400
Leg Finish			Add							
P2			\$100							
P3			\$160							
P4			\$400							
R Reff				<p>When ordering: Power center grommets (PE), upcharges apply for: - lids and sleeves = \$144. - undermount wire basket kit = \$93</p> <p>Grommet options; 2E and 3E are drilled options only.</p> <p>Products on this page do not include electrical components. For electrical components, see page 403.</p> <p>Modesty sold separately.</p> <p>Installation instruction sheets available on Knoll Exchange. Refer to reference number 6TP00388, for drop in electrical.</p>						
TR Table Rectangular TS = Table Square										
D 1 1/2"										
RL Reverse L-Leg										
48 Width										
30 Depth										
2 28 ³ / ₈ " height										
PE Grommet option										
111 Grommet finish										
V316 Finish										
() Edge finish										
111 Leg Finish										

Tables with Soft Rectangular Legs

Rectangular and Square

description	d	w	th	pattern no.	L	M/V1	V2	V3
Table Top Rectangle 30" Deep with 28 ³ / ₈ " height leg	30"	48"	1 1/2"	RTRDS48302 () () ()	\$1,567.	\$1,813.	\$2,076.	\$2,343.
	30"	60"	1 1/2"	RTRDS60302 () () ()	1,633.	1,910.	2,148.	2,522.
	30"	72"	1 1/2"	RTRDS72302 () () ()	1,697.	1,974.	2,225.	2,663.

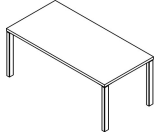

Table Top Rectangle 36" Deep with 28 ³ / ₈ " height leg	36"	72"	1 1/2"	RTRDS72362 () () ()	1,572.	1,835.	2,083.	2,584.
--	-----	-----	--------	-------------------------------	--------	--------	--------	--------

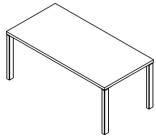
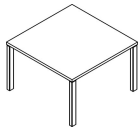

Table Top Square with 28 ³ / ₈ " height legs	42"	42"	1 1/2"	RTSDS42422 () () ()	1,625.	1,867.	2,100.	2,460.
	48"	48"	1 1/2"	RTSDS48482 () () ()	1,729.	1,954.	2,208.	2,657.



Order Code

Example:	RTRDS48301 () () ()
R	Reff
TR	Table Rectangular TS = Table Square
D	1 1/2"
S	Soft Rectangular Leg
48	Width
30	Depth
2	28 ³ / ₈ " height
PE	Grommet option
111	Grommet finish
V316	Finish
()	Edge finish
111	Leg Finish

Specification Information

- To order please specify pattern number including:*
- Grommet option:
PE = Power center plus end grommet
2E = 2 + 2 Drop in electrical unit end
3E = 3 + 3 Drop in electrical unit end
 - Worksurface finish:
PE = Painted or plated
2E, 3E = Drilled location only, finish not applicable
 - Worksurface finish
L, V1, V2, V3
 - Edge finish: L, V1, V2, V3
(Edge options are available on laminate tops only.)
 - Leg finish
Painted / Anodized

It is not advisable to mix 28³/₈"h desk height product with 26 1/2"h standard height products.

Table height = 28³/₈"h to the underside of worksurface.

Product on this page will accept woodgrain laminate where laminate is currently an option.

Assembly required, ships knock down.

Worksurface stiffeners, recommended to provide additional support for open spans greater than 54"w.

Upcharges apply to legs with P2, P3 and P4 finishes.

Additional upcharges;

Leg Finish	Add
P2	\$100
P3	\$160
P4	\$400

Application Notes

When ordering: Power center grommets (PE), upcharges apply for:
- lids and sleeves = \$144.
- undermount wire basket kit = \$93

Grommet options; 2E and 3E are drilled options only.

Products on this page do not include electrical components. For electrical components, see page 403.

Modesty sold separately.

Installation instruction sheets available on Knoll Exchange. Refer to reference number 6TP00388, for drop in electrical.

Tables with Column Legs

Round, Square, Rectangular and Racetrack

description	d	w	th	pattern no.	L	M/V1	V2	V3
Table Top Round with 28 ³ / ₈ " height legs	42"		1 1/2"	RTNDC422 () () ()	\$1,610.	\$2,335.	\$2,569.	\$3,339.
	48"		1 1/2"	RTNDC482 () () ()	1,774.	2,573.	2,830.	3,679.



Table Top Square with 28 ³ / ₈ " height legs	36"	36"	1 1/2"	RTSDC362 () ()	1,306.	1,502.	1,652.	2,148.
	42"	42"	1 1/2"	RTSDC422 () ()	1,429.	1,643.	1,807.	2,349.
	48"	48"	1 1/2"	RTSDC482 () ()	1,653.	1,901.	2,091.	2,718.

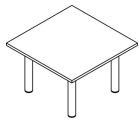

Table Top Rectangular with 28 ³ / ₈ " height legs	36"	72"	1 1/2"	RTRDC72362 () ()	1,543.	1,774.	1,952.	2,538.
	42"	84"	1 1/2"	RTRDC84422 () ()	1,746.	2,007.	2,208.	2,870.
	48"	96"	1 1/2"	RTRDC96482 () ()	2,031.	2,335.	2,569.	3,339.

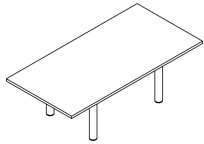
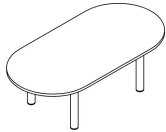

Table Top Racetrack with 28 ³ / ₈ " height legs	36"	72"	1 1/2"	RTTDC72362 () ()	1,714.	2,486.	2,735.	3,555.
	42"	84"	1 1/2"	RTTDC84422 () ()	1,873.	2,715.	2,987.	3,883.
	48"	96"	1 1/2"	RTTDC96482 () ()	2,096.	3,039.	3,344.	4,346.



Order Code	Specification Information	Application Notes
Example: RTNDC361 () () ()	<i>To order please specify pattern number including:</i>	It is not advisable to mix 28 ³ / ₈ "h desk height product with 26 1/2" standard height products.
R Reff	1. Worksurface finish L, V1, V2, V3	Grommets are NOT optional for these tables.
TN Table Round	2. Edge finish: L, V1, V2, V3 (Edge options are available on laminate tops only.)	Modesty sold separately.
D 1 1/2"	3. Leg finish Painted / Plated	36"d tops come with 2 1/2" dia. legs. 42"d tops come with 3" dia. legs. 48"d tops come with 4" dia. legs.
C Column Leg	Upcharges apply to legs with P2, P3 and P4 finishes.	Product on this page will accept woodgrain laminate where laminate is currently an option.
36 Diameter	Additional upcharges;	Assembly required, ships knock down.
2 28 ³ / ₈ " height leg	Leg Finish Add	
V316 Finish	P2 \$140	
() Edge finish	P3 \$200	
111 Leg Finish	P4 \$607	

Tables - Mobile

Rectangular, Square and Round

description	d	w	th	pattern no.	L	M/V1	V2	V3
Table Top Round with 28 ³ / ₈ "h	36"		1 1/2"	RTNDC364 () () ()	\$2,153.	\$2,366.	\$2,430.	\$2,627.
Column legs with casters	42"		1 1/2"	RTNDC424 () () ()	2,212.	2,457.	2,523.	2,778.
	48"		1 1/2"	RTNDC484 () () ()	2,290.	2,535.	2,620.	2,939.



Table Top Square, 42" and 48" Deep, with 28 ³ / ₈ "h Column legs with casters	42"	42"	1 1/2"	RTSDC42424 () () ()	1,743.	1,881.	1,968.	2,307.
	48"	48"	1 1/2"	RTSDC48484 () () ()	1,811.	1,955.	2,066.	2,485.



Table Top Rectangle, 30" Deep, with 28 ³ / ₈ "h Column legs with casters	30"	48"	1 1/2"	RTRDC48304 () () ()	1,705.	1,836.	1,910.	2,200.
	30"	60"	1 1/2"	RTRDC60304 () () ()	1,781.	1,919.	2,007.	2,358.
	30"	72"	1 1/2"	RTRDC72304 () () ()	1,832.	1,973.	2,077.	2,486.



Table Top Rectangle, 36" Deep, with 28 ³ / ₈ "h Column legs with casters	36	72"	1 1/2"	RTRDC72364 () () ()	1,884.	2,029.	2,151.	2,622.
---	----	-----	--------	-------------------------------	--------	--------	--------	--------



Order Code	Specification Information	Application Notes
Example: RTRDC48304 () ()	<i>To order please specify pattern number including:</i>	It is not advisable to mix 28 ³ / ₈ "h desk height product with 26 1/2" standard height products.
R Reff	1. Worksurface Finish: L, V1, V2, V3	Table height = 28 ³ / ₈ "h to the underside of worksurface.
TR Table Rectangular TS = Table Square TN = Table Round	2. Edge finish: L, V1, V2, V3 (Edge options are available on laminate tops only.)	Product on this page will accept woodgrain laminate where laminate is currently an option.
D 1 1/2"	3. Leg Finish: Painted and plated finishes	Worksurface stiffeners, recommended to provide additional support for open spans greater than 54"w.
C Column Leg	Upcharges apply to legs with P2, P3 and P4 finishes.	All column legs for the products on this page are 3" diameters.
48 width	Additional upcharges:	Castors are black, swivel type. Ships with 2 locking and 2 non-locking type.
30 depth	Leg Finish Add	Grommets and drilling are not an option for these tables.
4 28 ³ / ₈ " height leg with castor	P2 \$140	Assembly required, ships knock down.
V316 Worksurface Finish	P3 \$200	
() Edge finish	P4 \$607	
111 Leg Finish		

Tables with 2 x 4 Legs - 28³/₈"h

Rectangular

description	d	w	th	pattern no.	L	M/V1	V2	V3
Table Top Rectangle, 36" Deep with 28 ³ / ₈ " height legs	36"	72"	1 1/2"	RTM272362 () () () ()	\$2,218.	\$2,330.	\$2,423.	\$2,811.
	36"	78"	1 1/2"	RTM278362 () () () ()	2,237.	2,360.	2,460.	2,878.
	36"	84"	1 1/2"	RTM284362 () () () ()	2,277.	2,415.	2,523.	2,967.
	36"	90"	1 1/2"	RTM290362 () () () ()	2,303.	2,446.	2,559.	3,033.
	36"	96"	1 1/2"	RTM296362 () () () ()	2,322.	2,474.	2,596.	3,099.

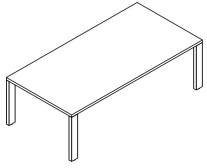
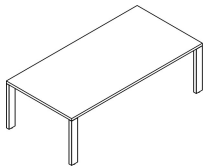

Table Top Rectangle, 42" Deep with 28 ³ / ₈ " height legs	42"	72"	1 1/2"	RTM272422 () () () ()	2,253.	2,388.	2,497.	2,936.
	42"	78"	1 1/2"	RTM278422 () () () ()	2,272.	2,422.	2,539.	3,010.
	42"	84"	1 1/2"	RTM284422 () () () ()	2,325.	2,516.	2,641.	3,143.
	42"	90"	1 1/2"	RTM290422 () () () ()	2,338.	2,550.	2,683.	3,216.
	42"	96"	1 1/2"	RTM296422 () () () ()	2,367.	2,584.	2,725.	3,290.



Order Code	Specification Information	Application Notes
Example: RTM272362 () () () ()	To order please specify pattern number including:	The tables on this page, come complete with structural frame. No additional stiffeners are required.
R Reff	1. Grommet Drilling Options: NG = no grommet PB = power center grommet both ends PC = power center grommet center * PE = power center grommet end *	Table's frame ships knockdown. Assembly required.
TM Table	2B = 2 + 2 Drop in electrical unit both ends 2C = 2 + 2 Drop in electrical unit center 2E = 2 + 2 Drop in electrical unit end 3B = 3 + 3 Drop in electrical unit both ends 3C = 3 + 3 Drop in electrical unit center 3E = 3 + 3 Drop in electrical unit end	For laminate tops (including wood grain laminate) leg finish options are: all core paint finishes only.
2 2 x 4 leg	2. Grommet Finish: NG = Finish not required PC, PE, PB = Painted and plated finishes 3C, 3E, 3B, 2C, 2E, 2B = Drilling location only, finish not applicable.	The product on this page will accept wood grain laminate where laminate is currently an option.
72 Width	3. Worksurface finish: L, V1, V2, V3	For veneer tops, leg finish options are: all core paint finishes or same wood veneer as the top. The prices indicated above, are for painted legs and no grommet.
36 Depth	4. Edge finish: L, V1, V2, V3 (Edge options are available on laminate tops only.)	Upcharges apply to legs with V1, V2 or V3 finishes. Additional upcharges;
2 28 ³ / ₈ " h leg	5. Leg finish: All core paint or veneer to match top, where applicable.	Leg Finish Add V1 \$2,529 V2 \$2,658 V3 \$3,229
PC Grommet option:	6. Leg reveal finish: All core paint options.	The apron finish always matches the leg finish.
PU Grommet finish		
V316 Worksurface Finish		
() Edge finish		
V316 Leg finish		
111 Leg reveal finish		

Table height = 2³/₈"h to the underside of worksurface.
Additional upcharges;

* Upcharges apply for the following power center grommets.

Grommet	Add
PB	\$288
PC	\$144
PE	\$144

Power center grommets (lids and sleeves) are included when PB, PC and PE are selected.

Products on this page do not include electrical components. For electrical components refer to page 403.

Installation instruction sheets available on Knoll Exchange. Refer to reference number 6TP00385.

Tables with 2 x 4 Legs - 28³/₈"h

Rectangular

description	d	w	th	pattern no.	L	M/V1	V2	V3
Table Top Rectangle, 48" Deep with 28 ³ / ₈ " height legs	48"	72"	1 1/2"	RTM272482 () () () ()	\$2,318.	\$2,511.	\$2,635.	\$3,123.
	48"	78"	1 1/2"	RTM278482 () () () ()	2,341.	2,551.	2,684.	3,208.
	48"	84"	1 1/2"	RTM284482 () () () ()	2,387.	2,611.	2,753.	3,313.
	48"	90"	1 1/2"	RTM290482 () () () ()	2,410.	2,661.	2,813.	3,407.
	48"	96"	1 1/2"	RTM296482 () () () ()	2,433.	2,698.	2,860.	3,491.

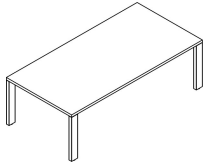

Order Code	Specification Information	Application Notes
Example: RTM272362 () () () ()	To order please specify pattern number including:	The tables on this page, come complete with structural frame. No additional stiffeners are required.
R Ref	1. Grommet Drilling Options: NG = no grommet PB = power center grommet both ends	Table's frame ships knockdown. Assembly required.
TM Table	PC = power center grommet center *	For laminate tops (including wood grain laminate) leg finish options are: all core paint finishes only.
2 2 x 4 leg	PE = power center grommet end *	The product on this page will accept wood grain laminate where laminate is currently an option.
72 Width	2B = 2 + 2 Drop in electrical unit both ends	For veneer tops, leg finish options are: all core paint finishes or same wood veneer as the top. The prices indicated above, are for painted legs and no grommet.
36 Depth	2C = 2 + 2 Drop in electrical unit center	Upcharges apply to legs with V1, V2 or V3 finishes.
2 28 ³ / ₈ " h leg	2E = 2 + 2 Drop in electrical unit end	Additional upcharges;
PC Grommet option:	3B = 3 + 3 Drop in electrical unit both ends	Leg Finish Add V1 \$2,529 V2 \$2,658 V3 \$3,229
PU Grommet finish	3C = 3 + 3 Drop in electrical unit center	The apron finish always matches the leg finish.
V316 Worksurface Finish	3E = 3 + 3 Drop in electrical unit end	
() Edge finish	2. Grommet Finish: NG = Finish not required PC, PE, PB = Painted and plated finishes	
V316 Leg finish	3C, 3E, 3B, 2C, 2E, 2B = Drilling location only, finish not applicable.	
111 Leg reveal finish	3. Worksurface finish: L, V1, V2, V3	
	4. Edge finish: L, V1, V2, V3 (Edge options are available on laminate tops only.)	
	5. Leg finish: All core paint or veneer to match top, where applicable.	
	6. Leg reveal finish: All core paint options.	

Table height = 2³/₈"h to the underside of worksurface. Additional upcharges;

* Upcharges apply for the following power center grommets.

Grommet	Add
PB	\$288
PC	\$144
PE	\$144

Power center grommets (lids and sleeves) are included when PB, PC and PE are selected.

Products on this page do not include electrical components. For electrical components refer to page 403.

Installation instruction sheets available on Knoll Exchange. Refer to reference number 6TP00385.

Tables with 4 x 4 Legs - 28³/₈" Rectangular

description	d	w	th	pattern no.	L	M/V1	V2	V3
Table Top Rectangle, 36" Deep with 28 ³ / ₈ " height legs	36"	72"	1 1/2"	RTM472362 () () () ()	\$2,506.	\$2,618.	\$2,712.	\$3,100.
	36"	78"	1 1/2"	RTM478362 () () () ()	2,539.	2,663.	2,764.	3,181.
	36"	84"	1 1/2"	RTM484362 () () () ()	2,653.	2,790.	2,899.	3,343.
	36"	90"	1 1/2"	RTM490362 () () () ()	2,680.	2,821.	2,936.	3,408.
	36"	96"	1 1/2"	RTM496362 () () () ()	2,719.	2,872.	2,994.	3,495.

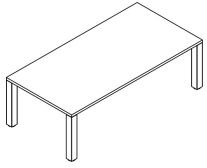
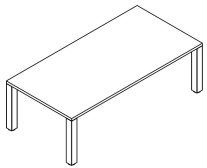

Table Top Rectangle, 42" Deep with 28 ³ / ₈ " height legs	42"	72"	1 1/2"	RTM472422 () () () ()	2,555.	2,691.	2,799.	3,237.
	42"	78"	1 1/2"	RTM478422 () () () ()	2,576.	2,724.	2,842.	3,312.
	42"	84"	1 1/2"	RTM484422 () () () ()	2,620.	2,811.	2,937.	3,438.
	42"	90"	1 1/2"	RTM490422 () () () ()	2,727.	2,939.	3,072.	3,606.
	42"	96"	1 1/2"	RTM496422 () () () ()	2,756.	2,974.	3,115.	3,681.



Order Code	Specification Information	Application Notes
Example: RTM472362 () () () ()	To order please specify pattern number including:	The tables on this page, come complete with structural frame. No additional stiffeners are required.
R Reff	1. Grommet Drilling Options: NG = no grommet PB = power center grommet both ends PC = power center grommet center * PE = power center grommet end *	Table's frame ships knockdown. Assembly required.
TM Table	2B = 2 + 2 Drop in electrical unit both ends 2C = 2 + 2 Drop in electrical unit center 2E = 2 + 2 Drop in electrical unit end 3B = 3 + 3 Drop in electrical unit both ends 3C = 3 + 3 Drop in electrical unit center 3E = 3 + 3 Drop in electrical unit end	For laminate tops (including wood grain laminate) leg finish options are: all core paint finishes only.
4 4 x 4 leg	2. Grommet Finish: NG = Finish not required PC, PE, PB = Painted and plated finishes 3C, 3E, 3B, 2C, 2E, 2B = Drilling location only, finish not applicable.	The product on this page accept wood grain laminate where laminate is currently an option.
72 Width	3. Worksurface finish: L, V1, V2, V3	For veneer tops, leg finish options are: all core paint finishes or same wood veneer as the top. The prices indicated above, are for painted legs and no grommet. Upcharges apply to legs with V1, V2 or V3 finishes. Additional upcharges;
36 Depth	4. Edge finish: L, V1, V2, V3 (Edge options are available on laminate tops only)	Leg Finish Add V1 \$1,430 V2 \$1,494 V3 \$1,731
2 28 ³ / ₈ " h leg	5. Leg finish: All core paint or veneer to match top, where applicable.	Table height = 28 ³ / ₈ "h to the underside of worksurface. * Upcharges apply for the following power center grommets. Grommet Add PB \$288 PC \$144 PE \$144
PC Grommet option:	6. Leg reveal finish: All core paint options.	Power center grommets (lids and sleeves) are included when PB, PC and PE are selected.
PU Grommet finish		Product on this page do not include electrical components for electrical components, see page 403.
V316 Worksurface Finish		Installation instruction sheets available on Knoll Exchange. Refer to reference number 6TP00384.
() Edge finish		
V316 Leg finish		
111 Leg reveal finish		

Tables with 4 x 4 Legs - 28³/₈"h Rectangular

description	d	w	th	pattern no.	L	M/V1	V2	V3
Table Top Rectangle, 48" Deep with 28 ³ / ₈ " height legs	48"	72"	1 1/2"	RTM472482 () () () ()	\$2,574.	\$2,768.	\$2,891.	\$3,379.
	48"	78"	1 1/2"	RTM478482 () () () ()	2,629.	2,837.	2,970.	3,495.
	48"	84"	1 1/2"	RTM484482 () () () ()	2,653.	2,876.	3,019.	3,577.
	48"	90"	1 1/2"	RTM490482 () () () ()	2,691.	2,940.	3,092.	3,686.
	48"	96"	1 1/2"	RTM496482 () () () ()	2,809.	3,073.	3,235.	3,865.

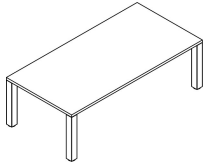

Order Code	Specification Information	Application Notes
Example: RTM472362 () () () ()	To order please specify pattern number including:	The tables on this page, come complete with structural frame. No additional stiffeners are required.
R Ref	1. Grommet Drilling Options: NG = no grommet PB = power center grommet both ends PC = power center grommet center * PE = power center grommet end *	Table's frame ships knockdown. Assembly required.
TM Table	2B = 2 + 2 Drop in electrical unit both ends	For laminate tops (including wood grain laminate) leg finish options are: all core paint finishes only.
4 4 x 4 leg	2C = 2 + 2 Drop in electrical unit center	The product on this page accept wood grain laminate where laminate is currently an option.
72 Width	2E = 2 + 2 Drop in electrical unit end	For veneer tops, leg finish options are: all core paint finishes or same wood veneer as the top. The prices indicated above, are for painted legs and no grommet.
36 Depth	3B = 3 + 3 Drop in electrical unit both ends	Upcharges apply to legs with V1, V2 or V3 finishes.
2 28 ³ / ₈ " h leg	3C = 3 + 3 Drop in electrical unit center	Additional upcharges;
PC Grommet option:	3E = 3 + 3 Drop in electrical unit end	Leg Finish Add V1 \$1,430 V2 \$1,494 V3 \$1,731
PU Grommet finish	2. Grommet Finish: NG = Finish not required PC, PE, PB = Painted and plated finishes 3C, 3E, 3B, 2C, 2E, 2B = Drilling location only, finish not applicable.	Table height = 28 ³ / ₈ "h to the underside of worksurface. * Upcharges apply for the following power center grommets. Grommet Add PB \$288 PC \$144 PE \$144 Power center grommets (lids and sleeves) are included when PB, PC and PE are selected.
V316 Worksurface Finish	3. Worksurface finish: L, V1, V2, V3	Product on this page do not include electrical components for electrical components, see page 403.
() Edge finish	4. Edge finish: L, V1, V2, V3 (Edge options are available on laminate tops only)	Installation instruction sheets available on Knoll Exchange. Refer to reference number 6TP00384.
V316 Leg finish	5. Leg finish: All core paint or veneer to match top, where applicable.	
111 Leg reveal finish	6. Leg reveal finish: All core paint options.	

Meeting Tables

Meeting Tables are based upon the Tables with 4 x 4 Legs and are offered in larger sizes suited to a variety of larger meeting spaces and small conference rooms.

Meeting Tables are available in a variety of configurations. Tables 30" to 48" deep are one worksurface deep by either two or three pieces wide of equal size. Tables 60" x 72" deep are two worksurfaces deep by either one, two or three pieces wide of equal size. Meeting Tables are available in two heights: desk height - which is 28 3/8" high to the underside of the worksurface and service height - which is 34 3/8" high to the underside of the worksurface. See Figure 1 for scope of table sizes and number of worksurface pieces per Meeting Table.

Meeting Tables offer a vast selection of power and communications functionality. Options for power and communications include several configurations; power center grommets which elegantly conceal the outlets below the table surface; or drop-in table outlets which provide outlets flush with the table top. See Figures 2, 3 and 4 for grommet options and locations. Meeting Tables are UL listed for use with all power and communications accessories are ordered separately.

Table tops and legs may be specified in different finishes creating a variety of aesthetic possibilities.

Seating Capacity

Seating capacity is based upon two module widths; 30" wide for Meeting Spaces and 36" wide for more generous Conference Spaces.

Seating capacity includes side seating and end seating. For tables 30" to 48" deep, end seating includes one place at each end. For tables 60" and 72" deep, end seating includes two places at each end. See Figure 1 for Seating Capacity.

Power and Communications Management

Generally power is supplied to the Meeting Table by means of a floor monument outlet centered inside the Center Support footprint.

Refer to Grommet Details for a description of the available power and communications outlets ordered separately.

For cable management, Meeting Tables will accept Undermounted Wire Baskets (RWMT...) which may be used to contain electrical outlet cables and conceal electrical equipment transformer blocks which may be plugged in to power outlets. For tables without a center support, a Flexible Vertical Wire Manager (RWMVF) may be specified separately.

Figure 1: Scope of Meeting Table Sizes & Seating Capacity

Depth	Width	Height	Number of Work-surfaces	Number of Center Supports	Seating Capacity 30" Module	Seating Capacity 36" Module
30"	108"	34 3/8"	2	1	8	8
	120"		2	1	10	8
	132"		2	1	10	8
	144"		2	1	10	10
	156"		2	1	12	10
	180"		2	1	14	12
	216"		3	2	16	14
36"	108"	34 3/8"	2	1	8	8
	120"		2	1	10	8
	132"		2	1	10	8
	144"		2	1	10	10
	156"		2	1	12	10
	180"		2	1	14	12
	216"		3	2	16	14
42" 48"	108"	28 3/8"	2	1	8	8
	120"		2	1	10	8
	132"		2	1	10	8
	144"		2	1	10	10
	156"		2	1	12	10
	180"		2	1	14	12
	216"		3	2	16	14
60" 72"	60"	28 3/8"	2	0	8	-
	72"		2	0	8	8
	84"		2	0	8	8
	108"		4	1	10	10
	120"		4	1	12	10
	144"		4	1	12	12
	156"		4	1	14	12
	180"		4	1	16	14
	216"		6	2	18	16

Grommet Details

Meeting Tables are designed to accept a variety of power and communications outlets to suit every need. All electrical outlets are ordered separately.

Edge mounted electrical outlets are mounted under the meeting table close to the edge of the table and provide direct access to power and communications while partially concealing the outlet for a more refined aesthetic. Tables should be specified with the "no grommet" (NG) option when edge mounted option is chosen.

Power Centers have a hinged flip lid neatly framed by a grommet body and conceals the electrical and communications outlets mounted below the worksurface. Meeting Tables specified with this option come with the cut-outs pre-drilled in the worksurface and includes all grommet body and lid assemblies.

Drop-in electrical outlets provide power and communications outlets flush mounted to the worksurface for direct access. Tables specified with this option are supplied with the appropriate sized cut-out pre-drilled to suit the desired Drop-in outlet.

Refer to Power and Data Accessories Planning Guide pages for further details of electrical outlets.

See Figures 2 and 3 for definitions of grommet options and associated power and communications outlets. See Figure 4 for grommet locations.

See Finish Details for power center grommet finish options.

Figure 2: Grommet Options for Meeting Tables in sizes 30" to 48" deep

Code	Purpose	Description	Power and Data Outlet Options
NG	No Grommet	For use with Desktop Outlet for Table Edge or if no power outlets are desired	RDTUME...
PB	Power Center, Both Ends	Has one power center grommet at each end of the table. Use Desktop Outlet for Table Power Center – Undermounted	RDTUMP...
P4	Power Center, Four Locations	Has four power center grommets spaced evenly along the length of the table. Use Desktop Outlet for Table Power Center – Undermounted	RDTUMP...
2B	4-Position Drop-in Outlet, Both Ends	Has cut-outs for one 4-position drop-in outlet at each end of the table. Use Electrical Component for Table Drop-in.	RDTDE22... RDTDE2U... RDTDE31U... RDTDE40...
24	4-Position Drop-in Outlet, Four Locations	Has cut-outs for four 4-position drop-in outlets spaced evenly along the length of the table. Use Electrical Component for Table Drop-in.	RDTDE22... RDTDE2U... RDTDE31U... RDTDE40...
3B	6-Position Drop-in Outlet, Both Ends	Has cut-outs for one 6-position drop-in outlet at each end of the table. Use Electrical Component for Table Drop-in.	RDTDE33... RDTDE3U... RDTDE42... RDTDE4U... RDTDE60...
34	6-Position Drop-in Outlet, Four Locations	Has cut-outs for four 6-position drop-in outlets spaced evenly along the length of the table. Use Electrical Component for Table Drop-in.	RDTDE33... RDTDE3U... RDTDE42... RDTDE4U... RDTDE60...

Figure 3: Grommet Options for Meeting Tables in sizes 60" and 72" deep

Code	Purpose	Description	Power and Data Outlet Options
24	No Grommet	For use with Desktop Outlet for Table Edge or if no power outlets are desired	RDTUME...
3B	Power Center	On widths 108" to 144", 4 power center grommets are provided; On widths 156" to 216", 8 power center grommets are provided; Use Desktop Outlet for Table Power	RDTUMP...
34	4-Position Drop-in Outlets	On widths 108" to 144", four cut-outs for 4-position drop-in outlets are provided; On widths 156" to 216", eight cut-outs for 4-position drop-in outlets are provided; Use Electrical Component for Table Drop-in.	RDTDE22... RDTDE2U... RDTDE31U... RDTDE40...
2B	6-Position Drop-in Outlets	On widths 108" to 144", four cut-outs for 6-position drop-in outlets are provided; On widths 156" to 216", eight cut-outs for 6-position drop-in outlets are provided; Use Electrical Component for Table Drop-in.	RDTDE33... RDTDE3U... RDTDE42... RDTDE4U... RDTDE60...

Locations for Power Center Grommets – Meeting Tables 30", 36", 42" and 48" deep

Locations for Drop-in Outlet Cut-outs – Meeting Tables 30", 36", 42" and 48" deep

Available Grommet Options

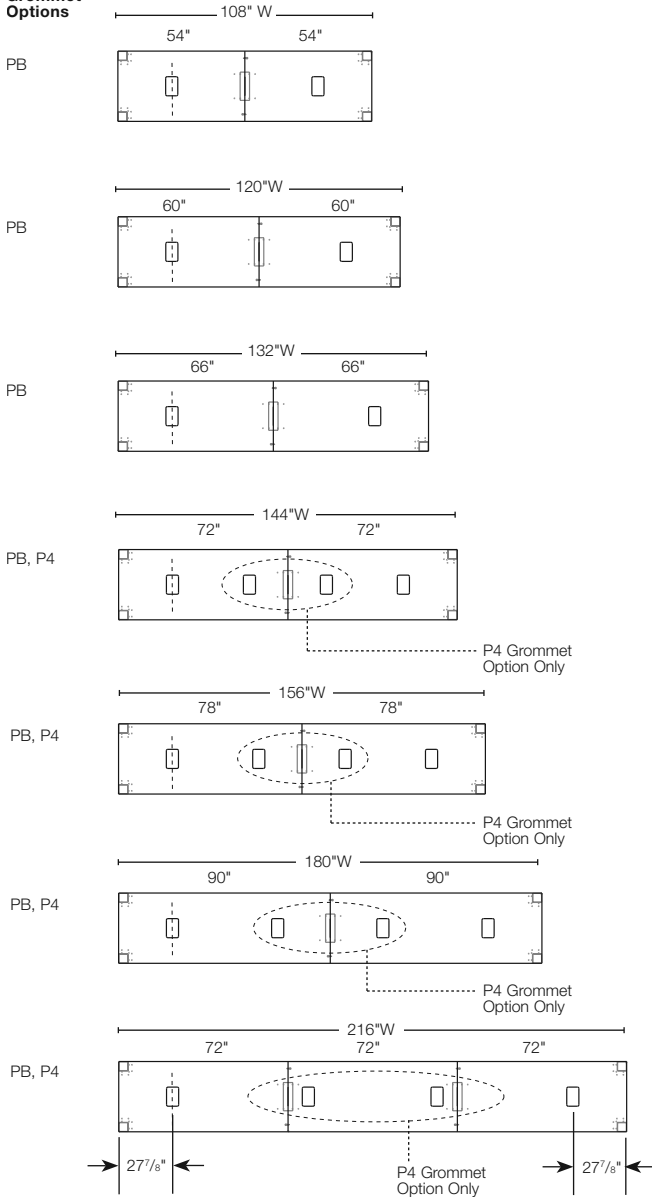

Available Grommet Options

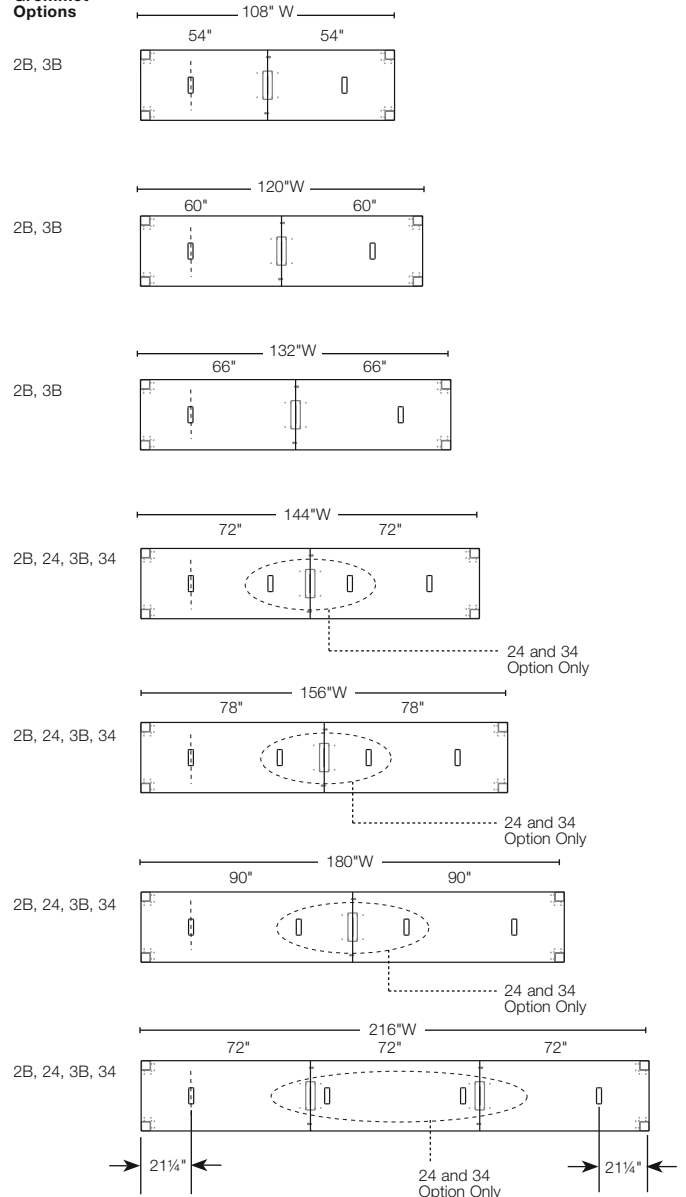
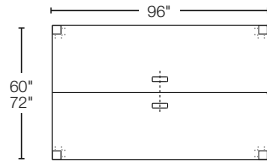
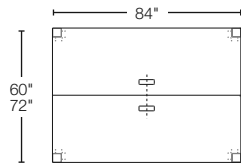
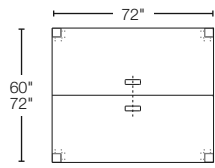
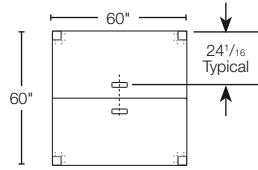
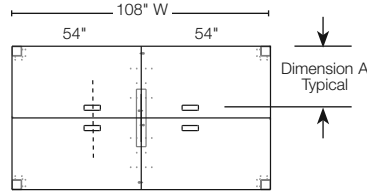

Figure 4A: Grommet Locations for Meeting Tables

Locations for Power Center grommets and Drop-in outlet cut-out options – Meeting Tables 60" to 72" deep, 60" to 96" wide.



Locations for Power Center grommet and Drop-in outlet cut-out options – Meeting Tables 60" and 72" deep, 108" and wider.



Dimension A

60"D	25 ¹ / ₁₆ "
72"D	24 ³ / ₈ "

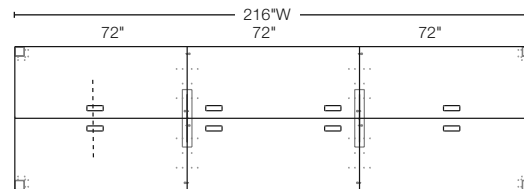
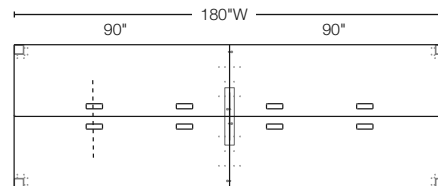
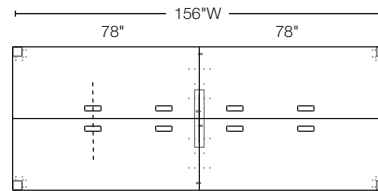
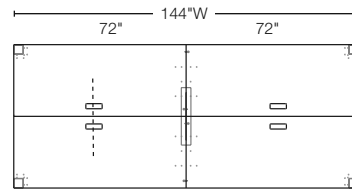
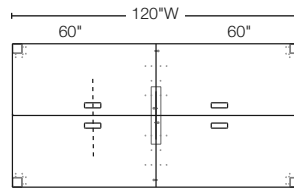

Figure 4B: Grommet Locations for Meeting Tables

Construction Details

Meeting Table tops are in multiple pieces. Tables 30" to 48" deep are one worksurface deep by either two or three pieces wide of equal size. Tables 60" x 72" deep are two worksurfaces deep by either two or three pieces wide of equal size. See Figure 1 for number of worksurface pieces per Meeting Table size. See Figure 4 for worksurface configurations. See Figure 5 for Grommet Cut-out sizes.

Meeting table support consists of four 4 x 4 legs positioned flush to the edges of the corners of the table and a center support positioned at each of the longitudinal divisions of the worksurfaces.

Center Support Details

The center support provides both support and cable management for the table. Tables which are two worksurfaces wide have one center support while tables which are three worksurfaces wide have two center supports. See Figure 1 for the quantity of center supports for each table size. The legs and center support(s) are connected to an integral substructure.

The center support is required to have two covers which are ordered separately. See following section for Center Support Covers. Center supports come in two depths, 9" and 24"; and two heights, 28 3/8" for desk height tables and 34 3/8" for service height tables. Tables 30" to 48" deep come with 9" deep center supports. All other tables come with 24" deep center supports. See Figure 12 for Center Support sizes.

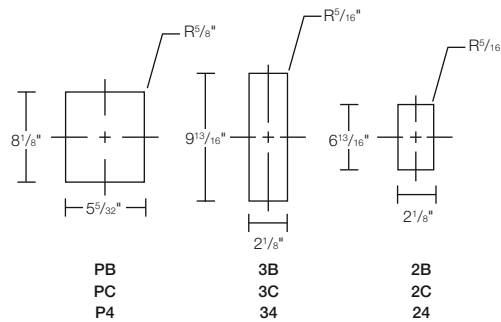

Figure 5: Grommet Cut-out sizes

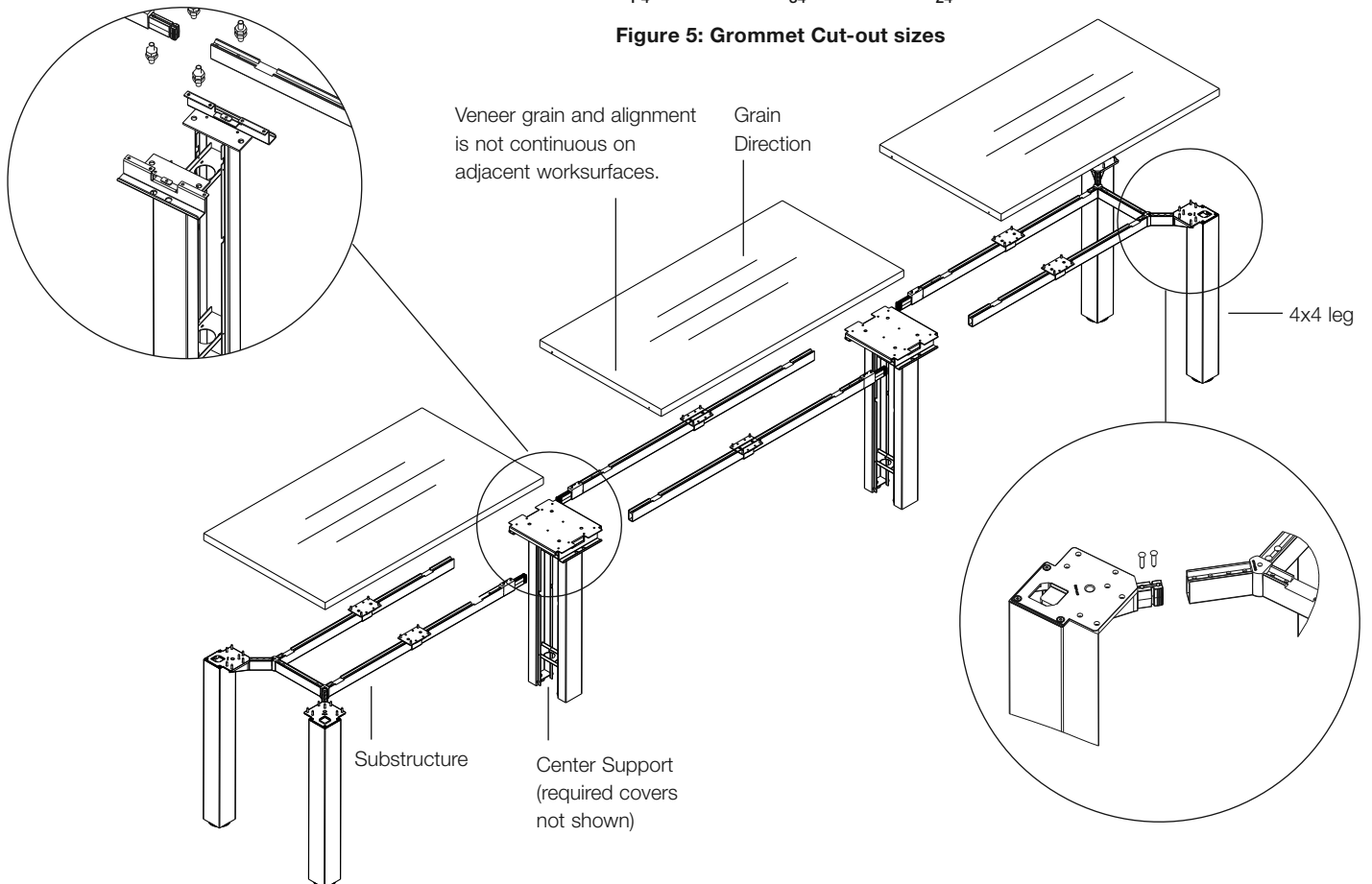

Figure 6: Construction 30" to 48" deep x 108" to 216" wide

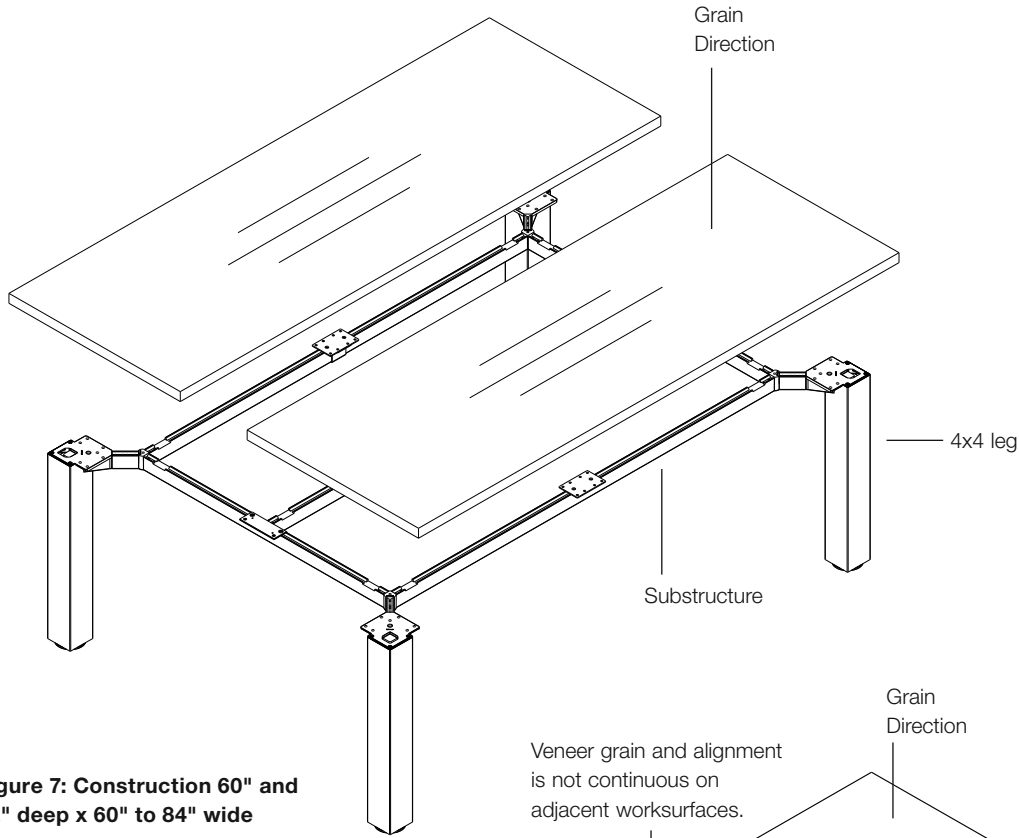

Figure 7: Construction 60" and 72" deep x 60" to 84" wide

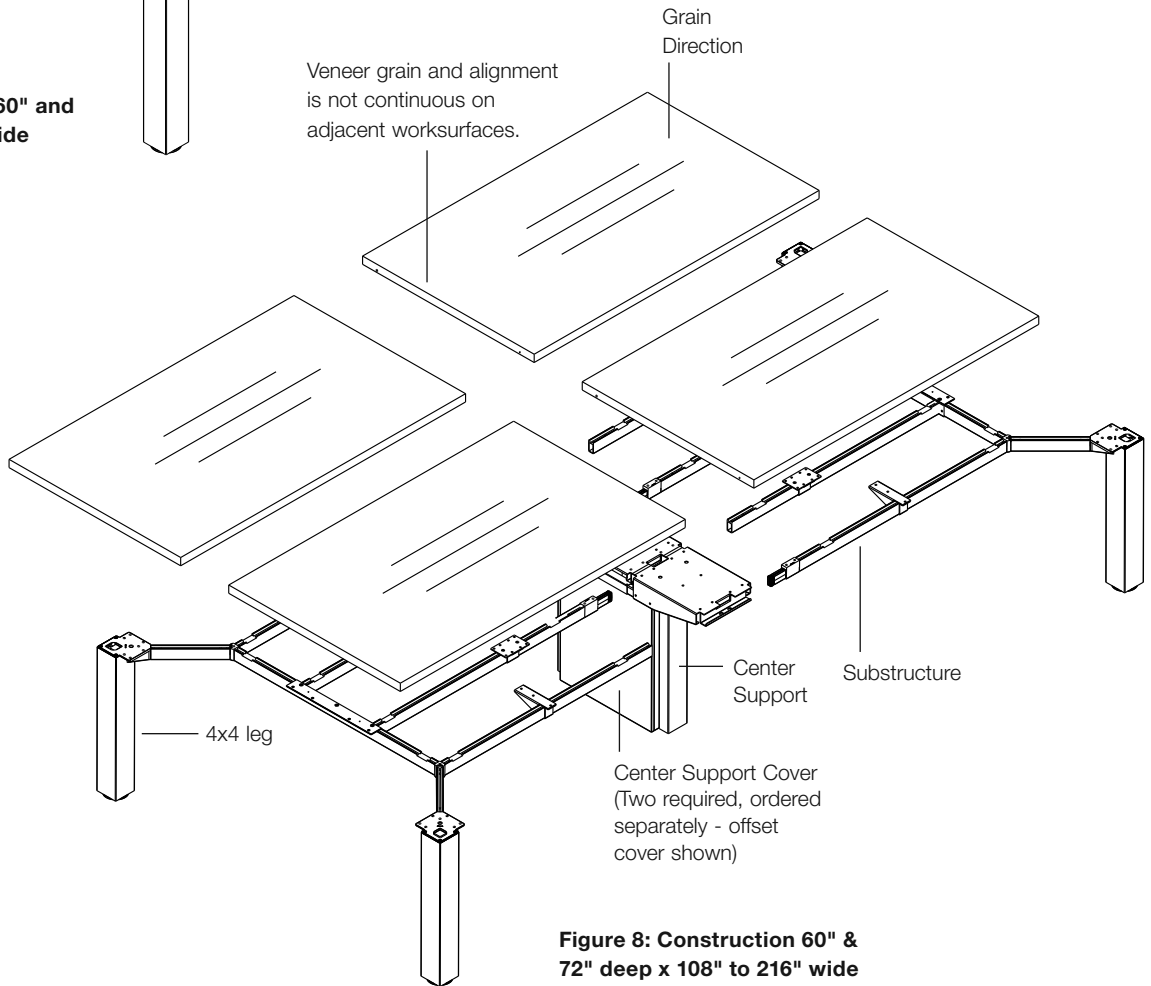

Figure 8: Construction 60" & 72" deep x 108" to 216" wide

Finish Details

Power Center Grommet is offered in Polished Chrome (PD) or Satin Nickel (PU) and any core paint finish.

Worksurface tops are available in all core laminates, wood grain laminates, mixed finish (laminated tops with wood edges), and all core wood veneer finishes including synthetic edge options. Grain direction for wood veneer and wood grain laminate worksurfaces is along the width of the table. See figures 6, 7 and 8 for grain direction.

Grain pattern for wood veneer and wood grain laminate will not be continuous on adjacent worksurfaces. To enhance the beauty of the wood veneer, Meeting Tables with domestic flat cut veneers (V2) are laid up using reverse slip matching, with sequential cathedrals arranged in opposite directions. See Figure 9 for arrangement of veneer for reverse slip match.

Legs may be specified in all core paint finishes or in wood veneer finishes. When specified with wood veneer finish, the leg finish must match the worksurface veneer finish. Contact Custom Product Development if the wood veneer finish of the legs is desired to be a different veneer finish than the top.

Leg reveals may be any core paint finish.

The table substructure is painted and defaults to the leg reveal color.

The center support covers are available in laminate, wood veneer or metal finishes.

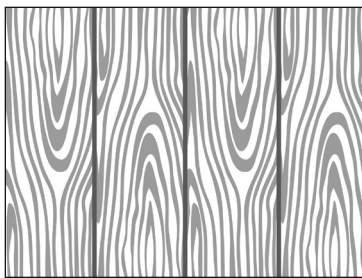

Figure 9: Reverse Slip Match

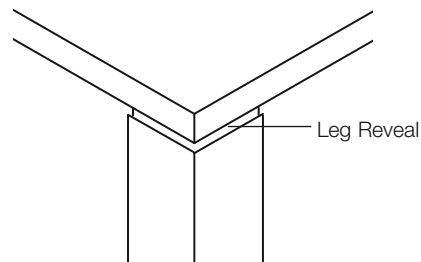

Figure 10: Leg Reveal

Center Support Covers

Center support covers are required to enclose the center support of the Meeting Tables. Each center support requires two covers; one for each side of the support.

There are two types of center support cover; flat and offset. The Flat cover sits flush to the center support.

The Offset cover is 1 1/2" thick, adding an extra 3" of interior depth to the center support (when two are ordered) which helps to conceal an electrical floor monument.

The center support covers are available in laminate, wood veneer or metal finishes.

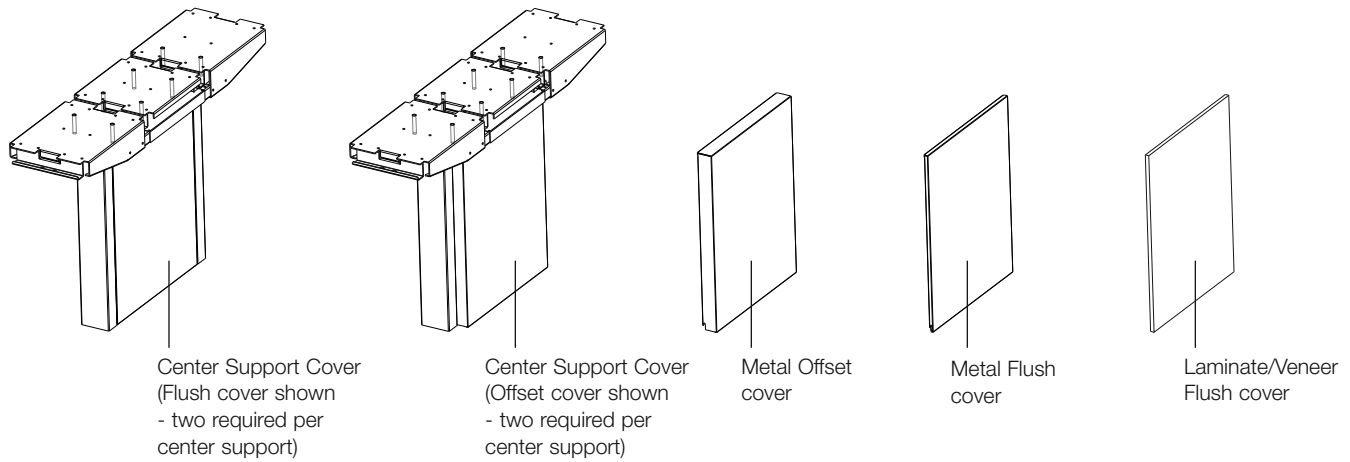

Figure 11: Center Support and Covers

Table Depth	Table/Center Support Height	Center Support Depth
30"	34 3/8"	9"
36"	34 3/8"	9"
42"	28 3/8"	9"
48"	28 3/8"	9"
60"	28 3/8"	24"
72"	28 3/8"	24"

Figure 12: Center Support Sizes

Electrical Components for Reff Profiles Meeting Table

Reff Profiles Meeting Table can be powered by a modular distribution system featuring standard Knoll 2+2 and 3+3 eight- and ten-wire power systems. From a single point of connection to the building power supply, Reff Profiles raceway can distribute four or six 20-amp circuits. Depending on national and local electric codes, and anticipated load of a particular application, each circuit may support as much as 10 or more duplex outlets.

The central component is the power harness, which can be mounted under the table rails, anywhere along the length of the table rail.

The harness is suspended from a power harness mounting bracket attached to either or both center table rails.

The power harness accepts snap-in duplex outlets on each face, and is enclosed by steel raceway covers, specified separately. Each end of the harness has ports for two jumper cables, or a power infeed and a jumper cable. The power infeed connects power from a building junction box, and jumpers connect power from one harness to another, in either direction.

Power harnesses are available in two sizes: 12" wide, with two duplex outlet locations on each face, and 24" wide, with four outlet locations on each face. Duplex outlets must be specified separately to access one of the four or six circuits. Outlets for circuits can be specified in black with white letters identifying circuits. Outlets for circuits X, Y, Z, are also available in orange with black letters, or black with orange triangles and letters to designate protected circuits.

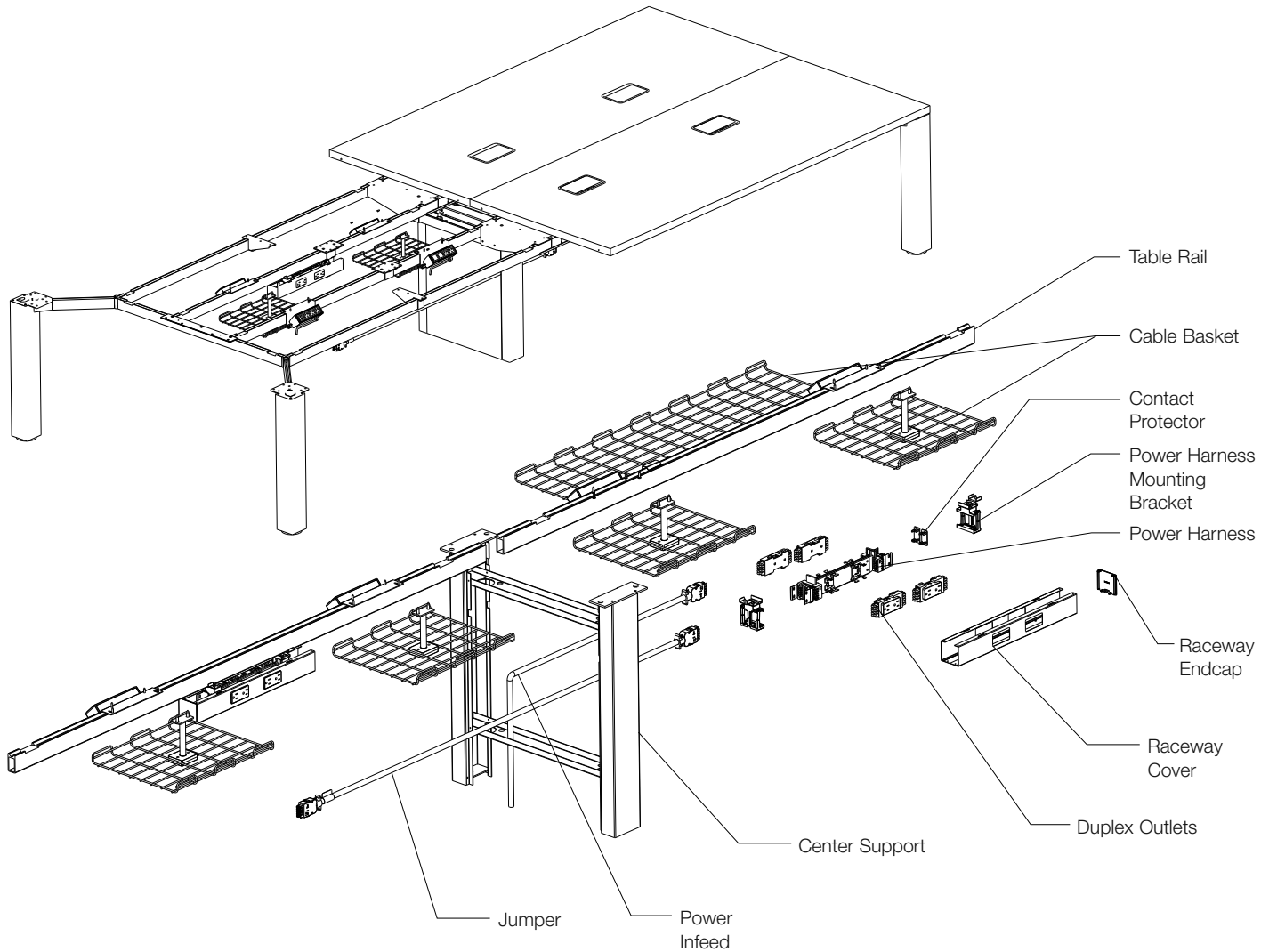

Figure 1. Reff Profiles Meeting Table with Electrical Components

Corresponding raceway covers for 12" harness are 18" wide; covers for 24" harness are 30" wide. Raceway covers can be ordered in pairs that include two covers with openings or one cover without openings.

Jumper cables are available in various lengths up to 72" to link power between harnesses.

Jumper cables should be managed by cable clips for desk rails (RCMC10, set of 10).

Two types of infeeds are available to connect the power harness from the building power supply.

- 1) The power harness infeed has a modular connector with a six foot pigtail to connect from a junction box in the floor or wall to a power harness. See Figure 1.
- 2) A hardwired infeed box, required in New York City, mounts inside the meeting table center support and includes a connector with six foot pigtail to connect to the closest power harness. See Figure 2.

Refer to Installation Instructions 6TP00481 available on Knoll Exchange.

Outlet fillers are a kit of ten plastic filler plates that flex to snap securely into any unused outlet opening in Reff Profiles raceway covers. Installed covers are designed to closely mimic the appearance of adjacent power outlets. Fillers are black injection molded plastic.

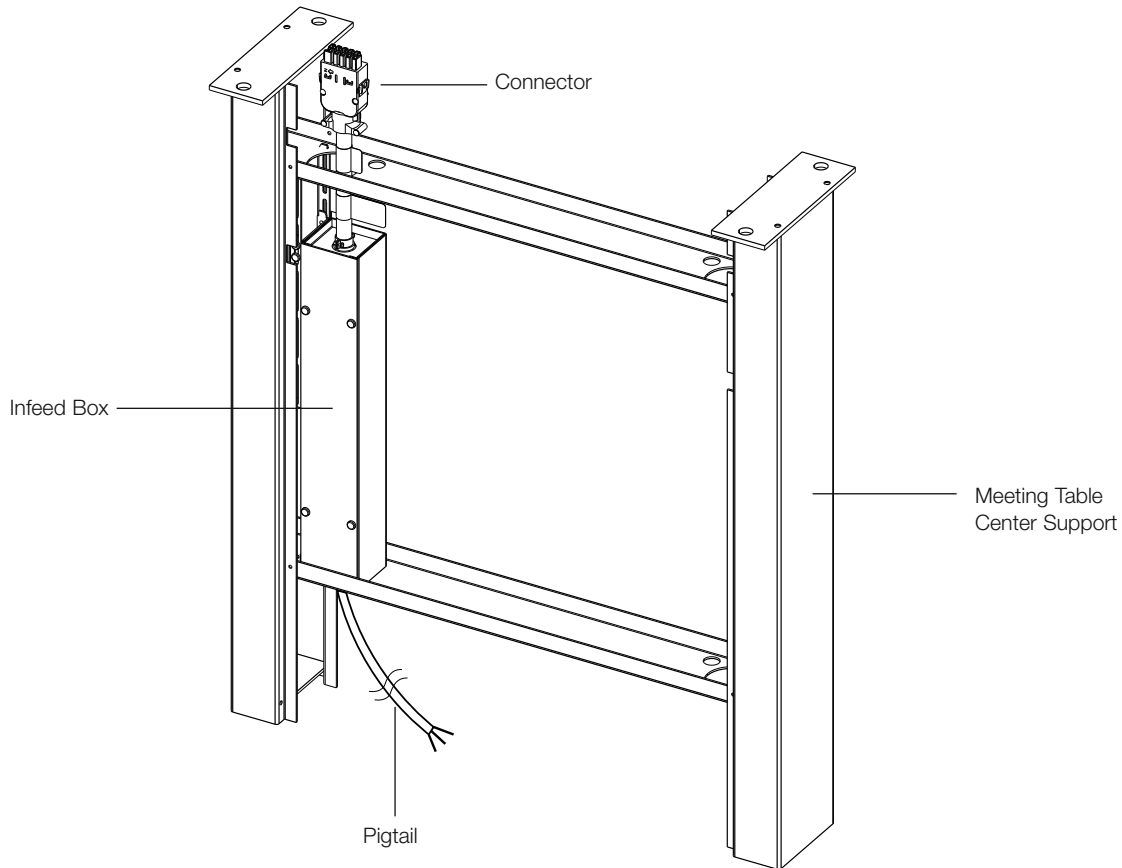

Figure 2. NYC Infeed

2+2

Four 20-amp circuits, 8 wire configuration with four hots (12 gauge), two neutrals (10 gauge, 35A rated), two grounds.

Power harness and outlet modules: steel enclosure between molded polypropylene distribution blocks, 8-wire.

Jumper cables: flexible steel conduit with strain relief, 8-wire

Outlets: molded polycarbonate duplex preconfigured as circuit A, B (black), X, Y (black, orange or black with orange triangle)

Infeed: watertight conduit with 6' whip or hardwire box mounted to desk rail, center beam or fence frame, 8-wire

Load should be balanced evenly among power circuits. In accordance with NEC2011 Article 210, the permissible load should not exceed 80% of the circuit ampere rating (which is 16 amps on each 20 amp branch circuit).

3+3

Six 20-amp circuits, 10 wire configuration with six hots (12 gauge), two neutrals (10 gauge, 35A rated), two grounds.

Power harness and outlet modules: steel enclosure between molded polypropylene distribution blocks, 10-wire.

Jumper cables: flexible steel conduit with strain relief, 10-wire

Outlets: molded polycarbonate duplex preconfigured as circuit A, B, C (black), X, Y, Z (black, orange or black with orange triangle)

Infeed: watertight conduit with 6' whip or hardwire box mounted to desk rail, center beam or fence frame, 10-wire

Load should be balanced evenly among power circuits. In accordance with NEC2011 Article 210, the permissible load should not exceed 80% of the circuit ampere rating (which is 16 amps on each 20 amp branch circuit).

Reff Profiles Meeting Tables are a listed product with U.L. in the QAWZ office furnishings category.

- File E76704 Volume 7, Section 3 (Furniture)
- File E76704 Volume 3, Section 2 (Electrical Accessories)

Wiring Diagram (2+2)

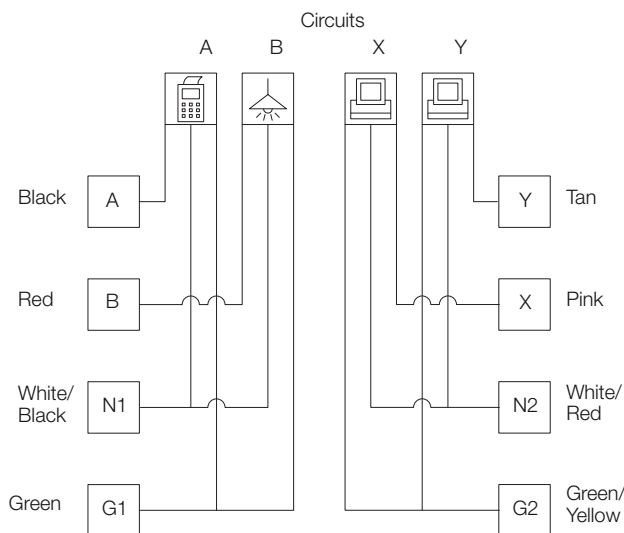

Wiring Diagram (3+3)

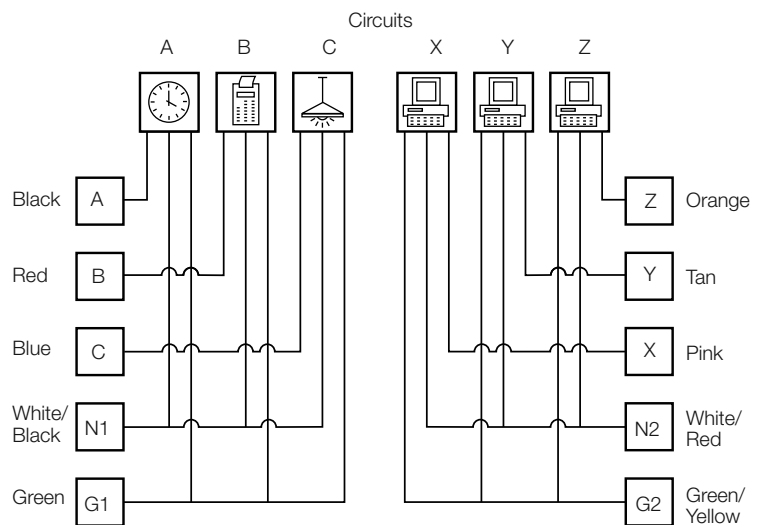

Meeting Tables with 4 x 4 Legs - Single Depth - 28³/₈"h

Double Width, Rectangular

description	d	w	th	pattern no.	L	M/V1	V2	V3
Table Top Rectangle, Double Width, with 28 ³ / ₈ " height legs	36"	108"	1 1/2"	RTM4108362() () () () ()	\$4,819.	\$4,957.	\$5,167.	\$5,910.
	36"	120"	1 1/2"	RTM4120362() () () () ()	4,911.	5,046.	5,281.	6,092.
	36"	144"	1 1/2"	RTM4144362() () () () ()	5,360.	5,460.	5,731.	6,683.
	36"	156"	1 1/2"	RTM4156362() () () () ()	5,462.	5,719.	6,003.	7,027.
	36"	180"	1 1/2"	RTM4180362() () () () ()	5,632.	5,825.	6,145.	7,310.

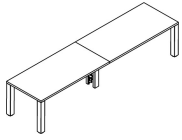
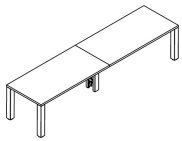

Table Top Rectangle, Double Width with 28 ³ / ₈ " height legs	42"	108"	1 1/2"	RTM4108422() () () () ()	4,894.	5,021.	5,257.	6,083.
	42"	120"	1 1/2"	RTM4120422() () () () ()	5,078.	5,189.	5,445.	6,349.
	42"	144"	1 1/2"	RTM4144422() () () () ()	5,280.	5,504.	5,794.	6,855.
	42"	156"	1 1/2"	RTM4156422() () () () ()	5,379.	5,565.	5,875.	7,013.
	42"	180"	1 1/2"	RTM4180422() () () () ()	5,852.	5,961.	6,311.	7,606.



Order Code	Specification Information	Application Notes
Example: RTM4108362 () () () ()	To order please specify pattern number including:	Table height = 28 ³ / ₈ "h to the underside of worksurface.
R Reff	1. Grommet Options: NG = no grommet PB = Power center grommet both ends, (Grommet and lid included) P4 = Four power center grommets, (Grommet and lid included) 2B = Cut out for 4 Positions, Drop in electrical unit both ends 24 = Cut out for 4 positions, Drop in electrical units 3B = Cut out for 6 positions, Drop in electrical units both ends 34 = Cut out for 6 position, Drop in electrical units * *Electrical components are not included with tables & need to be ordered separately.	The tables on this page, come complete with structural frame. No additional stiffeners are required. Table's frame ships knockdown. Assembly required. For laminate tops (including wood grain laminate) leg finish options are: all core paint finishes only. The product on this page except wood grain laminate where laminate is currently an option. The veneers are not intended to align with one another from top to top. For veneer tops, leg finish options are: all core paint finishes or same wood veneer as the top. The prices indicated above, are for painted legs without center grommet. *Upcharges apply to legs with V1, V2 or V3 finishes. Additional upcharges:
TM Table, Meeting	2. Grommet Finish: if NG then not applicable if PB & P4 then all core paint, PU, PD if 2B, 24, 3B, 34 then not applicable	Product on this page do not include electrical components *Upcharges apply for each Power Center Grommets; Grommet Add PB \$288 P4 \$576 PB Grommet option includes 2 power center grommets. P4 Grommet option, includes 4 power center grommets. Center Support Details; Tables on this page require Center Support Covers which are sold separately. All tables on this page, come with 2 piece tops and one center support. 36", 42" & 48" deep tables have 9" deep center support. Each center support requires two Center Support Covers, which are sold separately. For Center Support Covers, see pages 101 & 102. For electrical components, see page 374 to 378.
4 4 x 4 leg (2=2x2 legs)	3. Worksurface finish ()	
108 Width	4. Edge finish: L, V1, V2, V3 (Edge options are available on laminate tops only)	
36 Depth	5. Leg finish (all core paint, V1, V2, V3)	
2 28 ³ / ₈ " h leg	6. Leg reveal finish (all core paint)	
PB Grommet Option	7. Center support finish (all core paint) (sold separately)	
PD Grommet finish		
V316 Worksurface Finish		
() Edge finish		
V316 Leg finish		
111 Leg reveal finish		
111 Center support finish		

Specification Information

Application Notes

Meeting Tables with 4 x 4 Legs - Single Depth - 28³/₈"h

Multi Width, Rectangular

description	d	w	th	pattern no.	L	M/V1	V2	V3
Table Top Rectangle, Double width, with 28 ³ / ₈ " height legs	48"	108"	1 1/2"	RTM4108482()	\$5,048.	\$5,181.	\$5,437.	\$6,347.
	48"	120"	1 1/2"	RTM4120482()	5,208.	5,453.	5,724.	6,719.
	48"	144"	1 1/2"	RTM4144482()	5,464.	5,622.	5,936.	7,102.
	48"	156"	1 1/2"	RTM4156482()	5,807.	5,921.	6,258.	7,511.
	48"	180"	1 1/2"	RTM4180482()	6,075.	6,101.	6,482.	7,906.



Table Top Rectangle, Triple Width with 28 ³ / ₈ " height legs	36"	216"	1 1/2"	RTM4216362()	7,716.	7,814.	8,207.	9,605.
	42"	216"	1 1/2"	RTM4216422()	8,246.	8,324.	8,648.	10,203.
	48"	216"	1 1/2"	RTM4216482()	8,592.	8,690.	8,849.	10,557.

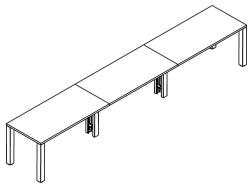

Order Code	Specification Information	Application Notes
Example: RTM4108362 () () () ()	To order please specify pattern number including:	Table height = 28 ³ / ₈ "h to the underside of worksurface.
R Reff		The tables on this page, come complete with structural frame. No additional stiffeners are required. Table's frame ships knockdown. Assembly required.
TM Table, Meeting	1. Grommet Options: NG = no grommet PB = Power center grommet both ends, (Grommet and lid included) P4 = Four power center grommets, (Grommet and lid included)	For laminate tops (including wood grain laminate) leg finish options are: all core paint finishes only. The product on this page except wood grain laminate where laminate is currently an option. The veneers are not intended to align with one another from top to top.
4 4 x 4 leg (2=2x2 legs)	2B = Cut out for 4 Positions, Drop in electrical unit both ends 24 = Cut out for 4 positions, Drop in electrical units 3B = Cut out for 6 positions, Drop in electrical units both ends 34 = Cut out for 6 position, Drop in electrical units	*Upcharges apply for each Power Center Grommets; Grommet Add PB \$288 P4 \$576 PB Grommet option includes 2 power center grommets. P4 Grommet option, includes 4 power center grommets.
108 Width	* *Electrical components are not included with tables & need to be ordered separately.	Center Support Details; Tables on this page require Center Support Covers which are sold separately.
36 Depth		All tables on this page, come with 2 piece tops and one center support. 36", 42" & 48" deep tables have 9" deep center support. Each center support requires two Center Support Covers, which are sold separately. For Center Support Covers, see pages 101 & 102.
2 28 ³ / ₈ " h leg		For electrical components, see page 374 to 378.
PB Grommet Option		Installation instruction sheets available on Knoll Exchange. Refer to reference number 6TP00462 for Table assembly instructions, and 6TP00465 for Support installation instructions.
PD Grommet finish		
V316 Worksurface Finish		
() Edge finish		
V316 Leg finish		
111 Leg reveal finish		
111 Center support finish		
	2. Grommet Finish: if NG then not applicable if PB & P4 then all core paint, PU, PD if 2B, 24, 3B, 34 then not applicable	Additional upcharges: Leg Finish Add V1 \$1,430 V2 \$1,494 V3 \$1,731
	3. Worksurface finish ()	
	4. Edge finish: L, V1, V2, V3 (Edge options are available on laminate tops only)	
	5. Leg finish (all core paint, V1, V2, V3)	
	6. Leg reveal finish (all core paint)	
	7. Center support finish (all core paint) (sold separately)	

Meeting Tables with 4 x 4 Legs - Double Depth - 28³/₈"h Single Width, Rectangular

description	d	w	th	pattern no.	L	M/V1	V2	V3
Table Top Rectangle, 60" Deep with 28 ³ / ₈ " height legs	60"	60"	1 1/2"	RTM460602 () () () () ()	\$3,679.	\$3,992.	\$4,180.	\$4,854.
	60"	72"	1 1/2"	RTM472602 () () () () ()	3,833.	4,122.	4,335.	5,115.
	60"	84"	1 1/2"	RTM484602 () () () () ()	4,159.	4,460.	4,704.	5,590.
	60"	96"	1 1/2"	RTM496602 () () () () ()	4,348.	4,585.	4,854.	5,846.

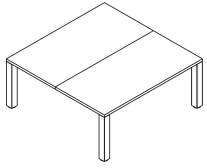
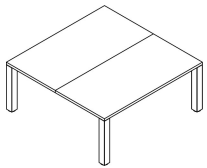
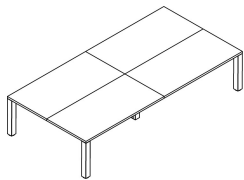
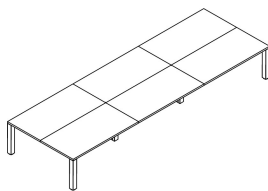

Table Top Rectangle, 72" Deep with 28 ³ / ₈ " height legs	72"	72"	1 1/2"	RTM472722 () () () () ()	4,386.	4,640.	4,887.	5,782.
	72"	84"	1 1/2"	RTM484722 () () () () ()	4,556.	4,770.	5,046.	6,062.
	72"	96"	1 1/2"	RTM496722 () () () () ()	4,957.	5,103.	5,407.	6,545.



Order Code	Specification Information	Application Notes
Example: RTM460602 () () () () ()		Table height = 28 ³ / ₈ "h to the underside of worksurface.
R Reff	To order please specify pattern number including:	Product on this page do not include electrical components.
TM Table, Meeting	1. Grommet Drilling Options: NG = no grommet PC = Power center grommet, (Grommet and lid included) 2C = Cutout for 4 unit Drop in electrical outlet 3C = Cutout for 6 unit Drop in electrical outlet	Note: Upcharges apply for Power Center Grommets; <u>Grommet Add</u> PC \$288
4 4 x 4 legs	Note: Electrical components are not included with tables & need to be ordered separately.	PC Grommet option includes 2 power center grommets.
60 Width	2. Grommet Finish: NG = Finish not required PC = all core paint, PU, PD 2C,3C = not applicable.	All tables on this page, come with 2 piece tops.
60 Depth	3. Worksurface finish: L, V1, V2, V3	For electrical components, see page 374 & 378.
2 28 ³ / ₈ " h leg	4. Edge finish: L, V1, V2, V3 (Edge options are available on laminate tops only.)	Installation instruction sheets available on Knoll Exchange. Refer to reference number 6TP00459.
PC Grommet Option	5. Leg finish: All core paint, V1, V2, V3	
PD Grommet finish	6. Leg reveal finish: All core paint	
V316 Worksurface Finish		For veneer tops, leg finish options are: all core paint finishes or same wood veneer as the top. The prices indicated above, are for painted legs without power center grommet.
() Edge finish		Upcharges apply to legs with V1, V2 or V3 finishes.
V316 Leg finish		Additional upcharges:
111 Leg reveal finish		Leg Finish Add V1 \$1,430 V2 \$1,494 V3 \$1,731

Meeting Tables with 4 x 4 Legs - Double Depth - 28³/₈"h Multi Width, Rectangular

description	d	w	th	pattern no.	L	M/V1	V2	V3
Table Top Rectangle, Double width, with 28 ³ / ₈ " height legs 	60"	108"	1 1/2"	RTM4108602() () () () ()	\$7,502.	\$7,756.	\$8,065.	\$9,203.
	60"	120"	1 1/2"	RTM4120602() () () () ()	7,656.	7,876.	8,210.	9,454.
	60"	144"	1 1/2"	RTM4144602() () () () ()	8,492.	8,673.	9,057.	10,513.
	60"	156"	1 1/2"	RTM4156602() () () () ()	8,646.	8,814.	9,223.	10,786.
	60"	180"	1 1/2"	RTM4180602() () () () ()	9,046.	9,150.	9,610.	11,385.
	72"	108"	1 1/2"	RTM4108722() () () () ()	7,652.	7,852.	8,201.	9,506.
	72"	120"	1 1/2"	RTM4120722() () () () ()	7,989.	8,171.	8,549.	9,979.
	72"	144"	1 1/2"	RTM4144722() () () () ()	8,420.	8,536.	8,982.	10,655.
	72"	156"	1 1/2"	RTM4156722() () () () ()	11,287.	11,788.	12,257.	14,049.
	72"	180"	1 1/2"	RTM4180722() () () () ()	11,715.	12,083.	12,608.	14,643.
Table Top Rectangle, Triple width, with 28 ³ / ₈ " height legs 	60"	216"	1 1/2"	RTM4216602() () () () ()	13,117.	13,396.	13,952.	16,087.
	72"	216"	1 1/2"	RTM4216722() () () () ()	13,222.	13,403.	14,048.	16,500.

Order Code	Specification Information
Example: RTM4108602 () () () ()	
R	Reff
TM	Table, Meeting
4	4 x 4 legs
108	Width
60	Depth
2	28 ³ / ₈ " h leg
PC	Grommet Option
PD	Grommet finish
V316	Worksurface Finish
()	Edge finish
V316	Leg finish
111	Leg reveal finish
111	Center support finish

Specification Information
To order please specify pattern number including:
1. Grommet Options: NG = no grommet PC = Power center grommet * (Grommet and lid included) 2C = Cut out for 4 position wide drop in electrical outlet 3C = Cut out for 6 position wide drop in electrical outlet Note: Electrical components are not included with tables & need to be ordered separately.
2. Grommet Finish: if NG then not applicable if PC then all core paint, PU, PD if 2C, or 3C then not applicable
3. Worksurface finish ()
4. Edge finish: L, V1, V2, V3 (Edge options are available on laminate tops only)
5. Leg finish (all core paint, V1, V2, V3)
6. Leg reveal finish (all core paint)
7. Center support finish (all core paint)

Application Notes
Table height = 28 ³ / ₈ "h to the underside of worksurface.
The tables on this page, come complete with structural frame. No additional stiffeners are required. Table's frame ships knockdown. Assembly required.
The product on this page accept wood grain laminate where laminate is currently an option.
For laminate tops (including wood grain laminate) leg finish options are: all core paint finishes only. The veneers are not intended to align with one another from top to top.
For veneer tops, leg finish options are: all core paint finishes or same wood veneer as the top. The prices indicated above, are for painted legs without center grommet.
Upcharges apply to legs with V1, V2 or V3 finishes.
Additional upcharges:
Leg Finish Add
V1 \$1,430
V2 \$1,494
V3 \$1,731

Product on this page do not include electrical components
 Note: Upcharges apply for Power Center Grommet options;

Table Width	Add
108",120",144"	\$576.

(includes 4 Power center grommets)

Table Width	Add
156",180",216"	\$1,152.

(includes 8 Power center grommets)

Center Support Details:
 Tables on this page require Center Support Covers which are sold separately.
 216" w tables come with 3 piece tops, and require two center supports.
 All other tables on this page, come with 2 piece tops, and require only one center support.
 Tables on this page have 24" deep center support. Each center support requires two Center Support Covers, which are sold separately.
 For Center Support covers, see page 101 & 102.
 For electrical components, see page 374 and 378. Installation instruction sheets available on Knoll Exchange. Refer to reference number 6TP00462 for Table assembly instructions, and 6TP00465 for Support installation instructions.

Meeting Tables with 4 x 4 Legs - Single Depth - 34 3/8" h

Multi Width, Rectangular

Reff Profiles Vol. Two

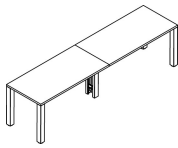
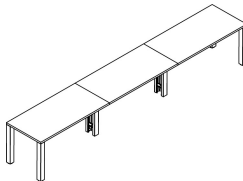
description	d	w	th	pattern no.	L	M/V1	V2	V3
Table Top Rectangle, Double Width, with 34 3/8" height legs 	30"	108"	1 1/2"	RTM4108303 () () () () ()	\$4,774.	\$4,936.	\$5,128.	\$5,786.
	30"	120"	1 1/2"	RTM4120303 () () () () ()	4,852.	5,012.	5,219.	5,941.
	30"	132"	1 1/2"	RTM4132303 () () () () ()	4,962.	5,094.	5,318.	6,102.
	30"	144"	1 1/2"	RTM4144303 () () () () ()	5,272.	5,415.	5,661.	6,508.
	30"	156"	1 1/2"	RTM4156303 () () () () ()	5,350.	5,500.	5,763.	6,672.
	30"	180"	1 1/2"	RTM4180303 () () () () ()	5,551.	5,638.	5,933.	5,968.
	36"	108"	1 1/2"	RTM4108363 () () () () ()	4,964.	5,102.	5,312.	6,055.
	36"	120"	1 1/2"	RTM4120363 () () () () ()	5,056.	5,191.	5,426.	6,237.
	36"	132"	1 1/2"	RTM4132363 () () () () ()	5,413.	5,516.	5,769.	6,652.
	36"	144"	1 1/2"	RTM4144363 () () () () ()	5,505.	5,605.	5,876.	6,828.
	36"	156"	1 1/2"	RTM4156363 () () () () ()	5,805.	5,864.	6,148.	7,172.
	36"	180"	1 1/2"	RTM4180363 () () () () ()	5,976.	6,060.	6,290.	7,256.
Table Top Rectangle, Triple Width, with 34 3/8" height legs 	30"	216"	1 1/2"	RTM4216303 () () () () ()	7,314.	7,530.	7,886.	9,130.
	36"	216"	1 1/2"	RTM4216363 () () () () ()	7,636.	7,775.	8,168.	9,566.

Order Code

Example:	RTM4108303 () () () () ()
R	Reff
TM	Table, Meeting
4	4 x 4 legs
108	Width
30	Depth
3	34 3/8" h leg
PB	Grommet Option
PD	Grommet finish
V316	Worksurface Finish
()	Edge finish
V316	Leg finish
111	Leg reveal finish
111	Center support finish

Specification Information

- To order please specify pattern number including:
- Grommet Drilling Options:
 NG = no grommet
 PB = power center grommet both ends, (Grommet and lid included)
 P4 = Four power center grommets (Grommet and lid included)
 2B = Cutout for 4 position Drop in electrical units, both ends
 24 = Cutout for 4 position Drop in electrical units, 4 locations
 3B = Cutout for 6 position Drop in electrical units, both ends
 34 = Cutout for 6 position Drop in electrical units, 4 locations
 Note: Electrical components are not included with tables & need to be ordered separately.
 - Grommet Finish:
 NG = Finish not required
 PB & P4 = all core paint, PU, PD
 2B, 24, 3B, 34 = not applicable.
 - Worksurface finish: L, V1, V2, V3
 - Edge finish: L, V1, V2, V3
 (Edge options are available on laminate tops only.)
 - Leg finish: All core paint, V1, V2, V3
 - Leg reveal finish: All core paint
 - Center support finish (all core paint)

Application Notes

- Table height = 34 3/8" to the underside of worksurface.
- The tables on this page, come complete with structural frame. No additional stiffeners are required.
- Table's frame ships knockdown. Assembly required.
- Products on this page will accept wood grain laminate where laminate is currently an option.
- For laminate tops (including wood grain laminate) leg finish options are: all core paint finishes only. The veneers are not intended to align with one another from top to top.
- For veneer tops, leg finish options are: all core paint finishes or same wood veneer as the top. The prices indicated above, are for painted legs and no grommet.
- Upcharges apply to legs with V1, V2 or V3 finishes.
 Additional upcharges:



Leg Finish	Add
V1	\$1,619
V2	\$1,767
V3	\$2,047
- Product on this page do **not** include electrical components.
- Note: Upcharges apply for Power Center Grommets.

Grommet	Add
PB	\$288
P4	\$576

 PB Grommet option includes 2 power center grommets.
 P4 Grommet option includes 4 power center grommets.
- Center Support Details;**
 Tables on this page require Center Support Covers which are ordered separately.
 216" w tables come with 3 piece tops, and require two center supports.
 All other tables on this page come with 2 piece top and require only one center support.
 Tables on this page have 9" deep center support. Each center support requires two Center Support Covers.
- For Center Support covers, see page 101 & 102.
- For electrical components, see page 374 & 378.
- Installation instruction sheets available on Knoll Exchange. Refer to reference number 6TP00462 for Table assembly instructions, and 6TP00465 for Support installation instruction.

Meeting Tables - Center Support Covers

Metal, 28³/₈"h and 34³/₈"h

description	h	d	pattern no.	P1	P2	P3	P4	
	Center Support Covers - Flat	28 ³ / ₈ "	9"	ROTAF12(M)()	\$122.	\$122.	\$122.	n/a
		28 ³ / ₈ "	24"	ROTAF22(M)()	147.	147.	147.	n/a
		34 ³ / ₈ "	9"	ROTAF13(M)()	128.	128.	128.	n/a
		34 ³ / ₈ "	24"	ROTAF23(M)()	153.	153.	153.	n/a
	Center Support Covers - Offset	28 ³ / ₈ "	9"	ROTAO12(M)()	124.	124.	124.	n/a
		28 ³ / ₈ "	24"	ROTAO22(M)()	149.	149.	149.	n/a
		34 ³ / ₈ "	9"	ROTAO13(M)()	130.	130.	130.	n/a
		34 ³ / ₈ "	24"	ROTAO23(M)()	155.	155.	155.	n/a

Order Code	
Example: ROTAF12(M)()	
R	Reff Profiles
OT	Open Table
A	Center Support
F	Flat (0 = Offset)
1	9" deep (2 = 24" deep)
2	28 ³ / ₈ " h leg (3 = 34 ³ / ₈ "h leg)
M	Metal Center Support Cover
111	Center Support Cover Finish

Specification Information

To order please specify pattern number including:

- Center support finish:
All core painted finishes

Application Notes

All connection hardware are included with the center support covers.

Meeting Tables - Center Support Covers

Wood, 28³/₈"h and 34³/₈"h



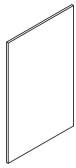

description	h	d	pattern no.	L	M/V1	V2	V3
Center Support Covers	28 ³ / ₈ "	9"	ROTAF12(W)()	\$235.	\$315.	\$323.	\$345.
	28 ³ / ₈ "	24"	ROTAF22(W)()	250.	357.	384.	446.
	34 ³ / ₈ "	9"	ROTAF13(W)()	236.	317.	326.	351.
	34 ³ / ₈ "	24"	ROTAF23(W)()	257.	365.	396.	473.

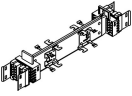

Order Code	Specification Information	Application Notes
Example: ROTAF12(W)()	<i>To order please specify pattern number including:</i>	All connection hardware are included with the center support covers.
R Reff Profiles		
OT Open Table	1. Center support finish: L, V1, V2, V3	Wood center supports, are available in "Flat" style only.
A Center Support		
F Flat (0 = Offset)		Products on this page will accept woodgrain laminate where laminate is currently an option.
1 9" deep (2 = 24" deep)		
2 28 ³ / ₈ " h leg (3 = 34 ³ / ₈ "h leg)		
W Wood Center Support Cover		
V316 Center Support Cover Finish		

Power Distribution components

Power Rail Components for Meeting and Open Tables

description	type	w	d	h	pattern no.	list price
 Power rail	2 + 2, (2) Duplex Outlets per side	12"	2"	2"	ROTRE12	\$179.
	2 + 2, (4) Duplex Outlets per side	24"	2"	2"	ROTRE24	325.
	3 + 3, (2) Duplex Outlets per side	24"	2"	2"	ROTRT12	204.
	3 + 3, (4) Duplex Outlets per side	24"	2"	2"	ROTRT24	391.
Power Rail Mounting Brackets (set of 1 pair)					ROTRM	93.
 Duplex Receptacles, Black	Circuit A	4 1/2"	1"	1 1/2"	RR3-DA	43.
	Circuit B	4 1/2"	1"	1 1/2"	RR3-DB	43.
	Circuit C	4 1/2"	1"	1 1/2"	RR3-DC	43.
	Circuit X	4 1/2"	1"	1 1/2"	RR3-DX	43.
	Circuit Y	4 1/2"	1"	1 1/2"	RR3-DY	43.
	Circuit Z	4 1/2"	1"	1 1/2"	RR3-DZ	43.
 Duplex Receptacles, Orange	Circuit X	4 1/2"	1"	1 1/2"	RR3-DXO	48.
	Circuit Y	4 1/2"	1"	1 1/2"	RR3-DYO	48.
	Circuit Z	4 1/2"	1"	1 1/2"	RR3-DZO	48.
 Duplex Receptacles, Orange triangle	Circuit X	4 1/2"	1"	1 1/2"	RR3-DXT	43.
	Circuit Y	4 1/2"	1"	1 1/2"	RR3-DYT	43.
	Circuit Z	4 1/2"	1"	1 1/2"	RR3-DZT	43.
Outlet Fillers	Pack of 10	1 1/4"	1/4"	2 1/2"	ROTRCF	35.



Order Code	Specification Information
Example: ROTRE12	
R	Reff Profiles
OT	Open Tables
R	Power Rail
E	Eight Wire (T=Ten Wire)
12	Width

Application Notes

Power Rails are suspended from a Power Rail Mounting Bracket attached to the Meeting Table rail sub-structure. Power Rails accept snap-in Duplex Outlets on each face and are enclosed by steel Raceway Covers, specified separately. Each end of a Power Rail has ports for two-jumper cables or a Power Infeed and a Jumper Cable. The Power Infeed connects power from the building supply and Jumpers connect power from one Power Rail to another, in either direction. Power Rails are available in Knoll Standard 2+2 (eight wire) or 3+3 (ten wire) power systems. Each power rail requires 1 set of Mounting Brackets (ordered separately); ROTRM - Mounting Brackets are black and supplied with mounting hardware. Outlet Fillers snap into Raceway Covers to cover un-used outlet openings. Outlet Fillers are supplied in black finish only.

Power Distribution components

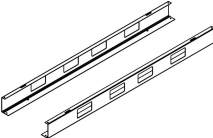
Power Rail Components for Meeting and Open Tables

description	type	w	d	h	pattern no.	list price
	For 12" wide power rail, outlets both sides	18"	3"	3"	ROTRC18D()	\$97.
	For 12" wide power rail, outlets one sides	18"	3"	3"	ROTRC18S()	97.
	For 24" wide power rail, outlets both sides	30"	3"	3"	ROTRC30D()	115.
	For 24" wide power rail, outlets one sides	30"	3"	3"	ROTRC30S()	115.
Raceway End Cap	Pack of 2				ROTRCE	17.
						
Covers for Exposed End of Power Rail					ROTRP	183.
	2 + 2 Modular Base Infeed	85"	2 1/8"	2 3/8"	ROTRIE	198.
	2 + 2 Modular Base Infeed for NYC	85"	2 1/8"	2 3/8"	ROTRIENY	616.
	3 + 3 Modular Base Infeed	85"	2 1/8"	2 3/8"	ROTRIT	229.
	3 + 3 Modular Base Infeed for NYC	85"	2 1/8"	2 3/8"	ROTRITNY	645.

Order Code	Specification Information	Application Notes
Example: ROTRC18D()		
R	Reff Profiles	
OT	Open Tables	
RC	Power Rail Raceway Cover	
18	Width	
D	Outlets both sides (S=Outlet single side)	
(118T)	Bright white paint (textured)	
		<p>Raceway End Caps finish the open end of two Raceway Covers.</p> <p>Cover for exposed end of Power Rail covers the end of the Power Rail that has no Jumper connected.</p> <p>Power Infeeds connect the Power Rail to the building power. They include a 6 foot liquid-tight conduit and pigtail for connection to a floor monument or wall electrical box.</p> <p>A hardwire Power Infeed, required in New York City, includes all required mounting brackets and hardware to mount vertically inside the Meeting Table Center Support; and includes a 6 foot connector with pigtails to connect to the building power.</p>

*Power Distribution components**Power Rail Components for Meeting and Open Tables*

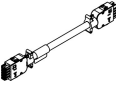
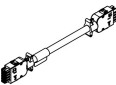
description	type	w	d	h	pattern no.	list price
 Jumper Cables 2 + 2	For 24" between power rails	24"	1"	1"	ROTRJE24	\$119.
	For 30" between power rails	30"	1"	1"	ROTRJE30	127.
	For 36" between power rails	36"	1"	1"	ROTRJE36	134.
	For 42" between power rails	42"	1"	1"	ROTRJE42	149.
	For 48" between power rails	48"	1"	1"	ROTRJE48	155.
	For 54" between power rails	54"	1"	1"	ROTRJE54	161.
	For 60" between power rails	60"	1"	1"	ROTRJE60	171.
	For 66" between power rails	66"	1"	1"	ROTRJE66	179.
	For 72" between power rails	72"	1"	1"	ROTRJE72	187.
 Jumper Cables 3 + 3	For 24" between power rails	24"	1"	1"	ROTRJT24	155.
	For 30" between power rails	30"	1"	1"	ROTRJT30	164.
	For 36" between power rails	36"	1"	1"	ROTRJT36	175.
	For 42" between power rails	42"	1"	1"	ROTRJT42	193.
	For 48" between power rails	48"	1"	1"	ROTRJT48	202.
	For 54" between power rails	54"	1"	1"	ROTRJT54	209.
	For 60" between power rails	60"	1"	1"	ROTRJT60	222.
	For 66" between power rails	66"	1"	1"	ROTRJT66	233.
	For 72" between power rails	72"	1"	1"	ROTRJT72	243.

Order CodeExample: **ROTRC18D()**

R	Reff Profiles
OT	Open Tables
RJ	Power Rail Jumper
E	Eight Wire (T=Ten Wire)
18	Width

Media Enclave Tables with 4 x 4 Leg

Wall mounted Rectangular - 28³/₈"h

description	d	w	th	pattern no.	L	M/V1	V2	V3
Table Top Rectangle, 48" Deep	48"	60"	1 1/2"	RMEW60482 () () () ()	\$1,822.	\$2,049.	\$2,118.	\$2,593.
Wall mounted, 1 piece top with 28 ³ / ₈ " height leg	48"	72"	1 1/2"	RMEW72482 () () () ()	1,990.	2,197.	2,277.	2,831.
	48"	90"	1 1/2"	RMEW90482 () () () ()	2,246.	2,443.	2,540.	3,211.
	48"	96"	1 1/2"	RMEW96482 () () () ()	2,287.	2,474.	2,578.	3,289.

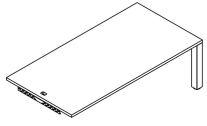

Table Top Rectangle, 60" Deep	60"	60"	1 1/2"	RMEW60602 () () () ()	2,403.	2,905.	3,005.	3,655.
Wall mounted, 2 piece tops with 28 ³ / ₈ " height leg	60"	72"	1 1/2"	RMEW72602 () () () ()	2,652.	3,150.	3,267.	4,022.
	60"	90"	1 1/2"	RMEW90602 () () () ()	3,036.	3,556.	3,695.	4,610.
	60"	96"	1 1/2"	RMEW96602 () () () ()	3,092.	3,600.	3,746.	4,715.

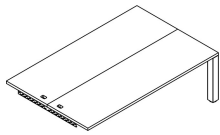
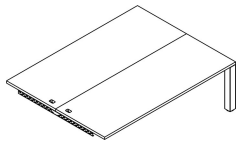

Table Top Rectangle, 72" Deep	72"	72"	1 1/2"	RMEW72722 () () () ()	2,757.	3,225.	3,360.	4,231.
Wall mounted, 2 piece tops with 28 ³ / ₈ " height leg	72"	90"	1 1/2"	RMEW90722 () () () ()	3,290.	3,767.	3,931.	4,987.
	72"	96"	1 1/2"	RMEW96722 () () () ()	3,357.	3,817.	3,989.	5,105.



Order Code	Specification Information	Application Notes
Example: RMEW60482 () () () ()	To order please specify pattern number including:	Table height = 28 ³ / ₈ "h to the underside of worksurface.
R Reff	1. Grommet Options: DG = Desk top grommet(s) only PC = power center grommet(s) centered *Upcharge of \$144 applies for each PC grommet	The tables on this page, come complete with structural frame. No additional stiffeners are required. Table's frame ships knockdown. Assembly required.
ME Media Enclave Table	2C = Drilling for 4 unit wide outlet	For laminate tops (including wood grain laminate) leg finish options are: all core paint finishes only.
W Wall mounted	3C = Drilling for 6 unit wide outlet	The product on this page accept wood grain laminate where laminate is currently an option.
60 Width	2. Grommet Finish: All core paint, PD, PU	For veneer tops, leg finish options are: all core paint finishes or same wood veneer as the top. The prices indicated above, are for painted legs without center grommet.
48 Depth	3. Worksurface finish: L, V1, V2, V3	*Upcharges apply to legs with V1, V2 or V3 finishes.
2 28 ³ / ₈ " h leg	4. Edge finish: L, V1, V2, V3 (Edge options are available on laminate tops only)	Additional upcharges:
DG Grommet option	5. Leg finish: All core paint or veneer to match top, where applicable.	Leg Finish Add
PD Grommet finish	6. Leg reveal finish: All core paint options.	V1 \$715
V316 Worksurface finish		V2 \$747
() Edge finish		V3 \$866
111 Leg finish		
111 Leg reveal finish		

Product on this page do not include electrical components
*Upcharge of \$144 applies for each Power Center grommet
Power center grommets (lids and sleeves) are included when PC is selected.
Note:
For 48" deep tables:
PC Option requires one PC electrical unit
2C Option requires one 4 unit wide Table drop in electrical unit
3C Options requires one 6 unit wide Table drop in electrical unit
For 60" deep tables:
PC Option requires two PC electrical unit
2C Option requires two 4 unit wide Table drop in electrical unit
3C Option requires two 6 unit wide Table drop in electrical unit
For electrical components, see page 345 to 347.

Installation instruction sheets available on Knoll Exchange. Refer to reference number 6TP00457.

Media Enclave Tables with 4 x 4 Leg

Freestanding Rectangular - 28^{3/8}"h

description	d	w	th	pattern no.	L	M/V1	V2	V3
Table Top Rectangle, 48" Deep	48"	60"	1 1/2"	RMEF60482 () () () ()	\$2,566.	\$2,858.	\$2,926.	\$3,402.
Freestanding, 1 piece top with 28 ^{3/8} " height leg	48"	72"	1 1/2"	RMEF72482 () () () ()	2,666.	2,939.	3,020.	3,574.
	48"	90"	1 1/2"	RMEF90482 () () () ()	2,842.	3,098.	3,196.	3,867.
	48"	96"	1 1/2"	RMEF96482 () () () ()	3,063.	3,310.	3,413.	4,126.

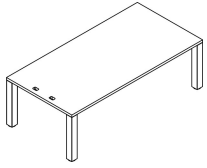

Table Top Rectangle, 60" Deep	60"	60"	1 1/2"	RMEF60602 () () () ()	3,227.	3,726.	3,825.	4,475.
Freestanding, 2 piece top with 28 ^{3/8} " height leg	60"	72"	1 1/2"	RMEF72602 () () () ()	3,430.	3,924.	4,040.	4,795.
	60"	90"	1 1/2"	RMEF90602 () () () ()	3,735.	4,253.	4,392.	5,307.
	60"	96"	1 1/2"	RMEF96602 () () () ()	3,971.	4,475.	4,623.	5,590.

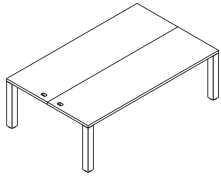
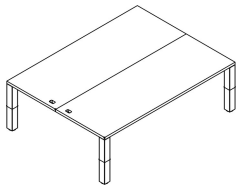

Table Top Rectangle, 72" Deep	72"	72"	1 1/2"	RMEF72722 () () () ()	3,654.	4,137.	4,272.	5,143.
Freestanding, 2 piece top with 28 ^{3/8} " height leg	72"	90"	1 1/2"	RMEF90722 () () () ()	3,945.	4,418.	4,581.	5,637.
	72"	96"	1 1/2"	RMEF96722 () () () ()	4,148.	4,603.	4,775.	5,892.



Order Code

Example:	RMEF60482 () () () ()
R	Reff
ME	Media Enclave Table
F	Freestanding
60	Width
48	Depth
2	28 ^{3/8} " h leg
DG	Grommet option
PD	Grommet finish
V316	Worksurface finish
()	Edge finish
111	Leg finish
111	Leg reveal finish

Specification Information

- To order please specify pattern number including:
- Grommet Options:
DG = Desk top grommet(s) only
PC = power center grommet(s) centered
*Upcharge of \$144 applies for each PC grommet
2C = Drilling for 4 unit wide outlet
3C = Drilling for 6 unit wide outlet
 - Grommet Finish:
All core paint, PD, PU
 - Worksurface finish: L, V1, V2, V3
 - Edge finish: L, V1, V2, V3 (Edge options are available on laminate tops only)
 - Leg finish: All core paint or veneer to match top, where applicable.
 - Leg reveal finish: All core paint options.

Application Notes

Table height = 28^{3/8}"h to the underside of worksurface.
The tables on this page, come complete with structural frame. No additional stiffeners are required. Table's frame ships knockdown. Assembly required.
For laminate tops (including wood grain laminate) leg finish options are: all core paint finishes only. The product on this page accept wood grain laminate where laminate is currently an option.
For veneer tops, leg finish options are: all core paint finishes or same wood veneer as the top. The prices indicated above, are for painted legs without center grommet.
*Upcharges apply to legs with V1, V2 or V3 finishes.
Additional upcharges:
Leg Finish Add
V1 \$1430
V2 \$1494
V3 \$1731

Product on this page do not include electrical components
*Upcharge of \$144 applies for each Power Center grommet
Power center grommets (lids and sleeves) are included when PC is selected.
Note:
For 48" deep tables:
PC Option requires one PC electrical unit
2C Option requires one 4 unit wide Table drop in electrical unit
3C Options requires one 6 unit wide Table drop in electrical unit
For 60" deep tables:
PC Option requires two PC electrical unit
2C Option requires two 4 unit wide Table drop in electrical unit
3C Option requires two 6 unit wide Table drop in electrical unit
For electrical components, see page 345 to 347.

Installation instruction sheets available on Knoll Exchange. Refer to reference number 6TP00458.

Center Column Tables

Center column tables have a single column support centered upon a base plate. See **Figure 1**.

Scope of Nominal Sizes

Round

36", 42"

Soft Square / Square:

36", 42"

Soft Rectangular / Rectangular

30"x48", 36"x54"

Sliding Tables



Round

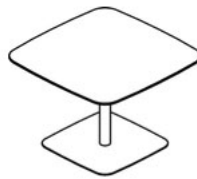

Soft Square



Soft Rectangular

Height Adjustable Sliding Tables



Round

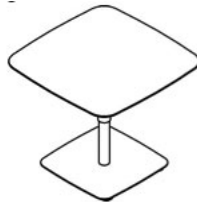

Soft Square



Soft Rectangular

Fixed Height Column Base Tables



Round

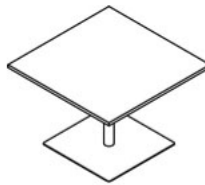

Square

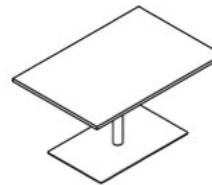

Rectangular

Height Adjustable Column Base Tables



Round

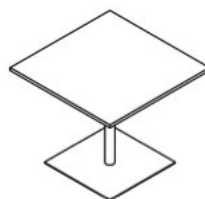

Square

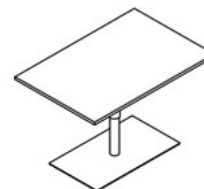

Rectangular

Figure 1: Table Types

Center Column Tables, cont'd

Construction Features

Worksurface Tops

All center column tables have 1" thick tops. Grommets are not available for these tables. Sliding Tables, both fixed height and height adjustable are available in three organically shaped tops; round, soft square and soft rectangular. Column Base Tables are available in geometric shapes; round, square and rectangular. See **Figure 2** for shapes and sizes. Worksurfaces are supplied with pilot holes pre-drilled to help center the leg in its design position. The worksurface top is field attached to the column base using wood screws supplied.

Center column tables have two styles of edge profile. Sliding Tables have a beveled edge with a half round under-cut to improve finger grip and ease the sliding of the table from one location to another. See **Figure 3**. The fixed height and height adjustable Column Base Tables have a square edge profile and no finger grip. See **Figure 4**. Refer to Worksurface planning guide pages for tops construction details.

Tops, vertical column supports and base plates are shipped in separate packages.

Column Base

Column bases consist of a vertical support column with a factory connected steel top plate which is field connected to a steel base plate using three hex bolts. The base plate is shaped to match the worksurface top shape. See **Figure 5**.

Fixed Height - The fixed height vertical support consists of a steel 3" diameter column, factory connected to a 10" square top plate.

Height Adjustable - The vertical support consists of a pneumatically activated adjustable height column, factory connected to an 11 3/4" square top plate. The upper column diameter is 3 1/2". The lower column diameter is 3".

Four 3 3/4" diameter nylon leveling glides are supplied with the table. Glides have a Teflon base to aide with movement over carpet. Glides have 3/8" height adjustment. With the glides in their fully closed position, the top of the base plate is 1 9/16" above the floor level.

Finish Details

All worksurface tops are available in all core laminates, wood grain laminates, mixed finish (laminated top with wood edges) and all core veneer finishes. Sliding Table worksurface tops are also available with Solid Surface material option in Arctic White.

For Sliding Tables with beveled edge, depending upon the top finish selected, the beveled surface will have the following finish:

Top Finish	Bevel Finish
Laminate	Clear Coat
V1, V2, V3	Veneer - to match top
Solid Surface	Solid Surface - to match top

The Column Base is available in all core paint finishes. The vertical column has a smooth finish while the base plate has a textured finish in the same color as the column. The column top plate is painted black. The glides are black.

Sliding Tables - Fixed height and Height Adjustable

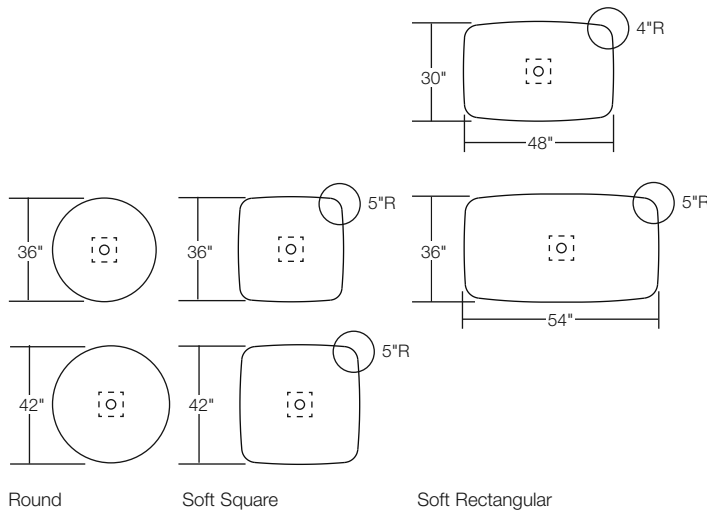

Column Base Tables - Fixed height and Height Adjustable

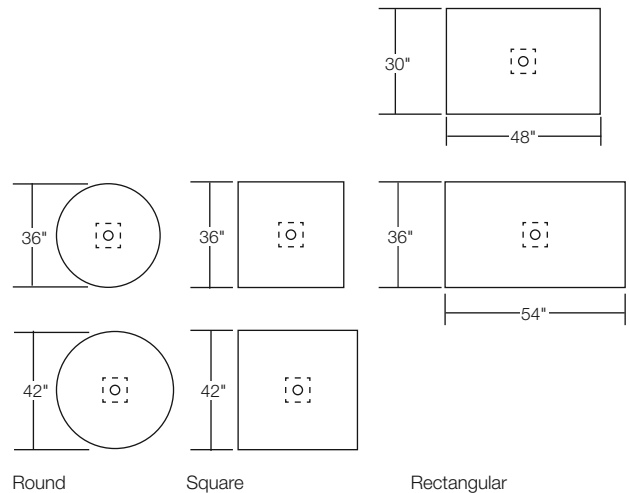

Figure 2: Worksurface Tops

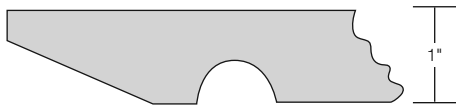
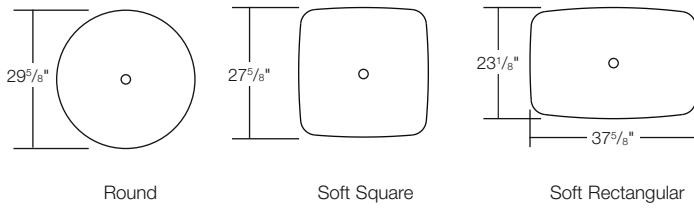

Figure 3: Sliding Table edge detail



Figure 4: Column Base Tables edge detail

Sliding Tables - Fixed height and Height Adjustable



Column Base Tables - Fixed height and Height Adjustable

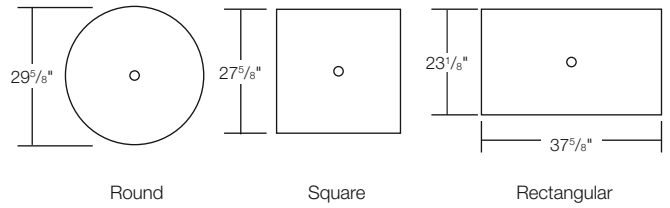





Figure 5: Base Plate

Center Column Tables - Sliding Laminate Surface, 1" Thick, Beveled Edges

description	d	w	th	pattern no.	L
 Round Table with 28 ³ / ₈ " height legs	36"		1"	RSTRLE362() ()	\$3,266.
	42"		1"	RSTRLE422() ()	3,329.
 Soft Square Table with 28 ³ / ₈ " height legs	36"		1"	RSTSLE362() ()	3,237.
	42"		1"	RSTSLE422() ()	3,306.
 Soft Rectangle Table with 28 ³ / ₈ " height legs	30"	48"	1"	RSTTLE30482() ()	3,053.
	36"	54"	1"	RSTTLE36542() ()	3,133.

Order Code	Specification Information	Application Notes
Example: RSTRLE361 () ()	To order please specify pattern number including:	It is not advisable to mix 28 ³ / ₈ "h desk height product with 26 ¹ / ₂ "h standard height products.
R Reff	1. Worksurface finish: Laminate only	Grommets are <u>NOT</u> an option for these tables.
ST Sliding Table	2. Edge finish: L, V1, V2, V3 (Edge options are available on laminate tops only.)	Column and base are color matched.
R Round	3. Leg Textured finish: All core paint colors.	Column = smooth
L Laminate surface		Base = textured
E 1" thick		The underside of sliding table tops are routed with a finger pull groove for easy movement.
42 42" diameter		The soft square and soft rectangular worksurfaces have softly curved sides.
2 28 ³ / ₈ " height		
114 Finish		
() Edge finish		
118T Leg Finish		

Center Column Tables - Sliding Wood Surface, 1" Thick, Beveled Edges

description	d	w	th	pattern no.	V1	V2	V3
Round Table with 28 ³ / ₈ " height legs	36"		1"	RSTRWE362()()	\$3,543.	\$3,597.	\$3,870.
	42"		1"	RSTRWE422()()	3,613.	3,685.	4,024.



Soft Square Table with 28 ³ / ₈ " height legs	36"		1"	RSTSWE362()()	3,514.	3,568.	3,864.
	42"		1"	RSTSWE422()()	3,587.	3,657.	4,024.

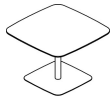



Soft Rectangle Table with 28 ³ / ₈ " height legs	30"	48"	1"	RSTTWE30482()()	3,314.	3,372.	3,694.
	36"	54"	1"	RSTTWE36542()()	3,400.	3,476.	3,871.



Order Code	Specification Information	Application Notes
Example: RSTRWE361 ()()	To order please specify pattern number including: 1. Worksurface finish V1, V2, V3 wood only 2. Leg Textured finish: All core paint colors.	It is not advisable to mix 28 ³ / ₈ "h desk height product with 26 ¹ / ₂ "h standard height products. Table height = 28 ³ / ₈ "h to the underside of worksurface. Assembly required, ships knock down. Grommets are <u>NOT</u> optional for these tables. Column and base are color matched. Column = smooth Base = textured The underside of sliding table tops are routed with a finger pull groove for easy movement. The soft square and soft rectangular worksurfaces have softly curved sides.
R Reff		
ST Sliding Table		
R Round		
W Wood surface		
E 1" thick		
42 42" diameter		
2 28 ³ / ₈ " height		
V316 Finish		
111T Leg Finish		

Center Column Tables - Sliding Solid Surface, 1" Thick, Beveled Edges

description	d	w	th	pattern no.	Solid
Round Table with 28 ³ / ₈ " height legs 	36"		1"	RSTRSE362 ()()	\$8,913.
	42"		1"	RSTRSE422 ()()	10,213.
Soft Square Table with 28 ³ / ₈ " height legs 	36"		1"	RSTSSE362 ()()	7,969.
	42"		1"	RSTSSE422 ()()	9,400.
Soft Rectangle Table with 28 ³ / ₈ " height legs 	30"	48"	1"	RSTTSE30482 ()()	9,822.
	36"	54"	1"	RSTTSE36542 ()()	10,891.

Order Code	Specification Information	Application Notes
Example: RSTRSE361 ()()	To order please specify pattern number including: 1. Worksurface finish: AW=Artic White, only 2. Leg finish Textured: All core paint colors.	It is not advisable to mix 28 ³ / ₈ "h desk height product with 26 ¹ / ₂ "h standard height products. Table height = 28 ³ / ₈ "h to the underside of worksurface. Assembly required. ships knocked down. Grommets are <u>NOT</u> optional for these tables. Column and base are color matched. Column = smooth Base = textured The underside of sliding table tops are routed with a finger pull groove for easy movement. The soft square and soft rectangular worksurfaces have softly curved sides. Artic White finish available for solid tops.
R Reff		
ST Sliding Table		
R Round		
S Solid		
E 1" thick		
42 42" diameter		
2 28 ³ / ₈ " height		
AW Worksurface finish		
111T Leg Finish		

Center Column Tables - Fixed Height with Column Base Leg^{Reff} Profiles Vol. Two

Laminate Surface, 1" Thick, Square Edges

description	d	w	th	pattern no.	L
Round Column Base Table with 28 ³ / ₈ " height legs	36"		1"	RCTRLE362()()	\$2,462.
	42"		1"	RCTRLE422()()	2,524.



Square Column Base Table with 28 ³ / ₈ " height legs	36"	36"	1"	RCTSLE362()()	2,616.
	42"	42"	1"	RCTSLE422()()	2,682.

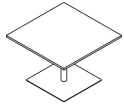

Rectangle Column Base Table with 28 ³ / ₈ " height legs	30"	48"	1"	RCTTLE30482()()	2,546.
	36"	54"	1"	RCTTLE36542()()	2,597.

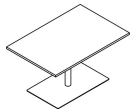

Order Code	Specification Information	Application Notes
Example: RCTRLE362()()	<i>To order please specify pattern number including:</i>	It is not advisable to mix 28 ³ / ₈ "h desk height product with 26 ¹ / ₂ "h standard height products.
R Reff	1. Worksurface finish: Laminate	Table height = 28 ³ / ₈ "h to the underside of worksurface.
CT Column Table	2. Edge finish: L, V1, V2, V3 (Edge options are available on laminate tops only.)	Product on this page will accept woodgrain laminate where laminate is currently an option.
S Square	3. Leg finish: All core paint colors.	Assembly required, ships knocked down.
L Laminate surface	Column and base are color matched.	Grommets are <u>NOT</u> an option for these tables.
E 1" thick	Column = smooth	There are no grooves for finger pull, underside of the table tops.
42 42" deep	Base = textured	The square and Rectangular worksurfaces have straight edges.
2 28 ³ / ₈ " height leg		
114 Work surface finish		
() Edge finish		
118T Base Finish		

Center Column Tables - Fixed Height with Column Base Leg^{Reff} Profiles Vol. Two

Wood Surface, 1" Thick, Square Edges

description	d	w	th	pattern no.	V1	V2	V3
Round Column Base Table with 28 ³ / ₈ " height legs	36"		1"	RCTRWE362 () ()	\$2,778.	\$2,806.	\$2,962.
	42"		1"	RCTRWE422 () ()	2,824.	2,860.	3,076.



Square Column Base Table with 28 ³ / ₈ " height legs	36"	36"	1"	RCTSWE362 () ()	2,738.	2,783.	2,966.
	42"	42"	1"	RCTSWE422 () ()	2,812.	2,868.	3,140.

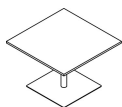

Rectangle Column Base Table with 28 ³ / ₈ " height legs	30"	48"	1"	RCTTWE30482 () ()	2,675.	2,723.	2,942.
	36"	54"	1"	RCTTWE36542 () ()	2,769.	2,830.	3,142.

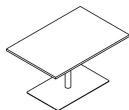

Order Code	Specification Information	Application Notes
Example: RCTRWE362 () ()	<i>To order please specify pattern number including:</i>	It is not advisable to mix 28 ³ / ₈ "h desk height product with 26 ¹ / ₂ "h standard height products.
R Reff	1. Worksurface finish: V1, V2, V3	
CT Column Table	2. Leg finish: All core paint colors.	Table height = 28 ³ / ₈ "h to the underside of worksurface.
S Square	Column and base are color matched.	Product on this page will accept woodgrain laminate where laminate is currently an option.
W Wood surface	Column = smooth	Assembly required, ships knocked down.
E 1" thick	Base = textured	
42 42" deep		Grommets are <u>NOT</u> an option for these tables.
2 28 ³ / ₈ " height leg		There are no grooves for finger pull, underside of the table tops.
V316 Work surface finish		The square and Rectangular worksurfaces have straight edges.
118T Base Finish		

Center Column Tables - Height Adjustable Sliding Laminate Surface, 1" Thick, Beveled Edges

description	d	w	th	pattern no.	L
Round Sliding Table with height adjustable base	36"		1"	RSTRLE363 ()()	\$4,332.
	42"		1"	RSTRLE423 ()()	4,395.

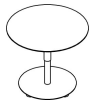

Soft Square Sliding Table with height adjustable base	36"	36"	1"	RSTSLE363 ()()	4,303.
	42"	42"	1"	RSTSLE423 ()()	4,372.

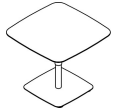

Soft Rectangle Sliding Table with height adjustable base	30"	48"	1"	RSTTLE30483 ()()	4,119.
	36"	54"	1"	RSTTLE36543 ()()	4,199.



Order Code	Specification Information	Application Notes
Example: RSTRLE363 ()()	<i>To order please specify pattern number including:</i>	It is not advisable to mix 28 ³ / ₈ "h desk height product with 26 ¹ / ₂ "h standard height products.
R Reff	1. Worksurface finish: Laminate	
ST Sliding Table	2. Edge finish: L, V1, V2, V3 (Edge options are available on laminate tops only.)	Height range is from 27" - 42" to the underside of worksurface.
R Round, S=Square, T=Rectangle	3. Base textured finish: All core paint colors.	
L Laminate surface		Product on this page will accept woodgrain laminate where laminate is currently an option.
E 1" thick		
30 30" deep		Assembly required, ships knock down.
48 48" wide		
3 Height Adjustable Base		Grommets are <u>NOT</u> optional for these tables.
114 Work surface finish		
() Edge finish		Load capacity for Height Adjustable tables is 200 lbs, functional load.
118T Base Finish		
		Column and base are color matched. Column = smooth Base = textured
		The underside of table tops are routed with a finger pull groove for easy movement.
		The soft square and soft rectangular worksurfaces have softly curved sides.

Center Column Tables - Height Adjustable Sliding Wood Surface, 1" Thick, Beveled Edges

description	d	w	th	pattern no.	V1	V2	V3
Round Sliding Table with height adjustable base	36"		1"	RSTRWE363()()	\$4,609.	\$4,663.	\$4,936.
	42"		1"	RSTRWE423()()	4,679.	4,751.	5,090.

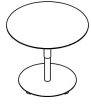

Soft Square Sliding Table with height adjustable base	36"	36"	1"	RSTSWE363()()	4,580.	4,634.	4,930.
	42"	42"	1"	RSTSWE423()()	4,654.	4,723.	5,090.

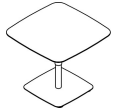

Soft Rectangle Sliding Table with height adjustable base	30"	48"	1"	RSTTWE30483()()	4,380.	4,438.	4,760.
	36"	54"	1"	RSTTWE36543()()	4,466.	4,542.	4,937.

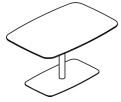

Order Code	Specification Information
Example: RSTRWE363()()	
R	Reff
ST	Sliding Table
R	Round, S=Square, T=Rectangle
W	Wood surface
E	1" thick
30	30" deep
48	48" wide
3	Height Adjustable Base
V316	Maple work surface finish
111T	Base Finish

Specification Information

To order please specify pattern number including:

1. Worksurface finish:
V1, V2, V3
2. Base textured finish:
All core paint colors.

It is not advisable to mix 28³/₈"h desk height product with 26¹/₂"h standard height products.

Height range is from 27" - 42" to the underside of worksurface.

Assembly required, ships knock down.

Application Notes

Grommets are NOT optional for these tables.

Load capacity for Height Adjustable tables, is 200 lbs, functional load.

Column and base are color matched.
Column = smooth
Base = textured

The underside of sliding table tops are routed with a finger pull groove for easy movement.

The soft square and soft rectangular worksurfaces have softly curved sides.

Center Column Tables - Height Adjustable Sliding Solid Surface, 1" Thick, Beveled Edges

description	d	w	th	pattern no.	Solid
Round Sliding Table with height adjustable base	36"		1"	RSTRSE363 ()()	\$9,979.
	42"		1"	RSTRSE423 ()()	11,279.

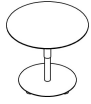

Soft Square Sliding Table with height adjustable base	36"	36"	1"	RSTSSE363 ()()	9,035.
	42"	42"	1"	RSTSSE423 ()()	10,466.

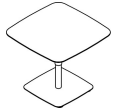

Soft Rectangle Sliding Table with height adjustable base	30"	48"	1"	RSTTSE30483 ()()	10,888.
	36"	54"	1"	RSTTSE36543 ()()	11,957.



Order Code	Specification Information	Application Notes
Example: RSTRSE363 ()()	<i>To order please specify pattern number including:</i>	It is not advisable to mix 28 ³ / ₈ "h desk height product with 26 ¹ / ₂ "h standard height products.
R Reff	1. Worksurface finish: Solid Finish only AW = Artic White	Height range is from 27" - 42" to the underside of worksurface.
ST Sliding Table	2. Base textured finish: All core paint colors.	Assembly required, ships knock down.
R Round, S=Square, T=Rectangle		Grommets are <u>NOT</u> optional for these tables.
S Solid surface		Load capacity for Height Adjustable tables, is 200 lbs, functional load.
E 1" thick		Column and base are color matched. Column = smooth Base = textured
30 30" deep		The underside of sliding table tops are routed with a finger pull groove for easy movement.
48 48" wide		The soft square and soft rectangular worksurfaces have softly curved sides.
3 Height Adjustable Base		Artic White finish available for Solid Tops.
AW Solid Table finish		
118T Base Finish		

Center Column Tables - Height Adjustable

Laminate Surface, 1" Thick, Square Edges

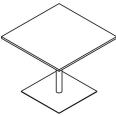
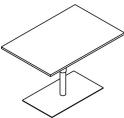
description	d	w	th	pattern no.	L
Round Table with height adjustable base 	36"		1"	RCTRLE363 () ()	\$3,338.
	42"		1"	RCTRLE423 () ()	3,387.
Square Table with height adjustable base 	36"	36"	1"	RCTSLE363 () ()	3,431.
	42"	42"	1"	RCTSLE423 () ()	3,479.
Rectangle Table with height adjustable base 	30"	48"	1"	RCTTLE30483 () ()	3,378.
	36"	54"	1"	RCTTLE36543 () ()	3,414.

Order Code	Specification Information	Application Notes
Example: RCTRLE363 () ()	<i>To order please specify pattern number including:</i> 1. Worksurface finish: Laminate 2. Edge finish: L, V1, V2, V3 (Edge options are available on laminate tops only.) 3. Base Textured finish: All core paint colors.	It is not advisable to mix 28 ³ / ₈ "h desk height product with 26 ¹ / ₂ "h standard height products. Height range is from 27"-42" to the underside of worksurface. Product on this page will accept woodgrain laminate where laminate is currently an option. Assembly required, ships knocked down. Grommets are <u>NOT</u> an option for these tables. Load capacity for Height Adjustable tables is 200 lbs, functional load. Column and base are color matched. Column = smooth Base = textured The tops have the standard square edge. There are no grooves for finger pull, underside of the table tops. The square and Rectangular worksurfaces have straight edges.
R Reff		
CT Column Table		
R Round, S=Square, T=Rectangle		
L Laminate surface		
E 1" thick		
30 30" deep		
48 48" wide		
3 Height Adjustable Base		
114 Work surface finish		
() Edge finish		
118T Base Finish		

Center Column Tables - Height Adjustable

Wood Surface, 1" Thick, Square Edges

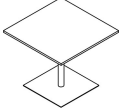
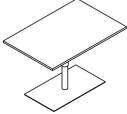
description	d	w	th	pattern no.	V1	V2	V3
Round Table with height adjustable base 	36"		1"	RCTRWE363() ()	\$3,604.	\$3,647.	\$3,836.
	42"		1"	RCTRWE423() ()	3,648.	3,704.	3,945.
Square Table with height adjustable base 	36"	36"	1"	RCTSWE363() ()	3,597.	3,641.	3,828.
	42"	42"	1"	RCTSWE423() ()	3,649.	3,705.	3,946.
Rectangle Table with height adjustable base 	30"	48"	1"	RCTTWE30483() ()	3,586.	3,634.	3,840.
	36"	54"	1"	RCTTWE36543() ()	3,625.	3,687.	3,948.

Order Code

Example: RSTRWE363 () ()
R Reff
ST Sliding Table
R Round, S=Square, T=Rectangle
W Wood surface
E 1" thick
30 30" deep
48 48" wide
3 Height Adjustable Base
V316 Maple work surface finish
111T Base Finish

Specification Information

To order please specify pattern number including:

1. Worksurface finish: V1, V2, V3
2. Base Textured finish: All core paint colors.

It is not advisable to mix 28^{3/8}"h desk height product with 26^{1/2}"h standard height products.

Height range is from 27"-42" to the underside of worksurface.

Assembly required, ships knocked down.

Application Notes

Grommets are NOT an option for these tables.

Load capacity for Height Adjustable tables is 200 lbs, functional load.

Column and base are color matched.
Column = smooth
Base = textured



The tops have the standard square edge.

There are no grooves for finger pull, underside of the table tops.

The square and Rectangular worksurfaces have straight edges.

Top support components

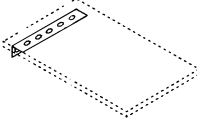
Bracketry

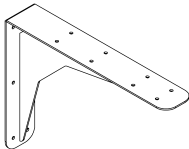
description	d	pattern no.	P1& black only	P2	P3
Panel to pedestal bracket		RBPP (L/R)	\$8.		
	Black only				
Top to top bracket	6" x 1"	RBFP (Pair)	5.		
	Black only				
Wall hung support bracket	20"	RSBWH20	45.	49.	51.
	24"	RSBWH24	47.	52.	55.
	30"	RSBWH30	51.	56.	59.
	36"	RSBWH36	57.	64.	67.
	42"	RSBWH42	60.	67.	70.
	48"	RSBWH48	74.	81.	85.
	Specify paint finish				
Z-bracket for bridge applications		RBZ (A/B) (Pair)	36.		
	Black only				
Mid-span cantilever bracket, free standing	17"	RMSCB ()	80.	93.	98.
					

Order Code

Example: RMSCB	
R	Reff
MS	Mid Span
CB	Cantilever Bracket
()	Finish

L brackets may be used in off module applications for L bases, T bases and half depth end panels.

Specification Information

To order please specify pattern number including:

1. Finish - () - Painted Finish

When planning with Reff overheads half depth and panel may be required for additional support. Refer to pages 32 and 33 in the Planning Guide.

Application Notes

For wood tops black bracketry is recommended.

Utility bracket for use in securing free end of modesty on D and P tops when a return panel is not used or for T-bases in off module application.



Knoll takes no responsibility for the installation or security of tops to the wall.

Cantilever should be specified with top to top brackets.

Cantilevers can be used for corner worksurfaces or to join two adjacent straight worksurfaces together.

Top support components

Bracketry

description	d	pattern no.	P1& black only	P2	P3
Modesty panel offset bracket Required to join modesty panel to end panel of adjacent top assembly - order separately.		RBPR (Pair)	\$7.	\$8.	\$9.
		Specify paint finish			
					
Panel to storage tower bracket Used to attach office tower to panels.		RBPS (L/R)	11.	12.	13.
		Specify paint finish			
Utility bracket		RUTB	11.		
		Black only			
L Bracket for off-module applications		R113B	5.		
		One by one by three bracket			
Worksurface to cabinet bracket for 24" worksurface		RBWC24	58.	0.	0.
		bracket can be used with 20" and 24" worksurface			
Worksurface to cabinet bracket for 30" worksurface		RBWC30	64.	0.	0.
		bracket can be used with 30" and 36" worksurface			

Order Code	Specification Information	Application Notes
Example: RMSCB	<i>To order please specify pattern number including:</i>	For wood tops black bracketry is recommended.
R Reff	1. Finish - () - Painted Finish	Utility bracket for use in securing free end of modesty on D and P tops when a return panel is not used or for T-bases in off module application.
MS Mid Span	When planning with Reff overheads half depth and panel may be required for additional support. Refer to pages 32 and 33 in the Planning Guide.	Cantilever should be specified with top to top brackets.
CB Cantilever Bracket		Cantilevers can be used for corner worksurfaces or to join two adjacent straight worksurfaces together.
() Finish		
L brackets may be used in off module applications for L bases, T bases and half depth end panels.		Knoll takes no responsibility for the installation or security of tops to the wall.

Top support components
 28³/₈" high planning
 Modesty

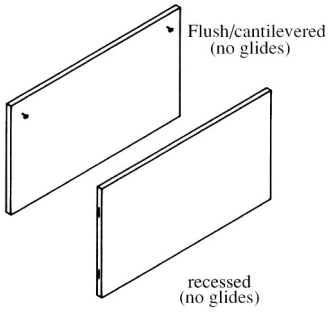
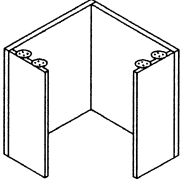
description	d	w	h	pattern no.	L	V1	V2	V3
 <p>Flush/cantilevered (no glides)</p> <p>recessed (no glides)</p>	Modesty panels with hardware (desk height)							
	1"	24"	28 ³ / ₈ "	RBDH24M(F/R) ()()	\$172.	\$248.	\$284.	\$381.
	1"	30"	28 ³ / ₈ "	RBDH30M(F/R) ()()	311.	445.	511.	689.
	1"	36"	28 ³ / ₈ "	RBDH36M(F/R) ()()	345.	486.	557.	751.
	1"	42"	28 ³ / ₈ "	RBDH42M(F/R) ()()	371.	527.	608.	820.
	1"	48"	28 ³ / ₈ "	RBDH48M(F/R) ()()	417.	593.	682.	921.
	1"	54"	28 ³ / ₈ "	RBDH54M(F/R) ()()	437.	622.	713.	962.
	1"	60"	28 ³ / ₈ "	RBDH60M(F/R) ()()	454.	639.	737.	995.
	1"	66"	28 ³ / ₈ "	RBDH66M(F/R) ()()	470.	669.	774.	1,044.
	1"	72"	28 ³ / ₈ "	RBDH72M(F/R) ()()	519.	737.	848.	1,144.
	1"	78"	28 ³ / ₈ "	RBDH78M(F/R) ()()	555.	782.	907.	1,225.
	1"	84"	28 ³ / ₈ "	RBDH84M(F/R) ()()	587.	832.	956.	1,290.
	1"	90"	28 ³ / ₈ "	RBDH90M(F/R) ()()	621.	880.	1,013.	1,367.
	1"	96"	28 ³ / ₈ "	RBDH96M(F/R) ()()	633.	904.	1,037.	1,401.
	 <p>ships with glides</p>	Desk height corner worksurface support						
36"		36"	28 ³ / ₈ "	RBDH3636 ()()	1,125.	1,687.	1,943.	2,621.
36"		42"	28 ³ / ₈ "	RBDH3642 ()()	1,150.	1,731.	1,991.	2,689.
36"		48"	28 ³ / ₈ "	RBDH3648 ()()	1,199.	1,796.	2,061.	2,784.
42"		36"	28 ³ / ₈ "	RBDH4236 ()()	1,150.	1,731.	1,991.	2,689.
42"		42"	28 ³ / ₈ "	RBDH4242 ()()	1,179.	1,771.	2,040.	2,753.
42"		48"	28 ³ / ₈ "	RBDH4248 ()()	1,227.	1,835.	2,116.	2,858.
48"		36"	28 ³ / ₈ "	RBDH4836 ()()	1,199.	1,796.	2,061.	2,784.
48"		42"	28 ³ / ₈ "	RBDH4842 ()()	1,227.	1,835.	2,116.	2,858.
48"	48"	28 ³ / ₈ "	RBDH4848 ()()	1,273.	1,904.	2,205.	2,978.	

depth = left return, width = right return

Order Code	Specification Information	Application Notes
Example: RBDH24MFL114	<i>To order please specify pattern number including:</i>	<p>It is not advisable to mix 28³/₈"h desk height product with 26¹/₂"h standard height products.</p> <p>Product on this page will accept wood grain laminate where laminate is currently an option. For more information on grain direction on vertical surfaces, please see page 5. Modesty panels and end panels ship with all hardware necessary to attach to tops and each other to build freestanding desks. To join tops to tops or bridge assemblies to desk, hardware must be ordered separately.</p>
R Reff	1. <i>Modesty placement</i> F = Flush, cantilevered R = Recessed	
B Back panel/modesty	2. <i>Finish type</i> L = laminate 1 = V1 2 = V2 3 = V3	
DH Desk height (28 ³ / ₈ ")	3. <i>Finish</i>	<p>Modesty support for corner worksurface includes 12" deep end panels to support in freestanding applications.</p> <p>Modesty panel lengths are nominal, length changes on option selected.</p> <p>* Half depth end panels</p> <p>Please see Reff Planning Guide for freestanding planning instructions.</p>
24 24"		
M Full height modesty		
F Modesty placement, flush		
L Finish type, laminate		
114 Finish, Folkstone grey		

Top support components
 28³/₈" high planning
 End panels

description	d	w	h	pattern no.	L	V1	V2	V3
Desk height end panels with hardware for recessed modesty worksurfaces (sold in pairs)	1"	30"	28 ³ / ₈ "	REDH30 () ()	\$533.	\$875.	\$1,006.	\$1,358.
	1"	36"	28 ³ / ₈ "	REDH36 () ()	562.	916.	1,051.	1,420.

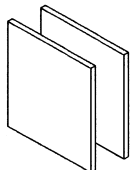

Desk height end panel for panel (hardware included)	1"	13"	28 ³ / ₈ "	RSEDH1(L/R) () ()	203.	361.	410.	555.
	1"	16"	28 ³ / ₈ "	RSEDH2(L/R) () ()	218.	379.	439.	593.
	1"	20"	28 ³ / ₈ "	RSEDH3(L/R) () ()	236.	398.	457.	617.
	1"	24"	28 ³ / ₈ "	RSEDH4(L/R) () ()	249.	416.	480.	650.
	1"	30"	28 ³ / ₈ "	RSEDH5(L/R) () ()	264.	442.	504.	681.
	1"	36"	28 ³ / ₈ "	RSEDH6(L/R) () ()	282.	457.	527.	712.

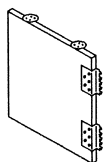

left hand shown

Desk height end panels with hardware for building flush or cantilevered worksurfaces	1"	12"	28 ³ / ₈ "	REDH12F () () *	203.	361.	410.	555.
	1"	15"	28 ³ / ₈ "	REDH15F () () *	218.	379.	439.	593.
	1"	19"	28 ³ / ₈ "	REDH19F () ()	236.	398.	457.	617.
	1"	23"	28 ³ / ₈ "	REDH23F () ()	249.	416.	480.	650.
	1"	29"	28 ³ / ₈ "	REDH29F () ()	264.	442.	504.	681.

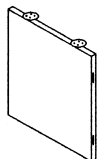

Order Code

Example: REDH30	
R	Reff
E	End panel
DH	Desk height (28 ³ / ₈ ")
30	30"
L	Left hand
L	Finish type, laminate
114	Finish, Folkstone grey

Specification Information

To order please specify pattern number including:

1. *Finish type*
 L = laminate
 1 = V1
 2 = V2
 3 = V3
2. *Finish*

Application Notes

It is not advisable to mix 28³/₈"h desk height product with 26¹/₂"h standard height products.

Product on this page will accept wood grain laminate where laminate is currently an option. For more information on grain direction on vertical surfaces, please see page 5. Modesty panels and end panels ship with all hardware necessary to attach to tops and each other to build freestanding desks. To join tops to tops or bridge assemblies to desk, hardware must be ordered separately.

Modesty support for corner worksurface includes 12" deep end panels to support in freestanding applications.

* Half depth end panels

Please see Reff Planning Guide for freestanding planning instructions.

Top support components

28³/₈" high planning

Modesty and Bulkhead

description	d	w	h	pattern no.	L	V1	V2	V3
Desk height bow top front, short modesty (pedestals ordered separately)	1"	40"	28 ³ / ₈ "	RBDH40MR () ()	\$371.	\$527.	\$608.	\$820.
	1"	52"	28 ³ / ₈ "	RBDH52MR () ()	437.	622.	713.	962.
	1"	64"	28 ³ / ₈ "	RBDH64MR () ()	470.	669.	774.	1,044.

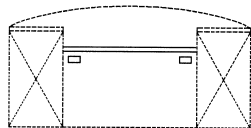

Use of short modesty panel

Pedestals and finished back for pedestal must each be ordered separately
 Short modesty comes with attachment brackets to secure modesty panel to sides of pedestals.
 Order:
 40" modesty for 72" bow top
 52" modesty for 84" bow top
 64" modesty for 96" bow top
 When ordering 30"d bow top for use with short modesty, specify **recessed** grommet location
 When ordering 36"d bow top for use with short modesty, specify **alternate** grommet location

Desk height bulkhead (false pedestal)	24"	16"	28 ³ / ₈ "	REDHBH124 () ()	524.	873.	1,013.	1,367.
	30"	16"	28 ³ / ₈ "	REDHBH130 () ()	542.	890.	1,037.	1,401.

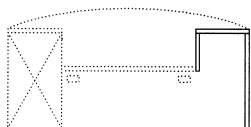





Bulkhead takes the place of a pedestal in applications using the short modesty panel but not requiring a double pedestal application

Order Code	Specification Information	Application Notes
Example: RBDH40MR	<i>To order please specify pattern number including:</i>	<p>It is not advisable to mix 28³/₈" desk height product with 26¹/₂" standard height products.</p> <p>Modesty panels and end panels ship with all hardware necessary to attach to tops and each other to build freestanding desks. To join tops to tops or bridge assemblies to desk, hardware must be ordered separately.</p> <p>Product on this page will accept wood grain laminate where laminate is currently an option. For more information on grain direction on vertical surfaces, please see page 5.</p>
R Reff	1. <i>Modesty placement</i> F = Flush, cantilevered R = Recessed	
B Back panel/modesty	2. <i>Finish type</i> L = laminate 1 = V1 2 = V2 3 = V3	
DH Desk height (28 ³ / ₈ ")	3. <i>Finish</i>	<p>Modesty support for corner worksurface includes 12" deep end panels to support in freestanding applications.</p> <p>Modesty panel lengths are nominal.</p> <p>Glides ship with all supports on this page except the recessed modesty panel.</p> <p>Please see Reff Planning Guide for freestanding planning instructions.</p>
40 Width		
M Full height modesty		
R Modesty placement, recessed		
L Finish type, laminate		
114 Finish, Folkstone grey		

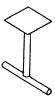
Top support components

Legs, Painted or Plated, 28³/₈" high planning

description	dia.	d	w	h	pattern no.	P1	P2	P3	P4
T-Leg, plain tube style (desk height) 		20"	–	28 ³ / ₈ "	RCDHB20T () ()	\$438.	\$482.	\$505.	\$591.
		24"	–	28 ³ / ₈ "	RCDHB24T () ()	447.	492.	517.	601.
		30"	–	28 ³ / ₈ "	RCDHB30T () ()	492.	541.	568.	646.
		40"	–	28 ³ / ₈ "	RCDHB40T () ()	521.	573.	602.	674.
Ships with wood screws for fastening to underside of worksurface into pilot hole location. Painted and PD, PT and PZ plated finishes.									
Set of four column legs (3" dia.) with casters with triangular plates (desk height) 	3"	–	–		RSDHCC4 ()	1,495.	1,645.	1,727.	2,118.
Painted, PD and PU plated finishes.									
Set of 4 Column legs 	2 1/2"	–		28 ³ / ₈ "	RSDHC254 ()	960.	1,057.	1,109.	1,731.
	3"	–		28 ³ / ₈ "	RSDHC304 ()	1,027.	1,130.	1,186.	1,808.
	4"	–		28 ³ / ₈ "	RSDHC404 ()	1,188.	1,307.	1,372.	1,995.
Support Column, 3" dia. 				28 ³ / ₈ "	RSDHC3 () ()	343.	377.	396.	497.
Painted and PD and PU plated finishes.									

Order Code	Specification Information	Application Notes
Example: RSDHCP111	<i>To order please specify pattern number including:</i>	It is NOT advisable to mix 28³/₈" desk height product with 26 1/2" standard height product.
R Reff	1. <i>Finish Type, where applicable</i> P = Paint (P1, P2, P3)	The plain cylinder and the tube legs can be ordered in plated and painted finishes.
S Support	2. <i>Finish: Core paint finishes</i>	All legs include 1 1/2" leveller, allowing 1 1/4" adjustability.
DH Desk Height		Casters are black, swivel type. Ships with 2 locking and 2 non-locking type.
C Column Leg		
P Finish type, paint		
111 Finish, Jet Black		
		The base matrix for T-leg (tube style) is; 20" T-leg is used with 24"d top 24" T-leg is used with 30"d top 30" T-leg is used with 36"d top 40" and 42" T-leg is used with 48"d top
		For all other Top to Base matrix, please refer to pages 140 and 141 in the Reff planning guide.

Top support components
Open Frame legs, 28³/₈" high planning
Painted or Plated

description	d	w	h	pattern no.	P1	P2	P3	P4
 Open Frame Legs, Set of one For Peninsulas	20"		28 ³ / ₈ "	RPOFL1202()	\$561.	\$617.	\$648.	\$919.
	24"		28 ³ / ₈ "	RPOFL1242()	567.	623.	655.	926.
	30"		28 ³ / ₈ "	RPOFL1302()	576.	633.	665.	1,037.
	36"		28 ³ / ₈ "	RPOFL1362()	576.	633.	665.	1,037.

Ships with wood screws for fastening to underside of worksurface.
 Painted and Anodized finishes only.

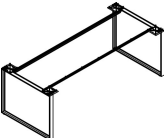

description	d	w	h	pattern no.	P1	P2	P3	P4
 Open Frame Legs, Set of two For Tables	20"	60"	28 ³ / ₈ "	RPOFL260202()	1,171.	1,287.	1,352.	1,888.
	20"	66"	28 ³ / ₈ "	RPOFL266202()	1,194.	1,313.	1,380.	1,912.
	20"	72"	28 ³ / ₈ "	RPOFL272202()	1,196.	1,316.	1,382.	1,914.
	20"	78"	28 ³ / ₈ "	RPOFL278202()	1,208.	1,329.	1,396.	1,926.
	20"	84"	28 ³ / ₈ "	RPOFL284202()	1,212.	1,332.	1,399.	1,929.
	24"	60"	28 ³ / ₈ "	RPOFL260242()	1,182.	1,300.	1,365.	1,899.
	24"	66"	28 ³ / ₈ "	RPOFL266242()	1,205.	1,326.	1,392.	1,923.
	24"	72"	28 ³ / ₈ "	RPOFL272242()	1,207.	1,328.	1,395.	1,925.
	24"	78"	28 ³ / ₈ "	RPOFL278242()	1,220.	1,342.	1,409.	1,937.
	24"	84"	28 ³ / ₈ "	RPOFL284242()	1,223.	1,345.	1,412.	1,940.
	30"	60"	28 ³ / ₈ "	RPOFL260302()	1,201.	1,321.	1,387.	2,124.
	30"	66"	28 ³ / ₈ "	RPOFL266302()	1,224.	1,347.	1,415.	2,146.
	30"	72"	28 ³ / ₈ "	RPOFL272302()	1,227.	1,349.	1,417.	2,149.
	30"	78"	28 ³ / ₈ "	RPOFL278302()	1,239.	1,362.	1,431.	2,162.
	30"	84"	28 ³ / ₈ "	RPOFL284302()	1,241.	1,366.	1,434.	2,164.
	36"	60"	28 ³ / ₈ "	RPOFL260362()	1,201.	1,321.	1,387.	2,124.
	36"	66"	28 ³ / ₈ "	RPOFL266362()	1,224.	1,347.	1,415.	2,146.
	36"	72"	28 ³ / ₈ "	RPOFL272362()	1,227.	1,349.	1,417.	2,149.
	36"	78"	28 ³ / ₈ "	RPOFL278362()	1,239.	1,362.	1,431.	2,162.
	36"	84"	28 ³ / ₈ "	RPOFL284362()	1,241.	1,366.	1,434.	2,164.

Ships with two stiffeners and threaded metal insets with machine screws, for fastening to underside of worksurface.
 Painted and Anodized finishes only.

Order Code	Specification Information	Application Notes
Example: RPOFL1202()	<i>To order please specify pattern number including:</i>	It is NOT advisable to mix 28³/₈"h desk height products with 26¹/₂"h standard height product.
RP Reff Profiles	1. <i>Leg Finish:</i>	
OFL Open Frame Leg	Painted or Anodized	For Peninsulas : Stiffeners are required for 1 ¹ / ₂ " thick tops with a span greater than 54". The end of the worksurface, opposite the open frame legs must be anchored securely.
1 Set of 1(for Peninsula) 2 = Set of 2 (for Tables)	P1 = All core painted options P2 = All core metallic painted options, plus AA P3 = 613 Silver P4 = Anodized finishes AP & AU	
20 depth		Open Frame legs include glides with 1" height adjustability. Open Frame legs are not intended or able to be used adjacent to full height - 28 ³ / ₈ "h desk height storage. Note: These legs are intended to be used with Knoll worksurfaces, only. Installation instruction sheets available on Knoll.Exchange. For Peninsulas, refer to part number 6TP00440. For Tables; refer to part number 6TP00441.
2 28 ³ / ₈ "h		
AU Leg Finish		
		For Tables : Stiffeners must be installed in a specific location relative to the leg top plates and may not be arbitrarily located. Stiffeners are finished black.

Top support components

Legs, Painted or Anodized, 28³/₈" high planning

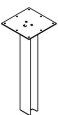
description	h	pattern no.	P1	P2	P3	P4
L-Leg (Pair) 	28 ³ / ₈ "	RPL2()	\$503.	\$554.	\$581.	\$708.
Reverse L-Leg (Pair) 	28 ³ / ₈ "	RPRL2()	503.	554.	581.	708.
Soft Rectangular Leg (Pair) 	28 ³ / ₈ "	RPS2()	571.	628.	660.	776.
Wide Flange Leg (Single) 28 ³ / ₈ "h 	28 ³ / ₈ "	RPWFL28()	550.	610.	650.	996.

Order Code

Example: RPL2 ()	
RP	Reff Profiles
L	Leg
2	28 ³ / ₈ "h
AU	Leg finish

RL = Reverse Leg
S = Soft Rectangular Leg

Specification Information

To order please specify pattern number including:

1. Finish: Painted or Anodized (AA, AP, AU)

Application Notes

It is NOT advisable to mix 28³/₈"h desk height product with 26¹/₂"h standard height product.

For "L", "Reverse L" and "Soft Rectangular" Legs, same criteria applies as the column legs, when referencing the planning guide; pages 140 and 141

All legs, excluding "Wide Flange Legs" are sold in pairs. These legs (excluding the Wide flange legs) include 1" leveller allowing ³/₄" adjustability.

Wide Flange legs have 2" leg height adjustability at the top of the leg to the worksurface connection. Wide Flange legs are for use with Peninsula applications only.

Top support components

Bases, Painted or Plated, 28³/₈" high planning

description	dia.	w	h	d	pattern no.	P1	P2	P3	P4
 Spider base, plain tube style (desk height)		–	28 ³ / ₈ "	24"	RCBDH24X () ()	\$686.	\$754.	\$794.	\$839.
		–	28 ³ / ₈ "	28"	RCBDH28X () ()	716.	788.	827.	870.
		–	28 ³ / ₈ "	36"	RCBDH36X () ()	778.	856.	899.	932.

Ships with wood screws for fastening to underside of worksurface into pilot hole location.
Painted and PD, PT and PZ plated finishes.





description	dia.	w	h	d	pattern no.	P1	P2	P3	P4
 Drum Base (desk height)	14"	–	28 ³ / ₈ "	–	RSDHD1428 () ()	1,345.	1,479.	1,553.	n/a
	18"	–	28 ³ / ₈ "	–	RSDHD1828 () ()	1,462.	1,599.	1,679.	n/a
	20"	–	28 ³ / ₈ "	–	RSDHD2028 () ()	1,505.	1,655.	1,738.	n/a
	24"	–	28 ³ / ₈ "	–	RSDHD2428 () ()	1,805.	1,985.	2,085.	n/a
	30"	–	28 ³ / ₈ "	–	RSDHD3028 () ()	2,015.	2,217.	2,328.	n/a

Painted finishes only.

Order Code	Specification Information	Application Notes
Example: RCBDH28X	<i>To order please specify pattern number including:</i>	It is NOT advisable to mix 28³/₈"h desk height product with 26¹/₂"h standard height product.
R Reff	1. <i>Finish Type, where applicable</i> P = Paint (P1, P2, P3)	
C Support Spider	2. <i>Finish: Core paint finish</i>	The Plain cylinder and tube style legs can be ordered in plated and painted finishes. The legs on this page include a 1 1/2" leveller allowing 1 1/4" adjustability.
B Base		
DH Desk height		
28 Diameter		
X X-base		
P Finish type, paint		
111 Finish, Jet Black		

Top support components

Bases, Laminate or Wood, 28³/₈" high planning

description	dia.	w	h	d	pattern no.	L	V1	V2	V3
 Drum Base (desk height)	14"	–	28 ³ / ₈ "	–	RSDHD1428 () ()	n/a	\$1,512.	\$1,737.	\$2,345.
	18"	–	28 ³ / ₈ "	–	RSDHD1828 () ()	n/a	1,642.	1,888.	2,550.
	20"	–	28 ³ / ₈ "	–	RSDHD2028 () ()	n/a	1,694.	1,946.	2,629.
	24"	–	28 ³ / ₈ "	–	RSDHD2428 () ()	n/a	2,030.	2,337.	3,154.
	30"	–	28 ³ / ₈ "	–	RSDHD3028 () ()	n/a	2,268.	2,607.	3,519.
	36"	–	28 ³ / ₈ "	–	RSDHD3628 () ()	n/a	2,608.	2,996.	4,044.
 Drum Base with hinged Access door	20"	–	28 ³ / ₈ "	–	RSDHHA2028 () ()	n/a	2,719.	2,971.	3,654.
	24"	–	28 ³ / ₈ "	–	RSDHHA2428 () ()	n/a	3,293.	3,632.	4,544.
	30"	–	28 ³ / ₈ "	–	RSDHHA3028 () ()	n/a	3,385.	3,736.	4,684.
	36"	–	28 ³ / ₈ "	–	RSDHHA3628 () ()	n/a	3,740.	4,129.	5,176.
 T-base, desk height (hardware included)	20"		28 ³ / ₈ "	12"	RSDHT1 () ()	479.	549.	638.	862.
	24"		28 ³ / ₈ "	12"	RSDHT2 () ()	514.	588.	676.	913.
	30"		28 ³ / ₈ "	12"	RSDHT3 () ()	602.	686.	790.	1,068.
	36"		28 ³ / ₈ "	12"	RSDHT4 () ()	685.	784.	900.	1,215.
	42"		28 ³ / ₈ "	12"	RSDHT5 () ()	759.	872.	1,006.	1,358.
	48"		28 ³ / ₈ "	12"	RSDHT6 () ()	846.	964.	1,111.	1,502.
 L-base, desk height (hardware included, non-handed)	12"		28 ³ / ₈ "	12"	RSDHL12 () ()	479.	549.	638.	862.
	15"		28 ³ / ₈ "	12"	RSDHL15 () ()	488.	557.	644.	871.
	20"		28 ³ / ₈ "	12"	RSDHL20 () ()	514.	578.	670.	906.
	24"		28 ³ / ₈ "	12"	RSDHL24 () ()	521.	588.	677.	913.
	30"		28 ³ / ₈ "	12"	RSDHL30 () ()	602.	686.	790.	1,068.
	36"		28 ³ / ₈ "	12"	RSDHL36 () ()	685.	784.	900.	1,215.
	42"		28 ³ / ₈ "	12"	RSDHL42 () ()	759.	872.	1,006.	1,358.
	48"		28 ³ / ₈ "	12"	RSDHL48 () ()	846.	964.	1,111.	1,502.

Order Code	
Example: RSDHD1428	
R	Reff
S	Support
DH	Desk Height
D	Drum base, HA = Hinged with Access door
14	Diameter
28	Height
2	Finish type, V2
V316	Finish, Maple

Specification Information

To order please specify pattern number including:

1. *Finish Type, where applicable*
L = Laminate
1 = V1
2 = V2
3 = V3
2. *Finish: Core paint finishes*

Application Notes

It is NOT advisable to mix 28³/₈"h desk height product with 26¹/₂"h standard height product.

Product on this page will accept wood grain laminate where laminate is currently an option. For more information on grain direction on vertical surfaces, please see page 5.

Wood T and L bases are not recommended for supporting conference tops.

Refer to Top to Base matrix, pages 140 and 141 in the Reff planning guide.

All bases include 1¹/₂" leveler, allowing 1¹/₄" adjustability.

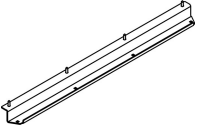
description	type	width	depth	height	pattern number	list
	Stiffener for worksurface, full depths	36"	20"	1 1/2"	1"	AWM1 S36 \$60.
		42"	26"	1 1/2"	1"	AWM1 S42 64.
		48"	32"	1 1/2"	1"	AWM1 S48 66.
		60"	44"	1 1/2"	1"	AWM1 S60 68.
		66"	50"	1 1/2"	1"	AWM1 S66 72.
		72"	56"	1 1/2"	1"	AWM1 S72 74.
		78"	62"	1 1/2"	1"	AWM1 S78 77.
		84"	68"	1 1/2"	1"	AWM1 S84 79.

Order CodeExample: **AWM1 S36****AWM1** Stiffener**S** Straight**36** Application**Specification Information**

Stiffeners are black painted finish.







Application Notes

AutoStrada worksurfaces require stiffeners when the span between structural supports exceeds 60". Stiffener also serves as horizontal cable manager.

Stiffener corresponds in width to straight or corner worksurface back edge. Specify 12" less wide stiffener to mount adjacent to floor standing pedestal.





For 90" application span, use AWM1-S84 stiffener.

*Removable Application for Between End panel and Storage Unit
28^{3/8}" planning*

description	end panel	storage	modesty width	h	pattern no.	L	V1	V2	V3
72" Removable Modesty 	1"	16"	55"	25"	RDHMR7210	\$385.	\$487.	\$560.	\$728.
	1"	19"	52"	25"	RDHMR7220	379.	479.	551.	716.
	1"	30"	41"	25"	RDHMR7230	354.	446.	513.	666.
	1"	36"	35"	25"	RDHMR7240	341.	432.	496.	645.
78" Removable Modesty 	1"	16"	61"	25"	RDHMR7810	397.	501.	576.	747.
	1"	19"	58"	25"	RDHMR7820	392.	494.	566.	738.
	1"	30"	47"	25"	RDHMR7830	365.	459.	529.	688.
	1"	36"	41"	25"	RDHMR7840	354.	446.	513.	666.
84" Removable Modesty 	1"	16"	67"	25"	RDHMR8410	412.	522.	601.	779.
	1"	19"	64"	25"	RDHMR8420	402.	508.	583.	759.
	1"	30"	53"	25"	RDHMR8430	380.	480.	552.	719.
	1"	36"	47"	25"	RDHMR8440	365.	459.	529.	688.
90" Removable Modesty 	1"	16"	73"	25"	RDHMR9010	424.	535.	616.	801.
	1"	19"	70"	25"	RDHMR9020	418.	528.	607.	789.
	1"	30"	59"	25"	RDHMR9030	393.	495.	568.	740.
	1"	36"	53"	25"	RDHMR9040	380.	480.	552.	719.
96" Removable Modesty 	1"	16"	79"	25"	RDHMR9610	441.	556.	640.	832.
	1"	19"	76"	25"	RDHMR9620	429.	542.	623.	811.
	1"	30"	65"	25"	RDHMR9630	403.	509.	585.	762.
	1"	36"	59"	25"	RDHMR9640	393.	495.	568.	740.
102" Removable Modesty 	1"	16"	85"	25"	RDHMR10210	468.	583.	667.	859.
	1"	19"	82"	25"	RDHMR10220	456.	569.	651.	838.
	1"	30"	71"	25"	RDHMR10230	431.	537.	614.	788.
	1"	36"	65"	25"	RDHMR10240	419.	523.	597.	768.
108" Removable Modesty 	1"	16"	91"	25"	RDHMR10810	496.	612.	695.	887.
	1"	19"	88"	25"	RDHMR10820	484.	598.	678.	865.
	1"	30"	77"	25"	RDHMR10830	458.	564.	641.	817.
	1"	36"	71"	25"	RDHMR10840	447.	550.	624.	795.



Order Code	Specification Information	Application Notes
Example: RDHMR7810	<i>To order please specify pattern number including:</i>	Products on this page will accept wood grain laminate, where laminate is currently an option. For any vertical surface greater than 60" wide, the grain direction is horizontal.
R Reff	1. <i>Finish Type</i> L, V1, V2, V3	All noted dimensions are nominal.
DH Desk height	2. <i>Finish</i> V316	Please see Planning Guide for freestanding planning instruction.
M Modesty	Installation instruction sheets available on Knoll Exchange. Refer to reference number 6TP00084.	These removable modesty's backs are finished in veneer / laminate on inside (user side) and paper finished on the outside (approach side).
R Removable		Modesty End panel and storage unit.
78 Width		10= 16" storage
10 16" storage		20= 19" storage
V2 Finish type		30= 30" storage
V316 Light Maple		40= 36" storage
		Modesty between two storage units.
		11= 16"/16" storage
		12= 16"/19" storage
		13= 16"/30" storage
		14= 16"/36" storage
		22= 19"/19" storage
		23= 19"/30" storage
		24= 19"/36" storage
		33= 30"/30" storage

Removable Application for Between two Storage Elements
28³/₈" planning

description	storage 1	storage 2	modesty width	th	h	pattern no.	L	V1	V2	V3
72" Removable Modesty 	16"	16"	41"	1"	25"	RDHMR7211	\$353.	\$446.	\$513.	\$666.
	16"	19"	38"	1"	25"	RDHMR7212	341.	442.	496.	645.
	19"	19"	35"	1"	25"	RDHMR7222	346.	438.	504.	656.
78" Removable Modesty 	16"	16"	47"	1"	25"	RDHMR7811	364.	458.	528.	687.
	16"	19"	44"	1"	25"	RDHMR7812	358.	452.	521.	675.
	19"	19"	41"	1"	25"	RDHMR7822	353.	446.	513.	666.
84" Removable Modesty 	16"	16"	53"	1"	25"	RDHMR8411	379.	480.	552.	718.
	16"	19"	50"	1"	25"	RDHMR8412	370.	467.	537.	697.
	16"	30"	38"	1"	25"	RDHMR8413	350.	441.	507.	659.
	19"	19"	47"	1"	25"	RDHMR8422	364.	458.	528.	687.
	19"	30"	35"	1"	25"	RDHMR8423	342.	433.	498.	646.
90" Removable Modesty 	16"	16"	59"	1"	25"	RDHMR9011	393.	495.	568.	740.
	16"	19"	56"	1"	25"	RDHMR9012	387.	488.	561.	730.
	16"	30"	44"	1"	25"	RDHMR9013	359.	453.	522.	677.
	16"	36"	38"	1"	25"	RDHMR9014	350.	441.	507.	659.
	19"	19"	53"	1"	25"	RDHMR9022	379.	480.	552.	718.
	19"	30"	41"	1"	25"	RDHMR9023	354.	447.	515.	668.
	19"	36"	35"	1"	25"	RDHMR9024	342.	433.	498.	646.
96" Removable Modesty 	16"	16"	65"	1"	25"	RDHMR9611	403.	509.	585.	762.
	16"	19"	62"	1"	25"	RDHMR9612	397.	502.	577.	749.
	16"	30"	50"	1"	25"	RDHMR9613	376.	475.	547.	710.
	16"	36"	44"	1"	25"	RDHMR9614	359.	453.	522.	677.
	19"	19"	59"	1"	25"	RDHMR9622	393.	495.	568.	740.
	19"	30"	47"	1"	25"	RDHMR9623	366.	460.	531.	690.
	19"	36"	41"	1"	25"	RDHMR9624	354.	447.	515.	668.
	30"	30"	36"	1"	25"	RDHMR9633	343.	434.	500.	649.

Order Code	Specification Information	Application Notes
Example: RDHMR7211	<i>To order please specify pattern number including:</i>	Products on this page will accept wood grain laminate, where laminate is currently an option. For any vertical surface greater than 60" wide, the grain direction is horizontal.
R Reff	1. <i>Finish Type</i> L, V1, V2, V3	All noted dimensions are nominal.
DH Desk height	2. <i>Finish</i> V316	Please see Planning Guide for freestanding planning instruction.
M Modesty	Installation instruction sheets available on Knoll Exchange. Refer to reference number 6TP00084.	These removable modesty's backs are finished in veneer / laminate on inside (user side) and paper finished on the outside (approach side).
R Removable		Modesty End panel and storage unit.
72 Width		10= 16" storage
11 16"/16" storage		20= 19" storage
V2 Finish type		30= 30" storage
V316 Light Maple		40= 36" storage
		Modesty between two storage units.
		11= 16"/16" storage
		12= 16"/19" storage
		13= 16"/30" storage
		14= 16"/36" storage
		22= 19"/19" storage
		23= 19"/30" storage
		24= 19"/36" storage
		33= 30"/30" storage

*Removable Application for Between two Storage Elements
28³/₈" planning*

description	storage 1	storage 2	modesty width	th	h	pattern no.	L	V1	V2	V3
102" Removable Modesty 	16"	16"	71"	1"	25"	RDHMR10211	\$431.	\$537.	\$614.	\$788.
	16"	19"	68"	1"	25"	RDHMR10212	424.	529.	605.	777.
	16"	30"	56"	1"	25"	RDHMR10213	404.	503.	575.	738.
	16"	36"	50"	1"	25"	RDHMR10214	387.	481.	549.	705.
	19"	19"	65"	1"	25"	RDHMR10222	419.	523.	597.	768.
	19"	30"	53"	1"	25"	RDHMR10223	394.	489.	559.	718.
	19"	36"	47"	1"	25"	RDHMR10224	380.	475.	542.	696.
	30"	30"	42"	1"	25"	RDHMR10233	371.	460.	527.	675.
108" Removable Modesty 	16"	16"	77"	1"	25"	RDHMR10811	458.	564.	641.	817.
	16"	19"	74"	1"	25"	RDHMR10812	451.	557.	632.	805.
	16"	30"	62"	1"	25"	RDHMR10813	432.	530.	603.	766.
	16"	36"	56"	1"	25"	RDHMR10814	414.	509.	577.	734.
	19"	19"	71"	1"	25"	RDHMR10822	447.	550.	624.	795.
	19"	30"	59"	1"	25"	RDHMR10823	420.	517.	586.	745.
	19"	36"	53"	1"	25"	RDHMR10824	408.	503.	569.	725.
	30"	30"	48"	1"	25"	RDHMR10833	399.	489.	555.	704.

Order Code

Example: RDHMR7212	
R	Reff
DH	Desk height
M	Modesty
R	Removable
72	Width
12	16"/19" storage
V2	Finish type
V316	Light Maple

Specification Information

To order please specify pattern number including:

1. *Finish Type*
L, V1, V2, V3
2. *Finish*
V316

Installation instruction sheets available on Knoll Exchange. Refer to reference number 6TP00084.

Application Notes

Products on this page will accept wood grain laminate, where laminate is currently an option. For any vertical surface greater than 60", the grain direction is horizontal.

All noted dimensions are nominal.

Please see Planning Guide for freestanding planning instruction.

These removable modesty's backs are finished in veneer / laminate on inside (user side) and paper finished on the outside (approach side).

Modesty End panel and storage unit.

10= 16" storage
20= 19" storage
30= 30" storage
40= 36" storage
Modesty between two storage units.

11= 16"/16" storage
12= 16"/19" storage
13= 16"/30" storage
14= 16"/36" storage
22= 19"/19" storage
23= 19"/30" storage
24= 19"/36" storage
33= 30"/30" storage

*Hinged Application for Between End Panel and Storage Unit
28³/₈" planning*

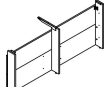
description	End panel	storage 1	modesty width	h	pattern no.	L	V1	V2	V3
	1"	16"	56"	25"	RDHMH7210	\$842.	\$1,038.	\$1,092.	\$1,309.
	1"	19"	53"	25"	RDHMH7220	834.	1,034.	1,083.	1,300.
	1"	30"	41"	25"	RDHMH7230	670.	862.	909.	1,092.
	1"	36"	35"	25"	RDHMH7240	660.	852.	891.	1,070.

Back side shown

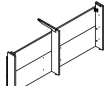
	1"	16"	62"	25"	RDHMH7810	856.	1,049.	1,108.	1,329.
	1"	19"	59"	25"	RDHMH7820	846.	1,043.	1,099.	1,318.
	1"	30"	47"	25"	RDHMH7830	684.	879.	926.	1,110.
	1"	36"	41"	25"	RDHMH7840	670.	862.	909.	1,092.

Back side shown

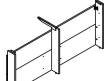
	1"	16"	68"	25"	RDHMH8410	872.	1,068.	1,131.	1,357.
	1"	19"	65"	25"	RDHMH8420	862.	1,055.	1,121.	1,347.
	1"	30"	53"	25"	RDHMH8430	835.	1,034.	1,084.	1,302.
	1"	36"	47"	25"	RDHMH8440	684.	879.	926.	1,110.

Back side shown

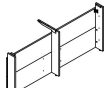
	1"	16"	74"	25"	RDHMH9010	883.	1,077.	1,147.	1,377.
	1"	19"	71"	25"	RDHMH9020	876.	1,072.	1,140.	1,366.
	1"	30"	59"	25"	RDHMH9030	848.	1,044.	1,100.	1,320.
	1"	36"	53"	25"	RDHMH9040	835.	1,034.	1,084.	1,302.

Back side shown

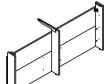
	1"	16"	80"	25"	RDHMH9610	895.	1,089.	1,163.	1,396.
	1"	19"	77"	25"	RDHMH9620	888.	1,083.	1,154.	1,385.
	1"	30"	65"	25"	RDHMH9630	863.	1,057.	1,123.	1,351.
	1"	36"	59"	25"	RDHMH9640	848.	1,044.	1,100.	1,320.

Back side shown

Order Code

Example: RDHMH7210	
R	Reff
DH	Desk height
M	Modesty
H	Hinged
72	Width
10	16" storage
V2	Finish type
V316	Light Maple

Specification Information

To order please specify pattern number including:
 1. *Finish Type*
 L, V1, V2, V3
 2. *Finish*
 V316

Installation instruction sheets available on Knoll Exchange.

Application Notes

Products on this page will accept wood grain laminate, where laminate is currently an option. For any vertical surface greater than 60", the grain direction is horizontal.

Hardware shipped with modesty to attach to worksurface.

J-Extrusion Wire Trough sold separately.

These removable modesty's backs are finished in veneer / laminate on inside (user side) and paper finished on the outside (approach side).

Modesty End panel and storage unit.

10= 16" storage
 20= 19" storage
 30= 30" storage
 40= 36" storage
 Modesty between two storage units.

11= 16"/16" storage
 12= 16"/19" storage
 13= 16"/30" storage
 14= 16"/36" storage
 22= 19"/19" storage
 23= 19"/30" storage
 24= 19"/36" storage
 33= 30"/30" storage

Modesty

Hinged Application for Between Two Storage Elements

28³/₈" planning

description	storage 1	storage 2	th	h	modesty width	pattern no.	L	V1	V2	V3
72" Hinged Modesty	16"	16"	1"	25"	41"	RDHMH7211	\$670.	\$862.	\$908.	\$1,090.
	16"	19"	1"	25"	35"	RDHMH7222	660.	852.	891.	1,070.
	19"	19"	1"	25"	38"	RDHMH7212	664.	857.	899.	1,078.

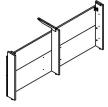

Back side shown

78" Hinged Modesty	16"	16"	1"	25"	47"	RDHMH7811	684.	879.	926.	1,110.
	16"	19"	1"	25"	44"	RDHMH7812	675.	874.	917.	1,100.
	16"	30"	1"	25"	33"	RDHMH7813	655.	848.	879.	1,057.
	19"	19"	1"	25"	41"	RDHMH7822	670.	862.	908.	1,090.
	19"	30"	1"	25"	30"	RDHMH7823	649.	843.	865.	1,039.

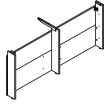

Back side shown

84" Hinged Modesty	16"	16"	1"	25"	53"	RDHMH8411	835.	1,034.	1,084.	1,302.
	16"	19"	1"	25"	50"	RDHMH8412	829.	1,029.	1,075.	1,290.
	16"	30"	1"	25"	39"	RDHMH8413	666.	858.	901.	1,082.
	16"	36"	1"	25"	32"	RDHMH8414	655.	848.	879.	1,057.
	19"	19"	1"	25"	47"	RDHMH8422	684.	879.	926.	1,110.
	19"	30"	1"	25"	36"	RDHMH8423	660.	852.	894.	1,072.

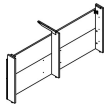

Back side shown

90" Hinged Modesty	16"	16"	1"	25"	59"	RDHMH9011	848.	1,044.	1,100.	1,320.
	16"	19"	1"	25"	56"	RDHMH9012	842.	1,039.	1,093.	1,310.
	16"	30"	1"	25"	45"	RDHMH9013	678.	875.	918.	1,102.
	16"	36"	1"	25"	39"	RDHMH9014	666.	858.	901.	1,082.
	19"	19"	1"	25"	53"	RDHMH9022	835.	1,034.	1,084.	1,302.
	19"	30"	1"	25"	42"	RDHMH9023	671.	863.	909.	1,092.
	19"	36"	1"	25"	36"	RDHMH9024	660.	852.	894.	1,072.

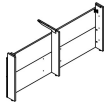

Back side shown

96" Hinged Modesty	16"	16"	1"	25"	65"	RDHMH9611	863.	1,056.	1,122.	1,349.
	16"	19"	1"	25"	62"	RDHMH9612	857.	1,050.	1,109.	1,330.
	16"	30"	1"	25"	51"	RDHMH9613	831.	1,030.	1,076.	1,292.
	16"	36"	1"	25"	45"	RDHMH9614	678.	875.	918.	1,102.
	19"	19"	1"	25"	59"	RDHMH9622	848.	1,044.	1,100.	1,320.
	19"	30"	1"	25"	48"	RDHMH9623	684.	880.	927.	1,111.
	19"	36"	1"	25"	42"	RDHMH9624	671.	863.	909.	1,092.
	30"	30"	1"	25"	36"	RDHMH9633	662.	854.	895.	1,073.

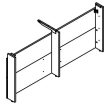

Back side shown

Order Code	Specification Information	Application Notes
Example: RDHMH7211	<i>To order please specify pattern number including:</i>	Products on this page will accept wood grain laminate, where laminate is currently an option. For any vertical surface greater than 60", the grain direction is horizontal.
R Reff	1. <i>Finish Type</i> L, V1, V2, V3	Hardware shipped with modesty to attach to worksurface.
DH Desk height	2. <i>Finish</i> V316	J-Extrusion Wire Trough sold separately.
M Modesty	Installation instruction sheets available on Knoll Exchange.	These removable modesty's backs are finished in veneer / laminate on inside (user side) and paper finished on the outside (approach side).
H Hinged		Modesty End panel and storage unit.
72 Width		10= 16" storage
11 16"/16" storage		20= 19" storage
V2 Finish type		30= 30" storage
V316 Light Maple		40= 36" storage
		Modesty between two storage units.
		11= 16"/16" storage
		12= 16"/19" storage
		13= 16"/30" storage
		14= 16"/36" storage
		22= 19"/19" storage
		23= 19"/30" storage
		24= 19"/36" storage
		33= 30"/30" storage

*Hinged Application for Wall Mounted Media Enclave Tables
28^{3/8}" planning*

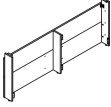
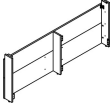
description	w	d	h	pattern no.	L	V1	V2	V3
48" Hinged Modesty 	48"		28"	RDHMH48200()	\$920.	\$1,193.	\$1,270.	\$1,414.
60" Hinged Modesty 	60"		28"	RDHMH60200()	1,018.	1,316.	1,401.	1,580.
72" Hinged Modesty 	72"		28"	RDHMH72200()	1,056.	1,350.	1,441.	1,655.

Order Code	
Example: RDHMH48200()	
R	Reff
DH	Desk height
M	Modesty
H	Hinged
48	Width
2	28 ^{3/8} "h
00	No storage
V316	Finish

Specification Information
To order please specify pattern number including:
 1. *Finish: Laminate or Veneer*

Application Notes
 Products on this page will accept wood grain laminate, where laminate is currently an option. For any vertical surface greater than 60", the grain direction is horizontal.
 Hardware shipped with modesty to attach to worksurface.
 J-Extrusion Wire Trough sold separately.
 These removable modesty's backs are finished in veneer / laminate on inside (user side) and paper finished on the outside (approach side). Exterior of gables shall have same finish as door.

Modesty
Partial / Suspended
 28^{3/8}" planning

description	th	w	h	pattern no.	L	V1	V2	V3
Partial / Half Height Modesty	1"	26"	12"	RDHPM26 ()	\$308.	\$434.	\$500.	\$649.
	1"	32"	12"	RDHPM32 ()	318.	448.	516.	669.
	1"	38"	12"	RDHPM38 ()	334.	473.	543.	705.
	1"	44"	12"	RDHPM44 ()	352.	497.	570.	743.
	1"	50"	12"	RDHPM50 ()	376.	532.	613.	796.
	1"	56"	12"	RDHPM56 ()	387.	547.	629.	819.
	1"	62"	12"	RDHPM62 ()	415.	586.	674.	877.
	1"	68"	12"	RDHPM68 ()	438.	620.	713.	927.
	1"	74"	12"	RDHPM74 ()	448.	634.	729.	948.

Order Code

Example: RDHPM26 ()
R Reff
DH Desk height
PM Partial Modesty
26 Width
V316 Light Maple

These partial modesty's backs are finished in veneer on inside (user side) and veneer on the outside (approach side).

Specification Information

To order please specify pattern number including:

1. Finish
L, V1, V2, V3

Products on this page will accept wood grain laminate, where laminate is currently an option. For any vertical surface greater than 60", the grain direction is horizontal.

Installation instruction sheets available on Knoll Exchange. For Suspended modesties, refer to reference number 6TP00089.

Hardware shipped with modesty to attach to worksurface.

J-Extrusion Wire Trough sold separately.

Pedestals, 28^{3/8}" planning

22^{3/8}" high

Metal interiors

description	w	d	pattern no.	L/L	L/V1	L/V2	L/V3	V1/V1	V2/V2	V3/V3
 Pedestal, 22 ^{3/8} " high box/file configuration	16"	19"	RP161R () () L () ()	\$1,204.	\$1,290.	\$1,333.	\$1,376.	\$1,419.	\$1,596.	\$2,146.
	16"	23"	RP162R () () L () ()	1,258.	1,348.	1,393.	1,438.	1,483.	1,670.	2,245.
	19"	19"	RP191R () () L () ()	1,263.	1,353.	1,398.	1,443.	1,488.	1,675.	2,251.
	19"	23"	RP192R () () L () ()	1,320.	1,415.	1,462.	1,509.	1,556.	1,753.	2,356.
	30"	19"	RP301R () () L () ()	1,282.	1,375.	1,422.	1,468.	1,514.	1,703.	2,289.
	30"	23"	RP302R () () L () ()	1,352.	1,449.	1,498.	1,547.	1,595.	1,791.	2,407.
	36"	19"	RP361R () () L () ()	1,366.	1,464.	1,513.	1,561.	1,610.	1,812.	2,440.
	36"	23"	RP362R () () L () ()	1,432.	1,533.	1,585.	1,635.	1,686.	1,899.	2,556.

Pedestals may require counterweights when used in unsecured fashion (ie freestanding)
 *3 counterweights per pedestal
 * Pencil tray not included.

 Pedestal, 22 ^{3/8} " high box/box/box configuration	30"	19"	RP301G () () M () () L ()	1,608.	1,696.	1,741.	1,786.	1,830.	2,048.	2,743.
	30"	23"	RP302G () () M () () L ()	1,688.	1,778.	1,822.	1,868.	1,913.	2,137.	2,862.
	36"	19"	RP361G () () M () () L ()	1,712.	1,803.	1,849.	1,894.	1,940.	2,178.	2,925.
	36"	23"	RP362G () () M () () L ()	1,786.	1,879.	1,925.	1,972.	2,018.	2,266.	3,043.

Pedestals may require counterweights when used in unsecured fashion (ie freestanding)
 *3 counterweights per pedestal
 * Pencil tray not included.

Order Code	Specification Information	Application Notes
Example: RP161R () () L () ()	<i>To order please specify pattern number including:</i>	<p>It is NOT advisable to mix 28^{3/8}"h desk height products with 26^{1/2}"h standard height products. These pedestals to be used in conjunction with 28^{3/8}" planning.</p> <p>Applied back ordered separately for finished back.</p> <p>File drawer do not support bottom loading</p> <p>File drawers include bars for front to back and side to side filing.</p> <p>Pencil trays can be ordered separately for 16" and 19" wide pedestals with metal interior. See page 415.</p> <p>Product on this page Excluding J-pull option will accept wood grain laminate, where laminate is currently an option.</p> <p>Keying instructions must accompany all orders, refer to page 432 . Pedestals do not come with lock included. Random locks are factory installed. Key-alike are field installed using the KnollKey order form. Each locking pedestal on this page counts for one lock core.</p> <p>These pedestals are key hole construction.</p>
R Reff	1. <i>Case Finish type</i> L = Laminate 1 = V1 2 = V2 3 = V3	
P Pedestal	2. <i>Front Finish type</i> L = Laminate 1 = V1 2 = V2 3 = V3	
16 16" wide (<i>nominal</i>)	3. Interior option: M= Metal interior	
1 19" deep (<i>nominal</i>)	4. <i>Pull option</i> B = No pull, No drilling Customer's own pull C = Metal C-pull D = Metal D-pull F = Bar (1 pull / Door set) H = Outline J = Routed J-pull S = Metal S-pull R = Cylinder T = Tab (1 pull / Door set)	
R Box/File configuration, G = BBB	5. <i>Lock option</i> Pedestals with drawers always lock drilled L = drilled to accept lock	
2 Case Finish type	6. <i>Lock finish</i> B = Black S = Matte silver	
2 Front Finish type	7. <i>Case finish:</i> L, V1, V2, V3	
M Interior option	8. <i>Front finish:</i> L, V1, V2, V3	
H Pull option	9. <i>Pull finish</i> Painted or Plated	
L Lock option	*If case is Laminate, the front can be laminate or wood. *If case is wood, the front can only be wood.	
B Lock finish		
V316 Case finish		
V316 Front finish		
PU Pull finish		

Pedestals, 28³/₈" planning
22³/₈" high
Metal interiors

description	w	d	h	pattern no.	L	L/V1	L/V2	L/V3	V1	V2	V3
Pedestal, 22 ³ / ₈ " high open file configuration 	30"	19"	22 ³ / ₈ "	RP301T () () () L () () ()	\$918.	\$984.	\$1,017.	\$1,050.	\$1,082.	\$1,207.	\$1,605.
	30"	23"	22 ³ / ₈ "	RP302T () () () L () () ()	1,104.	1,183.	1,222.	1,262.	1,301.	1,450.	1,937.
	36"	19"	22 ³ / ₈ "	RP361T () () () L () () ()	1,156.	1,239.	1,281.	1,322.	1,364.	1,525.	2,036.
	36"	23"	22 ³ / ₈ "	RP362T () () () L () () ()	1,388.	1,485.	1,534.	1,583.	1,632.	1,830.	2,444.

Pedestals may require counterweights when used in unsecured fashion (ie freestanding)

*3 counterweights per pedestal

Supplied with hardware kit including wood screws for attachment to underside of worksurface

Pedestal, 22 ³ / ₈ " high open bookcase configuration, with adjustable shelf 	30"	19"	22 ³ / ₈ "	RP301S () () ()	854.	n/a	n/a	n/a	1,011.	1,139.	1,538.
	30"	23"	22 ³ / ₈ "	RP302S () () ()	1,040.	n/a	n/a	n/a	1,229.	1,383.	1,868.
	36"	19"	22 ³ / ₈ "	RP361S () () ()	1,093.	n/a	n/a	n/a	1,294.	1,458.	1,966.
	36"	23"	22 ³ / ₈ "	RP362S () () ()	1,323.	n/a	n/a	n/a	1,561.	1,759.	2,375.

Supplied with hardware kit including wood screws for attachment to underside of worksurface

Order Code	Specification Information	Application Notes
Example: RP301T () () () L () () ()	<i>To order please specify pattern number including:</i>	
R Reff		
P Pedestal		
30 30" wide (<i>nominal</i>)	1. <i>Case Finish type</i> L = Laminate 1 = V1 2 = V2 3 = V3	It is NOT advisable to mix 28³/₈"h desk height products with 26¹/₂"h standard height products. These pedestals to be used in conjunction with 28³/₈" planning.
1 19" deep (<i>nominal</i>)	2. <i>Front Finish type</i> L = Laminate 1 = V1 2 = V2 3 = V3	
T Open/File configuration, S = Open configuration	3. <i>Interior option: M= Metal interior</i>	Applied back ordered separately for finished back.
2 Case Finish type	4. <i>Pull option</i> B = No pull, No drilling Customer's own pull C = Metal C-pull D = Metal D-pull F = Bar (1 pull / Door set) H = Outline J = Routed J-pull S = Metal S-pull R = Cylinder T = Tab (1 pull / Door set)	File drawer do not support bottom loading
2 Front Finish type		File drawers include bars for front to back and side to side filing.
M Interior option		Pencil trays can be ordered separately for 16" and 19" wide pedestals with metal interior. See page 415.
H Pull option		Pedestals are supplied with hardware kit including wood screws for attachment to underside of worksurface.
L Lock option		
B Lock finish		
V316 Case finish		
W316 Front finish		
PU Pull finish		
Open book case:		
1. <i>Finish type</i> L = Laminate 1 = V1 2 = V2 3 = V3	5. <i>Lock option</i> Pedestals with drawers always lock drilled L = drilled to accept lock	
2. Interior option	6. <i>Lock finish</i> B = Black S = Matte silver	
3. Cabinet finish	7. <i>Case finish:</i> L, V1, V2, V3 8. <i>Front finish:</i> L, V1, V2, V3 9. <i>Pull finish</i> Painted or Plated	
	* If case is Laminate, the front can be laminate or wood. * If case if wood, the front can only be wood.	
	Product on this page Excluding J-pull option will accept wood grain laminate, where laminate is currently an option.	
	Keying instructions must accompany all orders, refer to page 432 . Pedestals do not come with lock included. Random locks are factory installed. Key-alike are field installed using the KnollKey order form. Each locking pedestal on this page counts for one lock core.	
	These pedestals are key hole construction.	

Pedestals, 28³/₈" planning

22³/₈" high

Wood interiors

description	w	d	pattern no.	L/L	L/V1	L/V2	L/V3	V1/V1	V2/V2	V3/V3
 Pedestal, 22 ³ / ₈ " high box/file configuration	16"	19"	RP161R () () L () ()	\$1,277.	\$1,367.	\$1,411.	\$1,457.	\$1,502.	\$1,691.	\$2,274.
	16"	23"	RP162R () () L () ()	1,418.	1,520.	1,570.	1,622.	1,673.	1,882.	2,532.
	19"	19"	RP191R () () L () ()	1,339.	1,434.	1,481.	1,529.	1,576.	1,777.	2,388.
	19"	23"	RP192R () () L () ()	1,488.	1,595.	1,649.	1,703.	1,756.	1,975.	2,659.
	30"	19"	RP301R () () L () ()	1,530.	1,640.	1,695.	1,750.	1,805.	2,032.	2,735.
	30"	23"	RP302R () () L () ()	1,798.	2,013.	2,121.	2,228.	2,336.	2,378.	3,202.
	36"	19"	RP361R () () L () ()	1,889.	2,024.	2,091.	2,159.	2,226.	2,507.	3,375.
	36"	23"	RP362R () () L () ()	2,196.	2,354.	2,433.	2,513.	2,592.	2,914.	3,930.

Pedestals may require counterweights when used in unsecured fashion (ie freestanding)

*3 counterweights per pedestal

* Pencil trays available in 16" and 19" w box drawers only.

 Pedestal, 22 ³ / ₈ " high box/box/box configuration	30"	19"	RP301G () () W () () L ()	2,005.	2,116.	2,171.	2,226.	2,282.	2,552.	3,411.
	30"	23"	RP302G () () W () () L ()	2,377.	2,502.	2,564.	2,626.	2,689.	3,001.	4,008.
	36"	19"	RP361G () () W () () L ()	2,471.	2,605.	2,672.	2,739.	2,805.	3,147.	4,212.
	36"	23"	RP362G () () W () () L ()	2,899.	3,052.	3,130.	3,207.	3,284.	3,675.	4,921.

Pedestals may require counterweights when used in unsecured fashion (ie freestanding)

*3 counterweights per pedestal

* Pencil trays available in 16" and 19" w box drawers only.

Order Code	Specification Information	Application Notes
Example: RP161R () () L () ()	<i>To order please specify pattern number including:</i>	<p>It is NOT advisable to mix 28³/₈"h desk height products with 26¹/₂"h standard height products. These pedestals to be used in conjunction with 28³/₈" planning.</p> <p>Applied back ordered separately for finished back.</p> <p>File drawer do not support bottom loading</p> <p>File drawers include bars for front to back and side to side filing.</p> <p>Pencil trays included in pedestals 16" and 19" wide with wood interior; only.</p> <p>Product on this page Excluding J-pull option will accept wood grain laminate, where laminate is currently an option.</p> <p>Keying instructions must accompany all orders, refer to page 432 . Pedestals do not come with lock included. Random locks are factory installed. Key-alike are field installed using the KnollKey order form. Each locking pedestal on this page counts for one lock core.</p> <p>These pedestals are key hole construction.</p>
R Reff	1. <i>Case Finish type</i> L = Laminate 1 = V1 2 = V2 3 = V3	
P Pedestal	2. <i>Front Finish type</i> L = Laminate 1 = V1 2 = V2 3 = V3	
16 16" wide (nominal)	3. Interior option: W = Wood interior	
1 19" deep (nominal)	4. <i>Pull option</i> B = No pull, No drilling Customer's own pull C = Metal C-pull D = Metal D-pull F = Bar (1 pull / Door set) H = Outline J = Routed J-pull S = Metal S-pull R = Cylinder T = Tab (1 pull / Door set)	
R Box/File configuration G = BBB configuration	5. <i>Lock option</i> Pedestals with drawers always lock drilled L = drilled to accept lock	
2 Case Finish type	6. <i>Lock finish</i> B = Black S = Matte silver	
2 Front Finish type	7. <i>Case finish:</i> L, V1, V2, V3	
W Interior option	8. <i>Front finish:</i> L, V1, V2, V3	
H Pull option	9. <i>Pull finish</i> Painted or Plated	
L Lock option	*If case is Laminate, the front can be laminate or wood.	
B Lock finish	*If case is Wood, the front can only be wood.	
V316 Case finish		
V316 Front finish		
PU Pull finish		

Pedestals, 28³/₈" planning

22³/₈" high

Wood interiors

description	w	d	pattern no.	L	L/V1	L/V2	L/V3	V1	V2	V3
Pedestal, 22 ³ / ₈ " high open file configuration	30"	19"	RP301T () () L () () ()	\$1,015.	\$1,084.	\$1,120.	\$1,155.	\$1,190.	\$1,330.	\$1,771.
	30"	23"	RP302T () () L () () ()	1,195.	1,280.	1,322.	1,365.	1,407.	1,576.	2,102.
	36"	19"	RP361T () () L () () ()	1,251.	1,340.	1,384.	1,429.	1,473.	1,651.	2,205.
	36"	23"	RP362T () () L () () ()	1,482.	1,585.	1,636.	1,687.	1,738.	1,951.	2,609.



Pedestals may require counterweights when used in unsecured fashion (ie freestanding)
 *3 counterweights per pedestal
 Supplied with hardware kit including wood screws for attachment to underside of worksurface

Pedestal, 22 ³ / ₈ " high open bookcase configuration, with adjustable shelf	30"	19"	RP301S () () ()	952.	n/a	n/a	n/a	1,119.	1,262.	1,704.
	30"	23"	RP302S () () ()	1,132.	n/a	n/a	n/a	1,336.	1,508.	2,032.
	36"	19"	RP361S () () ()	1,185.	n/a	n/a	n/a	1,402.	1,583.	2,135.
	36"	23"	RP362S () () ()	1,417.	n/a	n/a	n/a	1,668.	1,882.	2,540.



Supplied with hardware kit includes wood screws for attachment to underside of worksurface

Order Code	Specification Information	Application Notes
Example: RP301T () () L () () ()	<i>To order please specify pattern number including:</i>	<p>It is NOT advisable to mix 28³/₈"h desk height products with 26¹/₂"h standard height products. These pedestals to be used in conjunction with 28³/₈" planning.</p> <p>Applied back ordered separately for finished back.</p> <p>File drawer do not support bottom loading</p> <p>File drawers include bars for front to back and side to side filing.</p> <p>Pencil trays included in pedestals 16" and 19" wide with wood interior; only.</p> <p>Pedestals are supplied with hardware kit including wood screws for attachment to underside of worksurface.</p>
R Reff	1. <i>Case Finish type</i> L = Laminate 1 = V1 2 = V2 3 = V3	
P Pedestal	2. <i>Front Finish type</i> L = Laminate 1 = V1 2 = V2 3 = V3	
30 30" wide (<i>nominal</i>)	3. <i>Interior option: W = Wood interior</i>	
1 19" deep (<i>nominal</i>)	4. <i>Pull option</i> B = No pull, No drilling Customer's own pull C = Metal C-pull D = Metal D-pull F = Bar (1 pull / Door set) H = Outline J = Routed J-pull S = Metal S-pull R = Cylinder T = Tab (1 pull / Door set)	
T Open/File configuration S = Open configuration	5. <i>Lock option</i> Pedestals with drawers always lock drilled L = drilled to accept lock	
2 Finish type	6. <i>Lock finish</i> B = Black S = Matte silver	
W Interior option	7. <i>Case finish:</i> L, V1, V2, V3	
H Pull option	8. <i>Front finish:</i> L, V1, V2, V3	
L Lock option	9. <i>Pull finish</i> Painted or Plated	
B Lock finish	*If case is Laminate, the front can be laminate or wood. *If case is Wood, the front can only be wood.	
V316 Case finish	Product on this page Excluding J-pull option will accept wood grain laminate, where laminate is currently an option.	
PU Pull finish	Keying instructions must accompany all orders, refer to page 432 . Pedestals do not come with lock included. Random locks are factory installed. Key-alike are field installed using the Knoll Key order form. Each locking pedestal on this page counts for one lock core.	
Open book case:	These pedestals are key hole construction.	
1. <i>Finish type</i> L = Laminate 1 = V1 2 = V2 3 = V3		
2. Interior option		
3. Cabinet finish		

Pedestals, 28³/₈" planning

22³/₈" high, Box File with Single Front

Metal interiors

description	w	d	pattern no.	L	L/V1	L/V2	L/V3	V1	V2	V3
Pedestal, 22 ³ / ₈ " high	30"	19"	RP301H () () () L ()	\$1,335.	\$1,445.	\$1,500.	\$1,555.	\$1,610.	\$1,806.	\$2,413.
box/file configuration with	30"	23"	RP302H () () () L ()	1,404.	1,519.	1,575.	1,633.	1,690.	1,894.	2,531.
single common front	36"	19"	RP361H () () () L ()	1,419.	1,534.	1,592.	1,650.	1,708.	1,916.	2,563.
	36"	23"	RP362H () () () L ()	1,484.	1,604.	1,664.	1,724.	1,784.	2,003.	2,680.



Pedestals may require counterweights when used in unsecured fashion (ie freestanding)

*3 counterweights per pedestal

Supplied with hardware kit including wood screws for attachment to underside of worksurface

Order Code	Specification Information	Application Notes
Example: RP301H () () () L ()	<i>To order please specify pattern number including:</i>	It is NOT advisable to mix 28³/₈"h desk height products with 26¹/₂"h standard height products. These pedestals to be used in conjunction with 28³/₈" planning.
R Reff	1. <i>Case Finish:</i> L, V1, V2, V3	The single front is attached to the file drawer.
P Pedestal	2. <i>Front Finish:</i> L, V1, V2, V3	Box drawer is hidden behind the single front, and gets the same front finish as the case. Box drawer gets no applied pulls. Finger space is provided for access.
30 30" wide, 36=36" wide	3. <i>Interior option:</i> M= Metal interior	Pedestals are key hole construction.
1 19" deep, 2 = 23" deep	4. <i>Pull option</i> B = No pull, No drilling Customer's own pull C = C-pull (Nickel finish only) D = D-pull (Painted, PZ or PT finishes only) F = Bar (1 pull / Drawer) H = Outline (2 pull / Drawer) J = Routed J-pull R = Cylinder (2 pull / Drawer) S = S-pull (Stainless steel only) T = Tab (1 pull / Drawer)	Pencil trays are not included.
H Box/File config. with single front	5. <i>Pull finish:</i> Painted or plated (except as noted)	
V316 Case Finish	6. <i>Lock option</i> Pedestals with drawers always lock drilled L = drilled to accept lock	
V316 Front Finish	7. <i>Lock finish</i> B = Black S = Matte silver	
M Metal Interior option		
T Tab Pull option		
111 Pull finish		
L Lock option		
B Lock finish		
	*If case is Laminate, the front can be laminate or wood. *If case is Wood, the front can only be wood.	Product on this page Excluding J-pull option will accept wood grain laminate, where laminate is currently an option. Keying instructions must accompany all orders, refer to page 325. Pedestals do not come with lock included. Key-alike are field installed using the Knoll Key order form. Each locking pedestal on this page counts for one lock core. Applied back ordered separately for finished back. File drawers do not support bottom loading. File drawers include bars for front to back and side to side filing. Pedestals are supplied with hardware kit including wood screws for attachment to underside of worksurface. Pedestals are key hole construction.

Pedestals, 28³/₈" planning

22³/₈" high, Box File with Single Front

Wood interiors

description	w	d	pattern no.	L	L/V1	L/V2	L/V3	V1	V2	V3
Pedestal, 22 ³ / ₈ " high	30"	19"	RP301H () () () () L ()	\$1,583.	\$1,710.	\$1,774.	\$1,838.	\$1,901.	\$2,135.	\$2,791.
box/file configuration with	30"	23"	RP302H () () () () L ()	1,850.	1,996.	2,067.	2,140.	2,213.	2,482.	3,326.
single common front	36"	19"	RP361H () () () () L ()	1,941.	2,093.	2,170.	2,246.	2,322.	2,611.	3,498.
	36"	23"	RP362H () () () () L ()	2,248.	2,424.	2,512.	2,600.	2,689.	3,018.	4,054.



Pedestals may require counterweights when used in unsecured fashion (ie freestanding)

*3 counterweights per pedestal

Supplied with hardware kit including wood screws for attachment to underside of worksurface

Order Code	Specification Information	Application Notes
Example: RP301H () () () () L ()	<i>To order please specify pattern number including:</i>	It is NOT advisable to mix 28³/₈"h desk height products with 26¹/₂"h standard height products. These pedestals to be used in conjunction with 28³/₈" planning.
R Reff	1. <i>Case Finish:</i> L, V1, V2, V3	The single front is attached to the file drawer.
P Pedestal	2. <i>Front Finish:</i> L, V1, V2, V3	Box drawer is hidden behind the single front, and gets the same front finish as the case. Box drawer gets no applied pulls. Finger space is provided for access.
30 30" wide, 36=36" wide	3. Interior option: W= Wood interior option	Pencil trays are not included.
1 19" deep, 2 = 23" deep	4. <i>Pull option</i> B = No pull, No drilling Customer's own pull C = C-pull (Nickel finish only) D = D-pull (Painted, PZ or PT finishes only) F = Bar (1 pull / Drawer) H = Outline (2 pull / Drawer) J = Routed J-pull R = Cylinder (2 pull / Drawer) S = S-pull (Stainless steel only) T = Tab (1 pull / Drawer)	Product on this page Excluding J-pull option will accept wood grain laminate, where laminate is currently an option.
H Box/File config. with single front	5. <i>Pull finish:</i> Painted or plated	Keying instructions must accompany all orders, refer to page 325. Pedestals do not come with lock included. Key-alike are field installed using the Knoll Key order form. Each locking pedestal on this page counts for one lock core.
V316 Case Finish	6. <i>Lock option</i> Pedestals with drawers always lock drilled L = drilled to accept lock	Applied back ordered separately for finished back. File drawers do not support bottom loading. File drawers include bars for front to back and side to side filing.
V316 Front Finish	7. <i>Lock finish</i> B = Black S = Matte silver	Pedestals are supplied with hardware kit including wood screws for attachment to underside of worksurface.
W Wood Interior option		Pedestals are key hole construction.
T Tab Pull option		
111 Pull finish		
L Lock option		
B Lock finish		
	*If case is Laminate, the front can be laminate or wood. *If case is Wood, the front can only be wood.	

Pedestals, 28³/₈" planning
Removable Back with access, 22³/₈" high
Wood interiors

description	w	d	pattern no.	L	L/V1	L/V2	L/V3	V1	V2	V3
Desk Height, 22 ³ / ₈ "	30"	19"	RPH301A () () () ()	\$1,576.	\$1,721.	\$1,794.	\$1,866.	\$1,938.	\$2,354.	\$3,264.
Access Pedestal, Hinge doors	30"	23"	RPH302A () () () ()	1,615.	1,869.	1,996.	2,122.	2,249.	2,707.	3,734.
	36"	19"	RPH361A () () () ()	1,624.	1,912.	2,056.	2,200.	2,344.	2,816.	3,883.
	36"	23"	RPH362A () () () ()	1,661.	2,085.	2,298.	2,510.	2,722.	3,243.	4,461.



Pedestal, 22 ³ / ₈ " high	30"	19"	RP301A () ()	1,062.	n/a	n/a	n/a	1,248.	1,407.	1,899.
cabinet access bookcase	30"	23"	RP302A () ()	1,262.	n/a	n/a	n/a	1,490.	1,680.	2,266.
* with removable back	36"	19"	RP361A () ()	1,322.	n/a	n/a	n/a	1,565.	1,765.	2,380.
	36"	23"	RP362A () ()	1,581.	n/a	n/a	n/a	1,859.	2,099.	2,832.



Order Code	Specification Information	Application Notes
Example: RPH301A () () () ()	<i>To order please specify pattern number including:</i>	It is NOT advisable to mix 28³/₈" desk height products with 26¹/₂"h standard height products. These pedestals to be used in conjunction with 28³/₈" planning.
R Reff	1. <i>Lock option</i> L = Drilled for lock N = No lock drilling	Comes with one adjustable, wood shelf.
P Pedestal	2. <i>Lock finish:</i> B = Black S = Matte Silver	Wood shelf only, no metal interior.
H Hinge doors	3. <i>Pull option</i> B = No pull, No drilling Customer's own pull C = Metal C-pull D = Metal D-pull F = Bar (1 pull / Door set) H = Outline J = Routed J-pull S = Metal S-pull R = Cylinder T = Tab (1 pull / Door set)	Open access is above adjustable shelf.
30 30" wide	4. <i>Pull finish:</i> Painted or Plated	Pedestal backs and Fillers, are NOT intended for products on this page.
1 19" deep	5. <i>Case Finish:</i> Wood or Laminate	Inside height clearance of the open bookcase; Top shelf = 4.9" Bottom shelf = 11.6"
A Access	6. <i>Front Finish:</i> Wood or Laminate	
L Lock option	*If case is Laminate, the front can be laminate or wood.	
B Lock finish	*If case is Wood, the front can only be wood.	
B Pull option		
111 Pull finish		
118 Case Finish		
V613 Front finish		
<i>To order the bookcase, please specify pattern number including:</i>		
1. <i>Finish type</i> L = Laminate 1 = V1 2 = V2 3 = V3		
2. <i>Cabinet finish:</i> Laminate, V1, V2, V3		

Pedestals, 28³/₈" planning
Equipment Pedestal, 22³/₈" high
Wood interiors

description	w	d	pattern no.	L	L/V1	L/V2	L/V3	V1	V2	V3
Pedestal, 22 ³ / ₈ " high	30"	19"	RP301E(L/R) () () () () () ()	\$2,008.	\$2,369.	\$2,548.	\$2,729.	\$2,909.	\$3,152.	\$3,761.
equipment configuration	30"	23"	RP302E(L/R) () () () () () ()	2,045.	2,412.	2,595.	2,779.	2,962.	3,203.	3,879.
(wood interior only)	36"	19"	RP361E(L/R) () () () () () ()	2,057.	2,422.	2,604.	2,786.	2,968.	3,219.	3,871.
	36"	23"	RP362E(L/R) () () () () () ()	2,091.	2,460.	2,646.	2,830.	3,015.	3,284.	3,989.



Left hand shown

Order Code	Specification Information	Application Notes
Example: RP301E(L/R)	<i>To order please specify pattern number including:</i>	It is NOT advisable to mix 28³/₈" desk height products with 26¹/₂" standard height products. These pedestals to be used in conjunction with 28³/₈" planning.
R Reff	1. Case type: L = laminate 1 = V1 2 = V2 3 = V3	Equipment Pedestal's Clearance: Enclosed Area: For 30" w X 19" d 19 1/2" w X 16 1/2" d X 13 1/4" h For 30" w X 23" d 19 1/2" w X 20 1/2" d X 13 1/4" h For 36" w X 19" d 25 1/2" w X 16 1/2" d X 13 1/4" h For 36" w X 23" d 25 1/2" w X 20 1/2" d X 13 1/4" h
P Pedestal	2. Front Finish type: L = Laminate 1 = V1 2 = V2 3 = V3	Product on this page Excluding J-pull option will accept wood grain laminate, where laminate is currently an option.
30 30" wide	3. Interior option: W (wood)	From the viewer's perspective, the drawer location determines the pedestal Right/Left orientation.
1 19" deep (nominal)	4. Pull option B = No pull, No drilling Customer's own pull C = nickel finish C-pull (nickel finish only) D = metal D-pull F = Bar pull H = Outline pull R = Cylinder pull S = S-pull (stainless steel finish only) T = Tab pull	Applied back can be ordered separately, but NOT recommended for it restricts ventilation.
E Equipment Ped.	5. Case finish	Not advised to use in a stand alone application.
L Left hand	6. Front finish	
V2 Case finish type	7. Pull finish: Painted or Plated	
V2 Front finish type	8. Lock option L = Lock hole drilled N = No lock drilling	
W Interior option, wood	9. Lock finish: B = Black S = Silver	
H Pull option		
V316 Case finish		
V316 Front Finish		
111 Pull finish		
L Lock option		
B Lock finish		

*If case is Laminate, the front can be laminate or wood.
 *If case is Wood, the front can only be wood.

Pedestals, 28³/₈" planning
Mobile Pedestal, 23" high
Wood interiors

description	w	d	h	pattern no.	L/L	L/V1	L/V2	L/V3	V1	V2	V3
Mobile Pedestal	16"	19"	23"	RMPU () () () () () ()	\$2,366.	\$2,616.	\$2,669.	\$2,736.	\$2,725.	\$3,120.	\$4,018.



Order Code	Specification Information	Application Notes
Example: RMPU () () () () () ()	<i>To order please specify pattern number including:</i>	<p>It is NOT advisable to mix 28³/₈" desk height products with 26¹/₂" standard height products. These pedestals to be used in conjunction with 28³/₈" planning.</p> <p>Product on this page will accept woodgrain laminate where laminate is currently an option.</p> <p>These products are Glue and Dowel Construction</p> <p>Always comes with lock.</p> <p>Always comes with finished back</p> <p>Grommet pull only.</p> <p>Actual width = 15¹⁵/₁₆"</p> <p>Actual depth = 19¹/₁₆"</p> <p>Actual total height = 23³/₈"</p>
R Reff		
M Mobile		
P Pedestal		
U Cubby above with drawer/box/file	1. Lock option Pedestals with drawers always lock drilled.	
L Lock Option	2. Lock finish B = Black S = Matte silver	
B Lock Finish	3. Pull option G = Grommet pull only	
G Pull Finish	4. Pull finish: Painted or Plated	
V316 Case Finish	5. Case finish	
V316 Front Drawer Finish	6. Front finish	
111 Pencil Tray Finish	7. Pencil tray finish Painted / Anodized	

BBF/FF/BBBB

Metal interiors

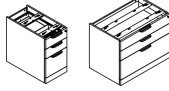
description	w	d	pattern no.	L	L/V1	L/V2	L/V3	V1	V2	V3
Pedestal, 28 ³ / ₈ " high, box/box/file configuration 	16"	19"	RP161J () () L () ()	\$1,313.	\$1,406.	\$1,453.	\$1,500.	\$1,547.	\$1,744.	\$2,347.
	16"	23"	RP162J () () L () ()	1,375.	1,473.	1,523.	1,572.	1,622.	1,827.	2,457.
	16"	29"	RP163J () () L () ()	1,432.	1,534.	1,585.	1,636.	1,687.	1,902.	2,559.
	30"	19"	RP301J () () L () ()	1,725.	1,850.	1,913.	1,975.	2,038.	2,293.	3,094.
	30"	23"	RP302J () () L () ()	1,818.	1,950.	2,014.	2,080.	2,145.	2,416.	3,262.
	36"	19"	RP361J () () L () ()	1,837.	1,971.	2,039.	2,105.	2,173.	2,448.	3,306.
	36"	23"	RP362J () () L () ()	1,929.	2,067.	2,136.	2,206.	2,274.	2,565.	3,465.

*Pencil Tray not included

Pedestals may require counterweights when used in unsecured fashion (ie freestanding)

*3 counterweights per pedestal

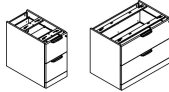
Pedestal, 28 ³ / ₈ " high, file/file configuration 	16"	19"	RP161K () () L () ()	1,205.	1,293.	1,336.	1,380.	1,423.	1,604.	2,168.
	16"	23"	RP162K () () L () ()	1,290.	1,383.	1,430.	1,476.	1,522.	1,720.	2,323.
	16"	29"	RP163K () () L () ()	1,378.	1,475.	1,524.	1,572.	1,622.	1,832.	2,470.
	30"	19"	RP301K () () L () ()	1,380.	1,480.	1,529.	1,580.	1,630.	1,835.	2,475.
	30"	23"	RP302K () () L () ()	1,455.	1,560.	1,611.	1,664.	1,716.	1,933.	2,610.
	36"	19"	RP361K () () L () ()	1,469.	1,576.	1,630.	1,684.	1,737.	1,958.	2,645.
	36"	23"	RP362K () () L () ()	1,544.	1,654.	1,709.	1,764.	1,819.	2,052.	2,772.

*Pencil Tray not included

Pedestals may require counterweights when used in unsecured fashion (ie freestanding)

*3 counterweights per pedestal

Order Code	Specification Information	Application Notes
Example: RP161J(L)(M)(J)L(118)	<i>To order please specify pattern number including:</i>	<p>7. Cabinet finish</p> <p>8. Front finish</p> <p>9. Pull finish Painted or Plated</p> <p>*If case is Laminate, the front can be laminate or wood. *If case is Wood, the front can only be wood.</p> <p>Product on this page Excluding J-pull option will accept wood grain laminate, where laminate is currently an option.</p> <p>Keying instructions must accompany all orders, refer to page 432 . Pedestals do not come with lock included. Random locks are factory installed. Key-alike are field installed using the KnollKey order form. Each locking pedestal on this page counts for one lock core.</p> <p>Pencil trays not included in pedestals with metal interiors.</p> <p>Pencil tray to be ordered separately; see page 415.</p> <p>Finished back must be ordered separately to achieve full depth without a modesty. (page 159)</p>
R Reff		
P Pedestal		
16 16" wide (nominal)		
1 19" deep (nominal)		
J Box/Box/File config.		
L Case finish type, laminate	1. <i>Case Finish type</i> L = laminate 1 = V1 2 = V2 3 = V3	
2 Front finish type, V2	2. <i>Front Finish type</i> L = laminate 1 = V1 2 = V2 3 = V3	
M Interior option, metal	3. <i>Interior option</i>	
J Pull option, J	4. <i>Pull option</i> B = No pull, No drilling Customer's own pull C = nickel finish C-pull (nickel finish only) D = metal D-pull (finish optional) F = Bar H = Out Line J = routed J-pull (finish matches case) R = Cylinder S = S-pull (stainless steel finish only)T = Tab	
L Lock option	5. <i>Lock option</i> Pedestals with drawers always lock drilled L = drilled to accept lock	
118 Case finish	6. <i>Lock finish:</i> B = Black S = Matte Silver	
V319 Front finish		
118 Pull finish		

BBF/FF/BBBB

Metal interiors

description	w	d	pattern no.	L	L/V1	L/V2	L/V3	V1	V2	V3
Pedestal, 28 ³ / ₈ " high 4 Box configuration	30"	19"	RP301N () () () () L ()	\$1,827.	\$1,953.	\$2,015.	\$2,079.	\$2,141.	\$2,394.	\$3,196.
	30"	23"	RP302N () () () () L ()	1,895.	2,026.	2,093.	2,159.	2,224.	2,493.	3,338.
	36"	19"	RP361N () () () () L ()	1,940.	2,076.	2,143.	2,211.	2,279.	2,551.	3,409.
	36"	23"	RP362N () () () () L ()	2,008.	2,146.	2,216.	2,285.	2,354.	2,643.	3,543.



Order Code	Specification Information	Application Notes
Example: RP161J(L)(M)(J)L(118)	<i>To order please specify pattern number including:</i>	
R Reff		
P Pedestal		
16 16" wide (<i>nominal</i>)	1. <i>Case Finish type</i> L = laminate 1 = V1 2 = V2 3 = V3	It is NOT advisable to mix 28³/₈"h desk height products with 26¹/₂"h standard height products. These pedestals to be used in conjunction with 28³/₈" planning.
1 19" deep (<i>nominal</i>)	2. <i>Front Finish type</i> L = laminate 1 = V1 2 = V2 3 = V3	File drawers include file bars for front to back and side to side filing.
J Box/Box/File config.	3. <i>Interior option</i>	File drawers do not support bottom loading.
L Case finish type, laminate	4. <i>Pull option</i> B = No pull, No drilling Customer's own pull C = nickel finish C-pull (nickel finish only) D = metal D-pull (finish optional) F = Bar H = Out Line J = routed J-pull (finish matches case) R = Cylinder S = S-pull (stainless steel finish only)T = Tab	Each pedestal may require 3 counterweights when used in unsecured fashion. (ie. Freestanding)
2 Front finish type, V2		1 counterweight = 10 lbs.
M Interior option, metal		Pedestals are supplied with hardware kit including wood screws for attachment to underside of worksurface.
J Pull option, J		
L Lock option		
118 Case finish		
V319 Front finish		
118 Pull finish		
	7. <i>Cabinet finish</i>	
	8. <i>Front finish</i>	
	9. <i>Pull finish</i> Painted or Plated	
	*If case is Laminate, the front can be laminate or wood. *If case is Wood, the front can only be wood.	
	Product on this page Excluding J-pull option will accept wood grain laminate, where laminate is currently an option.	
	Keying instructions must accompany all orders, refer to page 482 . Pedestals do not come with lock included. Random locks are factory installed. Key-alike are field installed using the KnollKey order form. Each locking pedestal on this page counts for one lock core.	
	Pencil trays not included in pedestals with metal interiors.	
	Pencil tray to be ordered separately; see page 415.	
	Finished back must be ordered separately to achieve full depth without a modesty. (page 159)	

BBF/FF/BBBB

Metal interior legal width

description	w	d	pattern no.	L	L/V1	L/V2	L/V3	V1	V2	V3
Pedestal, 28 ³ / ₈ " high	19"	19"	RP191J () () L () ()	\$1,378.	\$1,476.	\$1,525.	\$1,574.	\$1,624.	\$1,831.	\$2,463.
box/box/file configuration	19"	23"	RP192J () () L () ()	1,442.	1,529.	1,573.	1,616.	1,661.	1,916.	2,580.
	19"	29"	RP193J () () L () ()	1,503.	1,610.	1,665.	1,718.	1,772.	1,997.	2,688.

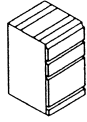

Pencil tray not included
 Pedestals may require counterweights when used in unsecured fashion (ie freestanding)
 *3 counterweights per pedestal

Pedestal, 28 ³ / ₈ " high	19"	19"	RP191K () () L () ()	1,265.	1,357.	1,402.	1,448.	1,494.	1,685.	2,277.
file/file configuration	19"	23"	RP192K () () L () ()	1,356.	1,453.	1,502.	1,551.	1,599.	1,806.	2,440.
	19"	29"	RP193K () () L () ()	1,446.	1,549.	1,600.	1,651.	1,703.	1,922.	2,593.

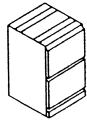

Pencil tray not included
 Pedestals may require counterweights when used in unsecured fashion (ie freestanding)
 *3 counterweights per pedestal

Order Code	Specification Information	Application Notes
Example: RP191J(L)(M)(J)L(118)	<i>To order please specify pattern number including:</i>	<p>It is NOT advisable to mix 28³/₈"h desk height products with 26¹/₂"h standard height products. These pedestals to be used in conjunction with 28³/₈" planning.</p> <p>File drawers include file bars for front to back and side to side filing.</p> <p>File drawers do not support bottom loading.</p> <p>Each pedestal may require 3 counterweights when used in unsecured fashion.(ie. Freestanding)</p> <p>1 counterweight = 10 lbs.</p> <p>Pedestals are supplied with hardware kit including wood screws for attachment to underside of worksurface.</p>
R Reff		
P Pedestal		
19 19" wide (nominal)		
1 19" deep (nominal)		
J Box/Box/File configuration		
L Case finish type, laminate	1. <i>Case Finish type</i> L = laminate 1 = V1 2 = V2 3 = V3	
2 Front finish type, V2	2. <i>Front Finish type</i> L = laminate 1 = V1 2 = V2 3 = V3	
M Interior option, metal	3. <i>Interior option</i> M = metal interior	
J Pull option, J	4. <i>Pull option</i> B = No pull, No drilling Customer's own pull C = nickel finish C-pull (nickel finish only) D = metal D-pull (finish optional) F = Bar H = Out Line J = routed J-pull (finish matches case) R = Cylinder S = S-pull (stainless steel finish only) T = Tab	
L Lock option	5. <i>Lock option</i> Pedestals with drawers always lock drilled L = drilled to accept lock	
118 Case finish	6. <i>Lock finish</i> B = Black S = Matte Silver	
V316 Front finish	7. <i>Case finish</i>	
118 Pull finish	8. <i>Front finish:</i> 9. <i>Pull finish</i> Painted or Plated	
	*If case is Laminate, the front can be laminate or wood. *If case is Wood, the front can only be wood.	
	Product on this page Excluding J-pull option will accept wood grain laminate, where laminate is currently an option.	
	Keying instructions must accompany all orders, refer to page 432 . Pedestals do not come with lock included. Random locks are factory installed. Key-alike are field installed using the KnollKey order form. Each locking pedestal on this page counts for one lock core.	
	Pencil trays not included in pedestals with metal interiors.	
	Pencil tray to be ordered separately; see page 415.	
	Finished back must be ordered separately to achieve full depth without a modesty. (page159)	

BBF/FF/BBBB

Wood interior

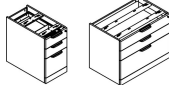
description	w	d	pattern no.	L	L/V1	L/V2	L/V3	V1	V2	V3
Pedestal, 28 ³ / ₈ " high, box/box/file configuration 	16"	19"	RP161J () () () () ()	\$1,395.	\$1,493.	\$1,542.	\$1,591.	\$1,640.	\$1,846.	\$2,484.
	16"	23"	RP162J () () () () ()	1,548.	1,661.	1,716.	1,772.	1,829.	2,058.	2,769.
	16"	29"	RP163J () () () () ()	1,685.	1,807.	1,868.	1,929.	1,990.	2,237.	3,009.
	30"	19"	RP301J () () () () ()	1,982.	2,125.	2,196.	2,267.	2,338.	2,637.	3,562.
	30"	23"	RP302J () () () () ()	2,329.	2,497.	2,581.	2,665.	2,749.	3,093.	4,173.
	36"	19"	RP361J () () () () ()	2,449.	2,624.	2,712.	2,799.	2,887.	3,262.	4,402.
36"	23"	RP362J () () () () ()	2,854.	3,062.	3,165.	3,270.	3,373.	3,801.	5,129.	

Pedestals may require counterweights when used in unsecured fashion (ie freestanding)
*3 counterweights per pedestal

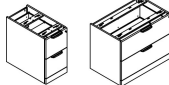
Pedestal, 28 ³ / ₈ " high, file/file configuration 	16"	19"	RP161K () () () () ()	1,279.	1,370.	1,416.	1,462.	1,507.	1,699.	2,293.
	16"	23"	RP162K () () () () ()	1,507.	1,615.	1,669.	1,723.	1,777.	2,002.	2,702.
	16"	29"	RP163K () () () () ()	1,642.	1,761.	1,821.	1,881.	1,940.	2,187.	2,953.
	30"	19"	RP301K () () () () ()	1,652.	1,771.	1,830.	1,889.	1,949.	2,198.	2,967.
	30"	23"	RP302K () () () () ()	1,941.	2,081.	2,151.	2,221.	2,291.	2,578.	3,477.
	36"	19"	RP361K () () () () ()	2,041.	2,187.	2,260.	2,334.	2,407.	2,718.	3,670.
36"	23"	RP362K () () () () ()	2,378.	2,551.	2,637.	2,724.	2,811.	3,167.	4,274.	

Pedestals may require counterweights when used in unsecured fashion (ie freestanding)
*3 counterweights per pedestal

Pedestal, 28 ³ / ₈ " high 4 Box configuration 	30"	19"	RP301N () () () () () ()	2,047.	2,189.	2,260.	2,332.	2,403.	2,701.	3,625.
	30"	23"	RP302N () () () () () ()	2,393.	2,561.	2,647.	2,731.	2,815.	3,157.	4,236.
	36"	19"	RP361N () () () () () ()	2,517.	2,694.	2,783.	2,871.	2,959.	3,331.	4,472.
	36"	23"	RP362N () () () () () ()	2,921.	3,129.	3,234.	3,337.	3,442.	3,867.	5,197.

Order Code	Specification Information	Application Notes
Example: RP161J(L)(W)(J)L(118)	<i>To order please specify pattern number including:</i>	<p>It is NOT advisable to mix 28³/₈"h desk height products with 26¹/₂"h standard height products. These pedestals to be used in conjunction with 28³/₈" planning.</p> <p>File drawers include file bars for front to back and side to side filing.</p> <p>File drawers do not support bottom loading.</p> <p>Each pedestal may require 3 counterweights when used in unsecured fashion. (ie. Freestanding)</p> <p>1 counterweight = 10 lbs.</p> <p>Pedestals are supplied with hardware kit including wood screws for attachment to underside of worksurface.</p>
R Reff	6. <i>Lock Finish</i> B = Black S = Matte Silver	
P Pedestal	7. <i>Case finish</i>	
16 16" wide (nominal)	8. <i>Front finish:</i>	
1 19" deep (nominal)	9. <i>Pull finish</i> Painted or Plated	
J Box/Box/File configuration	*If case is Laminate, the front can be laminate or wood. *If case is Wood, the front can only be wood.	
L Case Finish type, laminate	Product on this page Excluding J-pull option will accept wood grain laminate, where laminate is currently an option.	
2 Front Finish type, V2	Keying instructions must accompany all orders, refer to page 432 . Pedestals do not come with lock included. Random locks are factory installed. Key-alike are field installed using the KnollKey order form. Each locking pedestal on this page counts for one lock core.	
W Interior option, wood	Box-box-file configuration pedestals with wood drawers includes pencil tray and two tray dividers in top box drawer.	
D Pull option	Finished back must be ordered separately to achieve full depth without a modesty. (page 159)	
L Lock option		
118 Case finish		
V316 Front Finish		
118 Pull finish		

Pedestals, 28³/₈" planning

BBF/FF/BBBB

Wood interior legal width

description	w	d	pattern no.	L	L/V1	L/V2	L/V3	V1	V2	V3
Pedestal, 28 ³ / ₈ " high	19"	19"	RP191J(L)(W)(J)L(118)	\$1,464.	\$1,567.	\$1,618.	\$1,671.	\$1,722.	\$1,938.	\$2,608.
box/box/file configuration	19"	23"	RP192J(L)(W)(J)L(118)	1,625.	1,743.	1,802.	1,860.	1,920.	2,160.	2,907.
	19"	29"	RP193J(L)(W)(J)L(118)	1,767.	1,895.	1,959.	2,023.	2,087.	2,347.	3,160.

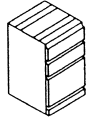

Pedestals may require counterweights when used in unsecured fashion (ie freestanding)
*3 counterweights per pedestal

Pedestal, 28 ³ / ₈ " high	19"	19"	RP191K(L)(W)(J)L(118)	1,420.	1,484.	1,517.	1,549.	1,582.	1,784.	2,407.
file/file configuration	19"	23"	RP192K(L)(W)(J)L(118)	1,581.	1,695.	1,753.	1,810.	1,868.	2,103.	2,837.
	19"	29"	RP193K(L)(W)(J)L(118)	1,725.	1,850.	1,913.	1,975.	2,038.	2,297.	3,100.

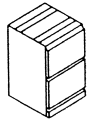

Pedestals may require counterweights when used in unsecured fashion (ie freestanding)
*3 counterweights per pedestal

Order Code	Specification Information	Application Notes
Example: RP191J(L)(W)(J)L(118)	<i>To order please specify pattern number including:</i>	
R Reff		
P Pedestal		
19 19" wide (nominal)	1. <i>Finish type</i> L = laminate 1 = V1 2 = V2 3 = V3	
1 19" deep (nominal)	2. <i>Front Finish type</i> L = laminate 1 = V1 2 = V2 3 = V3	
J Box/Box/File configuration	3. <i>Interior option</i> W = wood interior	
L Case Finish type, laminate	4. <i>Pull option</i> B = No pull, No drilling Customer's own pull C = nickel finish C-pull (nickel finish only) D = metal D-pull (finish optional) F = Bar H = Out Line J = routed J-pull (finish matches case) R = Cylinder S = S-pull (stainless steel finish only) T = Tab	
2 Front Finish Type, V2	5. <i>Lock option</i> Pedestals with drawers always lock drilled L = drilled to accept lock	
W Interior option, wood		
J Pull option, J		
L Lock option		
118 Case finish		
V316 Front finish		
118 Pull finish		
	6. <i>Lock Finish</i> B = Black S = Matte Silver	
	7. <i>Case finish</i>	
	8. <i>Front finish:</i>	
	9. <i>Pull finish</i> Painted or Plated	
	*If case is Laminate, the front can be laminate or wood. *If case is Wood, the front can only be wood.	
	Product on this page Excluding J-pull option will accept wood grain laminate, where laminate is currently an option.	
	Keying instructions must accompany all orders, refer to page 432 . Pedestals do not come with lock included. Random locks are factory installed. Key-alike are field installed using the KnollKey order form. Each locking pedestal on this page counts for one lock core.	
	Box-box-file configuration pedestals with wood drawers includes pencil tray and two tray dividers in top box drawer.	
	Finished back must be ordered separately to achieve full depth without a modesty. (page 159)	
		It is NOT advisable to mix 28³/₈"h desk height products with 26¹/₂"h standard height products. These pedestals to be used in conjunction with 28³/₈" planning.
		File drawers include file bars for front to back and side to side filing.
		File drawers do not support bottom loading.
		Each pedestal may require 3 counterweights when used in unsecured fashion.(ie.Freestanding)
		1 counterweight = 10 lbs.
		Pedestals are supplied with hardware kit including wood screws for attachment to underside of worksurface.

Pedestals, 28³/₈" planning

Open / Hinge Door

Metal interiors

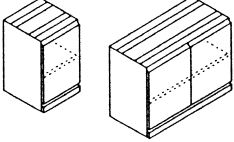
description	w	d	pattern no.	L	L/V1	L/V2	L/V3	V1	V2	V3
Pedestal, 28 ³ / ₈ " high hinge door configuration adjustable shelf 	16"	19"	RP161L(L/R) () () () () ()	\$1,059.	\$1,135.	\$1,172.	\$1,210.	\$1,247.	\$1,407.	\$1,900.
	16"	23"	RP162L(L/R) () () () () ()	1,285.	1,378.	1,425.	1,471.	1,517.	1,709.	2,308.
	16"	29"	RP163L(L/R) () () () () ()	1,469.	1,526.	1,555.	1,584.	1,612.	1,958.	2,645.
	30"	19"	RP301L () () () () ()	1,367.	1,515.	1,590.	1,664.	1,737.	1,818.	2,454.
	30"	23"	RP302L () () () () ()	1,597.	1,713.	1,770.	1,829.	1,886.	2,125.	2,869.
	36"	19"	RP361L () () () () ()	1,732.	1,856.	1,919.	1,980.	2,043.	2,307.	3,114.
	36"	23"	RP362L () () () () ()	2,025.	2,172.	2,246.	2,319.	2,392.	2,697.	3,641.

Inside height clearance top shelf 11", bottom shelf 11.5" when shelf located in center position.
Metal interior means shelf metal.

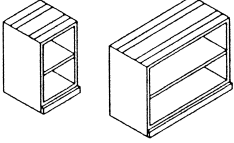
description	w	d	pattern no.	L	L/V1	L/V2	L/V3	V1	V2	V3
Pedestal, 28 ³ / ₈ " high open shelf configuration adjustable shelf 	16"	19"	RP161M () () ()	803.	n/a	n/a	n/a	933.	1,071.	1,445.
	16"	23"	RP162M () () ()	939.	n/a	n/a	n/a	1,087.	1,249.	1,686.
	16"	29"	RP163M () () ()	1,107.	n/a	n/a	n/a	1,281.	1,475.	1,993.
	30"	19"	RP301M () () ()	936.	n/a	n/a	n/a	1,083.	1,245.	1,681.
	30"	23"	RP302M () () ()	1,138.	n/a	n/a	n/a	1,315.	1,513.	2,042.
	36"	19"	RP361M () () ()	1,195.	n/a	n/a	n/a	1,387.	1,592.	2,147.
	36"	23"	RP362M () () ()	1,447.	n/a	n/a	n/a	1,676.	1,926.	2,600.

Inside height clearance top shelf 11", bottom shelf 11.5" when shelf located in center position.
Metal interior means shelf metal.

Order Code	Specification Information	Application Notes
Example: RP161LL(L)(M)(J)L(118)	<i>To order please specify pattern number including:</i>	<p>It is NOT advisable to mix 28³/₈" desk height products with 26¹/₂" standard height products. These pedestals to be used in conjunction with 28³/₈" planning.</p> <p>Note: Hinge door cabinets have optional lock drilling which can be specified in the cabinet product code.</p> <p>Finished back must be ordered separately to achieve full depth without a modesty. (page 159)</p> <p>Pedestals are supplied with hardware kit including wood screws for attachment to underside of worksurface.</p>
R Reff	1. <i>Hinge location, where applicable</i> L = left hand R = right hand	
P Pedestal	2. <i>Finish type</i> L = laminate 1 = V1 2 = V2 3 = V3	
16 16" wide (nominal)	3. <i>Front finish type;</i> L = Laminate 1 = V2 2 = V2 3 = V3	
1 19" deep (nominal)	4. <i>Interior option</i> M = metal interior Pedestals with metal interior, the shelves come painted. For laminate cases, the shelves are painted to match ie. 114 case = 114 painted shelves. For wood cases, the shelves are painted black ie. V316 case = black shelves.	
L Hinge door config.	5. <i>Pull option</i> B = No pull, No drilling Customer's own pull C = nickel finish C-pull (nickel finish only) D = metal D-pull (finish optional) F = Bar (1 pull per door set) H = Out Line J = routed J-pull (finish matches case) R = Cylinder S = S-pull (stainless steel finish only) T = Tab (1 pull per door set)	
L Left hand hinge location	6. <i>Lock option</i> Optional for hinged door configurations only L = drilled to accept lock N = no drilling	
L Case Finish type, laminate	7. <i>Lock Finish:</i> B = Black S = Matte Silver	
2 Front Finish type	8. <i>Case finish</i> 9. <i>Front finish</i> 10. <i>Pull finish</i> Painted or Plated	
M Interior option, metal	*If case is Laminate, the front can be laminate or wood. *If case is Wood, the front can only be wood.	
J Pull option, J	Product on this page Excluding J-pull option will accept wood grain laminate, where laminate is currently an option.	
L Lock option	Keying instructions must accompany all orders, refer to page 482 . Pedestals do not come with lock included. Random locks are factory installed. Key-alike are field installed using the KnollKey order form. Each locking pedestal on this page counts for one lock core.	
118 Case finish		
V319 Front finish		
118 Pull finish		

For Open pedestals;

- 1. Finish type
- 2. Interior option
- 3. Cabinet finish

Pedestals, 28³/₈" planning

Open / Hinge Door

Wood interiors

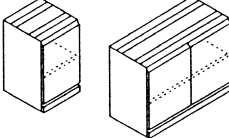
description	w	d	pattern no.	L	L/V1	L/V2	L/V3	V1	V2	V3
Pedestal, 28 ³ / ₈ " high hinge door configuration adjustable shelf 	16"	19"	RP161L(L/R) () () () () ()	\$1,157.	\$1,241.	\$1,282.	\$1,324.	\$1,366.	\$1,541.	\$2,080.
	16"	23"	RP162L(L/R) () () () () ()	1,391.	1,489.	1,539.	1,588.	1,637.	1,848.	2,497.
	16"	29"	RP163L(L/R) () () () () ()	1,574.	1,638.	1,670.	1,702.	1,733.	2,089.	2,822.
	30"	19"	RP301L () () () () ()	1,466.	1,622.	1,700.	1,778.	1,856.	1,954.	2,638.
	30"	23"	RP302L () () () () ()	1,700.	1,823.	1,886.	1,948.	2,009.	2,263.	3,057.
	36"	19"	RP361L () () () () ()	1,837.	1,967.	2,033.	2,097.	2,163.	2,437.	3,292.
	36"	23"	RP362L () () () () ()	2,129.	2,282.	2,359.	2,434.	2,511.	2,828.	3,818.

Inside height clearance top shelf 11", bottom shelf 11.5" when shelf located in center position.

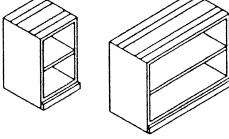
description	w	d	pattern no.	L	L/V1	L/V2	L/V3	V1	V2	V3
Pedestal, 28 ³ / ₈ " high open shelf configuration adjustable shelf 	16"	19"	RP161M () () ()	909.	n/a	n/a	n/a	1,044.	1,204.	1,627.
	16"	23"	RP162M () () ()	1,042.	n/a	n/a	n/a	1,208.	1,391.	1,877.
	16"	29"	RP163M () () ()	1,211.	n/a	n/a	n/a	1,397.	1,613.	2,179.
	30"	19"	RP301M () () ()	1,040.	n/a	n/a	n/a	1,201.	1,381.	1,863.
	30"	23"	RP302M () () ()	1,240.	n/a	n/a	n/a	1,434.	1,651.	2,226.
	36"	19"	RP361M () () ()	1,297.	n/a	n/a	n/a	1,507.	1,728.	2,337.
	36"	23"	RP362M () () ()	1,549.	n/a	n/a	n/a	1,787.	2,057.	2,779.

Inside height clearance top shelf 11", bottom shelf 11.5" when shelf located in center position.

Order Code	Specification Information
Example: RP161LL(L)(W)(J)L(118)	<i>To order please specify pattern number including:</i>
R Reff	1. <i>Hinge location, were applicable</i>
P Pedestal	L = left hand
16 16" wide (nominal)	R = right hand
1 19" deep (nominal)	2. <i>Case type</i>
L Hinge door config.	L = laminate
L Left hand hinge location	1 = V1
L Case Finish type, laminate	2 = V2
2 Front Finish type	3 = V3
W Interior option, wood	3. <i>Front finish type;</i>
J Pull option, J	L = Laminate
L Lock option	1 = V1
118 Case finish	2 = V2
V319 Front finish	3 = V3
118 Pull finish	4. <i>Interior option</i>

For Open pedestals:

1. Finish type
2. Interior option
3. Cabinet finish

Specification Information

1. *Hinge location, were applicable*
L = left hand
R = right hand
2. *Case type*
L = laminate
1 = V1
2 = V2
3 = V3
3. *Front finish type;*
L = Laminate
1 = V1
2 = V2
3 = V3
4. *Interior option*
W = wood interior
5. *Pull option*
B = No pull, No drilling
Customer's own pull
C = nickel finish C-pull
D = metal D-pull
F = Bar (1 pull per door set)
H = Out Line
J = routed J-pull
R = Cylinder
S = S-pull
T = Tab (1 pull per door set)

Application Notes

6. *Lock option*
Optional for hinged door configurations only
Lock default is Black
L = drilled to accept lock
N = no drilling
 7. *Lock Finish:*
B = Black
S = Matte Silver
 8. *Case finish*
 9. *Front finish*
 10. *Pull finish*
Painted or Plated
- *If case is Laminate, the front can be laminate or wood.
*If case is Wood, the front can only be wood.
- Product on this page **Excluding J-pull option** will accept wood grain laminate, where laminate is currently an option.
- It is NOT advisable to mix 28³/₈"h desk height products with 26¹/₂"h standard height products. These pedestals to be used in conjunction with 28³/₈" planning.**
- Hinge door cabinets have optional lock drilling which can be specified in the cabinet product code.
- Finished back must be ordered separately to achieve full depth without a modesty.(page159)
- Pedestals are supplied with hardware kit including wood screws for attachment to underside of worksurface.

Pedestals, 28³/₈" planning
Removable Back
Wood interiors

description	w	d	pattern no.	L	L/V1	L/V2	L/V3	V1	V2	V3
Pedestal, 28 ³ / ₈ " high hinge door configuration	30"	19"	RPDHH301A()()()	\$1,658.	\$1,811.	\$1,888.	\$1,964.	\$2,041.	\$2,479.	\$3,436.
Access with removable back	30"	23"	RPDHH302A()()()	1,700.	1,967.	2,100.	2,233.	2,367.	2,850.	3,930.
(wood interior only)	36"	19"	RPDHH361A()()()	1,709.	2,012.	2,164.	2,315.	2,467.	2,963.	4,087.
	36"	23"	RPDHH362A()()()	1,749.	2,196.	2,419.	2,642.	2,866.	3,413.	4,696.



Pedestal, 28 ³ / ₈ " high open book case	30"	20"	RPDH301A()	1,274.	n/a	n/a	n/a	1,499.	1,688.	2,281.
Access with removable back	30"	24"	RPDH302A()	1,514.	n/a	n/a	n/a	1,788.	2,016.	2,719.
(wood interior only)	36"	20"	RPDH361A()	1,588.	n/a	n/a	n/a	1,878.	2,118.	2,857.
	36"	24"	RPDH362A()	1,897.	n/a	n/a	n/a	2,231.	2,517.	3,400.



Order Code	Specification Information	Application Notes
Example: RPDHH301A	<i>To order please specify pattern number including:</i>	
R Reff	1. <i>Lock Option:</i> L = Drilled to accept lock N = no drilling	4. <i>Pull Finish:</i> Painted Plated
P Pedestal	2. <i>Lock Finish:</i> B = Black S = Matte Silver	5. <i>Case Finish:</i> L, V1, V2, V3
DH Desk Height	3. <i>Pull option:</i> B = no pull, no drilling Customer's own pull C = nickel finish C-pull D = metal D-pull F = Bar pull (1 pull per door set) H = Outline pull J = routed J-pull R = Cylinder pull S = S-pull T = Tab pull (1 pull per door set)	6. <i>Front finish:</i> L, V1, V2, V3
H Hinge doors		*If case is Laminate, the front can be laminate or wood. *If case is Wood, the front can only be wood.
30 30" wide		It is NOT advisable to mix 28³/₈"h desk height products with 26¹/₂"h standard height products. These pedestals to be used in conjunction with 28³/₈" planning.
1 19" deep		Product on this page Excluding J-pull option will accept wood grain laminate, where laminate is currently an option.
A Access		The pedestals on this page come with one adjustable shelf
L Lock option		Wood shelf only
B Lock finish		Not available in metal interior
B Pull option, B		Removable back is above adjustable shelf
() Pull finish		Works the same way as the 3/4" access ped
118 Case finish		Inside height clearance: Top shelf = 10.9" Bottom shelf = 11.6"
V319 Front finish		

Pedestals, 28³/₈" planning

24" Wide Pedestals

Multiple Configurations

description	w	d	pattern no.	L	L/V1	L/V2	L/V3	V1	V2	V3
Hinge Door pedestal, 28 ³ / ₈ " high 24" width	24"	19"	RP241L(L/R)() () () ()	\$1,184.	\$1,279.	\$1,327.	\$1,375.	\$1,423.	\$1,606.	\$2,170.
	24"	23"	RP242L(L/R)() () () ()	1,308.	1,439.	1,504.	1,569.	1,635.	1,885.	2,548.



Waste - Recycle Basket Pedestals with drawer fronts 28 ³ / ₈ " high	24"	19"	RP241W() () ()	1,823.	1,924.	1,975.	2,025.	2,076.	2,246.	2,810.
	24"	23"	RP242W() () ()	1,948.	2,084.	2,151.	2,220.	2,288.	2,525.	3,188.



Order Code	Specification Information
Example: RP241L(L/R)() () () ()	<i>To order please specify pattern number including:</i>
R Reff	1. <i>Hinge location, where applicable,</i> L = left hand R = right hand
P Pedestal	2. <i>Case Finish:</i>
24 24" wide	3. <i>Front finish</i>
1 19" deep (2=23" deep)	4. <i>Pull option</i> B = No pull, No drilling Customer's own pull C = nickel finish only D = metal D-pull (painted, PZ, PT only) F = Bar H = Outline pull (1 pull/door) J = routed J-pull R = Cylinder pull (1 pull/door) S = S-pull (stainless steel only) T = Tab (1 pull per door) (Note: F,H,R and T Pulls are centered on the door)
L Hinge door config. W = Waste - recycle drawer config.	5. <i>Pull finish:</i> Painted or plated
L Left (R = right)	6. <i>Lock option, where applicable:</i> L = Lock N = No lock
V319 Cabinet Case Finish	7. <i>Lock Finish, where applicable:</i> B = Black S = Matte Silver
V319 Front finish	
F Pull option	
PD Pull finish	
L Lock option	
B Lock finish	

Interior clearance dimensions;
For 19" deep pedestals:

Depth: 16.5"
Height: 23.7"
Width: 21"

For 23" deep pedestals:

Depth: 20.5"
Height: 23.7"
Width: 21"

Specification Information

- Hinge location, where applicable,*
L = left hand
R = right hand
- Case Finish:*
- Front finish*
- Pull option*
B = No pull, No drilling
Customer's own pull
C = nickel finish only
D = metal D-pull (painted, PZ, PT only)
F = Bar
H = Outline pull (1 pull/door)
J = routed J-pull
R = Cylinder pull (1 pull/door)
S = S-pull (stainless steel only)
T = Tab (1 pull per door)
(Note: F,H,R and T Pulls are centered on the door)
- Pull finish:*
Painted or plated
- Lock option, where applicable:*
L = Lock
N = No lock
- Lock Finish, where applicable:*
B = Black
S = Matte Silver

*If case is Laminate, the front can be laminate or wood.
*If case is Wood, the front can only be wood.

Application Notes

It is NOT advisable to mix 28³/₈" desk height products with 26¹/₂" standard height products. These pedestals to be used in conjunction with 28³/₈" planning.

Keying instructions must accompany all orders, refer to page 432 . Pedestals do not come with lock included. Key-alike are field installed using the KnollKey order form. Each locking pedestal on this page counts for one lock core.

Product on this page **Excluding J-pull option** will accept wood grain laminate, where laminate is currently an option.

The waste - recycle units come fully assembled, include 2 bins for recycling and waste. Waste recycle pedestals do not have a lock option. The drawer body which holds the bins, come in black only. Bins are grey and have 35 (US) quarts capacity.

The intent of the hinged door pedestals, is to be customized to your preference, and are to be used in conjunction with interior options, such as; shelves (which can be ordered separately) or empty for use with a mini refrigerator.

To order shelf kits for these pedestals, refer to page 416.

The shelf drillings in these units are continuously 2.5" apart from top to bottom.

Suitable tops for these units are; 1 1/2" thick rectilinear tops (with desk top grommet) or 1 1/2" thick Credenza tops (with edge grommet).

6" filler is optional and can be ordered separately to achieve full depth.

Finished back not recommended for use with a refrigerator as it restricts ventilation.

Pedestals, 28³/₈" planning
Equipment Pedestal, 28³/₈" high
Wood interior

description	w	d	pattern no.	L	L/V1	L/V2	L/V3	V1	V2	V3
Pedestal, 28 ³ / ₈ " high	30"	19"	RPDH301E(L/R)() () () () () ()	\$2,409.	\$2,841.	\$3,058.	\$3,274.	\$3,490.	\$3,783.	\$4,513.
Equipment configuration (wood interior only)	30"	23"	RPDH302E(L/R)() () () () () () ()	2,454.	2,895.	3,114.	3,334.	3,555.	3,844.	4,724.
	36"	19"	RPDH361E(L/R)() () () () () () ()	2,469.	2,907.	3,125.	3,345.	3,563.	3,862.	4,645.
	36"	23"	RPDH362E(L/R)() () () () () () ()	2,510.	2,953.	3,174.	3,396.	3,617.	3,941.	4,788.





Order Code	Specification Information	Application Notes
Example: RPDH301E(L/R)	<i>To order please specify pattern number including:</i>	It is NOT advisable to mix 28³/₈" desk height products with 26¹/₂" standard height products. These pedestals to be used in conjunction with 28³/₈" planning.
R Reff		Equipment Pedestal's interior clearance:
P Pedestal	1. <i>Case Finish type:</i> L = Laminate 1 = V1 2 = V2 3 = V3	Enclosed Area: For 30" w X 19" d; 22.5" w X 16.5" d X 13.25" h For 30" w X 23" d; 22.5" w X 20.5" d X 13.25" h For 36" w X 19" d; 26.5" w X 16.5" d X 13.25" h For 36" w X 23" d; 26.5" w X 20.5" d X 13.25" h
DH Desk height	2. <i>Front Finish type:</i> L = Laminate 1 = V1 2 = V2 3 = V3	Product on this page Excluding J-pull option will accept wood grain laminate, where laminate is currently an option.
30 30" wide	3. <i>Interior option: W (wood)</i>	From the viewer's perspective, the drawer location determines the pedestal Right/Left orientation.
1 19" deep (nominal)	4. <i>Pull option</i> B = No pull, No drilling Customer's own pull C = Nickel finish C-pull D = Metal D-pull F = Bar pull H = Outline pull J = Rounded J-pull R = Cylinder pull S = S-pull (Stainless Steel Finish only) T = Tab pull	Applied back can be ordered separately but NOT recommended, for it restricts ventilation.
E Equipment Ped.		Not advised to use in a stand alone application.
L Left hand		
2 V2 Case finish type		
2 V2 Front Finish type		
W Interior option, wood		
H Pull option		
V316 Case finish		
V316 Front finish		
111 Pull finish		
L Lock option		
B Lock finish		
	5. Cabinet finish	
	6. Front finish	
	7. Pull finish: Painted or Plated	
	8. <i>Lock option</i> L = Lock hole drilled N = No lock drilling	
	9. Lock finish: B = Black S = Matte Silver	

*If case is Laminate, the front can be laminate or wood.
 *If case is Wood, the front can only be wood.

Pedestals, 34³/₈" high

24" Wide Pedestals, Service Height

Multiple Configurations



description	w	d	pattern no.	L	L/V1	L/V2	L/V3	V1	V2	V3
 Hinge Door pedestal 34 ³ / ₈ " high	24"	19"	RPSH241L(L/R)() () () ()	\$1,230.	\$1,329.	\$1,379.	\$1,429.	\$1,478.	\$1,669.	\$2,254.
	24"	23"	RPSH242L(L/R)() () () ()	1,358.	1,493.	1,562.	1,630.	1,697.	1,957.	2,646.
 Waste - Recycle Basket Pedestals with drawer fronts 34 ³ / ₈ " high	24"	19"	RPSH241W() () ()	1,881.	1,985.	2,038.	2,090.	2,142.	2,320.	2,905.
	24"	23"	RPSH242W() () ()	2,009.	2,150.	2,220.	2,291.	2,362.	2,608.	3,296.

Order Code	Specification Information	Application Notes
Example: RPSH241L(L/R) () () () () R Reff P Pedestal SH Service Height, 34 ³ / ₈ "H 24 24" wide 1 19" deep (2=23" deep) L Hinge door config. W = Waste - recycle drawer config. L Left (R = right) V319 Case Finish V319 Front Finish F Pull option PD Pull finish L Lock option B Lock finish	To order please specify pattern number including: 1. <i>Hinge location, where applicable,</i> L = left hand R = right hand 2. <i>Case Finish:</i> Wood or Laminate 3. <i>Front Finish</i> 4. <i>Pull option</i> B = No pull, No drilling Customer's own pull C = nickel finish only D = metal D-pull (painted, PZ, PT only) F = Bar H = Outline pull (1 pull/door) J = routed J-pull R = Cylinder pull (1 pull/door) S = S-pull (stainless steel only) T = Tab (1 pull per door) (Note: F,H,R and T Pulls are centered on the door) 5. <i>Pull finish:</i> Painted or plated 6. <i>Lock option, where applicable:</i> L = Lock N = No lock 7. <i>Lock Finish, where applicable:</i> B = Black S = Matte Silver	<p>It is NOT advisable to mix 28³/₈"h desk height products with 26¹/₂"h standard height products. These pedestals to be used in conjunction with 28³/₈" planning.</p> <p>Keying instructions must accompany all orders, refer to page 432 . Pedestals do not come with lock included. Key-alike are field installed using the KnollKey order form. Each locking pedestal on this page counts for one lock core.</p> <p>Product on this page Excluding J-pull option will accept wood grain laminate, where laminate is currently an option.</p> <p>The waste - recycle units come fully assembled, include 2 bins for recycling and waste. Waste recycle pedestals do not have a lock option. The drawer body which holds the bins, come in black only. Bins are grey and have 35 (US) quarts capacity.</p> <p>The intent of the hinged door pedestals, is to be customized to your preference, and are to be used in conjunction with interior options, such as; shelves (which can be ordered separately) or empty for use with a mini refrigerator.</p> <p>To order shelf kits for these pedestals, refer to page 416.</p> <p>The shelf drillings in these units are continuously 2.5" apart from top to bottom.</p> <p>Suitable tops for these units are; 1¹/₂" thick rectilinear tops (with desk top grommet) or 1¹/₂" thick Credenza tops (with edge grommet).</p> <p>6" filler is optional and can be ordered separately to achieve full depth.</p> <p>Finished back not recommended for use with a refrigerator as it restricts ventilation.</p>
Interior clearance dimensions; For 19" deep pedestals: Depth: 16.5" Height: 29.7" Width: 21"		
For 23" deep pedestals: Depth: 20.5" Height: 29.7" Width: 21"	*If case is Laminate, the front can be laminate or wood. *If case is Wood, the front can only be wood.	

Pedestals

22³/₈" , 28³/₈" and 34³/₈" high

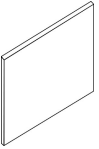
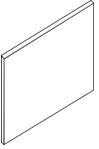
Pedestal back, filler and flush modesty 28³/₈" planning

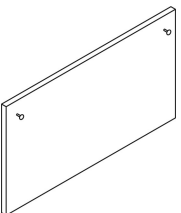
description	w	th	h	pattern no.	L	V1	V2	V3
 Pedestal Back 22 ³ / ₈ "h	16"		22 ³ / ₈ "	RPCB16 () ()	\$171.	\$221.	\$267.	\$371.
	19"		22 ³ / ₈ "	RPCB19 () ()	177.	229.	275.	381.
	30"		22 ³ / ₈ "	RPCB30 () ()	203.	258.	310.	426.
	36"		22 ³ / ₈ "	RPCB36 () ()	216.	275.	328.	452.
 Pedestal back, (desk height)	16"		28 ³ / ₈ "	RPDHB16 () ()	251.	301.	346.	451.
	19"		28 ³ / ₈ "	RPDHB19 () ()	257.	309.	355.	461.
	24"		28 ³ / ₈ "	RPDHB24 () ()	272.	325.	374.	486.
	30"		28 ³ / ₈ "	RPDHB30 () ()	283.	338.	390.	506.
	36"		28 ³ / ₈ "	RPDHB36 () ()	296.	355.	408.	532.
pedestal back for pedestals with metal or wood interiors								
Pedestal Back, (service height)	24"		34 ³ / ₈ "	RPSHB24 () ()	328.	393.	453.	588.
Credenza Back, Service Height	78"	1"	34 ³ / ₈ "	RPSHC78MF () ()	578.	822.	953.	1,584.
	84"	1"	34 ³ / ₈ "	RPSHC84MF () ()	596.	846.	986.	1,666.
 Pedestal Filler	6"		22 ³ / ₈ "	RPFC6 () ()	178.	215.	235.	281.
	6"		28 ³ / ₈ "	RPDHBF6 () ()	214.	254.	274.	322.
	6"		34 ³ / ₈ "	RPSHBF6 () ()	241.	281.	301.	350.
 Flush Modesty Panel, 22 ³ / ₈ "h	42"	1"	22 ³ / ₈ "	RPDHC42MF () ()	368.	446.	513.	666.
	48"	1"	22 ³ / ₈ "	RPDHC48MF () ()	384.	465.	536.	698.
	54"	1"	22 ³ / ₈ "	RPDHC54MF () ()	402.	486.	560.	726.
	60"	1"	22 ³ / ₈ "	RPDHC60MF () ()	443.	536.	617.	802.
	66"	1"	22 ³ / ₈ "	RPDHC66MF () ()	458.	556.	640.	830.
	72"	1"	22 ³ / ₈ "	RPDHC72MF () ()	475.	576.	662.	861.
	78"	1"	22 ³ / ₈ "	RPDHC78MF () ()	498.	603.	694.	902.
	84"	1"	22 ³ / ₈ "	RPDHC84MF () ()	515.	622.	716.	932.
	90"	1"	22 ³ / ₈ "	RPDHC90MF () ()	552.	668.	770.	1,000.
96"	1"	22 ³ / ₈ "	RPDHC96MF () ()	567.	688.	791.	1,029.	

Order Code	Specification Information	Application Notes
Example: RPCB16 () ()	1. <i>Finish type</i>	It is NOT advisable to mix 28³/₈"h desk height products with 26¹/₂"h standard height products. These pedestals to be used in conjunction with 28³/₈" planning.
R Reff	L = Laminate	
P Pedestal	1 = V1	
C For use with 22 ³ / ₈ " pedestal	2 = V2	
B Back	3 = V3	
16 Width	2. <i>Finish:</i>	
2 Finish type	Laminate or V1, V2, V3	
V316 Finish		

Products on this page will accept wood grain laminate, where laminate is currently an option.

Progressive Credenzas, 28³/₈" planning

23³/₈" high, file drawer

Wood or Laminate door

description	w	d	h	pattern no.	L/L	L/V1	L/V2	L/V3	V1/V1	V2/V2	V3/V3
Low credenza, file drawer left and right and cubby	90"	20"	23 ³ / ₈ "	RRLCFDC2090	\$3,662.	\$4,029.	\$4,213.	\$4,396.	\$5,494.	\$6,319.	\$8,214.
	108"	20"	23 ³ / ₈ "	RRLCFDC20108	3,829.	4,212.	4,402.	4,595.	5,744.	6,605.	8,586.

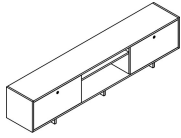

*90" and 108"w credenzas with file drawer require 4 counter weights

Low credenza, file drawer center with cubby	90"	20"	23 ³ / ₈ "	RRLCFDCC2090	3,264.	3,591.	3,755.	3,917.	4,896.	5,630.	7,320.
	108"	20"	23 ³ / ₈ "	RRLCFDCC20108	3,441.	3,785.	3,956.	4,130.	5,264.	5,937.	7,718.

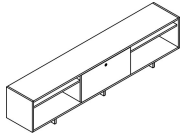

*90" and 108"w credenzas with file drawer require 4 counter weights

Low credenza, left	60"	20"	23 ³ / ₈ "	RRLCFDCL2060	2,531.	2,783.	2,911.	3,037.	3,796.	4,365.	5,675.
	72"	20"	23 ³ / ₈ "	RRLCFDCL2072	2,634.	2,898.	3,029.	3,160.	3,950.	4,543.	5,906.

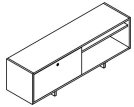

*60" and 72"w credenzas with file drawer require 3 counter weights

*Left hand credenza; File drawer is on left.

Left hand credenza shown

Low credenza, right	60"	20"	23 ³ / ₈ "	RRLCFDCR2060	2,531.	2,783.	2,911.	3,037.	3,796.	4,365.	5,675.
	72"	20"	23 ³ / ₈ "	RRLCFDCR2072	2,634.	2,898.	3,029.	3,160.	3,950.	4,543.	5,906.

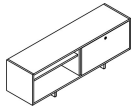

*60" and 72"w credenzas with file drawer require 3 counter weights

*Right hand credenza; File drawer is on right.

Right hand credenza shown

Order Code	Specification Information	Application Notes
Example: RRLCFDC2090	<i>To order please specify pattern number including:</i>	<p>It is NOT advisable to mix 28³/₈"h desk height products with 26¹/₂"h standard height products. These pedestals to be used in conjunction with 28³/₈" planning.</p> <p>Product on this page will accept woodgrain laminate where laminate is currently an option. For more information on grain direction on vertical surfaces, please see page 5.</p> <p>All credenzas with file drawers may require counter weights when used in an unsecured fashion (ie. free-standing). To order counter weights, refer to page 416.</p> <p>If file drawer on right side, credenza is right handed.</p> <p>These products are Glue and Dowel Construction</p> <p>Grommet Pull option for these products.</p> <p>Legs shipped with credenza.</p> <p>Legs available in painted finish only.</p> <p>Shelves are fixed.</p> <p>Glass top and cushion sold separately.</p> <p>Nominal depth 20"</p> <p>Actual depth 19"</p>
RR Reff	1. Lock option: Drawers are always lock drilled. L=drilled to accept lock	
LC Low Credenza	2. Lock finish: B=Black S=Matte Silver	
FDC File Drawer with cubby	3. Pull option Grommet pull, only	
20 20" deep	4. Pull finish Painted / Plated	
90 90" wide	5. Leg finish Painted only	
L Lock option	6. Case finish: Wood or Laminate	
S Lock finish	7. Front finish: Wood or Laminate	
G Pull option		
115 Pull finish		
115 Leg finish		
V316 Case finish		
V316 Front finish		
	* If case is Laminate, the front can be laminate or wood.	
	* If case is Wood, the front can only be wood.	

23^{3/8}" high, open

Open with cubby

description	w	d	h	pattern no.	L	V1	V2	V3
	60"	20"	23 ^{3/8} "	RRLCO2060 () ()	\$2,244.	\$3,187.	\$3,665.	\$4,765.
	72"	20"	23 ^{3/8} "	RRLCO2072 () ()	2,248.	3,328.	3,828.	4,976.
	90"	20"	23 ^{3/8} "	RRLCO2090 () ()	2,744.	4,142.	4,764.	6,192.
	108"	20"	23 ^{3/8} "	RRLCO20108 () ()	2,914.	4,400.	5,060.	6,579.

Order Code

Example:	RRLCO2060 () ()
RR	Reff Profiles
LC	Low Credenza
O	Open
20	20" deep
60	60" wide
115	Leg finish
2	Finish type
V316	Case finish

Specification Information

To order please specify pattern number including:

1. Leg finish
Painted only
2. Case finish type:
L = Laminate
1 = V1
2 = V2
3 = V3
3. Case finish:
V316

Application Notes

It is NOT advisable to mix 28^{3/8}"h desk height products with 26^{1/2}"h standard height products. These pedestals to be used in conjunction with 28^{3/8}" planning.

Product on this page will accept woodgrain laminate where laminate is currently an option. For more information on grain direction on vertical surfaces, please see page 5.

These products are Glue and Dowel Construction.

Legs shipped with credenza.

Legs available in painted finish only.

Shelves are fixed in these credenzas.

Glass top and cushion sold separately.

Nominal depth 20"

Actual depth 19"

Progressive Credenzas, 28^{3/8}" planning
 23^{3/8}" high sliding door
 Glass door

description	w	d	h	pattern no.	L/GL	V1/GL	V2/GL	V3/GL
Low credenza, sliding glass door	90"	20"	23 ^{3/8} "	RRLCSGD2090() () () () ()	\$5,019.	\$6,025.	\$6,928.	\$9,007.
	108"	20"	23 ^{3/8} "	RRLCSGD20108() () () () ()	5,590.	6,708.	7,713.	10,028.

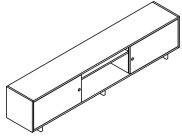

Low credenza, sliding glass door left	60"	20"	23 ^{3/8} "	RRLCSGDL2060() () () () ()	3,348.	4,018.	4,620.	6,005.
	72"	20"	23 ^{3/8} "	RRLCSGDL2072() () () () ()	3,534.	4,240.	4,876.	6,340.

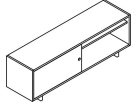

Left hand shown

Low credenza, sliding glass door right	60"	20"	23 ^{3/8} "	RRLCSGDR2060() () () () ()	3,348.	4,018.	4,620.	6,005.
	72"	20"	23 ^{3/8} "	RRLCSGDR2072() () () () ()	3,534.	4,240.	4,876.	6,340.

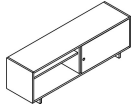

right hand shown

Order Code	Specification Information	Application Notes
Example: RRLCSGD2090 () () () () ()	<i>To order please specify pattern number including:</i>	It is NOT advisable to mix 28^{3/8}"h desk height products with 26^{1/2}"h standard height products. These pedestals to be used in conjunction with 28 ^{3/8} " planning.
RR Reff	1. Lock option: L = Lock N = No lock	These products are Glue and Dowel Construction
LC Low Credenza	2. Lock finish: B = Black S = Matte silver	Grommet Pull option for these products.
SGD Sliding Glass Door	3. Pull option Grommet pull	Legs shipped with credenza.
20 20" deep	4. Pull finish Painted / Plated	Legs available in Painted finishes only.
90 90" wide	5. Leg finish Painted only	Shelves are fixed.
L Lock option	6. Case finish L, V1, V2, V3	Glass top and cushion sold separately.
S Lock finish	7. Glass frame finish: Anodized or Painted	All sliding doors including wood, laminate and glass are non-locking.
G Pull type	8. Glass finish: GL11, GL14, GL15, GL17, GL18	Nominal depth 20"
PN Pull finish		Actual depth 19"
115 Leg finish		
V316 Case finish		
AU Glass frame finish, Anodized satin		
GL11 Door / front finish		

Progressive Credenzas, 28^{3/8}" planning
 23^{3/8}" high sliding door
 Wood / Laminate door

description	w	d	h	pattern no.	L/L	L/V1	L/V2	L/V3	V1/V1	V2/V2	V3/V3
Low credenza, sliding wood/ laminate door	90"	20"	23 ^{3/8} "	RRLCSWD2090 () () () ()	\$3,901.	\$4,292.	\$4,486.	\$4,682.	\$5,657.	\$6,506.	\$8,457.
	108"	20"	23 ^{3/8} "	RRLCSWD20108 () () () ()	4,311.	4,743.	4,957.	5,172.	6,251.	7,188.	9,345.

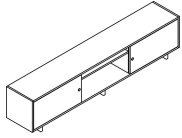

Low credenza, sliding wood/ laminate door left	60"	20"	23 ^{3/8} "	RRLCSWDL2060 () () () ()	2,712.	2,984.	3,119.	3,254.	3,933.	4,523.	5,880.
	72"	20"	23 ^{3/8} "	RRLCSWDL2072 () () () ()	2,837.	3,120.	3,262.	3,404.	4,112.	4,729.	6,150.

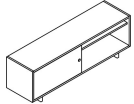

Left hand shown

Low credenza, sliding wood/ laminate door right	60"	20"	23 ^{3/8} "	RRLCSWDR2060 () () () ()	2,712.	2,984.	3,119.	3,254.	3,933.	4,523.	5,880.
	72"	20"	23 ^{3/8} "	RRLCSWDR2072 () () () ()	2,837.	3,120.	3,262.	3,404.	4,112.	4,729.	6,150.

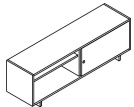

right hand shown

Order Code	Specification Information	Application Notes
Example: RRLCSWD2090 () () () ()	To order please specify pattern number including:	<p>It is NOT advisable to mix 28^{3/8}"h desk height products with 26^{1/2}"h standard height products. These pedestals to be used in conjunction with 28^{3/8}" planning.</p> <p>Product on this page will accept woodgrain laminate where laminate is currently an option. For more information on grain direction on vertical surfaces, please see page 5.</p> <p>* If case is Laminate, the front can be laminate or wood.</p> <p>* If case is Wood, the front can only be wood.</p>
RR Reff	1. Lock option: L = Lock N = No lock	
LC Low Credenza	2. Lock finish: B = Black S = Matte silver	These products are Glue and Dowel Construction
SWD Sliding Wood Door	3. Pull option Grommet	Grommet Pull option for these products.
20 20" deep	4. Pull finish Painted / Plated	Legs shipped with credenza.
90 90" wide	5. Leg finish Painted only	Legs available in Painted finishes only.
L Lock option	6. Case finish L, V1, V2, V3	Shelves are fixed.
S Lock finish	7. Door finish L, V1, V2, V3	Glass top and cushion sold separately.
G Pull option		Nominal depth 20"
115 Pull finish		Actual depth 19"
115 Leg finish		
V316 Case finish		
V316 Door / front glass finish		

Progressive Credenzas, 28^{3/8}" planning

Glass top

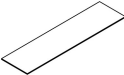
description	d	w	pattern no.	list
Lower Credenza Glass Top 	20"	30"	RLCGT301()	\$423.
	20"	36"	RLCGT361()	505.
	20"	60"	RLCGT601()	812.
	20"	72"	RLCGT721()	960.

Order Code	Specification Information	Application Notes
<i>Example:</i> RLCGT301()	<i>To order please specify pattern number including:</i> 1. Glass finish GL35 Grey GL85 Star Clear	It is NOT advisable to mix 28^{3/8}"h desk height products with 26^{1/2}"h standard height products. These pedestals to be used in conjunction with 28 ^{3/8} " planning. Grommet not an option.
R Reff		
LC Lower Credenza		
GT Glass Top		
30 Width		
1 20" deep		
GL35 Glass finish		

description	w	d	th	pattern no.	A	B	C	D	E	F	G	H	I
 Lower Credenza Cushion Top	30"	18"	1 1/4"	RLCCT3018()	\$400.	\$434.	\$458.	\$498.	\$508.	\$557.	\$586.	\$637.	\$719.
	30"	22"	1 1/4"	RLCCT3022()	407.	442.	465.	505.	516.	564.	593.	644.	725.
	36"	18"	1 1/4"	RLCCT3618()	419.	453.	479.	517.	528.	576.	607.	657.	738.
	36"	22"	1 1/4"	RLCCT3622()	428.	462.	487.	527.	537.	585.	615.	665.	747.

Order Code	Specification Information	Application Notes	
<i>Example:</i> RLCCT3018	<i>To order please specify pattern number including:</i> 1. Fabric : See matrix on page 7.	These Cushions are for use on lower credenzas only. 18" deep cushions recommended to be used on 20" credenzas 22" deep cushions recommended to be used on 24" credenzas tops Suitable only for the lower credenza	
R Reff			There is a \$77 upcharge on CAL133 backing on the cushions.
LC Lower Credenza			
CT Cushion Top			
30 Width			
18 18" deep			
Fabric			

Wall Storage Units Overview

Wall Storage Units expand the private office and meeting spaces storage options in the Reff Profiles line and are designed to enhance the performance of the office with improved cable management and storage options.

These units include a cable drop area behind each shelf allowing corded articles to be easily stored and used. Units must be attached to a wall or back-to-back. Adjacent units need to be attached to each other for alignment.

Reveals are installed between Bookcase, Stack-on and Shoulder Units.

Climbing or stepping upon the shelves will exceed the design load and may cause the shelf to collapse, resulting in personal injury and product damage. Do not climb or step upon the Bookcase.

Bookcases:

Wall Storage includes a series of Bookcases available in 14" and 11" depth, 86", 72", 53", 41" and 28" height; 36" and 30" width.

All dimensions are nominal.
 Actual dimensions are:

Depth

11" = 10 3/4"
 14" = 13 13/16"

Width (without vertical reveals)

30" = 29 15/16"
 36" = 35 15/16"

Height

86" = 86"
 72" = 72 1/2"
 53" = 52 5/8"
 41" = 41 1/2"
 28" = 28 3/8"

Actual Bookcase heights are with levelers at lowest extension (shortest height).

Wall Storage Units are offered in Discrete and Ganged types.

All Bookcases are available with or without a center gable.

Stack-on Units:

Stack-on Units are used to increase the number of shelves for storage to take greater advantage of available ceiling height.

Stack-on Units include a series of 11" and 14" deep units which are 32" high by 30" and 36" wide offered in Discrete and Ganged types. All Stack-on Units are available with or without a center gable.

When used with a 72" high Bookcase, the overall height is 72"H + 32"H = 104" high, suitable for a 9' high ceiling.

When used with an 86" high Bookcase, the overall height is 86"H + 32"H = 118" high, suitable for 10' high ceiling.

Discrete units have finished laminate or veneer on the outside of the exterior vertical gables. **See Figure 1.** Reveals are ordered separately.

Ganged units have a neutral tone material on both exterior vertical gables.

See Figure 1. They ship with vertical Reveals and a Ganging Kit.

Bookcases and Stack-on Units are shipped assembled with wood or laminate shelves installed. Glass shelves are packed together and shipped separately.

Discrete Bookcases and Stack-on

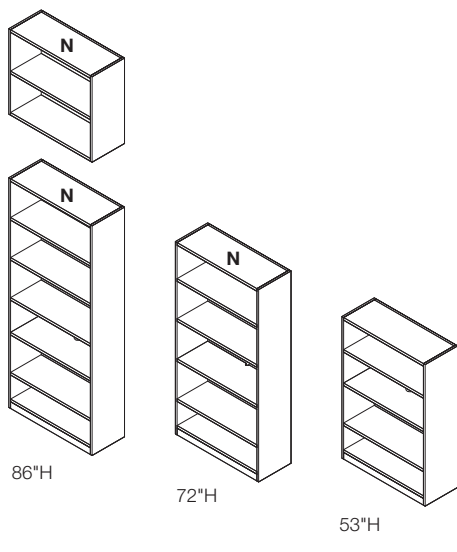

Ganged Bookcases and Stack-on

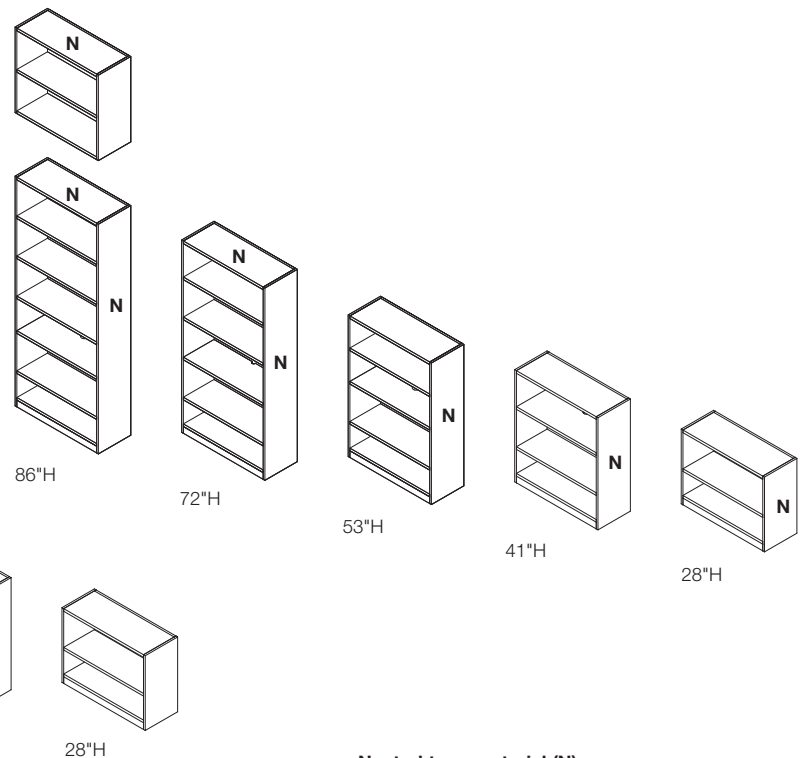

Neutral tone material (N)
 All backs are finished with neutral tone material

Figure 1

Construction Details

Bookcase and Stack-on Units:

Certain surfaces are generally not exposed and are therefore finished with a neutral tone material.

These surfaces include:

1. Tops of 86"H, 72"H and Stack-on units.
2. Backs of all units
3. Exterior of gables on all ganged units.

Gables are 3/4" thick. Shelf thickness for veneer and laminate adjustable shelves is 1". Fixed shelf is 1", and adjustable glass shelves are 1/2" thick. The second shelf from the bottom is always fixed. The top of the fixed shelf is nominally 28 3/4" above ground level.

Shelves are adjustable on 2 1/2" spacing to within 5" of the top and bottom shelves and the fixed shelf. Bottom shelf has four access holes for cabinet leveling with translucent removable caps.

Stack-on Unit bottom shelf is counter-bored in four locations for attachment screws and translucent caps provided.

There is a 1/2" space between shelf and cabinet back for cord drop. Each fixed shelf has a 1 1/4" diameter half round opening to allow plug head pass-through.

The wood grain on veneer and wood grain laminate shelves is side to side.

The wood grain on veneer and wood grain laminate gables, inside backs and baseboards is vertical.

Bookcase glides have 2" of adjustment for leveling. Allow 3/8" clearance between the wall and the back of the cabinet for wall attachment bracket. Cabinet back is inset flush with the back edge of the gables.

Actual depth on 11" Units = 10 3/4"
 Interior depth = 10"
 Shelf depth = 9 1/2"

Actual depth on 14" Units = 13 13/16"
 Interior depth = 13"
 Shelf depth = 12"

Included with the Bookcase are wall attachment brackets with mounting hardware for attachment to the cabinet.

Fasteners for attachment of the bracket to the wall are not included.

Shoulder Units:

Shoulder Units are ordered separately to finish and complete a run of Ganged units. Shoulder Units create a full height uniform veneer grain and finish to cover the seam between a Bookcase and a Stack-on Unit.

Shoulder units are available in single depths and double depths. Double depth units are used to finish a run of Ganged units which are installed back to back.

Shoulder heights are 28"H, 41"H, 53"H, 72"H and 86"H for use with Ganged Bookcases, 104"H for use with 72"H Bookcases with 32"H Stack-on Units and 118"H for use with 86"H Bookcases with 32"H Stack-on Units.

Single Depths:

- 11" deep nominal = 10 3/4"
- 14" deep nominal = 13 13/16"

Double Depths:

- 22" deep nominal = 21 1/2"
- 28" deep nominal = 27 5/8"

Shoulder thickness = 3/4"

Shoulder Units have veneer or laminate on the outside, neutral tone material on the inside.

Included with Shoulder Units are two black Reveals with double sided tape (field installation required) and attachment hardware kit. Attachment hardware kit includes eight (8) flat head wood screws.

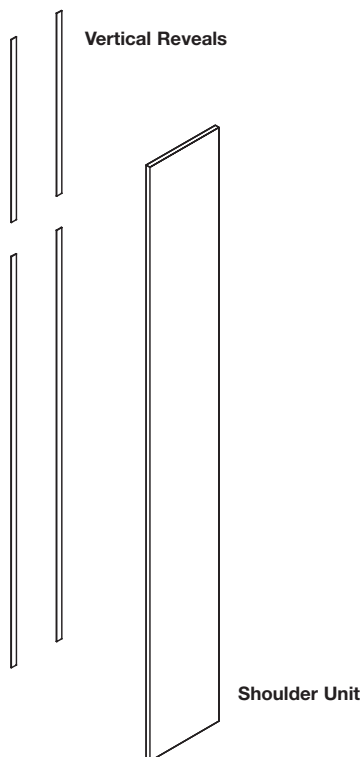

Figure 2

Finish Options

Wall Storage Units are available in several different finish approaches.

Figure 1
All Veneer
(V1/V1, V2/V2, V3/V3)

The case is veneer and the shelves are also veneer. In this instance, the shelf finish must match the case finish.

Note: Veneer direction on shelves runs side to side.

Figure 2
Veneer case with laminate shelves
(V1/L, V2/L, V3/L)

Laminate shelf options include all Reff Profiles core solid color laminates but do not include the use of impact resistant core laminate or wood grain laminates. The fixed shelf will match the adjustable shelves.

Figure 3
Laminate case with laminate shelves
(L/L)

These shelves can be any core laminate including wood grain laminate. Fixed shelf will match adjustable shelves.

Note: Veneer shelves are not available with laminate case

Figure 4
Veneer case with center gable
(V1/V1, V2/V2, V3/V3)
(V1/L, V2/L, V3/L)
(V1/G, V2/G, V3/G)

This option allows for veneer, laminate or glass shelves. Fixed shelf will match case veneer.

Center gable will match the case finish.

Note: Glass shelves are only available on units with a center gable.

Figure 5
Laminate case with center gable
(L/L, L/G)

This option allows for laminate or glass shelves.

With glass shelves, the fixed shelf will match the case.

With laminate shelves, the fixed shelf will match the case.

Center gable will match the case finish.

Note: Glass shelves are only available on units with a center gable.

Glass shelves are available in:
 GL35 – Grey
 GL85 – Star Clear

Neutral tone material (N)

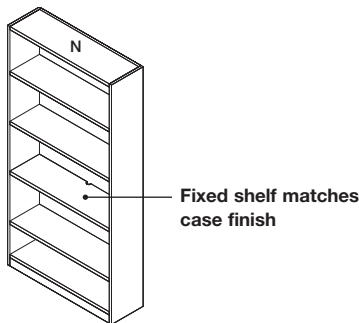

Figure 1: All Veneer

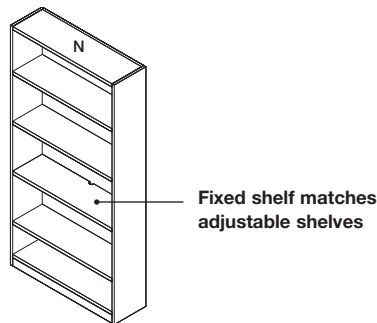

Figure 3: Laminate Case with Laminate Shelves

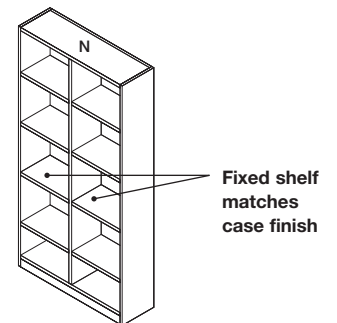

Figure 5: Laminate Case with Glass or Laminate Shelves

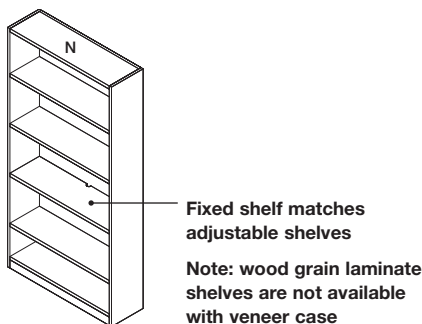

Figure 2: Veneer Case with Laminate Shelves

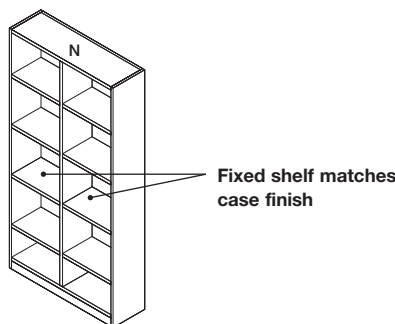

Figure 4: Veneer Case with Glass, Laminate or Veneer Shelves

Finish Options

Wall Storage Units are available in several different finish approaches.

Case Finish / Shelf Finish	Fixed Shelf Matches Case	Fixed Shelf Matches Adjustable Shelf
V1 / V1	✓	✓
V2 / V2	✓	✓
V3 / V3	✓	✓
L1 / L1	✓	✓
L1 / L2		✓
Wood Grain L1 / Wood Grain L2		✓
L / Glass	✓	
V1 / Glass	✓	
V2 / Glass	✓	
V3 / Glass	✓	

Shelf Kit

When a Shelf Kit is needed it can be ordered 11" and 14" deep and 30" and 36" wide. For Bookcases with center gables, 15" wide Shelf Kits are available for 30" wide Bookcases and 18" Shelf Kits are available for 36" wide Bookcases. Core laminate and veneer can be applied on all size Shelf Kits. Glass shelves are available 15" and 18" wide. Included with each Shelf Kit is (1) Shelf and (1) Hardware Kit.

Periodical Display Shelf Kit

Periodical Display Shelf Kits are intended for angular display. See Figure 1. These units fit into Bookcases using the existing shelf adjustment holes. No additional drilling is required. When installed, Display Shelf hinges down from the top. **See Figure 2.**

The Periodical Shelf Kit can be adjusted up or down on the bookcase every 2 1/2".

Periodical Display Shelf may be specified in laminate or veneer. Retention lip may be specified in all Reff Profiles core paint finishes.

The Periodical Display Shelf is 3/4" thick. The lip at the base of the Periodical Display Shelf is 3/8" high.

The shelf and lip are shipped assembled. Included with the Periodical Display Shelf is a hardware kit with (2) hinge mounting brackets and (4) attachment screws; (2) shoulder screws for hinge point and (2) threaded support pins.

Periodical Display Shelf Installation Instruction 6TP00437 is available on Knoll Exchange.

Baseboard Kit

Bookcases are constructed with a flush kick plate. A Baseboard Kit may be ordered and field installed over the flush kick plate for a classic Reff Profiles aesthetic. Baseboards have a vertical grain direction. Baseboards are 1" thick and 3 3/8" high.

Baseboard Kits are available in all Reff Profiles core laminates or veneers. The back of the baseboard is black backer material.

Included with the Baseboard Kit is (1) roll of double sided tape for field installation.

Reveals

Reveals provide a clean seam between each unit with consistent spacing.

Reveal dimensions are 1" wide x 3/32" thick. Reveal material is ABS plastic and the color is black. Reveals are available in kit quantities of 1, 10 or 50. Included in each kit are (2) Reveal Strips with double sided tape.

Reveal Installation Instruction 6TP00436 is available on Knoll Exchange.

Vertical Reveals

The length of the Reveal equals the height of the Bookcase. (Some field trimming may be required). Reveals are included with Ganged Bookcases and Shoulder Units. The Reveals are packed flat with the Bookcases and Shoulder Units for field installation. **See Figure 3.**

For Discrete type Bookcases and Stack-on Units they are ordered separately (shipped flat).

Horizontal Reveals

The width of the Reveal is equal to the width of the Bookcase. (Some field trimming may be required).

All Stack-on Units are supplied with Horizontal Reveals installed. Horizontal Reveals go between the top of a Bookcase and the bottom of the Stack-on Unit. **See Figure 3.**

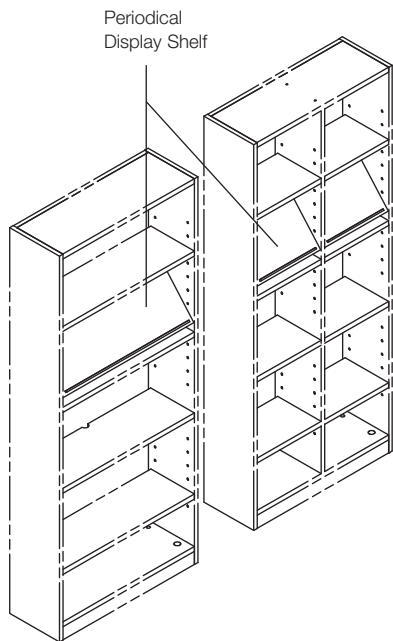

Figure 1: Periodical Display Shelf

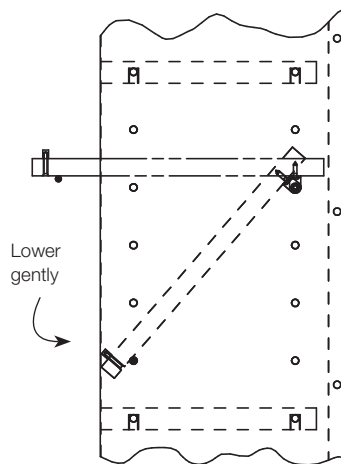

Figure 2

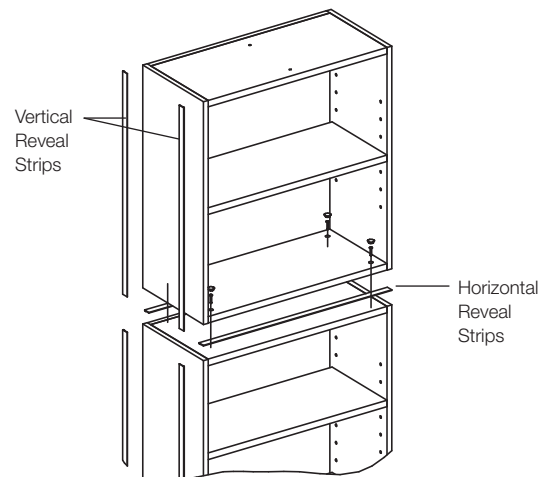

Figure 3

Ganging Kit

Ganging Kits are used to attach adjacent Bookcases and Stack-on Units to one another.

These ship with each Ganged Bookcase and Stack-On Unit. One extra Ganging Kit is needed when the ends of a run are Discrete Bookcases and Discrete Stack-on Units. **See Figure 4 and Figure 5.**

Included with the Ganging Kit are (4) Barrel Bolts and Drill Template. Ganging Kits are available in quantities of 1, 10 or 50.

Quantity (1) has (1) drill template.
 Quantity (10) has (2) drill templates.
 Quantity (50) has (10) drill templates.

Ganging Kit Installation Instruction 6TP00436 is available on Knoll Exchange.

Bookcase Grommet

The Bookcase Grommet is intended to trim a field drilled 3 1/2" hole to align with and for access to a wall power receptacle. **See Figure 6.**

Grommet color is black. Access may be limited for larger transformer plugs.

Included with Bookcase Grommet is (1) 3 1/2" D grommet sleeve.

Bookcase Grommet Installation Instruction 6TP00389 is available on Knoll Exchange.

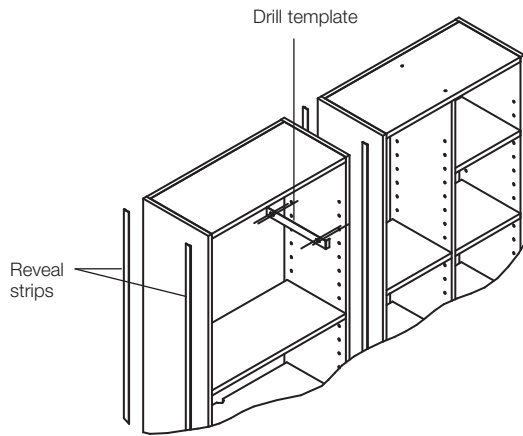

Figure 4

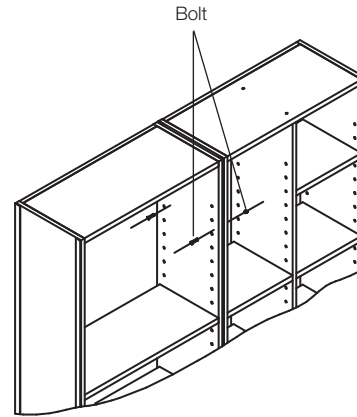

Figure 5

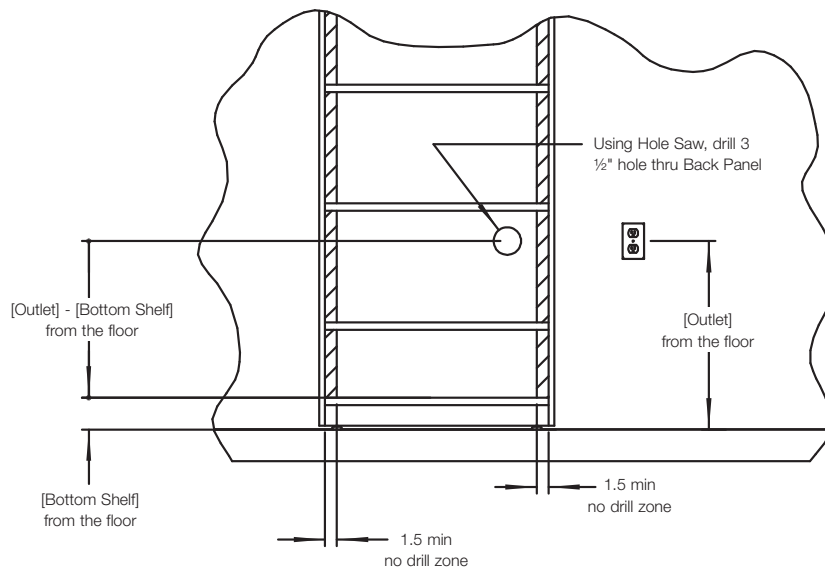

Figure 6

Planning Guidelines

Wall Storage Units are offered in two types.

Discrete (D) units have finished Laminate or Veneer on the outside of the exterior vertical gables. They ship assembled and reveals are ordered separately.

Ganged (G) units have a neutral tone material on both exterior vertical gables. They ship assembled and include Vertical Reveals and a Ganging Kit.

Wall Storage Units can be planned in a variety of configurations providing a wide range of storage solutions.

**Planning Sample 1
 Discrete Bookcase 72" high**

Discrete Bookcases have a finished exterior vertical gable. This is finished in any core laminate or veneer.

**Planning Sample 2
 Two Discrete Bookcases
 ganged side by side.**

Order (1) Reveal Kit each time two Discrete Bookcases meet. In addition, order (1) Ganging Kit each time two Discrete Bookcases meet.

**Planning Sample 3
 Discrete and Ganged units joined
 adjacent to each other.**

Since Ganged Units ship with Ganging Kits and Reveal Kits, order (1) additional of each for this application.

**Planning Sample 4
 Stack-on Units (S)- Discrete
 and Ganging used.**

Since Ganged Units ship with Ganging Kits and Reveal Kits, order (1) additional of each is needed for ordering.

On veneer units, the wood grain on the exterior of the gables of the Stack-on Unit and the Bookcase, will not match. Specify a full height shoulder to cover both the Bookcase and Stack-on Unit for veneer and wood grain laminate.

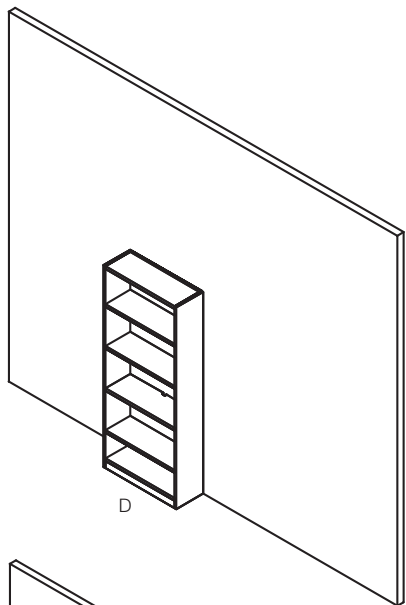

**Planning Sample 1:
 Discrete Bookcase,
 72" high**

- Secured to a wall
- 3/8" gap along back for wall cleat

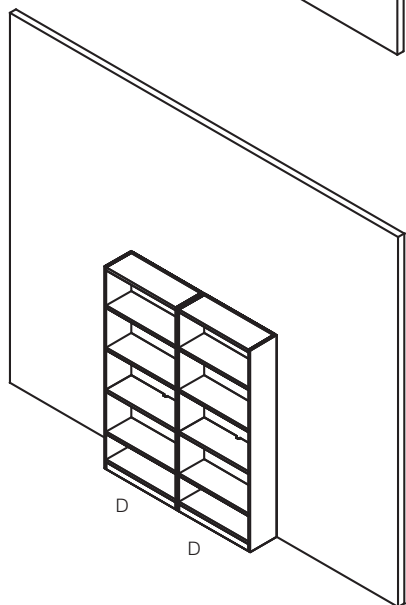

**Planning Sample 2:
 Two Discrete
 Bookcases Ganged
 Side to Side**

- Secured to a wall
- 3/8" gap along back for wall cleat
- Order (1) Reveal Kit
- Order (1) Ganging Kit

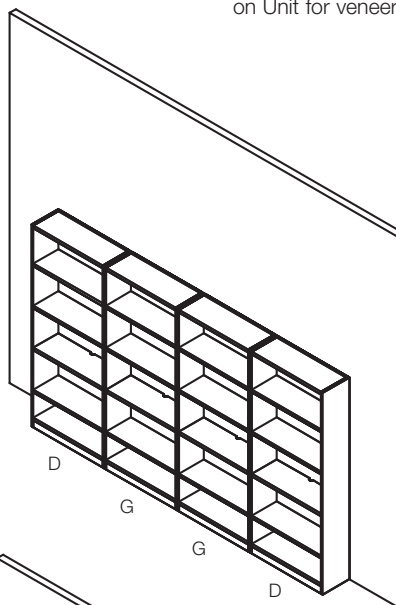

**Planning Sample 3:
 Discrete and Ganged
 Units Joined Adjacent
 to each other**

- Secured to a wall
- 3/8" gap along back for wall cleat
- Bookcases adjacent to each other are ganged together
- Each ganged unit includes (1) Reveal Kit and (1) Ganging Kit
- Order (1) Reveal Kit
- Order (1) Ganging Kit

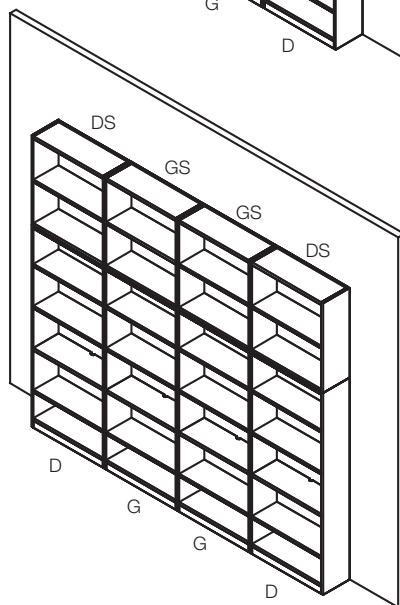

**Planning Sample 4:
 Stack-on Units - Discrete
 and Ganged used**

- Secured to a wall
- 3/8" gap along back for wall cleat
- Horizontal Reveal Kits included with each Stack-on Unit
- A seam between gables of the Bookcase and the Stack-on Unit is visible.
- Order (1) full height Reveal Kit
- Order (2) Ganging Kits (one for Bookcase and one for Stack-on Unit)

Planning Sample 5
Using all Ganged Bookcases (G)
and Ganged Stack-on (GS) Units

The outside of these units are finished with a neutral tone backer sheet.
 Order a full height Shoulder Unit (S) to finish the exterior vertical gables with core laminate or veneer.

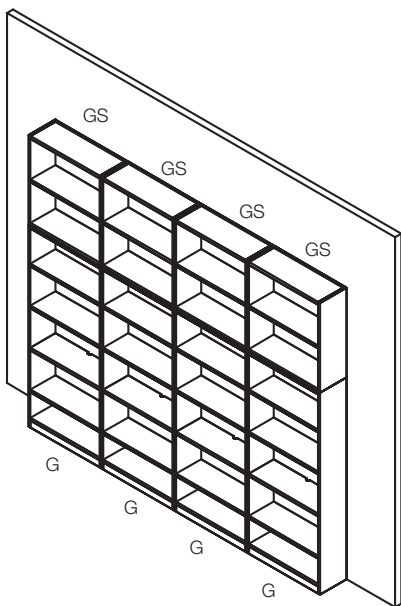

Planning Sample 5
Example A
 (4) Ganged Bookcases and Stack-on Units joined together

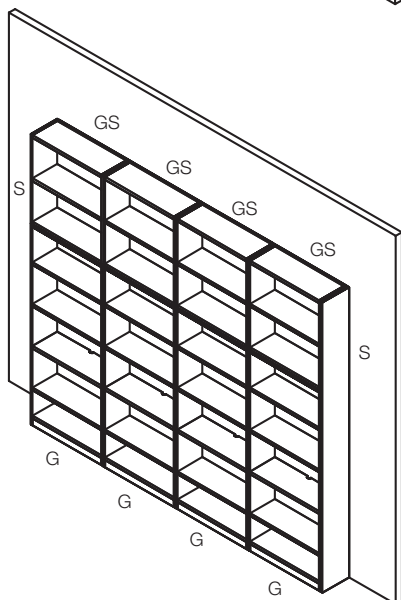

Planning Sample 5
Example B
 (4) Ganged Bookcases and Stack-on Units joined together With Shoulders (S) added

- Secured to a wall
- 3/8" gap along back for wall cleat.
- Horizontal Reveal Kits are included with each Stack-on Unit.
- Vertical Reveals are included with each Ganged Bookcase and Stack-on Unit.
- Ganging Kits are included with each Ganged Bookcase and Stack-on Unit.

Planning Sample 6
Discrete or Ganged Units
attached back-to-back

Back-to-back attachment is required for stability.
 Order (1) Ganging Kit for attaching (2) Bookcases back to back.

See Example A.

In **Example B** below, (1) additional Ganging Kit should be ordered to attach the Stack-on Units back to back.

Order (2) Ganging Kits Total for **Example B.**

Ganging Kit includes (4) barrel bolts and (1) drill template.

Refer to Bookcase Ganging Kit Installation Instructions, 6TP00436 available on Knoll Exchange

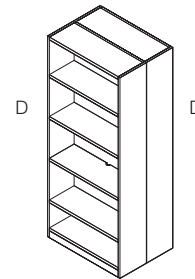

Planning Sample 6
Example A
 (2) Discrete Bookcases (D) 72" high

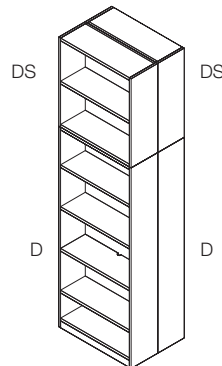





Planning Sample 6
Example B
 (2) Discrete Bookcases (D) 72" high and (2) Discrete Stack-on Units (DS)

Wall Storage Units, 28^{3/8}" planning

Bookcase, Discrete, 11" deep

Wood and Laminate Shelves

28" and 41" high

description	w	d	h	pattern no.	Case/Shelf						
					L/L	V1/L	V2/L	V3/L	V1/V1	V2/V2	V3/V3
 	30"	11"	28"	RC230DHB DG ()()	\$1,575.	\$2,225.	\$2,468.	\$3,143.	\$2,818.	\$3,203.	\$4,040.
	30"	11"	28"	RC230DHB D0 ()()	1,246.	1,739.	1,918.	2,434.	2,044.	2,302.	2,979.
	36"	11"	28"	RC260DHB DG ()()	1,598.	2,237.	2,472.	3,159.	2,831.	3,215.	4,113.
	36"	11"	28"	RC260DHB D0 ()()	1,286.	1,796.	1,985.	2,551.	2,117.	2,394.	3,171.
 	30"	11"	41"	RC430DHB DG ()()	1,786.	2,435.	2,678.	3,353.	3,043.	3,456.	4,371.
	30"	11"	41"	RC430DHB D0 ()()	1,457.	1,950.	2,128.	2,645.	2,269.	2,555.	3,310.
	36"	11"	41"	RC460DHB DG ()()	1,813.	2,452.	2,688.	3,374.	3,066.	3,478.	4,456.
	36"	11"	41"	RC460DHB D0 ()()	1,502.	2,011.	2,201.	2,766.	2,351.	2,657.	3,514.

Order Code	Specification Information	Application Notes
Example: RC230DHB D0()()	<i>To order, please specify pattern number including:</i>	Second shelf from the bottom is fixed. The top of the fixed shelf is nominally 28 ^{3/4} " above ground level. All other shelves are adjustable on 2.5" centers within 5" from the top and bottom of cabinet and away from the fixed middle shelf. All adjustable shelves are supported on field installed threaded pins.
R Reff	1. Case Finish: Laminate / Wood veneer	Shelves are flush with the front edge of the gables and have a nominal 10" inside depth. The back of each shelf has a 1/2" space for cable management. Centered at the back of the fixed shelf is an additional 1 1/4" diameter half round hole for plug head pass-through. 3 1/2" diameter grommet is available for field installation over wall electrical outlet.
C Cabinets	2. Shelf Finish: Laminate / Wood veneer	Overall depth of units = 10 ^{3/4} " (not including wall attachment hardware).
2 28" high, 4 = 41" high	It is Not advisable to mix 28^{3/8}" desk height products with 26 1/2" standard height products.	Base kick plate is flush with front edge of gable. For Classic esthetic an additional kick plate is available in Accessories for wall storage units. See page 190.
3 30" wide, 6 = 36" wide	Product on this page will accept woodgrain laminate where laminate is currently an option. For more information on grain direction on vertical surfaces, please see page 5.	Outer surface of exterior gable Exterior of back is finished with neutral tone backer sheet. Interior of back has the same finish as the case (gables).
0 11" deep	Installation instruction sheets available on Knoll Exchange. For grommet location refer to reference number 6TP00389.	
DH Desk height	Cabinet is key hole construction. Cabinet back is inset.	
BD Bookcase discrete		
O Open, G = Center gable		
V316 Case finish		
111 Shelf finish		

28" nominal height = 28^{3/8}" actual height.
 41" nominal height = 41 1/2" actual height
 Glides add 2" of height adjustment. To prevent tipping, the back of each bookcase **must** be attached to a wall or to the back of another bookcase using the wall attachment hardware provided.

Wall Storage Units, 28³/₈" planning

Bookcase, Discrete, 11" deep

Wood and Laminate Shelves

72", 86" high and Stack-on Units

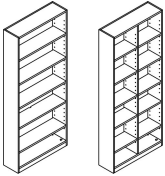
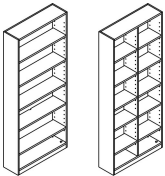
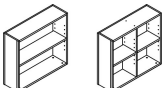
description	w	d	h	pattern no.	Case/Shelf							
					L/L	V1/L	V2/L	V3/L	V1/V1	V2/V2	V3/V3	
 Open bookcase, discrete 72"h	30"	11"	72"	RC7230DHBDG () ()	\$2,614.	\$3,321.	\$3,712.	\$4,654.	\$3,461.	\$3,890.	\$5,175.	
	30"	11"	72"	RC7230DHBDO () ()	1,913.	2,523.	2,837.	3,693.	2,574.	2,893.	3,847.	
	36"	11"	72"	RC7260DHBDG () ()	2,894.	3,675.	4,108.	5,150.	3,879.	4,349.	5,694.	
	36"	11"	72"	RC7260DHBDO () ()	2,165.	2,861.	3,212.	4,140.	2,912.	3,267.	4,275.	
 Open bookcase, discrete 86"h	30"	11"	86"	RC830DHBDG () ()	3,132.	3,410.	3,836.	5,119.	4,374.	4,870.	6,936.	
	30"	11"	86"	RC830DHBDO () ()	2,323.	2,634.	2,946.	3,790.	3,206.	3,570.	5,086.	
	36"	11"	86"	RC860DHBDG () ()	3,479.	3,827.	4,295.	5,637.	4,897.	5,437.	7,580.	
	36"	11"	86"	RC860DHBDO () ()	2,643.	2,946.	3,294.	4,219.	3,626.	4,026.	5,614.	
 Stack-on units, discrete 32"h	30"	11"	32"	RC330DHS DG () ()	1,517.	2,093.	2,350.	2,835.	2,274.	2,593.	3,164.	
	30"	11"	32"	RC330DHS DO () ()	1,297.	1,751.	1,944.	2,346.	1,854.	2,095.	2,577.	
	36"	11"	32"	RC360DHS DG () ()	1,545.	2,131.	2,394.	2,887.	2,317.	2,641.	3,248.	
	36"	11"	32"	RC360DHS DO () ()	1,330.	1,796.	1,997.	2,408.	1,902.	2,150.	2,666.	

Order Code	Specification Information	Application Notes
Example: RC7230DHBDO () () R Reff C Cabinets 72 72" high 3 30" wide, 6 = 36"W 0 11" deep DH Desk height BD Bookcase discrete, SD = Stack-on discrete O Open, G = Center gable V316 Case finish 111 Shelf finish	<p><i>To order, please specify pattern number including:</i></p> <ol style="list-style-type: none"> Case Finish: Laminate / Wood veneer Shelf Finish: Laminate / Wood veneer <p>It is Not advisable to mix 28³/₈" desk height products with 26¹/₂" standard height products.</p> <p>Product on this page will accept woodgrain laminate where laminate is currently an option. For more information on grain direction on vertical surfaces, please see page 5.</p> <p>Installation instruction sheets available on Knoll Exchange. For grommet location refer to reference number 6TP00389.</p> <p>Cabinet is key hole construction. Cabinet back is inset.</p>	<p>Second shelf from the bottom is fixed. The top of the fixed shelf is nominally 28³/₈" above ground level. All other shelves are adjustable on 2.5" centers within 5" from the top and bottom of cabinet and away from the fixed middle shelf. All adjustable shelves are supported on field installed threaded pins. Shelves are flush with the front edge of the gables and have a nominal 10" inside depth. The back of each shelf has a 1/2" space for cable management. Centered at the back of the fixed shelf is an additional 1 1/4" diameter half round hole for plug head pass-through. 3 1/2" diameter grommet is available for field installation over wall electrical outlet.</p> <p>The shelves on cabinets with center gable, are adjustable on both sides (2.5" intervals within 5" from the top and bottom of cabinet) Center gable is fixed.</p> <p>In mix finish options, the fix shelf is the same finish as the adjustable shelves</p> <p>Overall depth of units = 10³/₄" (not including wall attachment hardware).</p> <p>Base kick plate is flush with front edge of gable. For Classic esthetic an additional kick plate is available in Accessories for wall storage units. See page 190. Exterior of back is finished with neutral tone backer sheet. Interior of back has the same finish as the case (gables).</p> <p>Adjacent bookcases are intended to be field attached to one another using ganging kits.</p> <p>Ganging kits and Reveals are not included, and can be ordered separately. See Accessories for Wall Storage Units, page 190.</p>

32" nominal height = 32" actual height.
 72" nominal height = 72 1/2" actual height
 86" nominal height = 86" actual height
 Glides add 2" of height adjustment. To prevent tipping, the back of each bookcase **must** be attached to a wall or to the back of another bookcase using the wall attachment hardware provided.

Wall Storage Units, 28³/₈" planning
Bookcase, Discrete, 11" deep
Glass Shelves
28" and 41" high

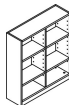
description	w	d	h	pattern no.	Case/Shelf L/G	V1/G	V2/G	V3/G
Open bookcase, discrete 28"h 	30"	11"	28"	RC230DHBDG () ()	\$2,038.	\$3,023.	\$3,381.	\$4,282.
	36"	11"	28"	RC260DHBDG () ()	2,124.	3,098.	3,449.	4,382.
Open bookcase, discrete 41"h 	30"	11"	41"	RC430DHBDG () ()	2,468.	3,453.	3,812.	4,713.
	36"	11"	41"	RC460DHBDG () ()	2,606.	3,579.	3,931.	4,864.

Order Code	Specification Information	Application Notes
Example: RC230DHBDG () ()	<i>To order, please specify pattern number including:</i>	<p>Glass shelves are available in GL35 and GL85 only. Bookcase units with glass shelves are available with Center Gable only. Center gable is fixed. Second shelf from the bottom is fixed. The top of the fixed shelf is nominally 28³/₄" above ground level. All other shelves are adjustable on 2.5" centers within 5" from the top and bottom of cabinet and away from the fixed middle shelf. All adjustable shelves are supported on field installed threaded pins. Shelves are flush with the front edge of the gables and have a nominal 10" inside depth. The back of each shelf has a 1/2" space for cable management. Centered at the back of the fixed shelf is an additional 1 1/4" diameter half round hole for plug head pass-through. 3 1/2" diameter grommet is available for field installation over wall electrical outlet.</p> <p>The shelves on cabinets with center gable, are adjustable on both sides (2.5" intervals within 5" from the top and bottom of cabinet) Center gable is fixed.</p> <p>The fixed shelf is the same finish as the case</p>
R Reff	1. Case Finish: Laminate / Wood veneer	
C Cabinets	2. Shelf Finish: Glass Finish; GL35 or GL85	<p>Overall depth of units = 10³/₄" (not including wall attachment hardware).</p> <p><u>Base kick plate</u> is flush with front edge of gable. For Classic esthetic an additional kick plate is available in Accessories for wall storage units. See page 190. Cabinet is key hole construction. Cabinet back is inset. Exterior of back is finished with neutral tone backer sheet. Interior of back has the same finish as the case (gables).</p> <p>Adjacent bookcases are intended to be field attached to one another using ganging kits.</p> <p>Ganging kits and Reveals are not included, and can be ordered separately. See Accessories for Wall Storage Units, page 190.</p>
2 28" high, 4 = 41"high	It is Not advisable to mix 28³/₈" desk height products with 26 1/2" standard height products.	
3 30" wide, 6 = 36"W	Product on this page will accept woodgrain laminate where laminate is currently an option. For more information on grain direction on vertical surfaces, please see page 5.	
0 11" deep	Installation instruction sheets available on Knoll Exchange. For grommet location refer to reference number 6TP00389.	
DH Desk height	Cabinet is key hole construction. Cabinet back is inset.	
BD Bookcase discrete		
G G = Center gable		
V316 Case finish		
GL35 Shelf finish		
28" nominal height = 28 ³ / ₈ " actual height 41" nominal height = 41 1/2" actual height Glides add 2" of height adjustment. To prevent tipping, the back of each bookcase must be attached to a wall or to the back of another bookcase using the wall attachment hardware provided.		

Wall Storage Units, 28³/₈" planning
 Bookcase, Discrete, 11" deep
 Glass Shelves
 72", 86" high and Stack-on Units

description	w	d	h	pattern no.	Case/Shelf L/G	V1/G	V2/G	V3/G
Open bookcase, discrete 72"h	30"	11"	72"	RC7230DHBGDG () ()	\$3,246.	\$4,024.	\$4,629.	\$6,017.
	36"	11"	72"	RC7260DHBGDG () ()	3,468.	4,265.	4,905.	6,376.

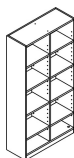

Open bookcase, discrete 86"h	30"	11"	86"	RC830DHBGDG () ()	3,687.	4,498.	5,172.	6,724.
	36"	11"	86"	RC860DHBGDG () ()	3,986.	4,783.	5,500.	7,150.

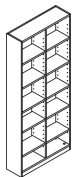

Stack-on units, discrete 32"h	30"	11"	32"	RC330DHSDDG () ()	1,690.	2,248.	2,496.	2,994.
	36"	11"	32"	RC360DHSDDG () ()	1,750.	2,326.	2,582.	3,099.



Order Code	Specification Information	Application Notes
Example: RC7230DHBGDG () ()	<i>To order, please specify pattern number including:</i>	Glass shelves are available in GL35 and GL85 only. Bookcase units with glass shelves are available with Center Gable only. Center gable is fixed. Second shelf from the bottom is fixed. The top of the fixed shelf is nominally 28 ³ / ₄ " above ground level. All other shelves are adjustable on 2.5" centers within 5" from the top and bottom of cabinet and away from the fixed middle shelf. All adjustable shelves are supported on field installed threaded pins. Shelves are flush with the front edge of the gables and have a nominal 10" inside depth. The back of each shelf has a 1/2" space for cable management. Centered at the back of the fixed shelf is an additional 1 1/4" diameter half round hole for plug head pass-through. 3 1/2" diameter grommet is available for field installation over wall electrical outlet.
R Reff	1. Case Finish: Laminate / Wood veneer	Overall depth of units = 10 ³ / ₄ " (not including wall attachment hardware).
C Cabinets	2. Shelf Finish: Glass Finish; GL35 or GL85	Base kick plate is flush with front edge of gable. For Classic esthetic an additional kick plate is available in Accessories for wall storage units. See page 190. Cabinet is key hole construction. Cabinet back is inset. Exterior of back is finished with neutral tone backer sheet. Interior of back has the same finish as the case (gables).
72 72" high, 8 = 86", 3 = 32" high (stack-on)	It is Not advisable to mix 28³/₈"h desk height products with 26 1/2" standard height products.	Adjacent bookcases are intended to be field attached to one another using ganging kits.
3 30" wide, 6 = 36"W	Product on this page will accept woodgrain laminate where laminate is currently an option. For more information on grain direction on vertical surfaces, please see page 5.	Ganging kits and Reveals are not included, and can be ordered separately. See Accessories for Wall Storage Units, page 190.
0 11" deep	Installation instruction sheets available on Knoll Exchange. For grommet location refer to reference number 6TP00389.	
DH Desk height	Cabinet is key hole construction. Cabinet back is inset.	
BD Bookcase discrete, SD = Stack-on discrete		
G G = Center gable		
V316 Case finish		
GL35 Shelf finish		
32" nominal height = 32" actual height 72" nominal height = 72 1/2" actual height 86" nominal height = 86" actual height Glides add 2" of height adjustment. To prevent tipping, the back of each bookcase must be attached to a wall or to the back of another bookcase using the wall attachment hardware provided.		
	The shelves on cabinets with center gable, are adjustable on both sides (2.5" intervals within 5" from the top and bottom of cabinet) Center gable is fixed.	
	The fixed shelf is the same finish as the case	

Wall Storage Units, 28^{3/8}" planning

Bookcase, Ganged, 11" deep

Wood and Laminate Shelves

28" and 41" high

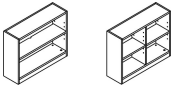
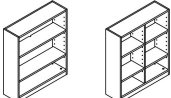
description	w	d	h	pattern number	Case/Shelf			V1/V1	V2/V2	V3/V3	
					L/L	V1/L	V2/L				
 Open bookcase, ganged 28"h	30"	11"	28"	RC230DHBGG ()	\$1,560.	\$2,211.	\$2,418.	\$2,945.	\$2,803.	\$3,153.	\$3,841.
	30"	11"	28"	RC230DHBGO ()	1,231.	1,726.	1,868.	2,237.	2,028.	2,252.	2,782.
	36"	11"	28"	RC260DHBGG ()	1,583.	2,221.	2,422.	2,961.	2,816.	3,166.	3,916.
	36"	11"	28"	RC260DHBGO ()	1,271.	1,780.	1,935.	2,354.	2,101.	2,344.	2,974.
 Open bookcase, ganged 41"h	30"	11"	41"	RC430DHBGG ()	1,770.	2,421.	2,628.	3,155.	3,029.	3,406.	4,172.
	30"	11"	41"	RC430DHBGO ()	1,441.	1,936.	2,078.	2,447.	2,254.	2,505.	3,113.
	36"	11"	41"	RC460DHBGG ()	1,798.	2,436.	2,637.	3,176.	3,050.	3,429.	4,258.
	36"	11"	41"	RC460DHBGO ()	1,486.	1,996.	2,150.	2,570.	2,336.	2,607.	3,316.

Order Code

Example:	RC230DHBGO ()
R	Reff
C	Cabinets
2	28" high, 4 = 41" high
3	30" wide, 6 = 36"W
0	11" deep
DH	Desk height
BG	Bookcase Ganged
O	Open, G = Center gable
V316	Case finish
111	Shelf finish

28" nominal height = 28^{3/8}" actual height.
 41" nominal height = 41^{1/2}" actual height
 Glides add 2" of height adjustment.
 To prevent tipping, the back of each bookcase **must** be attached to a wall or to the back of another bookcase using the wall attachment hardware provided.

Specification Information

To order, please specify pattern number including:

- Case Finish: Laminate / Wood veneer
- Shelf Finish: Laminate / Wood veneer

It is Not advisable to mix 28^{3/8}"h desk height products with 26^{1/2}" standard height products.

Product on this page will accept woodgrain laminate where laminate is currently an option. For more information on grain direction on vertical surfaces, please see page 5.

Installation instruction sheets available on Knoll Exchange. For grommet location refer to reference number 6TP00389.

For ganging instructions, refer to reference number 6TP00436.

Cabinet is key hole construction. Cabinet back is inset.

Application Notes

Second shelf from the bottom is fixed and the top of the fixed shelf is nominally 28^{3/4}" above ground level. All other shelves are adjustable on 2.5" centers within 5" from the top and bottom of cabinet and away from the fixed middle shelf. All adjustable shelves are supported on field installed threaded pins.

Shelves are flush with the front edge of the gables and have a nominal 10" inside depth. The back of each shelf has a 1/2" space for cable management. Centered at the back of the fixed shelf is an additional 1 1/4" diameter half round hole for plug head pass-through. 3 1/2" diameter grommet is available for field installation over wall electrical outlet. Overall depth of units = 10^{3/4}" (not including wall attachment hardware).

The shelves on cabinets with center gable, are adjustable on both sides (2.5" intervals within 5" from the top and bottom of cabinet) Center gable is fixed.

In mix finish options, the fixed shelf is the same finish as the adjustable shelves.

Overall depth of units = 10^{3/4}" (not including wall attachment hardware).

Base kick plate is flush with front edge of gable. For Classic esthetic an additional kick plate is available in Accessories for wall storage units. See page 190.

Outer surface of exterior gable in "Ganged" units are finished with neutral tone backer sheet. Interior of back has the same finish as the case (gables).

Ganged bookcase are intended to be place adjacent to one another and attached to each other. Black vertical reveals are included to go between adjacent units.

Additional shoulder units are available and ordered separately to finish the ends. Alternatively, "Discrete" bookcases may be used to finish the ends of a run. Ganged units include a ganging kit consisting of hardware and drilling template to field attach adjacent units together.

Wall Storage Units, 28³/₈" planning

Bookcase, Ganged, 11" deep

Wood and Laminate Shelves

72", 86" high and Stack-on Units

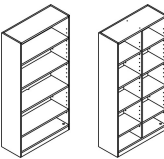
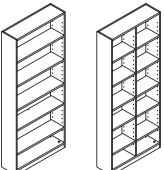
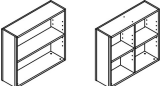
description	w	d	h	pattern no.	Case/Shelf							
					L/L	V1/L	V2/L	V3/L	V1/V1	V2/V2	V3/V3	
 Open bookcase, Ganged, 72" h	30"	11"	72"	RC7230DHBGG () ()	\$2,600.	\$3,214.	\$3,520.	\$4,397.	\$3,400.	\$3,820.	\$5,083.	
	30"	11"	72"	RC7230DHBGO () ()	1,898.	2,416.	2,646.	3,437.	2,511.	2,822.	3,754.	
	36"	11"	72"	RC7260DHBGG () ()	2,879.	3,568.	3,917.	4,894.	3,811.	4,274.	5,594.	
	36"	11"	72"	RC7260DHBGO () ()	2,151.	2,754.	3,020.	3,885.	2,845.	3,191.	4,177.	
 Open bookcase, Ganged, 86" h	30"	11"	86"	RC830DHBGG () ()	3,118.	3,304.	3,644.	4,863.	4,290.	4,775.	6,803.	
	30"	11"	86"	RC830DHBGO () ()	2,311.	2,528.	2,753.	3,535.	3,123.	3,477.	4,953.	
	36"	11"	86"	RC860DHBGG () ()	3,565.	3,721.	4,103.	5,381.	4,805.	5,336.	7,439.	
	36"	11"	86"	RC860DHBGO () ()	2,630.	2,839.	3,102.	3,964.	3,536.	3,926.	5,474.	
 Stack-on units, Ganged, 32" h	30"	11"	32"	RC330DHS GG () ()	1,517.	2,093.	2,296.	2,700.	2,274.	2,559.	3,046.	
	30"	11"	32"	RC330DHS GO () ()	1,297.	1,751.	1,930.	2,226.	1,854.	2,061.	2,453.	

Order Code	Specification Information	Application Notes
Example: RC7230DHBDO () () R Reff C Cabinets 72 72" high 3 30" wide, 6 = 36"W 0 11" deep DH Desk height BG Bookcase Ganged, SG = Stack-on Ganged O Open, G = Center gable V316 Case finish 111 Shelf finish	<p>To order, please specify pattern number including:</p> <ol style="list-style-type: none"> Case Finish: Laminate / Wood veneer Shelf Finish: Laminate / Wood veneer <p>It is Not advisable to mix 28³/₈" h desk height products with 26¹/₂" standard height products.</p> <p>Product on this page will accept woodgrain laminate where laminate is currently an option. For more information on grain direction on vertical surfaces, please see page 5.</p> <p>Installation instruction sheets available on Knoll Exchange. For grommet location refer to reference number 6TP00389.</p> <p>For ganging instructions, refer to reference number 6TP00436.</p> <p>Cabinet is key hole construction. Cabinet back is inset.</p>	<p>Second shelf from the bottom is fixed and the top of the fixed shelf is nominally 28³/₄" above ground level. All other shelves are adjustable on 2.5" centers within 5" from the top and bottom of cabinet and away from the fixed middle shelf. All adjustable shelves are supported on field installed threaded pins. Shelves are flush with the front edge of the gables and have a nominal 10" inside depth. The back of each shelf has a 1/2" space for cable management. Centered at the back of the fixed shelf is an additional 1 1/4" diameter half round hole for plug head pass-through. 3 1/2" diameter grommet is available for field installation over wall electrical outlet. Overall depth of units = 10³/₄" (not including wall attachment hardware).</p> <p>The shelves on cabinets with center gable, are adjustable on both sides (2.5" intervals within 5" from the top and bottom of cabinet) Center gable is fixed.</p> <p>In mix finish options, the fixed shelf is the same finish as the adjustable shelves.</p>

32" nominal height = 32" actual height.
 72" nominal height = 72 1/2" actual height
 86" nominal height = 86" actual height
 Glides add 2" of height adjustment. To prevent tipping, the back of each bookcase **must** be attached to a wall or to the back of another bookcase using the wall attachment hardware provided.

Overall depth of units = 10³/₄" (not including wall attachment hardware).

Base kick plate is flush with front edge of gable. For Classic esthetic an additional kick plate is available in Accessories for wall storage units. See page 190.

Outer surface of exterior gable in "Ganged" units are finished with neutral tone backer sheet. Interior of back has the same finish as the case (gables).

Ganged bookcase are intended to be placed adjacent to one another and attached to each other. Black vertical reveals are included to go between adjacent units.

Additional shoulder units are available and ordered separately to finish the ends. Alternatively, "Discrete" bookcases may be used to finish the ends of a run. Ganged units include a ganging kit consisting of hardware and drilling template to field attach adjacent units together.

Wall Storage Units, 28^{3/8}" planning

Bookcase, Ganged, 11" deep

Glass Shelves

28" and 41" high

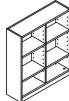
description	w	d	h	pattern no.	Case/Shelf L/G	V1/G	V2/G	V3/G
Open bookcase, ganged 28" h 	30"	11"	28"	RC230DHBGG () ()	\$2,155.	\$3,025.	\$3,325.	\$4,054.
	36"	11"	28"	RC260DHBGG () ()	2,242.	3,100.	3,393.	4,153.
Open bookcase, ganged 41" h 	30"	11"	41"	RC430DHBGG () ()	2,585.	3,455.	3,756.	4,484.
	36"	11"	41"	RC460DHBGG () ()	2,723.	3,581.	3,875.	4,635.

Order Code	Specification Information	Application Notes
Example: RC230DHBGG () ()	<i>To order, please specify pattern number including:</i>	Glass shelves are available in GL35 and GL85 only. Bookcase units with glass shelves are available with Center Gable only. Center gable is fixed. Second shelf from the bottom is fixed and is in the same finish as the case. The top of the fixed shelf is nominally 28 ^{3/4} " above ground level. All other shelves are adjustable on 2.5" centers within 5" from the top and bottom of cabinet and away from the fixed middle shelf. All adjustable shelves are supported on field installed threaded pins. Shelves are flush with the front edge of the gables and have a nominal 10" inside depth. The back of each shelf has a 1/2" space for cable management. Centered at the back of the fixed shelf is an additional 1 1/4" diameter half round hole for plug head pass-through. 3 1/2" diameter grommet is available for field installation over wall electrical outlet. Overall depth of units = 10 ^{3/4} " (not including wall attachment hardware). The shelves on cabinets with center gable, are adjustable on both sides (2.5" intervals within 5" from the top and bottom of cabinet) Center gable is fixed. The fixed shelf is the same finish as the case.
R Reff	1. Case Finish: Laminate / Wood veneer	
C Cabinets	2. Shelf Finish: Glass Finish; GL35 or GL85	Overall depth of units = 10 ^{3/4} " (not including wall attachment hardware). Base kick plate is flush with front edge of gable. For Classic esthetic an additional kick plate is available in Accessories for wall storage units. See page 190. Exterior of back is finished with neutral tone backer sheet. Interior of back has the same finish as the case (gables). Outer surface of exterior gable in " Ganged " units are finished with neutral tone backer sheet. Interior of back has the same finish as the case (gables). Ganged bookcase are intended to be placed adjacent to one another and attached to each other. Black vertical reveals are included to go between adjacent units. Additional shoulder units are available and ordered separately to finish the ends. Alternatively, "Discrete" bookcases may be used to finish the ends of a run. Ganged units include a ganging kit consisting of hardware and drilling template to field attach adjacent units together.
2 28" high, 4 = 41" high	It is Not advisable to mix 28^{3/8}" desk height products with 26 1/2" standard height products.	
3 30" wide, 6 = 36" wide	Product on this page will accept woodgrain laminate where laminate is currently an option. For more information on grain direction on vertical surfaces, please see page 5.	
0 11" deep	Installation instruction sheets available on Knoll Exchange. For grommet location refer to reference number 6TP00389.	
DH Desk height	For ganging instructions, refer to reference number 6TP00436.	
BG Bookcase Ganged	Cabinet is key hole construction.	
GL35 Shelf finish	Cabinet back is inset.	

28" nominal height = 28^{3/8}" actual height.
 41" nominal height = 41 1/2" actual height
 Glides add 2" of height adjustment.
 To prevent tipping, the back of each bookcase **must** be attached to a wall or to the back of another bookcase using the wall attachment hardware provided.

Wall Storage Units, 28³/₈" planning

Bookcase, Ganged, 11" deep

Glass Shelves

72", 86" high and Stack-on Units

description	w	d	h	pattern no.	Case/Shelf L/G	V1/G	V2/G	V3/G
Open bookcase, Ganged, 72"h	30"	11"	72"	RC7230DHBGG () ()	\$3,232.	\$3,949.	\$4,542.	\$5,905.
	36"	11"	72"	RC7260DHBGG () ()	3,454.	4,189.	4,819.	6,263.

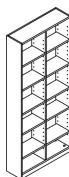

Open bookcase, Ganged, 86"h	30"	11"	86"	RC830DHBGG () ()	3,674.	4,405.	5,067.	6,588.
	36"	11"	86"	RC860DHBGG () ()	3,865.	4,691.	5,395.	7,013.

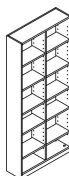

Stack-on units, Ganged, 32"h	30"	11"	32"	RC330DHS GG () ()	1,690.	2,248.	2,462.	2,856.
	36"	11"	32"	RC360DHS GG () ()	1,750.	2,326.	2,549.	2,956.



Order Code	Specification Information	Application Notes
Example: RC7230DHBG () ()	<i>To order, please specify pattern number including:</i>	<p>Glass shelves are available in GL35 and GL85 only. Bookcase units with glass shelves are available with Center Gable only. Center gable is fixed. Second shelf from the bottom is fixed and is in the same finish as the case. The top of the fixed shelf is nominally 28³/₈" above ground level. All other shelves are adjustable on 2.5" centers within 5" from the top and bottom of cabinet and away from the fixed middle shelf. All adjustable shelves are supported on field installed threaded pins. Shelves are flush with the front edge of the gables and have a nominal 10" inside depth. The back of each shelf has a 1/2" space for cable management. Centered at the back of the fixed shelf is an additional 1 1/4" diameter half round hole for plug head pass-through. 3 1/2" diameter grommet is available for field installation over wall electrical outlet. Overall depth of units = 10³/₄" (not including wall attachment hardware).</p> <p>The shelves on cabinets with center gable, are adjustable on both sides (2.5" intervals within 5" from the top and bottom of cabinet) Center gable is fixed.</p> <p>The fixed shelf is the same finish as the case.</p>
R Reff	1. Case Finish: Laminate / Wood veneer	
C Cabinets	2. Shelf Finish: Glass Finish; GL35 or GL85	
72 72" high, 8 = 86", 3 = 32" high (stack-on)	<p>It is Not advisable to mix 28³/₈" h desk height products with 26 1/2" standard height products.</p> <p>Product on this page will accept woodgrain laminate where laminate is currently an option. For more information on grain direction on vertical surfaces, please see page 5.</p> <p>Installation instruction sheets available on Knoll Exchange. For grommet location refer to reference number 6TP00389.</p> <p>For ganging instructions, refer to reference number 6TP00436.</p> <p>Cabinet is key hole construction.</p> <p>Cabinet back is inset.</p>	
3 30" wide, 6 = 36"W		
0 11" deep		
DH Desk height		
BG Bookcase Ganged, SG = Stack-on Ganged		
G G = Center gable		
V316 Case finish		
GL35 Shelf finish		

32" nominal height = 32" actual height.
 72" nominal height = 72 1/2" actual height
 86" nominal height = 86" actual height
 Glides add 2" of height adjustment. To prevent tipping, the back of each bookcase **must** be attached to a wall or to the back of another bookcase using the wall attachment hardware provided.

Overall depth of units = 10³/₄" (not including wall attachment hardware).

Base kick plate is flush with front edge of gable. For Classic esthetic an additional kick plate is available in Accessories for wall storage units. See page 190. Cabinet is key hole construction. Cabinet back is inset. Exterior of back is finished with neutral tone backer sheet. Interior of back has the same finish as the case (gables).

Outer surface of exterior gable in "Ganged" units are finished with neutral tone backer sheet. Interior of back has the same finish as the case (gables).

Ganged bookcase are intended to be placed adjacent to one another and attached to each other. Black vertical reveals are included to go between adjacent units.



Additional shoulder units are available and ordered separately to finish the ends. Alternatively, "Discrete" bookcases may be used to finish the ends of a run. Ganged units include a ganging kit consisting of hardware and drilling template to field attach adjacent units together.

Wall Storage Units, 28^{3/8}" planning

Bookcase, Discrete, 14" deep

Wood and Laminate Shelves

28" and 41" high

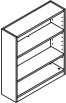
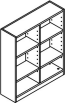
description	w	d	h	pattern no.	Case/Shelf			V1/V1	V2/V2	V3/V3	
					L/L	V1/L	V2/L				
  Open bookcase, discrete, 28" h	30"	14"	28"	RC234DHBGDG () ()	\$1,603.	\$2,263.	\$2,524.	\$3,321.	\$2,865.	\$3,274.	\$4,271.
	30"	14"	28"	RC234DHBDO () ()	1,269.	1,769.	1,962.	2,575.	2,079.	2,354.	3,155.
	36"	14"	28"	RC264DHBGDG () ()	1,626.	2,274.	2,528.	3,338.	2,878.	3,287.	4,349.
	36"	14"	28"	RC264DHBDO () ()	1,310.	1,827.	2,031.	2,699.	2,153.	2,449.	3,358.
  Open bookcase, discrete, 41" h	30"	14"	41"	RC434DHBGDG () ()	1,813.	2,473.	2,734.	3,531.	3,090.	3,527.	4,602.
	30"	14"	41"	RC434DHBDO () ()	1,479.	1,979.	2,172.	2,225.	2,304.	2,608.	3,486.
	36"	14"	41"	RC464DHBGDG () ()	1,841.	2,490.	2,743.	3,554.	3,113.	3,550.	4,691.
	36"	14"	41"	RC464DHBDO () ()	1,525.	2,042.	2,246.	2,914.	2,387.	2,711.	3,700.

Order Code	Specification Information	Application Notes
Example: RC234DHBDO () ()	<i>To order, please specify pattern number including:</i>	Second shelf from the bottom is fixed. The top of the fixed shelf is nominally 28 ^{3/8} " above ground level. All other shelves are adjustable on 2.5" centers within 5" from the top and bottom of cabinet and away from the fixed middle shelf. All adjustable shelves are supported on field installed threaded pins. Shelves are flush with the front edge of the gables and have a nominal 13" inside depth. The back of each shelf has a 1/2" space for cable management. Centered at the back of the fixed shelf is an additional 1 1/4" diameter half round hole for plug head pass-through. 3 1/2" diameter grommet is available for field installation over wall electrical outlet.
R Reff	1. Case Finish: Laminate / Wood veneer	Overall depth of units = 14" (not including wall attachment hardware). Base kick plate is flush with front edge of gable. For Classic esthetic an additional kick plate is available in Accessories for wall storage units. See page 190. Exterior of back is finished with neutral tone backer sheet. Interior of back has the same finish as the case (gables).
C Cabinets	2. Shelf Finish: Laminate / Wood veneer	Adjacent bookcases are intended to be field attached to one another using ganging kits.
2 28" high, 4 = 41" high	It is Not advisable to mix 28^{3/8}" desk height products with 26 1/2" standard height products.	Ganging kits and Reveals are not included, and can be ordered separately. See Accessories for Wall Storage Units, page 190.
3 30" wide, 6 = 36" W	Product on this page will accept woodgrain laminate where laminate is currently an option. For more information on grain direction on vertical surfaces, please see page 5.	
4 14" deep	Installation instruction sheets available on Knoll Exchange. For grommet location refer to reference number 6TP00389.	
DH Desk height	For ganging instructions, refer to reference number 6TP00436.	
BD Bookcase discrete	The cabinet is key hole construction. Cabinet back is inset.	
O Open, G = Center gable		
V316 Case finish		
111 Shelf finish		

28" nominal height = 28^{3/8}" actual height.
 41" nominal height = 41 1/2" actual height
 Glides add 2" of height adjustment. To prevent tipping, the back of each bookcase **must** be attached to a wall or to the back of another bookcase using the wall attachment hardware provided.

Wall Storage Units, 28³/₈" planning

Bookcase, Discrete, 14" deep

Wood and Laminate Shelves

53", 72" & 86" high and Stack-on Units

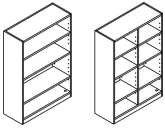
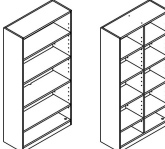
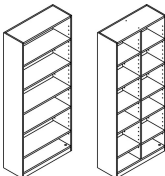
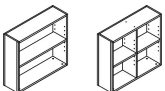
description	w	d	h	pattern no.	Case/Shelf							
					L/L	V1/L	V2/L	V3/L	V1/V1	V2/V2	V3/V3	
 Open bookcase, discrete, 53"h	30"	14"	53"	RC534DHB DG ()()	\$1,918.	\$2,605.	\$2,875.	\$3,704.	\$3,246.	\$3,700.	\$4,819.	
	30"	14"	53"	RC534DHB DO ()()	1,570.	2,090.	2,291.	2,928.	2,428.	2,744.	3,657.	
	36"	14"	53"	RC564DHB DG ()()	1,930.	2,606.	2,831.	3,512.	3,253.	3,672.	4,695.	
	36"	14"	53"	RC564DHB DO ()()	1,618.	2,156.	2,368.	3,063.	2,514.	2,852.	3,881.	
 Open bookcase, discrete, 72"h	30"	14"	72"	RC7234DHB DG ()()	2,653.	3,459.	3,873.	5,195.	3,813.	4,399.	5,740.	
	30"	14"	72"	RC7234DHB DO ()()	2,071.	2,624.	3,021.	4,077.	2,822.	3,244.	4,379.	
	36"	14"	72"	RC7264DHB DG ()()	2,907.	3,854.	4,328.	5,713.	4,213.	4,862.	6,328.	
	36"	14"	72"	RC7264DHB DO ()()	2,325.	2,969.	3,416.	4,611.	3,166.	3,642.	4,915.	
 Open bookcase, discrete, 86"h	30"	14"	86"	RC834DHB DG ()()	3,150.	4,020.	4,630.	6,851.	4,658.	5,374.	7,610.	
	30"	14"	86"	RC834DHB DO ()()	2,478.	3,197.	3,680.	5,440.	3,393.	3,903.	5,748.	
	36"	14"	86"	RC864DHB DG ()()	3,540.	4,510.	5,192.	7,663.	5,144.	5,934.	8,376.	
	36"	14"	86"	RC864DHB DO ()()	2,799.	3,616.	4,160.	6,148.	3,811.	4,385.	6,454.	
 Stack-on units, discrete, 32"h	30"	14"	32"	RC334DHS DG ()()	1,769.	2,330.	2,530.	3,118.	2,578.	2,847.	3,545.	
	30"	14"	32"	RC334DHS DO ()()	1,601.	2,022.	2,177.	2,665.	2,154.	2,350.	2,947.	
	36"	14"	32"	RC364DHS DG ()()	1,833.	2,378.	2,586.	3,223.	2,629.	2,910.	3,678.	
	36"	14"	32"	RC364DHS DO ()()	1,636.	2,072.	2,235.	2,771.	2,210.	2,421.	3,086.	

Order Code	Specification Information	Application Notes
Example: RC534DHBDO ()() R Reff C Cabinets 5 53" high 3 30" wide, 6 = 36"W 4 14" deep DH Desk height BD Bookcase discrete, SD = Stack-on discrete O Open, G = Center gable V316 Case finish 111 Shelf finish	<p>To order, please specify pattern number including:</p> <ol style="list-style-type: none"> Case Finish: Laminate / Wood veneer Shelf Finish: Laminate / Wood veneer <p>It is Not advisable to mix 28³/₈"h desk height products with 26¹/₂" standard height products.</p> <p>Product on this page will accept woodgrain laminate where laminate is currently an option. For more information on grain direction on vertical surfaces, please see page 5.</p> <p>Installation instruction sheets available on Knoll Exchange. For grommet location refer to reference number 6TP00389.</p> <p>For ganging instructions, refer to reference number 6TP00436.</p> <p>The cabinet is key hole construction. Cabinet back is inset.</p>	<p>Second shelf from the bottom is fixed. The top of the fixed shelf is nominally 28³/₈" above ground level. All other shelves are adjustable on 2.5" centers within 5" from the top and bottom of cabinet and away from the fixed middle shelf. All adjustable shelves are supported on field installed threaded pins. Shelves are flush with the front edge of the gables and have a nominal 13" inside depth. The back of each shelf has a 1/2" space for cable management. Centered at the back of the fixed shelf is an additional 1 1/4" diameter half round hole for plug head pass-through. 3 1/2" diameter grommet is available for field installation over wall electrical outlet.</p> <p>The shelves on cabinets with center gable, are adjustable on both sides (2.5" intervals within 5" from the top and bottom of cabinet) Center gable is fixed.</p> <p>In mix finish options, the fix shelf is the same finish as the adjustable shelves.</p> <p>Overall depth of units = 14" (not including wall attachment hardware). Base kick plate is flush with front edge of gable. For Classic esthetic an additional kick plate is available in Accessories for wall storage units. See page 190. Exterior of back is finished with neutral tone backer sheet. Interior of back has the same finish as the case (gables).</p> <p>Adjacent bookcases are intended to be field attached to one another using ganging kits.</p> <p>Ganging kits and Reveals are not included, and can be ordered separately. See Accessories for Wall Storage Units, page 190.</p>

Wall Storage Units, 28³/₈" planning
Bookcase, Discrete, 14" deep
Glass Shelves
28" and 41" high

description	w	d	h	pattern no.	Case/Shelf L/G	V1/G	V2/G	V3/G
Open bookcase, discrete, 28" h	30"	14"	28"	RC234DHBDG () ()	\$2,005.	\$3,007.	\$3,377.	\$4,410.
	36"	14"	28"	RC264DHBDG () ()	2,082.	3,072.	3,435.	4,502.



Open bookcase, discrete, 41" h	30"	14"	41"	RC434DHBDG () ()	2,558.	3,561.	3,931.	4,963.
	36"	14"	41"	RC464DHBDG () ()	2,701.	3,691.	4,054.	5,121.

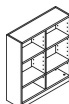



Order Code	Specification Information	Application Notes	
Example: RC234DHBDG () ()	<i>To order, please specify pattern number including:</i>	Glass shelves are available in GL35 and GL85 only. Bookcase units with glass shelves are available with Center Gable only. Center gable is fixed. Second shelf from the bottom is fixed. The top of the fixed shelf is nominally 28 ³ / ₄ " above ground level. All other shelves are adjustable on 2.5" centers within 5" from the top and bottom of cabinet and away from the fixed middle shelf. All adjustable shelves are supported on field installed threaded pins. Shelves are flush with the front edge of the gables and have a nominal 13" inside depth. The back of each shelf has a 1/2" space for cable management. Centered at the back of the fixed shelf is an additional 1 1/4" diameter half round hole for plug head pass-through. 3 1/2" diameter grommet is available for field installation over wall electrical outlet.	Overall depth of units = 14" (not including wall attachment hardware). Base kick plate is flush with front edge of gable. For Classic esthetic an additional kick plate is available in Accessories for wall storage units. See page 190. Exterior of back is finished with neutral tone backer sheet. Interior of back has the same finish as the case (gables). Adjacent bookcases are intended to be field attached to one another using ganging kits. Ganging kits and Reveals are not included, and can be ordered separately. See Accessories for Wall Storage Units, page 190.
R Reff	1. Case Finish: Laminate / Wood veneer		
C Cabinets	2. Shelf Finish: Glass Finish; GL35 or GL85		
2 28" high, 4 = 41" high	It is Not advisable to mix 28³/₈" desk height product with 26 1/2" standard height products.		
3 30" wide, 6 = 36"W	Product on this page will accept woodgrain laminate where laminate is currently an option. For more information on grain direction on vertical surfaces, please see page 5.		
4 14" deep	Installation instruction sheets available on Knoll Exchange. For grommet location refer to reference number 6TP00389.		
DH Desk height	For ganging instructions, refer to reference number 6TP00436.		
BD Bookcase discrete	The cabinet is key hole construction. Cabinet back is inset.		
G G = Center gable			
V316 Case finish			
GL35 Shelf finish			
28" nominal height = 28" actual height. 41" nominal height = 41" actual height Glides add 2" of height adjustment. To prevent tipping, the back of each bookcase must be attached to a wall or to the back of another bookcase using the wall attachment hardware provided.			

Wall Storage Units, 28³/₈" planning

Bookcase, Discrete, 14" deep

Glass Shelves

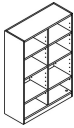
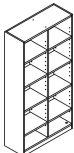
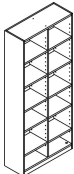
53", 72" & 86" high and Stack-on Units

description	w	d	h	pattern no.	Case/Shelf L/G	V1/G	V2/G	V3/G
Open bookcase, discrete, 53"h 	30"	14"	53"	RC534DHBDG ()()	\$2,693.	\$3,735.	\$4,121.	\$5,194.
	36"	14"	53"	RC564DHBDG ()()	2,841.	3,870.	4,248.	5,358.
Open bookcase, discrete, 72"h 	30"	14"	72"	RC7234DHBDG ()()	3,279.	4,365.	4,782.	6,095.
	36"	14"	72"	RC7264DHBDG ()()	3,514.	4,621.	5,057.	6,470.
Open bookcase, discrete, 86"h 	30"	14"	86"	RC834DHBDG ()()	3,802.	4,924.	5,379.	6,886.
	36"	14"	86"	RC864DHBDG ()()	4,103.	5,239.	5,713.	7,333.
Stack-on units, discrete, 32"h 	30"	14"	32"	RC334DHSDG ()()	2,007.	2,569.	2,769.	3,357.
	36"	14"	32"	RC364DHSDG ()()	2,127.	2,673.	2,881.	3,517.

Order Code	Specification Information	Application Notes
Example: RC534DHBDG ()()	<i>To order, please specify pattern number including:</i>	Glass shelves are available in GL35 and GL85 only. Bookcase units with glass shelves are available with Center Gable only. Center gable is fixed. Second shelf from the bottom is fixed. The top of the fixed shelf is nominally 28 ³ / ₈ " above ground level. All other shelves are adjustable on 2.5" centers within 5" from the top and bottom of cabinet and away from the fixed middle shelf. All adjustable shelves are supported on field installed threaded pins. Shelves are flush with the front edge of the gables and have a nominal 13" inside depth. The back of each shelf has a 1/2" space for cable management. Centered at the back of the fixed shelf is an additional 1 1/4" diameter half round hole for plug head pass-through. 3 1/2" diameter grommet is available for field installation over wall electrical outlet.
R Reff	1. Case Finish: Laminate / Wood veneer	
C Cabinets	2. Shelf Finish: Glass Finish; GL35 or GL85	Overall depth of units = 14" (not including wall attachment hardware).
5 53" high	It is Not advisable to mix 28³/₈" desk height product with 26 1/2" standard height products.	Base kick plate is flush with front edge of gable. For Classic esthetic an additional kick plate is available in Accessories for wall storage units. See page 190. Exterior of back is finished with neutral tone backer sheet. Interior of back has the same finish as the case (gables).
3 30" wide, 6 = 36"W		Product on this page will accept woodgrain laminate where laminate is currently an option.
4 14" deep	Installation instruction sheets available on Knoll Exchange. For grommet location refer to reference number 6TP00389.	Adjacent bookcases are intended to be field attached to one another using ganging kits.
DH Desk height	For ganging instructions, refer to reference number 6TP00436.	Ganging kits and Reveals are not included, and can be ordered separately. See Accessories for Wall Storage Units, page 190.
BD Bookcase discrete, SD = Stack-on discrete	The cabinet is key hole construction. Cabinet back is inset.	
G G = Center gable		
V316 Case finish		
GL35 Shelf finish		





32" nominal height = 32" actual height.
 53" nominal height = 52.6 actual height
 72" nominal height = 72 1/2" actual height
 86" nominal height = 86" actual height
 Glides add 2" of height adjustment. To prevent tipping, the back of each bookcase **must** be attached to a wall or to the back of another bookcase using the wall attachment hardware provided.

Wall Storage Units, 28³/₈" planning

Bookcase, Ganged, 14" deep

Wood and Laminate Shelves

28" and 41" high

description	w	d	h	pattern no.	Case/Shelf						
					L/L	V1/L	V2/L	V3/L	V1/V1	V2/V2	V3/V3
  Open bookcase, ganged, 28"h	30"	14"	28"	RC234DHBGG () ()	\$1,588.	\$2,248.	\$2,472.	\$3,113.	\$2,850.	\$3,223.	\$4,062.
	30"	14"	28"	RC234DHBGO () ()	1,254.	1,756.	1,911.	2,367.	2,063.	2,303.	2,947.
	36"	14"	28"	RC264DHBGG () ()	1,610.	2,259.	2,476.	3,130.	2,863.	3,237.	4,141.
	36"	14"	28"	RC264DHBGO () ()	1,295.	1,811.	1,979.	2,491.	2,137.	2,397.	3,150.
  Open bookcase, ganged, 41"h	30"	14"	41"	RC434DHBGG () ()	1,798.	2,458.	2,682.	3,323.	3,075.	3,476.	4,393.
	30"	14"	41"	RC434DHBGO () ()	1,464.	1,966.	2,121.	2,577.	2,289.	2,556.	3,278.
	36"	14"	41"	RC464DHBGG () ()	1,826.	2,474.	2,692.	3,346.	3,098.	3,499.	4,483.
	36"	14"	41"	RC464DHBGO () ()	1,510.	2,026.	2,195.	2,706.	2,372.	2,660.	3,492.

Order Code

Example:	RC234DHBDO () ()
R	Reff
C	Cabinets
2	28" high, 4 = 41" high
3	30" wide, 6 = 36" wide
4	14" deep
DH	Desk height
BG	Bookcase Ganged
O	Open, G = Center gable
V316	Case finish
111	Shelf finish

28" nominal height = 28³/₈" actual height.
 41" nominal height = 41¹/₂" actual height
 Glides add 2" of height adjustment.
 To prevent tipping, the back of each bookcase must be attached to a wall or to the back of another bookcase using the wall attachment hardware provided.

Specification Information

To order, please specify pattern number including:

- Case Finish: Laminate / Wood veneer
- Shelf Finish: Laminate / Wood veneer

It is Not advisable to mix 28³/₈" desk height products with 26¹/₂" standard height products.

Product on this page will accept woodgrain laminate where laminate is currently an option. For more information on grain direction on vertical surfaces, please see page 5.

Installation instruction sheets available on Knoll Exchange. For grommet location refer to reference number 6TP00389.

For ganging instructions, refer to reference number 6TP00436.

Cabinet is key hole construction. Cabinet back is inset.

Application Notes

Second shelf from the bottom is fixed and the top of the fixed shelf is nominally 28³/₄" above ground level. All other shelves are adjustable on 2.5" centers within 5" from the top and bottom of cabinet and away from the fixed middle shelf. All adjustable shelves are supported on field installed threaded pins. Shelves are flush with the front edge of the gables and have a nominal 13" inside depth. The back of each shelf has a 1/2" space for cable management. Centered at the back of the fixed shelf is an additional 1 1/4" diameter half round hole for plug head pass-through. 3 1/2" diameter grommet is available for field installation over wall electrical outlet.

Overall depth of units = 14" (not including wall attachment hardware).

The shelves on cabinets with center gable, are adjustable on both sides (2.5" intervals within 5" from the top and bottom of cabinet) Center gable is fixed.

In mix finish options, the fixed shelf is the same finish as the adjustable shelves.

Overall depth of units = 14" (not included wall attachment hardware).

Base kick plate is flush with front edge of gable. For Classic esthetic an additional kick plate is available in Accessories for wall storage units. See page 190.

Outer surface of exterior gable in "Ganged" units are finished with neutral tone backer sheet. Interior of back has the same finish as the case (gables).

Ganged bookcase are intended to be placed adjacent to one another and attached to each other. Black vertical reveals are included to go between adjacent units.

Additional shoulder units are available and ordered separately to finish the ends. Alternatively, "Discrete" bookcases may be used to finish the ends of a run. Ganged units include a ganging kit consisting of hardware and drilling template to field attach adjacent units together.

Wall Storage Units, 28³/₈" planning

Bookcase, Ganged, 14" deep

Wood and Laminate Shelves

53", 72" & 86" high and Stack-on Units

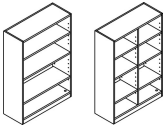
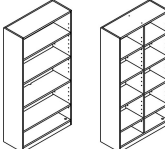
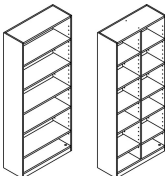
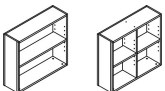
description	w	d	h	pattern no.	Case/Shelf						
					L/L	V1/L	V2/L	V3/L	V1/V1	V2/V2	V3/V3
 Open bookcase, ganged, 53"h	30"	14"	53"	RC534DHBGG () ()	\$1,901.	\$2,588.	\$2,822.	\$3,488.	\$3,230.	\$3,647.	\$4,601.
	30"	14"	53"	RC534DHBGO () ()	1,554.	2,077.	2,238.	2,712.	2,413.	2,691.	3,441.
	36"	14"	53"	RC564DHBGG () ()	1,930.	2,606.	2,831.	3,512.	3,253.	3,672.	4,695.
	36"	14"	53"	RC564DHBGO () ()	1,602.	2,139.	2,314.	2,846.	2,499.	2,798.	3,663.
 Open bookcase, ganged, 72"h	30"	14"	72"	RC7234DHBGG () ()	2,553.	3,346.	3,686.	4,912.	3,797.	4,324.	5,442.
	30"	14"	72"	RC7234DHBGO () ()	2,054.	2,609.	2,936.	3,721.	2,805.	3,169.	4,151.
	36"	14"	72"	RC7264DHBGG () ()	2,845.	3,780.	4,140.	5,472.	4,196.	4,782.	6,014.
	36"	14"	72"	RC7264DHBGO () ()	2,309.	2,954.	3,324.	4,226.	3,161.	3,562.	4,600.
 Open bookcase, ganged, 86"h	30"	14"	86"	RC834DHBGG () ()	3,092.	4,004.	4,520.	6,339.	4,641.	5,281.	7,200.
	30"	14"	86"	RC834DHBGO () ()	2,462.	3,181.	3,569.	4,927.	3,377.	3,811.	5,338.
	36"	14"	86"	RC864DHBGG () ()	3,462.	4,495.	5,071.	7,109.	5,128.	5,833.	7,945.
	36"	14"	86"	RC864DHBGO () ()	2,783.	3,600.	4,040.	5,594.	3,795.	4,285.	6,022.
 Stack-on units, Ganged, 32"h	30"	14"	32"	RC334DHS GG () ()	1,769.	2,330.	2,530.	3,118.	2,578.	2,847.	3,545.
	30"	14"	32"	RC334DHS GO () ()	1,601.	2,022.	2,177.	2,665.	2,154.	2,350.	2,947.
	36"	14"	32"	RC364DHS GG () ()	1,833.	2,378.	2,586.	3,223.	2,629.	2,910.	3,678.
	36"	14"	32"	RC364DHS GO () ()	1,636.	2,072.	2,235.	2,771.	2,210.	2,421.	3,086.

Order Code	Specification Information
Example: RC534DHBDO () ()	
R Reff	
C Cabinets	
5 53" high	
3 30" wide, 6 = 36"W	
4 14" deep	
DH Desk height	
BG Bookcase Ganged, SG = Stack-on Ganged	
O Open, G = Center gable	
V316 Case finish	
111 Shelf finish	

To order, please specify pattern number including:

- Case Finish: Laminate / Wood veneer
- Shelf Finish: Laminate / Wood veneer

It is Not advisable to mix 28³/₈" desk height products with 26¹/₂" standard height products.

Product on this page will accept woodgrain laminate where laminate is currently an option. For more information on grain direction on vertical surfaces, please see page 5.

Installation instruction sheets available on Knoll Exchange. For grommet location refer to reference number 6TP00389.

For ganging instructions, refer to reference number 6TP00436.

Cabinet is key hole construction. Cabinet back is inset.

Application Notes

Second shelf from the bottom is fixed and the top of the fixed shelf is nominally 28³/₈" above ground level. All other shelves are adjustable on 2.5" centers within 5" from the top and bottom of cabinet and away from the fixed middle shelf. All adjustable shelves are supported on field installed threaded pins. Shelves are flush with the front edge of the gables and have a nominal 13" inside depth. The back of each shelf has a 1/2" space for cable management. Centered at the back of the fixed shelf is an additional 1 1/4" diameter half round hole for plug head pass-through. 3 1/2" diameter grommet is available for field installation over wall electrical outlet.

Overall depth of units = 14" (not including wall attachment hardware).

Base kick plate is flush with front edge of gable. For Classic esthetic an additional kick plate is available in Accessories for wall storage units. See page 190.

Outer surface of exterior gable in "Ganged" units are finished with neutral tone backer sheet. Interior of back has the same finish as the case (gables).

Ganged bookcase are intended to be placed adjacent to one another and attached to each other. Black vertical reveals are included to go between adjacent units.

Additional shoulder units are available and ordered separately to finish the ends. Alternatively, "Discrete" bookcases may be used to finish the ends of a run. Ganged units include a ganging kit consisting of hardware and drilling template to field attach adjacent units together.



Overall depth of units = 14" (not including wall attachment hardware).

The shelves on cabinets with center gable, are adjustable on both sides (2.5" intervals within 5" from the top and bottom of cabinet) Center gable is fixed.

In mix finish options, the fixed shelf is the same finish as the adjustable shelves.

32" nominal height = 32" actual height.
 53" nominal height = 52.6 actual height
 72" nominal height = 72 1/2" actual height
 86" nominal height = 86" actual height
 Glides add 2" of height adjustment. To prevent tipping, the back of each bookcase must be attached to a wall or to the back of another bookcase using the wall attachment hardware provided.

Wall Storage Units, 28^{3/8}" planning
 Bookcase, Ganged, 14" deep
 Glass Shelves
 28" and 41" high

description	w	d	h	pattern no.	Case/Shelf L/G	V1/G	V2/G	V3/G
Open bookcase, ganged, 28"h 	30"	14"	28"	RC234DHBGG () ()	\$2,127.	\$2,456.	\$3,319.	\$4,169.
	36"	14"	28"	RC264DHBGG () ()	2,204.	3,074.	3,376.	4,262.
Open bookcase, ganged, 41"h 	30"	14"	41"	RC434DHBGG () ()	2,680.	3,563.	3,872.	4,722.
	36"	14"	41"	RC464DHBGG () ()	2,823.	3,693.	3,995.	4,881.

Order Code

Example:	RC234DHBGG () ()
R	Reff
C	Cabinets
2	28" high, 4 = 41" high
3	30" wide, 6 = 36" wide
4	14" deep
DH	Desk height
BG	Bookcase Ganged
G	G = Center gable
V316	Case finish
GL35	Shelf finish

28" nominal height = 28^{3/8}" actual height
 41" nominal height = 41 1/2" actual height
 Glides add 2" of height adjustment.
 To prevent tipping, the back of each bookcase **must** be attached to a wall or to the back of another bookcase using the wall attachment hardware provided.

Specification Information

To order, please specify pattern number including:

- Case Finish: Laminate / Wood veneer
- Shelf Finish: Glass Finish; GL35 or GL85

It is Not advisable to mix 28^{3/8}"h desk height products with 26 1/2" standard height products.

Product on this page will accept woodgrain laminate where laminate is currently an option. For more information on grain direction on vertical surfaces, please see page 5.

Installation instruction sheets available on Knoll Exchange. For grommet location refer to reference number 6TP00389.

For ganging instructions, refer to reference number 6TP00436.

The cabinet is key hole construction. Cabinet back is inset.

Application Notes

Glass shelves are available in GL35 and GL85 only. Bookcase units with glass shelves are available with Center Gable only. Center gable is fixed. Second shelf from the bottom is fixed and is in the same finish as the case. The top of the fixed shelf is nominally 28^{3/4}" above ground level. All other shelves are adjustable on 2.5" centers within 5" from the top and bottom of cabinet and away from the fixed middle shelf. All adjustable shelves are supported on field installed threaded pins. Shelves are flush with the front edge of the gables and have a nominal 13" inside depth. The back of each shelf has a 1/2" space for cable management. Centered at the back of the fixed shelf is an additional 1 1/4" diameter half round hole for plug head pass-through. 3 1/2" diameter grommet is available for field installation over wall electrical outlet.

The fixed shelf is the same finish as the case.

The shelves on cabinets with center gable, are adjustable on both sides (2.5" intervals within 5" from the top and bottom of cabinet) Center gable is fixed.

Overall depth of units = 14" (not included wall attachment hardware).

Base kick plate is flush with front edge of gable. For Classic esthetic an additional kick plate is available in Accessories for wall storage units. See page 190.

Outer surface of exterior gable in "Ganged" units are finished with neutral tone backer sheet. Interior of back has the same finish as the case (gables).

Ganged bookcase are intended to be placed adjacent to one another and attached to each other. Black vertical reveals are included to go between adjacent units.



Additional shoulder units are available and ordered separately to finish the ends. Alternatively, "Discrete" bookcases may be used to finish the ends of a run. Ganged units include a ganging kit consisting of hardware and drilling template to field attach adjacent units together.

Wall Storage Units, 28³/₈" planning

Bookcase, Ganged, 14" deep

Glass Shelves

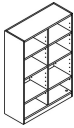
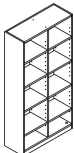
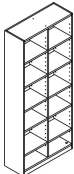
53", 72" & 86" high and Stack-on Units

description	w	d	h	pattern no.	Case/Shelf L/G	V1/G	V2/G	V3/G
Open bookcase, ganged, 53"h 	30"	14"	53"	RC534DHBGG () ()	\$2,820.	\$3,737.	\$4,059.	\$4,943.
	36"	14"	53"	RC564DHBGG () ()	2,967.	3,872.	4,187.	5,109.
Open bookcase, ganged, 72"h 	30"	14"	72"	RC7234DHBGG () ()	3,416.	4,358.	4,698.	5,748.
	36"	14"	72"	RC7264DHBGG () ()	3,650.	4,614.	4,973.	6,123.
Open bookcase, ganged, 86"h 	30"	14"	86"	RC834DHBGG () ()	3,947.	4,913.	5,280.	6,475.
	36"	14"	86"	RC864DHBGG () ()	4,249.	5,228.	5,616.	6,921.
Stack-on units, Ganged, 32"h 	30"	14"	32"	RC334DHSGG () ()	2,007.	2,569.	2,769.	3,357.
	36"	14"	32"	RC364DHSGG () ()	2,127.	2,673.	2,881.	3,517.

Order Code

Example:	RC534DHBGG () ()
R	Reff
C	Cabinets
5	53" high
3	30" wide, 6 = 36"W
4	14" deep
DH	Desk height
BG	Bookcase Ganged, SG = Stack-on Ganged
G	G = Center gable
V316	Case finish
GL35	Shelf finish

32" nominal height = 32" actual height
 53" nominal height = 52.6" actual height
 72" nominal height = 72 1/2" actual height
 86" nominal height = 86" actual height
 Glides add 2" of height adjustment. To prevent tipping, the back of each bookcase **must** be attached to a wall or to the back of another bookcase using the wall attachment hardware provided.

Specification Information

To order, please specify pattern number including:

- Case Finish: Laminate / Wood veneer
- Shelf Finish: Glass Finish; GL35 or GL85

It is Not advisable to mix 28³/₈" desk height products with 26 1/2" standard height products.

Product on this page will accept woodgrain laminate where laminate is currently an option. For more information on grain direction on vertical surfaces, please see page 5.

Installation instruction sheets available on Knoll Exchange. For grommet location refer to reference number 6TP00389.

For ganging instructions, refer to reference number 6TP00436.

The cabinet is key hole construction. Cabinet back is inset.

Application Notes

Glass shelves are available in GL35 and GL85 only. Bookcase units with glass shelves are available with Center Gable only. Center gable is fixed. Second shelf from the bottom is fixed and is in the same finish as the case. The top of the fixed shelf is nominally 28³/₈" above ground level. All other shelves are adjustable on 2.5" centers within 5" from the top and bottom of cabinet and away from the fixed middle shelf. All adjustable shelves are supported on field installed threaded pins. Shelves are flush with the front edge of the gables and have a nominal 13" inside depth. The back of each shelf has a 1/2" space for cable management. Centered at the back of the fixed shelf is an additional 1 1/4" diameter half round hole for plug head pass-through. 3 1/2" diameter grommet is available for field installation over wall electrical outlet.

The fixed shelf is the same finish as the case.

The shelves on cabinets with center gable, are adjustable on both sides (2.5" intervals within 5" from the top and bottom of cabinet) Center gable is fixed.

Overall depth of units = 14" (not including wall attachment hardware).

Base kick plate is flush with front edge of gable. For Classic esthetic an additional kick plate is available in Accessories for wall storage units. See page 190. Exterior of back is finished with neutral tone backer sheet. Interior of back has the same finish as the case (gables).





Ganged bookcase are intended to be place adjacent to one another and attached to each other. Black vertical reveals are included to go between adjacent units.

Adjacent bookcases are intended to be field attached to one another using ganging kits.

Additional shoulder units are available and ordered separately to finish the ends. Alternatively, "Discrete" bookcases may be used to finish the ends of a run. Ganged units include a ganging kit consisting of hardware and drilling template to field attach adjacent units together.

Accessories

Shoulder units

description	d	h	th	pattern no.	L	V1	V2	V3
Shoulder Units, 11" deep 	11"	28"	3/4"	RCS1280 ()	\$172.	\$264.	\$282.	\$328.
	11"	42"	3/4"	RCS1420 ()	186.	289.	300.	367.
	11"	72"	3/4"	RCS1720 ()	318.	412.	457.	572.
	11"	86"	3/4"	RCS1860 ()	334.	434.	482.	612.
	11"	104"	3/4"	RCS11040 ()	353.	470.	531.	691.
	11"	118"	3/4"	RCS11180 ()	369.	498.	563.	737.
Shoulder Units, 14" deep 	14"	28"	3/4"	RCS1284 ()	176.	270.	289.	345.
	14"	42"	3/4"	RCS1424 ()	193.	297.	319.	400.
	14"	53"	3/4"	RCS1534 ()	336.	439.	472.	578.
	14"	72"	3/4"	RCS1724 ()	368.	479.	518.	661.
	14"	86"	3/4"	RCS1864 ()	385.	499.	543.	712.
	14"	104"	3/4"	RCS11044 ()	410.	544.	596.	802.
	14"	118"	3/4"	RCS11184 ()	425.	575.	630.	861.
Shoulder Units, Double Deep For two 11" deep wall storage units 	22"	28"	3/4"	RCSD12800 ()	238.	342.	365.	449.
	22"	42"	3/4"	RCSD14200 ()	264.	376.	407.	524.
	22"	72"	3/4"	RCSD17200 ()	344.	475.	521.	723.
	22"	86"	3/4"	RCSD18600 ()	367.	511.	565.	805.
	22"	104"	3/4"	RCSD110400 ()	415.	604.	665.	955.
	22"	118"	3/4"	RCSD111800 ()	435.	628.	697.	1,022.
Shoulder Units, Double Deep For 11" d and 14" d wall storage units 	25"	28"	3/4"	RCSD12804 ()	243.	349.	375.	468.
	25"	42"	3/4"	RCSD14204 ()	272.	386.	419.	552.
	25"	72"	3/4"	RCSD17204 ()	356.	502.	554.	781.
	25"	86"	3/4"	RCSD18604 ()	380.	541.	600.	869.
	25"	104"	3/4"	RCSD110404 ()	432.	627.	696.	1,022.
	25"	118"	3/4"	RCSD111804 ()	454.	655.	731.	1,098.

Order Code

Example:	RCS1720 ()
R	Reff
C	Cabinets
S	Shoulder
1	Thickness: 3/4"
72	Height (86, 104, 118)
0	11"d
V316	Case finish

Specification Information

To order, please specify pattern number including:

1. Finish: Laminate / Wood or Glass (where applicable)
Glass shelf options are GL35 or GL85

It is Not advisable to mix 28³/₈"h desk height products with 26¹/₂" standard height products.

Product on this page **Excluding any vertical surface over 60"**, will accept wood grain laminate, where laminate is currently an option.

Installation instruction sheets available on Knoll Exchange. For ganging instructions, refer to reference number 6TP00436.

For periodical shelf; refer to reference number 6TP00437.

Application Notes

Shoulder units have veneer on outside, paper on inside. (except Laminate)
Shoulder thickness = 3/4" thick
Shoulder units are ordered separately to finish and complete a run of Ganged units. Shoulders come with black reveals and attachment hardware kit.

Shelf thickness:
Glass = 1/2" thick
Wood or Laminate = 1" thick
Glass shelves are only available in 15" and 18" width.

Baseboard kits are to create a classic esthetic.

104"h and 118"h shoulders are to accommodate 72"h and 86"h bookcases with 32"h mounted stack-on units.

Shoulder units include attachment hardware kit.
Black reveal kits are included with the shoulder units.

Accessories

Shoulder units

description	d	h	th	pattern no.	L	V1	V2	V3
Shoulder Units, Double Deep For two 14" deep wall storage units	28"	28"	3/4"	RCSD12844 ()	\$247.	\$354.	\$382.	\$486.
	28"	42"	3/4"	RCSD14244 ()	278.	394.	431.	578.
	28"	53"	3/4"	RCSD15344 ()	299.	431.	475.	661.
	28"	72"	3/4"	RCSD17244 ()	368.	516.	572.	824.
	28"	86"	3/4"	RCSD18644 ()	395.	557.	621.	920.
	28"	104"	3/4"	RCSD110444 ()	449.	649.	726.	1,089.
	28"	118"	3/4"	RCSD111844 ()	474.	680.	765.	1,174.
Shoulder / Back Unit	30"	28"	3/4"	RCSB1283 ()	207.	315.	344.	456.
	30"	42"	3/4"	RCSB1423 ()	234.	351.	390.	548.
	36"	28"	3/4"	RCSB1286 ()	216.	334.	371.	503.
	36"	42"	3/4"	RCSB1426 ()	247.	381.	428.	618.

Order Code

Example: RCS1720 ()
R Reff
C Cabinets
S Shoulder
1 Thickness: 3/4"
72 Height (86, 104, 118)
0 11"d
V316 Case finish

Specification Information

To order, please specify pattern number including:

1. Finish: Laminate / Wood or Glass (where applicable)
Glass shelf options are GL35 or GL85

It is Not advisable to mix 28³/₈"h desk height products with 26¹/₂" standard height products.

Product on this page **Excluding any vertical surface over 60"**, will accept wood grain laminate, where laminate is currently an option.

Installation instruction sheets available on Knoll Exchange. For ganging instructions, refer to reference number 6TP00436.

For periodical shelf; refer to reference number 6TP00437.

Application Notes

Shoulder units have veneer on outside, paper on inside. (except Laminate)
Shoulder thickness = 3/4" thick
Shoulder units are ordered separately to finish and complete a run of Ganged units. Shoulders come with black reveals and attachment hardware kit.

104"h and 118"h shoulders are to accommodate 72"h and 86"h bookcases with 32"h mounted stack-on units.

Shoulder units include attachment hardware kit.
Black reveal kits are included with the shoulder units.





Shelf thickness:
Glass = 1/2" thick
Wood or Laminate = 1" thick
Glass shelves are only available in 15" and 18" width.

Baseboard kits are to create a classic esthetic.

Wall Storage Units, 28³/₈" planning

Accessories

Shelf kits and Baseboard kits

description	w	d	h	pattern no.	L	V1	V2	V3	glass
Shelf Kits, 11" deep 	15"	11"		RCAS1511 ()	\$167.	\$187.	\$207.	\$257.	\$208.
	18"	11"		RCAS1811 ()	171.	193.	212.	261.	235.
	30"	11"		RCAS3011 ()	187.	203.	232.	313.	n/a
	36"	11"		RCAS3611 ()	192.	212.	241.	324.	n/a
Shelf Kits, 14" deep 	15"	14"		RCAS1514 ()	182.	221.	248.	290.	272.
	18"	14"		RCAS1814 ()	186.	224.	254.	303.	305.
	30"	14"		RCAS3014 ()	204.	242.	275.	356.	n/a
	36"	14"		RCAS3614 ()	211.	254.	290.	388.	n/a
Periodical Display shelf kits, 11" deep 	15"	11"	10"	RCPS1511 ()()	249.	327.	345.	372.	n/a
	18"	11"	10"	RCPS1811 ()()	255.	332.	352.	383.	n/a
	30"	11"	10"	RCPS3011 ()()	275.	354.	376.	428.	n/a
	36"	11"	10"	RCPS3611 ()()	285.	369.	394.	457.	n/a
Periodical Display shelf kits, 14" deep 	15"	14"	10"	RCPS1514 ()()	252.	330.	349.	380.	n/a
	18"	14"	10"	RCPS1814 ()()	258.	338.	358.	396.	n/a
	30"	14"	10"	RCPS3014 ()()	282.	365.	390.	451.	n/a
	36"	14"	10"	RCPS3614 ()()	291.	374.	401.	475.	n/a
Baseboard Kits 	30"		4"	RCAB30 ()	98.	208.	215.	241.	n/a
	36"		4"	RCAB36 ()	101.	211.	218.	270.	n/a

Order Code

Example: RCS1720 ()
R Reff
C Cabinets
S Shoulder
1 Thickness: 3/4"
72 Height (86, 104, 118)
0 11"d
V316 Case finish

Specification Information

To order, please specify pattern number including:

1. Finish: Laminate / Wood or Glass (where applicable)
Glass shelf options are GL35 or GL85

It is Not advisable to mix 28³/₈"h desk height products with 26¹/₂" standard height products.

Product on this page **Excluding any vertical surface over 60"**, will accept wood grain laminate, where laminate is currently an option.

Installation instruction sheets available on Knoll Exchange. For ganging instructions, refer to reference number 6TP00436.

For periodical shelf; refer to reference number 6TP00437.

Additional Information

Shoulder units have veneer on outside, paper on inside. (except Laminate)
Shoulder thickness = 3/4" thick
Shoulder units are ordered separately to finish and complete a run of Ganged units. Shoulders come with black reveals and attachment hardware kit.

104"h and 118"h shoulders are to accommodate 72"h and 86"h bookcases with 32"h mounted stack-on units.



Shoulder units include attachment hardware kit.
Black reveal kits are included with the shoulder units.

Shelf thickness:
Glass = 1/2" thick
Wood or Laminate = 1" thick
Glass shelves are only available in 15" and 18" width.

Baseboard kits are to create a classic esthetic.

Accessories

Reveal kits and Ganging kits

description	w	d	h	dia	pattern no.	1 Kit	10 Kit	50 Kit	list
Vertical Reveals 			28"		RCRV28 ()	\$89.	\$201.	\$695.	
			42"		RCRV42 ()	94.	250.	943.	
			53"		RCRV53 ()	108.	290.	1,103.	
			72"		RCRV72 ()	124.	417.	1,623.	
			86"		RCRV86 ()	134.	479.	1,904.	
			104"		RCRV104 ()	149.	557.	2,266.	
			118"		RCRV118 ()	156.	595.	2,446.	
Horizontal Reveals 	30"				RCRH30 ()	90.	235.	777.	
	36"				RCRH36 ()	95.	261.	898.	
Ganging Kits 		11"			RCGKIT11 ()	56.	107.	473.	
		14"			RCGKIT14 ()	56.	107.	473.	
Bookcase Grommet				3 1/2"	RBGR				36.

Order Code	Specification Information	Application Notes
Example: RCRV72 ()	<i>To order, please specify pattern number including:</i> 1. Reveal Kit Set: 1 = 1 kit 2 = 10 kits 3 = 50 kits	It is Not advisable to mix 28³/₈"h desk height products with 26 1/2" standard height products. Each reveal kit set, includes; 2 strips of reveal, cut to length, double sided tape in a roll and installation instructions. Reveals are included with ganged bookcases. Reveals come in Black only. Reveals are ³ / ₃₂ " thick. A pair of reveals is intended to go between each set of adjacent bookcases, stack-on units or shoulders. Each Ganging kit includes; attachment hardware, drilling template and installation instructions. Intended for use with Discrete units. Ganging kits are included with Ganged units.
R Reff		
C Cabinets		
RV Reveal Vertical RH = Reveal Horizontal		
72 Height (86, 104, 118)		
1 Kit set quantity		

Accessories

Sliding Display Boards

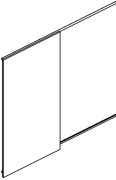
description	w	d	pattern no.	LW
Sliding Display Board 	30"		RCDB7230() ()	\$1,427.
	30"		RCDB8630() ()	1,477.
	36"		RCDB7236() ()	1,475.
	36"		RCDB8636() ()	1,523.

Order Code

Example:	RCDB7230 () ()
R	Reff
C	Cabinets
DB	Display Board
72	Height (86, 104, 118)
30	Width
LW	Marker Board
AA	Frame/Track Finish

Specification Information

To order, please specify pattern number including:

- Sliding Door Option:
LW (only)
- Frame /Track Finish:
AA (only)

Application Notes

It is Not advisable to mix 28^{3/8}"h desk height products with 26^{1/2}" standard height products.

The sliding display boards are available only in LW. Marker board finish on both sides.

Frame / Track finish is only available in AA.

Cabinets, 28³/₈" planning
53 high, metal interiors
Bookcase and Lateral File

description	w	d	pattern no.	L	L/V1	L/V2	L/V3	V1	V2	V3
Open bookcase w/2 adjustable shelves, 53" high (for desk height planning)	30"	15"	RC531DHB () ()	\$1,299.	n/a	n/a	n/a	\$1,768.	\$2,036.	\$2,749.
	30"	20"	RC532DHB () ()	1,466.	n/a	n/a	n/a	1,998.	2,297.	3,102.
	30"	24"	RC533DHB () ()	1,652.	n/a	n/a	n/a	2,250.	2,587.	3,493.
	36"	15"	RC561DHB () ()	1,441.	n/a	n/a	n/a	1,964.	2,261.	3,050.
	36"	20"	RC562DHB () ()	1,626.	n/a	n/a	n/a	2,216.	2,550.	3,443.
	36"	24"	RC563DHB () ()	1,831.	n/a	n/a	n/a	2,498.	2,871.	3,875.

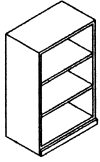

Interior shelves painted metal

4 drawer lateral file, 53" high (for desk height planning)	30"	20"	RC532DHF () () (L) ()	2,232.	2,581.	2,754.	2,928.	3,103.	3,497.	4,722.
	30"	24"	RC533DHF () () (L) ()	2,463.	2,846.	3,037.	3,229.	3,420.	3,857.	5,211.
	36"	20"	RC562DHF () () (L) ()	2,830.	3,271.	3,490.	3,711.	3,931.	4,433.	5,986.
	36"	24"	RC563DHF () () (L) ()	3,124.	3,612.	3,856.	4,100.	4,344.	4,897.	6,612.

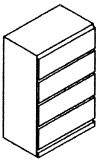

Drawer interiors painted metal

Order Code

Example:	RC531DHB
R	Reff
C	Cabinet
5	53" high
3	30" wide
1	15" deep
DH	Desk height
B	Open Bookcase
2	Finish Type, V2
M	Metal Interior
V316	Cabinet Finish: Maple
B	= Open Bookcase
F	= 4 Drawer Lateral File

Specification Information

To order the Open Bookcase, please specify pattern number including:

1. Finish type:
L = Laminate
1 = V1
2 = V2
3 = V3
2. Interior options:
M = Metal
3. Cabinet Finish:
Wood or Laminate

Please note: Shelf adjustability is limited to approximately 2.5" up or down per shelf from predetermined shelf height.

To order the cabinet with 4 Lateral files, please specify pattern number including:

1. Case Finish type:
L = Laminate
1 = V1
2 = V2
3 = V3
2. Front Finish type:
L = Laminate
1 = V1
2 = V2
3 = V3
3. Interior options:
M = Metal Interior
4. Pull options:
B = No pull, No Drilling, Customer's own Pull
C = C-Pull, (Nickel finish only)
D = Metal D-pull (PZ or PT only)
F = Bar Pull
H = Outline Pull
J = J (Routed) Pull
R = Cylinder Pull
S = S Pull
(Stainless Steel Finish only)
T = Tab pull
5. Lock Option Files:
L = Lock hole drilled
Drawers are always drilled for locks
6. Lock finish:
B = Black
S = Matte Silver
7. Case finish:
Wood or Laminate
8. Pull Finish:
Painted or Plated

It is Not advisable to mix 2⁷/₈"h desk height product with 26 1/2" standard height product.

Product on this page **Excluding J-pull option** will accept wood grain laminate, where laminate is currently an option.

Cabinets do not come with lock included. keying instructions must accompany all cabinet orders.

After specifying product code, provide keying instructions. Refer to page 482 for keying instructions.

53" nominal height - actual height 52.625"

File drawers include file bars for front to back and side to side filing.

File drawers do not support bottom loading.

*If case is Laminate, the front can be laminate or wood.

*If case is Wood, the front can only be wood.

Cabinets, 28³/₈" planning
53" high, wood interiors
Bookcase and Lateral File

description	w	d	pattern no.	L	L/V1	L/V2	L/V3	V1	V2	V3
Open bookcase w/2 adjustable shelves, 53" high (for desk height planning)	30"	15"	RC531DHB () () ()	\$1,457.	n/a	n/a	n/a	\$1,986.	\$2,277.	\$3,072.
	30"	20"	RC532DHB () () ()	1,621.	n/a	n/a	n/a	2,211.	2,542.	3,431.
	30"	24"	RC533DHB () () ()	1,808.	n/a	n/a	n/a	2,464.	2,833.	3,825.
	36"	15"	RC561DHB () () ()	1,599.	n/a	n/a	n/a	2,178.	2,506.	3,383.
	36"	20"	RC562DHB () () ()	1,784.	n/a	n/a	n/a	2,431.	2,796.	3,774.
	36"	24"	RC563DHB () () ()	1,987.	n/a	n/a	n/a	2,710.	3,116.	4,206.

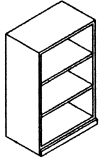

4 drawer lateral file, 53" high (for desk height planning)	30"	20"	RC532DHF () () (L) ()	2,387.	2,759.	2,946.	3,131.	3,318.	3,740.	5,051.
	30"	24"	RC533DHF () () (L) ()	2,621.	3,031.	3,236.	3,441.	3,646.	4,104.	5,541.
	36"	20"	RC562DHF () () (L) ()	2,985.	3,450.	3,683.	3,915.	4,148.	4,676.	6,312.
	36"	24"	RC563DHF () () (L) ()	3,280.	3,790.	4,047.	4,302.	4,557.	5,140.	6,938.

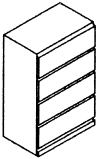

Order Code	Specification Information	Application Notes
<p>Example: RC531DHB</p> <p>R Reff</p> <p>C Cabinet</p> <p>5 53" high</p> <p>3 30" wide</p> <p>1 15" deep</p> <p>DH Desk height</p> <p>B Open Bookcase</p> <p>2 Finish Type, V2</p> <p>W Wood Interior</p> <p>V316 Cabinet Finish: Maple</p> <p>B = Open Bookcase</p> <p>F = 4 Drawer Lateral File</p>	<p>To order the Open Bookcase, please specify pattern number including:</p> <p>1. <i>Finish type:</i> L = Laminate 1 = V1 2 = V2 3 = V3</p> <p>2. <i>Interior options:</i> W = Wood</p> <p>3. <i>Cabinet Finish:</i> Wood or Laminate</p> <p>Please note: Shelf adjustability is limited to approximately 2.5" up or down per shelf from predetermined shelf height.</p>	<p>To order the cabinet with 4 Lateral files, please specify pattern number including:</p> <p>1. <i>Finish type:</i> L = Laminate 1 = V1 2 = V2 3 = V3</p> <p>2. <i>Interior options:</i> W = Wood Interior</p> <p>3. <i>Pull options:</i> B = No pull, No Drilling, Customer's own Pull C = C-Pull, (Nickel finish only) D = Metal D-pull (PZ or PT only) F = Bar Pull H = Outline Pull J = J (Routed) Pull R = Cylinder Pull S = S Pull (Stainless Steel Finish only) T = Tab pull</p> <p>4. <i>Lock Option Files:</i> L = Lock hole drilled Drawers are always drilled for locks</p> <p>5. <i>Lock Finish:</i> B = Black S = Matte Silver</p> <p>6. <i>Cabinet finish:</i> Wood or Laminate</p> <p>7. <i>Pull Finish:</i> Painted or Plated</p>
		<p>It is Not advisable to mix 28³/₈"h desk height products with 26¹/₂" standard height products.</p> <p>Product on this page Excluding J-pull option will accept wood grain laminate, where laminate is currently an option.</p> <p>Cabinets do not come with lock included.</p> <p>Keying instructions must accompany all cabinet orders.</p> <p>After specifying product code, provide keying instructions. Refer to page 482 for keying instructions.</p> <p>53" nominal height - actual height 52.625"</p> <p>File drawers include file bars for front to back and side to side filing.</p> <p>File drawers do not support bottom loading.</p>

Cabinets, 28³/₈" planning 53" high, wood interiors Wardrobe

description	w	d	pattern no.	L	L/V1	L/V2	L/V3	V1	V2	V3
Cabinet, 53" high with hinged doors and coat rod (wood interior only)	30"	15"	RC531DHH()()()	\$1,747.	\$2,019.	\$2,157.	\$2,293.	\$2,429.	\$2,733.	\$3,687.
	30"	20"	RC532DHH()()()	1,903.	2,201.	2,348.	2,497.	2,646.	2,986.	4,028.
	30"	24"	RC533DHH()()()	2,090.	2,416.	2,579.	2,742.	2,905.	3,277.	4,423.
	36"	15"	RC561DHH()()()	1,919.	2,218.	2,367.	2,516.	2,666.	3,007.	4,058.
	36"	20"	RC562DHH()()()	2,084.	2,408.	2,569.	2,731.	2,893.	3,254.	4,379.
	36"	24"	RC563DHH()()()	2,289.	2,645.	2,822.	3,000.	3,178.	3,575.	4,811.

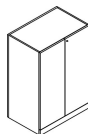

Order Code	Specification Information	Application Notes
Example: RC531DHH	<i>To order the Cabinet with hinge Doors, please specify pattern number including:</i>	It is Not advisable to mix 28³/₈"h desk height product with 26¹/₂" standard height products.
R Reff	1. <i>Lock Option:</i> L = Lock hole drilled N = No lock drilled	Product on this page Excluding J-pull option will accept wood grain laminate, where laminate is currently an option.
C Cabinet	2. <i>Lock Finish:</i> B = Black S = Matte Silver	Cabinets do not come with lock included.
5 53" high	3. <i>Pull options:</i> B = No pull, No Drilling, Customer's own Pull C = C-Pull, (Nickel finish only) D = Metal D-pull (PZ or PT only) F = Bar Pull (1 pull per door set) H = Outline Pull J = J (Routed) Pull R = Cylinder Pull S = S Pull (Stainless Steel Finish only) T = Tab pull (1 pull per door set)	Keying instructions must accompany all cabinet orders.
3 30" wide	4. <i>Pull Finish:</i> Painted or Plated	After specifying product code, provide keying instructions. Refer to page 482 for keying instructions.
1 15" deep	5. <i>Cabinet finish:</i> Wood or Laminate	53" nominal height - actual height 52.625"
DH Desk height	6. <i>Front Finish:</i> Wood or Laminate	*If case is Laminate, the front can be laminate or wood. *If case is Wood, the front can only be wood.
L Lock option		15" wardrobe cabinets come with 2 coat hooks.
B Lock finish		20" and 24" deep wardrobe cabinet comes with a coat rod.
H Pull option		20" deep Wardrobe Cabinets provides only 18" of clear storage space.
111 Pull interior		Wardrobe cabinets do not come equipped with boot tray. Please specify separately. See page 417.
W Wood Interior		
V316 Case Finish: Maple		
V316 Front Finish: Maple		

Cabinets, 28³/₈" planning
72" high, metal interiors
Bookcase

description	w	d	pattern no.	L	L/V1	L/V2	L/V3	V1	V2	V3
Open bookcase 72" high (for desk height planning)	30"	15"	RC7231DHB () ()	\$1,926.	n/a	n/a	n/a	\$2,624.	\$3,021.	\$4,077.
	30"	20"	RC7232DHB () ()	2,068.	n/a	n/a	n/a	2,821.	3,244.	4,381.
	30"	24"	RC7233DHB () ()	2,293.	n/a	n/a	n/a	3,123.	3,596.	4,853.
	36"	15"	RC7261DHB () ()	2,179.	n/a	n/a	n/a	2,969.	3,416.	4,611.
	36"	20"	RC7262DHB () ()	2,341.	n/a	n/a	n/a	3,191.	3,668.	4,953.
	36"	24"	RC7263DHB () ()	2,566.	n/a	n/a	n/a	3,494.	4,021.	5,429.

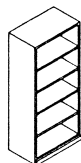

Order Code

Example:	RC731BDHB () ()
R	Reff
C	Cabinets
72	72 1/2" high
3	30" wide
1	15" deep, 2 = 20" deep, 3 = 24" deep
DH	Desk height
B	Open Bookcase
2	Finish Type: V2
M	Metal Interior
V316	Case Finish: Maple

Specification Information

To order the Open Bookcase, please specify pattern number including:

1. *Finish type:*
L = Laminate
1 = V1
2 = V2
3 = V3
2. *Interior options:*
M = Metal
Cabinets with metal interior, the shelves are in painted metal.
For laminate cases, the shelves are painted to match ie. 114 case = 114 painted shelves.
For wood cases, the shelves are painted black ie. V316 case = black shelves.
3. *Cabinet Finish:*
Wood or Laminate

Application Notes

It is Not advisable to mix 28³/₈" desk height products with 26¹/₂" standard height products.

Product on this page **Excluding J-pull option** will accept wood grain laminate, where laminate is currently an option. For more information on grain direction on vertical surfaces, please see page 5.

Keying instructions must accompany all cabinet orders. After specifying product code, provide keying instructions. Refer to page 482 for keying instructions.

Please note: Shelf adjustability is limited to approximately 2.5" up or down per shelf from predetermined shelf height.

Cabinets, 28³/₈" planning
72" high, metal interiors
Bookcase and file drawers

description	w	d	pattern no.	L	L/V1	L/V2	L/V3	V1	V2	V3
Cabinet, 72" high, double high with file/file below, top open with one adjustable shelf	30"	20"	RC7232DHK () () () ()	\$3,427.	\$3,963.	\$4,230.	\$4,499.	\$4,766.	\$5,355.	\$7,175.
	30"	24"	RC7233DHK () () () ()	3,787.	4,378.	4,672.	4,967.	5,262.	5,918.	7,938.
	36"	20"	RC7262DHK () () () ()	3,735.	4,319.	4,610.	4,903.	5,195.	5,844.	7,836.
	36"	24"	RC7263DHK () () () ()	4,072.	4,723.	5,049.	5,374.	5,700.	6,411.	8,602.

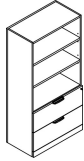

Cabinet, 72" high, double high with 4 files below, top open with one adjustable shelf	30"	20"	RC7232DHO () () () ()	3,654.	4,248.	4,544.	4,841.	5,137.	5,785.	7,826.
	30"	24"	RC7233DHO () () () ()	4,089.	4,749.	5,080.	5,410.	5,740.	6,467.	8,746.
	36"	20"	RC7262DHO () () () ()	4,065.	4,723.	5,052.	5,381.	5,710.	6,428.	8,694.
	36"	24"	RC7263DHO () () () ()	4,543.	5,275.	5,640.	6,005.	6,371.	7,177.	9,706.

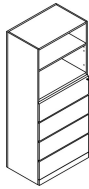

Order Code	Specification Information	Application Notes
Example: RC7232DHK () () () ()	<i>To order, please specify pattern number including:</i>	It is Not advisable to mix 28³/₈"h desk height products with 26¹/₂" standard height products.
R Reff	1. <i>Interior options:</i> M = Metal	Please note: Shelf adjustability is limited to approximately 2.5" up or down per shelf from predetermined shelf height.
C Cabinet	2. <i>Lock Option Doors:</i> L = Lock hole drilled N = No lock drilling Drawers are always drilled for lock. Not optional.	*File drawers include file bars for front to back and side to side filing. File drawers do not support bottom loading.
72 72 ¹ / ₂ " high	3. <i>Lock Finish:</i> B = Black S = Matte Silver	Product on this page Excluding J-pull option will accept wood grain laminate, where laminate is currently an option. For more information on grain direction on vertical surfaces, please see page 5.
3 30" wide	4. <i>Pull Options:</i> B = No pull, No Drilling, C = Nickel finish C-pull (nickel finish only) D = Metal D-pull (finish optional) F = Bar Pull (1 pull per door set) H = Outline Pull JN = Routed J-pull on drawers and touch latch on Hinge doors (finish matches case) R = Cylinder Pull S = S Pull (Stainless Steel Finish only) T = Tab Pull (1 pull per door set)	Cabinets do not come with lock included.
2 20" deep	5. <i>Pull Finish:</i> Painted and Plated	Keying instructions must accompany all cabinet orders.
DH Desk Height	6. <i>Case Finish:</i> Wood or Laminate	After specifying product code, provide keying instructions. Refer to page 482 for keying instructions.
K Open Shelves with 2 File drawers	7. <i>Front Finish:</i> Wood or Laminate	* If case is Laminate, the front can be laminate or wood. * If case is Wood, the front can only be wood.
M Metal Interior		
L Lock option		
B Lock Finish		
T Pull Option		
111 Pull Finish		
V316 Case Finish: Maple		
V316 Front Finish: Maple		
K =Open shelves and 2 file drawers O = Open shelves and 4 file drawers		

Cabinets, 28³/₈" planning 72" high, metal interiors Hinge doors and file drawers

description	width	depth	pattern number	L	L/V1	L/V2	L/V3	V1	V2	V3
Storage w/4 file drwrs & hinged doors above 72" high, (for desk height planning)	30"	20"	RC7232DHFH () () () () () ()	\$3,400.	\$3,929.	\$4,193.	\$4,458.	\$4,722.	\$5,327.	\$7,188.
	30"	24"	RC7233DHFH () () () () () ()	3,776.	4,364.	4,658.	4,952.	5,246.	5,915.	7,986.
	36"	20"	RC7262DHFH () () () () () ()	3,755.	4,339.	4,632.	4,924.	5,216.	5,880.	7,940.
	36"	24"	RC7263DHFH () () () () () ()	4,167.	4,818.	5,143.	5,468.	5,794.	6,530.	8,815.

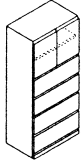

Order Code	Specification Information	Application Notes
Example: RC7232DHFH	<i>To order, please specify pattern number including:</i>	It is Not advisable to mix 28³/₈" desk height products with 26¹/₂" standard height products.
R Reff	1. <i>Case Finish type:</i> L = Laminate 1 = V1 2 = V2 3 = V3	File drawers include file bars for front to back and side to side filing.
C Cabinet	2. <i>Front Finish type:</i> L = Laminate 1 = V2 2 = V2 3 = V3	File drawers do not support bottom loading.
72 72 1/2" high	3. <i>Interior options:</i> M = Metal Pedestals with metal interior, the shelves are in painted metal. For laminate cases, the shelves are painted to match ie. 114 case = 114 painted shelves. For wood cases, the shelves are painted black ie. V316 case = black shelves.	Product on this page Excluding J-pull option will accept wood grain laminate, where laminate is currently an option. For more information on grain direction on vertical surfaces, please see page 5.
3 30" wide	4. <i>Pull Options:</i> B = No pull, No Drilling, Customer's own Pull C = Nickel Finish C-Pull D = Metal D-pull F = Bar Pull (1 pull per door set) H = Outline Pull JN = J (Routed) Pull on Drawers and Touch latch on hinge doors R = Cylinder Pull S = S Pull (Stainless Steel Finish only) T = Tab Pull (1 pull per door set)	Hinge door cabinets have optional lock drilling which can be specified in the cabinet product code. Keying instructions must accompany all cabinet orders.
2 20" deep	5. <i>Lock options Files:</i> L = Lock hole drilled (not optional)	Drawers are always drilled for locks.
DH Desk Height	6. <i>Lock Option Doors:</i> L = Lock hole drilled N = No lock drilling	After specifying product code, provide keying instructions. Refer to page 482 for keying instructions.
F Storage with Hinge Door with 4 file drawers	7. <i>Lock Finish:</i> B = Black S = Matte Silver	*If case is Laminate, the front can be laminate of wood. *If case is wood, the front can only be wood.
H Wood hinge doors	8. <i>Cabinet Case Finish:</i> Wood or Laminate	
L Case Finish Type: Laminate	9. <i>Front Finish:</i> Wood or Laminate	
2 Front finish type, V2	10. <i>Pull Finish:</i> Painted or Plated	
M Metal Interior		
T Tab pull option		
L Lock option, files		
N Lock option, doors		
B Lock Finish		
118 Case Finish		
V316 Front Finish		
111 Pull Finish		

F = Hinge door cabinet with 4 file drawers
G = Hinge door cabinet with FF

Cabinets, 28³/₈" planning 72" high, metal interiors Hinge doors and file drawers

description	width	depth	pattern number	L	L/V1	L/V2	L/V3	V1	V2	V3
Storage w/upper hinged doors & 2 adj shelves, 72" high, bottom 2 file drawers (for desk height planning)	16"	20"	RC7212DHGH(L/R) () () () () () ()	\$2,470.	\$2,854.	\$3,045.	\$3,237.	\$3,429.	\$3,869.	\$5,222.
	16"	24"	RC7213DHGH(L/R) () () () () () ()	2,706.	3,146.	3,366.	3,585.	3,806.	4,292.	5,791.
	30"	20"	RC7232DHGH () () () () () ()	3,134.	3,623.	3,868.	4,112.	4,357.	4,911.	6,632.
	30"	24"	RC7233DHGH () () () () () ()	3,446.	3,983.	4,253.	4,521.	4,790.	5,398.	7,290.
	36"	20"	RC7262DHGH () () () () () ()	3,405.	3,935.	4,199.	4,465.	4,729.	5,335.	7,202.
	36"	24"	RC7263DHGH () () () () () ()	3,719.	4,298.	4,588.	4,877.	5,167.	5,826.	7,864.

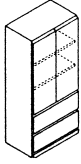

Order Code	Specification Information	Application Notes
Example: RC7232DHFH	<i>To order, please specify pattern number including:</i>	It is Not advisable to mix 28³/₈"h desk height products with 26¹/₂" standard height products.
R Reff	1. <i>Case Finish type:</i> L = Laminate 1 = V1 2 = V2 3 = V3	File drawers include file bars for front to back and side to side filing.
C Cabinet	2. <i>Front Finish type:</i> L = Laminate 1 = V2 2 = V2 3 = V3	File drawers do not support bottom loading.
72 72 1/2" high	3. <i>Interior options:</i> M = Metal Pedestals with metal interior, the shelves are in painted metal. For laminate cases, the shelves are painted to match ie. 114 case = 114 painted shelves. For wood cases, the shelves are painted black ie. V316 case = black shelves.	Product on this page Excluding J-pull option will accept wood grain laminate, where laminate is currently an option. For more information on grain direction on vertical surfaces, please see page 5.
3 30" wide	4. <i>Pull Options:</i> B = No pull, No Drilling, Customer's own Pull C = Nickel Finish C-Pull D = Metal D-pull F = Bar Pull (1 pull per door set) H = Outline Pull JN = J (Routed) Pull on Drawers and Touch latch on hinge doors R = Cylinder Pull S = S Pull (Stainless Steel Finish only) T = Tab Pull (1 pull per door set)	Hinge door cabinets have optional lock drilling which can be specified in the cabinet product code. Keying instructions must accompany all cabinet orders.
2 20" deep	5. <i>Lock options Files:</i> L = Lock hole drilled (not optional)	Drawers are always drilled for locks.
DH Desk Height	6. <i>Lock Option Doors:</i> L = Lock hole drilled N = No lock drilling	After specifying product code, provide keying instructions. Refer to page 482 for keying instructions.
F Storage with Hinge Door with 4 file drawers	7. <i>Lock Finish:</i> B = Black S = Matte Silver	*If case is Laminate, the front can be laminate of wood. *If case is wood, the front can only be wood.
H Wood hinge doors	8. <i>Cabinet Case Finish:</i> Wood or Laminate	
L Case Finish Type: Laminate	9. <i>Front Finish:</i> Wood or Laminate	
2 Front finish type, V2	10. <i>Pull Finish:</i> Painted or Plated	
M Metal Interior		
T Tab pull option		
L Lock option, files		
N Lock option, doors		
B Lock Finish		
118 Case Finish		
V316 Front Finish		
111 Pull Finish		

F = Hinge door cabinet with 4 file drawers
G = Hinge door cabinet with FF

Cabinets, 28³/₈" planning 72" high, metal interiors Hinge doors and Box/Box/File

description	w	d	pattern no.	L	L/V1	L/V2	L/V3	V1	V2	V3
Storage, 72" high, w/upper hinged doors & 2 adj shelves, bottom box/box/file (for desk height planning)	16"	20"	RC7212DHPH(L/R) () () () ()	\$2,564.	\$2,962.	\$3,161.	\$3,361.	\$3,560.	\$4,014.	\$5,420.
	16"	24"	RC7213DHPH(L/R) () () () ()	2,825.	3,266.	3,485.	3,705.	3,926.	4,428.	5,979.

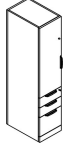

Left hand shown

Order Code	Specification Information	Application Notes
Example: RC7212DHPH(L/R)	<i>To order, please specify pattern number including:</i>	It is Not advisable to mix 28³/₈"h desk height products with 26¹/₂" standard height products.
R Reff	1. <i>Interior options:</i> M = Metal	File drawers include file bars for front to back and side to side filing.
C Cabinet	2. <i>Lock Option Doors:</i> L = Lock hole drilled N = No lock drilling Drawers are always drilled for lock. Not optional.	File drawers do not support bottom loading.
72 72 1/2" high	3. <i>Lock Finish:</i> B = Black S = Matte Silver	Product on this page Excluding J-pull option will accept wood grain laminate, where laminate is currently an option. For more information on grain direction on vertical surfaces, please see page 5.
1 16" wide	4. <i>Pull Options:</i> B = No pull, No Drilling, C = Nickel finish C-pull (nickel finish only) D = Metal D-pull (finish optional) F = Bar Pull (1 pull per door set) H = Outline Pull JN = Routed J-pull on drawers and touch latch on Hinge doors (finish matches case) R = Cylinder Pull S = S Pull (Stainless Steel Finish only) T = Tab Pull (1 pull per door set)	Hinge door cabinets have optional lock drilling which can be specified in the cabinet product code. Keying instructions must accompany all cabinet orders.
2 20" deep, 3 = 24" deep	5. <i>Pull Finish:</i> Painted and Plated	Drawers are always drilled for locks.
DH Desk Height	6. <i>Case Finish:</i> Wood or Laminate	After specifying product code, provide keying instructions. Refer to page 482 for keying instructions.
P Storage with Hinge Door with Box/Box/File	7. <i>Front Finish:</i> Wood or Laminate	*If case is Laminate, the front can be laminate of wood. *If case is wood, the front can only be wood.
H Wood hinge doors		
L/R Left or Right hand		
M Metal Interior		
L Lock option, door		
111 Lock finish		
T Pull option		
111 Pull finish		
118 Case finish		
V316 Front finish		
P =Hinge door cabinet with Box/Box/File		

Cabinets, 28³/₈" planning 72" high, metal interiors Hinge doors and wardrobe

description	w	d	pattern no.	L	V1	V2	V3	V1	V2	V3
Wardrobe/bookcase combo 72" high, w/full height doors (for desk height planning)	30"	20"	RC7232DHEH(L/R) () () () () () ()	\$3,348.	\$3,868.	\$4,129.	\$4,389.	\$4,649.	\$5,246.	\$7,081.
	30"	24"	RC7233DHEH(L/R) () () () () () ()	3,742.	4,326.	4,617.	4,909.	5,200.	5,866.	7,918.
	36"	20"	RC7262DHEH(L/R) () () () () () ()	3,668.	4,240.	4,526.	4,812.	5,098.	5,748.	7,757.
	36"	24"	RC7263DHEH(L/R) () () () () () ()	4,095.	4,737.	5,056.	5,377.	5,698.	6,419.	8,666.

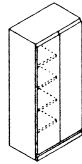

Left hand shown

Requires one lock core per cabinet.
Coat rod included.
Shelves determine (L/R) hand.

Order Code	Specification Information	Application Notes
Example: RC7232DHEH (L/R)	<i>To order, please specify pattern number including:</i>	<p>It is Not advisable to mix 28³/₈"h desk height products with 26¹/₂" standard height products.</p> <p>Product on this page Excluding J-pull option will accept wood grain laminate, where laminate is currently an option. For more information on grain direction on vertical surfaces, please see page 5.</p> <p>Hinge door cabinets have optional lock drilling which can be specified in the cabinet product code. Keying instructions must accompany all cabinet orders.</p> <p>After specifying product code, provide keying instructions. Refer to page 482 for keying instructions.</p> <p>*If case is Laminate, the front can be laminate of wood. *If case is wood, the front can only be wood.</p> <p>Please note: Shelf adjustability is limited to approximately 2.5" up or down per shelf from predetermined shelf height.</p> <p>* Note: 72" high Wardrobe cabinets do not come equipped with boot tray. Please specify separately. See page 417. 20" deep Wardrobe Cabinets provide only 18" of clear storage space.</p>
R Reff	1. <i>Case Finish type:</i> L = Laminate 1 = V1 2 = V2 3 = V3	
C Cabinet	2. <i>Front Finish type:</i> L = Laminate 1 = V1 2 = V2 3 = V3	
72 72 ¹ / ₂ " high	3. <i>Interior options:</i> M = Metal Interior Pedestals with metal interior, the shelves are in painted metal. For laminate cases, the shelves are painted to match ie. 114 case = 114 painted shelves. For wood cases, the shelves are painted black ie. V316 case = black shelves.	
3 30" wide	4. <i>Pull Options:</i> B = No pull, No Drilling, Customer's own Pull C = Nickel finish C-pull D = Metal finish C-pull F = Bar Pull (1 pull per door set) H = Outline Pull N = No pulls, touch latch R = Cylinder Pull S = S Pull (Stainless Steel Finish only) T = Tab Pull (1 pull per door set)	
2 20" deep	5. <i>Lock Option Doors:</i> L = Lock hole drilled N = No lock drilling	
DH Desk Height	6. <i>Lock Finish:</i> B = Black S = Matte Silver	
E Wardrobe / Bookcase combo	7. <i>Case Finish:</i> Wood or Laminate	
H Wood hinge doors	8. <i>Front Finish:</i> Wood or Laminate	
L Case finish Type: Laminate	9. <i>Pull Finish:</i> Painted or Plated	
2 Front finish type: V2		
M Metal Interior		
T Tab pull option		
N Lock option, doors		
B Lock Finish		
118 Case Finish		
V316 Front Finish		
111 Pull Finish		

E = Hinge door cabinet with full height doors, half wardrobe and shelves

Cabinets, 28³/₈" planning 72" high, metal interiors Wardrobe Combo with BBF and FF

description	w	d	pattern no.	L	L/V1	L/V2	L/V3	V1	V2	V3
Wardrobe 72" high, with 1/2 height hinged door & box/box/file Cabinet	30"	20"	RC7232DHPHW(L/R) () () () () ()	\$3,495.	\$4,236.	\$4,606.	\$4,977.	\$5,347.	\$6,029.	\$8,139.
	30"	24"	RC7233DHPHW(L/R) () () () () ()	3,633.	4,402.	4,788.	5,172.	5,558.	6,267.	8,459.
	36"	20"	RC7262DHPHW(L/R) () () () () ()	3,613.	4,379.	4,761.	5,144.	5,527.	6,232.	8,413.
	36"	24"	RC7263DHPHW(L/R) () () () () ()	3,754.	4,549.	4,948.	5,345.	5,743.	6,475.	8,741.

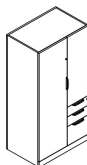

Left hand shown

Wardrobe determines (L/R) hand

Wardrobe 72" high, with 1/2 height hinged door & file/file Cabinet	30"	20"	RC7232DHGHW(L/R) () () () () ()	3,354.	4,065.	4,420.	4,775.	5,131.	5,785.	7,811.
	30"	24"	RC7233DHGHW(L/R) () () () () ()	3,481.	4,219.	4,587.	4,956.	5,325.	6,002.	8,104.
	36"	20"	RC7262DHGHW(L/R) () () () () ()	3,472.	4,208.	4,576.	4,944.	5,312.	5,989.	8,084.
	36"	24"	RC7263DHGHW(L/R) () () () () ()	3,601.	4,363.	4,746.	5,127.	5,508.	6,210.	8,386.

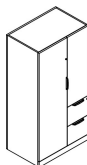

Left hand shown

Wardrobe determines (L/R) hand

Order Code	Specification Information	Application Notes
Example: RC7232DHPHW (L/R)	<i>To order, please specify pattern number including:</i>	It is Not advisable to mix 28³/₈"h desk height products with 26¹/₂" standard height products.
R Reff	1. <i>Interior options:</i> M = Metal Interior	The Wardrobe Cabinets on this page come equipped with a coat rod.
C Cabinet	2. <i>Lock Options Doors:</i> L = Lock hold drilled N = No lock drilling Drawers are always drilled for lock. Not optional	The 1/2 height hinge door comes with touch latch only and is non locking. It also comes with 2 adjustable shelves.
72 72 ¹ / ₂ " high	3. <i>Lock Finish:</i> B = Black S = Matte Silver	Please note: Shelf adjustability is limited to approximately 2.5" up or down per shelf from predetermined shelf height.
3 30" wide	4. <i>Pull Options:</i> B = No pull, No Drilling, Customer's own Pull C = Nickel finish C-pull (nickel finish only) D = Metal D-pull (finish optional) F = Bar Pull (1 pull per door set) H = Outline Pull JN = Routed J-pull on drawers and touch latch on Hinge doors (finish matches case) R = Cylinder Pull S = S Pull (Stainless Steel Finish only) T = Tab Pull (1 pull per door set)	File drawers include file bars for front to back and side to side filing. File drawers do not support bottom loading.
2 20" deep	5. <i>Pull Finish:</i> Painted or Plated	Drawers are always drilled for locks.
DH Desk Height	6. <i>Case Finish:</i> Wood or Laminate	After specifying product code, provide keying instructions. Refer to page 482 for keying instructions.
PHW Box/Box/File Wardrobe combo GHW = FF Wardrobe combo	7. <i>Front Finish:</i> Wood or Laminate	*If case is Laminate, the front can be laminate or wood. *If case is Wood, the front can only be wood.
L/R Left or Right hand		
M Metal Interior		
L Lock option, doors		
111 Lock Finish		
T Pull option		
111 Pull Finish		
118 Case Finish		
V316 Front Finish		

Cabinets, 28³/₈" planning
72" high, wood interiors
Bookcase

description	w	d	pattern no.	L	L/V1	L/V2	L/V3	V1	V2	V3
Open bookcase 72" high (for desk height planning)	30"	15"	RC7231DHB () () ()	\$2,071.	n/a	n/a	n/a	\$2,822.	\$3,244.	\$4,379.
	30"	20"	RC7232DHB () () ()	2,223.	n/a	n/a	n/a	3,031.	3,486.	4,703.
	30"	24"	RC7233DHB () () ()	2,448.	n/a	n/a	n/a	3,337.	3,836.	5,178.
	36"	15"	RC7261DHB () () ()	2,325.	n/a	n/a	n/a	3,166.	3,642.	4,915.
	36"	20"	RC7262DHB () () ()	2,498.	n/a	n/a	n/a	3,403.	3,912.	5,208.
	36"	24"	RC7263DHB () () ()	2,720.	n/a	n/a	n/a	3,707.	4,262.	5,755.

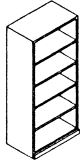

Order Code	Specification Information	Application Notes
Example: RC7231DHB () () ()	<p>To order the Open Bookcase, please specify pattern number including:</p> <ol style="list-style-type: none"> Finish type: L = Laminate 1 = V1 2 = V2 3 = V3 Interior options: W = Wood Interior Cabinet Finish: Wood or Laminate 	<p>It is Not advisable to mix 28³/₈"h desk height products with 26¹/₂" standard height products.</p> <p>Product on this page Excluding J-pull option and any vertical surface over 60", will accept wood grain laminate, where laminate is currently an option.</p> <p>Anchor brackets are included for 15" deep bookcases.</p> <p>Please note: Shelf adjustability is limited to approximately 2.5" up or down per shelf from predetermined shelf height.</p>
R Reff		
C Cabinets		
72 72 1/2" high		
3 30" wide		
1 15" deep, 2 = 20" deep, 3 = 24" deep		
DH Desk Height		
B Open Bookcase		
2 Finish Type: V2		
W Wood Interior		
V316 Cabinet Finish: Maple		

Cabinets, 28³/₈" planning 72" high, wood interiors Bookcase and file drawers

description	w	d	pattern no.	L	L/V1	L/V2	L/V3	V1	V2	V3
Cabinet, 72" high, double high with 4 files below, top open with one adjustable shelf	30"	20"	RC7232DHO () () () ()	\$3,852.	\$4,473.	\$4,783.	\$5,093.	\$5,404.	\$6,084.	\$8,221.
	30"	24"	RC7233DHO () () () ()	4,288.	4,977.	5,322.	5,667.	6,012.	6,764.	9,141.
	36"	20"	RC7262DHO () () () ()	4,262.	4,949.	5,291.	5,634.	5,978.	6,748.	9,120.
	36"	24"	RC7263DHO () () () ()	4,738.	5,497.	5,877.	6,257.	6,637.	7,478.	10,105.

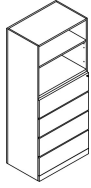

Cabinet, 72" high, double high with file/file below, top open with one adjustable shelf	30"	20"	RC7232DHK () () () ()	3,605.	4,167.	4,449.	4,729.	5,010.	5,633.	7,551.
	30"	24"	RC7233DHK () () () ()	3,965.	4,584.	4,892.	5,202.	5,511.	6,201.	8,318.
	36"	20"	RC7262DHK () () () ()	3,914.	4,527.	4,834.	5,140.	5,447.	6,125.	8,216.
	36"	24"	RC7263DHK () () () ()	4,278.	4,948.	5,282.	5,617.	5,951.	6,692.	8,981.

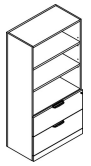

Order Code	Specification Information	Application Notes
Example: RC832DHK () () () ()	<i>To order, please specify pattern number including:</i>	<p>It is Not advisable to mix 28³/₈" desk height products with 26¹/₂" standard height products.</p> <p>Product on this page Excluding J-pull option and any vertical surface over 60", will accept wood grain laminate, where laminate is currently an option.</p> <p>Cabinets do not come with lock included.</p> <p>Keying instructions must accompany all cabinet orders.</p> <p>After specifying product code, provide keying instructions. Refer to page 482 for keying instructions.</p> <p>* If case is Laminate, the front can be laminate or wood. * If case is Wood, the front can only be wood.</p>
R Reff	1. <i>Interior options:</i> W = Wood Interior Cabinets with wood interior, the shelves come in the same finish as the case.	
C Cabinet	2. <i>Lock options Files:</i> L = Lock hole drilled (not optional)	
8 86" high	3. <i>Lock finish:</i> B = Black S = Matte silver	
3 30" wide	4. <i>Pull Options:</i> B = No pull, No Drilling, Customer's own Pull C = C-Pull, (Nickel finish only) D = D - Pull (PZ or PT) F = Bar Pull H = Outline Pull J = J (Routed) Pull R = Cylinder Pull S = S Pull (Stainless Steel Finish only) T = Tab Pull.	
2 20" deep, 3 = 24" deep	5. <i>Pull finish:</i> Painted or Plated	
DH Desk Height	6. <i>Case Finish:</i> Wood or Laminate	
K Open Shelves with 2 File drawers	7. <i>Front Finish:</i> Wood or Laminate	
2 Finish Type: 2		
W Wood Interior		
L Lock Option, files		
B Lock finish		
T Pull option		
111 Pull finish		
V316 Case Finish: Maple		
V316 Front Finish: Maple		
K = Open shelves and 2 file drawers		
O = Open shelves and 4 file drawers		

Cabinets, 28³/₈" planning

72" high, wood interiors

Hinge doors and file drawers

description	w	d	pattern no.	L	L/V1	L/V2	L/V3	V1	V2	V3
Storage w/4 file drwrs & hinged doors above 72" high, (for desk height planning)	30"	20"	RC7232DHFH () () () () () ()	\$3,553.	\$4,106.	\$4,383.	\$4,660.	\$4,936.	\$5,567.	\$7,514.
	30"	24"	RC7233DHFH () () () () () ()	3,932.	4,544.	4,849.	5,156.	5,461.	6,156.	8,311.
	36"	20"	RC7262DHFH () () () () () ()	3,909.	4,520.	4,825.	5,130.	5,436.	6,141.	8,290.
	36"	24"	RC7263DHFH () () () () () ()	4,320.	4,995.	5,332.	5,669.	6,007.	6,775.	9,148.

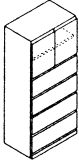

Order Code

Example:	RC7232DHFH
R	Reff
C	Cabinet
72	72 1/2" high
3	30" wide
2	20" deep
DH	Desk Height
F	Storage with Hinge Door with 4 file drawers
H	Wood hinge doors
L	Case Finish Type: Laminate
2	Front Finish type, V2
W	Wood Interior
T	Tab pull Option
L	Lock option, files
N	Lock option, doors
118	Case Finish
V316	Front Finish
111	Pull Finish

- K** = Hinge door cabinet with 4 file drawers
- G** = Hinge door cabinet with FF

Specification Information

- To order, please specify pattern number including:
- Case Finish Type:** L = Laminate
1 = V1
2 = V2
3 = V3
 - Front Finish Type:** L = Laminate
1 = V1
2 = V2
3 = V3
 - Interior options:** W = Wood interior
 - Pull Options:** B = No pull, No Drilling, Customer's own Pull
C = Nickel finish C-pull (nickel finish only)
D = Metal D-Pull (finish optional)
F = Bar Pull
H = Outline Pull
J = routed J-pull (finish matches case)
R = Cylinder Pull
S = S Pull (Stainless Steel Finish only)
T = Tab Pull
 - Lock Option files:** L = Lock hole drilled
Drawers are always drilled for lock. Not optional.
 - Lock option Doors:** L = Lock hole drilled
N = No lock drilling
 - Lock Finish:** B = Black
S = Matte Silver
 - Cabinet Case Finish:** Wood or Laminate
 - Front Finish:** Wood or Laminate
 - Pull Finish:** Painted and Plated

Application Notes

- It is Not advisable to mix 28³/₈"h desk height products with 26¹/₂" standard height products.**
- Product on this page **Excluding J-pull option and any vertical surface over 60"**, will accept wood grain laminate, where laminate is currently an option.
- Hinge door cabinets have optional lock drilling which can be specified in the cabinet product code. Keying instructions must accompany all cabinet orders.
- Drawers are always drilled for locks.
- Cabinets do not come with lock included.
- Keying instructions must accompany all cabinet orders.
- After specifying product code, provide keying instructions. Refer to page 482 for keying instructions.
- * If case is Laminate, the front can be laminate or wood.
 - * If case is Wood, the front can only be wood.
- Please note: Shelf adjustability is limited to approximately 2.5" up or down per shelf from predetermined shelf height.
- * File drawers include file bars for front to back and side to side filing. File drawers do not support bottom loading.

Cabinets, 28³/₈" planning 72" high, wood interiors Hinge doors and file drawers

description	w	d	pattern no.	L	L/V1	L/V2	L/V3	V1	V2	V3
Storage w/upper hinged doors & 2 adj shelves, 72" high, bottom 2 file drawers (for desk height planning)	16"	20"	RC7212DHGH(L/R) () () () () () ()	\$2,624.	\$3,034.	\$3,238.	\$3,443.	\$3,648.	\$4,112.	\$5,549.
	16"	24"	RC7213DHGH(L/R) () () () () () ()	2,894.	3,345.	3,570.	3,796.	4,021.	4,532.	6,118.
	30"	20"	RC7232DHGH () () () () () ()	3,292.	3,803.	4,059.	4,314.	4,569.	5,153.	6,958.
	30"	24"	RC7233DHGH () () () () () ()	3,600.	4,163.	4,443.	4,725.	5,006.	5,642.	7,617.
	36"	20"	RC7262DHGH () () () () () ()	3,560.	4,115.	4,392.	4,670.	4,948.	5,577.	7,530.
	36"	24"	RC7263DHGH () () () () () ()	3,875.	4,478.	4,781.	5,082.	5,384.	6,070.	8,193.

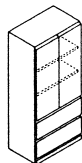

Order Code	Specification Information
Example: RC7232DHFH	
R	Reff
C	Cabinet
72	72 1/2" high
3	30" wide
2	20" deep
DH	Desk Height
F	Storage with Hinge Door with 4 file drawers
H	Wood hinge doors
L	Case Finish Type: Laminate
2	Front Finish type, V2
W	Wood Interior
T	Tab pull Option
L	Lock option, files
N	Lock option, doors
118	Case Finish
V316	Front Finish
111	Pull Finish

- K** = Hinge door cabinet with 4 file drawers
- G** = Hinge door cabinet with FF

- Specification Information**
- To order, please specify pattern number including:*
- Case Finish Type:** L = Laminate
1 = V1
2 = V2
3 = V3
 - Front Finish Type:** L = Laminate
1 = V1
2 = V2
3 = V3
 - Interior options:** W = Wood interior
 - Pull Options:** B = No pull, No Drilling, Customer's own Pull
C = Nickel finish C-pull (nickel finish only)
D = Metal D-Pull (finish optional)
F = Bar Pull
H = Outline Pull
J = routed J-pull (finish matches case)
R = Cylinder Pull
S = S Pull (Stainless Steel Finish only)
T = Tab Pull
 - Lock Option files:** L = Lock hole drilled
Drawers are always drilled for lock. Not optional.
 - Lock option Doors:** L = Lock hole drilled
N = No lock drilling
 - Lock Finish:** B = Black
S = Matte Silver
 - Cabinet Case Finish:** Wood or Laminate
 - Front Finish:** Wood or Laminate
 - Pull Finish:** Painted and Plated

- Application Notes**
- It is Not advisable to mix 28³/₈"h desk height products with 26¹/₂" standard height products.**
- Product on this page **Excluding J-pull option and any vertical surface over 60"**, will accept wood grain laminate, where laminate is currently an option.
- Hinge door cabinets have optional lock drilling which can be specified in the cabinet product code. Keying instructions must accompany all cabinet orders.
- Drawers are always drilled for locks.
- Cabinets do not come with lock included.
- Keying instructions must accompany all cabinet orders.
- After specifying product code, provide keying instructions. Refer to page 482 for keying instructions.
- * If case is Laminate, the front can be laminate or wood.
 - * If case is Wood, the front can only be wood.
- Please note: Shelf adjustability is limited to approximately 2.5" up or down per shelf from predetermined shelf height.
- * File drawers include file bars for front to back and side to side filing. File drawers do not support bottom loading.

Cabinets, 28³/₈" planning

72" high, wood interiors

Hinge doors and Box/Box/File

description	w	d	pattern no.	L	L/V1	L/V2	L/V3	V1	V2	V3
Storage, 72" high, w/upper hinged doors & 2 adj shelves, bottom box/box/file (for desk height planning)	16"	20"	RC7212DHPH(L/R) () () () ()	\$2,717.	\$3,141.	\$3,352.	\$3,564.	\$3,775.	\$4,258.	\$5,750.
	16"	24"	RC7213DHPH(L/R) () () () ()	2,982.	3,447.	3,679.	3,911.	4,144.	4,671.	6,308.



Left hand shown

Order Code	Specification Information	Application Notes
Example: RC7212DHPH (L/R)	<i>To order, please specify pattern number including:</i>	It is Not advisable to mix 28³/₈"h desk height products with 26¹/₂" standard height products.
R Ref	1. <i>Interior options:</i> W = Wood	File drawers include file bars for front to back and side to side filing.
C Cabinet	2. <i>Lock Option Doors:</i> L = Lock hole drilled N = No lock drilling Drawers are always drilled for lock. Not optional.	File drawers do not support bottom loading.
72 72 ¹ / ₂ " high	3. <i>Lock Finish:</i> B = Black S = Matte Silver	Product on this page Excluding J-pull option and any vertical surface over 60" , will accept wood grain laminate, where laminate is currently an option.
1 16" wide	4. <i>Pull Options:</i> B = No pull, No Drilling, Customer's own Pull C = Nickel finish C-pull (nickel finish only) D = Metal D-pull (finish optional) F = Bar Pull (1 pull per door set) H = Outline Pull JN = rounded J-pull on drawers and Touch latch on Hinge doors (finish matches case) R = Cylinder Pull S = S Pull (Stainless Steel Finish only) T = Tab Pull (1 pull per door set)	Hinge door cabinets have optional lock drilling which can be specified in the cabinet product code. Keying instructions must accompany all cabinet orders.
2 20" deep	5. <i>Pull Finish:</i> Painted and Plated	Drawers are always drilled for locks.
DH Desk Height	6. <i>Case Finish:</i> Wood or Laminate	After specifying product code, provide keying instructions. Refer to page 482 for keying instructions.
P Storage with Hinge Door with Box/Box/File	7. <i>Front Finish:</i> Wood or Laminate	* If case is Laminate, the front can be laminate or wood. * If case is Wood, the front can only be wood.
H Wood hinge doors		
W Wood Interior		
T Tab pull option		
L Lock option, files		
N Lock option, doors		
118 Case Finish		
V316 Front Finish		
B Lock Finish		
111 Pull Finish		

P = Hinge door cabinet with Box/Box/File

Cabinets, 28³/₈" planning 72" high, wood interiors Hinge doors and wardrobe

description	w	d	pattern no.	L	L/V1	L/V2	L/V3	V1	V2	V3
Wardrobe/bookcase combo 72" high, w/full height doors (for desk height planning)	30"	20"	RC7232DHEH(L/R) () () () () ()	\$3,500.	\$4,047.	\$4,319.	\$4,593.	\$4,866.	\$5,486.	\$7,406.
	30"	24"	RC7233DHEH(L/R) () () () () ()	3,896.	4,505.	4,808.	5,113.	5,417.	6,108.	8,244.
	36"	20"	RC7262DHEH(L/R) () () () () ()	3,823.	4,420.	4,717.	5,015.	5,314.	5,992.	8,090.
	36"	24"	RC7263DHEH(L/R) () () () () ()	4,254.	4,916.	5,248.	5,579.	5,910.	6,665.	8,997.

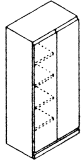

Left hand shown

Coat rod included.
Requires one lock core per cabinet.
Shelves painted metal
Shelves determine (L/R) hand.

Order Code	Specification Information	Application Notes
Example: RC7232DHEH (L/R)	<i>To order, please specify pattern number including:</i>	<p>It is Not advisable to mix 28³/₈"h desk height products with 26¹/₂" standard height products.</p> <p>Product on this page Excluding J-pull option and any vertical surface over 60", will accept wood grain laminate, where laminate is currently an option.</p> <p>Hinge door cabinets have optional lock drilling which can be specified in the cabinet product code. Keying instructions must accompany all cabinet orders.</p> <p>After specifying product code, provide keying instructions. Refer to page 482 for keying instructions.</p> <p>* If case is Laminate, the front can be laminate or wood. * If case is Wood, the front can only be wood.</p>
R Reff	1. <i>Hinge Location, where applicable:</i> L = Left hand R = Right hand	
C Cabinet	2. <i>Case Finish type:</i> L = Laminate 1 = V1 2 = V2 3 = V3	
72 72 ¹ / ₂ " high	3. <i>Front Finish type:</i> L = Laminate 1 = V1 2 = V2 3 = V3	
3 30" wide	4. <i>Interior options:</i> W = Wood Interior	
2 20" deep	5. <i>Pull Options:</i> B = No pull, No Drilling, Customer's own Pull C = Nickel finish C-pull D = Metal D-pull F = Bar Pull (1 pull per door set) H = Outline Pull N = No pulls, Touch latch R = Cylinder Pull S = S-pull (Stainless Steel Finish only) T = Tab Pull (1 pull per door set)	
DH Desk Height	6. <i>Lock Option Doors:</i> L = Lock hole drilled N = No lock drilling	
E Wardrobe / Bookcase combo	7. <i>Lock Finish:</i> B = Black S = Matte Silver	
H Wood hinge doors	8. <i>Cabinet Case Finish:</i> Wood or Laminate	
L Left hand	9. <i>Front Finish:</i> Wood or Laminate	
L Case Finish Type: Laminate	10. <i>Pull Finish:</i> Painted or Plated	
2 Front Finish type: V2		
W Wood Interior		
T Tab pull option		
N Lock option, doors		
B Lock Finish		
118 Case Finish		
V316 Front Finish		
111 Pull Finish		

E = Hinge door cabinet with full height doors, half wardrobe and shelves.
D = Wardrobe cabinet

Cabinets, 28³/₈" planning
72" high, wood interiors
Hinge doors and wardrobe

description	w	d	pattern no.	L	L/V1	L/V2	L/V3	V1	V2	V3
Wardrobe cabinet 72" high (for desk height planning)	12"	20"	RC7202DHDH(L/R)() () () ()	\$1,731.	\$2,025.	\$2,173.	\$2,320.	\$2,467.	\$2,800.	\$3,835.
	12"	24"	RC7203DHDH(L/R)() () () ()	1,782.	2,077.	2,224.	2,371.	2,518.	2,852.	3,886.
	16"	20"	RC7212DHDH(L/R)() () () ()	1,963.	2,270.	2,423.	2,577.	2,731.	3,079.	4,155.
	16"	24"	RC7213DHDH(L/R)() () () ()	2,161.	2,498.	2,667.	2,835.	3,004.	3,385.	4,569.
	19"	20"	RC7222DHDH(L/R)() () () ()	2,201.	2,573.	2,759.	2,945.	3,131.	3,528.	4,927.
	19"	24"	RC7223DHDH(L/R)() () () ()	2,231.	2,623.	2,820.	3,016.	3,211.	3,658.	5,089.
	30"	20"	RC7232DHDH() () () ()	2,473.	2,859.	3,052.	3,245.	3,438.	3,872.	5,229.
	30"	24"	RC7233DHDH() () () ()	2,717.	3,141.	3,352.	3,564.	3,775.	4,258.	5,750.
	36"	20"	RC7262DHDH() () () ()	2,718.	3,143.	3,355.	3,567.	3,779.	4,261.	5,754.
	36"	24"	RC7263DHDH() () () ()	2,989.	3,454.	3,688.	3,921.	4,153.	4,684.	6,322.

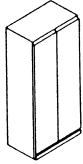

Wood interior only

Coat rod included. Order boot tray from accessories
Requires one lock core per cabinet.
Wood interior only

Order Code	Specification Information	Application Notes
Example: RC7232DHEH (L/R)	<i>To order, please specify pattern number including:</i>	<p>Please note: Shelf adjustability is limited to approximately 2.5" up or down per shelf from predetermined shelf height.</p> <p>* Note: 72" high Wardrobe cabinets do not come equipped with boot tray. Please specify separately. See page 417. 20" deep Wardrobe Cabinets provide only 18" of clear storage space.</p> <p>Product on this page Excluding J-pull option and any vertical surface over 60", will accept wood grain laminate, where laminate is currently an option.</p> <p>Hinge door cabinets have optional lock drilling which can be specified in the cabinet product code. Keying instructions must accompany all cabinet orders.</p> <p>After specifying product code, provide keying instructions. Refer to page 482 for keying instructions.</p> <p>* If case is Laminate, the front can be laminate or wood. * If case is Wood, the front can only be wood.</p>
R Reff	1. <i>Hinge Location, where applicable:</i> L = Left hand R = Right hand	
C Cabinet	2. <i>Case Finish type:</i> L = Laminate 1 = V1 2 = V2 3 = V3	
72 72 1/2" high	3. <i>Front Finish type:</i> L = Laminate 1 = V1 2 = V2 3 = V3	
3 30" wide	4. <i>Interior options:</i> W = Wood Interior	
2 20" deep	5. <i>Pull Options:</i> B = No pull, No Drilling, Customer's own Pull C = Nickel finish C-pull D = Metal D-pull F = Bar Pull (1 pull per door set) H = Outline Pull N = No pulls, Touch latch R = Cylinder Pull S = S-pull (Stainless Steel Finish only) T = Tab Pull (1 pull per door set)	
DH Desk Height	6. <i>Lock Option Doors:</i> L = Lock hole drilled N = No lock drilling	
E Wardrobe / Bookcase combo	7. <i>Lock Finish:</i> B = Black S = Matte Silver	
H Wood hinge doors	8. <i>Cabinet Case Finish:</i> Wood or Laminate	
L Left hand	9. <i>Front Finish:</i> Wood or Laminate	
L Case Finish Type: Laminate	10. <i>Pull Finish:</i> Painted or Plated	
2 Front Finish type: V2		
W Wood Interior		
T Tab pull option		
N Lock option, doors		
B Lock Finish		
118 Case Finish		
V316 Front Finish		
111 Pull Finish		

E = Hinge door cabinet with full height doors, half wardrobe and shelves.
D = Wardrobe cabinet

Cabinets, 28³/₈" planning
72" high, wood interiors
Wardrobe Combo with *BBF* and *FF*

description	w	d	pattern no.	L	L/V1	L/V2	L/V3	V1	V2	V3
Wardrobe 72" high, with 1/2 height hinged door & box/box/file Cabinet	30"	20"	RC7232DHPHW(L/R) () () () () ()	\$4,188.	\$5,007.	\$5,417.	\$5,826.	\$6,236.	\$7,033.	\$9,493.
	30"	24"	RC7233DHPHW(L/R) () () () () ()	4,342.	5,192.	5,617.	6,041.	6,467.	7,291.	9,842.
	36"	20"	RC7262DHPHW(L/R) () () () () ()	4,309.	5,153.	5,574.	5,996.	6,418.	7,234.	9,766.
	36"	24"	RC7263DHPHW(L/R) () () () () ()	4,466.	5,340.	5,777.	6,215.	6,651.	7,498.	10,123.

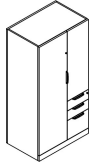

Left hand shown

Wardrobe determines (L/R) hand

Wardrobe 72" high, with 1/2 height hinged door & file/file Cabinet	30"	20"	RC7232DHGHW(L/R) () () () () ()	3,930.	4,699.	5,084.	5,468.	5,853.	6,600.	8,908.
	30"	24"	RC7233DHGHW(L/R) () () () () ()	4,076.	4,874.	5,273.	5,671.	6,070.	6,845.	9,240.
	36"	20"	RC7262DHGHW(L/R) () () () () ()	4,051.	4,844.	5,240.	5,636.	6,033.	6,802.	9,076.
	36"	24"	RC7263DHGHW(L/R) () () () () ()	4,200.	5,023.	5,434.	5,845.	6,256.	7,053.	9,520.

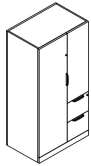

Left hand shown

Wardrobe determines (L/R) hand

Order Code	Specification Information	Application Notes
Example: RC7232DHPHW (L/R)	<i>To order, please specify pattern number including:</i>	It is Not advisable to mix 28³/₈"h desk height products with 26¹/₂" standard height products.
R Reff	1. <i>Interior options:</i> W = Wood Interior	The Wardrobe Cabinets on this page come equipped with a coat rod.
C Cabinet	2. <i>Lock Options Doors:</i> L = Lock hold drilled N = No lock drilling Drawers are always drilled for lock. Not optional	The 1/2 height hinge door comes with touch latch only and is non locking. It also comes with 2 adjustable shelves.
72 72 ¹ / ₂ " high	3. <i>Lock Finish:</i> B = Black S = Matte Silver	Please note: Shelf adjustability is limited to approximately 2.5" up or down per shelf from predetermined shelf height.
3 30" wide	4. <i>Pull Options:</i> B = No pull, No Drilling, Customer's own Pull C = Nickel finish C-pull (nickel finish only) D = Metal D-pull (finish optional) F = Bar Pull (1 pull per door set) H = Outline Pull JN = Routed J-pull on drawers and touch latch on Hinge doors (finish matches case) R = Cylinder Pull S = S Pull (Stainless Steel Finish only) T = Tab Pull (1 pull per door set)	File drawers include file bars for front to back and side to side filing. File drawers do not support bottom loading.
2 20" deep	5. <i>Pull Finish:</i> Painted or Plated	
DH Desk Height	6. <i>Case Finish:</i> Wood or Laminate	
PHW Box/Box/File Wardrobe combo GHW = FF Wardrobe combo	7. <i>Front Finish:</i> Wood or Laminate	
L/R Left or Right hand		
W Wood Interior		
L Lock option, doors		
111 Lock Finish		
T Pull option		
111 Pull Finish		
118 Cabinet Finish		

Cabinets, 28³/₈" planning
86" high, metal interiors
Bookcase

description	w	d	pattern no.	L	L/V1	L/V2	L/V3	V1	V2	V3
Cabinet, 86" high, with shelving	30"	15"	RC831DHB () ()	\$2,334.	n/a	n/a	n/a	\$3,197.	\$3,680.	\$5,440.
	36"	15"	RC861DHB () ()	2,655.	n/a	n/a	n/a	3,616.	4,160.	6,148.

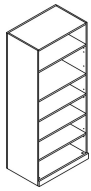

Order Code

Example:	RC831DHB () ()
R	Reff
C	Cabinet
8	86" high, Actual height
3	30" wide
1	15" deep
DH	Desk Height
B	Open Bookcase
2	Finish Type: V2
M	Metal Interior
V316	Cabinet Finish: Maple

Specification Information

To order, please specify pattern number including:

- Finish Type:**
L = Laminate
1 = V1
2 = V2
3 = V3
- Interior Options:**
M = Metal Interior
Cabinets with metal interior, the shelves are in painted metal.
For laminate cases, the shelves are painted to match ie. 114 case = 114 painted shelves.
For wood cases, the shelves are painted black ie. V316 case = black shelves.
- Cabinet Finish:** Wood or Laminate

Application Notes

It is Not advisable to mix 28³/₈" desk height products with 26¹/₂" standard height products.

Product on this page **Excluding J-pull option and any vertical surface over 60"**, will accept wood grain laminate, where laminate is currently an option.

Anchor brackets are included for 15" deep bookcases.

Please note: Shelf adjustability is limited to approximately 2.5" up or down per shelf from predetermined shelf height.

Cabinets, 28³/₈" planning
86" high, metal interiors
Bookcase and file drawers

description	w	d	pattern no.	L	L/V1	L/V2	L/V3	V1	V2	V3
Cabinet, 86" high, double high with file/file below, top open with one adjustable shelf	30"	20"	RC832DHK() () () () ()	\$3,508.	\$4,057.	\$4,332.	\$4,606.	\$4,881.	\$5,523.	\$7,455.
	30"	24"	RC833DHK() () () () ()	3,868.	4,471.	4,773.	5,075.	5,376.	6,086.	8,216.
	36"	20"	RC862DHK() () () () ()	3,815.	4,413.	4,712.	5,010.	5,310.	6,013.	8,117.
	36"	24"	RC863DHK() () () () ()	4,180.	4,834.	5,160.	5,487.	5,814.	6,579.	8,882.

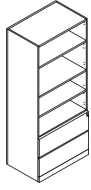

Cabinet, 86" high, double high with 4 files below, top open with one adjustable shelf	30"	20"	RC832DHO() () () () ()	3,735.	4,342.	4,644.	4,948.	5,251.	5,953.	8,105.
	30"	24"	RC833DHO() () () () ()	4,170.	4,843.	5,180.	5,517.	5,854.	6,634.	9,026.
	36"	20"	RC862DHO() () () () ()	4,146.	4,818.	5,153.	5,489.	5,824.	6,597.	8,975.
	36"	24"	RC863DHO() () () () ()	4,625.	5,369.	5,742.	6,114.	6,486.	7,345.	9,986.

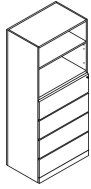

Order Code	Specification Information	Application Notes
Example: RC832DHK() () () () ()	<i>To order, please specify pattern number including:</i>	<p>Cabinets on this page are engineered to align with front sets of 28³/₈"h pedestals and are intended for "desk height" planning application. Do not mix products from 26 1/2" h (standard ht.) planning model with 28 3/8" h (desk height) planning model in any one configuration.</p> <p>Please note: Shelf adjustability is limited to approximately 2.5" up or down per shelf from predetermined shelf height.</p> <p>* File drawers include file bars for front to back and side to side filing. File drawers do not support bottom loading.</p>
R Reff		
C Cabinet		
8 86" high , Actual height		
3 30" wide		
2 20" deep, 3 = 24" deep		
DH Desk Height		
K Open Shelves with 2 File drawers		
2 Finish Type: 2		
M Metal Interior		
T Pull Option		
L Lock Option, files		
V316 Case Finish: Maple		
V316 Front Finish: Maple		
111 Pull Finish		
K = Open shelves and 2 file drawers		
O = Open shelves and 4 file drawers		
	<p>1. <i>Finish type:</i> L = Laminate 1 = V1 2 = V2 3 = V3</p> <p>2. <i>Interior options:</i> M = Metal Interior Cabinets with metal interior, the shelves come in painted metal. For laminate cases, the shelves are painted to match ie. 114 case = 114 painted shelves. For wood cases, the shelves are painted black ie. V316 case = black shelves.</p> <p>3. <i>Pull Options:</i> B = No pull, No Drilling, Customer's own Pull C = C-Pull, (Nickel finish only) D = D - Pull (PZ or PT) F = Bar Pull H = Outline Pull J = J (Routed) Pull R = Cylinder Pull S = S Pull (Stainless Steel Finish only) T = Tab Pull.</p> <p>4. <i>Lock options Files:</i> L = Lock hole drilled (not optional)</p> <p>5. <i>Case Finish:</i> Wood or Laminate</p> <p>6. <i>Pull Finish:</i> Painted or Plated</p> <p>7. <i>Front Finish:</i> Wood or Laminate</p>	
	<p>It is Not advisable to mix 28³/₈"h desk height products with 26 1/2" standard height products.</p> <p>Product on this page Excluding J-pull option and any vertical surface over 60", will accept wood grain laminate, where laminate is currently an option.</p> <p>Drawers are always drilled for lock.</p> <p>After specifying product code, provide keying instructions. Refer to page 482 for keying instructions.</p> <p>* If case is Laminate, the front can be laminate or wood. * If case is Wood, the front can only be wood.</p>	

Cabinets, 28³/₈" planning 86" high, metal interiors Hinge doors and file drawers

description	w	d	pattern no.	L	L/V1	L/V2	L/V3	V1	V2	V3
Cabinet, 86" high, hinged doors/ shelves 4 file drawers	30"	20"	RC832DHF () () (L) () () ()	\$3,925.	\$4,537.	\$4,842.	\$5,149.	\$5,454.	\$6,152.	\$8,304.
	30"	24"	RC833DHF () () (L) () () ()	4,359.	5,039.	5,378.	5,718.	6,058.	6,832.	9,223.
	36"	20"	RC862DHF () () (L) () () ()	4,336.	5,012.	5,352.	5,690.	6,027.	6,795.	9,173.
	36"	24"	RC863DHF () () (L) () () ()	4,815.	5,565.	5,940.	6,314.	6,689.	7,543.	10,183.

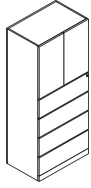

Order Code	Specification Information	Application Notes
Example: RC832DHF () () (L) () () ()	<i>To order, please specify pattern number including:</i>	It is Not advisable to mix 28³/₈"h desk height products with 26¹/₂" standard height products.
R Reff		Please note: Shelf adjustability is limited to approximately 2.5" up or down per shelf from predetermined shelf height.
C Cabinet	1. <i>Case Finish type:</i>	File drawers include file bars for front to back and side to side filing. File drawers do not support bottom loading.
8 86" high, Actual height	L = Laminate	
3 30" wide	1 = V1	
2 20" deep	2 = V2	
DH Desk Height	3 = V3	
F Storage with Hinge Door with 4 file drawers	2. <i>Front Finish Type:</i>	Hinge door cabinets have optional lock drilling which can be specified in the cabinet product code. Keying instructions must accompany all cabinet orders.
L Case Finish Type: Laminate	L = Laminate	Drawers are always drilled for locks.
2 Front finish type : V2	1 = V1	After specifying product code, provide keying instructions. Refer to page482 for keying instructions.
M Metal Interior	2 = V2	* If case is Laminate, the front can be laminate or wood.
T Tab pull option	3 = V3	* If case is Wood, the front can only be wood.
L Lock option, files	3. <i>Interior options:</i>	
N Lock option, doors	M = Metal Interior	
B Lock Finish	Cabinets with metal interior, the shelves come in painted metal.	
118 Case Finish	For laminate cases, the shelves are painted to match ie. 114 case = 114 painted shelves.	
V316 Front Finish	For wood cases, the shelves are painted black ie. V316 case = black shelves.	
111 Pull Finish	4. <i>Pull Options:</i>	
	B = No pull, No Drilling,	
	Customer's own Pull	
	C = C-Pull, (Nickel finish only)	
	D = D - Pull (PZ or PT only)	
	F = Bar Pull (1 pull per door set)	
	H = Outline Pull	
	JN = J (Routed) Pull on drawers,	
	Touch latch on hinge doors	
	R = Cylinder Pull	
	S = S Pull	
	(Stainless Steel Finish only)	
	T = Tab Pull (1 pull per door set)	
	5. <i>Lock options Files:</i>	
	L = Lock hole drilled (not optional)	
	6. <i>Lock Option Doors:</i>	
	L = Lock hole drilled	
	N = No lock drilling	
	7. <i>Lock Finish:</i>	
	B = Black	
	S = Matte Silver	
	8. <i>Case Finish:</i>	
	Wood or Laminate	
	9. <i>Front Finish:</i>	
	Wood or Laminate	
	10. <i>Pull Finish:</i>	
	Painted or Plated	

F = Hinge door cabinet with 4 file drawers

G = Hinge door cabinet with FF

P = Hinge door cabinet with BBF

Cabinets, 28³/₈" planning 86" high, metal interiors Hinge doors and file drawers

description	w	d	pattern no.	L	L/V1	L/V2	L/V3	V1	V2	V3
Cabinet, 86" high, hinged doors/ shelves 2 file drawers	16"	20"	RC812DHGH(L/R)() () () ()	\$3,107.	\$3,766.	\$4,096.	\$4,425.	\$4,755.	\$5,320.	\$6,659.
	16"	24"	RC813DHGH(L/R)() () () ()	3,187.	3,865.	4,204.	4,543.	4,882.	5,490.	6,991.
	30"	20"	RC832DHG() () (L)() () ()	3,622.	4,186.	4,467.	4,749.	5,031.	5,671.	7,658.
	30"	24"	RC833DHG() () (L)() () ()	3,982.	4,601.	4,912.	5,221.	5,531.	6,238.	8,419.
	36"	20"	RC862DHG() () (L)() () ()	3,930.	4,543.	4,848.	5,155.	5,461.	6,160.	8,321.
	36"	24"	RC863DHG() () (L)() () ()	4,294.	4,963.	5,298.	5,632.	5,968.	6,728.	9,086.

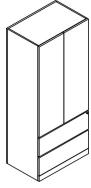

Coat rod included.

Order Code	Specification Information	Application Notes
Example: RC832DHF() () (L)() () ()	<i>To order, please specify pattern number including:</i>	It is Not advisable to mix 28³/₈"h desk height products with 26¹/₂" standard height products.
R Reff	1. <i>Case Finish type:</i> L = Laminate 1 = V1 2 = V2 3 = V3	Product on this page Excluding J-pull option and any vertical surface over 60" , will accept wood grain laminate, where laminate is currently an option.
C Cabinet	2. <i>Front Finish Type:</i> L = Laminate 1 = V1 2 = V2 3 = V3	Hinge door cabinets have optional lock drilling which can be specified in the cabinet product code. Keying instructions must accompany all cabinet orders.
8 86" high, Actual height	3. <i>Interior options:</i> M = Metal Interior Cabinets with metal interior, the shelves come in painted metal. For laminate cases, the shelves are painted to match ie. 114 case = 114 painted shelves. For wood cases, the shelves are painted black ie. V316 case = black shelves.	Drawers are always drilled for locks.
3 30" wide	4. <i>Pull Options:</i> B = No pull, No Drilling, Customer's own Pull C = C-Pull, (Nickel finish only) D = D - Pull (PZ or PT only) F = Bar Pull (1 pull per door set) H = Outline Pull JN = J (Routed) Pull on drawers, Touch latch on hinge doors R = Cylinder Pull S = S Pull (Stainless Steel Finish only) T = Tab Pull (1 pull per door set)	After specifying product code, provide keying instructions. Refer to page482 for keying instructions.
2 20" deep	5. <i>Lock options Files:</i> L = Lock hole drilled (not optional)	* If case is Laminate, the front can be laminate or wood. * If case is Wood, the front can only be wood.
DH Desk Height	6. <i>Lock Option Doors:</i> L = Lock hole drilled N = No lock drilling	
F Storage with Hinge Door with 4 file drawers	7. <i>Lock Finish:</i> B = Black S = Matte Silver	
L Case Finish Type: Laminate	8. <i>Case Finish:</i> Wood or Laminate	
2 Front finish type : V2	9. <i>Front Finish:</i> Wood or Laminate	
M Metal Interior	10. <i>Pull Finish:</i> Painted or Plated	
T Tab pull option		
L Lock option, files		
N Lock option, doors		
B Lock Finish		
118 Case Finish		
V316 Front Finish		
111 Pull Finish		

F = Hinge door cabinet with 4 file drawers
G = Hinge door cabinet with FF
P = Hinge door cabinet with BBF

Cabinets, 28³/₈" planning

86" high, metal interiors

Hinge doors and Box box file drawers

description	w	d	pattern no.	L	L/V1	L/V2	L/V3	V1	V2	V3
Cabinet, 86" high, hinged doors shelve Box box	16"	20"	RC812DHPH(L/R)() () ()	\$3,276.	\$3,939.	\$4,271.	\$4,602.	\$4,934.	\$5,508.	\$6,870.
file drawers	16"	24"	RC813DHPH(L/R)() () ()	3,365.	4,048.	4,389.	4,730.	5,072.	5,688.	7,210.



Left hand shown

Coat rod included
Hinges determine (L/R) hand

Order Code	Specification Information	Application Notes
Example: RC812DHPH(L/R)() () ()	<i>To order, please specify pattern number including:</i>	It is Not advisable to mix 28³/₈"h desk height products with 26¹/₂" standard height products.
R Reff		Please note: Shelf adjustability is limited to approximately 2.5" up or down per shelf from predetermined shelf height.
C Cabinet		Product on this page Excluding J-pull option and any vertical surface over 60" , will accept wood grain laminate, where laminate is currently an option.
8 86" high, Actual height	1. <i>Interior options:</i> M = Metal Interior Cabinets with metal interior, the shelves come in painted metal. For laminate cases, the shelves are painted to match ie. 114 case = 114 painted shelves. For wood cases, the shelves are painted black ie. V316 case = black shelves.	Hinge door cabinets have optional lock drilling which can be specified in the cabinet product code. Keying instructions must accompany all cabinet orders.
3 30" wide	2. <i>Lock Option Doors:</i> L = Lock hole drilled N = No lock drilling	Drawers are always drilled for locks.
1 16" deep	3. <i>Lock Finish:</i> B = Black S = Matte Silver	After specifying product code, provide keying instructions. Refer to page482 for keying instructions.
DH Desk Height	4. <i>Pull Options:</i> B = No pull, No Drilling, Customer's own Pull C = C-Pull, (Nickel finish only) D = D - Pull (PZ or PT only) F = Bar Pull (1 pull per door set) H = Outline Pull JN = J (Routed) Pull on drawers, Touch latch on hinge doors R = Cylinder Pull S = S Pull (Stainless Steel Finish only) T = Tab Pull (1 pull per door set)	* If case is Laminate, the front can be laminate or wood. * If case is Wood, the front can only be wood.
P Hinge door with BBF	5. <i>Pull Finish:</i> Painted or Plated	
H Hinge door	6. <i>Case Finish:</i> Wood or Laminate	
M Metal Interior Option	7. <i>Front Finish:</i> Wood or Laminate	
L Lock option doors		
B Lock finish		
T Pull option		
111 Pull finish		
118 Case Finish		
V316 Front Finish		

F = Hinge door cabinet with 4 file drawers
G = Hinge door cabinet with FF
P = Hinge door cabinet with BBF

Cabinets, 28³/₈" planning 86" high, metal interiors Hinge doors with shelves and wardrobe

description	w	d	pattern no.	L	L/V1	L/V2	L/V3	V1	V2	V3
Cabinet, 86" high, wardrobe/ bookcase combo full height doors	30"	20"	RC832DHEH(L/R) () () () ()	\$3,654.	\$4,226.	\$4,511.	\$4,797.	\$5,083.	\$5,725.	\$7,729.
	30"	24"	RC833DHEH(L/R) () () () ()	4,051.	4,684.	5,001.	5,318.	5,634.	6,347.	8,570.
	36"	20"	RC862DHEH(L/R) () () () ()	3,978.	4,599.	4,909.	5,219.	5,530.	6,231.	8,414.
	36"	24"	RC863DHEH(L/R) () () () ()	4,405.	5,093.	5,438.	5,781.	6,125.	6,903.	9,321.

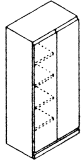

Left hand shown

Shelves determine (L/R) hand

Order Code

Example:	RC832DHEH (L/R)
R	Reff
C	Cabinet
8	86" high, Actual height
3	30" wide
2	20" deep
DH	Desk Height
E	Wardrobe / Bookcase combo
H	Wood hinge doors
(L/R)	Left hand or Right hand
L	Case Finish Type: Laminate
2	Front Finish Type: V2
M	Metal Interior
T	Tab pull option
N	Lock option, doors
B	Lock Finish
118	Case Finish
V316	Front Finish
111	Pull Finish

E = Hinge door cabinet with full height doors, half wardrobe and shelves

Specification Information

To order, please specify pattern number including:

- Hinge Location where applicable:**
L = Left hand
R = Right hand
- Case Finish type:**
L = Laminate
1 = V1
2 = V2
3 = V3
- Front Finish Type:**
L = Laminate
1 = V1
2 = V2
3 = V3
- Interior options:**
M = Metal Interior
Cabinets with metal interior, the shelves come in painted metal. For laminate cases, the shelves are painted to match ie. 114 case = 114 painted shelves. For wood cases, the shelves are painted black ie. V316 case = black shelves.
- Pull Options:**
B = No pull, No Drilling, Customer's own Pull
C = C-Pull, (Nickel finish only)
D = D-Pull (PZ or PT only)
F = Bar Pull (1 pull per door set)
H = Outline Pull
N = No pull, Touch Latch
R = Cylinder Pull
S = S Pull
(Stainless Steel Finish only)
T = Tab Pull (1 pull per door set)
- Lock Option Doors:**
L = Lock hole drilled
N = No lock drilling
- Lock Finish:**
B = Black
S = Matte Silver
- Case Finish:**
Wood or Laminate
- Front Finish:**
Wood or Laminate
- Pull Finish:**
Painted or Plated

It is Not advisable to mix 28³/₈"h desk height products with 26¹/₂" standard height products.

Product on this page **Excluding J-pull option and any vertical surface over 60"**, will accept wood grain laminate, where laminate is currently an option.

Hinge door cabinets have optional lock drilling which can be specified in the cabinet product code. Keying instructions must accompany all cabinet orders.

After specifying product code, provide keying instructions. Refer to page 482 for keying instructions.

- * If case is Laminate, the front can be laminate or wood.
- * If case is Wood, the front can only be wood.

Please note: Shelf adjustability is limited to approximately 2.5" up or down per shelf from predetermined shelf height

*Note:
86" high wardrobe cabinets come equipped with a coat rod.

20" deep wardrobe cabinets provide only 18" of clear storage space.

Cabinets, 28³/₈" planning
86" high, metal interiors
Wardrobe Combo with BBF and FF

description	w	d	pattern no.	L	L/V1	L/V2	L/V3	V1	V2	V3
Wardrobe 86" high, with 1/2 height hinged door & box/box/file Cabinet	30"	20"	RC832DHPHW(L/R) () () () () ()	\$3,877.	\$4,699.	\$5,109.	\$5,520.	\$5,931.	\$6,687.	\$9,362.
	30"	24"	RC833DHPHW(L/R) () () () () ()	4,048.	4,906.	5,335.	5,764.	6,193.	6,982.	9,775.
	36"	20"	RC862DHPHW(L/R) () () () () ()	4,031.	4,886.	5,314.	5,741.	6,168.	6,955.	9,735.
	36"	24"	RC863DHPHW(L/R) () () () () ()	4,207.	5,098.	5,544.	5,990.	6,436.	7,256.	10,159.

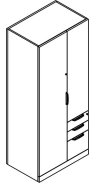

Left hand shown

Wardrobe 86" high, with 1/2 height hinged door & file/file Cabinet	30"	20"	RC832DHGHW(L/R) () () () () ()	3,735.	4,527.	4,923.	5,320.	5,715.	6,444.	9,022.
	30"	24"	RC833DHGHW(L/R) () () () () ()	3,895.	4,721.	5,133.	5,546.	5,959.	6,719.	9,406.
	36"	20"	RC862DHGHW(L/R) () () () () ()	3,891.	4,715.	5,128.	5,540.	5,952.	6,711.	9,396.
	36"	24"	RC863DHGHW(L/R) () () () () ()	4,054.	4,913.	5,343.	5,773.	6,202.	6,993.	9,789.

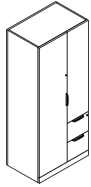

Left hand shown

Order Code	Specification Information	Application Notes
Example: RC822DHPHW (L/R)	<i>To order, please specify pattern number including:</i>	It is Not advisable to mix 28³/₈"h desk height products with 26¹/₂" standard height products.
R Reff	1. <i>Interior options:</i> M = Metal Interior	The Wardrobe Cabinets on this page come equipped with a coat rod and top shelf.
C Cabinet	2. <i>Lock Options Doors:</i> L = Lock hold drilled N = No lock drilling Drawers are always drilled for lock. Not optional	The 1/2 height hinge door comes with touch latch only and is non locking. It also comes with 2 adjustable shelves.
8 86" high	3. <i>Lock Finish:</i> B = Black S = Matte Silver	Please note: Shelf adjustability is limited to approximately 2.5" up or down per shelf from predetermined shelf height.
3 30" wide	4. <i>Pull Options:</i> B = No pull, No Drilling, Customer's own Pull C = Nickel finish C-pull (nickel finish only) D = Metal D-pull (finish optional) F = Bar Pull (1 pull per door set) H = Outline Pull JN = Routed J-pull on drawers and touch latch on Hinge doors (finish matches case) R = Cylinder Pull S = S Pull (Stainless Steel Finish only) T = Tab Pull (1 pull per door set)	File drawers include file bars for front to back and side to side filing. File drawers do not support bottom loading.
2 20" deep	5. <i>Pull Finish:</i> Painted or Plated	
DH Desk Height	6. <i>Case Finish:</i> Wood or Laminate	
PHW Box/Box/File Wardrobe combo GHW = FF Wardrobe combo	7. <i>Front Finish:</i> Wood or Laminate	
L/R Left or Right hand		
M Metal Interior		
L Lock option, doors		
111 Lock Finish		
T Pull option		
111 Pull Finish		
118 Case Finish		
V316 Front Finish		

Cabinets, 28³/₈" planning
86" high, wood interiors
Bookcase

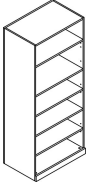
description	w	d	pattern no.	L	L/V1	L/V2	L/V3	V1	V2	V3
	30"	20"	RC832DHB () ()	\$2,555.	n/a	n/a	n/a	\$3,497.	\$4,025.	\$5,926.
	30"	24"	RC833DHB () ()	2,829.	n/a	n/a	n/a	3,854.	4,430.	6,523.
	36"	20"	RC862DHB () ()	2,885.	n/a	n/a	n/a	3,929.	4,520.	6,654.
	36"	24"	RC863DHB () ()	3,142.	n/a	n/a	n/a	4,283.	4,925.	7,254.

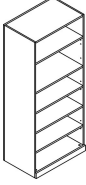
	30"	15"	RC831DHB () ()	2,478.	n/a	n/a	n/a	3,393.	3,903.	5,748.
	36"	15"	RC861DHB () ()	2,799.	n/a	n/a	n/a	3,811.	4,385.	6,454.

Order Code

Example:	RC831DHB () ()
R	Reff
C	Cabinet
8	86" high, Actual height
3	30" wide
1	15" deep, 2 = 20" deep, 3 = 24" deep
DH	Desk Height
B	Open Bookcase
2	Finish Type: V2
W	Wood Interior
V316	Cabinet Finish: Maple

Specification Information

To order, please specify pattern number including:

- Finish Type:*
L = Laminate
1 = V1
2 = V2
3 = V3
- Interior Options:*
W = Wood Interior
Cabinets with wood interior, the shelves come in the same finish as the case.
- Cabinet Finish:* Wood or Laminate

Application Notes

It is Not advisable to mix 28³/₈"h desk height products with 26¹/₂" standard height products.

Product on this page **Excluding J-pull option and any vertical surface over 60"**, will accept wood grain laminate, where laminate is currently an option.

Anchor brackets are included for 15" deep bookcases.

Please note: Shelf adjustability is limited to approximately 2.5" up or down per shelf from predetermined shelf height.

Cabinets, 28³/₈" planning
86" high, wood interiors
Bookcase and File drawers

description	w	d	pattern no.	L	L/V1	L/V2	L/V3	V1	V2	V3
Cabinet, 86" high, double high with file/file below, top open with one adjustable shelf	30"	20"	RC832DHK()	\$3,686.	\$4,262.	\$4,549.	\$4,837.	\$5,125.	\$5,802.	\$7,832.
	30"	24"	RC833DHK()	4,046.	4,678.	4,994.	5,311.	5,626.	6,369.	8,598.
	36"	20"	RC862DHK()	3,995.	4,622.	4,935.	5,248.	5,562.	6,292.	8,497.
	36"	24"	RC863DHK()	4,358.	5,041.	5,382.	5,724.	6,065.	6,859.	9,262.

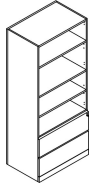

Cabinet, 86" high, double high with 4 files below, top open with one adjustable shelf	30"	20"	RC832DHO()	3,933.	4,567.	4,884.	5,202.	5,519.	6,253.	8,501.
	30"	24"	RC833DHO()	4,369.	5,072.	5,422.	5,774.	6,125.	6,932.	9,422.
	36"	20"	RC862DHO()	4,342.	5,042.	5,393.	5,742.	6,093.	6,917.	9,401.
	36"	24"	RC863DHO()	4,819.	5,591.	5,978.	6,364.	6,751.	7,647.	10,386.

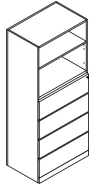

Order Code	Specification Information	Application Notes
Example: RC832DHK()	<i>To order, please specify pattern number including:</i>	It is Not advisable to mix 28³/₈" desk height products with 26¹/₂" standard height products.
R Reff	1. <i>Finish type:</i> L = Laminate 2 = V2 3 = V3	
C Cabinet	2. <i>Interior options:</i> W = Wood Interior	Product on this page Excluding J-pull option and any vertical surface over 60" , will accept wood grain laminate, where laminate is currently an option.
8 86" high	Cabinets with wood interior, the shelves come in the same finish as the case.	Drawers are always drilled for locks.
3 30" wide	3. <i>Pull Options:</i> B = No pull, No Drilling, Customer's own Pull C = C-Pull, (Nickel finish only) D = D - Pull (PZ or PT) F = Bar Pull H = Outline Pull J = J (Routed) Pull R = Cylinder Pull S = S Pull (Stainless Steel Finish only) T = Tab Pull.	Cabinets do not come with lock included.
2 20" deep, 3 = 24" deep		Keying instructions must accompany all cabinet orders.
DH Desk Height		After specifying product code, provide keying instructions. Refer to page 482 for keying instructions.
K Open Shelves with 2 File drawers		* If case is Laminate, the front can be laminate or wood. * If case is Wood, the front can only be wood.
2 Finish Type: 2	4. <i>Lock options Files:</i> L = Lock hole drilled (not optional)	
W Wood Interior	5. <i>Case Finish:</i> Wood or Laminate	
T Pull Option	6. <i>Front Finish:</i> Wood or Laminate	
L Lock Option, files	7. <i>Pull Finish:</i> Painted or Plated	
V316 Case Finish: Maple		
V316 Front Finish: Maple		
111 Pull Finish		
K = Open shelves and 2 file drawers		
O = Open shelves and 4 file drawers		

Cabinets, 28³/₈" planning

86" high, wood interiors

Hinge doors and file drawers

description	w	d	pattern no.	L	L/V1	L/V2	L/V3	V1	V2	V3
Cabinet, 86" high, hinged doors/ shelves 4 file drawers	30"	20"	RC832DHF () () (L) () ()	\$4,105.	\$4,744.	\$5,062.	\$5,382.	\$5,701.	\$6,431.	\$8,683.
	30"	24"	RC833DHF () () (L) () ()	4,541.	5,248.	5,603.	5,956.	6,310.	7,114.	9,602.
	36"	20"	RC862DHF () () (L) () ()	4,515.	5,219.	5,572.	5,923.	6,276.	7,096.	9,580.
	36"	24"	RC863DHF () () (L) () ()	4,991.	5,769.	6,158.	6,547.	6,936.	7,828.	10,534.

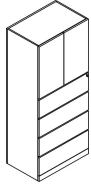

Cabinet, 86" high, hinged doors/ shelves 2 file drawers	16"	20"	RC812DHGH (L/R) () () ()	3,521.	4,229.	4,584.	4,937.	5,292.	5,882.	7,231.
	16"	24"	RC813DHGH (L/R) () () ()	3,610.	4,344.	4,712.	5,079.	5,446.	6,085.	7,603.
	30"	20"	RC832DHG () () (L) () ()	3,801.	4,522.	4,882.	5,243.	5,604.	6,309.	8,036.
	30"	24"	RC833DHG () () (L) () ()	4,160.	4,808.	5,133.	5,457.	5,781.	6,518.	8,798.
	36"	20"	RC862DHG () () (L) () ()	4,109.	4,751.	5,072.	5,393.	5,713.	6,441.	8,694.
	36"	24"	RC863DHG () () (L) () ()	4,474.	5,171.	5,521.	5,869.	6,218.	7,010.	9,465.

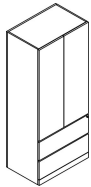

Coat rod included.

Order Code	Specification Information	Application Notes
Example: RC832DHF () () (L) () ()	<i>To order, please specify pattern number including:</i>	It is Not advisable to mix 28³/₈"h desk height products with 26¹/₂" standard height products.
R Reff	1. <i>Case Finish type:</i> L = Laminate 1 = V1 2 = V2 3 = V3	Please note: Shelf adjustability is limited to approximately 2.5" up or down per shelf from predetermined shelf height.
C Cabinet	2. <i>Front Finish type:</i> L = Laminate 1 = V1 2 = V2 3 = V3	Product on this page Excluding J-pull option and any vertical surface over 60" , will accept wood grain laminate, where laminate is currently an option.
8 86" high, Actual height	3. <i>Interior options:</i> W = Wood Interior	Hinge door cabinets have optional lock drilling which can be specified in the cabinet product code. Keying instructions must accompany all cabinet orders.
3 30" wide	4. <i>Pull Options:</i> B = No pull, No Drilling, Customer's own Pull C = C-Pull, (Nickel finish only) D = D - Pull (PZ or PT only) F = Bar Pull (1 pull per door set) H = Outline Pull JN = J (Routed) Pull on drawers, Touch latch on Hinge doors R = Cylinder Pull S = S Pull (Stainless Steel Finish only) T = Tab Pull (1 pull per door set)	File drawers include file bars for front to back and side to side filing. File drawers do not support bottom loading.
2 20" deep	5. <i>Lock options Files:</i> L = Lock hole drilled (not optional)	*Note: 86" high Wardrobe Cabinets do not come equipped with boot tray. Please specify separately. See page417. 20" deep Wardrobe Cabinets provide only 18" of clear storage space.
DH Desk Height	6. <i>Lock Option Doors:</i> L = Lock hole drilled N = No lock drilling	Drawers are always drilled for locks.
F Storage with Hinge Door with 4 file drawers	7. <i>Lock Finish:</i> B = Black S = Matte Silver	After specifying product code, provide keying instructions. Refer to page482 for keying instructions.
H Wood hinge doors	8. <i>Case Finish:</i> Wood or Laminate	* If case is Laminate, the front can be laminate or wood. * If case is Wood, the front can only be wood.
L Case Finish Type: Laminate	9. <i>Front Finish:</i> Wood or Laminate	
2 Front Finish Type: V2	10. <i>Pull Finish:</i> Painted or Plated	
W Wood Interior		
T Tab pull option		
L Lock option, files		
N Lock option, doors		
B Lock Finish		
118 Case Finish		
W316 Front Finish		
111 Pull Finish		

F = Hinge door cabinet with 4 file drawers
G = Hinge door cabinet with FF
P = Hinge door cabinet with BBF

Cabinets, 28³/₈" planning
 86" high, wood interiors
 Hinge doors and Box box file drawers

description	w	d	pattern no.	L	L/V1	L/V2	L/V3	V1	V2	V3
Cabinet, 86" high, hinged doors shelve Box box	16"	20"	RC812DHPH(L/R)() () ()	\$4,257.	\$5,021.	\$5,404.	\$5,786.	\$6,168.	\$6,804.	\$8,269.
file drawers	16"	24"	RC813DHPH(L/R)() () ()	4,367.	5,160.	5,556.	5,952.	6,349.	7,036.	8,682.

Coat rod included
 Hinges determine (L/R) hand



Left hand shown

Order Code	Specification Information	Application Notes
Example: RC812DHPH(L/R)() () ()	<i>To order, please specify pattern number including:</i>	It is Not advisable to mix 28³/₈" desk height products with 26¹/₂" standard height products.
R Reff		Please note: Shelf adjustability is limited to approximately 2.5" up or down per shelf from predetermined shelf height.
C Cabinet	1. <i>Interior options:</i> W = Wood Interior	File drawers include file bars for front to back and side to side filing. File drawers do not support bottom loading.
8 86" high, Actual height	2. <i>Lock Option Doors:</i> L = Lock hole drilled N = No lock drilling	*Note: 86" high Wardrobe Cabinets do not come equipped with boot tray. Please specify separately. See page 417.
3 30" wide	3. <i>Lock Finish:</i> B = Black S = Silver	20" deep Wardrobe Cabinets provide only 18" of clear storage space.
1 16" deep	4. <i>Pull Options:</i> B = No pull, No Drilling, Customer's own Pull C = C-Pull, (Nickel finish only) D = D - Pull (PZ or PT only) F = Bar Pull (1 pull per door set) H = Outline Pull JN = J (Routed) Pull on drawers, Touch latch on Hinge doors R = Cylinder Pull S = S Pull (Stainless Steel Finish only) T = Tab Pull (1 pull per door set)	
DH Desk Height	5. <i>Pull Finish:</i> Painted or Plated	
P Hinge door with BBF	6. <i>Case Finish:</i> Wood or Laminate	
H Hinge doors	7. <i>Front Finish:</i> Wood or Laminate	
W Wood Interior Option		
L Lock option doors		
B Lock finish		
T Pull option		
111 Pull finish		
V319 Case Finish		
V316 Front Finish		
F = Hinge door cabinet with 4 file drawers		
G = Hinge door cabinet with FF		
P = Hinge door cabinet with BBF		

Cabinets, 28³/₈" planning
 86" high, wood interiors
 Hinge doors with shelves and wardrobe

description	w	d	pattern no.	L	L/V1	L/V2	L/V3	V1	V2	V3
Cabinet, 86" high, wardrobe/ bookcase combo full height doors	30"	20"	RC832DHEH(L/R) () () () ()	\$3,850.	\$4,451.	\$4,751.	\$5,051.	\$5,352.	\$6,034.	\$8,146.
	30"	24"	RC833DHEH(L/R) () () () ()	4,287.	4,955.	5,290.	5,624.	5,958.	6,718.	9,068.
	36"	20"	RC862DHEH(L/R) () () () ()	4,207.	4,862.	5,190.	5,517.	5,845.	6,591.	8,899.
	36"	24"	RC863DHEH(L/R) () () () ()	4,678.	5,407.	5,772.	6,136.	6,501.	7,332.	9,896.

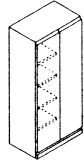

Left hand shown

Requires one lock core per cabinet.
 Coat rod included. Order boot tray from accessories

Order Code	Specification Information	Application Notes
Example: RC832DHEH (L/R)	<i>To order, please specify pattern number including:</i>	<p>It is Not advisable to mix 28³/₈"h desk height products with 26¹/₂" standard height products.</p> <p>Product on this page Excluding J-pull option and any vertical surface over 60", will accept wood grain laminate, where laminate is currently an option.</p> <p>Hinge door cabinets have optional lock drilling which can be specified in the cabinet product code. Keying instructions must accompany all cabinet orders.</p> <p>After specifying product code, provide keying instructions. Refer to page 482 for keying instructions.</p> <p>* If case is Laminate, the front can be laminate or wood. * If case is Wood, the front can only be wood.</p> <p>Please note: Shelf adjustability is limited to approximately 2.5" up or down per shelf from predetermined shelf height</p> <p>*Note: 86" high wardrobe cabinets come equipped with a coat rod.</p> <p>20" deep wardrobe cabinets provide only 18" of clear storage space.</p> <p>Boot trays are not included with these cabinets. To order boot trays, refer to page 417.</p> <p>In 16" and 19" wide cabinets, the hinges determine (L/R) hand.</p>
R Reff	1. <i>Hinge Location where applicable:</i> L = Left hand R = Right hand	
C Cabinet	2. <i>Case Finish type:</i> L = Laminate 1 = V1 2 = V2 3 = V3	
8 86" high, Actual height	3. <i>Front Finish type:</i> L = Laminate 1 = V1 2 = V2 3 = V3	
3 30" wide	4. <i>Interior options:</i> W = Wood Interior	
2 20" deep	5. <i>Pull Options:</i> B = No pull, No Drilling, Customer's own Pull C = Nickel Finish C-pull D = Metal D-pull F = Bar Pull (1 pull per door set) H = Outline Pull N = No pull, Touch Latch R = Cylinder Pull S = S-pull (Stainless Steel Finish only) T = Tab Pull (1 pull per door set)	
DH Desk Height	6. <i>Lock Option Doors:</i> L = Lock hole drilled N = No lock drilling	
E Wardrobe / Bookcase combo	7. <i>Lock Finish:</i> B = Black S = Matte Silver	
H Wood hinge doors	8. <i>Case Finish:</i> Wood or Laminate	
(L/R) Left hand or Right hand	9. <i>Front Finish:</i> Wood or Laminate	
L Case Finish Type: Laminate	10. <i>Pull Finish:</i> Painted or Plated	
2 Front Finish Type: V2		
W Wood Interior		
T Tab pull option		
N Lock option, doors		
B Lock Finish		
118 Case Finish		
V316 Front Finish		
111 Pull Finish		
E = Hinge door cabinet with full height doors, half wardrobe and shelves		
D = Wardrobe Cabinet		

Cabinets, 28³/₈" planning
 86" high, wood interiors
 Hinge doors with shelves and wardrobe

description	w	d	pattern no.	L	L/V1	L/V2	L/V3	V1	V2	V3
Cabinet, 86" high, wardrobe (for desk height planning)	12"	20"	RC802DHDH(L/R)() () () ()	\$2,388.	\$2,989.	\$3,289.	\$3,590.	\$3,890.	\$4,405.	\$5,772.
	12"	24"	RC803DHDH(L/R)() () () ()	2,440.	3,040.	3,340.	3,641.	3,941.	4,457.	5,823.
	16"	20"	RC812DHDH(L/R)() () () ()	2,542.	3,143.	3,442.	3,742.	4,043.	4,559.	5,926.
	16"	24"	RC813DHDH(L/R)() () () ()	2,634.	3,257.	3,568.	3,880.	4,191.	4,724.	6,142.
	19"	20"	RC822DHDH(L/R)() () () ()	2,641.	3,266.	3,578.	3,890.	4,203.	4,739.	6,159.
	19"	24"	RC823DHDH(L/R)() () () ()	2,737.	3,384.	3,707.	4,030.	4,353.	4,908.	6,380.
	30"	20"	RC832DHDH() () () ()	3,019.	3,732.	4,088.	4,444.	4,801.	5,414.	7,038.
	30"	24"	RC833DHDH() () () ()	3,122.	3,860.	4,229.	4,598.	4,967.	5,600.	7,279.
	36"	20"	RC862DHDH() () () ()	3,254.	4,023.	4,408.	4,792.	5,176.	5,836.	7,587.
	36"	24"	RC863DHDH() () () ()	3,366.	4,163.	4,560.	4,959.	5,357.	6,039.	7,850.

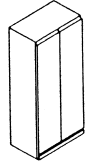

Wood interior only

Requires one lock core per cabinet.
 Coat rod included. Order boot tray from accessories

Order Code	Specification Information	Application Notes
Example: RC832DHEH (L/R)	<i>To order, please specify pattern number including:</i>	<p>It is Not advisable to mix 28³/₈"h desk height products with 26¹/₂" standard height products.</p> <p>Product on this page Excluding J-pull option and any vertical surface over 60", will accept wood grain laminate, where laminate is currently an option.</p> <p>Hinge door cabinets have optional lock drilling which can be specified in the cabinet product code. Keying instructions must accompany all cabinet orders.</p> <p>After specifying product code, provide keying instructions. Refer to page 482 for keying instructions.</p> <p>* If case is Laminate, the front can be laminate or wood. * If case is Wood, the front can only be wood.</p>
R Reff	1. <i>Hinge Location where applicable:</i> L = Left hand R = Right hand	
C Cabinet	2. <i>Case Finish type:</i> L = Laminate 1 = V1 2 = V2 3 = V3	
8 86" high, Actual height	3. <i>Front Finish type:</i> L = Laminate 1 = V1 2 = V2 3 = V3	
3 30" wide	4. <i>Interior options:</i> W = Wood Interior	
2 20" deep	5. <i>Pull Options:</i> B = No pull, No Drilling, Customer's own Pull C = Nickel Finish C-pull D = Metal D-pull F = Bar Pull (1 pull per door set) H = Outline Pull N = No pull, Touch Latch R = Cylinder Pull S = S-pull (Stainless Steel Finish only) T = Tab Pull (1 pull per door set)	
DH Desk Height	6. <i>Lock Option Doors:</i> L = Lock hole drilled N = No lock drilling	
E Wardrobe / Bookcase combo	7. <i>Lock Finish:</i> B = Black S = Matte Silver	
H Wood hinge doors	8. <i>Case Finish:</i> Wood or Laminate	
(L/R) Left hand or Right hand	9. <i>Front Finish:</i> Wood or Laminate	
L Case Finish Type: Laminate	10. <i>Pull Finish:</i> Painted or Plated	
2 Front Finish Type: V2		
W Wood Interior		
T Tab pull option		
N Lock option, doors		
B Lock Finish		
118 Case Finish		
V316 Front Finish		
111 Pull Finish		
E = Hinge door cabinet with full height doors, half wardrobe and shelves		
D = Wardrobe Cabinet		

Cabinets, 28³/₈" planning 86" high, wood interiors Wardrobe Combo with BBF and FF

description	w	d	pattern no.	L	L/V1	L/V2*	L/V3	V1	V2	V3
Wardrobe 86" high, with 1/2 height hinged door & box/box/file Cabinet	30"	20"	RC832DHPHW(L/R) () () () () ()	\$4,551.	\$5,516.	\$5,997.	\$6,480.	\$6,962.	\$7,849.	\$10,831.
	30"	24"	RC833DHPHW(L/R) () () () () ()	4,734.	5,738.	6,240.	6,741.	7,244.	8,166.	11,270.
	36"	20"	RC862DHPHW(L/R) () () () () ()	4,706.	5,703.	6,202.	6,700.	7,200.	8,117.	11,200.
	36"	24"	RC863DHPHW(L/R) () () () () ()	4,893.	5,931.	6,448.	6,967.	7,486.	8,441.	11,648.

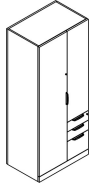

Left hand shown

Wardrobe determines (L/R) hand

Wardrobe 86" high, with 1/2 height hinged door & file Cabinet	30"	20"	RC832DHGHW(L/R) () () () () ()	4,301.	5,213.	5,668.	6,124.	6,581.	7,419.	10,239.
	30"	24"	RC833DHGHW(L/R) () () () () ()	4,476.	5,425.	5,899.	6,373.	6,848.	7,721.	10,656.
	36"	20"	RC862DHGHW(L/R) () () () () ()	4,454.	5,399.	5,870.	6,343.	6,815.	7,683.	10,605.
	36"	24"	RC863DHGHW(L/R) () () () () ()	4,635.	5,618.	6,109.	6,601.	7,092.	7,995.	11,033.

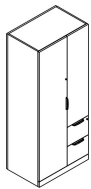

Left hand shown

Wardrobe determines (L/R) hand

Order Code

Example:	RC832DHPHW (L/R)
R	Reff
C	Cabinet
8	86" high
3	30" wide
2	20" deep
DH	Desk Height
PHW	Box/Box/File Wardrobe combo GHW = FF Wardrobe combo
L/R	Left or Right hand
W	Wood Interior
L	Lock option, doors
111	Lock Finish
T	Pull option
111	Pull Finish
118	Case Finish
V316	Front Finish

E = Hinge door cabinet with full height doors, half wardrobe and shelves

To order, please specify pattern number including:

- Interior options:**
W = Wood Interior
- Lock Options Doors:**
L = Lock hold drilled
N = No lock drilling
Drawers are always drilled for lock. Not optional
- Lock Finish:**
B = Black
S = Matte Silver
- Pull Options:**
B = No pull, No Drilling, Customer's own Pull
C = Nickel finish C-pull (nickel finish only)
D = Metal D-pull (finish optional)
F = Bar Pull (1 pull per door set)
H = Outline Pull
JN = Routed J-pull on drawers and touch latch on Hinge doors (finish matches case)
R = Cylinder Pull
S = S Pull (Stainless Steel Finish only)
T = Tab Pull (1 pull per door set)
- Pull Finish:**
Painted or Plated
- Case Finish:**
Wood or Laminate
- Front Finish:**
Wood or Laminate

It is Not advisable to mix 28³/₈"h desk height products with 26¹/₂" standard height products.

Product on this page **Excluding J-pull option and any vertical surface over 60"**, will accept wood grain laminate, where laminate is currently an option.

Hinge door cabinets have optional lock drilling which can be specified in the cabinet product code. Keying instructions must accompany all cabinet orders.

Drawers are always drilled for locks.

After specifying product code, provide keying instructions. Refer to page 482 for keying instructions.

- * If case is Laminate, the front can be laminate or wood.
- * If case is Wood, the front can only be wood.

The Wardrobe Cabinets on this page come equipped with a coat rod and top shelf.

The 1/2 height hinge door comes with **touch latch only** and is non locking. It also comes with 2 adjustable shelves.

Please note: Shelf adjustability is limited to approximately 2.5" up or down per shelf from predetermined shelf height.

File drawers include file bars for front to back and side to side filing. File drawers do not support bottom loading.

Cabinets Progressive, 28 3/8 planning 42" high, metal interior

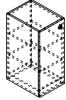
description	w	d	h	pattern no.	L/L	L/V1	L/V2	L/V3	V1/V1	V2/V2	V3/V3
Cabinet, hinge door with shelves 	18"	20"	42"	RCFS4212C(L/R)M () () () () ()	\$1,871.	\$2,057.	\$2,150.	\$2,245.	\$2,842.	\$3,268.	\$4,248.
	18"	24"	42"	RCFS4213C(L/R)M () () () () ()	1,927.	2,120.	2,216.	2,311.	2,939.	3,379.	4,393.

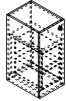
Cabinets, hinge door with shelves & File/File 	18"	20"	42"	RCFS4212Y(L/R)M () () () () ()	2,410.	2,651.	2,771.	2,893.	3,614.	4,157.	5,405.
	18"	24"	42"	RCFS4213Y(L/R)M () () () () ()	2,486.	2,736.	2,860.	2,984.	3,730.	4,290.	5,576.

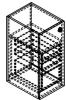
Cabinets, hinge door with shelves & Box/File/File 	18"	20"	42"	RCFS4212Z(L/R)M () () () () ()	2,489.	2,739.	2,864.	2,988.	3,735.	4,295.	5,584.
	18"	24"	42"	RCFS4213Z(L/R)M () () () () ()	2,600.	2,828.	2,956.	3,085.	3,857.	4,532.	5,766.

Order Code	Specification Information	Application Notes
Example: RCFS4212C(L/R)M () () () () ()	<i>To order please specify pattern number including:</i>	Configurations;
R Reff	1. Lock	C = all shelves for 18" w cabinets
C Cabinet	L=Drill for lock	Y = hinge door with shelves and FF -18" w
FS Free Standing	N=No lock	Z = hinge door with shelves BBF for 18" w
42 Height	2. Lock finish	V = all shelves for 24" w cabinets
1 18" Wide	S=Silver	W = hinge door with shelves and FF and wardrobe for 24" w
2 20" d (nominal) & 3 = 24" d (nominal)	B=Black	X = hinge door with shelves and BBF and wardrobe for 24" w
C Hinge door with shelves	3. Pull options	The images on this page are shown as a right hand cabinets.
L/R Left/Right hinge	Grommet	From the users perspective, if the hinges are on the right side, the cabinet is classified as "right hand" cabinet.
M Metal interior	4. Pull finish	
N Lock	Paint / Plated	
S Lock finish	5. Case finish	
G Pull option	L, V1, V2, V3	
115 Pull finish option	6. Door finish	
114 Case finish	L, V1, V2, V3	
115 Door finish		

It is Not advisable to mix 28 3/8" h desk height products with 26 1/2" standard height products.

Product on this page will accept woodgrain laminate where laminate is currently an option.

These products are Glue and Dowel Construction

Grommet pulls only

Shelves and File Front will default to the case finish

42" h cabinets are compatible with panel height.

When case finish is Laminate, shelves are painted to match.

When case finish is wood, shelves are painted black.

Drawer interiors always painted black.

Cabinets with wardrobe come with a coat rod.

Cabinets Progressive, 28 3/8 planning

42" high, metal interior

description	w	d	h	pattern no.	L/L	L/V1	L/V2	L/V3	V1/V1	V2/V2	V3/V3
Cabinets, hinge door with shelves & wardrobe	24"	20"	42"	RCFS4232V(L/R)M()()()()()	\$2,238.	\$2,462.	\$2,575.	\$2,687.	\$3,474.	\$3,994.	\$5,195.
	24"	24"	42"	RCFS4233V(L/R)M()()()()()	2,307.	2,538.	2,654.	2,770.	3,605.	4,147.	5,389.

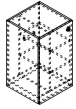

Cabinets, hinge door with shelves, File/File & wardrobe	24"	20"	42"	RCFS4233W(L/R)M()()()()()	2,587.	2,844.	2,975.	3,103.	4,007.	4,607.	5,990.
	24"	24"	42"	RCFS4232W(L/R)M()()()()()	2,662.	2,928.	3,061.	3,195.	4,148.	4,770.	6,200.

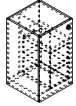

Cabinets, hinge door with shelves, Box/Box/File & wardrobe	24"	20"	42"	RCFS4232X(L/R)M()()()()()	2,749.	3,025.	3,161.	3,299.	4,178.	4,805.	6,246.
	24"	24"	42"	RCFS4233X(L/R)M()()()()()	2,831.	3,114.	3,255.	3,398.	4,327.	4,973.	6,465.

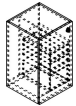

Order Code	Specification Information	Application Notes
Example: RCFS4212C(L/R)M () () () () ()	<i>To order please specify pattern number including:</i>	Configurations;
R Reff	1. Lock L=Drill for lock N=No lock	C = all shelves for 18" w cabinets
C Cabinet	2. Lock finish S=Silver B=Black	Y = hinge door with shelves and FF -18" w
FS Free Standing	3. Pull options Grommet	Z = hinge door with shelves BBF for 18" w
42 Height	4. Pull finish Paint / Plated	V = all shelves for 24" w cabinets
1 18" Wide	5. Case finish L, V1, V2, V3	W = hinge door with shelves and BBF and wardrobe for 24" w
2 20" d (nominal)	6. Door finish L, V1, V2, V3	X = hinge door with shelves and BBF and wardrobe for 24" w
C Hinge door with shelves	It is Not advisable to mix 28 3/8" h desk height products with 26 1/2" standard height products.	The images on this page are shown as a right hand cabinets.
L/R Left/Right hinge	Product on this page will accept woodgrain laminate where laminate is currently an option.	From the users perspective, if the hinges are on the right side, the cabinet is classified as "right hand" cabinet.
M Metal interior		These products are Glue and Dowel Construction
N Lock		Grommet pulls only
S Lock finish		Shelves and File Front will default to the case finish
G Pull option		42" h cabinets are compatible with panel height.
115 Pull finish option		When case finish is Laminate, shelves are painted to match.
114 Case finish		When case finish is wood, shelves are painted black.
115 Door finish		Drawer interiors always painted black.
		Cabinets with wardrobe come with a coat rod.

Cabinets Progressive, 28 3/8 planning 49" high, metal interior

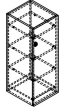
description	w	d	h	pattern no.	L/L	L/V1	L/V2	L/V3	V1/V1	V2/V2	V3/V3
Cabinet, hinge door with shelves 	18"	20"	49"	RCFS4912C(L/R)M () () () () ()	\$1,909.	\$2,098.	\$2,194.	\$2,290.	\$2,899.	\$3,333.	\$4,333.
	18"	24"	49"	RCFS4913C(L/R)M () () () () ()	1,966.	2,162.	2,260.	2,358.	2,997.	3,447.	4,481.

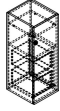
Cabinets, hinge door with shelves & File/File 	18"	20"	49"	RCFS4912Y(L/R)M () () () () ()	2,458.	2,704.	2,826.	2,950.	3,687.	4,240.	5,512.
	18"	24"	49"	RCFS4913Y(L/R)M () () () () ()	2,536.	2,790.	2,917.	3,043.	3,805.	4,376.	5,688.

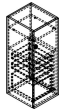
Cabinets, hinge door with shelves & Box/Box/File 	18"	20"	49"	RCFS4912Z(L/R)M () () () () ()	2,539.	2,793.	2,921.	3,047.	3,810.	4,381.	5,696.
	18"	24"	49"	RCFS4913Z(L/R)M () () () () ()	2,622.	2,884.	3,016.	3,147.	3,934.	4,622.	5,881.

Order Code	Specification Information	Application Notes
Example: RCFS4912C(L/R)M () () () () ()	<i>To order please specify pattern number including:</i>	Configurations;
R Reff	1. Lock	C = all shelves for 18" w cabinets
C Cabinet	L=Drill for lock	Y = hinge door with shelves and FF -18" w
FS Free Standing	N=No lock	Z = hinge door with shelves BBF for 18" w
49 Height	2. Lock finish	V = all shelves for 24" w cabinets
1 18" Wide	S=Silver	W = hinge door with shelves and FF and wardrobe for 24" w
2 20" d (nominal)	B=Black	X = hinge door with shelves and BBF and wardrobe for 24" w
C Hinge door with shelves	3. Pull options	The images on this page are shown as a right hand cabinets.
L/R Left/Right hinge	Grommet	From the users perspective, if the hinges are on the right side, the cabinet is classified as "right hand" cabinet.
M Metal interior	4. Pull finish	
N Lock	Paint / Plated	
S Lock finish	5. Case finish	
G Pull option	L, V1, V2, V3	
115 Pull finish option	6. Door finish	
114 Case finish	L, V1, V2, V3	
115 Door finish		

It is Not advisable to mix 28 3/8" h desk height products with 26 1/2" standard height products.

Product on this page will accept woodgrain laminate where laminate is currently an option.

These products are Glue and Dowel Construction

Grommet pulls only

Shelves and File Front will default to the case finish

49" h cabinets are compatible with panel height.

When case finish is Laminate, shelves are painted to match.

When case finish is wood, shelves are painted black.

Drawer interiors always painted black.

Cabinets with wardrobe come with a coat rod.

Cabinets Progressive, 28 3/8 planning

49" high, metal interior

description	w	d	h	pattern no.	L/L	L/V1	L/V2	L/V3	V1/V1	V2/V2	V3/V3
Cabinets, hinge door with shelves & wardrobe	24"	20"	49"	RCFS4932V(L/R)M()()()()()	\$2,283.	\$2,511.	\$2,626.	\$2,740.	\$3,543.	\$4,074.	\$5,298.
	24"	24"	49"	RCFS4933V(L/R)M()()()()()	2,353.	2,589.	2,707.	2,825.	3,677.	4,230.	5,497.

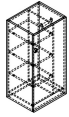

Cabinets, hinge door with shelves, File/File & wardrobe	24"	20"	49"	RCFS4932W(L/R)M()()()()()	2,638.	2,902.	3,034.	3,165.	4,087.	4,700.	6,110.
	24"	24"	49"	RCFS4933W(L/R)M()()()()()	2,715.	2,987.	3,122.	3,258.	4,231.	4,866.	6,324.

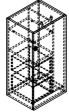

Cabinets, hinge door with shelves, Box/Box/File & wardrobe	24"	20"	49"	RCFS4932X(L/R)M()()()()()	2,804.	3,085.	3,225.	3,365.	4,262.	4,902.	6,371.
	24"	24"	49"	RCFS4933X(L/R)M()()()()()	2,887.	3,176.	3,321.	3,466.	4,413.	5,073.	6,594.

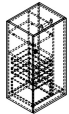

Order Code	Specification Information	Application Notes
Example: RCFS4912C(L/R)M () () () () ()	<i>To order please specify pattern number including:</i>	Configurations;
R Reff	1. Lock	C = all shelves for 18" w cabinets
C Cabinet	L=Drill for lock N=No lock	Y = hinge door with shelves and FF -18" w
FS Free Standing	2. Lock finish	Z = hinge door with shelves BBF for 18" w
49 Height	S=Silver B=Black	V = all shelves for 24" w cabinets
1 18" Wide	3. Pull options	W = hinge door with shelves and FF and wardrobe for 24" w
2 20" d (nominal)	Grommet	X = hinge door with shelves and BBF and wardrobe for 24" w
C Hinge door with shelves	4. Pull finish	The images on this page are shown as a right hand cabinets.
L/R Left/Right hinge	Paint / Plated	From the users perspective, if the hinges are on the right side, the cabinet is classified as "right hand" cabinet.
M Metal interior	5. Case finish	
N Lock	L, V1, V2, V3	
S Lock finish	6. Door finish	
G Pull option	L, V1, V2, V3	
115 Pull finish option	It is Not advisable to mix 28 3/8" h desk height products with 26 1/2" standard height products.	
114 Case finish	Product on this page will accept woodgrain laminate where laminate is currently an option.	
115 Door finish		

Cabinets Progressive, 28 3/8 planning 64" high, metal interior

description	w	d	h	pattern no.	L/L	L/V1	L/V2	L/V3	V1/V1	V2/V2	V3/V3
Cabinet, hinge door with shelves	18"	20"	64"	RCFS6412C(L/R)M()	\$2,073.	\$2,278.	\$2,382.	\$2,486.	\$3,172.	\$3,649.	\$4,743.
	18"	24"	64"	RCFS6413C(L/R)M()	2,143.	2,356.	2,464.	2,571.	3,313.	3,810.	4,953.

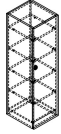

Cabinets, hinge door with shelves & File/File	18"	20"	64"	RCFS6412Y(L/R)M()	2,647.	2,912.	3,044.	3,176.	3,972.	4,566.	5,937.
	18"	24"	64"	RCFS6413Y(L/R)M()	2,794.	3,074.	3,214.	3,355.	4,192.	4,822.	6,267.

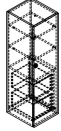

Cabinets, hinge door with shelves & Box/Box/File	18"	20"	64"	RCFS6412Z(L/R)M()	2,730.	3,003.	3,140.	3,275.	4,095.	4,709.	6,121.
	18"	24"	64"	RCFS6413Z(L/R)M()	2,881.	3,169.	3,313.	3,457.	4,321.	4,969.	6,461.

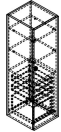

Order Code	Specification Information	Application Notes
Example: RCFS6412C(L/R)M ()()()()()	<i>To order please specify pattern number including:</i>	Configurations;
R Reff	1. Lock	C = all shelves for 18" w cabinets
C Cabinet	L=Drill for lock	Y = hinge door with shelves and FF -18" w
FS Free Standing	N=No lock	Z = hinge door with shelves BBF for 18" w
64 Height	2. Lock finish	V = all shelves for 24" w cabinets
1 18" Wide	S=Silver	W = hinge door with shelves and FF and wardrobe for 24" w
2 20" d (nominal)	B=Black	X = hinge door with shelves and BBF and wardrobe for 24" w
C Hinge door with shelves	3. Pull options	The images on this page are shown as a right hand cabinets.
L/R Left/Right hinge	Grommet	From the users perspective, if the hinges are on the right side, the cabinet is classified as "right hand" cabinet.
M Metal interior	4. Pull finish	
N Lock	Paint / Plated	
S Lock finish	5. Case finish	
G Pull option	L, V1, V2, V3	
115 Pull finish option	6. Door finish	
114 Case finish	L, V1, V2, V3	
115 Door finish		
	It is Not advisable to mix 28 3/8" h desk height products with 26 1/2" standard height products.	
	Product on this page will accept woodgrain laminate where laminate is currently an option.	

Cabinets Progressive, 28 3/8 planning 64" high, metal interior

description	w	d	h	pattern no.	L/L	L/V1	L/V2	L/V3	V1/V1	V2/V2	V3/V3
Cabinets, hinge door with shelves & wardrobe	24"	20"	64"	RCFS6432V(L/R)M()()()()()	\$2,464.	\$2,712.	\$2,834.	\$2,959.	\$3,889.	\$4,473.	\$5,815.
	24"	24"	64"	RCFS6433V(L/R)M()()()()()	2,554.	2,810.	2,937.	3,065.	4,078.	4,691.	6,099.

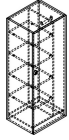

Cabinets, hinge door with shelves, File/File & wardrobe	24"	20"	64"	RCFS6432W(L/R)M()()()()()	2,821.	3,103.	3,244.	3,385.	4,432.	5,097.	6,628.
	24"	24"	64"	RCFS6433W(L/R)M()()()()()	2,991.	3,289.	3,440.	3,590.	4,702.	5,409.	7,032.

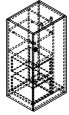

Cabinets, hinge door with shelves, Box/Box/File & wardrobe	24"	20"	64"	RCFS6432X(L/R)M()()()()()	2,988.	3,286.	3,436.	3,585.	4,608.	5,299.	6,888.
	24"	24"	64"	RCFS6433X(L/R)M()()()()()	3,163.	3,480.	3,637.	3,796.	4,883.	5,616.	7,300.

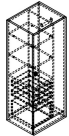

Order Code	Specification Information	Application Notes
Example: RCFS6412C(L/R)M ()()()()()	<i>To order please specify pattern number including:</i>	Configurations;
R Reff	1. Lock	C = all shelves for 18" w cabinets
C Cabinet	L=Drill for lock	Y = hinge door with shelves and FF -18" w
FS Free Standing	N=No lock	Z = hinge door with shelves BBF for 18" w
64 Height	2. Lock finish	V =all shelves for 24" w cabinets
1 18" Wide	S=Silver	W = hinge door with shelves and BBF and wardrobe for 24" w
2 20" d (nominal)	B=Black	X = hinge door with shelves and BBF and wardrobe for 24" w
C Hinge door with shelves	3. Pull options	The images on this page are shown as a right hand cabinets.
L/R Left/Right hinge	Grommet	From the users perspective, if the hinges are on the right side, the cabinet is classified as "right hand" cabinet.
M Metal interior	4. Pull finish	
N Lock	Paint / Plated	
S Lock finish	5. Case finish	
G Pull option	L, V1, V2, V3	
115 Pull finish option	6. Door finish	
114 Case finish	L, V1,V2, V3	
115 Door finish		
	It is Not advisable to mix 28 3/8" h desk height products with 26 1/2" standard height products.	
	Product on this page will accept woodgrain laminate where laminate is currently an option.	
		These products are Glue and Dowel Construction
		Grommet pulls only
		Shelves and file front will default to the case finish
		No wardrobe option in the 18" w cabinets.
		64" h cabinets are compatible with panel heights.
		When case finish is Laminate, shelves are painted to match.
		When case finish is wood, shelves are painted black.
		Drawer interiors always painted black.
		Cabinets with wardrobe come with a coat rod.

Cabinets Progressive, 28 3/8 planning 68" high, metal interior

description	w	d	h	pattern no.	L/L	L/V1	L/V2	L/V3	V1/V1	V2/V2	V3/V3
Cabinet, hinge door with shelves	18"	20"	68"	RCFS6812C(L/R)M()()()()()()	\$2,095.	\$2,304.	\$2,410.	\$2,514.	\$3,247.	\$3,734.	\$4,854.
	18"	24"	68"	RCFS6813C(L/R)M()()()()()()	2,168.	2,386.	2,495.	2,602.	3,379.	3,887.	5,053.

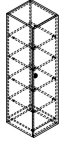

Cabinets, hinge door with shelves & File/File	18"	20"	68"	RCFS6812Y(L/R)M()()()()()()	2,703.	2,975.	3,110.	3,245.	4,056.	4,664.	6,064.
	18"	24"	68"	RCFS6813Y(L/R)M()()()()()()	2,846.	3,132.	3,273.	3,415.	4,269.	4,910.	6,382.

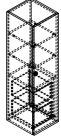

Cabinets, hinge door with shelves & Box/Box/File	18"	20"	68"	RCFS6812Z(L/R)M()()()()()()	2,786.	3,065.	3,204.	3,343.	4,179.	4,805.	6,247.
	18"	24"	68"	RCFS6813Z(L/R)M()()()()()()	2,933.	3,226.	3,372.	3,519.	4,398.	5,058.	6,576.

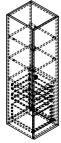

Order Code	Ordering Information	Application Notes
Example: RCFS6812C(L/R)M ()()()()()()	<i>To order please specify pattern number including:</i>	Configurations;
R Reff	1. Lock	C = all shelves for 18" w cabinets
C Cabinet	L=Drill for lock	Y = hinge door with shelves and FF -18" w
FS Free Standing	N=No lock	Z = hinge door with shelves BBF for 18" w
68 Height	2. Lock finish	V = all shelves for 24" w cabinets
1 18" Wide	S=Silver	W = hinge door with shelves and FF and wardrobe for 24" w
2 20" d (nominal)	B=Black	X = hinge door with shelves and BBF and wardrobe for 24" w
C Hinge door with shelves	3. Pull options	The images on this page are shown as a right hand cabinets.
L/R Left/Right hinge	Grommet	From the users perspective, if the hinges are on the right side, the cabinet is classified as "right hand" cabinet.
M Metal interior	4. Pull finish	
L Lock	Paint / Plated	
S Lock finish	5. Case finish	
G Pull option	L, V1, V2, V3	
115 Pull finish option	6. Door finish	
114 Case finish	L, V1, V2, V3	
115 Door finish		

It is Not advisable to mix 28 3/8" h desk height products with 26 1/2" standard height products.

Product on this page will accept woodgrain laminate where laminate is currently an option.

These products are Glue and Dowel Construction
Grommet pulls only.
Shelves and files front will default to the case finish.
68" h Cabinets are for the private offices application to align with a single high overhead, and are compatible with panel height.
No wardrobe options for 18" w cabinets.
When case finish is Laminate, shelves are painted to match.
When case finish is wood, shelves are painted black.
Drawer interiors always painted black.
Cabinets with wardrobe come with coat rod.

Cabinets Progressive, 28 3/8 planning 68" high, metal interior

description	w	d	h	pattern no.	L/L	L/V1	L/V2	L/V3	V1/V1	V2/V2	V3/V3
Cabinets, hinge door with shelves & wardrobe	24"	20"	68"	RCFS6832V(L/R)M()()()()()	\$2,497.	\$2,746.	\$2,871.	\$2,995.	\$3,986.	\$4,584.	\$5,959.
	24"	24"	68"	RCFS6833V(L/R)M()()()()()	2,587.	2,846.	2,976.	3,104.	4,173.	4,798.	6,237.

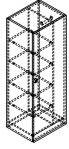

Cabinets, hinge door with shelves, File/File & wardrobe	24"	20"	68"	RCFS6832W(L/R)M()()()()()	2,862.	3,149.	3,292.	3,435.	4,557.	5,241.	6,813.
	24"	24"	68"	RCFS6833W(L/R)M()()()()()	3,035.	3,337.	3,490.	3,643.	4,805.	5,527.	7,185.

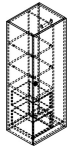

Cabinets, hinge door with shelves, Box/Box/File & wardrobe	24"	20"	68"	RCFS6832X(L/R)M()()()()()	3,029.	3,331.	3,483.	3,634.	4,715.	5,421.	7,048.
	24"	24"	68"	RCFS6833X(L/R)M()()()()()	3,207.	3,527.	3,688.	3,848.	4,987.	5,735.	7,456.

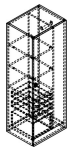

Order Code	Ordering Information	Specification Information
Example: RCFS6812C(L/R)M ()()()()()()	<i>To order please specify pattern number including:</i>	Configurations;
R Reff	1. Lock	C = all shelves for 18" w cabinets
C Cabinet	L=Drill for lock	Y = hinge door with shelves and FF -18" w
FS Free Standing	N=No lock	Z = hinge door with shelves BBF for 18" w
68 Height	2. Lock finish	V = all shelves for 24" w cabinets
1 18" Wide	S=Silver	W = hinge door with shelves and FF and wardrobe for 24" w
2 20" d (nominal)	B=Black	X = hinge door with shelves and BBF and wardrobe for 24" w
C Hinge door with shelves	3. Pull options	The images on this page are shown as a right hand cabinets.
L/R Left/Right hinge	Grommet	From the users perspective, if the hinges are on the right side, the cabinet is classified as "right hand" cabinet.
M Metal interior	4. Pull finish	
L Lock	Paint / Plated	
S Lock finish	5. Case finish	
G Pull option	L, V1, V2, V3	
115 Pull finish option	6. Door finish	
114 Case finish	L, V1, V2, V3	
115 Door finish		

It is Not advisable to mix 28 3/8" h desk height products with 26 1/2" standard height products.

Product on this page will accept woodgrain laminate where laminate is currently an option.

These products are Glue and Dowel Construction
Grommet pulls only.
Shelves and files front will default to the case finish.
68" h Cabinets are for the private offices application to align with a single high overhead, and are compatible with panel height.
No wardrobe options for 18" w cabinets.
When case finish is Laminate, shelves are painted to match.
When case finish is wood, shelves are painted black.
Drawer interiors always painted black.
Cabinets with wardrobe come with coat rod.

Cabinets Progressive, 28 3/8 planning 42" high, wood interior

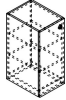
description	w	d	h	pattern no.	L/L	L/V1	L/V2	L/V3	V1/V1	V2/V2	V3/V3
Cabinet, hinge door with shelves 	18"	20"	42"	RCFS4212C(L/R)W () () () () ()	\$2,014.	\$2,216.	\$2,317.	\$2,416.	\$3,358.	\$3,862.	\$5,020.
	18"	24"	42"	RCFS4213C(L/R)W () () () () ()	2,060.	2,266.	2,370.	2,472.	3,463.	3,982.	5,177.

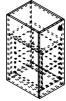
Cabinets, hinge door with shelves & File/File 	18"	20"	42"	RCFS4212Y(L/R)W () () () () ()	2,891.	3,180.	3,323.	3,468.	4,334.	4,985.	6,480.
	18"	24"	42"	RCFS4213Y(L/R)W () () () () ()	2,933.	3,225.	3,371.	3,518.	4,397.	5,057.	6,575.

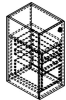
Cabinets, hinge door with shelves & Box/File/File 	18"	20"	42"	RCFS4212Z(L/R)W () () () () ()	3,350.	3,685.	3,852.	4,020.	4,690.	5,393.	7,010.
	18"	24"	42"	RCFS4213Z(L/R)W () () () () ()	3,425.	3,767.	3,939.	4,110.	4,795.	5,513.	7,168.

Order Code	Specification Information	Application Notes
Example: RCFS4212C(L/R)W () () () () ()	<i>To order please specify pattern number including:</i>	Configurations;
R Reff	1. Lock	C = all shelves for 18" w cabinets
C Cabinet	L=Drill for lock	Y = hinge door with shelves and FF -18" w
FS Free Standing	N=No lock	Z = hinge door with shelves BBF for 18" w
42 Height	2. Lock finish	V = all shelves for 24" w cabinets
1 18" Wide	S=Silver	W = hinge door with shelves and FF and wardrobe for 24" w
2 20" d (nominal)	B=Black	X = hinge door with shelves and BBF and wardrobe for 24" w
C Hinge door with shelves	3. Pull options	The images on this page are shown as a right hand cabinets.
L/R Left/Right hinge	Grommet	From the users perspective, if the hinges are on the right side, the cabinet is classified as "right hand" cabinet.
W Wood interior	4. Pull finish	
L Lock	Paint / Plated	
S Lock finish	5. Case finish	
G Pull option	L, V1, V2, V3	
115 Pull finish option	6. Door finish	
114 Case finish	L, V1, V2, V3	
115 Door finish		

It is Not advisable to mix 28 3/8" h desk height products with 26 1/2" standard height products.

Product on this page will accept woodgrain laminate where laminate is currently an option.

Cabinets Progressive, 28 3/8 planning

42" high, wood interior

description	w	d	h	pattern no.	L/L	L/V1	L/V2	L/V3	V1/V1	V2/V2	V3/V3
Cabinets, hinge door with shelves & wardrobe	24"	20"	42"	RCFS4232V(L/R)W()	\$2,375.	\$2,613.	\$2,732.	\$2,848.	\$3,974.	\$4,569.	\$5,941.
	24"	24"	42"	RCFS4233V(L/R)W()	2,435.	2,680.	2,800.	2,922.	4,113.	4,731.	6,149.

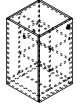

Cabinets, hinge door with shelves, File/File & wardrobe	24"	20"	42"	RCFS4232W(L/R)W()	3,217.	3,539.	3,700.	3,862.	4,722.	5,429.	7,058.
	24"	24"	42"	RCFS4233W(L/R)W()	3,225.	3,548.	3,708.	3,869.	4,803.	5,523.	7,181.

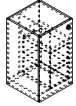

Cabinets, hinge door with shelves, Box/Box/File & wardrobe	24"	20"	42"	RCFS4232X(L/R)W()	3,633.	3,995.	4,177.	4,358.	5,129.	5,898.	7,667.
	24"	24"	42"	RCFS4233X(L/R)W()	3,683.	4,051.	4,234.	4,419.	5,251.	6,038.	7,850.

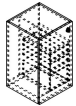

Order Code	Specification Information	Application Notes
Example: RCFS4212V(L/R)W ()()()()()	<i>To order please specify pattern number including:</i>	Configurations;
R Reff	1. Lock L=Drill for lock N=No lock	C = all shelves for 18" w cabinets
C Cabinet	2. Lock finish S=Silver B=Black	Y = hinge door with shelves and FF -18" w
FS Free Standing	3. Pull options Grommet	Z = hinge door with shelves BBF for 18" w
42 Height	4. Pull finish Paint / Plated	V = all shelves for 24" w cabinets
1 18" Wide	5. Case finish L, V1, V2, V3	W = hinge door with shelves and FF and wardrobe for 24" w
2 20" d (nominal)	6. Door finish L, V1, V2, V3	X = hinge door with shelves and BBF and wardrobe for 24" w
V all shelves for 24" cabinets with wardrobe	It is Not advisable to mix 28 3/8" h desk height products with 26 1/2" standard height products.	The images on this page are shown as a right hand cabinets.
L/R Left/Right hinge	Product on this page will accept woodgrain laminate where laminate is currently an option.	From the users perspective, if the hinges are on the right side, the cabinet is classified as "right hand" cabinet.
W Wood interior		
L Lock		
S Lock finish		
G Pull option		
115 Pull finish option		
114 Case finish		
115 Door finish		

Cabinets Progressive, 28 3/8 planning 49" high, wood interior

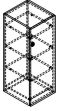
description	w	d	h	pattern no.	L/L	L/V1	L/V2	L/V3	V1/V1	V2/V2	V3/V3
Cabinet, hinge door with shelves 	18"	20"	49"	RCFS4912C(L/R)W () () () () ()	\$2,054.	\$2,260.	\$2,363.	\$2,464.	\$3,426.	\$3,939.	\$5,121.
	18"	24"	49"	RCFS4913C(L/R)W () () () () ()	2,101.	2,311.	2,417.	2,522.	3,533.	4,062.	5,281.

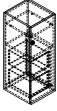
Cabinets, hinge door with shelves & File/File 	18"	20"	49"	RCFS4912Y(L/R)W () () () () ()	2,948.	3,243.	3,390.	3,537.	4,421.	5,084.	6,609.
	18"	24"	49"	RCFS4913Y(L/R)W () () () () ()	2,991.	3,289.	3,439.	3,589.	4,485.	5,159.	6,707.

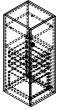
Cabinets, hinge door with shelves & Box/File/File 	18"	20"	49"	RCFS4912Z(L/R)W () () () () ()	3,416.	3,759.	3,929.	4,100.	4,785.	5,500.	7,150.
	18"	24"	49"	RCFS4913Z(L/R)W () () () () ()	3,493.	3,843.	4,018.	4,192.	4,891.	5,624.	7,311.

Order Code	Specification Information	Application Notes
Example: RCFS4912C(L/R)W () () () () ()	<i>To order please specify pattern number including:</i>	Configurations;
R Reff	1. Lock	C = all shelves for 18" w cabinets
C Cabinet	L=Drill for lock N=No lock	Y = hinge door with shelves and FF -18" w
FS Free Standing	2. Lock finish	Z = hinge door with shelves BBF for 18" w
49 Height	S=Silver B=Black	V = all shelves for 24" w cabinets
1 18" Wide	3. Pull options	W = hinge door with shelves and FF and wardrobe for 24" w
2 20" d (nominal)	Grommet	X = hinge door with shelves and BBF and wardrobe for 24" w
C Hinge door with shelves	4. Pull finish	The images on this page are shown as a right hand cabinets.
L/R Left/Right hinge	Paint / Plated	From the users perspective, if the hinges are on the right side, the cabinet is classified as "right hand" cabinet.
W Wood interior	5. Case finish	
L Lock	L, V1, V2, V3	
S Lock finish	6. Door finish	
G Pull option	L, V1, V2, V3	
115 Pull finish option	It is Not advisable to mix 28 3/8" h desk height products with 26 1/2" standard height products.	
114 Case finish	Product on this page will accept woodgrain laminate where laminate is currently an option.	
115 Door finish		

Cabinets Progressive, 28 3/8 planning

49" high, wood interior

description	w	d	h	pattern no.	L/L	L/V1	L/V2	L/V3	V1/V1	V2/V2	V3/V3
Cabinets, hinge door with shelves & wardrobe	24"	20"	49"	RCFS4932V(L/R)W () () () () ()	\$2,422.	\$2,665.	\$2,786.	\$2,906.	\$4,054.	\$4,661.	\$6,060.
	24"	24"	49"	RCFS4933V(L/R)W () () () () ()	2,485.	2,734.	2,857.	2,981.	4,195.	4,826.	6,272.

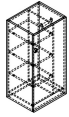

Cabinets, hinge door with shelves, File/File & wardrobe	24"	20"	49"	RCFS4932W(L/R)W () () () () ()	3,282.	3,610.	3,774.	3,939.	4,816.	5,538.	7,200.
	24"	24"	49"	RCFS4933W(L/R)W () () () () ()	3,289.	3,618.	3,782.	3,947.	4,900.	5,633.	7,325.

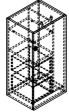

Cabinets, hinge door with shelves, Box/Box/File & wardrobe	24"	20"	49"	RCFS4932X(L/R)W () () () () ()	3,705.	4,075.	4,261.	4,445.	5,232.	6,016.	7,821.
	24"	24"	49"	RCFS4933X(L/R)W () () () () ()	3,757.	4,132.	4,319.	4,507.	5,356.	6,159.	8,007.

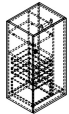

Order Code	Ordering Information	Application Notes
Example: RCFS4912C(L/R)W () () () () ()	<i>To order please specify pattern number including:</i>	Configurations;
R Reff	1. Lock	C = all shelves for 18" w cabinets
C Cabinet	L=Drill for lock	Y = hinge door with shelves and FF -18" w
FS Free Standing	N=No lock	Z = hinge door with shelves BBF for 18" w
49 Height	2. Lock finish	V = all shelves for 24" w cabinets
1 18" Wide	S=Silver	W = hinge door with shelves and FF and wardrobe for 24" w
2 20" d (nominal)	B=Black	X = hinge door with shelves and BBF and wardrobe for 24" w
C Hinge door with shelves	3. Pull options	The images on this page are shown as a right hand cabinets.
L/R Left/Right hinge	Grommet	From the users perspective, if the hinges are on the right side, the cabinet is classified as "right hand" cabinet.
W Wood interior	4. Pull finish	
L Lock	Paint / Plated	
S Lock finish	5. Case finish	
G Pull option	L, V1, V2, V3	
115 Pull finish option	6. Door finish	
114 Case finish	L, V1, V2, V3	
115 Door finish	Product on this page will accept woodgrain laminate where laminate is currently an option.	

Cabinets Progressive, 28 3/8 planning

64" high, wood interior

description	w	d	h	pattern no.	L/L	L/V1	L/V2	L/V3	V1/V1	V2/V2	V3/V3
Cabinet, hinge door with shelves	18"	20"	64"	RCFS6412C(L/R)W()	\$2,266.	\$2,493.	\$2,607.	\$2,719.	\$3,875.	\$4,456.	\$5,792.
	18"	24"	64"	RCFS6413C(L/R)W()	2,325.	2,557.	2,673.	2,790.	4,025.	4,629.	6,018.

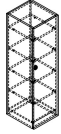

Cabinets, hinge door with shelves & File/File	18"	20"	64"	RCFS6412Y(L/R)W()	3,253.	3,578.	3,740.	3,903.	4,879.	5,612.	7,295.
	18"	24"	64"	RCFS6413Y(L/R)W()	3,372.	3,708.	3,879.	4,047.	5,058.	5,817.	7,562.

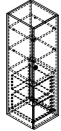

Cabinets, hinge door with shelves & Box/Box/File	18"	20"	64"	RCFS6412Z(L/R)W()	3,745.	4,121.	4,308.	4,495.	5,243.	6,030.	7,838.
	18"	24"	64"	RCFS6413Z(L/R)W()	3,902.	4,292.	4,487.	4,683.	5,463.	6,283.	8,167.

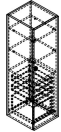

Order Code	Ordering Information	Application Notes
Example: RCFS6412C(L/R)W () () () () ()	<i>To order please specify pattern number including:</i>	Configurations;
R Reff	1. Lock	C = all shelves for 18" w cabinets
C Cabinet	L=Drill for lock	Y = hinge door with shelves and FF -18" w
FS Free Standing	N=No lock	Z = hinge door with shelves BBF for 18" w
64 Height	2. Lock finish	V = all shelves for 24" w cabinets
1 18" Wide	S=Silver	W = hinge door with shelves and FF and wardrobe for 24" w
2 20" d (nominal)	B=Black	X = hinge door with shelves and BBF and wardrobe for 24" w
C Hinge door with shelves	3. Pull options	The images on this page are shown as a right hand cabinets.
L/R Left/Right hinge	Grommet	From the users perspective, if the hinges are on the right side, the cabinet is classified as "right hand" cabinet.
W Wood interior	4. Pull finish	
L Lock	Paint / Plated	
S Lock finish	5. Case finish	
G Pull option	L, V1, V2, V3	
115 Pull finish option	6. Door finish	
114 Case finish	L, V1, V2, V3	
115 Door finish		

It is Not advisable to mix 28 3/8" h desk height products with 26 1/2" standard height products.

Product on this page will accept woodgrain laminate where laminate is currently an option.

Cabinets Progressive, 28 3/8 planning 64" high, wood interior

description	w	d	h	pattern no.	L/L	L/V1	L/V2	L/V3	V1/V1	V2/V2	V3/V3
Cabinets, hinge door with shelves & wardrobe	24"	20"	64"	RCFS6432V(L/R)W()()()()()	\$2,651.	\$2,916.	\$3,048.	\$3,182.	\$4,569.	\$5,255.	\$6,832.
	24"	24"	64"	RCFS6433V(L/R)W()()()()()	2,728.	3,001.	3,138.	3,273.	4,770.	5,486.	7,132.

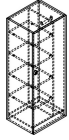

Cabinets, hinge door with shelves, File/File & wardrobe	24"	20"	64"	RCFS6432W(L/R)W()()()()()	3,512.	3,862.	4,036.	4,213.	5,332.	6,132.	7,971.
	24"	24"	64"	RCFS6433W(L/R)W()()()()()	3,608.	3,969.	4,149.	4,329.	5,545.	6,376.	8,288.

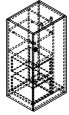

Cabinets, hinge door with shelves, Box/Box/File & wardrobe	24"	20"	64"	RCFS6432X(L/R)W()()()()()	3,934.	4,328.	4,525.	4,721.	5,748.	6,610.	8,593.
	24"	24"	64"	RCFS6433X(L/R)W()()()()()	4,075.	4,482.	4,686.	4,891.	6,001.	6,902.	8,972.

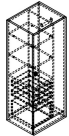

Order Code	Ordering Information	Specification Information
Example: RCFS6412C(L/R)W ()()()()()	<i>To order please specify pattern number including:</i>	Configurations;
R Reff	1. Lock	C = all shelves for 18" w cabinets
C Cabinet	L=Drill for lock	Y = hinge door with shelves and FF -18" w
FS Free Standing	N=No lock	Z = hinge door with shelves BBF for 18" w
64 Height	2. Lock finish	V = all shelves for 24" w cabinets
1 18" Wide	S=Silver	W = hinge door with shelves and FF and wardrobe for 24" w
2 20" d (nominal)	B=Black	X = hinge door with shelves and BBF and wardrobe for 24" w
C Hinge door with shelves	3. Pull options	The images on this page are shown as a right hand cabinets.
L/R Left/Right hinge	Grommet	From the users perspective, if the hinges are on the right side, the cabinet is classified as "right hand" cabinet.
W Wood interior	4. Pull finish	
L Lock	Paint / Plated	
S Lock finish	5. Case finish	
G Pull option	L, V1, V2, V3	
115 Pull finish option	6. Door finish	
114 Case finish	L, V1, V2, V3	
115 Door finish		

It is Not advisable to mix 28 3/8" h desk height products with 26 1/2" standard height products.

Product on this page will accept woodgrain laminate where laminate is currently an option.

Cabinets Progressive, 28 3/8 planning 68" high wood interior

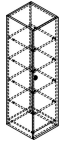
description	w	d	h	pattern no.	L/L	L/V1	L/V2	L/V3	V1/V1	V2/V2	V3/V3
Cabinet, hinge door with shelves 	18"	20"	68"	RCFS6812C(L/R)W()()()()()	\$2,291.	\$2,519.	\$2,634.	\$2,748.	\$3,949.	\$4,541.	\$5,904.
	18"	24"	68"	RCFS6813C(L/R)W()()()()()	2,350.	2,586.	2,703.	2,821.	4,093.	4,707.	6,118.

Cabinets, hinge door with shelves & File/File 	18"	20"	68"	RCFS6812Y(L/R)W()()()()()	3,309.	3,640.	3,806.	3,972.	4,964.	5,708.	7,421.
	18"	24"	68"	RCFS6813Y(L/R)W()()()()()	3,424.	3,766.	3,938.	4,108.	5,135.	5,906.	7,677.

Cabinets, hinge door with shelves & Box/Box/File 	18"	20"	68"	RCFS6812Z(L/R)W()()()()()	3,806.	4,186.	4,377.	4,566.	5,328.	6,126.	7,965.
	18"	24"	68"	RCFS6813Z(L/R)W()()()()()	3,957.	4,353.	4,551.	4,749.	5,540.	6,371.	8,283.

Order Code	Ordering Information	Application Notes
Example: RCFS6812C(L/R)W ()()()()()	<i>To order please specify pattern number including:</i>	Configurations;
R Reff	1. Lock	C = all shelves for 18" w cabinets
C Cabinet	L=Drill for lock	Y = hinge door with shelves and FF
FS Free Standing	N=No lock	-18" w
68 Height	2. Lock finish	Z = hinge door with shelves BBF for
1 18" Wide	S=Silver	18" w
2 20" d (nominal)	B=Black	V = all shelves for 24" w cabinets
C Hinge door with shelves	3. Pull options	W = hinge door with shelves and FF
L/R Left/Right hinge	Grommet	and wardrobe for 24" w
W Wood interior	4. Pull finish	X = hinge door with shelves and
L Lock	Paint / Plated	BBF and wardrobe for 24" w
S Lock finish	5. Case finish	The images on this page are shown
G Pull option	L, V1, V2, V3	as a right hand cabinets.
115 Pull finish option	6. Door finish	From the users perspective, if the
114 Case finish	L, V1, V2, V3	hinges are on the right side, the
115 Door finish	It is Not advisable to mix 28 3/8" h desk height products with 26 1/2" standard height products.	cabinet is classified as "right hand" cabinet.
	Product on this page will accept woodgrain laminate where laminate is currently an option.	

Cabinets Progressive, 28 3/8 planning

68" high wood interior

description	w	d	h	pattern no.	L/L	L/V1	L/V2	L/V3	V1/V1	V2/V2	V3/V3
Cabinets, hinge door with shelves & wardrobe	24"	20"	68"	RCFS6832V(L/R)W()()()()()	\$2,682.	\$2,951.	\$3,084.	\$3,219.	\$4,665.	\$5,366.	\$6,976.
	24"	24"	68"	RCFS6833V(L/R)W()()()()()	2,760.	3,037.	3,175.	3,313.	4,863.	5,593.	7,271.

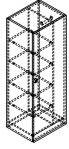

Cabinets, hinge door with shelves, File/File & wardrobe	24"	20"	68"	RCFS6832W(L/R)W()()()()()	3,553.	3,908.	4,086.	4,263.	5,439.	6,255.	8,130.
	24"	24"	68"	RCFS6833W(L/R)W()()()()()	3,652.	4,018.	4,200.	4,382.	5,647.	6,494.	8,444.

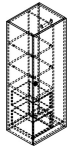

Cabinets, hinge door with shelves, Box/Box/File & wardrobe	24"	20"	68"	RCFS6832X(L/R)W()()()()()	3,976.	4,373.	4,573.	4,770.	5,855.	6,732.	8,751.
	24"	24"	68"	RCFS6833X(L/R)W()()()()()	4,121.	4,532.	4,737.	4,943.	6,105.	7,020.	9,126.

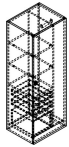

Order Code	Ordering Information	Application Notes
Example: RCFS6812C(L/R)W ()()()()()	<i>To order please specify pattern number including:</i>	Configurations;
R Reff	1. Lock	C = all shelves for 18" w cabinets
C Cabinet	L=Drill for lock N=No lock	Y = hinge door with shelves and FF -18" w
FS Free Standing	2. Lock finish	Z = hinge door with shelves BBF for 18" w
68 Height	S=Silver B=Black	V = all shelves for 24" w cabinets
1 18" Wide	3. Pull options	W = hinge door with shelves and FF and wardrobe for 24" w
2 20" d (nominal)	Grommet	X = hinge door with shelves and BBF and wardrobe for 24" w
C Hinge door with shelves	4. Pull finish	The images on this page are shown as a right hand cabinets.
L/R Left/Right hinge	Paint / Plated	From the users perspective, if the hinges are on the right side, the cabinet is classified as "right hand" cabinet.
W Wood interior	5. Case finish	
L Lock	L, V1, V2, V3	
S Lock finish	6. Door finish	
G Pull option	L, V1,V2, V3	
115 Pull finish option	It is Not advisable to mix 28 3/8" h desk height products with 26 1/2" standard height products.	
114 Case finish	Product on this page will accept woodgrain laminate where laminate is currently an option.	
115 Door finish		

Desktop Towers, 28³/₈" planning

Single Wide, 42" and 56" High

Bookcase

description	w	d	h	pattern no.	L	V1	V2	V3
42" h Desk top tower, single width bookcase open wood shelves	16"	15"	42"	RDTSBWT142 () ()	\$1,269.	\$2,175.	\$2,501.	\$3,251.
	19"	15"	42"	RDTSBWG142 () ()	1,302.	2,230.	2,564.	3,333.



56" h Desk top tower, single width bookcase open wood shelves	16"	15"	56"	RDTSBWT156 () ()	1,467.	2,515.	2,894.	3,761.
	19"	15"	56"	RDTSBWG156 () ()	1,504.	2,578.	2,964.	3,854.

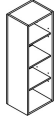

Order Code

Example:	RDTSBWT142 () ()
R	Reff
DT	Reff Desktop Tower
S	Single width
B	Bookcase
W	Wood Shelves
T	Letter width 16" nominal
1	Letter depth 15" nominal
42	42" high nominal
V2	Case finish type
V316	Case finish

Specification Information

To order please specify pattern number including:
Left or right hand as applicable and embedded in the pattern number.

- Case finish type:
L = Laminate
1 = V1
2 = V2
3 = V3
- Case finish:
Wood or Laminate

Application Notes

It is Not advisable to mix 28³/₈" desk height products with 26¹/₂" standard height products.

Product on this page **Excluding J-pull option and any vertical surface over 60"**, will accept wood grain laminate, where laminate is currently an option.

1 1/2" thick worksurfaces are recommended to be used with these Desktop towers. See page 250.

These products are Glue and Dowel Construction.

42" h desk top towers for use with single tier overhead bridges and floorstanding cabinet.

56" h desk top tower for use with double tier overhead bridges and floor standing cabinet.

Shelves to match case finish.

Shelves on single high available with 2 adjustable shelves.

Shelves on double high available with one fixed middle shelf, one upper and one lower adjustable shelf.

All adjustable shelves have 2 1/2", up or down flexibility.

Desktop Towers, 28^{3/8}" planning

Single Wide, 42" and 56" High

Wood Hinge Door

description	w	d	h	pattern no.	L/L	L/V1	L/V2	L/V3	V1/V1	V2/V2	V3/V3
42" h Desk top tower, single width	16"	15"	42"	RDTSHWT142(L/R) () () () () ()	\$1,650.	\$1,815.	\$1,897.	\$2,062.	\$2,828.	\$3,253.	\$4,230.
wood shelves behind wood hinge door	19"	15"	42"	RDTSHWG142(L/R) () () () () ()	1,696.	1,867.	1,951.	2,122.	2,908.	3,346.	4,348.



56" h Desk top tower, single width	16"	15"	56"	RDTSHWT156(L/R) () () () () ()	1,881.	2,069.	2,276.	2,503.	3,225.	3,707.	4,822.
wood shelves behind wood hinge door	19"	15"	56"	RDTSHWG156(L/R) () () () () ()	1,934.	2,127.	2,339.	2,573.	3,314.	3,811.	4,954.

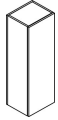

Order Code	Specification Information	Application Notes
Example: RDTSHWT142 () ()	<i>To order please specify pattern number including:</i>	It is Not advisable to mix 28^{3/8}" h desk height products with 26^{1/2}" standard height products.
R Reff	Left or right hand as applicable and embedded in the pattern number.	42" h desk top towers for use with single tier overhead bridges and floorstanding cabinet.
DT Reff Desktop Tower		
S Single width		
H Hinge Door		
W Wood Shelves		
T Letter width 16" nominal		
1 Letter depth 15" nominal	1. Case finish type L = Laminate 1 = V1 2 = V2 3 = V3	56" h desk top tower for use with double tier overhead bridges and floor standing cabinet
42 42" high nominal	2. Front finish type L = Laminate 1 = V1 2 = V2 3 = V3	Shelves to match case finish.
2 Finish type	3. Pull option: B=No pull, No drilling Customer's own pull. F=Bar pull (1 pull per door set) H=Outline pull N=No pull, touch latch R=Cylinder pull T=Tab pull (1 pull per door set)	Shelves on single high available with 2 adjustable shelves.
T Pull option	4. Lock option L or N	Shelves on double high available with one fixed middle shelf, one upper and one lower adjustable shelf.
L Lock option	5. Lock finish B=Black S=Matte Silver	All adjustable shelves have 2 ^{1/2} ", up or down flexibility.
B Lock finish	6. Case finish=*V316	
V316 Case finish	7. Front finish=V316	
V316 Front finish	8. Pull finish=111	
111 Pull finish		

Desktop Towers, 28³/₈" planning
*Single Wide, 42" and 56" High
 Glass Hinge Door*

description	w	d	h	pattern no.	L	V1	V2	V3
42" h Desk top tower, single width bookcase	16"	15"	42"	RDTSJWT142(L/R)() () ()	\$2,356.	\$3,065.	\$3,524.	\$4,582.
	19"	15"	42"	RDTSJWT142(L/R)() () ()	2,456.	3,193.	3,672.	4,814.

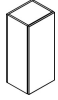

56" h Desk top tower, single width bookcase	16"	15"	56"	RDTSJWT156(L/R)() () ()	2,729.	3,547.	4,078.	5,303.
	19"	15"	56"	RDTSJWT156(L/R)() () ()	2,850.	3,703.	4,259.	5,537.



Order Code	Specification Information	Application Notes
Example: RDTSJWT142 () () ()	<i>To order please specify pattern number including:</i> Left or right hand as applicable and embedded in the pattern number.	It is Not advisable to mix 28³/₈" h desk height products with 26¹/₂" standard height products.
R Reff		
DT Reff Desktop Tower	1. <i>Case finish type:</i> L = Laminate 1 = V1 2 = V2 3 = V3	Product on this page Excluding J-pull option and any vertical surface over 60" , will accept wood grain laminate, where laminate is currently an option.
S Single width		
G Hinge glass door	2. <i>Case finish:</i> V316	1 1/2" thick worksurfaces are recommended to be used with these Desktop towers. See page 250.
W Wood Shelves		
T Letter width 16" nominal	3. <i>Door frame type:</i> Anodized or Painted	These products are Glue and Dowel Construction.
1 Letter depth 15" nominal		
42 42" high nominal	4. <i>Door glass finish:</i> GL11, GL14, GL15, GL17, GL18	Shelves on single high available with 2 adjustable shelves.
L Left / Right hand		
2 Case finish type	5. Lock options: L = Lock N = No lock	All adjustable shelves have 2 1/2", up or down flexibility.
V316 Case finish		
AU Door frame finish	6. Lock finish: B = Black S = Matte silver	
GL11 Door glass finish		
L Lock		
S Matte silver		

Desktop Towers, 28³/₈" planning

Double Wide, 42" and 56" High

Bookcase

description	w	d	h	pattern no.	L	V1	V2	V3
42" h Desk top tower, double width bookcase / open shelves	30"	15"	42"	RDTDBW3142() ()	\$1,929.	\$3,086.	\$3,549.	\$4,614.
	36"	15"	42"	RDTDBW6142() ()	1,983.	3,175.	3,651.	4,747.

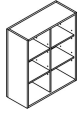

56" h Desk top tower, double width bookcase / open shelves	30"	15"	56"	RDTDBW3156() ()	2,302.	3,683.	4,236.	5,506.
	36"	15"	56"	RDTDBW6156() ()	2,366.	3,783.	4,351.	5,657.

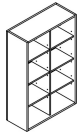

Order Code

Example:	RDTSBWT142() ()
R	Reff
DT	Reff Desktop Tower
S	Single width
B	Bookcase
W	Wood Shelves
T	Letter width 16" nominal
1	Letter depth 15" nominal
42	42" high nominal
V2	Case finish type
V316	Case finish

Specification Information

To order please specify pattern number including:
Left or right hand as applicable and embedded in the pattern number.

- Case finish type:
L = Laminate
1 = V1
2 = V2
3 = V3
- Case finish:
Wood or Laminate

Application Notes

It is Not advisable to mix 28³/₈" h desk height products with 26¹/₂" standard height products.

Product on this page **Excluding J-pull option and any vertical surface over 60"**, will accept wood grain laminate, where laminate is currently an option.

1 1/2" thick worksurfaces are recommended to be used with these Desktop towers. See page 250.

These products are Glue and Dowel Construction.

42" h desk top towers for use with single tier overhead bridges and floorstanding cabinet.

56" h desk top tower for use with double tier overhead bridges and floor standing cabinet.

Shelves to match case finish.

Shelves on single height available with 2 adjustable shelves.

Shelves on double high available with one fixed middle shelf, one upper and one lower adjustable shelf.

All adjustable shelves have 2 1/2", up or down flexibility.

Desktop Towers, 28^{3/8}" planning

Double Wide, 42" and 56" High

Wood hinged doors

description	w	d	h	pattern no.	L/L	L/V1	L/V2	L/V3	V1/V1	V2/V2	V3/V3
42" h Desk top tower, double width	30"	15"	42"	RDTDHW3142()	\$2,265.	\$2,606.	\$2,718.	\$2,946.	\$3,624.	\$4,168.	\$5,418.
wood shelves behind wood hinge door	36"	15"	42"	RDTDHW6142()	2,351.	2,704.	2,822.	3,059.	3,763.	4,327.	5,626.

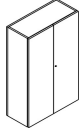

56" h Desk top tower, double width	30"	15"	56"	RDTDHW3156()	2,620.	2,882.	3,171.	3,487.	4,192.	4,822.	6,267.
wood shelves behind wood hinge door	36"	15"	56"	RDTDHW6156()	2,741.	3,014.	3,316.	3,648.	4,385.	5,042.	6,555.

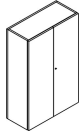

Order Code

Example:	RDTDHW3142 ()
RDT	Reff Desktop Tower
D	Double width
H	Hinge door wood
W	Wood Shelves
3	30" wide
1	Letter depth 15" nominal
42	42" high nominal
L	Left/ Right hand option
V2	Case finish type
V2	Font finish type
F	Pull option
L	Lock option doors
B	Lock finish
V316	Case finish
V316	Front finish
111	Pull finish

Specification Information

- To order please specify pattern number including:
Left or right hand as applicable and embedded in the pattern number.
- Case finish type
L = Laminate
1 = V1
2 = V2
3 = V3
 - Case finish V316
 - Pull option:
B=No pull
(Customer's own pull)
F=Bar pull (1 pull per door set)
H=Outline pull
R=Cylinder pull
T=Tab pull (1 pull per door set)
 - Lock option L, N
 - Lock finish
S=Matte Silver
B=Black
 - Case finish V316
 - Front finish V313
 - Pull finish 111

Application Notes

- It is Not advisable to mix 28^{3/8}"h desk height products with 26^{1/2}" standard height products.**
- Product on this page **Excluding J-pull option and any vertical surface over 60"**, will accept wood grain laminate, where laminate is currently an option.
- 1 1/2" thick worksurfaces are recommended to be used with these Desktop towers. See page 250.
- These products are Glue and Dowel Construction.
- 42" h desk top towers for use with single tier overhead bridges and floorstanding cabinet.
- 56" h desk top tower for use with double tier overhead bridges and floor standing cabinet.
- Shelves to match case finish.
- Shelves on single height available with 2 adjustable shelves.
- Shelves on double high available with one fixed middle shelf, one upper and one lower adjustable shelf.
- All adjustable shelves have 2 1/2", up or down flexibility.

Desktop Towers, 28^{3/8}" planning

Double Wide, 42" and 56" High

Glass hinged door

description	w	d	h	pattern no.	L	V1	V2	V3
Desk top tower, double width - Asymmetrical	30"	15"	42"	RDTAGW3142(L/R)() () ()	\$3,146.	\$4,089.	\$4,702.	\$6,113.
Split glass hinged door / open shelves all wood	30"	15"	56"	RDTAGW3156(L/R)() () ()	3,732.	4,852.	5,579.	7,254.
	36"	15"	42"	RDTAGW6142(L/R)() () ()	3,352.	4,355.	5,009.	6,512.
	36"	15"	56"	RDTAGW6156(L/R)() () ()	3,998.	5,197.	5,976.	7,769.

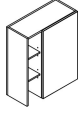

Wood interior & exterior shelves.

Left hand Desktop Tower shown. Hinged off of the center gable.

Desk top tower, double width - Asymmetrical	30"	15"	42"	RDTAGG3142(L/R)() () ()	3,016.	3,921.	4,509.	5,862.
Split glass hinged door / open shelves all glass	30"	15"	56"	RDTAGG3156(L/R)() () ()	3,539.	4,601.	5,292.	6,878.
	36"	15"	42"	RDTAGG6142(L/R)() () ()	3,222.	4,187.	4,818.	6,261.
	36"	15"	56"	RDTAGG6156(L/R)() () ()	3,805.	4,946.	5,687.	7,393.

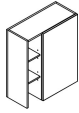

Wood interior shelves and Glass exterior shelves.

Left hand Desktop Tower shown. Hinged off of the center gable.

Desk top tower, double width	30"	15"	42"	RDTDGW3142() () ()	3,957.	4,749.	5,461.	7,099.
wood shelves behind glass hinge door	30"	15"	56"	RDTDGW3156() () ()	4,564.	5,478.	6,298.	8,188.
	36"	15"	42"	RDTDGW6142() () ()	4,129.	4,954.	5,698.	7,407.
	36"	15"	56"	RDTDGW6156() () ()	4,861.	5,832.	6,708.	8,720.

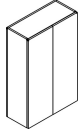

Order Code	Specification Information	Application Notes
Example: RDTAGW3142	<i>To order please specify pattern number including:</i>	It is Not advisable to mix 28^{3/8}"h desk height products with 26^{1/2}" standard height products.
RDT Reff Desktop Tower	Left or right hand as applicable and embedded in the pattern number.	Hinge glass doors feature <u>no</u> pulls, only touch latch.
A Asymmetrical split		Shelves to match case finish.
G Hinge door glass	1. <i>Case finish type:</i>	Shelves on single height available with 2 adjustable shelves.
W Wood Shelves	L = Laminate	Shelves on double high available with one fixed middle shelf, one upper and one lower adjustable shelf.
3 30" wide nominal	1 = V1	All adjustable shelves have 2 1/2", up or down flexibility.
1 Letter depth 15" nominal	2 = V2	From users perspective, the open shelves' location determines handedness.
42 42" high nominal	3 = V3	ie. Right hand - open shelves on right hand.
(L) Left / Right hand option	2. <i>Case finish:</i>	
V2 Case finish type	Wood or Laminate	
V316 Case finish	3. <i>Door frame finish:</i>	
AU Door frame finish	Anodized or Painted	
GL11 Door glass finish	4. <i>Door glass finish:</i>	
L Lock	GL11, GL14, GL15, GL17, GL18	
S Matte silver	5. Lock option:	
	L = Lock	
	N = No lock	
	6. Lock finish:	
	B = Black	
	S = Matte Silver	

Desktop Towers, 28³/₈" planning

Double Wide, 42" and 56" High

Asymmetrical with mix casing

description	w	d	h	pattern no.	L/L	L/V1	L/V2	L/V3	V1/V1	V2/V2	V3/V3
Desk top tower, double width -Asymmetrical	30"	15"	42"	RDTAHW3142(L/R) () () () () ()	\$2,403.	\$2,641.	\$2,762.	\$2,882.	\$3,675.	\$4,226.	\$5,494.
Split hinged door / open shelves all wood	30"	15"	56"	RDTAHW3156(L/R) () () () () ()	2,804.	3,084.	3,225.	3,365.	4,290.	4,933.	6,414.
	36"	15"	42"	RDTAHW6142(L/R) () () () () ()	2,496.	2,745.	2,869.	2,994.	3,817.	4,390.	5,707.
	36"	15"	56"	RDTAHW6156(L/R) () () () () ()	2,929.	3,223.	3,369.	3,516.	4,482.	5,155.	6,701.

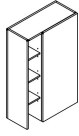

Left hand Desktop Tower shown. Hinged off of the center gable.

Desk top tower, double width -Asymmetrical	30"	15"	42"	RDTAHG3142(L/R) () () () () ()	2,600.	2,840.	2,960.	3,080.	3,872.	4,424.	5,693.
Split hinged door / open shelves all glass	30"	15"	56"	RDTAHG3156(L/R) () () () () ()	3,101.	3,380.	3,521.	3,661.	4,586.	5,230.	6,711.
	36"	15"	42"	RDTAHG6142(L/R) () () () () ()	2,694.	2,942.	3,067.	3,192.	4,016.	4,587.	5,905.
	36"	15"	56"	RDTAHG6156(L/R) () () () () ()	3,226.	3,519.	3,666.	3,812.	4,780.	5,452.	6,999.

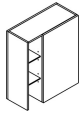

Left hand Desktop Tower shown. Hinged off of the center gable.

Order Code	Specification Information	Application Notes
Example: RDTAHW3142(L/R) () () () () ()	<i>To order please specify pattern number including:</i>	It is Not advisable to mix 28³/₈" desk height products with 26¹/₂" standard height products.
RDT	Reff Desktop Tower	Hinge glass doors feature <u>no</u> pulls, only touch latch.
A	Asymmetrical split	Wood interior shelves to match case finish.
H	Hinge door wood	Shelves on single height available with 2 adjustable shelves.
W	Wood Shelves	Shelves on double high available with one fixed middle shelf, one upper and one lower adjustable shelf.
3	30" wide nominal	All adjustable shelves have 2 ¹ / ₂ ", up or down flexibility.
1	Letter depth 15" nominal	For Desktop with open shelves, need to specify glass finish
42	42" high nominal	Glass options are:
L	Left / Right hand option	GL35 = Grey
V2	Case finish type	GL85 = Star Clear
V2	Front finish type	From users perspective, the open shelves' location determines handedness.
F	Pull option	ie. Right hand - open shelves on right hand.
L	Lock option	
B	Lock finish	
V316	Case finish	
V316	Front finish	
111	Pull finish	
GL35	Glass finish	
	1. Case finish type: L, V1, V2, V3	Product on this page Excluding J-pull option and any vertical surface over 60" , will accept wood grain laminate, where laminate is currently an option.
	2. Front finish type: L, V1, V2, V3	1 ¹ / ₂ " thick worksurfaces are recommended to be used with these Desktop towers. See page 250.
	3. Pull option: B=No pull (Customer's own pull) F=Bar pull (1 pull per door set) H=Outline pull N=No pull, touch latch R=Cylinder pull T=Tab pull (1 pull per door set)	These products are Glue and Dowel Construction.
	4. Lock option: L, N	42"h desk top towers for use with single tier overhead bridges and floorstanding cabinet.
	5. Lock finish: B=Black S=Matte Silver	56"h desk top tower for use with double tier overhead bridges and floor standing cabinet.
	6. Case finish: V316	
	7. Front finish: V316	
	8. Pull finish: Painted or Plated	

Overhead, 28³/₈" planning

Return and Bridges for overdesk units

L and U Configurations

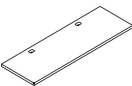
description	d	w	pattern no.	L	V1	V2	V3
Return / Bridge 1 1/2" thick 	20"	36"	RSDR361(H/V)() ()	\$427.	\$476.	\$545.	\$739.
	20"	36"	RSDR362(H/V)() ()	452.	508.	583.	785.
	20"	42"	RSDR421(H/V)() ()	443.	497.	571.	771.
	20"	48"	RSDR481(H/V)() ()	465.	515.	592.	798.
	20"	54"	RSDR541(H/V)() ()	484.	535.	619.	836.
	20"	60"	RSDR601(H/V)() ()	547.	581.	667.	903.
	20"	66"	RSDR661(H/V)() ()	535.	597.	689.	929.
	24"	42"	RSDR422(H/V)() ()	472.	524.	602.	810.
	24"	48"	RSDR482(H/V)() ()	500.	562.	645.	869.
	24"	54"	RSDR542(H/V)() ()	535.	597.	689.	929.
	24"	60"	RSDR602(H/V)() ()	577.	643.	738.	994.
	24"	66"	RSDR662(H/V)() ()	591.	672.	763.	1,030.
	24"	72"	RSDR721(H/V)() ()	565.	630.	721.	975.
	24"	72"	RSDR722(H/V)() ()	621.	692.	797.	1,077.

Order Code

Example: RSDR361(H/V)() ()	
R	Reff
S	Straight top
D	1 1/2" top
R	Return
36	36" wide
1	20" deep
H/V	Horizontal or Vertical grain
()	Grommet type
()	Grommet finish
()	Worksurface finish

Specification Information

To order please specify pattern number including:

1. Grommet type:
F = Flush
N = No Grommet
2. Grommet finish:
Painted or Plated
3. Worksurface finish:
L, V1, V2, V3

Application Notes

It is Not advisable to mix 28³/₈"h desk height products with 26¹/₂" standard height products.

Product on this page will accept wood grain laminate, where laminate is currently an option.

For any vertical surface greater than 60" wide, the grain direction is horizontal.

The above pattern codes must be used in any 'L' and 'U' configurations as shown below.

L-shaped / Double: Spanning 2 worksurfaces

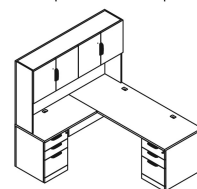

U-shaped / Triple: Spanning 3 worksurfaces

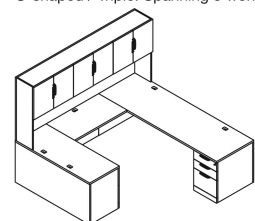

Overhead, 28³/₈" planning Modesty Panels L and U Configuration

description	w	h	th	pattern no.	L	V1	V2	V3
 Full Height Modesty, 28 ³ / ₈ "h	36"	28"	1"	RBR36MS()	\$349.	\$490.	\$562.	\$759.
	42"	28"	1"	RBR42MS()	374.	532.	613.	827.
	48"	28"	1"	RBR48MS()	421.	599.	689.	930.
	54"	28"	1"	RBR54MS()	442.	629.	720.	972.
	60"	28"	1"	RBR60MS()	458.	645.	744.	1,007.
	66"	28"	1"	RBR66MS()	475.	675.	781.	1,055.
	72"	28"	1"	RBR72MS()	525.	744.	856.	1,154.

* use with 1 1/2" thick worksurfaces.

Order Code

Example: RBR36	
R	Reff
B	Bridge
R	Return
36	36" wide
M	Full Height Modesty Placement for 28 ³ / ₈ "
()	Finish

Specification Information

To order please specify pattern number including:

1. Modesty Finish:
L, V1, V2, V3

Application Notes

It is Not advisable to mix 28³/₈"h desk height products with 26¹/₂" standard height products.

Products on this page will accept wood grain laminate, where laminate is currently an option. For any vertical surface greater than 60", the grain direction is horizontal.

The above pattern codes must be used in any 'L' and 'U' configurations as shown below.

L-shaped / Double: Spanning 2 worksurfaces

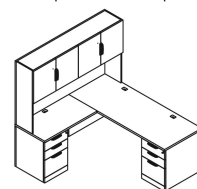

U-shaped / Triple: Spanning 3 worksurfaces

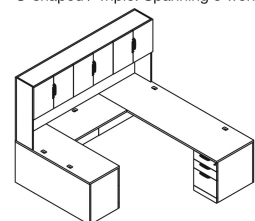

Single high

Wall hung, Open

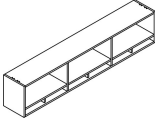
description	w	d	h	cubby divider	interior gable	pattern no.	L	V1	V2	V3
Wall-hung overhead cabinet open /cubby with center gable 	30"	15"	20"	1		ROMCGSHP301 () ()	\$1,294.	\$1,846.	\$2,124.	\$2,761.
	36"	15"	20"	1		ROMCGSHP361 () ()	1,334.	1,904.	2,190.	2,847.
	42"	15"	20"	2		ROMCGSHP421 () ()	1,449.	2,069.	2,381.	3,094.
	48"	15"	20"	2		ROMCGSHP481 () ()	1,508.	2,154.	2,475.	3,217.
	54"	15"	20"	2		ROMCGSHP541 () ()	1,767.	2,525.	2,904.	3,774.
	60"	15"	20"	2	1	ROMCGSHP601 () ()	2,051.	2,929.	3,368.	4,379.
	66"	15"	20"	2	1	ROMCGSHP661 () ()	2,089.	2,984.	3,431.	4,460.
	72"	15"	20"	2	1	ROMCGSHP721 () ()	2,130.	3,041.	3,498.	4,549.
	78"	15"	20"	2	1	ROMCGSHP781 () ()	2,237.	3,195.	3,674.	4,775.
	84"	15"	20"	3	2	ROMCGSHP841 () ()	2,601.	3,715.	4,271.	5,552.
90"	15"	20"	3	2	ROMCGSHP901 () ()	2,645.	3,777.	4,344.	5,647.	
96"	15"	20"	3	2	ROMCGSHP961 () ()	2,687.	3,838.	4,413.	5,737.	

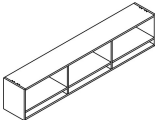
Wall-hung overhead cabinet open /cubby without center gable 	30"	15"	20"			ROMCSHP301 () ()	1,164.	1,663.	1,911.	2,486.
	36"	15"	20"			ROMCSHP361 () ()	1,201.	1,715.	1,971.	2,564.
	42"	15"	20"	1		ROMCSHP421 () ()	1,305.	1,862.	2,141.	2,786.
	48"	15"	20"	1		ROMCSHP481 () ()	1,357.	1,938.	2,228.	2,897.
	54"	15"	20"	1		ROMCSHP541 () ()	1,591.	2,272.	2,614.	3,396.
	60"	15"	20"		1	ROMCSHP601 () ()	1,845.	2,637.	3,032.	3,942.
	66"	15"	20"		1	ROMCSHP661 () ()	1,881.	2,686.	3,088.	4,016.
	72"	15"	20"		1	ROMCSHP721 () ()	1,917.	2,737.	3,149.	4,094.
	78"	15"	20"		1	ROMCSHP781 () ()	2,013.	2,875.	3,307.	4,298.
	84"	15"	20"		2	ROMCSHP841 () ()	2,341.	3,344.	3,845.	4,998.
	90"	15"	20"		2	ROMCSHP901 () ()	2,380.	3,401.	3,910.	5,082.
	96"	15"	20"		2	ROMCSHP961 () ()	2,418.	3,453.	3,971.	5,163.

Without center gable

Order Code

Example: ROMCGSHP301	
R	Reff
O	Overhead
M	Wall mount
CG	Center Gable
SH	Single high
P	Planning
30	30" width
1	Letter depth
2	Case finish type
V316	V2 finish

Specification Information

To order please specify:

- Finish type:
L = Laminate
1 = V1
2 = V2
3 = V3
- Case finish

It is Not advisable to mix 28³/₈"h desk height products with 26¹/₂" standard height products.

Product on this page will accept wood grain laminate, where laminate is currently an option. For any vertical surface greater than 60", the grain direction is horizontal.

These products are Glue and Dowel Construction.

Knoll does not assume any responsibility for the installation, attachment or the securing of wall hung units to the wall.

A certified building contractor should be consulted.

Please refer to wall mounting information on page 463.

Letter depth is 15" nominal.

Fascias ordered separately

Tasklights ordered separately

Tack/Task panel order separately

Wall hung cabinets come with wall hung cleates

Overhead backs are finished in Veneer/Laminate on inside and paper finished on the outside.

Interior clearance dimensions:
Above opening: 13¹/₈"h x 13¹/₂"d
Cubby: 3¹/₂"h x 13¹/₂"d

dimensions noted nominal

Single high

Wall hung, Open with Recessed Gables and open ends

description	h	d	w	pattern no.	L	V1	V2	V3
Wall-hung overhead cabinet	20"	15"	60"	ROMACSH601()	\$2,256.	\$3,222.	\$3,705.	\$4,817.
Single high, Open with center gable (Cantilevered open ends)	20"	15"	66"	ROMACSH661()	2,298.	3,282.	3,774.	4,906.
	20"	15"	72"	ROMACSH721()	2,343.	3,345.	3,848.	5,004.
	20"	15"	78"	ROMACSH781()	2,460.	3,514.	4,041.	5,253.
	20"	15"	84"	ROMACSH841()	2,862.	4,086.	4,698.	6,108.
	20"	15"	90"	ROMACSH901()	2,909.	4,155.	4,778.	6,211.
	20"	15"	96"	ROMACSH961()	2,955.	4,221.	4,854.	6,311.

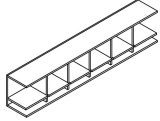

Wall-hung overhead cabinet	20"	15"	60"	ROMASH601()	2,030.	2,901.	3,335.	4,336.
Single high, Open without center gable (Cantilevered open ends)	20"	15"	66"	ROMASH661()	2,069.	2,954.	3,397.	4,418.
	20"	15"	72"	ROMASH721()	2,108.	3,010.	3,464.	4,503.
	20"	15"	78"	ROMASH781()	2,214.	3,163.	3,637.	4,728.
	20"	15"	84"	ROMASH841()	2,575.	3,678.	4,229.	5,498.
	20"	15"	90"	ROMASH901()	2,618.	3,741.	4,301.	5,590.
	20"	15"	96"	ROMASH961()	2,660.	3,799.	4,368.	5,679.

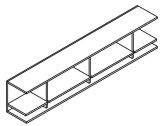

Order Code

Example: ROMACSH601()	
R	Reff
O	Overhead
M	Wall mount
A	Open Configuration
C	Center Gable
SH	Single high
60	60" width
1	Letter depth
V316	V2 finish

Specification Information

To order please specify:

- Finish type:
L = Laminate
1 = V1
2 = V2
3 = V3

It is Not advisable to mix 28³/₈"h desk height products with 26¹/₂" standard height products.

Product on this page will accept wood grain laminate, where laminate is currently an option. For any vertical surface greater than 60", the grain direction is horizontal.

These products are Glue and Dowel Construction.

Knoll does not assume any responsibility for the installation, attachment or the securing of wall hung units to the wall.

A certified building contractor should be consulted.

Please refer to wall mounting information on page 463.

Letter depth is 15" nominal.

Fascias ordered separately

Tasklights ordered separately

Tack/Task panel order separately

Wall hung cabinets come with wall hung cleates

Overhead backs are finished in Veneer/Laminate on inside and paper finished on the outside.

Interior clearance dimensions:
Above opening: 13¹/₈"h x 13¹/₂"d
Cubby: 3¹/₂"h x 13¹/₂"d

Note: The open ended overheads are not intended to be placed adjacent to one another.

dimensions noted nominal

Single high

Wall hung with wood doors

description	w	d	h	dr	pattern no.	L/L	L/V1	L/V2	L/V3	V1/V1	V2/V2	V3/V3
Wall-hung overhead cabinet hinge door, cubby concealed	30"	15"	20"	2	ROMHSHP301()	\$1,996.	\$2,238.	\$2,340.	\$2,442.	\$2,847.	\$3,276.	\$4,258.
	36"	15"	20"	2	ROMHSHP361()	2,047.	2,296.	2,400.	2,504.	2,922.	3,360.	4,369.
	42"	15"	20"	3	ROMHSHP421()	2,627.	2,947.	3,082.	3,214.	3,750.	4,313.	5,606.
	48"	15"	20"	3	ROMHSHP481()	2,696.	3,026.	3,163.	3,299.	3,850.	4,427.	5,755.
	54"	15"	20"	4	ROMHSHP541()	2,864.	3,214.	3,360.	3,506.	4,090.	4,705.	6,114.
	60"	15"	20"	4	ROMHSHP601()	3,233.	3,629.	3,794.	3,960.	4,619.	5,311.	6,904.
	66"	15"	20"	4	ROMHSHP661()	3,287.	3,688.	3,856.	4,024.	4,693.	5,399.	7,017.
	72"	15"	20"	4	ROMHSHP721()	3,342.	3,750.	3,921.	4,092.	4,773.	5,490.	7,136.
	78"	15"	20"	4	ROMHSHP781()	3,463.	3,886.	4,062.	4,239.	4,946.	5,687.	7,393.
	84"	15"	20"	6	ROMHSHP841()	4,361.	4,893.	5,115.	5,337.	6,228.	7,162.	9,308.
90"	15"	20"	6	ROMHSHP901()	4,415.	4,953.	5,177.	5,403.	6,304.	7,249.	9,423.	
96"	15"	20"	6	ROMHSHP961()	4,472.	5,016.	5,247.	5,475.	6,386.	7,345.	9,548.	

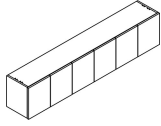

Wall-hung overhead cabinet hinge door, cubby exposed	30"	15"	20"	2	ROMHCSHP301()	1,892.	2,124.	2,219.	2,317.	2,702.	3,108.	4,040.
	36"	15"	20"	2	ROMHCSHP361()	1,942.	2,179.	2,280.	2,378.	2,774.	3,191.	4,147.
	42"	15"	20"	3	ROMHCSHP421()	2,564.	2,876.	3,007.	3,139.	3,660.	4,210.	5,472.
	48"	15"	20"	3	ROMHCSHP481()	2,665.	2,990.	3,127.	3,262.	3,806.	4,377.	5,691.
	54"	15"	20"	3	ROMHCSHP541()	2,723.	3,057.	3,196.	3,333.	3,890.	4,473.	5,815.
	60"	15"	20"	4	ROMHCSHP601()	3,024.	3,393.	3,547.	3,701.	4,318.	4,965.	6,455.
	66"	15"	20"	4	ROMHCSHP661()	3,071.	3,445.	3,601.	3,759.	4,386.	5,043.	6,557.
	72"	15"	20"	4	ROMHCSHP721()	3,124.	3,506.	3,663.	3,823.	4,462.	5,129.	6,671.
	78"	15"	20"	4	ROMHCSHP781()	3,192.	3,581.	3,743.	3,907.	4,558.	5,241.	6,814.
	84"	15"	20"	6	ROMHCSHP841()	4,030.	4,522.	4,728.	4,933.	5,755.	6,618.	8,604.
90"	15"	20"	6	ROMHCSHP901()	4,100.	4,600.	4,808.	5,016.	5,855.	6,732.	8,751.	
96"	15"	20"	6	ROMHCSHP961()	4,152.	4,660.	4,871.	5,082.	5,931.	6,819.	8,864.	

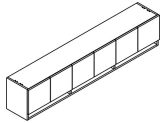

Order Code	Specification Information	Application Notes
Example: ROMHSHP301 () () () () ()	<i>To order please specify:</i>	It is Not advisable to mix 28³/₈"h desk height products with 26¹/₂" standard height products.
R Reff	1. <i>Case finish type:</i> L = Laminate 1 = V1 2 = V2 3 = V3	Letter depth is 15" nominal. Fascias ordered separately Tasklights not included Task/Task panel order separately
O Overhead	2. <i>Front finish type:</i> L = Laminate 1 = V1 2 = V2 3 = V3	Product on this page Excluding J-pull , will accept wood grain laminate, where laminate is currently an option. For any vertical surface greater than 60", the grain direction is horizontal.
M Wall mount	3. <i>Pull option:</i> B = Blank, no drilling, Customer's own pull C = nickel finish C-pull (nickel finish only) D = metal D-pull (PZ or PT) F = Bar (1 pull per door set) H = Outline R = Cylinder S = S-pull (stainless steel finish only) T = Tab (1 pull per door set)	These products are Glue and Dowel Construction. Knoll does not assume any responsibility for the installation, attachment or the securing of wall hung units to the wall. A certified building contractor should be consulted. Please refer to wall mounting information on page 463.
H Hinge door	4. <i>Lock option:</i> N=no drilling L=locking	Overhead backs are finished in Veneer/Laminate on inside and paper finished on the outside. Wall hung cabinets come with wall hung cleats.
SH Single High	5. <i>Lock finish:</i> B=Black S=Matte silver	Interior clearance dimensions: Above opening: 13 ¹ / ₈ "h x 13 ¹ / ₂ "d Cubby: 3 ¹ / ₂ "h x 13 ¹ / ₂ "d
P Planning	6. <i>Case finish:</i> V316	The single door in a 3 door unit, such as 42" w and 48" w units, is hinged on the left hand side.
30 Width	7. <i>Front finish:</i> V316	
1 Depth (letter)	8. <i>Pull finish:</i> Painted or plated	
2 Case finish type		
2 Front finish type		
H Pull option		
L Lock option		
B Lock finish		
V316 Case finish		
V316 Front finish		
PU Pull finish		

dimensions noted nominal

Single high

Wall hung with wood doors and open ends

description	w	d	h	dr	pattern no.	L/L	L/V1	L/V2	L/V3	V1/V1	V2/V2	V3/V3
Wall-hung overhead cabinet Single high, Wood doors/Open Cubby concealed (Cantilevered open ends)	60"	15"	20"		ROMFSH601(X)(X)(X)	\$3,556.	\$3,991.	\$4,173.	\$4,356.	\$5,081.	\$5,842.	\$7,595.
	66"	15"	20"		ROMFSH661(X)(X)(X)	3,616.	4,057.	4,242.	4,427.	5,163.	5,939.	7,719.
	72"	15"	20"		ROMFSH721(X)(X)(X)	3,676.	4,126.	4,313.	4,501.	5,251.	6,039.	7,850.
	78"	15"	20"		ROMFSH781(X)(X)(X)	3,810.	4,274.	4,468.	4,663.	5,440.	6,255.	8,133.
	84"	15"	20"		ROMFSH841(X)(X)(X)	4,798.	5,383.	5,626.	5,871.	6,851.	7,878.	10,239.
	90"	15"	20"		ROMFSH901(X)(X)(X)	4,856.	5,448.	5,695.	5,943.	6,934.	7,974.	10,365.
	96"	15"	20"		ROMFSH961(X)(X)(X)	4,919.	5,518.	5,772.	6,022.	7,024.	8,080.	10,503.

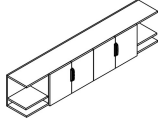

Wall-hung overhead cabinet Single high, Wood doors/Open Cubby exposed (Cantilevered open ends)	60"	15"	20"		ROMFCSH601(X)(X)(X)	3,326.	3,732.	3,901.	4,071.	4,750.	5,462.	7,101.
	66"	15"	20"		ROMFCSH661(X)(X)(X)	3,378.	3,790.	3,961.	4,135.	4,825.	5,547.	7,213.
	72"	15"	20"		ROMFCSH721(X)(X)(X)	3,437.	3,856.	4,030.	4,206.	4,908.	5,642.	7,338.
	78"	15"	20"		ROMFCSH781(X)(X)(X)	3,511.	3,939.	4,118.	4,298.	5,014.	5,765.	7,496.
	84"	15"	20"		ROMFCSH841(X)(X)(X)	4,433.	4,975.	5,201.	5,427.	6,331.	7,280.	9,464.
	90"	15"	20"		ROMFCSH901(X)(X)(X)	4,510.	5,060.	5,289.	5,518.	6,440.	7,405.	9,627.
	96"	15"	20"		ROMFCSH961(X)(X)(X)	4,568.	5,126.	5,358.	5,590.	6,524.	7,501.	9,751.

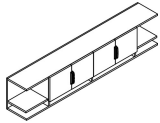

Order Code	Specification Information	Application Notes
Example: ROMFSH601 (X)(X)(X)(X)(X)	To order please specify:	It is Not advisable to mix 28 ³ / ₈ "h desk height products with 26 ¹ / ₂ " standard height products.
R Reff	1. Case finish: Laminate, V1, V2, V3	Letter depth is 15" nominal.
O Overhead	2. Front finish: Laminate, V1, V2, V3	Fascias ordered separately
M Wall mount	3. Pull option: B = Blank, no drilling, Customer's own pull C = nickel finish C-pull (nickel finish only) D = metal D-pull (PZ or PT) F = Bar (1 pull per door set) H = Outline R = Cylinder S = S-pull (stainless steel finish only) T = Tab (1 pull per door set)	Tasklights not included Tack/Task panel order separately
F Open/Wood Hinged doors	4. Pull finish: Painted or Plated	Wall hung cabinets come with wall hung cleats.
SH Single High	5. Lock option: N=no drilling L=locking	Overhead backs are finished in Veneer/Laminate on inside and paper finished on the outside.
30 Width	6. Lock finish: B=Black S=Matte silver	Interior clearance dimensions: Above opening: 13 ¹ / ₈ "h x 13 ¹ / ₂ "d Cubby: 3 ¹ / ₂ "h x 13 ¹ / ₂ "d
1 Depth (letter)		The single door in a 3 door unit, such as 42" w and 48" w units, is hinged on the left hand side.
(V316) Case finish type		Note: The open ended overheads are not intended to be placed adjacent to one another.
(V316) Front finish type		
T Pull option		
111 Pull finish		
L Lock option		
B Lock finish		

dimensions noted nominal

Single high

Wall hung with glass doors

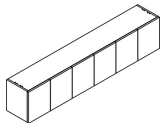
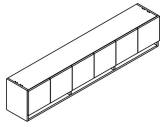
description	w	d	h	dr	pattern no.	L	V1	V2	V3
Wall-hung overhead cabinet glass hinge door, <i>cubby concealed</i> 	30"	15"	20"	2	ROMGHSHSP301()()()	\$3,055.	\$3,676.	\$4,227.	\$5,494.
	36"	15"	20"	2	ROMGHSHSP361()()()	3,203.	3,856.	4,434.	5,765.
	42"	15"	20"	3	ROMGHSHSP421()()()	4,096.	4,929.	5,668.	7,370.
	48"	15"	20"	3	ROMGHSHSP481()()()	4,219.	5,079.	5,839.	7,593.
	54"	15"	20"	3	ROMGHSHSP541()()()	4,518.	5,438.	6,254.	8,129.
	60"	15"	20"	4	ROMGHSHSP601()()()	4,844.	5,830.	6,706.	8,717.
	66"	15"	20"	4	ROMGHSHSP661()()()	4,977.	5,991.	6,890.	8,956.
	72"	15"	20"	4	ROMGHSHSP721()()()	5,119.	6,160.	7,085.	9,211.
	78"	15"	20"	4	ROMGHSHSP781()()()	5,376.	6,471.	7,442.	9,674.
	84"	15"	20"	6	ROMGHSHSP841()()()	6,388.	7,688.	8,842.	11,493.
90"	15"	20"	6	ROMGHSHSP901()()()	6,536.	7,868.	9,049.	11,762.	
96"	15"	20"	6	ROMGHSHSP961()()()	6,664.	8,017.	9,224.	11,990.	
Wall-hung overhead cabinet glass hinge door, <i>cubby exposed</i> 	30"	15"	20"	2	ROMGHCSHP301()()()	2,712.	3,015.	3,468.	4,508.
	36"	15"	20"	2	ROMGHCSHP361()()()	2,837.	3,155.	3,627.	4,716.
	42"	15"	20"	3	ROMGHCSHP421()()()	3,639.	4,046.	4,655.	6,049.
	48"	15"	20"	3	ROMGHCSHP481()()()	3,762.	4,183.	4,809.	6,253.
	54"	15"	20"	3	ROMGHCSHP541()()()	4,029.	4,479.	5,152.	6,696.
	60"	15"	20"	4	ROMGHCSHP601()()()	4,478.	4,979.	5,726.	7,444.
	66"	15"	20"	4	ROMGHCSHP661()()()	4,614.	5,128.	5,899.	7,668.
	72"	15"	20"	4	ROMGHCSHP721()()()	4,728.	5,257.	6,045.	7,861.
	78"	15"	20"	4	ROMGHCSHP781()()()	4,927.	5,479.	6,300.	8,189.
	84"	15"	20"	6	ROMGHCSHP841()()()	6,072.	6,750.	7,762.	10,092.
90"	15"	20"	6	ROMGHCSHP901()()()	6,146.	6,832.	7,857.	10,214.	
96"	15"	20"	6	ROMGHCSHP961()()()	6,281.	6,982.	8,031.	10,441.	

Order Code

Example:	ROMGHCSHP301 () () ()
R	Reff
O	Overhead
M	Wall mount
GHC	Glass hinge door/ cubby
SH	Single High
P	Planning
30	Width
1	Depth (letter)
2	Case finish type
V316	Case finish
AU	Door frame finish
GL11	Door glass finish
L	Lock option
S	Lock finish

Specification Information

- To order please specify:
- Case Finish type:
L = Laminate
1 = V1
2 = V2
3 = V3
 - Case finish:
Laminate, V1, V2, V3
 - Door frame finish:
Anodized or painted
 - Glass door finish:
GL11
GL14
GL15
GL17
GL18
 - Lock option:
L = Lock
N = No lock
 - Lock finish:
B = Black
S = Matte silver

Application Notes

- It is Not advisable to mix 28³/₈"h desk height products with 26¹/₂" standard height products.**
- Product on this page **Excluding J-pull option**, will accept wood grain laminate, where laminate is currently an option. For any vertical surface greater than 60", the grain direction is horizontal.
- These products are Glue and Dowel Construction.
- Knoll does not assume any responsibility for the installation, attachment or the securing of wall hung units to the wall. A certified building contractor should be consulted. Please refer to wall mounting information on page 463.
- Letter depth is 15" nominal.
- Fascias ordered separately
- Tasklights not included
- Tack/Task panel order separately
- Overhead backs are finished in Veneer/Laminate on inside and paper finished on the outside.
- Wall hung cabinets come with wall hung cleats.
- Interior clearance dimensions:
Above opening: 13¹/₈"h x 13¹/₂"d
Cubby: 3¹/₂"h x 13¹/₂"d
- The single door in a 3 door unit, such as 42" w and 48" w units, is hinged on the left hand side.
- No pull option on Glass doors. Glass doors project below shelf for opening.

dimensions noted nominal

Single high

Wall hung with glass doors and open ends

description	w	d	h	pattern no.	L	V1	V2	V3
Wall-hung overhead cabinet Single high, Glass doors/Open Cubby concealed (Cantilevered open ends)	60"	15"	19"	ROMGSH601()()()()	\$5,329.	\$6,413.	\$7,376.	\$9,588.
	66"	15"	19"	ROMGSH661()()()()	5,475.	6,590.	7,579.	9,852.
	72"	15"	19"	ROMGSH721()()()()	5,631.	6,776.	7,793.	10,132.
	78"	15"	19"	ROMGSH781()()()()	5,914.	7,118.	8,186.	10,641.
	84"	15"	19"	ROMGSH841()()()()	7,027.	8,456.	9,726.	12,643.
	90"	15"	19"	ROMGSH901()()()()	7,190.	8,655.	9,954.	12,938.
	96"	15"	19"	ROMGSH961()()()()	7,330.	8,818.	10,146.	13,189.

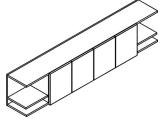

Wall-hung overhead cabinet Single high, Glass doors/Open Cubby exposed (Cantilevered open ends)	60"	15"	19"	ROMGCSH601()()()()	4,926.	5,477.	6,298.	8,188.
	66"	15"	19"	ROMGCSH661()()()()	5,075.	5,641.	6,489.	8,435.
	72"	15"	19"	ROMGCSH721()()()()	5,201.	5,783.	6,650.	8,647.
	78"	15"	19"	ROMGCSH781()()()()	5,420.	6,026.	6,930.	9,008.
	84"	15"	19"	ROMGCSH841()()()()	6,679.	7,425.	8,539.	11,101.
	90"	15"	19"	ROMGCSH901()()()()	6,760.	7,515.	8,642.	11,236.
	96"	15"	19"	ROMGCSH961()()()()	6,909.	7,681.	8,834.	11,485.

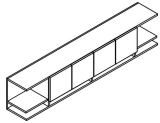

Order Code	Specification Information	Application Notes
Example: ROMGCSH601()()()()	To order please specify:	Letter depth is 15" nominal.
R Reff	1. Case finish:	Fascias ordered separately
O Overhead	Laminate, V1, V2, V3	Tasklights not included
M Wall mount	2. Door frame finish:	Tack/Task panel order separately
G Open/glass Hinged doors	Anodized or painted	Overhead backs are finished in Veneer/Laminate on inside and paper finished on the outside.
C Cubby exposed	3. Glass door finish:	Wall hung cabinets come with wall hung cleats.
SH Single High	GL11	Interior clearance dimensions:
60 Width	GL14	Above opening: 13 1/8" h x 13 1/2" d
1 Depth (letter)	GL15	Cubby: 3 1/2" h x 13 1/2" d
V316 Case finish	GL17	The single door in a 3 door unit, such as 42" w and 48" w units, is hinged on the left hand side.
AA Door frame finish	GL18	No pull option on Glass doors. Glass doors project below shelf for opening.
GL11 Door glass finish	4. Lock option:	Note: The open ended overheads are not intended to be placed adjacent to one another.
L Lock option	L = Lock	
S Lock finish	N = No lock	
	5. Lock finish:	
	B = Black	
	S = Matte silver	

dimensions noted nominal

Single high

Wall hung with doors, open

description	w	d	h	dr	pattern no.	L/L	L/V1	L/V2	L/V3	V1/V1	V2/V2	V3/V3
Wall Hung overhead cabinet	60"	15"	20"	2	ROMHOC SHP 601() () () () () ()	\$2,729.	\$3,062.	\$3,201.	\$3,338.	\$4,035.	\$4,640.	\$6,033.
hinge door / open /	66"	15"	20"	2	ROMHOC SHP 661() () () () () ()	2,770.	3,107.	3,249.	3,390.	4,096.	4,711.	6,124.
cubby exposed	72"	15"	20"	2	ROMHOC SHP 721() () () () () ()	2,815.	3,159.	3,302.	3,444.	4,164.	4,787.	6,224.
	78"	15"	20"	2	ROMHOC SHP 781() () () () () ()	2,884.	3,237.	3,385.	3,532.	4,266.	4,906.	6,379.
	84"	15"	20"	4	ROMHOC SHP 841() () () () () ()	3,353.	3,761.	3,930.	4,102.	4,957.	5,701.	7,411.
	90"	15"	20"	4	ROMHOC SHP 901() () () () () ()	3,404.	3,818.	3,992.	4,167.	5,035.	5,788.	7,525.
	96"	15"	20"	4	ROMHOC SHP 961() () () () () ()	3,446.	3,867.	4,043.	4,219.	5,098.	5,862.	7,621.

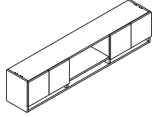

Wall Hung overhead cabinet	60"	15"	20"	2	ROMHOSH P 601() () () () () ()	2,919.	3,276.	3,426.	3,572.	4,318.	4,965.	6,455.
hinge door / open /	66"	15"	20"	2	ROMHOSH P 661() () () () () ()	2,963.	3,324.	3,477.	3,626.	4,383.	5,041.	6,553.
cubby concealed	72"	15"	20"	2	ROMHOSH P 721() () () () () ()	3,011.	3,380.	3,532.	3,685.	4,455.	5,122.	6,659.
	78"	15"	20"	2	ROMHOSH P 781() () () () () ()	3,086.	3,463.	3,621.	3,779.	4,564.	5,249.	6,825.
	84"	15"	20"	4	ROMHOSH P 841() () () () () ()	3,588.	4,024.	4,205.	4,389.	5,304.	6,100.	7,929.
	90"	15"	20"	4	ROMHOSH P 901() () () () () ()	3,642.	4,086.	4,272.	4,459.	5,387.	6,193.	8,051.
	96"	15"	20"	4	ROMHOSH P 961() () () () () ()	3,687.	4,138.	4,326.	4,514.	5,455.	6,272.	8,154.

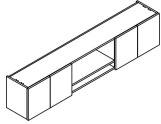

Order Code	Specification Information	Application Notes
Example: ROMHOC SHP 601 () () ()	To order please specify:	It is Not advisable to mix 28 ³ / ₈ "h desk height products with 26 ¹ / ₂ " standard height products.
R Reff	1. Case finish type: L = Laminate 1 = V1 2 = V2 3 = V3	Letter depth is 15" nominal.
O Overhead	2. Front finish type: L = Laminate 1 = V1 2 = V2 3 = V3	Fascias ordered separately
M Wall mount	3. Pull option: B = Blank, no drilling, Customer's own pull C = nickel finish C-pull (nickel finish only) D = metal D-pull (PZ or PT) F = Bar (1 pull per door set) H = Outline R = Cylinder S = S-pull (stainless steel finish only) T = Tab (1 pull per door set)	Tasklights not included
HOC Hinge door/Open/Cubby	4. Lock Option: N = no lock drilling L = locking	Tack/Task panel order separately
SH Single high	5. Lock finish: B=Black S=Matte silver	Wall hung cabinets come with wall hung cleats.
P Planning	6. Case Finish:	Interior clearance dimensions: Above opening: 13 ¹ / ₈ "h x 13 ¹ / ₂ "d Cubby: 3 ¹ / ₂ "h x 13 ¹ / ₂ "d
60 Width	7. Front Finish:	Doors project below shelf for openings.
1 Letter depth	8. Pull Finish: Painted or plated	
2 Case finish type		
2 Front finish type		
L Lock option		
B Lock Finish		
B Black lock		
V316 Case finish		
V316 Front finish		

dimensions noted nominal

Overhead, 28³/₈" planning
 Single high
 Wall hung with glass doors, open

description	w	d	h	dr	pattern no.	L	V1	V2	V3
Wall Hung overhead cabinet	60"	15"	20"	2	ROMGHOC SHP601() () ()	\$3,350.	\$4,270.	\$4,910.	\$6,384.
glass hinge door / open / cubby exposed	66"	15"	20"	2	ROMGHOC SHP661() () ()	3,429.	4,371.	5,027.	6,534.
	72"	15"	20"	2	ROMGHOC SHP721() () ()	3,499.	4,462.	5,129.	6,671.
	78"	15"	20"	2	ROMGHOC SHP781() () ()	3,597.	4,586.	5,275.	6,857.
	84"	15"	20"	4	ROMGHOC SHP841() () ()	4,408.	5,396.	6,204.	8,067.
	90"	15"	20"	4	ROMGHOC SHP901() () ()	4,462.	5,461.	6,282.	8,165.
	96"	15"	20"	4	ROMGHOC SHP961() () ()	4,555.	5,575.	6,412.	8,335.

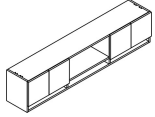

description	w	d	h	dr	pattern no.	L	V1	V2	V3
Wall Hung overhead cabinet	60"	15"	20"	2	ROMGHOSH P601() () ()	4,074.	5,196.	5,974.	7,766.
glass hinge door / open / cubby concealed	66"	15"	20"	2	ROMGHOSH P661() () ()	4,160.	5,304.	6,100.	7,930.
	72"	15"	20"	2	ROMGHOSH P721() () ()	4,265.	5,438.	6,254.	8,129.
	78"	15"	20"	2	ROMGHOSH P781() () ()	4,386.	5,592.	6,430.	8,361.
	84"	15"	20"	4	ROMGHOSH P841() () ()	5,143.	6,559.	7,543.	9,805.
	90"	15"	20"	4	ROMGHOSH P901() () ()	5,253.	6,698.	7,704.	10,014.
	96"	15"	20"	4	ROMGHOSH P961() () ()	5,338.	6,806.	7,828.	10,175.

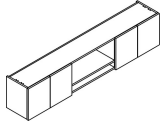

Order Code	Specification Information	Application Notes
Example: ROMGHOC SHP601 () () () ()	To order please specify:	It is Not advisable to mix 28 ³ / ₈ "h desk height products with 26 ¹ / ₂ " standard height products.
R Reff	1. Case finish type: L = Laminate	Letter depth is 15" nominal.
O Overhead	1 = V1	Fascias ordered separately
M Wall mount	2 = V2	Tasklights not included
GHOC Glass hinge door/Open/Cubby	3 = V3	Tack/Task panel order separately
SH Single high	2. Case finish: Laminate, V1, V2, V3	Overhead backs are finished in Veneer/Laminate on inside and paper finished on the outside.
P Planning	3. Door Frame finish: Painted or Anodized	Wall hung cabinets come with wall hung cleats.
60 Width	4. Door Glass finish: GL11, GL14, GL15, GL17, GL18	Interior clearance dimensions: Above opening: 13 ¹ / ₈ "h x 13 ¹ / ₂ "d Cubby: 3 ¹ / ₂ "h x 13 ¹ / ₂ "d
1 Depth, Letter	5. Lock option: L = Lock	No pull options on glass doors.
2 Case finish type, V2	N = No lock	Glass doors project below shelf for opening.
V316 Case finish	6. Lock finish: B = Black	
AA Door frame finish	S = Matte silver	
GL11 Back painted glass door finish		
L Lock option		
S Lock finish		

dimensions noted nominal

Single high

Cabinet hung with and without Center Gables

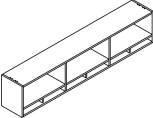
description	w	d	h	cubby divider	interior gable	pattern no.	L	V1	V2	V3
Cabinet-hung overhead cabinet open /cubby with center gable 	30"	15"	20"	1		ROCCGSH301 ()()	\$1,370.	\$1,958.	\$2,251.	\$2,927.
	36"	15"	20"	1		ROCCGSH361 ()()	1,410.	2,014.	2,315.	3,010.
	42"	15"	20"	2		ROCCGSH421 ()()	1,524.	2,177.	2,503.	3,254.
	48"	15"	20"	2		ROCCGSH481 ()()	1,567.	2,237.	2,573.	3,346.
	54"	15"	20"	2		ROCCGSH541 ()()	1,825.	2,607.	2,996.	3,896.
	60"	15"	20"	2	1	ROCCGSH601 ()()	2,107.	3,009.	3,461.	4,500.
	66"	15"	20"	2	1	ROCCGSH661 ()()	2,143.	3,060.	3,519.	4,576.
	72"	15"	20"	2	1	ROCCGSH721 ()()	2,185.	3,120.	3,588.	4,664.
	78"	15"	20"	2	1	ROCCGSH781 ()()	2,273.	3,247.	3,734.	4,853.
	84"	15"	20"	3	2	ROCCGSH841 ()()	2,635.	3,764.	4,329.	5,627.
90"	15"	20"	3	2	ROCCGSH901 ()()	2,677.	3,822.	4,397.	5,715.	
96"	15"	20"	3	2	ROCCGSH961 ()()	2,718.	3,882.	4,465.	5,804.	

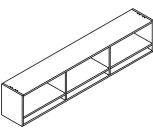
Cabinet-hung overhead cabinet open /cubby without center gable 	30"	15"	20"			ROCOSH301 ()()	1,234.	1,762.	2,026.	2,635.
	36"	15"	20"			ROCOSH361 ()()	1,270.	1,812.	2,083.	2,710.
	42"	15"	20"	1		ROCOSH421 ()()	1,370.	1,961.	2,253.	2,928.
	48"	15"	20"	1		ROCOSH481 ()()	1,410.	2,013.	2,315.	3,009.
	54"	15"	20"	1		ROCOSH541 ()()	1,643.	2,345.	2,697.	3,508.
	60"	15"	20"		1	ROCOSH601 ()()	1,896.	2,709.	3,114.	4,048.
	66"	15"	20"		1	ROCOSH661 ()()	1,929.	2,754.	3,167.	4,118.
	72"	15"	20"		1	ROCOSH721 ()()	1,967.	2,807.	3,228.	4,196.
	78"	15"	20"		1	ROCOSH781 ()()	2,047.	2,922.	3,361.	4,369.
	84"	15"	20"		2	ROCOSH841 ()()	2,372.	3,388.	3,896.	5,065.
	90"	15"	20"		2	ROCOSH901 ()()	2,410.	3,441.	3,957.	5,146.
	96"	15"	20"		2	ROCOSH961 ()()	2,447.	3,493.	4,018.	5,223.

Without center gable

Order Code	Specification Information	Application Notes
Example: ROCCGSH301S0 ()()	<i>To order please specify:</i>	It is Not advisable to mix 28³/₈"h desk height products with 26¹/₂" standard height products.
R Reff	1. Case Finish type: L = Laminate	Letter depth is 15" nominal.
O Overhead	1 = V1	Place holder for legal depth if required (20").
C Cabinet hung	2 = V2	Fascias ordered separately
CG Center Gable	3 = V3	Tasklights ordered separately
SH Single high	2. Case finish: Laminate, V1, V2, V3	Tack/Task panel order separately
P Planning		Overhead backs are finished in Veneer/Laminate on inside and paper finished on the outside.
30 30" width		Interior clearance dimensions: Above opening: 13 ¹ / ₈ "h x 13 ¹ / ₂ "d Cubby: 3 ¹ / ₂ "h x 13 ¹ / ₂ "d
1 Depth (letter)		
2 Case finish		
V316 Case finish		
		These products are Glue and Dowel Construction.
		Installation instruction sheets available on Knoll Exchange.
		Reference number 6TP00080.

dimensions noted nominal

Single high

Cabinet hung with doors

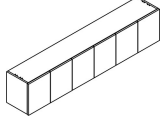
description	w	d	h	dr	pattern no.	L/L	L/V1	L/V2	L/V3	V1/V1	V2/V2	V3/V3	
Cabinet-hung overhead cabinet hinge door, cubby concealed 	30"	15"	20"	2	ROCHSHP301	() () () () () ()	\$2,060.	\$2,312.	\$2,417.	\$2,523.	\$2,942.	\$3,384.	\$4,399.
	36"	15"	20"	2	ROCHSHP361	() () () () () ()	2,109.	2,368.	2,475.	2,583.	3,012.	3,466.	4,505.
	42"	15"	20"	3	ROCHSHP421	() () () () () ()	2,689.	3,016.	3,153.	3,290.	3,840.	4,415.	5,740.
	48"	15"	20"	3	ROCHSHP481	() () () () () ()	2,743.	3,077.	3,217.	3,358.	3,917.	4,505.	5,856.
	54"	15"	20"	3	ROCHSHP541	() () () () () ()	2,908.	3,263.	3,412.	3,560.	4,153.	4,777.	6,209.
	60"	15"	20"	4	ROCHSHP601	() () () () () ()	3,278.	3,677.	3,845.	4,012.	4,680.	5,382.	6,997.
	66"	15"	20"	4	ROCHSHP661	() () () () () ()	3,328.	3,734.	3,905.	4,074.	4,752.	5,465.	7,106.
	72"	15"	20"	4	ROCHSHP721	() () () () () ()	3,383.	3,796.	3,968.	4,140.	4,830.	5,554.	7,221.
	78"	15"	20"	4	ROCHSHP781	() () () () () ()	3,487.	3,913.	4,092.	4,269.	4,980.	5,727.	7,445.
	84"	15"	20"	6	ROCHSHP841	() () () () () ()	4,385.	4,919.	5,142.	5,366.	6,261.	7,199.	9,358.
90"	15"	20"	6	ROCHSHP901	() () () () () ()	4,434.	4,976.	5,202.	5,428.	6,335.	7,283.	9,468.	
96"	15"	20"	6	ROCHSHP961	() () () () () ()	4,492.	5,039.	5,269.	5,496.	6,413.	7,376.	9,587.	

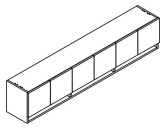
Cabinet-hung overhead cabinet hinge door, cubby exposed 	30"	15"	20"	2	ROCHCSHP301	() () () () () ()	1,957.	2,197.	2,297.	2,396.	2,796.	3,215.	4,180.
	36"	15"	20"	2	ROCHCSHP361	() () () () () ()	2,006.	2,250.	2,352.	2,456.	2,866.	3,295.	4,283.
	42"	15"	20"	3	ROCHCSHP421	() () () () () ()	2,626.	2,947.	3,081.	3,214.	3,749.	4,312.	5,605.
	48"	15"	20"	3	ROCHCSHP481	() () () () () ()	2,712.	3,043.	3,181.	3,320.	3,872.	4,454.	5,790.
	54"	15"	20"	3	ROCHCSHP541	() () () () () ()	2,769.	3,106.	3,247.	3,388.	3,953.	4,547.	5,910.
	60"	15"	20"	4	ROCHCSHP601	() () () () () ()	3,068.	3,441.	3,598.	3,755.	4,380.	5,038.	6,548.
	66"	15"	20"	4	ROCHCSHP661	() () () () () ()	3,112.	3,492.	3,650.	3,809.	4,444.	5,111.	6,643.
	72"	15"	20"	4	ROCHCSHP721	() () () () () ()	3,164.	3,550.	3,711.	3,872.	4,519.	5,197.	6,755.
	78"	15"	20"	4	ROCHCSHP781	() () () () () ()	3,216.	3,608.	3,772.	3,936.	4,592.	5,281.	6,866.
	84"	15"	20"	6	ROCHCSHP841	() () () () () ()	4,054.	4,549.	4,754.	4,961.	5,788.	6,656.	8,654.
90"	15"	20"	6	ROCHCSHP901	() () () () () ()	4,122.	4,623.	4,833.	5,043.	5,885.	6,766.	8,797.	
96"	15"	20"	6	ROCHCSHP961	() () () () () ()	4,172.	4,680.	4,893.	5,107.	5,957.	6,849.	8,905.	

Order Code	Specification Information	Application Notes
Example: ROCHSHP30 () () () () () ()	<i>To order please specify:</i>	It is Not advisable to mix 28³/₈"h desk height products with 26¹/₂" standard height products.
R Reff	1. Case Finish type: L = Laminate 1 = V1 2 = V2 3 = V3	Letter depth is 15" nominal. Fascias ordered separately Tasklights not included Tack/Task panel order separately
O Overhead	2. Front Finish type: L = Laminate 1 = V1 2 = V2 3 = V3	Overhead backs are finished in Veneer/Laminate on inside and paper finished on the outside.
C Cabinet mount	3. Pull option: B = Blank, no drilling, Customer's own pull C = nickel finish C-pull (nickel finish only) D = metal D-pull (PZ or PT) F = Bar (1 pull per door set) H = Outline R = Cylinder S = S-pull (stainless steel finish only) T = Tab (1 pull per door set)	Interior clearance dimensions: Above opening: 13 ¹ / ₈ "h x 13 ¹ / ₂ "d Cubby: 3 ¹ / ₂ "h x 13 ¹ / ₂ "d
H Hinge door	4. Lock option: N = no drilling, L = locking (wood or laminate doors only)	The single door in a 3 door unit, such as 42" w and 48" w units, is hinged on the left hand side.
SH Single High	5. Lock finish: B=Black, S=Matte silver	Doors project below shelf for opening.
P Planning	6. Case finish: Laminate or Wood	
30 Width	7. Front finish: Laminate or Wood	
1 Depth (letter)	8. Pull finish: Painted or Plated	
2 Case finish type		
2 Front finish type		
H Pull option		
L Lock option		
B Lock finish		
PU Pull finish		

dimensions noted nominal

Overhead, 28³/₈" planning
Single high
Cabinet hung with glass doors

description	w	d	h	dr	pattern no.	L	V1	V2	V3
Cabinet-hung overhead cabinet glass hinge door, <i>cubby exposed</i>	30"	15"	20"	2	ROCGHCSHP301()()()	\$2,795.	\$3,108.	\$3,575.	\$4,645.
	36"	15"	20"	2	ROCGHCSHP361()()()	2,919.	3,245.	3,732.	4,850.
	42"	15"	20"	3	ROCGHCSHP421()()()	3,720.	4,135.	4,753.	6,182.
	48"	15"	20"	3	ROCGHCSHP481()()()	3,821.	4,249.	4,886.	6,352.
	54"	15"	20"	3	ROCGHCSHP541()()()	4,087.	4,545.	5,224.	6,793.
	60"	15"	20"	4	ROCGHCSHP601()()()	4,534.	5,041.	5,797.	7,537.
	66"	15"	20"	4	ROCGHCSHP661()()()	4,667.	5,188.	5,967.	7,756.
	72"	15"	20"	4	ROCGHCSHP721()()()	4,780.	5,314.	6,111.	7,945.
	78"	15"	20"	4	ROCGHCSHP781()()()	4,958.	5,512.	6,340.	8,241.
	84"	15"	20"	6	ROCGHCSHP841()()()	6,101.	6,783.	7,800.	10,141.
90"	15"	20"	6	ROCGHCSHP901()()()	6,173.	6,861.	7,890.	10,258.	
96"	15"	20"	6	ROCGHCSHP961()()()	6,305.	7,010.	8,061.	10,480.	

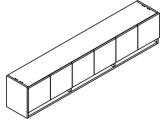

Cabinet-hung overhead cabinet glass hinge door, <i>cubby concealed</i>	30"	15"	20"	2	ROCGHSHP301()()()	3,020.	3,635.	4,180.	5,434.
	36"	15"	20"	2	ROCGHSHP361()()()	3,167.	3,811.	4,383.	5,698.
	42"	15"	20"	3	ROCGHSHP421()()()	4,056.	4,882.	5,615.	7,299.
	48"	15"	20"	3	ROCGHSHP481()()()	4,187.	5,040.	5,795.	7,536.
	54"	15"	20"	3	ROCGHSHP541()()()	4,455.	5,362.	6,165.	8,016.
	60"	15"	20"	4	ROCGHSHP601()()()	4,780.	5,753.	6,616.	8,601.
	66"	15"	20"	4	ROCGHSHP661()()()	4,910.	5,910.	6,796.	8,836.
	72"	15"	20"	4	ROCGHSHP721()()()	5,049.	6,078.	6,989.	8,977.
	78"	15"	20"	4	ROCGHSHP781()()()	5,286.	6,363.	7,317.	9,512.
	84"	15"	20"	6	ROCGHSHP841()()()	6,296.	7,577.	8,715.	11,328.
90"	15"	20"	6	ROCGHSHP901()()()	6,438.	7,749.	8,910.	11,584.	
96"	15"	20"	6	ROCGHSHP961()()()	6,540.	7,871.	9,053.	11,768.	

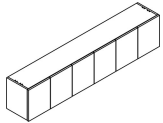

Order Code	Specification Information	Application Notes
Example: ROCGHCSHP301 ()()()	<i>To order please specify:</i>	any vertical surface greater than 60", the grain direction is horizontal
R Reff	1. <i>Case Finish type:</i> L = Laminate 1 = V1 2 = V2 3 = V3	Letter depth is 15" nominal.
O Overhead	2. <i>Case finish:</i> Laminate, V1, V2, V3	Fascias ordered separately
C Cabinet mount	3. <i>Door frame finish:</i> Anodized or Painted	Tasklights not included
GHC Glas hinge door/ cubby	4. <i>Glass door finish:</i> GL11, GL14, GL15, GL17, GL18	Tack/Task panel order separately
SH Single High	5. <i>Lock option:</i> L = Lock N = No lock	Overhead backs are finished in Veneer/Laminate on inside and paper finished on the outside.
P Planning	6. <i>Lock finish:</i> B = Black S = Matte silver	Interior clearance dimensions: Above opening: 13 1/8"h x 13 1/2"d Cubby: 3 1/2"h x 13 1/2"d
30 Width		The single door in a 3 door unit, such as 42"w and 48"w units, is hinged on the left hand side.
1 Depth (letter)		No pull option on Glass doors. Glass doors project below shelf for opening.
2 Case finish type		
V316 Case finish		
AU Door frame finish		
GL11 Door glass finish		
L Lock option		
S Lock finish		

dimensions noted nominal

Overhead, 28³/₈" planning
 Single high
 Cabinet hung with doors, open

description	w	d	h	dr	pattern no.	L/L	L/V1	L/V2	L/V3	V1/V1	V2/V2	V3/V3
Cabinet Hung overhead cabinet hinge door / open / cubby exposed	60"	15"	20"	2	ROCHOCSH601	\$2,707.	\$3,037.	\$3,174.	\$3,313.	\$4,004.	\$4,604.	\$5,985.
	66"	15"	20"	2	ROCHOCSH661	2,745.	3,082.	3,221.	3,361.	4,061.	4,670.	6,071.
	72"	15"	20"	2	ROCHOCSH721	2,790.	3,130.	3,273.	3,414.	4,127.	4,745.	6,167.
	78"	15"	20"	2	ROCHOCSH781	2,845.	3,193.	3,336.	3,482.	4,208.	4,840.	6,291.
	84"	15"	20"	4	ROCHOCSH841	3,310.	3,715.	3,884.	4,053.	4,896.	5,631.	7,322.
	90"	15"	20"	4	ROCHOCSH901	3,361.	3,770.	3,943.	4,113.	4,969.	5,715.	7,431.
	96"	15"	20"	4	ROCHOCSH961	3,402.	3,816.	3,990.	4,165.	5,032.	5,785.	7,520.

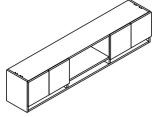

Cabinet Hung overhead cabinet hinge door / open / cubby concealed	60"	15"	20"	2	ROCHOSH601	2,897.	3,249.	3,397.	3,544.	4,283.	4,926.	6,404.
	66"	15"	20"	2	ROCHOSH661	2,937.	3,297.	3,446.	3,597.	4,345.	4,997.	6,496.
	72"	15"	20"	2	ROCHOSH721	2,986.	3,350.	3,502.	3,653.	4,416.	5,077.	6,599.
	78"	15"	20"	2	ROCHOSH781	3,044.	3,416.	3,570.	3,726.	4,502.	5,179.	6,732.
	84"	15"	20"	4	ROCHOSH841	3,541.	3,975.	4,155.	4,337.	5,239.	6,026.	7,834.
	90"	15"	20"	4	ROCHOSH901	3,597.	4,033.	4,219.	4,401.	5,317.	6,115.	7,952.
	96"	15"	20"	4	ROCHOSH961	3,640.	4,084.	4,270.	4,456.	5,384.	6,190.	8,047.

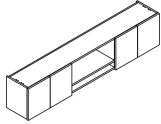

Order Code	Specification Information	Application Notes
Example: ROCHOCSH601 () () () () () ()	<i>To order please specify:</i>	It is Not advisable to mix 28³/₈"h desk height products with 26¹/₂" standard height products.
R Reff	1. <i>Case finish type:</i> L = Laminate 1 = V1 2 = V2 3 = V3	Letter depth is 15" nominal. Fascias ordered separately Tasklights not included
O Overhead	2. <i>Front finish type:</i> L = Laminate 1 = V1 2 = V2 3 = V3	Product on this page Excluding J-pull option , will accept wood grain laminate, where laminate is currently an option. For any vertical surface greater than 60", the grain direction is horizontal. Tack/Task panel order separately
C Cabinet mount	3. <i>Pull option:</i> B = Blank, no drilling, Customer's own pull C = nickel finish C-pull (nickel finish only) D = metal D-pull (PZ or PT) F = Bar (1 pull per door set) H = Outline R = Cylinder S = S-pull (stainless steel finish only) T = Tab (1 pull per door set)	Overhead backs are finished in Veneer/Laminate on inside and paper finished on the outside. Interior clearance dimensions: Above opening: 13 ¹ / ₈ "h x 13 ¹ / ₂ "d Cubby: 3 ¹ / ₂ "h x 13 ¹ / ₂ "d
HOC Hinge door / Open / Cubby	4. <i>Lock option:</i> N=no drilling, L=locking	Doors project below shelf for opening.
SH Single High	5. <i>Lock finish:</i> B=Black, S=Matte silver	
P Planning	6. <i>Case finish:</i> Wood or Laminate	
60 Width	7. <i>Front finish:</i> Wood or Laminate	
1 Depth (letter)	8. <i>Pull finish:</i> Painted or Plated	
2 Case finish type		
2 Front finish type		
T Tab pull option		
L Lock option		
B Lock finish		
V316 Case finish		
V316 Front finish		

dimensions noted nominal

Single high

Cabinet hung with glass doors, open

description	w	d	h	dr	pattern no.	L	V1	V2	V3
Cabinet Hung overhead cabinet glass hinge door / open / cubby exposed	60"	15"	20"	2	ROCGHOC SHP 601() () ()	\$3,324.	\$4,238.	\$4,874.	\$6,337.
	66"	15"	20"	2	ROCGHOC SHP 661() () ()	3,401.	4,336.	4,987.	6,482.
	72"	15"	20"	2	ROCGHOC SHP 721() () ()	3,471.	4,425.	5,089.	6,615.
	78"	15"	20"	2	ROCGHOC SHP 781() () ()	3,551.	4,527.	5,206.	6,769.
	84"	15"	20"	4	ROCGHOC SHP 841() () ()	4,359.	5,335.	6,135.	7,977.
	90"	15"	20"	4	ROCGHOC SHP 901() () ()	4,412.	5,399.	6,208.	8,071.
	96"	15"	20"	4	ROCGHOC SHP 961() () ()	4,501.	5,509.	6,337.	8,237.

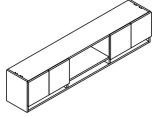

description	w	d	h	dr	pattern no.	L	V1	V2	V3
Cabinet Hung overhead cabinet glass hinge door / open / cubby concealed	60"	15"	20"	2	ROCGHOSH P 601() () ()	4,016.	5,120.	5,888.	7,654.
	66"	15"	20"	2	ROCGHOSH P 661() () ()	4,099.	5,225.	6,011.	7,813.
	72"	15"	20"	2	ROCGHOSH P 721() () ()	4,203.	5,358.	6,160.	8,009.
	78"	15"	20"	2	ROCGHOSH P 781() () ()	4,303.	5,487.	6,310.	8,202.
	84"	15"	20"	4	ROCGHOSH P 841() () ()	5,059.	6,451.	7,418.	9,644.
	90"	15"	20"	4	ROCGHOSH P 901() () ()	5,167.	6,588.	7,576.	9,849.
	96"	15"	20"	4	ROCGHOSH P 961() () ()	5,249.	6,692.	7,697.	10,005.

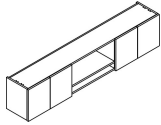

Order Code	Specification Information	Application Notes
Example: ROCGHOC SHP 601() () ()	To order please specify:	It is Not advisable to mix 28³/₈"h desk height products with 26¹/₂" standard height products.
R Reff	1. Case finish type: L = Laminate 1 = V1 2 = V2 3 = V3	Letter depth is 15" nominal. Fascias ordered separately
O Overhead	2. Case finish: Laminate, V1, V2, V3	Tasklights not included
C Cabinet mount	3. Door Frame finish: Painted or Anodized	Tack/Task panel order separately
GHOC Glass hinge door / Open / Cubby	4. Door Glass finish: GL11, GL14, GL15, GL17, GL18	Overhead backs are finished in Veneer/Laminate on inside and paper finished on the outside.
SH Single High	5. Lock option: L = Lock N = No lock	Interior clearance dimensions: Above opening: 13 ¹ / ₈ "h x 13 ¹ / ₂ "d Cubby: 3 ¹ / ₂ "h x 13 ¹ / ₂ "d
P Planning	6. Lock finish: B = Black S = Matte silver	The single door in a 3 door unit, such as 42"w and 48"w units, is hinged on the left hand side.
60 Width		Doors project below shelf for opening.
1 Depth (letter)		
2 Case finish type; V2		
V316 Case finish		
AA Door frame finish		
GL11 Back painted glass door		
L Lock option		
S Lock finish		

dimensions noted nominal

Double high

Wall hung, Open

description	w	h	d	cubby divider	interior gable	pattern no.	L	V1	V2	V3
Wall-hung overhead cabinet open /cubby with center gable	30"	33"	15"		1	ROMCGDHP301 ()()	\$1,951.	\$2,786.	\$3,203.	\$4,166.
	36"	33"	15"		1	ROMCGDHP361 ()()	2,003.	2,860.	3,287.	4,275.
	42"	33"	15"		2	ROMCGDHP421 ()()	2,461.	3,516.	4,043.	5,256.
	48"	33"	15"		2	ROMCGDHP481 ()()	2,526.	3,605.	4,146.	5,389.
	54"	33"	15"		2	ROMCGDHP541 ()()	2,802.	4,002.	4,602.	5,982.
	60"	33"	15"		3	ROMCGDHP601 ()()	3,328.	4,752.	5,466.	7,106.
	66"	33"	15"		3	ROMCGDHP661 ()()	3,430.	4,897.	5,632.	7,322.
	72"	33"	15"		3	ROMCGDHP721 ()()	3,482.	4,972.	5,718.	7,434.
	78"	33"	15"		3	ROMCGDHP781 ()()	3,603.	5,146.	5,918.	7,694.
	84"	33"	15"		5	ROMCGDHP841 ()()	4,540.	6,483.	7,456.	9,692.
	90"	33"	15"		5	ROMCGDHP901 ()()	4,596.	6,563.	7,547.	9,811.
96"	33"	15"		5	ROMCGDHP961 ()()	4,645.	6,634.	7,628.	9,917.	

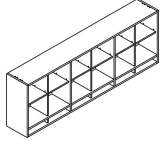

Wall-hung overhead cabinet open /cubby without center gable	30"	33"	15"			ROMOCDHP301 ()()	1,756.	2,506.	2,882.	3,748.
	36"	33"	15"			ROMOCDHP361 ()()	1,803.	2,574.	2,958.	3,847.
	42"	33"	15"		1	ROMOCDHP421 ()()	2,216.	3,164.	3,639.	4,731.
	48"	33"	15"		1	ROMOCDHP481 ()()	2,272.	3,245.	3,732.	4,851.
	54"	33"	15"		1	ROMOCDHP541 ()()	2,523.	3,601.	4,141.	5,384.
	60"	33"	15"		1	ROMOCDHP601 ()()	2,995.	4,279.	4,921.	6,396.
	66"	33"	15"		1	ROMOCDHP661 ()()	3,086.	4,408.	5,069.	6,588.
	72"	33"	15"		1	ROMOCDHP721 ()()	3,134.	4,475.	5,147.	6,690.
	78"	33"	15"		1	ROMOCDHP781 ()()	3,244.	4,631.	5,327.	6,923.
	84"	33"	15"		2	ROMOCDHP841 ()()	4,087.	5,834.	6,710.	8,723.
	90"	33"	15"		2	ROMOCDHP901 ()()	4,136.	5,907.	6,793.	8,830.
	96"	33"	15"		2	ROMOCDHP961 ()()	4,181.	5,971.	6,866.	8,926.

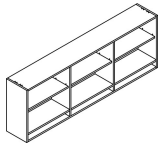

Without center gable

Order Code	Specification Information	Application Notes
Example: ROMCGDHP301 ()()()()()()	<i>To order please specify:</i>	It is Not advisable to mix 28³/₈"h desk height products with 26¹/₂" standard height products.
R Reff	1. <i>Case finish type:</i> L = Laminate	Letter depth is 15" nominal.
O Overhead	1 = V1	No glass shelves
M Wall mount	2 = V2	Fascias ordered separately
CG Center Gable	3 = V3	Tasklights not included
DH Double High	2. <i>Case finish:</i> Wood or Laminate	Tack/Task panel order separately
P Planning		Overhead backs are finished in Veneer/Laminate on inside and paper finished on the outside.
30 Width		Interior clearance dimensions: Above opening: 26 ³ / ₈ "h x 13 ¹ / ₂ "d Cubby: 3 ¹ / ₂ "h x 13 ¹ / ₂ "d *(includes one adjustable shelf)
1 Depth (letter)		These products are Glue and Dowel Construction.
2 Case finish type		Knoll does not assume any responsibility for the installation, attachment or the securing of wall hung units to the wall.
V316 Case finish		A certified building contractor should be consulted. Please refer to wall mounting information on page 463.

dimensions noted nominal

*Double high**Wall hung, Open with Recessed Gables and open ends*

description	w	d	h	pattern no.	L	V1	V2	V3
Wall-hung overhead cabinet	60"	15"	33"	ROMACDH601()	\$3,661.	\$5,227.	\$6,013.	\$7,817.
Double high, Open with center gable (Cantilevered open ends)	66"	15"	33"	ROMACDH661()	3,773.	5,387.	6,196.	8,054.
	72"	15"	33"	ROMACDH721()	3,830.	5,470.	6,290.	8,178.
	78"	15"	33"	ROMACDH781()	3,963.	5,660.	6,510.	8,463.
	84"	15"	33"	ROMACDH841()	4,994.	7,131.	8,201.	10,662.
	90"	15"	33"	ROMACDH901()	5,056.	7,219.	8,302.	10,792.
	96"	15"	33"	ROMACDH961()	5,110.	7,297.	8,391.	10,909.

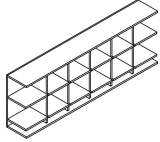

Wall-hung overhead cabinet	60"	15"	33"	ROMADH601()	3,295.	4,707.	5,413.	7,036.
Double high, Open without center gable (Cantilevered open ends)	66"	15"	33"	ROMADH661()	3,395.	4,848.	5,575.	7,246.
	72"	15"	33"	ROMADH721()	3,448.	4,923.	5,661.	7,359.
	78"	15"	33"	ROMADH781()	3,569.	5,094.	5,860.	7,615.
	84"	15"	33"	ROMADH841()	4,495.	6,418.	7,381.	9,595.
	90"	15"	33"	ROMADH901()	4,549.	6,498.	7,472.	9,713.
	96"	15"	33"	ROMADH961()	4,599.	6,568.	7,553.	9,818.

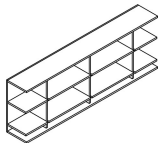
**Order Code**

Example: ROMACSH601 ()	
R	Reff
O	Overhead
M	Wall mount
A	Open Configuration
C	Center Gable
DH	Double Hung
60	Width
1	Depth (letter)
V316	Case finish

Specification Information

To order please specify:
1. Case finish:
Laminate, V1, V2, V3

Application Notes

It is Not advisable to mix 28³/₈"h desk height products with 26¹/₂" standard height products.

Product on this page **Excluding J-pull option**, will accept wood grain laminate, where laminate is currently an option. For any vertical surface greater than 60", the grain direction is horizontal.

These products are Glue and Dowel Construction.

Knoll does not assume any responsibility for the installation, attachment or the securing of wall hung units to the wall.

A certified building contractor should be consulted.

Please refer to wall mounting information on page 463.

Letter depth is 15" nominal.

Fascias ordered separately

Tasklights not included

Tack/Task panel order separately

Wall hung cabinets come with wall hung cleats.

Overhead backs are finished in Veneer/Laminate on inside and paper finished on the outside.

Interior clearance dimensions:
Above opening: 26⁵/₈"h x 13¹/₂"d
Cubby: 3¹/₂"h x 13¹/₂"d

Note: The open ended overheads are not intended to be placed adjacent to one another.

dimensions noted nominal

Double high

Wall hung with wood doors

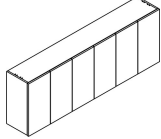
description	w	d	h	dr	pattern no.	L/L	L/V1	L/V2	L/V3	V1/V1	V2/V2	V3/V3
Wall-hung overhead cabinet hinge door, cubby concealed 	30"	15"	33"	2	ROMHDHP301()	\$2,342.	\$2,627.	\$2,748.	\$2,868.	\$3,346.	\$3,846.	\$5,000.
	36"	15"	33"	2	ROMHDHP361()	2,421.	2,717.	2,840.	2,963.	3,458.	3,976.	5,168.
	42"	15"	33"	3	ROMHDHP421()	3,244.	3,639.	3,805.	3,970.	4,632.	5,327.	6,924.
	48"	15"	33"	3	ROMHDHP481()	3,337.	3,743.	3,914.	4,084.	4,766.	5,482.	7,125.
	54"	15"	33"	3	ROMHDHP541()	3,540.	3,972.	4,152.	4,334.	5,055.	5,814.	7,558.
	60"	15"	33"	4	ROMHDHP601()	3,898.	4,373.	4,572.	4,770.	5,565.	6,400.	8,320.
	66"	15"	33"	4	ROMHDHP661()	4,021.	4,511.	4,717.	4,923.	5,742.	6,603.	8,584.
	72"	15"	33"	4	ROMHDHP721()	4,103.	4,604.	4,814.	5,023.	5,860.	6,739.	8,761.
	78"	15"	33"	4	ROMHDHP781()	4,239.	4,755.	4,972.	5,189.	6,053.	6,960.	9,049.
	84"	15"	33"	6	ROMHDHP841()	5,356.	6,011.	6,283.	6,557.	7,649.	8,797.	11,434.
	90"	15"	33"	6	ROMHDHP901()	5,452.	6,118.	6,395.	6,673.	7,785.	8,953.	11,639.
96"	15"	33"	6	ROMHDHP961()	5,523.	6,197.	6,479.	6,760.	7,886.	9,070.	11,791.	

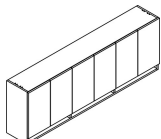
Wall-hung overhead cabinet hinge door, cubby exposed 	30"	15"	33"	2	ROMHCDHP301()	2,242.	2,514.	2,629.	3,864.	3,201.	3,682.	4,786.
	36"	15"	33"	2	ROMHCDHP361()	2,317.	2,600.	2,717.	2,835.	3,309.	3,805.	4,946.
	42"	15"	33"	3	ROMHCDHP421()	3,147.	3,532.	3,692.	3,853.	4,495.	5,168.	6,719.
	48"	15"	33"	3	ROMHCDHP481()	3,266.	3,663.	3,830.	3,998.	4,664.	5,363.	6,972.
	54"	15"	33"	3	ROMHCDHP541()	3,358.	3,767.	3,939.	4,110.	4,794.	5,513.	7,168.
	60"	15"	33"	4	ROMHCDHP601()	3,686.	4,135.	4,323.	4,511.	5,262.	6,052.	7,869.
	66"	15"	33"	4	ROMHCDHP661()	3,805.	4,269.	4,463.	4,658.	5,434.	6,247.	8,123.
	72"	15"	33"	4	ROMHCDHP721()	3,884.	4,358.	4,555.	4,752.	5,546.	6,377.	8,291.
	78"	15"	33"	4	ROMHCDHP781()	3,968.	4,453.	4,656.	4,856.	5,667.	6,518.	8,473.
	84"	15"	33"	6	ROMHCDHP841()	5,041.	5,656.	5,913.	6,172.	7,199.	8,279.	10,761.
	90"	15"	33"	6	ROMHCDHP901()	5,134.	5,761.	6,023.	6,285.	7,332.	8,432.	10,962.
96"	15"	33"	6	ROMHCDHP961()	5,203.	5,837.	6,102.	6,368.	7,430.	8,544.	11,108.	

Order Code	Specification Information	Application Notes
Example: ROMHDHP301 ()()()()()()()	To order please specify: 1. Case Finish type: L = Laminate 1 = V1 2 = V2 3 = V3 2. Front Finish type: L = Laminate 1 = V1 2 = V2 3 = V3 3. Pull option: B = Blank, no drilling, Customer's own pull C = C-pull (nickel finish only) D = metal D-pull (PZ or PT only) F = Bar (1 pull per door set) H = Outline R = Cylinder S = S-pull (stainless steel finish only) T = Tab (1 pull per door set)	It is Not advisable to mix 28 ³ / ₈ "h desk height products with 26 ¹ / ₂ " standard height products. Product on this page Excluding J-pull option , will accept wood grain laminate, where laminate is currently an option. For any vertical surface greater than 60", the grain direction is horizontal. These products are Glue and Dowel Construction. Knoll does not assume any responsibility for the installation, attachment or the securing of wall hung units to the wall. A certified building contractor should be consulted. Please refer to wall mounting information on page 463.
R Reff O Overhead M Wall mount H Hinge door DH Double High P Planning 30 Width 1 Depth (letter) 2 Case finish type 2 Front finish type H Pull option L Lock option B Lock finish PU Pull finish	Letter depth is 15" nominal. Fascias ordered separately Tasklights not included Tack/Task panel order separately Overhead backs are finished in Veneer/Laminate on inside and paper finished on the outside. Interior clearance dimensions: Above opening: 26 ⁵ / ₈ "h x 13 ¹ / ₂ "d Cubby: 3 ¹ / ₂ "h x 13 ¹ / ₂ "d *(includes one adjustable shelf) The single door in a 3 door unit, such as 42"w and 48"w units, is hinged on the left hand side. Doors project below shelf for opening.	
dimensions noted nominal	4. Lock option: N=no drilling, L=locking 5. Lock finish: B=Black, S=Matte silver 6. Case finish: 7. Front finish: 8. Pull finish: Painted or Plated	

Double high

Wall hung with wood Doors and Open ends

description	w	d	h	pattern no.	L/L	L/V1	L/V2	L/V3	V1/V1	V2/V2	V3/V3
Wall-hung overhead cabinet, Double high, Wood door/Open cubby concealed (Cantilevered open ends)	60"	15"	33"	ROMFDH601(X)(X)(X)	\$4,288.	\$4,810.	\$5,029.	\$5,247.	\$6,121.	\$7,040.	\$9,152.
	66"	15"	33"	ROMFDH661(X)(X)(X)	4,423.	4,962.	5,189.	5,415.	6,316.	7,263.	9,443.
	72"	15"	33"	ROMFDH721(X)(X)(X)	4,513.	5,065.	5,296.	5,525.	6,446.	7,413.	9,637.
	78"	15"	33"	ROMFDH781(X)(X)(X)	4,663.	5,230.	5,470.	5,707.	6,658.	7,656.	9,954.
	84"	15"	33"	ROMFDH841(X)(X)(X)	5,891.	6,612.	6,912.	7,213.	8,413.	9,676.	12,577.
	90"	15"	33"	ROMFDH901(X)(X)(X)	5,997.	6,730.	7,034.	7,340.	8,563.	9,849.	12,803.
	96"	15"	33"	ROMFDH961(X)(X)(X)	6,075.	6,817.	7,127.	7,436.	8,675.	9,977.	12,970.

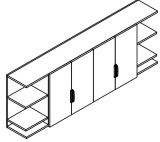

Wall-hung overhead cabinet, Double high, Wood door/Open Cubby exposed (Cantilevered open ends)	60"	15"	33"	ROMFCDH601(X)(X)(X)	4,054.	4,548.	4,756.	4,962.	5,789.	6,657.	8,656.
	66"	15"	33"	ROMFCDH661(X)(X)(X)	4,185.	4,696.	4,909.	5,123.	5,977.	6,872.	8,935.
	72"	15"	33"	ROMFCDH721(X)(X)(X)	4,272.	4,794.	5,011.	5,227.	6,101.	7,014.	9,120.
	78"	15"	33"	ROMFCDH781(X)(X)(X)	4,365.	4,898.	5,121.	5,342.	6,234.	7,170.	9,320.
	84"	15"	33"	ROMFCDH841(X)(X)(X)	5,545.	6,222.	6,505.	6,789.	7,918.	9,107.	11,838.
	90"	15"	33"	ROMFCDH901(X)(X)(X)	5,648.	6,337.	6,625.	6,914.	8,065.	9,275.	12,059.
	96"	15"	33"	ROMFCDH961(X)(X)(X)	5,723.	6,421.	6,712.	7,005.	8,173.	9,399.	12,219.

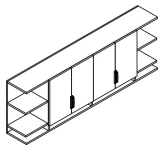

Order Code	Specification Information	Application Notes
Example: ROMFCDHSH601 (X)(X)(X)(X)(X)	<i>To order please specify:</i>	It is Not advisable to mix 28³/₈"h desk height products with 26¹/₂" standard height products.
R Reff	1. <i>Case Finish:</i> Laminate, V1,V2, V3	Letter depth is 15" nominal.
O Overhead	2. <i>Front Finish:</i> Laminate, V1, V2, V3	Fascias ordered separately
M Wall mount	3. <i>Pull option:</i> B = Blank, no drilling, Customer's own pull C = C-pull (nickel finish only) D = metal D-pull (PZ or PT only) F = Bar (1 pull per door set) H = Outline R = Cylinder S = S-pull (stainless steel finish only) T = Tab (1 pull per door set)	Tasklights not included Tack/Task panel order separately
F Open/Wood Hinge door	4. <i>Pull finish:</i> Painted or Plated	Overhead backs are finished in Veneer/Laminate on inside and paper finished on the outside.
C Cubby exposed	5. <i>Lock option:</i> N=no drilling, L=locking	Interior clearance dimensions: Above opening: 26 ⁵ / ₈ "h x 13 ¹ / ₂ "d Cubby: 3 ¹ / ₂ "h x 13 ¹ / ₂ "d
DH Double High	6. <i>Lock finish:</i> B=Black, S=Matte silver	The single door in a 3 door unit, such as 42"w and 48"w units, is hinged on the left hand side.
60 Width		Note: The open ended overheads are not intended to be placed adjacent to one another.
1 Depth (letter)		
(V316) Case finish		
(V316) Front finish		
T Pull option		
111 Pull finish		
L Lock option		
B Lock finish		

dimensions noted nominal

Double high

Wall hung with glass door

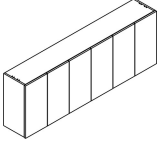
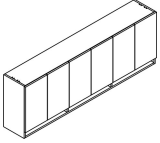
description	w	d	h	dr	pattern no.	L	V1	V2	V3
Wall-hung overhead cabinet glass hinge door, <i>cubby concealed</i> 	30"	15"	33"	2	ROMGHDHP301()()()	\$3,680.	\$4,428.	\$5,093.	\$6,620.
	36"	15"	33"	2	ROMGHDHP361()()()	3,890.	4,682.	5,384.	7,001.
	42"	15"	33"	3	ROMGHDHP421()()()	5,116.	6,156.	7,081.	9,203.
	48"	15"	33"	3	ROMGHDHP481()()()	5,304.	6,385.	7,341.	9,545.
	54"	15"	33"	3	ROMGHDHP541()()()	5,662.	6,815.	7,837.	10,189.
	60"	15"	33"	4	ROMGHDHP601()()()	6,159.	7,413.	8,526.	11,083.
	66"	15"	33"	4	ROMGHDHP661()()()	6,361.	7,656.	8,804.	11,445.
	72"	15"	33"	4	ROMGHDHP721()()()	6,558.	7,893.	9,077.	11,800.
	78"	15"	33"	4	ROMGHDHP781()()()	6,893.	8,296.	9,540.	12,403.
	84"	15"	33"	6	ROMGHDHP841()()()	8,266.	9,948.	11,440.	14,873.
	90"	15"	33"	6	ROMGHDHP901()()()	8,467.	10,189.	11,719.	15,234.
96"	15"	33"	6	ROMGHDHP961()()()	8,629.	10,386.	11,944.	15,529.	
Wall-hung overhead cabinet glass hinge door, <i>cubby exposed</i> 	30"	15"	33"	2	ROMGHCDHP301()()()	3,366.	3,776.	4,343.	5,647.
	36"	15"	33"	2	ROMGHCDHP361()()()	3,548.	3,980.	4,578.	5,949.
	42"	15"	33"	3	ROMGHCDHP421()()()	4,661.	5,229.	6,014.	7,817.
	48"	15"	33"	3	ROMGHCDHP481()()()	4,828.	5,416.	6,230.	8,098.
	54"	15"	33"	3	ROMGHCDHP541()()()	5,162.	5,791.	6,660.	8,658.
	60"	15"	33"	4	ROMGHCDHP601()()()	5,765.	6,468.	7,437.	9,670.
	66"	15"	33"	4	ROMGHCDHP661()()()	6,012.	6,746.	7,757.	10,083.
	72"	15"	33"	4	ROMGHCDHP721()()()	6,177.	6,929.	7,968.	10,359.
	78"	15"	33"	4	ROMGHCDHP781()()()	6,432.	7,217.	8,299.	10,789.
	84"	15"	33"	6	ROMGHCDHP841()()()	7,983.	8,956.	10,299.	13,390.
	90"	15"	33"	6	ROMGHCDHP901()()()	8,110.	9,099.	10,463.	13,602.
96"	15"	33"	6	ROMGHCDHP961()()()	8,291.	9,303.	10,698.	13,908.	

Order Code	Specification Information	Application Notes
Example: ROMGHCDHP301 ()()()	<i>To order please specify:</i>	It is Not advisable to mix 28³/₈"h desk height products with 26¹/₂" standard height products.
R Reff	1. <i>Case finish type:</i> L = Laminate 1 = V1 2 = V2 3 = V3	Letter depth is 15" nominal.
O Overhead	2. <i>Case finish:</i> Laminate or Wood	No glass shelves
M Wall mount	3. <i>Door frame finish:</i> Anodized / Painted	Fascias ordered separately
GHC Glass hinge door / cubby	4. <i>Door glass finish:</i> GL11 GL14 GL15 GL17 GL18	Tasklights not included
DH Double High	5. <i>Lock option:</i> L = Lock N = No lock	Tack/Task panel order separately
P Planning	6. <i>Lock finish:</i> B = Black S = Matte silver	Overhead backs are finished in Veneer/Laminate on inside and paper finished on the outside.
30 Width		Interior clearance dimensions: Above opening: 26 ³ / ₈ "h x 13 ¹ / ₂ "d Cubby: 3 ¹ / ₂ "h x 13 ¹ / ₂ "d *(includes one adjustable shelf)
1 Depth (letter)		No pull options on glass doors.
2 Case finish type		Doors project below shelf for opening.
V316 Case finish		
AU Door frame finish		
GL11 Door glass finish		
L Lock option		
S Lock finish		

dimensions noted nominal

Double high

Wall hung with glass doors and open ends

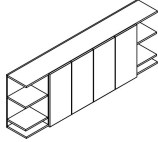
description	w	d	h	pattern no.	L	V1	V2	V3
 Wall-hung overhead cabinet glass hinge door, open, cubby concealed	60"	15"	33"	ROMGDH601 () () () ()	\$6,775.	\$8,154.	\$9,379.	\$12,192.
	66"	15"	33"	ROMGDH661 () () () ()	6,997.	8,421.	9,684.	12,590.
	72"	15"	33"	ROMGDH721 () () () ()	7,214.	8,682.	9,985.	12,980.
	78"	15"	33"	ROMGDH781 () () () ()	7,582.	9,126.	10,494.	13,643.
	84"	15"	33"	ROMGDH841 () () () ()	9,092.	10,942.	12,584.	16,370.
	90"	15"	33"	ROMGDH901 () () () ()	9,313.	11,207.	12,891.	16,757.
	96"	15"	33"	ROMGDH961 () () () ()	9,492.	11,425.	13,139.	17,082.

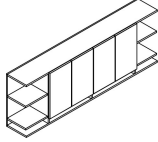
description	w	d	h	pattern no.	L	V1	V2	V3
 Wall-hung overhead cabinet glass hinge door, open, cubby exposed	60"	15"	33"	ROMGCDH601 () () () ()	6,341.	7,115.	8,181.	10,637.
	66"	15"	33"	ROMGCDH661 () () () ()	6,613.	7,420.	8,533.	11,091.
	72"	15"	33"	ROMGCDH721 () () () ()	6,794.	7,622.	8,765.	11,395.
	78"	15"	33"	ROMGCDH781 () () () ()	7,075.	7,939.	9,129.	11,868.
	84"	15"	33"	ROMGCDH841 () () () ()	8,781.	9,852.	11,329.	14,729.
	90"	15"	33"	ROMGCDH901 () () () ()	8,921.	10,006.	11,510.	14,962.
	96"	15"	33"	ROMGCDH961 () () () ()	9,120.	10,233.	11,768.	15,299.

Order Code	Specification Information	Application Notes
Example: ROMGCDH601 ()	<i>To order please specify:</i>	
R Reff	1. <i>Case finish:</i> Laminate, V1, V2, V3	Letter depth is 15" nominal.
O Overhead	2. <i>Door frame finish:</i> Anodized / Painted	No glass shelves
M Wall mount	3. <i>Door glass finish:</i> GL11 GL14 GL15 GL17 GL18	Fascias ordered separately
G Open/Glass hinge door/Open	4. <i>Lock option:</i> L = Lock N = No lock	Tasklights not included
C Cubby exposed	5. <i>Lock finish:</i> B = Black S = Matte silver	Tack/Task panel order separately
DH Double High		Overhead backs are finished in Veneer/Laminate on inside and paper finished on the outside.
60 Width		Interior clearance dimensions: Above opening: 26 ⁵ / ₈ "h x 13 ¹ / ₂ "d Cubby: 3 ¹ / ₂ "h x 13 ¹ / ₂ "d *(includes one adjustable shelf)
1 Depth (letter)		No pull options on glass doors.
V316 Case finish		Doors project below shelf for opening.
AA Door frame finish		Note: The open ended overheads are not intended to be placed adjacent to one another.
GL11 Door glass finish		
L Lock option		
B Lock finish		

dimensions noted nominal

Double high

Wall hung with doors, open

description	w	d	h	dr	pattern no.	L/L	L/V1	L/V2	L/V3	V1/V1	V2/V2	V3/V3	
Wall Hung overhead cabinet hinge door/ open / cubby exposed	60"	15"	33"	2	ROMHOC DHP601	(X)(X)(X)(X)(X)	\$3,485.	\$3,911.	\$4,088.	\$4,265.	\$5,154.	\$5,928.	\$7,706.
	66"	15"	33"	2	ROMHOC DHP661	(X)(X)(X)(X)(X)	3,543.	3,976.	4,155.	4,337.	5,240.	6,026.	7,834.
	72"	15"	33"	2	ROMHOC DHP721	(X)(X)(X)(X)(X)	3,610.	4,052.	4,234.	4,419.	5,339.	6,140.	7,984.
	78"	15"	33"	2	ROMHOC DHP781	(X)(X)(X)(X)(X)	3,681.	4,130.	4,317.	4,506.	5,444.	6,261.	8,139.
	84"	15"	33"	4	ROMHOC DHP841	(X)(X)(X)(X)(X)	4,239.	4,755.	4,972.	5,189.	6,269.	7,211.	9,374.
	90"	15"	33"	4	ROMHOC DHP901	(X)(X)(X)(X)(X)	4,311.	4,836.	5,056.	5,276.	6,374.	7,331.	9,530.
	96"	15"	33"	4	ROMHOC DHP961	(X)(X)(X)(X)(X)	4,373.	4,906.	5,128.	5,353.	6,468.	7,438.	9,670.

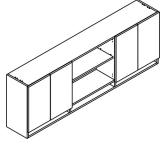

Wall Hung overhead cabinet hinge door/ open / cubby concealed	60"	15"	33"	2	ROMHODHP601	(X)(X)(X)(X)(X)	3,729.	4,185.	4,374.	4,563.	5,515.	6,343.	8,245.
	66"	15"	33"	2	ROMHODHP661	(X)(X)(X)(X)(X)	3,791.	4,255.	4,446.	4,640.	5,607.	6,448.	8,382.
	72"	15"	33"	2	ROMHODHP721	(X)(X)(X)(X)(X)	3,863.	4,336.	4,531.	4,728.	5,713.	6,569.	8,542.
	78"	15"	33"	2	ROMHODHP781	(X)(X)(X)(X)(X)	3,938.	4,419.	4,620.	4,822.	5,825.	6,699.	8,708.
	84"	15"	33"	4	ROMHODHP841	(X)(X)(X)(X)(X)	4,537.	5,088.	5,321.	5,551.	6,708.	7,715.	10,030.
	90"	15"	33"	4	ROMHODHP901	(X)(X)(X)(X)(X)	4,613.	5,174.	5,410.	5,645.	6,820.	7,844.	10,198.
	96"	15"	33"	4	ROMHODHP961	(X)(X)(X)(X)(X)	4,679.	5,249.	5,487.	5,728.	6,921.	7,959.	10,346.

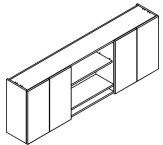

Order Code	Specification Information	Application Notes
Example: ROMHOC DHP601 (X)(X)(X)(X)(X)	<i>To order please specify:</i>	It is Not advisable to mix 28³/₈"h desk height products with 26¹/₂" standard height products.
R Reff	1. <i>Case Finish type:</i> L = Laminate 1 = V1 2 = V2 3 = V3	Letter depth is 15" nominal. Fascias ordered separately Tasklights not included
O Overhead	2. <i>Front Finish type:</i> L = Laminate 1 = V1 2 = V2 3 = V3	Product on this page Excluding J-pull option , will accept wood grain laminate, where laminate is currently an option. For any vertical surface greater than 60", the grain direction is horizontal.
M Wall mount	3. <i>Pull option:</i> B = Blank, no drilling, Customer's own pull C = nickel finish C-pull (nickel finish only) D = metal D-pull (finish optional) F = Bar (1 pull per door set) H = Outline R = Cylinder S = S-pull (stainless steel finish only) T = Tab (1 pull per door set)	Tack/Task panel order separately Overhead backs are finished in Veneer/Laminate on inside and paper finished on the outside. Interior clearance dimensions: Above opening: 26 ³ / ₈ "h x 13 ¹ / ₂ "d Cubby: 3 ¹ / ₂ "h x 13 ¹ / ₂ "d *(includes one adjustable shelf)
HOC Hinge door / open / cubby	4. <i>Lock Option:</i> N=no lock, L=locking	These products are Glue and Dowel Construction.
DH Double High	5. <i>Lock finish:</i> B=Black, S=Matte silver	Knoll does not assume any responsibility for the installation, attachment or the securing of wall hung units to the wall. A certified building contractor should be consulted. Please refer to wall mounting information on page 463.
P Planning	6. <i>Case Finish</i>	Doors project below shelf for opening.
60 Width	7. <i>Front Finish</i>	
1 Depth (letter)	8. <i>Pull finish:</i> Painted or Plated	
2 Case finish type		
2 Front finish type		
L Lock option		
B Lock finish		
V316 Case finish		
V316 Front finish		

dimensions noted nominal

Double high

Wall hung with glass doors, open

description	w	d	h	dr	pattern no.	L	V1	V2	V3
Wall Hung overhead cabinet	60"	15"	33"	2	ROMGHODHP601()()()	\$5,205.	\$6,637.	\$7,631.	\$9,922.
glass hinge door / open /	66"	15"	33"	2	ROMGHODHP661()()()	5,346.	6,816.	7,839.	10,191.
cubby concealed	72"	15"	33"	2	ROMGHODHP721()()()	5,478.	6,982.	8,031.	10,440.
	78"	15"	33"	2	ROMGHODHP781()()()	5,646.	7,197.	8,277.	10,760.
	84"	15"	33"	4	ROMGHODHP841()()()	6,611.	8,430.	9,694.	12,602.
	90"	15"	33"	4	ROMGHODHP901()()()	6,755.	8,613.	9,906.	12,877.
	96"	15"	33"	4	ROMGHODHP961()()()	6,888.	8,784.	10,100.	13,131.

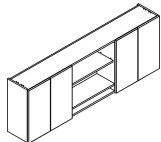

Wall Hung overhead cabinet	60"	15"	33"	2	ROMGHODHP601()()()	4,430.	5,648.	6,495.	8,444.
glass hinge door / open /	66"	15"	33"	2	ROMGHODHP661()()()	4,546.	5,797.	6,667.	8,664.
cubby exposed	72"	15"	33"	2	ROMGHODHP721()()()	4,651.	5,931.	6,819.	8,864.
	78"	15"	33"	2	ROMGHODHP781()()()	4,792.	6,083.	6,997.	9,095.
	84"	15"	33"	4	ROMGHODHP841()()()	5,753.	7,218.	8,300.	10,790.
	90"	15"	33"	4	ROMGHODHP901()()()	5,843.	7,330.	8,430.	10,959.
	96"	15"	33"	4	ROMGHODHP961()()()	5,972.	7,493.	8,615.	11,200.

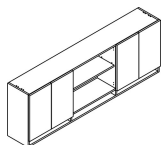

Order Code	Specification Information	Application Notes
Example: ROMGHODHP601 ()()()()	To order please specify:	Letter depth is 15" nominal.
R Reff	1. Case Finish type: L = Laminate	Fascias ordered separately
O Overhead	1 = V1	Tasklights not included
M Wall mount	2 = V2	Tack/Task panel order separately
GHOC Glass hinge door / open / cubby	3 = V3	Overhead backs are finished in Veneer/Laminate on inside and paper finished on the outside.
DH Double High	2. Case finish: Laminate or Wood	Interior clearance dimensions: Above opening: 26 ⁵ / ₈ "h x 13 ¹ / ₂ "d Cubby: 3 ¹ / ₂ "h x 13 ¹ / ₂ "d *(includes one adjustable shelf)
P Planning	3. Door Frame finish: Anodized or Painted	Doors project below shelf for opening.
60 Width	4. Door Glass finish: GL11, GL14, GL15, GL17, GL18	No pull option on glass doors.
1 Depth (letter)	5. Lock option: L = Lock	
L Lock option	N = No lock	
S Lock finish	6. Lock finish: B = Black	
	S = Matte silver	
		Product on this page Excluding J-pull option , will accept wood grain laminate, where laminate is currently an option. For any vertical surface greater than 60", the grain direction is horizontal.
		These products are Glue and Dowel Construction.
		Knoll does not assume any responsibility for the installation, attachment or the securing of wall hung units to the wall. A certified building contractor should be consulted. Please refer to wall mounting information on page 463.

dimensions noted nominal

Double high
Cabinet hung

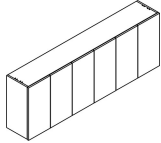
description	w	d	h	dr	pattern no.	L/L	L/V1	L/V2	L/V3	V1/V1	V2/V2	V3/V3
 Cabinet-hung overhead cabinet hinge door, cubby concealed	30"	15"	33"	2	ROCHDHP301()	\$2,420.	\$2,716.	\$2,839.	\$2,961.	\$3,457.	\$3,974.	\$5,166.
	36"	15"	33"	2	ROCHDHP361()	2,497.	2,802.	2,928.	3,057.	3,567.	4,101.	5,331.
	42"	15"	33"	3	ROCHDHP421()	3,319.	3,723.	3,892.	4,062.	4,739.	5,449.	7,084.
	48"	15"	33"	3	ROCHDHP481()	3,396.	3,811.	3,983.	4,156.	4,850.	5,577.	7,250.
	54"	15"	33"	3	ROCHDHP541()	3,597.	4,035.	4,220.	4,402.	5,138.	5,908.	7,679.
	60"	15"	33"	4	ROCHDHP601()	3,952.	4,435.	4,636.	4,839.	5,646.	6,492.	8,440.
	66"	15"	33"	4	ROCHDHP661()	4,074.	4,572.	4,780.	4,988.	5,818.	6,691.	8,698.
	72"	15"	33"	4	ROCHDHP721()	4,158.	4,665.	4,878.	5,089.	5,937.	6,829.	8,877.
	78"	15"	33"	4	ROCHDHP781()	4,275.	4,796.	5,014.	5,233.	6,106.	7,020.	9,129.
	84"	15"	33"	6	ROCHDHP841()	5,390.	6,049.	6,322.	6,599.	7,698.	8,852.	11,509.
90"	15"	33"	6	ROCHDHP901()	5,485.	6,153.	6,432.	6,713.	7,832.	9,006.	11,708.	
96"	15"	33"	6	ROCHDHP961()	5,554.	6,232.	6,515.	6,798.	7,931.	9,120.	11,858.	

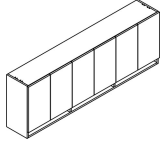
 Cabinet-hung overhead cabinet hinge door, cubby exposed	30"	15"	33"	2	ROCHCDHP301()	2,319.	2,602.	2,719.	2,837.	3,311.	3,808.	4,950.
	36"	15"	33"	2	ROCHCDHP361()	2,391.	2,683.	2,804.	2,926.	3,414.	3,926.	5,106.
	42"	15"	33"	3	ROCHCDHP421()	3,245.	3,642.	3,806.	3,971.	4,633.	5,329.	6,927.
	48"	15"	33"	3	ROCHCDHP481()	3,323.	3,729.	3,897.	4,068.	4,745.	5,457.	7,093.
	54"	15"	33"	3	ROCHCDHP541()	3,412.	3,829.	4,003.	4,178.	4,875.	5,604.	7,286.
	60"	15"	33"	4	ROCHCDHP601()	3,738.	4,193.	4,386.	4,577.	5,338.	6,139.	7,981.
	66"	15"	33"	4	ROCHCDHP661()	3,855.	4,327.	4,522.	4,719.	5,505.	6,331.	8,230.
	72"	15"	33"	4	ROCHCDHP721()	3,936.	4,415.	4,616.	4,816.	5,619.	6,462.	8,400.
	78"	15"	33"	4	ROCHCDHP781()	4,002.	4,490.	4,695.	4,898.	5,714.	6,572.	8,544.
	84"	15"	33"	6	ROCHCDHP841()	5,072.	5,691.	5,948.	6,207.	7,242.	8,327.	10,826.
90"	15"	33"	6	ROCHCDHP901()	5,163.	5,792.	6,055.	6,318.	7,373.	8,478.	11,022.	
96"	15"	33"	6	ROCHCDHP961()	5,230.	5,867.	6,134.	6,401.	7,467.	8,587.	11,164.	

Order Code	Specification Information	Application Notes
Example: ROCH-DHP301() R Reff O Overhead C Cabinet Hung H Hinge door DH Double High P Planning 30 Width 1 Depth (letter) 2 Case finish type 2 Front finish type H Pull option L Lock option B Lock finish V316 Case finish V316 Front finish PU Pull finish	To order please specify: 1. Case Finish type: L = Laminate 1 = V1 2 = V2 3 = V3 2. Front Finish type: L = Laminate 1 = V1 2 = V2 3 = V3 3. Pull option: B = Blank, no drilling, Customer's own pull C = nickel finish C-pull (nickel finish only) D = metal D-pull (finish optional) F = Bar (1 pull per door set) H = Outline R = Cylinder S = S-pull (stainless steel finish only) T = Tab (1 pull per door set) 4. Lock option: N=no lock, L=locking (wood or laminate doors only) 5. Lock finish: B=Black, S=Matte silver 6. Case finish: Wood or Laminate 7. Front finish: Wood or Laminate 8. Pull finish: Painted or Plated	It is Not advisable to mix 28 ³ / ₈ "h desk height products with 26 ¹ / ₂ " standard height products. Product on this page Excluding J-pull option , will accept wood grain laminate, where laminate is currently an option. For any vertical surface greater than 60", the grain direction is horizontal. These products are Glue and Dowel Construction. Letter depth is 15" nominal. Fascias ordered separately Tasklights not included Tack/Task panel order separately Overhead backs are finished in Veneer/Laminate on inside and paper finished on the outside. Interior clearance dimensions: Above opening: 26 ⁵ / ₈ "h x 13 ¹ / ₂ "d Cubby: 3 ¹ / ₂ "h x 13 ¹ / ₂ "d *(includes one adjustable shelf) The single door in a 3 door unit, such as 42"w and 48"w units, is hinged on the left hand side. Doors project below shelf for opening. Installation instruction sheets available on Knoll Exchange. For Cabinet hung overheads, refer to reference number 6TP00080.

dimensions noted nominal

Overhead, 28³/₈" planning
Double high
Cabinet hung with glass door

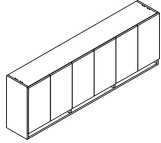
description	w	d	h	dr	pattern n	L	V1	V2	V3
Cabinet-hung overhead cabinet glass hinge door, cubby exposed 	30"	15"	33"	2	ROCGHCDHP301()()()	\$3,412.	\$3,794.	\$4,362.	\$5,671.
	36"	15"	33"	2	ROCGHCDHP361()()()	3,593.	3,993.	4,592.	5,972.
	42"	15"	33"	3	ROCGHCDHP421()()()	4,714.	5,241.	6,027.	7,835.
	48"	15"	33"	3	ROCGHCDHP481()()()	4,863.	5,406.	6,217.	8,081.
	54"	15"	33"	3	ROCGHCDHP541()()()	5,197.	5,778.	6,644.	8,638.
	60"	15"	33"	4	ROCGHCDHP601()()()	5,580.	6,205.	7,136.	9,278.
	66"	15"	33"	4	ROCGHCDHP661()()()	5,819.	6,470.	7,440.	9,673.
	72"	15"	33"	4	ROCGHCDHP721()()()	6,007.	6,680.	7,680.	9,986.
	78"	15"	33"	4	ROCGHCDHP781()()()	6,246.	6,945.	7,987.	10,382.
	84"	15"	33"	6	ROCGHCDHP841()()()	7,602.	8,451.	9,720.	12,635.
	90"	15"	33"	6	ROCGHCDHP901()()()	7,727.	8,592.	9,882.	12,844.
96"	15"	33"	6	ROCGHCDHP961()()()	7,909.	8,793.	10,111.	13,145.	

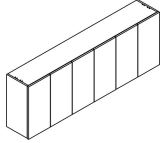
description	w	d	h	dr	pattern n	L	V1	V2	V3
Cabinet-hung overhead cabinet glass hinge door, cubby concealed 	30"	15"	33"	2	ROCGHDHP301()()()	3,663.	4,410.	5,071.	6,592.
	36"	15"	33"	2	ROCGHDHP361()()()	3,871.	4,660.	5,359.	6,965.
	42"	15"	33"	3	ROCGHDHP421()()()	5,094.	6,133.	7,053.	9,168.
	48"	15"	33"	3	ROCGHDHP481()()()	5,279.	6,353.	7,305.	9,497.
	54"	15"	33"	3	ROCGHDHP541()()()	5,618.	6,762.	7,777.	10,109.
	60"	15"	33"	4	ROCGHDHP601()()()	6,097.	7,338.	8,439.	10,971.
	66"	15"	33"	4	ROCGHDHP661()()()	6,288.	7,568.	8,703.	11,315.
	72"	15"	33"	4	ROCGHDHP721()()()	6,507.	7,832.	9,007.	11,708.
	78"	15"	33"	4	ROCGHDHP781()()()	6,820.	8,209.	9,441.	12,274.
	84"	15"	33"	6	ROCGHDHP841()()()	8,192.	9,859.	11,339.	14,741.
	90"	15"	33"	6	ROCGHDHP901()()()	8,390.	10,098.	11,613.	15,096.
96"	15"	33"	6	ROCGHDHP961()()()	8,551.	10,290.	11,835.	15,384.	

Order Code	Specification Information	Application Notes
Example: ROCGHCDHP301 () () ()	<i>To order please specify:</i>	It is Not advisable to mix 28³/₈"h desk height products with 26¹/₂" standard height products.
R Reff	1. <i>Case Finish Type:</i> L = Laminate 1 = V1 2 = V2 3 = V3	Letter depth is 15" nominal.
O Overhead	2. <i>Case Finish:</i> V316	No glass shelves
C Cabinet Hung	3. <i>Door frame finish:</i> Anotized or Painted	Fascias ordered separately
GHC Glass hinge door / cubby	4. <i>Door Glass finish:</i> GL11, GL14, GL15, GL17, GL18	Tasklights not included
DH Double High	5. <i>Lock option:</i> L = Lock N = No lock	Tack/Task panel order separately
P Planning	6. <i>Lock finish:</i> B = Black S = Matte Silver	Overhead backs are finished in Veneer/Laminate on inside and paper finished on the outside.
30 Width		Interior clearance dimensions: Above opening: 26 ³ / ₈ "h x 13 ¹ / ₂ "d Cubby: 3 ¹ / ₂ "h x 13 ¹ / ₂ "d *(includes one adjustable shelf)
1 Depth (letter)		No pull option for glass doors.
2 Case finish type		The single door in a 3 door unit, such as 42"w and 48"w units, is hinged on the left hand side.
2 Caese finish		Doors project below shelf for opening.
AU Door frame finish		Installation instruction sheets available on Knoll Exchange.
GL11 Door glass finish		For Cabinet hung overheads, refer to reference number 6TP00080.

dimensions noted nominal

Double high

Cabinet hung with and without center gable

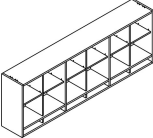
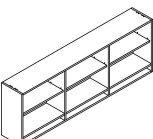
description	w	d	h	interior gable	pattern no.	L	V1	V2	V3
Cabinet-hung overhead cabinet open /cubby with center gable 	30"	15"	33"	1	ROCCGDHP301 () ()	\$2,030.	\$2,899.	\$3,332.	\$4,334.
	36"	15"	33"	1	ROCCGDHP361 () ()	2,080.	2,969.	3,414.	4,439.
	42"	15"	33"	2	ROCCGDHP421 () ()	2,537.	3,623.	4,168.	5,417.
	48"	15"	33"	2	ROCCGDHP481 () ()	2,585.	3,690.	4,245.	5,519.
	54"	15"	33"	2	ROCCGDHP541 () ()	2,860.	4,083.	4,696.	6,105.
	60"	15"	33"	3	ROCCGDHP601 () ()	3,385.	4,833.	5,559.	7,226.
	66"	15"	33"	3	ROCCGDHP661 () ()	3,484.	4,975.	5,721.	7,436.
	72"	15"	33"	3	ROCCGDHP721 () ()	3,537.	5,051.	5,809.	7,550.
	78"	15"	33"	3	ROCCGDHP781 () ()	3,641.	5,199.	5,978.	7,772.
	84"	15"	33"	5	ROCCGDHP841 () ()	4,575.	6,532.	7,512.	9,766.
	90"	15"	33"	5	ROCCGDHP901 () ()	4,628.	6,609.	7,601.	9,882.
96"	15"	33"	5	ROCCGDHP961 () ()	4,678.	6,679.	7,680.	9,985.	
Cabinet-hung overhead cabinet open /cubby without center gable 	30"	15"	33"		ROCOCDHP301 () ()	1,828.	2,609.	2,999.	3,899.
	36"	15"	33"		ROCOCDHP361 () ()	1,872.	2,672.	3,073.	3,994.
	42"	15"	33"	1	ROCOCDHP421 () ()	2,284.	3,261.	3,750.	4,876.
	48"	15"	33"	1	ROCOCDHP481 () ()	2,327.	3,322.	3,819.	4,965.
	54"	15"	33"	1	ROCOCDHP541 () ()	2,575.	3,675.	4,227.	5,494.
	60"	15"	33"	1	ROCOCDHP601 () ()	3,046.	4,350.	5,003.	6,504.
	66"	15"	33"	1	ROCOCDHP661 () ()	3,137.	4,477.	5,149.	6,692.
	72"	15"	33"	1	ROCOCDHP721 () ()	3,183.	4,547.	5,226.	6,796.
	78"	15"	33"	1	ROCOCDHP781 () ()	3,277.	4,679.	5,380.	6,994.
	84"	15"	33"	2	ROCOCDHP841 () ()	4,115.	5,880.	6,761.	8,789.
	90"	15"	33"	2	ROCOCDHP901 () ()	4,166.	5,947.	6,841.	8,894.
96"	15"	33"	2	ROCOCDHP961 () ()	4,210.	6,012.	6,912.	8,986.	

Without center gable

Order Code	Specification Information	Application Notes
Example: ROCCGDHP301 () ()	<i>To order please specify:</i>	
R Reff	1. Case finish type:	It is Not advisable to mix 28³/₈"h desk height products with 26¹/₂" standard height products.
O Overhead	L = Laminate	Product on this page Excluding J-pull option , will accept wood grain laminate, where laminate is currently an option. For any vertical surface greater than 60", the grain direction is horizontal.
C Cabinet hung	1 = V1	These products are Glue and Dowel Construction.
CG Center gable	2 = V2	
DH Double High	3 = V3	
P Planning	2. Case finish: Wood or Laminate	
30 Width		
1 Depth (letter)		
2 Case finish type		
V316 Case finish		

Letter depth is 15" nominal.

Fascias ordered separately

Tasklights not included

Tack/Task panel order separately

Overhead backs are finished in Veneer/Laminate on inside and paper finished on the outside.

Interior clearance dimensions:
Above opening: 26⁵/₈"h x 13¹/₂"d
Cubby: 3¹/₂"h x 13¹/₂"d
*(includes one adjustable shelf)

Installation instruction sheets available on Knoll Exchange.

For Cabinet hung overheads, refer to reference number 6TP00080.

dimensions noted nominal

Overhead, 28³/₈" planning

Double high

Cabinet hung with doors, open

description	w	d	h	dr	pattern no.	L/L	L/V1	L/V2	L/V3	V1/V1	V2/V2	V3/V3
Cabinet Hung overhead cabinet hinge door / open / cubby exposed	60"	15"	33"	2	ROCHODHP601()	\$3,475.	\$3,898.	\$4,075.	\$4,254.	\$5,140.	\$5,910.	\$7,682.
	66"	15"	33"	2	ROCHODHP661()	3,530.	3,962.	4,141.	4,322.	5,222.	6,004.	7,807.
	72"	15"	33"	2	ROCHODHP721()	3,597.	4,034.	4,219.	4,402.	5,321.	6,119.	7,952.
	78"	15"	33"	2	ROCHODHP781()	3,652.	4,098.	4,285.	4,470.	5,402.	6,210.	8,075.
	84"	15"	33"	4	ROCHODHP841()	4,210.	4,723.	4,937.	5,153.	6,227.	6,040.	9,307.
	90"	15"	33"	4	ROCHODHP901()	4,279.	4,800.	5,017.	5,236.	6,327.	7,278.	9,460.
	96"	15"	33"	4	ROCHODHP961()	4,340.	4,869.	5,090.	5,311.	6,418.	7,381.	9,594.

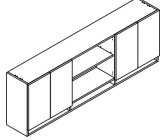

Cabinet Hung overhead cabinet hinge door / open / cubby concealed	60"	15"	33"	2	ROCHODHP601()	3,718.	4,171.	4,360.	4,552.	5,500.	6,324.	8,221.
	66"	15"	33"	2	ROCHODHP661()	3,777.	4,239.	4,431.	4,625.	5,588.	6,425.	8,354.
	72"	15"	33"	2	ROCHODHP721()	3,849.	4,317.	4,514.	4,711.	5,693.	6,548.	8,509.
	78"	15"	33"	2	ROCHODHP781()	3,907.	4,385.	4,585.	4,783.	5,780.	6,645.	8,640.
	84"	15"	33"	2	ROCHODHP841()	4,504.	5,054.	5,283.	5,513.	6,663.	6,464.	9,959.
	90"	15"	33"	2	ROCHODHP901()	4,579.	5,136.	5,369.	5,603.	6,770.	7,787.	10,122.
	96"	15"	33"	2	ROCHODHP961()	4,643.	5,210.	5,447.	5,683.	6,866.	7,898.	10,265.

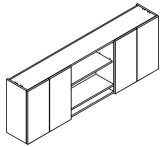

Order Code	Specification Information	Application Notes
Example: ROCH- OCDHP601()	<i>To order please specify:</i>	It is Not advisable to mix 28³/₈"h desk height products with 26¹/₂" standard height products.
R Reff	1. Case Finish type: L = Laminate 1 = V1 2 = V2 3 = V3	Letter depth is 15" nominal. Fascias ordered separately Tasklights not included Tack/Task panel order separately
O Overhead	2. Front Finish type: L = Laminate 1 = V1 2 = V2 3 = V3	Overhead backs are finished in Veneer/Laminate on inside and paper finished on the outside.
C Cabinet Hung	3. Pull option: B = Blank, no drilling, Customer's own pull C = nickel finish C-pull (nickel finish only) D = metal D-pull (finish optional) F = Bar (1 pull per door set) H = Outline R = Cylinder S = S-pull (stainless steel finish only) T = Tab (1 pull per door set)	Interior clearance dimensions: Above opening: 26 ⁵ / ₈ "h x 13 ¹ / ₂ "d Cubby: 3 ¹ / ₂ "h x 13 ¹ / ₂ "d *(includes one adjustable shelf)
HOC Hinge door / open / cubby	4. Lock option: N=no lock, L=locking (wood or laminate doors only)	Doors project below shelf for opening.
DH Double High	5. Lock finish: B=Black, S=Matte silver	Installation instruction sheets available on Knoll Exchange.
P Planning	6. Case finish: Wood or Laminate	For Cabinet hung overheads, refer to reference number 6TP00080.
30 Width	7. Front finish: Wood or Laminate	
1 Depth (letter)	8. Pull finish: Painted or Plated	
2 Case finish type		
2 Front finish type		
L Lock option		
B Lock finish		
V316 Case finish		
V316 Front finish		

dimensions noted nominal

Double high

Cabinet hung with glass doors, open

description	w	d	h	dr	pattern no.	L	V1	V2	V3
Cabinet Hung overhead cabinet glass hinge door / open / cubby exposed	60"	15"	33"	2	ROCGHOC DHP601() () ()	\$4,419.	\$5,633.	\$6,478.	\$8,422.
	66"	15"	33"	2	ROCGHOC DHP661() () ()	4,532.	5,778.	6,644.	8,638.
	72"	15"	33"	2	ROCGHOC DHP721() () ()	4,635.	5,910.	6,796.	8,837.
	78"	15"	33"	2	ROCGHOC DHP781() () ()	4,739.	6,044.	6,948.	9,032.
	84"	15"	33"	4	ROCGHOC DHP841() () ()	5,718.	7,174.	8,250.	10,724.
	90"	15"	33"	4	ROCGHOC DHP901() () ()	5,806.	7,283.	8,374.	10,889.
	96"	15"	33"	4	ROCGHOC DHP961() () ()	5,932.	7,442.	8,558.	11,125.

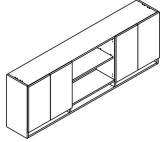

description	w	d	h	dr	pattern no.	L	V1	V2	V3
Cabinet Hung overhead cabinet glass hinge door / open / cubby concealed	60"	15"	33"	2	ROCGHODHP601() () ()	5,162.	6,581.	7,568.	9,838.
	66"	15"	33"	2	ROCGHODHP661() () ()	5,300.	6,758.	7,772.	10,102.
	72"	15"	33"	2	ROCGHODHP721() () ()	5,429.	6,922.	7,960.	10,347.
	78"	15"	33"	2	ROCGHODHP781() () ()	5,577.	7,111.	8,177.	10,631.
	84"	15"	33"	4	ROCGHODHP841() () ()	6,542.	8,340.	9,592.	12,470.
	90"	15"	33"	4	ROCGHODHP901() () ()	6,693.	8,534.	9,814.	12,759.
	96"	15"	33"	4	ROCGHODHP961() () ()	6,815.	8,689.	9,993.	12,990.

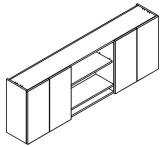

description	w	d	h	dr	pattern no.	L	V1	V2	V3
Overhead shoulder	2"	15"	68"		ROSSH681() ()	404.	424.	487.	658.
	2"	15"	82"		ROSDH821() ()	439.	464.	533.	720.



To be used with Single and Double high overheads

Order Code	Specification Information	Application Notes
Example: ROCG- HOC DHP601() () ()	<i>To order please specify:</i>	It is Not advisable to mix 28³/₈"h desk height products with 26¹/₂" standard height products.
R Reff	1. <i>Case Finish type:</i> L = Laminate	Letter depth is 15" nominal.
O Overhead	1 = V1 2 = V2	Fascias ordered separately
C Cabinet Hung	3 = V3	Tasklights not included
GHOC Glass hinge door / open / cubby	2. <i>Case finish: Laminate or Wood</i>	Tack/Task panel order separately
DH Double High	3. <i>Door Frame finish:</i> Anodized or Painted	Overhead backs are finished in Veneer/Laminate on inside and paper finished on the outside.
P Planning	4. <i>Door Glass finish:</i> GL11, GL14, GL15, GL17, GL18	Interior clearance dimensions: Above opening: 26 ³ / ₈ "h x 13 ¹ / ₂ "d Cubby: 3 ¹ / ₂ "h x 13 ¹ / ₂ "d *(includes one adjustable shelf)
60 Width	5. <i>Lock option:</i> L = Lock N = No lock	Doors project below shelf for opening.
1 Depth (letter)	6. <i>Lock finish:</i> B = Black S = Matte Silver	Installation instruction sheets available on Knoll Exchange.
		For Cabinet hung overheads, refer to reference number 6TP00080.

dimensions noted nominal

Hutches, 28³/₈" planning

Single High Surround

Open and Hinge

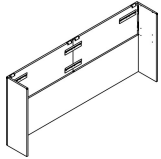
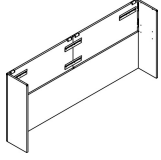
description	w	d	h	y	pattern no.	L	V1	V2	V3
 Single high surround, Open	60"	15"	42"	1.7	ROHOSHS601DH(A/D)(N/F)() ()	\$1,180.	\$1,439.	\$1,574.	\$1,887.
	65"	15"	42"	1.9	ROHOSHS661DH(A/D)(N/F)() ()	1,223.	1,485.	1,624.	1,941.
	72"	15"	42"	2.1	ROHOSHS721DH(A/D)(N/F)() ()	1,265.	1,533.	1,674.	1,997.
	78"	15"	42"	2.2	ROHOSHS781DH(A/D)(N/F)() ()	1,322.	1,599.	1,744.	2,079.
	84"	15"	42"	2.4	ROHOSHS841DH(A/D)(N/F)() ()	1,533.	1,882.	2,064.	2,486.
	90"	15"	42"	2.6	ROHOSHS901DH(A/D)(N/F)() ()	1,575.	1,928.	2,114.	2,540.
	96"	15"	42"	2.7	ROHOSHS961DH(A/D)(N/F)() ()	1,620.	1,977.	2,165.	2,596.
 Single high surround, Hinge	60"	15"	42"	1.7	ROHSHS601DH(A/D)(N/F)() ()	1,180.	1,439.	1,574.	1,887.
	66"	15"	42"	1.9	ROHSHS661DH(A/D)(N/F)() ()	1,223.	1,485.	1,624.	1,941.
	72"	15"	42"	2.1	ROHSHS721DH(A/D)(N/F)() ()	1,265.	1,533.	1,674.	1,997.
	78"	15"	42"	2.2	ROHSHS781DH(A/D)(N/F)() ()	1,322.	1,599.	1,744.	2,079.
	84"	15"	42"	2.4	ROHSHS841DH(A/D)(N/F)() ()	1,533.	1,882.	2,064.	2,486.
	90"	15"	42"	2.6	ROHSHS901DH(A/D)(N/F)() ()	1,575.	1,928.	2,114.	2,540.
	96"	15"	42"	2.7	ROHSHS961DH(A/D)(N/F)() ()	1,620.	1,977.	2,165.	2,596.

Order Code

Example: **ROHOSHS601DH**
(A/D)(N/F)() ()

R	Reff
O	Overhead
H	Hutches
O	Open, H = Hinge
SH	Single High
S	Surround
60	60" Width
DH	Desk height
A	1 1/4" worksurface
N	Unfinished
V316	Surround Finish
W281	Fabric Finish

Specification Information

To order please specify pattern number including:

1. Worksurface thickness:
A = 1 1/4" thick top
D = 1 1/2" thick top
2. Outside back finish:
N = Unfinished
F = Finished
3. Surround finish: Wood or Laminate
4. Fabric option: See page 7.

Note: Surround with unfinished outside back come with wire management hole.
Surround with finished outside back has no wire management hole.

Application Notes

It is Not advisable to mix 28³/₈"h desk height products with 26 1/2" standard height products.

Products on this page will accept wood grain laminate, where laminate is currently an option. For any vertical surface greater than 60", the grain direction is horizontal.

Actual height of Single high Surround;

*For use with 1 1/2" thick top: 42⁵/₈" high

*For use with 1 1/4" thick top: 42³/₃₂" high.

For worksurfaces, please refer to page 26 .

Note: Single high surround is to be ordered in conjunction with single high case.

Shipped knocked down.

Hardware is included.

Tackboard is included with the surrounds.

The Fabric for tackboard is railroaded.

Installation instruction sheets available on Knoll Exchange.

For Hutches, refer to reference number 6TP00321.

Hutches, 28³/₈" planning

Double High Surround

Open and Hinge

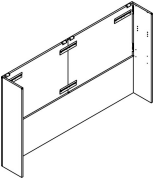
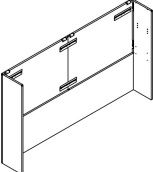
description	w	d	h	y	pattern no.	L	V1	V2	V3
 Double high surround, Open	60"	15"	56"	1.7	ROHODHS601DH(A/D)(N/F)() ()	\$1,312.	\$1,625.	\$1,788.	\$2,164.
	66"	15"	56"	1.9	ROHODHS661DH(A/D)(N/F)() ()	1,368.	1,690.	1,860.	2,248.
	72"	15"	56"	2.1	ROHODHS721DH(A/D)(N/F)() ()	1,418.	1,747.	1,919.	2,319.
	78"	15"	56"	2.2	ROHODHS781DH(A/D)(N/F)() ()	1,476.	1,815.	1,994.	2,403.
	84"	15"	56"	2.4	ROHODHS841DH(A/D)(N/F)() ()	1,732.	2,161.	2,386.	2,903.
	90"	15"	56"	2.6	ROHODHS901DH(A/D)(N/F)() ()	1,784.	2,219.	2,449.	2,976.
	96"	15"	56"	2.7	ROHODHS961DH(A/D)(N/F)() ()	1,830.	2,271.	2,503.	3,037.
 Double high surround, Hinge	60"	15"	56"	1.7	ROHHDHS601DH(A/D)(N/F)() ()	1,312.	1,625.	1,788.	2,164.
	66"	15"	56"	1.9	ROHHDHS661DH(A/D)(N/F)() ()	1,368.	1,690.	1,860.	2,248.
	72"	15"	56"	2.1	ROHHDHS721DH(A/D)(N/F)() ()	1,418.	1,747.	1,919.	2,319.
	78"	15"	56"	2.2	ROHHDHS781DH(A/D)(N/F)() ()	1,476.	1,815.	1,994.	2,403.
	84"	15"	56"	2.4	ROHHDHS841DH(A/D)(N/F)() ()	1,732.	2,161.	2,386.	2,903.
	90"	15"	56"	2.6	ROHHDHS901DH(A/D)(N/F)() ()	1,784.	2,219.	2,449.	2,976.
	96"	15"	56"	2.7	ROHHDHS961DH(A/D)(N/F)() ()	1,830.	2,271.	2,503.	3,037.

Order Code

Example:	ROHOSHS601DH (A/D)(N/F)() ()
R	Reff
O	Overhead
H	Hutches
O	Open, H = Hinge
DH	Double High
S	Surround
60	60" Width
1	Letter depth
DH	Desk Height
A	1 1/4" thick worksurface
N	Unfinished
V316	Surround Finish
W281	Fabric Finish

Specification Information

To order please specify pattern number including:

1. Worksurface thickness:
A = 1 1/4" thick top
D = 1 1/2" thick top
2. Outside back finish:
N = Unfinished
F = Finished
3. Surround finish: Wood or Laminate
4. Fabric option: See page 7.

Note: Surround with unfinished outside back come with wire management hole. Surround with finished outside back has no wire management hole.

Application Notes

It is Not advisable to mix 28³/₈"h desk height products with 26 1/2" standard height products.

Products on this page will accept wood grain laminate, where laminate is currently an option. For any vertical surface greater than 60", the grain direction is horizontal.

Actual height of Double high Surround;
*For use with 1 1/2" thick top: 56 1/8" high
*For use with 1 1/4" thick top: 56 13/32" high.

For worksurfaces, please refer to page 26.

Note: Double high surround is to be ordered in conjunction with double high case.

Shipped knocked down.

Hardware is included.

Tackboard is included with the surrounds.

The Fabric for tackboard is railroaded.

Installation instruction sheets available on Knoll Exchange.

For Hutches, refer to reference number 6TP00321.

Hutches, 28³/₈" planning Case, Single and Double High Open

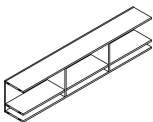
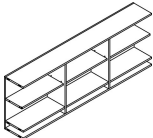
description	w	d	h	pattern no.	L	V1	V2	V3
 Single high Case, Open	60"	15"	20"	ROHOSHC601DH()	\$1,845.	\$2,585.	\$2,973.	\$3,864.
	66"	15"	20"	ROHOSHC661DH()	1,881.	2,633.	3,028.	3,937.
	72"	15"	20"	ROHOSHC721DH()	1,917.	2,683.	3,086.	4,014.
	78"	15"	20"	ROHOSHC781DH()	2,013.	2,819.	3,242.	4,214.
	84"	15"	20"	ROHOSHC841DH()	2,341.	3,278.	3,769.	4,900.
	90"	15"	20"	ROHOSHC901DH()	2,380.	3,333.	3,834.	4,983.
 Double high Case, Open	60"	15"	33"	ROHODHC601DH()	2,995.	4,194.	4,824.	6,270.
	66"	15"	33"	ROHODHC661DH()	3,086.	4,321.	4,969.	6,459.
	72"	15"	33"	ROHODHC721DH()	3,134.	4,388.	5,045.	6,559.
	78"	15"	33"	ROHODHC781DH()	3,244.	4,540.	5,222.	6,788.
	84"	15"	33"	ROHODHC841DH()	4,087.	5,721.	6,578.	8,553.
	90"	15"	33"	ROHODHC901DH()	4,136.	5,790.	6,659.	8,658.
96"	15"	33"	ROHODHC961DH()	4,181.	5,854.	6,732.	8,750.	

Order Code	Specification Information	Application Notes
Example: ROHOSHC601DH()	<i>To order please specify pattern number including:</i> 1. Case finish: Wood or Laminate	It is Not advisable to mix 28³/₈"h desk height products with 26¹/₂" standard height products. Products on this page will accept wood grain laminate, where laminate is currently an option. These products are glue and dowel construction.
R Reff O Overhead H Hutches O Open SH Single High C Case 60 60" Width 1 Letter depth DH Desk Height V613 Case Finish		

Hutches, 28³/₈" planning

Case, Single High

Wood Hinge Doors

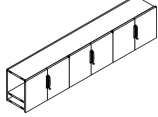
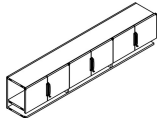
description	w	d	h	dr	pattern no.	L/L	L/V1	L/V2	L/V3	V1/V1	V2/V2	V3/V3
Single high Case with long hinge doors, cubby concealed 	60"	15"	20"	4	ROHSHC601DH()	\$3,233.	\$3,557.	\$3,720.	\$3,882.	\$4,528.	\$5,206.	\$6,769.
	66"	15"	20"	4	ROHSHC661DH()	3,288.	3,616.	3,780.	3,945.	4,602.	5,293.	6,880.
	72"	15"	20"	4	ROHSHC721DH()	3,342.	3,677.	3,844.	4,012.	4,680.	5,382.	6,997.
	78"	15"	20"	4	ROHSHC781DH()	3,463.	3,810.	3,982.	4,147.	4,848.	5,575.	7,249.
	84"	15"	20"	6	ROHSHC841DH()	4,361.	4,797.	5,014.	5,233.	6,105.	7,020.	9,126.
	90"	15"	20"	6	ROHSHC901DH()	4,415.	4,855.	5,076.	5,297.	6,180.	7,107.	9,238.
	96"	15"	20"	6	ROHSHC961DH()	4,472.	4,919.	5,143.	5,367.	6,261.	7,201.	9,360.
Single high Case with short hinge doors, cubby exposed 	60"	15"	20"	4	ROHC601DH()	3,024.	3,327.	3,477.	3,629.	4,234.	4,869.	6,328.
	66"	15"	20"	4	ROHC661DH()	3,071.	3,378.	3,530.	3,685.	4,299.	4,945.	6,428.
	72"	15"	20"	4	ROHC721DH()	3,124.	3,437.	3,593.	3,749.	4,375.	5,030.	6,540.
	78"	15"	20"	4	ROHC781DH()	3,192.	3,512.	3,671.	3,830.	4,469.	5,138.	6,681.
	84"	15"	20"	6	ROHC841DH()	4,030.	4,433.	4,636.	4,836.	5,643.	6,488.	8,436.
	90"	15"	20"	6	ROHC901DH()	4,100.	4,509.	4,715.	4,919.	5,739.	6,600.	8,580.
	96"	15"	20"	6	ROHC961DH()	4,152.	4,567.	4,774.	4,983.	5,814.	6,686.	8,690.

Order Code	Specification Information	Application Notes
Example: ROHSHC601DH () () () ()	<i>To order please specify pattern number including:</i>	It is Not advisable to mix 28³/₈"h desk height products with 26¹/₂" standard height products.
R Reff	1. Lock option: L = Drill for lock N = No lock drilling	Products on this page will accept wood grain laminate, where laminate is currently an option.
O Overhead	2. Lock finish: B = Black S = Silver	These products are glue and dowel construction.
H Hutches	3. Pull option: B = Blank, no drilling customer's own pull C = C-Pull (Nickel finish only) D = D-Pull (PT or PZ only) F = Bar pull H = Outline pull R = Cylinder pull S = S-pull, (Stainless steel finish only) T = Tab pull	Installation instructions available on Knoll Exchange.
SH Single High		For Hutches, refer to reference number 6TP00321.
C Case		
60 60" Width		
1 Letter depth		
DH Desk height		
L Lock option		
B Lock finish		
H Pull option		
111 Pull finish		
V316 Case finish	4. Pull finish: Painted or plated, unless otherwise indicated.	Note: Above Cases MUST be accompanied with Surrounds, Hinge. For Single high surrounds, refer to page 278 . Letter depth is 15" nominal. Faciars and task lights ordered separately. The case backs are finished in veneer / laminate on the inside and paper finished on the outside. Interior clearance dimension; Cubby: 3 ¹ / ₂ "h x 13 ¹ / ₂ "d Single high opening: 13 ¹ / ₈ "h x 13 ¹ / ₂ "d
V316 Front finish	5. Case finish: Wood or Laminate 6. Front finish: Wood or Laminate	Doors project below shelf for opening.

Hutches, 28³/₈" planning

Case, Single High

Glass Hinge Door

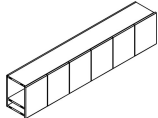
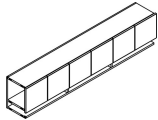
description	w	d	h	dr	pattern no.	L	V1	V2	V3
Single high Case with long Glass doors, cubby concealed 	60"	15"	20"	4	ROHGSHHC601DH()()	\$4,780.	\$5,641.	\$6,486.	\$8,432.
	66"	15"	20"	4	ROHGSHHC661DH()()	4,910.	5,793.	6,663.	8,661.
	72"	15"	20"	4	ROHGSHHC721DH()()	5,049.	5,959.	6,852.	8,907.
	78"	15"	20"	4	ROHGSHHC781DH()()	5,286.	6,238.	7,173.	9,325.
	84"	15"	20"	6	ROHGSHHC841DH()()	6,296.	7,429.	8,544.	11,107.
	90"	15"	20"	6	ROHGSHHC901DH()()	6,438.	7,596.	8,736.	11,356.
Single high Case with short Glass doors, cubby exposed 	60"	15"	20"	4	ROHGCHSHC601DH()()	4,478.	4,881.	5,614.	7,298.
	66"	15"	20"	4	ROHGCHSHC661DH()()	4,614.	5,029.	5,783.	7,517.
	72"	15"	20"	4	ROHGCHSHC721DH()()	4,728.	5,154.	5,927.	7,706.
	78"	15"	20"	4	ROHGCHSHC781DH()()	4,927.	5,371.	6,177.	8,028.
	84"	15"	20"	6	ROHGCHSHC841DH()()	6,072.	6,617.	7,611.	9,893.
	90"	15"	20"	6	ROHGCHSHC901DH()()	6,146.	6,697.	7,702.	10,014.
96"	15"	20"	6	ROHGCHSHC961DH()()	6,281.	6,846.	7,873.	10,236.	

Order Code	Specification Information	Application Notes
Example: ROHGSHHC601DH () ()	<i>To order please specify pattern number including:</i>	It is Not advisable to mix 28³/₈" desk height products with 26¹/₂" standard height products.
R Reff	1. <i>Case finish:</i> Wood or Laminate	Products on this page will accept wood grain laminate, where laminate is currently an option.
O Overhead	2. <i>Door frame finish:</i> Anodized or Painted	
H Hutches	3. <i>Glass door finish:</i> GL11, GL14, GL15, GL17, GL18	These products are glue and dowel construction.
GH Glass Hinge Doors	4. <i>Lock options:</i> L = Lock N = No lock	
SH Single High	5. <i>Lock finish:</i> B = Black S = Matte Silver	<p>Note: Above Cases MUST be accompanied with Surrounds, Hinge. For Single high surrounds, refer to page 278 .</p> <p>Letter depth is 15" nominal.</p> <p>Facias and task lights ordered separately.</p> <p>The case backs are finished in veneer / laminate on the inside and paper finished on the outside.</p> <p>Interior clearance dimension; Cubby: 3 1/2" h x 13 1/2" d Single high opening: 13 1/8" h x 13 1/2" d</p> <p>Installation instructions available on Knoll Exchange.</p> <p>For Hutches, refer to reference number 6TP00321.</p>
C Case	No Glass shelves.	
60 60" Width	No pull option on glass doors. Glass doors project below shelf for opening.	
1 Letter depth		
DH Desk height		
V316 Case finish		
AU Front finish		
GI14 Glass Door finish		

Case, Single High

Glass Hinge Door / Open / Cubby Concealed or Exposed

description	w	d	h	dr	pattern no.	L	V1	V2	V3
Single high Case with long Glass hinge doors, long glass hinge doors/open/cubby concealed	60"	15"	20"	2	ROHGOSHHC601DH()()	\$4,016.	\$5,019.	\$5,773.	\$7,504.
	66"	15"	20"	2	ROHGOSHHC661DH()()	4,099.	5,123.	5,892.	7,659.
	72"	15"	20"	2	ROHGOSHHC721DH()()	4,203.	5,252.	6,040.	7,853.
	78"	15"	20"	2	ROHGOSHHC781DH()()	4,303.	5,379.	6,186.	8,041.
	84"	15"	20"	4	ROHGOSHHC841DH()()	5,059.	6,324.	7,273.	9,456.
	90"	15"	20"	4	ROHGOSHHC901DH()()	5,167.	6,459.	7,428.	9,656.
	96"	15"	20"	4	ROHGOSHHC961DH()()	5,249.	6,561.	7,545.	9,809.

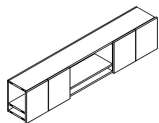

Single high Case with short Glass hinge doors, short glass hinge doors/open/cubby exposed	60"	15"	20"	2	ROGHOCSHHC601DH()()	3,324.	4,155.	4,778.	6,212.
	66"	15"	20"	2	ROGHOCSHHC661DH()()	3,401.	4,250.	4,888.	6,355.
	72"	15"	20"	2	ROGHOCSHHC721DH()()	3,471.	4,339.	4,989.	6,485.
	78"	15"	20"	2	ROGHOCSHHC781DH()()	3,551.	4,439.	5,105.	6,636.
	84"	15"	20"	4	ROGHOCSHHC841DH()()	4,359.	5,231.	6,015.	7,820.
	90"	15"	20"	4	ROGHOCSHHC901DH()()	4,412.	5,293.	6,086.	7,913.
	96"	15"	20"	4	ROGHOCSHHC961DH()()	4,501.	5,402.	6,212.	8,075.

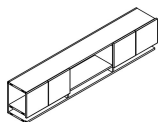

Order Code	Specification Information	Application Notes
Example: ROHGOSHHC601DH () ()	<i>To order please specify pattern number including:</i>	It is Not advisable to mix 28³/₈" desk height products with 26¹/₂" standard height products.
R Reff	1. <i>Case finish:</i> Wood or Laminate	Products on this page will accept wood grain laminate, where laminate is currently an option.
O Overhead	2. <i>Door frame finish:</i> Anodized or Painted	
H Hutches	3. <i>Glass door finish:</i> GL11, GL14, GL15, GL17, GL18	These products are glue and dowel construction.
GHO Glass Hinge Door, Open, Cubby Concealed	4. <i>Lock options:</i> L = Lock N = No lock	
SH Single High	5. <i>Lock finish:</i> B = Black S = Matte Silver	Installation instructions available on Knoll Exchange.
C Case		For Hutches, refer to reference number 6TP00321.
60 60" width		
1 Letter depth		
DH Desk Height		
V316 Case Finish	No Glass shelves.	
AU Door Frame Finish	No pull option on glass doors. Glass doors project below shelf for opening.	
GL14 Glass Door Finish		

Note: Above Cases MUST be accompanied with Surrounds, Hinge.
For Single high surrounds, refer to page 278 .

Letter depth is 15" nominal.

Facias and task lights ordered separately.

The case backs are finished in veneer / laminate on the inside and paper finished on the outside.

Interior clearance dimension;
Cubby: 3¹/₂"h x 13¹/₂"d
Single high opening: 13¹/₈"h x 13¹/₂"d

Hutches, 28³/₈" planning

Case, Single High

Wood Hinge Door / Open / Cubby Concealed or Exposed

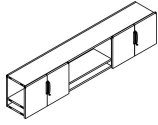
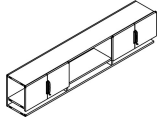
description	w	d	h	dr	pattern no.	L/L	L/V1	L/V2	L/V3	V1/V1	V2/V2	V3/V3
Single high Case with long hinge doors, hinge door/open/cubby concealed 	60"	15"	20"	4	ROHHOSHC601DH()	\$2,882.	\$3,171.	\$3,315.	\$3,459.	\$4,180.	\$4,806.	\$6,248.
	66"	15"	20"	4	ROHHOSHC661DH()	2,923.	3,217.	3,363.	3,510.	4,240.	4,876.	6,339.
	72"	15"	20"	4	ROHHOSHC721DH()	2,970.	3,269.	3,417.	3,565.	4,309.	4,955.	6,441.
	78"	15"	20"	4	ROHHOSHC781DH()	3,030.	3,333.	3,484.	3,635.	4,394.	5,053.	6,568.
	84"	15"	20"	6	ROHHOSHC841DH()	3,525.	3,880.	4,055.	4,231.	5,113.	5,880.	7,644.
	90"	15"	20"	6	ROHHOSHC901DH()	3,579.	3,937.	4,116.	4,295.	5,190.	5,969.	7,758.
	96"	15"	20"	6	ROHHOSHC961DH()	3,622.	3,985.	4,167.	4,348.	5,253.	6,041.	7,854.
Single high Case with short hinge doors, hinge door/open/cubby exposed 	60"	15"	20"	4	ROHHOCSHC601DH()	2,707.	2,978.	3,113.	3,248.	3,925.	4,513.	5,867.
	66"	15"	20"	4	ROHHOCSHC661DH()	2,745.	3,021.	3,157.	3,295.	3,981.	4,579.	5,951.
	72"	15"	20"	4	ROHHOCSHC721DH()	2,790.	3,069.	3,208.	3,348.	4,237.	4,652.	6,048.
	78"	15"	20"	4	ROHHOCSHC781DH()	2,845.	3,129.	3,272.	3,413.	4,126.	4,745.	6,167.
	84"	15"	20"	6	ROHHOCSHC841DH()	3,310.	3,643.	3,808.	3,973.	4,800.	5,521.	7,177.
	90"	15"	20"	6	ROHHOCSHC901DH()	3,361.	3,697.	3,865.	4,032.	4,873.	5,604.	7,285.
	96"	15"	20"	6	ROHHOCSHC961DH()	3,402.	3,741.	3,912.	4,083.	4,932.	5,672.	7,374.

Order Code

Example:	ROHHSHC601DH () () () ()
R	Reff
O	Overhead
H	Hutches
HO	Hinge / Open
SH	Single High
C	Case
60	60" width
1	Letter depth
DH	Desk height
L	Lock option
B	Lock finish
F	Pull option
111	Pull finish
V316	Case finish
V316	Front finish

Specification Information

To order please specify pattern number including:

- Lock option:
L = Drill for lock
N = No lock drilling
- Lock finish:
B = Black
S = Silver
- Pull option:
B = Blank, no drilling customer's own pull
C = C-Pull (Nickel finish only)
D = D-Pull (PT or PZ only)
F = Bar pull
H = Outline pull
R = Cylinder pull
S = S-pull, (Stainless steel finish only)
T = Tab pull
- Pull finish: Painted or plated, unless otherwise indicated.
- Case finish: Wood or Laminate
- Front finish: Wood or Laminate

Application Notes

It is Not advisable to mix 28³/₈"h desk height products with 26¹/₂" standard height products.

Products on this page will accept wood grain laminate, where laminate is currently an option.

These products are glue and dowel construction.

Installation instructions available on Knoll Exchange.

For Hutches, refer to reference number 6TP00321.

Note: Above Cases MUST be accompanied with Surrounds, Hinge.
For Single high surrounds, refer to page 278 .

Letter depth is 15" nominal.

Facias and task lights ordered separately.

The case backs are finished in veneer / laminate on the inside and paper finished on the outside.

Interior clearance dimension;
Cubby: 3¹/₂"h x 13¹/₂"d
Single high opening: 13¹/₈"h x 13¹/₂"d

Doors project below shelf for opening.

Hutches, 28³/₈" planning

Case, Double High

Wood Hinge Doors

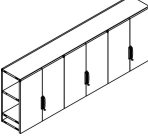
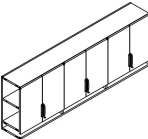
description	w	d	h	dr	pattern no.	L/L	L/V1	L/V2	L/V3	V1/V1	V2/V2	V3/V3
Double high Case with long hinge doors, cubby concealed 	60"	15"	33"	4	ROHHDHC601DH()	\$3,898.	\$4,288.	\$4,481.	\$4,676.	\$5,456.	\$6,274.	\$8,157.
	66"	15"	33"	4	ROHHDHC661DH()	4,021.	4,423.	4,625.	4,826.	5,629.	6,474.	8,416.
	72"	15"	33"	4	ROHHDHC721DH()	4,103.	4,513.	4,719.	4,925.	5,745.	6,607.	8,608.
	78"	15"	33"	4	ROHHDHC781DH()	4,239.	4,663.	4,875.	5,087.	5,935.	6,823.	8,871.
	84"	15"	33"	6	ROHHDHC841DH()	5,356.	5,892.	6,159.	6,428.	7,498.	8,624.	11,210.
	90"	15"	33"	6	ROHHDHC901DH()	5,452.	5,997.	6,269.	6,542.	7,632.	8,777.	11,410.
	96"	15"	33"	6	ROHHDHC961DH()	5,523.	6,075.	6,352.	6,628.	7,732.	8,893.	11,560.
Double high Case with short hinge doors, cubby exposed 	60"	15"	33"	4	ROHCDHC601DH()	3,686.	4,054.	4,238.	4,423.	5,160.	5,934.	7,714.
	66"	15"	33"	4	ROHCDHC661DH()	3,805.	4,185.	4,376.	4,565.	5,327.	6,125.	7,964.
	72"	15"	33"	4	ROHCDHC721DH()	3,884.	4,272.	4,466.	4,660.	5,438.	6,253.	8,128.
	78"	15"	33"	4	ROHCDHC781DH()	3,968.	4,365.	4,563.	4,762.	5,556.	6,390.	8,307.
	84"	15"	33"	6	ROHCDHC841DH()	5,041.	5,545.	5,797.	6,050.	7,058.	8,117.	10,550.
	90"	15"	33"	6	ROHCDHC901DH()	5,134.	5,648.	5,905.	6,161.	7,188.	8,267.	10,747.
	96"	15"	33"	6	ROHCDHC961DH()	5,203.	5,724.	5,982.	6,243.	7,284.	8,376.	10,891.

Order Code	Specification Information	Application Notes
Example: ROHHDHC601DH () () () ()	<i>To order please specify pattern number including:</i>	It is Not advisable to mix 28³/₈" desk height products with 26¹/₂" standard height products.
R Reff	1. Lock option: L = Drill for lock N = No lock drilling	Note: Above Cases MUST be accompanied with Surrounds, Hinge. For Double high surrounds, refer to page 279 .
O Overhead	2. Lock finish: B = Black S = Silver	Letter depth is 15" nominal.
H Hutches	3. Pull option: B = Blank, no drilling customer's own pull C = C-Pull (Nickel finish only) D = D-Pull (PT or PZ only) F = Bar pull H = Outline pull R = Cylinder pull S = S-pull, (Stainless steel finish only) T = Tab pull	Facias and task lights ordered separately.
H Hinge	4. Pull finish: Painted or plated, unless otherwise indicated.	The case backs are finished in veneer / laminate on the inside and paper finished on the outside.
DH Double High	5. Case finish: Wood or Laminate	Interior clearance dimension; Cubby: 3 ¹ / ₂ "h x 13 ¹ / ₂ "d Double high opening: 26 ³ / ₈ "h x 13 ¹ / ₂ "d (includes one adjustable shelf)
C Case	6. Front finish: Wood or Laminate	Doors project below shelf for opening.
60 60" width		
1 Letter depth		
DH Desk Height		
L Lock Option		
B Lock Finish		
H Pull Finish		
111 Pull Finish		
V316 Case Finish		
V316 Front Finish		

Hutches, 28³/₈" planning Case, Double High Glass Hinge Doors

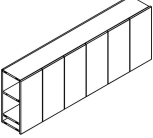
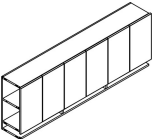
description	w	d	h	dr	pattern no.	L	V1	V2	V3
Double high Case with long Glass doors, cubby concealed 	60"	15"	33"	4	ROGHHDHC601DH()()()	\$6,097.	\$7,194.	\$8,273.	\$10,755.
	66"	15"	33"	4	ROGHHDHC661DH()()()	6,288.	7,419.	8,532.	11,093.
	72"	15"	33"	4	ROGHHDHC721DH()()()	6,507.	7,678.	8,829.	11,479.
	78"	15"	33"	4	ROGHHDHC781DH()()()	6,820.	8,048.	9,256.	12,034.
	84"	15"	33"	6	ROGHHDHC841DH()()()	8,192.	9,667.	11,116.	14,473.
	90"	15"	33"	6	ROGHHDHC901DH()()()	8,390.	9,899.	11,385.	14,800.
	96"	15"	33"	6	ROGHHDHC961DH()()()	8,551.	10,089.	11,602.	15,083.
Double high Case with short Glass doors, cubby exposed 	60"	15"	33"	4	ROGHCDHC601DH()()()	5,580.	6,083.	6,997.	9,096.
	66"	15"	33"	4	ROGHCDHC661DH()()()	5,819.	6,343.	7,295.	9,483.
	72"	15"	33"	4	ROGHCDHC721DH()()()	6,007.	6,549.	7,531.	9,789.
	78"	15"	33"	4	ROGHCDHC781DH()()()	6,246.	6,808.	7,830.	10,178.
	84"	15"	33"	6	ROGHCDHC841DH()()()	7,602.	8,286.	9,529.	12,388.
	90"	15"	33"	6	ROGHCDHC901DH()()()	7,727.	8,423.	9,688.	12,593.
	96"	15"	33"	6	ROGHCDHC961DH()()()	7,909.	8,620.	9,913.	12,887.

Order Code	Specification Information	Application Notes
Example: ROGHHDHC601DH () ()	<i>To order please specify pattern number including:</i>	It is Not advisable to mix 28³/₈"h desk height products with 26¹/₂" standard height products.
R Reff	1. <i>Case finish:</i> Wood or Laminate	Products on this page will accept wood grain laminate, where laminate is currently an option.
O Overhead	2. <i>Door frame finish:</i> Anodized or Painted	
H Hutches	3. <i>Glass door finish:</i> GL11, GL14, GL15, GL17, GL18	These products are glue and dowel construction.
GH Glass Hinge Doors	4. <i>Lock options:</i> L = Lock N = No lock	
DH Double High	5. <i>Lock finish:</i> B = Black S = Matte Silver	Installation instructions available on Knoll Exchange.
C Case	No Glass shelves.	For Hutches, refer to reference number 6TP00321.
60 60" width	No pull option on glass doors. Glass doors project below shelf for opening.	Note: Above Cases MUST be accompanied with Surrounds, Hinge. For Double high surrounds, refer to page 279 .
1 Letter depth		Letter depth is 15" nominal.
DH Desk height		Facias and task lights ordered separately.
V316 Case finish		The case backs are finished in veneer / laminate on the inside and paper finished on the outside.
AU Door Frame Finish		Interior clearance dimension; Cubby: 3 ¹ / ₂ "h x 13 ¹ / ₂ "d Double high opening: 26 ³ / ₈ "h x 13 ¹ / ₂ "d (includes one adjustable shelf)
GL14 Glass Door Finish		

Case, Double High

Glass Hinge Doors / Open / Cubby Concealed or Exposed

description	w	d	h	dr	pattern no.	L	V1	V2	V3
Double high Case with long Glass hinge doors, long glass hinge doors/open/cubby concealed	60"	15"	33"	2	ROHGHODHC601DH()()	\$5,162.	\$6,451.	\$7,419.	\$9,645.
	66"	15"	33"	2	ROHGHODHC661DH()()	5,300.	6,626.	7,619.	9,905.
	72"	15"	33"	2	ROHGHODHC721DH()()	5,429.	6,787.	7,804.	10,145.
	78"	15"	33"	2	ROHGHODHC781DH()()	5,577.	6,972.	8,018.	10,422.
	84"	15"	33"	4	ROHGHODHC841DH()()	6,542.	8,177.	9,404.	12,226.
	90"	15"	33"	4	ROHGHODHC901DH()()	6,693.	8,367.	9,622.	12,508.
96"	15"	33"	4	ROHGHODHC961DH()()	6,815.	8,519.	9,797.	12,736.	

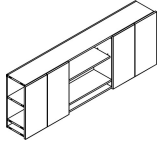

Double high Case with short Glass hinge doors, short glass hinge doors/open/cubby exposed	60"	15"	33"	2	ROHGHODHC601DH()()	4,419.	5,523.	6,351.	8,257.
	66"	15"	33"	2	ROHGHODHC661DH()()	4,532.	5,665.	6,514.	8,469.
	72"	15"	33"	2	ROHGHODHC721DH()()	4,635.	5,793.	6,663.	8,662.
	78"	15"	33"	2	ROHGHODHC781DH()()	4,739.	5,926.	6,812.	8,852.
	84"	15"	33"	4	ROHGHODHC841DH()()	5,718.	7,034.	8,087.	10,514.
	90"	15"	33"	4	ROHGHODHC901DH()()	5,806.	7,140.	8,210.	10,675.
	96"	15"	33"	4	ROHGHODHC961DH()()	5,932.	7,296.	8,391.	10,907.

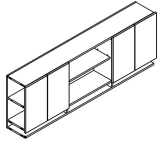

Order Code	Specification Information	Application Notes
Example: ROHGHODHC601DH ()()		
R Reff	<i>To order please specify pattern number including:</i>	It is Not advisable to mix 28³/₈"h desk height products with 26¹/₂" standard height products.
O Overhead	1. <i>Case finish:</i> Wood or Laminate	Products on this page will accept wood grain laminate, where laminate is currently an option.
H Hutches	2. <i>Door frame finish:</i> Anodized or Painted	Installation instructions available on Knoll Exchange.
GHO Glass Hinge Door, Open, Cubby Concealed	3. <i>Glass door finish:</i> GL11, GL14, GL15, GL17, GL18	For Hutches, refer to reference number 6TP00321.
DH Double High	4. <i>Lock options:</i> L = Lock N = No lock	
C Case	5. <i>Lock finish:</i> B = Black S = Matte Silver	
60 60" width	No Glass shelves.	
1 Letter depth	No pull option on glass doors. Glass doors project below shelf for opening.	
DH Desk Height		Note: Above Cases MUST be accompanied with Surrounds, Hinge.
V316 Case Finish		For Double high surrounds, refer to page 279 .
AU Door Frame Finish		Letter depth is 15" nominal.
GL14 Glass Door Finish		Facias and task lights ordered separately.
		The case backs are finished in veneer / laminate on the inside and paper finished on the outside.
		Interior clearance dimension; Cubby: 3 ¹ / ₂ "h x 13 ¹ / ₂ "d Double high opening: 26 ³ / ₈ "h x 13 ¹ / ₂ "d (includes one adjustable shelf)

Case, Double High

Wood Hinge Doors / Open / Cubby Concealed or Exposed

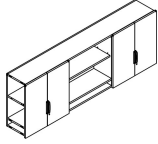
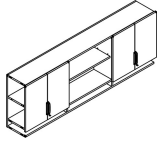
description	w	d	h	dr	pattern no.	L/L	L/V1	L/V2	L/V3	V1/V1	V2/V2	V3/V3
Double high Case with long hinge doors, hinge door/open/cubby concealed 	60"	15"	33"	4	ROHHODHC601DH()	\$3,940.	\$4,334.	\$4,532.	\$4,728.	\$5,517.	\$6,344.	\$8,246.
	66"	15"	33"	4	ROHHODHC661DH()	4,062.	4,471.	4,673.	4,876.	5,688.	6,542.	8,504.
	72"	15"	33"	4	ROHHODHC721DH()	4,148.	4,561.	4,769.	4,976.	5,807.	6,678.	8,680.
	78"	15"	33"	4	ROHHODHC781DH()	4,218.	4,639.	4,851.	5,061.	5,906.	6,791.	8,828.
	84"	15"	33"	6	ROHHODHC841DH()	5,346.	5,880.	6,147.	6,414.	7,484.	8,606.	11,188.
	90"	15"	33"	6	ROHHODHC901DH()	5,442.	5,986.	6,258.	6,529.	7,618.	8,761.	11,388.
	96"	15"	33"	6	ROHHODHC961DH()	5,512.	6,062.	6,339.	6,614.	7,717.	8,873.	11,536.
Double high Case with short hinge doors, hinge door/open/cubby exposed 	60"	15"	33"	4	ROHHOCDHC601DH()	3,475.	3,821.	3,995.	4,170.	5,039.	5,793.	7,533.
	66"	15"	33"	4	ROHHOCDHC661DH()	3,530.	3,884.	4,060.	4,237.	5,120.	5,888.	7,654.
	72"	15"	33"	4	ROHHOCDHC721DH()	3,597.	3,955.	4,136.	4,316.	5,216.	5,998.	7,797.
	78"	15"	33"	4	ROHHOCDHC781DH()	3,652.	4,018.	4,200.	4,382.	5,296.	6,089.	7,916.
	84"	15"	33"	6	ROHHOCDHC841DH()	4,210.	4,631.	4,841.	5,052.	6,104.	5,921.	9,125.
	90"	15"	33"	4	ROHHOCDHC901DH()	4,279.	4,707.	4,920.	5,134.	6,204.	7,135.	9,274.
	96"	15"	33"	6	ROHHOCDHC961DH()	4,340.	4,772.	4,990.	5,206.	6,291.	7,237.	9,406.

Order Code	Specification Information	Application Notes
Example: ROHHDHC601DH ()()()()()	To order please specify pattern number including:	It is Not advisable to mix 28³/₈"h desk height products with 26¹/₂" standard height products.
R Reff	1. Lock option: L = Drill for lock N = No lock drilling	Products on this page will accept wood grain laminate, where laminate is currently an option.
O Overhead	2. Lock finish: B = Black S = Silver	These products are glue and dowel construction.
H Hutches	3. Pull option: B = Blank, no drilling customer's own pull C = C-Pull (Nickel finish only) D = D-Pull (PT or PZ only) F = Bar pull H = Outline pull R = Cylinder pull S = S-pull, (Stainless steel finish only) T = Tab pull	Installation instructions available on Knoll Exchange.
HO Hinge / Open		For Hutches, refer to reference number 6TP00321.
DH Double High		
C Case		
60 60" width		
1 Letter depth		
DH Desk height		
L Lock option		
B Lock finish		
F Pull option		
111 Pull finish		
V316 Case finish	4. Pull finish: Painted or plated, unless otherwise indicated.	
V316 Front finish	5. Case finish: Wood or Laminate 6. Front finish: Wood or Laminate	

Note: Above Cases MUST be accompanied with Surrounds, Hinge.
For Double high surrounds, refer to page 279 .

Letter depth is 15" nominal.

Facias and task lights ordered separately.

The case backs are finished in veneer / laminate on the inside and paper finished on the outside.

Interior clearance dimension;
 Cubby: 3¹/₂"h x 13¹/₂"d
 Double high opening: 26³/₈"h x 13¹/₂"d
 (includes one adjustable shelf)

Doors project below shelf for opening.

Progressive Overheads, 28³/₈" Planning
 Cabinet Hung
 Glass door

description	w	d	h	dr	pattern no.	L	V1	V2	V3
Cabinet Hung Shelf	90"	15"	15"	1	RROCGSD90GB () () () ()	\$3,223.	\$3,867.	\$4,447.	\$5,782.
Glass Sliding Doors Closed Ends	108"	15"	15"	1	RROCGSD108GB () () () ()	3,525.	4,231.	4,866.	6,324.

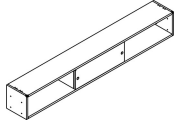

Cabinet Hung Shelf with 2 Glass Sliding Doors	90"	15"	15"	2	RROC2GSD90 () () () ()	4,434.	5,011.	5,457.	7,093.
	108"	15"	15"	2	RROC2GSD108 () () () ()	5,006.	5,657.	6,086.	7,913.

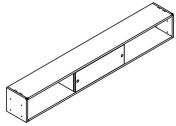

Cabinet Hung Shelf with Glass Sliding Door Left Hand	60"	15"	15"	1	RROCGSDL60GB () () () ()	2,737.	3,147.	3,619.	4,705.
	72"	15"	15"	1	RROCGSDL72GB () () () ()	2,936.	3,376.	3,884.	5,048.

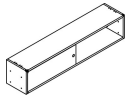

Cabinet Hung Shelf with Glass Sliding Door Right Hand	60"	15"	15"	1	RROCGSDR60GB () () () ()	2,737.	3,147.	3,619.	4,705.
	72"	15"	15"	1	RROCGSDR72GB () () () ()	2,936.	3,376.	3,884.	5,048.

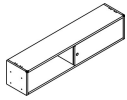

Order Code	Specification Information	Application Notes
Example: RROCGSD90GB () ()	<i>To order please specify:</i>	It is Not advisable to mix 28³/₈"h desk height products with 26¹/₂" standard height products.
RR Reff Profiles	1. Lock option: L = Lock N = No lock	For progressive overheads, LED light is recommended without fascia.
O Overhead	2. Lock finish: B = Black S = Matte silver	Overhead backs are finished in Veneer/Laminate on inside and paper finished on the outside.
C Cabinet Hung	3. Pull option G=Grommet pull B=No pull, No drilling	Actual dimensions: 14 ³ / ₄ "h x 14 ¹ / ₁₆ "d
GSD Glass Sliding Door	4. Pull finish = Painted/plated	Interior clearance dimension: 12 ⁷ / ₈ "high x 12" deep
90 90" wide	5. Case finish = V316	Installation instruction sheets available on Knoll Exchange.
GB Gable Both	6. Door frame finish = Anodized / painted	For Cabinet hung overheads, refer to reference number 6TP00080.
L Lock option	7. Door Glass finish GL11 = Black GL14 = Folkstone Grey GL15 = Med. Grey GL17 = Soft Grey GL18 = White	For overhead with sliding doors, reference to part number 6TP00088.
S Lock finish		
G Pull option		
111 Pull finish		
V316 Case finish		
AU Door frame finish		
GL11 Glass finish		

Cabinet Hung

Wood door

description	w	d	h	dr	pattern no.	L/L	L/V1	L/V2	L/V3	V1/V1	V2/V2	V3/V3
Cabinet Hung Shelf	90"	15"	15"	1	RROCWSD90GB () () ()	\$2,769.	\$3,045.	\$3,184.	\$3,323.	\$3,599.	\$4,138.	\$5,380.
Sliding Doors Closed Ends	108"	15"	15"	1	RROCWSD108GB () () ()	3,002.	3,302.	3,452.	3,602.	3,902.	4,487.	5,833.

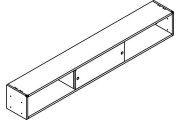

Cabinet Hung Shelf with 2 Wood/Laminate Sliding Doors	90"	15"	15"	2	RROC2WSD90 () () ()	3,343.	3,678.	3,844.	4,012.	4,346.	4,886.	6,352.
	108"	15"	15"	2	RROC2WSD108 () () ()	3,732.	4,105.	4,292.	4,478.	4,851.	5,386.	7,003.

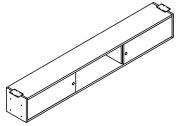

Cabinet Hung Shelf with Wood/Laminate Sliding Door Right Hand	60"	15"	15"	1	RROCWSDR60GB () () ()	2,331.	2,564.	2,680.	2,797.	2,914.	3,352.	4,355.
	72"	15"	15"	1	RROCWSDR72GB () () ()	2,467.	2,714.	2,837.	2,941.	3,084.	3,547.	4,610.

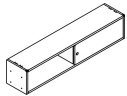

Cabinet Hung Shelf with Wood/Laminate Sliding Door Left Hand	60"	15"	15"	1	RROCWSDL60GB () () ()	2,331.	2,564.	2,680.	2,797.	2,914.	3,352.	4,355.
	72"	15"	15"	1	RROCWSDL72GB () () ()	2,467.	2,714.	2,837.	2,941.	3,084.	3,547.	4,610.

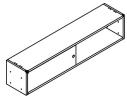

Order Code	Specification Information	Application Notes
Example: RROCWSDR60GB	To order please specify	It is Not advisable to mix 28^{3/8}"h desk height products with 26^{1/2}" standard height products.
RR Reff	1. Lock option: L = Lock N = No lock	For progressive overheads, LED light is recommended without fascia.
O Overhead	2. Lock finish: B = Black S = Matte silver	Overhead backs are finished in Veneer/Laminate on inside and paper finished on the outside.
C Cabinet Hung	3. Pull option: G=Grommet pull B=No pull, No drilling	Actual dimensions: 14 ^{3/4} "h x 14 ^{9/16} "d.
WSDR Wood/Lam. Sliding Door	4. Pull finish: Painted or Plated	Interior clearance dimension: 12 ^{3/8} "high x 12" deep
60 60" wide	5. Case finish: L, V1, V2, V3	Installation instruction sheets available on Knoll Exchange.
GB Cable Both	6. Front finish: L, V1, V2, V3	For Cabinet hung overheads, refer to reference number 6TP00080.
L Lock option		For overhead with sliding doors, reference to part number 6TP00088.
S Lock finish		
G Pull Option		
115 Pull Finish		
V316 Case Finish		
V316 Front Finish		

Progressive Overheads, 28^{3/8}" Planning
Cabinet Hung
Open shelf

description	w	d	h	pattern no.	L	V1	V2	V3
Cabinet Hung Open Shelf Closed Ends	60"	15"	15"	RROCOS60GB () ()	\$1,672.	\$2,171.	\$2,498.	\$3,247.
	72"	15"	15"	RROCOS72GB () ()	1,781.	2,315.	2,663.	3,462.
	90"	15"	15"	RROCOS90GB () ()	1,941.	2,525.	2,903.	3,774.
	108"	15"	15"	RROCOS108GB () ()	2,208.	2,871.	3,302.	4,292.

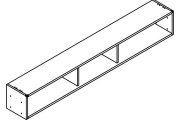

Order Code	Specification Information	Application Notes
Example: RROCOS60GB () ()	To order please specify	<p>It is Not advisable to mix 28^{3/8}"h desk height products with 26^{1/2}" standard height products.</p> <p>Product on this page will accept wood grain laminate, where laminate is currently an option.</p> <p>For vertical surfaces greater than 60", the grain direction is horizontal.</p> <p>These products are Glue and Dowel Construction.</p>
RR Reff	1. Finish type:	
O Overhead	L = Laminate	
C Cabinet Hung	1 = V1	
OS Open shelf	2 = V2	
60 60" wide	3 = V3	
2 Finish type	2. Finish	
V316 Case Finish		<p>For progressive overheads, LED light is recommended without fascia.</p> <p>Overhead backs are finished in Veneer/Laminate on inside and paper finished on the outside.</p> <p>Above sizes are nominal.</p> <p>Actual dimensions: 14^{3/4}"h x 14^{9/16}"d</p> <p>Interior clearance dimension: 12^{5/8}"high x 12^{13/32}" deep</p> <p>Installation instruction sheets available on Knoll Exchange.</p> <p>For Cabinet hung overheads, refer to reference number 6TP00080.</p>

Wall Hung
Glass door

description	w	d	h	dr	pattern no.	L	V1	V2	V3
Wall Hung Shelf with Glass Sliding Door	90"	15"	15"	1	RROMGSD90GN () () () () () ()	\$3,049.	\$3,660.	\$4,210.	\$5,472.
	108"	15"	15"	1	RROMGSD108GN () () () () () ()	3,460.	4,151.	4,774.	6,207.

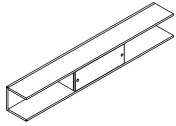

Wall Hung Shelf with Glass Sliding Door Gable Right	60"	15"	15"	1	RROMGSD60GR () () () () () ()	2,638.	3,165.	3,641.	4,733.
	72"	15"	15"	1	RROMGSD72GR () () () () () ()	2,906.	3,487.	4,012.	5,213.

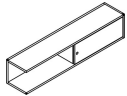

Wall Hung Shelf with Glass Sliding Door Gable Left	60"	15"	15"	1	RROMGSD60GL () () () () () ()	2,638.	3,165.	3,641.	4,733.
	72"	15"	15"	1	RROMGSD72GL () () () () () ()	2,906.	3,487.	4,012.	5,213.

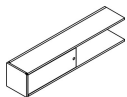

Order Code	Specification Information	Application Notes
Example: RROMGSD90GN ()	To order please specify	It is Not advisable to mix 28^{3/8}"h desk height products with 26^{1/2}" standard height products.
RR Reff	1. Lock option: L = Lock N = No lock	For progressive overheads, LED light is recommended without fascia.
O Overhead	2. Lock finish: B = Black S = Matte silver	Product on this page will accept wood grain laminate, where laminate is currently an option.
M Wall hung	3. Pull option: G=Grommet pull B=No pull, No drilling	Overhead backs are finished in Veneer/Laminate on inside and paper finished on the outside.
GSD Glass sliding door	4. Pull finish: 115	Above sizes are nominal.
90 90" wide	5. Case finish: V319	Actual dimensions: 14 ^{3/4} "h x 14 ^{9/16} "d
GN No gable	6. Door frame: Anodized / painted	Interior clearance dimension: 12 ^{5/8} " high x 12" deep
L Lock option	7. Glass finish: GL11 = Black GL14 = Folkstone Grey GL15 = Med. Grey GL17 = Soft Grey GL18 = White	Installation instruction sheets available on Knoll Exchange.
S Lock finish		For overheads with sliding doors, refer to reference number 6TP00088.
G Pull Option		
115 Pull Finish		
V319 Case Finish		
AP Door Frame Finish		
GL11 Glass Finish		

Keying instructions must accompany all orders, refer to page 482. These products do not come with lock included. Random locks are factory installed. Key-alike are field installed using the KnollKey order form. Each locking pedestal on this page counts for one lock core.

For vertical surfaces greater than 60", the grain direction is horizontal.

These products are Glue and Dowel Construction.

Knoll does not assume any responsibility for the installation, attachment or the securing of wall hung units to the wall. A certified building contractor should be consulted. Please refer to wall mounting information on page 463.

*Wall Hung
Glass door, closed ends*

description	w	d	h	dr	pattern no.	L	V1	V2	V3
Wall Hung Shelf with Glass Sliding Door	90"	15"	15"	1	RROMGSD90GB () () () ()	\$3,414.	\$3,927.	\$4,515.	\$5,870.
	108"	15"	15"	1	RROMGSD108GB () () () ()	3,836.	4,412.	5,072.	6,593.

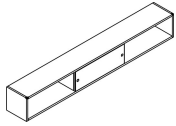

Wall Hung Shelf with 2 Glass Sliding Doors	90"	15"	15"	2	RROM2GSD90 () () () () ()	4,744.	5,218.	5,664.	7,363.
	108"	15"	15"	2	RROM2GSD108 () () () () ()	5,379.	5,916.	6,346.	8,250.

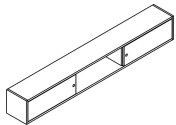

Wall Hung Shelf with Glass Sliding Door Right Hand	60"	15"	15"	1	RROMGSDR60GB () () () ()	2,786.	3,203.	3,684.	4,789.
	72"	15"	15"	1	RROMGSDR72GB () () () ()	3,021.	3,474.	3,994.	5,194.

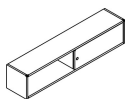

Wall Hung Shelf with Glass Sliding Door Left Hand	60"	15"	15"	1	RROMGSDL60GB () () () ()	2,786.	3,203.	3,684.	4,789.
	72"	15"	15"	1	RROMGSDL72GB () () () ()	3,021.	3,474.	3,994.	5,194.

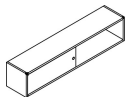

Order Code	Specification Information	Application Notes
Example: RROMGSD90GN ()	To order please specify	It is Not advisable to mix 28³/₈"h desk height products with 26¹/₂" standard height products.
RR Reff	1. Lock option: L = Lock N = No lock	For progressive overheads, LED light is recommended without fascia.
O Overhead	2. Lock finish: B = Black S = Matte silver	Product on this page will accept wood grain laminate, where laminate is currently an option.
M Wall hung	3. Pull option: G=Grommet pull B=No pull, No drilling	For vertical surfaces greater than 60", the grain direction is horizontal.
GSD Glass sliding door	4. Pull finish: 115	These products are Glue and Dowel Construction.
90 90" wide	5. Case finish: V319	Knoll does not assume any responsibility for the installation, attachment or the securing of wall hung units to the wall.
GN No gable	6. Door frame: Anodized / painted	A certified building contractor should be consulted.
L Lock option	7. Glass finish: GL11 = Black GL14 = Folkstone Grey GL15 = Med. Grey GL17 = Soft Grey GL18 = White	Please refer to wall mounting information on page 463.
S Lock finish		
G Pull Option		
115 Pull Finish		
V319 Case Finish		
AP Door Frame Finish		
GL11 Glass Finish		

Keying instructions must accompany all orders, refer to page 482. These products do not come with lock included. Random locks are factory installed. Key-alike are field installed using the KnollKey order form. Each locking pedestal on this page counts for one lock core.

Wall Hung

Wood door

description	w	d	h	dr	pattern no.	L/L	L/V1	L/V2	L/V3	V1/V1	V2/V2	V3/V3
Wall Hung Shelf with Wood / Laminate Sliding Door	90"	15"	15"	1	RROMWSD90GN () () () () () ()	\$2,826.	\$3,110.	\$3,251.	\$3,392.	\$3,392.	\$3,901.	\$5,072.
	108"	15"	15"	1	RROMWSD108GN () () () () () ()	3,187.	3,506.	3,663.	3,822.	3,822.	4,398.	5,715.

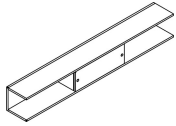

Wall Hung Shelf with Wood/Laminate Sliding Door Gable Right	60"	15"	15"	1	RROMWSD60GR () () () () () ()	2,427.	2,670.	2,792.	2,914.	2,914.	3,352.	4,355.
	72"	15"	15"	1	RROMWSD72GR () () () () () ()	2,645.	2,910.	3,042.	3,174.	3,174.	3,651.	4,746.

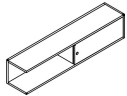

Wall Hung Shelf with Wood/Laminate Sliding Door Gable Left	60"	15"	15"	1	RROMWSD60GL () () () () () ()	2,427.	2,670.	2,792.	2,914.	2,914.	3,352.	4,355.
	72"	15"	15"	1	RROMWSD72GL () () () () () ()	2,645.	2,910.	3,042.	3,174.	3,174.	3,651.	4,746.

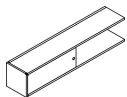

Wall Hung Shelf with Wood/Laminate Sliding Door Closed Ends	90"	15"	15"	1	RROMWSD90GB () () () () () ()	2,927.	3,221.	3,366.	3,513.	3,659.	4,208.	5,469.
	108"	15"	15"	1	RROMWSD108GB () () () () () ()	3,266.	3,593.	3,756.	3,919.	4,083.	4,693.	6,103.

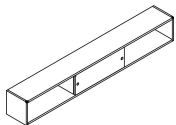

Order Code	Specification Information	Application Notes
Example: RROMWSD90GB () () () () () ()	To order please specify	It is Not advisable to mix 28^{3/8}"h desk height products with 26^{1/2}" standard height products.
RR Reff	1. Lock option: L = Lock N = No lock	For progressive overheads, LED light is recommended without fascia.
O Overhead	2. Lock finish: B = Black S = Matte silver	Product on this page will accept wood grain laminate, where laminate is currently an option.
M Wall mount	3. Pull option: G=Grommet pull B=No pull, No drilling	Overhead backs are finished in Veneer/Laminate on inside and paper finished on the outside.
WSD Wood/Lam. Sliding Door	4. Pull finish: Painted and Plated	Above sizes are nominal.
90 90" wide	5. Case finish: L, V1, V2, V3	Actual dimensions: 14 ^{3/4} "h x 14 ^{7/16} "d
GB Gable both	6. Door finish: L, V1, V2, V3	Interior clearance dimension: 12 ^{5/8} " high x 12" deep
L Lock option	Keying instructions must accompany all orders, refer to page 482. These products do not come with lock included. Random locks are factory installed. Key-alike are field installed using the KnollKey order form. Each locking pedestal on this page counts for one lock core.	Installation instruction sheets available on Knoll Exchange.
S Lock finish		For overheads with sliding doors, refer to reference number 6TP00088.
G Pull Option		
115 Pull Finish		
V319 Case Finish		
V319 Door Finish		

Wall Hung

Wood door, closed ends

description	w	d	h	dr	pattern no.	L/L	L/V1	L/V2	L/V3	V1/V1	V2/V2	V3/V3
Wall Hung Shelf with Wood/Laminate Sliding Door right Closed Ends	60"	15"	15"	1	RROMWSDR60GB () () ()	\$2,360.	\$2,595.	\$2,714.	\$2,831.	\$2,950.	\$3,392.	\$4,409.
	72"	15"	15"	1	RROMWSDR72GB () () ()	2,529.	2,781.	2,908.	3,035.	3,161.	3,635.	4,725.

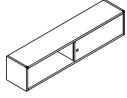

Wall Hung Shelf with Wood/Laminate Sliding Door left Closed Ends	60"	15"	15"	1	RROMWSDL60GB () () ()	2,360.	2,595.	2,714.	2,831.	2,950.	3,392.	4,409.
	72"	15"	15"	1	RROMWSDL72GB () () ()	2,529.	2,781.	2,908.	3,035.	3,161.	3,635.	4,725.

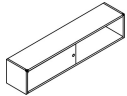

Wall Hung Shelf with 2 Wood/Laminate Sliding Doors	90"	15"	15"	2	RROM2WSD90 () () () () () ()	3,614.	3,975.	4,155.	4,337.	4,553.	5,093.	6,622.
	108"	15"	15"	2	RROM2WSD108 () () () () () ()	4,056.	4,462.	4,665.	4,869.	5,112.	5,647.	7,340.

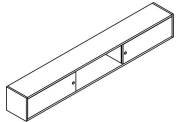

Order Code	Specification Information	Application Notes
Example: RROMWSD90GB () () () () ()	To order please specify	It is Not advisable to mix 28³/₈"h desk height products with 26¹/₂" standard height products.
RR Reff	1. Lock option: L = Lock N = No lock	For progressive overheads, LED light is recommended without fascia.
O Overhead	2. Lock finish: B = Black S = Matte silver	Product on this page will accept wood grain laminate, where laminate is currently an option.
M Wall mount	3. Pull option: G=Grommet pull B=No pull, No drilling	Overhead backs are finished in Veneer/Laminate on inside and paper finished on the outside.
WSD Wood/Lam. Sliding Door	4. Pull finish: Painted and Plated	Above sizes are nominal.
90 90" wide	5. Case finish: L, V1, V2, V3	Actual dimensions: 14 ³ / ₄ "h x 14 ⁷ / ₁₆ "d
GB Gable both	6. Door finish: L, V1, V2, V3	Interior clearance dimension: 12 ⁵ / ₈ " high x 12" deep
L Lock option	Keying instructions must accompany all orders, refer to page 482. These products do not come with lock included. Random locks are factory installed. Key-alike are field installed using the KnollKey order form. Each locking pedestal on this page counts for one lock core.	Installation instruction sheets available on Knoll Exchange.
S Lock finish		For overheads with sliding doors, refer to reference number 6TP00088.
G Pull Option		
115 Pull Finish		
V319 Case Finish		
V319 Door Finish		

*Wall Hung
Open Shelf*

description	w	d	h	pattern no.	L	V1	V2	V3
Wall Hung Open Shelf Left Gable	60"	15"	15"	RROMOS60GL()	\$1,801.	\$2,072.	\$2,381.	\$3,096.
	72"	15"	15"	RROMOS72GL()	2,003.	2,303.	2,649.	3,444.

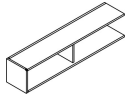

Wall Hung Open Shelf Right Gable	60"	15"	15"	RROMOS60GR()	1,801.	2,072.	2,381.	3,096.
	72"	15"	15"	RROMOS72GR()	2,003.	2,303.	2,649.	3,444.

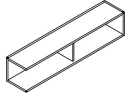

Wall Hung Open Shelf Closed Ends Left & Right Gable - 60" & 72" wide	60"	15"	15"	RROMOS60GB()()	1,715.	2,229.	2,564.	3,332.
	72"	15"	15"	RROMOS72GB()()	1,863.	2,423.	2,787.	3,622.

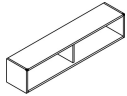

Wall Hung Open Shelf Closed Ends Left & Right Gable - 90" & 108" wide	90"	15"	15"	RROMOS90GB()()	2,194.	2,852.	3,280.	4,263.
	108"	15"	15"	RROMOS108GB()()	2,358.	3,066.	3,525.	4,583.

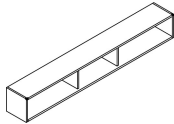

Wall Hung Open Shelf No Gable	90"	15"	15"	RROMOS90GN()	2,280.	2,621.	3,014.	3,919.
	108"	15"	15"	RROMOS108GN()	2,520.	2,898.	3,332.	4,332.

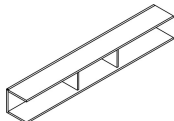

Order Code	Specification Information	Application Notes
Example: RROMOS60GL()()	To order please specify <i>pattern number including:</i>	It is Not advisable to mix 28³/₈"h desk height products with 26¹/₂" standard height products.
RR Reff	1. Case finish:	For progressive overheads, LED light is recommended without fascia.
O Overhead		Overhead backs are finished in Veneer/Laminate on inside and paper finished on the outside.
M Wall Hung		Above sizes are nominal.
OS Open shelf		Actual dimensions: 14 ³ / ₄ "h x 14 ⁹ / ₁₆ "d
60 60" wide		Interior clearance dimension: 12 ⁵ / ₈ " high x 12" deep
GL Gable Left		
V316 Case Finish		
		Product on this page will accept wood grain laminate, where laminate is currently an option.
		For vertical surfaces greater than 60", the grain direction is horizontal.
		These products are Glue and Dowel Construction.
		Knoll does not assume any responsibility for the installation, attachment or the securing of wall hung units to the wall. A certified building contractor should be consulted. Please refer to wall mounting information on page 463.

Wall Hung

L-Shelf

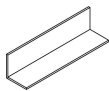
description	w	d	h	pattern no.	L	V1	V2	V3
 L-Shelf	60"	15"	15"	RRML60() ()	\$906.	\$1,088.	\$1,251.	\$1,626.
	72"	15"	15"	RRML72() ()	1,008.	1,219.	1,389.	1,806.
	90"	15"	15"	RRML90() ()	1,139.	1,366.	1,571.	2,044.
	108"	15"	15"	RRML108() ()	1,304.	1,565.	1,800.	2,339.

Order Code	Specification Information	Application Notes	
Example: RRML60() ()	<p><i>To order please specify pattern number including:</i></p> <ol style="list-style-type: none"> Finish type: L = Laminate 1 = V1 2 = V2 3 = V3 Finish: Laminate or wood 	<p>It is Not advisable to mix 28³/₈"h desk height products with 26¹/₂" standard height products.</p> <p>Product on this page will accept wood grain laminate, where laminate is currently an option.</p> <p>For vertical surfaces greater than 60", the grain direction is horizontal.</p> <p>The woodgrain on the L-Shelves, run perpendicular to the length.</p> <p>These products are Glue and Dowel Construction.</p> <p>Knoll does not assume any responsibility for the installation, attachment or the securing of wall hung units to the wall. A certified building contractor should be consulted. Please refer to wall mounting information on page 463.</p>	
RR Reff Refresh			For progressive overheads, LED light is recommended without fascia.
M Wall Hung			Overhead backs are finished in Veneer/Laminate on inside and paper finished on the outside.
L L-Shelf			Shipped knocked down. Hardware kit included.
60 60" Wide			Actual dimensions: 14 ³ / ₄ "h x 14 ⁷ / ₁₆ "d
L Finish Type			Installation instruction sheets available on Knoll Exchange.
114 Finish	For wall hung L shelf, refer to reference number 6TP00083.		

description	w	d	pattern no.	L	V1	V2	V3
Desk Top Cubbies 30" and 36"	30"	10"	RDTC3010()	\$910.	\$1,138.	\$1,308.	\$1,699.
	36"	10"	RDTC3610()	1,028.	1,147.	1,320.	1,715.



Desk Top Cubbies 60" and 72"	60"	10"	RDTC6010()	1,117.	1,396.	1,605.	2,087.
	72"	10"	RDTC7210()	1,140.	1,425.	1,638.	2,130.



Desk Top Cubbies Open	60"	10"	RDTCO6010()	1,234.	1,544.	1,774.	2,307.
	72"	10"	RDTCO7210()	1,252.	1,564.	1,798.	2,338.



Wall Mounted Cubbies 30" and 36"	30"	10"	RRMC3010()	997.	1,247.	1,434.	1,864.
	36"	10"	RRMC3610()	1,008.	1,258.	1,447.	1,881.



Wall Mounted Cubbies 60" and 72"	60"	10"	RRMC6010()	1,148.	1,434.	1,651.	2,147.
	72"	10"	RRMC7210()	1,172.	1,465.	1,684.	2,190.



Under Mounted Cubbies 30" and 36"	30"	10"	RUMC3010()	965.	1,206.	1,388.	1,804.
	36"	10"	RUMC3610()	977.	1,221.	1,404.	1,825.



Under Mounted Cubbies 60" and 72"	60"	10"	RUMC6010()	1,096.	1,368.	1,574.	2,048.
	72"	10"	RUMC7210()	1,123.	1,403.	1,614.	2,098.

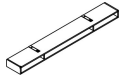

Order Code

Example: RDTC3010()	
R	Reff
DT	Desk Top
C	Cubby
30	Width
10	Depth
	Finish

Specification Information

To order please specify pattern number including:

1. Finish:
Laminate or wood

Product on this page will accept wood grain laminate, where laminate is currently an option.

Installation instruction sheets available on Knoll Exchange.

For Wall Mounted cubbies, please refer to reference number 6TP00086.

For Under Mounted cubbies, please refer to reference number 6TP00087.

Classic Desks, 28³/₈" planning With Recessed Modesty

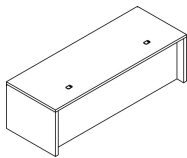
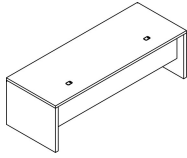
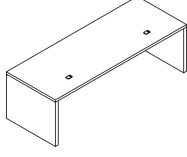
description	d	w	h	pattern no.	L	V1	V2	V3
 <p>Classic Desk Full Modesty Recessed 28³/₈"</p>	30"	60"	28 ³ / ₈ "	RCDFMR60302 () ()	\$1,750.	\$2,944.	\$3,386.	\$4,401.
	30"	72"	28 ³ / ₈ "	RCDFMR72302 () ()	1,837.	3,091.	3,554.	4,621.
	30"	84"	28 ³ / ₈ "	RCDFMR84302 () ()	1,918.	3,228.	3,712.	4,826.
	30"	96"	28 ³ / ₈ "	RCDFMR96302 () ()	1,994.	3,356.	3,859.	5,016.
	36"	60"	28 ³ / ₈ "	RCDFMR60362 () ()	1,853.	3,118.	3,586.	4,662.
	36"	72"	28 ³ / ₈ "	RCDFMR72362 () ()	1,945.	3,274.	3,769.	4,894.
	36"	84"	28 ³ / ₈ "	RCDFMR84362 () ()	2,032.	3,419.	3,933.	5,113.
	36"	96"	28 ³ / ₈ "	RCDFMR96362 () ()	2,114.	3,559.	4,092.	5,321.
 <p>Classic Desk Half Modesty Recessed 28³/₈"</p>	30"	60"	28 ³ / ₈ "	RCDHMR60302 () ()	1,687.	2,840.	3,266.	4,245.
	30"	72"	28 ³ / ₈ "	RCDHMR72302 () ()	1,759.	2,959.	3,404.	4,424.
	30"	84"	28 ³ / ₈ "	RCDHMR84302 () ()	1,829.	3,077.	3,539.	4,601.
	30"	96"	28 ³ / ₈ "	RCDHMR96302 () ()	1,889.	3,178.	3,655.	4,751.
	36"	60"	28 ³ / ₈ "	RCDHMR60362 () ()	1,791.	3,012.	3,466.	4,505.
	36"	72"	28 ³ / ₈ "	RCDHMR72362 () ()	1,867.	3,143.	3,613.	4,697.
	36"	84"	28 ³ / ₈ "	RCDHMR84362 () ()	1,942.	3,270.	3,760.	4,887.
	36"	96"	28 ³ / ₈ "	RCDHMR96362 () ()	2,009.	3,380.	3,889.	5,055.
 <p>Classic Desk Quarter Modesty Recessed 28³/₈"</p>	30"	60"	28 ³ / ₈ "	RCDQMR60302 () ()	1,613.	2,714.	3,121.	4,058.
	30"	72"	28 ³ / ₈ "	RCDQMR72302 () ()	1,674.	2,818.	3,240.	4,211.
	30"	84"	28 ³ / ₈ "	RCDQMR84302 () ()	1,731.	2,914.	3,352.	4,355.
	30"	96"	28 ³ / ₈ "	RCDQMR96302 () ()	1,781.	2,997.	3,447.	4,481.
	36"	60"	28 ³ / ₈ "	RCDQMR60362 () ()	1,716.	2,887.	3,321.	4,317.
	36"	72"	28 ³ / ₈ "	RCDQMR72362 () ()	1,782.	3,000.	3,448.	4,483.
	36"	84"	28 ³ / ₈ "	RCDQMR84362 () ()	1,845.	3,106.	3,571.	4,642.
	36"	96"	28 ³ / ₈ "	RCDQMR96362 () ()	1,901.	3,201.	3,681.	4,786.

Order Code	Specification Information	Application Notes
Example: RCDFMR60301	<i>To order please specify pattern number including:</i>	<p>It is Not advisable to mix 28³/₈"h desk height products with 26¹/₂" standard height products.</p> <p>28³/₈" high desk will only work with 28³/₈" high lower storage.</p> <p>Product on this page, excluding any vertical surface over 60", will accept wood grain laminate, where laminate is currently an option.</p> <p>Grommets are located 20" in from the sides and 3.5" in from the back.</p> <p>Grommets ship separately in a kit.</p> <p>Knoll accepts no responsibility for special grommet locations which interfere with support or other hardware. All requests for special grommet locations must be approved through custom product development.</p>
R Reff	1. Grommet Option F=Flush or Standard Corner location N=No Grommet R=Recessed Grommet	
CD Classic Desk	2. Grommet Finish: Painted or Plated	
FMR Full Modesty Recessed	3. Finish: L,V1,V2,V3	<p>Total height = 28³/₈"h to the underside of worksurface.</p> <p>Worksurface is 1¹/₂" thick. End panels are 2" thick.</p> <p>Lower storage sold separately.</p> <p>30" deep desk with recessed modesty will accept 19" and 23" deep pedestals.</p> <p>36" deep desk with recessed modesty will accept 19", 23" and 29" deep pedestals.</p> <p>Classic desks with half recessed and quarter recessed modesty, accepts <u>NO</u> lower storage.</p> <p>Classic Desks ship knocked down, with all hardware.</p>
HMR = Half Modesty Recessed		
QMR = Quarter Modesty Recessed		
60 Width		
30 Depth		
2 28 ³ / ₈ " high		
() Grommet Option		
() Grommet Finish		
() Finish		

Classic Desks, 28³/₈" planning With Full Flush Modesty

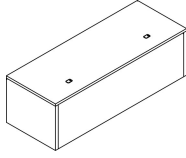
description	d	w	h	pattern no.	L	V1	V2	V3
	30"	60"	28 ³ / ₈ "	RCDFMF60302 () ()	\$1,750.	\$2,944.	\$3,386.	\$4,401.
	30"	72"	28 ³ / ₈ "	RCDFMF72302 () ()	1,837.	3,091.	3,554.	4,621.
	30"	84"	28 ³ / ₈ "	RCDFMF84302 () ()	1,918.	3,228.	3,712.	4,826.
	30"	96"	28 ³ / ₈ "	RCDFMF96302 () ()	1,994.	3,356.	3,859.	5,016.
	36"	60"	28 ³ / ₈ "	RCDFMF60362 () ()	1,750.	2,944.	3,386.	4,401.
	36"	72"	28 ³ / ₈ "	RCDFMF72362 () ()	1,837.	3,091.	3,554.	4,621.
	36"	84"	28 ³ / ₈ "	RCDFMF84362 () ()	1,918.	3,228.	3,712.	4,826.
	36"	96"	28 ³ / ₈ "	RCDFMF96362 () ()	1,994.	3,356.	3,859.	5,016.

Order Code	Specification Information	Application Notes
Example: RCDFMF60302	<i>To order please specify pattern number including:</i>	<p>It is Not advisable to mix 28³/₈"h desk height products with 26¹/₂" standard height products.</p> <p>28³/₈" high desk will only work with 28³/₈" high lower storage.</p> <p>Product on this page Excluding any vertical surface over 60", will accept wood grain laminate, where laminate is currently an option.</p> <p>Grommets are located 20" in from the sides and 3.5" in from the back.</p> <p>Grommets ship separately in a kit.</p> <p>Knoll accepts no responsibility for special grommet locations which interfere with support or other hardware. All requests for special grommet locations must be approved through custom product development.</p>
R Reff	1. Grommet Option	
CD Classic Desk	F=Flush or Standard Corner location	
FMF Full Modesty Flush	N=No Grommet	
60 Width	R=Recessed Grommet	
30 Depth	2. Grommet Finish: Painted or Plated	
2 28 ³ / ₈ " high	3. Finish: L,V1,V2,V3	
() Grommet Option		
() Grommet Finish		
() Finish		<p>Total height = 28³/₈"h to the underside of worksurface.</p> <p>Worksurface is 1¹/₂" thick.</p> <p>End panels are 2" thick.</p> <p>Lower storage sold separately.</p> <p>30" deep desk with flush modesty will accept up to 29" deep pedestals.</p> <p>36" deep desk with flush modesty will accept up to 29" deep pedestals.</p> <p>Classic Desks ship knocked down, with all hardware.</p>

Classic Credenza, 28³/₈" h
Preconfigured, Type A, Box File Center
Metal interiors

description	w	d	h	pattern no.	Top/Case										
					L/L	V1/L	V2/L	V3/L	V1/V1	V2/V2	V3/V3				
Classic Credenzas, Type HAH	78"	20"	28 ³ / ₈ "	RCDHHAH11()	M()	()()	()()	()()	\$4,960.	\$5,091.	\$5,151.	\$5,425.	\$5,894.	\$6,625.	\$8,818.
Hinge door / 22 ³ / ₈ "h Box File / Hinge door	78"	24"	28 ³ / ₈ "	RCDHHAH12()	M()	()()	()()	()()	5,158.	5,272.	5,339.	5,650.	6,562.	7,394.	9,671.
Cabinet	84"	20"	28 ³ / ₈ "	RCDHHAH21()	M()	()()	()()	()()	5,004.	5,141.	5,205.	5,497.	6,105.	6,798.	9,066.
	84"	24"	28 ³ / ₈ "	RCDHHAH22()	M()	()()	()()	()()	5,211.	5,332.	5,406.	5,736.	6,708.	7,559.	9,783.

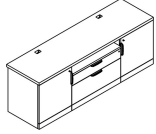

Classic Credenzas, Type HAW	78"	20"	28 ³ / ₈ "	RCDHHAH11()	M()	()()	()()	()()	5,384.	5,510.	5,568.	5,831.	6,171.	6,984.	9,094.
Hinge door / 22 ³ / ₈ "h Box File / Waste Recycle	78"	24"	28 ³ / ₈ "	RCDHHAH12()	M()	()()	()()	()()	5,574.	5,684.	5,749.	6,048.	6,801.	7,725.	9,914.
Cabinet	84"	20"	28 ³ / ₈ "	RCDHHAH21()	M()	()()	()()	()()	5,426.	5,559.	5,620.	5,901.	6,369.	7,151.	9,333.
	84"	24"	28 ³ / ₈ "	RCDHHAH22()	M()	()()	()()	()()	5,625.	5,742.	5,813.	6,131.	6,938.	7,883.	10,021.

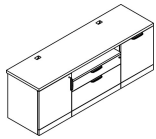

Order Code	Specification Information	Application Notes
Example: RCDHHAH11 ()(M)()()()()()	To order please specify pattern number including:	It is Not advisable to mix 28³/₈"h desk height products with 26¹/₂" standard height products.
R Reff	1. Top Finish: L, V1, V2, V3	Upper top is 1 1/2" thick, with standard grommet locations.
C Credenza	2. Edge finish: L, V1, V2, V3 (Edge options are available on laminate tops only.)	Lower top (3/4 height pedestal's top) is 1" thick, and comes in the same finish as the pedestal.
DH Desk height	3. Cabinet Finish: L, V1, V2, V3 Note: V1/L=Veneer worksurface, Laminate case	The preconfigured credenzas come with two 6" wide pedestal fillers, in the same finish as the cabinets.
H LH position; Hinged door pedestal, 28 ³ / ₈ "h W=Waste Recycle pedestal	4. Interior Option: M = Metal Interior	Applied back ordered separately for finished back.
A Center position; BF pedestal, 22 ³ / ₈ "h	5. Grommet Option: N = No grommet G = Grommet	Note: Full pedestal back will restrict ventilation.
H RH position; Hinged door pedestal, 28 ³ / ₈ "h W = Waste Recycle pedestal	6. Grommet Finish: Painted or Plated	Pencil trays are not included.
1 78" wide, 2 = 84" wide	7. Pull option: B = No pull, No drilling customer's own pull	For further details on individual pedestals, refer to Application Notes;
1 20" deep, 2 = 24" deep	C = C-Pull (Nickel finish only)	for Hinge door pedestals, see page 156.
V316 Top finish	D = D-Pull (Painted, PT or PZ only)	for BF, see page 139.
() Edge finish	F = Bar (1 pull / Door set)	for Waste recycle pedestals, see page 156.
V316 Cabinet Finish	H = Outline (1 pull / Door set)	for replacement waste recycle bins, see page 416.
M Metal Interior option	J = Routed J-pull	
G Grommet option	R = Cylinder (1 pull / Door set)	
111 Grommet finish	S = S-pull (Stainless steel only)	
T Pull option	T = Tab (1 pull / Door set)	
111 Pull finish	8. Pull finish: Painted or plated	
L Lock option	9. Lock Option Doors: L = Lock hole drilled	
B Lock finish	N = No lock drilling	
	Pedestals with drawers always lock drilled	
	10. Lock finish: B = Black S = Matte silver	

Classic Credenza, 28^{3/8}" h
Preconfigured, Type A, Box File Center
Metal interiors

description	w	d	h	pattern no.	Top/Case												
					L/L	V1/L	V2/L	V3/L	V1/V1	V2/V2	V3/V3						
Classic Credenzas, Type WAH	78"	20"	28 ^{3/8} "	RCDHWAH11()	()	(M)	()	()	()	()	\$5,384.	\$5,510.	\$5,568.	\$5,831.	\$6,171.	\$6,984.	\$9,094.
Waste Recycle bin / 22 ^{3/8} "h Box File / Hinge door Cabinet	78"	24"	28 ^{3/8} "	RCDHWAH12()	()	(M)	()	()	()	()	5,574.	5,684.	5,749.	6,048.	6,801.	7,725.	9,914.
	84"	20"	28 ^{3/8} "	RCDHWAH21()	()	(M)	()	()	()	()	5,426.	5,559.	5,620.	5,901.	6,369.	7,151.	9,333.
	84"	24"	28 ^{3/8} "	RCDHWAH22()	()	(M)	()	()	()	()	5,625.	5,742.	5,813.	6,131.	6,938.	7,883.	10,021.

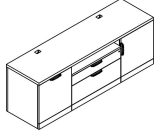

Order Code	Specification Information	Application Notes
Example: RCDHHAH11 () (M) () () () ()	<i>To order please specify pattern number including:</i>	It is Not advisable to mix 28^{3/8}" desk height products with 26^{1/2}" standard height products.
R Reff	1. Top Finish: L, V1, V2, V3	Upper top is 1 1/2" thick, with standard grommet locations.
C Credenza	2. Edge finish: L, V1, V2, V3 (Edge options are available on laminate tops only.)	Lower top (3/4 height pedestal's top) is 1" thick, and comes in the same finish as the pedestal.
DH Desk height	3. Cabinet Finish: L, V1, V2, V3 Note: V1/L=Veneer worksurface, Laminate case	The preconfigured credenzas come with two 6" wide pedestal fillers, in the same finish as the cabinets.
H LH position; Hinged door pedestal, 28 ^{3/8} "h W=Waste Recycle pedestal	4. Interior Option: M = Metal Interior	Applied back ordered separately for finished back.
A Center position; BF pedestal, 22 ^{3/8} "h	5. Grommet Option: N = No grommet G = Grommet	Note: Full pedestal back will restrict ventilation.
H RH position; Hinged door pedestal, 28 ^{3/8} "h W = Waste Recycle pedestal	6. Grommet Finish: Painted or Plated	Pencil trays are not included.
1 78" wide, 2 = 84" wide	7. Pull option: B = No pull, No drilling customer's own pull	For further details on individual pedestals, refer to Application Notes;
1 20" deep, 2 = 24" deep	C = C-Pull (Nickel finish only)	for Hinge door pedestals, see page 156.
V316 Top finish	D = D-Pull (Painted, PT or PZ only)	for BF, see page 139.
() Edge finish	F = Bar (1 pull / Door set)	for Waste recycle pedestals, see page 156.
V316 Cabinet Finish	H = Outline (1 pull / Door set)	for replacement waste recycle bins, see page 416.
M Metal Interior option	J = Routed J-pull	
G Grommet option	R = Cylinder (1 pull / Door set)	
111 Grommet finish	S = S-pull (Stainless steel only)	
T Pull option	T = Tab (1 pull / Door set)	
111 Pull finish	8. Pull finish: Painted or plated	
L Lock option	9. Lock Option Doors: L = Lock hole drilled	
B Lock finish	N = No lock drilling Pedestals with drawers always lock drilled	
	10. Lock finish: B = Black S = Matte silver	

Classic Credenza, 28^{3/8}" h
Preconfigured, Type A, Box File Center
Wood interiors

description	w	d	h	pattern no.	Top/Case						
					L/L	V1/L	V2/L	V3/L	V1/V1	V2/V2	V3/V3
Classic Credenzas, Type HAH	78"	20"	28 ^{3/8} "	RCDHHAH11() () W () () () () ()	\$5,285.	\$5,347.	\$5,444.	\$5,702.	\$6,185.	\$6,954.	\$9,264.
Hinge door / 22 ^{3/8} "h Box File / Hinge door	78"	24"	28 ^{3/8} "	RCDHHAH12() () W () () () () ()	5,647.	5,761.	5,829.	6,139.	7,086.	7,983.	10,160.
	84"	20"	28 ^{3/8} "	RCDHHAH21() () W () () () () ()	5,483.	5,621.	5,684.	5,976.	6,720.	7,493.	9,785.
	84"	24"	28 ^{3/8} "	RCDHHAH22() () W () () () () ()	5,718.	5,838.	5,912.	6,242.	7,614.	8,359.	10,289.

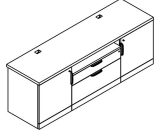

Classic Credenzas, Type HAW	78"	20"	28 ^{3/8} "	RCDHHAW11() () W () () () () ()	5,697.	5,756.	5,850.	6,098.	6,445.	7,301.	9,522.
Hinge door / 22 ^{3/8} "h Box File / Waste Recycle Bin	78"	24"	28 ^{3/8} "	RCDHHAW12() () W () () () () ()	6,044.	6,154.	6,220.	6,518.	7,294.	8,290.	10,384.
	84"	20"	28 ^{3/8} "	RCDHHAW21() () W () () () () ()	5,887.	6,020.	6,080.	6,361.	6,950.	7,820.	10,023.
	84"	24"	28 ^{3/8} "	RCDHHAW22() () W () () () () ()	6,113.	6,229.	6,300.	6,617.	7,792.	8,652.	10,508.

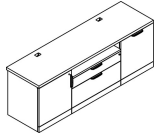

Order Code	Specification Information	Application Notes
Example: RCDHHAH11 () () W () () () ()	To order please specify pattern number including:	It is Not advisable to mix 28^{3/8}"h desk height products with 26^{1/2}" standard height products.
R Reff	1. Top Finish: L, V1, V2, V3	Upper top is 1 ^{1/2} " thick, with standard grommet locations.
C Credenza	2. Edge finish: L, V1, V2, V3 (Edge options are available on laminate tops only.)	Lower top (3/4 height pedestal's top) is 1" thick, and comes in the same finish as the pedestal.
DH Desk height	3. Cabinet Finish: L, V1, V2, V3 Note: V1/L=Veneer worksurface, Laminate case	The preconfigured credenzas come with two 6" wide pedestal fillers, in the same finish as the cabinets.
H LH position; Hinged door pedestal, 28 ^{3/8} "h W = Waste Recycle pedestal	4. Interior Option: W = Wood Interior	Applied back ordered separately for finished back.
A Center position; BF pedestal, 22 ^{3/8} "h	5. Grommet Option: N = No grommet G = Grommet	Note: Full pedestal back will restrict ventilation.
H RH position; Hinged door pedestal, 28 ^{3/8} "h W = Waste Recycle pedestal	6. Grommet Finish: Painted or Plated	Pencil trays are not included.
1 78" wide, 2 = 84" wide	7. Pull option: B = No pull, No drilling customer's own pull C = C-Pull (Nickel finish only) D = D-Pull (Painted, PT or PZ only) F = Bar (1 pull / Door set) H = Outline (1 pull / Door set) J = Routed J-pull R = Cylinder (1 pull / Door set) S = S-pull (Stainless steel only) T = Tab (1 pull / Door set)	For further details on individual pedestals, refer to Application Notes; for Hinge door pedestals, see page 156. for BF with single front, see page 141. for Waste recycle pedestals see page 156. or replacement waste recycle bins, see Accessories, page 416.
1 20" deep, 2 = 24" deep	8. Pull finish: Painted or plated	
V316 Top finish	9. Lock Option Doors: L = Lock hole drilled N = No lock drilling Pedestals with drawers always lock drilled	
() Edge finish	10. Lock finish: B = Black S = Matte silver	
V316 Cabinet Finish		
W Wood Interior option		
G Grommet option		
111 Grommet finish		
T Pull option		
111 Pull finish		
L Lock option		
B Lock finish		

Classic Credenza, 28^{3/8}" h
Preconfigured, Type A, Box File Center
Wood interiors

description	w	d	h	pattern no.	Top/Case						
					L/L	V1/L	V2/L	V3/L	V1/V1	V2/V2	V3/V3
Classic Credenzas, Type WAH	78"	20"	28 ^{3/8} "	RCDHWAH11()	\$5,697.	\$5,756.	\$5,850.	\$6,098.	\$6,445.	\$7,301.	\$9,522.
Waste Recycle bin / 22 ^{3/8} "h Box File / Hinge door	78"	24"	28 ^{3/8} "	RCDHWAH12()	6,044.	6,154.	6,220.	6,518.	7,294.	8,290.	10,384.
	84"	20"	28 ^{3/8} "	RCDHWAH21()	5,887.	6,020.	6,080.	6,361.	6,950.	7,820.	10,023.
	84"	24"	28 ^{3/8} "	RCDHWAH22()	6,113.	6,229.	6,300.	6,617.	7,792.	8,652.	10,508.

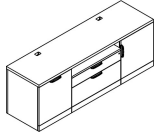

Order Code	Specification Information	Application Notes
Example: RCDHHAH11 ()(J)W ()(())()	<i>To order please specify pattern number including:</i>	It is Not advisable to mix 28^{3/8}"h desk height products with 26^{1/2}" standard height products.
R Reff	1. Top Finish: L, V1, V2, V3	Upper top is 1 1/2" thick, with standard grommet locations. Lower top (3/4 height pedestal's top) is 1" thick, and comes in the same finish as the pedestal.
C Credenza	2. Edge finish: L, V1, V2, V3 (Edge options are available on laminate tops only.)	
DH Desk height	3. Cabinet Finish: L, V1, V2, V3 Note: V1/L=Veneer worksurface, Laminate case	The preconfigured credenzas come with two 6" wide pedestal fillers, in the same finish as the cabinets. Applied back ordered separately for finished back. Note: Full pedestal back will restrict ventilation.
H LH position; Hinged door pedestal, 28 ^{3/8} "h W = Waste Recycle pedestal	4. Interior Option: W = Wood Interior	
A Center position; BF pedestal, 22 ^{3/8} "h	5. Grommet Option: N = No grommet G = Grommet	Pencil trays are not included.
H RH position; Hinged door pedestal, 28 ^{3/8} "h W = Waste Recycle pedestal	6. Grommet Finish: Painted or Plated	
1 78" wide, 2 = 84" wide	7. Pull option: B = No pull, No drilling customer's own pull	For further details on individual pedestals, refer to Application Notes; for Hinge door pedestals, see page 156. for BF with single front, see page 141. for Waste recycle pedestals see page 156. or replacement waste recycle bins, see Accessories, page 416.
1 20" deep, 2 = 24" deep	C = C-Pull (Nickel finish only) D = D-Pull (Painted, PT or PZ only)	
V316 Top finish	F = Bar (1 pull / Door set)	These products are key hole construction.
() Edge finish	H = Outline (1 pull / Door set) J = Routed J-pull	
V316 Cabinet Finish	R = Cylinder (1 pull / Door set) S = S-pull (Stainless steel only)	
W Wood Interior option	T = Tab (1 pull / Door set)	
G Grommet option	8. Pull finish: Painted or plated	
111 Grommet finish	9. Lock Option Doors: L = Lock hole drilled N = No lock drilling	
T Pull option	Pedestals with drawers always lock drilled	
111 Pull finish	10. Lock finish: B = Black S = Matte silver	
L Lock option		
B Lock finish		

Classic Credenza, 28^{3/8}" h

Preconfigured, Type B, Box File with Single front center Metal interiors

description	w	d	h	pattern no.	Top/Case												
					L/L	V1/L	V2/L	V3/L	V1/V1	V2/V2	V3/V3						
Classic Credenzas, Type HBH	78"	20"	28 ^{3/8} "	RCDHBBH11()	()	(M)	()	()	()	()	\$4,835.	\$4,966.	\$5,037.	\$5,300.	\$5,990.	\$6,727.	\$8,942.
Hinge door / 22 ^{3/8} "h Box File with single front/	78"	24"	28 ^{3/8} "	RCDHBBH12()	()	(M)	()	()	()	()	5,011.	5,125.	5,027.	5,300.	5,990.	6,727.	8,942.
Hinge door	84"	20"	28 ^{3/8} "	RCDHBBH21()	()	(M)	()	()	()	()	4,882.	5,019.	5,083.	5,375.	6,201.	6,901.	9,190.
	84"	24"	28 ^{3/8} "	RCDHBBH22()	()	(M)	()	()	()	()	5,068.	5,190.	5,262.	5,593.	6,804.	7,663.	9,568.

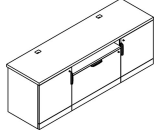

Classic Credenzas, Type HBW	78"	20"	28 ^{3/8} "	RCDHBBW11()	()	(M)	()	()	()	()	5,264.	5,390.	5,448.	5,711.	6,262.	7,084.	9,213.
Hinge door / 22 ^{3/8} "h Box File with single front/	78"	24"	28 ^{3/8} "	RCDHBBW12()	()	(M)	()	()	()	()	5,434.	5,543.	5,609.	5,907.	6,892.	7,825.	9,701.
Waste Recycle Pedestal	84"	20"	28 ^{3/8} "	RCDHBBW21()	()	(M)	()	()	()	()	5,310.	5,442.	5,502.	5,783.	6,461.	7,251.	9,452.
	84"	24"	28 ^{3/8} "	RCDHBBW22()	()	(M)	()	()	()	()	5,488.	5,605.	5,675.	5,993.	7,029.	7,983.	9,815.

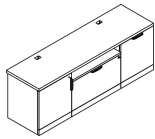

Order Code	Specification Information	Application Notes
Example: RCDHAAH11 () (M) () () () ()	<i>To order please specify pattern number including:</i>	It is Not advisable to mix 28^{3/8}"h desk height products with 26^{1/2}" standard height products.
R Reff	1. Top Finish: L, V1, V2, V3	Upper top is 1 1/2" thick, with standard grommet locations.
C Credenza	2. Edge finish: L, V1, V2, V3 (Edge options are available on laminate tops only.)	Lower top (3/4 height pedestal's top) is 1" thick, and comes in the same finish as the pedestal.
DH Desk height	3. Cabinet Finish: L, V1, V2, V3 Note: V1/L=Veneer worksurface, Laminate case	The preconfigured credenzas come with two 6" wide pedestal fillers, in the same finish as the cabinets.
H LH position; Hinged door pedestal, or W = Waste Recycle pedestal: 28 ^{3/8} "h	4. Interior Option: M = Metal Interior	Applied back ordered separately for finished back.
B Center position; BF with common front pedestal, 22 ^{3/8} "h	5. Grommet Option: N = No grommet G = Grommet	Note: Full pedestal back will restrict ventilation.
H RH position; Hinged door pedestal, or W = Waste Recycle pedestal 28 ^{3/8} "h	6. Grommet Finish: Painted or Plated	Pencil trays are not included.
1 78" wide, 2 = 84" wide	7. Pull option: B = No pull, No drilling customer's own pull C = C-Pull (Nickel finish only) D = D-Pull (Painted, PT or PZ only) F = Bar (1 pull / Door set) H = Outline (1 pull / Door set) J = Routed J-pull R = Cylinder (1 pull / Door set) S = S-pull (Stainless steel only) T = Tab (1 pull / Door set)	For further details on individual pedestals, refer to Application Notes; for Hinge door pedestals, see page 156. for BF with common front, see page 143. for Waste recycle pedestals, see page 156. for replacement waste recycle bins, see page 416.
1 20" deep, 2 = 24" deep	8. Pull finish: Painted or plated	
V316 Top finish	9. Lock Option Doors: L = Lock hole drilled N = No lock drilling Pedestals with drawers always lock drilled	
() Edge finish	10. Lock finish: B = Black S = Matte silver	
V316 Cabinet Finish		
M Metal Interior option		
G Grommet option		
111 Grommet finish		
T Pull option		
111 Pull finish		
L Lock option		
B Lock finish		

Classic Credenza, 28^{3/8}" h
 Preconfigured, Type B, Box File with Single front center
 Metal interiors

description	w	d	h	pattern no.	Top/Case											
					L/L	V1/L	V2/L	V3/L	V1/V1	V2/V2	V3/V3					
Classic Credenzas, Type WBH	78"	20"	28 ^{3/8} "	RCDHWHB11()	(M)	()	()	()	()	\$5,264.	\$5,390.	\$5,448.	\$5,711.	\$6,262.	\$7,084.	\$9,213.
Waste Recycle pedestal / 22 ^{3/8} "h Box File with single front/ Hinge door	78"	24"	28 ^{3/8} "	RCDHWHB12()	(M)	()	()	()	()	5,434.	5,543.	5,609.	5,907.	6,892.	7,825.	9,701.
	84"	20"	28 ^{3/8} "	RCDHWHB21()	(M)	()	()	()	()	5,310.	5,442.	5,502.	5,783.	6,461.	7,251.	9,452.
	84"	24"	28 ^{3/8} "	RCDHWHB22()	(M)	()	()	()	()	5,488.	5,605.	5,675.	5,993.	7,029.	7,983.	9,815.

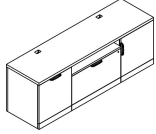

Order Code	Specification Information	Application Notes
Example: RCDHHAH11 () (M) () () () ()	To order please specify pattern number including:	It is Not advisable to mix 28^{3/8}"h desk height products with 26^{1/2}" standard height products.
R Reff	1. Top Finish: L, V1, V2, V3	Upper top is 1 1/2" thick, with standard grommet locations.
C Credenza	2. Edge finish: L, V1, V2, V3 (Edge options are available on laminate tops only.)	Lower top (3/4 height pedestal's top) is 1" thick, and comes in the same finish as the pedestal.
DH Desk height	3. Cabinet Finish: L, V1, V2, V3 Note: V1/L=Veneer worksurface, Laminate case	The preconfigured credenzas come with two 6" wide pedestal fillers, in the same finish as the cabinets.
H LH position; Hinged door pedestal, or W = Waste Recycle pedestal: 28 ^{3/8} "h	4. Interior Option: M = Metal Interior	Applied back ordered separately for finished back.
B Center position; BF with common front pedestal, 22 ^{3/8} "h	5. Grommet Option: N = No grommet G = Grommet	Note: Full pedestal back will restrict ventilation.
H RH position; Hinged door pedestal, or W = Waste Recycle pedestal 28 ^{3/8} "h	6. Grommet Finish: Painted or Plated	Pencil trays are not included.
1 78" wide, 2 = 84" wide	7. Pull option: B = No pull, No drilling customer's own pull	For further details on individual pedestals, refer to Application Notes;
1 20" deep, 2 = 24" deep	C = C-Pull (Nickel finish only) D = D-Pull (Painted, PT or PZ only) F = Bar (1 pull/ Door set) H = Outline (1 pull / Door set) J = Routed J-pull R = Cylinder (1 pull / Door set) S = S-pull (Stainless steel only) T = Tab (1 pull / Door set)	for Hinge door pedestals, see page 156.
V316 Top finish	8. Pull finish: Painted or plated	for BF with common front, see page 143.
() Edge finish	9. Lock Option Doors: L = Lock hole drilled N = No lock drilling Pedestals with drawers always lock drilled	for Waste recycle pedestals, see page 156.
V316 Cabinet Finish	10. Lock finish: B = Black S = Matte silver	for replacement waste recycle bins, see page 416.
M Metal Interior option		
G Grommet option		
111 Grommet finish		
T Pull option		
111 Pull finish		
L Lock option		
B Lock finish		

Classic Credenza, 28³/₈" h

Preconfigured, Type B, Box File with Single front center Wood interiors

description	w	d	h	pattern no.	Top/Case											
					L/L	V1/L	V2/L	V3/L	V1/V1	V2/V2	V3/V3					
Classic Credenzas, Type HBH	78"	20"	28 ³ / ₈ "	RCDHHBH11()	()	()	()	()	()	\$5,301.	\$5,400.	\$5,491.	\$5,754.	\$6,281.	\$7,057.	\$9,320.
Hinge door / 22 ³ / ₈ "h Box File with single front/	78"	24"	28 ³ / ₈ "	RCDHHBH12()	()	()	()	()	()	5,501.	5,616.	5,685.	5,994.	7,181.	8,085.	9,939.
Hinge door	84"	20"	28 ³ / ₈ "	RCDHHBH21()	()	()	()	()	()	5,362.	5,499.	5,563.	5,855.	6,816.	7,596.	9,684.
	84"	24"	28 ³ / ₈ "	RCDHHBH22()	()	()	()	()	()	5,575.	5,697.	5,771.	6,101.	7,639.	8,206.	10,076.

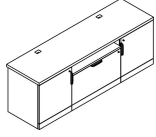

Classic Credenzas, Type HBW	78"	20"	28 ³ / ₈ "	RCDHHBW11()	()	()	()	()	()	5,712.	5,807.	5,895.	6,148.	6,536.	7,401.	9,577.
Hinge door / 22 ³ / ₈ "h Box File with single front/	78"	24"	28 ³ / ₈ "	RCDHHBW12()	()	()	()	()	()	5,905.	6,015.	6,081.	6,379.	7,385.	8,390.	10,172.
Waste Recycle Pedestal	84"	20"	28 ³ / ₈ "	RCDHHBW21()	()	()	()	()	()	5,771.	5,903.	5,963.	6,244.	7,041.	7,919.	9,927.
	84"	24"	28 ³ / ₈ "	RCDHHBW22()	()	()	()	()	()	5,976.	6,093.	6,163.	6,481.	7,817.	8,505.	10,303.

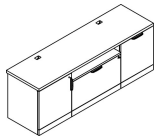

Order Code	Specification Information	Application Notes
Example: RCDHHAH11 () () JW () () () ()	<i>To order please specify pattern number including:</i>	It is Not advisable to mix 28³/₈"h desk height products with 26¹/₂" standard height products.
R Reff	1. Top Finish: L, V1, V2, V3	Upper top is 1 1/2" thick, with standard grommet locations. Lower top (3/4 height pedestal's top) is 1" thick, and comes in the same finish as the pedestal.
C Credenza	2. Edge finish: L, V1, V2, V3 (Edge options are available on laminate tops only.)	
DH Desk height	3. Cabinet Finish: L, V1, V2, V3 Note: V1/L=Veneer worksurface, Laminate case	The preconfigured credenzas come with two 6" wide pedestal fillers, in the same finish as the cabinets. Applied back ordered separately for finished back. Note: Full pedestal back will restrict ventilation.
H LH position; Hinged door pedestal, or W = Waste Recycle pedestal; 28 ³ / ₈ "h	4. Interior Option: W = Wood Interior	
B Center position; BF with common front pedestal, 22 ³ / ₈ "h	5. Grommet Option: N = No grommet G = Grommet	Pencil trays are not included.
H RH position; Hinged door pedestal, or W = Waste Recycle pedestal 28 ³ / ₈ "h	6. Grommet Finish: Painted or Plated	
1 78" wide, 2 = 84" wide	7. Pull option: B = No pull, No drilling customer's own pull C = C-Pull (Nickel finish only) D = D-Pull (Painted, PT or PZ only) F = Bar (1 pull / Door set) H = Outline (1 pull / Door set) J = Routed J-pull R = Cylinder (1 pull / Door set) S = S-pull (Stainless steel only) T = Tab (1 pull / Door set)	For further details on individual pedestals, refer to Application Notes; for Hinge door pedestals, see page 156. for BF with single front, see page 144. for Waste recycle pedestals see page 156. or replacement waste recycle bins, see Accessories, page 416.
1 20" deep, 2 = 24" deep	8. Pull finish: Painted or plated	
V316 Top finish	9. Lock Option Doors: L = Lock hole drilled N = No lock drilling Pedestals with drawers always lock drilled	These products are key hole construction.
() Edge finish	10. Lock finish: B = Black S = Matte silver	
V316 Cabinet Finish		
W Wood Interior option		
G Grommet option		
111 Grommet finish		
T Pull option		
111 Pull finish		
L Lock option		
B Lock finish		

Classic Credenza, 28^{3/8}" h
 Preconfigured, Type B, Box File with Single front center
 Wood interiors

description	w	d	h	pattern no.	Top/Case											
					L/L	V1/L	V2/L	V3/L	V1/V1	V2/V2	V3/V3					
Classic Credenzas, Type WBH	78"	20"	28 ^{3/8} "	RCDHWHB11()	(JW)	()	()	()	()	\$5,712.	\$5,807.	\$5,895.	\$6,148.	\$6,536.	\$7,401.	\$9,577.
Waste Recycle pedestal / 22 ^{3/8} "h Box File with single front/ Hinge door	78"	24"	28 ^{3/8} "	RCDHWHB12()	(JW)	()	()	()	()	5,905.	6,015.	6,081.	6,379.	7,385.	8,390.	10,172.
	84"	20"	28 ^{3/8} "	RCDHWHB21()	(JW)	()	()	()	()	5,771.	5,903.	5,963.	6,244.	7,041.	7,919.	9,927.
	84"	24"	28 ^{3/8} "	RCDHWHB22()	(JW)	()	()	()	()	5,976.	6,093.	6,163.	6,481.	7,817.	8,505.	10,303.

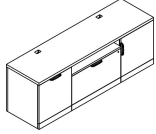

Order Code	Specification Information	Application Notes
Example: RCDHHAH11 () (JW) () () () ()	To order please specify pattern number including:	It is Not advisable to mix 28^{3/8}"h desk height products with 26^{1/2}" standard height products.
R Reff	1. Top Finish: L, V1, V2, V3	Upper top is 1 1/2" thick, with standard grommet locations.
C Credenza	2. Edge finish: L, V1, V2, V3 (Edge options are available on laminate tops only.)	Lower top (3/4 height pedestal's top) is 1" thick, and comes in the same finish as the pedestal.
DH Desk height	3. Cabinet Finish: L, V1, V2, V3 Note: V1/L=Veneer worksurface, Laminate case	The preconfigured credenzas come with two 6" wide pedestal fillers, in the same finish as the cabinets.
H LH position; Hinged door pedestal, or W = Waste Recycle pedestal; 28 ^{3/8} "h	4. Interior Option: W = Wood Interior	Applied back ordered separately for finished back.
B Center position; BF with common front pedestal, 22 ^{3/8} "h	5. Grommet Option: N = No grommet G = Grommet	Note: Full pedestal back will restrict ventilation.
H RH position; Hinged door pedestal, or W = Waste Recycle pedestal 28 ^{3/8} "h	6. Grommet Finish: Painted or Plated	Pencil trays are not included.
1 78" wide, 2 = 84" wide	7. Pull option: B = No pull, No drilling customer's own pull C = C-Pull (Nickel finish only) D = D-Pull (Painted, PT or PZ only) F = Bar (1 pull / Door set) H = Outline (1 pull / Door set) J = Routed J-pull R = Cylinder (1 pull / Door set) S = S-pull (Stainless steel only) T = Tab (1 pull / Door set)	For further details on individual pedestals, refer to Application Notes; for Hinge door pedestals, see page 156. for BF with single front, see page 144. for Waste recycle pedestals see page 156. or replacement waste recycle bins, see Accessories, page 416.
1 20" deep, 2 = 24" deep	8. Pull finish: Painted or plated	
V316 Top finish	9. Lock Option Doors: L = Lock hole drilled N = No lock drilling Pedestals with drawers always lock drilled	
() Edge finish	10. Lock finish: B = Black S = Matte silver	
V316 Cabinet Finish		
W Wood Interior option		
G Grommet option		
111 Grommet finish		
T Pull option		
111 Pull finish		
L Lock option		
B Lock finish		

Classic Credenza, 28 3/8" h
Preconfigured, Type C, Box Box Box Center
Metal interiors

description	w	d	h	pattern no.	Top/Case						
					L/L	V1/L	V3/L	V3/L	V1/V1	V2/V2	V3/V3
Classic Credenzas, Type HCH	78"	20"	28 3/8"	RCDHHCH11()JM() () () () ()	\$5,363.	\$5,425.	\$5,522.	\$5,780.	\$6,209.	\$6,970.	\$9,272.
Hinge door / 22 3/8" h Box Box Box / Hinge door	78"	24"	28 3/8"	RCDHHCH12()JM() () () () ()	5,787.	5,858.	5,971.	6,263.	6,881.	7,741.	10,324.
	84"	20"	28 3/8"	RCDHHCH21()JM() () () () ()	5,521.	5,593.	5,693.	5,964.	6,435.	7,164.	9,552.
	84"	24"	28 3/8"	RCDHHCH22()JM() () () () ()	5,925.	6,002.	6,115.	6,420.	7,040.	7,925.	10,594.

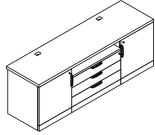

Classic Credenzas, Type HCW	78"	20"	28 3/8"	RCDHHCW11()JM() () () () ()	5,772.	5,831.	5,925.	6,173.	6,469.	7,316.	9,530.
Hinge door / 22 3/8" h Box Box Box / Waste	78"	24"	28 3/8"	RCDHHCW12()JM() () () () ()	6,180.	6,247.	6,356.	6,637.	7,101.	8,059.	10,542.
Recycle pedestal	84"	20"	28 3/8"	RCDHHCW21()JM() () () () ()	5,923.	5,993.	6,089.	6,350.	6,681.	7,503.	9,800.
	84"	24"	28 3/8"	RCDHHCW22()JM() () () () ()	6,312.	6,387.	6,495.	6,788.	7,251.	8,236.	10,801.

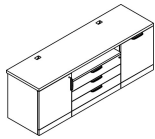

Order Code	Specification Information	Application Notes
Example: RCDHHA11 ()JM() () () ()	<i>To order please specify pattern number including:</i>	It is Not advisable to mix 28 3/8" h desk height products with 26 1/2" standard height products.
R	1. Top Finish: L, V1, V2, V3	Upper top is 1 1/2" thick, with standard grommet locations. Lower top (3/4 height pedestal's top) is 1" thick, and comes in the same finish as the pedestal.
C	2. Edge finish: L, V1, V2, V3 (Edge options are available on laminate tops only.)	
DH	3. Cabinet Finish: L, V1, V2, V3 Note: V1/L=Veneer worksurface, Laminate case	The preconfigured credenzas come with two 6" wide pedestal fillers, in the same finish as the cabinets. Applied back ordered separately for finished back. Note: Full pedestal back will restrict ventilation.
H	4. Interior Option: M = Metal Interior	Pencil trays are not included.
C	5. Grommet Option: N = No grommet G = Grommet	
H	6. Grommet Finish: Painted or Plated	For further details on individual pedestals, refer to Application Notes; for Hinge door pedestals, see page 156 for BBB, see page 139. for Waste recycle pedestals, see page 156. for replacement waste recycle bins, see page 416.
1	7. Pull option: B = No pull, No drilling customer's own pull	
1	C = C-Pull (Nickel finish only) D = D-Pull (Painted, PT or PZ only)	
V316	F = Bar (1 pull / Door set)	
()	H = Outline (1 pull / Door set) J = Routed J-pull	
V316	R = Cylinder (1 pull / Door set)	
M	S = S-pull (Stainless steel only)	
G	T = Tab (1 pull / Door set)	
111	8. Pull finish: Painted or plated	
T	9. Lock Option Doors: L = Lock hole drilled N = No lock drilling	
111	Pedestals with drawers always lock drilled	
L	10. Lock finish: B = Black S = Matte silver	
B		

Classic Credenza, 28^{3/8}" h
 Preconfigured, Type C, Box Box Box Center
 Metal interiors

description	w	d	h	pattern no.	Top/Case										
					L/L	V1/L	V3/L	V3/L	V1/V1	V2/V2	V3/V3				
Classic Credenzas, Type WCH	78"	20"	28 ^{3/8} "	RCDHWCH11()	M()	()()	()()	()()	\$5,772.	\$5,831.	\$5,925.	\$6,173.	\$6,469.	\$7,316.	\$9,530.
Waste Recycle pedestal / 22 ^{3/8} "h Box Box Box /	78"	24"	28 ^{3/8} "	RCDHWCH12()	M()	()()	()()	()()	6,180.	6,247.	6,356.	6,637.	7,101.	8,059.	10,542.
Hinge door	84"	20"	28 ^{3/8} "	RCDHWCH21()	M()	()()	()()	()()	5,923.	5,993.	6,089.	6,350.	6,681.	7,503.	9,800.
	84"	24"	28 ^{3/8} "	RCDHWCH22()	M()	()()	()()	()()	6,312.	6,387.	6,495.	6,788.	7,251.	8,236.	10,801.

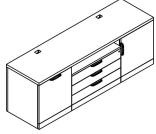

Order Code	Specification Information	Application Notes
Example: RCDHHAH11 () () M () () () ()	<i>To order please specify pattern number including:</i>	It is Not advisable to mix 28^{3/8}"h desk height products with 26^{1/2}" standard height products.
R Reff	1. Top Finish: L, V1, V2, V3	Upper top is 1 1/2" thick, with standard grommet locations.
C Credenza	2. Edge finish: L, V1, V2, V3 (Edge options are available on laminate tops only.)	Lower top (3/4 height pedestal's top) is 1" thick, and comes in the same finish as the pedestal.
DH Desk height	3. Cabinet Finish: L, V1, V2, V3 Note: V1/L=Veneer worksurface, Laminate case	The preconfigured credenzas come with two 6" wide pedestal fillers, in the same finish as the cabinets.
H LH position; Hinged door pedestal, 28 ^{3/8} "h W = Waste Recycle pedestal 28 ^{3/8} "h	4. Interior Option: M = Metal Interior	Applied back ordered separately for finished back.
C BBB pedestal, 22 ^{3/8} "h	5. Grommet Option: N = No grommet G = Grommet	Note: Full pedestal back will restrict ventilation.
H RH position; Hinged door pedestal, 28 ^{3/8} "h W = Waste Recycle pedestal 28 ^{3/8} "h	6. Grommet Finish: Painted or Plated	Pencil trays are not included.
1 78" wide, 2 = 84" wide	7. Pull option: B = No pull, No drilling customer's own pull	For further details on individual pedestals, refer to Application Notes;
1 20" deep, 2 = 24" deep	C = C-Pull (Nickel finish only)	for Hinge door pedestals, see page 156
V316 Top finish	D = D-Pull (Painted, PT or PZ only)	for BBB, see page 139.
() Edge finish	F = Bar (1 pull / Door set)	for Waste recycle pedestals, see page 156.
V316 Cabinet Finish	H = Outline (1 pull / Door set)	for replacement waste recycle bins, see page 416.
M Metal Interior option	J = Routed J-pull	
G Grommet option	R = Cylinder (1 pull / Door set)	
111 Grommet finish	S = S-pull (Stainless steel only)	
T Pull option	T = Tab (1 pull / Door set)	
111 Pull finish	8. Pull finish: Painted or plated	
L Lock option	9. Lock Option Doors: L = Lock hole drilled	
B Lock finish	N = No lock drilling Pedestals with drawers always lock drilled	
	10. Lock finish: B = Black S = Matte silver	

Classic Credenza, 28³/₈" h
 Preconfigured, Type C, Box Box Box Center
 Wood interiors

description	w	d	h	pattern no.	Top/Case										
					L/L	V1/L	V2/L	V3/L	V1/V1	V2/V2	V3/V3				
Classic Credenzas, Type HCH	78"	20"	28 ³ / ₈ "	RCDHHCH11()	W()	()()	()()	()()	\$5,759.	\$5,821.	\$5,918.	\$6,177.	\$6,660.	\$7,473.	\$9,940.
Hinge door / 22 ³ / ₈ "h BBB / Hinge door pedestal	78"	24"	28 ³ / ₈ "	RCDHHCH12()	W()	()()	()()	()()	6,476.	6,547.	6,659.	6,952.	7,657.	8,605.	11,470.
	84"	20"	28 ³ / ₈ "	RCDHHCH21()	W()	()()	()()	()()	6,280.	6,352.	6,451.	6,723.	7,300.	8,132.	10,839.
	84"	24"	28 ³ / ₈ "	RCDHHCH22()	W()	()()	()()	()()	7,038.	7,116.	7,228.	7,533.	8,306.	9,334.	12,471.

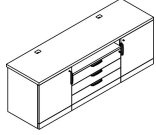

Classic Credenzas, Type HCW	78"	20"	28 ³ / ₈ "	RCDHHCW11()	W()	()()	()()	()()	6,153.	6,213.	6,306.	6,554.	6,894.	7,801.	10,173.
Hinge door / 22 ³ / ₈ "h Box Box Box / Waste Recycle pedestal	78"	24"	28 ³ / ₈ "	RCDHHCW12()	W()	()()	()()	()()	6,842.	6,910.	7,018.	7,299.	7,833.	8,889.	11,644.
	84"	20"	28 ³ / ₈ "	RCDHHCW21()	W()	()()	()()	()()	6,653.	6,723.	6,818.	7,080.	7,496.	8,435.	11,037.
	84"	24"	28 ³ / ₈ "	RCDHHCW22()	W()	()()	()()	()()	7,382.	7,457.	7,566.	7,858.	8,444.	9,590.	12,606.

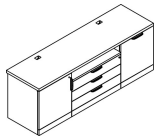

Order Code	Specification Information	Application Notes
Example: RCDHHAH11 ()(W) ()()()()	<i>To order please specify pattern number including:</i>	It is Not advisable to mix 28³/₈"h desk height products with 26¹/₂" standard height products.
R Reff	1. Top Finish: L, V1, V2, V3	Upper top is 1 1/2" thick, with standard grommet locations.
C Credenza	2. Edge finish: L, V1, V2, V3 (Edge options are available on laminate tops only.)	Lower top (3/4 height pedestal's top) is 1" thick, and comes in the same finish as the pedestal.
DH Desk height	3. Cabinet Finish: L, V1, V2, V3 Note: V1/L=Veneer worksurface, Laminate case	The preconfigured credenzas come with two 6" wide pedestal fillers, in the same finish as the cabinets.
H LH position; Hinged door pedestal, 28 ³ / ₈ "h W = Waste Recycle pedestal 28 ³ / ₈ "h	4. Interior Option: W = Wood Interior	Applied back ordered separately for finished back.
C BBB pedestal, 22 ³ / ₈ "h	5. Grommet Option: N = No grommet G = Grommet	Note: Full pedestal back will restrict ventilation.
H RH position; Hinged door pedestal, 28 ³ / ₈ "h W = Waste Recycle pedestal 28 ³ / ₈ "h	6. Grommet Finish: Painted or Plated	Pencil trays are not included.
1 78" wide, 2 = 84" wide	7. Pull option: B = No pull, No drilling customer's own pull C = C-Pull (Nickel finish only) D = D-Pull (Painted, PT or PZ only) F = Bar (1 pull / Door set) H = Outline (1 pull / Door set) J = Routed J-pull R = Cylinder (1 pull / Door set) S = S-pull (Stainless steel only) T = Tab (1 pull / Door set)	For further details on individual pedestals, refer to Application Notes; for Hinge door pedestals, see page 156. for BBB, see page 141. for Waste recycle pedestals see page 103. or replacement waste recycle bins, see Accessories, page 416.
1 20" deep, 2 = 24" deep	8. Pull finish: Painted or plated	
V316 Top finish	9. Lock Option Doors: L = Lock hole drilled N = No lock drilling Pedestals with drawers always lock drilled	
() Edge finish	10. Lock finish: B = Black S = Matte silver	
V316 Cabinet Finish		
W Wood Interior option		
G Grommet option		
111 Grommet finish		
T Pull option		
111 Pull finish		
L Lock option		
B Lock finish		

Classic Credenza, 28^{3/8}" h
 Preconfigured, Type C, Box Box Box Center
 Wood interiors

description	w	d	h	pattern no.	Top/Case											
					L/L	V1/L	V2/L	V3/L	V1/V1	V2/V2	V3/V3					
Classic Credenzas, Type WCH	78"	20"	28 ^{3/8} "	RCDHWCH11()	()	()	()	()	()	\$6,153.	\$6,213.	\$6,306.	\$6,554.	\$6,894.	\$7,801.	\$10,173.
Waste Recycle pedestal / 22 ^{3/8} "h Box Box Box /	78"	24"	28 ^{3/8} "	RCDHWCH12()	()	()	()	()	()	6,842.	6,910.	7,018.	7,299.	7,833.	8,889.	11,644.
Hinge door	84"	20"	28 ^{3/8} "	RCDHWCH21()	()	()	()	()	()	6,653.	6,723.	6,818.	7,080.	7,496.	8,435.	11,037.
	84"	24"	28 ^{3/8} "	RCDHWCH22()	()	()	()	()	()	7,382.	7,457.	7,566.	7,858.	8,444.	9,590.	12,606.

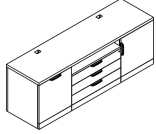

Order Code	Specification Information	Application Notes
Example: RCDHHAH11 () () W () () () ()	<i>To order please specify pattern number including:</i>	It is Not advisable to mix 28^{3/8}"h desk height products with 26^{1/2}" standard height products.
R Reff	1. Top Finish: L, V1, V2, V3	Upper top is 1 1/2" thick, with standard grommet locations.
C Credenza	2. Edge finish: L, V1, V2, V3 (Edge options are available on laminate tops only.)	Lower top (3/4 height pedestal's top) is 1" thick, and comes in the same finish as the pedestal.
DH Desk height	3. Cabinet Finish: L, V1, V2, V3 Note: V1/L=Veneer worksurface, Laminate case	The preconfigured credenzas come with two 6" wide pedestal fillers, in the same finish as the cabinets.
H LH position; Hinged door pedestal, 28 ^{3/8} "h W = Waste Recycle pedestal 28 ^{3/8} "h	4. Interior Option: W = Wood Interior	Applied back ordered separately for finished back.
C BBB pedestal, 22 ^{3/8} "h	5. Grommet Option: N = No grommet G = Grommet	Note: Full pedestal back will restrict ventilation.
H RH position; Hinged door pedestal, 28 ^{3/8} "h W = Waste Recycle pedestal 28 ^{3/8} "h	6. Grommet Finish: Painted or Plated	Pencil trays are not included.
1 78" wide, 2 = 84" wide	7. Pull option: B = No pull, No drilling customer's own pull	For further details on individual pedestals, refer to Application Notes;
1 20" deep, 2 = 24" deep	C = C-Pull (Nickel finish only)	for Hinge door pedestals, see page 156.
V316 Top finish	D = D-Pull (Painted, PT or PZ only)	for BBB, see page 141.
() Edge finish	F = Bar (1 pull / Door set)	for Waste recycle pedestals see page 103.
V316 Cabinet Finish	H = Outline (1 pull / Door set)	or replacement waste recycle bins, see Accessories, page 416.
W Wood Interior option	J = Routed J-pull	
G Grommet option	R = Cylinder (1 pull / Door set)	
111 Grommet finish	S = S-pull (Stainless steel only)	
T Pull option	T = Tab (1 pull / Door set)	
111 Pull finish	8. Pull finish: Painted or plated	
L Lock option	9. Lock Option Doors: L = Lock hole drilled	
B Lock finish	N = No lock drilling Pedestals with drawers always lock drilled	
	10. Lock finish: B = Black S = Matte silver	

Classic Credenza, 34³/₈" h

Preconfigured Service Height, Type A, Box Box File Center Metal interiors

description	w	d	h	pattern no.	Top/Case											
					L/L	V1/L	V2/L	V3/L	V1/V1	V2/V2	V3/V3					
Classic Credenzas - Service Height, Type HAH; Hinge door / 28 ³ / ₈ "h Box Box File/Hinge door	78"	20"	34 ³ / ₈ "	RCSHHAH11()	(M)	()	()	()	()	\$5,521.	\$6,220.	\$6,671.	\$8,187.	\$6,517.	\$7,260.	\$9,668.
	78"	24"	34 ³ / ₈ "	RCSHHAH12()	(M)	()	()	()	()	5,960.	6,856.	7,456.	9,210.	7,167.	8,077.	10,783.
	84"	20"	34 ³ / ₈ "	RCSHHAH21()	(M)	()	()	()	()	5,681.	6,393.	6,843.	8,372.	6,704.	7,470.	9,965.
	84"	24"	34 ³ / ₈ "	RCSHHAH22()	(M)	()	()	()	()	6,106.	7,012.	7,609.	9,374.	7,341.	8,274.	11,063.

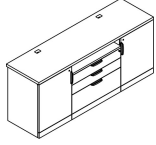

Classic Credenzas, Type HAW Hinge door / 28 ³ / ₈ "h Box Box File/Waste Recycle Bin	78"	20"	34 ³ / ₈ "	RCSHHAW11()	(M)	()	()	()	()	6,172.	6,660.	6,883.	7,814.	7,181.	7,912.	10,319.
	78"	24"	34 ³ / ₈ "	RCSHHAW12()	(M)	()	()	()	()	6,611.	7,207.	7,507.	8,573.	7,830.	8,727.	11,434.
	84"	20"	34 ³ / ₈ "	RCSHHAW21()	(M)	()	()	()	()	6,331.	6,835.	7,056.	7,999.	7,369.	8,122.	10,616.
	84"	24"	34 ³ / ₈ "	RCSHHAW22()	(M)	()	()	()	()	6,757.	7,363.	7,660.	8,737.	8,004.	8,924.	11,714.

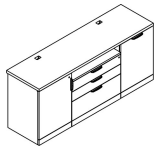

Order Code	Specification Information	Application Notes
Example: RCSHHAH11 () (M) () () () ()	<i>To order please specify pattern number including:</i>	It is Not advisable to mix 28³/₈"h desk height products with 26¹/₂" standard height products.
R	1. Top Finish: L, V1, V2, V3	Upper top is 1 1/2" thick, with standard grommet locations. Lower top (3/4 height pedestal's top) is 1" thick, and comes in the same finish as the pedestal.
C	2. Edge finish: L, V1, V2, V3 (Edge options are available on laminate tops only.)	
SH	3. Cabinet Finish: L, V1, V2, V3	Product on this page excluding J pull and any vertical surface over 60", will accept wood grain laminate, where laminate is currently an option.
H	4. Interior Option: M = Metal Interior	
A	5. Grommet Option: N = No grommet G = Grommet	Keying instructions must accompany all orders, refer to page 325. Pedestals do not come with lock included. Key-alike are field installed using the Knoll Key order form. Each locking pedestal on this page counts for one lock core.
H	6. Grommet Finish: Painted or Plated	
1	7. Pull option: B = No pull, No drilling customer's own pull C = C-Pull (Nickel finish only) D = D-Pull (Painted, PT or PZ only) F = Bar (1 pull / Door set) H = Outline (1 pull / Door set) J = Routed J-pull R = Cylinder (1 pull / Door set) S = S-pull (Stainless steel only) T = Tab (1 pull / Door set)	The preconfigured credenzas come with two 6" wide pedestal fillers, in the same finish as the cabinets. Applied back ordered separately for finished back. Note: Full pedestal back will restrict ventilation.
1	8. Pull finish: Painted or plated	
V316	9. Lock Option Doors: L = Lock hole drilled N = No lock drilling Pedestals with drawers always lock drilled	Pencil trays are not included. For further details on individual pedestals, refer to Application Notes; for Hinge door pedestal 34 ³ / ₈ "h, see page 158 for Open pedestals; 28 ³ / ₈ "h, see page 148. for Waste recycle pedestals; 34 ³ / ₈ "h, see page 158. for replacement waste recycle bins, see page 416.
()	10. Lock finish: B = Black S = Matte silver	
V316		
()		
V316		
M		
G		
111		
T		
111		
L		
B		

Classic Credenza, 34³/₈" h

Preconfigured Service Height, Type A, Box Box File Center Metal interiors

description	w	d	h	pattern no.	Top/Case											
					L/L	V1/L	V2/L	V3/L	V1/V1	V2/V2	V3/V3					
Classic Credenzas, Type WAH	78"	20"	34 ³ / ₈ "	RCSHWAH11()	(JM)	()	()	()	()	\$6,172.	\$6,660.	\$6,883.	\$7,814.	\$7,181.	\$7,912.	\$10,319.
Waste Recycle bin / 28 ³ / ₈ "h Box Box File/ Hinge door	78"	24"	34 ³ / ₈ "	RCSHWAH12()	(JM)	()	()	()	()	6,611.	7,207.	7,507.	8,573.	7,830.	8,727.	11,434.
	84"	20"	34 ³ / ₈ "	RCSHWAH21()	(JM)	()	()	()	()	6,331.	6,835.	7,056.	7,999.	7,369.	8,122.	10,616.
	84"	24"	34 ³ / ₈ "	RCSHWAH22()	(JM)	()	()	()	()	6,757.	7,363.	7,660.	8,737.	8,004.	8,924.	11,714.

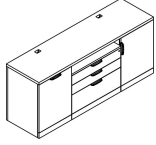

Order Code	Specification Information	Application Notes
Example: RCSHHAH11 () (JM) () () () ()	<i>To order please specify pattern number including:</i>	It is Not advisable to mix 28³/₈"h desk height products with 26¹/₂" standard height products.
R	Reff	Upper top is 1 ¹ / ₂ " thick, with standard grommet locations.
C	Credenza	Lower top (3/4 height pedestal's top) is 1" thick, and comes in the same finish as the pedestal.
SH	Service height	The preconfigured credenzas come with two 6" wide pedestal fillers, in the same finish as the cabinets.
H	LH position; Hinged door pedestal, 34 ³ / ₈ "h W=Waste Recycle pedestal	Applied back ordered separately for finished back.
A	Center position; BFF pedestal, 28 ³ / ₈ "h	Note: Full pedestal back will restrict ventilation.
H	RH position; Hinged door pedestal, or W = waste recycle cabinet 34 ³ / ₈ "h	Pencil trays are not included.
1	78" wide, 2 = 84" wide	For further details on individual pedestals, refer to Application Notes;
1	20" deep, 2 = 24" deep	for Hinge door pedestal 34 ³ / ₈ "h, see page 158
V316	Top finish	for Open pedestals; 28 ³ / ₈ "h, see page 148.
()	Edge finish	for Waste recycle pedestals; 34 ³ / ₈ "h, see page 158.
V316	Cabinet Finish	for replacement waste recycle bins, see page 416.
M	Metal Interior option	
G	Grommet option	
111	Grommet finish	
T	Pull option	
111	Pull finish	
L	Lock option	
B	Lock finish	
	1. Top Finish: L, V1, V2, V3	Product on this page excluding J pull and any vertical surface over 60", will accept wood grain laminate, where laminate is currently an option.
	2. Edge finish: L, V1, V2, V3 (Edge options are available on laminate tops only.)	Keying instructions must accompany all orders, refer to page 325. Pedestals do not come with lock included. Key-alike are field installed using the Knoll Key order form. Each locking pedestal on this page counts for one lock core.
	3. Cabinet Finish: L, V1, V2, V3	File drawers do Not support bottom loading.
	4. Interior Option: M = Metal Interior	File drawers include bars for front to back and side to side filing.
	5. Grommet Option: N = No grommet G = Grommet	These products are key hole construction.
	6. Grommet Finish: Painted or Plated	
	7. Pull option: B = No pull, No drilling customer's own pull C = C-Pull (Nickel finish only) D = D-Pull (Painted, PT or PZ only) F = Bar (1 pull/ Door set) H = Outline (1 pull / Door set) J = Routed J-pull R = Cylinder (1 pull / Door set) S = S-pull (Stainless steel only) T = Tab (1 pull / Door set)	
	8. Pull finish: Painted or plated	
	9. Lock Option Doors: L = Lock hole drilled N = No lock drilling Pedestals with drawers always lock drilled	
	10. Lock finish: B = Black S = Matte silver	

Preconfigured Service Height, Type A, Box Box File Center

Wood interiors

description	w	d	h	pattern no.	Top/Case						
					L/L	V1/L	V2/L	V3/L	V1/V1	V2/V2	V3/V3
Classic Credenzas - Service Height, Type HAH; Hinge door / 28 ^{3/8} "h Box Box File/Hinge door	78"	20"	34 ^{3/8} "	RCSHHAH11 () (JW) () () () () ()	\$5,769.	\$6,777.	\$7,549.	\$9,953.	\$6,806.	\$7,592.	\$10,117.
	78"	24"	34 ^{3/8} "	RCSHHAH12 () (JW) () () () () ()	6,452.	7,716.	8,681.	11,474.	7,747.	8,728.	11,659.
	84"	20"	34 ^{3/8} "	RCSHHAH21 () (JW) () () () () ()	6,269.	7,369.	8,213.	10,839.	7,391.	8,253.	11,020.
	84"	24"	34 ^{3/8} "	RCSHHAH22 () (JW) () () () () ()	6,996.	8,363.	9,407.	12,451.	8,399.	9,462.	12,664.

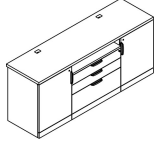

Classic Credenzas, Type HAW Hinge door / 28 ^{3/8} "h Box Box File/Waste Recycle Bin	78"	20"	34 ^{3/8} "	RCSHHAW11 () (JW) () () () () ()	6,420.	7,217.	7,761.	9,580.	7,470.	8,243.	10,768.
	78"	24"	34 ^{3/8} "	RCSHHAW12 () (JW) () () () () ()	7,102.	8,067.	8,733.	10,837.	8,411.	9,379.	12,310.
	84"	20"	34 ^{3/8} "	RCSHHAW21 () (JW) () () () () ()	6,920.	7,808.	8,427.	10,466.	8,055.	8,905.	11,671.
	84"	24"	34 ^{3/8} "	RCSHHAW22 () (JW) () () () () ()	7,645.	8,714.	9,460.	11,814.	9,061.	10,113.	13,315.

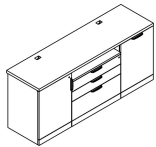

Order Code	Specification Information	Application Notes
Example: RCSHHAH11 () (JW) () () () ()	<i>To order please specify pattern number including:</i>	It is Not advisable to mix 28^{3/8}"h desk height products with 26^{1/2}" standard height products.
R Reff	1. Top Finish: L, V1, V2, V3	Upper top is 1 1/2" thick, with standard grommet locations.
C Credenza	2. Edge finish: L, V1, V2, V3 (Edge options are available on laminate tops only.)	Lower top (3/4 height pedestal's top) is 1" thick, and comes in the same finish as the pedestal.
SH Service height	3. Cabinet Finish: L, V1, V2, V3	The preconfigured credenzas come with two 6" wide pedestal fillers, in the same finish as the cabinets.
H LH position; Hinged door pedestal, 34 ^{3/8} "h W=Waste Recycle pedestal	4. Interior Option: W = Wood Interior	Applied back ordered separately for finished back.
A Center position; BFF pedestal, 28 ^{3/8} "h	5. Grommet Option: N = No grommet G = Grommet	Note: Full pedestal back will restrict ventilation.
H RH position; Hinged door pedestal, or W = waste recycle cabinet 34 ^{3/8} "h	6. Grommet Finish: Painted or Plated	Pencil trays are not included.
1 78" wide, 2 = 84" wide	7. Pull option: B = No pull, No drilling customer's own pull C = C-Pull (Nickel finish only) D = D-Pull (Painted, PT or PZ only) F = Bar (1 pull / Door set) H = Outline (1 pull / Door set) J = Routed J-pull R = Cylinder (1 pull / Door set) S = S-pull (Stainless steel only) T = Tab (1 pull / Door set)	For further details on individual pedestals, refer to Application Notes; for Hinge door pedestal 34 ^{3/8} "h, see page 158 for BBF; 28 ^{3/8} "h, see page 151. for Waste recycle pedestals; 34 ^{3/8} "h, see page 158. for replacement waste recycle bins, see page 416.
1 20" deep, 2 = 24" deep	8. Pull finish: Painted or plated	
V316 Top finish	9. Lock Option Doors: L = Lock hole drilled N = No lock drilling Pedestals with drawers always lock drilled	
() Edge finish	10. Lock finish: B = Black S = Matte silver	
V316 Cabinet Finish		
W Wood Interior option		
G Grommet option		
111 Grommet finish		
T Pull option		
111 Pull finish		
L Lock option		
B Lock finish		

Classic Credenza, 34³/₈" h
 Preconfigured Service Height, Type A, Box Box File Center
 Wood interiors

description	w	d	h	pattern no.	Top/Case											
					L/L	V1/L	V2/L	V3/L	V1/V1	V2/V2	V3/V3					
Classic Credenzas, Type WAH	78"	20"	34 ³ / ₈ "	RCSHWAH11()	(JW)	()	()	()	()	\$6,420.	\$7,217.	\$7,761.	\$9,580.	\$7,470.	\$8,243.	\$10,768.
Waste Recycle bin / 28 ³ / ₈ "h Box Box File/ Hinge door	78"	24"	34 ³ / ₈ "	RCSHWAH12()	(JW)	()	()	()	()	7,102.	8,067.	8,733.	10,837.	8,411.	9,379.	12,310.
	84"	20"	34 ³ / ₈ "	RCSHWAH21()	(JW)	()	()	()	()	6,920.	7,808.	8,427.	10,466.	8,055.	8,905.	11,671.
	84"	24"	34 ³ / ₈ "	RCSHWAH22()	(JW)	()	()	()	()	7,645.	8,714.	9,460.	11,814.	9,061.	10,113.	13,315.

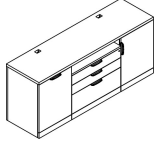

Order Code	Specification Information	Application Notes
Example: RCSHHAH11 () (JW) () () () ()	<i>To order please specify pattern number including:</i>	It is Not advisable to mix 28³/₈"h desk height products with 26¹/₂" standard height products.
R	Reff	Upper top is 1 1/2" thick, with standard grommet locations.
C	Credenza	Lower top (3/4 height pedestal's top) is 1" thick, and comes in the same finish as the pedestal.
SH	Service height	The preconfigured credenzas come with two 6" wide pedestal fillers, in the same finish as the cabinets.
H	LH position; Hinged door pedestal, 34 ³ / ₈ "h W=Waste Recycle pedestal	Applied back ordered separately for finished back.
A	Center position; BFF pedestal, 28 ³ / ₈ "h	Note: Full pedestal back will restrict ventilation.
H	RH position; Hinged door pedestal, or W = waste recycle cabinet 34 ³ / ₈ "h	Pencil trays are not included.
1	78" wide, 2 = 84" wide	For further details on individual pedestals, refer to Application Notes;
1	20" deep, 2 = 24" deep	for Hinge door pedestal 34 ³ / ₈ "h, see page 158
V316	Top finish	for BFF; 28 ³ / ₈ "h, see page 151.
()	Edge finish	for Waste recycle pedestals; 34 ³ / ₈ "h, see page 158.
V316	Cabinet Finish	for replacement waste recycle bins, see page 416.
W	Wood Interior option	
G	Grommet option	
111	Grommet finish	
T	Pull option	
111	Pull finish	
L	Lock option	
B	Lock finish	
	1. Top Finish: L, V1, V2, V3	Product on this page excluding J pull and any vertical surface over 60", will accept wood grain laminate, where laminate is currently an option.
	2. Edge finish: L, V1, V2, V3 (Edge options are available on laminate tops only.)	Keying instructions must accompany all orders, refer to page 325. Pedestals do not come with lock included. Key-alike are field installed using the Knoll Key order form. Each locking pedestal on this page counts for one lock core.
	3. Cabinet Finish: L, V1, V2, V3	File drawers do Not support bottom loading.
	4. Interior Option: W = Wood Interior	File drawers include bars for front to back and side to side filing.
	5. Grommet Option: N = No grommet G = Grommet	These products are key hole construction.
	6. Grommet Finish: Painted or Plated	
	7. Pull option: B = No pull, No drilling customer's own pull C = C-Pull (Nickel finish only) D = D-Pull (Painted, PT or PZ only) F = Bar (1 pull/ Door set) H = Outline (1 pull / Door set) J = Routed J-pull R = Cylinder (1 pull / Door set) S = S-pull (Stainless steel only) T = Tab (1 pull / Door set)	
	8. Pull finish: Painted or plated	
	9. Lock Option Doors: L = Lock hole drilled N = No lock drilling Pedestals with drawers always lock drilled	
	10. Lock finish: B = Black S = Matte silver	

Classic Credenza, 34³/₈" h

Preconfigured Service Height, Type B, File File Center

Metal interiors

description	w	d	h	pattern no.	Top/Case												
					L/L	V1/L	V2/L	V3/L	V1/V1	V2/V2	V3/V3						
Classic Credenzas - Service Height,	78"	20"	34 ³ / ₈ "	RCSHHBH11	()	(M)	()	()	()	()	\$5,189.	\$5,881.	\$6,339.	\$7,855.	\$6,124.	\$6,819.	\$9,072.
Type HBH; Hinge door / 28 ³ / ₈ "h FF/Hinge door	78"	24"	34 ³ / ₈ "	RCSHHBH12	()	(M)	()	()	()	()	5,611.	6,500.	7,106.	8,860.	6,754.	7,613.	10,156.
Cabinet	84"	20"	34 ³ / ₈ "	RCSHHBH21	()	(M)	()	()	()	()	5,327.	6,032.	6,489.	8,019.	6,285.	7,000.	9,330.
	84"	24"	34 ³ / ₈ "	RCSHHBH22	()	(M)	()	()	()	()	5,735.	6,634.	7,238.	9,003.	6,904.	7,781.	10,397.

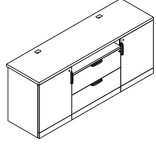

Classic Credenzas, Type HBW	78"	20"	34 ³ / ₈ "	RCSHHBW11	()	(M)	()	()	()	()	5,839.	6,322.	6,552.	7,481.	6,790.	7,471.	9,723.
Hinge door / 28 ³ / ₈ "h FF/Waste Recycle Cabinet	78"	24"	34 ³ / ₈ "	RCSHHBW12	()	(M)	()	()	()	()	6,262.	6,850.	7,158.	8,224.	7,417.	8,263.	10,807.
	84"	20"	34 ³ / ₈ "	RCSHHBW21	()	(M)	()	()	()	()	5,978.	6,474.	6,702.	7,645.	6,951.	7,652.	9,980.
	84"	24"	34 ³ / ₈ "	RCSHHBW22	()	(M)	()	()	()	()	6,386.	6,984.	7,289.	8,366.	7,568.	8,431.	11,047.

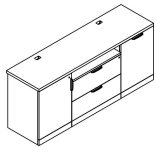

Order Code	Specification Information	Application Notes
Example: RCSHHBH11 () (M) () () () ()	<i>To order please specify pattern number including:</i>	It is Not advisable to mix 28³/₈"h desk height products with 26¹/₂" standard height products.
R	1. Top Finish: L, V1, V2, V3	Upper top is 1 1/2" thick, with standard grommet locations.
C	2. Edge finish: L, V1, V2, V3 (Edge options are available on laminate tops only.)	Lower top (3/4 height pedestal's top) is 1" thick, and comes in the same finish as the pedestal.
SH	3. Cabinet Finish: L, V1, V2, V3	The preconfigured credenzas come with two 6" wide pedestal fillers, in the same finish as the cabinets.
H	4. Interior Option: M = Metal Interior	Applied back ordered separately for finished back.
B	5. Grommet Option: N = No grommet G = Grommet	Note: Full pedestal back will restrict ventilation.
H	6. Grommet Finish: Painted or Plated	Pencil trays are not included.
H	7. Pull option: B = No pull, No drilling customer's own pull C = C-Pull (Nickel finish only) D = D-Pull (Painted, PT or PZ only) F = Bar (1 pull / Door set) H = Outline (1 pull / Door set) J = Routed J-pull R = Cylinder (1 pull / Door set) S = S-pull (Stainless steel only) T = Tab (1 pull / Door set)	For further details on individual pedestals, refer to Application Notes; for Hinge door pedestal 34 ³ / ₈ "h, see page 158 for FF; 28 ³ / ₈ "h, see page 148. for Waste recycle pedestals; 34 ³ / ₈ "h, see page 158. for replacement waste recycle bins, see page 416.
1	8. Pull finish: Painted or plated	
1	9. Lock Option Doors: L = Lock hole drilled N = No lock drilling	
V316	10. Lock finish: B = Black S = Matte silver	
()		
V316		
M		
G		
111		
T		
111		
L		
B		

Classic Credenza, 34³/₈" h
 Preconfigured Service Height, Type B, File File Center
 Metal interiors

description	w	d	h	pattern no.	Top/Case						
					L/L	V1/L	V2/L	V3/L	V1/V1	V2/V2	V3/V3
Classic Credenzas, Type WBH	78"	20"	34 ³ / ₈ "	RCSHWB11 () () M () () () () () ()	\$5,839.	\$6,322.	\$6,552.	\$7,481.	\$6,790.	\$7,471.	\$9,723.
Waste Recycle bin / 28 ³ / ₈ "h FF/ Hinge door	78"	24"	34 ³ / ₈ "	RCSHWB12 () () M () () () () () ()	6,262.	6,850.	7,158.	8,224.	7,417.	8,263.	10,807.
Cabinet	84"	20"	34 ³ / ₈ "	RCSHWB21 () () M () () () () () ()	5,978.	6,474.	6,702.	7,645.	6,951.	7,652.	9,980.
	84"	24"	34 ³ / ₈ "	RCSHWB22 () () M () () () () () ()	6,386.	6,984.	7,289.	8,366.	7,568.	8,431.	11,047.

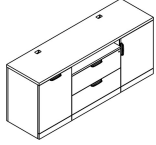

Order Code	Specification Information	Application Notes
Example: RCSHHB11 () () JM () () () ()	<i>To order please specify pattern number including:</i>	It is Not advisable to mix 28³/₈"h desk height products with 26¹/₂" standard height products.
R Reff	1. Top Finish: L, V1, V2, V3	Upper top is 1 1/2" thick, with standard grommet locations.
C Credenza	2. Edge finish: L, V1, V2, V3 (Edge options are available on laminate tops only.)	Lower top (3/4 height pedestal's top) is 1" thick, and comes in the same finish as the pedestal.
SH Service height	3. Cabinet Finish: L, V1, V2, V3	The preconfigured credenzas come with two 6" wide pedestal fillers, in the same finish as the cabinets.
H LH position; Hinged door pedestal, 34 ³ / ₈ "h W=Waste Recycle pedestal	4. Interior Option: M = Metal Interior	Applied back ordered separately for finished back.
B Center position; FF pedestal, 28 ³ / ₈ "h	5. Grommet Option: N = No grommet G = Grommet	Note: Full pedestal back will restrict ventilation.
H LH position; Hinged door , or W = waste recycle cabinet 34 ³ / ₈ "h	6. Grommet Finish: Painted or Plated	Pencil trays are not included.
1 78" wide, 2 = 84" wide	7. Pull option: B = No pull, No drilling customer's own pull C = C-Pull (Nickel finish only) D = D-Pull (Painted, PT or PZ only) F = Bar (1 pull/ Door set) H = Outline (1 pull / Door set) J = Routed J-pull R = Cylinder (1 pull / Door set) S = S-pull (Stainless steel only) T = Tab (1 pull / Door set)	For further details on individual pedestals, refer to Application Notes; for Hinge door pedestal 34 ³ / ₈ "h, see page 158 for FF; 28 ³ / ₈ "h, see page 148. for Waste recycle pedestals; 34 ³ / ₈ "h, see page 158. for replacement waste recycle bins, see page 416.
1 20" deep, 2 = 24" deep	8. Pull finish: Painted or plated	
V316 Top finish	9. Lock Option Doors: L = Lock hole drilled N = No lock drilling Pedestals with drawers always lock drilled	
() Edge finish	10. Lock finish: B = Black S = Matte silver	
V316 Cabinet Finish		
M Metal Interior option		
G Grommet option		
111 Grommet finish		
T Pull option		
111 Pull finish		
L Lock option		
B Lock finish		

Classic Credenza, 34^{3/8}" h
*Preconfigured Service Height, Type B, File File Center
 Wood interiors*

description	w	d	h	pattern no.	Top/Case			V1/V1	V2/V2	V3/V3	
					L/L	V1/L	V2/L				
Classic Credenzas - Service Height, Type HBH; Hinge door / 28 ^{3/8} "h FF/Hinge door Cabinet	78"	20"	34 ^{3/8} "	RCSHHBH11 () () () () () () () () () () () ()	\$5,451.	\$6,149.	\$6,601.	\$8,117.	\$6,431.	\$7,169.	\$9,546.
	78"	24"	34 ^{3/8} "	RCSHHBH12 () () () () () () () () () () () ()	6,078.	6,976.	7,574.	9,328.	7,307.	8,233.	10,990.
	84"	20"	34 ^{3/8} "	RCSHHBH21 () () () () () () () () () () () ()	5,876.	6,593.	7,039.	8,568.	6,929.	7,731.	10,315.
	84"	24"	34 ^{3/8} "	RCSHHBH22 () () () () () () () () () () () ()	6,537.	7,453.	8,040.	9,805.	7,858.	8,853.	11,842.

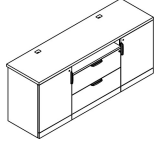

Classic Credenzas, Type HBW	78"	20"	34 ^{3/8} "	RCSHHBW11 () () () () () () () () () () () ()	6,102.	6,590.	6,814.	7,744.	7,096.	7,821.	10,197.
Hinge door / 28 ^{3/8} "h FF/Waste Recycle Cabinet	78"	24"	34 ^{3/8} "	RCSHHBW12 () () () () () () () () () () () ()	6,729.	7,327.	7,625.	8,691.	7,969.	8,883.	11,641.
	84"	20"	34 ^{3/8} "	RCSHHBW21 () () () () () () () () () () () ()	6,527.	7,035.	7,252.	8,195.	7,593.	8,382.	10,965.
	84"	24"	34 ^{3/8} "	RCSHHBW22 () () () () () () () () () () () ()	7,188.	7,802.	8,091.	9,169.	8,521.	9,503.	12,493.

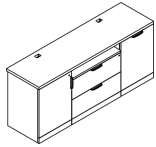

Order Code	Specification Information	Application Notes
Example: RCSHHBH11 () () () () () () () () () () () ()	To order please specify pattern number including:	It is Not advisable to mix 28^{3/8}"h desk height products with 26^{1/2}" standard height products.
R Reff	1. Top Finish: L, V1, V2, V3	Upper top is 1 1/2" thick, with standard grommet locations. Lower top (3/4 height pedestal's top) is 1" thick, and comes in the same finish as the pedestal.
C Credenza	2. Edge finish: L, V1, V2, V3 (Edge options are available on laminate tops only.)	
SH Service height	3. Cabinet Finish: L, V1, V2, V3	
H LH position; Hinged door pedestal, 34 ^{3/8} "h W=Waste Recycle pedestal	4. Interior Option: W = Wood Interior	The preconfigured credenzas come with two 6" wide pedestal fillers, in the same finish as the cabinets. Applied back ordered separately for finished back. Note: Full pedestal back will restrict ventilation.
B Center position; FF pedestal, 28 ^{3/8} "h	5. Grommet Option: N = No grommet G = Grommet	
H LH position; Hinged door, or W = waste recycle cabinet 34 ^{3/8} "h	6. Grommet Finish: Painted or Plated	Pencil trays are not included. For further details on individual pedestals, refer to Application Notes; for Hinge door pedestal 34 ^{3/8} "h, see page 158 for FF; 28 ^{3/8} "h, see page 151. for Waste recycle pedestals; 34 ^{3/8} "h, see page 158. for replacement waste recycle bins, see page 416.
1 78" wide, 2 = 84" wide	7. Pull option: B = No pull, No drilling customer's own pull C = C-Pull (Nickel finish only) D = D-Pull (Painted, PT or PZ only) F = Bar (1 pull / Door set) H = Outline (1 pull / Door set) J = Routed J-pull R = Cylinder (1 pull / Door set) S = S-pull (Stainless steel only) T = Tab (1 pull / Door set)	
1 20" deep, 2 = 24" deep	8. Pull finish: Painted or plated	
V316 Top finish	9. Lock Option Doors: L = Lock hole drilled N = No lock drilling Pedestals with drawers always lock drilled	These products are key hole construction.
() Edge finish	10. Lock finish: B = Black S = Matte silver	
V316 Cabinet Finish		
W Wood Interior option		
G Grommet option		
111 Grommet finish		
T Pull option		
111 Pull finish		
L Lock option		
B Lock finish		

Classic Credenza, 34³/₈" h
Preconfigured Service Height, Type B, File File Center
Wood interiors

description	w	d	h	pattern no.	Top/Case						
					L/L	V1/L	V2/L	V3/L	V1/V1	V2/V2	V3/V3
Classic Credenzas, Type WBH	78"	20"	34 ³ / ₈ "	RCSHWB11 ()(W)()(W)()(W)()(W)	\$6,102.	\$6,590.	\$6,814.	\$7,744.	\$7,096.	\$7,821.	\$10,197.
Waste Recycle bin / 28 ³ / ₈ "h FF / Hinge door	78"	24"	34 ³ / ₈ "	RCSHWB12 ()(W)()(W)()(W)()(W)	6,729.	7,327.	7,625.	8,691.	7,969.	8,883.	11,641.
Cabinet	84"	20"	34 ³ / ₈ "	RCSHWB21 ()(W)()(W)()(W)()(W)	6,527.	7,035.	7,252.	8,195.	7,593.	8,382.	10,965.
	84"	24"	34 ³ / ₈ "	RCSHWB22 ()(W)()(W)()(W)()(W)	7,188.	7,802.	8,091.	9,169.	8,521.	9,503.	12,493.

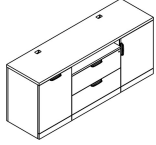

Order Code	Specification Information	Application Notes
Example: RCSHHB11 ()(W) ()(W)()(W)	<i>To order please specify pattern number including:</i>	It is Not advisable to mix 28³/₈"h desk height products with 26¹/₂" standard height products.
R Reff	1. Top Finish: L, V1, V2, V3	Upper top is 1 1/2" thick, with standard grommet locations. Lower top (3/4 height pedestal's top) is 1" thick, and comes in the same finish as the pedestal.
C Credenza	2. Edge finish: L, V1, V2, V3 (Edge options are available on laminate tops only.)	The preconfigured credenzas come with two 6" wide pedestal fillers, in the same finish as the cabinets. Applied back ordered separately for finished back. Note: Full pedestal back will restrict ventilation.
SH Service height	3. Cabinet Finish: L, V1, V2, V3	Pencil trays are not included.
H LH position; Hinged door pedestal, 34 ³ / ₈ "h W=Waste Recycle pedestal	4. Interior Option: W = Wood Interior	For further details on individual pedestals, refer to Application Notes; for Hinge door pedestal 34 ³ / ₈ "h, see page 158 for FF; 28 ³ / ₈ "h, see page 151. for Waste recycle pedestals; 34 ³ / ₈ "h, see page 158. for replacement waste recycle bins, see page 416.
B Center position; FF pedestal, 28 ³ / ₈ "h	5. Grommet Option: N = No grommet G = Grommet	
H LH position; Hinged door , or W = waste recycle cabinet 34 ³ / ₈ "h	6. Grommet Finish: Painted or Plated	
1 78" wide, 2 = 84" wide	7. Pull option: B = No pull, No drilling customer's own pull C = C-Pull (Nickel finish only) D = D-Pull (Painted, PT or PZ only) F = Bar (1 pull/ Door set) H = Outline (1 pull / Door set) J = Routed J-pull R = Cylinder (1 pull / Door set) S = S-pull (Stainless steel only) T = Tab (1 pull / Door set)	Product on this page excluding J pull and any vertical surface over 60", will accept wood grain laminate, where laminate is currently an option. Keying instructions must accompany all orders, refer to page 325. Pedestals do not come with lock included. Key-alike are field installed using the Knoll Key order form. Each locking pedestal on this page counts for one lock core. File drawers do Not support bottom loading. File drawers include bars for front to back and side to side filing.
1 20" deep, 2 = 24" deep	8. Pull finish: Painted or plated	These products are key hole construction.
V316 Top finish	9. Lock Option Doors: L = Lock hole drilled N = No lock drilling Pedestals with drawers always lock drilled	
() Edge finish	10. Lock finish: B = Black S = Matte silver	
V316 Cabinet Finish		
W Wood Interior option		
G Grommet option		
111 Grommet finish		
T Pull option		
111 Pull finish		
L Lock option		
B Lock finish		

Classic Credenza, 34³/₈" h

Preconfigured Service Height, Type C, Box Box Box Box Center Metal interiors

description	w	d	h	pattern no.	Top/Case										
					L/L	V1/L	V2/L	V3/L	V1/V1	V2/V2	V3/V3				
Classic Credenzas - Service Height, Type HCH; Hinge door / 28 ³ / ₈ "h BBBB/Hinge door Cabinet	78"	20"	34 ³ / ₈ "	RCSHHCH11()	M()	()()	()()	()()	\$5,618.	\$6,319.	\$6,768.	\$8,284.	\$6,616.	\$7,357.	\$9,765.
	78"	24"	34 ³ / ₈ "	RCSHHCH12()	M()	()()	()()	()()	6,034.	6,932.	7,530.	9,283.	7,243.	8,151.	10,857.
	84"	20"	34 ³ / ₈ "	RCSHHCH21()	M()	()()	()()	()()	5,780.	6,494.	6,942.	8,472.	6,805.	7,570.	10,064.
	84"	24"	34 ³ / ₈ "	RCSHHCH22()	M()	()()	()()	()()	6,182.	7,090.	7,684.	9,449.	7,419.	8,350.	11,139.

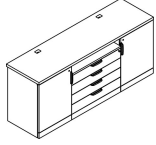

Classic Credenzas - Service Height, Type HCW; Hinge door / 28 ³ / ₈ "h BBBB/Waste recycle Cabinet	78"	20"	34 ³ / ₈ "	RCSHHCW11()	M()	()()	()()	()()	6,269.	6,760.	6,981.	7,911.	7,281.	8,009.	10,416.
	78"	24"	34 ³ / ₈ "	RCSHHCW12()	M()	()()	()()	()()	6,685.	7,282.	7,581.	8,647.	7,905.	8,801.	11,508.
	84"	20"	34 ³ / ₈ "	RCSHHCW21()	M()	()()	()()	()()	6,431.	6,936.	7,156.	8,099.	7,470.	8,222.	10,715.
	84"	24"	34 ³ / ₈ "	RCSHHCW22()	M()	()()	()()	()()	6,833.	7,439.	7,736.	8,813.	8,082.	9,000.	11,790.

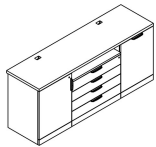

Order Code	Specification Information	Application Notes
Example: RCSHHCH11 () (M) ()()()()	<i>To order please specify pattern number including:</i>	It is Not advisable to mix 28³/₈"h desk height products with 26¹/₂" standard height products.
R	1. Top Finish: L, V1, V2, V3	Upper top is 1 ¹ / ₂ " thick, with standard grommet locations.
C	2. Edge finish: L, V1, V2, V3 (Edge options are available on laminate tops only.)	Lower top (3/4 height pedestal's top) is 1" thick, and comes in the same finish as the pedestal.
SH	3. Cabinet Finish: L, V1, V2, V3	The preconfigured credenzas come with two 6" wide pedestal fillers, in the same finish as the cabinets.
H	4. Interior Option: M = Metal Interior	Applied back ordered separately for finished back.
C	5. Grommet Option: N = No grommet G = Grommet	Note: Full pedestal back will restrict ventilation.
H	6. Grommet Finish: Painted or Plated	Pencil trays are not included.
1	7. Pull option: B = No pull, No drilling customer's own pull	For further details on individual pedestals, refer to Application Notes;
1	C = C-Pull (Nickel finish only)	for Hinge door pedestal 34 ³ / ₈ "h, see page 158
V316	D = D-Pull (Painted, PT or PZ only)	for BBB pedestals; 28 ³ / ₈ "h, see page 148.
()	F = Bar (1 pull / Door set)	for Waste recycle pedestals; 34 ³ / ₈ "h, see page 158.
V316	H = Outline (1 pull / Door set)	for replacement waste recycle bins, see page 416.
M	J = Routed J-pull	
G	R = Cylinder (1 pull / Door set)	
111	S = S-pull (Stainless steel only)	
T	T = Tab (1 pull / Door set)	
111	8. Pull finish: Painted or plated	
L	9. Lock Option Doors: L = Lock hole drilled	
B	N = No lock drilling	
	Pedestals with drawers always lock drilled	
	10. Lock finish: B = Black	
	S = Matte silver	

Classic Credenza, 34³/₈" h

Reff Profiles Vol. Two

Preconfigured Service Height, Type C, Box Box Box Box Center

Metal interiors

description	w	d	h	pattern no.	Top/Case											
					L/L	V1/L	V2/L	V3/L	V1/V1	V2/V2	V3/V3					
Classic Credenzas - Service Height,	78"	20"	34 ³ / ₈ "	RCSHWCH11()	()	()	()	()	()	\$6,269.	\$6,760.	\$6,981.	\$7,911.	\$7,281.	\$8,009.	\$10,416.
Type WCH; Waste recycle / 28 ³ / ₈ "h BBBB/ Hinge	78"	24"	34 ³ / ₈ "	RCSHWCH12()	()	()	()	()	()	6,685.	7,282.	7,581.	8,647.	7,905.	8,801.	11,508.
door Cabinet	84"	20"	34 ³ / ₈ "	RCSHWCH21()	()	()	()	()	()	6,431.	6,936.	7,156.	8,099.	7,470.	8,222.	10,715.
	84"	24"	34 ³ / ₈ "	RCSHWCH22()	()	()	()	()	()	6,833.	7,439.	7,736.	8,813.	8,082.	9,000.	11,790.

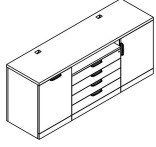

Order Code	Specification Information	Application Notes
Example: RCSHHCH11 () () JM () () () () ()	<i>To order please specify pattern number including:</i>	It is Not advisable to mix 28³/₈"h desk height products with 26¹/₂" standard height products.
R Reff	1. Top Finish: L, V1, V2, V3	Upper top is 1 ¹ / ₂ " thick, with standard grommet locations.
C Credenza	2. Edge finish: L, V1, V2, V3 (Edge options are available on laminate tops only.)	Lower top (3/4 height pedestal's top) is 1" thick, and comes in the same finish as the pedestal.
SH Service height	3. Cabinet Finish: L, V1, V2, V3	The preconfigured credenzas come with two 6" wide pedestal fillers, in the same finish as the cabinets.
H LH position; Hinged door or, W=Waste Recycle Cabinet	4. Interior Option: M = Metal Interior	Applied back ordered separately for finished back.
C Center position; BBBB Cabinet	5. Grommet Option: N = No grommet G = Grommet	Note: Full pedestal back will restrict ventilation.
H LH position; Hinged door, or W = Waste Recycle Cabinet	6. Grommet Finish: Painted or Plated	Pencil trays are not included.
1 78" wide, 2 = 84" wide	7. Pull option: B = No pull, No drilling customer's own pull	For further details on individual pedestals, refer to Application Notes;
1 20" deep, 2 = 24" deep	C = C-Pull (Nickel finish only)	for Hinge door pedestal 34 ³ / ₈ "h, see page 158
V316 Top finish	D = D-Pull (Painted, PT or PZ only)	for BBB pedestals; 28 ³ / ₈ "h, see page 148.
() Edge finish	F = Bar (1 pull/ Door set)	for Waste recycle pedestals; 34 ³ / ₈ "h, see page 158.
V316 Cabinet Finish	H = Outline (1 pull / Door set)	for replacement waste recycle bins, see page 416.
M Metal Interior option	J = Routed J-pull	
G Grommet option	R = Cylinder (1 pull / Door set)	
111 Grommet finish	S = S-pull (Stainless steel only)	
T Pull option	T = Tab (1 pull / Door set)	
111 Pull finish	8. Pull finish: Painted or plated	
L Lock option	9. Lock Option Doors: L = Lock hole drilled	
B Lock finish	N = No lock drilling	
	Pedestals with drawers always lock drilled	
	10. Lock finish: B = Black	
	S = Matte silver	

Classic Credenza, 34³/₈" h

Preconfigured Service Height, Type C, Box Box Box Box Center

Wood interiors

description	w	d	h	pattern no.	Top/Case											
					L/L	V1/L	V2/L	V3/L	V1/V1	V2/V2	V3/V3					
Classic Credenzas - Service Height, Type HCH; Hinge door / 28 ³ / ₈ "h BBBB/Hinge door Cabinet	78"	20"	34 ³ / ₈ "	RCSHHCH11()	(JW)	()	()	()	()	\$5,830.	\$6,535.	\$6,980.	\$8,496.	\$6,868.	\$7,653.	\$10,178.
	78"	24"	34 ³ / ₈ "	RCSHHCH12()	(JW)	()	()	()	()	6,513.	7,420.	8,008.	9,762.	7,809.	8,790.	11,720.
	84"	20"	34 ³ / ₈ "	RCSHHCH21()	(JW)	()	()	()	()	6,336.	7,061.	7,498.	9,027.	7,460.	8,320.	11,086.
	84"	24"	34 ³ / ₈ "	RCSHHCH22()	(JW)	()	()	()	()	7,059.	7,985.	8,562.	10,327.	8,464.	9,526.	12,728.

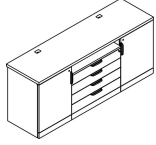

Classic Credenzas - Service Height, Type HCW; Hinge door / 28 ³ / ₈ "h BBBB/Waste recycle Cabinet	78"	20"	34 ³ / ₈ "	RCSHHCW11()	(JW)	()	()	()	()	6,481.	6,976.	7,193.	8,123.	7,533.	8,305.	10,829.
	78"	24"	34 ³ / ₈ "	RCSHHCW12()	(JW)	()	()	()	()	7,164.	7,771.	8,060.	9,126.	8,473.	9,440.	12,371.
	84"	20"	34 ³ / ₈ "	RCSHHCW21()	(JW)	()	()	()	()	6,986.	7,503.	7,711.	8,654.	8,124.	8,972.	11,737.
	84"	24"	34 ³ / ₈ "	RCSHHCW22()	(JW)	()	()	()	()	7,710.	8,334.	8,613.	9,690.	9,128.	10,176.	13,379.

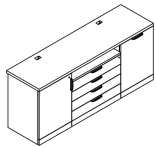

Order Code	Specification Information	Application Notes
Example: RCSHHCH11 () (JW) () () () ()	<i>To order please specify pattern number including:</i>	It is Not advisable to mix 28³/₈"h desk height products with 26¹/₂" standard height products.
R	1. Top Finish: L, V1, V2, V3	Upper top is 1 ¹ / ₂ " thick, with standard grommet locations.
C	2. Edge finish: L, V1, V2, V3 (Edge options are available on laminate tops only.)	Lower top (3/4 height pedestal's top) is 1" thick, and comes in the same finish as the pedestal.
SH	3. Cabinet Finish: L, V1, V2, V3	The preconfigured credenzas come with two 6" wide pedestal fillers, in the same finish as the cabinets.
H	4. Interior Option: W = Wood Interior	Applied back ordered separately for finished back.
C	5. Grommet Option: N = No grommet G = Grommet	Note: Full pedestal back will restrict ventilation.
H	6. Grommet Finish: Painted or Plated	Pencil trays are not included.
1	7. Pull option: B = No pull, No drilling customer's own pull	For further details on individual pedestals, refer to Application Notes;
1	C = C-Pull (Nickel finish only)	for Hinge door pedestal 34 ³ / ₈ "h, see page 158
V316	D = D-Pull (Painted, PT or PZ only)	for BBB pedestals; 28 ³ / ₈ "h, see page 148.
()	F = Bar (1 pull / Door set)	for Waste recycle pedestals; 34 ³ / ₈ "h, see page 158.
V316	H = Outline (1 pull / Door set)	for replacement waste recycle bins, see page 416.
W	J = Routed J-pull	
G	R = Cylinder (1 pull / Door set)	
111	S = S-pull (Stainless steel only)	
T	T = Tab (1 pull / Door set)	
111	8. Pull finish: Painted or plated	
L	9. Lock Option Doors: L = Lock hole drilled	
B	N = No lock drilling	
	Pedestals with drawers always lock drilled	
	10. Lock finish: B = Black	
	S = Matte silver	

Classic Credenza, 34³/₈" h

Preconfigured Service Height, Type C, Box Box Box Box Center

Wood interiors

description	w	d	h	pattern no.	Top/Case												
					L/L	V1/L	V2/L	V3/L	V1/V1	V2/V2	V3/V3						
Classic Credenzas - Service Height,	78"	20"	34 ³ / ₈ "	RCSHWCH11()	(J)	(W)	()	()	()	()	\$6,481.	\$6,976.	\$7,193.	\$8,123.	\$7,533.	\$8,305.	\$10,829.
Type WCH; Waste recycle / 28 ³ / ₈ "h BBBB/ Hinge	78"	24"	34 ³ / ₈ "	RCSHWCH12()	(X)	(W)	()	()	()	()	7,164.	7,771.	8,060.	9,126.	8,473.	9,440.	12,371.
door Cabinet	84"	20"	34 ³ / ₈ "	RCSHWCH21()	(X)	(W)	()	()	()	()	6,986.	7,503.	7,711.	8,654.	8,124.	8,972.	11,737.
	84"	24"	34 ³ / ₈ "	RCSHWCH22()	(X)	(W)	()	()	()	()	7,710.	8,334.	8,613.	9,690.	9,128.	10,176.	13,379.

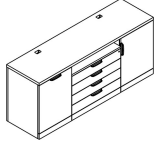

Order Code	Specification Information	Application Notes
Example: RCSHHCH11 ()(JW)(X)(X)(X)	<i>To order please specify pattern number including:</i>	It is Not advisable to mix 28³/₈"h desk height products with 26¹/₂" standard height products.
R	1. Top Finish: L, V1, V2, V3	Upper top is 1 1/2" thick, with standard grommet locations. Lower top (3/4 height pedestal's top) is 1" thick, and comes in the same finish as the pedestal. The preconfigured credenzas come with two 6" wide pedestal fillers, in the same finish as the cabinets. Applied back ordered separately for finished back. Note: Full pedestal back will restrict ventilation. Pencil trays are not included. For further details on individual pedestals, refer to Application Notes; for Hinge door pedestal 34 ³ / ₈ "h, see page 158 for BBB pedestals; 28 ³ / ₈ "h, see page 148. for Waste recycle pedestals; 34 ³ / ₈ "h, see page 158. for replacement waste recycle bins, see page 416.
C	2. Edge finish: L, V1, V2, V3 (Edge options are available on laminate tops only.)	
SH	3. Cabinet Finish: L, V1, V2, V3	
H	4. Interior Option: W = Wood Interior	
C	5. Grommet Option: N = No grommet G = Grommet	
H	6. Grommet Finish: Painted or Plated	
1	7. Pull option: B = No pull, No drilling customer's own pull C = C-Pull (Nickel finish only) D = D-Pull (Painted, PT or PZ only) F = Bar (1 pull/ Door set) H = Outline (1 pull / Door set) J = Routed J-pull R = Cylinder (1 pull / Door set) S = S-pull (Stainless steel only) T = Tab (1 pull / Door set)	
1		
V316		
()		
V316		
W		
G		
111	8. Pull finish: Painted or plated	
T	9. Lock Option Doors: L = Lock hole drilled N = No lock drilling Pedestals with drawers always lock drilled	
111	10. Lock finish: B = Black S = Matte silver	
L		
B		

Classic Credenza, 34³/₈" h

Preconfigured Service Height, Type D, Hinge Door Center Metal interiors

description	w	d	h	pattern no.	Top/Case											
					LM/L	V1/L	V2/L	V3/L	V1/V1	V2/V2	V3/V3					
Classic Credenzas - Service Height, Type HDH; Hinge door / 28 ³ / ₈ "h Hinge door/Hinge door Cabinet	78"	20"	34 ³ / ₈ "	RCSHHDH11()	(JM)	()	()	()	()	\$5,177.	\$5,869.	\$6,327.	\$7,843.	\$6,108.	\$6,804.	\$9,052.
	78"	24"	34 ³ / ₈ "	RCSHHDH12()	(JM)	()	()	()	()	5,747.	6,639.	7,243.	8,996.	6,918.	7,797.	10,405.
	84"	20"	34 ³ / ₈ "	RCSHHDH21()	(JM)	()	()	()	()	5,580.	6,290.	6,742.	8,272.	6,579.	7,335.	9,781.
	84"	24"	34 ³ / ₈ "	RCSHHDH22()	(JM)	()	()	()	()	6,198.	7,106.	7,701.	9,466.	7,456.	8,401.	11,232.

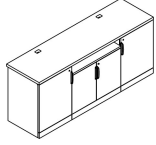

Classic Credenzas - Service Height, Type HDW; Hinge door / 28 ³ / ₈ "h Hinge door/Waste recycle Cabinet	78"	20"	34 ³ / ₈ "	RCSHHDW11()	(JM)	()	()	()	()	5,828.	6,311.	6,541.	7,470.	6,773.	7,456.	9,703.
	78"	24"	34 ³ / ₈ "	RCSHHDW12()	(JM)	()	()	()	()	6,398.	6,989.	7,294.	8,360.	7,581.	8,447.	11,056.
	84"	20"	34 ³ / ₈ "	RCSHHDW21()	(JM)	()	()	()	()	6,231.	6,732.	6,956.	7,899.	7,245.	7,987.	10,431.
	84"	24"	34 ³ / ₈ "	RCSHHDW22()	(JM)	()	()	()	()	6,849.	7,457.	7,752.	8,829.	8,118.	9,051.	11,883.

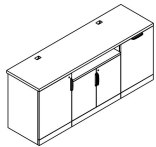

Order Code	Specification Information	Application Notes
Example: RCSHHDH11 () (JM) () () () ()	<i>To order please specify pattern number including:</i>	It is Not advisable to mix 28³/₈"h desk height products with 26¹/₂" standard height products.
R	1. Top Finish: L, V1, V2, V3	Upper top is 1 1/2" thick, with standard grommet locations.
C	2. Edge finish: L, V1, V2, V3 (Edge options are available on laminate tops only.)	Lower top (3/4 height pedestal's top) is 1" thick, and comes in the same finish as the pedestal.
SH	3. Cabinet Finish: L, V1, V2, V3	The preconfigured credenzas come with two 6" wide pedestal fillers, in the same finish as the cabinets.
H	4. Interior Option: M = Metal Interior	Applied back ordered separately for finished back.
D	5. Grommet Option: N = No grommet G = Grommet	Note: Full pedestal back will restrict ventilation.
H	6. Grommet Finish: Painted or Plated	Pencil trays are not included.
1	7. Pull option: B = No pull, No drilling customer's own pull	For further details on individual pedestals, refer to Application Notes;
1	C = C-Pull (Nickel finish only)	for Hinge door pedestal 34 ³ / ₈ "h, see page 158
V316	D = D-Pull (Painted, PT or PZ only)	for HD pedestals; 28 ³ / ₈ "h, see page 153.
()	F = Bar (1 pull / Door set)	for Waste recycle pedestals; 34 ³ / ₈ "h, see page 158.
V316	H = Outline (1 pull / Door set)	for replacement waste recycle bins, see page 416.
M	J = Routed J-pull	
G	R = Cylinder (1 pull / Door set)	
111	S = S-pull (Stainless steel only)	
T	T = Tab (1 pull / Door set)	
111	8. Pull finish: Painted or plated	
L	9. Lock Option Doors: L = Lock hole drilled	
B	N = No lock drilling	
	Pedestals with drawers always lock drilled	
	10. Lock finish: B = Black	
	S = Matte silver	

Classic Credenza, 34³/₈" h

Preconfigured Service Height, Type D, Hinge Door Center Metal interiors

description	w	d	h	pattern no.	Top/Case											
					LM/L	V1/L	V2/L	V3/L	V1/V1	V2/V2	V3/V3					
Classic Credenzas - Service Height,	78"	20"	34 ³ / ₈ "	RCSHWDH11()	()	()	()	()	()	\$5,828.	\$6,311.	\$6,541.	\$7,470.	\$6,773.	\$7,456.	\$9,703.
Type WDH; Waste recycle / 28 ³ / ₈ "h Hinge door/	78"	24"	34 ³ / ₈ "	RCSHWDH12()	()	()	()	()	()	6,398.	6,989.	7,294.	8,360.	7,581.	8,447.	11,056.
Hinge door Cabinet	84"	20"	34 ³ / ₈ "	RCSHWDH21()	()	()	()	()	()	6,231.	6,732.	6,956.	7,899.	7,245.	7,987.	10,431.
	84"	24"	34 ³ / ₈ "	RCSHWDH22()	()	()	()	()	()	6,849.	7,457.	7,752.	8,829.	8,118.	9,051.	11,883.

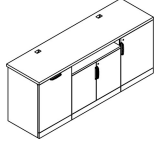

Order Code	Specification Information	Application Notes
Example: RCSHWDH11() () () () () () () () () ()	<i>To order please specify pattern number including:</i>	It is Not advisable to mix 28³/₈"h desk height products with 26¹/₂" standard height products.
R	1. Top Finish: L, V1, V2, V3	Upper top is 1 1/2" thick, with standard grommet locations.
C	2. Edge finish: L, V1, V2, V3 (Edge options are available on laminate tops only.)	Lower top (3/4 height pedestal's top) is 1" thick, and comes in the same finish as the pedestal.
SH	3. Cabinet Finish: L, V1, V2, V3	The preconfigured credenzas come with two 6" wide pedestal fillers, in the same finish as the cabinets.
H	4. Interior Option: M = Metal Interior	Applied back ordered separately for finished back.
D	5. Grommet Option: N = No grommet G = Grommet	Note: Full pedestal back will restrict ventilation.
H	6. Grommet Finish: Painted or Plated	Pencil trays are not included.
1	7. Pull option: B = No pull, No drilling customer's own pull	For further details on individual pedestals, refer to Application Notes;
1	C = C-Pull (Nickel finish only)	for Hinge door pedestal 34 ³ / ₈ "h, see page 158
V316	D = D-Pull (Painted, PT or PZ only)	for HD pedestals; 28 ³ / ₈ "h, see page 153.
()	F = Bar (1 pull / Door set)	for Waste recycle pedestals; 34 ³ / ₈ "h, see page 158.
V316	H = Outline (1 pull / Door set)	for replacement waste recycle bins, see page 416.
M	J = Routed J-pull	
G	R = Cylinder (1 pull / Door set)	
111	S = S-pull (Stainless steel only)	
T	T = Tab (1 pull / Door set)	
111	8. Pull finish: Painted or plated	
L	9. Lock Option Doors: L = Lock hole drilled	
B	N = No lock drilling	
	Pedestals with drawers always lock drilled	
	10. Lock finish: B = Black S = Matte silver	

Classic Credenza, 34^{3/8}" h

Preconfigured Service Height, Type D, Hinge Door Center

Wood interiors

description	w	d	h	pattern no.	Top/Case											
					L/L	V1/L	V2/L	V3/L	V1/V1	V2/V2	V3/V3					
Classic Credenzas - Service Height, Type HDH; Hinge door / 28 ^{3/8} "h Hinge door/Hinge door Cabinet	78"	20"	34 ^{3/8} "	RCSHHDH11()	(JW)	()	()	()	()	\$5,272.	\$5,966.	\$6,422.	\$7,938.	\$6,224.	\$6,934.	\$9,229.
	78"	24"	34 ^{3/8} "	RCSHHDH12()	(JW)	()	()	()	()	5,847.	6,740.	7,342.	9,096.	7,037.	7,930.	10,585.
	84"	20"	34 ^{3/8} "	RCSHHDH21()	(JW)	()	()	()	()	5,681.	6,393.	6,843.	8,372.	6,694.	7,461.	9,952.
	84"	24"	34 ^{3/8} "	RCSHHDH22()	(JW)	()	()	()	()	6,298.	7,208.	7,800.	9,565.	7,571.	8,527.	11,403.

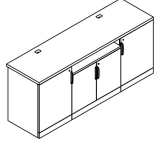

Classic Credenzas - Service Height, Type HDW; Hinge door / 28 ^{3/8} "h Hinge door/Waste recycle Cabinet	78"	20"	34 ^{3/8} "	RCSHHDW11()	(JW)	()	()	()	()	5,922.	6,407.	6,635.	7,565.	6,889.	7,586.	9,880.
	78"	24"	34 ^{3/8} "	RCSHHDW12()	(JW)	()	()	()	()	6,497.	7,091.	7,393.	8,459.	7,699.	8,580.	11,236.
	84"	20"	34 ^{3/8} "	RCSHHDW21()	(JW)	()	()	()	()	6,331.	6,835.	7,056.	7,999.	7,360.	8,113.	10,603.
	84"	24"	34 ^{3/8} "	RCSHHDW22()	(JW)	()	()	()	()	6,948.	7,558.	7,852.	8,929.	8,234.	9,177.	12,054.

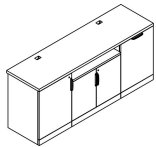

Order Code	Specification Information	Application Notes
Example: RCSHHDH11 () (JW) () () () ()	<i>To order please specify pattern number including:</i>	It is Not advisable to mix 28^{3/8}"h desk height products with 26^{1/2}" standard height products.
R Reff	1. Top Finish: L, V1, V2, V3	Upper top is 1 1/2" thick, with standard grommet locations.
C Credenza	2. Edge finish: L, V1, V2, V3 (Edge options are available on laminate tops only.)	Lower top (3/4 height pedestal's top) is 1" thick, and comes in the same finish as the pedestal.
SH Service height	3. Cabinet Finish: L, V1, V2, V3	The preconfigured credenzas come with two 6" wide pedestal fillers, in the same finish as the cabinets.
H LH position; Hinged door, or W=Waste Recycle pedestal	4. Interior Option: W = Wood Interior	Applied back ordered separately for finished back.
D Center position; Hinge door	5. Grommet Option: N = No grommet G = Grommet	Note: Full pedestal back will restrict ventilation.
H LH position; Hinged door, or W = waste recycle cabinet 34 ^{3/8} "h	6. Grommet Finish: Painted or Plated	Pencil trays are not included.
1 78" wide, 2 = 84" wide	7. Pull option: B = No pull, No drilling customer's own pull C = C-Pull (Nickel finish only) D = D-Pull (Painted, PT or PZ only) F = Bar (1 pull / Door set) H = Outline (1 pull / Door set) J = Routed J-pull R = Cylinder (1 pull / Door set) S = S-pull (Stainless steel only) T = Tab (1 pull / Door set)	For further details on individual pedestals, refer to Application Notes; for Hinge door pedestal 34 ^{3/8} "h, see page 158 for Hinge door pedestals; 28 ^{3/8} "h, see page 154. for Waste recycle pedestals; 34 ^{3/8} "h, see page 158. for replacement waste recycle bins, see page 416.
1 20" deep, 2 = 24" deep	8. Pull finish: Painted or plated	
V316 Top finish	9. Lock Option Doors: L = Lock hole drilled N = No lock drilling Pedestals with drawers always lock drilled	
() Edge finish	10. Lock finish: B = Black S = Matte silver	
V316 Cabinet Finish		
W Wood Interior option		
G Grommet option		
111 Grommet finish		
T Pull option		
111 Pull finish		
L Lock option		
B Lock finish		

Classic Credenza, 34³/₈" h

Reff Profiles Vol. Two

Preconfigured Service Height, Type D, Hinge Door Center Wood interiors

description	w	d	h	pattern no.	Top/Case						
					L/L	V1/L	V2/L	V3/L	V1/V1	V2/V2	V3/V3
Classic Credenzas - Service Height,	78"	20"	34 ³ / ₈ "	RCSHWDH11 () () () () () () ()	\$5,922.	\$6,407.	\$6,635.	\$7,565.	\$6,889.	\$7,586.	\$9,880.
Type WDH; Waste recycle / 28 ³ / ₈ "h Hinge door/	78"	24"	34 ³ / ₈ "	RCSHWDH12 () () () () () () ()	6,497.	7,091.	7,393.	8,459.	7,699.	8,580.	11,236.
Hinge door Cabinet	84"	20"	34 ³ / ₈ "	RCSHWDH21 () () () () () () ()	6,331.	6,835.	7,056.	7,999.	7,360.	8,113.	10,603.
	84"	24"	34 ³ / ₈ "	RCSHWDH22 () () () () () () ()	6,948.	7,558.	7,852.	8,929.	8,234.	9,177.	12,054.

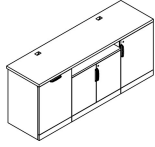

Order Code	Specification Information	Application Notes
Example: RCSHDDH11 () () () () () () ()	<i>To order please specify pattern number including:</i>	It is Not advisable to mix 28³/₈"h desk height products with 26¹/₂" standard height products.
R Reff	1. Top Finish: L, V1, V2, V3	Upper top is 1 1/2" thick, with standard grommet locations.
C Credenza	2. Edge finish: L, V1, V2, V3 (Edge options are available on laminate tops only.)	Lower top (3/4 height pedestal's top) is 1" thick, and comes in the same finish as the pedestal.
SH Service height	3. Cabinet Finish: L, V1, V2, V3	The preconfigured credenzas come with two 6" wide pedestal fillers, in the same finish as the cabinets.
H LH position; Hinged door, or W=Waste Recycle pedestal	4. Interior Option: W = Wood Interior	Applied back ordered separately for finished back.
D Center position; Hinge door	5. Grommet Option: N = No grommet G = Grommet	Note: Full pedestal back will restrict ventilation.
H LH position; Hinged door, or W = waste recycle cabinet 34 ³ / ₈ "h	6. Grommet Finish: Painted or Plated	Pencil trays are not included.
1 78" wide, 2 = 84" wide	7. Pull option: B = No pull, No drilling customer's own pull C = C-Pull (Nickel finish only) D = D-Pull (Painted, PT or PZ only) F = Bar (1 pull / Door set) H = Outline (1 pull / Door set) J = Routed J-pull R = Cylinder (1 pull / Door set) S = S-pull (Stainless steel only) T = Tab (1 pull / Door set)	For further details on individual pedestals, refer to Application Notes; for Hinge door pedestal 34 ³ / ₈ "h, see page 158 for Hinge door pedestals; 28 ³ / ₈ "h, see page 154. for Waste recycle pedestals; 34 ³ / ₈ "h, see page 158. for replacement waste recycle bins, see page 416.
1 20" deep, 2 = 24" deep	8. Pull finish: Painted or plated	
V316 Top finish	9. Lock Option Doors: L = Lock hole drilled N = No lock drilling Pedestals with drawers always lock drilled	
() Edge finish	10. Lock finish: B = Black S = Matte silver	
V316 Cabinet Finish		
W Wood Interior option		
G Grommet option		
111 Grommet finish		
T Pull option		
111 Pull finish		
L Lock option		
B Lock finish		

Classic Credenza, 34³/₈" h
 Preconfigured Service Height, Type E, Open Center
 Metal interiors

description	w	d	h	pattern no.	Top/Case											
					L/L	V1/L	V2/L	V3/L	V1/V1	V2/V2	V3/V3					
Classic Credenzas - Service Height, Type HEH; Hinge door / 28 ³ / ₈ "h Open/Hinge door Cabinet	78"	20"	34 ³ / ₈ "	RCSHHEH11()	(M)	()	()	()	()	\$4,762.	\$5,446.	\$5,912.	\$7,428.	\$5,620.	\$6,253.	\$8,309.
	78"	24"	34 ³ / ₈ "	RCSHHEH12()	(M)	()	()	()	()	5,305.	6,188.	6,801.	8,555.	6,394.	7,209.	9,609.
	84"	20"	34 ³ / ₈ "	RCSHHEH21()	(M)	()	()	()	()	5,064.	5,764.	6,226.	7,755.	5,975.	6,647.	8,851.
	84"	24"	34 ³ / ₈ "	RCSHHEH22()	(M)	()	()	()	()	5,643.	6,540.	7,145.	8,910.	6,799.	7,660.	10,232.

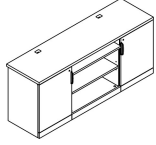

Classic Credenzas - Service Height, Type HEW; Hinge door / 28 ³ / ₈ "h Open/ Waste recycle Cabinet	78"	20"	34 ³ / ₈ "	RCSHHEW11()	(M)	()	()	()	()	5,413.	5,888.	6,125.	7,055.	6,284.	6,904.	8,960.
	78"	24"	34 ³ / ₈ "	RCSHHEW12()	(M)	()	()	()	()	5,956.	6,538.	6,852.	7,918.	7,057.	7,859.	10,260.
	84"	20"	34 ³ / ₈ "	RCSHHEW21()	(M)	()	()	()	()	5,714.	6,205.	6,439.	7,382.	6,640.	7,299.	9,502.
	84"	24"	34 ³ / ₈ "	RCSHHEW22()	(M)	()	()	()	()	6,294.	6,890.	7,197.	8,274.	7,462.	8,310.	10,882.

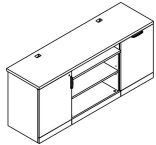

Order Code	Specification Information	Application Notes
Example: RCSHHEH11() (M) () () () ()	<i>To order please specify pattern number including:</i>	It is Not advisable to mix 28³/₈"h desk height products with 26¹/₂" standard height products.
R Reff	1. Top Finish: L, V1, V2, V3	Upper top is 1 1/2" thick, with standard grommet locations. Lower top (3/4 height pedestal's top) is 1" thick, and comes in the same finish as the pedestal.
C Credenza	2. Edge Finish: L, V1, V2, V3	The preconfigured credenzas come with two 6" wide pedestal fillers, in the same finish as the cabinets. Applied back ordered separately for finished back.
SH Service height	3. Cabinet Finish: L, V1, V2, V3	Note: Full pedestal back will restrict ventilation.
H LH position: Hinged door, or W=Waste Recycle Cabinet	4. Interior Option: M = Metal Interior	Pencil trays are not included.
E Center position: Open Cabinet	5. Grommet Option: N = No grommet G = Grommet	For further details on individual pedestals, refer to Application Notes; for Hinge door pedestal 34 ³ / ₈ "h, see page 158; for Open pedestals; 28 ³ / ₈ "h, see page 153; for Waste recycle pedestals; 34 ³ / ₈ "h, see page 158; for replacement waste recycle bins, see page 416.
H LH position: Hinged door, or W = Waste Recycle Cabinet	6. Grommet Finish: Painted or Plated	
1 78" wide, 2 = 84" wide	7. Pull option: B = No pull, No drilling customer's own pull C = C-Pull (Nickel finish only) D = D-Pull (Painted, PT or PZ only) F = Bar (1 pull / Door set) H = Outline (1 pull / Door set) J = Routed J-pull R = Cylinder (1 pull / Door set) S = S-pull (Stainless steel only) T = Tab (1 pull / Door set)	
1 20" deep, 2 = 24" deep	8. Lock Option: Painted or plated	
V316 Top finish	9. Lock Option Doors: L = Lock hole drilled N = No lock drilling Pedestals with drawers always lock drilled	
V316 Cabinet Finish	10. Lock finish: B = Black S = Matte silver	
M Metal Interior option		
G Grommet option		
111 Grommet finish		
T Pull option		
111 Pull finish		
L Lock option		
B Lock finish		

Classic Credenza, 34³/₈" h
 Preconfigured Service Height, Type E, Open Center
 Metal interiors

description	w	d	h	pattern no.	Top/Case											
					L/L	V1/L	V2/L	V3/L	V1/V1	V2/V2	V3/V3					
Classic Credenzas - Service Height,	78"	20"	34 ³ / ₈ "	RCSHWEH11()	(M)	()	()	()	()	\$5,413.	\$5,888.	\$6,125.	\$7,055.	\$6,284.	\$6,904.	\$8,960.
Type WEH; Waste recycle / 28 ³ / ₈ "h Open/ Hinge	78"	24"	34 ³ / ₈ "	RCSHWEH12()	(M)	()	()	()	()	5,956.	6,538.	6,852.	7,918.	7,057.	7,859.	10,260.
door Cabinet	84"	20"	34 ³ / ₈ "	RCSHWEH21()	(M)	()	()	()	()	5,714.	6,205.	6,439.	7,382.	6,640.	7,299.	9,502.
	84"	24"	34 ³ / ₈ "	RCSHWEH22()	(M)	()	()	()	()	6,294.	6,890.	7,197.	8,274.	7,462.	8,310.	10,882.

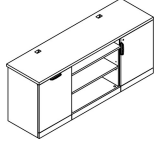

Order Code	Specification Information	Application Notes
Example: RCSHHEH11 () (M) () () () ()	<i>To order please specify pattern number including:</i>	It is Not advisable to mix 28³/₈"h desk height products with 26¹/₂" standard height products.
R Reff	1. Top Finish: L, V1, V2, V3	Upper top is 1 1/2" thick, with standard grommet locations. Lower top (3/4 height pedestal's top) is 1" thick, and comes in the same finish as the pedestal.
C Credenza	2. Edge Finish: L, V1, V2, V3	The preconfigured credenzas come with two 6" wide pedestal fillers, in the same finish as the cabinets. Applied back ordered separately for finished back. Note: Full pedestal back will restrict ventilation. Pencil trays are not included.
SH Service height	3. Cabinet Finish: L, V1, V2, V3	For further details on individual pedestals, refer to Application Notes; for Hinge door pedestal 34 ³ / ₈ "h, see page 158 for Open pedestals; 28 ³ / ₈ "h, see page 153. for Waste recycle pedestals; 34 ³ / ₈ "h, see page 158. for replacement waste recycle bins, see page 416.
H LH position: Hinged door, or W=Waste Recycle Cabinet	4. Interior Option: M = Metal Interior	
E Center position: Open Cabinet	5. Grommet Option: N = No grommet G = Grommet	
H LH position: Hinged door, or W = Waste Recycle Cabinet	6. Grommet Finish: Painted or Plated	
1 78" wide, 2 = 84" wide	7. Pull option: B = No pull, No drilling customer's own pull C = C-Pull (Nickel finish only) D = D-Pull (Painted, PT or PZ only) F = Bar (1 pull/ Door set) H = Outline (1 pull / Door set) J = Routed J-pull R = Cylinder (1 pull / Door set) S = S-pull (Stainless steel only) T = Tab (1 pull / Door set)	Keying instructions must accompany all orders, refer to page 325. Pedestals do not come with lock included. Key-alike are field installed using the Knoll Key order form. Each locking pedestal on this page counts for one lock core. File drawers do Not support bottom loading. File drawers include bars for front to back and side to side filing. These products are key hole construction.
1 20" deep, 2 = 24" deep	8. Pull finish: Painted or plated	
V316 Top finish	9. Lock Option Doors: L = Lock hole drilled N = No lock drilling Pedestals with drawers always lock drilled	
V316 Cabinet Finish	10. Lock finish: B = Black S = Matte silver	
M Metal Interior option		
G Grommet option		
111 Grommet finish		
T Pull option		
111 Pull finish		
L Lock option		
B Lock finish		

Classic Credenza, 34³/₈" h
 Preconfigured Service Height, Type E, Open Center
 Wood interiors

description	w	d	h	pattern no.	Top/Case												
					L/L	V1/L	V2/L	V3/L	V1/V1	V2/V2	V3/V3						
Classic Credenzas - Service Height, Type HEH; Hinge door / 28 ³ / ₈ "h Open/Hinge door Cabinet	78"	20"	34 ³ / ₈ "	RCSHHEH11()	(J)	(W)	()	()	()	()	\$4,863.	\$5,548.	\$6,013.	\$7,529.	\$5,736.	\$6,383.	\$8,484.
	78"	24"	34 ³ / ₈ "	RCSHHEH12()	(J)	(W)	()	()	()	()	5,404.	6,288.	6,899.	8,653.	6,511.	7,342.	9,787.
	84"	20"	34 ³ / ₈ "	RCSHHEH21()	(J)	(W)	()	()	()	()	5,161.	5,863.	6,323.	7,853.	6,093.	6,778.	9,033.
	84"	24"	34 ³ / ₈ "	RCSHHEH22()	(J)	(W)	()	()	()	()	5,740.	6,639.	7,243.	9,008.	6,907.	7,786.	10,404.

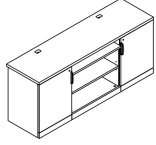

Classic Credenzas - Service Height, Type HEW; Hinge door / 28 ³ / ₈ "h Open/ Waste recycle Cabinet	78"	20"	34 ³ / ₈ "	RCSHHEW11()	(J)	(W)	()	()	()	()	5,513.	5,990.	6,226.	7,156.	6,400.	7,035.	9,135.
	78"	24"	34 ³ / ₈ "	RCSHHEW12()	(J)	(W)	()	()	()	()	6,055.	6,639.	6,951.	8,017.	7,173.	7,992.	10,438.
	84"	20"	34 ³ / ₈ "	RCSHHEW21()	(J)	(W)	()	()	()	()	5,812.	6,305.	6,536.	7,479.	6,757.	7,430.	9,684.
	84"	24"	34 ³ / ₈ "	RCSHHEW22()	(J)	(W)	()	()	()	()	6,391.	6,989.	7,294.	8,371.	7,571.	8,436.	11,055.

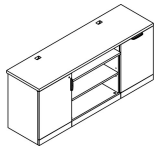

Order Code	Specification Information	Application Notes
Example: RCSHHEH11 () (J) (W) () () () ()	<i>To order please specify pattern number including:</i>	It is Not advisable to mix 28³/₈"h desk height products with 26¹/₂" standard height products.
R	1. Top Finish: L, V1, V2, V3	Upper top is 1 1/2" thick, with standard grommet locations.
C	2. Edge finish: L, V1, V2, V3 (Edge options are available on laminate tops only.)	Lower top (3/4 height pedestal's top) is 1" thick, and comes in the same finish as the pedestal.
SH	3. Cabinet Finish: L, V1, V2, V3	The preconfigured credenzas come with two 6" wide pedestal fillers, in the same finish as the cabinets.
H	4. Interior Option: W = Wood Interior	Applied back ordered separately for finished back.
E	5. Grommet Option: N = No grommet G = Grommet	Note: Full pedestal back will restrict ventilation.
H	6. Grommet Finish: Painted or Plated	Pencil trays are not included.
H	7. Pull option: B = No pull, No drilling customer's own pull C = C-Pull (Nickel finish only) D = D-Pull (Painted, PT or PZ only) F = Bar (1 pull / Door set) H = Outline (1 pull / Door set) J = Routed J-pull R = Cylinder (1 pull / Door set) S = S-pull (Stainless steel only) T = Tab (1 pull / Door set)	For further details on individual pedestals, refer to Application Notes; for Hinge door pedestal 34 ³ / ₈ "h, see page 158 for Open pedestals; 28 ³ / ₈ "h, see page 153. for Waste recycle pedestals; 34 ³ / ₈ "h, see page 158. for replacement waste recycle bins, see page 416.
1	8. Pull finish: Painted or plated	
1	9. Lock Option Doors: L = Lock hole drilled N = No lock drilling Pedestals with drawers always lock drilled	
V316	10. Lock finish: B = Black S = Matte silver	
V316		
()		
V316		
W		
G		
111		
T		
111		
L		
B		

Classic Credenza, 34³/₈" h
 Preconfigured Service Height, Type E, Open Center
 Wood interiors

description	w	d	h	pattern no.	Top/Case						
					L/L	V1/L	V2/L	V3/L	V1/V1	V2/V2	V3/V3
Classic Credenzas - Service Height,	78"	20"	34 ³ / ₈ "	RCSHWEH11 ()(W)()()()	\$5,513.	\$5,990.	\$6,226.	\$7,156.	\$6,400.	\$7,035.	\$9,135.
Type WEH; Waste recycle / 28 ³ / ₈ "h Open/ Hinge	78"	24"	34 ³ / ₈ "	RCSHWEH12 ()(W)()()()	6,055.	6,639.	6,951.	8,017.	7,173.	7,992.	10,438.
door Cabinet	84"	20"	34 ³ / ₈ "	RCSHWEH21 ()(W)()()()	5,812.	6,305.	6,536.	7,479.	6,757.	7,430.	9,684.
	84"	24"	34 ³ / ₈ "	RCSHWEH22 ()(W)()()()	6,391.	6,989.	7,294.	8,371.	7,571.	8,436.	11,055.

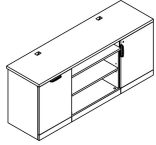

Order Code	Specification Information	Application Notes
Example: RCSHHEH11 ()(W ()()()()	To order please specify pattern number including:	It is Not advisable to mix 28³/₈"h desk height products with 26¹/₂" standard height products.
R Reff	1. Top Finish: L, V1, V2, V3	Upper top is 1 1/2" thick, with standard grommet locations. Lower top (3/4 height pedestal's top) is 1" thick, and comes in the same finish as the pedestal.
C Credenza	2. Edge finish: L, V1, V2, V3 (Edge options are available on laminate tops only.)	The preconfigured credenzas come with two 6" wide pedestal fillers, in the same finish as the cabinets. Applied back ordered separately for finished back.
SH Service height	3. Cabinet Finish: L, V1, V2, V3	Note: Full pedestal back will restrict ventilation.
H LH position: Hinged door, or W=Waste Recycle Cabinet	4. Interior Option: W = Wood Interior	Pencil trays are not included.
E Center position: Open Cabinet	5. Grommet Option: N = No grommet G = Grommet	For further details on individual pedestals, refer to Application Notes; for Hinge door pedestal 34 ³ / ₈ "h, see page 158 for Open pedestals; 28 ³ / ₈ "h, see page 153. for Waste recycle pedestals; 34 ³ / ₈ "h, see page 158. for replacement waste recycle bins, see page 416.
H LH position: Hinged door, or W = Waste Recycle Cabinet	6. Grommet Finish: Painted or Plated	
1 78" wide, 2 = 84" wide	7. Pull option: B = No pull, No drilling customer's own pull C = C-Pull (Nickel finish only) D = D-Pull (Painted, PT or PZ only) F = Bar (1 pull/ Door set) H = Outline (1 pull / Door set) J = Routed J-pull R = Cylinder (1 pull / Door set) S = S-pull (Stainless steel only) T = Tab (1 pull / Door set)	
1 20" deep, 2 = 24" deep	8. Pull finish: Painted or plated	
V316 Top finish	9. Lock Option Doors: L = Lock hole drilled N = No lock drilling Pedestals with drawers always lock drilled	
() Edge finish	10. Lock finish: B = Black S = Matte silver	
V316 Cabinet Finish		
W Wood Interior option		
G Grommet option		
111 Grommet finish		
T Pull option		
111 Pull finish		
L Lock option		
B Lock finish		

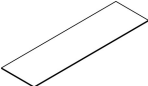
description	w	d	h	pattern no.	list
Classic Credenza Glass Accent Top 	78"	20"	1/2"	RCGT781()	\$1,281.
	78"	24"	1/2"	RCGT782()	1,499.
	84"	20"	1/2"	RCGT841()	1,374.
	84"	24"	1/2"	RCGT842()	1,605.

Order Code

Example:	RCGT781 ()
R	Reff
C	Credenza
GT	Glass Accent Top
78	78" wide, 84 = 84" wide
1	20" deep, 2 = 24" deep
GL85	Glass Finish

Specification Information

To order please specify pattern number including:

- Glass finish: GL35, GL45, or GL85
 GL35 = Grey colored glass
 GL45 = Star back painted White
 *(\$903 upcharge applicable for GL45)
 GL85 = Star Clear colored glass

Application Notes

Grommets and cut outs are not optional for the glass accent tops.

Credenza glass tops on this page are supplied with anti skid bumpers.

Task Panels

The high performance Task Panel is designed to augment the utility of the zone immediately above the credenza in a Private Office setting, by offering tool rail capability and cable management features in addition to tackable and decorative inserts. All Task Panels have a cable curtain along the full length of the bottom edge which, when used in conjunction with notched back credenza tops, provides access to in-wall power sources and for cable concealment. See figure on following page for cable management details. The optional tool rail is designed to accept slatwall accessories and the Reff Profiles Task Panel Shelf. Slatwall accessories are available from KnollExtra. Insert panels may be conveniently removed, exposing a 7/8" wire clearance space which allows cable drops at any point along the entire width of the Task Panel. Check local electrical codes for suitability.

Task Panels are configured in eight heights (H1 – H8) to correspond to their application. See application diagrams on the following pages. H1 and H2 are designed for focused work applications whereas H3 through H8 are designed for collaborative or team work applications.

Construction

The Task Panel consists of a framework and optional tool rail, with decorative trims and a variety of functional and decorative inserts. Bottom right; The frame assembly consists of two vertical members, a bottom and top frame member and an optional tool rail. These are connected together and supported by mounting brackets. Edges have decorative trims; a top cover and two end covers.

Connected to the bottom frame member is a nylon brush which forms the cable curtain. Frames are clad with either one or two inserts depending upon the use of the tool rail. Bottom left (upper); single monolithic insert with spacers. Bottom left (lower); top segmented insert and bottom segmented insert and spacers.

Task Panels are shipped with frame and trim components, cable curtain and hardware in one container and inserts and spacers in a separate container.

The unit is field-assembled; fastened together using brackets and screws in pre-punched holes. See part #6TP00085 for assembly and installations instructions.

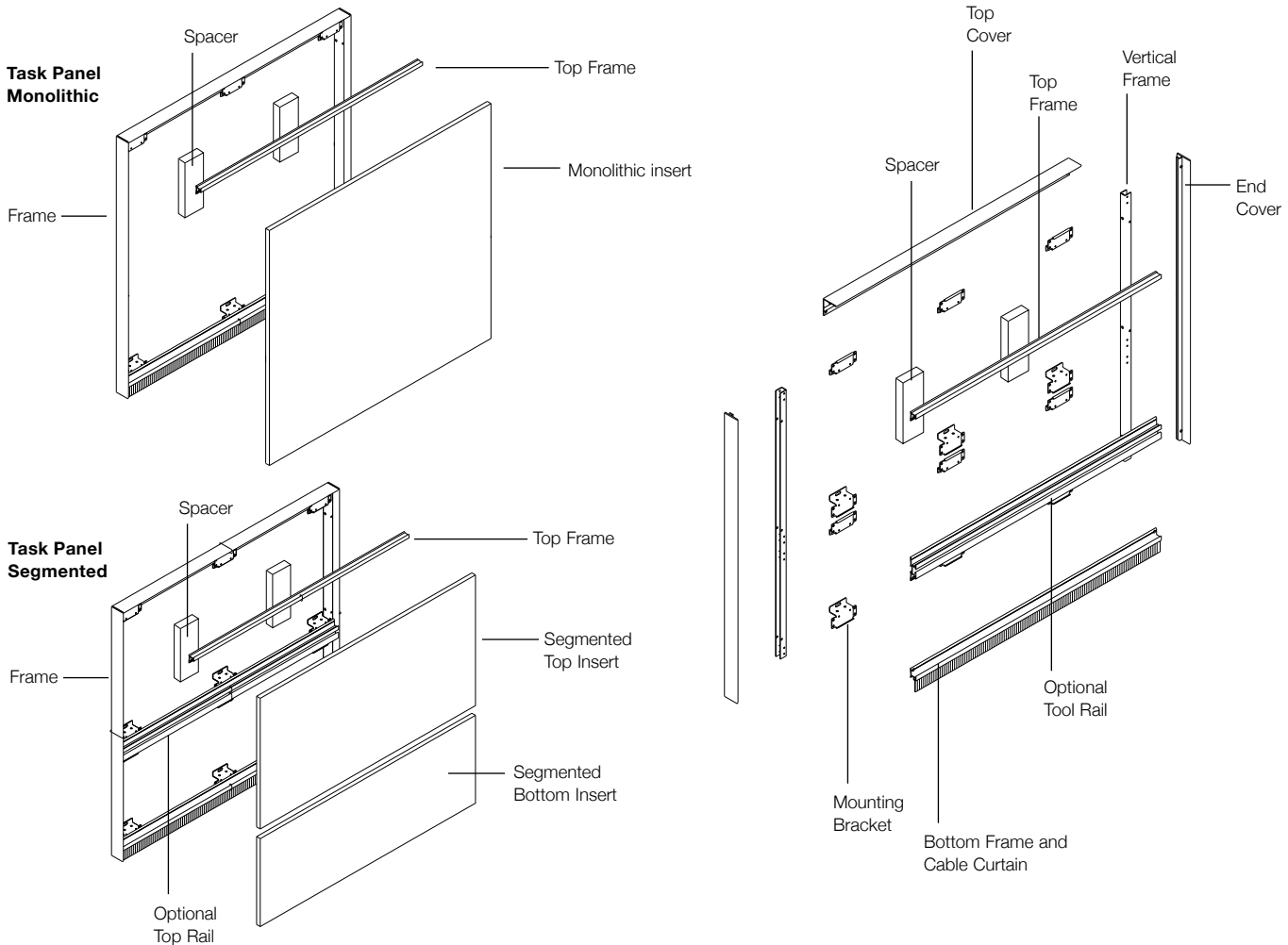

Specification Options

Task Panels are offered in widths from 30" to 96" in 6" increments; and in eight application heights, H1 to H8. Overall thickness of the Task Panel is 1 1/2".

Task Panels are available in two basic configurations; monolithic (with a single insert) and segmented (with two inserts divided by the horizontal tool rail). See diagrams, previous page, for description.

The Task Panel cover trims and optional tool rail are offered in three anodized metallic finishes; Black (AA), Polished (AP) and Satin (AU) as well as all core paint colors. Refer to Reff Profiles finish options page for more information.

Task Panel inserts are available in a variety of finishes including fabric (tackable), Forbo™ (tackable linoleum), laminate, veneer, glass and marker board.

Note that segmented Task Panels with fabric lower inserts are available up to 72" wide.

Planning Notes

1. H1, H3, H5 and H7 Task Panels are intended for use with 1 1/2" thick credenza tops. H2, H4, H6 and H8 Task Panels are intended for use with 1" credenza tops.
2. Fabric is applied to inserts railroad style only
3. Forbo™ is available on lower segmented inserts only
4. Grain direction for veneer inserts is vertical
5. Glass is not available for lower segmented inserts.

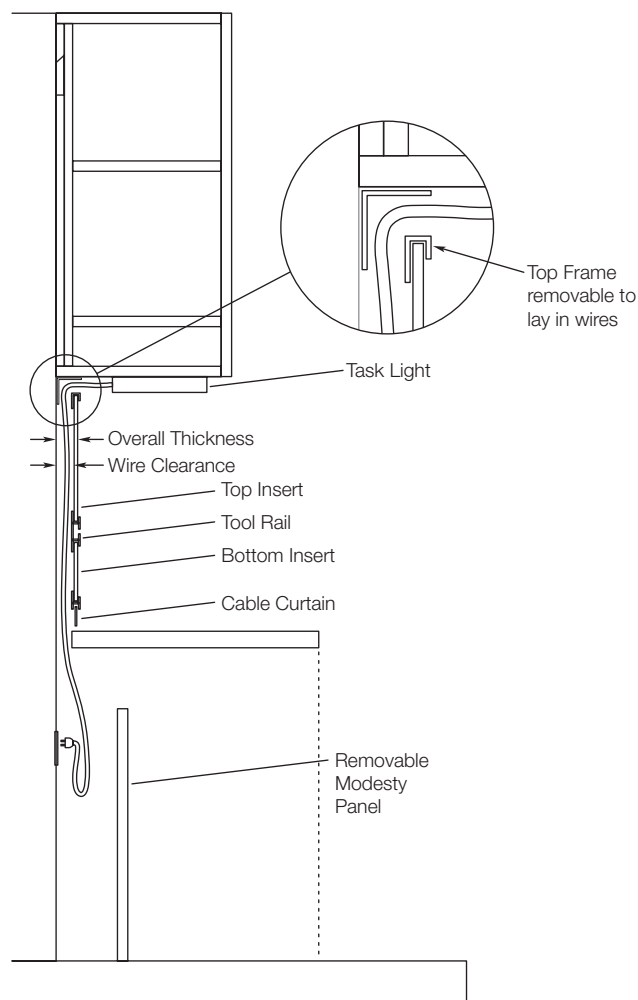

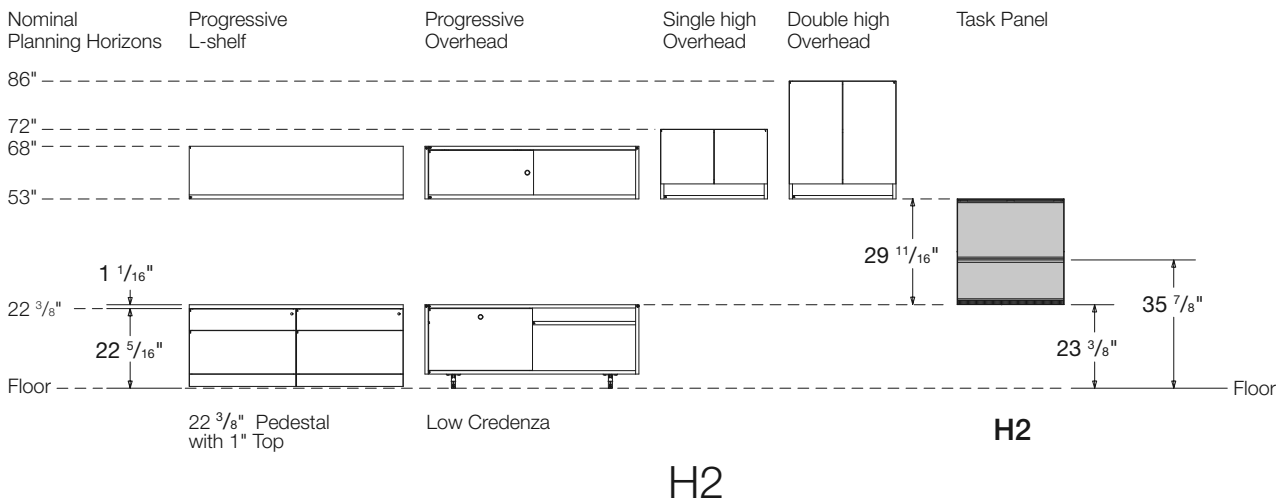
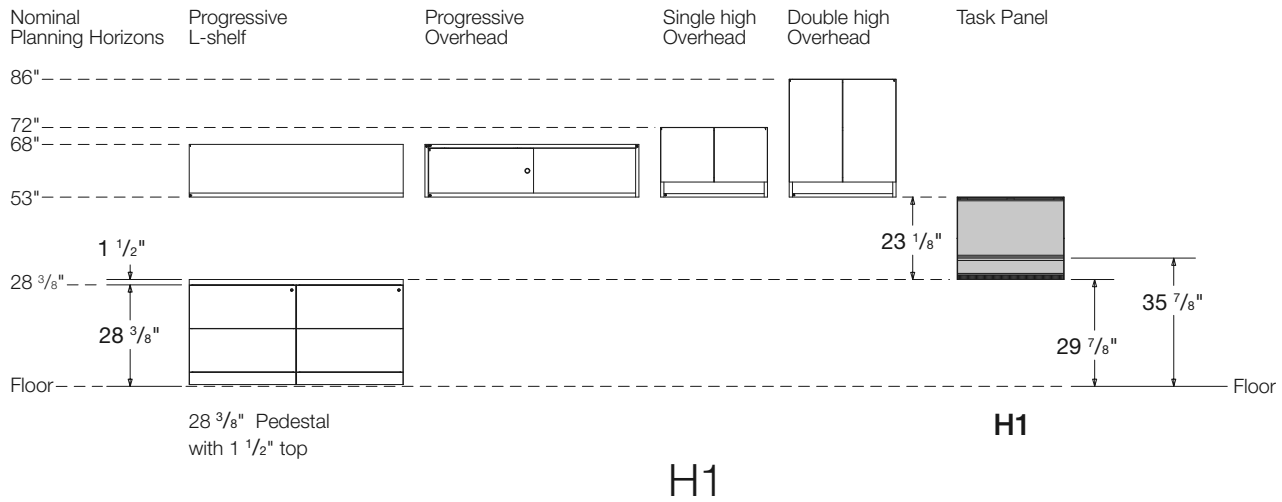

Notes

- Planning horizons are nominal. Dimensions are actual.
- Images displayed to the left of the Task Panel are examples only and do not represent the complete scope of products available.
- Task Panels available in monolithic and segmented; segmented shown
- H1 Task Panel is intended for use with 1 1/2" thick tops.
- H2 Task Panel is intended for use with 1" thick credenza tops.

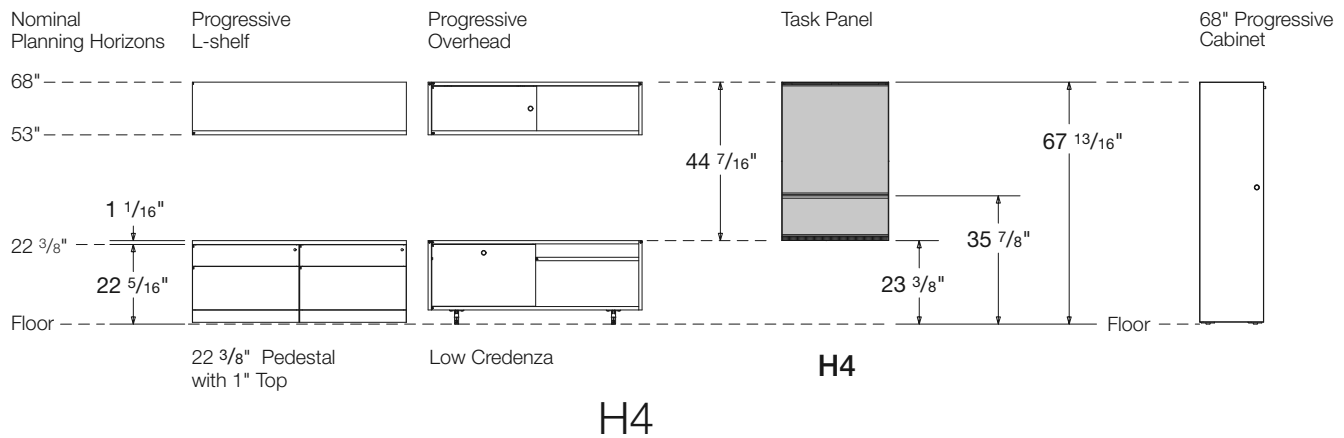
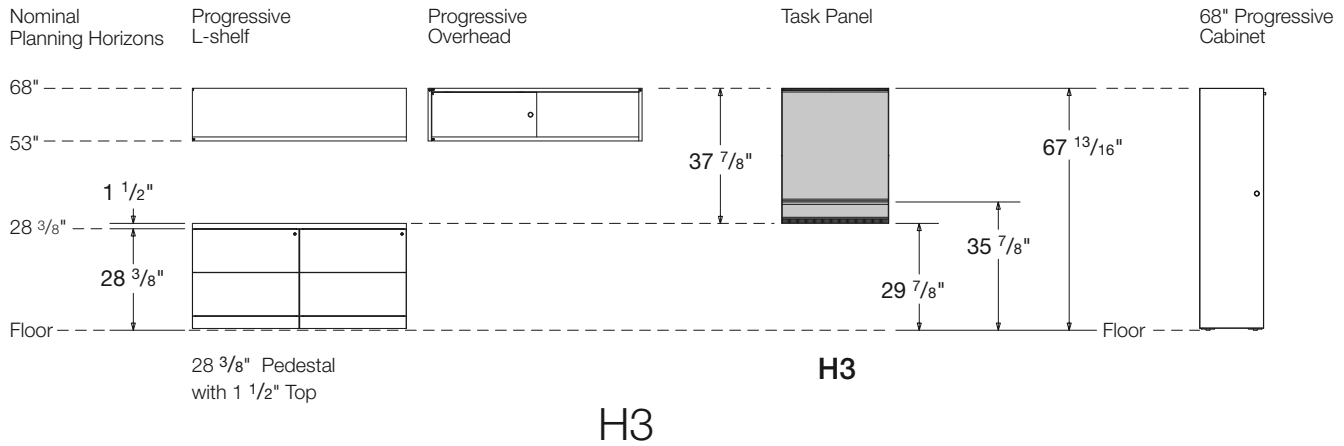

Notes

- Planning horizons are nominal. Dimensions are actual.
- Images displayed to the left and right of the Task Panel are examples only and do not represent the complete scope of products available.
- Task Panels available in monolithic and segmented; segmented shown
- H3 Task Panel is intended for use with 1 1/2" thick tops.
- H4 Task Panel is intended for use with 1" thick credenza tops.

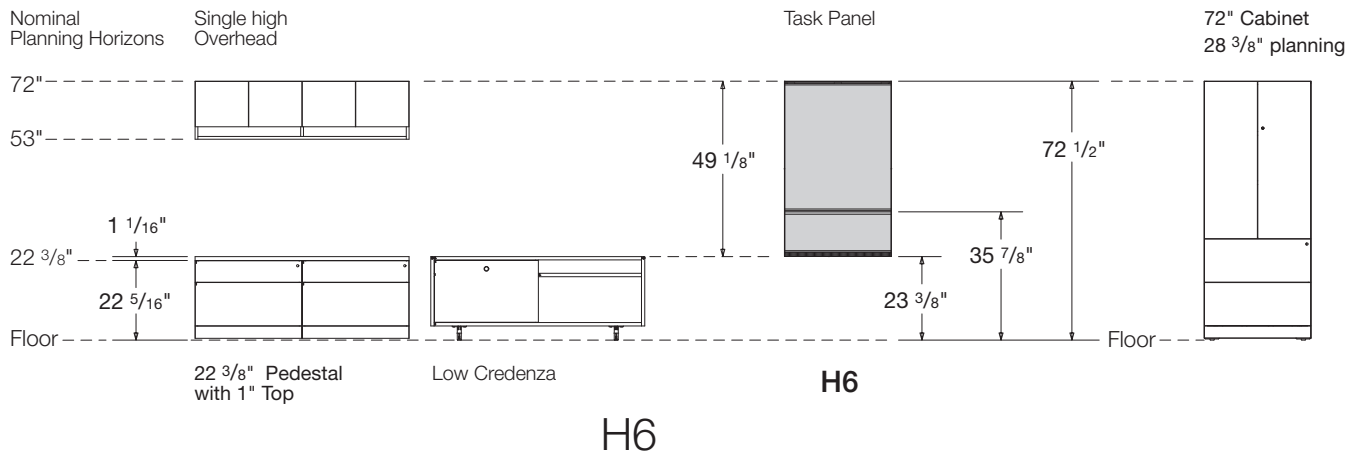
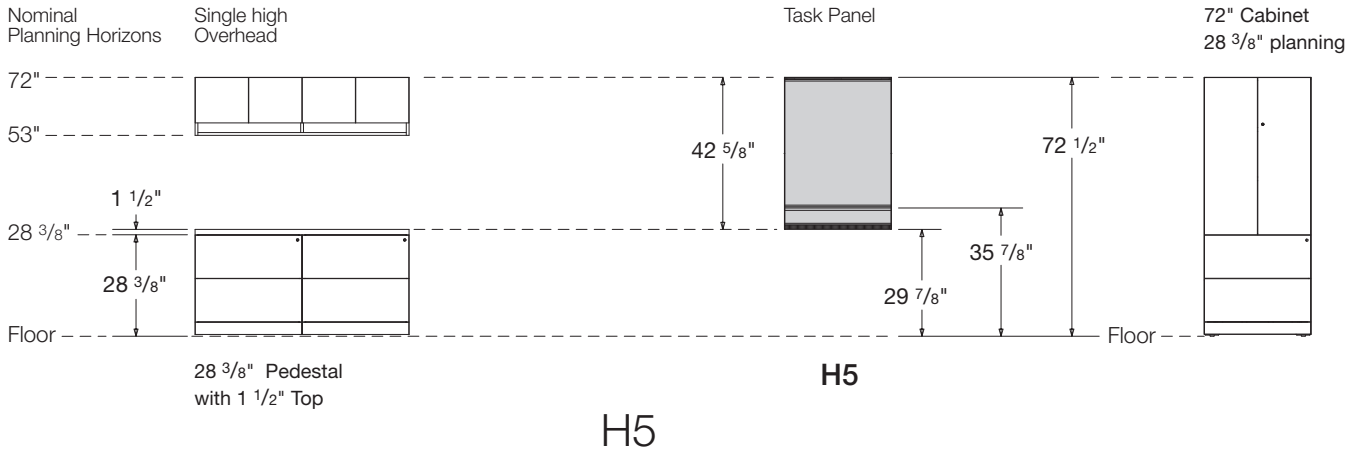

Notes

- Planning horizons are nominal. Dimensions are actual.
- Images displayed to the left and right of the Task Panel are examples only and do not represent the complete scope of products available.
- Task Panels available in monolithic and segmented; segmented shown
- H5 Task Panel is intended for use with 1/2" thick tops.
- H6 Task Panel is intended for use with 1" thick credenza tops.

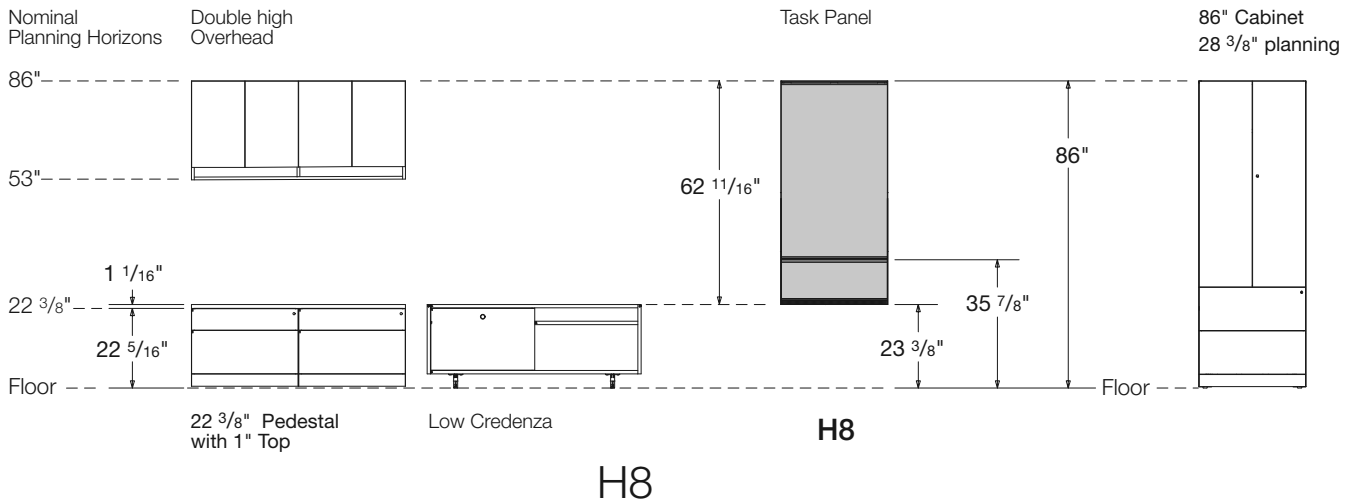
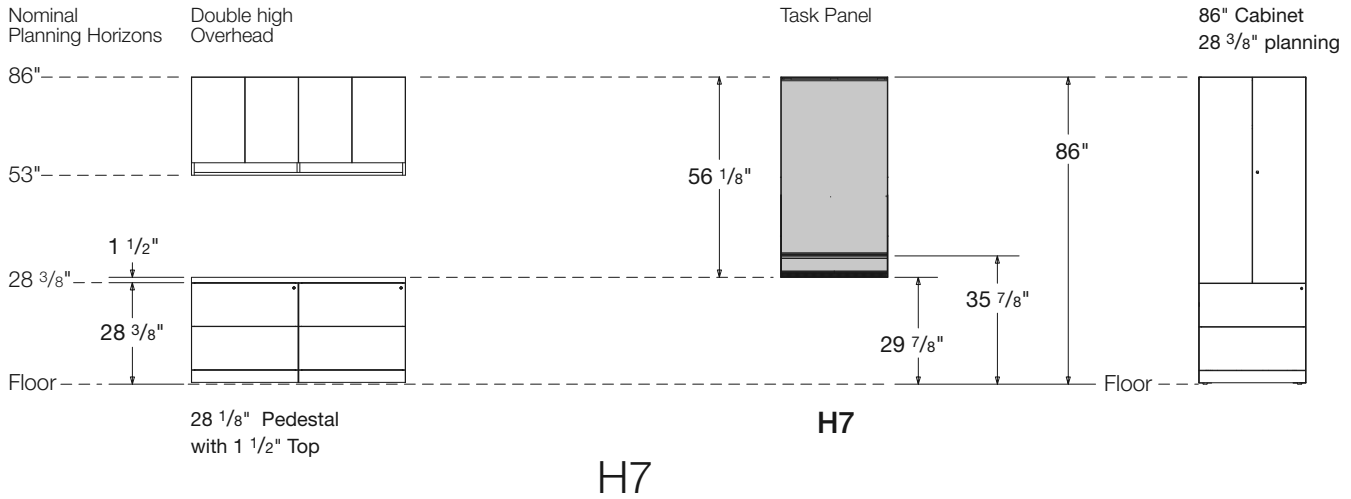

Notes

- Planning horizons are nominal. Dimensions are actual.
- Images displayed to the left and right of the Task Panel are examples only and do not represent the complete scope of products available.
- Task Panels available in monolithic and segmented; segmented shown
- H7 Task Panel is intended for use with 1 1/2" thick tops.
- H8 Task Panel is intended for use with 1" thick credenza tops.

Task Panels
H1 23 1/8" high
Monolithic, Without Tool rail
Fabric

description	th	w	y	pattern no.	grade								
					10	15	20	30	35	40	45	50	55
Task Panel, mono	1 1/2"	30"	0.9	RTPNM30H1	\$791.	\$807.	\$823.	\$837.	\$863.	\$879.	\$900.	\$932.	\$976.
Without tool rail	1 1/2"	36"	1.1	RTPNM36H1	850.	869.	889.	909.	936.	954.	975.	1,005.	1,044.
	1 1/2"	42"	1.3	RTPNM42H1	1,113.	1,137.	1,160.	1,184.	1,220.	1,241.	1,269.	1,284.	1,301.
	1 1/2"	48"	1.4	RTPNM48H1	1,126.	1,152.	1,179.	1,203.	1,240.	1,261.	1,290.	1,307.	1,323.
	1 1/2"	54"	1.6	RTPNM54H1	1,146.	1,175.	1,203.	1,233.	1,270.	1,294.	1,321.	1,337.	1,354.
	1 1/2"	60"	1.8	RTPNM60H1	1,215.	1,246.	1,279.	1,311.	1,351.	1,375.	1,406.	1,520.	1,716.
	1 1/2"	66"	1.9	RTPNM66H1	1,469.	1,504.	1,538.	1,572.	1,620.	1,647.	1,685.	1,713.	1,730.
	1 1/2"	72"	2.1	RTPNM72H1	1,490.	1,528.	1,567.	1,605.	1,652.	1,682.	1,721.	1,759.	1,798.
	1 1/2"	78"	2.3	RTPNM78H1	1,676.	1,717.	1,758.	1,800.	1,854.	1,887.	1,928.	1,956.	1,969.
	1 1/2"	84"	2.4	RTPNM84H1	1,685.	1,729.	1,773.	1,816.	1,871.	1,903.	1,948.	1,982.	2,009.
	1 1/2"	90"	2.6	RTPNM90H1	1,754.	1,801.	1,849.	1,896.	1,953.	1,987.	2,032.	2,075.	2,116.
	1 1/2"	96"	2.8	RTPNM96H1	1,775.	1,827.	1,876.	1,927.	1,986.	2,019.	2,066.	2,120.	2,180.

Order Code

Example:	RTPNM30H1 () ()
R	Reff
TP	Task Panel
N	No tool rail
M	Monolithic
30	Width
H1	23 1/8" high
111	Trim finish
W281	Fabric selection

Specification Information

To order please specify pattern number including;

1. Trim Finish: Painted or Anodized
2. Insert Finish: Fabric

Application Notes

It is Not advisable to mix 28 3/8" h desk height products with 26 1/2" standard height products.

All Fabric to be applied railroded as current tackboard.

*Installation instruction sheets available on Knoll Exchange.

For Task Panels refer to reference number 6TP00085

H1 Height: Underside of any overhead to top 1 1/2" thick desk height worksurface. See elevation drawings, page 279.

Always supplied including cable curtain.

Always supplied including all trim pieces.

All trims supplied with the same finish specification.

LH & RH side full height trims. (no hi-lo trims)

Y = Yardage required

Task Panels

H1 23 1/8" high

Monolithic, Without Tool rail

Wood, Laminate, Marker board or Glass Inserts

description	th	w	pattern no.	glass	LW	L	V1	V2	V3
Task Panel, mono Without tool rail 	1 1/2"	30"	RTPNM30H1	\$1,057.	\$850.	\$325.	\$949.	\$1,017.	\$1,172.
	1 1/2"	36"	RTPNM36H1	1,183.	901.	873.	1,001.	1,077.	1,260.
	1 1/2"	42"	RTPNM42H1	1,443.	1,107.	1,072.	1,207.	1,289.	1,501.
	1 1/2"	48"	RTPNM48H1	1,545.	1,120.	1,085.	1,224.	1,312.	1,555.
	1 1/2"	54"	RTPNM54H1	1,631.	1,130.	1,094.	1,233.	1,334.	1,605.
	1 1/2"	60"	RTPNM60H1	1,764.	1,190.	1,150.	1,294.	1,404.	1,705.
	1 1/2"	66"	RTPNM66H1	2,096.	1,478.	1,432.	1,582.	1,708.	2,041.
	1 1/2"	72"	RTPNM72H1	2,182.	1,490.	1,442.	1,596.	1,736.	2,105.
	1 1/2"	78"	RTPNM78H1	2,434.	1,669.	1,614.	1,773.	1,916.	2,307.
	1 1/2"	84"	RTPNM84H1	2,522.	1,685.	1,630.	1,796.	1,944.	2,364.
	1 1/2"	90"	RTPNM90H1	2,656.	1,744.	1,685.	1,848.	2,014.	2,463.
	1 1/2"	96"	RTPNM96H1	2,742.	1,763.	1,705.	1,871.	2,041.	2,517.

Order Code

Example:	RTPNM30H1 () ()
R	Reff
TP	Task Panel
N	No tool rail
M	Monolithic
30	Width
H1	23 1/8" high
111	Trim finish
V319	Veneer selection

Specification Information

To order please specify pattern number including:

1. Trim Finish: Painted or Anodized
2. Insert Finish: G, LW, L, V1, V2, V3

It is Not advisable to mix 28 3/8" h desk height products with 26 1/2" standard height products.

Product on this page **Excluding any vertical surface over 60"**, will accept woodgrain laminate where laminate is currently an option.

All Fabric to be applied railroaded as current tackboard.

*Installation instruction sheets available on Knoll Exchange.

For Task Panels refer to reference number 6TP00085.

H1 Height: Underside of any overhead to top 1 1/2" thick desk height worksurface. See elevation drawings, page 279.

Always supplied including cable curtain.

Always supplied including all trim pieces.

All trims supplied with the same finish specification.

LH & RH side full height trims. (no hi-lo trims)

Tool rails are not supplied to this Task Panel.

Task Panels

H1 23 1/8" high

Segmented With Tool rail

Fabric Insert Above / Fabric Insert Below

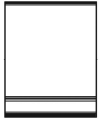
description	th	w	y	pattern no.	grade								
					10	15	20	30	35	40	45	50	55
Task Panel, segmented With tool rail 	1 1/2"	30"	0.9	RTPRS30H1	\$1,227.	\$1,259.	\$1,294.	\$1,324.	\$1,356.	\$1,389.	\$1,420.	\$1,459.	\$1,503.
	1 1/2"	36"	1.1	RTPRS36H1	1,320.	1,360.	1,401.	1,441.	1,475.	1,510.	1,543.	1,582.	1,627.
	1 1/2"	42"	1.3	RTPRS42H1	1,594.	1,641.	1,687.	1,734.	1,777.	1,817.	1,859.	1,904.	1,955.
	1 1/2"	48"	1.4	RTPRS48H1	1,616.	1,668.	1,718.	1,768.	1,811.	1,854.	1,895.	1,952.	2,024.
	1 1/2"	54"	1.6	RTPRS54H1	1,649.	1,708.	1,765.	1,825.	1,868.	1,912.	1,955.	2,031.	2,138.
	1 1/2"	60"	1.8	RTPRS60H1	1,683.	1,749.	1,814.	1,880.	1,924.	1,969.	2,015.	2,268.	2,731.
	1 1/2"	66"	1.9	RTPRS66H1	2,059.	2,129.	2,197.	2,267.	2,321.	2,376.	2,429.	2,561.	2,773.
	1 1/2"	72"	2.1	RTPRS72H1	2,096.	2,171.	2,248.	2,325.	2,381.	2,435.	2,493.	2,645.	2,895.

Order Code

Example:	RTPRS30H1 () ()
R	Reff
TP	Task Panel
R	Tool rail
S	Segmented
30	Width
H1	23 1/8" high
111	Trim finish
W281	Fabric selection top insert; 16"H
W281	Fabric selection bottom insert; 4"H

Specification Information

To order please specify pattern number including;

1. Trim Finish: Painted or Anodized
2. Top insert finish: Fabric
3. Bottom insert finish: Fabric

It is Not advisable to mix 28 3/8" h desk height products with 26 1/2" standard height products.

All Fabric to be applied railroded as current tackboard.

Note: Need to "double the yardage", for this task panel; Fabric above, Fabric below.

Top insert = 15 1/16"H
 Bottom insert = 3 13/16"H

*Installation instruction sheets available on Knoll Exchange.

For Task Panels refer to reference number 6TP00085

H1 Height: Underside of any overhead to top 1 1/2" thick desk height worksurface. See elevation drawings, page 279.

Always supplied including cable curtain.

Always supplied including all trim pieces.

All trims supplied with the same finish specification.

LH & RH side full height trims. (no hi-lo trims)

Y = Yardage required

Task Panels

H1 23 1/8" high

Segmented With Tool rail

Marker board Insert Above / Fabric Insert Below

description	th	w	y	pattern no.	grade								
					LW10	LW15	LW20	LW30	LW35	LW40	LW45	LW50	LW55
Task Panel, segmented With tool rail 	1 1/2"	30"	0.9	RTPRS30H1	\$1,294.	\$1,309.	\$1,324.	\$1,342.	\$1,382.	\$1,406.	\$1,438.	\$1,457.	\$1,474.
	1 1/2"	36"	1.1	RTPRS36H1	1,377.	1,396.	1,416.	1,435.	1,478.	1,504.	1,539.	1,557.	1,576.
	1 1/2"	42"	1.3	RTPRS42H1	1,576.	1,600.	1,625.	1,647.	1,696.	1,726.	1,765.	1,788.	1,809.
	1 1/2"	48"	1.4	RTPRS48H1	1,596.	1,622.	1,646.	1,673.	1,723.	1,753.	1,792.	1,814.	1,837.
	1 1/2"	54"	1.6	RTPRS54H1	1,626.	1,653.	1,683.	1,713.	1,763.	1,794.	1,836.	1,858.	1,882.
	1 1/2"	60"	1.8	RTPRS60H1	1,651.	1,684.	1,717.	1,750.	1,802.	1,834.	1,874.	2,069.	2,420.
	1 1/2"	66"	1.9	RTPRS66H1	2,053.	2,087.	2,123.	2,158.	2,222.	2,261.	2,312.	2,380.	2,466.
	1 1/2"	72"	2.1	RTPRS72H1	2,080.	2,118.	2,158.	2,195.	2,262.	2,300.	2,352.	2,432.	2,540.

Order Code	Specification Information	Application Notes	Application Notes
Example: RTPRS30H1 () ()	To order please specify pattern number including:	It is Not advisable to mix 28 3/8" desk height products with 26 1/2" standard height products.	H1 Height: Underside of any overhead to top 1 1/2" thick desk height worksurface. See elevation drawings, page 279.
R Reff	1. Trim Finish: Painted or Anodized	All Fabric to be applied railroded as current tackboard.	Always supplied including cable curtain.
TP Task Panel	2. Top insert finish: Marker board	Top insert = 15 1/16"H Bottom insert = 3 15/16"H	Always supplied including all trim pieces.
R Tool rail	3. Bottom insert finish: Fabric	*Installation instruction sheets available on Knoll Exchange.	All trims supplied with the same finish specification.
S Segmented		For Task Panels refer to reference number 6TP00085	LH & RH side full height trims. (no hi-lo trims)
30 Width			
H1 23 1/8" high			
111 Trim finish			
LW Marker board top insert; 16"h			
W281 Fabric selection bottom insert; 4"h			

Y = Yardage required

H1 23 1/8" high

Segmented With Tool rail

Glass or Fabric Insert Above / Forbo, Laminate or Wood Below

description	th	w	y	pattern no.	G/FORB	FAB/FORB	FAB/L	FAB/V1	FAB/V2	FAB/V3
Task Panel, segmented	1 1/2"	30"	0.9	RTPRS30H1	\$1,371.	\$1,233.	\$1,335.	\$1,382.	\$1,398.	\$1,434.
With tool rail	1 1/2"	36"	1.1	RTPRS36H1	1,509.	1,383.	1,424.	1,472.	1,491.	1,535.
	1 1/2"	42"	1.3	RTPRS42H1	1,761.	1,551.	1,634.	1,682.	1,704.	1,755.
	1 1/2"	48"	1.4	RTPRS48H1	1,842.	1,581.	1,653.	1,744.	1,765.	1,825.
	1 1/2"	54"	1.6	RTPRS54H1	1,919.	1,621.	1,685.	1,776.	1,798.	1,862.
	1 1/2"	60"	1.8	RTPRS60H1	1,996.	1,661.	1,717.	1,806.	1,833.	1,902.
	1 1/2"	66"	1.9	RTPRS66H1	2,431.	2,048.	2,130.	2,219.	2,248.	2,326.
	1 1/2"	72"	2.1	RTPRS72H1	2,510.	2,089.	2,164.	2,254.	2,285.	2,370.
	1 1/2"	78"	2.3	RTPRS78H1	2,704.	2,247.	2,312.	2,403.	2,435.	2,529.
	1 1/2"	84"	2.4	RTPRS84H1	2,780.	2,274.	2,330.	2,423.	2,457.	2,556.
	1 1/2"	90"	2.6	RTPRS90H1	2,859.	2,315.	2,362.	2,454.	2,491.	2,599.
	1 1/2"	96"	2.8	RTPRS96H1	2,938.	2,355.	2,394.	2,488.	2,527.	2,641.

Order Code

Example:	RTPRS30H1 () ()
R	Reff
TP	Task Panel
R	Tool rail
S	Segmentated
30	Width
H1	23 1/8" high
111	Trim finish
W281	Fabric selection top insert; 16"h
V319	Veneer selection bottom insert; 4"h

Specification Information

To order please specify pattern number including;

1. Trim Finish: Painted or Anodized
2. Top insert finish: Glass or Fabric
3. Bottom insert finish: Forbo, L, V1, V2, V3

Application Notes

It is Not advisable to mix 28 3/8" h desk height products with 26 1/2" standard height products.

Product on this page **Excluding any vertical surface over 60"**, will accept woodgrain laminate where laminate is currently an option.

All Fabric to be applied railroded as current tackboard.

Top insert = 15 1/16"H
Bottom insert = 3 15/16"H

*Installation instruction sheets available on Knoll Exchange.

For Task Panels refer to reference number 6TP00085.

H1 Height: Underside of any overhead to top 1 1/2" thick desk height worksurface. See elevation drawings, page 279.

Always supplied including cable curtain.

Always supplied including all trim pieces.

All trims supplied with the same finish specification.

LH & RH side full height trims. (no hi-lo trims)

Y = Yardage required

Task Panels
H2 29³/₄" high
Monolithic, Without Tool Rail
Fabric

description	th	w	y	pattern no.	grade								
					10	15	20	30	35	40	45	50	55
Task Panel, mono	1 1/2"	30"	0.9	RTPNM30H2	\$871.	\$888.	\$904.	\$921.	\$948.	\$965.	\$986.	\$1,010.	\$1,034.
Without tool rail	1 1/2"	36"	1.1	RTPNM36H2	932.	953.	972.	992.	1,022.	1,039.	1,065.	1,087.	1,104.
	1 1/2"	42"	1.3	RTPNM42H2	1,140.	1,162.	1,188.	1,210.	1,246.	1,269.	1,299.	1,324.	1,340.
	1 1/2"	48"	1.4	RTPNM48H2	1,154.	1,181.	1,204.	1,231.	1,268.	1,290.	1,318.	1,351.	1,367.
	1 1/2"	54"	1.6	RTPNM54H2	1,175.	1,203.	1,232.	1,261.	1,300.	1,321.	1,352.	1,380.	1,405.
	1 1/2"	60"	1.8	RTPNM60H2	1,243.	1,275.	1,309.	1,342.	1,382.	1,406.	1,438.	1,563.	1,780.
	1 1/2"	66"	1.9	RTPNM66H2	1,500.	1,534.	1,569.	1,604.	1,651.	1,681.	1,720.	1,758.	1,796.
	1 1/2"	72"	2.1	RTPNM72H2	1,522.	1,561.	1,598.	1,636.	1,685.	1,715.	1,754.	1,804.	1,864.
	1 1/2"	78"	2.3	RTPNM78H2	1,708.	1,750.	1,792.	1,834.	1,889.	1,920.	1,966.	2,005.	2,037.
	1 1/2"	84"	2.4	RTPNM84H2	1,721.	1,763.	1,807.	1,851.	1,907.	1,940.	1,984.	2,031.	2,079.
	1 1/2"	90"	2.6	RTPNM90H2	1,789.	1,836.	1,884.	1,931.	1,990.	2,023.	2,069.	2,124.	2,186.
	1 1/2"	96"	2.8	RTPNM96H2	1,811.	1,861.	1,913.	1,964.	2,021.	2,057.	2,104.	2,169.	2,251.

Order Code

Example:	RTPNM30H2 () ()
R	Reff
TP	Task Panel
N	No tool rail
M	Monolithic
30	Width
H2	29 ³ / ₄ " high
111	Trim finish
W281	Fabric selection

Specification Information

To order please specify pattern number including:
 1. Trim Finish: Painted or Anodized
 2. Insert Finish: Fabric

It is Not advisable to mix 28³/₈"h desk height products with 26¹/₂" standard height products.

All Fabric to be applied railroaded as current tackboard.

*Installation instruction sheets available on Knoll Exchange.

For Task Panels refer to reference number 6TP00085

H2 Height: Underside of any overhead to top 1" thick credenza top for 3/4 height cabinets or low credenza. See elevation drawings, page 279.

Always supplied including cable curtain.

Always supplied including all trim pieces.

All trims supplied with the same finish specification.

LH & RH side full height trims. (no hi-lo trims)

Y = Yardage required

Task Panels

H2 29³/₄" high

Monolithic, Without Tool Rail

Wood, Laminate, Marker board or Glass Inserts

description	th	w	pattern no.	glass	LW	L	V1	V2	V3	
Task Panel, mono Without tool rail 	1 1/2"	30"	RTPNM30H2		\$1,219.	\$888.	\$859.	\$990.	\$1,067.	\$1,264.
	1 1/2"	36"	RTPNM36H2		1,373.	945.	914.	1,048.	1,137.	1,374.
	1 1/2"	42"	RTPNM42H2		1,675.	1,146.	1,109.	1,249.	1,352.	1,628.
	1 1/2"	48"	RTPNM48H2		1,792.	1,171.	1,131.	1,274.	1,394.	1,708.
	1 1/2"	54"	RTPNM54H2		1,907.	1,183.	1,141.	1,288.	1,420.	1,773.
	1 1/2"	60"	RTPNM60H2		2,069.	1,245.	1,201.	1,351.	1,497.	1,889.
	1 1/2"	66"	RTPNM66H2		2,428.	1,538.	1,485.	1,644.	1,802.	2,232.
	1 1/2"	72"	RTPNM72H2		2,544.	1,554.	1,499.	1,659.	1,831.	2,298.
	1 1/2"	78"	RTPNM78H2		2,825.	1,739.	1,679.	1,846.	2,024.	2,532.
	1 1/2"	84"	RTPNM84H2		2,939.	1,753.	1,689.	1,861.	2,052.	2,597.
	1 1/2"	90"	RTPNM90H2		3,101.	1,822.	1,756.	1,963.	2,139.	2,723.
	1 1/2"	96"	RTPNM96H2		3,217.	1,838.	1,769.	1,948.	2,168.	2,790.

Order Code

Example:	RTPNM30H2 () ()
R	Reff
TP	Task Panel
N	No tool rail
M	Monolithic
30	Width
H2	29 ³ / ₄ " high
111	Trim finish
V319	Veneer selection

Specification Information

To order please specify pattern number including:
 1. Trim Finish: Painted or Anodized
 2. Insert Finish: G, LW, L, V1, V2, V3

Application Notes

It is Not advisable to mix 28³/₈"h desk height products with 26¹/₂" standard height products.

Product on this page **Excluding any vertical surface over 60"**, will accept woodgrain laminate where laminate is currently an option.

All Fabric to be applied railroaded as current tackboard.

*Installation instruction sheets available on Knoll Exchange.

For Task Panels refer to reference number 6TP00085.

H2 Height: Underside of any overhead to top 1" thick credenza top for 3/4 height cabinets or low credenza. See elevation drawings, page 279.

Always supplied including cable curtain.

Always supplied including all trim pieces.

All trims supplied with the same finish specification.

LH & RH side full height trims. (no hi-lo trims)

Task Panels

H2 29³/₄" high

Segmented With Tool Rail

Fabric Insert Above / Fabric Insert Below

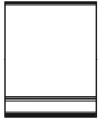
description	th	w	y	pattern no.	grade								
					10	15	20	30	35	40	45	50	55
Task Panel, segmented With tool rail 	1 1/2"	30"	0.9	RTPRS30H2	\$1,369.	\$1,381.	\$1,393.	\$1,405.	\$1,447.	\$1,471.	\$1,505.	\$1,535.	\$1,562.
	1 1/2"	36"	1.1	RTPRS36H2	1,405.	1,445.	1,484.	1,524.	1,570.	1,597.	1,634.	1,664.	1,686.
	1 1/2"	42"	1.3	RTPRS42H2	1,615.	1,663.	1,710.	1,757.	1,809.	1,841.	1,884.	1,942.	2,016.
	1 1/2"	48"	1.4	RTPRS48H2	1,640.	1,689.	1,741.	1,792.	1,845.	1,878.	1,920.	1,990.	2,086.
	1 1/2"	54"	1.6	RTPRS54H2	1,674.	1,731.	1,790.	1,848.	1,902.	1,937.	1,980.	2,069.	2,202.
	1 1/2"	60"	1.8	RTPRS60H2	1,708.	1,773.	1,839.	1,903.	1,962.	1,995.	2,042.	2,308.	2,795.
	1 1/2"	66"	1.9	RTPRS66H2	2,086.	2,156.	2,224.	2,292.	2,361.	2,402.	2,457.	2,602.	2,837.
	1 1/2"	72"	2.1	RTPRS72H2	2,195.	2,249.	2,304.	2,360.	2,430.	2,472.	2,530.	2,693.	2,961.

Order Code

Example:	RTPRS30H2 () ()
R	Reff
TP	Task Panel
R	Tool rail
S	Segmented
30	Width
H2	29 ³ / ₄ " high
111	Trim finish
W281	Fabric selection top insert, 16"H
W281	Fabric selection bottom insert, 11"H

Specification Information

To order please specify pattern number including;

1. Trim Finish: Painted or Anodized
2. Top Insert Finish: Fabric
3. Bottom Insert Finish: Fabric

Application Notes

It is Not advisable to mix 28³/₈"h desk height products with 26¹/₂" standard height products.

All Fabric to be applied railroded as current tackboard.

Note: Need to "double the yardage", for this task panel; Fabric above, Fabric below.

Top insert = 15⁹/₁₆"H
 Bottom insert = 10¹⁵/₃₂"H

*Installation instruction sheets available on Knoll Exchange.

For Task Panels refer to reference number 6TP00085

H2 Height: Underside of any overhead to top 1" thick credenza top for 3/4 height cabinets or low credenza. See elevation drawings, page 279.

Always supplied including cable curtain.

Always supplied including all trim pieces.

All trims supplied with the same finish specification.

LH & RH side full height trims. (no hi-lo trims)

Y = Yardage required

Task Panels

H2 29³/₄" high

Segmented With Tool Rail

Marker board Insert Above / Fabric Insert Below

description	th	w	y	pattern no.	grade								
					LW10	LW15	LW20	LW30	LW35	LW40	LW45	LW50	LW55
Task Panel, segmented With tool rail 	1 1/2"	30"	0.9	RTPRS30H2	\$1,312.	\$1,329.	\$1,345.	\$1,361.	\$1,403.	\$1,427.	\$1,460.	\$1,477.	\$1,495.
	1 1/2"	36"	1.1	RTPRS36H2	1,402.	1,421.	1,442.	1,462.	1,505.	1,531.	1,567.	1,587.	1,606.
	1 1/2"	42"	1.3	RTPRS42H2	1,602.	1,627.	1,650.	1,675.	1,725.	1,755.	1,794.	1,816.	1,839.
	1 1/2"	48"	1.4	RTPRS48H2	1,625.	1,649.	1,675.	1,700.	1,751.	1,782.	1,822.	1,845.	1,869.
	1 1/2"	54"	1.6	RTPRS54H2	1,652.	1,682.	1,711.	1,740.	1,793.	1,823.	1,866.	1,902.	1,936.
	1 1/2"	60"	1.8	RTPRS60H2	1,681.	1,714.	1,748.	1,780.	1,834.	1,864.	1,908.	2,114.	2,484.
	1 1/2"	66"	1.9	RTPRS66H2	2,084.	2,120.	2,154.	2,187.	2,251.	2,292.	2,344.	2,424.	2,532.
	1 1/2"	72"	2.1	RTPRS72H2	1,896.	2,009.	2,122.	2,235.	2,301.	2,342.	2,394.	2,483.	2,608.

Order Code	Specification Information	Application Notes
Example: RTPRS30H2 () () R Reff TP Task Panel R Tool rail S Segmented 30 Width H2 29 ³ / ₄ " high 111 Trim finish LW Marker board top insert; 16"H W281 Fabric selectin bottom insert; 11"H	To order please specify pattern number including: 1. Trim Finish: Painted or Anodized 2. Top Insert Finish: Marker board 3. Bottom Insert Finish: Fabric	<p>It is Not advisable to mix 28³/₈"h desk height products with 26¹/₂" standard height products.</p> <p>All Fabric to be applied railroded as current tackboard.</p> <p>Top insert = 15¹/₁₆"H Bottom insert = 10¹⁵/₃₂"H</p> <p>*Installation instruction sheets available on Knoll Exchange.</p> <p>For Task Panels refer to reference number 6TP00085</p> <p>H2 Height: Underside of any overhead to top 1" thick credenza top for 3/4 height cabinets or low credenza. See elevation drawings, page 279.</p> <p>Always supplied including cable curtain.</p> <p>Always supplied including all trim pieces.</p> <p>All trims supplied with the same finish specification.</p> <p>LH & RH side full height trims. (no hi-lo trims)</p>

Y = Yardage required

Task Panels

H2 29³/₄" high

Segmented With Tool Rail

Glass or Fabric Insert Above / Forbo, Laminate or Wood Below

description	th	w	y	pattern no.	G/FORB	FAB/FORB	FAB/L	FAB/V1	FAB/V2	FAB/V3
Task Panel, segmented	1 1/2"	30"	0.9	RTPRS30H2	\$1,488.	\$1,256.	\$1,344.	\$1,418.	\$1,461.	\$1,542.
With tool rail	1 1/2"	36"	1.1	RTPRS36H2	1,649.	1,473.	1,442.	1,516.	1,565.	1,663.
	1 1/2"	42"	1.3	RTPRS42H2	1,923.	1,710.	1,655.	1,731.	1,786.	1,898.
	1 1/2"	48"	1.4	RTPRS48H2	2,023.	1,762.	1,680.	1,789.	1,846.	1,977.
	1 1/2"	54"	1.6	RTPRS54H2	2,122.	1,822.	1,714.	1,822.	1,887.	2,031.
	1 1/2"	60"	1.8	RTPRS60H2	2,217.	1,884.	1,748.	1,857.	1,925.	2,086.
	1 1/2"	66"	1.9	RTPRS66H2	2,673.	2,289.	2,154.	2,265.	2,338.	2,514.
	1 1/2"	72"	2.1	RTPRS72H2	2,780.	2,451.	2,201.	2,315.	2,388.	2,580.
	1 1/2"	78"	2.3	RTPRS78H2	2,988.	2,531.	2,344.	2,458.	2,536.	2,744.
	1 1/2"	84"	2.4	RTPRS84H2	3,085.	2,577.	2,368.	2,484.	2,566.	2,792.
	1 1/2"	90"	2.6	RTPRS90H2	3,182.	2,638.	2,401.	2,516.	2,607.	2,846.
	1 1/2"	96"	2.8	RTPRS96H2	3,280.	2,700.	2,435.	2,554.	2,647.	2,903.

Order Code

Example:	RTPRS30H2 () ()
R	Reff
TP	Task Panel
R	Tool rail
S	Segmented
30	Width
H2	29 ³ / ₄ " high
111	Trim finish
W281	Fabric selectin top insert; 16"H
V319	Veneer selection bottom insert; 11"H

Specification Information

To order please specify pattern number including;

1. Trim Finish: Painted or Anodized
2. Top Insert Finish: Glass or Fabric
3. Bottom Insert Finish: Forbo, L, V1, V2, V3

Application Notes

It is Not advisable to mix 28³/₈"h desk height products with 26¹/₂" standard height products.

Product on this page **Excluding any vertical surface over 60"**, will accept woodgrain laminate where laminate is currently an option.

All Fabric to be applied railroaded as current tackboard.

Top insert = 15⁹/₁₆"H
Bottom insert = 10¹⁵/₃₂"H

*Installation instruction sheets available on Knoll Exchange.

For Task Panels refer to reference number 6TP00085.

H2 Height: Underside of any overhead to top 1" thick credenza top for 3/4 height cabinets or low credenza. See elevation drawings, page 279.

Always supplied including cable curtain.

Always supplied including all trim pieces.

All trims supplied with the same finish specification.

LH & RH side full height trims. (no hi-lo trims)

Y = Yardage required

Task Panels
H3 37⁷/₈" high
Monolithic, Without Tool rail
Fabric

description	th	w	y	pattern no.	grade								
					10	15	20	30	35	40	45	50	55
Task Panel, mono	1 1/2"	30"	0.9	RTPNM30H3	\$912.	\$929.	\$944.	\$961.	\$990.	\$1,008.	\$1,031.	\$1,051.	\$1,067.
Without tool rail	1 1/2"	36"	1.1	RTPNM36H3	975.	994.	1,014.	1,034.	1,066.	1,083.	1,108.	1,130.	1,147.
	1 1/2"	42"	1.3	RTPNM42H3	1,183.	1,205.	1,230.	1,254.	1,292.	1,313.	1,344.	1,370.	1,392.
	1 1/2"	48"	1.4	RTPNM48H3	1,199.	1,226.	1,249.	1,275.	1,313.	1,338.	1,367.	1,395.	1,416.
	1 1/2"	54"	1.6	RTPNM54H3	1,221.	1,249.	1,279.	1,308.	1,348.	1,370.	1,403.	1,431.	1,451.
	1 1/2"	60"	1.8	RTPNM60H3	1,290.	1,322.	1,356.	1,389.	1,430.	1,457.	1,488.	1,572.	1,800.
	1 1/2"	66"	1.9	RTPNM66H3	1,548.	1,583.	1,617.	1,651.	1,702.	1,731.	1,770.	1,763.	1,817.
	1 1/2"	72"	2.1	RTPNM72H3	1,571.	1,609.	1,648.	1,686.	1,737.	1,767.	1,807.	1,810.	1,887.
	1 1/2"	78"	2.3	RTPNM78H3	1,759.	1,801.	1,843.	1,885.	1,941.	1,975.	2,020.	2,007.	2,061.
	1 1/2"	84"	2.4	RTPNM84H3	1,773.	1,816.	1,860.	1,903.	1,962.	1,996.	2,042.	2,035.	2,104.
	1 1/2"	90"	2.6	RTPNM90H3	1,843.	1,891.	1,938.	1,984.	2,045.	2,080.	2,128.	2,129.	2,213.
	1 1/2"	96"	2.8	RTPNM96H3	1,866.	1,916.	1,968.	2,018.	2,079.	2,115.	2,164.	2,175.	2,281.

Order Code	Specification Information	Application Notes
Example: RTPNM30H3 () ()	To order please specify pattern number including;	It is Not advisable to mix 28³/₈"h desk height products with 26¹/₂" standard height products.
R Reff	1. Trim Finish: Painted or Anodized	H3 Height: Top of U-shelf or L-shelf overhead to top 1 1/2" thick desk height worksurface.
TP Task Panel	2. Insert Finish: Fabric	Always supplied including cable curtain.
N No tool rail		*Installation instruction sheets available on Knoll Exchange.
M Monolithic		For Task Panels refer to reference number 6TP00085
30 Width		Always supplied including all trim pieces.
H3 37 ⁷ / ₈ " high		All trims supplied with the same finish specification.
111 Trim finish		LH & RH side full height trims. (no hi-lo trims)
W281 Fabric selection		

Y = Yardage required

Task Panels

H3 37⁷/₈" high

Monolithic, Without Tool rail

Wood, Laminate, Marker board or Glass Inserts

description	th	w	pattern no.	glass	LW	L	V1	V2	V3
Task Panel, mono	1 1/2"	30"	RTPNM30H3	\$1,412.	\$942.	\$910.	\$1,046.	\$1,141.	\$1,396.
Without tool rail	1 1/2"	36"	RTPNM36H3	1,599.	1,000.	964.	1,103.	1,216.	1,521.
	1 1/2"	42"	RTPNM42H3	1,910.	1,211.	1,170.	1,315.	1,449.	1,804.
	1 1/2"	48"	RTPNM48H3	2,083.	1,238.	1,194.	1,345.	1,493.	1,899.
	1 1/2"	54"	RTPNM54H3	2,230.	1,256.	1,207.	1,361.	1,527.	1,981.
	1 1/2"	60"	RTPNM60H3	2,426.	1,329.	1,277.	1,436.	1,614.	2,120.
	1 1/2"	66"	RTPNM66H3	2,817.	1,617.	1,557.	1,726.	1,919.	2,474.
	1 1/2"	72"	RTPNM72H3	2,965.	1,644.	1,580.	1,753.	1,969.	2,573.
	1 1/2"	78"	RTPNM78H3	3,279.	1,828.	1,758.	1,937.	2,169.	2,823.
	1 1/2"	84"	RTPNM84H3	3,426.	1,843.	1,770.	1,954.	2,204.	2,906.
	1 1/2"	90"	RTPNM90H3	3,621.	1,910.	1,834.	2,021.	2,292.	3,057.
	1 1/2"	96"	RTPNM96H3	3,769.	1,928.	1,849.	2,043.	2,322.	3,123.

Order Code	Specification Information	Application Notes	Application Notes
Example: RTPNM30H3 () ()	To order please specify pattern number including;	It is Not advisable to mix 28⁷/₈"h desk height products with 26 1/2" standard height products.	H3 Height: Top of U-shelf or L-shelf overhead to top 1 1/2" thick desk height worksurface.
R Reff	1. Trim Finish: Painted or Anodized	Product on this page Excluding any vertical surface over 60" , will accept woodgrain laminate where laminate is currently an option.	Always supplied including cable curtain.
TP Task Panel	2. Insert Finish: G, LW, L, V1, V2, V3	All Fabric to be applied railroaded as current tackboard.	Always supplied including all trim pieces.
N No tool rail		*Installation instruction sheets available on Knoll Exchange.	All trims supplied with the same finish specification.
M Monolithic		For Task Panels refer to reference number 6TP00085.	LH & RH side full height trims. (no hi-lo trims)
30 Width			
H3 37 ⁷ / ₈ " high			
111 Trim finish			
V319 Veneer selection			

Task Panels

H3 37⁷/₈" high

Segmented With Tool rail

Fabric Insert Above / Fabric Insert Below

description	th	w	y	pattern no.	grade								
					10	15	20	30	35	40	45	50	55
Task Panel, segmented With tool rail 	1 1/2"	30"	0.9	RTPRS30H3	\$1,351.	\$1,383.	\$1,417.	\$1,449.	\$1,492.	\$1,519.	\$1,554.	\$1,585.	\$1,617.
	1 1/2"	36"	1.1	RTPRS36H3	1,446.	1,486.	1,525.	1,566.	1,613.	1,641.	1,678.	1,711.	1,747.
	1 1/2"	42"	1.3	RTPRS42H3	1,658.	1,706.	1,754.	1,801.	1,855.	1,888.	1,931.	1,970.	2,009.
	1 1/2"	48"	1.4	RTPRS48H3	1,683.	1,733.	1,786.	1,836.	1,891.	1,924.	1,968.	1,989.	2,104.
	1 1/2"	54"	1.6	RTPRS54H3	1,720.	1,778.	1,836.	1,894.	1,951.	1,984.	2,030.	2,071.	2,229.
	1 1/2"	60"	1.8	RTPRS60H3	1,755.	1,821.	1,887.	1,952.	2,010.	2,046.	2,091.	2,309.	2,824.
	1 1/2"	66"	1.9	RTPRS66H3	2,134.	2,205.	2,272.	2,342.	2,413.	2,454.	2,509.	2,596.	2,869.
	1 1/2"	72"	2.1	RTPRS72H3	2,174.	2,249.	2,326.	2,402.	2,474.	2,516.	2,575.	2,681.	2,993.

Order Code

Example:	RTPRS30H3 () ()
R	Reff
TP	Task Panel
R	Tool rail
S	Segmented
30	Width
H3	37 ⁷ / ₈ " high
111	Trim finish
W281	Fabric selection top insert, 31"H
W281	Fabric selection bottom insert, 4"H

Specification Information

To order please specify pattern number including;

1. Trim Finish: Painted or Anodized
2. Top Insert Finish: Fabric
3. Bottom Insert Finish: Fabric

Application Notes

It is Not advisable to mix 28³/₈"h desk height products with 26¹/₂" standard height products.

All Fabric to be applied railroded as current tackboard.

Note: Need to "double the yardage", for this task panel; Fabric above, Fabric below.

Top insert = 30⁹/₁₆"H
Bottom insert = 3¹⁵/₁₆"H

*Installation instruction sheets available on Knoll Exchange.

For Task Panels refer to reference number 6TP00085

H3 Height: Top of U-shelf or L-shelf overhead to top 1 1/2" thick desk height worksurface.

Always supplied including cable curtain.

Always supplied including all trim pieces.

All trims supplied with the same finish specification.

LH & RH side full height trims. (no hi-lo trims)

Y = Yardage required

Task Panels

H3 37⁷/₈" high

Segmented With Tool rail

Marker Board Insert Above / Fabric Insert Below

description	th	w	y	pattern no.	grade	LW15	LW20	LW30	LW35	LW40	LW45	LW50	LW55
					LW10								
Task Panel, segmented With tool rail	1 1/2"	30"	0.9	RTPRS30H3	\$1,387.	\$1,403.	\$1,419.	\$1,434.	\$1,477.	\$1,503.	\$1,538.	\$1,568.	\$1,599.
	1 1/2"	36"	1.1	RTPRS36H3	1,476.	1,497.	1,517.	1,536.	1,582.	1,610.	1,647.	1,680.	1,713.
	1 1/2"	42"	1.3	RTPRS42H3	1,689.	1,714.	1,738.	1,761.	1,814.	1,845.	1,889.	1,926.	1,966.
	1 1/2"	48"	1.4	RTPRS48H3	1,716.	1,741.	1,767.	1,793.	1,846.	1,880.	1,921.	1,960.	1,999.
	1 1/2"	54"	1.6	RTPRS54H3	1,754.	1,784.	1,812.	1,841.	1,896.	1,930.	1,973.	2,013.	2,053.
	1 1/2"	60"	1.8	RTPRS60H3	1,785.	1,816.	1,850.	1,883.	1,939.	1,973.	2,018.	2,174.	2,565.
	1 1/2"	66"	1.9	RTPRS66H3	2,192.	2,228.	2,262.	2,296.	2,364.	2,405.	2,460.	2,481.	2,618.
	1 1/2"	72"	2.1	RTPRS72H3	2,232.	2,270.	2,308.	2,346.	2,417.	2,458.	2,514.	2,546.	2,706.

Order Code	Specification Information	Application Notes
Example: RTPRS30H3 () ()	To order please specify pattern number including:	It is Not advisable to mix 28³/₈" desk height products with 26¹/₂" standard height products.
R Reff	1. Trim Finish: Painted or Anodized	H3 Height: Top of U-shelf or L-shelf overhead to top 1 1/2" thick desk height worksurface.
TP Task Panel	2. Top Insert Finish: Marker board	Always supplied including cable curtain.
R Tool rail	3. Bottom Insert Finish: Fabric	Always supplied including all trim pieces.
S Segmented		All trims supplied with the same finish specification.
30 Width		LH & RH side full height trims. (no hi-lo trims)
H3 37 ⁷ / ₈ " high		
111 Trim finish		
LW Marker board top insert; 31"H		
W281 Fabric selection bottom insert; 4"H		

Y = Yardage required

Task Panels

H3 37⁷/₈" high

Segmented With Tool rail

Glass or Fabric Insert Above / Forbo, Laminate or Wood Below

description	th	w	y	pattern no.	G/FORB	FAB/FORB	FAB/L	FAB/V1	FAB/V2	FAB/V3
Task Panel, segmented	1 1/2"	30"	0.9	RTPRS30H3	\$1,728.	\$1,299.	\$1,398.	\$1,447.	\$1,463.	\$1,500.
With tool rail	1 1/2"	36"	1.1	RTPRS36H3	1,925.	1,401.	1,491.	1,540.	1,560.	1,602.
	1 1/2"	42"	1.3	RTPRS42H3	2,239.	1,620.	1,704.	1,753.	1,773.	1,825.
	1 1/2"	48"	1.4	RTPRS48H3	2,381.	1,652.	1,727.	1,815.	1,838.	1,896.
	1 1/2"	54"	1.6	RTPRS54H3	2,517.	1,695.	1,759.	1,849.	1,872.	1,937.
	1 1/2"	60"	1.8	RTPRS60H3	2,657.	1,738.	1,793.	1,883.	1,910.	1,979.
	1 1/2"	66"	1.9	RTPRS66H3	3,152.	2,126.	2,210.	2,299.	2,327.	2,405.
	1 1/2"	72"	2.1	RTPRS72H3	3,294.	2,171.	2,245.	2,337.	2,367.	2,452.
	1 1/2"	78"	2.3	RTPRS78H3	3,548.	2,331.	2,395.	2,488.	2,520.	2,613.
	1 1/2"	84"	2.4	RTPRS84H3	3,686.	2,248.	2,417.	2,509.	2,543.	2,643.
	1 1/2"	90"	2.6	RTPRS90H3	3,822.	2,403.	2,451.	2,543.	2,580.	2,687.
	1 1/2"	96"	2.8	RTPRS96H3	3,964.	2,449.	2,487.	2,579.	2,618.	2,731.

Order Code

Example:	RTPRS30H3 () ()
R	Reff
TP	Task Panel
R	Tool rail
S	Segmented
30	Width
H3	37 ⁷ / ₈ " high
111	Trim finish
W281	Fabric selection top insert; 31"H
V319	Veneer selection bottom insert; 4"H

Specification Information

To order please specify pattern number including:

1. Trim Finish: Painted or Anodized
2. Top Insert Finish: Glass or Fabric
3. Bottom Insert Finish: Forbo, L, V1, V2, V3

Application Notes

It is Not advisable to mix 28⁷/₈"h desk height products with 26¹/₂" standard height products.

Product on this page **Excluding any vertical surface over 60"**, will accept woodgrain laminate where laminate is currently an option.

All Fabric to be applied railroaded as current tackboard.

Top insert = 30⁷/₁₆"H
Bottom insert = 3¹⁵/₁₆"H

*Installation instruction sheets available on Knoll Exchange.

For Task Panels refer to reference number 6TP00085.

H3 Height: Top of U-shelf or L-shelf overhead to top 1 1/2" thick desk height worksurface.

Always supplied including cable curtain.

Always supplied including all trim pieces.

All trims supplied with the same finish specification.

LH & RH side full height trims. (no hi-lo trims)

Y = Yardage required

Task Panels
H4 44 1/2" high
Monolithic, Without Tool rail
Fabric

description	th	w	y	pattern no.	grade								
					10	15	20	30	35	40	45	50	55
Task Panel, mono without tool rail 	1 1/2"	30"	0.9	RTPNM30H4	\$986.	\$1,002.	\$1,019.	\$1,035.	\$1,067.	\$1,084.	\$1,110.	\$1,123.	\$1,138.
	1 1/2"	36"	1.1	RTPNM36H4	1,049.	1,070.	1,089.	1,109.	1,143.	1,162.	1,189.	1,203.	1,219.
	1 1/2"	42"	1.3	RTPNM42H4	1,259.	1,282.	1,306.	1,329.	1,369.	1,393.	1,424.	1,442.	1,461.
	1 1/2"	48"	1.4	RTPNM48H4	1,276.	1,303.	1,327.	1,353.	1,393.	1,418.	1,450.	1,469.	1,487.
	1 1/2"	54"	1.6	RTPNM54H4	1,300.	1,328.	1,357.	1,387.	1,428.	1,453.	1,486.	1,504.	1,523.
	1 1/2"	60"	1.8	RTPNM60H4	1,369.	1,403.	1,435.	1,468.	1,513.	1,539.	1,573.	1,688.	1,710.
	1 1/2"	66"	1.9	RTPNM66H4	1,630.	1,665.	1,697.	1,732.	1,785.	1,815.	1,857.	1,886.	1,910.
	1 1/2"	72"	2.1	RTPNM72H4	1,653.	1,691.	1,730.	1,768.	1,821.	1,854.	1,896.	1,937.	1,961.
	1 1/2"	78"	2.3	RTPNM78H4	1,842.	1,816.	1,790.	1,763.	1,816.	1,849.	1,891.	1,992.	2,016.
	1 1/2"	84"	2.4	RTPNM84H4	1,857.	1,900.	1,944.	1,989.	2,048.	2,083.	2,131.	2,168.	2,195.
	1 1/2"	90"	2.6	RTPNM90H4	1,927.	1,974.	2,022.	2,069.	2,131.	2,169.	2,218.	2,263.	2,292.
	1 1/2"	96"	2.8	RTPNM96H4	1,952.	2,003.	2,054.	2,104.	2,167.	2,206.	2,255.	2,310.	2,339.

Order Code	Specification Information	Application Notes
Example: RTPNM30H4 () ()	To order please specify pattern number including:	It is Not advisable to mix 28 3/8" h desk height products with 26 1/2" standard height products.
R Reff	1. Trim Finish: Painted or Anodized	
TP Task Panel	2. Insert Finish: Fabric	All Fabric to be applied railroaded as current tackboard.
N No tool rail		*Installation instruction sheets available on Knoll Exchange.
M Monolithic		For Task Panels refer to reference number 6TP00085
30 Width		H4 Height: Top of U-shelf or L-shelf overhead to top 1" thick credenza top for 3/4 height cabinet or low credenza.
H4 44 1/2" high		Always supplied including cable curtain.
111 Trim finish		Always supplied including all trim pieces.
W281 Fabric selection		All trims supplied with the same finish specification.

Y = Yardage required

LH & RH side full height trims. (no hi-lo trims)

Task Panels

H4 44 1/2" high

Monolithic, Without Tool rail

Wood, Laminate, Marker board or Glass Inserts

description	th	w	pattern no.	glass	LW	L	V1	V2	V3
Task Panel, mono without tool rail 	1 1/2"	30"	RTPNM30H4	\$1,602.	\$1,028.	\$990.	\$1,130.	\$1,241.	\$1,543.
	1 1/2"	36"	RTPNM36H4	1,814.	1,094.	1,055.	1,198.	1,335.	1,694.
	1 1/2"	42"	RTPNM42H4	2,143.	1,310.	1,263.	1,415.	1,570.	1,990.
	1 1/2"	48"	RTPNM48H4	2,347.	1,333.	1,281.	1,439.	1,613.	2,089.
	1 1/2"	54"	RTPNM54H4	2,517.	1,359.	1,306.	1,467.	1,654.	2,191.
	1 1/2"	60"	RTPNM60H4	2,739.	1,428.	1,368.	1,536.	1,744.	2,338.
	1 1/2"	66"	RTPNM66H4	3,155.	1,727.	1,658.	1,837.	2,068.	2,721.
	1 1/2"	72"	RTPNM72H4	3,327.	1,750.	1,678.	1,859.	2,112.	2,824.
	1 1/2"	78"	RTPNM78H4	3,665.	1,935.	1,857.	2,047.	2,318.	3,087.
	1 1/2"	84"	RTPNM84H4	3,837.	1,954.	1,873.	2,067.	2,356.	3,187.
	1 1/2"	90"	RTPNM90H4	4,057.	2,022.	1,938.	2,136.	2,447.	3,332.
	1 1/2"	96"	RTPNM96H4	4,229.	2,045.	1,955.	2,161.	2,489.	3,435.

Order Code

Example: RTPNM30H4 () ()
R Reff
TP Task Panel
N No tool rail
M Monolithic
30 Width
H4 44 1/2" high
111 Trim finish
V319 Veneer selection

Specification Information

To order please specify pattern number including:
 1. Trim Finish: Painted or Anodized
 2. Insert Finish: Fabric

Application Notes

It is Not advisable to mix 28 3/8" h desk height products with 26 1/2" standard height products.

Product on this page **Excluding any vertical surface over 60"**, will accept woodgrain laminate where laminate is currently an option.

All Fabric to be applied railroded as current tackboard.

*Installation instruction sheets available on Knoll Exchange.

For Task Panels refer to reference number 6TP00085.

H4 Height: Top of U-shelf or L-shelf overhead to top 1" thick credenza top for 3/4 height cabinet or low credenza.

Always supplied including cable curtain.

Always supplied including all trim pieces.

All trims supplied with the same finish specification.

LH & RH side full height trims. (no hi-lo trims)

Task Panels

H4 44 1/2" high

Segmented With Tool rail

Fabric Insert Above / Fabric Insert Below

description	th	w	y	pattern no.	grade								
					10	15	20	30	35	40	45	50	55
Task Panel, segmented With tool rail 	1 1/2"	30"	0.9	RTPRS30H4	\$1,424.	\$1,458.	\$1,490.	\$1,523.	\$1,569.	\$1,596.	\$1,633.	\$1,653.	\$1,674.
	1 1/2"	36"	1.1	RTPRS36H4	1,522.	1,563.	1,601.	1,642.	1,690.	1,721.	1,759.	1,780.	1,802.
	1 1/2"	42"	1.3	RTPRS42H4	1,734.	1,782.	1,831.	1,877.	1,934.	1,967.	2,011.	2,060.	2,115.
	1 1/2"	48"	1.4	RTPRS48H4	1,760.	1,812.	1,862.	1,914.	1,971.	2,006.	2,052.	2,113.	2,187.
	1 1/2"	54"	1.6	RTPRS54H4	1,797.	1,856.	1,914.	1,972.	2,031.	2,066.	2,115.	2,197.	2,312.
	1 1/2"	60"	1.8	RTPRS60H4	1,835.	1,900.	1,966.	2,031.	2,091.	2,129.	2,177.	2,436.	2,909.
	1 1/2"	66"	1.9	RTPRS66H4	2,215.	2,285.	2,352.	2,423.	2,496.	2,539.	2,596.	2,736.	2,954.
	1 1/2"	72"	2.1	RTPRS72H4	2,254.	2,330.	2,408.	2,485.	2,558.	2,604.	2,662.	2,821.	3,081.

Order Code

Example:	RTPRS30H4 () ()
R	Reff
TP	Task Panel
R	Tool rail
S	Segmented
30	Width
H4	44 1/2" high
111	Trim finish
W281	Fabric selection top insert, 31"H
W281	Fabric selection bottom insert, 11"H

Specification Information

To order please specify pattern number including;

1. Trim Finish: Painted or Anodized
2. Top Insert Finish: Fabric
3. Bottom Insert Finish: Fabric

Application Notes

It is Not advisable to mix 28 3/8" h desk height products with 26 1/2" standard height products.

All Fabric to be applied railroaded as current tackboard.

Note: Need to "double the yardage", for this task panel; Fabric above, Fabric below.

Top insert = 30 5/16"H
Bottom insert = 10 15/32"H

*Installation instruction sheets available on Knoll Exchange.

For Task Panels refer to reference number 6TP00085

H4 Height: Top of U-shelf or L-shelf overhead to top 1" thick credenza top for 3/4 height cabinet or low credenza.

Always supplied including cable curtain.

Always supplied including all trim pieces.

All trims supplied with the same finish specification.

LH & RH side full height trims. (no hi-lo trims)

Y = Yardage required

Task Panels

H4 44 1/2" high

Segmented With Tool rail

Marker Board Insert Above / Fabric Insert Below

description	th	w	y	pattern no.	grade								
					LW10	LW15	LW20	LW30	LW35	LW40	LW45	LW50	LW55
Task Panel, segmented With tool rail 	1 1/2"	30"	0.9	RTPRS30H4	\$1,461.	\$1,477.	\$1,492.	\$1,510.	\$1,555.	\$1,582.	\$1,618.	\$1,638.	\$1,658.
	1 1/2"	36"	1.1	RTPRS36H4	1,552.	1,571.	1,592.	1,611.	1,659.	1,688.	1,727.	1,749.	1,769.
	1 1/2"	42"	1.3	RTPRS42H4	1,767.	1,791.	1,814.	1,838.	1,893.	1,926.	1,970.	1,995.	2,019.
	1 1/2"	48"	1.4	RTPRS48H4	1,794.	1,819.	1,844.	1,870.	1,926.	1,961.	2,005.	2,030.	2,055.
	1 1/2"	54"	1.6	RTPRS54H4	1,833.	1,861.	1,891.	1,919.	1,976.	2,011.	2,057.	2,083.	2,108.
	1 1/2"	60"	1.8	RTPRS60H4	1,863.	1,896.	1,930.	1,963.	2,020.	2,056.	2,103.	2,300.	2,649.
	1 1/2"	66"	1.9	RTPRS66H4	2,273.	2,308.	2,342.	2,377.	2,449.	2,491.	2,547.	2,618.	2,704.
	1 1/2"	72"	2.1	RTPRS72H4	2,314.	2,351.	2,390.	2,428.	2,501.	2,544.	2,604.	2,687.	2,793.

Order Code

Example:	RTPRS30H4 () ()
R	Reff
TP	Task Panel
R	Tool rail
S	Segmented
30	Width
H4	44 1/2" high
111	Trim finish
LW	Marker Board top insert; 31"H
W281	Fabric selection bottom insert; 11"H

Specification Information

To order please specify pattern number including:

1. Trim Finish: Painted or Anodized
2. Top Insert Finish: Marker board
3. Bottom Insert Finish: Fabric

Application Notes

It is Not advisable to mix 28 3/8" desk height products with 26 1/2" standard height products.

All Fabric to be applied railroded as current tackboard.

Top insert = 30 3/16"H
Bottom insert = 10 15/16"H

*Installation instruction sheets available on Knoll Exchange.

For Task Panels refer to reference number 6TP00085

H4 Height: Top of U-shelf or L-shelf overhead to top 1" thick credenza top for 3/4 height cabinet or low credenza.

Always supplied including cable curtain.

Always supplied including all trim pieces.

All trims supplied with the same finish specification.

LH & RH side full height trims. (no hi-lo trims)

Y = Yardage required

Task Panels

H4 44 1/2" high

Segmented With Tool rail

Glass or Fabric Insert Above / Forbo, Laminate or Wood Below

description	th	w	y	pattern no.	G/FORB	FAB/FORB	FAB/L	FAB/V1	FAB/V2	FAB/V3
Task Panel, segmented	1 1/2"	30"	0.9	RTPRS30H4	\$1,898.	\$1,468.	\$1,464.	\$1,536.	\$1,578.	\$1,661.
With tool rail	1 1/2"	36"	1.1	RTPRS36H4	2,116.	1,591.	1,560.	1,633.	1,681.	1,780.
	1 1/2"	42"	1.3	RTPRS42H4	2,451.	1,831.	1,777.	1,851.	1,904.	2,018.
	1 1/2"	48"	1.4	RTPRS48H4	2,613.	1,884.	1,802.	1,911.	1,969.	2,099.
	1 1/2"	54"	1.6	RTPRS54H4	2,771.	1,948.	1,838.	1,948.	2,010.	2,158.
	1 1/2"	60"	1.8	RTPRS60H4	2,928.	2,010.	1,873.	1,984.	2,053.	2,213.
	1 1/2"	66"	1.9	RTPRS66H4	3,444.	2,418.	2,282.	2,388.	2,467.	2,646.
	1 1/2"	72"	2.1	RTPRS72H4	3,606.	2,485.	2,320.	2,433.	2,510.	2,704.
	1 1/2"	78"	2.3	RTPRS78H4	3,881.	2,664.	2,478.	2,592.	2,670.	2,878.
	1 1/2"	84"	2.4	RTPRS84H4	4,040.	2,714.	2,504.	2,619.	2,702.	2,928.
	1 1/2"	90"	2.6	RTPRS90H4	4,196.	2,777.	2,540.	2,657.	2,746.	2,986.
	1 1/2"	96"	2.8	RTPRS96H4	4,358.	2,842.	2,577.	2,696.	2,789.	3,044.

Order Code

Example:	RTPRS30H4 () ()
R	Reff
TP	Task Panel
R	Tool rail
S	Segmented
30	Width
H4	44 1/2" high
111	Trim finish
W281	Fabric selection top insert; 31"H
V319	Veneer selection bottom insert; 11"H

Specification Information

To order please specify pattern number including;

1. Trim Finish: Painted or Anodized
2. Top Insert Finish: Glass or Fabric
3. Bottom Insert Finish: Forbo, L, V1, V2, V3

Application Notes

It is Not advisable to mix 28 3/8" h desk height products with 26 1/2" standard height products.

Product on this page **Excluding any vertical surface over 60"**, will accept woodgrain laminate where laminate is currently an option.

All Fabric to be applied railroaded as current tackboard.

Top insert = 30 3/16"H
Bottom insert = 10 15/32"H

*Installation instruction sheets available on Knoll Exchange.

For Task Panels refer to reference number 6TP00085.

H4 Height: Top of U-shelf or L-shelf overhead to top 1" thick credenza top for 3/4 height cabinet or low credenza.

Always supplied including cable curtain.

Always supplied including all trim pieces.

All trims supplied with the same finish specification.

LH & RH side full height trims. (no hi-lo trims)

Y = Yardage required

Task Panels
H5 42⁵/₈" high
Monolithic, Without Tool rail
Fabric

description	th	w	y	pattern no.	grade								
					10	15	20	30	35	40	45	50	55
Task Panel, mono without tool rail	1 1/2"	30"	0.9	RTPNM30H5	\$976.	\$992.	\$1,009.	\$1,024.	\$1,055.	\$1,074.	\$1,098.	\$1,123.	\$1,149.
	1 1/2"	36"	1.1	RTPNM36H5	1,038.	1,058.	1,078.	1,098.	1,131.	1,151.	1,179.	1,205.	1,233.
	1 1/2"	42"	1.3	RTPNM42H5	1,247.	1,271.	1,296.	1,317.	1,357.	1,381.	1,413.	1,445.	1,480.
	1 1/2"	48"	1.4	RTPNM48H5	1,265.	1,292.	1,315.	1,342.	1,382.	1,407.	1,438.	1,471.	1,505.
	1 1/2"	54"	1.6	RTPNM54H5	1,286.	1,315.	1,345.	1,375.	1,416.	1,441.	1,472.	1,507.	1,541.
	1 1/2"	60"	1.8	RTPNM60H5	1,357.	1,390.	1,423.	1,457.	1,500.	1,525.	1,562.	1,678.	1,873.
	1 1/2"	66"	1.9	RTPNM66H5	1,617.	1,651.	1,685.	1,721.	1,771.	1,803.	1,844.	1,874.	1,891.
	1 1/2"	72"	2.1	RTPNM72H5	1,641.	1,679.	1,717.	1,755.	1,807.	1,839.	1,882.	1,923.	1,963.
	1 1/2"	78"	2.3	RTPNM78H5	1,830.	1,870.	1,913.	1,954.	2,013.	2,049.	2,096.	2,126.	2,137.
	1 1/2"	84"	2.4	RTPNM84H5	1,843.	1,888.	1,931.	1,974.	2,033.	2,069.	2,117.	2,155.	2,181.
	1 1/2"	90"	2.6	RTPNM90H5	1,914.	1,962.	2,009.	2,056.	2,118.	2,156.	2,205.	2,249.	2,291.
	1 1/2"	96"	2.8	RTPNM96H5	1,939.	1,989.	2,040.	2,087.	2,151.	2,187.	2,238.	2,294.	2,358.

Order Code	Specification Information	Application Notes
Example: RTPNM30H5 () ()	To order please specify pattern number including;	It is Not advisable to mix 28³/₈"h desk height products with 26¹/₂" standard height products.
R Reff	1. Trim Finish: Painted or Anodized	H5 Height: Top of single high overhead to top of 1 1/2" thick desk height worksurface.
TP Task Panel	2. Insert Finish: Fabric	Always supplied including cable curtain.
N No tool rail		*Installation instruction sheets available on Knoll Exchange.
M Monolithic		For Task Panels refer to reference number 6TP00085
30 Width		Always supplied including all trim pieces.
H5 42 ⁵ / ₈ " high		All trims supplied with the same finish specification.
111 Trim finish		LH & RH side full height trims. (no hi-lo trims)
W281 Fabric selection		

Y = Yardage required

Task Panels

H5 42⁵/₈" high

Monolithic, Without Tool rail

Wood, Laminate, Marker board or Glass Inserts

description	th	w	pattern no.	glass	LW	L	V1	V2	V3
Task Panel, mono without tool rail 	1 1/2"	30"	RTPNM30H5	\$1,573.	\$1,014.	\$979.	\$1,117.	\$1,224.	\$1,513.
	1 1/2"	36"	RTPNM36H5	1,781.	1,080.	1,040.	1,185.	1,314.	1,659.
	1 1/2"	42"	RTPNM42H5	2,107.	1,296.	1,247.	1,401.	1,547.	1,950.
	1 1/2"	48"	RTPNM48H5	2,306.	1,315.	1,268.	1,422.	1,591.	2,048.
	1 1/2"	54"	RTPNM54H5	2,472.	1,343.	1,289.	1,450.	1,631.	2,142.
	1 1/2"	60"	RTPNM60H5	2,689.	1,411.	1,354.	1,519.	1,718.	2,287.
	1 1/2"	66"	RTPNM66H5	3,101.	1,709.	1,643.	1,817.	2,043.	2,668.
	1 1/2"	72"	RTPNM72H5	3,271.	1,730.	1,661.	1,840.	2,082.	2,765.
	1 1/2"	78"	RTPNM78H5	3,603.	1,915.	1,839.	2,025.	2,287.	3,026.
	1 1/2"	84"	RTPNM84H5	3,769.	1,935.	1,856.	2,047.	2,325.	3,120.
	1 1/2"	90"	RTPNM90H5	3,986.	2,002.	1,918.	2,115.	2,413.	3,262.
	1 1/2"	96"	RTPNM96H5	4,154.	2,021.	1,936.	2,136.	2,453.	3,380.

Order Code

Example:	RTPNM30H5 () ()
R	Reff
TP	Task Panel
N	No tool rail
M	Monolithic
30	Width
H5	42 ⁵ / ₈ " high
111	Trim finish
V319	Veneer selection

Specification Information

To order please specify pattern number including;

1. Trim Finish: Painted or Anodized
2. Insert Finish: G, LW, L, V1, V2, V3

Application Notes

It is Not advisable to mix 28³/₈"h desk height products with 26¹/₂" standard height products.

Product on this page **Excluding any vertical surface over 60"**, will accept woodgrain laminate where laminate is currently an option.

*Installation instruction sheets available on Knoll Exchange.

For Task Panels refer to reference number 6TP00085.

H5 Height: Top of single high overhead to top of 1 1/2" thick desk height work surface.

Always supplied including cable curtain.

Always supplied including all trim pieces.

All trims supplied with the same finish specification.

LH & RH side full height trims. (no hi-lo trims)

Task Panels

H5 42⁵/₈" high

Segmented With Tool rail

Fabric Insert Above / Fabric Insert Below

description	th	w	y	pattern no.	grade								
					10	15	20	30	35	40	45	50	55
Task Panel, segmented With tool rail 	1 1/2"	30"	0.9	RTPRS30H5	\$1,415.	\$1,447.	\$1,480.	\$1,513.	\$1,557.	\$1,584.	\$1,621.	\$1,633.	\$1,646.
	1 1/2"	36"	1.1	RTPRS36H5	1,511.	1,552.	1,591.	1,631.	1,680.	1,709.	1,749.	1,761.	1,773.
	1 1/2"	42"	1.3	RTPRS42H5	1,724.	1,770.	1,818.	1,866.	1,921.	1,955.	2,001.	2,053.	2,104.
	1 1/2"	48"	1.4	RTPRS48H5	1,750.	1,800.	1,851.	1,901.	1,958.	1,993.	2,040.	2,108.	2,177.
	1 1/2"	54"	1.6	RTPRS54H5	1,787.	1,844.	1,902.	1,962.	2,019.	2,055.	2,102.	2,203.	2,301.
	1 1/2"	60"	1.8	RTPRS60H5	1,822.	1,889.	1,953.	2,019.	2,080.	2,116.	2,165.	2,532.	2,898.
	1 1/2"	66"	1.9	RTPRS66H5	2,204.	2,272.	2,341.	2,410.	2,482.	2,526.	2,584.	2,763.	2,942.
	1 1/2"	72"	2.1	RTPRS72H5	2,243.	2,320.	2,395.	2,471.	2,546.	2,590.	2,650.	2,860.	3,069.

Order Code

Example:	RTPRS30H5 () ()
R	Reff
TP	Task Panel
R	Tool rail
S	Segmented
30	Width
H5	42 ⁵ / ₈ " high
111	Trim finish
W281	Fabric selection top insert, 36"H
W281	Fabric selection bottom insert, 4"H

Specification Information

To order please specify pattern number including;

1. Trim Finish: Painted or Anodized
2. Top insert finish: Fabric
3. Bottom insert finish: Fabric

Application Notes

It is Not advisable to mix 28³/₈"h desk height products with 26¹/₂" standard height products.

All Fabric to be applied railroaded as current tackboard.

Note: Need to "double the yardage", for this task panel; Fabric above, Fabric below.

Top insert = 35¹/₁₆"H
Bottom insert = 3¹⁵/₁₆"H

*Installation instruction sheets available on Knoll Exchange.

For Task Panels refer to reference number 6TP00085

H5 Height: Top of single high overhead to top of 1 1/2" thick desk height work worksurface.

Always supplied including cable curtain.

Always supplied including all trim pieces.

All trims supplied with the same finish specification.

LH & RH side full height trims. (no hi-lo trims)

Y = Yardage required

Task Panels

H5 42⁵/₈" high

Segmented With Tool rail

Marker board Insert Above / Fabric Insert Below

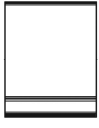
description	th	w	y	pattern no.	grade								
					LW10	LW15	LW20	LW30	LW35	LW40	LW45	LW50	LW55
Task Panel, segmented With tool rail 	1 1/2"	30"	0.9	RTPRS30H5	\$1,458.	\$1,473.	\$1,489.	\$1,507.	\$1,552.	\$1,577.	\$1,615.	\$1,652.	\$1,689.
	1 1/2"	36"	1.1	RTPRS36H5	1,548.	1,569.	1,590.	1,609.	1,656.	1,686.	1,725.	1,764.	1,805.
	1 1/2"	42"	1.3	RTPRS42H5	1,764.	1,789.	1,812.	1,836.	1,891.	1,924.	1,968.	2,013.	2,059.
	1 1/2"	48"	1.4	RTPRS48H5	1,801.	1,828.	1,851.	1,877.	1,934.	1,967.	2,011.	2,057.	2,105.
	1 1/2"	54"	1.6	RTPRS54H5	1,834.	1,862.	1,892.	1,920.	1,977.	2,013.	2,058.	2,105.	2,155.
	1 1/2"	60"	1.8	RTPRS60H5	1,873.	1,907.	1,939.	1,971.	2,030.	2,064.	2,113.	2,311.	2,661.
	1 1/2"	66"	1.9	RTPRS66H5	2,283.	2,318.	2,351.	2,387.	2,458.	2,501.	2,558.	2,630.	2,716.
	1 1/2"	72"	2.1	RTPRS72H5	2,326.	2,364.	2,402.	2,441.	2,512.	2,556.	2,616.	2,700.	2,807.

Order Code	Specification Information	Application Notes
Example: RTPRS30H5 () ()	To order please specify pattern number including:	It is Not advisable to mix 28³/₈" desk height products with 26¹/₂" standard height products.
R Reff	1. Trim Finish: Painted or Anodized	H5 Height: Top of single high overhead to top of 1 1/2" thick desk height worksurface.
TP Task Panel	2. Top insert finish: Marker board	Always supplied including cable curtain.
R Tool rail	3. Bottom insert finish: Fabric	Always supplied including all trim pieces.
S Segmented		All trims supplied with the same finish specification.
30 Width		LH & RH side full height trims. (no hi-lo trims)
H5 42 ⁵ / ₈ " high		
111 Trim finish		
LW Marker board top insert; 36"H		
W281 Fabric selection bottom insert; 4"H		

Y = Yardage required

Task Panels

H5 42⁵/₈" high

Segmented With Tool rail

Glass or Fabric Insert Above / Forbo, Laminate or Wood Below

description	th	w	y	pattern no.	FAB/L	G/FORB	FAB/FORB	FAB/V1	FAB/V2	FAB/V3
Task Panel, segmented	1 1/2"	30"	0.9	RTPRS30H5	\$1,463.	\$1,890.	\$1,361.	\$1,511.	\$1,526.	\$1,564.
With tool rail	1 1/2"	36"	1.1	RTPRS36H5	1,556.	2,106.	1,465.	1,605.	1,623.	1,669.
	1 1/2"	42"	1.3	RTPRS42H5	1,768.	2,442.	1,684.	1,817.	1,839.	1,890.
	1 1/2"	48"	1.4	RTPRS48H5	1,793.	2,605.	1,720.	1,882.	1,903.	1,760.
	1 1/2"	54"	1.6	RTPRS54H5	1,828.	2,762.	1,762.	1,916.	1,940.	2,004.
	1 1/2"	60"	1.8	RTPRS60H5	1,860.	2,920.	1,805.	1,950.	1,976.	2,048.
	1 1/2"	66"	1.9	RTPRS66H5	2,278.	3,436.	2,194.	2,368.	2,396.	2,474.
	1 1/2"	72"	2.1	RTPRS72H5	2,315.	3,597.	2,241.	2,405.	2,435.	2,522.
	1 1/2"	78"	2.3	RTPRS78H5	2,464.	2,753.	2,401.	2,556.	2,589.	2,682.
	1 1/2"	84"	2.4	RTPRS84H5	2,488.	4,030.	2,431.	2,580.	2,615.	2,715.
	1 1/2"	90"	2.6	RTPRS90H5	2,523.	4,188.	2,475.	2,615.	2,651.	2,759.
	1 1/2"	96"	2.8	RTPRS96H5	2,558.	4,348.	2,522.	2,653.	2,690.	2,804.

Order Code

Example:	RTPRS30H5 () ()
R	Reff
TP	Task Panel
R	Tool rail
S	Segmentated
30	Width
H5	42 ⁵ / ₈ " high
111	Trim finish
W281	Fabric selection top insert; 36"H
V319	Veneer selection bottom insert; 4"H

Specification Information

To order please specify pattern number including;

1. Trim Finish: Painted or Anodized
2. Top insert finish: Glass or Fabric
3. Bottom insert finish: Forbo, L, V1, V2, V3

Application Notes

It is Not advisable to mix 28³/₈"h desk height products with 26¹/₂" standard height products.

Product on this page **Excluding any vertical surface over 60"**, will accept woodgrain laminate where laminate is currently an option.

All Fabric to be applied railroaded as current tackboard.

Top insert = 35¹/₁₆"H
Bottom insert = 3¹⁵/₁₆"H

*Installation instruction sheets available on Knoll Exchange.

For Task Panels refer to reference number 6TP00085.

H5 Height: Top of single high overhead to top of 1 1/2" thick desk height work worksurface.

Always supplied including cable curtain.

Always supplied including all trim pieces.

All trims supplied with the same finish specification.

LH & RH side full height trims. (no hi-lo trims)

Y = Yardage required

Task Panels
H6 49 1/8" high
Monolithic, Without Tool rail
Fabric

description	th	w	y	pattern no.	grade								
					10	15	20	30	35	40	45	50	55
Task Panel, mono	1 1/2"	30"	0.9	RTPNM30H6	\$1,028.	\$1,042.	\$1,059.	\$1,075.	\$1,108.	\$1,126.	\$1,152.	\$1,178.	\$1,203.
Without tool rail	1 1/2"	36"	1.1	RTPNM36H6	1,091.	1,111.	1,130.	1,150.	1,185.	1,204.	1,233.	1,260.	1,287.
	1 1/2"	42"	1.3	RTPNM42H6	1,301.	1,323.	1,349.	1,371.	1,413.	1,438.	1,470.	1,502.	1,535.
	1 1/2"	48"	1.4	RTPNM48H6	1,318.	1,345.	1,369.	1,395.	1,436.	1,463.	1,497.	1,529.	1,563.
	1 1/2"	54"	1.6	RTPNM54H6	1,342.	1,370.	1,401.	1,429.	1,471.	1,498.	1,531.	1,566.	1,600.
	1 1/2"	60"	1.8	RTPNM60H6	1,415.	1,447.	1,481.	1,514.	1,560.	1,585.	1,622.	1,735.	1,928.
	1 1/2"	66"	1.9	RTPNM66H6	1,675.	1,709.	1,743.	1,778.	1,832.	1,862.	1,904.	1,934.	1,948.
	1 1/2"	72"	2.1	RTPNM72H6	1,699.	1,737.	1,776.	1,813.	1,868.	1,900.	1,944.	1,983.	2,020.
	1 1/2"	78"	2.3	RTPNM78H6	1,889.	1,930.	1,972.	2,014.	2,075.	2,110.	2,159.	2,187.	2,196.
	1 1/2"	84	2.4	RTPNM84H6	1,903.	1,948.	1,992.	2,035.	2,097.	2,132.	2,181.	2,217.	2,241.
	1 1/2"	90	2.6	RTPNM90H6	1,975.	2,022.	2,071.	2,118.	2,181.	2,219.	2,270.	2,315.	2,352.
	1 1/2"	96"	2.8	RTPNM96H6	2,002.	2,052.	2,103.	2,155.	2,218.	2,257.	2,308.	2,363.	2,421.

Order Code	Specification Information	Application Notes
Example: RTPNM30H6 () ()	To order please specify pattern number including;	It is Not advisable to mix 28 3/8" h desk height products with 26 1/2" standard height products.
R Reff	1. Trim Finish: Painted or Anodized	
TP Task Panel	2. Insert Finish: Fabric	All Fabric to be applied railroaded as current tackboard.
N No tool rail		*Installation instruction sheets available on Knoll Exchange.
M Monolithic		For Task Panels refer to reference number 6TP00085
30 Width		H6 Height: Top of single high overhead to top of 1" thick credenza top for 3/4 height cabinet or lower credenza.
H6 49 1/8" high		Always supplied including cable curtain.
111 Trim finish		Always supplied including all trim pieces.
W281 Fabric selection		All trims supplied with the same finish specification.

Y = Yardage required

LH & RH side full height trims. (no hi-lo trims)

Task Panels

H6 49 1/8" high

Monolithic, Without Tool rail

Wood, Laminate, Marker board or Glass Inserts

description	th	w	pattern no.	glass	LW	L	V1	V2	V3
Task Panel, mono	1 1/2"	30"	RTPNM30H6	\$1,741.	\$1,082.	\$1,043.	\$1,187.	\$1,312.	\$1,648.
Without tool rail	1 1/2"	36"	RTPNM36H6	1,973.	1,152.	1,108.	1,257.	1,406.	1,805.
	1 1/2"	42"	RTPNM42H6	2,321.	1,360.	1,310.	1,467.	1,637.	2,103.
	1 1/2"	48"	RTPNM48H6	2,547.	1,393.	1,339.	1,501.	1,686.	2,216.



Order Code	Specification Information	Application Notes	Application Notes
Example: RTPNM30H6 () ()	To order please specify pattern number including:	It is Not advisable to mix 28 3/8" h desk height products with 26 1/2" standard height products.	H6 Height: Top of single high overhead to top of 1" thick credenza top for 3/4 height cabinet or lower credenza.
R Reff	1. Trim Finish: Painted or Anodized	Product on this page Excluding any vertical surface over 60" , will accept woodgrain laminate where laminate is currently an option.	Always supplied including cable curtain.
TP Task Panel	2. Insert Finish: G, LW, L, V1, V2, V3	*Installation instruction sheets available on Knoll Exchange.	Always supplied including all trim pieces.
N No tool rail		For Task Panels refer to reference number 6TP00085.	All trims supplied with the same finish specification.
M Monolithic			LH & RH side full height trims. (no hi-lo trims)
30 Width			
H6 49 1/8" high			
111 Trim finish			
V319 Veneer selection			

Task Panels

H6 49 1/8" high

Segmented With Tool rail

Fabric Insert Above / Fabric Insert Below

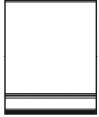
description	th	w	y	pattern no.	10	15	20	30	35	40	45	50	55
Task Panel, segmented With tool rail 	1 1/2"	30"	0.9	RTPRS30H6	\$1,466.	\$1,499.	\$1,530.	\$1,564.	\$1,600.	\$1,638.	\$1,676.	\$1,685.	\$1,695.
	1 1/2"	36"	1.1	RTPRS36H6	1,563.	1,602.	1,642.	1,682.	1,723.	1,762.	1,803.	1,813.	1,822.
	1 1/2"	42"	1.3	RTPRS42H6	1,778.	1,825.	1,871.	1,918.	1,965.	2,010.	2,056.	2,104.	2,156.
	1 1/2"	48"	1.4	RTPRS48H6	1,804.	1,855.	1,907.	1,956.	2,004.	2,051.	2,098.	2,164.	2,229.
	1 1/2"	54"	1.6	RTPRS54H6	1,841.	1,899.	1,957.	2,016.	2,063.	2,113.	2,161.	2,258.	2,354.
	1 1/2"	60"	1.8	RTPRS60H6	1,880.	1,944.	2,010.	2,076.	2,125.	2,175.	2,224.	2,588.	2,952.
	1 1/2"	66"	1.9	RTPRS66H6	2,261.	2,329.	2,397.	2,467.	2,527.	2,586.	2,645.	2,822.	2,999.
	1 1/2"	72"	2.1	RTPRS72H6	2,300.	2,377.	2,454.	2,531.	2,607.	2,651.	2,712.	2,919.	3,125.

Order Code

Example:	RTPRS30H6 () ()
R	Reff
TP	Task Panel
N	No tool rail
S	Segmented
30	Width
H6	49 1/8" high
111	Trim finish
W281	Fabric selection top insert; 36"H
W281	Fabric selection bottom insert; 11"H

Specification Information

To order please specify pattern number including;

1. Trim Finish: Painted or Anodized
2. Top insert finish: Fabric
3. Bottom insert finish: Fabric

Application Notes

It is Not advisable to mix 28 3/8" desk height products with 26 1/2" standard height products.

All Fabric to be applied railroded as current tackboard.

Note: Need to "double the yardage", for this task panel; Fabric above, Fabric below.

Top insert = 35 1/16"H
Bottom insert = 10 15/32"H

*Installation instruction sheets available on Knoll Exchange.

For Task Panels refer to reference number 6TP00085

H6 Height: Top of single high overhead to top of 1" thick credenza top for 3/4 height cabinet or lower credenza.

Always supplied including cable curtain.

Always supplied including all trim pieces.

All trims supplied with the same finish specification.

LH & RH side full height trims. (no hi-lo trims)

Y = Yardage required

Task Panels

H6 49 1/8" high

Segmented With Tool rail

Marker board Insert Above / Fabric Insert Below

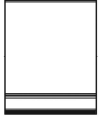
description	th	w	y	pattern no.	LW10	LW15	LW20	LW30	LW35	LW40	LW45	LW50	LW55
Task Panel, segmented	1 1/2"	30"	0.9	RTPRS30H6	\$1,509.	\$1,524.	\$1,541.	\$1,557.	\$1,604.	\$1,632.	\$1,670.	\$1,706.	\$1,744.
With tool rail	1 1/2"	36"	1.1	RTPRS36H6	1,601.	1,622.	1,641.	1,661.	1,710.	1,740.	1,781.	1,820.	1,860.
	1 1/2"	42"	1.3	RTPRS42H6	1,817.	1,841.	1,864.	1,889.	1,944.	1,978.	2,023.	2,068.	2,113.
	1 1/2"	48"	1.4	RTPRS48H6	1,856.	1,882.	1,907.	1,933.	1,991.	2,024.	2,071.	2,116.	2,162.
	1 1/2"	54"	1.6	RTPRS54H6	1,889.	1,917.	1,946.	1,975.	2,035.	2,071.	2,118.	2,165.	2,212.
	1 1/2"	60"	1.8	RTPRS60H6	1,930.	1,963.	1,996.	2,027.	2,088.	2,126.	2,174.	2,371.	2,716.
	1 1/2"	66"	1.9	RTPRS66H6	2,340.	2,375.	2,409.	2,444.	2,515.	2,561.	2,619.	2,690.	2,773.

Order Code

Example:	RTPRS30H6 () ()
R	Reff
TP	Task Panel
R	Tool rail
S	Segmentated
30	Width
H6	49 1/8" high
111	Trim finish
LW	Marker board top insert; 36"H
W281	Fabric selection bottom insert; 11"H

Specification Information

To order please specify pattern number including:

1. Trim Finish: Painted or Anodized
2. Top insert finish: Marker board
3. Bottom insert finish: Fabric

Application Notes

It is Not advisable to mix 28 3/8" desk height products with 26 1/2" standard height products.

All Fabric to be applied railroded as current tackboard.

Top insert = 35 1/16"H
Bottom insert = 10 15/32"H

*Installation instruction sheets available on Knoll Exchange.

For Task Panels refer to reference number 6TP00085

H6 Height: Top of single high overhead to top of 1" thick credenza top for 3/4 height cabinet or lower credenza.

Always supplied including cable curtain.

Always supplied including all trim pieces.

All trims supplied with the same finish specification.

LH & RH side full height trims. (no hi-lo trims)

Y = Yardage required

Task Panels

H6 49 1/8" high

Segmented With Tool rail

Glass or Fabric Insert Above / Forbo, Laminate or Wood Below

description	th	w	y	pattern no.	G/FORB	FAB/FORB	FAB/L	FAB/V1	FAB/V2	FAB/V3
Task Panel, segmented	1 1/2"	30"	0.9	RTPRS30H6	\$2,036.	\$1,509.	\$1,504.	\$1,576.	\$1,620.	\$1,702.
With tool rail	1 1/2"	36"	1.1	RTPRS36H6	2,274.	1,632.	1,599.	1,674.	1,723.	1,821.
	1 1/2"	42"	1.3	RTPRS42H6	2,629.	1,872.	1,817.	1,894.	1,946.	2,059.
	1 1/2"	48"	1.4	RTPRS48H6	2,811.	1,926.	1,844.	1,953.	2,011.	2,141.
	1 1/2"	54"	1.6	RTPRS54H6	2,990.	1,991.	1,882.	1,991.	2,054.	2,200.
	1 1/2"	60"	1.8	RTPRS60H6	3,168.	2,054.	1,917.	2,027.	2,097.	2,257.
	1 1/2"	66"	1.9	RTPRS66H6	3,704.	2,462.	2,327.	2,437.	2,511.	2,690.
	1 1/2"	72"	2.1	RTPRS72H6	3,886.	2,531.	2,366.	2,479.	2,556.	2,751.
	1 1/2"	78"	2.3	RTPRS78H6	4,182.	2,711.	2,525.	2,639.	2,716.	2,924.
	1 1/2"	84"	2.4	RTPRS84H6	4,360.	2,762.	2,551.	2,666.	2,751.	2,977.
	1 1/2"	90"	2.6	RTPRS90H6	4,540.	2,825.	2,588.	2,704.	2,792.	3,033.
	1 1/2"	96"	2.8	RTPRS96H6	4,719.	2,889.	2,626.	2,746.	2,836.	3,093.

Order Code

Example:	RTPRS30H6 () ()
R	Reff
TP	Task Panel
R	Tool rail
S	Segmentated
30	Width
H6	49 1/8" high
111	Trim finish
W281	Fabric selection top insert; 36"H
V319	Veneer selection bottom insert; 11"H

Specification Information

To order please specify pattern number including;

1. Trim Finish: Painted or Anodized
2. Top insert finish: Glass or Fabric
3. Bottom insert finish: Forbo, L, V1, V2, V3

Application Notes

It is Not advisable to mix 28 3/8" high desk height products with 26 1/2" standard height products.

Product on this page **Excluding any vertical surface over 60"**, will accept woodgrain laminate where laminate is currently an option.

All Fabric to be applied railroaded as current tackboard.

Top insert = 35 1/16"H
Bottom insert = 10 15/32"H

*Installation instruction sheets available on Knoll Exchange.

For Task Panels refer to reference number 6TP00085.

H6 Height: Top of single high overhead to top of 1" thick credenza top for 3/4 height cabinet or lower credenza.

Always supplied including cable curtain.

Always supplied including all trim pieces.

All trims supplied with the same finish specification.

LH & RH side full height trims. (no hi-lo trims)

Y = Yardage required

Task Panels

H7 56 1/8" high

Monolithic, Without Tool rail

Wood, Laminate, Marker board or Glass Inserts

description	th	w	pattern n	glass	LW	L	V1	V2	V3	
Task Panel, mono	1 1/2"	30"	RTPNM30H7()()		\$1,885.	\$1,099.	\$1,059.	\$1,195.	\$1,348.	\$1,744.
Without tool rail	1 1/2"	36"	RTPNM36H7()()		2,144.	1,173.	1,125.	1,279.	1,446.	1,916.
	1 1/2"	42"	RTPNM42H7()()		2,515.	1,393.	1,339.	1,501.	1,700.	2,246.
	1 1/2"	48"	RTPNM48H7()()		2,776.	1,428.	1,368.	1,538.	1,754.	2,377.



Order Code

Example:	RTPNM30H7()()
R	Reff
TP	Task Panel
N	No tool rail
M	Monolithic
30	Width
H7	56 1/8" high
111	Trim finish
V319	Veneer selection

Specification Information

To order please specify pattern number including;

1. Trim Finish: Painted or Anodized
2. Insert Finish: G, LW, L, V1, V2, V3

Application Notes

It is Not advisable to mix 28 3/8" h desk height products with 26 1/2" standard height products.

Product on this page **Excluding any vertical surface over 60"**, will accept woodgrain laminate where laminate is currently an option.

*Installation instruction sheets available on Knoll Exchange.

For Task Panels refer to reference number 6TP00085.

H7 Height: Top of double high overhead to top of 1 1/2" thick desk height worksurface.

Always supplied including cable curtain.

Always supplied including all trim pieces.

All trims supplied with the same finish specification.

LH & RH side full height trims. (no hi-lo trims)

Task Panels

H7 56 1/8" high

Segmented With Tool rail

Fabric Insert Above / Fabric Insert Below

description	th	w	y	pattern no.	grade								
					10	15	20	30	35	40	45	50	55
Task Panel, segmented	1 1/2"	30"	0.9	RTPRS30H7	\$1,472.	\$1,505.	\$1,538.	\$1,570.	\$1,608.	\$1,645.	\$1,683.	\$1,721.	\$1,730.
With tool rail	1 1/2"	36"	1.1	RTPRS36H7	1,571.	1,611.	1,650.	1,690.	1,731.	1,771.	1,813.	1,853.	1,863.
	1 1/2"	42"	1.3	RTPRS42H7	1,787.	1,834.	1,882.	1,928.	1,974.	2,021.	2,067.	2,117.	2,166.
	1 1/2"	48"	1.4	RTPRS48H7	1,814.	1,864.	1,916.	1,967.	2,014.	2,060.	2,107.	2,175.	2,241.

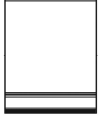

Order Code

Example:	RTPRS30H7 () ()
R	Reff
TP	Task Panel
R	Tool rail
S	Segmented
30	Width
H7	56 1/8" high
111	Trim finish
W281	Fabric selection top insert; 49"H
W281	Fabric selection bottom insert; 4"H

Specification Information

To order please specify pattern number including;

1. Trim Finish: Painted or Anodized
2. Top insert finish: Fabric
3. Bottom insert finish: Fabric

Application Notes

It is Not advisable to mix 28 3/8" desk height products with 26 1/2" standard height products.

All Fabric to be applied railroaded as current tackboard.

Note: Need to "double the yardage", for this task panel; Fabric above, Fabric below.

Top insert = 49 9/16"H
Bottom insert = 3 15/16"H

*Installation instruction sheets available on Knoll Exchange.

For Task Panels refer to reference number 6TP00085

H7 Height: Top of double high overhead to top of 1 1/2" thick desk height worksurface.

Always supplied including cable curtain.

Always supplied including all trim pieces.

All trims supplied with the same finish specification.

LH & RH side full height trims. (no hi-lo trims)

Y = Yardage required

Task Panels

H7 56 1/8" high

Segmented With Tool rail

Marker board Insert Above / Fabric Insert Below

description	th	w	y	pattern no.	LW10	LW15	LW20	LW30	LW35	LW40	LW45	LW50	LW55
Task Panel, segmented	1 1/2"	30"	0.9	RTPRS30H7	\$1,543.	\$1,561.	\$1,575.	\$1,593.	\$1,631.	\$1,670.	\$1,707.	\$1,744.	\$1,782.
With tool rail	1 1/2"	36"	1.1	RTPRS36H7	1,648.	1,670.	1,687.	1,708.	1,750.	1,790.	1,832.	1,872.	1,913.
	1 1/2"	42"	1.3	RTPRS42H7	1,870.	1,894.	1,918.	1,942.	1,990.	2,035.	2,082.	2,128.	2,175.
	1 1/2"	48"	1.4	RTPRS48H7	1,904.	1,931.	1,955.	1,980.	2,027.	2,077.	2,124.	2,170.	2,218.



Order Code	Specification Information	Application Notes
Example: RTPRS30H7 () ()	To order please specify pattern number including:	It is Not advisable to mix 28 3/8" desk height products with 26 1/2" standard height products.
R Reff	1. Trim Finish: Painted or Anodized	H7 Height: Top of double high overhead to top of 1 1/2" thick desk height worksurface.
TP Task Panel	2. Top insert finish: Marker board	Always supplied including cable curtain.
R Tool rail	3. Bottom insert finish: Fabric	Always supplied including all trim pieces.
S Segmented		All trims supplied with the same finish specification.
30 Width		LH & RH side full height trims. (no hi-lo trims)
H7 56 1/8" high		
111 Trim finish		
LW Marker board top insert; 49"H		
W281 Fabric selection bottom insert; 4"H		

Y = Yardage required

Task Panels

H7 56 1/8" high

Segmented With Tool rail

Glass or Fabric Insert Above / Forbo, Laminate or Wood Below

description	th	w	y	pattern no.	G/FORB	FAB/FORB	FAB/L	FAB/V1	FAB/V2	FAB/V3
Task Panel, segmented	1 1/2"	30"	0.9	RTPRS30H7	\$2,201.	\$1,419.	\$1,520.	\$1,568.	\$1,584.	\$1,622.
With tool rail	1 1/2"	36"	1.1	RTPRS36H7	2,471.	1,524.	1,616.	1,665.	1,683.	1,727.
	1 1/2"	42"	1.3	RTPRS42H7	2,860.	1,748.	1,898.	1,881.	1,900.	1,952.
	1 1/2"	48"	1.4	RTPRS48H7	3,074.	1,784.	1,857.	1,946.	1,969.	2,026.

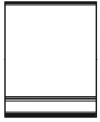

Order Code

Example:	RTPRS30H7 () ()
R	Reff
TP	Task Panel
R	Tool rail
S	Segmentated
30	Width
H7	56 1/8" high
111	Trim finish
W281	Fabric selection top insert; 49"H
V319	Veneer selection bottom insert; 4"H

Specification Information

To order please specify pattern number including;

1. Trim Finish: Painted or Anodized
2. Top insert finish: Glass or Fabric
3. Bottom insert finish: Forbo, L, V1, V2, V3

Application Notes

It is Not advisable to mix 28 3/8" h desk height products with 26 1/2" standard height products.

Product on this page **Excluding any vertical surface over 60"**, will accept woodgrain laminate where laminate is currently an option.

All Fabric to be applied railroaded as current tackboard.

Top insert = 48 1/16"H
Bottom insert = 3 15/16"H

*Installation instruction sheets available on Knoll Exchange.

For Task Panels refer to reference number 6TP00085.

H7 Height: Top of double high overhead to top of 1 1/2" thick desk height worksurface.

Always supplied including cable curtain.

Always supplied including all trim pieces.

All trims supplied with the same finish specification.

LH & RH side full height trims. (no hi-lo trims)

Y = Yardage required

Task Panels

H8 62³/₄" high

Monolithic, Without Tool rail

Wood, Laminate, Marker board or Glass Inserts

description	th	w	pattern no.	glass	LW	L	V1	V2	V3
Task Panel, mono	1 1/2"	30"	RTPNM30H8	\$2,206.	\$1,326.	\$1,278.	\$1,432.	\$1,591.	\$2,020.
Without tool rail	1 1/2"	36"	RTPNM36H8	2,495.	1,404.	1,350.	1,510.	1,689.	2,203.
	1 1/2"	42"	RTPNM42H8	2,887.	1,627.	1,564.	1,734.	1,948.	2,542.
	1 1/2"	48"	RTPNM48H8	3,182.	1,655.	1,589.	1,767.	2,008.	2,687.



Order Code

Example:	RTPNM30H8 () ()
R	Reff
TP	Task Panel
N	No tool rail
M	Monolithic
30	Width
H8	62 ³ / ₄ " high
111	Trim finish
V319	Veneer selection

Specification Information

To order please specify pattern number including;

1. Trim Finish: Painted or Anodized
2. Insert Finish: G, LW, L, V1, V2, V3

Application Notes

It is Not advisable to mix 28³/₈"h desk height products with 26¹/₂" standard height products.

Product on this page **Excluding any vertical surface over 60"**, will accept woodgrain laminate where laminate is currently an option.

*Installation instruction sheets available on Knoll Exchange.

For Task Panels refer to reference number 6TP00085.

H8 Height: Top of double high overhead to top of 1" thick credenza top for 3/4 height cabinet.

Always supplied including cable curtain.

Always supplied including all trim pieces.

All trims supplied with the same finish specification.

LH & RH side full height trims. (no hi-lo trims)

Task Panels

H8 62³/₄" high

Segmented With Tool rail

Fabric Insert Above / Fabric Insert Below

description	th	w	y	pattern no.	grade								
					10	15	20	30	35	40	45	50	55
Task Panel, segmented	1 1/2"	30"	0.9	RTPRS30H8	\$1,654.	\$1,687.	\$1,722.	\$1,754.	\$1,806.	\$1,838.	\$1,881.	\$1,925.	\$1,969.
With tool rail	1 1/2"	36"	1.1	RTPRS36H8	1,755.	1,795.	1,835.	1,874.	1,931.	1,965.	2,010.	2,056.	2,104.
	1 1/2"	42"	1.3	RTPRS42H8	1,971.	2,018.	2,066.	2,114.	2,177.	2,215.	2,266.	2,319.	2,372.
	1 1/2"	48"	1.4	RTPRS48H8	2,001.	2,051.	2,102.	2,154.	2,217.	2,255.	2,307.	2,361.	2,415.

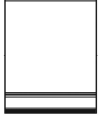

Order Code

Example:	RTPRS30H8 () ()
R	Reff
TP	Task Panel
N	No tool rail
M	Monolithic
30	Width
H8	62 ³ / ₄ " high
111	Trim finish
W281	Fabric selection top insert; 49"H
W281	Fabric selection bottom insert; 11"H

Specification Information

To order please specify pattern number including;

1. Trim Finish: Painted or Anodized
2. Top insert finish: Fabric
3. Bottom insert finish: Fabric

Application Notes

It is Not advisable to mix 28³/₈"h desk height products with 26¹/₂" standard height products.

All Fabric to be applied railroaded as current tackboard.

Note: Need to "double the yardage", for this task panel; Fabric above, Fabric below.

Top insert = 48⁹/₁₆"H
Bottom insert = 10¹⁵/₃₂"H

*Installation instruction sheets available on Knoll Exchange.

For Task Panels refer to reference number 6TP00085

H8 Height: Top of double high overhead to top of 1" thick credenza top for 3/4 height cabinet.

Always supplied including cable curtain.

Always supplied including all trim pieces.

All trims supplied with the same finish specification.

LH & RH side full height trims. (no hi-lo trims)

Y = Yardage required

Task Panels

H8 62³/₄" high

Segmented With Tool rail

Marker board Insert Above / Fabric Insert Below

description	th	w	y	pattern no.	LW10	LW15	LW20	LW30	LW35	LW40	LW45	LW50	LW55
Task Panel, segmented	1 1/2"	30"	0.9	RTPRS30H8	\$1,726.	\$1,743.	\$1,758.	\$1,776.	\$1,817.	\$1,860.	\$1,902.	\$1,946.	\$1,992.
With tool rail	1 1/2"	36"	1.1	RTPRS36H8	1,833.	1,853.	1,871.	1,892.	1,938.	1,981.	2,027.	2,075.	2,122.
	1 1/2"	42"	1.3	RTPRS42H8	2,056.	2,080.	2,103.	2,127.	2,178.	2,229.	2,281.	2,333.	2,387.
	1 1/2"	48"	1.4	RTPRS48H8	2,090.	2,117.	2,140.	2,167.	2,218.	2,271.	2,323.	2,376.	2,430.



Order Code	Specification Information	Application Notes
Example: RTPRS30H8 () ()	To order please specify pattern number including:	It is Not advisable to mix 28³/₈"h desk height products with 26¹/₂" standard height products.
R Reff	1. Trim Finish: Painted or Anodized	H8 Height: Top of double high overhead to top of 1" thick credenza top for 3/4 height cabinet.
TP Task Panel	2. Top insert finish: Marker board	Always supplied including cable curtain.
R Tool rail	3. Bottom insert finish: Fabric	Always supplied including all trim pieces.
S Segmented		All trims supplied with the same finish specification.
30 Width		LH & RH side full height trims. (no hi-lo trims)
H8 62 ³ / ₄ " high		
111 Trim finish		
LW Marker board top insert; 49"H		
W281 Fabric selection bottom insert; 11"H		

Y = Yardage required

Task Panels

H8 62³/₄" high

Segmented With Tool rail

Glass or Fabric Insert Above / Forbo, Laminate or Wood Below

description	th	w	y	pattern no.	G/FORB	FAB/FORB	FAB/L	FAB/V1	FAB/V2	FAB/V3
Task Panel, segmented	1 1/2"	30"	0.9	RTPRS30H8	\$2,479.	\$1,699.	\$1,693.	\$1,767.	\$1,809.	\$1,891.
With tool rail	1 1/2"	36"	1.1	RTPRS36H8	2,771.	1,823.	1,792.	1,866.	1,914.	2,013.
	1 1/2"	42"	1.3	RTPRS42H8	3,178.	2,066.	2,013.	2,087.	2,139.	2,254.
	1 1/2"	48"	1.4	RTPRS48H8	3,413.	2,124.	2,043.	2,150.	2,209.	2,339.



Order Code

Example:	RTPRS30H8 () ()
R	Reff
TP	Task Panel
R	Tool rail
S	Segmentated
30	Width
H8	62 ³ / ₄ " high
111	Trim finish
W281	Fabric selection top insert; 49"H
V319	Veneer selection bottom insert; 11"H

Specification Information

To order please specify pattern number including:

1. Trim Finish: Painted or Anodized
2. Top insert finish: Glass or Fabric
3. Bottom insert finish: Forbo, L, V1, V2, V3

Application Notes

It is Not advisable to mix 28³/₈"h desk height products with 26¹/₂" standard height products.

Product on this page **Excluding any vertical surface over 60"**, will accept woodgrain laminate where laminate is currently an option.

All Fabric to be applied railroaded as current tackboard.

Top insert = 48⁹/₁₆"H
Bottom insert = 10¹⁵/₃₂"H

*Installation instruction sheets available on Knoll Exchange.

For Task Panels refer to reference number 6TP00085.

H8 Height: Top of double high overhead to top of 1" thick credenza top for 3/4 height cabinet.

Always supplied including cable curtain.

Always supplied including all trim pieces.

All trims supplied with the same finish specification.

LH & RH side full height trims. (no hi-lo trims)

Y = Yardage required

Tackboards
H1 23 1/8" high
Wall applied, fabric

description	w	y	pattern no.	grade								
				10	15	20	30	35	40	45	50	55
Tackboard, wall hung	30"	1.0	RWHDHTB30H1()	\$285.	\$313.	\$341.	\$370.	\$375.	\$380.	\$385.	\$423.	\$459.
	36"	1.1	RWHDHTB36H1()	303.	335.	366.	397.	403.	409.	416.	455.	496.
	42"	1.3	RWHDHTB42H1()	334.	371.	406.	444.	451.	457.	465.	513.	560.
	48"	1.5	RWHDHTB48H1()	364.	405.	447.	489.	498.	506.	515.	569.	623.
	54"	1.6	RWHDHTB54H1()	382.	427.	474.	518.	527.	536.	545.	604.	660.
	60"	1.8	RWHDHTB60H1()	412.	462.	514.	564.	575.	585.	595.	660.	724.
	66"	1.9	RWHDHTB66H1()	433.	486.	538.	592.	604.	613.	625.	693.	761.
	72"	2.1	RWHDHTB72H1()	462.	523.	581.	640.	651.	663.	674.	750.	825.
	78"	2.3	RWHDHTB78H1()	491.	557.	620.	686.	699.	711.	724.	807.	888.
	84"	2.5	RWHDHTB84H1()	523.	592.	662.	732.	747.	761.	775.	864.	953.
	90"	2.6	RWHDHTB90H1()	540.	613.	687.	759.	774.	790.	805.	898.	988.
	96"	2.8	RWHDHTB96H1()	571.	649.	729.	808.	823.	837.	855.	954.	1,052.

Order Code	Specification Information	Application Notes
Example: RWHDHTB30H1()	To order please specify pattern number including: 1. Finish: Fabric	It is Not advisable to mix 28 3/8" h desk height products with 26 1/2" standard height products. All Fabric to be applied railroaded as current tackboard. Tackboards are 1" thick.
R Reff		
WH Wall hung		
DH Desk height planning		
TB Tackboard		
30 Width		
H1 23 1/8" high		
W281 Fabric selection	H1 Height: Underside of overhead to top 1 1/2" thick desk height worksurface. Always supplied including a U-channel for cord escape. U-channel is placed in the center of the width of tackboard. Always supplied including Velcro for attachment.	

Y = Yardage required

Tackboards
H2 29³/₄" high
Wall applied, fabric

description	w	y	pattern no.	grade								
				10	15	20	30	35	40	45	50	55
Tackboard , wall hung	30"	1.0	RWHDHTB30H2()	\$301.	\$328.	\$356.	\$381.	\$387.	\$394.	\$399.	\$436.	\$474.
	36"	1.1	RWHDHTB36H2()	324.	354.	382.	414.	420.	425.	433.	474.	511.
	42"	1.3	RWHDHTB42H2()	357.	393.	426.	462.	470.	478.	484.	532.	579.
	48"	1.5	RWHDHTB48H2()	390.	431.	472.	510.	521.	528.	536.	590.	645.
	54"	1.6	RWHDHTB54H2()	412.	455.	498.	542.	551.	560.	568.	627.	685.
	60"	1.8	RWHDHTB60H2()	445.	494.	542.	591.	602.	611.	621.	687.	750.
	66"	1.9	RWHDHTB66H2()	468.	519.	569.	621.	633.	643.	655.	722.	789.
	72"	2.1	RWHDHTB72H2()	500.	558.	613.	670.	684.	695.	707.	781.	856.
	78"	2.3	RWHDHTB78H2()	533.	596.	658.	720.	735.	746.	759.	841.	923.
	84"	2.5	RWHDHTB84H2()	565.	634.	701.	770.	783.	797.	812.	901.	988.
	90"	2.6	RWHDHTB90H2()	589.	660.	729.	800.	815.	829.	846.	936.	1,028.
	96"	2.8	RWHDHTB96H2()	621.	698.	773.	850.	864.	882.	898.	995.	1,094.

Order Code	Specification Information	Application Notes
Example: RWHDHTB30H2()	To order please specify pattern number including: 1. Finish: Fabric	It is Not advisable to mix 28³/₄"h desk height products with 26¹/₂" standard height products. All Fabric to be applied railroded as current tackboard. Tackboards are 1" thick.
R Reff		
WH Wall hung		
DH Desk height planning		
TB Tackboard		
30 Width		
H2 29 ³ / ₄ " high		
W281 Fabric selection	H2 Height = Underside of overhead to top of 1" thick credenza top for 3/4 height cabinets. Always supplied including a U-channel for cord escape. U-channel is placed in the center of the width of tackboard. Always supplied including Velcro for attachment.	

Y = Yardage required

Tackboards
H3 37⁷/₈" high
Wall applied, fabric

description	w	y	pattern no.	grade								
				10	15	20	30	35	40	45	50	55
Tackboard , wall hung	30"	1.0	RWHDHTB30H3()	\$317.	\$343.	\$372.	\$399.	\$404.	\$410.	\$416.	\$452.	\$488.
	36"	1.1	RWHDHTB36H3()	342.	373.	402.	433.	439.	445.	451.	491.	531.
	42"	1.3	RWHDHTB42H3()	378.	414.	449.	484.	491.	498.	506.	554.	601.
	48"	1.5	RWHDHTB48H3()	416.	455.	496.	536.	545.	554.	562.	616.	669.
	54"	1.6	RWHDHTB54H3()	441.	484.	527.	569.	580.	589.	598.	656.	712.
	60"	1.8	RWHDHTB60H3()	478.	526.	575.	622.	633.	644.	655.	719.	781.
	66"	1.9	RWHDHTB66H3()	501.	554.	605.	657.	667.	677.	689.	755.	823.
	72"	2.1	RWHDHTB72H3()	538.	596.	651.	689.	700.	711.	723.	819.	892.
	78"	2.3	RWHDHTB78H3()	575.	638.	699.	762.	775.	787.	801.	882.	962.
	84"	2.5	RWHDHTB84H3()	611.	678.	747.	815.	828.	844.	857.	944.	1,033.
	90"	2.6	RWHDHTB90H3()	637.	707.	776.	848.	861.	876.	891.	983.	1,074.
	96"	2.8	RWHDHTB96H3()	672.	748.	824.	900.	915.	932.	947.	1,046.	1,144.

Order Code	Specification Information	Application Notes
Example: RWHDHTB30H3()	To order please specify pattern number including:	It is Not advisable to mix 28³/₈"h desk height products with 26¹/₂" standard height products.
R Reff	1. Finish: Fabric	H3 Height = Top of U-shelf or L-shelf overhead to top of 1 ¹ / ₂ " thick desk height worksurface.
WH Wall hung		Always supplied including a U-channel for cord escape.
DH Desk height planning		U-channel is placed in the center of the width of tackboard.
TB Tackboard		Always supplied including Velcro for attachment.
30 Width		
H3 37 ⁷ / ₈ " high		
W281 Fabric selection		

Y = Yardage required

Tackboards
H4 44 1/2" high
Wall applied, fabric

description	w	y	pattern no.	grade								
				10	15	20	30	35	40	45	50	55
Tackboard , wall hung	30"	1.0	RWHDHTB30H4()	\$330.	\$358.	\$384.	\$412.	\$418.	\$423.	\$428.	\$465.	\$502.
	36"	1.1	RWHDHTB36H4()	359.	388.	418.	448.	454.	459.	468.	506.	545.
	42"	1.3	RWHDHTB42H4()	398.	433.	469.	502.	510.	518.	526.	572.	618.
	48"	1.5	RWHDHTB48H4()	436.	477.	518.	558.	566.	575.	584.	638.	691.
	54"	1.6	RWHDHTB54H4()	464.	508.	551.	595.	604.	612.	621.	678.	736.
	60"	1.8	RWHDHTB60H4()	502.	551.	601.	648.	659.	669.	681.	744.	807.
	66"	1.9	RWHDHTB66H4()	531.	583.	634.	686.	697.	707.	718.	784.	853.
	72"	2.1	RWHDHTB72H4()	569.	628.	684.	741.	752.	764.	776.	851.	924.
	78"	2.3	RWHDHTB78H4()	609.	670.	735.	795.	809.	822.	834.	915.	995.
	84"	2.5	RWHDHTB84H4()	647.	714.	782.	851.	864.	878.	892.	981.	1,068.
	90"	2.6	RWHDHTB90H4()	674.	746.	817.	887.	902.	917.	932.	1,023.	1,113.
	96"	2.8	RWHDHTB96H4()	713.	790.	864.	940.	957.	974.	988.	1,087.	1,184.

Order Code	Specification Information	Application Notes
Example: RWHDHTB30H4()	To order please specify pattern number including;	It is Not advisable to mix 28 3/8" h desk height products with 26 1/2" standard height products.
R Reff	1. Finish: Fabric	H4 Height = Top of U-shelf or L-shelf overhead to top of 1" thick credenza top for 3/4" height cabinet.
WH Wall hung		Always supplied including a U-channel for cord escape.
DH Desk height planning		U-channel is placed in the center of the width of tackboard.
TB Tackboard		Always supplied including Velcro for attachment.
30 Width		
H4 44 1/2" high		
W281 Fabric selection		

Y = Yardage required

Tackboards
H5 42⁵/₈" high
Wall applied, fabric

description	w	y	pattern no.	grade								
				10	15	20	30	35	40	45	50	55
Tackboard , wall hung	30"	1.0	RWHDHTB30H5()	\$327.	\$354.	\$380.	\$408.	\$414.	\$420.	\$425.	\$462.	\$498.
	36"	1.1	RWHDHTB36H5()	356.	383.	415.	444.	450.	455.	462.	502.	542.
	42"	1.3	RWHDHTB42H5()	393.	426.	462.	497.	505.	511.	521.	566.	613.
	48"	1.5	RWHDHTB48H5()	431.	472.	511.	552.	561.	568.	578.	632.	686.
	54"	1.6	RWHDHTB54H5()	457.	501.	544.	588.	597.	606.	614.	671.	728.
	60"	1.8	RWHDHTB60H5()	495.	544.	592.	642.	651.	662.	671.	737.	800.
	66"	1.9	RWHDHTB66H5()	524.	575.	625.	675.	688.	699.	710.	777.	845.
	72"	2.1	RWHDHTB72H5()	561.	618.	673.	731.	744.	754.	768.	842.	915.
	78"	2.3	RWHDHTB78H5()	599.	661.	723.	784.	798.	811.	824.	906.	986.
	84"	2.5	RWHDHTB84H5()	638.	704.	773.	841.	855.	868.	883.	971.	1,058.
	90"	2.6	RWHDHTB90H5()	664.	736.	806.	875.	890.	905.	920.	1,012.	1,101.
	96"	2.8	RWHDHTB96H5()	703.	778.	855.	930.	944.	962.	978.	1,075.	1,174.

Order Code	Specification Information	Application Notes
Example: RWHDHTB30H5()	To order please specify pattern number including: 1. Finish: Fabric	It is Not advisable to mix 28³/₈"h desk height products with 26¹/₂" standard height products. All Fabric to be applied railroaded as current tackboard. Tackboards are 1" thick.
R Reff		
WH Wall hung		
DH Desk height planning		
TB Tackboard		
30 Width		
H5 42 ⁵ / ₈ " high		
W281 Fabric selection	H5 Height = Top of Single high overhead to top of 1 1/2" thick desk height worksurface. Always supplied including a U-channel for cord escape. U-channel is placed in the center of the width of tackboard. Always supplied including Velcro for attachment.	

Y = Yardage required

Reff Screens

Reff screens provide partial enclosure for workspaces to a nominal horizon of 42"—seated visual access—or 49"—seated visual privacy. Screens are available in a variety of surface finishes for aesthetics, performance and price point.

Desk Mounted Screens

Desk mounted screens provide enclosure both above and below the top, starting from either 9 3/8" or 21 7/8" above the floor for 26 1/2" high planning and from either 11 1/4" or 23 3/4" above the floor for 28 3/8" high planning. Desk mounted screens attach directly to the back of a desk top with two brackets that also define a 1 1/4" offset for wire management and clamp-on accessories. Bracket centers are located 3 1/4" from each end of screens 24"-30" wide and 12" from each end of screens 36" and wider.

Screens are available in the following widths 24", 27", 30", and 36"-72" wide in 6" increments. In most applications screens can be mounted to matching width or wider tops.

Two types of screens are available:

- Frameless laminate, marker surface or veneer screens are 3/4" thick with matching edge and crisp, eased corners.
- Fabric screens are 1 1/4" thick, with painted perimeter frame capturing a wood structural core and tackable, fabric wrapped inserts on each face.

Specification Options

For frameless screens surface type: laminate (L) or veneer (V); specify finish, any core laminate or dry-erase marker surface (M), or any core Techwood or natural veneer. Also specify bracket color, in any Reff Profiles core paint finish.

For fabric screens specify fabric, perimeter frame and brackets painted finishes. Fabric is oriented railroad style for screens wider than 60".

Bracket and frame paint finish codes with suffix "T" indicate textured.

Construction

Frameless screens are 3/4" MDF construction, with threaded inserts at bracket locations.

Fabric screens have a 1/2" MDF core, with 3/8" thick tackable PET material inserts on each side wrapped in fabric, and aluminum perimeter frame with seamless corners. Fabric screens have threaded metal inserts at bracket locations.

Laminate screens are edged with color matching ABS edgeband. Marker surface screens are edged with White ABS edgeband. Veneer screens are edged with matching veneer.

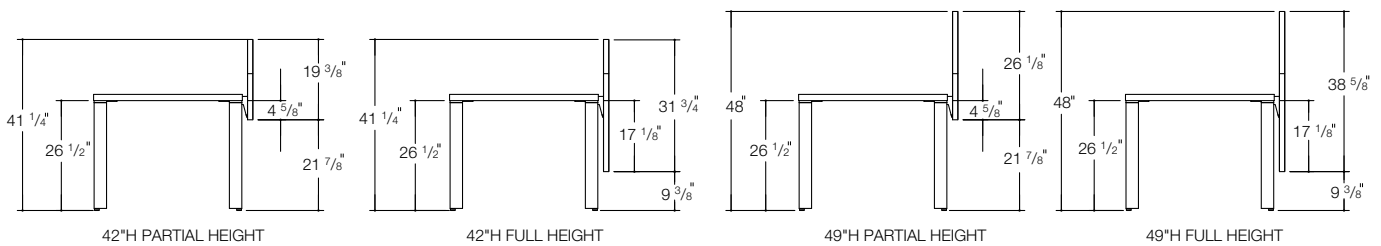
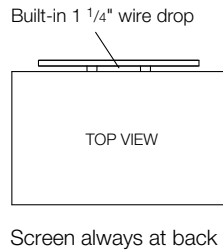

For applications with work surface 26 1/2" off the floor

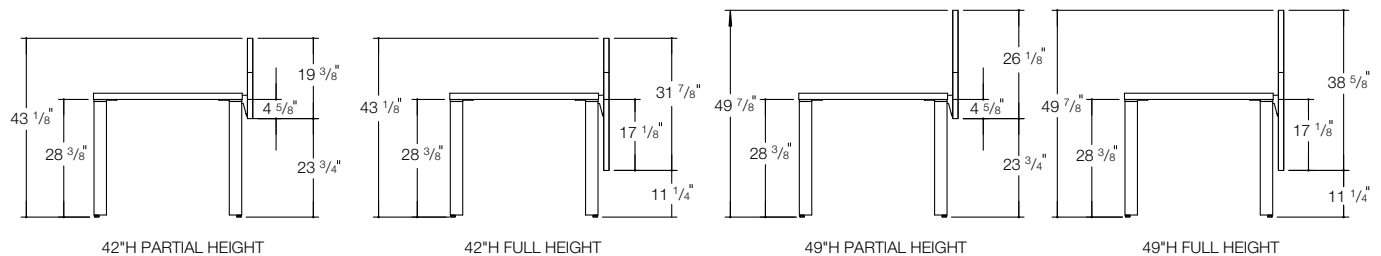

For applications with work surface 28 3/8" off the floor

Desk Screens
Fabric
 For 42" High Horizon

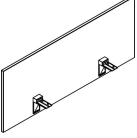
description	w	d	h	pattern no.	10	20	30	40	45
Fabric Screens with Partial Modesty For Desks, 42" High Horizon 	24"	1 1/4"	20"	YPSB2024F	\$638.	\$670.	\$703.	\$734.	\$765.
	27"	1 1/4"	20"	YPSB2027F	657.	688.	721.	754.	787.
	30"	1 1/4"	20"	YPSB2030F	674.	709.	742.	776.	809.
	36"	1 1/4"	20"	YPSB2036F	751.	788.	826.	863.	900.
	42"	1 1/4"	20"	YPSB2042F	780.	819.	857.	897.	936.
	48"	1 1/4"	20"	YPSB2048F	803.	844.	884.	924.	964.
	54"	1 1/4"	20"	YPSB2054F	863.	906.	948.	993.	1,035.
	60"	1 1/4"	20"	YPSB2060F	916.	962.	1,008.	1,054.	1,099.
	66"	1 1/4"	20"	YPSB2066FRR	958.	1,006.	1,054.	1,101.	1,148.
72"	1 1/4"	20"	YPSB2072FRR	987.	1,036.	1,087.	1,134.	1,185.	

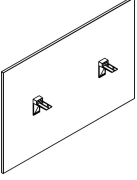
description	w	d	h	pattern no.	10	20	30	40	45
Fabric Screens with Half Modesty For Desks, 42" High Horizon 	24"	1 1/4"	32"	YPSB3224F	740.	776.	813.	850.	887.
	27"	1 1/4"	32"	YPSB3227F	792.	832.	871.	912.	949.
	30"	1 1/4"	32"	YPSB3230F	816.	856.	897.	938.	979.
	36"	1 1/4"	32"	YPSB3236F	922.	968.	1,014.	1,060.	1,105.
	42"	1 1/4"	32"	YPSB3242F	975.	1,024.	1,072.	1,122.	1,170.
	48"	1 1/4"	32"	YPSB3248F	981.	1,030.	1,079.	1,129.	1,177.
	54"	1 1/4"	32"	YPSB3254F	1,063.	1,117.	1,170.	1,223.	1,276.
	60"	1 1/4"	32"	YPSB3260F	1,152.	1,211.	1,268.	1,325.	1,382.
	66"	1 1/4"	32"	YPSB3266FRR	1,311.	1,378.	1,443.	1,509.	1,574.
	72"	1 1/4"	32"	YPSB3272FRR	1,382.	1,452.	1,521.	1,590.	1,658.

Ordering Information

Desk Screens

1. Pattern Number
2. Inside Fabric Finish
3. Outside Fabric Finish
4. Frame Paint Finish
5. Bracket Paint Finish

Order Code

Desk Screens

Example: **YPSB2048F, W351, 118T, 118T**

YPSB	Desk Screen
20	Height
48	Width
F	Fabric
W351	Foundation
W351	Foundation
118T	Bright White Paint
118T	Bright White Paint

Included With

Desk Screens
 Brackets
 Hardware

Options

Desk Screens

The price of screens specified with a combination of fabrics is the higher of the two fabric grades.

(RR) Fabric is applied railroaded

Desk Screens
Fabric
 For 49" High Horizon

description	w	d	h	pattern no.	10	20	30	40	45
Fabric Screens with Partial Modesty For Desks, 49" High Horizon	24"	1 1/4"	26"	YPSB2624F	\$697.	\$732.	\$766.	\$802.	\$836.
	27"	1 1/4"	26"	YPSB2627F	726.	762.	800.	835.	872.
	30"	1 1/4"	26"	YPSB2630F	745.	783.	819.	856.	894.
	36"	1 1/4"	26"	YPSB2636F	833.	874.	917.	959.	1,000.
	42"	1 1/4"	26"	YPSB2642F	874.	918.	962.	1,006.	1,051.
	48"	1 1/4"	26"	YPSB2648F	939.	987.	1,033.	1,080.	1,128.
	54"	1 1/4"	26"	YPSB2654F	1,005.	1,056.	1,104.	1,155.	1,207.
	60"	1 1/4"	26"	YPSB2660F	1,048.	1,098.	1,151.	1,204.	1,256.
	66"	1 1/4"	26"	YPSB2666FRR	1,094.	1,147.	1,204.	1,258.	1,311.
	72"	1 1/4"	26"	YPSB2672FRR	1,141.	1,196.	1,256.	1,311.	1,369.
Fabric Screens with Half Modesty For Desks, 49" High Horizon	24"	1 1/4"	38"	YPSB3824F	798.	838.	878.	917.	958.
	27"	1 1/4"	38"	YPSB3827F	856.	899.	942.	986.	1,028.
	30"	1 1/4"	38"	YPSB3830F	880.	924.	969.	1,012.	1,057.
	36"	1 1/4"	38"	YPSB3836F	1,005.	1,056.	1,104.	1,155.	1,207.
	42"	1 1/4"	38"	YPSB3842F	1,063.	1,117.	1,170.	1,223.	1,276.
	48"	1 1/4"	38"	YPSB3848F	1,146.	1,206.	1,261.	1,317.	1,376.
	54"	1 1/4"	38"	YPSB3854F	1,207.	1,266.	1,326.	1,385.	1,446.
	60"	1 1/4"	38"	YPSB3860F	1,270.	1,335.	1,398.	1,462.	1,524.
	66"	1 1/4"	38"	YPSB3866FRR	1,424.	1,495.	1,567.	1,638.	1,708.
	72"	1 1/4"	38"	YPSB3872FRR	1,501.	1,577.	1,651.	1,726.	1,803.

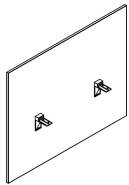
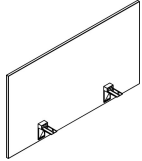

Ordering Information

Desk Screens

1. Pattern Number
2. Inside Fabric Finish
3. Outside Fabric Finish
4. Frame Paint Finish
5. Bracket Paint Finish

Order Code

Desk Screens

Example: **YPSB2648F, W351, 118T, 118T**

YPSB	Desk Screen
26	Height
48	Width
F	Fabric
W351	Foundation
W351	Foundation
118T	Bright White Paint
118T	Bright White Paint

Included With

Desk Screens
 Brackets
 Hardware

Options

Desk Screens

The price of screens specified with a combination of fabrics is the higher of the two fabric grades.

(RR) Fabric is applied railroaded

Desk Screens
Laminate, Markerboard or Veneer
For 42" High Horizon

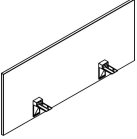
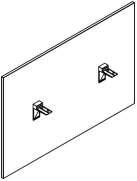
description	w	d	h	pattern no.	Laminate (L)	Markerboard (LM)	V1 (V)	V2 (V)	V3 (V)
Screens with Partial Modesty For Desks, 42" High Horizon 	24"	3/4"	20"	YPSB2024()	\$261.	\$451.	\$501.	\$576.	\$749.
	30"	3/4"	20"	YPSB2030()	268.	458.	522.	600.	782.
	36"	3/4"	20"	YPSB2036()	301.	579.	545.	626.	816.
	42"	3/4"	20"	YPSB2042()	307.	584.	586.	673.	874.
	48"	3/4"	20"	YPSB2048()	397.	935.	613.	705.	914.
	54"	3/4"	20"	YPSB2054()	405.	941.	634.	730.	948.
	60"	3/4"	20"	YPSB2060()	410.	947.	686.	789.	1,027.
	66"	3/4"	20"	YPSB2066()	417.	955.	717.	825.	1,071.
	72"	3/4"	20"	YPSB2072()	423.	961.	741.	851.	1,104.
Screens with Half Modesty For Desks, 42" High Horizon 	24"	3/4"	32"	YPSB3224()	293.	692.	582.	668.	870.
	27"	3/4"	32"	YPSB3227()	299.	697.	606.	698.	909.
	30"	3/4"	32"	YPSB3230()	340.	703.	625.	719.	935.
	36"	3/4"	32"	YPSB3236()	400.	938.	662.	760.	989.
	42"	3/4"	32"	YPSB3242()	410.	947.	725.	834.	1,086.
	48"	3/4"	32"	YPSB3248()	432.	1,643.	760.	874.	1,138.
	54"	3/4"	32"	YPSB3254()	440.	1,651.	803.	924.	1,202.
	60"	3/4"	32"	YPSB3260()	600.	1,657.	887.	1,019.	1,325.
	66"	3/4"	32"	YPSB3266()	613.	1,667.	930.	1,068.	1,388.
	72"	3/4"	32"	YPSB3272()	621.	1,679.	964.	1,107.	1,442.

Ordering Information

- Desk Screens**
1. Pattern Number
2. Surface Finish
3. Bracket Paint Finish

Order Code

Desk Screens
Example: **YPSB2048V, V316, 118T**
YPSB Desk Screen
20 Height
48 Width
V Veneer
V316 Maple
118T Bright White Paint

Included With

Desk Screens
Brackets
Hardware

Options

Desk Screens
Finish Options:
(L)= Laminate
(LM)= Markerboard
(V)= Veneer

Desk Screens

Laminate, Markerboard or Veneer

For 49" High Horizon

description	w	d	h	pattern no.	Laminate (L)	Markerboard (LM)	V1 (V)	V2 (V)	V3 (V)
Screens with Partial Modesty For Desks, 49" High Horizon	24"	3/4"	26"	YPSB2624()	\$285.	\$685.	\$555.	\$639.	\$831.
	27"	3/4"	26"	YPSB2627()	289.	690.	569.	656.	852.
	30"	3/4"	26"	YPSB2630()	294.	693.	593.	683.	888.
	36"	3/4"	26"	YPSB2636()	302.	703.	623.	716.	932.
	42"	3/4"	26"	YPSB2642()	346.	711.	675.	776.	1,008.
	48"	3/4"	26"	YPSB2648()	379.	1,629.	712.	819.	1,064.
	54"	3/4"	26"	YPSB2654()	386.	1,638.	742.	851.	1,106.
	60"	3/4"	26"	YPSB2660()	408.	1,644.	825.	948.	1,232.
	66"	3/4"	26"	YPSB2666()	416.	1,653.	854.	982.	1,277.
	72"	3/4"	26"	YPSB2672()	534.	1,658.	884.	1,017.	1,321.

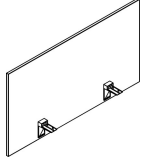

Screens with Half Modesty For Desks, 49" High Horizon	24"	3/4"	38"	YPSB3824()	339.	703.	621.	714.	928.
	27"	3/4"	38"	YPSB3827()	344.	708.	642.	740.	960.
	30"	3/4"	38"	YPSB3830()	348.	713.	663.	761.	990.
	36"	3/4"	38"	YPSB3836()	412.	948.	714.	820.	1,067.
	42"	3/4"	38"	YPSB3842()	425.	961.	785.	902.	1,174.
	48"	3/4"	38"	YPSB3848()	528.	1,654.	827.	951.	1,236.
	54"	3/4"	38"	YPSB3854()	541.	1,666.	877.	1,008.	1,310.
	60"	3/4"	38"	YPSB3860()	621.	1,679.	989.	1,137.	1,478.
	66"	3/4"	38"	YPSB3866()	631.	1,690.	1,038.	1,194.	1,553.
	72"	3/4"	38"	YPSB3872()	643.	1,701.	1,082.	1,243.	1,616.

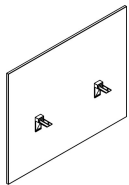

Ordering Information

Desk Screens

1. Pattern Number
2. Surface Finish
3. Bracket Paint Finish

Order Code

Desk Screens

Example: **YPSB2648V, V316, 118T**

YPSB Desk Screen

26 Height

48 Width

V Veneer

V316 Maple

118T Bright White Paint

Included With

Desk Screens

Brackets
Hardware

Options

Desk Screens

Finish Options:

(L)= Laminate
(LM)= Markerboard
(V)= Veneer

J-Wire Troughs are available in two types, Wall Mount & Under Mount. Wall mount J-wire troughs may be attached to both architectural walls and fixed modesty panels. Under mount J-wire troughs may be attached directly under worksurfaces.

Both types are available in 6" increments, in lengths ranging from 24" to 72". Troughs are 3" high by 3" deep. They are constructed of 18-gauge cold rolled steel. Wall mount is available in black. Under mount is available in all Reff Profiles core paint finishes.

Application notes:

Wires may run along the length of the trough and may exit at the trough ends or over the open front of the trough at any point. Under mount troughs also have a 1 1/2" diameter, U-shaped mouse hole for wire entry/exit.

Wall mount J-wire troughs are attached to a vertical surface such as a full modesty panel, suspended modesty panel, or architectural wall. Refer to Figure 1 and 2.

Fasteners are not included with wall mount J-wire troughs. Attachment fasteners should be selected with consideration given to the vertical surface's material type and thickness. Care should be taken so that screws will not protrude through or damage the visitor side of a modesty panel.

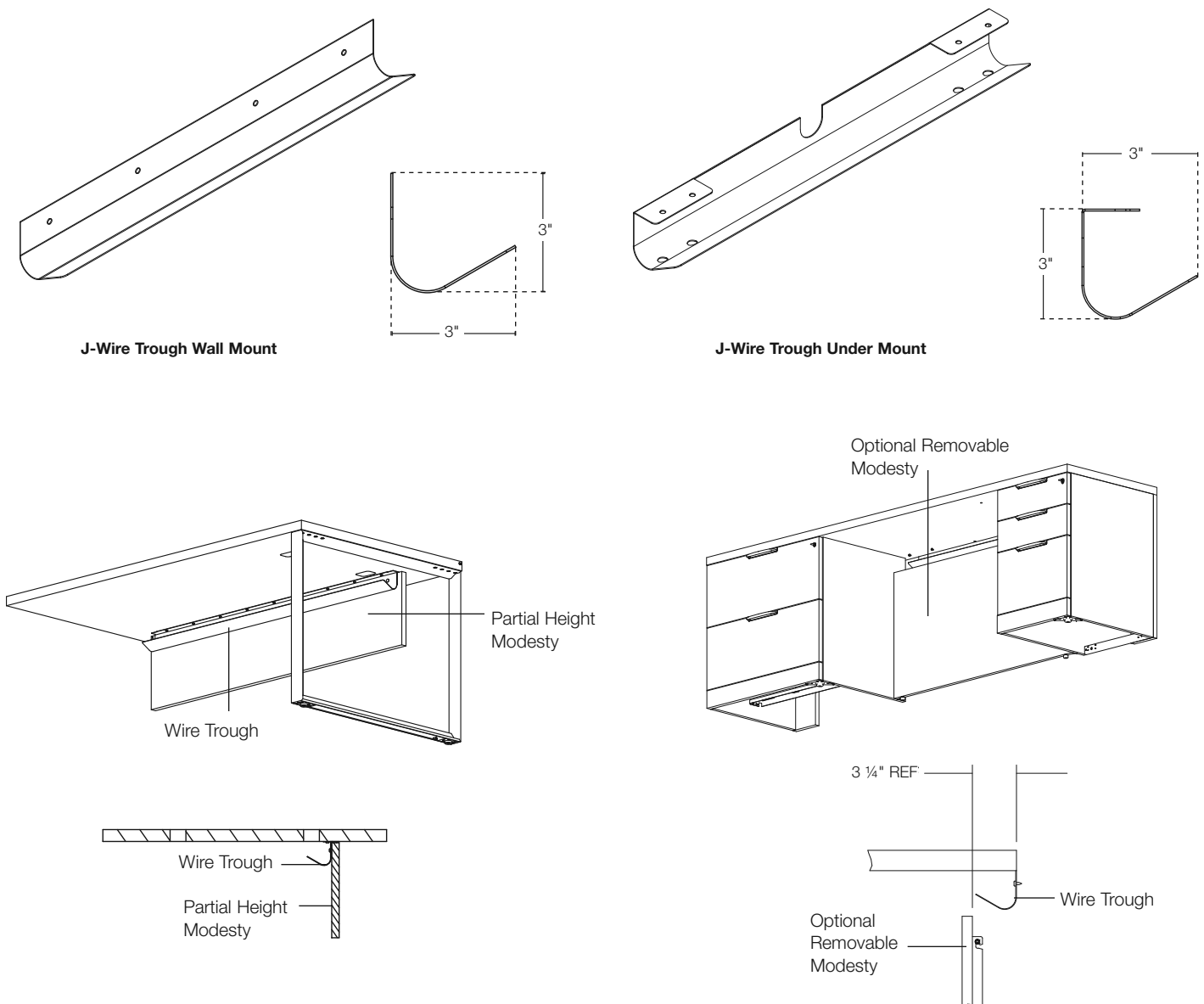

Figure 1: Partial Height Modesty Applications

Figure 2: Wire Trough Wall Mounted Applications

Under mount J-wire troughs have two tabs at the top that allow them to be attached to the underside of a worksurface. Wood screws are included with under mount J-wire troughs.

Under mount J-wire troughs are designed to work with worksurfaces specified with flush, recessed, edge or no grommets. When edge grommets are specified, the trough is attached

with the opening towards the wall which will enable the ability to run wires anywhere along the opening in the worksurface while still allowing the ability to run wires through the grommet of the wire manager. Refer to Figure 5.

Under mount J-wire troughs may be specified when a desk screen (i.e. Antenna) is to be used as a modesty panel. Refer to Figure 6.

The width of the J-wire trough should be specified so that the trough spans and falls beneath grommet locations, but does not interfere with leg or pedestal positions. (i.e. A 72" w double letter-wide pedestal desk with flush grommets would be get a 36" trough.) Refer to Figure 3 and 4.

Wire troughs may not be used to stiffen a worksurface.

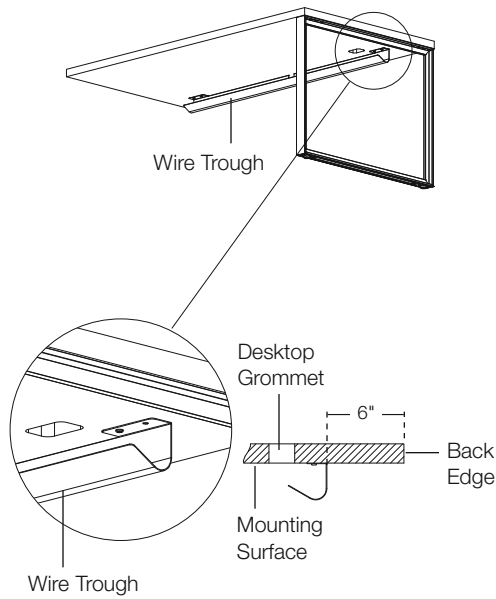

Figure 3: Peninsula

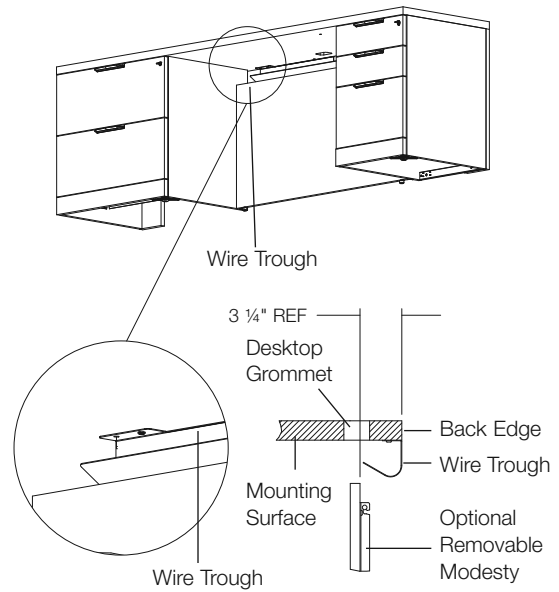

Figure 4: Top with Desktop Grommet

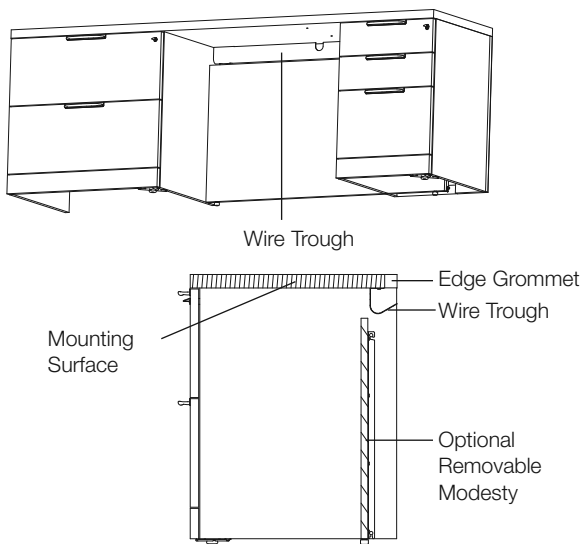

Figure 5: Top with Edge Grommet

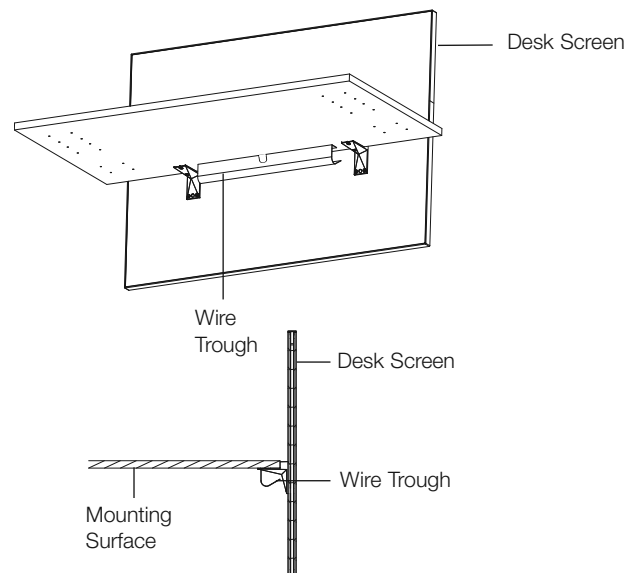

Figure 6: Desk Screen

The wire manager for credenza may be specified for use with a 1" or 1 1/2" thick credenza top with edge grommet. Wires, transformers, or personal accessory chargers may then be pushed off the worksurface, but will not drop all the way to the floor.

The wire manager for credenza top is 24" wide, 1" high and 1 1/4" deep, and will fit any standard width credenza top with edge grommet. It is constructed of 24-gauge cold rolled steel and is available in black.

Application notes:

The wire manager for credenza is intended to be mounted to the inside edge of the edge grommet. Wires may run along the length of the trough, exiting at the trough ends between the trough and the un-notched portion of the worksurface top.

Note: There will be a visible black lip (approx. 1/8" wide) at the edge of the worksurface where the wire manager is mounted.

For installation, wood screws and double sided tape are included with the wire manager.

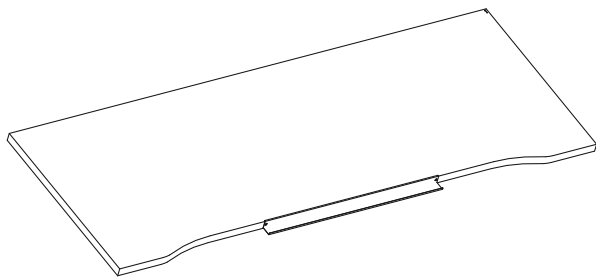

Application of Wire Manager for Credenza Top

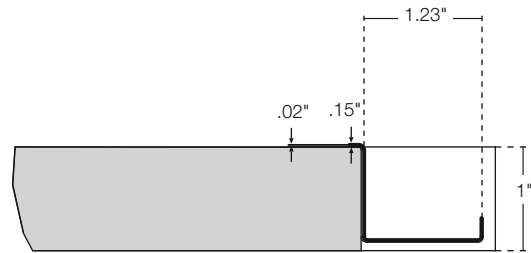

Wire Manager Dimensions

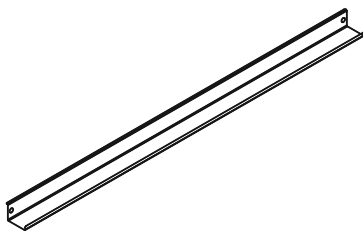

Wire Manager

Power and Data Outlets

Power and Data Outlets are available in a variety of configurations for use with worksurfaces, peninsulas and tables.

The electrical accessories make power and data taps more accessible to the end user.

All Power and Data Accessories are ordered separately from the furniture elements which they support.

These accessories are offered in a variety of configurations consisting of simplex receptacles, double USB charging ports and blank spaces which may be used to field install data outlets. The Power and Data Outlets are available in either 4 position wide or 6 position wide configurations. See **Figure 1** and **Figure 2** for available configurations.

Power and Data Accessories come in the following forms:

- Electrical component for Peninsula Power Center
- Electrical component for Peninsula Simple Stand-off - Drop-in
- Electrical component - Clamp-on
- Electrical component for Tables - Drop-in
- Electrical component for Tables - Edge Mounted
- Electrical Component for Tables - Power Center

See **Figure 4** for available configuration options for each of these Power and Data Accessories.

General Notes

Simplex outlets and USB charging ports are wired together and on the same circuit. All units have a 15 Amp overall rating. The double USB charging ports share a total of 2 Amps. All units are available with choice of 72" or 120" long cordset or 72" long hardwire cord. The 72" or 120" long cordsets have a standard 3 prong plug on units with 3 or fewer simplex receptacles.

Units configured with more than 3 simplex receptacles come with a Circuit Breaker cordset. See **Figure 3** for dimensions. This applies to the following configurations:

- 4P
- 4P+2D
- 4P+1U+1D
- 6P

The 72" long hardwire cord is 3/4" diameter flexible metal conduit with pigtails for direct connection to building power.

Connection option selected must comply with local and/or national electrical code.

Power and data outlets are UL certified.

All power and data outlets are available in either white or black color options. The finish color refers to the face and bezel of the units only. The cord sets are always black. The body of the units is clear anodized aluminum. Bands of clear anodized aluminum appear on the face of the outlets just above and below the receptacles.

Data jacks are not available through Knoll and must be coordinated and provided by a communications equipment supplier. Jack adapters are provided with the Power and Data Outlets to accept various types of connections. Refer to the 'Jack Adapter Options' in this section.

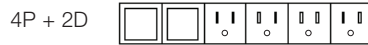
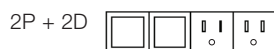

Figure 1: 4 position units

Figure 2: 6 position units

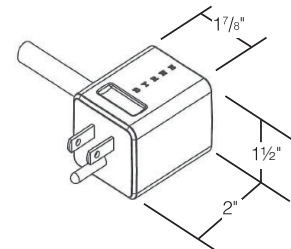
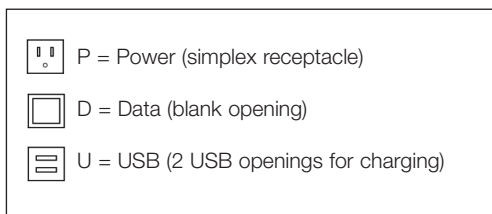

Figure 3: Circuit Breaker Cordset

Electrical Components for:	4 Position Units					6 Position Units				
	2P+2D	2P+1U+1D	3P+1U	3P+1D	4P	3P+3D	3P+1U+1D	4P+2P	4P+1U+1D	6P
Peninsula Power Center	✓	✓	✓	✓	✓					
Peninsula Simple Stand-off - Drop-in						✓	✓	✓	✓	✓
Clamp-on	✓	✓	✓	✓	✓	✓	✓	✓	✓	✓
Tables - Drop-in	✓	✓	✓		✓	✓	✓	✓	✓	✓
Tables - Edge Mounted	✓	✓	✓	✓	✓	✓	✓	✓	✓	✓
Tables - Power Center	✓	✓	✓	✓	✓					

Figure 4: Application Options

Desktop Outlet for Peninsula Power Center Stand-off

The Desktop Outlet for Peninsula Power Center Stand-off works in conjunction with the Power Center Stand-off and the Power Center Grommet to bring electrical receptacles and data outlets to the worksurface. The Power Center Standoff and Power Center are included with a Peninsula top when specified. See **Figure 6**.

Refer to **Figure 4** for available configurations. Note that this electrical unit is only available in 4 position configurations.

The width of a 4 position unit fits within the power center stand off cavity and attaches to the sides of the stand-off with regular screws provided with the unit. Refer to **Figure 5**. Refer to power center standoff Installation instruction 6TP0081 on Knoll Exchange.

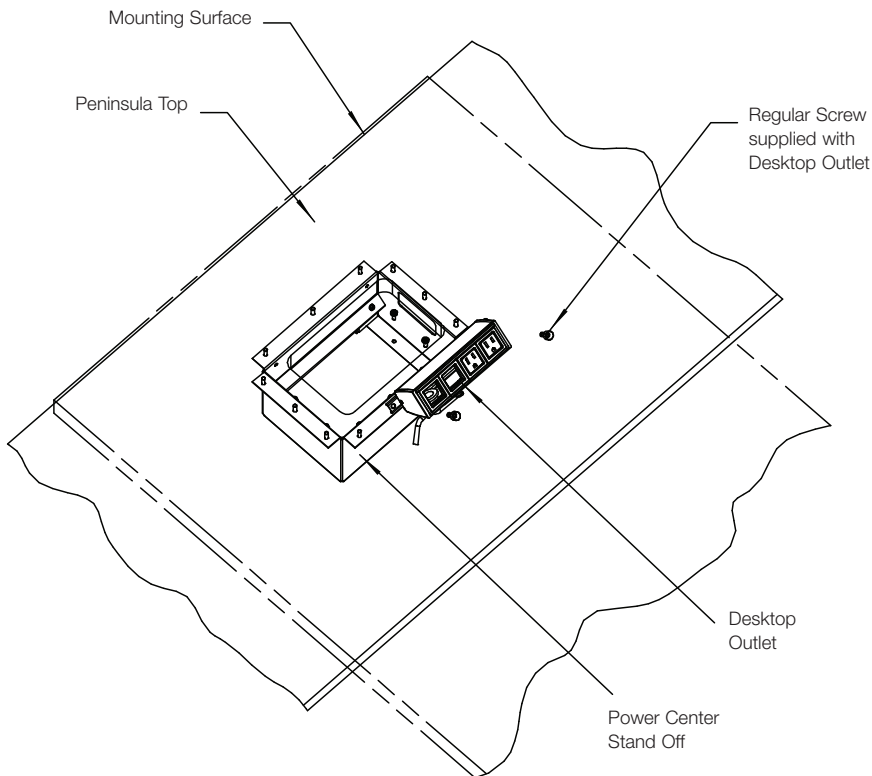

Figure 5

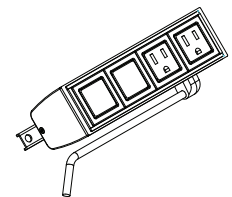

Figure 6: Desktop Outlet for Power Center Stand-off (2P+2D shown)

Clamp-on Electrical Component

The Clamp-on Electrical Outlet brings electrical and data receptacles to worksurface height without needing to field install grommets. See **Figure 9**. The Clamp-on Electrical Outlet is available in 4 position units and 6 position units. Refer to **Figure 4** for configurations.

This component may be utilized on any worksurface, up to 1 1/2" thick where power and data access is desired. See **Figure 10**.

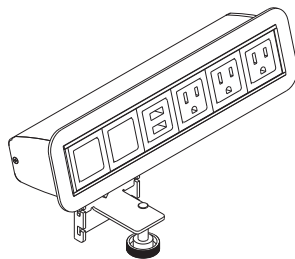

Figure 9: Clamp on Electrical Component (3P+1U+2D shown)

Electrical Component for Tables - Drop-in

The Drop-in Electrical Outlet for Tables works in conjunction with Tables with 4x4 Legs and Tables with 2x4 Legs to bring electrical receptacles and data outlets directly to the worksurface and flush to the worksurface.

This Drop-in Electrical Outlet is offered with 10 possible configurations. Refer to **Figure 4** for configurations.

The cut-out is provided when specified with a Table with 2 x 4 legs or a Table with 4 x 4 legs. **Figure 12**

The grommet hole is 2 1/8" wide x 6 13/16" long for 4 position outlets and 2 1/8" wide x 9 13/16" long for 6 position outlets.

To use this product in other applications, special tops must be ordered with the required cut-out to suit.

This component may be utilized on worksurfaces up to 1 1/2" thick.

Refer to Drop-In Electrical for Tables installation instruction 6TP00388.

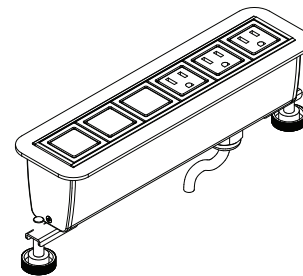

Figure 11: Electrical Component for Tables - Drop-in (3P+3D shown)

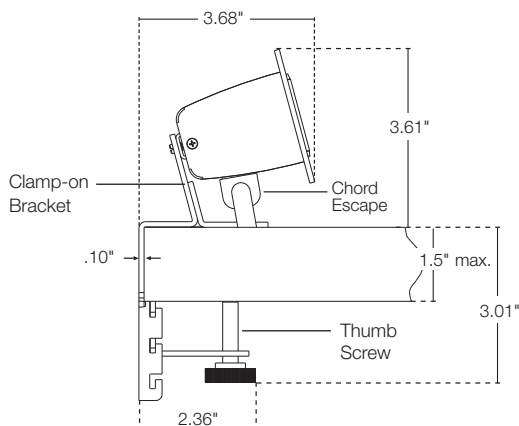

Figure 10: Clamp on Electrical Component Side

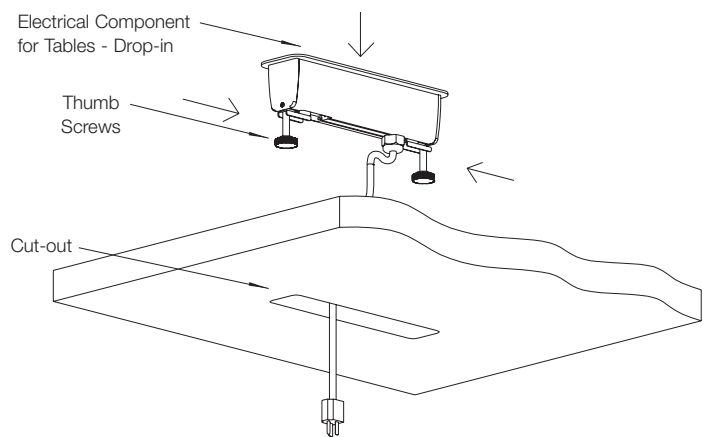

Figure 12: Electrical Component for Tables - Drop-in

Electrical Component for Tables – Power Center

This electrical component (**Figure 15**) mounts to the underside of a worksurface and is used when a Table with 2x4 Legs or a Table with 4x4 Legs is specified with a power center grommet option. This unit presents the face of the electrical receptacles and data outlet(s) to the user at a convenient 45 degree angle for ease of plug insertion and is available in 4 position wide sizes only.

Refer to **Figure 4** for available configurations for this unit.

The Electrical Component for Tables – Power Center mounts adjacent to the power center cut-out (**Figure 16**) and is retained to the worksurface using a single bracket and associated hardware included with the unit for one power center. When a table is specified with several power centers, the equivalent number of electrical components will be required.

Refer to Electrical Component for Tables – Power Center installation instruction 6TP00473 available on Knoll Exchange.

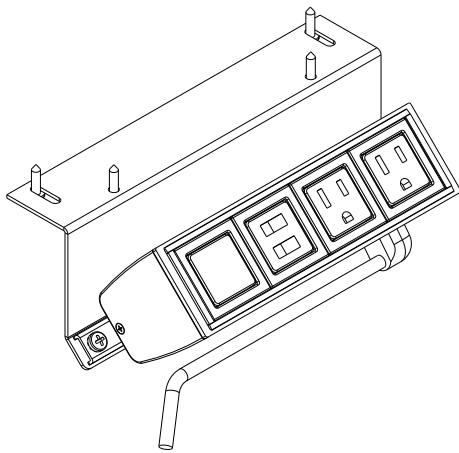

Figure 15: Electrical Component for Tables – Power Center (3P+1U shown)

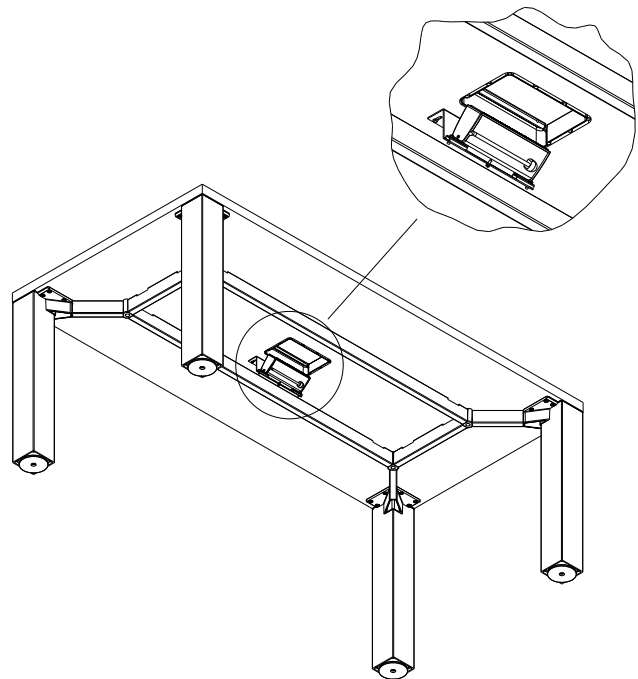

Figure 16: Image from below the table showing the electrical unit adjacent the grommet opening

Voice/Data Jack Adapter Options

Jack Adapters are required when the blank data port option is selected for the electrical outlet. One data jack adapter kit, shown in **Figure 1**, is included with each Electrical Outlet Unit.

The Jack Adapter kits are available separately in either white or black. The Voice/Data Jack Adapter kit has snap-off adapters for the jacks listed in **Figure 2**. (Example: Uniprise jack would use AA adapter).

Jacks are not included. UL Listed (DUXR) or Recognized (DUXR2) jacks required.

Give a copy of this page to your local Tele/Data contractor and /or Tele/Data installer.

Notes

Snap jack into adapter following the instructions provided with the jack.

Once assembled, snap adapter into the notched, square holes in electrical accessory data opening the orientation shown.

Verify fit of jack in adapter before ordering large quantities as manufacturer designs may change without notice.

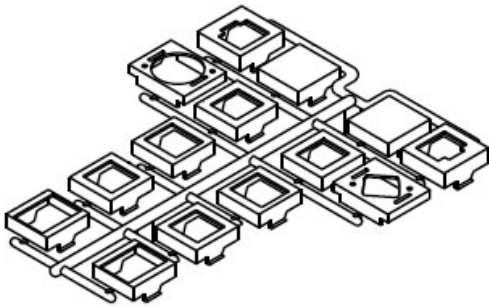

Figure 1: Voice/Data Jack Adapter Kit

Adapter	Manufacturer	Website
AA	Uniprise	www.UnipriseSolutions.com
BB	Tyco SL, and 110 Connect Series Modular Jacks	www.Ampconnect.com
BB	Siemon Keystone Style	www.Siemon.com
BB	Allen Tel Versa Tap Series	www.Allentel.com
BB	Leviton Quick Port	www.Leviton.com
BB	Nordx Keystone Style	www.Nordx.com
CC	Tyco SL Coupler Series	www.Ampconnect.com
CC	Krone 6000 Series	www.Adc.com
CC	Hubbell Xcelerator Keystone Series	www.Hubbell.com
DD	Blank (no coupler/jack)	
EE	Ortronics TracJack Series	www.Ortronics.com
FF	Panduit Mini-Com Series	www.Panduit.com
GG	Microphone jack/3-pin XLR, solder type only	
HH	Video Monitor jack/DB-15, panel mount solder style	

Figure 2: Jack Adapter Options

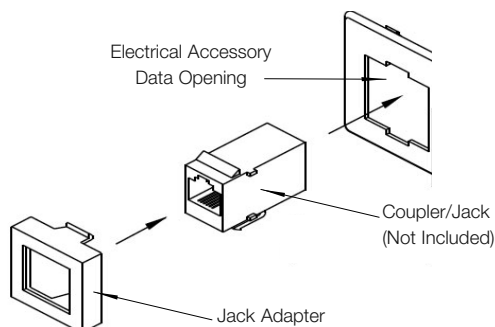

Figure 3: Jack Adapter Installation

HDMI Connector Cable

The HDMI Connector Cable provides a convenient HDMI plug-in to connect between any Desktop Electrical Outlet and a remote display.

The HDMI connector cable is an 18" long female-female HDMI cable which fits into an available blank data opening in any Desktop Electrical Outlet. A standard male-male HDMI cable (supplied by others) is required to complete the connection between the HDMI Connector Cable and the output device. An HDMI patch cable (supplied by others) is required to connect between the input device (typically a computer) and the Desktop Electrical Outlet.

The HDMI cable is black. The coupler face is available in black or white options and is included with the cable kit. See **Figures 1 and 2.**

The HDMI coupler face fits into the CC Jack Adapter provided with the Voice-Data Adapter kit included with the Desktop Electrical Outlet. When installed, the coupler face is oriented vertically. See **Figure 3.**

Refer to installation instruction 6TP00471 available on Knoll Exchange.

Stereo Connector Cable

The Stereo Connector Cable provides a convenient audio plug-in to connect between a Desktop Electrical Outlet and an output device (typically a video monitor).

The Stereo connector cable is a 120" long, male-female cable with 3.5mm mini audio jack and coupler. It comes with its own face plate to fit into an available blank data opening in a Desktop Electrical Outlet. A patch cord (supplied by others) is required to connect between the input device and the Desktop Electrical Outlet.

The cable is black. The face plate is available in black or white options. See **Figure 4.**

VGA Connector Cable

The VGA Connector Cable provides a convenient plug-in to a Desktop Electrical Outlet to connect between a VGA enabled device and a remote display.

The VGA connector cable is a 120" long male-female 15-pin VGA cable which fits into an available blank data opening in any Desktop Electrical Outlet. See **Figure 5.** A VGA patch cord (supplied by others) is required to connect between the input device and the Desktop Electrical Outlet.

The VGA connector cable attaches to the HH Jack Adapter provided with the Voice-Data Adapter kit included with the Desktop Electrical Outlet. When installed, the VGA plug-in is oriented diagonally. See **Figure 6.**

Refer to installation instruction 6TP00472 available on Knoll Exchange.



Figure 1: Black option



Figure 3: Coupler orientation



Figure 5: VGA Connector Cable



Figure 2: White option

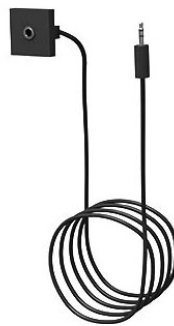

Figure 4: Stereo Connector Cable



Figure 5: VGA coupler orientation

Simple Stand Off

Simple Stand Offs provide support for 1 1/2" thick worksurface tops mounted to low credenzas or 3/4 height storage cabinets with a 1" top. The simple standoff is included when specified with peninsula tops.

Simple Stand Off assemblies are 2 1/4" deep, 12" wide, and 5 1/32" high. They are constructed of 16 gauge cold rolled steel and are available in all core painted finishes for 28 3/8" high planning.

The Simple Stand Off comes with the stand off weldment, mounting bracket, mounting hardware and round grommet. Refer to figure 13.

Application notes:

The Simple Stand Off must be permanently and securely affixed to the underside of a worksurface and also to whatever support unit it rests upon.

The Simple Stand Off is designed to support a top without additional worksurface supported storage such as hutches or desktop towers for example.

To access the cavity of the Simple Stand Off, a special top must be ordered with the appropriate cut-out for a Drop-In Electrical Component or Desktop Grommet which must be specified separately and field installed.

Refer to 6TP00305 for Installation Instructions

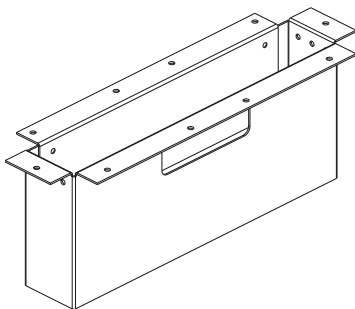

Figure 13: Simple Stand Off

Stand Off for Power Center

Stand Offs for Power Center provide support for 1 1/2" thick worksurface tops mounted to low credenzas or 3/4 height storage cabinets with a 1" top while also providing opportunity for wire management and power/data capabilities. The power center standoff is included when specified with peninsula tops.

Power Center Stand Off assemblies are 6 3/8" deep, 9 1/4" wide, and 5 1/32" high. They are constructed of 16-gauge cold rolled steel and are available in all core painted finishes for 28 3/8" high planning.

Application notes:

The Power Center Stand Off is designed to support a top without additional worksurface supported storage mounted upon it, such as hutches or desktop towers for example.

The Power Center Stand Off must be permanently and securely affixed to the underside of a worksurface and also to whatever support unit it rests upon.

To access the cavity of the Stand Off for Power Center, a special top must be ordered with the appropriate cut-out for a Power Center Grommet which must be specified separately and field installed.

When power and data capability is desired for use with this unit, the Desktop Outlet electrical options must be specified separately. Refer to figure 14.

A 1 3/4" round grommet is included for field drilling of cable route from the power center standoff through the lower storage element.

Refer to 6TP00081 for Installation Instructions.

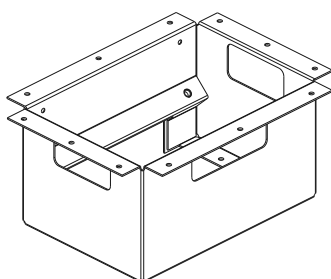

Figure 14: Stand Off for Power Center

Power Center Grommet

The Power Center Grommet must be specified when utilizing a stand-off for power center. The grommet trims the opening in the peninsula top that allows access into the stand-off for power center. It includes an attached, hinged lid. Refer to figure 15.

Power Center Grommets are 8" wide x 5" deep and are available in all core painted and plated finishes for 28 3/8" high planning.

The Power Center Grommet is included when specified with a peninsula top.

To utilize the Power Center Grommet, special tops must be ordered with the required cut out pre-drilled to suit.

Grommets

Desktop Grommets are included with certain worksurfaces when specified. Desktop grommets may be ordered separately, if desired, for field installation.

To use this product in non-standard applications, special tops must be ordered with the required cut-out pre-drilled to suit.

The Desktop Grommet includes a grommet sleeve and lid. The grommet sleeve is 2" deep x 3" wide with a 1/8" flange all round which sits 1/16" above the finished worksurface. The outside to outside dimension of the flange is 2 1/4" deep and 3 1/4" wide. The grommet lid sits inside the sleeve and is flush with the top of the sleeve. Refer to figure 16.

Desktop Grommets are available in all core painted and plated finishes for 28 3/8" high planning.

Application notes:

Desktop Grommets are available for use in 1", 1 1/4" and 1 1/2" thick worksurfaces. Care should be taken to specify the grommet appropriate for the worksurface's thickness.

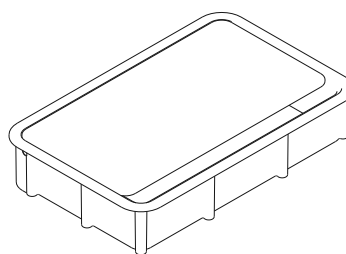

Figure 15: Power Center Grommet

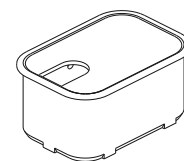







Figure 16: Grommet

Accessories
 Power and Data
 Electrical Components - Peninsula Power Center

description	type	w	d	h	pattern no.	list
Desktop Outlet - 4 Units wide Power Center stand off - 2 power / 2 data 	72" cord				RDTE2272(B/W)	\$383.
	120" cord				RDTE22120(B/W)	413.
	72" hardwire				RDTE22H(B/W)	441.
Desktop Outlet - 4 Units wide Power Center stand off - 2 power / 2 double USB 	72" cord				RDTE2U72(B/W)	586.
	120" cord				RDTE2U120(B/W)	605.
	72" hardwire				RDTE2UH(B/W)	669.
Desktop Outlet - 4 Units wide Power Center stand off - 3 power / 1 data 	72" cord				RDTE3172(B/W)	463.
	120" cord				RDTE31120(B/W)	482.
	72" hardwire				RDTE31H(B/W)	546.
Desktop Outlet - 4 Units wide Power Center stand off - 3 power / 1 double USB 	72" cord				RDTE31U72(B/W)	609.
	120" cord				RDTE31U120(B/W)	627.
	72" hardwire				RDTE31UH(B/W)	692.
Desktop Outlet - 4 Units wide Power Center stand off - 4 power 	72" cord				RDTE4072(B/W)	589.
	120" cord				RDTE40120(B/W)	608.
	72" hardwire				RDTE40H(B/W)	672.

Order Code	Specification Information	Application Notes
Example: RDTE2272 (B/W)	To order please specify pattern number including: 1. Color: B=Black Unit with black bezel has clear anodized extruded body W = White Units with white bezel has clear anodized extruded body. White is complimentary, not an exact match	Installation instruction sheet available on Knoll Exchange.
R Reff		
DT Desktop Outlet		
E Power Center Electrical		
2 2 Power outlets, 3 = 3 Power outlets		
2 Blank/Data, 1=1 Blank/Data, U=1 double USB		Refer to planning guide pages for complete description.
72 72" cord, 120 = 120" cord, H = 72" Hardwire	USB outlet is for recharging purposes only. No data transfer. All Desktop outlets are UL listed.	
B Black, W = White	Simlexes and USB charging ports are wired together and on the same circuit.	

Power and Data

Electrical components for Peninsula Simple stand off - Drop-In

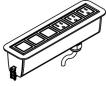
description	type	w	d	h	pattern no.	list
Electrical component for Simple Stand-Off - 6 units wide Drop-In - 3 power / 3 data 	72" cord				RDTSTE3372(B/W)	\$621.
	120" cord				RDTSTE33120(B/W)	640.
	72" hardwire				RDTSTE33H(B/W)	704.

Electrical component for Simple Stand-Off - 6 units wide Drop-In - 3 power / 1 double USB / 2 data 	72" cord				RDTSTE3U72(B/W)	767.
	120" cord				RDTSTE3U120(B/W)	784.
	72" hardwire				RDTSTE3UH(B/W)	850.

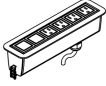
Electrical component for Simple Stand-Off - 6 units wide Drop-In - 4 power / 2 data 	72" cord				RDTSTE4272(B/W)	737.
	120" cord				RDTSTE42120(B/W)	755.
	72" hardwire				RDTSTE42H(B/W)	820.

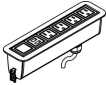
Electrical component for Simple Stand-Off - 6 units wide Drop-In - 4 power / 1 double USB / 1 data 	72" cord				RDTSTE4U72(B/W)	882.
	120" cord				RDTSTE4U120(B/W)	900.
	72" hardwire				RDTSTE4UH(B/W)	965.

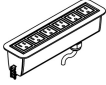
Electrical component for Simple Stand-Off - 6 units wide Drop-In - 6 power 	72" cord				RDTSTE6072(B/W)	820.
	120" cord				RDTSTE60120(B/W)	838.
	72" hardwire				RDTSTE60H(B/W)	903.

Order Code	Specification Information	Application Notes
Example: RDTSTE3372 (B/W)	<i>To order please specify pattern number including:</i>	Installation instruction sheet available on Knoll Exchange.
R Reff		
DT Desktop Outlet		
SET Stand off Electrical		For Power Center stand off, refer to Installation Instruction #6TP00081.
3 Electrical, 4 = 4 Power outlets, 6 = 6 Power outlets	1. Color: B=Black Unit with black bezel has clear anodized extruded body W = White Units with white bezel has clear anodized extruded body. White is complimentary, not an exact match	Refer to planning guide pages for complete description.
2 Blank/Data, 0 = 0 Blank/Data, 1=1 Blank/Data, U=1 double USB		USB outlet is for recharging purposes only. No data transfer. All Desktop outlets are UL listed.
72 72" cord, H = 72" Hardwire		Simlexes and USB charging ports are wired together and on the same circuit.
B Black, W = White		

Accessories
Power and Data
Electrical components - Clamp on

description	type	w	d	h	pattern no.	list
Electrical component with 4 units wide Clamp on - 2 power / 2 data	72" cord				RDTC2272(B/W)	\$462.
	120" cord				RDTC22120(B/W)	481.
	72" hardwire				RDTC22H(B/W)	545.



Electrical component with 4 units wide Clamp on - 2 power / 1 double USB / 1 data	72" cord				RDTC2U72(B/W)	608.
	120" cord				RDTC2U120(B/W)	626.
	72" hardwire				RDTC2UH(B/W)	691.



Electrical component with 4 units wide Clamp on - 3 power / 1 data	72" cord				RDTC3172(B/W)	486.
	120" cord				RDTC31120(B/W)	503.
	72" hardwire				RDTC31H(B/W)	569.



Electrical component with 4 units wide Clamp on - 3 power / 1 double USB	72" cord				RDTC31U72(B/W)	630.
	120" cord				RDTC31U120(B/W)	649.
	72" hardwire				RDTC31UH(B/W)	713.



Electrical component with 4 units wide Clamp on - 4 power	72" cord				RDTC4072(B/W)	611.
	120" cord				RDTC40120(B/W)	629.
	72" hardwire				RDTC40H(B/W)	694.



Order Code	Specification Information	Application Notes	
Example: RDTC2272 (B/W)	<i>To order please specify pattern number including:</i> 1. Color: B=Black Unit with black bezel has clear anodized extruded body W = White Units with white bezel has clear anodized extruded body. White is complimentary, not an exact match	Installation instruction sheet available on Knoll Exchange.	
R Reff			Refer to planning guide pages for complete description.
DT Desktop Outlet		USB outlet is for recharging purposes only. No data transfer. All Desktop outlets are UL listed.	
CE Clamp on Electrical			
2 2 Power outlets, 3 = 3 Power outlets 4=4 Power outlets, 6 = 6 Power outlets			
2 Blank/Data, 0=0 Blank/Data,1=1 Blank/Data, 3=3 Blank/Data,U=1 double USB			
72 72" cord, 120 = 120" cord, H = 72" Hardwire			
B Black, W = White			

Accessories
Power and Data
Electrical components - Clamp on

description	type	w	d	h	pattern no.	list
Electrical component with 6 units wide Clamp on - 3 power / 3 data	72" cord				RDTCCE3372(B/W)	\$591.
	120" cord				RDTCCE33120(B/W)	609.
	72" hardwire				RDTCCE33H(B/W)	674.

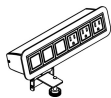

3 + 3 shown

Electrical component with 6 units wide Clamp on - 3 power / 1 double USB / 2 data	72" cord				RDTCCE3U72(B/W)	736.
	120" cord				RDTCCE3U120(B/W)	754.
	72" hardwire				RDTCCE3UH(B/W)	819.

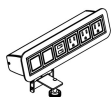

3 + USB + 2 Blank Shown

Electrical component with 6 units wide Clamp on - power / 2 data	72" cord				RDTCCE4272(B/W)	705.
	120" cord				RDTCCE42120(B/W)	724.
	72" hardwire				RDTCCE42H(B/W)	788.

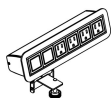

Electrical component with 6 units wide Clamp on - 4 power / 1 double USB / 1 data	72" cord				RDTCCE4U72(B/W)	852.
	120" cord				RDTCCE4U120(B/W)	870.
	72" hardwire				RDTCCE4UH(B/W)	934.

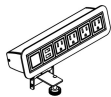



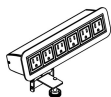

Electrical component with 6 units wide Clamp on - 6 power	72" cord				RDTCCE6072(B/W)	790.
	120" cord				RDTCCE60120(B/W)	809.
	72" hardwire				RDTCCE60H(B/W)	873.



Order Code	Specification Information	Application Notes
Example: RDTCCE2272 (B/W)	<i>To order please specify pattern number including:</i>	Installation instruction sheet available on Knoll Exchange.
R Ref		
DT Desktop Outlet		Refer to planning guide pages for complete description.
CE Clamp on Electrical		USB outlet is for recharging purposes only. No data transfer. All Desktop outlets are UL listed.
2 2 Power outlets, 3 = 3 Power outlets 4=4 Power outlets, 6 = 6 Power outlets	1. Color: B=Black Unit with black bezel has clear anodized extruded body W = White Units with white bezel has clear anodized extruded body. White is complimentary, not an exact match	Simlexes and USB charging ports are wired together and on the same circuit.
2 Blank/Data, 0=0 Blank/Data,1=1 Blank/Data, 3=3 Blank/Data,U=1 double USB		
72 72" cord, 120 = 120" cord, H = 72" Hardwire		
B Black, W = White		

Accessories
Power and Data
Electrical components for Tables - Drop in

description	type	w	d	h	pattern no.	list
Electrical component for Table - 4 Unit wide Drop-In - 2 power / 2 data 	72" cord				RDDE2272(B/W)	\$462.
	120" cord				RDDE22120(B/W)	481.
	72" hardwire				RDDE22H(B/W)	545.
Electrical component for Table - 4 Unit wide Drop-In - 2 power / 1 double USB / 1 data 	72" cord				RDDE2U72(B/W)	608.
	120" cord				RDDE2U120(B/W)	626.
	72" hardwire				RDDE2UH(B/W)	691.
Electrical component for Table - 4 Unit wide Drop-In - 3 power / 1 double USB 	72" cord				RDDE31U72(B/W)	630.
	120" cord				RDDE31U120(B/W)	649.
	72" hardwire				RDDE31UH(B/W)	713.
Electrical component for Table - 4 Unit wide Drop-In - 4 powers 	72" cord				RDDE4072(B/W)	611.
	120" cord				RDDE40120(B/W)	629.
	72" hardwire				RDDE40H(B/W)	694.

Order Code	Specification Information	Application Notes
Example: RDDE2272 (B/W)	<i>To order please specify pattern number including:</i>	Installation instruction sheet available on Knoll Exchange.
R Ref		
DT Desktop Outlet		
DE Drop in Electrical		
2 Power outlets, 3 = 3 Power outlets, 4 = 4 Power outlets, 6 = 6 Power outlets	1. Color: B=Black Unit with black bezel has clear anodized extruded body W = White Units with white bezel has clear anodized extruded body. White is complimentary, not an exact match	For Electrical components for Table Drop-in, refer to Installation Instruction #6TP00388. Refer to planning guide pages for complete description.
2 Blank/Data, 0 = 0 Blank/Data, 1 = 1 Blank/Data, 3 = 3 Blank/Data, U = 1 double USB		USB outlet is for recharging purposes only. No data transfer. All Desktop outlets are UL listed.
72 72" cord, 120 = 120" cord, H = Hardwire		Simplex and USB charging ports are wired together and on the same circuit.
B Black, W = White		

*Power and Data**Electrical components for Tables - Drop in*

description	type	w	d	h	pattern no.	list
Electrical component for Table - 6 unit wide Drop-In - 3 power / 3 data	72" cord				RDTDE3372(B/W)	\$591.
	120" cord				RDTDE33120(B/W)	609.
	72" hardwire				RDTDE33H(B/W)	674.



Electrical component for Table - 6 unit wide Drop-In - 3 power / 1 double USB / 2 data	72" cord				RDTDE3U72(B/W)	736.
	120" cord				RDTDE3U120(B/W)	754.
	72" hardwire				RDTDE3UH(B/W)	819.



Electrical component for Table - 6 unit wide Drop-In - 4 power / 2 data	72" cord				RDTDE4272(B/W)	706.
	120" cord				RDTDE42120(B/W)	725.
	72" hardwire				RDTDE42H(B/W)	789.



Electrical component for Table - 6 unit wide Drop-In - 4 power / 1 double USB / 1 data	72" cord				RDTDE4U72(B/W)	852.
	120" cord				RDTDE4U120(B/W)	870.
	72" hardwire				RDTDE4UH(B/W)	935.



Electrical component for Table - 6 unit wide Drop-In - 6 powers	72" cord				RDTDE6072(B/W)	790.
	120" cord				RDTDE60120(B/W)	809.
	72" hardwire				RDTDE60H(B/W)	873.





Order Code	Specification Information	Application Notes
Example: RDTDE2272 (B/W)	<i>To order please specify pattern number including:</i> 1. Color: B=Black Unit with black bezel has clear anodized extruded body W = White Units with white bezel has clear anodized extruded body. White is complimentary, not an exact match3	Installation instruction sheet available on Knoll Exchange.
R Reff		
DT Desktop Outlet		For Electrical components for Table Drop-in, refer to part number 6TP00388.
DE Drop in Electrical		Refer to planning guide pages for complete description.
2 Power outlets, 3 = 3 Power outlets, 4 = 4 Power outlets, 6 = 6 Power outlets		USB outlet is for recharging purposes only. No data transfer. All Desktop outlets are UL listed.
2 Blank/Data, 0 = 0 Blank/Data, 1 = 1 Blank/Data, 3 = 3 Blank/Data, U = 1 double USB		Simplexes and USB charging ports are wired together and on the same circuit.
72 72" cord, 120 = 120" cord, H = Hardwire		
B Black, W = White		

Power and Data

Electrical Components for Table Edge - Under Mounted

description	type	w	d	h	pattern no.	list
Desktop Outlets for Table Edge - 4 unit wide Undermounted - 2 power / 2 data 	72" cord				RDTUME2272(B/W)	\$446.
	120" cord				RDTUME22120(B/W)	486.
	72" hardwire				RDTUME22H(B/W)	558.

Desktop Outlets for Table Edge - 4 unit wide Undermounted - 2 power / 1 double USB / 1 data 	72" cord				RDTUME2U72(B/W)	620.
	120" cord				RDTUME2U120(B/W)	638.
	72" hardwire				RDTUME2UH(B/W)	702.

Desktop Outlets for Table Edge - 4 unit wide Undermounted - 3 power / 1 data 	72" cord				RDTUME3172(B/W)	497.
	120" cord				RDTUME31120(B/W)	516.
	72" hardwire				RDTUME31H(B/W)	580.

Desktop Outlets for Table Edge - 4 unit wide Undermounted - 3 power / 1 double USB 	72" cord				RDTUME31U72(B/W)	643.
	120" cord				RDTUME31U120(B/W)	661.
	72" hardwire				RDTUME31UH(B/W)	726.

Desktop Outlets for Table Edge - 4 unit wide Undermounted - 4 powers 	72" cord				RDTUME4072(B/W)	623.
	120" cord				RDTUME40120(B/W)	641.
	72" hardwire				RDTUME40H(B/W)	706.

Order Code	Specification Information	Application Notes
Example: RDTUM2272 (B/W)	<i>To order please specify pattern number including:</i>	Installation instruction sheet available on Knoll Exchange.
R Reff		
DT Desktop Outlet	1. Color: B=Black Unit with black bezel has clear anodized extruded body W = White Units with white bezel has clear anodized extruded body. White is complimentary, not an exact match.	For Desktop Outlet for Tables - Undermounted, refer to Installation Instruction #6TP00439.
UME Undermounted Electrical, Edge		
2 Power outlets, 3 = 3 Power outlets, 4 = 4 Power outlets, 6 = 6 Power outlets		Refer to planning guide pages for complete description.
2 Blank/Data, 0 = 0 Blank/Data, 1 = 1 Blank/Data, 3 = 3 Blank/Data, U = 1 double USB		USB outlet is for recharging purposes only. No data transfer. All Desktop outlets are UL listed.
72 72" cord, 120 = 120" cord, H = Hardwire		Simplexes and USB charging ports are wired together and on the same circuit.
B Black, W = White		

Power and Data

Electrical Components for Table Edge - Under Mounted

description	type	w	d	h	pattern no.	list
Desktop Outlets for Table Edge - 6 unit wide Undermounted - 3 power / 3 data	72" cord				RDTUME3372(B/W)	\$597.
	120" cord				RDTUME33120(B/W)	614.
	72" hardwire				RDTUME33H(B/W)	679.

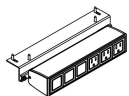

Desktop Outlets for Table Edge - 6 unit wide Undermounted - 3 power / 1 double USB / 2 data	72" cord				RDTUME3U72(B/W)	741.
	120" cord				RDTUME3U120(B/W)	760.
	72" hardwire				RDTUME3UH(B/W)	824.

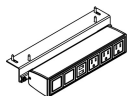

Desktop Outlets for Table Edge - 6 unit wide Undermounted - 4 power / 2 data	72" cord				RDTUME4272(B/W)	711.
	120" cord				RDTUME42120(B/W)	730.
	72" hardwire				RDTUME42H(B/W)	794.

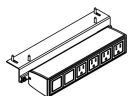

Desktop Outlets for Table Edge - 6 unit wide Undermounted - 4 power / 1 double USB / 1 data	72" cord				RDTUME4U72(B/W)	857.
	120" cord				RDTUME4U120(B/W)	875.
	72" hardwire				RDTUME4UH(B/W)	940.

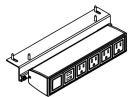

Desktop Outlets for Table Edge - 6 unit wide Undermounted - 6 powers	72" cord				RDTUME6072(B/W)	795.
	120" cord				RDTUME60120(B/W)	814.
	72" hardwire				RDTUME60H(B/W)	878.

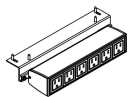

Order Code	Specification Information	Application Notes
Example: RDTUM2272 (B/W)	<p>To order please specify pattern number including:</p> <p>1. Color: B=Black Unit with black bezel has clear anodized extruded body W = White Units with white bezel has clear anodized extruded body. White is complimentary, not an exact match.</p>	<p>Installation instruction sheet available on Knoll Exchange.</p> <p>For Desktop Outlet for Tables - Undermounted, refer to Installation Instruction #6TP00439.</p> <p>Refer to planning guide pages for complete description.</p> <p>USB outlet is for recharging purposes only. No data transfer. All Desktop outlets are UL listed.</p> <p>Simplexes and USB charging ports are wired together and on the same circuit.</p>
R Reff		
DT Desktop Outlet		
UME Undermounted Electrical, Edge		
2 Power outlets, 3 = 3 Power outlets, 4 = 4 Power outlets, 6 = 6 Power outlets		
2 Blank/Data, 0 = 0 Blank/Data, 1 = 1 Blank/Data, 3 = 3 Blank/Data, U = 1 double USB		
72 72" cord, 120 = 120" cord, H = Hardwire		
B Black, W = White		

Power and Data

Electrical Components for Table Power Center - Under Mounted

description	type	pattern no.	list
Desktop Outlets for Table Power Center - 4 unit wide	72" cord	RDTUMP2272(B/W)	\$446.
Undermounted - 2 power / 2 data	120" cord	RDTUMP22120(B/W)	486.
	72" hardwire	RDTUMP22H(B/W)	558.

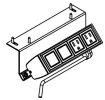

Desktop Outlets for Table Power Center - 4 unit wide	72" cord	RDTUMP2U72(B/W)	620.
Undermounted - 2 power / 1 double USB / 1 data	120" cord	RDTUMP2U120(B/W)	638.
	72" hardwire	RDTUMP2UH(B/W)	702.



Desktop Outlets for Table Power Center - 4 unit wide	72" cord	RDTUMP3172(B/W)	497.
Undermounted - 3 power / 1 data	120" cord	RDTUMP31120(B/W)	516.
	72" hardwire	RDTUMP31H(B/W)	580.

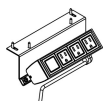

Desktop Outlets for Table Power Center - 4 unit wide	72" cord	RDTUMP31U72(B/W)	643.
Undermounted - 3 power / 1 double USB	120" cord	RDTUMP31U120(B/W)	661.
	72" hardwire	RDTUMP31UH(B/W)	726.



Order Code	Specification Information	Application Notes
Example: RDTUM2272 (B/W)	<i>To order please specify pattern number including:</i>	Installation instruction sheet available on Knoll Exchange.
R Reff		
DT Desktop Outlet	1. Color: B=Black Unit with black bezel has clear anodized extruded body W = White Units with white bezel has clear anodized extruded body. White is complimentary, not an exact match.	For Desktop Outlet for Tables Power Center - Undermounted, refer to Installation Instruction 6TP00473.
UMP Undermounted Electrical, Power Center		Refer to planning guide pages for complete description.
2 Power outlets, 3 = 3 Power outlets, 4 = 4 Power outlets, 6 = 6 Power outlets		USB outlet is for recharging purposes only. No data transfer. All Desktop outlets are UL listed.
2 Blank/Data, 0 = 0 Blank/Data, 1 = 1 Blank/Data, 3 = 3 Blank/Data, U = 1 double USB		Simplex and USB charging ports are wired together and on the same circuit.
72 72" cord, 120 = 120" cord, H = Hardwire		
B Black, W = White		

Power and Data

Electrical Components for Table Power Center - Under Mounted

description	type	pattern no.	list
Desktop Outlets for Table Power Center - 4 unit wide	72" cord	RDTUMP4072(B/W)	\$623.
Undermounted - 4 powers	120" cord	RDTUMP40120(B/W)	641.
	72" hardwire	RDTUMP40H(B/W)	706.



Order Code	Specification Information	Application Notes
Example: RDTUM2272 (B/W)	<i>To order please specify pattern number including:</i>	Installation instruction sheet available on Knoll Exchange.
R Reff		
DT Desktop Outlet	1. Color: B=Black Unit with black bezel has clear anodized extruded body W = White Units with white bezel has clear anodized extruded body. White is complimentary, not an exact match.	For Desktop Outlet for Tables Power Center - Undermounted, refer to Installation Instruction 6TP00473.
UMP Undermounted Electrical, Power Center		
2 Power outlets, 3 = 3 Power outlets, 4 = 4 Power outlets, 6 = 6 Power outlets	Refer to planning guide pages for complete description.	USB outlet is for recharging purposes only. No data transfer. All Desktop outlets are UL listed.
2 Blank/Data, 0 = 0 Blank/Data, 1 = 1 Blank/Data, 3 = 3 Blank/Data, U = 1 double USB		
72 72" cord, 120 = 120" cord, H = Hardwire		
B Black, W = White	Simplexes and USB charging ports are wired together and on the same circuit.	

Accessories
Power and Data
Desktop Outlet Accessories

description	pattern no.	list
Voice Data Adapter kit Includes 2 units per pack	RDAD(B/W)	\$24.

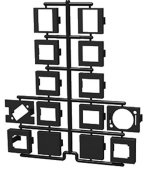

HDMI connector cable, 18", Includes one unit per pack	RDAH(B/W)	129.
--	------------------	------



Stereo connector cable, 120", Includes one unit per pack	RDAS(B/W)	49.
---	------------------	-----





VGA connector cable, 120", black Includes one unit per pack	RDAV	156.
--	-------------	------



Order Code	Specification Information	Application Notes
Example: RDAD		
R Reff	HDMI whip requires a standard HDMI cable to connect from the whip to the Monitor.	Installation instruction sheets available on Knoll Exchange.
D Desktop Outlet	VGA whip is 120" long, female-to-male cable to connect directly to a display. Device cable is not included.	For HDMI Connector Cable, refer to Installation Instruction #6TP00471.
A Electrical	Stereo whip is a 3.5mm audio jack with a 120" long black cable. This is a female-to-male connector.	For VGA Connector Cable, refer to reference number 6TP00472.
D Voice Data Adapter kit, (H-HDMI whip; 5 = Stereo whip; V = VGA whip)	Voice Data Adapter kit is included with all Desktop Electrical Outlets.	
B Black, W = White	Voice Dada Adapter kit provides a sheet of adapters which snap-off for use with a variety of manufacturers jacks & couplers.	

Accessories

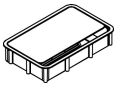
Grommets and Stand-Offs

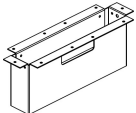
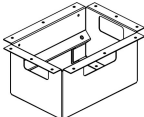
description	type	w	d	h	pattern no.	list
Power Center Grommet (Electrical component not included)		8"	5"	1 1/2"	RPCG()	\$166.
						
Desktop Grommet	For 1 1/2" thick top			1 1/2"	RDTGA()	36.
	For 1 1/4" thick top			1 1/4"	RDTGB()	36.
	For 1" thick top			1"	RDTGC()	36.
						
Simple Stand Off		12"	2 1/4"	5"	RST()	114.
						
Stand Off for Power Center (Electrical component not included)		8"	6 3/8"	5"	RPCST()	146.
						

Order Code

Example: RST	
R	Reff
ST	Stand Off
()	Finish

Specification Information





To order please specify pattern number including;
 1. Stand Off Finish: Painted options only
 For Grommets;
 1. Grommet Finish: Painted or plated options

Application Notes

Installation instruction sheet available on Knoll Exchange.
 For Power Center stand off, refer to Installation Instruction #6TP00081.

Accessories

Wire management

description	w	d	h	pattern no.	list
 Wire manager used under any top in kneespace*	24"	4 1/2"	5 3/4"	RWMWT24	\$46.
	30"	4 1/2"	5 3/4"	RWMWT30	52.
	36"	4 1/2"	5 3/4"	RWMWT36	57.
	Available black only				
 Hinged vertical wire	24"	1"	3/8"	RWMV24 ()	37.
Ships with overdesk unit. Specify paint finish.					
 Multi-purpose manager*	24"	2 1/2"	1 1/4"	RWMMP24	41.
	30"	2 1/2"	1 1/4"	RWMMP30	46.
	36"	2 1/2"	1 1/4"	RWMMP36	47.
	Available black only				
 Worksurface vertical/horizontal wire manager*	24"	1 1/2"	3/4"	RWMVH24	44.
	30"	1 1/2"	3/4"	RWMVH30	48.
	36"	1 1/2"	3/4"	RWMVH36	52.
	Available black only				
 Power bar, fits into wire manager				RWMPB	159.

Order Code	Specification Information	Application Notes
Example: RWMWT24	<i>To order please specify:</i>	Specify color for hinged vertical wire management only from paint finish list on page 5.
R Reff	1. Pattern number	Flexible Vertical wire manager is intended to be under mounted to a worksurface; using self tapping wood screws.
WM Wire Manager	2. Finish: painted finishes, where applicable	
W Wall and Modesty mount		
T Top Mount		
24 Width		

Accessories

Wire management

description	type	w	d	h	pattern no.	list
Flexible Vertical Wire Manager with Functional height range; for 26 1/2" and 28 3/8"H					RWMVF	\$138.

*translucent with metallic silver base (613)



Cable clip for column legs	3" dia.				RCC30()	24.
	4" dia				RCC40()	27.



* 2 clips per kit

J-Wire Trough Wall Mount		24"			RJBW24()	69.
		30"			RJBW30()	71.
		36"			RJBW36()	77.
		42"			RJBW42()	90.
		48"			RJBW48()	96.
		54"			RJBW54()	98.
		60"			RJBW60()	99.
		66"			RJBW66()	112.
	72"			RJBW72()	113.	

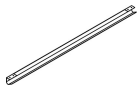

*Installation Instruction Sheet: 6TP00078

J-Wire Trough Under Mount		24"			RJBU24()	83.
		30"			RJBU30()	85.
		36"			RJBU36()	92.
		42"			RJBU42()	107.
		48"			RJBU48()	114.
		54"			RJBU54()	116.
		60"			RJBU60()	118.
		66"			RJBU66()	131.
	72"			RJBU72()	133.	

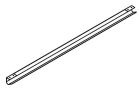

*Installation Instruction Sheet: 6TP00078

Order Code	Specification Information	Application Notes
Example: RMMWT24	<i>To order please specify:</i> 1. Pattern number 2. Finish: painted finishes, where applicable	Specify color for hinged vertical wire management only from paint finish list on page 5. Installation instruction sheets available on Knoll Exchange. For vertical wire manager, reference number 6TP00435. For J-wire manager; reference number 6TP0078.
R Reff		
WM Wire Manager		
W Wall and Modesty mount		
T Top Mount		
24 Width		
		Flexible Vertical wire manager is intended to be under mounted to a worksurface; using self tapping wood screws.

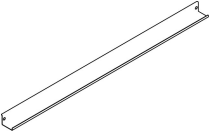
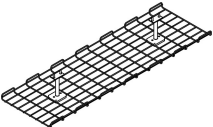
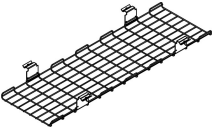

Accessories

Wire management

description	w	d	h	pattern no.	list
Wire manager for credenza top 	24"			RWMT24	\$136.
Cable Basket Kits Under Mounted 	15"	12"	1"	RWMT1512U	55.
	27"	12"	1"	RWMT2712U	98.
	39"	12"	1"	RWMT3912U	119.
*All hardware included *Baskets and hardware are painted med. grey (115)					
Cable Basket Kits Rail Mounted 	15"	12"	1"	RWMT1512R	276.
	27"	12"	1"	RWMT2712R	328.
	39"	12"	1"	RWMT3912R	505.
*All hardware included *Baskets and hardware are painted med. grey (115) *Not for use on 30" deep Meeting Tables with 4x4 legs					



Order Code	Specification Information	Application Notes
Example: RMMWT24	<i>To order please specify:</i> 1. Pattern number 2. Finish: painted finishes, where applicable	Specify color for hinged vertical wire management only from paint finish list on page 5. Installation instruction sheets available on Knoll Exchange. For cable baskets, under mount, reference number 6TP00435. For cable basket, rail mount; reference number 6TP00433.
R Reff		
WM Wire Manager		
W Wall and Modesty mount		
T Top Mount		
24 Width	Flexible Vertical wire manager is intended to be under mounted to a worksurface; using self tapping wood screws.	

Accessories For Worksurfaces

description	w	d	h	pattern no.	L	V1	V2	V3	list price
CRT turntable 	31" diameter			RKT31					\$581.
Pencil drawer used under worktop 	16"	17"	1"	RPAD-()	325.	578.	578.	748.	
	Specify wood or laminate finish								
Reff Profiles Spacer kit for Pencil drawer				RPADKIT					35.
Replacement hardware	Top to endpanel disk			RBDD					5.
	Top to workwall endpanel disk			RBDW					5.
	Panel to endpanel bracket			RBPE(L/R)()					22.
	Specify paint finish for RBPE(L/R) RBDD and RBDW available black only								



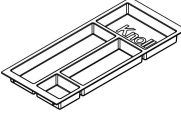
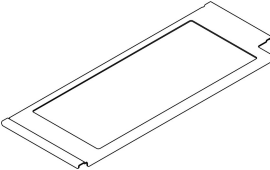

Order Code	Specification Information	Application Notes
Example: RKT31	<i>To order please specify pattern number including:</i> 1. Finish, where applicable	See Reff Planning Guide for more information. Pencil drawer includes sides. Note: The spacer kit (RPADKIT) is required to mount pencil drawer (RPAD) to a table with an open frame leg. Installation instruction sheets available on Knoll Exchange. For Spacer kits, refer to reference number 6TP00311.
R Reff		
KT Turntable		
31 31" Diameter		

Accessories For Pedestals

description	type	w	h	pattern no.	list
Pencil tray, wood (ordered separately)		12"	–	RPAPT	\$104.
Pencil tray, plastic 	black	13 1/4"	–	RPETRAY3N	40.
	clear	13 1/4"	–	RPETRAY3C	47.
<p>Recommended for use with metal drawer interiors on 16" w peds. Letter width pedestal. These pencil trays work with all pedestals with metal interior, including Mobile pedestals.</p>					
Pencil tray adapter 				RPETAD	89.
<p>Includes metal adapter pencil tray and plastic pencil tray to be used with 19" wide (Legal width) pedestals. Available in painted and anodized finishes.</p>					
Box drawer dividers, wood box drawers (Acrylic)		16"	–	RPADSS	54.
File bars, wood file drawers (replacement)		16"	–	RPAHFB16	31.
		30"	–	RPAHFB30	58.
		36"	–	RPAHFB36	90.
File bars, metal file drawers (replacement)		16"	–	RPAHFM162 *	22.
		30"	–	RPAHFM30	31.
		36"	–	RPAHFM36	31.
<p>Sold as individuals</p>					
Metal box divider, for desk height products 				RDHMBD	32.
<p>for 16" w desk height metal box drawer for use in pedestals with metal interior</p>					

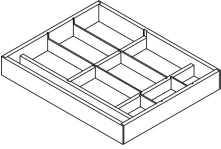



Order Code	Specification Information	Application Notes
Example: RDHMBD		
R Reff		The dividers come in black paint only.
DH Desk height		Replacement file bars for all mobile pedestals and pedestals shipped July 2001 and prior, should order KR5231078.
M Metal		
B Box		
D Divider		

Accessories For Pedestals

description	h	w	d	pattern no.	list	metal	L	V1	V2	V3
Metal file drawer divider, for desk height products 				RDHMF	\$32.					
				for 16" w desk height metal box drawer for use in pedestals with metal interior						
Box drawer divider 				RFBDD	275.					
Metal Shelf kit for 24" Pedestals 		24"	20"	RCAS2420M ()		88.				
		24"	24"	RCAS2424M ()		98.				
Wood Shelf kit for 24" Pedestals 		24"	20"	RCAS2420W ()			159.	171.	199.	268.
		24"	24"	RCAS2424W ()			182.	198.	229.	308.
Counter weight (for file/file configuration pedestals when used in freestanding applications) 	-	-	-	RCOUNTWT	109.					
				1 counterweight = 10 lbs.						
Waste recycle bin 		15"	9"	RWRB	116.					
				Note: For use with desk height and serving height pedestals.						

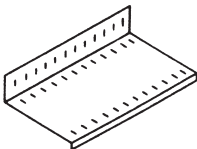
Order Code	Specification Information	Application Notes
Example: RDHMBD		
R Reff		The dividers come in black paint only.
DH Desk height		
M Metal		
B Box		
D Divider		
		Actual shelf dimensions; 24" w = 22 ^{23/64} " w 20" d = 13 ^{11/32} " d 24" d = 17 ^{11/32} " d
		The replacement waste recycle bins, are for use with 24" w waste recycle pedestals and are available in grey finish only.



Accessories For Cabinets

description	d	w	pattern no.	metal	L	V1	V2	V3	list
Cabinet shelves, (replacement)	15"	30"	RCAS3015-()	\$99.	\$194.	\$213.	\$243.	\$328.	
	15"	36"	RCAS3615-()	109.	207.	222.	252.	340.	
 Wood shelf	20"	12"	RCAS1220-()	n/a	147.	159.	184.	248.	
	20"	16"	RCAS1620-()	80.	149.	161.	186.	250.	
 Metal shelf	20"	19"	RCAS1920-()	84.	151.	163.	189.	254.	
	20"	30"	RCAS3020-()	96.	166.	182.	212.	285.	
	20"	36"	RCAS3620-()	109.	178.	194.	222.	301.	
	24"	12"	RCAS1224-()	n/a	167.	182.	211.	283.	
	24"	16"	RCAS1624-()	89.	166.	182.	212.	285.	
	24"	19"	RCAS1924-()	94.	171.	187.	216.	290.	
	24"	30"	RCAS3024-()	107.	194.	213.	243.	328.	
	24"	36"	RCAS3624-()	114.	209.	228.	260.	351.	
Cabinet boot tray	17"	14"	RCABT1417						79.
	17"	29"	RCABT2917						132.
Cabinet coat rod 		Half of 30" cabinets	RCACR30H						77.
		Half of 36" cabinets	RCACR36H						84.
		16" cabinets	RCACR16						79.
		30" cabinets	RCACR30						106.
		36" cabinets	RCACR36						118.
Plate divider 			RPD11						24.
			RPD14						24.
			RPD11 to be used with 15" D open cabinet/bookcase with metal shelves. RPD14 to be used with 20"/24"D open cabinet/bookcase with metal shelves.						
Metal lateral file drawer divider, for desk height products 			RDHMLD						25.
				for 20" and 24" deep metal lateral drawers Also works with AutoStrada for use in pedestals with metal interior					
Utility Hook 			RAUH						21.

Order Code	Specification Information
Example: RCAS2420W ()	
R Ref	
CA Cabinet	
AS Add-on shelf	
24 Width 24" nominal	
20 Depth (20 = 19" deep 24 = 23" deep)	
W Wood shelf, M = Metal	
V316 Shelf finish	



Specification Information	Actual shelf dimensions;
<i>To order cabinet shelf, please specify pattern number including:</i>	24" w = 22 23/64" w
1. Finish type:	20" d = 13 11/32" d
M = Metal	24" d = 17 11/32" d
1 = V1	
2 = V2	
3 = V3	
2. Shelf finish: L, V1, V2, V3 or Metal	
Metal shelves are available in all core paint finishes.	

Accessories
For Overhead
Fascias, Metal

description	w	pattern no.	P1	P2	P3
Metal Fascia - Both left and right recess 	30"	ROMDHMTF130RB	\$154.	\$169.	\$177.
	36"	ROMDHMTF136RB	157.	172.	181.
	42"	ROMDHMTF142RB	158.	173.	182.
	48"	ROMDHMTF148RB	160.	176.	185.
	54"	ROMDHMTF154RB	163.	179.	189.
	60"	ROMDHMTF160RB	165.	181.	191.
	66"	ROMDHMTF166RB	175.	193.	203.
	72"	ROMDHMTF172RB	177.	195.	205.
	78"	ROMDHMTF178RB	179.	196.	207.
	84"	ROMDHMTF184RB	181.	200.	209.
	90"	ROMDHMTF190RB	183.	202.	212.
96"	ROMDHMTF196RB	186.	204.	214.	
Metal Fascia - Left recess 	30"	ROMDHMTF130RL	154.	169.	177.
	36"	ROMDHMTF136RL	157.	172.	181.
	42"	ROMDHMTF142RL	158.	173.	182.
	48"	ROMDHMTF148RL	160.	176.	185.
	54"	ROMDHMTF154RL	163.	179.	189.
	60"	ROMDHMTF160RL	165.	181.	191.
	66"	ROMDHMTF166RL	175.	193.	203.
	72"	ROMDHMTF172RL	177.	195.	205.
	78"	ROMDHMTF178RL	179.	198.	207.
	84"	ROMDHMTF184RL	181.	200.	209.
	90"	ROMDHMTF190RL	183.	202.	212.
96"	ROMDHMTF196RL	186.	204.	214.	

Order Code	Specification Information	Application Notes
Example: ROMDHMTF130RB	<i>To order please specify pattern number including:</i> 1. Finish Anodized and Core paint finishes.	For single and double high overheads. Wood and metal options. Letter depth only. For P4 Anodized finishes (AP & AU), please add \$55 to P3 List Price.
R Reff		
O Overhead		
M Wall hung		
DH Desk height		
M Metal		
T Task light		
F Fascia		
1 Letter depth		
30 30"		
R Recess		
B Recess location		
118 Finish		

Accessories
For Overhead
Fascias, Metal

description	w	pattern no.	P1	P2	P3
Metal Fascia - No recess 	30"	ROMDHMTF130RN	\$154.	\$169.	\$177.
	36"	ROMDHMTF136RN	157.	172.	181.
	42"	ROMDHMTF142RN	158.	173.	182.
	48"	ROMDHMTF148RN	160.	176.	185.
	54"	ROMDHMTF154RN	163.	179.	189.
	60"	ROMDHMTF160RN	165.	181.	191.
	66"	ROMDHMTF166RN	175.	193.	203.
	72"	ROMDHMTF172RN	177.	195.	205.
	78"	ROMDHMTF178RN	179.	198.	207.
	84"	ROMDHMTF184RN	181.	200.	209.
	90"	ROMDHMTF190RN	183.	202.	212.
96"	ROMDHMTF196RN	186.	204.	214.	
Metal Fascia - Right recess 	30"	ROMDHMTF130RR	154.	169.	177.
	36"	ROMDHMTF136RR	157.	172.	181.
	42"	ROMDHMTF142RR	158.	173.	182.
	48"	ROMDHMTF148RR	160.	176.	185.
	54"	ROMDHMTF154RR	163.	179.	189.
	60"	ROMDHMTF160RR	165.	181.	191.
	66"	ROMDHMTF166RR	175.	193.	203.
	72"	ROMDHMTF172RR	177.	195.	205.
	78"	ROMDHMTF178RR	179.	198.	207.
	84"	ROMDHMTF184RR	181.	200.	209.
	90"	ROMDHMTF190RR	183.	202.	212.
96"	ROMDHMTF196RR	186.	204.	214.	

Order Code	Specification Information	Application Notes
Example: ROMDHMTF130RB	<i>To order please specify pattern number including:</i> 1. Finish Anodized and Core paint finishes.	For single and double high overheads. Wood and metal options. Letter depth only. For P4 Anodized finishes (AP & AU), please add \$55 to P3 List Price.
R Reff		
O Overhead		
M Wall hung		
DH Desk height		
M Metal		
T Task light		
F Fascia		
1 Letter depth		
30 30"		
R Recess		
B Recess location		
118 Finish		

Accessories
For Overhead
Fascias, Wood

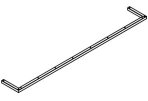
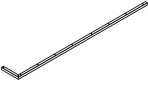
description	w	pattern no.	V1	V2	V3
Wood Fascia - Both left and right recess 	30"	ROMDHWTF130RB	\$283.	\$305.	\$381.
	36"	ROMDHWTF136RB	285.	310.	385.
	42"	ROMDHWTF142RB	287.	313.	391.
	48"	ROMDHWTF148RB	289.	316.	396.
	54"	ROMDHWTF154RB	291.	320.	400.
	60"	ROMDHWTF160RB	420.	444.	555.
	66"	ROMDHWTF166RB	422.	447.	559.
	72"	ROMDHWTF172RB	424.	450.	563.
	78"	ROMDHWTF178RB	426.	453.	567.
	84"	ROMDHWTF184RB	428.	456.	572.
	90"	ROMDHWTF190RB	432.	459.	577.
96"	ROMDHWTF196RB	589.	613.	768.	
Wood Fascia - Left recess 	30"	ROMDHWTF130RL	283.	305.	381.
	36"	ROMDHWTF136RL	285.	310.	385.
	42"	ROMDHWTF142RL	287.	313.	391.
	48"	ROMDHWTF148RL	289.	316.	396.
	54"	ROMDHWTF154RL	291.	320.	400.
	60"	ROMDHWTF160RL	420.	444.	555.
	66"	ROMDHWTF166RL	422.	447.	559.
	72"	ROMDHWTF172RL	424.	450.	563.
	78"	ROMDHWTF178RL	426.	453.	567.
	84"	ROMDHWTF184RL	428.	456.	572.
	90"	ROMDHWTF190RL	432.	459.	577.
96"	ROMDHWTF196RL	589.	613.	768.	

Order Code	Specification Information	Application Notes
Example: ROMDHWTF130RB	<i>To order please specify pattern number including:</i> 1. Finish Type: 1 = V1 2 = V2 3 = V3 2. Finish V1, V2, V3	For single and double high overheads. Wood and metal options. Letter depth only.
R Reff		
O Overhead		
M Wall hung		
DH Desk height		
W Wood		
T Task light		
F Fascia		
1 Letter depth		
30 30"		
R Recess		
B Recess location		
V316 Finish		

Accessories
For Overhead
Fascias, Wood

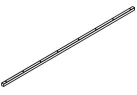
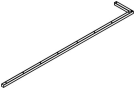
description	w	pattern no.	V1	V2	V3
Wood Fascia - No recess 	30"	ROMDHWTF130RN	\$283.	\$305.	\$381.
	36"	ROMDHWTF136RN	285.	310.	385.
	42"	ROMDHWTF142RN	287.	313.	391.
	48"	ROMDHWTF148RN	289.	316.	396.
	54"	ROMDHWTF154RN	291.	320.	400.
	60"	ROMDHWTF160RN	420.	444.	555.
	66"	ROMDHWTF166RN	422.	447.	559.
	72"	ROMDHWTF172RN	424.	450.	563.
	78"	ROMDHWTF178RN	426.	453.	567.
	84"	ROMDHWTF184RN	428.	456.	572.
	90"	ROMDHWTF190RN	432.	459.	577.
96"	ROMDHWTF196RN	589.	613.	768.	
Wood Fascia - Right recess 	30"	ROMDHWTF130RR	283.	305.	381.
	36"	ROMDHWTF136RR	285.	310.	385.
	42"	ROMDHWTF142RR	287.	313.	391.
	48"	ROMDHWTF148RR	289.	316.	396.
	54"	ROMDHWTF154RR	291.	320.	400.
	60"	ROMDHWTF160RR	420.	444.	555.
	66"	ROMDHWTF166RR	422.	447.	559.
	72"	ROMDHWTF172RR	424.	450.	563.
	78"	ROMDHWTF178RR	426.	453.	567.
	84"	ROMDHWTF184RR	428.	456.	572.
	90"	ROMDHWTF190RR	432.	459.	577.
96"	ROMDHWTF196RR	589.	613.	768.	

Order Code	Specification Information	Application Notes
Example: ROMDHWTF130RB	<i>To order please specify pattern number including:</i> 1. Finish Type: 1 = V1 2 = V2 3 = V3 2. Finish V1, V2, V3	For single and double high overheads. Wood and metal options. Letter depth only.
R Reff		
O Overhead		
M Wall hung		
DH Desk height		
W Wood		
T Task light		
F Fascia		
1 Letter depth		
30 30"		
R Recess		
B Recess location		
V316 Finish		

Accessories

For Overhead

Task Lights and Tackboards

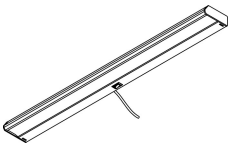
description	type	y	w	d	h	pattern no.	list
	Use with 24" and wider overhead		19"	4"	1 1/2"	RTL5E19S	\$300.
	Use with 30" and wider overhead		25"	4"	1 1/2"	RTL5E25S	308.
	Use with 42" and wider overhead		37"	4"	1 1/2"	RTL5E37S	313.
	Use with 60" and wider overhead		49"	4"	1 1/2"	RTL5E49S	320.
	Use with 72" and wider overhead		61"	4"	1 1/2"	RTL5E61S	337.
	Use with 84" and wider overhead		73"	4"	1 1/2"	RTL5E73S	368.
	Use with 96" and wider overhead		85"	4"	1 1/2"	RTL5E85S	459.

	Use with 30" and wider overhead		25"	4"	1 1/2"	RTL5E25A	442.
	Use with 42" and wider overhead		37"	4"	1 1/2"	RTL5E37A	464.
	Use with 60" and wider overhead		49"	4"	1 1/2"	RTL5E49A	485.
	Use with 72" and wider overhead		61"	4"	1 1/2"	RTL5E61A	502.
	Use with 84" and wider overhead		73"	4"	1 1/2"	RTL5E73A	520.
	Use with 96" and wider overhead		85"	4"	1 1/2"	RTL5E85A	540.

	Use with 24" and wider overhead (24 LED's)		17"	2"	1/2"	RL4L17	520.
	Use with 36" and wider overhead (48 LED's)		31"	2"	1/2"	RL4L31	867.
	Use with 48" and wider overhead (72 LED's)		44"	2"	1/2"	RL4L44	1,130.
	Use with 66" and wider overhead (96 LED's)		58"	2"	1/2"	RL4L58	1,419.

	Wall-hung tackboard for desk height (28 3/8" h)	0.9	30"	26"		RWHDHTB3026	364.
	planning	1.1	36"	26"		RWHDHTB3626	401.
	Note: Fabric railroaded Velcro supplied	1.3	42"	26"		RWHDHTB4226	443.
		1.5	48"	26"		RWHDHTB4826	480.



for use with 28 3/8" h support planning module

	Wall rails (paint options only)	-	-	8 7/8"		RWHRA-()	41.
		-	-	17 5/8"		RWHRB-()	44.
		-	-	18 1/4"		RWHRC-()	44.
		-	-	21 1/16"		RWHRD-()	46.
		-	-	22"		RWHRE-()	46.
		-	-	59 1/2"		RWHRF-()	104.
		-	-	67"		RWHRG-()	104.

Order Code	Specification Information	Application Notes
Example: RTL5E19S		
RTL Task Light		<p>T5 Task Lights: 120v and includes T5 cool white (4100K) fluorescent lamp, electronic ballast, 9' grounded cordset, prismatic lens, rocker switch, one cord exit management clip and mounting hardware. Housings are black.</p> <p>T5 Task Lights: Specify suffix -CH and add \$46 list for City of Chicago installations. Example: DL3T5E25S-CH</p> <p>Cordset is center exit. On smaller units cord exit is off-center, but still not handed.</p> <p>T5 advanced task lights are fitted with ballasts and lamps compliant with LEED requirements, meeting the LEED EB standard for mercury content.</p>
T5 T5 lamp		
L LED		
E Electronic ballast		
19 Width		
S Standard		

Y = Yardage Required

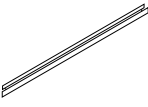
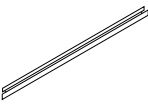
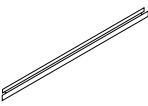
Accessories For Overhead Sliding Rails

description	w	pattern no.	list
Sliding rail for open shelves 	30"	RSDR30	\$57.
	36"	RSDR36	57.
	42"	RSDR42	57.
	48"	RSDR48	57.
	54"	RSDR54	57.
	60"	RSDR60	90.
	66"	RSDR66	90.
	72"	RSDR72	90.
	78"	RSDR78	90.
	84"	RSDR84	101.
	90"	RSDR90	101.
96"	RSDR96	101.	
Sliding rail for open or hinged door overhead cabinets 	30"	ROHDR30	57.
	36"	ROHDR36	57.
	42"	ROHDR42	57.
	48"	ROHDR48	57.
	60"	ROHDR60	101.
	72"	ROHDR72	101.
	90"	ROHDR90	137.
	96"	ROHDR96	137.
Sliding rail for flip door overhead cabinets 	30"	RFDR30	57.
	36"	RFDR36	57.
	42"	RFDR42	57.
	48"	RFDR48	57.
	60"	RFDR60	101.
	72"	RFDR72	101.
	84"	RFDR84	101.
	96"	RFDR96	101.
Sliding rail divider 		R5ZNN (3 dividers)	24.

Order Code	
Example: RSDR30	
R	Reff
SDR	Sliding rail for open shelves
30	For 30" shelf

Specification Information
To order please specify pattern number.

Application Notes
 Match cabinet width to rail width.
 Parts come in black only.
 These rails allow the use of metal "D"-ring divider to locate and separate binders and standing materials in Reff overhead cabinets. The rail which attaches to the inside back section of the cabinet is sold according to cabinet size door configuration.

Accessories
For Hutches
Fascias, Metal

description	w	pattern no.	P1	P2	P3
Metal Fascia 	60"	ROHMTF160 ()	\$162.	\$178.	\$187.
	66"	ROHMTF166 ()	171.	189.	198.
	72"	ROHMTF172 ()	174.	192.	201.
	78"	ROHMTF178 ()	176.	194.	204.
	84"	ROHMTF184 ()	178.	196.	206.
	90"	ROHMTF190 ()	180.	199.	208.
	96"	ROHMTF196 ()	182.	201.	211.

Order Code	
Example: ROHMTF160	
R	Reff
O	Overhead
H	Hutch
M	Metal
T	Task light
F	Fascia
1	Letter depth
60	60"
()	Fascia finish

Specification Information

To order please specify pattern number including:

1. Fascia Finish: Anodized and painted options

Application Notes

For single and double high Hutches.
 Wood or Metal options.

Accessories
For Hutches
Fascias, Wood

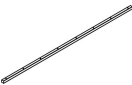
description	w	pattern no.	V1	V2	V3
Wood Fascia 	60"	ROHWTF160 ()	\$411.	\$435.	\$543.
	66"	ROHWTF166 ()	414.	438.	548.
	72"	ROHWTF172 ()	416.	442.	552.
	78"	ROHWTF178 ()	418.	445.	557.
	84"	ROHWTF184 ()	420.	448.	561.
	90"	ROHWTF190 ()	423.	451.	565.
	96"	ROHWTF196 ()	578.	602.	752.

Order Code

Example: ROHWTF160
R Reff
O Overhead
H Hutch
W Wood
T Task light
F Fascia
1 Letter depth
60 60"
() Trim Finish

Specification Information

To order please specify pattern number including:
 1. Trim Finish: Wood or Laminate

Application Notes

For single and double high Hutches.
 Wood or Metal options.

Accessories

For Task panels

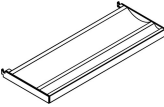
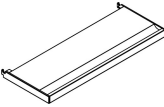
description	w	pattern no.	list
Task Panel shelf	14"	RTST14	\$177.
			
Task Panel flat tray	14"	RTSF14	177.
	28"	RTSF28	211.
			

Order Code

Example: RTST14
R Reff
TS Task Panel
T Shelf
F = Tray
14 Width

Specification Information

To order please specify pattern number including:
 1. Finish where applicable

Application Notes

See Reff Planning Guide for more information.

Accessories

Presentation Samples

description	w	d	h	pattern no.	L	M	V2	V3	list
Presentation wood sample, 16" x 16"	16"	16"	-	RSAMP1616-() ()	\$142.	\$204.	\$262.	\$303.	
	Optional edge details available								
Presentation stackable/tiled mini panel (for demonstrations)	24"	-	34"	R3SMP () ()					1,173.
	Specify trim profile, base height, base type and applicable finishes								
Presentation monolithic mini panel	4"H base			RR3MP4 ()					642.
	6"H base			RR3MP6 ()					687.
	Specify trim profile and applicable finishes								
Presentation worksurface cutaway sample	12"	12"	1 1/4"	RTOP2 ()	117.	179.	239.	282.	
	12"	12"	1 3/4"	RTOP1 ()	117.	179.	239.	282.	
Sample, cascade edge worksurface 	12"	12"		RCE1R1212G	133.				
Rangeboard	27"	12"	1 1/4"	RRBRD2712 ()					322.
	Rangeboards are available in the following clear coat finishes; V316, V440, V515 & V518)								

Order Code

Example: RWHRA()
R Reff
WH Wall Hung
R Rails
A Height
() Paint options only

Specification Information

To order please specify pattern number including:
1. Finish, where applicable

Specification Information

See Reff Planning Guide for more information.

Metal D-pull sample board represents the following standard Reff finishes (PT, 111, 118, 611, 612, 613)

Specify board finish in laminate, techwood, conventional or laminate with a wood edge.

Specify edge detail if applicable for presentation wood samples.

Product on this page will accept woodgrain laminate where laminate is currently an option. The wall rails will accept two sets of brackets for panel hung components.

Accessories

Presentation Pull Samples

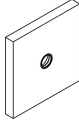
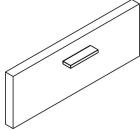
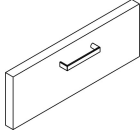
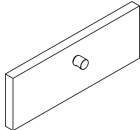
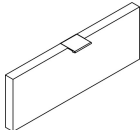
description	type	w	d	pattern no.	L	V1	V2	V3	list
Presentation drawer front with pull samples	Grommet pull	8"	8"	RPULLSMPG () ()	\$155.	\$196.	\$212.	\$245.	
									
	Bar pull	8"	8"	RPULLSMPF () ()	155.	196.	212.	245.	
									
	Outline pull	8"	8"	RPULLSMPH () ()	155.	196.	212.	245.	
									
	Cylinder pull	8"	8"	RPULLSMPR () ()	155.	196.	212.	245.	
									
	Tab pull	8"	8"	RPULLSMPT () ()	155.	196.	212.	245.	
									

Order Code

Example:	RPULLSMPG () ()
R	Reff Profiles
PULL	Pull
SM	Sample
PG	Pull Grommet

Specification Information

To order please specify pattern number including:

1. Drawer Front finish:
Wood or Laminate
2. Pull Finish:
Painted or plated

Product on this page will accept wood grain laminate, where laminate is currently an option.

Accessories

Presentation Pull Samples

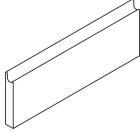
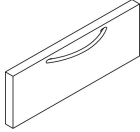
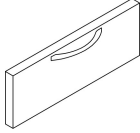
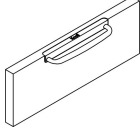
description	type	w	d	pattern no.	L	V1	V2	V3	list
Presentation drawer front with pull samples	J-Pull	8"	8"	RPULLSMPJ() ()	\$155.	\$196.	\$212.	\$245.	
									
	C-Pull	8"	8"	RPULLSMP() ()	155.	196.	212.	245.	
									
	S-Pull	8"	8"	RPULLSMP() ()	155.	196.	212.	245.	
									
	D-Pull	8"	8"	RPULLSMPD() ()	155.	196.	212.	245.	
									

Order Code

Example:	RPULLSMPG() ()
R	Reff Profiles
PULL	Pull
SM	Sample
PG	Pull Grommet

Specification Information

To order please specify pattern number including:

1. Drawer Front finish:
Wood or Laminate
2. Pull Finish:
Painted or plated

Product on this page will accept wood grain laminate, where laminate is currently an option.

Single Wide Desk

Single Finishes

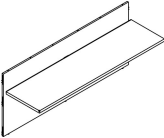
description	w*	d	h	pattern no.	L	V1	V2	V3
 Single Wide Desk	66"	30"	42"	RASW6630 () ()	\$1,280.	\$1,502.	\$1,727.	\$2,245.
	72"	30"	42"	RASW7230 () ()	1,337.	1,568.	1,803.	2,344.
	78"	30"	42"	RASW7830 () ()	1,379.	1,617.	1,859.	2,417.
	84"	30"	42"	RASW8430 () ()	1,457.	1,708.	1,965.	2,554.
	90"	30"	42"	RASW9030 () ()	1,498.	1,757.	2,021.	2,627.
	96"	30"	42"	RASW9630 () ()	1,546.	1,813.	2,085.	2,712.

W* = Overall foot print width - Nominal

Note: All noted width dimensions are an "out to out" overall foot print, including all additional components which are required and ordered separately.

Order Code	Specification Information	Application Notes																									
Example: RASW6630 RA Reff Administrative SW Single Wide with worksurface <hr/> 66 66" wide, Nominal 30 30" overall <hr/> () Modesty finish () Worksurface finish	<p><i>To order please specify pattern number including:</i></p> <ol style="list-style-type: none"> Modesty Finish: Wood or Laminate Worksurface Finish: Wood or Laminate, (excluding wood grain laminate) <p>All dimensions are nominal.</p> <p>Nominal vs Actual widths</p> <table border="1"> <thead> <tr> <th>Width</th> <th>Modesty</th> <th>Top</th> </tr> <tr> <th><i>Nominal</i></th> <th><i>Actual</i></th> <th><i>Actual</i></th> </tr> </thead> <tbody> <tr> <td>66"</td> <td>61.8"</td> <td>61.8"</td> </tr> <tr> <td>72"</td> <td>67.8"</td> <td>67.8"</td> </tr> <tr> <td>78"</td> <td>73.8"</td> <td>73.8"</td> </tr> <tr> <td>84"</td> <td>79.8"</td> <td>79.8"</td> </tr> <tr> <td>90"</td> <td>85.8"</td> <td>85.8"</td> </tr> <tr> <td>96"</td> <td>91.8"</td> <td>91.8"</td> </tr> </tbody> </table> <p>Overall Depth: 30" Nominal Worksurface Depth: = 24.5" Actual Height: 42" Nominal = 41.5" Actual</p> <p>Above dimension allow for 2 end supports.</p>	Width	Modesty	Top	<i>Nominal</i>	<i>Actual</i>	<i>Actual</i>	66"	61.8"	61.8"	72"	67.8"	67.8"	78"	73.8"	73.8"	84"	79.8"	79.8"	90"	85.8"	85.8"	96"	91.8"	91.8"	<p>It is Not advisable to mix 28^{3/8}"h desk height products with 26^{1/2}" standard height products.</p> <p>Products on this page are engineered to work with 28^{3/8}" planning.</p> <p>Products on this page will accept all Laminates except "wood grain laminates".</p> <p>Products on this page are manufactured to be finished on the user's side (inside), and paper finished on the approach side (outside).</p> <p>The approach side needs to be completed with an additional infill panel.</p> <p>Installation instruction sheets available on Knoll Exchange. Reference number 6TP00320.</p>	<p>All worksurfaces are 1 1/2" thick.</p> <p>No Drilling Options. No Grommet Options.</p> <p>Worksurface includes 2" gap along the back edge to accommodate full wire access and Pencil Lip.</p> <p>Pencil Lip will be assembled to the top. Pencil Lip dimension: 1/4"H above worksurface. Pencil Lip is located along the back edge. Pencil Lip is available in black only.</p> <p>Comes with hardware kit, including attachment kit.</p> <p>Mid-span cantilever bracket (RMSCB) or a return must be ordered for additional support for spans greater than 54" wide.</p> <p>To be used with end support, return, or bridge. Includes front modesty and worksurface.</p>
Width	Modesty	Top																									
<i>Nominal</i>	<i>Actual</i>	<i>Actual</i>																									
66"	61.8"	61.8"																									
72"	67.8"	67.8"																									
78"	73.8"	73.8"																									
84"	79.8"	79.8"																									
90"	85.8"	85.8"																									
96"	91.8"	91.8"																									

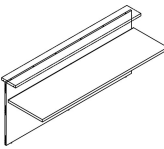

Single Wide Desk

Mixed Finishes

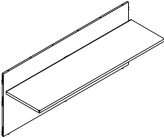
description	w*	d	h	pattern no.	L/V1	L/V2	L/V3	V1/L	V2/L	V3/L
Single Wide Desk	66"	30"	42"	RASW6630 () ()	\$1,405.	\$1,482.	\$1,764.	\$1,462.	\$1,585.	\$1,835.
	72"	30"	42"	RASW7230 () ()	1,454.	1,538.	1,844.	1,503.	1,636.	1,910.
	78"	30"	42"	RASW7830 () ()	1,492.	1,583.	1,913.	1,533.	1,677.	1,973.
	84"	30"	42"	RASW8430 () ()	1,581.	1,678.	2,030.	1,584.	1,737.	2,058.
	90"	30"	42"	RASW9030 () ()	1,621.	1,724.	2,099.	1,616.	1,779.	2,124.
	96"	30"	42"	RASW9630 () ()	1,669.	1,777.	2,176.	1,646.	1,818.	2,187.

W* = Overall foot print width - Nominal

Note: All noted width dimensions are an "out to out" overall foot print, including all additional components which are required and ordered separately.

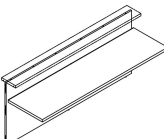
Order Code	Specification Information	Application Notes
Example: RASW6630	<i>To order please specify pattern number including:</i>	All worksurfaces are 1 1/2" thick.
RA Reff Administrative	1. Modesty Finish: Wood or Laminate	No Drilling Options. No Grommet Options.
SW Single Wide with worksurface	2. Worksurface Finish: Wood or Laminate, (excluding wood grain laminate)	Worksurface includes 2" gap along the back edge to accommodate full wire access and Pencil Lip.
66 66" wide, Nominal	All dimensions are nominal.	Pencil Lip will be assembled to the top.
30 30" overall	Nominal vs Actual widths	Pencil Lip dimension: 1/4" H above worksurface.
() Modesty finish	Width Modesty Top Nominal Actual Actual	Pencil Lip is located along the back edge.
() Worksurface finish	66" 61.8" 61.8"	Pencil Lip is available in black only.
	72" 67.8" 67.8"	Comes with hardware kit, including attachment kit.
	78" 73.8" 73.8"	Mid-span cantilever bracket (RMSCB) or a return must be ordered for additional support for spans greater than 54" wide.
	84" 79.8" 79.8"	To be used with end support, return, or bridge.
	90" 85.8" 85.8"	Includes front modesty and worksurface.
	96" 91.8" 91.8"	
	Overall Depth: 30" Nominal Worksurface Depth: = 24.5" Actual Height: 42" Nominal = 41.5" Actual	
	Above dimension allow for 2 end supports.	
	It is Not advisable to mix 28 3/8" h desk height products with 26 1/2" standard height products.	
	Products on this page are engineered to work with 28 3/8" planning.	
	Products on this page will accept all Laminates except "wood grain laminates".	
	Products on this page are manufactured to be finished on the user's side (inside), and paper finished on the approach side (outside).	
	The approach side needs to be completed with an additional infill panel.	
	Installation instruction sheets available on Knoll Exchange. Reference number 6TP00320.	

Double Wide Desk

Single Finishes

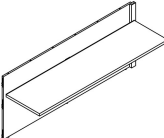
description	w*	d	h	pattern no.	L	V1	V2	V3
Double Wide Desk	51"	30"	42"	RADW(L/R)5130 ()	\$1,238.	\$1,453.	\$1,671.	\$2,171.
	54"	30"	42"	RADW(L/R)5430 ()	1,267.	1,485.	1,708.	2,220.
	57"	30"	42"	RADW(L/R)5730 ()	1,295.	1,518.	1,745.	2,269.
	60"	30"	42"	RADW(L/R)6030 ()	1,381.	1,620.	1,862.	2,422.
	63"	30"	42"	RADW(L/R)6330 ()	1,403.	1,646.	1,893.	2,460.
	66"	30"	42"	RADW(L/R)6630 ()	1,434.	1,682.	1,935.	2,514.
	69"	30"	42"	RADW(L/R)6930 ()	1,462.	1,714.	1,971.	2,561.
	72"	30"	42"	RADW(L/R)7230 ()	1,483.	1,739.	2,001.	2,601.
	75"	30"	42"	RADW(L/R)7530 ()	1,503.	1,762.	2,026.	2,635.
	78"	30"	42"	RADW(L/R)7830 ()	1,523.	1,788.	2,055.	2,672.
	81"	30"	42"	RADW(L/R)8130 ()	1,551.	1,818.	2,091.	2,719.
	84"	30"	42"	RADW(L/R)8430 ()	1,603.	1,881.	2,163.	2,813.
	87"	30"	42"	RADW(L/R)8730 ()	1,623.	1,902.	2,188.	2,845.
	90"	30"	42"	RADW(L/R)9030 ()	1,644.	1,928.	2,218.	2,882.
	93"	30"	42"	RADW(L/R)9330 ()	1,672.	1,961.	2,255.	2,932.
	96"	30"	42"	RADW(L/R)9630 ()	1,691.	1,984.	2,283.	2,967.

Left hand shown

W* = Overall foot print width - Nominal

Note: All noted width dimensions are an "out to out" overall foot print, including all additional components which are required and ordered separately.

Order Code	Specification Information	Application Notes
Example: RADW(L/R)5130	<i>To order please specify pattern number including:</i>	All worksurfaces are 1 1/2" thick.
RA Reff Administrative	1. Modesty Finish: Wood or Laminate	No Drilling Options. No Grommet Options.
DW Double Wide with worksurface	2. Worksurface Finish: Wood or Laminate	Worksurface includes 2" gap along the back edge to accommodate full wire access and Pencil Lip.
L Left hand	To complete your double wide unit, you must order 2 pieces.	Pencil Lip will be assembled to the top. Pencil Lip dimension: 1/4"H above worksurface.
51 51" wide, Nominal	Width <i>Nominal</i>	Pencil Lip is located along the back edge. Pencil Lip is available in black only.
30 30" overall	Width <i>Actual</i>	Products on this page do not include infill panels. Returns and supports need to be ordered separately.
() Modesty finish	102" 2 x 48.9"	Mid-span cantilever bracket (RMSCB) or a return must be ordered for additional support for spans greater than 54" wide.
() Worksurface finish	108" 2 x 51.9"	Left hand and Right hand units are sold separately (not as set), therefore the veneer sides will not match.
	114" 2 x 54.9"	Left hand unit includes 2 kits; Kit #1: Joinery hardware to connect 2 units together. Kit # 2: Multi clip.
	120" 2 x 57.9"	
	120" 2 x 60.9"	
	132" 2 x 63.9"	
	138" 2 x 66.9"	
	144" 2 x 69.9"	
	150" 2 x 72.9"	
	156" 2 x 75.9"	
	162" 2 x 78.9"	
	168" 2 x 81.9"	
	174" 2 x 84.9"	
	180" 2 x 87.9"	
	186" 2 x 90.9"	
	192" 2 x 93.9"	
	Overall Depth: 30" Nominal Worksurface Depth: 24.5" Actual Height: 42" Nominal = 41.5" Actual	

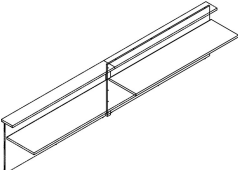

Double Wide Desk

Mixed Finishes

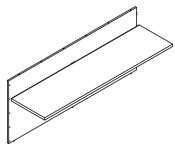
description	w*	d	h	pattern no.	L/V1	L/V2	L/V3	V1/L	V2/L	V3/L
Double Wide Desk	51"	30"	42"	RADW(L/R)5130()	\$1,349.	\$1,412.	\$1,646.	\$1,469.	\$1,571.	\$1,797.
	54"	30"	42"	RADW(L/R)5430()	1,377.	1,444.	1,688.	1,485.	1,592.	1,831.
	57"	30"	42"	RADW(L/R)5730()	1,395.	1,466.	1,724.	1,511.	1,622.	1,871.
	60"	30"	42"	RADW(L/R)6030()	1,504.	1,577.	1,846.	1,569.	1,685.	1,948.
	63"	30"	42"	RADW(L/R)6330()	1,525.	1,602.	1,884.	1,600.	1,722.	1,996.
	66"	30"	42"	RADW(L/R)6630()	1,548.	1,629.	1,920.	1,630.	1,756.	2,043.
	69"	30"	42"	RADW(L/R)6930()	1,576.	1,659.	1,963.	1,645.	1,777.	2,074.
	72"	30"	42"	RADW(L/R)7230()	1,598.	1,684.	1,999.	1,662.	1,797.	2,107.
	75"	30"	42"	RADW(L/R)7530()	1,617.	1,705.	2,031.	1,707.	1,847.	2,168.
	78"	30"	42"	RADW(L/R)7830()	1,635.	1,728.	2,066.	1,723.	1,868.	2,203.
	81"	30"	42"	RADW(L/R)8130()	1,665.	1,759.	2,108.	1,737.	1,889.	2,233.
	84"	30"	42"	RADW(L/R)8430()	1,726.	1,823.	2,185.	1,775.	1,930.	2,287.
	87"	30"	42"	RADW(L/R)8730()	1,744.	1,845.	2,217.	1,790.	1,950.	2,319.
	90"	30"	42"	RADW(L/R)9030()	1,763.	1,868.	2,253.	1,805.	1,970.	2,351.
	93"	30"	42"	RADW(L/R)9330()	1,793.	1,900.	2,296.	1,819.	1,991.	2,382.
	96"	30"	42"	RADW(L/R)9630()	1,811.	1,921.	2,328.	1,836.	2,010.	2,416.

W* = Overall foot print width - Nominal

Note: All noted width dimensions are an "out to out" overall foot print, including all additional components which are required and ordered separately.

Order Code	Specification Information	Application Notes
Example: RADW(L/R)5130	<i>To order please specify pattern number including:</i>	All worksurfaces are 1 1/2" thick.
RA Reff Administrative	1. Modesty Finish: Wood or Laminate	No Drilling Options. No Grommet Options.
DW Double Wide with worksurface	2. Worksurface Finish: Wood or Laminate	Worksurface includes 2" gap along the back edge to accommodate full wire access and Pencil Lip.
L Left hand	To complete your double wide unit, you must order 2 pieces.	Pencil Lip will be assembled to the top. Pencil Lip dimension: 1/4"H above worksurface. Pencil Lip is located along the back edge. Pencil Lip is available in black only.
51 51" wide, Nominal	Width <i>Nominal</i>	Products on this page do not include infill panels. Returns and supports need to be ordered separately.
30 30" overall	Width <i>Actual</i>	Mid-span cantilever bracket (RMSCB) or a return must be ordered for additional support for spans greater than 54" wide.
() Modesty finish	102" 2 x 48.9"	Left hand and Right hand units are sold separately (not as set), therefore the veneer sides will not match.
() Worksurface finish	108" 2 x 51.9"	Left hand unit includes 2 kits; Kit #1: Joinery hardware to connect 2 units together. Kit # 2: Multi clip.
	114" 2 x 54.9"	
	120" 2 x 57.9"	
	120" 2 x 60.9"	
	132" 2 x 63.9"	
	138" 2 x 66.9"	
	144" 2 x 69.9"	
	150" 2 x 72.9"	
	156" 2 x 75.9"	
	162" 2 x 78.9"	
	168" 2 x 81.9"	
	174" 2 x 84.9"	
	180" 2 x 87.9"	
	186" 2 x 90.9"	
	192" 2 x 93.9"	
	Overall Depth: 30" Nominal Worksurface Depth: 24.5" Actual Height: 42" Nominal = 41.5"H Actual	

Bridge

Single Finishes

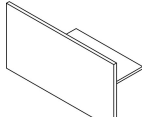
description	w*	d	h	pattern no.	L	V1	V2	V3
	72"	20"	42"	RABR(L/R)7220 () () ()	\$1,162.	\$1,896.	\$2,181.	\$2,835.
	78"	20"	42"	RABR(L/R)7820 () () ()	1,261.	2,057.	2,367.	3,076.
	84"	20"	42"	RABR(L/R)8420 () () ()	1,317.	2,150.	2,472.	3,214.
	90"	20"	42"	RABR(L/R)9020 () () ()	1,370.	2,238.	2,573.	3,346.
	96"	20"	42"	RABR(L/R)9620 () () ()	1,424.	2,324.	2,672.	3,474.

Left hand shown

w* = Overall foot print width - Nominal

Note: All noted width dimensions are an "out to out" overall foot print, including all additional components which are required and ordered separately.

Order Code

Example:	RABR(L/R)7220
RA	Reff Administrative
BR	Bridge Return
R	Right hand
72	72" wide
20	20" overall
()	Grommet option
()	Grommet finish
()	Modesty finish
()	Worksurface finish

Specification Information

To order please specify pattern number including:

- Grommet Option:
F = Flush
N = No Grommet
- Grommet Finish:
Painted or Plated
- Modesty Finish:
Wood or Laminate
- Worksurface Finish:
Wood or Laminate, (excluding wood grain laminate)

All dimensions are nominal.

left hand/ right hand

Nominal vs Actual widths

Width	Modesty	Top
<i>Nominal</i>	<i>Actual</i>	<i>Actual</i>
72"	54.5"	24.5"
78"	60.5"	30.5"
84"	66.5"	36.5"
90"	72.5"	42.5"
96"	78.5"	48.5"

Overall Depth: 20" Nominal
Worksurface Depth: 18.9" Actual
Height: 42" Nominal = 41.5" Actual

Application Notes

It is Not advisable to mix 28^{3/8}"h desk height products with 26^{1/2}" standard height products.

Products on this page are engineered to work with 28^{3/8}" planning.

Products on this page will accept all Laminates except "wood grain laminates".

Installation instruction sheets available on Knoll Exchange. Reference number 6TP00320.

All worksurfaces are 1 1/2" thick.

Includes a 20"d nominal work surface.

Includes thick modesty panel.

Use in conjunction with end cabinets.

Bridge + Cabinet + End Panel = Nominals.

Cabinet to be ordered separately.

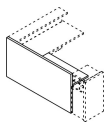

Bridge

Mixed Finishes

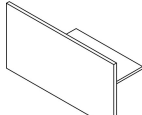
description	w*	d	h	pattern no.	L/V1	L/V2	L/V3	V1/L	V2/L	V3/L
	72"	20"	42"	RABR(L/R)7220 () () ()	\$1,303.	\$1,339.	\$1,456.	\$1,743.	\$1,995.	\$2,423.
	78"	20"	42"	RABR(L/R)7820 () () ()	1,435.	1,475.	1,611.	1,901.	2,176.	2,651.
	84"	20"	42"	RABR(L/R)8420 () () ()	1,499.	1,544.	1,699.	1,966.	2,263.	2,786.
	90"	20"	42"	RABR(L/R)9020 () () ()	1,556.	1,606.	1,781.	2,033.	2,351.	2,925.
	96"	20"	42"	RABR(L/R)9620 () () ()	1,608.	1,662.	1,856.	2,096.	2,436.	3,057.

Left hand shown

w* = Overall foot print width - Nominal

Note: All noted width dimensions are an "out to out" overall foot print, including all additional components which are required and ordered separately.

Order Code	Specification Information	Application Notes
Example: RABR(L/R)7220	<i>To order please specify pattern number including:</i>	All worksurfaces are 1 1/2" thick.
RA Reff Administrative	1. Grommet Option: F = Flush N = No Grommet	Includes a 20"d nominal work surface.
BR Bridge Return	2. Grommet Finish: Painted or Plated	Includes thick modesty panel.
R Right hand	3. Modesty Finish: Wood or Laminate	Use in conjunction with end cabinets.
72 72" wide	4. Worksurface Finish: Wood or Laminate, (excluding wood grain laminate)	Bridge + Cabinet + End Panel = Nominals.
20 20" deep	All dimensions are nominal.	Cabinet to be ordered separately.
() Grommet option	left hand/ right hand	
() Grommet finish	Nominal vs Actual widths	
() Modesty finish	Width Modesty Top	
() Worksurface finish	<i>Nominal Actual Actual</i>	
	72" 54.5" 24.5"	
	78" 60.5" 30.5"	
	84" 66.5" 36.5"	
	90" 72.5" 42.5"	
	96" 78.5" 48.5"	
	Overall Depth: 20" Nominal	
	Worksurface Depth: 18.9" Actual	
	Height: 42" Nominal = 41.5" Actual	
		Note: All noted width dimensions are an "out to out" overall foot print, including all additional components which are required and ordered separately.
		Products on this page are engineered to work with 28 3/8" planning.
		All worksurfaces are 1 1/2" thick.
		Products on this page will accept all Laminates except "wood grain laminates".
		Note: All installation instructions are available on the Knoll Exchange.
		42" height is Nominal

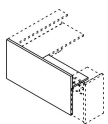

Return Single Finishes

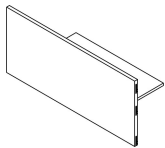
description	w*	d	h	pattern no.	L	V1	V2	V3
 Left hand shown	54"	20"	42"	RAFR(L/R)5420 () () () ()	\$1,280.	\$1,984.	\$2,283.	\$2,966.
	60"	20"	42"	RAFR(L/R)6020 () () () ()	1,333.	2,066.	2,377.	3,089.
	66"	20"	42"	RAFR(L/R)6620 () () () ()	1,440.	2,233.	2,568.	3,337.
	72"	20"	42"	RAFR(L/R)7220 () () () ()	1,494.	2,318.	2,665.	3,465.
	78"	20"	42"	RAFR(L/R)7820 () () () ()	1,557.	2,415.	2,777.	3,610.
	84"	20"	42"	RAFR(L/R)8420 () () () ()	1,630.	2,529.	2,906.	3,779.
	90"	20"	42"	RAFR(L/R)9020 () () () ()	1,696.	2,629.	3,023.	3,929.
	96"	20"	42"	RAFR(L/R)9620 () () () ()	1,766.	2,738.	3,149.	4,093.

W* = Overall foot print width - Nominal

Note: All noted width dimensions are an "out to out" overall foot print, including all additional components which are required and ordered separately.

Order Code

Example:	RAFR(L/R)5420
RA	Reff Administrative
FR	Full Return
L	Left hand
54	54" wide, Nominal
20	20" overall
()	Grommet option
()	Grommet finish
()	Modesty finish
()	Worksurface finish
G	Drilling options

Specification Information

To order please specify pattern number including:

- Grommet Option:
F = Flush
N = No Grommet
- Grommet Finish:
Painted or Plated
- Modesty Finish:
Wood or Laminate
- Worksurface Finish:
Wood or Laminate
- Drilling Options:
E = End Support drilling 28³/₈"
G = Gable Support drilling 42"

Nominal vs Actual widths

Width	Modesty Actual	Top Actual
54"	51.9"	22"
60"	57.9"	28"
66"	63.9"	34"
72"	69.9"	40"
78"	75.9"	46"
84"	81.9"	52"
90"	87.9"	58"
96"	93.9"	64"

Overall Depth: 20" Nominal
 Worksurface Depth: 18.9" Actual
 Height: 42" Nominal = 41.5" Actual

Application Notes

It is Not advisable to mix 28³/₈"h desk height products with 26¹/₂" standard height products.

Products on this page are engineered to work with 28³/₈" planning.

Products on this page will accept all Laminates except "wood grain laminates".

Installation instruction sheets available on Knoll Exchange. Reference number 6TP00320.

All worksurfaces are 1 1/2" thick.

Includes a 20"d (nominal) worksurface. Includes thick modesty.

Return with Cabinet support (TG)

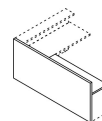

Return with "end support" - 28³/₈"h

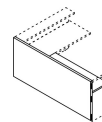

Return with Gable support - 42"h

See page 458 for End Support options.

Return

Mixed Finishes

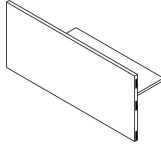
description	w*	d	h	pattern no.	L/V1	L/V2	L/V3	V1/L	V2/L	V3/L
 <p>Left hand shown</p>	54"	20"	42"	RAFR(L/R)5420 () () ()	\$1,422.	\$1,457.	\$1,564.	\$1,881.	\$2,123.	\$2,532.
	60"	20"	42"	RAFR(L/R)6020 () () ()	1,473.	1,512.	1,641.	1,944.	2,209.	2,665.
	66"	20"	42"	RAFR(L/R)6620 () () ()	1,614.	1,655.	1,803.	2,104.	2,391.	2,896.
	72"	20"	42"	RAFR(L/R)7220 () () ()	1,669.	1,716.	1,884.	2,170.	2,479.	3,032.
	78"	20"	42"	RAFR(L/R)7820 () () ()	1,738.	1,790.	1,977.	2,241.	2,573.	3,171.
	84"	20"	42"	RAFR(L/R)8420 () () ()	1,825.	1,882.	2,087.	2,303.	2,659.	3,307.
	90"	20"	42"	RAFR(L/R)9020 () () ()	1,897.	1,960.	2,186.	2,387.	2,764.	3,459.
	96"	20"	42"	RAFR(L/R)9620 () () ()	1,980.	2,048.	2,293.	2,466.	2,867.	3,608.

W* = Overall foot print width - Nominal

Note: All noted width dimensions are an "out to out" overall foot print, including all additional components which are required and ordered separately.

Order Code

Example:	RAFR(L/R)5420
RA	Reff Administrative
FR	Full Return
L	Left hand
54	54" wide, Nominal
20	20" overall
()	Grommet option
()	Grommet finish
()	Modesty finish
()	Worksurface finish
G	Drilling options

Specification Information

To order please specify pattern number including:

- Grommet Option:
F = Flush
N = No Grommet
- Grommet Finish:
Painted or Plated
- Modesty Finish:
Wood or Laminate
- Worksurface Finish:
Wood or Laminate
- Drilling Options:
E = End Support drilling 28³/₈"
G = Gable Support drilling 42"

Nominal vs Actual widths

Width	Modesty	Top
Nominal	Actual	Actual
54"	51.9"	22"
60"	57.9"	28"
66"	63.9"	34"
72"	69.9"	40"
78"	75.9"	46"
84"	81.9"	52"
90"	87.9"	58"
96"	93.9"	64"

Overall Depth: 20" Nominal
Worksurface Depth: 18.9" Actual
Height: 42" Nominal = 41.5" Actual

Application Notes

All worksurfaces are 1 1/2" thick.

Includes a 20" (nominal) worksurface.
Includes thick modesty.

Return with Cabinet support. (TG)

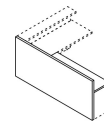

Return with "end support" - 28³/₈"h

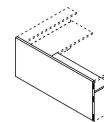

Return with Gable support - 42"h

See page 458 for End Support options.

It is Not advisable to mix 28³/₈"h desk height products with 26¹/₂" standard height products.

Products on this page are engineered to work with 28³/₈" planning.

Products on this page will accept all Laminates except "wood grain laminates".

Installation instruction sheets available on Knoll Exchange.
Reference number 6TP00320.

Shared Return One Sided

Single Finishes

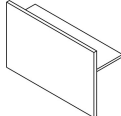
description	w*	d	h	pattern no.	L	V1	V2	V3
 Shared Return One Side	66"	20"	42"	RASRS(L/R)6620() () ()	\$1,017.	\$1,661.	\$1,910.	\$2,482.
	72"	20"	42"	RASRS(L/R)7220() () ()	1,092.	1,781.	2,049.	2,663.
	78"	20"	42"	RASRS(L/R)7820() () ()	1,147.	1,872.	2,154.	2,798.
	84"	20"	42"	RASRS(L/R)8420() () ()	1,235.	2,017.	2,320.	3,015.
	90"	20"	42"	RASRS(L/R)9020() () ()	1,285.	2,099.	2,413.	3,138.
	96"	20"	42"	RASRS(L/R)9620() () ()	1,400.	2,285.	2,627.	3,415.

Left hand shown

w* = Overall foot print widths - Nominal

Note: All noted width dimensions are an "out to out" overall foot print, including all additional components which are required and ordered separately.

Order Code

Example:	RASRS(L/R)6620
RA	Reff Administrative
SR	Shared Return
S	Single
R	Right hand
66	66" wide overall foot print
20	20" overall depth
()	Grommet option
()	Grommet finish
()	Modesty finish
()	Worksurface finish

Specification Information

To order please specify pattern number including:

- Grommet Option:
F = Flush
N = No Grommet
- Grommet Finish:
Painted or Plated
- Modesty Finish:
Wood or Laminate
- Worksurface Finish:
Wood or Laminate

Nominal vs Actual widths

Width	Modesty Actual	Top Actual
66"	34"	34"
72"	40"	40"
78"	46"	46"
84"	52"	52"
90"	58"	58"
96"	64"	64"

Overall Depth: 20" Nominal
 Worksurface Depth: 18.9" Actual
 Height: 42" Nominal = 41.5" Actual

Application Notes

It is Not advisable to mix 28 3/8" h desk height products with 26 1/2" standard height products.

Products on this page are engineered to work with 28 3/8" planning.

Products on this page will accept all Laminates except "wood grain laminates".

Installation instruction sheets available on Knoll Exchange.
 Reference number 6TP00320.

All worksurfaces are 1 1/2" thick.

Must be used with end support. Always comes with drilling to accept 28 3/8" h (only) end support components.

End support must be ordered separately. 42" high Gable cannot be used in this application. Hardware for attachment included.

Use Desk Height End Support if no storage. See page 458.

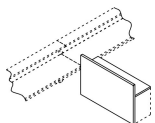

Shared Return One Sided

Mixed Finishes

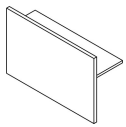
description	w*	d	h	pattern no.	L/V1	L/V2	L/V3	V1/L	V2/L	V3/L
 Shared Return One Side	66"	20"	42"	RASRS(L/R)6620() () () ()	\$1,173.	\$1,215.	\$1,362.	\$1,536.	\$1,711.	\$1,977.
	72"	20"	42"	RASRS(L/R)7220() () () ()	1,259.	1,306.	1,474.	1,642.	1,839.	2,154.
	78"	20"	42"	RASRS(L/R)7820() () () ()	1,321.	1,374.	1,561.	1,700.	1,920.	2,283.
	84"	20"	42"	RASRS(L/R)8420() () () ()	1,433.	1,489.	1,696.	1,836.	2,078.	2,488.
	90"	20"	42"	RASRS(L/R)9020() () () ()	1,485.	1,547.	1,774.	1,894.	2,159.	2,617.
	96"	20"	42"	RASRS(L/R)9620() () () ()	1,647.	1,714.	1,960.	2,067.	2,354.	2,861.

Left hand shown

w* = Overall foot print width - Nominal

Note: All noted width dimensions are an "out to out" overall foot print, including all additional components which are required and ordered separately.

Order Code

Example:	RASPS(L/R)6620
RA	Reff Administrative
SR	Shared Return
S	Single
R	Right hand
66	66" wide overall foot print
20	20" overall depth
()	Grommet option
()	Grommet finish
()	Modesty finish
()	Worksurface finish

Specification Information

To order please specify pattern number including:

- Grommet Option:
F = Flush
N = No Grommet
- Grommet Finish:
Painted or Plated
- Modesty Finish:
Wood or Laminate
- Worksurface Finish:
Wood or Laminate

Nominal vs Actual widths

Width	Modesty	Top
Nominal	Actual	Actual
66"	34"	34"
72"	40"	40"
78"	46"	46"
84"	52"	52"
90"	58"	58"
96"	64"	64"

Overall Depth: 20" Nominal
 Worksurface Depth: 18.9" Actual
 Height: 42" Nominal = 41.5" Actual

Application Notes

It is Not advisable to mix 28^{3/8}"h desk height products with 26^{1/2}" standard height products.

Products on this page are engineered to work with 28^{3/8}" planning.

Products on this page will accept all Laminates except "wood grain laminates".

Installation instruction sheets available on Knoll Exchange. Reference number 6TP00320.

All worksurfaces are 1^{1/2}" thick.

Must be used with end support. Always comes with drilling to accept 28^{3/8}"h (only) end support components. End support must be ordered separately.

42" height Gable cannot be used in this application. Hardware for attachment included.

Use Desk Height End Support if no storage. See page 458.

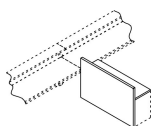

Shared Return Two Sided Single Finishes

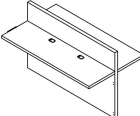
description	w*	d	h	pattern no.	L	V1	V2	V3
 Shared Return Two Sided	66"	20"	42"	RASRD6620 () () () ()	\$1,353.	\$2,138.	\$2,459.	\$3,197.
	72"	20"	42"	RASRD7220 () () () ()	1,442.	2,281.	2,621.	3,409.
	78"	20"	42"	RASRD7820 () () () ()	1,518.	2,400.	2,760.	3,588.
	84"	20"	42"	RASRD8420 () () () ()	1,616.	2,555.	2,939.	3,820.
	90"	20"	42"	RASRD9020 () () () ()	1,681.	2,658.	3,057.	3,973.
	96"	20"	42"	RASRD9620 () () () ()	1,821.	2,881.	3,313.	4,307.

w* = Overall foot print width - Nominal

Note: All noted width dimensions are an "out to out" overall foot print, including all additional components which are required and ordered separately.

Order Code	Specification Information	Application Notes
Example: RASRD6620	<i>To order please specify pattern number including:</i>	<p>It is Not advisable to mix 28^{3/8}"h desk height products with 26^{1/2}" standard height products.</p> <p>Products on this page are engineered to work with 28^{3/8}" planning.</p> <p>Products on this page will accept all Laminates except "wood grain laminates".</p> <p>Installation instruction sheets available on Knoll Exchange. Reference number 6TP00320.</p>
RA Reff Administrative	1. Grommet Option: F = Flush N = No Grommet	
SR Shared Return	2. Grommet Finish: Painted or Plated	
D Double	3. Modesty Finish: Wood or Laminate	
66 66" wide overall foot print	4. Worksurface Finish: Wood or Laminate	<p>All worksurfaces are 1 1/2" thick.</p> <p>Must be used with end support. Always comes with drilling to accept 28^{3/8}"h (only) end support components. End support must be ordered separately. 42" height Gable cannot be used in this application. Hardware for attachment included.</p> <p>Use Desk Height End Support if no storage. See page 458.</p>
20 20" overall depth	Nominal vs Actual widths	
() Grommet option	Width Modesty Top Nominal Actual Actual	
() Grommet finish	66" 34" 34"	
() Modesty finish	72" 40" 40"	
() Worksurface finish	78" 46" 46"	
	84" 52" 52"	
	90" 58" 58"	
	96" 64" 64"	

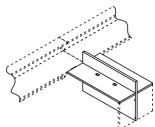

Overall Depth: 20" Nominal
 Worksurface Depth: 18.9" Actual
 Height: 42" Nominal = 41.5" Actual

Shared Return Two Sided

Mixed Finishes

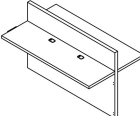
description	w*	d	h	pattern no.	L/V1	L/V2	L/V3	V1/L	V2/L	V3/L
 Shared Return Two Sided	66"	20"	42"	RASRD6620()	\$1,680.	\$1,764.	\$2,060.	\$1,890.	\$2,063.	\$2,331.
	72"	20"	42"	RASRD7220()	1,785.	1,881.	2,216.	2,005.	2,203.	2,515.
	78"	20"	42"	RASRD7820()	1,876.	1,979.	2,353.	2,074.	2,293.	2,656.
	84"	20"	42"	RASRD8420()	1,998.	2,110.	2,523.	2,214.	2,456.	2,867.
	90"	20"	42"	RASRD9020()	2,066.	2,189.	2,643.	2,283.	2,548.	3,005.
	96"	20"	42"	RASRD9620()	2,267.	2,399.	2,891.	2,481.	2,769.	3,274.

w* = Overall foot print width - Nominal

Note: All noted width dimensions are an "out to out" overall foot print, including all additional components which are required and ordered separately.

Order Code	Specification Information	Application Notes
Example: RASRD6620	To order please specify pattern number including:	<p>It is Not advisable to mix 28^{3/8}"h desk height products with 26^{1/2}" standard height products.</p> <p>Products on this page are engineered to work with 28^{3/8}"</p> <p>Products on this page will accept all Laminates except "wood grain laminates".</p> <p>Installation instruction sheets available on Knoll Exchange. Reference number 6TP00320.</p>
RA Reff Administrative	1. Grommet Option: F = Flush N = No Grommet	
SR Shared Return	2. Grommet Finish: Painted or Plated	
R Right hand	3. Modesty Finish: Wood or Laminate	
S Single	4. Worksurface Finish: Wood or Laminate	
66 66" wide overall foot print	Nominal vs Actual widths	
20 20" overall depth	Width Modesty Top Nominal Actual Actual	
() Grommet option	66" 34" 34"	
() Grommet finish	72" 40" 40"	
() Modesty finish	78" 46" 46"	
() Worksurface finish	84" 52" 52"	
	90" 58" 58"	
	96" 64" 64"	

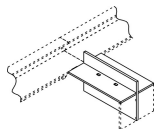

Overall Depth: 20" Nominal
 Worksurface Depth: 18.9" Actual
 Height: 42" Nominal = 41.5" Actual

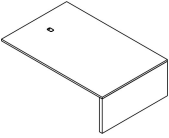
description	w	d	h	pattern no.	L	V1	V2	V3
 Peninsula	62"	40"	22 ³ / ₈ "	RAIE6240() ()	\$1,179.	\$1,743.	\$2,005.	\$2,607.
	68"	40"	22 ³ / ₈ "	RAIE6840() ()	1,202.	1,779.	2,047.	2,660.
	74"	40"	22 ³ / ₈ "	RAIE7440() ()	1,222.	1,806.	2,077.	2,700.
	62"	48"	22 ³ / ₈ "	RAIE6248() ()	1,272.	1,881.	2,163.	2,811.
	68"	48"	22 ³ / ₈ "	RAIE6848() ()	1,292.	1,912.	2,198.	2,858.
	74"	48"	22 ³ / ₈ "	RAIE7448() ()	1,314.	1,944.	2,236.	2,906.

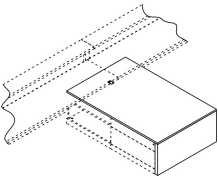
Order Code	Specification Information	Application Notes
Example: RAIE6240 RA Reff Administrative I Island Peninsula E 1" thick top 62 Width 40 Depth () Grommet Finish () Top Finish () End Panel Finish	<p><i>To order please specify pattern number including:</i></p> <ol style="list-style-type: none"> Grommet Finish: Painted or plated Worksurface finish: Wood or Laminate End panel finish: 	<p>It is Not advisable to mix 28³/₈"h desk height products with 26¹/₂" standard height products.</p> <p>Products on this page are engineered to work with 28³/₈" planning.</p> <p>Products on this page will accept all Laminates except "wood grain laminates".</p> <p>Installation instruction sheets available on Knoll Exchange. Reference number 6TP00320.</p> <p>Mid-span cantilever bracket (RMSCB) or a return must be ordered for additional support for units greater than 54" wide.</p>
		<p>The worksurfaces for Island Peninsulas are 1" thick.</p> <p>These worksurfaces come with standard grommet. 12" inset from back edge, center or depth.</p> <p>Peninsula height = 22³/₃₂" to the underside of worksurface.</p> <p>Intended to have full storage under tops. (30 x 30, 30 x 36, 36 x 36)</p> <p>22³/₈"h lower storage to be used with this product.</p> <p>Drilled to accept 30" and 36" wide x 22³/₈" high storage units.</p> <p>Intended to be freestanding slide or sit under the primary worksurface.</p>

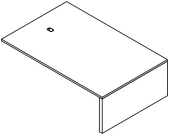
description	w	d	h	pattern no.	L/V1	L/V2	L/V3	V1/L	V2/L	V3/L
 Peninsula	62"	40"	22 ³ / ₈ "	RAIE6240() ()	\$1,299.	\$1,408.	\$1,786.	\$1,667.	\$1,791.	\$1,957.
	68"	40"	22 ³ / ₈ "	RAIE6840() ()	1,329.	1,449.	1,857.	1,687.	1,836.	1,978.
	74"	40"	22 ³ / ₈ "	RAIE7440() ()	1,352.	1,480.	1,918.	1,710.	1,837.	2,002.
	62"	48"	22 ³ / ₈ "	RAIE6248() ()	1,395.	1,524.	1,961.	1,834.	1,976.	2,176.
	68"	48"	22 ³ / ₈ "	RAIE6848() ()	1,420.	1,561.	2,031.	1,860.	2,004.	2,203.
	74"	48"	22 ³ / ₈ "	RAIE7448() ()	1,446.	1,598.	2,105.	1,887.	2,030.	2,229.

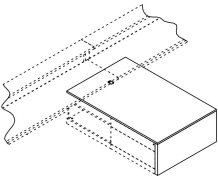
Order Code	Specification Information	Application Notes
Example: RAIE6240 RA Reff Administrative I Island Peninsula E 1" thick top 62 Width 40 Depth () Grommet Finish () Top Finish () End Panel Finish	<i>To order please specify pattern number including:</i> 1. Grommet Finish: Painted or plated 2. Worksurface finish: Wood or Laminate 3. End panel finish:	<p>It is Not advisable to mix 28³/₈"h desk height products with 26¹/₂" standard height products.</p> <p>Products on this page are engineered to work with 28³/₈" planning.</p> <p>Products on this page will accept all Laminates except "wood grain laminates".</p> <p>Installation instruction sheets available on Knoll Exchange. Reference number 6TP00320.</p> <p>Mid-span cantilever bracket (RMSCB) or a return must be ordered for additional support for units greater than 54" wide.</p> <p>The worksurfaces for Island Peninsulas are 1" thick.</p> <p>These worksurfaces come with standard grommet. 12" inset from back edge, center or depth.</p> <p>Peninsula height = 22³/₃₂" to the underside of worksurface.</p> <p>Intended to have full storage under tops. (30 x 30, 30 x 36, 36 x 36)</p> <p>22³/₈"h lower storage to be used with this product.</p> <p>Drilled to accept 30" and 36" wide x 22³/₈" high storage units.</p> <p>Intended to be freestanding slide or sit under the primary worksurface.</p>
		

Infill Panel
Flush Single / Double
Type A; Recessed on Top

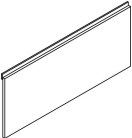
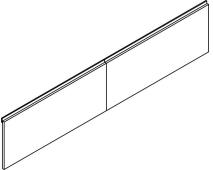
description	w	h	th	pattern no.	L	V1	V2	V3
Flush Infill Panel, 1 piece 	66"	39"	2 1/2"	RAIPFAWS66()	\$889.	\$1,042.	\$1,199.	\$1,560.
	72"	39"	2 1/2"	RAIPFAWS72()	927.	1,087.	1,249.	1,625.
	78"	39"	2 1/2"	RAIPFAWS78()	1,003.	1,177.	1,353.	1,758.
	84"	39"	2 1/2"	RAIPFAWS84()	1,032.	1,210.	1,392.	1,809.
	90"	39"	2 1/2"	RAIPFAWS90()	1,073.	1,259.	1,448.	1,884.
	96"	39"	2 1/2"	RAIPFAWS96()	1,103.	1,295.	1,488.	1,935.
Flush Infill Panel, 2 pieces 	102"	39"	2 1/2"	RAIPFAWD102()	1,780.	2,088.	2,402.	3,122.
	108"	39"	2 1/2"	RAIPFAWD108()	1,818.	2,133.	2,454.	3,191.
	114"	39"	2 1/2"	RAIPFAWD114()	1,872.	2,196.	2,526.	3,282.
	120"	39"	2 1/2"	RAIPFAWD120()	1,911.	2,241.	2,577.	3,351.
	126"	39"	2 1/2"	RAIPFAWD126()	2,027.	2,378.	2,735.	3,555.
	132"	39"	2 1/2"	RAIPFAWD132()	2,064.	2,423.	2,786.	3,622.
	138"	39"	2 1/2"	RAIPFAWD138()	2,118.	2,485.	2,858.	3,715.
	144"	39"	2 1/2"	RAIPFAWD144()	2,250.	2,639.	3,035.	3,946.
	150"	39"	2 1/2"	RAIPFAWD150()	2,289.	2,684.	3,088.	4,015.
	156"	39"	2 1/2"	RAIPFAWD156()	2,327.	2,729.	3,140.	4,081.
	162"	39"	2 1/2"	RAIPFAWD162()	2,366.	2,774.	3,191.	4,147.
	168"	39"	2 1/2"	RAIPFAWD168()	2,403.	2,820.	3,242.	4,215.
	174"	39"	2 1/2"	RAIPFAWD174()	2,463.	2,889.	3,323.	4,319.
	180"	39"	2 1/2"	RAIPFAWD180()	2,501.	2,934.	3,374.	4,387.
	186"	39"	2 1/2"	RAIPFAWD186()	2,539.	2,980.	3,427.	4,454.
	192"	39"	2 1/2"	RAIPFAWD192()	2,578.	3,024.	3,434.	4,520.

* Pattern number includes 2 pieces

Order Code

Example: RAIPFAWS66	
RA	Reff Administrative
IP	Infill Panel
FA	Flush Type A
WS	Wood, single (1pc)
66	Width
()	Finish

Specification Information

To order please specify pattern number including:
 1. Infill Finish:
 Wood or Laminate

It is Not advisable to mix 28 3/8" h desk height products with 26 1/2" standard height products.

Products on this page will accept all Laminates except "wood grain laminates".

For detailed information please refer to the installation instruction sheets.

All installation instructions available on the Knoll Exchange. Reference number 6TP00320.

Application Notes

Type A = recessed on top only.

These infill panels sit flush to both end supports with a reveal at the top of the infill.

Double wide = Two equal width pieces

Veneer finishes come matched.

Infill Panel
Flush Single / Double
Type B, Recessed on top and bottom

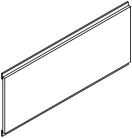
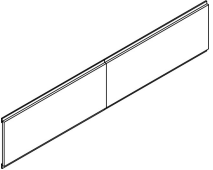
description	w	h	th	pattern no.	L	V1	V2	V3
Flush Infill Panel, 1 piece 	66"	39"	2 1/2"	RAIPFBWS66()	\$979.	\$1,148.	\$1,321.	\$1,717.
	72"	39"	2 1/2"	RAIPFBWS72()	1,010.	1,183.	1,361.	1,769.
	78"	39"	2 1/2"	RAIPFBWS78()	1,094.	1,283.	1,475.	1,918.
	84"	39"	2 1/2"	RAIPFBWS84()	1,122.	1,316.	1,515.	1,969.
	90"	39"	2 1/2"	RAIPFBWS90()	1,165.	1,366.	1,572.	2,045.
	96"	39"	2 1/2"	RAIPFBWS96()	1,195.	1,403.	1,613.	2,097.
Flush Infill Panel, 2 pieces 	102"	39"	2 1/2"	RAIPFBWD102()	1,965.	2,303.	2,650.	3,445.
	108"	39"	2 1/2"	RAIPFBWD108()	2,004.	2,350.	2,704.	3,516.
	114"	39"	2 1/2"	RAIPFBWD114()	2,060.	2,417.	2,780.	3,614.
	120"	39"	2 1/2"	RAIPFBWD120()	2,098.	2,460.	2,830.	3,680.
	126"	39"	2 1/2"	RAIPFBWD126()	2,217.	2,601.	2,991.	3,889.
	132"	39"	2 1/2"	RAIPFBWD132()	2,255.	2,645.	3,041.	3,954.
	138"	39"	2 1/2"	RAIPFBWD138()	2,310.	2,710.	3,115.	4,051.
	144"	39"	2 1/2"	RAIPFBWD144()	2,441.	2,862.	3,292.	4,279.
	150"	39"	2 1/2"	RAIPFBWD150()	2,482.	2,911.	3,349.	4,351.
	156"	39"	2 1/2"	RAIPFBWD156()	2,517.	2,953.	3,395.	4,415.
	162"	39"	2 1/2"	RAIPFBWD162()	2,557.	3,000.	3,449.	4,485.
	168"	39"	2 1/2"	RAIPFBWD168()	2,596.	3,045.	3,501.	4,553.
	174"	39"	2 1/2"	RAIPFBWD174()	2,656.	3,115.	3,582.	4,658.
	180"	39"	2 1/2"	RAIPFBWD180()	2,692.	3,157.	3,632.	4,720.
	186"	39"	2 1/2"	RAIPFBWD186()	2,734.	3,206.	3,687.	4,793.
	192"	39"	2 1/2"	RAIPFBWD192()	2,771.	3,250.	3,737.	4,857.

* Pattern number includes 2 pieces

Order Code

Example:	RAIPFBWS66
RA	Reff Administrative
IP	Infill Panel
FB	Flush Type B
WS	Wood
66	Width
()	Finish

Specification Information

To order please specify pattern number including:
 1. Infill Finish:
 Wood or Laminate

It is Not advisable to mix 28 3/8" h desk height products with 26 1/2" standard height products.

Products on this page will accept all Laminates except "wood grain laminates".

For detailed information please refer to the installation instruction sheets.

All installation instructions available on the Knoll Exchange. Reference number 6TP00320.

Application Notes

Type B = recessed on top and bottom.

Does not extend to the floor.

Type B infill panels, sit flush between both end supports and has a reveal at the top and bottom of the infill panel.

Double wide = two equal width pieces.

Veneer finishes come matched.

Infill Panel

Recessed Single / Double

Wood

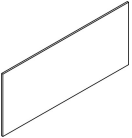
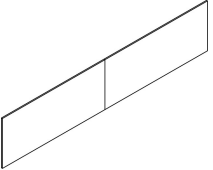
description	w	h	th	pattern no.	L	V1	V2	V3
Recessed Infill Panel, 1 piece 	66"	39"	1"	RAIPRWS66()	\$662.	\$776.	\$892.	\$1,160.
	72"	39"	1"	RAIPRWS72()	691.	810.	932.	1,211.
	78"	39"	1"	RAIPRWS78()	751.	882.	1,015.	1,317.
	84"	39"	1"	RAIPRWS84()	773.	906.	1,041.	1,355.
	90"	39"	1"	RAIPRWS90()	809.	948.	1,091.	1,418.
	96"	39"	1"	RAIPRWS96()	829.	974.	1,119.	1,456.
Recessed Infill Panel, 2 pieces 	102"	39"	1"	RAIPRWD102()	1,388.	1,628.	1,871.	2,433.
	108"	39"	1"	RAIPRWD108()	1,416.	1,661.	1,910.	2,482.
	114"	39"	1"	RAIPRWD114()	1,462.	1,714.	1,971.	2,561.
	120"	39"	1"	RAIPRWD120()	1,488.	1,747.	2,008.	2,611.
	126"	39"	1"	RAIPRWD126()	1,567.	1,838.	2,114.	2,748.
	132"	39"	1"	RAIPRWD132()	1,609.	1,888.	2,170.	2,822.
	138"	39"	1"	RAIPRWD138()	1,641.	1,923.	2,213.	2,876.
	144"	39"	1"	RAIPRWD144()	1,748.	2,050.	2,356.	3,064.
	150"	39"	1"	RAIPRWD150()	1,775.	2,082.	2,394.	3,113.
	156"	39"	1"	RAIPRWD156()	1,806.	2,118.	2,435.	3,167.
	162"	39"	1"	RAIPRWD162()	1,834.	2,151.	2,474.	3,215.
	168"	39"	1"	RAIPRWD168()	1,863.	2,185.	2,513.	3,269.
	174"	39"	1"	RAIPRWD174()	1,921.	2,253.	2,591.	3,368.
	180"	39"	1"	RAIPRWD180()	1,952.	2,290.	2,633.	3,422.
	186"	39"	1"	RAIPRWD186()	1,979.	2,323.	2,670.	3,472.
192"	39"	1"	RAIPRWD192()	2,009.	2,356.	2,711.	3,524.	

Pattern number includes 2 pieces

Order Code

Example: RAIPRWS66	
RA	Reff Administrative
IP	Infill Panel
R	Recessed
W	Wood
S	Single (1 pc)
66	Width
()	Finish

Specification Information

To order please specify pattern number including:
 1. Finish:
 Wood or Laminate

It is Not advisable to mix 28 3/8" h desk height products with 26 1/2" standard height products.

Products on this page will accept all Laminates except "wood grain laminates".

For detailed information please refer to the installation instruction sheets.

All installation instructions available on the Knoll Exchange. Reference number 6TP00320.

Application Notes

Double wide = Two equal width pieces

This product sits recessed between both end supports. This product has no reveal.

Natural Veneer finishes come matched.

Infill Panel

Recessed Single / Double Glass

description	Overall width	w	h	th	pattern no.	glass
Recessed Infill Panel 1 piece required 	66"	66"	39"	1"	RAIPRGS66()	\$2,802.
	72"	72"	39"	1"	RAIPRGS72()	3,002.
	78"	78"	39"	1"	RAIPRGS78()	3,314.
	84"	84"	39"	1"	RAIPRGS84()	3,517.
	90"	90"	39"	1"	RAIPRGS90()	3,697.
	96"	96"	39"	1"	RAIPRGS96()	3,876.

Single pattern number includes 1 piece of glass

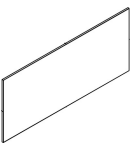
Recessed Infill Panel 2 pieces required 	102"	51"	39"	1"	RAIPRGD51()	2,413.
	108"	54"	39"	1"	RAIPRGD54()	2,502.
	114"	57"	39"	1"	RAIPRGD57()	2,593.
	120"	60"	39"	1"	RAIPRGD60()	2,682.
	126"	63"	39"	1"	RAIPRGD63()	2,772.
	132"	66"	39"	1"	RAIPRGD66()	2,862.
	138"	69"	39"	1"	RAIPRGD69()	2,973.
	144"	72"	39"	1"	RAIPRGD72()	3,194.
	150"	75"	39"	1"	RAIPRGD75()	3,283.
	156"	78"	39"	1"	RAIPRGD78()	3,373.
	162"	81"	39"	1"	RAIPRGD81()	3,486.
	168"	84"	39"	1"	RAIPRGD84()	3,576.
	174"	87"	39"	1"	RAIPRGD87()	3,666.
	180"	90"	39"	1"	RAIPRGD90()	3,756.
	186"	93"	39"	1"	RAIPRGD93()	3,846.
	192"	96"	39"	1"	RAIPRGD96()	3,935.

Pattern numbers for Double Wide Glass Infill Panels, include 1 piece of Glass only.
Must order 2 piece to complete infill

Order Code	Specification Information	Application Notes
Example: RAIPRGS66	To order please specify pattern number including:	To complete your double wide unit, you must order 2 pieces.
RA Reff Administrative	1. Frame Finish: Painted and Anodized	Glass Infill thickness, including frame = ¹⁵ / ₁₆ " overall.
IP Infill Panel	2. Glass Finish: GL11, GL14, GL15, GL17, GL18	Same hardware as the wood infill.
R Recessed		Glass infill panels are available in inset flush type, only.
G Glass		This product sits recessed between both end supports with no reveal at top or bottom.
S Single		
66 Width		
() Frame Finish		
() Glass Finish		

Infill Panel
Recessed Single / Double
Aluminum Frame Kit Customer's Own Glass

description	Overall width	w	h	th	pattern no.	P1/P2	P3/P4
Reff Administrative Infill Panel, Single Aluminum Frame Kit with Customer's Own Glass	66"	66"	39"	1"	RAIPKGS66()	\$652.	\$846.
	72"	72"	39"	1"	RAIPKGS72()	673.	855.
	78"	78"	39"	1"	RAIPKGS78()	810.	1,134.
	84"	84"	39"	1"	RAIPKGS84()	835.	1,138.
	90"	90"	39"	1"	RAIPKGS90()	836.	1,139.
	96"	96"	39"	1"	RAIPKGS96()	836.	1,139.
Reff Administrative Infill Panel, Double Aluminum Frame Kit with Customer's Own Glass 2 Kits required	102"	51"	39"	1"	RAIPKGD51()	650.	845.
	108"	54"	39"	1"	RAIPKGD54()	651.	845.
	114"	57"	39"	1"	RAIPKGD57()	651.	845.
	120"	60"	39"	1"	RAIPKGD60()	651.	846.
	126"	63"	39"	1"	RAIPKGD63()	652.	846.
	132"	66"	39"	1"	RAIPKGD66()	652.	847.
	138"	69"	39"	1"	RAIPKGD69()	673.	855.
	144"	72"	39"	1"	RAIPKGD72()	809.	1,132.
	150"	75"	39"	1"	RAIPKGD75()	810.	1,134.
	156"	78"	39"	1"	RAIPKGD78()	810.	1,134.
	162"	81"	39"	1"	RAIPKGD81()	835.	1,138.
	168"	84"	39"	1"	RAIPKGD84()	835.	1,138.
	174"	87"	39"	1"	RAIPKGD87()	835.	1,138.
	180"	90"	39"	1"	RAIPKGD90()	836.	1,139.
186"	93"	39"	1"	RAIPKGD93()	836.	1,139.	
192"	96"	39"	1"	RAIPKGD96()	837.	1,140.	

Order Code	Specification Information	Application Notes
Example: RAIPKGS66	To order please specify pattern number including: 1. Finish type 2. Frame Finish: Painted and Anodized	<p>It is Not advisable to mix 28^{3/8}"h desk height product with 26^{1/2}" standard height products.</p> <p>For detailed information please refer to the installation instruction sheets.</p> <p>All installation instructions available on Knoll Exchange. For Administrative / Reception; reference number 6TP00320. For customers' own Glass; reference number 6TP00442. For customers' own Solid; reference number 6TP00302.</p> <p>To complete your double wide unit, you must order 2 pieces.</p> <p>Glass Infill frame thickness 15/16".</p> <p>Same hardware as the wood infill.</p> <p>Glass infill panels are available in inset flush type, only.</p> <p>This product sits recessed between both end supports with no reveal at top or bottom.</p> <p>To calculate glass height and width subtract 3/16 ± 0.031 from frame values.</p> <p>Recommended glass thickness is 5mm.</p>
RA Reff Administrative		
IP Infill Panel		
K Frame Kit		
G Glass		
S Single, D = Double		
66 Width		
() Finish Type		
() Frame Finish		

Transaction Tops Bridge

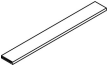
description	w	d	th	pattern no.	L	V1	V2	V3
 Bridge	72"	8"	1 1/2"	RATTBR72()	\$410.	\$433.	\$498.	\$648.
	78"	8"	1 1/2"	RATTBR78()	429.	450.	518.	671.
	84"	8"	1 1/2"	RATTBR84()	442.	462.	532.	691.
	90"	8"	1 1/2"	RATTBR90()	461.	502.	578.	750.
	96"	8"	1 1/2"	RATTBR96()	474.	514.	591.	769.

Note: All noted width dimensions are an "out to out" overall foot print, including all additional components which are required and ordered separately.

Order Code	Specification Information	Application Notes
Example: RATTBR72	<i>To order please specify pattern number including:</i>	Between front shelf and end support. Used on full Bridge Return Units Only. This unit is not intended to be used on its own. Retro fit kit included to attach to the accompanying unit. Hardware kit included. All transaction tops are manufactured to fit within the end supports components.
RA Reff Administrative	1. Transaction Top Finish: Wood and Laminate	
TT Transaction Tops	Nominal double vs Actual sizes	
BR Bridge Return	<i>Nominal Actual</i>	
72 72" wide	72" 44.1"	
() Finish	78" 50.1"	
	84" 56.1"	
	90" 62.1"	
	96" 68.1"	
	It is Not advisable to mix 28 3/8" h desk height products with 26 1/2" standard height products. Products on this page will accept all Laminates except "wood grain laminates". Note: All installation instructions available on the Knoll Exchange. Reference number 6TP00320. For customers' own material: Reference number 6TP00301.	

Transaction Tops Return

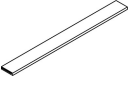
description	w	d	th	pattern no.	L	V1	V2	V3
 Full Return	54"	8"	1 1/2"	RATTFR54()	\$406.	\$428.	\$492.	\$641.
	60"	8"	1 1/2"	RATTFR60()	424.	444.	509.	662.
	66"	8"	1 1/2"	RATTFR66()	436.	456.	526.	684.
	72"	8"	1 1/2"	RATTFR72()	453.	498.	572.	744.
	78"	8"	1 1/2"	RATTFR78()	469.	509.	586.	763.
	84"	8"	1 1/2"	RATTFR84()	490.	522.	599.	778.
	90"	8"	1 1/2"	RATTFR90()	501.	537.	617.	804.
	96"	8"	1 1/2"	RATTFR96()	513.	566.	651.	848.

Note: All noted width dimensions are an "out to out" overall foot print, including all additional components which are required and ordered separately.

Order Code	Specification Information	Application Notes
Example: RATTFR54	<i>To order please specify pattern number including:</i>	It is Not advisable to mix 28 3/8" h desk height products with 26 1/2" standard height products.
RA Reff Administrative	1. Transaction Top Finish: Wood and Laminate	
TT Transaction Tops	Nominal vs Actual sizes	Products on this page will accept all Laminates except "wood grain laminates". Note: All installation instructions available on the Knoll Exchange. Reference number 6TP00320. For customers' own material: Reference number 6TP00301.
FR Full Return	<i>Nominal Actual</i>	
54 54" wide, Nominal	54" 41.6"	
() Finish	60" 47.6"	
	66" 53.6"	
	72" 59.6"	
	78" 65.6"	
	84" 71.6"	
	90" 77.6"	
	96" 83.6"	
		All transaction tops are manufactured to fit within the end supports components. Between front shelf and end support Used on full Return Units Only This unit is not intended to be used on its own Retro fit kit included to attach to the accompanying unit Hardware kit included

Transaction Tops
Single and Double
Wood / Laminate

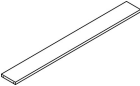
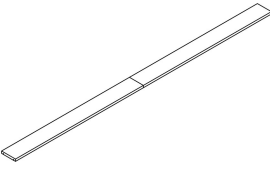

description	w	d	th	pattern no.	L	V1	V2	V3
Front Single 	66"	10"	1 1/2"	RATTDS66()	\$506.	\$536.	\$616.	\$802.
	72"	10"	1 1/2"	RATTDS72()	514.	550.	633.	823.
	78"	10"	1 1/2"	RATTDS78()	522.	565.	649.	846.
	84"	10"	1 1/2"	RATTDS84()	529.	589.	677.	880.
	90"	10"	1 1/2"	RATTDS90()	536.	620.	714.	929.
	96"	10"	1 1/2"	RATTDS96()	542.	636.	730.	950.
Front Double comes in 2 pieces 	102"	10"	1 1/2"	RATTDD102()	887.	1,015.	1,165.	1,516.
	108"	10"	1 1/2"	RATTDD108()	895.	1,033.	1,188.	1,544.
	114"	10"	1 1/2"	RATTDD114()	902.	1,052.	1,210.	1,573.
	120"	10"	1 1/2"	RATTDD120()	909.	1,072.	1,233.	1,604.
	126"	10"	1 1/2"	RATTDD126()	952.	1,148.	1,321.	1,717.
	132"	10"	1 1/2"	RATTDD132()	959.	1,167.	1,343.	1,745.
	138"	10"	1 1/2"	RATTDD138()	967.	1,188.	1,365.	1,775.
	144"	10"	1 1/2"	RATTDD144()	975.	1,206.	1,389.	1,805.
	150"	10"	1 1/2"	RATTDD150()	988.	1,227.	1,411.	1,835.
	156"	10"	1 1/2"	RATTDD156()	995.	1,255.	1,443.	1,876.
	162"	10"	1 1/2"	RATTDD162()	1,003.	1,285.	1,478.	1,921.
	168"	10"	1 1/2"	RATTDD168()	1,011.	1,305.	1,502.	1,952.
	174"	10"	1 1/2"	RATTDD174()	1,018.	1,360.	1,565.	2,033.
	180"	10"	1 1/2"	RATTDD180()	1,025.	1,377.	1,583.	2,058.
	186"	10"	1 1/2"	RATTDD186()	1,032.	1,397.	1,606.	2,088.
	192"	10"	1 1/2"	RATTDD192()	1,039.	1,419.	1,631.	2,122.

Note: All noted width dimensions are an "out to out" overall foot print, including all additional components which are required and ordered separately.

Order Code	Specification Information	Application Notes
Example: RATTDS66	To order please specify pattern number including: 1. Transaction Top Finish: Wood and Laminate	It is Not advisable to mix 28 3/8" h desk height products with 26 1/2" standard height products. Products on this page will accept all Laminates except "wood grain laminates". Note: All installation instructions available on the Knoll Exchange. Reference number 6TP00320. For customers' own material: Reference number 6TP00301.
RA Reff Administrative		
TT Transaction Tops		
DS Desk Single		
66 66" wide		
() Finish		
		No grommet options. Double comes in two pieces, Veneer matched. Hardware kit included for each unit. All transaction tops are manufactured to fit within the end supports.

Accent Tops

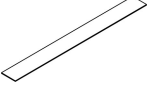
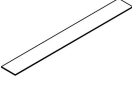
Glass Finish



description	w	d	th	pattern no.	Back painted glass	Colored glass
Accent top for Desk 	51"	10"	1/2"	RAATDG51()	\$656.	\$491.
	54"	10"	1/2"	RAATDG54()	694.	519.
	57"	10"	1/2"	RAATDG57()	730.	544.
	60"	10"	1/2"	RAATDG60()	768.	572.
	63"	10"	1/2"	RAATDG63()	806.	599.
	66"	10"	1/2"	RAATDG66()	844.	627.
	69"	10"	1/2"	RAATDG69()	880.	654.
	72"	10"	1/2"	RAATDG72()	918.	681.
	75"	10"	1/2"	RAATDG75()	955.	707.
	78"	10"	1/2"	RAATDG78()	993.	735.
	81"	10"	1/2"	RAATDG81()	1,031.	761.
	84"	10"	1/2"	RAATDG84()	1,068.	787.
	87"	10"	1/2"	RAATDG87()	1,106.	815.
	90"	10"	1/2"	RAATDG90()	1,143.	841.
93"	10"	1/2"	RAATDG93()	1,180.	867.	
96"	10"	1/2"	RAATDG96()	1,217.	894.	
Accent top for Return Full 	54"	10"	1/2"	RAATFRG54()	568.	429.
	60"	10"	1/2"	RAATFRG60()	643.	483.
	66"	10"	1/2"	RAATFRG66()	627.	536.
	72"	10"	1/2"	RAATFRG72()	794.	590.
	78"	10"	1/2"	RAATFRG78()	868.	644.
	84"	10"	1/2"	RAATFRG84()	943.	697.
	90"	10"	1/2"	RAATFRG90()	1,018.	751.
Accent top for Bridge Return 	72"	10"	1/2"	RAATBRG72()	581.	438.
	78"	10"	1/2"	RAATBRG78()	656.	491.
	84"	10"	1/2"	RAATBRG84()	730.	544.
	90"	10"	1/2"	RAATBRG90()	806.	599.
	96"	10"	1/2"	RAATBRG96()	880.	654.

Note: All noted width dimensions are an "out to out" overall foot print, including all additional components which are required and ordered separately.

Order Code	Specification Information	Application Notes
Example: RAATDG51 RA Reff Administrative AT Accent for Transaction Tops D Desk G Glass 51 Width () Glass finish	To order please specify pattern number including: 1. Glass Finish: Colored Glass: GL35, GL85 Back Painted Glass: GL11, GL14, GL15, GL17, GL18 D=Desk RF=Return Full BR=Bridge Return	It is Not advisable to mix 28 3/8" h desk height products with 26 1/2" standard height products. Note: All installation instructions available on the Knoll Exchange. Reference number 6TP00320. For customers' own material: Reference number 6TP00303.
		All accent tops are manufactured to fit over the end supports and are intended to be placed on top of transaction top. Comes with anti-skid bumper; 1/4" thick. Glass has a Polished edge, 1/2" thick. Overall thickness = 3/4" thick.

Accent Tops

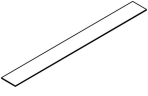
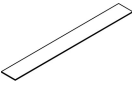
Solid Finish

description	w	d	th	pattern no.	Solid
Accent top for Desk 	51"	10"	1/2"	RAATDS51()	\$2,194.
	54"	10"	1/2"	RAATDS54()	2,257.
	57"	10"	1/2"	RAATDS57()	2,443.
	60"	10"	1/2"	RAATDS60()	2,505.
	63"	10"	1/2"	RAATDS63()	2,693.
	66"	10"	1/2"	RAATDS66()	2,754.
	69"	10"	1/2"	RAATDS69()	2,940.
	72"	10"	1/2"	RAATDS72()	3,003.
	75"	10"	1/2"	RAATDS75()	3,411.
	78"	10"	1/2"	RAATDS78()	3,477.
	81"	10"	1/2"	RAATDS81()	3,610.
	84"	10"	1/2"	RAATDS84()	3,679.
	87"	10"	1/2"	RAATDS87()	3,812.
	90"	10"	1/2"	RAATDS90()	3,879.
93"	10"	1/2"	RAATDS93()	3,946.	
96"	10"	1/2"	RAATDS96()	4,013.	
Accent top for Return Full 	54"	10"	1/2"	RAATFRS54()	1,699.
	60"	10"	1/2"	RAATFRS60()	2,071.
	66"	10"	1/2"	RAATFRS66()	2,319.
	72"	10"	1/2"	RAATFRS72()	2,568.
	78"	10"	1/2"	RAATFRS78()	2,817.
	84"	10"	1/2"	RAATFRS84()	3,344.
	90"	10"	1/2"	RAATFRS90()	3,544.
96"	10"	1/2"	RAATFRS96()	3,745.	
Accent top for Bridge Return 	72"	10"	1/2"	RAATBRS72()	1,751.
	78"	10"	1/2"	RAATBRS78()	2,132.
	84"	10"	1/2"	RAATBRS84()	2,379.
	90"	10"	1/2"	RAATBRS90()	2,630.
	96"	10"	1/2"	RAATBRS96()	2,878.

Note: All noted width dimensions are an "out to out" overall foot print, including all additional components which are required and ordered separately.

Order Code

Example: RAATDS51
RA Reff Administrative
AT Accent Transaction Tops
D Desk
S Solid Formica
51 Width

Specification Information

To order please specify pattern number including:
 1. Transaction Top Finish:
 Solid Option: AW = Artic White
 D=Desk
 RF=Return Full
 BR=Bridge Return

It is Not advisable to mix 28 3/8" h desk height products with 26 1/2" standard height products.

Note: All installation instructions available on the Knoll Exchange. Reference number 6TP00320.

For customers' own material: Reference number 6TP00303.

Application Notes

All accent tops are manufactured to fit over the end supports components.

1. Comes with "Anti Skid" bottoms; 1/4" thick.
2. Solid formica; AW = 1/2" thick.
3. Overall Accent top thickness is 3/4" thick.

Cabinets

16" Wide, Hinge Door - Both Sides

Single Finishes

description	w	d	h	pattern no.	L	V1	V2	V3
Transaction Cabinet with Trays	16"	20"	42"	RAC(L/R)HT4212() () () () ()	\$3,072.	\$4,387.	\$5,044.	\$6,558.

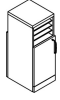

Left hand shown

Transaction Cabinet with Cubby	16"	20"	42"	RAC(L/R)HC4212() () () () ()	3,072.	4,387.	5,044.	6,558.
--------------------------------	-----	-----	-----	---	--------	--------	--------	--------



Left hand shown

Gable for Transaction Cabinet	2"	22"	42"	RACG4220()	658.	928.	1,175.	1,525.
-------------------------------	----	-----	-----	-------------------	------	------	--------	--------



Order Code

Example:	RAC(L/R)HT4212
RA	Reff Administrative
C	Cabinet
R	Right Hand
HT	Hinge Door with Trays
42	Height, Nominal
1	16" wide, Nominal
2	20" deep, Nominal
()	Lock option
()	Lock finish
()	Pull option
()	Pull finish
()	Case finish
()	Top finish
()	Drilling options

HT = Hinge Door with Trays
HC = Hinge Door with Cubby



shown with gable

Specification Information

To order please specify pattern number including:

- Lock option:
L / N
- Lock finish:
B = Black
S = Matte Black
- Pull option:
B = No pull, No drilling
Customer's own pull
C = C Pull (Nickel finish only)
D = D Pull (Metal Finishes only)
F = Bar Pull
H = Outline Pull
N = Touch Latch, No pull
R = Cylinder Pull
S = S Pull (Stainless Steel finish only)
T = Tab Pull
- Pull Finish: Core Paint Finishes and Plated
- Case Finish: Wood or Laminate
- Top Finish: Wood or Laminate
- Drilling Options:
N = None, Stand alone unit
T = Drilled to accept worksurface
TT = Drill to accept worksurface on both sides
TG = Worksurface and Gable drilling.
Gable ordered separately

It is Not advisable to mix 28^{3/8}"h desk height products with 26^{1/2}" standard height products.

Products on this page are engineered to work with 28^{3/8}" planning.

Products on this page will accept all Laminates except "wood grain laminates".

These products are glue and dowel construction.

Note: All Installation instructions are available on the Knoll Exchange. Reference number 6TP00320.

Application Notes

Wood interior only, no metal shelves.

When choose lock, it will lock both hinge doors.

Adjustable shelf above.

Fixed shelves below Hinged doors.

On the approach side, the doors only have the Touch Latch option.

Base board only on the user's side.

On the User's side, the door has lock and pull options.

"T" Drilling option:
Left hand units are drilled on the right hand side, and right hand units are drilled on left side for worksurface attachments.

From users perspective, the hinge determines handedness. ie; If hinge is on left, the unit is left handed.

Cabinets

16" Wide, Hinge Door - Both Sides

Mixed Finishes

description	w	d	h	pattern no.	L/V1	L/V2	L/V3	V1/L	V2/L	V3/L
Transaction Cabinet with Trays	16"	20"	42"	RAC(L/R)HT4212 () () () () ()	\$3,276.	\$3,330.	\$3,410.	\$4,394.	\$4,862.	\$5,641.

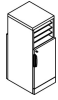

right hand shown

Transaction Cabinet with Cubby	16"	20"	42"	RAC(L/R)HC4212 () () () () ()	3,276.	3,330.	3,410.	4,394.	4,862.	5,641.
--------------------------------	-----	-----	-----	---	--------	--------	--------	--------	--------	--------



right hand shown

Order Code

Example:	RAC(L/R)HT4212
RA	Reff Administrative
C	Cabinet
R	Right Hand
HT	Hinge Door with Trays
42	Height, Nominal
1	16" wide, Nominal
2	20" deep, Nominal
()	Lock option
()	Lock finish
()	Pull option
()	Pull finish
()	Case finish
()	Top finish
()	Drilling options

HT = Hinge Door with Trays
HC = Hinge Door with Cubby



shown with gable

Specification Information

- To order please specify pattern number including:
- Lock option:
L / N
 - Lock finish:
B = Black
S = Matte Silver
 - Pull option:
B = No pull, No drilling
Customer's own pull
C = C Pull (Nickel finish only)
D = D Pull (Metal Finishes only)
F = Bar Pull
H = Outline Pull
N = Touch Latch, No pull
R = Cylinder Pull
S = S Pull (Stainless Steel finish only)
T = Tab Pull
 - Pull Finish: Core Paint
Finishes and Plated
 - Case Finish: Wood or Laminate
 - Top Finish: Wood or Laminate
 - Drilling Options:
N = None, Stand alone unit
T = Drilled to accept worksurface
TT = Drill to accept worksurface on both sides
TG = Work surface and Gable drilling.
Gable ordered separately

It is Not advisable to mix 28 3/8" desk height products with 26 1/2" standard height products.

Products on this page are engineered to work with 28 3/8" planning.

Products on this page will accept all Laminates except "wood grain laminates".

These products are glue and dowel construction.

Note: All Installation instructions are available on the Knoll Exchange. Reference number 6TP00320.

Application Notes

Wood interior only, no metal shelves.

When choose lock, it will lock both hinge doors.

Adjustable shelf above.

Fixed shelves below Hinged doors.

On the approach side, the doors only have the Touch Latch option.

Base board only on the user's side.

On the User's side, the door has lock and pull options.

"T" Drilling option:

Left hand units are drilled on the right hand side, and right hand units are drilled on left side for worksurface attachments.

From users perspective, the hinge determines handedness. ie; If hinge is on left, the unit is left handed.

Cabinets

Shelves and Coat Rod

description	w	d	h	pattern no.	L	V1	V2	V3
Storage Cabinet 72"h 	24"	20"	72"	RAC7242DH(L/R)H() ()	\$2,771.	\$4,521.	\$5,199.	\$6,759.
	24"	24"	72"	RAC7243DH(L/R)H() ()	2,882.	4,705.	5,410.	7,032.
	33"	20"	72"	RAC7232DH(L/R)H() ()	3,027.	4,938.	5,679.	7,383.
	33"	24"	72"	RAC7233DH(L/R)H() ()	3,165.	5,166.	5,940.	7,722.

Left hand shown

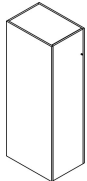
Storage Cabinet 86"h 	24"	20"	86"	RAC8642DH(L/R)H() ()	3,058.	4,990.	5,738.	7,459.
	24"	24"	86"	RAC8643DH(L/R)H() ()	3,190.	5,206.	5,987.	7,782.
	33"	20"	86"	RAC8632DH(L/R)H() ()	3,358.	5,481.	6,302.	8,193.
	33"	24"	86"	RAC8633DH(L/R)H() ()	3,518.	5,741.	6,602.	8,583.

Left hand shown

Order Code	Specification Information	Application Notes
Example: RAC7242DH(L/R)H	To order please specify pattern number including:	Inset doors.
RA Reff Administrative		Inset face - same as 42" cabinet.
C Cabinet	1. Lock option: L=Lock hold drill N=No drilling	Hinge door with touch latch.
72 Height nominal	2. Lock finish: B= Black S= Matte Silver	Note: Side access cabinet only.
4 Width nominal	3. Cabinet Finish: Laminate or Wood	No pulls.
2 Depth nominal		No visible base board, Full length door.
DH Desk Height		Left/right hand.
R Right handed		Comes with coat rod and hat rack (shelf) 72"h Cabinet comes with 3 adjustable shelves.
H Hinged door		86"h Cabinet comes with 4 adjustable shelves.
() Lock Option		Not available in mixed finishes.
() Lock Finish		Available with Wood interior only.
() Cabinet Finish		If hinges are on left gable, the cabinet is left handed.

Cabinets

Coat Rod Only

description	w	d	h	pattern no.	L	V1	V2	V3
Storage Cabinet 72" h	24"	20"	72"	RAC7242WDH(L/R)H() ()	\$2,164.	\$3,530.	\$4,061.	\$5,279.
Without shelves	24"	24"	72"	RAC7243WDH(L/R)H() ()	2,276.	3,713.	4,271.	5,551.
	33"	20"	72"	RAC7232WDH(L/R)H() ()	2,420.	3,948.	4,541.	5,904.
	33"	24"	72"	RAC7233WDH(L/R)H() ()	2,558.	4,176.	4,801.	6,242.

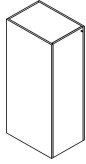

Left hand shown

Storage Cabinet 86" h	24"	20"	86"	RAC8642WDH(L/R)H() ()	2,637.	4,303.	4,950.	6,434.
Without shelves	24"	24"	86"	RAC8643WDH(L/R)H() ()	2,780.	4,536.	5,217.	6,783.
	33"	20"	86"	RAC8632WDH(L/R)H() ()	2,961.	4,832.	5,558.	7,224.
	33"	24"	86"	RAC8633WDH(L/R)H() ()	3,133.	5,114.	5,880.	7,644.

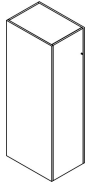

Left hand shown

Order Code	Specification Information	Application Notes
Example: RAC7242WDH(L/R)H	To order please specify pattern number including:	Inset doors.
RA Reff Administrative	1. Lock option: L = Lock hold drill N = No drilling	Inset face - same as 42" cabinet.
C Cabinet	2. Lock finish: B = Black S = Matte Silver	Hinge door with touch latch.
72 Height nominal	3. Cabinet Finish: Laminate or Wood	Note: Side access cabinet only.
4 Width nominal		No pulls.
2 Depth nominal		No visible base board, Full length door.
W Wardrobe		Left/right hand.
DH Desk Height		72"H cabinet comes with coat rod.
R Right handed		86" h Cabinet comes with a hat rack (shelf).
H Hinged door		Not available in mixed finishes.
() Lock Option		Available with Wood interior only.
() Lock Finish		If hinges are on left gable, the cabinet is left handed.
() Cabinet Finish		

Supports

Gables / End Panels

description	w	d	h	pattern no.	L	V1	V2	V3
End Support for Return	2"	20"	42"	RAGS(L/R)20()	\$559.	\$969.	\$1,113.	\$1,448.



Left hand shown

End Support for Desks	2"	30"	42"	RAGS(L/R)30()	617.	1,071.	1,231.	1,600.
-----------------------	----	-----	-----	-----------------------	------	--------	--------	--------



Left hand shown

Desk height End Support	2"	20	28 ³ / ₈ "	RAESDH(L/R)20()	491.	853.	980.	1,273.
-------------------------	----	----	----------------------------------	-------------------------	------	------	------	--------





Left hand shown

Order Code	Specification Information	Application Notes
Example: RAGS(L/R)20	To order please specify pattern number including:	Solid Finishes only: L, V1, V2, V3
RA Reff Administrative	1. Finish: Wood or Laminate	Always drilled to attach to returns or desks.
GS Gable Support		20" = for Returns
R Right hand		30" = for Desks
20 20" deep		Hardware kit includes brackets.
() Finish		
	It is Not advisable to mix 28³/₈"h desk height products with 26¹/₂" standard height products.	
	Products on this page are engineered to work with 28 ³ / ₈ " planning.	
	Products on this page will accept all Laminates except "wood grain laminates".	
	Note: All installation instructions are available on the Knoll Exchange. Reference number 6TP00320.	

Accessories

For Reception Desks

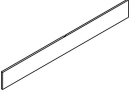
Tackboards, 11" high



description	th	w	y	h	pattern no.	grade									
						10	15	20	30	35	40	45	50	55	
Wall Hung Tackboard For a Single Wide desk 	3/4"	66"	1.8	11"	RAWHDHTBS66()	\$299.	\$328.	\$359.	\$388.	\$395.	\$401.	\$408.	\$415.	\$421.	
	3/4"	72"	2	11"	RAWHDHTBS72()	318.	350.	383.	417.	423.	431.	437.	444.	451.	
	3/4"	78"	2.2	11"	RAWHDHTBS78()	338.	374.	411.	447.	454.	462.	470.	478.	485.	
	3/4"	84"	2.3	11"	RAWHDHTBS84()	349.	387.	425.	463.	472.	480.	487.	495.	503.	
	3/4"	90"	2.5	11"	RAWHDHTBS90()	367.	408.	449.	490.	499.	507.	517.	526.	534.	
	3/4"	96"	2.7	11"	RAWHDHTBS96()	383.	428.	474.	518.	528.	536.	545.	556.	564.	
Wall Hung Tackboard For a Double Wide desk 	3/4"	51"	1.4	11"	RAWHDHTBD51()	260.	283.	308.	329.	335.	339.	344.	350.	355.	
	3/4"	54"	1.5	11"	RAWHDHTBD54()	272.	296.	322.	346.	352.	357.	363.	368.	372.	
	3/4"	57"	1.6	11"	RAWHDHTBD57()	281.	308.	334.	361.	366.	371.	376.	381.	387.	
	3/4"	60"	1.7	11"	RAWHDHTBD60()	289.	318.	344.	373.	379.	384.	392.	398.	403.	
	3/4"	63"	1.8	11"	RAWHDHTBD63()	299.	328.	359.	388.	395.	400.	406.	414.	419.	
	3/4"	66"	1.8	11"	RAWHDHTBD66()	308.	338.	370.	401.	408.	415.	421.	427.	434.	
	3/4"	69"	1.9	11"	RAWHDHTBD69()	310.	340.	372.	403.	410.	417.	423.	429.	436.	
	3/4"	72"	2	11"	RAWHDHTBD72()	322.	355.	388.	421.	427.	435.	442.	448.	455.	
	3/4"	75"	2.1	11"	RAWHDHTBD75()	334.	369.	403.	438.	446.	452.	459.	468.	475.	
	3/4"	78"	2.2	11"	RAWHDHTBD78()	342.	379.	416.	452.	459.	468.	476.	483.	490.	
	3/4"	81"	2.3	11"	RAWHDHTBD81()	351.	390.	427.	465.	474.	482.	489.	497.	505.	
	3/4"	84"	2.3	11"	RAWHDHTBD84()	354.	392.	429.	468.	476.	484.	491.	499.	507.	
	3/4"	87"	2.4	11"	RAWHDHTBD87()	363.	401.	442.	481.	489.	497.	505.	514.	523.	
	3/4"	90"	2.5	11"	RAWHDHTBD90()	371.	412.	453.	495.	503.	511.	522.	530.	538.	
	3/4"	93"	2.6	11"	RAWHDHTBD93()	379.	423.	465.	508.	518.	528.	536.	544.	555.	
3/4"	96"	2.7	11"	RAWHDHTBD96()	388.	433.	478.	523.	532.	540.	550.	560.	568.		

Order Code	Specification Information	Application Notes
Example: RAWHDHTBS66 RA Reff Administrative WH Wall hung DH Desk Height TB Tackboard S Single 66 Width () Fabric Grade	To order please specify pattern number including: 1. Finish: Fabric	All fabric to be applied rail rooded as current tackboard. To complete your double wide unit, you must order 2 pieces. <i>Nominal double vs Actual double sizes</i> <i>Actual is 2" less than Nominal.</i> N=51/ A=49 N=54/ A=52 N=57/ A=55 N=60/ A=58 N=63/ A=61 N=66/ A=64 N=69/ A=67 N=72/ A=70 N=75/ A=73 N=78/ A=76 N=81/ A=79 N=84/ A=82 N=87/ A=85 N=90/ A=88 N=93/ A=91 N=96/ A=94

Y = Yardage required

Accessories

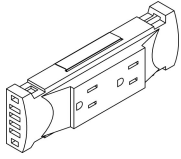
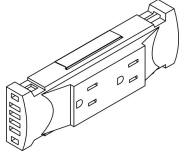

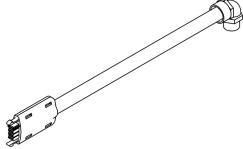
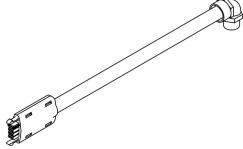

Electrical

description	type	d	h	pattern no.	list
Electrical Duplex Kit - Cir 1				RPEDK1	\$100.
					
Electrical Duplex Kit - Cir 2				RPEDK2	100.
					
Electrical "H" Connector				RPEHC	49.
					
Electrical Power Entry	10 Feet			RPEPE10	230.
	5 Feet			RPEPE5	169.
					
Electrical Power Entry - SF	10 Feet			RPEPE10SF	270.
	5 Feet			RPEPE5SF	199.
					

Order Code	Specification Information	Application Notes
Example: RPEDK1	To order please specify pattern number including:	Note: All installation instructions are available on the Knoll Exchange. Reference number 6TP00306.
RP Reff Profiles		
E Electrical		
DK Duplex Kit Cir 1		
		No finish options for the Utility hook.
		Features 4 wire, 2 circuit, 20 amps each.
		UL listed as a manufactured wiring system.

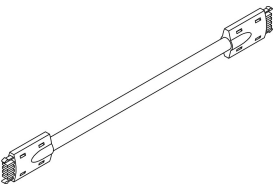
Accessories

Electrical

description	type	d	h	pattern no.	list
	12"			RPEJ12	\$95.
	24"			RPEJ24	106.
	36"			RPEJ36	115.
	48"			RPEJ48	130.
	60"			RPEJ60	144.
	72"			RPEJ72	156.
	84"			RPEJ84	167.
	96"			RPEJ96	179.
Electrical, Rec - 2 and Rec Connector				RPER2RC	39.
					
Electrical Cable clips, 10 per pack				RPECC10	30.
					
Electrical dust cap / Contact cover 1 Kit includes 2 units.				RPEDC()	103.
					

Order Code	Specification Information	Application Notes
Example: RPEDK1	To order please specify pattern number including:	Note: All installation instructions are available on the Knoll Exchange. Reference number 6TP00306.
RP Reff Profiles		
E Electrical		
DK Duplex Kit Cir 1		
		No finish options for the Utility hook.
		Features 4 wire, 2 circuit, 20 amps each.
		UL listed as a manufactured wiring system.

Accessories

COM Hardware Kits

description	type	pattern no.	list
Hardware Kits for COM materials Transaction tops	Transaction Tops for Double Wide Desks Left Hand Reference # 6TP00301	RACDTTDL1	\$28.
		RACDTTDL2	28.
		RACDTTDL3	28.
	Transaction Tops for Double Wide Desks Right Hand Reference # 6TP00301	RACDTTDR1	28.
		RACDTTDR2	28.
		RACDTTDR3	28.
	Transaction Tops for Single Wide Desks Reference # 6TP00301	RACDTTDS1	28.
		RACDTTDS2	28.
	Hardware Kits for COM materials Accent Transaction tops	Accent Transaction Tops, Single/Double Wide Reference # 6TP00303	RACDAT1
RACDAT2			28.
Hardware Kits for COM materials Infill panels	Infill Panels for Single/Double Wide Desk Reference # 6TP00302	RACDIPF1	217.
		RACDIPF2	217.

Order Code

Example: RACDTTDL1
RA Reff Administrative
CD Customer own Drawings
TT Transaction Top
DL Double Desk, Left Hand
1 Kit # 1

1 = Kit #1
2 = Kit #2
3 = Kit #3

Specification Information

To order please specify pattern number including:

Application Notes

The above Hardware Kits must be purchased when using "COM" Material.

All Installation Instruction for the COM material is available on Knoll Exchange. Please refer to the reference number indicated in the description for more details.

The above Hardware Kits must be purchased when using "COM" Material.

Wall Mounting Suggestions

The following information is provided only as a guide, and represents minimum recommendations only. Knoll does not accept responsibility for the attachment of any Knoll product to a Customer's site wall. Wall specification/construction is the responsibility of the Customer and its structural engineer/architect. Failure to properly attach Knoll products to adequate wall structures can lead to property damage and/or personal injury.

You should consult your own structural engineers and/or architects and must not rely on the information provided herein.

It is the responsibility of the Customer and its structural engineers/architects to verify that the permanent structural walls (studs, blocks, solid masonry, etc.) on which the Knoll products are intended to be mounted are designed appropriately to support the product weight, PLUS 3 lbs. per linear inch for each useable shelf length

NOTE: A cabinet's top is considered a "useable shelf" and MUST be included in the calculation of the total load for an overhead cabinet.

It is the responsibility of the Customer and its structural engineer/architects to specify the fasteners and method for attaching the Knoll supplied wall mounting cleat, bracket, frame, etc. to the supporting wall and to confirm that the installers have adhered to these specifications. For all local building standards and codes, and additional requirements (including, but not limited to, seismic conditions) the Customer should always consult local code agencies.

	EXISTING CONSTRUCTION					
	NEW CONSTRUCTION	Cinder Block or Poured Concrete Masonry Wall	Wood Stud Wall, the studs being FULL HEIGHT to the roof/floor above	Wood Stud Wall, the studs being only Ceiling Height	Steel Stud Wall, the studs being FULL HEIGHT to the roof/floor above	Steel Stud Wall, the studs being only Ceiling Height
Stud Specification	Wood studs, grade #2 or better, 3 1/2" minimum width, OR Metal studs, minimum 25 gage thickness, 3 5/8" minimum width	The wall must be a minimum of 6" thick, and must be full height to the roof/ floor structure above	Wood studs must be Grade #2, or better, 3 1/2" minimum width	Wood studs must be Grade #2, or better, 3 1/2" minimum width	Metal studs must be minimum 25 gage thickness, 3 5/8" minimum width	Metal studs must be minimum 25 gage thickness, 3 5/8" minimum width
Stud Centers	Metal and wood studs must be spaced at 16" c/c maximum	N/A	Wood studs must be spaced at 16" c/c maximum	Wood studs must be spaced at 16" c/c maximum"	Metal studs must be spaced at 16" c/c maximum	Metal studs must be spaced at 16" c/c maximum
Stud Height	Metal and wood studs must extend upwards, and be securely attached to the roof/ floor structure above			Wood studs must be braced above the ceiling, and be securely attached to the roof/floor structure above Affix #2 grade 'cap' across the top of the studs, then place diagonal studs from the top cap up to underside of the roof/ floor structure above		Metal studs must be braced above the ceiling, and be securely attached to the roof/floor structure above Affix metal bracing 'cap' across the top of the studs, then place diagonal studs from the top cap up to underside of the roof / floor structure above
Mounting the Knoll Supplied Cleat, Bracket, Frame, etc*	Insert a 2" X 6" wood block, #2 grade or better, [or a Danback™ flexible wood backing system] horizontally between each of the studs to accommodate the full width of the cabinet, and beyond to the next stud. Fasten the wood block to each stud using three screws at the ends of each block. (Fasten the Danback™ as directed by the manufacturer) Fasten the Knoll supplied wall mounting cleat, bracket, frame, etc directly to each wood block every 6" For wall mounting structures that have a rectangular frame-like configuration: fasten the top horizontal element of the frame to the wood blocking every 6", and fasten the lower horizontal element to each wall stud, using one fastener per stud.	Fasten the Knoll supplied cabinet wall mounting cleat, bracket, frame, etc. directly to the masonry wall every 6" For wall mounting structures that have a rectangular frame-like configuration: fasten the top horizontal element of the frame to the wall every 6", and fasten the lower horizontal element to the wall every 16"	In the desired location of the cabinet mounting rail, remove an 8" high section of drywall the width of the cabinet, and beyond to the next stud. Insert a 2" X 6" wood block, #2 grade or better, horizontally between each of the exposed studs. Fasten the wood block to each stud using three screws at the ends of each block. Replace the drywall and repair as desired. Fasten the Knoll supplied wall mounting cleat, rail, frame, etc directly to the wood block every 6" For wall mounting structures that have a rectangular frame-like configuration: fasten the top horizontal element of the frame to the wood blocking every 6", and fasten the lower horizontal element to each wall stud, using one fastener per stud.	In the desired location of the cabinet mounting rail, remove an 8" high section of drywall the width of the cabinet, and beyond to the next stud. Insert a 2" X 6" wood block, #2 grade or better, horizontally between each of the exposed studs. Fasten the wood block to each stud using three screws at the ends of each block. Replace the drywall and repair as desired. Fasten the Knoll supplied wall mounting cleat, rail, frame, etc directly to the wood block every 6" For wall mounting structures that have a rectangular frame-like configuration: fasten the top horizontal element of the frame to the wood blocking every 6", and fasten the lower horizontal element to each wall stud, using one fastener per stud.	In the desired location of the cabinet mounting rail, remove an 8" high section of drywall the width of the cabinet, and beyond to the next stud. Insert a 2" X 6" wood block, #2 grade or better, [or a Danback™ flexible wood backing system] horizontally between each of the exposed studs. Fasten the wood block to each stud using three screws at the ends of each block. Replace the drywall and repair as desired. Fasten the Knoll supplied wall mounting cleat, rail, frame, etc directly to the wood block every 6" For wall mounting structures that have a rectangular frame-like configuration: fasten the top horizontal element of the frame to the wood blocking every 6", and fasten the lower horizontal element to each wall stud, using one fastener per stud.	In the desired location of the cabinet mounting rail, remove an 8" high section of drywall the width of the cabinet, and beyond to the next stud. Insert a 2" X 6" wood block, #2 grade or better, [or a Danback™ flexible wood backing system] horizontally between each of the exposed studs. Fasten the wood block to each stud using three screws at the ends of each block. Replace the drywall and repair as desired. Fasten the Knoll supplied wall mounting cleat, rail, frame, etc directly to the wood block every 6" For wall mounting structures that have a rectangular frame-like configuration: fasten the top horizontal element of the frame to the wood blocking every 6", and fasten the lower horizontal element to each wall stud, using one fastener per stud.
*Graham Wall Hung Shelf	The Graham Wall Hung Shelf Bracket (and others like it) requires full support behind the full height of the bracket This should be accomplished by insertion of additional 2"X 6" wood blocking between the studs as defined above	Fasten the Knoll supplied wall mounting brackets directly to the masonry wall, using the holes provided in each bracket	The Graham Wall Hung Shelf Bracket (and others like it) requires full support behind the full height of the bracket This should be accomplished by insertion of additional 2"X 6" wood blocking between the studs as defined above	The Graham Wall Hung Shelf Bracket (and others like it) requires full support behind the full height of the bracket This should be accomplished by insertion of additional 2"X 6" wood blocking between the studs as defined above	The Graham Wall Hung Shelf Bracket (and others like it) requires full support behind the full height of the bracket This should be accomplished by insertion of additional 2"X 6" wood blocking between the studs as defined above	The Graham Wall Hung Shelf Bracket (and others like it) requires full support behind the full height of the bracket This should be accomplished by insertion of additional 2"X 6" wood blocking between the studs as defined above
Fasten the Knoll supplied wall cleat with...	#10 x 2 1/2" Grabber Woodys Screws or equiv. @ 6" c/c, screwed directly into the wood blocking	3/16" x 3 1/2" Tapcon Masonry Screws or equiv. @ 6" c/c with 1-1/4" embedment, screwed directly into the masonry wall	#10 x 2 1/2" Grabber Woodys Screws or equiv. @ 6" c/c, screwed directly into the wood blocking	#10 x 2 1/2" Grabber Woodys Screws or equiv. @ 6" c/c, screwed directly into the wood blocking	#10 x 2 1/2" Grabber Woodys Screws or equiv. @ 6" c/c, screwed directly into the wood blocking	#10 x 2 1/2" Grabber Woodys Screws or equiv. @ 6" c/c, screwed directly into the wood blocking

Alpha-Numeric Index

<i>pattern no.</i>	<i>page</i>	<i>pattern no.</i>	<i>page</i>	<i>pattern no.</i>	<i>page</i>	<i>pattern no.</i>	<i>page</i>
AWM1 S36	131	RAATFRG90	452	RAFR(L/R)8420	436, 437	RAIPKGD69	448
AWM1 S42	131	RAATFRG96	452	RAFR(L/R)9020	436, 437	RAIPKGD72	448
AWM1 S48	131	RAATFRS54	453	RAFR(L/R)9620	436, 437	RAIPKGD75	448
AWM1 S60	131	RAATFRS60	453	RAGS(L/R)20	458	RAIPKGD78	448
AWM1 S66	131	RAATFRS66	453	RAGS(L/R)30	458	RAIPKGD81	448
AWM1 S72	131	RAATFRS72	453	RAIE6240	442, 443	RAIPKGD84	448
AWM1 S78	131	RAATFRS78	453	RAIE6248	442, 443	RAIPKGD87	448
AWM1 S84	131	RAATFRS84	453	RAIE6840	442, 443	RAIPKGD90	448
R113B	122	RAATFRS90	453	RAIE6848	442, 443	RAIPKGD93	448
R3SMP	427	RAATFRS96	453	RAIE7440	442, 443	RAIPKGD96	448
R5ZNNE (3 dividers)	423	RABR(L/R)7220	434, 435	RAIE7448	442, 443	RAIPKGS66	448
R9TDCFM8430	58	RABR(L/R)7820	434, 435	RAIPFAWD102	444	RAIPKGS72	448
R9TDCFM9630	58	RABR(L/R)8420	434, 435	RAIPFAWD108	444	RAIPKGS78	448
RAATBRG72	452	RABR(L/R)9020	434, 435	RAIPFAWD114	444	RAIPKGS84	448
RAATBRG78	452	RABR(L/R)9620	434, 435	RAIPFAWD120	444	RAIPKGS90	448
RAATBRG84	452	RAC7232DH(L/R)H	456	RAIPFAWD126	444	RAIPKGS96	448
RAATBRG90	452	RAC7232WDH(L/R)H	457	RAIPFAWD132	444	RAIPRGD51	447
RAATBRG96	452	RAC7233DH(L/R)H	456	RAIPFAWD138	444	RAIPRGD54	447
RAATBRS72	453	RAC7233WDH(L/R)H	457	RAIPFAWD144	444	RAIPRGD57	447
RAATBRS78	453	RAC7242DH(L/R)H	456	RAIPFAWD150	444	RAIPRGD60	447
RAATBRS84	453	RAC7242WDH(L/R)H	457	RAIPFAWD156	444	RAIPRGD63	447
RAATBRS90	453	RAC7243DH(L/R)H	456	RAIPFAWD162	444	RAIPRGD66	447
RAATBRS96	453	RAC7243WDH(L/R)H	457	RAIPFAWD168	444	RAIPRGD69	447
RAATDCG51	452	RAC8632DH(L/R)H	456	RAIPFAWD174	444	RAIPRGD72	447
RAATDCG54	452	RAC8632WDH(L/R)H	457	RAIPFAWD180	444	RAIPRGD75	447
RAATDCG57	452	RAC8633DH(L/R)H	456	RAIPFAWD186	444	RAIPRGD78	447
RAATDCG60	452	RAC8633WDH(L/R)H	457	RAIPFAWD192	444	RAIPRGD81	447
RAATDCG63	452	RAC8642DH(L/R)H	456	RAIPFAWS66	444	RAIPRGD84	447
RAATDCG66	452	RAC8642WDH(L/R)H	457	RAIPFAWS72	444	RAIPRGD87	447
RAATDCG69	452	RAC8643DH(L/R)H	456	RAIPFAWS78	444	RAIPRGD90	447
RAATDCG72	452	RAC8643WDH(L/R)H	457	RAIPFAWS84	444	RAIPRGD93	447
RAATDCG75	452	RACDAT1	462	RAIPFAWS90	444	RAIPRGD96	447
RAATDCG78	452	RACDIPF1	462	RAIPFAWS96	444	RAIPRGS66	447
RAATDCG81	452	RACDITDL1	462	RAIPFBWD102	445	RAIPRGS72	447
RAATDCG84	452	RACDITDR1	462	RAIPFBWD108	445	RAIPRGS78	447
RAATDCG87	452	RACDITDS1	462	RAIPFBWD114	445	RAIPRGS84	447
RAATDCG90	452	RACC4220	454	RAIPFBWD120	445	RAIPRGS90	447
RAATDCG93	452	RAC(L/R)HC4212	454, 455	RAIPFBWD126	445	RAIPRGS96	447
RAATDCG96	452	RAC(L/R)HT4212	454, 455	RAIPFBWD132	445	RAIPRWD102	446
RAATDS51	453	RADW(L/R)5130	432, 433	RAIPFBWD138	445	RAIPRWD108	446
RAATDS54	453	RADW(L/R)5430	432, 433	RAIPFBWD144	445	RAIPRWD114	446
RAATDS57	453	RADW(L/R)5730	432, 433	RAIPFBWD150	445	RAIPRWD120	446
RAATDS60	453	RADW(L/R)6030	432, 433	RAIPFBWD156	445	RAIPRWD126	446
RAATDS63	453	RADW(L/R)6330	432, 433	RAIPFBWD162	445	RAIPRWD132	446
RAATDS66	453	RADW(L/R)6630	432, 433	RAIPFBWD168	445	RAIPRWD138	446
RAATDS69	453	RADW(L/R)6930	432, 433	RAIPFBWD174	445	RAIPRWD144	446
RAATDS72	453	RADW(L/R)7230	432, 433	RAIPFBWD180	445	RAIPRWD150	446
RAATDS75	453	RADW(L/R)7530	432, 433	RAIPFBWD186	445	RAIPRWD156	446
RAATDS78	453	RADW(L/R)7830	432, 433	RAIPFBWD192	445	RAIPRWD162	446
RAATDS81	453	RADW(L/R)8130	432, 433	RAIPFBWS66	445	RAIPRWD168	446
RAATDS84	453	RADW(L/R)8430	432, 433	RAIPFBWS72	445	RAIPRWD174	446
RAATDS87	453	RADW(L/R)8730	432, 433	RAIPFBWS78	445	RAIPRWD180	446
RAATDS90	453	RADW(L/R)9030	432, 433	RAIPFBWS84	445	RAIPRWD186	446
RAATDS93	453	RADW(L/R)9330	432, 433	RAIPFBWS90	445	RAIPRWD192	446
RAATDS96	453	RADW(L/R)9630	432, 433	RAIPFBWS96	445	RAIPRWS66	446
RAATFRG54	452	RAESDH(L/R)20	458	RAIPKGD51	448	RAIPRWS72	446
RAATFRG60	452	RAFR(L/R)5420	436, 437	RAIPKGD54	448	RAIPRWS78	446
RAATFRG66	452	RAFR(L/R)6020	436, 437	RAIPKGD57	448	RAIPRWS84	446
RAATFRG72	452	RAFR(L/R)6620	436, 437	RAIPKGD60	448	RAIPRWS90	446
RAATFRG78	452	RAFR(L/R)7220	436, 437	RAIPKGD63	448	RAIPRWS96	446
RAATFRG84	452	RAFR(L/R)7820	436, 437	RAIPKGD66	448	RASRD6620	440, 441

<i>pattern no.</i>	<i>page</i>	<i>pattern no.</i>	<i>page</i>	<i>pattern no.</i>	<i>page</i>	<i>pattern no.</i>	<i>page</i>
RASRD7220	440, 441	RATTDD156	451	RBDH3648	123	RC364DHSDC	183, 185
RASRD7820	440, 441	RATTDD162	451	RBDH36M(F/R)	123	RC364DHSDO	183
RASRD8420	440, 441	RATTDD168	451	RBDH40MR	125	RC364DHSCG	187, 189
RASRD9020	440, 441	RATTDD174	451	RBDH4236	123	RC364DHSGO	187
RASRD9620	440, 441	RATTDD180	451	RBDH4242	123	RC430DHBDC	174, 176
RASRS(L/R)6620	438, 439	RATTDD186	451	RBDH4248	123	RC430DHBDO	174
RASRS(L/R)7220	438, 439	RATTDD192	451	RBDH42M(F/R)	123	RC430DHBGG	178, 180
RASRS(L/R)7820	438, 439	RATTDS66	451	RBDH4836	123	RC430DHBGO	178
RASRS(L/R)8420	438, 439	RATTDS72	451	RBDH4842	123	RC434DHBDC	182, 184
RASRS(L/R)9020	438, 439	RATTDS78	451	RBDH4848	123	RC434DHBDO	182
RASRS(L/R)9620	438, 439	RATTDS84	451	RBDH48M(F/R)	123	RC434DHBGG	186, 188
RASW6630	430, 431	RATTDS90	451	RBDH52MR	125	RC434DHBGO	186
RASW7230	430, 431	RATTDS96	451	RBDH54M(F/R)	123	RC460DHBDC	174, 176
RASW7830	430, 431	RATTFR54	450	RBDH60M(F/R)	123	RC460DHBDO	174
RASW8430	430, 431	RATTFR60	450	RBDH64MR	125	RC460DHBGG	178, 180
RASW9030	430, 431	RATTFR66	450	RBDH66M(F/R)	123	RC460DHBGO	178
RASW9630	430, 431	RATTFR72	450	RBDH72M(F/R)	123	RC464DHBDC	182, 184
RATDCFM(L/R)4830	57	RATTFR78	450	RBDH78M(F/R)	123	RC464DHBDO	182
RATDCFM(L/R)4836	57	RATTFR84	450	RBDH84M(F/R)	123	RC464DHBGG	186, 188
RATDCFM(L/R)5430	57	RATTFR90	450	RBDH90M(F/R)	123	RC464DHBGO	186
RATDCFM(L/R)5436	57	RATTFR96	450	RBDH96M(F/R)	123	RC531DHB	195, 196
RATDCFM(L/R)6030	57	RAUH	417	RBDW	414	RC531DHH	197
RATDCFM(L/R)6036	57	RAWHDHTBD51	459	RBF (Pair)	121	RC532DHB	195, 196
RATDCFM(L/R)6630	57	RAWHDHTBD54	459	RBCR	193	RC532DHF	195, 196
RATDCFM(L/R)6636	57	RAWHDHTBD57	459	RBPE(L/R)	414	RC532DHH	197
RATDCFM(L/R)7230	57	RAWHDHTBD60	459	RBPP (L/R)	121	RC533DHB	195, 196
RATDCFM(L/R)7236	57	RAWHDHTBD63	459	RBPR (Pair)	122	RC533DHF	195, 196
RATDCFM(L/R)7830	57	RAWHDHTBD66	459	RBPS (L/R)	122	RC533DHH	197
RATDCFM(L/R)7836	57	RAWHDHTBD69	459	RBR36MS	251	RC534DHBDC	183, 185
RATDCFM(L/R)8430	57	RAWHDHTBD72	459	RBR42MS	251	RC534DHBDO	183
RATDCFM(L/R)8436	57	RAWHDHTBD75	459	RBR48MS	251	RC534DHBGG	187, 189
RATDCPC(L/R)6030	55	RAWHDHTBD78	459	RBR54MS	251	RC534DHBGO	187
RATDCPC(L/R)6036	55	RAWHDHTBD81	459	RBR60MS	251	RC561DHB	195, 196
RATDCPC(L/R)6630	55	RAWHDHTBD84	459	RBR66MS	251	RC561DHH	197
RATDCPC(L/R)6636	55	RAWHDHTBD87	459	RBR72MS	251	RC562DHB	195, 196
RATDCPC(L/R)7230	55	RAWHDHTBD90	459	RBWC24	122	RC562DHF	195, 196
RATDCPC(L/R)7236	55	RAWHDHTBD93	459	RBWC30	122	RC562DHH	197
RATDCPC(L/R)7830	55	RAWHDHTBD96	459	RBZ (A/B) (Pair)	121	RC562DHB	195, 196
RATDCPC(L/R)7836	55	RAWHDHTBS66	459	RC230DHBDC	174, 176	RC563DHF	195, 196
RATDCPC(L/R)8430	55	RAWHDHTBS72	459	RC230DHBDO	174	RC563DHH	197
RATDCPC(L/R)8436	55	RAWHDHTBS78	459	RC230DHBGG	178, 180	RC564DHBDC	183, 185
RATDCST(L/R)6030	56	RAWHDHTBS84	459	RC230DHBGO	178	RC564DHBDO	183
RATDCST(L/R)6036	56	RAWHDHTBS90	459	RC234DHBDC	182, 184	RC564DHBGG	187, 189
RATDCST(L/R)6630	56	RAWHDHTBS96	459	RC234DHBDO	182	RC564DHBGO	187
RATDCST(L/R)6636	56	RBD361H	23	RC234DHBGG	186, 188	RC7202DHDH(L/R)	211
RATDCST(L/R)7230	56	RBD361V	23	RC234DHBGO	186	RC7203DHDH(L/R)	211
RATDCST(L/R)7236	56	RBD362H	23	RC260DHBDC	174, 176	RC7212DHDH(L/R)	211
RATDCST(L/R)7830	56	RBD362V	23	RC260DHBDO	174	RC7212DHGH(L/R)	201, 208
RATDCST(L/R)7836	56	RBD421H	23	RC260DHBGG	178, 180	RC7212DHPH(L/R)	202, 209
RATDCST(L/R)8430	56	RBD421V	23	RC260DHBGO	178	RC7213DHDH(L/R)	211
RATDCST(L/R)8436	56	RBD422H	23	RC264DHBDC	182, 184	RC7213DHGH(L/R)	201, 208
RATTBR72	449	RBD422V	23	RC264DHBDO	182	RC7213DHPH(L/R)	202, 209
RATTBR78	449	RBD481H	23	RC264DHBGG	186, 188	RC7222DHDH(L/R)	211
RATTBR84	449	RBD481V	23	RC264DHBGO	186	RC7223DHDH(L/R)	211
RATTBR90	449	RBD482H	23	RC330DHSDC	175, 177	RC7230DHBDC	175, 177
RATTBR96	449	RBD482V	23	RC330DHSDO	175	RC7230DHBDO	175
RATTDD102	451	RBD541H	23	RC330DHSCG	179, 181	RC7230DHBGG	179, 181
RATTDD108	451	RBD541V	23	RC330DHSGO	179	RC7230DHBGO	179
RATTDD114	451	RBD542H	23	RC334DHSDC	183, 185	RC7231DHB	198, 205
RATTDD120	451	RBD542V	23	RC334DHSDO	183	RC7232DHB	198, 205
RATTDD126	451	RBDD	414	RC334DHSCG	187, 189	RC7232DHDH	211
RATTDD132	451	RBDH24M(F/R)	123	RC334DHSGO	187	RC7232DHEH(L/R)	203, 210
RATTDD138	451	RBDH30M(F/R)	123	RC360DHSDC	175, 177	RC7232DHFH	200, 207
RATTDD144	451	RBDH3636	123	RC360DHSDO	175	RC7232DHGH	201, 208
RATTDD150	451	RBDH3642	123	RC360DHSCG	181	RC7232DHGH(L/R)	204, 212

<i>pattern no.</i>	<i>page</i>	<i>pattern no.</i>	<i>page</i>	<i>pattern no.</i>	<i>page</i>	<i>pattern no.</i>	<i>page</i>
RC7232DHK	199, 206	RC832DHO	214, 221	RCACR30	417	RCDFMR72302	299
RC7232DHO	199, 206	RC832DHPHW(L/R)	219, 226	RCACR30H	417	RCDFMR72362	299
RC7232DHPHW(L/R)	204, 212	RC833DHB	220	RCACR36	417	RCDFMR84302	299
RC7233DHB	198, 205	RC833DHDH	225	RCACR36H	417	RCDFMR84362	299
RC7233DHDH	211	RC833DHEH(L/R)	218, 224	RCAS1220	417	RCDFMR96302	299
RC7233DHEH(L/R)	203, 210	RC833DHF	215, 222	RCAS1224	417	RCDFMR96362	299
RC7233DHFH	200, 207	RC833DHG	216, 222	RCAS1511	192	RCDHB20T	126
RC7233DHGH	201, 208	RC833DHGHW(L/R)	219, 226	RCAS1514	192	RCDHB24T	126
RC7233DHGHW(L/R)	204, 212	RC833DHK	214, 221	RCAS1620	417	RCDHB30T	126
RC7233DHK	199, 206	RC833DHO	214, 221	RCAS1624	417	RCDHB40T	126
RC7233DHO	199, 206	RC833DHPHW(L/R)	219, 226	RCAS1811	192	RCDHHAH11	301, 303
RC7233DHPHW(L/R)	204, 212	RC834DHBDC	183, 185	RCAS1814	192	RCDHHAH12	301, 303
RC7234DHBDC	183, 185	RC834DHBDO	183	RCAS1920	417	RCDHHAH21	301, 303
RC7234DHBDO	183	RC834DHBGC	187, 189	RCAS1924	417	RCDHHAH22	301, 303
RC7234DHBGC	187, 189	RC834DHBGO	187	RCAS2420M	416	RCDHHAW11	301, 303
RC7234DHBGO	187	RC860DHBDC	175, 177	RCAS2420W	416	RCDHHAW12	301, 303
RC7260DHBDC	175, 177	RC860DHBDO	175	RCAS2424M	416	RCDHHAW21	301, 303
RC7260DHBDO	175	RC860DHBGC	179, 181	RCAS2424W	416	RCDHHAW22	301, 303
RC7260DHBGC	179, 181	RC860DHBGO	179	RCAS3011	192	RCDHHBH11	305, 307
RC7260DHBGO	179	RC861DHB	213, 220	RCAS3014	192	RCDHHBH12	305, 307
RC7261DHB	198, 205	RC862DHB	220	RCAS3015	417	RCDHHBH21	305, 307
RC7262DHB	198, 205	RC862DHDH	225	RCAS3020	417	RCDHHBH22	305, 307
RC7262DHDH	211	RC862DHEH(L/R)	218, 224	RCAS3024	417	RCDHHBW11	305, 307
RC7262DHEH(L/R)	203, 210	RC862DHF	215, 222	RCAS3611	192	RCDHHBW12	305, 307
RC7262DHFH	200, 207	RC862DHG	216, 222	RCAS3614	192	RCDHHBW21	305, 307
RC7262DHGH	201, 208	RC862DHGHW(L/R)	219, 226	RCAS3615	417	RCDHHBW22	305, 307
RC7262DHGHW(L/R)	204, 212	RC862DHK	214, 221	RCAS3620	417	RCDHHCH11	309, 311
RC7262DHK	199, 206	RC862DHO	214, 221	RCAS3624	417	RCDHHCH12	309, 311
RC7262DHO	199, 206	RC862DHPHW(L/R)	219, 226	RCBDH24X	129	RCDHHCH21	309, 311
RC7262DHPHW(L/R)	204, 212	RC863DHB	220	RCBDH28X	129	RCDHHCH22	309, 311
RC7263DHB	198, 205	RC863DHDH	225	RCBDH36X	129	RCDHHCW11	309, 311
RC7263DHDH	211	RC863DHEH(L/R)	218, 224	RCC30	412	RCDHHCW12	309, 311
RC7263DHEH(L/R)	203, 210	RC863DHF	215, 222	RCC40	412	RCDHHCW21	309, 311
RC7263DHFH	200, 207	RC863DHG	216, 222	RCD1021	27	RCDHHCW22	309, 311
RC7263DHGH	201, 208	RC863DHGHW(L/R)	219, 226	RCD1022	27	RCDHMR60302	299
RC7263DHGHW(L/R)	204, 212	RC863DHK	214, 221	RCD1081	27	RCDHMR60362	299
RC7263DHK	199, 206	RC863DHO	214, 221	RCD1082	27	RCDHMR72302	299
RC7263DHO	199, 206	RC863DHPHW(L/R)	219, 226	RCD601	27	RCDHMR72362	299
RC7263DHPHW(L/R)	204, 212	RC864DHBDC	183, 185	RCD602	27	RCDHMR84302	299
RC7264DHBDC	183, 185	RC864DHBDO	183	RCD661	27	RCDHMR84362	299
RC7264DHBDO	183	RC864DHBGC	187, 189	RCD662	27	RCDHMR96302	299
RC7264DHBGC	187, 189	RC864DHBGO	187	RCD721	27	RCDHMR96362	299
RC7264DHBGO	187	RCA1021	26	RCD722	27	RCDHWAH11	302, 304
RC802DHDH(L/R)	225	RCA1022	26	RCD781	27	RCDHWAH12	302, 304
RC803DHDH(L/R)	225	RCA1081	26	RCD782	27	RCDHWAH21	302, 304
RC812DHDH(L/R)	225	RCA1082	26	RCD841	27	RCDHWAH22	302, 304
RC812DHGH(L/R)	216, 222	RCA601	26	RCD842	27	RCDHWBH11	306, 308
RC812DHPH(L/R)	217, 223	RCA602	26	RCD901	27	RCDHWBH12	306, 308
RC813DHDH(L/R)	225	RCA661	26	RCD902	27	RCDHWBH21	306, 308
RC813DHGH(L/R)	216, 222	RCA662	26	RCD961	27	RCDHWBH22	306, 308
RC813DHPH(L/R)	217, 223	RCA721	26	RCD962	27	RCDHWCH11	310, 312
RC822DHDH(L/R)	225	RCA722	26	RCDB7230	194	RCDHWCH12	310, 312
RC823DHDH(L/R)	225	RCA781	26	RCDB7236	194	RCDHWCH21	310, 312
RC830DHBDC	175, 177	RCA782	26	RCDB8630	194	RCDHWCH22	310, 312
RC830DHBDO	175	RCA841	26	RCDB8636	194	RCDQMR60302	299
RC830DHBGC	179, 181	RCA842	26	RCDFMF60302	300	RCDQMR60362	299
RC830DHBGO	179	RCA901	26	RCDFMF60362	300	RCDQMR72302	299
RC831DHB	213, 220	RCA902	26	RCDFMF72302	300	RCDQMR72362	299
RC832DHB	220	RCA961	26	RCDFMF72362	300	RCDQMR84302	299
RC832DHDH	225	RCA962	26	RCDFMF84302	300	RCDQMR84362	299
RC832DHEH(L/R)	218, 224	RCAB30	192	RCDFMF84362	300	RCDQMR96302	299
RC832DHF	215, 222	RCAB36	192	RCDFMF96302	300	RCDQMR96362	299
RC832DHG	216, 222	RCABT1417	417	RCDFMF96362	300	RCE1021	25
RC832DHGHW(L/R)	219, 226	RCABT2917	417	RCDFMR60302	299	RCE1022	25
RC832DHK	214, 221	RCACR16	417	RCDFMR60362	299	RCE1081	25

<i>pattern no.</i>	<i>page</i>	<i>pattern no.</i>	<i>page</i>	<i>pattern no.</i>	<i>page</i>	<i>pattern no.</i>	<i>page</i>
RCE1082	25	RCFS4912Y(L/R)W	237	RCFS6833W(L/R)M	234	RCSHHAH12	313, 315
RCE1R1212G	427	RCFS4912Z(L/R)M	229	RCFS6833W(L/R)W	242	RCSHHAH21	313, 315
RCE301	25	RCFS4912Z(L/R)W	237	RCFS6833X(L/R)M	234	RCSHHAH22	313, 315
RCE302	25	RCFS4913C(L/R)M	229	RCFS6833X(L/R)W	242	RCSHHAW11	313, 315
RCE361	25	RCFS4913C(L/R)W	237	RCGKIT11	193	RCSHHAW21	313, 315
RCE362	25	RCFS4913Y(L/R)M	229	RCGKIT14	193	RCSHHAW22	313, 315
RCE601	25	RCFS4913Y(L/R)W	237	RCGT781	333	RCSHHBH11	317, 319
RCE602	25	RCFS4913Z(L/R)M	229	RCGT782	333	RCSHHBH12	317, 319
RCE661	25	RCFS4913Z(L/R)W	237	RCGT841	333	RCSHHBH21	317, 319
RCE662	25	RCFS4932V(L/R)M	230	RCGT842	333	RCSHHBH22	317, 319
RCE721	25	RCFS4932V(L/R)W	238	RCOUNTWT	416	RCSHHBW11	317, 319
RCE722	25	RCFS4932W(L/R)M	230	RCPS1511	192	RCSHHBW12	317, 319
RCE781	25	RCFS4932W(L/R)W	238	RCPS1514	192	RCSHHBW21	317, 319
RCE782	25	RCFS4932X(L/R)M	230	RCPS1811	192	RCSHHBW22	317, 319
RCE841	25	RCFS4932X(L/R)W	238	RCPS1814	192	RCSHHCH11	321, 323
RCE842	25	RCFS4933V(L/R)M	230	RCPS3011	192	RCSHHCH12	321, 323
RCE901	25	RCFS4933V(L/R)W	238	RCPS3014	192	RCSHHCH21	321, 323
RCE902	25	RCFS4933W(L/R)M	230	RCPS3611	192	RCSHHCH22	321, 323
RCE961	25	RCFS4933W(L/R)W	238	RCPS3614	192	RCSHHCW11	321, 323
RCE962	25	RCFS4933X(L/R)M	230	RCRH30	193	RCSHHCW12	321, 323
RCEEG1021	26	RCFS4933X(L/R)W	238	RCRH36	193	RCSHHCW21	321, 323
RCEEG1022	26	RCFS6412C(L/R)M	231	RCRV104	193	RCSHHCW22	321, 323
RCEEG1081	26	RCFS6412C(L/R)W	239	RCRV118	193	RCSHHDH11	325, 327
RCEEG1082	26	RCFS6412Y(L/R)M	231	RCRV28	193	RCSHHDH12	325, 327
RCEEG601	26	RCFS6412Y(L/R)W	239	RCRV42	193	RCSHHDH21	325, 327
RCEEG602	26	RCFS6412Z(L/R)M	231	RCRV53	193	RCSHHDH22	325, 327
RCEEG661	26	RCFS6412Z(L/R)W	239	RCRV72	193	RCSHHDW11	325, 327
RCEEG662	26	RCFS6413C(L/R)M	231	RCRV86	193	RCSHHDW12	325, 327
RCEEG721	26	RCFS6413C(L/R)W	239	RCS11040	190	RCSHHDW21	325, 327
RCEEG722	26	RCFS6413Y(L/R)M	231	RCS11044	190	RCSHHDW22	325, 327
RCEEG781	26	RCFS6413Y(L/R)W	239	RCS11180	190	RCSHHEH11	329, 331
RCEEG782	26	RCFS6413Z(L/R)M	231	RCS11184	190	RCSHHEH12	329, 331
RCEEG841	26	RCFS6413Z(L/R)W	239	RCS1280	190	RCSHHEH21	329, 331
RCEEG842	26	RCFS6432V(L/R)M	232	RCS1284	190	RCSHHEH22	329, 331
RCEEG901	26	RCFS6432V(L/R)W	240	RCS1420	190	RCSHHEW11	329, 331
RCEEG902	26	RCFS6432W(L/R)M	232	RCS1424	190	RCSHHEW12	329, 331
RCEEG961	26	RCFS6432W(L/R)W	240	RCS1534	190	RCSHHEW21	329, 331
RCEEG962	26	RCFS6432X(L/R)M	232	RCS1720	190	RCSHHEW22	329, 331
RCFS4212C(L/R)M	227	RCFS6432X(L/R)W	240	RCS1724	190	RCSHWAH11	314, 316
RCFS4212C(L/R)W	235	RCFS6433V(L/R)M	232	RCS1860	190	RCSHWAH12	314, 316
RCFS4212Y(L/R)M	227	RCFS6433V(L/R)W	240	RCS1864	190	RCSHWAH21	314, 316
RCFS4212Y(L/R)W	235	RCFS6433W(L/R)M	232	RCSB1283	191	RCSHWAH22	314, 316
RCFS4212Z(L/R)M	227	RCFS6433W(L/R)W	240	RCSB1286	191	RCSHWBH11	318, 320
RCFS4212Z(L/R)W	235	RCFS6433X(L/R)M	232	RCSB1423	191	RCSHWBH12	318, 320
RCFS4213C(L/R)M	227	RCFS6433X(L/R)W	240	RCSB1426	191	RCSHWBH21	318, 320
RCFS4213C(L/R)W	235	RCFS6812C(L/R)M	233	RCSD110400	190	RCSHWBH22	318, 320
RCFS4213Y(L/R)M	227	RCFS6812C(L/R)W	241	RCSD110404	190	RCSHWCH11	322, 324
RCFS4213Y(L/R)W	235	RCFS6812Y(L/R)M	233	RCSD110444	191	RCSHWCH12	322, 324
RCFS4213Z(L/R)M	227	RCFS6812Y(L/R)W	241	RCSD111800	190	RCSHWCH21	322, 324
RCFS4213Z(L/R)W	235	RCFS6812Z(L/R)M	233	RCSD111804	190	RCSHWCH22	322, 324
RCFS4232V(L/R)M	228	RCFS6812Z(L/R)W	241	RCSD111844	191	RCSHWDH11	326, 328
RCFS4232V(L/R)W	236	RCFS6813C(L/R)M	233	RCSD12800	190	RCSHWDH12	326, 328
RCFS4232W(L/R)M	228	RCFS6813C(L/R)W	241	RCSD12804	190	RCSHWDH21	326, 328
RCFS4232W(L/R)W	236	RCFS6813Y(L/R)M	233	RCSD12844	191	RCSHWDH22	326, 328
RCFS4232X(L/R)M	228	RCFS6813Y(L/R)W	241	RCSD14200	190	RCSHWEH11	330, 332
RCFS4232X(L/R)W	236	RCFS6813Z(L/R)M	233	RCSD14204	190	RCSHWEH12	330, 332
RCFS4233V(L/R)M	228	RCFS6813Z(L/R)W	241	RCSD14244	191	RCSHWEH21	330, 332
RCFS4233V(L/R)W	236	RCFS6832V(L/R)M	234	RCSD15344	191	RCSHWEH22	330, 332
RCFS4233W(L/R)M	228	RCFS6832V(L/R)W	242	RCSD17200	190	RCTRLE362	114
RCFS4233W(L/R)W	236	RCFS6832W(L/R)M	234	RCSD17204	190	RCTRLE363	119
RCFS4233X(L/R)M	228	RCFS6832W(L/R)W	242	RCSD17244	191	RCTRLE422	114
RCFS4233X(L/R)W	236	RCFS6832X(L/R)M	234	RCSD18600	190	RCTRLE423	119
RCFS4912C(L/R)M	229	RCFS6832X(L/R)W	242	RCSD18604	190	RCTRWE362	115
RCFS4912C(L/R)W	237	RCFS6833V(L/R)M	234	RCSD18644	191	RCTRWE363	120
RCFS4912Y(L/R)M	229	RCFS6833V(L/R)W	242	RCSHHAH11	313, 315		

<i>pattern no.</i>	<i>page</i>	<i>pattern no.</i>	<i>page</i>	<i>pattern no.</i>	<i>page</i>	<i>pattern no.</i>	<i>page</i>
RCTRWE422	115	RDHMH9040	135	RDHMR9014	133	RDTCE3UH(B/W)	402
RCTRWE423	120	RDHMH9610	135	RDHMR9020	132	RDTCE40120(B/W)	401
RCTSLE362	114	RDHMH9611	136	RDHMR9022	133	RDTCE4072(B/W)	401
RCTSLE363	119	RDHMH9612	136	RDHMR9023	133	RDTCE40H(B/W)	401
RCTSLE422	114	RDHMH9613	136	RDHMR9024	133	RDTCE42120(B/W)	402
RCTSLE423	119	RDHMH9614	136	RDHMR9030	132	RDTCE4272(B/W)	402
RCTSWE362	115	RDHMH9620	135	RDHMR9040	132	RDTCE42H(B/W)	402
RCTSWE363	120	RDHMH9622	136	RDHMR9610	132	RDTCE4U120(B/W)	402
RCTSWE422	115	RDHMH9623	136	RDHMR9611	133	RDTCE4U72(B/W)	402
RCTSWE423	120	RDHMH9624	136	RDHMR9612	133	RDTCE4UH(B/W)	402
RCTTLE30482	114	RDHMH9630	135	RDHMR9613	133	RDTCE60120(B/W)	402
RCTTLE30483	119	RDHMH9633	136	RDHMR9614	133	RDTCE6072(B/W)	402
RCTTLE36542	114	RDHMH9640	135	RDHMR9620	132	RDTCE60H(B/W)	402
RCTTLE36543	119	RDHMLD	417	RDHMR9622	133	RDTCO6010	298
RCTTWE30482	115	RDHMR10210	132	RDHMR9623	133	RDTCO7210	298
RCTTWE30483	120	RDHMR10211	134	RDHMR9624	133	RDTDBW3142	246
RCTTWE36542	115	RDHMR10212	134	RDHMR9630	132	RDTDBW3156	246
RCTTWE36543	120	RDHMR10213	134	RDHMR9633	133	RDTDBW6142	246
RDAD(B/W)	409	RDHMR10214	134	RDHMR9640	132	RDTDBW6156	246
RDAD(B/W)	409	RDHMR10220	132	RDHPM26	138	RDTDCFM(L/R)5430	61
RDAS(B/W)	409	RDHMR10222	134	RDHPM32	138	RDTDCFM(L/R)5436	61
RDAV	409	RDHMR10223	134	RDHPM38	138	RDTDCFM(L/R)6030	61
RDHMBD	415	RDHMR10224	134	RDHPM44	138	RDTDCFM(L/R)6036	61
RDHMF	416	RDHMR10230	132	RDHPM50	138	RDTDCFM(L/R)6630	61
RDHMH48200	137	RDHMR10233	134	RDHPM56	138	RDTDCFM(L/R)6636	61
RDHMH60200	137	RDHMR10240	132	RDHPM62	138	RDTDCFM(L/R)7230	61
RDHMH7210	135	RDHMR10810	132	RDHPM68	138	RDTDCFM(L/R)7236	61
RDHMH7211	136	RDHMR10811	134	RDHPM74	138	RDTDCFM(L/R)7830	61
RDHMH7212	136	RDHMR10812	134	RDTAGG3142(L/R)	248	RDTDCFM(L/R)7836	61
RDHMH7220	135	RDHMR10813	134	RDTAGG3156(L/R)	248	RDTDCFM(L/R)8430	61
RDHMH72200	137	RDHMR10814	134	RDTAGG6142(L/R)	248	RDTDCFM(L/R)8436	61
RDHMH7222	136	RDHMR10820	132	RDTAGG6156(L/R)	248	RDTDCPC(L/R)6630	59
RDHMH7230	135	RDHMR10822	134	RDTAGW3142(L/R)	248	RDTDCPC(L/R)6636	59
RDHMH7240	135	RDHMR10823	134	RDTAGW3156(L/R)	248	RDTDCPC(L/R)7230	59
RDHMH7810	135	RDHMR10824	134	RDTAGW6142(L/R)	248	RDTDCPC(L/R)7236	59
RDHMH7811	136	RDHMR10830	132	RDTAGW6156(L/R)	248	RDTDCPC(L/R)7830	59
RDHMH7812	136	RDHMR10833	134	RDTAHC3142(L/R)	249	RDTDCPC(L/R)7836	59
RDHMH7813	136	RDHMR10840	132	RDTAHC3156(L/R)	249	RDTDCPC(L/R)8430	59
RDHMH7820	135	RDHMR7210	132	RDTAHC6142(L/R)	249	RDTDCPC(L/R)8436	59
RDHMH7822	136	RDHMR7211	133	RDTAHC6156(L/R)	249	RDTDCPC(L/R)9030	59
RDHMH7823	136	RDHMR7212	133	RDTAHW3142(L/R)	249	RDTDCPC(L/R)9036	59
RDHMH7830	135	RDHMR7220	132	RDTAHW3156(L/R)	249	RDTDCPC(L/R)9630	59
RDHMH7840	135	RDHMR7222	133	RDTAHW6142(L/R)	249	RDTDCPC(L/R)9636	59
RDHMH8410	135	RDHMR7230	132	RDTAHW6156(L/R)	249	RDTDCST(L/R)6630	60
RDHMH8411	136	RDHMR7240	132	RDTC3010	298	RDTDCST(L/R)6636	60
RDHMH8412	136	RDHMR7810	132	RDTC3610	298	RDTDCST(L/R)7230	60
RDHMH8413	136	RDHMR7811	133	RDTC6010	298	RDTDCST(L/R)7236	60
RDHMH8414	136	RDHMR7812	133	RDTC7210	298	RDTDCST(L/R)7830	60
RDHMH8420	135	RDHMR7820	132	RDTCE22120(B/W)	401	RDTDCST(L/R)7836	60
RDHMH8422	136	RDHMR7822	133	RDTCE2272(B/W)	401	RDTDCST(L/R)8430	60
RDHMH8423	136	RDHMR7830	132	RDTCE22H(B/W)	401	RDTDCST(L/R)8436	60
RDHMH8424	136	RDHMR7840	132	RDTCE2U120(B/W)	401	RDTDCST(L/R)9030	60
RDHMH8430	135	RDHMR8410	132	RDTCE2U72(B/W)	401	RDTDCST(L/R)9036	60
RDHMH8440	135	RDHMR8411	133	RDTCE2UH(B/W)	401	RDTDCST(L/R)9630	60
RDHMH9010	135	RDHMR8412	133	RDTCE31120(B/W)	401	RDTDCST(L/R)9636	60
RDHMH9011	136	RDHMR8413	133	RDTCE3172(B/W)	401	RDTDE22120(B/W)	403
RDHMH9012	136	RDHMR8420	132	RDTCE31H(B/W)	401	RDTDE2272(B/W)	403
RDHMH9013	136	RDHMR8422	133	RDTCE31U120(B/W)	401	RDTDE22H(B/W)	403
RDHMH9014	136	RDHMR8423	133	RDTCE31U72(B/W)	401	RDTDE2U120(B/W)	403
RDHMH9020	135	RDHMR8430	132	RDTCE31UH(B/W)	401	RDTDE2U72(B/W)	403
RDHMH9022	136	RDHMR8440	132	RDTCE33120(B/W)	402	RDTDE2UH(B/W)	403
RDHMH9023	136	RDHMR9010	132	RDTCE3372(B/W)	402	RDTDE31U120(B/W)	403
RDHMH9024	136	RDHMR9011	133	RDTCE33H(B/W)	402	RDTDE31U72(B/W)	403
RDHMH9030	135	RDHMR9012	133	RDTCE3U120(B/W)	402	RDTDE31UH(B/W)	403
RDHMH9033	136	RDHMR9013	133	RDTCE3U72(B/W)	402	RDTDE33120(B/W)	404

<i>pattern no.</i>	<i>page</i>	<i>pattern no.</i>	<i>page</i>	<i>pattern no.</i>	<i>page</i>	<i>pattern no.</i>	<i>page</i>
RDTDE3372(B/W)	404	RDTSTE4U72(B/W)	400	RFDR72	423	RMEW96482	106
RDTDE33H(B/W)	404	RDTSTE4UH(B/W)	400	RFDR84	423	RMEW96602	106
RDTDE3U120(B/W)	404	RDTSTE60120(B/W)	400	RFDR96	423	RMEW96722	106
RDTDE3U72(B/W)	404	RDTSTE6072(B/W)	400	RIP202	75	RMPU	147
RDTDE3UH(B/W)	404	RDTSTE60H(B/W)	400	RIP242	75	RMSCB	121
RDTDE40120(B/W)	403	RDTUME22120(B/W)	405	RIP302	75	ROCCGDHP301	275
RDTDE4072(B/W)	403	RDTUME2272(B/W)	405	RIP362	75	ROCCGDHP361	275
RDTDE40H(B/W)	403	RDTUME22H(B/W)	405	RIPO202	75	ROCCGDHP421	275
RDTDE42120(B/W)	404	RDTUME2U120(B/W)	405	RIPO242	75	ROCCGDHP481	275
RDTDE4272(B/W)	404	RDTUME2U72(B/W)	405	RIPO302	75	ROCCGDHP541	275
RDTDE42H(B/W)	404	RDTUME2UH(B/W)	405	RIPO362	75	ROCCGDHP601	275
RDTDE4U120(B/W)	404	RDTUME31120(B/W)	405	RIPOC202	75	ROCCGDHP661	275
RDTDE4U72(B/W)	404	RDTUME3172(B/W)	405	RIPOC242	75	ROCCGDHP721	275
RDTDE4UH(B/W)	404	RDTUME31H(B/W)	405	RIPOC302	75	ROCCGDHP781	275
RDTDE60120(B/W)	404	RDTUME31U120(B/W)	405	RIPOC362	75	ROCCGDHP841	275
RDTDE6072(B/W)	404	RDTUME31U72(B/W)	405	RJBU24	412	ROCCGDHP901	275
RDTDE60H(B/W)	404	RDTUME31UH(B/W)	405	RJBU30	412	ROCCGDHP961	275
RDTDGW3142	248	RDTUME33120(B/W)	406	RJBU36	412	ROCCGSH301	260
RDTDGW3156	248	RDTUME3372(B/W)	406	RJBU42	412	ROCCGSH361	260
RDTDGW6142	248	RDTUME33H(B/W)	406	RJBU48	412	ROCCGSH421	260
RDTDGW6156	248	RDTUME3U120(B/W)	406	RJBU54	412	ROCCGSH481	260
RDTDHW3142	247	RDTUME3U72(B/W)	406	RJBU60	412	ROCCGSH541	260
RDTDHW3156	247	RDTUME3UH(B/W)	406	RJBU66	412	ROCCGSH601	260
RDTDHW6142	247	RDTUME40120(B/W)	405	RJBU72	412	ROCCGSH661	260
RDTDHW6156	247	RDTUME4072(B/W)	405	RJBW24	412	ROCCGSH721	260
RDTE22120(B/W)	399	RDTUME40H(B/W)	405	RJBW30	412	ROCCGSH781	260
RDTE2272(B/W)	399	RDTUME42120(B/W)	406	RJBW36	412	ROCCGSH841	260
RDTE22H(B/W)	399	RDTUME4272(B/W)	406	RJBW42	412	ROCCGSH901	260
RDTE2U120(B/W)	399	RDTUME42H(B/W)	406	RJBW48	412	ROCCGSH961	260
RDTE2U72(B/W)	399	RDTUME4U120(B/W)	406	RJBW54	412	ROCGHCDHP301	274
RDTE2UH(B/W)	399	RDTUME4U72(B/W)	406	RJBW60	412	ROCGHCDHP361	274
RDTE31120(B/W)	399	RDTUME4UH(B/W)	406	RJBW66	412	ROCGHCDHP421	274
RDTE3172(B/W)	399	RDTUME60120(B/W)	406	RJBW72	412	ROCGHCDHP481	274
RDTE31H(B/W)	399	RDTUME6072(B/W)	406	RKT31	414	ROCGHCDHP541	274
RDTE31U120(B/W)	399	RDTUME60H(B/W)	406	RLAL17	422	ROCGHCDHP601	274
RDTE31U72(B/W)	399	RDTUMP22120(B/W)	407	RLAL31	422	ROCGHCDHP661	274
RDTE31UH(B/W)	399	RDTUMP2272(B/W)	407	RLAL44	422	ROCGHCDHP721	274
RDTE40120(B/W)	399	RDTUMP22H(B/W)	407	RLAL58	422	ROCGHCDHP781	274
RDTE4072(B/W)	399	RDTUMP2U120(B/W)	407	RLCCT3018	165	ROCGHCDHP841	274
RDTE40H(B/W)	399	RDTUMP2U72(B/W)	407	RLCCT3022	165	ROCGHCDHP901	274
RDTGA	410	RDTUMP2UH(B/W)	407	RLCCT3618	165	ROCGHCDHP961	274
RDTGB	410	RDTUMP31120(B/W)	407	RLCCT3622	165	ROCGHCSHP301	262
RDTGC	410	RDTUMP3172(B/W)	407	RLCCT301	164	ROCGHCSHP361	262
RDTSBWG142	243	RDTUMP31H(B/W)	407	RLCCT361	164	ROCGHCSHP421	262
RDTSBWG156	243	RDTUMP31U120(B/W)	407	RLCCT601	164	ROCGHCSHP481	262
RDTSBWT142	243	RDTUMP31U72(B/W)	407	RLCCT721	164	ROCGHCSHP541	262
RDTSBWT156	243	RDTUMP31UH(B/W)	407	RMEF60482	107	ROCGHCSHP601	262
RDTSCWG142(L/R)	245	RDTUMP40120(B/W)	408	RMEF60602	107	ROCGHCSHP661	262
RDTSCWG156(L/R)	245	RDTUMP4072(B/W)	408	RMEF72482	107	ROCGHCSHP721	262
RDTSCWT142(L/R)	245	RDTUMP40H(B/W)	408	RMEF72602	107	ROCGHCSHP781	262
RDTSCWT156(L/R)	245	REDH12F	124	RMEF72722	107	ROCGHCSHP841	262
RDTSHWG142(L/R)	244	REDH15F	124	RMEF90482	107	ROCGHCSHP901	262
RDTSHWG156(L/R)	244	REDH19F	124	RMEF90602	107	ROCGHCSHP961	262
RDTSHWT142(L/R)	244	REDH23F	124	RMEF90722	107	ROCGHDHP301	274
RDTSHWT156(L/R)	244	REDH29F	124	RMEF96482	107	ROCGHDHP361	274
RDTSTE33120(B/W)	400	REDH30	124	RMEF96602	107	ROCGHDHP421	274
RDTSTE3372(B/W)	400	REDH36	124	RMEF96722	107	ROCGHDHP481	274
RDTSTE33H(B/W)	400	REDHBH124	125	RMEW60482	106	ROCGHDHP541	274
RDTSTE3U120(B/W)	400	REDHBH130	125	RMEW60602	106	ROCGHDHP601	274
RDTSTE3U72(B/W)	400	RFBD0	416	RMEW72482	106	ROCGHDHP661	274
RDTSTE3UH(B/W)	400	RFDR30	423	RMEW72602	106	ROCGHDHP721	274
RDTSTE42120(B/W)	400	RFDR36	423	RMEW72722	106	ROCGHDHP781	274
RDTSTE4272(B/W)	400	RFDR42	423	RMEW90482	106	ROCGHDHP841	274
RDTSTE42H(B/W)	400	RFDR48	423	RMEW90602	106	ROCGHDHP901	274
RDTSTE4U120(B/W)	400	RFDR60	423	RMEW90722	106	ROCGHDHP961	274

<i>pattern no.</i>	<i>page</i>	<i>pattern no.</i>	<i>page</i>	<i>pattern no.</i>	<i>page</i>	<i>pattern no.</i>	<i>page</i>
ROCGHOC DHP601	277	ROCHDHP361	273	ROCOC SHP421	260	ROHG HOSH C901DH	283
ROCGHOC DHP661	277	ROCHDHP421	273	ROCOC SHP481	260	ROHG HOSH C961DH	283
ROCGHOC DHP721	277	ROCHDHP481	273	ROCOC SHP541	260	ROHG HSH C601DH	282
ROCGHOC DHP781	277	ROCHDHP541	273	ROCOC SHP601	260	ROHG HSH C661DH	282
ROCGHOC DHP841	277	ROCHDHP601	273	ROCOC SHP661	260	ROHG HSH C721DH	282
ROCGHOC DHP901	277	ROCHDHP661	273	ROCOC SHP721	260	ROHG HSH C781DH	282
ROCGHOC DHP961	277	ROCHDHP721	273	ROCOC SHP781	260	ROHG HSH C841DH	282
ROCGHOC SHP601	264	ROCHDHP781	273	ROCOC SHP841	260	ROHG HSH C901DH	282
ROCGHOC SHP661	264	ROCHDHP841	273	ROCOC SHP901	260	ROHG HSH C961DH	282
ROCGHOC SHP721	264	ROCHDHP901	273	ROCOC SHP961	260	ROHH CDHC601DH	285
ROCGHOC SHP781	264	ROCHDHP961	273	ROHDR30	423	ROHH CDHC661DH	285
ROCGHOC SHP841	264	ROCHODHP601	276	ROHDR36	423	ROHH CDHC721DH	285
ROCGHOC SHP901	264	ROCHODHP661	276	ROHDR42	423	ROHH CDHC781DH	285
ROCGHOC SHP961	264	ROCHODHP721	276	ROHDR48	423	ROHH CDHC841DH	285
ROCGHODHP601	277	ROCHODHP781	276	ROHDR60	423	ROHH CDHC901DH	285
ROCGHODHP661	277	ROCHODHP841	276	ROHDR72	423	ROHH CDHC961DH	285
ROCGHODHP721	277	ROCHODHP901	276	ROHDR90	423	ROHH CSHC601DH	281
ROCGHODHP781	277	ROCHODHP961	276	ROHDR96	423	ROHH CSHC661DH	281
ROCGHODHP841	277	ROCHOC SHP601	263	ROHG CDHC601DH	286	ROHH CSHC721DH	281
ROCGHODHP901	277	ROCHOC SHP661	263	ROHG CDHC661DH	286	ROHH CSHC781DH	281
ROCGHODHP961	277	ROCHOC SHP721	263	ROHG CDHC721DH	286	ROHH CSHC841DH	281
ROCGHOSH P601	264	ROCHOC SHP781	263	ROHG CDHC781DH	286	ROHH CSHC901DH	281
ROCGHOSH P661	264	ROCHOC SHP841	263	ROHG CDHC841DH	286	ROHH CSHC961DH	281
ROCGHOSH P721	264	ROCHOC SHP901	263	ROHG CDHC901DH	286	ROHH DHC601DH	285
ROCGHOSH P781	264	ROCHOC SHP961	263	ROHG CDHC961DH	286	ROHH DHC661DH	285
ROCGHOSH P841	264	ROCHODHP601	276	ROHG CSH C601DH	282	ROHH DHC721DH	285
ROCGHOSH P901	264	ROCHODHP661	276	ROHG CSH C661DH	282	ROHH DHC781DH	285
ROCGHOSH P961	264	ROCHODHP721	276	ROHG CSH C721DH	282	ROHH DHC841DH	285
ROCGHSH P301	262	ROCHODHP781	276	ROHG CSH C781DH	282	ROHH DHC901DH	285
ROCGHSH P361	262	ROCHODHP841	276	ROHG CSH C841DH	282	ROHH DHC961DH	285
ROCGHSH P421	262	ROCHODHP901	276	ROHG CSH C901DH	282	ROHH DHS601DH(A/D)(N/F)	279
ROCGHSH P481	262	ROCHODHP961	276	ROHG CSH C961DH	282	ROHH DHS661DH(A/D)(N/F)	279
ROCGHSH P541	262	ROCHOSH P601	263	ROHG DHC601DH	286	ROHH DHS721DH(A/D)(N/F)	279
ROCGHSH P601	262	ROCHOSH P661	263	ROHG DHC661DH	286	ROHH DHS781DH(A/D)(N/F)	279
ROCGHSH P661	262	ROCHOSH P721	263	ROHG DHC721DH	286	ROHH DHS841DH(A/D)(N/F)	279
ROCGHSH P721	262	ROCHOSH P781	263	ROHG DHC781DH	286	ROHH DHS901DH(A/D)(N/F)	279
ROCGHSH P781	262	ROCHOSH P841	263	ROHG DHC841DH	286	ROHH DHS961DH(A/D)(N/F)	279
ROCGHSH P841	262	ROCHOSH P901	263	ROHG DHC841DH	286	ROHHOC DHC601DH	288
ROCGHSH P901	262	ROCHOSH P961	263	ROHG DHC901DH	286	ROHHOC DHC661DH	288
ROCGHSH P961	262	ROCHSHP301	261	ROHG DHC961DH	286	ROHHOC DHC721DH	288
ROCHCDHP301	273	ROCHSHP361	261	ROHG DHC961DH	286	ROHHOC DHC781DH	288
ROCHCDHP361	273	ROCHSHP421	261	ROHG DHC961DH	286	ROHHOC DHC841DH	288
ROCHCDHP421	273	ROCHSHP481	261	ROHG DHC961DH	286	ROHHOC DHC901DH	288
ROCHCDHP481	273	ROCHSHP541	261	ROHG DHC961DH	286	ROHHOC DHC961DH	288
ROCHCDHP541	273	ROCHSHP601	261	ROHG DHC961DH	286	ROHHOC SHC601DH	284
ROCHCDHP601	273	ROCHSHP661	261	ROHG DHC961DH	286	ROHHOC SHC661DH	284
ROCHCDHP661	273	ROCHSHP721	261	ROHG DHC961DH	286	ROHHOC SHC721DH	284
ROCHCDHP721	273	ROCHSHP781	261	ROHG DHC961DH	286	ROHHOC SHC781DH	284
ROCHCDHP781	273	ROCHSHP841	261	ROHG DHC961DH	286	ROHHOC SHC841DH	284
ROCHCDHP841	273	ROCHSHP901	261	ROHG DHC961DH	286	ROHHOC SHC901DH	284
ROCHCDHP901	273	ROCHSHP961	261	ROHG DHC961DH	286	ROHHOC SHC961DH	284
ROCHCDHP961	273	ROCOC DHP301	275	ROHG DHC961DH	286	ROHHODHC601DH	288
ROCHCSHP301	261	ROCOC DHP361	275	ROHG DHC961DH	286	ROHHODHC661DH	288
ROCHCSHP361	261	ROCOC DHP421	275	ROHG DHC961DH	286	ROHHODHC721DH	288
ROCHCSHP421	261	ROCOC DHP481	275	ROHG DHC961DH	286	ROHHODHC781DH	288
ROCHCSHP481	261	ROCOC DHP541	275	ROHG DHC961DH	286	ROHHODHC841DH	288
ROCHCSHP541	261	ROCOC DHP601	275	ROHG DHC961DH	286	ROHHODHC901DH	288
ROCHCSHP601	261	ROCOC DHP661	275	ROHG DHC961DH	286	ROHHODHC961DH	288
ROCHCSHP661	261	ROCOC DHP721	275	ROHG DHC961DH	286	ROHHOSH C601DH	284
ROCHCSHP721	261	ROCOC DHP781	275	ROHG DHC961DH	286	ROHHOSH C661DH	284
ROCHCSHP781	261	ROCOC DHP841	275	ROHG DHC961DH	286	ROHHOSH C721DH	284
ROCHCSHP841	261	ROCOC DHP901	275	ROHG DHC961DH	286	ROHHOSH C781DH	284
ROCHCSHP901	261	ROCOC DHP961	275	ROHG DHC961DH	286	ROHHOSH C841DH	284
ROCHCSHP961	261	ROCOC SHP301	260	ROHG DHC961DH	286	ROHHOSH C901DH	284
ROCHDHP301	273	ROCOC SHP361	260	ROHG DHC961DH	286	ROHHOSH C961DH	284

<i>pattern no.</i>	<i>page</i>	<i>pattern no.</i>	<i>page</i>	<i>pattern no.</i>	<i>page</i>	<i>pattern no.</i>	<i>page</i>
ROHSHC601DH	281	ROMACSH721	253	ROMDHMTF160RN	419	ROMDHWTF184RR	421
ROHSHC661DH	281	ROMACSH781	253	ROMDHMTF160RR	419	ROMDHWTF190RB	420
ROHSHC721DH	281	ROMACSH841	253	ROMDHMTF166RB	418	ROMDHWTF190RL	420
ROHSHC781DH	281	ROMACSH901	253	ROMDHMTF166RL	418	ROMDHWTF190RN	421
ROHSHC841DH	281	ROMACSH961	253	ROMDHMTF166RN	419	ROMDHWTF190RR	421
ROHSHC901DH	281	ROMADH601	266	ROMDHMTF166RR	419	ROMDHWTF196RB	420
ROHSHC961DH	281	ROMADH661	266	ROMDHMTF172RB	418	ROMDHWTF196RL	420
ROHSHS601DH(A/D)(N/F)	278	ROMADH721	266	ROMDHMTF172RL	418	ROMDHWTF196RN	421
ROHSHS661DH(A/D)(N/F)	278	ROMADH781	266	ROMDHMTF172RN	419	ROMDHWTF196RR	421
ROHSHS721DH(A/D)(N/F)	278	ROMADH841	266	ROMDHMTF172RR	419	ROMFCDH601	268
ROHSHS781DH(A/D)(N/F)	278	ROMADH901	266	ROMDHMTF178RB	418	ROMFCDH661	268
ROHSHS841DH(A/D)(N/F)	278	ROMADH961	266	ROMDHMTF178RL	418	ROMFCDH721	268
ROHSHS901DH(A/D)(N/F)	278	ROMASH601	253	ROMDHMTF178RN	419	ROMFCDH781	268
ROHSHS961DH(A/D)(N/F)	278	ROMASH661	253	ROMDHMTF178RR	419	ROMFCDH841	268
ROHMTF160	424	ROMASH721	253	ROMDHMTF184RB	418	ROMFCDH901	268
ROHMTF166	424	ROMASH781	253	ROMDHMTF184RL	418	ROMFCDH961	268
ROHMTF172	424	ROMASH841	253	ROMDHMTF184RN	419	ROMFCSH601	255
ROHMTF178	424	ROMASH901	253	ROMDHMTF184RR	419	ROMFCSH661	255
ROHMTF184	424	ROMASH961	253	ROMDHMTF190RB	418	ROMFCSH721	255
ROHMTF190	424	ROMCCDHP301	265	ROMDHMTF190RL	418	ROMFCSH781	255
ROHMTF196	424	ROMCCDHP361	265	ROMDHMTF190RN	419	ROMFCSH841	255
ROHODHC601DH	280	ROMCCDHP421	265	ROMDHMTF190RR	419	ROMFCSH901	255
ROHODHC661DH	280	ROMCCDHP481	265	ROMDHMTF196RB	418	ROMFCSH961	255
ROHODHC721DH	280	ROMCCDHP541	265	ROMDHMTF196RL	418	ROMFDH601	268
ROHODHC781DH	280	ROMCCDHP601	265	ROMDHMTF196RN	419	ROMFDH661	268
ROHODHC841DH	280	ROMCCDHP661	265	ROMDHMTF196RR	419	ROMFDH721	268
ROHODHC901DH	280	ROMCCDHP721	265	ROMDHMTF196RL	419	ROMFDH781	268
ROHODHC961DH	280	ROMCCDHP781	265	ROMDHMTF196RN	419	ROMFDH841	268
ROHODHS601DH(A/D)(N/F)	279	ROMCCDHP841	265	ROMDHMTF196RR	419	ROMFDH901	268
ROHODHS661DH(A/D)(N/F)	279	ROMCCDHP901	265	ROMDHMTF196RL	419	ROMFDH961	268
ROHODHS721DH(A/D)(N/F)	279	ROMCCDHP961	265	ROMDHMTF196RN	419	ROMFSH601	255
ROHODHS781DH(A/D)(N/F)	279	ROMCCSHP301	252	ROMDHMTF196RR	419	ROMFSH661	255
ROHODHS841DH(A/D)(N/F)	279	ROMCCSHP361	252	ROMDHMTF196RL	419	ROMFSH721	255
ROHODHS901DH(A/D)(N/F)	279	ROMCCSHP421	252	ROMDHMTF196RN	419	ROMFSH781	255
ROHODHS961DH(A/D)(N/F)	279	ROMCCSHP481	252	ROMDHMTF196RR	419	ROMFSH841	255
ROHOSH601DH	280	ROMCCSHP541	252	ROMDHMTF196RL	419	ROMFSH901	255
ROHOSH661DH	280	ROMCCSHP601	252	ROMDHMTF196RN	419	ROMFSH961	255
ROHOSH721DH	280	ROMCCSHP661	252	ROMDHMTF196RR	419	ROMGCDH601	270
ROHOSH781DH	280	ROMCCSHP721	252	ROMDHMTF196RL	419	ROMGCDH661	270
ROHOSH841DH	280	ROMCCSHP781	252	ROMDHMTF196RN	419	ROMGCDH721	270
ROHOSH901DH	280	ROMCCSHP841	252	ROMDHMTF196RR	419	ROMGCDH781	270
ROHOSH961DH	280	ROMCCSHP901	252	ROMDHMTF196RL	419	ROMGCDH841	270
ROHOSH601DH(A/D)(N/F)	278	ROMCCSHP961	252	ROMDHMTF196RN	419	ROMGCDH901	270
ROHOSH661DH(A/D)(N/F)	278	ROMDHMTF130RB	418	ROMDHMTF196RR	419	ROMGCDH961	270
ROHOSH721DH(A/D)(N/F)	278	ROMDHMTF130RL	418	ROMDHMTF196RN	419	ROMGCSH601	257
ROHOSH781DH(A/D)(N/F)	278	ROMDHMTF130RN	419	ROMDHMTF196RR	419	ROMGCSH661	257
ROHOSH841DH(A/D)(N/F)	278	ROMDHMTF130RR	419	ROMDHMTF196RL	419	ROMGCSH721	257
ROHOSH901DH(A/D)(N/F)	278	ROMDHMTF136RB	418	ROMDHMTF196RN	419	ROMGCSH781	257
ROHOSH961DH(A/D)(N/F)	278	ROMDHMTF136RL	418	ROMDHMTF196RR	419	ROMGCSH841	257
ROHWF160	425	ROMDHMTF136RN	419	ROMDHMTF196RL	419	ROMGCSH901	257
ROHWF166	425	ROMDHMTF136RR	419	ROMDHMTF196RN	419	ROMGCSH961	257
ROHWF172	425	ROMDHMTF142RB	418	ROMDHMTF196RR	419	ROMGDH601	270
ROHWF178	425	ROMDHMTF142RL	418	ROMDHMTF196RR	419	ROMGDH661	270
ROHWF184	425	ROMDHMTF142RN	419	ROMDHMTF196RL	419	ROMGDH721	270
ROHWF190	425	ROMDHMTF142RR	419	ROMDHMTF196RN	419	ROMGDH781	270
ROHWF196	425	ROMDHMTF148RB	418	ROMDHMTF196RR	419	ROMGDH841	270
ROMACDH601	266	ROMDHMTF148RL	418	ROMDHMTF196RL	419	ROMGDH841	270
ROMACDH661	266	ROMDHMTF148RN	419	ROMDHMTF196RR	419	ROMGDH901	270
ROMACDH721	266	ROMDHMTF148RR	419	ROMDHMTF196RN	419	ROMGDH961	270
ROMACDH781	266	ROMDHMTF154RB	418	ROMDHMTF196RR	419	ROMGDH961	270
ROMACDH841	266	ROMDHMTF154RL	418	ROMDHMTF196RL	419	ROMGDH961	270
ROMACDH901	266	ROMDHMTF154RN	419	ROMDHMTF196RR	419	ROMGDH961	270
ROMACDH961	266	ROMDHMTF154RR	419	ROMDHMTF196RR	419	ROMGCDH301	269
ROMACSH601	253	ROMDHMTF160RB	418	ROMDHMTF196RR	419	ROMGCDH361	269
ROMACSH661	253	ROMDHMTF160RL	418	ROMDHMTF196RR	419	ROMGCDHP421	269
				ROMDHMTF196RR	419	ROMGCDHP481	269
				ROMDHMTF196RR	419	ROMGCDHP541	269
				ROMDHMTF196RR	419	ROMGCDHP601	269
				ROMDHMTF196RR	419	ROMGCDHP661	269
				ROMDHMTF196RR	419	ROMGCDHP661	269
				ROMDHMTF196RR	419		

<i>pattern no.</i>	<i>page</i>	<i>pattern no.</i>	<i>page</i>	<i>pattern no.</i>	<i>page</i>	<i>pattern no.</i>	<i>page</i>
ROMGHCDHP721	269	ROMGHSHP781	256	ROMHODHP841	271	ROTRCF	103
ROMGHCDHP781	269	ROMGHSHP841	256	ROMHODHP901	271	ROTRE12	103
ROMGHCDHP841	269	ROMGHSHP901	256	ROMHODHP961	271	ROTRE24	103
ROMGHCDHP901	269	ROMGHSHP961	256	ROMHOSHP601	258	ROTRIE	104
ROMGHCDHP961	269	ROMGSH601	257	ROMHOSHP661	258	ROTRIENY	104
ROMGHCSHP301	256	ROMGSH661	257	ROMHOSHP721	258	ROTRIT	104
ROMGHCSHP361	256	ROMGSH721	257	ROMHOSHP781	258	ROTRITNY	104
ROMGHCSHP421	256	ROMGSH781	257	ROMHOSHP841	258	ROTRJE24	105
ROMGHCSHP481	256	ROMGSH841	257	ROMHOSHP901	258	ROTRJE30	105
ROMGHCSHP541	256	ROMGSH901	257	ROMHOSHP961	258	ROTRJE36	105
ROMGHCSHP601	256	ROMGSH961	257	ROMHSHP301	254	ROTRJE42	105
ROMGHCSHP661	256	ROMHCDHP301	267	ROMHSHP361	254	ROTRJE48	105
ROMGHCSHP721	256	ROMHCDHP361	267	ROMHSHP421	254	ROTRJE54	105
ROMGHCSHP781	256	ROMHCDHP421	267	ROMHSHP481	254	ROTRJE60	105
ROMGHCSHP841	256	ROMHCDHP481	267	ROMHSHP541	254	ROTRJE66	105
ROMGHCSHP901	256	ROMHCDHP541	267	ROMHSHP601	254	ROTRJE72	105
ROMGHCSHP961	256	ROMHCDHP601	267	ROMHSHP661	254	ROTRJT24	105
ROMGHDHP301	269	ROMHCDHP661	267	ROMHSHP721	254	ROTRJT30	105
ROMGHDHP361	269	ROMHCDHP721	267	ROMHSHP781	254	ROTRJT36	105
ROMGHDHP421	269	ROMHCDHP781	267	ROMHSHP841	254	ROTRJT42	105
ROMGHDHP481	269	ROMHCDHP841	267	ROMHSHP901	254	ROTRJT48	105
ROMGHDHP541	269	ROMHCDHP901	267	ROMHSHP961	254	ROTRJT54	105
ROMGHDHP601	269	ROMHCDHP961	267	ROMOCDHP301	265	ROTRJT60	105
ROMGHDHP661	269	ROMHCSHP301	254	ROMOCDHP361	265	ROTRJT66	105
ROMGHDHP721	269	ROMHCSHP361	254	ROMOCDHP421	265	ROTRJT72	105
ROMGHDHP781	269	ROMHCSHP421	254	ROMOCDHP481	265	ROTRM	103
ROMGHDHP841	269	ROMHCSHP481	254	ROMOCDHP541	265	ROTRP	104
ROMGHDHP901	269	ROMHCSHP541	254	ROMOCDHP601	265	ROTRT12	103
ROMGHDHP961	269	ROMHCSHP601	254	ROMOCDHP661	265	ROTRT24	103
ROMGHODHP601	272	ROMHCSHP661	254	ROMOCDHP721	265	RP161J	148, 151
ROMGHODHP661	272	ROMHCSHP721	254	ROMOCDHP781	265	RP161K	148, 151
ROMGHODHP721	272	ROMHCSHP781	254	ROMOCDHP841	265	RP161L(L/R)	153, 154
ROMGHODHP781	272	ROMHCSHP841	254	ROMOCDHP901	265	RP161M	153, 154
ROMGHODHP841	272	ROMHCSHP901	254	ROMOCDHP961	265	RP161R	139, 141
ROMGHODHP901	272	ROMHCSHP961	254	ROMOCSHP301	252	RP162J	148, 151
ROMGHODHP961	272	ROMHDHP301	267	ROMOCSHP361	252	RP162K	148, 151
ROMGHOCSDHP601	259	ROMHDHP361	267	ROMOCSHP421	252	RP162L(L/R)	153, 154
ROMGHOCSDHP661	259	ROMHDHP421	267	ROMOCSHP481	252	RP162M	139, 141
ROMGHOCSDHP721	259	ROMHDHP481	267	ROMOCSHP541	252	RP162R	153, 141
ROMGHOCSDHP781	259	ROMHDHP541	267	ROMOCSHP601	252	RP163J	148, 151
ROMGHOCSDHP841	259	ROMHDHP601	267	ROMOCSHP661	252	RP163K	148, 151
ROMGHOCSDHP901	259	ROMHDHP661	267	ROMOCSHP721	252	RP163L(L/R)	153, 154
ROMGHOCSDHP961	259	ROMHDHP721	267	ROMOCSHP781	252	RP163M	153, 154
ROMGHODHP601	272	ROMHDHP781	267	ROMOCSHP841	252	RP191J	150, 152
ROMGHODHP661	272	ROMHDHP841	267	ROMOCSHP901	252	RP191K	150, 152
ROMGHODHP721	272	ROMHDHP901	267	ROMOCSHP961	252	RP191R	139, 141
ROMGHODHP781	272	ROMHDHP961	267	ROSDH821	277	RP192J	150, 152
ROMGHODHP841	272	ROMHOCSDHP601	271	ROSSH681	277	RP192K	150, 152
ROMGHODHP901	272	ROMHOCSDHP661	271	ROTAF12(M)	101	RP192R	139, 141
ROMGHODHP961	272	ROMHOCSDHP721	271	ROTAF12(W)	102	RP193J	150, 152
ROMGHOSHP601	259	ROMHOCSDHP781	271	ROTAF13(M)	101	RP193K	150, 152
ROMGHOSHP661	259	ROMHOCSDHP841	271	ROTAF13(W)	102	RP241L(L/R)	156
ROMGHOSHP721	259	ROMHOCSDHP901	271	ROTAF22(M)	101	RP241W	156
ROMGHOSHP781	259	ROMHOCSDHP961	271	ROTAF22(W)	102	RP242L(L/R)	156
ROMGHOSHP841	259	ROMHOCSDHP601	258	ROTAF23(M)	101	RP242W	156
ROMGHOSHP901	259	ROMHOCSDHP661	258	ROTAF23(W)	102	RP301A	145
ROMGHOSHP961	259	ROMHOCSDHP721	258	ROTA012(M)	101	RP301E(L/R)	146
ROMGHSHP301	256	ROMHOCSDHP781	258	ROTA013(M)	101	RP301G	139, 141
ROMGHSHP361	256	ROMHOCSDHP841	258	ROTA022(M)	101	RP301H	143, 144
ROMGHSHP421	256	ROMHOCSDHP901	258	ROTA023(M)	101	RP301J	148, 151
ROMGHSHP481	256	ROMHOCSDHP961	258	ROTRC18D	104	RP301K	148, 151
ROMGHSHP541	256	ROMHODHP601	271	ROTRC18S	104	RP301L	153, 154
ROMGHSHP601	256	ROMHODHP661	271	ROTRC30D	104	RP301M	153, 154
ROMGHSHP661	256	ROMHODHP721	271	ROTRC30S	104	RP301N	149, 151
ROMGHSHP721	256	ROMHODHP781	271	ROTRCE	104	RP301R	139, 141

<i>pattern no.</i>	<i>page</i>	<i>pattern no.</i>	<i>page</i>	<i>pattern no.</i>	<i>page</i>	<i>pattern no.</i>	<i>page</i>
RP301S	140, 142	RPDHB19	159	RPOFL278362	127	RPTDEPC(L/R)7820	51
RP301T	140, 142	RPDHB24	159	RPOFL284202	127	RPTDEPC(L/R)7824	51
RP302A	145	RPDHB30	159	RPOFL284242	127	RPTDEPC(L/R)7830	51
RP302E(L/R)	146	RPDHB36	159	RPOFL284302	127	RPTDEPC(L/R)7836	51
RP302G	139, 141	RPDHB6	159	RPOFL284362	127	RPTDEPC(L/R)8420	51
RP302H	143, 144	RPDHC42MF	159	RPL2	128	RPTDEPC(L/R)8424	51
RP302J	148, 151	RPDHC48MF	159	RPS2	128	RPTDEPC(L/R)8430	51
RP302K	148, 151	RPDHC54MF	159	RPSH241L(L/R)	158	RPTDEPC(L/R)8436	51
RP302L	153, 154	RPDHC60MF	159	RPSH241W	158	RPTDEST(L/R)6020	52
RP302M	153, 154	RPDHC66MF	159	RPSH242L(L/R)	158	RPTDEST(L/R)6024	52
RP302N	149, 151	RPDHC72MF	159	RPSH242W	158	RPTDEST(L/R)6030	52
RP302R	139, 141	RPDHC78MF	159	RPSHB24	159	RPTDEST(L/R)6036	52
RP302S	140, 142	RPDHC84MF	159	RPSHBF6	159	RPTDEST(L/R)6620	52
RP302T	140, 142	RPDHC90MF	159	RPSHC78MF	159	RPTDEST(L/R)6624	52
RP361A	145	RPDHC96MF	159	RPSHC84MF	159	RPTDEST(L/R)6630	52
RP361E(L/R)	146	RPDHH301A	155	RPTDCFM8430	58	RPTDEST(L/R)6636	52
RP361G	139, 141	RPDHH302A	155	RPTDCFM9630	58	RPTDEST(L/R)7220	52
RP361H	143, 144	RPDHH361A	155	RPTDEFM(L/R)3620	53	RPTDEST(L/R)7224	52
RP361J	148, 151	RPDHH362A	155	RPTDEFM(L/R)3624	53	RPTDEST(L/R)7230	52
RP361K	148, 151	RPECC10	461	RPTDEFM(L/R)3630	54	RPTDEST(L/R)7236	52
RP361L	153, 154	RPEDC	461	RPTDEFM(L/R)3636	54	RPTDEST(L/R)7820	52
RP361M	153, 154	RPEDK1	460	RPTDEFM(L/R)4220	53	RPTDEST(L/R)7824	52
RP361N	149, 151	RPEDK2	460	RPTDEFM(L/R)4224	53	RPTDEST(L/R)7830	52
RP361R	139, 141	RPEHC	460	RPTDEFM(L/R)4230	54	RPTDEST(L/R)7836	52
RP361S	140, 142	RPEJ12	461	RPTDEFM(L/R)4236	54	RPTDEST(L/R)8420	52
RP361T	140, 142	RPEJ24	461	RPTDEFM(L/R)4820	53	RPTDEST(L/R)8424	52
RP362A	145	RPEJ36	461	RPTDEFM(L/R)4824	53	RPTDEST(L/R)8430	52
RP362E(L/R)	146	RPEJ48	461	RPTDEFM(L/R)4830	54	RPTDEST(L/R)8436	52
RP362G	139, 141	RPEJ60	461	RPTDEFM(L/R)4836	54	RPTDLFM(L/R)3620	37
RP362H	143, 144	RPEJ72	461	RPTDEFM(L/R)5420	53	RPTDLFM(L/R)3624	37
RP362J	148, 151	RPEJ84	461	RPTDEFM(L/R)5424	53	RPTDLFM(L/R)3630	38
RP362K	148, 151	RPEJ96	461	RPTDEFM(L/R)5430	54	RPTDLFM(L/R)3636	38
RP362L	153, 154	RPEPE10	460	RPTDEFM(L/R)5436	54	RPTDLFM(L/R)4220	37
RP362M	153, 154	RPEPE10SF	460	RPTDEFM(L/R)6020	53	RPTDLFM(L/R)4224	37
RP362N	149, 151	RPEPE5	460	RPTDEFM(L/R)6024	53	RPTDLFM(L/R)4230	38
RP362R	139, 141	RPEPE5SF	460	RPTDEFM(L/R)6030	54	RPTDLFM(L/R)4236	38
RP362S	140, 142	RPER2RC	461	RPTDEFM(L/R)6036	54	RPTDLFM(L/R)4820	37
RP362T	140, 142	RPETAD	415	RPTDEFM(L/R)6620	53	RPTDLFM(L/R)4824	37
RPAD	414	RPETRAY3C	415	RPTDEFM(L/R)6624	53	RPTDLFM(L/R)4830	38
RPADKIT	414	RPETRAY3N	415	RPTDEFM(L/R)6630	54	RPTDLFM(L/R)4836	38
RPADSS	415	RPFC6	159	RPTDEFM(L/R)6636	54	RPTDLFM(L/R)5420	37
RPAHFB16	415	RPH301A	145	RPTDEFM(L/R)7220	53	RPTDLFM(L/R)5424	37
RPAHFB30	415	RPH302A	145	RPTDEFM(L/R)7224	53	RPTDLFM(L/R)5430	38
RPAHFB36	415	RPH361A	145	RPTDEFM(L/R)7230	54	RPTDLFM(L/R)5436	38
RPAHFM162	415	RPH362A	145	RPTDEFM(L/R)7236	54	RPTDLFM(L/R)6020	37
RPAHFM30	415	RPL2	128	RPTDEFM(L/R)7820	53	RPTDLFM(L/R)6024	37
RPAHFM36	415	RPOFL1202	127	RPTDEFM(L/R)7824	53	RPTDLFM(L/R)6030	38
RPAPT	415	RPOFL1242	127	RPTDEFM(L/R)7830	54	RPTDLFM(L/R)6036	38
RPCB16	159	RPOFL1302	127	RPTDEFM(L/R)7836	54	RPTDLFM(L/R)6620	37
RPCB19	159	RPOFL1362	127	RPTDEFM(L/R)8420	53	RPTDLFM(L/R)6624	37
RPCB30	159	RPOFL260202	127	RPTDEFM(L/R)8424	53	RPTDLFM(L/R)6630	38
RPCB36	159	RPOFL260242	127	RPTDEFM(L/R)8430	54	RPTDLFM(L/R)6636	38
RPCG	410	RPOFL260302	127	RPTDEFM(L/R)8436	54	RPTDLFM(L/R)7220	37
RPCST	410	RPOFL260362	127	RPTDEPC(L/R)6020	51	RPTDLFM(L/R)7224	37
RPD11	417	RPOFL266202	127	RPTDEPC(L/R)6024	51	RPTDLFM(L/R)7230	38
RPD14	417	RPOFL266242	127	RPTDEPC(L/R)6030	51	RPTDLFM(L/R)7236	38
RPDH301A	155	RPOFL266302	127	RPTDEPC(L/R)6036	51	RPTDLFM(L/R)7820	37
RPDH301E(L/R)	157	RPOFL266362	127	RPTDEPC(L/R)6620	51	RPTDLFM(L/R)7824	37
RPDH302A	155	RPOFL272202	127	RPTDEPC(L/R)6624	51	RPTDLFM(L/R)7830	38
RPDH302E(L/R)	157	RPOFL272242	127	RPTDEPC(L/R)6630	51	RPTDLFM(L/R)7836	38
RPDH361A	155	RPOFL272302	127	RPTDEPC(L/R)6636	51	RPTDLFM(L/R)8420	37
RPDH361E(L/R)	157	RPOFL272362	127	RPTDEPC(L/R)7220	51	RPTDLFM(L/R)8424	37
RPDH362A	155	RPOFL278202	127	RPTDEPC(L/R)7224	51	RPTDLFM(L/R)8430	38
RPDH362E(L/R)	157	RPOFL278242	127	RPTDEPC(L/R)7230	51	RPTDLFM(L/R)8436	38
RPDHB16	159	RPOFL278302	127	RPTDEPC(L/R)7236	51	RPTDLPC(L/R)6020	35

<i>pattern no.</i>	<i>page</i>	<i>pattern no.</i>	<i>page</i>	<i>pattern no.</i>	<i>page</i>	<i>pattern no.</i>	<i>page</i>
RPTDSST(L/R)7824	44	RROC2GSD90	289	RSD1022	21	RSDHL24	130
RPTDSST(L/R)7830	44	RROC2WSD108	290	RSD1023	22	RSDHL30	130
RPTDSST(L/R)7836	44	RROC2WSD90	290	RSD1081	21	RSDHL36	130
RPTDSST(L/R)8420	44	RROCGSD108GB	289	RSD1082	21	RSDHL42	130
RPTDSST(L/R)8424	44	RROCGSD90GB	289	RSD1083	22	RSDHL48	130
RPTDSST(L/R)8430	44	RROCCSDL60GB	289	RSD241	21	RSDHT1	130
RPTDSST(L/R)8436	44	RROCCSDL72GB	289	RSD242	21	RSDHT2	130
RPULLSMP	429	RROCCSDR60GB	289	RSD243	22	RSDHT3	130
RPULLSMPD	429	RROCCSDR72GB	289	RSD301	21	RSDHT4	130
RPULLSMPF	428	RROCOS108GB	291	RSD302	21	RSDHT5	130
RPULLSMPG	428	RROCOS60GB	291	RSD303	22	RSDHT6	130
RPULLSMPH	428	RROCOS72GB	291	RSD361	21	RSDR30	423
RPULLSMPJ	429	RROCOS90GB	291	RSD362	21	RSDR36	423
RPULLSMPR	428	RROCWSD108GB	290	RSD363	22	RSDR361(H/V)	250
RPULLSMPS	429	RROCWSD90GB	290	RSD421	21	RSDR361(H/V)	24
RPULLSMPT	428	RROCWSDL60GB	290	RSD422	21	RSDR362(H/V)	250
RPWFL28	128	RROCWSDL72GB	290	RSD423	22	RSDR362(H/V)	24
RR3-DA	103	RROCWSDR60GB	290	RSD481	21	RSDR42	423
RR3-DB	103	RROCWSDR72GB	290	RSD482	21	RSDR421(H/V)	250
RR3-DC	103	RROM2GSD108	293	RSD483	22	RSDR421(H/V)	24
RR3-DX	103	RROM2GSD90	293	RSD541	21	RSDR422(H/V)	250
RR3-DXO	103	RROM2WSD108	295	RSD542	21	RSDR422(H/V)	24
RR3-DXT	103	RROM2WSD90	295	RSD543	22	RSDR48	423
RR3-DY	103	RROMGSD108GB	293	RSD601	21	RSDR481(H/V)	250
RR3-DYO	103	RROMGSD108GN	292	RSD602	21	RSDR481(H/V)	24
RR3-DYT	103	RROMGSD60GL	292	RSD603	22	RSDR482(H/V)	250
RR3-DZ	103	RROMGSD60GR	292	RSD604	22	RSDR482(H/V)	24
RR3-DZO	103	RROMGSD72CL	292	RSD661	21	RSDR54	423
RR3-DZT	103	RROMGSD72GR	292	RSD662	21	RSDR541(H/V)	250
RR3MP4	427	RROMGSD90GB	293	RSD663	22	RSDR541(H/V)	24
RR3MP6	427	RROMGSD90GN	292	RSD664	22	RSDR542(H/V)	250
RRBRD2712	427	RROMGSDL60GB	293	RSD721	21	RSDR542(H/V)	24
RRLCFDC20108	160	RROMGSDL72GB	293	RSD722	21	RSDR60	423
RRLCFDC2090	160	RROMGSDR60GB	293	RSD723	22	RSDR601(H/V)	250
RRLCFDC20108	160	RROMGSDR72GB	293	RSD724	22	RSDR601(H/V)	24
RRLCFDC2090	160	RROMOS108CB	296	RSD781	21	RSDR602(H/V)	250
RRLCFDCL2060	160	RROMOS108GN	296	RSD782	21	RSDR602(H/V)	24
RRLCFDCL2072	160	RROMOS60GB	296	RSD783	22	RSDR66	423
RRLCFDCR2060	160	RROMOS60GL	296	RSD841	21	RSDR661(H/V)	250
RRLCFDCR2072	160	RROMOS60GR	296	RSD842	21	RSDR661(H/V)	24
RRLCO20108	161	RROMOS72GB	296	RSD843	22	RSDR662(H/V)	250
RRLCO2060	161	RROMOS72GL	296	RSD901	21	RSDR662(H/V)	24
RRLCO2072	161	RROMOS72GR	296	RSD902	21	RSDR72	423
RRLCO2090	161	RROMOS90GB	296	RSD903	22	RSDR721(H/V)	250
RRLCSGD20108	162	RROMOS90GN	296	RSD961	21	RSDR721(H/V)	24
RRLCSGD2090	162	RROMWSD108GB	294	RSD962	21	RSDR722(H/V)	250
RRLCSGDL2060	162	RROMWSD108GN	294	RSD963	22	RSDR722(H/V)	24
RRLCSGDL2072	162	RROMWSD60GL	294	RSDHC254	126	RSDR78	423
RRLCSGDR2060	162	RROMWSD60GR	294	RSDHC3	126	RSDR84	423
RRLCSGDR2072	162	RROMWSD72GL	294	RSDHC304	126	RSDR90	423
RRLCSWD20108	163	RROMWSD72GR	294	RSDHC404	126	RSDR96	423
RRLCSWD2090	163	RROMWSD90GB	294	RSDHCC4	126	RSEDH1(L/R)	124
RRLCSWDL2060	163	RROMWSD90GN	294	RSDHD1428	129, 130	RSEDH2(L/R)	124
RRLCSWDL2072	163	RROMWSDL60GB	295	RSDHD1828	129, 130	RSEDH3(L/R)	124
RRLCSWDR2060	163	RROMWSDL72GB	295	RSDHD2028	129, 130	RSEDH4(L/R)	124
RRLCSWDR2072	163	RROMWSDR60GB	295	RSDHD2428	129, 130	RSEDH5(L/R)	124
RRMC3010	298	RROMWSDR72GB	295	RSDHD3028	129, 130	RSEDH6(L/R)	124
RRMC3610	298	RSAMP1616	427	RSDHD3628	130	RST	410
RRMC6010	298	RSBWH20	121	RSDHHA2028	130	RSTDCFM(L/R)4830	57
RRMC7210	298	RSBWH24	121	RSDHHA2428	130	RSTDCFM(L/R)4836	57
RRML108	297	RSBWH30	121	RSDHHA3028	130	RSTDCFM(L/R)5430	57
RRML60	297	RSBWH36	121	RSDHHA3628	130	RSTDCFM(L/R)5436	57
RRML72	297	RSBWH42	121	RSDHL12	130	RSTDCFM(L/R)6030	57
RRML90	297	RSBWH48	121	RSDHL15	130	RSTDCFM(L/R)6036	57
RROC2GSD108	289	RSD1021	21	RSDHL20	130	RSTDCFM(L/R)6630	57

<i>pattern no.</i>	<i>page</i>	<i>pattern no.</i>	<i>page</i>	<i>pattern no.</i>	<i>page</i>	<i>pattern no.</i>	<i>page</i>
RSTDCFM(L/R)6636	57	RTLT5E25S	422	RTM4216363	100	RTPNM48H8	374
RSTDCFM(L/R)7230	57	RTLT5E37A	422	RTM4216422	97	RTPNM54H1	340, 341
RSTDCFM(L/R)7236	57	RTLT5E37S	422	RTM4216482	97	RTPNM54H2	345, 346
RSTDCFM(L/R)7830	57	RTLT5E49A	422	RTM4216602	99	RTPNM54H3	350, 351
RSTDCFM(L/R)7836	57	RTLT5E49S	422	RTM4216722	99	RTPNM54H4	355, 356
RSTDCFM(L/R)8430	57	RTLT5E61A	422	RTM460602	98	RTPNM54H5	360, 361
RSTDCFM(L/R)8436	57	RTLT5E61S	422	RTM472362	83	RTPNM54H6	365
RSTDCPC(L/R)6030	55	RTLT5E73A	422	RTM472422	83	RTPNM60H1	340, 341
RSTDCPC(L/R)6036	55	RTLT5E73S	422	RTM472482	84	RTPNM60H2	345, 346
RSTDCPC(L/R)6630	55	RTLT5E85A	422	RTM472602	98	RTPNM60H3	350, 351
RSTDCPC(L/R)6636	55	RTLT5E85S	422	RTM472722	98	RTPNM60H4	355, 356
RSTDCPC(L/R)7230	55	RTM272362	81	RTM478362	83	RTPNM60H5	360, 361
RSTDCPC(L/R)7236	55	RTM272422	81	RTM478422	83	RTPNM60H6	365
RSTDCPC(L/R)7830	55	RTM272482	82	RTM478482	84	RTPNM66H1	340, 341
RSTDCPC(L/R)7836	55	RTM278362	81	RTM484362	83	RTPNM66H2	345, 346
RSTDCPC(L/R)8430	55	RTM278422	81	RTM484422	83	RTPNM66H3	350, 351
RSTDCPC(L/R)8436	55	RTM278482	82	RTM484482	84	RTPNM66H4	355, 356
RSTDCST(L/R)6030	56	RTM284362	81	RTM484602	98	RTPNM66H5	360, 361
RSTDCST(L/R)6036	56	RTM284422	81	RTM484722	98	RTPNM66H6	365
RSTDCST(L/R)6630	56	RTM284482	82	RTM490362	83	RTPNM72H1	340, 341
RSTDCST(L/R)6636	56	RTM290362	81	RTM490422	83	RTPNM72H2	345, 346
RSTDCST(L/R)7230	56	RTM290422	81	RTM490482	84	RTPNM72H3	350, 351
RSTDCST(L/R)7236	56	RTM290482	82	RTM496362	83	RTPNM72H4	355, 356
RSTDCST(L/R)7830	56	RTM296362	81	RTM496422	83	RTPNM72H5	360, 361
RSTDCST(L/R)7836	56	RTM296422	81	RTM496482	84	RTPNM72H6	365
RSTDCST(L/R)8430	56	RTM296482	82	RTM496602	98	RTPNM78H1	340, 341
RSTDCST(L/R)8436	56	RTM4108303	100	RTM496722	98	RTPNM78H2	345, 346
RSTRLE362	111	RTM4108362	96	RTNDC364	80	RTPNM78H3	350, 351
RSTRLE363	116	RTM4108363	100	RTNDC422	79	RTPNM78H4	355, 356
RSTRLE422	111	RTM4108422	96	RTNDC424	80	RTPNM78H5	360, 361
RSTRLE423	116	RTM4108482	97	RTNDC482	79	RTPNM78H6	365
RSTRSE362	113	RTM4108602	99	RTNDC484	80	RTPNM84H1	340, 341
RSTRSE363	118	RTM4108722	99	RTOP1	427	RTPNM84H2	345, 346
RSTRSE422	113	RTM4120303	100	RTOP2	427	RTPNM84H3	350, 351
RSTRSE423	118	RTM4120362	96	RTPNM30H1	340, 341	RTPNM84H4	355, 356
RSTRWE362	112	RTM4120363	100	RTPNM30H2	345, 346	RTPNM84H5	360, 361
RSTRWE363	117	RTM4120422	96	RTPNM30H3	350, 351	RTPNM84H6	365
RSTRWE422	112	RTM4120482	97	RTPNM30H4	355, 356	RTPNM90H1	340, 341
RSTRWE423	117	RTM4120602	99	RTPNM30H5	360, 361	RTPNM90H2	345, 346
RSTSLE362	111	RTM4120722	99	RTPNM30H6	365, 366	RTPNM90H3	350, 351
RSTSLE363	116	RTM4132303	100	RTPNM30H7	370	RTPNM90H4	355, 356
RSTSLE422	111	RTM4132363	100	RTPNM30H8	374	RTPNM90H5	360, 361
RSTSLE423	116	RTM4144303	100	RTPNM36H1	340, 341	RTPNM90H6	365
RSTSSE362	113	RTM4144362	96	RTPNM36H2	345, 346	RTPNM96H1	340, 341
RSTSSE363	118	RTM4144363	100	RTPNM36H3	350, 351	RTPNM96H2	345, 346
RSTSSE422	113	RTM4144422	96	RTPNM36H4	355, 356	RTPNM96H3	350, 351
RSTSSE423	118	RTM4144482	97	RTPNM36H5	360, 361	RTPNM96H4	355, 356
RSTSWE362	112	RTM4144602	99	RTPNM36H6	365, 366	RTPNM96H5	360, 361
RSTSWE363	117	RTM4144722	99	RTPNM36H7	370	RTPNM96H6	365
RSTSWE422	112	RTM4156303	100	RTPNM36H8	374	RTPRS30H1	342, 343, 344
RSTSWE423	117	RTM4156362	96	RTPNM42H1	340, 341	RTPRS30H2	347, 348, 349
RSTTLE30482	111	RTM4156363	100	RTPNM42H2	345, 346	RTPRS30H3	352, 353, 354
RSTTLE30483	116	RTM4156422	96	RTPNM42H3	350, 351	RTPRS30H4	357, 358, 359
RSTTLE36542	111	RTM4156482	97	RTPNM42H4	355, 356	RTPRS30H5	362, 363, 364
RSTTLE36543	116	RTM4156602	99	RTPNM42H5	360, 361	RTPRS30H6	367, 368, 369
RSTTSE30482	113	RTM4156722	99	RTPNM42H6	365, 366	RTPRS30H7	371, 372, 373
RSTTSE30483	118	RTM4180303	100	RTPNM42H7	370	RTPRS30H8	375, 376, 377
RSTTSE36542	113	RTM4180362	96	RTPNM42H8	374	RTPRS36H1	342, 343, 344
RSTTSE36543	118	RTM4180363	100	RTPNM48H1	340, 341	RTPRS36H2	347, 348, 349
RSTTWE30482	112	RTM4180422	96	RTPNM48H2	345, 346	RTPRS36H3	352, 353, 354
RSTTWE30483	117	RTM4180482	97	RTPNM48H3	350, 351	RTPRS36H4	357, 358, 359
RSTTWE36542	112	RTM4180602	99	RTPNM48H4	355, 356	RTPRS36H5	362, 363, 364
RSTTWE36543	117	RTM4180722	99	RTPNM48H5	360, 361	RTPRS36H6	367, 368, 369
RTLT5E19S	422	RTM4216303	100	RTPNM48H6	365, 366	RTPRS36H7	371, 372, 373
RTLT5E25A	422	RTM4216362	97	RTPNM48H7	370	RTPRS36H8	375, 376, 377

<i>pattern no.</i>	<i>page</i>	<i>pattern no.</i>	<i>page</i>	<i>pattern no.</i>	<i>page</i>	<i>pattern no.</i>	<i>page</i>
RTPRS42H1	342, 343, 344	RTRDC60304	80	RWHDHTB36H4	381	RWMPB	411
RTPRS42H2	347, 348, 349	RTRDC72304	80	RWHDHTB36H5	382	RWMT1512R	413
RTPRS42H3	352, 353, 354	RTRDC72362	79	RWHDHTB4226	422	RWMT1512U	413
RTPRS42H4	357, 358, 359	RTRDC72364	80	RWHDHTB42H1	378	RWMT2712R	413
RTPRS42H5	362, 363, 364	RTRDC84422	79	RWHDHTB42H2	379	RWMT2712U	413
RTPRS42H6	367, 368, 369	RTRDC96482	79	RWHDHTB42H3	380	RWMT3912R	413
RTPRS42H7	371, 372, 373	RTRDL48302	76	RWHDHTB42H4	381	RWMT3912U	413
RTPRS42H8	375, 376, 377	RTRDL60302	76	RWHDHTB42H5	382	RWMV24	411
RTPRS48H1	342, 343, 344	RTRDL72302	76	RWHDHTB4826	422	RWMVF	412
RTPRS48H2	347, 348, 349	RTRDL72362	76	RWHDHTB48H1	378	RWMVH24	411
RTPRS48H3	352, 353, 354	RTRDOF60242	74	RWHDHTB48H2	379	RWMVH30	411
RTPRS48H4	357, 358, 359	RTRDOF60302	74	RWHDHTB48H3	380	RWMVH36	411
RTPRS48H5	362, 363, 364	RTRDOF60362	74	RWHDHTB48H4	381	RWMWT24	411
RTPRS48H6	367, 368, 369	RTRDOF66242	74	RWHDHTB48H5	382	RWMWT30	411
RTPRS48H7	371, 372, 373	RTRDOF66302	74	RWHDHTB54H1	378	RWMWT36	411
RTPRS48H8	375, 376, 377	RTRDOF66362	74	RWHDHTB54H2	379	RWRB	416
RTPRS54H1	342, 343, 344	RTRDOF72242	74	RWHDHTB54H3	380	YPSB2024	386
RTPRS54H2	347, 348, 349	RTRDOF72302	74	RWHDHTB54H4	381	YPSB2024F	384
RTPRS54H3	352, 353, 354	RTRDOF72362	74	RWHDHTB54H5	382	YPSB2027F	384
RTPRS54H4	357, 358, 359	RTRDOF78242	74	RWHDHTB60H1	378	YPSB2030	386
RTPRS54H5	362, 363, 364	RTRDOF78302	74	RWHDHTB60H2	379	YPSB2030F	384
RTPRS54H6	367, 368, 369	RTRDOF78362	74	RWHDHTB60H3	380	YPSB2036	386
RTPRS60H1	342, 343, 344	RTRDOF84242	74	RWHDHTB60H4	381	YPSB2036F	384
RTPRS60H2	347, 348, 349	RTRDOF84302	74	RWHDHTB60H5	382	YPSB2042	386
RTPRS60H3	352, 353, 354	RTRDOF84362	74	RWHDHTB66H1	378	YPSB2042F	384
RTPRS60H4	357, 358, 359	RTRDRL48302	77	RWHDHTB66H2	379	YPSB2048	386
RTPRS60H5	362, 363, 364	RTRDRL60302	77	RWHDHTB66H3	380	YPSB2048F	384
RTPRS60H6	367, 368, 369	RTRDRL72302	77	RWHDHTB66H4	381	YPSB2054	386
RTPRS66H1	342, 343, 344	RTRDRL72362	77	RWHDHTB66H5	382	YPSB2054F	384
RTPRS66H2	347, 348, 349	RTRDS48302	78	RWHDHTB72H1	378	YPSB2060	386
RTPRS66H3	352, 353, 354	RTRDS60302	78	RWHDHTB72H2	379	YPSB2060F	384
RTPRS66H4	357, 358, 359	RTRDS72302	78	RWHDHTB72H3	380	YPSB2066	386
RTPRS66H5	362, 363, 364	RTRDS72362	78	RWHDHTB72H4	381	YPSB2066FRR	384
RTPRS66H6	367, 368, 369	RTSDC362	79	RWHDHTB72H5	382	YPSB2072	386
RTPRS72H1	342, 343, 344	RTSDC422	79	RWHDHTB78H1	378	YPSB2072FRR	384
RTPRS72H2	347, 348, 349	RTSDC42424	80	RWHDHTB78H2	379	YPSB2624	387
RTPRS72H3	352, 353, 354	RTSDC482	79	RWHDHTB78H3	380	YPSB2624F	385
RTPRS72H4	357, 358, 359	RTSDC48484	80	RWHDHTB78H4	381	YPSB2627	387
RTPRS72H5	362, 363, 364	RTSDL42422	76	RWHDHTB78H5	382	YPSB2627F	385
RTPRS72H6	367, 369	RTSDL48482	76	RWHDHTB84H1	378	YPSB2630	387
RTPRS78H1	344	RTSDRL42422	77	RWHDHTB84H2	379	YPSB2630F	385
RTPRS78H2	349	RTSDRL48482	77	RWHDHTB84H3	380	YPSB2636	387
RTPRS78H3	354	RTSDS42422	78	RWHDHTB84H4	381	YPSB2636F	385
RTPRS78H4	359	RTSDS48482	78	RWHDHTB84H5	382	YPSB2642	387
RTPRS78H5	364	RTSF14	426	RWHDHTB90H1	378	YPSB2642F	385
RTPRS78H6	369	RTSF28	426	RWHDHTB90H2	379	YPSB2648	387
RTPRS84H1	344	RTST14	426	RWHDHTB90H3	380	YPSB2648F	385
RTPRS84H2	349	RTTDC72362	79	RWHDHTB90H4	381	YPSB2654	387
RTPRS84H3	354	RTTDC84422	79	RWHDHTB90H5	382	YPSB2654F	385
RTPRS84H4	359	RTTDC96482	79	RWHDHTB96H1	378	YPSB2660	387
RTPRS84H5	364	RUMC3010	298	RWHDHTB96H2	379	YPSB2660F	385
RTPRS84H6	369	RUMC3610	298	RWHDHTB96H3	380	YPSB2666	387
RTPRS90H1	344	RUMC6010	298	RWHDHTB96H4	381	YPSB2666FRR	385
RTPRS90H2	349	RUMC7210	298	RWHDHTB96H5	382	YPSB2672	387
RTPRS90H3	354	RUTB	122	RWHRA	422	YPSB2672FRR	385
RTPRS90H4	359	RWHDHTB3026	422	RWHRB	422	YPSB3224	386
RTPRS90H5	364	RWHDHTB30H1	378	RWHRC	422	YPSB3224F	384
RTPRS90H6	369	RWHDHTB30H2	379	RWHRD	422	YPSB3227	386
RTPRS96H1	344	RWHDHTB30H3	380	RWHRE	422	YPSB3227F	384
RTPRS96H2	349	RWHDHTB30H4	381	RWHRF	422	YPSB3230	386
RTPRS96H3	354	RWHDHTB30H5	382	RWHRG	422	YPSB3230F	384
RTPRS96H4	359	RWHDHTB3626	422	RWMCT24	413	YPSB3236	386
RTPRS96H5	364	RWHDHTB36H1	378	RWMMP24	411	YPSB3236F	384
RTPRS96H6	369	RWHDHTB36H2	379	RWMMP30	411	YPSB3242	386
RTRDC48304	80	RWHDHTB36H3	380	RWMMP36	411	YPSB3242F	384

<i>pattern no.</i>	<i>page</i>
YPSB3248	386
YPSB3248F	384
YPSB3254	386
YPSB3254F	384
YPSB3260	386
YPSB3260F	384
YPSB3266	386
YPSB3266FRR	384
YPSB3272	386
YPSB3272FRR	384
YPSB3824	387
YPSB3824F	385
YPSB3827	387
YPSB3827F	385
YPSB3830	387
YPSB3830F	385
YPSB3836	387
YPSB3836F	385
YPSB3842	387
YPSB3842F	385
YPSB3848	387
YPSB3848F	385
YPSB3854	387
YPSB3854F	385
YPSB3860	387
YPSB3860F	385
YPSB3866	387
YPSB3866FRR	385
YPSB3872	387
YPSB3872FRR	385

Selling Policy

	<p>This Selling Policy supercedes all previous selling policies. Prices, discounts and product offerings are subject to change without notice.</p>
Terms & Conditions of Sales	<p>Sales by Knoll, Inc. or Knoll North America Corp. ("Seller") of Knoll Product Lines (hereinafter "Products") within the United States and Canada are made only on the terms which are contained in this Selling Policy. Seller hereby gives notice of its objection to any different or additional terms and conditions. This sale is expressly conditional upon Purchaser's assent to the terms and conditions set forth below. Additional terms and conditions may apply to KnollStudio and KnollTextiles orders. These terms and conditions may be modified or supplemented only by a written document signed by an authorized representative of Seller. These terms and conditions supercede any prior and/or contemporaneous agreements or correspondence between Purchaser and Seller. Written quotations expire thirty (30) days from the date of issuance and can be withdrawn by written notice anytime during that period. Where Purchaser and Seller have entered into the Knoll Electronic Terms and Conditions, all orders, acknowledgements, invoices and other business communications placed or transmitted in accordance with the Knoll Electronic Terms and Conditions shall be deemed to be in writing and signed and shall be valid for all purposes as if they were originated and maintained in documentary form.</p>
Ordering Information	<p>All orders must be in writing. The product pattern number(s) contained on Seller's order acknowledgement shall be the final expression of the order.</p>
Order Confirmation	<p>A purchase order is not binding on Seller until Purchaser has received Seller's order confirmation or acknowledgment.</p>
Pricing Policies	<p>List prices are subject to change without notice.</p> <p>List prices shall be those prices in effect on the date of receipt of a complete purchase order unless shipment is requested more than ninety (90) days after order entry in which case prices in effect on the date of shipment apply. List prices include specified freight costs. Unless specified in writing by Seller, no other charges are included in Seller's list prices.</p>
Taxes	<p>All sales, use, excise and other taxes applicable to the sale of the Products shall be paid by Purchaser. If Purchaser claims an exemption from any tax, Purchaser shall submit to Seller the appropriate exemption certificates.</p>
Terms of Payment	<p>Payment for one hundred percent (100%) of the net order amount is due within thirty (30) days of the date of invoice, which is generally issued upon shipment. In case of any discrepancies, such as shortages, and Seller is notified in writing within ten (10) days of receipt of Product, only that portion may be deducted and the balance paid. For orders greater than \$100,000 net, a fifty percent (50%) deposit is due at the time of order placement, with the remainder due within thirty (30) days of the date of invoice.</p> <p>KnollStudio orders less than \$2,000 require payment for one hundred percent (100%) of the net order amount (including any applicable sales tax and charges for inside delivery, special packaging, etc.), due at time of order placement. For KnollStudio orders greater than \$2,000, a one-half (50%) deposit is due at time of order placement with the remainder (including any applicable sales tax and charges for inside delivery, special packaging, etc.) due prior to shipment.</p> <p>If, in the judgment of Seller, Purchaser's financial condition does not justify the terms of the payment, Seller may require full or partial payment in advance.</p> <p>Past due accounts shall be charged one and one-half percent (1.5%) per month, or the highest rate permitted by law, whichever is less, and will be added to the outstanding balance. In the event Purchaser defaults on payment, Purchaser shall be liable for all collection costs, including reasonable attorney's fees and costs.</p>
Changes and Cancellation	<p>Purchase orders may not be changed or cancelled, in whole or in part, without prior written consent of Seller. Changes may effect delivery dates. Expenses incurred because of changes shall be charged to Purchaser. In the event of cancellations, Purchaser will be liable for reasonable cancellation charges established by Seller. Orders for special Product, orders including "COM" (hereinafter defined) material and orders pursuant to expedited delivery programs, may not be canceled.</p>
Freight Prepaid	<p>Freight is prepaid and included in the price of all Products, except KnollTextiles, within the 48 contiguous United States for orders placed with Knoll, Inc. and within Canada, excluding the Yukon, Northwest Territories, Nunavut and Newfoundland for orders placed with Knoll North America Corp. Packing is tested for rigorous motion and transportation but is not guaranteed to protect furniture from all conditions. If special packaging is required for any reason, please consult with your sales representative or dealer. Seller shall select the method of shipment and routing. Freight for all KnollTextiles orders is prepaid and added to the invoice.</p>
Delivery/Freight Charges	<p>Shipments outside the contiguous 48 United States and Canada shall be shipped F.O.B. Origin.</p> <p>For shipments outside the contiguous United States and Canada, Purchaser is responsible for the cost of freight from point of embarkation, including any handling and transportation charges incidental to loading at the point of departure and unloading at the final destination.</p> <p>Conditions beyond the control of Seller, including weather, available facilities and traffic conditions, may affect exact time of delivery. Seller shall not be responsible for specific carrier delivery date or time unless it has made a specific delivery commitment, in writing.</p> <p>Nonstandard methods of shipment and/or additional services are available upon request. Purchaser will be billed for the differential cost of any special services in excess of standard surface carrier freight costs. Premium charges, at Purchaser's request, will be added for airfreight, exclusive use of vehicle and extra, export or special packaging. Accessorial charges will be added for inside delivery, extra labor, reassignment and redelivery.</p> <p>Partial shipments may be made and invoiced by Seller.</p>
Claims	<p>All shipments for Knoll Products within the contiguous United States and Canada are F.O.B. Origin. All risk of loss passes to Purchaser at time of delivery to carrier. Purchaser shall inspect all Products upon receipt and notify Seller within ten (10) working days after receipt of any damage or defects which are, or should be, apparent from an inspection of the Product and its packaging. Failure of Purchaser to notify Seller during the ten (10) working day period shall constitute acceptance of the Products and waiver of any apparent defects, errors or shortages. For all claims relating to Product damaged in transit or for any other claims relating to or arising out of the transportation of the Product, Purchaser must seek recovery from the carrier and Seller has no liability to Purchaser for such claims. Seller may, upon request, assist Purchaser with filing of such claims with the carrier, but Seller will not be liable for any of these transportation related claims.</p>
Seller's Security Interest	<p>Until Seller receives the full payment for the Product, Seller shall have a security interest in the Product. Purchaser agrees to perform all acts, including but not limited to the execution and filing of documentation, which may be necessary to perfect and assure the security interest of Seller.</p>
Returns	<p>The return of Products without a written authorization by Seller shall not be accepted. To receive authorization for Product return, please call Customer Service. All Products that are returned pursuant to a valid authorization shall be subject to a twenty-five percent (25%) of list restocking charge. Products not currently offered for sale by Seller (including COM) shall not be authorized for return. All returned Products must be unused, in original condition and in the original Seller packing cartons. No refund or credit shall be given for damaged Products.</p>
Held Orders/Storage	<p>If Purchaser requests that an order be held or delayed, prices and terms and conditions in effect at the time of shipment shall apply. If Purchaser requests a delay after the time when Seller can defer production, Purchaser will be invoiced for the Product, payable in accordance with standard terms, when the order is ready for shipment. Seller may transfer the Product to storage, in which case all expenses incurred in connection with storage, including demurrage, preparation for storage, storage charges and handling shall be payable by Purchaser upon submission of invoices by Seller. Risk of loss to the Product shall pass to the Purchaser upon delivery of the Product into storage.</p>

Selling Policy

Customer's Own Material	<p>A Purchaser who requests a fabric or other surface material not standard to Seller's line of Products ("COM") must submit samples of the requested material to Seller prior to entry of a purchaser order. Seller shall determine if the material is suitable to its manufacturing processes and meets any requirements of Underwriters Laboratories. If the COM is acceptable, Seller will then establish a price for using the COM or the Product in question. For a description of the procedures for submitting samples and testing, contact customer resources or your sales representative. Seller shall have no responsibility for the appearance, condition, performance, durability, colorfastness or any other physical attribute of the COM. Purchaser shall indemnify and hold Seller harmless for any damages, injuries or losses arising out of or related to use of the COM on the Product.</p>
Warranty	<p>Seller warrants to the original Purchaser only that the Products Seller manufactures and sells to Purchaser are free of defects in workmanship and materials, during the applicable warranty period set forth below.</p> <p>Warranty period set forth below is for 24-hour, 7 days a week, multi shift use (includes parts and labor to repair).</p> <p>Should any failure to conform with this limited warranty appear to a Product listed below during the applicable warranty period from the date of shipment, Seller shall, upon prompt written notice, repair or replace, at its option and costs, the affected part or parts.</p> <p><i>Product and Period of Warranty</i></p> <p><i>Lifetime: Antenna Workspaces, AutoStrada, Calibre, Crinion Open Table, Currents, Dividends Horizon, Morrison, Reff Profiles laminate, Series 2 Storage, Template and other non-wood components (except cascade edge worksurfaces, operational parts, controls, electrical, Lighting, Series 2 Veneer Front Storage, special or custom products, see below)</i></p> <p><i>12 Years: Chadwick, Essentials Work Chairs, Generation by Knoll, Life, Moment, MultiGeneration by Knoll, ReGeneration by Knoll, Remix, and Toboggan seating (except seating upholstery, textiles, leathers and finishes, see below).</i></p> <p><i>10 Years: Anchor Storage except digital keypad lock, Antenna Workspaces, AutoStrada, Crinion Open Table, Dividends Horizon, Dividends Horizon Satellite Surfaces, Reff Profiles, Template wood components, Series 2 Veneer Front Storage, cascade edge worksurfaces, Wood Casegoods (The Graham Collection) (except wood casegoods upholstered surfaces, see below), Reuter overheads, Reuter vertical storage, KnollExtra Sapper Monitor Arm Collection, Sapper XYZ Monitor Arm, Adjustable keyboard mechanisms and platforms, Communication Boards (except fabric board textiles, see below), Smokador collection (except leathers, see below), and Orchestra Universal Systems Accessories, k. lounge structural components.</i></p> <p><i>5 Years: Operational parts, controls, electrical, Lighting (except light ballasts, bulbs and power supply, see below), special or custom product, wood veneer products, Currents handcrank, Interaction Counterforce, KnollStudio, Spark Series seating structural elements, structural elements of all KnollStudio outdoor products including all Richard Schultz designed products, KnollExtra CPU storage and all universal storage drawers and Power Collection, Tone Tables.</i></p> <p><i>3 Years: Seating upholstery, textiles, leathers and finishes. Fabric boards textiles and Smokador Collection leathers.</i></p> <p><i>2 Years: Anchor Storage digital keypad lock, all other KnollExtra product</i></p> <p><i>1 Year: Light ballasts, bulbs and power supply, seating upholstered amp pads and soft amp pads, wood casegoods upholstered surfaces. KnollStudio, outdoor product finishes, k. lounge upholstery and k. lounge fabric.</i></p> <p>This warranty does not apply to:</p> <ul style="list-style-type: none">• Damage caused by a carrier other than the Seller.• Normal wear and tear or acts or omissions of parties other than Seller (including user modification, improper use or installation of Products).• COM or other third party materials applied to Products.• Products not installed by or under the auspices of a Knoll Dealer.• Dramatic temperature variations or exposure to unusual conditions.• Changes in surface finishes, including colorfastness due to aging or exposure to light.• Except as specifically noted above, textiles and upholstery supplied by <i>KnollTextiles</i> (consult current <i>KnollTextiles</i> price list for applicable warranty). <p>Natural variations occurring in wood, marble, and leather shall not be considered defects, and the Seller does not guarantee the colorfastness or matching of the colors, grains or textures, or surface hardness of such materials. The Seller also does not guarantee the colorfastness of fiberglass panel surfaces. THE EXPRESS WARRANTIES CONTAINED HEREIN ARE IN LIEU OF ALL OTHER WARRANTIES, EXPRESS OR IMPLIED, INCLUDING ANY WARRANTIES OF MERCHANTABILITY AND FITNESS FOR PARTICULAR PURPOSE AND ALL OTHER WARRANTIES ARISING FROM COURSE OF DEALING OR USAGE OF TRADE.</p> <p>The remedies provided above are the Purchaser's sole remedies for any failure of Seller to comply with its obligations regarding the workmanship of its Products. Correction of any nonconformity in the manner and for the period of time provided shall constitute complete fulfillment of all liabilities of Seller, with respect to or arising out of the Product furnished hereunder.</p>
Delay/Force Majeure	<p>Seller shall not be liable for failure to perform or for delay in performance due to fire, flood, strike or other labor difficulty, act of God, act of any governmental authority or of the Purchaser, riot, embargo, fuel or energy shortage, wrecks or delay in transportation, inability to obtain necessary labor, materials or manufacturing facilities from usual sources or failure of suppliers to meet their contractual obligations, or due to any cause beyond its reasonable control. If any such event occurs, Seller may extend delivery dates by a period of time necessary to overcome the effect of such delay, allocate available Product or cancel any purchase order.</p>
Compliance with Law	<p>PURCHASER IS SOLELY RESPONSIBLE FOR COMPLIANCE WITH ALL APPLICABLE FEDERAL, STATE AND LOCAL LAWS, ORDINANCES, REGULATIONS, RULES AND STANDARDS RELATING TO THE INSTALLATION, MAINTENANCE, USE AND OPERATION OF THE PRODUCTS.</p>
Patents	<p>Subject to the following provisions, Seller shall, at its own expense, defend or, at its option, settle any claim, suit or proceeding brought against the Purchaser, and/or its vendees, mediate and immediate, so far as based on an allegation that any Product or any part thereof furnished hereunder constitutes a direct or a contributory infringement of any claim of any patent of the United States or Canada. This obligation shall be effective only if Purchaser shall have made all payments then due hereunder and if Seller is notified promptly in writing and given authority, information and assistance for the defense of said claim, suit or proceeding. Seller shall pay all damages and costs awarded in such suit or proceedings so defended.</p> <p>The foregoing indemnity does not apply to the following:</p> <ul style="list-style-type: none">• Products supplied according to a design other than that of Seller, and which is required by the Purchaser.• Combination of the Product with another product not furnished hereunder unless Seller is a contributory infringer.• Any settlements of a suit or proceeding made without Seller's written consent.
Limitations of Liability	<p>SELLER, ITS CONTRACTORS, AUTHORIZED DEALERS AND SUBCONTRACTORS OR SUPPLIERS OF ANY TIER SHALL NOT BE LIABLE TO PURCHASER FOR ANY SPECIAL, INDIRECT, INCIDENTAL OR CONSEQUENTIAL DAMAGES ARISING FROM A BREACH OF THIS AGREEMENT.</p> <p>Purchaser's remedies set forth herein are exclusive and the liability of Seller with respect to the breach of this agreement or any contract entered into between the parties pursuant hereto shall not exceed the price of the Product or part on which such liability is based.</p>

KnollKey Lock Program

KnollKey Lock Program General Information

Following is the KnollKey lock policy, applicable to all products.

Knoll furniture can be ordered keyed-alike or random keyed. Key-alike and random keying instructions cannot be mixed on any single order. Only one of the two instructions can be used on an individual order. When an order is submitted with mixed (key-alike and random) instructions, Knoll will release the order as key-alike only and lock cores will have to be specified separately.

Key-alike

For the convenience of the user, furniture may be keyed alike at no charge. Write "Key-alike" in the description of your purchase order for any pedestal, overhead, file or other item you wish to have keyed alike.

Using the key-alike instructions, order cores and keys as line items on your purchase order. Do NOT submit a key-alike form. The Knoll East Greenville Lock Center will select key numbers from the standard range of K 001 - K 250. Key numbers will not be repeated unless over 250 sets are ordered. Lock cores keyed-alike will ship separately from the product, ready for field installation.

There is no charge for key-alike orders if placed with the furniture order.

IF THE KEY-ALIKE ORDER IS NOT PLACED AT LEAST TWO WEEKS PRIOR TO THE FURNITURE SHIP DATE, A \$50 HANDLING CHARGE AND AIR FREIGHT CHARGES WILL APPLY.

If product is ordered and shipped random-keyed, additional lock cores for key-alike are billable.

Random-Keying

To specify product keyed-random, write "key-random" in the product description. Random-keyed product is shipped with the lock core factory installed. A shrouded key is included. Random means no effort has been made to match key numbers, or to make them different.

Keys

A Knoll shrouded key is shipped with every lock core. 250 Key numbers are available. For numbers above 250, contact Custom Product Development. Additional keys and key blanks are available. See service parts for more information.

Master Keying

Knoll locks can be controlled by means of a master key. There is no additional per-lock charge for master keying. A letter of approval from the client must accompany orders for master keys.

Installing Lock Cores

Lock cores can be installed or removed in the field by using a change key. Cores must be in the unlocked position to be removed. See service parts for change key pattern number and pricing.

Lock Distribution

All orders for key-alike lock cores/keys are packaged and shipped from the East Greenville Lock Center, regardless of where the pedestals, overhead, or other units are produced. Random keyed product will have cores factory-installed.

How to Specify Key-Alike

Following is an example of how to specify key-alike for a cluster of 10 workstations.

Step 1 - Using the project floorplan, count the number of locks in each workstation.

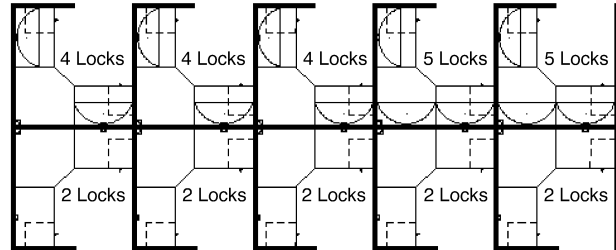

Step 2 - Count the number of workstations with the same quantity of locks. Group together the workstations with a like number of locks.

5 workstations with 2 locks per station
3 workstations with 4 locks per station
2 workstations with 5 locks per station

Step 3 - For the first group (5 sets of 2 locks), enter the number of workstations in the quantity column.

Qty	Pattern #	Description	Unit List	Ext. List
5				

Step 4 - Then enter the pattern number "KSPEC_ _" and add a suffix for the number of locks for that group (i.e., for 2 locks per station, add the suffix "2"). Up to 30 lock cores are available in a set (i.e., KSPEC 30).

Qty	Pattern #	Description	Unit List	Ext. List
5	KSPEC 2	Set of 2 cores/keys	N / C	N / C

Step 5 - Repeat for other groups.

Qty	Pattern #	Description	Unit List	Ext. List
5	KSPEC 2	Set of 2 cores/keys	N / C	N / C
3	KSPEC 4	Set of 4 cores/keys	N / C	N / C
2	KSPEC 5	Set of 5 cores/keys	N / C	N / C

Your Key instructions are complete.

Knoll will select key numbers for each set from 250 available numbers. Additional key numbers are available through Custom Product Development. **For additions to existing installations, specify desired key numbers in the description.**

Service Parts

Pattern #	Description	List Price
KKEY_ _ _	Shrouded Key Specify key number desired	\$10
KBLANK	Shrouded Key Blank	\$10
KSPECB_ _ _	Retrofit Universal Core/Key Specify key number desired	\$22
KCHANGE	Change Key	\$10
HLKRKMASTER*	Master Key	\$10

*Note: A letter of approval on company letterhead from the client must accompany all orders for master keys.

General Ordering Information

The Products

This guide encompasses all standard products for this product group.

Sizes

Dimensions listed in this guide are indicated as:

H = height

W = width

D = depth

Dia. = diameter

Rad. = radius

Pricing

All prices shown are list.

How to Order

Select pattern numbers and quantities required for your complete installation. Product questions can be addressed in the specific sections of this guide or by contacting your sales representative or customer resource representative at 1-800-343-5665.

Next, select options (if required), along with colors and finishes appropriate to each product. Reference the Finishes and Fabrics pages for color designations.

On large installations, an item's "designated area" can be specified to assist in product organization and handling.

To expedite complete / correct entry of your order, be certain all pattern numbers, quantities, colors and area identifications are completely specified. Also, include complete purchase order numbers, bill-to and ship-to addresses, a contact name and specific factory shipping dates required.

Mail all orders to:

Knoll, Inc.
1235 Water Street
P.O. Box 157
East Greenville, PA 18041
Attention: Order Entry

Once your order is entered at Knoll, an acknowledgment will be mailed to you. You will be advised of your scheduled shipping date within five days of the original acknowledgment. If it is necessary to revise your order, please contact your customer resource representative.

Sustainability Statement

Sustainable design is a key component of Knoll's environmental focus. Our commitment to social responsibility and a healthy environment has prompted us to further articulate our longstanding environmental programs and, with encouragement and support from our colleagues in the industry, we have re-energized our focus on such "green" initiatives as life cycle analysis and LEED™ certification. Knoll is proud to have contributed to projects that have received LEED certification from the U.S. Green Building Council.

For the latest information on Knoll products that help our customers achieve LEED certification, log on to knoll.com, click on "About Knoll" and then "Environmental Focus."