

Introduction	Knoll and Sustainable Design	3
	Knoll Color Program Finishes	4
	Dividends Legacy Finishes	6
	Dividends Horizon Fabrics	7
Planning Guidelines	Panel Specifications	8
Panels, Pre-Configured	Monolithic Panels	14
	Tiled Panels	22
	Beltway Panels	40
Panels, Build-To-Spec	Topway and Full View Panel Frame Assemblies	46
	Stack Frames	52
	Monolithic Panel Fabric Inserts	56
	Monolithic Panel Laminate Inserts	60
	Tiled Panel Fabric Inserts	64
	Tiled Panel Laminate Inserts	68
	Beltway Panel Inserts	72
	High Acoustic Core Inserts	76
	Window Insert Kits	78
	Markerboard Tiles	82
	Steel Tile Insert Kits	86
	Slatwall Tiles	94
	Technology Tiles	96
	Open Weave and Glass Screens	100
	Open Weave and Glass Stacking Screens	108
Frameless Add Up	112	
Post Connectors/End Trim	Dividends Horizon DP7 Post Assemblies	114
	Dividends Horizon DP7 Post Components	116
	Legacy Post Assemblies	120
	Legacy Post Components	122
	Panel End Trim and Panel Top Caps	126
	Panel Wall Starter, Panel-to-Panel Top Cap Transition	132
	Panel Rigidizer Brackets, Coat Hooks and Reveal Fillers	134
Alternative Planning	Concealed Post	136
	120° Planning	150
	120° Planning	156
Electrical/Data Components	Electrical Specifications	158
	Base Raceway Electrical	161
	Receptacles	166
	Vertical Electrical	168
	Desktop Power and Data Modules	172
	Beltway Electrical	174
	Electrical Infeeds and Power Poles	178
	New York City, San Francisco and Chicago Electrical	182
Cable Management	186	
Storage Components	Flip-Up Door Overheads	190
	Sliding Door Overheads	194
	Up Mounted Overheads	198
	Overhead Bookshelf and Corner Shelf	200
	Mounting Brackets and Accessories	202
	T5 Task Lights	206
	Pedestals	208
	Credenzas	214
	Flip-up Door Overdesk and Tackboards	236
	Sliding Door Overdesks	240

Worksurfaces	Worksurface Specifications	250
	Rectangular Worksurfaces	254
	Curvilinear Wave End Worksurfaces	260
	Smooth Wave Worksurfaces	262
	Trapezoidal Worksurfaces	263
	Corner Worksurfaces	264
	Peninsula Worksurfaces	270
	Curvilinear Half- and Corner-Round Worksurfaces	272
Cascade Edge Worksurfaces	Transaction Counter Worksurfaces	274
	Rectangular with Cascade Edge	276
	Blended “D” and Curvilinear Corner with Cascade Edge	277
	Blended “L” with Cascade Edge	278
	Half Round and Corner Round with Cascade Edge	279
Worksurface Supports	Wave End with Cascade Edge	280
	Panel Mounted Worksurface Brackets	282
	Screen-to-Worksurface Brackets	286
	Panel Mounted Worksurface Supports	288
Tables	Peninsula Worksurface Supports	290
	Y Leg Tables	292
	X Base Tables	300
	Table Supports	305
Freestanding Desks	Conference Tables	306
	Preconfigured Desks	310
	Desk Components	322
Alpha-Numeric Index	Desk Accessories	328
		331
Selling Policy		342
KnollKey Lock Program		344
General Ordering Information		345

Knoll and Sustainable Design

Each year Knoll sets key initiatives in our journey to sustainability. We are members of a global consortium on energy, have adopted a scientific, metrics-based approach to sustainable product design, and maintain a leadership position in establishing universal, verifiable, sustainability standards for our industry.

Knoll promotes independent third-party certification because it provides the most impartial and trustworthy foundation for industry-wide environmental compliance. Certification by established and respected third parties ensures that all manufacturers are held to the same high standards and that customers can trust a company's declaration about the environmental benefits of its products. Knoll third-party partners include: the International Standards Organization (ISO); Forest Stewardship Council (FSC®); Rainforest Alliance; GREENGUARD® Environmental Institute; and Chicago Climate Exchange (CCX®).

In addition, Knoll is aligned with the U.S. Green Building Council and can help companies, healthcare organizations and educational institutions achieve Leadership in Energy and Environmental Design (LEED®) workplace certification.

1. Global Climate Change

- Knoll is a sponsor of the Clinton Global Initiative, which brings together a community of global leaders to devise and implement solutions to some of the world's most pressing challenges, including environmental change.
- Knoll is a member of the Chicago Climate Exchange, which promotes greenhouse gas reduction through the trading of credits earned for reducing emissions.
- Knoll has a comprehensive Energy Management Program to increase energy efficiency in products and processes.

2. Life Cycle Assessment (LCA) Tool

- Life Cycle Assessment is a science-based measurement of a product's environmental impacts throughout its life cycle, from raw materials sourcing through manufacture, shipping, use and re-use or end-of-life. LCA enables cradle-to-cradle implementation of sustainable practices.
- Knoll has partnered with The Green Standard.org to develop an affordable, universal ISO-compliant computer-based LCA tool that can be used by the entire contract furniture industry and is partnering on the development of an Environmental Product Declaration System (EPDs) for Knoll products. EPDs are verified documents containing LCA results and additional environmental performance information about a product.

3. Setting Industry Standards

- Knoll partners with MTS (The Institute for Market Transformation to Sustainability) to develop the SMaRT® Consensus Sustainable Products Standards, a set of consensus-based sustainable product standards based on the LEED® model, for all building products, fabric, apparel, flooring and carpet. MTS, the developer of SMaRT®, is an accredited American National Standards Institute (ANSI) standard developer.
- Knoll has established FSC® (Forest Stewardship Council) certified wood as the standard for general office open plan office systems, casegoods and tables.
- Knoll also participates in an ongoing BIFMA (Business and Institutional Furniture Manufacturers Association) initiative to establish level™ sustainability standards for the contract furniture industry.
- Our goal is to encourage all manufacturers in the contract furniture industry and related industries to adopt standards that will lead to sustainable products and practices.

For more information about Knoll and sustainable design, visit knoll.com/environment.

Specify Core finishes for all new customers**Paint Finishes:**

Beige Mist Metallic (611)
 Bright White (118)
 Brown (112)
 Dark Grey (113)
 Folkstone Grey (114)
 Jet Black (111)
 Medium Grey (115)
 Medium Metallic Grey (612)
 Sandstone (116)
 Silver (613)
 Soft Grey (117)

Paint Finish Applications:

Panel base raceway covers
 Screen frames
 Steel and slatwall tile inserts
 D1 style tile supports
 DP7 metal panel trim
 DP7 power poles
 Worksurface supports
 Overhead and overdesk cases and doors
 Credenza case, top and door
 Pedestal case and fronts
 Table bases

Laminate Finishes:

Bright White (118)
 Brushed Grey (123)
 Brushed Sand (122)
 Fog (128)
 Folkstone Grey (114)
 Jet Black (111)
 Medium Cherry (124)
 Micro Grey (121)
 Micro Sand (129)
 Natural Cherry (126)
 Natural Maple (125)
 Pumice (119)
 Soft Grey (117)
 Walnut (127)

Laminate Finish Applications:

Worksurfaces
 Overhead and overdesk doors
 Credenza top and door
 Laminate tile inserts
 Freestanding desk worksurfaces
 Table tops

2mm Edgeband Finishes:

Bright White (118)
 Fog (128)
 Folkstone Grey (114)
 Jet Black (111)
 Medium Cherry (124)
 Natural Cherry (126)
 Natural Maple (125)
 Pumice (119)
 Soft Grey (117)
 Walnut (127)

2mm Edgeband Finish Applications:

Worksurfaces
 Freestanding desk worksurfaces
 Table tops

Cascade Worksurface Finishes:

Bright White (118)
 Folkstone Grey (114)
 Medium Cherry (124)
 Natural Cherry (126)
 Natural Maple (125)
 Pumice (119)
 Soft Grey (117)
 Walnut (127)

Cascade Worksurface Finish Applications:

Cascade edge worksurface

Techwood Finishes:

Black Oak (Y851)
 Blond Maple (Y821) (formerly known as maple techgrain)
 Cherry (Y319)
 Dark Grey Oak (Y343)
 Dark Mahogany (Y326)
 Espresso (Y344)
 Light Cherry (Y831) (formerly known as cherry techgrain)
 Light Oak (Y327)
 Maple (Y316)
 Medium Oak (Y329)
 Medium Teak (Y342)
 Medium Walnut (Y323)
 Natural (Y811)
 Wenge (Y341)

Techwood Finish Applications:

Worksurfaces
 Overhead and overdesk doors
 Credenza top and door
 Panel trim
 Veneer tile inserts
 Table tops

Plastic Trim Finishes:

Dark Grey (113)
 Medium Grey (115)
 Soft Grey (117)

Plastic Trim Finish Applications:

Plastic panel trim
 Beltway covers
 Legacy power pole covers

DS1 Storage Plastic Finishes:

Bright White (118)
 Brown (112)
 Dark Grey (113)
 Folkstone Grey (114)
 Jet Black (111)
 Medium Grey (115)
 Sandstone (116)
 Soft Grey (117)

DS1 Storage Plastic Finish Applications:

DS1 pedestal drawer plugs and handles
 DS1 overhead door end plugs

Note: All Dividends Horizon products except DS1 and DS2 pedestals and doublewide pedestals are painted with a textured finish excluding 613 Silver, which is available as a smooth finish only. X and Y base tables and the freestanding screen kits are always painted with a textured finish, including 613 Silver.

Note: Laminates and other finishes may vary in color due to different dye lots. Slight variations are to be expected.

Note: Worksurfaces, overhead and overdesk doors, credenza tops and doors, and veneer tile inserts will have the same Techwood finish on the surface and the edge.

Order Code	Color Name	Old Order Code	Paint Grade	Paint Finishes	Laminate Finishes	2mm Edgeband Finishes	Cascade Worksurface Finishes	Techwood Finishes	Plastic Trim Finishes	DS1 Storage Plastic Finishes
Paints and Laminates										
611	Beige Mist Metallic		P2	•						
118	Bright White	LH	P3	•	•	•	•			•
112	Brown		P1	•						•
123	Brushed Grey				•					
122	Brushed Sand				•					
113	Dark Grey	Y3	P1	•		•			•	•
128	Fog	G			•	•				
114	Folkstone Grey		P1	•	•	•	•			•
111	Jet Black	27	P1	•	•	•				•
124	Medium Cherry				•	•	•			
115	Medium Grey	Y2	P1	•		•			•	•
612	Medium Metallic Grey	J	P2	•						
121	Micro Grey				•					
129	Micro Sand				•					
126	Natural Cherry				•	•	•			
125	Natural Maple				•	•	•			
119	Pumice	LB, F			•	•	•			
116	Sandstone		P1	•						•
613	Silver	3	P3	•						
117	Soft Grey	E, M42	P1	•	•	•	•		•	•
127	Walnut				•	•	•			
Techwoods										
Y851	Black Oak							•		
Y821	Blond Maple (formerly known as maple techgrain)							•		
Y319	Cherry							•		
Y343	Dark Grey Oak							•		
Y326	Dark Mahogany							•		
Y344	Espresso							•		
Y831	Light Cherry (formerly known as cherry techgrain)							•		
Y327	Light Oak							•		
Y316	Maple							•		
Y329	Medium Oak							•		
Y342	Medium Teak							•		
Y323	Medium Walnut							•		
Y811	Natural							•		
Y341	Wenge							•		

Most products introduced after 2004 are not available in Legacy finishes. See individual pricing pages for availability.

Specify Legacy finishes to match existing product only. Legacy finishes are not available for new customers.

Trim Finishes

- Panel top caps
- Panel post trim
- Pedestal drawer top caps
- Overhead drawer top caps
- Pedestal drawer pulls
 - Y1 Pewter

Paint Finishes

- Panel base raceway covers
- Panel tiled insert supports
- Solid Steel panel inserts
- Perforated steel panel inserts
- Embossed steel panel inserts
- Overhead storage components
- Pedestals
- Desk components
- Metal panel topcaps and trim

P1 Finishes

- Y1 Pewter

P2 Finishes

- H Beige Metallic
- W Light Tan Metallic

All other Knoll paint finishes and custom finishes (Series 2 components only)

Laminates

Worksurfaces

An upcharge applies where specifying Legacy laminates. Add an amount equal to 10% of the solid PVC edgeband list price to the price of any product specified with a Legacy laminate.

- MC Caramel Maple
- CM Clear Maple
- M1 Light Grey
- PA Pearwood
- SD Sand
- B Snow
- WM Warm Cherry
- MR6 Winter Grey Matrix

Note: Laminates and other finishes may vary in color due to different dye lots. Slight variations are to be expected.

Worksurface Edges

2mm edgeband

- MC Caramel Maple
- CM Clear Maple
- Y3 Dark Grey
- Y2 Medium Grey
- MT Metal
- Y1 Pewter
- SD Sand
- B Snow
- WM Warm Cherry

Fabric Options**Grade 10**

Bailey II (W359)
 Broadcloth (W288)
 Element (W1077)
 Foundation (W351)
 Growth Spurt (W692)
 Newbury (W812)
 Solid Crepe (W257)
 Symbolic Details (W693)
 Tailor Made (W133)
 Versatility (W432)

Grade 15

Regency/Fairfield (W210/B)

Grade 20

Banyan (W443)
 Bauhaus Block (W296)
 Circle Line (W1146)
 Clarity (W281)
 Criss Cross (W305)
 Devon (W809)
 Melbourne (W228)
 Outback (W229)
 Photon (W1293)
 Reflect (W884)
 Resolution (W280)
 Walkabout (W230)
 Weave Three (W298)

Grade 30

Basket Draft (W249)
 Flow (W565)
 Harmony (W232)
 Interknit (W1090)
 Micro (W465)
 Progression (W403)

Grade 40

Amplify (W1215)
 Bandwidth (W1219)
 Clarkson (W1218)
 Ornament (W1078)
 Palladium (W1030)

Grade 45

Dristi (K872)

Grade 50

Knoll Hopsack (K1206)
 Presto (K1000)
 Ricochet (K498)

Grade 55

Transition (W816)

Open Weave Fabrics**Warpnet**

White (W1113/1)
 Medium Grey (W1113/2)
 Dark Value Grey (W1113/3)
 Warm Cool Neutral (W1113/4)
 Brushed Gold (W1113/5)

COM (Customer's Own Material)

COM can be applied to Dividends Horizon product on a select basis. Please consult your Knoll Customer Service Representative for details on the COM approval process and testing requirements.

Pricing for COM fabrics is at Grade 10.

Note: Always contact your Customer Service Representative prior to sending any COM (including pre-approved KnollTextiles) to the manufacturing facility.

Dividends Horizon Panels

Dividends Horizon is a furniture system comprised of a wide variety of panels, hanging components, storage, screens and freestanding desks.

At the heart of the system is a universal panel frame. The universal frame is an open design that accepts many styles of panel inserts. These include:

- Monolithic Fabric Insert
- Monolithic Laminate Insert
- Tiled Fabric Insert
- Tiled Laminate Insert
- Beltway Electrical
- Technology Tile
- Painted Steel
- Perforated Steel
- Embossed Steel
- Window Kits
- Markerboard

Panel Dimensions

- Widths: 15", 18", 24", 30", 36", 42", 48" and 60"
- Heights: worksurface height, 36", 42", 50", 57", 64" and 78"
- Thickness: 3"

Panel Frame Options

Dividends Horizon offers two panel frame options, which are selected depending on customer's aesthetic and functional needs. Both frames are available in preconfigured and build-to-spec panels.

Topway panel frames feature an integral top cable trough, and are used with D1 style stack frames.

Full View frames have no top trough, leaving a larger window opening in the top position. Full View frames are used with D2 style stack frames.

Dividends Horizon Panels and Components (Base Raceway shown)

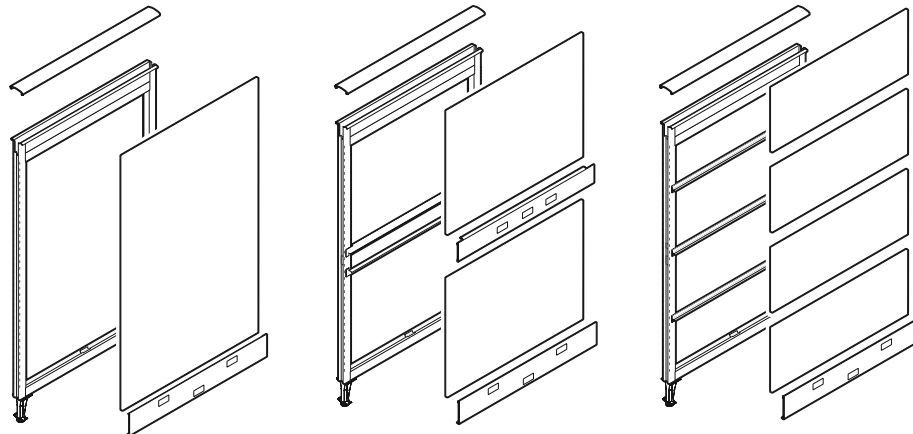

Monolithic Panel

Beltway Panel

Tiled Panel

Panel Frame Construction

Panel frames are robotically welded and consist of vertical channels, horizontal rails and panel feet with leveling glides.

- Topway trough: 22-gauge roll-formed steel (topway frames only)
- Vertical channels: 16-gauge roll-formed steel with 5/8" integral slotted standard with adjustments in 1 1/2" increments
- Horizontal rails: 15-gauge roll-formed steel
- Panel feet: extruded aluminum
- Leveling glides: Steel threads with 1-1/2" height adjustment and 1-1/2" diameter nylon foot

Preconfigured Panels

Dividends Horizon panels can be specified "Preconfigured" in various styles including:

- Monolithic Panel
- Tiled Panel
- Beltway Panel

Monolithic Panel Components

Monolithic panels provide a single fabric or laminate insert per panel side.

Preconfigured Dividends Horizon panels are shipped complete with panel frame, base components, top cap, panel to panel connection hardware and one full height panel insert per side.

Tiled Panel Components

Individual tiled panels allow for a "segmented" aesthetic. Individual tile supports create separation within the panel frame.

"Preconfigured" Dividends Horizon panels ship complete with panel frame, base components, top cap, panel to panel connection hardware, tile supports and tiles.

Beltway Panel Components

Beltway panels allow for electrical and/or data to be accessed above worksurface height. Beltway electrical/data can be specified on one or both sides of a panel.

"Preconfigured" Dividends Horizon beltway panels ship complete with panel frame, base components, top cap, panel to panel connection hardware, beltway panel inserts, beltway covers and beltway insert supports.

Base Options

- Base Raceway
- Open Base
- Tile to the Floor

Note: Standard base, Open base and Tile to the floor components can be retrofitted in either a topway or full view frame.

Stack Frames

Dividends Horizon stack frames increase the overall height of a standard panel.

The stack frame is available in three panel heights, 14", 21" and 28". Dividends Horizon stack panels may be attached to standard 36", 42", 50", 57", 64" and 78" high panel. Maximum stacking height above a base panel height is 28".

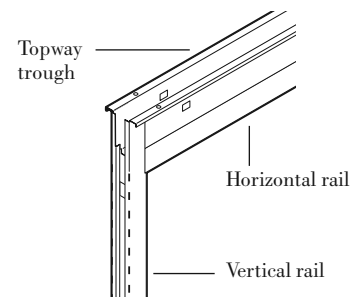

Topway Frame Construction

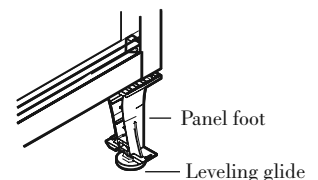

Panel Foot Construction

Open Position Planner

Dividends Horizon now offers an industry leading technology called Open Position Planner, allowing customers and dealers to design, specify and order factory-assembled Dividends Horizon panels in virtually any configuration.

This powerful specification tool eliminates the need for most built-to-spec panels. Since panels arrive at the job site assembled, installation labor is also reduced.

The functionality of Open Position Planner is available only to electronic specification users, and is not available in this price list.

“Build-to-Spec” Panels

“Build-to-Spec” panels are specified by component for special applications. These include: when a different fabric is required on each panel side and when retrofitting existing panels to another style. Panels and components are not shipped assembled.

Universal Panel Connectors

Universal panel connectors are included with Dividends panels. Panel connection hardware is universal to allow:

- Same-height straight panel-to-panel connections
- High-low straight panel-to-panel connections
- Straight high-low panel-to-post connections

Included with universal panel connection hardware:

- Upper wedge block connector
- Lower cactus connectors

Universal panel connection hardware construction:

- Lower connectors: Welded 14-gauge steel cactus style connectors
- Upper connector: Die cast wedge block with 13-gauge steel alignment bracket and 4 1/2" tension screw

Panel Attachment

The lower cactus style connectors engage the lower frames of adjacent panels. The upper wedge block engages the upper frames. The connection is secured by tightening the upper connector's tension screw.

Panel-to-Panel Top Cap Transition

Top cap transitions fill the gap between panel top cap sections in straight panel-to-panel configurations.

- **Construction:** Trim-color black when used with veneer top caps
- **Size:** 1" wide by 3" deep
- **Attachment:** Snaps between top cap sections in straight, same-height panel configurations

Note: Panel-to-panel top cap transitions are ordered separately from panels.

Top Cap

Top cap is included with preconfigured panels.

- **Construction:** Plastic top caps are trim colored, softly radiused plastic extrusion. Veneer top caps are techgrain veneer over plastic extrusion. Metal top caps, available in both radius and flat profiles, are powder coated steel.

- **Attachment:** Snaps onto the trough of a topway panel frame. Retainer clips are used to attach the top cap to the top rail of a full view frame.

Panel End Trim

Panel end trim matches the aesthetics of the panel top cap. It is used to end a panel run and for high-low, panel-to-panel applications.

Four panel trim options are available:

- Enhanced smooth plastic
- Radius Metal
- Flat Metal
- Thin Profile Flat

Note: Panel end trim is ordered separately from panels. Included with the panel end trim are panel end trim brackets.

- **Construction:** Standard panel end trims are trim colored, softly radiused plastic extrusions with a plastic injection molded end cap.

Metal trim is extruded aluminum with powder coat finish.

- **Attachment:** Panel-mount brackets are fastened to the panel with thread-forming screws into pre-punched holes. End trim snaps onto panel mount brackets.

The panel end top cap snaps over the panel end trim and panel top trim.

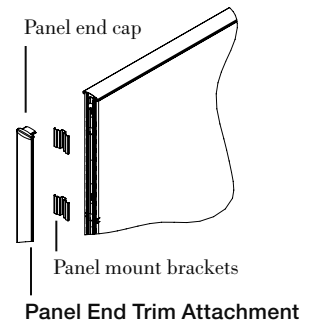
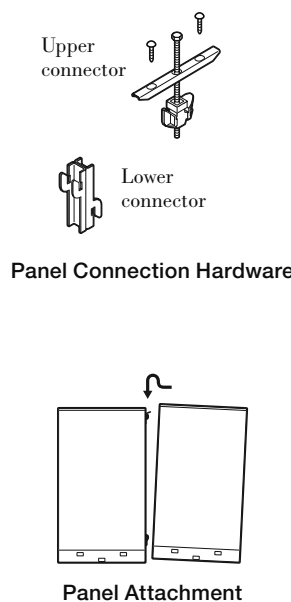
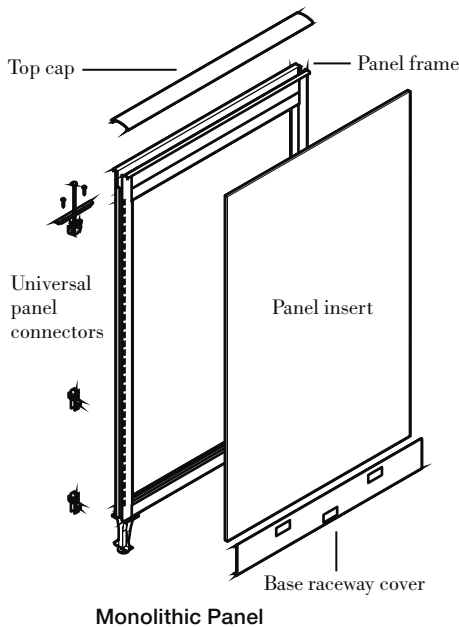

Post Connectors

Post connectors are required for all "L", "T", and "X" configurations. For same-height applications, post connectors are available as an assembly and include the post, vertical trim and top cap.

For high-low panel-to-post applications, post connectors are specified by component.

Post and Post Component Construction

- Post: 3" square extruded aluminum
- Plastic Post Cover: Trim-color plastic extrusion
- Metal Post Cover: 18 gauge steel with powder coat finish
- Post Top Cap: Trim-colored injection-molded plastic

Attachment: Post connectors use the universal panel connection hardware from adjacent panels

Electrical and data access: Posts have cut-outs that match the wire and cable access channels provided by panel frames. This allows wire conduits and data cables to be routed through the post at the topway, beltway and base raceway.

Electrical and Communications
Dividends Horizon provides a logical approach for planning and installing electrical systems and communication cables.

Power is installed along the base raceway with access available in both the base raceway and optional beltway.

Topway Panel Frame Electrical

Allows data cables to be routed horizontally and vertically within the panel.

- Interior dimension: 2 1/2"H x 3/4"W

Cables can be routed along the tops of panels, routed through the interior of panels and along both the beltway and base raceway. The primary channel for distributing cable is provided in the horizontal topway along the top of panels. The topway allows cables to be easily laid-in during initial installation and additional cables to be added as required. It also separates data from power to reduce the chance of interference. A vertical wire pathway is provided in the center of the topway. This allows cables to be run vertically through the interior of the panel to the beltway or base raceway without the use of exterior cable managers.

Data Cabling Bend Radius

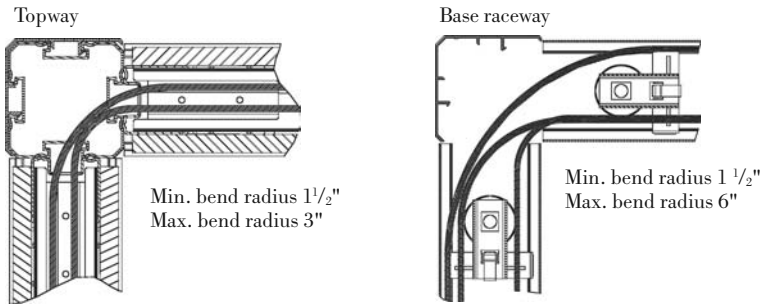

Topway Panel Frame Trough

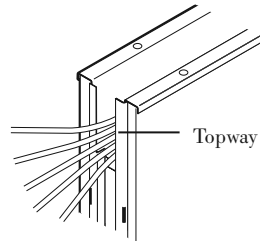

Topway Panel Frame Cable Routing

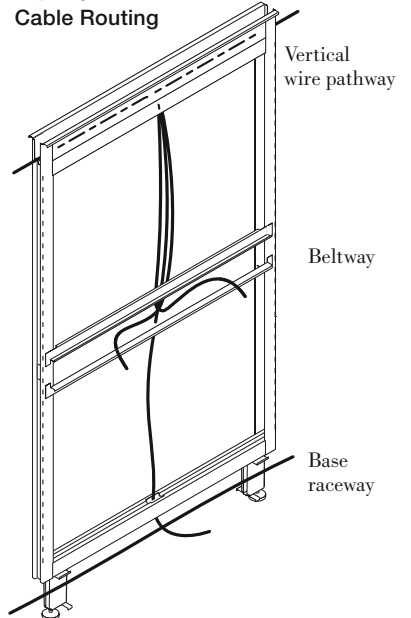

"L" Post Connection

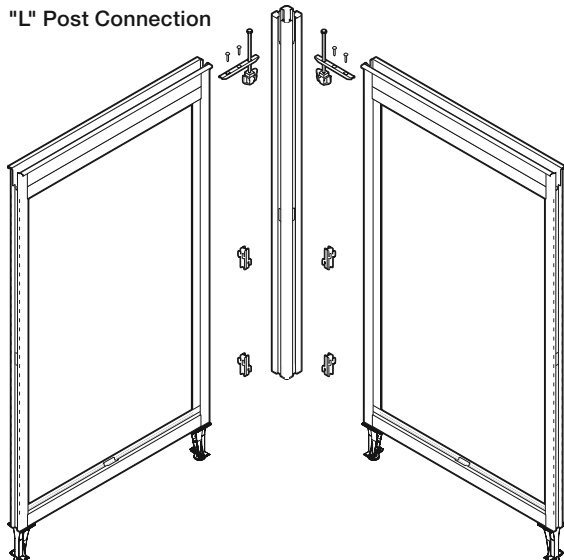

"L" Post Cover Attachment

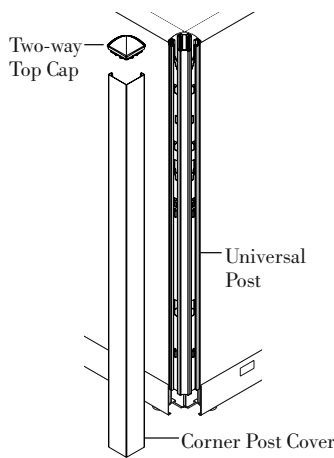

Beltway Electrical

Provides duplex receptacle and data port access at desk-height level.

- Exterior dimension: 4 1/4"H x 3"D
- Interior dimension: 3 1/2"H x 2 3/4"D
- Height from floor: 32 3/4" to center of beltway cover
- Beltway cover construction: Trim-color plastic extrusion
- Beltway cover attachment: Snaps onto beltway panel insert supports
- Duplex access: 30" and wider beltway covers have two duplex knockouts per panel side (18" and 24" wide beltways do not have duplex knockouts)
- Duplex location: Knockouts located 12" on center from each end of cover
- Data access: All beltway covers (except 30" wide) have one center-located data port knockout per panel side
- Additional data access: In panels 30" and wider, the two duplex knockouts can be used as additional data ports when the beltway is not used for duplex receptacles.
- Power capacity: One power module per panel (single or double-sided).

Panel Base Options

Dividends Horizon panels are available with three base options:

- Base Raceway
- Open Base
- Tile-to-Floor.

Overall panel heights, tile configurations and application rules are the same for all three base options.

Base Raceway

Provides duplex receptacle and data port access at base height. Base Raceway panels feature two roll formed steel raceway covers, which are available with or without electrical/data knockouts.

- Exterior dimension: 5"H x 2 15/16"D
- Interior dimension: 5"H x 2 7/8"D
- Dataport Knockout dimension: 1 3/8"H x 2 5/8"D
- Construction: Paint-colored 22-gauge roll-form steel cover
- Duplex access: 24" and wider base raceway covers have two duplex knockouts per panel side (18"W panels do not have duplex knockouts)

- Duplex location: 9" on center from each end
- Data access: All base raceway covers have one center-located data port knockout
- Additional data access: In panels 24" and wider, the outer knockouts can be used as additional data ports when the raceway is not used for duplex receptacles
- Power capacity: One power module or jumper

Note: Knockouts are standard unless specified without.

Open Base panels feature two extruded aluminum feet positioned at the end of each panel. A horizontal trim is located below the bottom tile.

Tile-To-Floor panels eliminate the raceway cover and access on one side, replaced by a fabric or steel tile extended to the floor. A heavy gauge steel internal raceway cover protects the raceway contents and the tile from deflecting when hit by shoes or vacuum cleaners. The other side of the panel features a raceway cover, available with or without electrical/data knockouts. If needed, use one-sided electrical and one-sided base cable trays with this base option.

Beltway Electrical

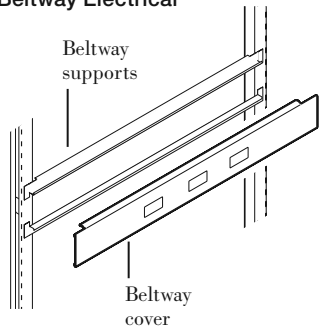

Base Raceway Electrical

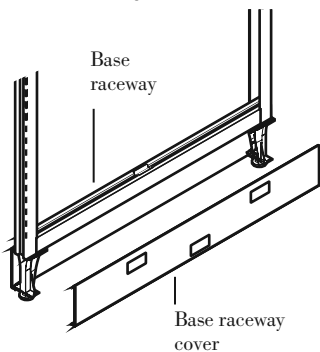

Cable Management Capacities

This chart shows the number of category 5, 4-pair cables that can be routed through various Dividends Horizon pathways. Cable capacities are based on 0.160, 0.200, and 0.250 diameter cables at a full fill capacity.

Pathway Description	Cable Pathway Area (Square Inches)	Cable Dia. 0.16"	Cable Dia. 0.20"	Cable Dia. 0.25"
Panel Top Way	3.00	109	75	41
Panel Base Raceway (w/o electrical)	8.52	270	178	108
Panel Base Raceway (with electrical)	3.65	162	102	56
Beltway (w/o electrical)	1.50	72	50	32
Beltway (with electrical)	1.10	26	18	11
Vertical Drop (within panel)	1.90	28	24	15

Panel Planning Guidelines

The following panel planning guidelines are provided to ensure stability of Dividends Horizon panels.

Three different scenarios are shown:

- Panel run supported by panels on one end
- Panel run supported by panels on both ends
- High density storage

Panel Run Supported by Panels at One End

- Minimum of an "L" panel connection on one end
- Maximum number of panels in run: 4
- End of panel run must be supported by a pedestal, panel-mounted Open Leg Support, C-leg Support or any height panel

Formula for Depth of Return

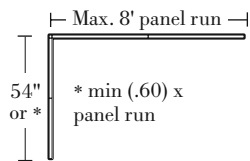

Panel Run Supported by Panels at One End

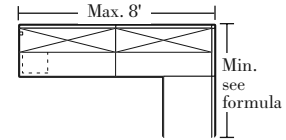
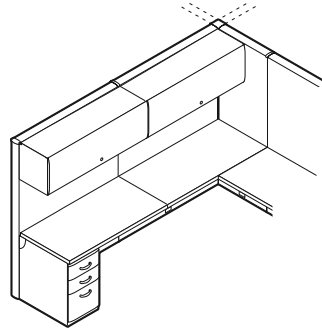

End of Run Supported by Pedestal

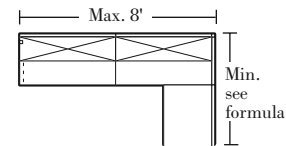
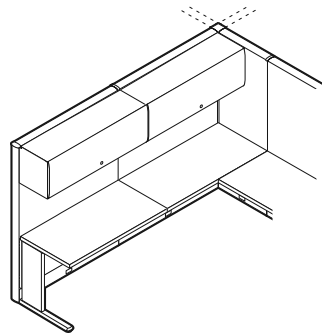

End of Run Supported by Panel Mount C-Leg Support

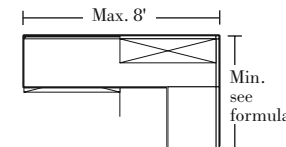
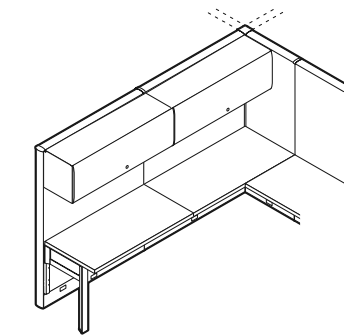

End of Run Supported by Open Leg Support

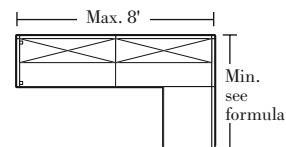
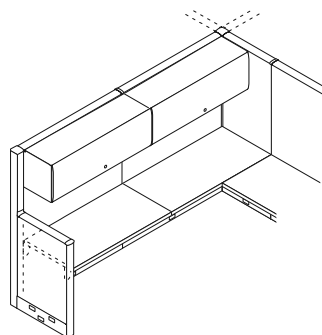

End of Run Supported by Panel of Any Height

Panel Run Supported by Panels at Both Ends

- Minimum of an "L" panel connection on both ends (see Formulas 2 and 3 below)
- Maximum length panel run: 12'
- Maximum number of panels in run: 4

- Both ends of panel run must be supported by matching height panels (see Formulas 2 and 3 below)
- Panel run must be floor supported every 8' with a pedestal, panel mounted Open Support Leg or C-Leg support

High Density Storage

If hanging more than one overhead component vertically per panel side the following is required:

- Panel must be supported by matching height return panels on both ends of the panel

Panel Run Supported by Panels at Both Ends

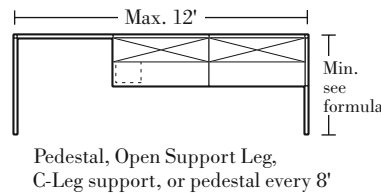
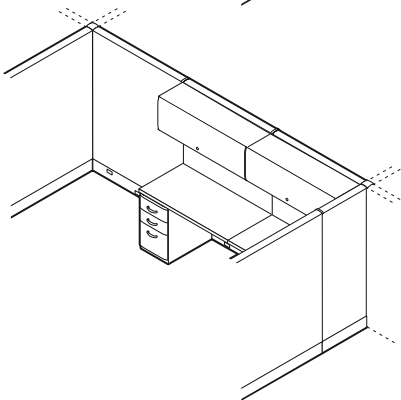
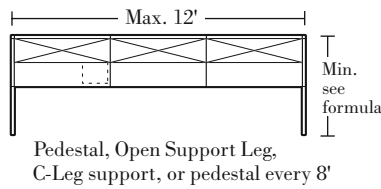
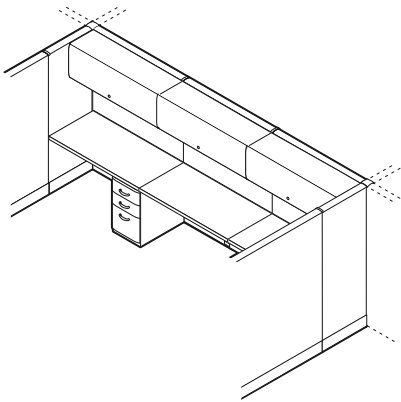

Formulas for Depth Return

Formula 1

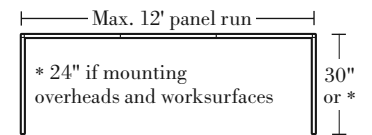

Formula 2

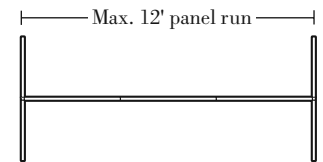

Formula 3

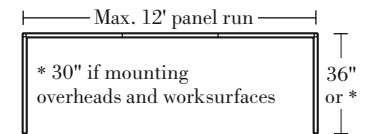

Return panel must be a minimum of 36" wide when laminate tiles are used along the spine panel run.

High Density Storage

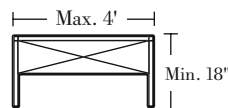
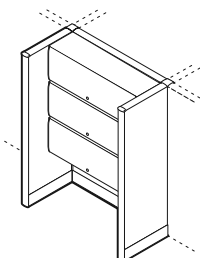

Monolithic Panel

Monolithic panels provide a single fabric insert per panel side.

Preconfigured Dividends Horizon panels are shipped complete with topway or full view panel frame, base components, top cap, panel to panel connection hardware and one full height fabric panel insert per side.

Panels may also be ordered by components for "Build-to-Spec" applications. This includes when different fabric insert is required on each side of the panel.

Monolithic Panel Insert Construction

Fabric laminated with web adhesive heat-cured to 7/16" thick tackable acoustical board.

Monolithic Panel Ratings

- Noise Reduction Coefficient (NRC) rating: .70
- Sound Transmission Class (STC) rating: 11

Dividends Horizon panels meet the flame spread and smoke generation criteria established in UL1286 safety standard for office furnishings.

Monolithic Panel Insert Attachment

Fabric panel inserts flex to attach to the troughs in the upper and lower horizontal frame supports. Mounting spring clips are attached to inserts for connection to the vertical frame for additional support. No tools are required for the insert attachment.

Top Cap Options

Three top cap options are available:

- Smooth Radius Plastic
- Radius Metal
- Flat Metal

Top Cap Construction

Smooth radiused plastic top caps are made from extruded plastic. Radius metal and flat metal top caps are made from extruded aluminum.

Top Cap Attachment

Snaps onto the trough of a topway panel frame. Retainer clips are included to attach top caps to a full view frame.

If additional support for monolithic panel inserts is required, a beltway cable tray can be installed.

Three Base Options Available:

- Base Raceway
- Tile to the Floor
- Open Base

Base Raceway covers are available with or without knockouts.

See the preconfigured tiled panel pages for more information on base options.

Carpet Grippers

Carpet grippers should be specified to increase rigidity of unsupported panel runs. The carpet grippers snap onto leveling glides to prevent panel runs from shifting on carpet. The glides rotate in carpet grippers to permit leveling. Carpet grippers have a black finish.

Universal Panel Connectors

Dividends Horizon panels include universal panel connectors to allow same-height straight panel-to-panel connections, high-low straight panel-to-panel connections and straight and high-low panel-to-post connections.

Electrical

Panels 24" and wider will accept two duplex receptacles per panel base side. 18" wide panels will provide pass-through electrical only. All electrical components are ordered separately and must be field-installed.

Preconfigured Monolithic Panel

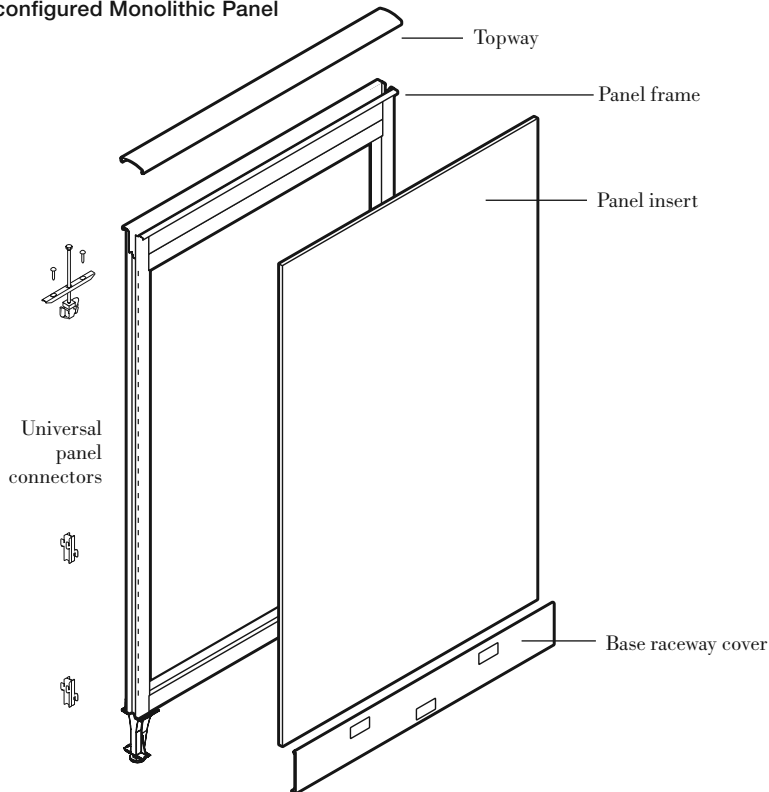



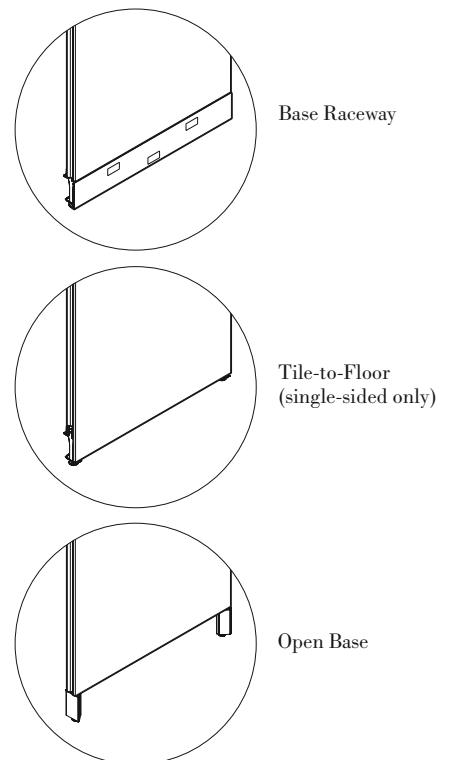

Panel Base Options



Monolithic Panels

Standard Base Raceway

Worksurface Height, 36", 42" and 50" High

description	h	w	d	pattern no.	grade							
					10	15	20	25	30	35	40	45
 Worksurface Height Monolithic Standard Base Raceway	28 1/2"	15"	3"	DP7CMMRRWH15	\$336.	\$348.	\$364.	\$369.	\$382.	\$388.	\$394.	\$404.
	28 1/2"	18"	3"	DP7CMMRRWH18	336.	348.	364.	369.	382.	388.	394.	404.
	28 1/2"	24"	3"	DP7CMMRRWH24	377.	388.	407.	414.	424.	432.	440.	450.
	28 1/2"	30"	3"	DP7CMMRRWH30	396.	409.	428.	436.	447.	456.	463.	475.
	28 1/2"	36"	3"	DP7CMMRRWH36	447.	462.	486.	493.	507.	516.	525.	539.
	28 1/2"	42"	3"	DP7CMMRRWH42	499.	513.	539.	548.	563.	573.	582.	599.
	28 1/2"	48"	3"	DP7CMMRRWH48	528.	543.	569.	579.	596.	606.	618.	632.
	28 1/2"	60"	3"	DP7CMMRRWH60	634.	653.	684.	697.	717.	730.	742.	760.
 36" High, Monolithic Standard Base Raceway	35 1/8"	15"	3"	DP7CMMRR3615	336.	348.	364.	369.	382.	388.	394.	404.
	35 1/8"	18"	3"	DP7CMMRR3618	336.	348.	364.	369.	382.	388.	394.	404.
	35 1/8"	24"	3"	DP7CMMRR3624	377.	388.	407.	414.	424.	432.	440.	450.
	35 1/8"	30"	3"	DP7CMMRR3630	396.	409.	428.	436.	447.	456.	463.	475.
	35 1/8"	36"	3"	DP7CMMRR3636	447.	462.	486.	493.	507.	516.	525.	539.
	35 1/8"	42"	3"	DP7CMMRR3642	499.	513.	539.	548.	563.	573.	582.	599.
	35 1/8"	48"	3"	DP7CMMRR3648	528.	543.	569.	579.	596.	606.	618.	632.
	35 1/8"	60"	3"	DP7CMMRR3660	634.	653.	684.	697.	717.	730.	742.	760.
 42" High, Monolithic Standard Base Raceway	42 3/16"	15"	3"	DP7CMMRR4215	352.	364.	382.	389.	399.	407.	414.	423.
	42 3/16"	18"	3"	DP7CMMRR4218	352.	364.	382.	389.	399.	407.	414.	423.
	42 3/16"	24"	3"	DP7CMMRR4224	382.	393.	413.	419.	431.	439.	445.	458.
	42 3/16"	30"	3"	DP7CMMRR4230	419.	432.	454.	462.	475.	485.	492.	505.
	42 3/16"	36"	3"	DP7CMMRR4236	459.	472.	496.	505.	519.	528.	537.	549.
	42 3/16"	42"	3"	DP7CMMRR4242	507.	522.	547.	557.	572.	582.	594.	608.
	42 3/16"	48"	3"	DP7CMMRR4248	538.	553.	580.	592.	608.	619.	629.	647.
	42 3/16"	60"	3"	DP7CMMRR4260	647.	665.	698.	711.	731.	743.	756.	775.
 50" High, Monolithic Standard Base Raceway	49 1/2"	15"	3"	DP7CMMRR5015	377.	388.	407.	414.	424.	432.	440.	450.
	49 1/2"	18"	3"	DP7CMMRR5018	377.	388.	407.	414.	424.	432.	440.	450.
	49 1/2"	24"	3"	DP7CMMRR5024	409.	421.	441.	449.	461.	468.	477.	490.
	49 1/2"	30"	3"	DP7CMMRR5030	453.	466.	489.	498.	512.	521.	530.	543.
	49 1/2"	36"	3"	DP7CMMRR5036	499.	513.	539.	548.	563.	573.	582.	599.
	49 1/2"	42"	3"	DP7CMMRR5042	549.	566.	594.	605.	622.	632.	642.	659.
	49 1/2"	48"	3"	DP7CMMRR5048	595.	612.	641.	654.	671.	683.	695.	713.
	49 1/2"	60"	3"	DP7CMMRR5060	713.	735.	770.	784.	805.	821.	834.	855.

Dimensions listed under h w d are actual to the nearest 1/16"



Ordering Information	Order Code	Included with:	Options
Monolithic Panel with Standard Base Raceway: 1. Pattern number 2. Top cap type 3. Top cap finish 4. Raceway knockout option 5. Raceway trim finish 6. Panel fabric	Monolithic Panel Standard Base Raceway <i>Example:</i> DP7CMMRR3618 4/117/K/117/B191 <hr/> DP7 Dividends Horizon Panel <hr/> C Topway frame <hr/> MM Monolithic both sides <hr/> RR Base Raceway <hr/> 4 Radius Metal top cap <hr/> 117 Soft Grey top cap finish <hr/> K Base raceway with knockouts both sides <hr/> 117 Soft Grey base raceway finish <hr/> B191 Fairfield fabric	Monolithic Panel with Standard Base Raceway: <ul style="list-style-type: none"> Panel frame Acoustic panel inserts (2) Base raceway covers Top cap Connection hardware Note: Worksurface Height panels do not connect to any other panel height. Note: Preconfigured Worksurface Height panels are not available with plastic top caps.	Monolithic Panel with Standard Base Raceway Options: Full View Frame Option: To specify full view frame for window or stacking applications, replace the "C" in pattern number with "V", No upcharge. Top Cap Options: (2) = Extruded Plastic (Smooth Radius) (3) = No Top Cap (4) = Radius Metal, add \$38 P1, \$40 P2, \$42 P3 (5) = Flat Metal add \$38 P1, \$40 P2, \$42 P3 paint grades Raceway Options: (K) = Knockouts both side (N) = No Knockouts

Monolithic Panels

Standard Base Raceway

57", 64" and 78" High

Dividends Horizon

description	h	w	d	pattern no.	grade							
					10	15	20	25	30	35	40	45
57" High, Monolithic Standard Base Raceway 	56 ¹³ / ₁₆ "	15"	3"	DP7CMMRR5715	\$407.	\$419.	\$439.	\$446.	\$460.	\$467.	\$475.	\$489.
	56 ¹³ / ₁₆ "	18"	3"	DP7CMMRR5718	407.	419.	439.	446.	460.	467.	475.	489.
	56 ¹³ / ₁₆ "	24"	3"	DP7CMMRR5724	440.	453.	475.	485.	498.	506.	515.	528.
	56 ¹³ / ₁₆ "	30"	3"	DP7CMMRR5730	490.	505.	529.	539.	607.	563.	572.	588.
	56 ¹³ / ₁₆ "	36"	3"	DP7CMMRR5736	537.	553.	579.	592.	492.	618.	628.	643.
	56 ¹³ / ₁₆ "	42"	3"	DP7CMMRR5742	583.	602.	631.	642.	660.	671.	683.	701.
	56 ¹³ / ₁₆ "	48"	3"	DP7CMMRR5748	630.	649.	681.	694.	712.	724.	737.	756.
	56 ¹³ / ₁₆ "	60"	3"	DP7CMMRR5760	714.	736.	772.	786.	807.	822.	835.	857.
64" High, Monolithic Standard Base Raceway 	64 ¹ / ₁₆ "	15"	3"	DP7CMMRR6415	436.	447.	470.	479.	492.	500.	510.	522.
	64 ¹ / ₁₆ "	18"	3"	DP7CMMRR6418	436.	447.	470.	479.	492.	500.	510.	522.
	64 ¹ / ₁₆ "	24"	3"	DP7CMMRR6424	470.	486.	509.	517.	531.	540.	550.	565.
	64 ¹ / ₁₆ "	30"	3"	DP7CMMRR6430	526.	542.	568.	578.	594.	604.	616.	630.
	64 ¹ / ₁₆ "	36"	3"	DP7CMMRR6436	573.	592.	620.	630.	650.	659.	671.	688.
	64 ¹ / ₁₆ "	42"	3"	DP7CMMRR6442	619.	637.	667.	681.	698.	712.	723.	743.
	64 ¹ / ₁₆ "	48"	3"	DP7CMMRR6448	665.	685.	719.	733.	752.	767.	778.	801.
	64 ¹ / ₁₆ "	60"	3"	DP7CMMRR6460	800.	824.	865.	878.	904.	920.	936.	960.
78" High, Monolithic Standard Base Raceway 	78 ⁹ / ₁₆ "	15"	3"	DP7CMMRR7815	623.	641.	673.	685.	706.	717.	728.	747.
	78 ⁹ / ₁₆ "	18"	3"	DP7CMMRR7818	623.	641.	673.	685.	706.	717.	728.	747.
	78 ⁹ / ₁₆ "	24"	3"	DP7CMMRR7824	687.	710.	744.	757.	778.	790.	806.	828.
	78 ⁹ / ₁₆ "	30"	3"	DP7CMMRR7830	746.	769.	806.	821.	844.	860.	873.	896.
	78 ⁹ / ₁₆ "	36"	3"	DP7CMMRR7836	816.	842.	881.	898.	923.	939.	955.	980.
	78 ⁹ / ₁₆ "	42"	3"	DP7CMMRR7842	885.	913.	959.	976.	1,000.	1,019.	1,038.	1,064.
	78 ⁹ / ₁₆ "	48"	3"	DP7CMMRR7848	945.	975.	1,022.	1,040.	1,069.	1,088.	1,106.	1,134.

Dimensions listed under h w d are actual to the nearest 1/16"

Ordering Information	Order Code	Included with:	Options
Monolithic Panel with Standard Base Raceway: 1. Pattern number 2. Top cap type 3. Top cap finish 4. Raceway knockout option 5. Raceway trim finish 6. Panel fabric	Monolithic Panel Standard Base Raceway <i>Example:</i> DP7CMMRR3618 4/117/K/117/B191 <hr/> DP7 Dividends Horizon Panel <hr/> C Topway frame <hr/> MM Monolithic both sides <hr/> RR Base Raceway <hr/> 4 Radius Metal top cap <hr/> 117 Soft Grey top cap finish <hr/> K Base raceway with knockouts both sides <hr/> 117 Soft Grey base raceway finish <hr/> B191 Fairfield fabric	Monolithic Panel with Standard Base Raceway: <ul style="list-style-type: none"> Panel frame Acoustic panel inserts (2) Base raceway covers Top cap Connection hardware 	Monolithic Panel with Standard Base Raceway Options: Full View Frame Option: To specify full view frame for window or stacking applications, replace the "C" in pattern number with "V", No upcharge. Top Cap Options: (2) = Extruded Plastic (Smooth Radius) (3) = No Top Cap (4) = Radius Metal, add \$38 P1, \$40 P2, \$42 P3 (5) = Flat Metal add \$38 P1, \$40 P2, \$42 P3 paint grades Raceway Options: (K) = Knockouts both side (N) = No Knockouts

Open Base

Worksurface Height, 36", 42" and 50" High

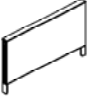
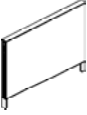
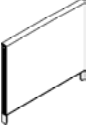
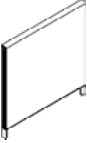
description	h	w	d	pattern no.	grade							
					10	15	20	25	30	35	40	45
Worksurface Height, Monolithic Open Base 	28 1/2"	18"	3"	DP7CMMLLWH18	\$391.	\$403.	\$419.	\$424.	\$437.	\$443.	\$449.	\$459.
	28 1/2"	24"	3"	DP7CMMLLWH24	432.	443.	462.	469.	479.	487.	495.	505.
	28 1/2"	30"	3"	DP7CMMLLWH30	451.	464.	483.	491.	502.	511.	518.	530.
	28 1/2"	36"	3"	DP7CMMLLWH36	502.	517.	541.	548.	562.	571.	580.	594.
	28 1/2"	42"	3"	DP7CMMLLWH42	554.	568.	594.	603.	618.	628.	637.	654.
	28 1/2"	48"	3"	DP7CMMLLWH48	583.	598.	624.	634.	651.	661.	673.	687.
	28 1/2"	60"	3"	DP7CMMLLWH60	689.	708.	739.	752.	772.	785.	797.	815.
36" High, Monolithic Open Base 	35 1/8"	18"	3"	DP7CMMLL3618	391.	403.	419.	424.	437.	443.	449.	459.
	35 1/8"	24"	3"	DP7CMMLL3624	432.	443.	462.	469.	479.	487.	495.	505.
	35 1/8"	30"	3"	DP7CMMLL3630	451.	464.	483.	491.	502.	511.	518.	530.
	35 1/8"	36"	3"	DP7CMMLL3636	502.	517.	541.	548.	562.	571.	580.	594.
	35 1/8"	42"	3"	DP7CMMLL3642	554.	568.	594.	603.	618.	628.	637.	654.
	35 1/8"	48"	3"	DP7CMMLL3648	583.	598.	624.	634.	651.	661.	673.	687.
	35 1/8"	60"	3"	DP7CMMLL3660	689.	708.	739.	752.	772.	785.	797.	815.
42" High, Monolithic Open Base 	42 3/16"	18"	3"	DP7CMMLL4218	407.	419.	437.	444.	454.	462.	469.	478.
	42 3/16"	24"	3"	DP7CMMLL4224	437.	448.	468.	474.	486.	494.	500.	513.
	42 3/16"	30"	3"	DP7CMMLL4230	474.	487.	509.	517.	530.	540.	547.	560.
	42 3/16"	36"	3"	DP7CMMLL4236	514.	527.	551.	560.	574.	583.	592.	604.
	42 3/16"	42"	3"	DP7CMMLL4242	562.	577.	602.	612.	627.	637.	649.	663.
	42 3/16"	48"	3"	DP7CMMLL4248	593.	608.	635.	647.	663.	674.	684.	702.
	42 3/16"	60"	3"	DP7CMMLL4260	702.	720.	753.	766.	786.	798.	811.	830.
50" High, Monolithic Open Base 	49 1/2"	18"	3"	DP7CMMLL5018	432.	443.	462.	469.	479.	487.	495.	505.
	49 1/2"	24"	3"	DP7CMMLL5024	464.	476.	496.	504.	516.	523.	532.	545.
	49 1/2"	30"	3"	DP7CMMLL5030	508.	521.	544.	553.	567.	576.	585.	598.
	49 1/2"	36"	3"	DP7CMMLL5036	554.	568.	594.	603.	618.	628.	637.	654.
	49 1/2"	42"	3"	DP7CMMLL5042	604.	621.	649.	660.	677.	687.	697.	714.
	49 1/2"	48"	3"	DP7CMMLL5048	650.	667.	696.	709.	726.	738.	750.	768.
	49 1/2"	60"	3"	DP7CMMLL5060	768.	790.	825.	839.	860.	876.	889.	910.

Dimensions listed under h w d are actual to the nearest 1/16"



Ordering Information	Order Code	Included with:	Options
Monolithic Panel with Open Base: 1. Pattern Number 2. Top cap type 3. Top cap finish 4. Base finish 5. Panel fabric	Monolithic Panel with Open Base <i>Example:</i> DP7CMMLL 3618 4/117/117/B191 <hr/> DP7 Dividends Horizon Panel <hr/> C Topway frame <hr/> MM Monolithic both sides <hr/> LL Open base <hr/> 4 Radius Metal top cap <hr/> 117 Soft Grey top cap finish <hr/> 117 Soft Grey raceway finish <hr/> B191 Fairfield light fabric	Monolithic Panel with Open Base: <ul style="list-style-type: none"> Panel frame Acoustic panel inserts (2) Open base Top cap Connection hardware Note: Worksurface Height panels do not connect to any other panel height. Note: Preconfigured Worksurface Height panels are not available with plastic top caps.	Monolithic Panel with Open Base: Full View Frame Option: To specify full view frame for window or stacking applications, replace the "C" in pattern number with "V". No upcharge. Top Cap Options: (2) = Extruded Plastic (Smooth Radius) (3) = No Top Cap (4) = Radius Metal, add \$38 P1, \$40 P2, \$42 P3 paint grades (5) = Flat Metal, add \$38 P1, \$40 P2, \$42 P3 paint grades

Monolithic Panels

Open Base

57", 64" and 78" High

Dividends Horizon

description	h	w	d	pattern no.	grade							
					10	15	20	25	30	35	40	45
57" High, Monolithic Open Base 	56 ¹³ / ₁₆ "	18"	3"	DP7CMMLL5718	\$462.	\$474.	\$494.	\$501.	\$515.	\$522.	\$530.	\$544.
	56 ¹³ / ₁₆ "	24"	3"	DP7CMMLL5724	495.	508.	530.	540.	553.	561.	570.	583.
	56 ¹³ / ₁₆ "	30"	3"	DP7CMMLL5730	545.	560.	584.	594.	608.	618.	627.	643.
	56 ¹³ / ₁₆ "	36"	3"	DP7CMMLL5736	592.	608.	634.	647.	662.	673.	683.	698.
	56 ¹³ / ₁₆ "	42"	3"	DP7CMMLL5742	638.	657.	686.	697.	715.	726.	738.	756.
	56 ¹³ / ₁₆ "	48"	3"	DP7CMMLL5748	685.	704.	736.	749.	767.	779.	792.	811.
	56 ¹³ / ₁₆ "	60"	3"	DP7CMMLL5760	769.	791.	827.	841.	862.	877.	890.	912.
64" High, Monolithic Open Base 	64 ¹ / ₁₆ "	18"	3"	DP7CMMLL6418	491.	502.	525.	534.	547.	555.	565.	577.
	64 ¹ / ₁₆ "	24"	3"	DP7CMMLL6424	525.	541.	564.	572.	586.	595.	605.	620.
	64 ¹ / ₁₆ "	30"	3"	DP7CMMLL6430	581.	597.	623.	633.	649.	659.	671.	685.
	64 ¹ / ₁₆ "	36"	3"	DP7CMMLL6436	628.	647.	675.	685.	705.	714.	726.	743.
	64 ¹ / ₁₆ "	42"	3"	DP7CMMLL6442	674.	692.	722.	736.	753.	767.	778.	798.
	64 ¹ / ₁₆ "	48"	3"	DP7CMMLL6448	720.	740.	774.	788.	807.	822.	833.	856.
	64 ¹ / ₁₆ "	60"	3"	DP7CMMLL6460	855.	879.	920.	933.	959.	975.	991.	1,015.
78" High, Monolithic Open Base 	78 ³ / ₁₆ "	18"	3"	DP7CMMLL7818	678.	696.	728.	740.	761.	772.	783.	802.
	78 ³ / ₁₆ "	24"	3"	DP7CMMLL7824	742.	765.	799.	812.	833.	845.	861.	883.
	78 ³ / ₁₆ "	30"	3"	DP7CMMLL7830	801.	824.	861.	876.	899.	915.	928.	951.
	78 ³ / ₁₆ "	36"	3"	DP7CMMLL7836	871.	897.	936.	953.	978.	994.	1,010.	1,035.
	78 ³ / ₁₆ "	42"	3"	DP7CMMLL7842	940.	968.	1,014.	1,031.	1,055.	1,074.	1,093.	1,119.
	78 ³ / ₁₆ "	48"	3"	DP7CMMLL7848	1,000.	1,030.	1,077.	1,095.	1,124.	1,143.	1,161.	1,189.

Dimensions listed under h w d are actual to the nearest 1/16"

Ordering Information	Order Code	Included with:	Options
Monolithic Panel with Open Base: 1. Pattern Number 2. Top cap type 3. Top cap finish 4. Base finish 5. Panel fabric	Monolithic Panel with Open Base <i>Example:</i> DP7CMMLL3618 4/117/117/B191 <hr/> DP7 Dividends Horizon Panel <hr/> C Topway frame <hr/> MM Monolithic both sides <hr/> LL Open Base <hr/> 4 Radius Metal top cap <hr/> 117 Soft Grey top cap finish <hr/> 117 Soft Grey base raceway finish <hr/> B191 Fairfield light fabric	Monolithic Panel with Open Base: <ul style="list-style-type: none"> Panel frame Acoustic panel inserts (2) Open base Top cap Connection hardware 	Monolithic Panel with Open Base: Full View Frame Option: To specify full view frame for window or stacking applications, replace the "C" in pattern number with "V". No upcharge. Top Cap Options: (2) = Extruded Plastic (Smooth Radius) (3) = No Top Cap (4) = Radius Metal, add \$38 P1, \$40 P2, \$42 P3 paint grades (5) = Flat Metal, add \$38 P1, \$40 P2, \$42 P3 paint grades

Monolithic Panels

Tile to Floor One Side

Worksurface Height, 36" and 42" High

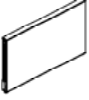
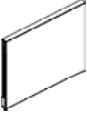
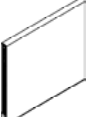
description	h	w	d	pattern no.	grade							
					10	15	20	25	30	35	40	45
Worksurface Height, Monolithic Tile to Floor 	28 1/2"	15"	3"	DP7CMMFRWH15	\$368.	\$380.	\$396.	\$401.	\$414.	\$420.	\$426.	\$436.
	28 1/2"	18"	3"	DP7CMMFRWH18	368.	380.	396.	401.	414.	420.	426.	436.
	28 1/2"	24"	3"	DP7CMMFRWH24	409.	420.	439.	446.	456.	464.	472.	482.
	28 1/2"	30"	3"	DP7CMMFRWH30	428.	441.	460.	468.	479.	488.	495.	507.
	28 1/2"	36"	3"	DP7CMMFRWH36	479.	494.	518.	525.	539.	548.	557.	571.
	28 1/2"	42"	3"	DP7CMMFRWH42	531.	545.	571.	580.	595.	605.	614.	631.
	28 1/2"	48"	3"	DP7CMMFRWH48	560.	575.	601.	611.	628.	638.	650.	664.
	28 1/2"	60"	3"	DP7CMMFRWH60	666.	685.	716.	729.	749.	762.	774.	792.
36" High, Monolithic Tile to Floor 	35 1/8"	15"	3"	DP7CMMFR3615	368.	380.	396.	401.	414.	420.	426.	436.
	35 1/8"	18"	3"	DP7CMMFR3618	368.	380.	396.	401.	414.	420.	426.	436.
	35 1/8"	24"	3"	DP7CMMFR3624	409.	420.	439.	446.	456.	464.	472.	482.
	35 1/8"	30"	3"	DP7CMMFR3630	428.	441.	460.	468.	479.	488.	495.	507.
	35 1/8"	36"	3"	DP7CMMFR3636	479.	494.	518.	525.	539.	548.	557.	571.
	35 1/8"	42"	3"	DP7CMMFR3642	531.	545.	571.	580.	595.	605.	614.	631.
	35 1/8"	48"	3"	DP7CMMFR3648	560.	575.	601.	611.	628.	638.	650.	664.
	35 1/8"	60"	3"	DP7CMMFR3660	666.	685.	716.	729.	749.	762.	774.	792.
42" High, Monolithic Tile to Floor 	42 3/16"	15"	3"	DP7CMMFR4215	384.	396.	414.	421.	431.	439.	446.	455.
	42 3/16"	18"	3"	DP7CMMFR4218	384.	396.	414.	421.	431.	439.	446.	455.
	42 3/16"	24"	3"	DP7CMMFR4224	414.	425.	445.	451.	463.	471.	477.	490.
	42 3/16"	30"	3"	DP7CMMFR4230	451.	464.	486.	494.	507.	517.	524.	537.
	42 3/16"	36"	3"	DP7CMMFR4236	491.	504.	528.	537.	551.	560.	569.	581.
	42 3/16"	42"	3"	DP7CMMFR4242	539.	554.	579.	589.	604.	614.	626.	640.
	42 3/16"	48"	3"	DP7CMMFR4248	570.	585.	612.	624.	640.	651.	661.	679.
	42 3/16"	60"	3"	DP7CMMFR4260	679.	697.	730.	743.	763.	775.	788.	807.

Dimensions listed under h w d are actual to the nearest 1/16"



Ordering Information	Order Code	Included with:	Options
Monolithic Panel with Tile to Floor: 1. Pattern Number 2. Top cap type 3. Top cap finish 4. Raceway knockout option 5. Base raceway finish 6. Panel fabric	Monolithic Panel with Tile to Floor <i>Example:</i> DP7CMMFR 3618 4/117/K/117/B191 <hr/> DP7 Dividends Horizon Panel <hr/> C Topway frame <hr/> MM Monolithic both sides <hr/> FR Tile to Floor <hr/> 4 Radius Metal top cap <hr/> 117 Soft Grey top cap finish <hr/> K Base raceway with knockouts one side <hr/> 117 Soft Grey base raceway finish <hr/> B191 Fairfield light fabric	Monolithic Panel with Tile to Floor: <ul style="list-style-type: none"> Panel frame Acoustic panel inserts (2) Top cap Connection hardware Base raceway on one side <p>Note: Worksurface Height panels do not connect to any other panel height.</p> <p>Note: Preconfigured Worksurface Height panels are not available with plastic top caps.</p>	Monolithic Panel with Tile to Floor: <p>Full View Frame Option: To specify full view frame for window or stacking applications, replace the "C" in pattern number with "V". No upcharge.</p> <p>Tile to Floor Side Option: Tile to Floor standard on side 2. To specify tile to floor on side 1, change "FR" in pattern number to "RF".</p> <p>Top Cap Options: (2) = Extruded Plastic (Smooth Radius) (3) = No Top Cap (4) = Radius Metal, add \$38 P1, \$40 P2, \$42 P3 (5) = Flat Metal, add \$38 P1, \$40 P2, \$42 P3 paint grades</p> <p>Raceway Knockout Options: (K) = Knockouts on raceway side (N) = No Knockouts</p>

Monolithic Panels

Tile to Floor One Side

50", 57" and 64" High

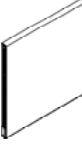
Dividends Horizon

description	h	w	d	pattern no.	grade							
					10	15	20	25	30	35	40	45
50" High, Monolithic Tile to Floor 	49 1/2"	15"	3"	DP7CMMFR5015	\$409.	\$420.	\$439.	\$446.	\$456.	\$464.	\$472.	\$482.
	49 1/2"	18"	3"	DP7CMMFR5018	409.	420.	439.	446.	456.	464.	472.	482.
	49 1/2"	24"	3"	DP7CMMFR5024	441.	453.	473.	481.	493.	500.	509.	522.
	49 1/2"	30"	3"	DP7CMMFR5030	485.	498.	521.	530.	544.	553.	562.	575.
	49 1/2"	36"	3"	DP7CMMFR5036	531.	545.	571.	580.	595.	605.	614.	631.
	49 1/2"	42"	3"	DP7CMMFR5042	581.	598.	626.	637.	654.	664.	674.	691.
	49 1/2"	48"	3"	DP7CMMFR5048	627.	644.	673.	686.	703.	715.	727.	745.
	49 1/2"	60"	3"	DP7CMMFR5060	745.	767.	802.	816.	837.	853.	866.	887.
57" High, Monolithic Tile to Floor 	56 13/16"	15"	3"	DP7CMMFR5715	439.	451.	471.	478.	492.	499.	507.	521.
	56 13/16"	18"	3"	DP7CMMFR5718	439.	451.	471.	478.	492.	499.	507.	521.
	56 13/16"	24"	3"	DP7CMMFR5724	472.	485.	507.	517.	530.	538.	547.	560.
	56 13/16"	30"	3"	DP7CMMFR5730	522.	537.	561.	571.	585.	595.	604.	620.
	56 13/16"	36"	3"	DP7CMMFR5736	569.	585.	611.	624.	639.	650.	660.	675.
	56 13/16"	42"	3"	DP7CMMFR5742	615.	634.	663.	674.	692.	703.	715.	733.
	56 13/16"	48"	3"	DP7CMMFR5748	662.	681.	713.	726.	744.	756.	769.	788.
	56 13/16"	60"	3"	DP7CMMFR5760	746.	768.	804.	818.	839.	854.	867.	889.
64" High, Monolithic Tile to Floor 	64 1/16"	15"	3"	DP7CMMFR6415	468.	479.	502.	511.	524.	532.	542.	554.
	64 1/16"	18"	3"	DP7CMMFR6418	468.	479.	502.	511.	524.	532.	542.	554.
	64 1/16"	24"	3"	DP7CMMFR6424	502.	518.	541.	549.	563.	572.	582.	597.
	64 1/16"	30"	3"	DP7CMMFR6430	558.	574.	600.	610.	626.	636.	648.	662.
	64 1/16"	36"	3"	DP7CMMFR6436	605.	624.	652.	662.	682.	691.	703.	720.
	64 1/16"	42"	3"	DP7CMMFR6442	651.	669.	699.	713.	730.	744.	755.	775.
	64 1/16"	48"	3"	DP7CMMFR6448	697.	717.	751.	765.	784.	799.	810.	833.
	64 1/16"	60"	3"	DP7CMMFR6460	832.	856.	897.	910.	936.	952.	968.	992.

Dimensions listed under h w d are actual to the nearest 1/16"

Ordering Information	Order Code	Included with:	Options
Monolithic Panel with Tile to Floor: 1. Pattern Number 2. Top cap type 3. Top cap finish 4. Raceway knockout option 5. Base raceway finish 6. Panel fabric	Monolithic Panel with Tile to Floor <i>Example:</i> DP7CMMFR 3618 4/117/K/117/B191 <hr/> DP7 Dividends Horizon Panel <hr/> C Topway frame <hr/> MM Monolithic both sides <hr/> FR Tile to Floor <hr/> 4 Radius Metal top cap <hr/> 117 Soft Grey top cap finish <hr/> K Base raceway with knockouts one side <hr/> 117 Soft Grey raceway finish <hr/> B191 Fairfield light fabric	Monolithic Panel with Tile to Floor: <ul style="list-style-type: none"> Panel frame Acoustic panel inserts (2) Top cap Connection hardware Base raceway on one side 	Monolithic Panel with Tile to Floor: Full View Frame Option: To specify full view frame for window or stacking applications, replace the "C" in pattern number with "V". No upcharge. Tile to Floor Side Option: Tile to Floor standard on side 2. To specify tile to floor on side 1, change "FR" in pattern number to "RF". Top Cap Options: (2) = Extruded Plastic (Smooth Radius) (3) = No Top Cap (4) = Radius Metal, add \$38 P1, \$40 P2, \$42 P3 (5) = Flat Metal, add \$38 P1, \$40 P2, \$42 P3 paint grades Raceway Knockout Options: (K) = Knockouts on raceway side (N) = No Knockouts

Monolithic Panels

Tile to Floor One Side

78" High

description	h	w	d	pattern no.	grade							
					10	15	20	25	30	35	40	45
78" High, Monolithic Tile to Floor	78 ¹ / ₁₆ "	15"	3"	DP7CMMFR7815	\$655.	\$673.	\$705.	\$717.	\$738.	\$749.	\$760.	\$779.
	78 ¹ / ₁₆ "	18"	3"	DP7CMMFR7818	655.	673.	705.	717.	738.	749.	760.	779.
	78 ¹ / ₁₆ "	24"	3"	DP7CMMFR7824	719.	742.	776.	789.	810.	822.	838.	860.
	78 ¹ / ₁₆ "	30"	3"	DP7CMMFR7830	778.	801.	838.	853.	876.	892.	905.	928.
	78 ¹ / ₁₆ "	36"	3"	DP7CMMFR7836	848.	874.	913.	930.	955.	971.	987.	1,012.
	78 ¹ / ₁₆ "	42"	3"	DP7CMMFR7842	977.	1,007.	1,054.	1,072.	1,101.	1,120.	1,138.	1,166.
	78 ¹ / ₁₆ "	48"	3"	DP7CMMFR7848	917.	945.	991.	1,008.	1,032.	1,051.	1,070.	1,096.



Dimensions listed under h w d are actual to the nearest 1/16"

Ordering Information	Order Code	Included with:	Options
Monolithic Panel with Tile to Floor: 1. Pattern Number 2. Top cap type 3. Top cap finish 4. Raceway knockout option 5. Base raceway finish 6. Panel fabric	Monolithic Panel with Tile to Floor <i>Example:</i> DP7CMMFR 3618 4/117/K/117/B191 <hr/> DP7 Dividends Horizon Panel <hr/> C Topway frame <hr/> MM Monolithic both sides <hr/> FR Tile to Floor <hr/> 4 Radius Metal top cap <hr/> 117 Soft Grey top cap finish <hr/> K Base raceway with knockouts one side <hr/> 117 Soft Grey raceway finish <hr/> B191 Fairfield light fabric	Monolithic Panel with Tile to Floor: <ul style="list-style-type: none"> Panel frame Acoustic panel inserts (2) Top cap Connection hardware Base raceway on one side 	Monolithic Panel with Tile to Floor: Full View Frame Option: To specify full view frame for window or stacking applications, replace the "C" in pattern number with "V". No upcharge. Tile to Floor Side Option: Tile to Floor standard on side 2. To specify tile to floor on side 1, change "FR" in pattern number to "RF". Top Cap Options: (2) = Extruded Plastic (Smooth Radius) (3) = No Top Cap (4) = Radius Metal, add \$38 P1, \$40 P2, \$42 P3 (5) = Flat Metal, add \$38 P1, \$40 P2, \$42 P3 paint grades Raceway Knockout Options: (K) = Knockouts on raceway side (N) = No Knockouts

Tiled Panel Components

"Preconfigured" Dividends Horizon tiled panels ship completely assembled with a topway or full view panel frame, choice of standard base options including a standard raceway, open base, and tile to the floor. Also, included with every tiled panel are the panel-to-panel connection hardware, top cap, tile inserts and supports.

Tiled Panel Insert Construction

Fabric laminated with roll coat adhesive, heat-cured to 7/16" thick tackable acoustical board.

One-Sided Tiled Panel

Tiled panels are available with fabric tiled inserts attached to one or both panel sides. Non-tiled panel side will have a monolithic insert.

Tiled Panel Insert Supports

All Dividends Horizon panel frames are prepunched to accept tiled panel insert supports which span horizontally across the panel frame. Tiled panel insert supports are mounted above a tiled insert with the exception of the uppermost tile. D2 style recessed insert supports are available in black only.

Tiled Panel Insert Attachment

Tiled panel inserts attach to the troughs in the horizontal panel frame and tiled insert supports. Mounting clips are attached to inserts for connection to frame for additional support. No tools are required for attachment.

Top Cap Options

Three Top Cap Options Available:

- Smooth Radius Plastic
- Radius Metal
- Flat Metal

Top Cap Construction

Smooth radiused plastic top caps are made from extruded plastic. Radius metal and flat metal top caps are made from extruded aluminum.

Top Cap Attachment

Snaps onto the trough of a topway panel frame. Retainer clips are included to attach top caps to full view frames.

Preconfigured Tiled Panel

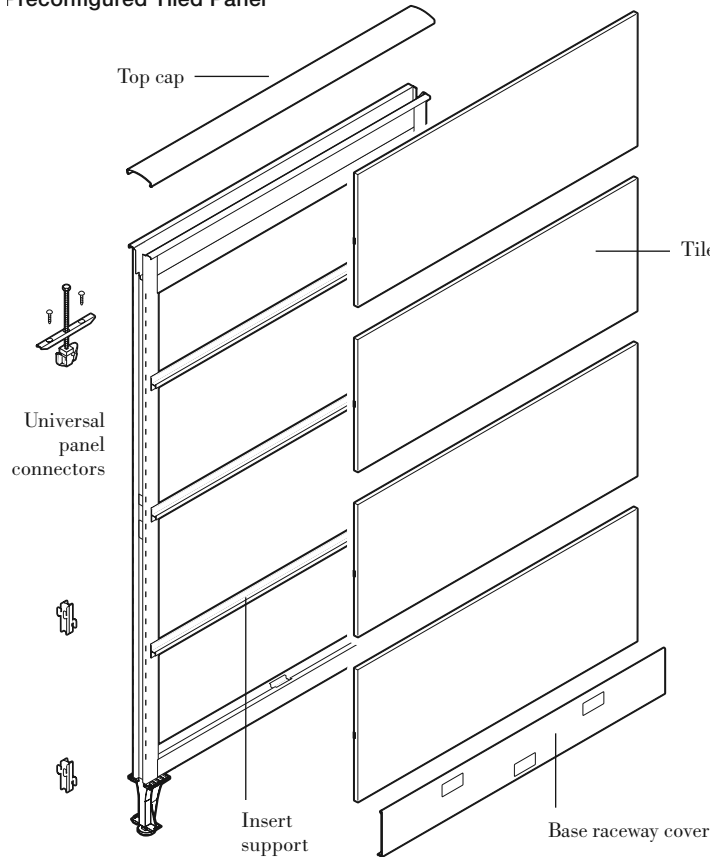

Tiled Panel Standard Configurations

Tiled panels include the following inserts and insert supports per panel side:

<p>36" High</p> <ul style="list-style-type: none"> • Two 14"H tiles • One tile supports 		<p>42" High</p> <ul style="list-style-type: none"> • One 7"H tile and two 14"H tiles • Two tile supports 	
<p>50" High</p> <ul style="list-style-type: none"> • Three 14"H tiles • Two tile supports 		<p>57" High</p> <ul style="list-style-type: none"> • One 7"H tile and three 14"H tiles • Three tile supports 	
<p>64" High</p> <ul style="list-style-type: none"> • Four 14"H tiles • Three tile supports 		<p>78" High</p> <ul style="list-style-type: none"> • Five 14"H tiles • Four tile supports 	

Panel Base Options

Dividends Horizon panels are available with three base options:

- Base Raceway
- Open Base
- Tile-to-Floor

Overall panel heights, tile configurations and application rules are the same for all three base options.

Base Raceway panels feature two roll formed steel raceway covers, which are available with or without electrical/data knockouts.

Open Base panels feature two extruded aluminum feet with triangular profile, positioned at the end of each panel. Open base panels offer a lighter aesthetic and improved ventilation over raceway panels.

Tile-To-Floor panels eliminate the raceway cover and access on one side, replaced by a fabric tile extended to the floor. A heavy gauge steel internal raceway cover protects the raceway contents and the tile from deflecting when hit by shoes or vacuum cleaners. The other side of the panel features a raceway cover, available with or without electrical/data knockouts. If electrical access is required, one-sided electrical and one-sided base cable trays must be used.

Open Position Planner

Dividends Horizon now offers an industry leading technology called Open Position Planner, allowing customers and dealers to design, specify and order factory-assembled Dividends Horizon panel frames in virtually any configuration.

This powerful specification tool eliminates the need for built-to-spec panels. Since panels arrive at the job site assembled, installation labor is also reduced.

The functionality of Open Position Planner is available only to Electronic Specification users, and is not available in this price list.

Panels may be ordered by component throughout the "Built-to-Spec" option, allowing personalized combinations of the tile types and colors.

Note: Standard configurations of "Preconfigured" tiled panels are also available with 28" base tiles with a standard base raceway, open base or tile to the floor options.

Note: Overheads can only be attached to the upper most position of tiled panels. On 78" high panels the overhead may be positioned on the 4th or 5th tile location from the bottom, but not both locations of a single panel.

Note: Insert dimensions are nominal

Panel Base Options

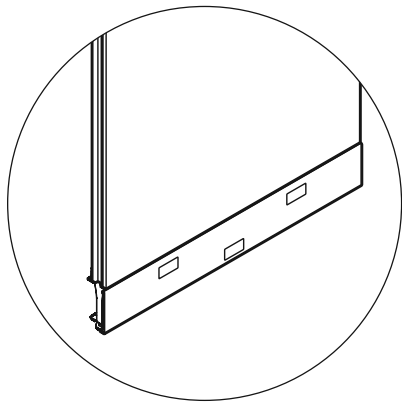

Base Raceway

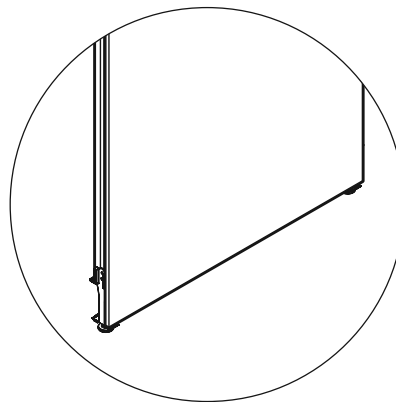

Tile-to-Floor
(single-sided only)

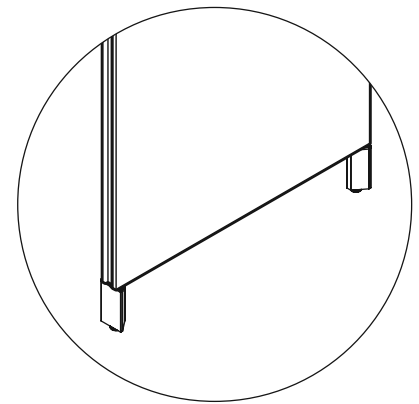



Open Base

Tiled Panels

Base Raceway

36", 42" and 50" High

Dividends Horizon

description	h	w	d	pattern no.	grade								Deduct for Monolithic One Side
					10	15	20	25	30	35	40	45	
 36" High Tiled Standard Base Raceway	35 1/8"	15"	3"	DP7CTTRR3615	\$544.	\$560.	\$589.	\$599.	\$616.	\$626.	\$636.	\$653.	\$85.
	35 1/8"	18"	3"	DP7CTTRR3618	544.	560.	589.	599.	616.	626.	636.	653.	85.
	35 1/8"	24"	3"	DP7CTTRR3624	579.	597.	626.	637.	654.	665.	678.	695.	86.
	35 1/8"	30"	3"	DP7CTTRR3630	615.	632.	661.	676.	693.	708.	718.	737.	87.
	35 1/8"	36"	3"	DP7CTTRR3636	673.	690.	724.	741.	758.	774.	786.	806.	89.
	35 1/8"	42"	3"	DP7CTTRR3642	721.	743.	778.	791.	815.	830.	844.	867.	88.
	35 1/8"	48"	3"	DP7CTTRR3648	756.	778.	817.	833.	854.	870.	884.	908.	90.
	35 1/8"	60"	3"	DP7CTTRR3660	907.	935.	980.	997.	1,024.	1,042.	1,061.	1,087.	92.
 42" High Tiled Standard Base Raceway	42 3/16"	15"	3"	DP7CTTRR4215	559.	575.	604.	616.	632.	642.	654.	671.	85.
	42 3/16"	18"	3"	DP7CTTRR4218	559.	575.	604.	616.	632.	642.	654.	671.	85.
	42 3/16"	24"	3"	DP7CTTRR4224	594.	612.	640.	653.	670.	682.	694.	712.	86.
	42 3/16"	30"	3"	DP7CTTRR4230	636.	655.	687.	702.	719.	733.	745.	766.	87.
	42 3/16"	36"	3"	DP7CTTRR4236	682.	704.	737.	750.	770.	783.	799.	817.	89.
	42 3/16"	42"	3"	DP7CTTRR4242	730.	751.	787.	803.	823.	839.	851.	874.	88.
	42 3/16"	48"	3"	DP7CTTRR4248	769.	790.	831.	846.	869.	882.	899.	923.	90.
	42 3/16"	60"	3"	DP7CTTRR4260	924.	952.	997.	1,016.	1,044.	1,062.	1,080.	1,107.	92.
 50" High Tiled Standard Base Raceway	49 1/2"	15"	3"	DP7CTTRR5015	579.	597.	626.	637.	654.	665.	678.	695.	84.
	49 1/2"	18"	3"	DP7CTTRR5018	579.	597.	626.	637.	654.	665.	678.	695.	84.
	49 1/2"	24"	3"	DP7CTTRR5024	625.	642.	676.	686.	708.	718.	731.	749.	87.
	49 1/2"	30"	3"	DP7CTTRR5030	660.	682.	714.	726.	747.	759.	774.	791.	84.
	49 1/2"	36"	3"	DP7CTTRR5036	702.	721.	756.	772.	790.	806.	820.	842.	79.
	49 1/2"	42"	3"	DP7CTTRR5042	746.	770.	807.	821.	844.	860.	873.	897.	74.
	49 1/2"	48"	3"	DP7CTTRR5048	787.	812.	850.	868.	890.	906.	922.	945.	72.
	49 1/2"	60"	3"	DP7CTTRR5060	943.	971.	1,019.	1,038.	1,065.	1,085.	1,103.	1,132.	92.



Dimensions listed under h w d are actual to the nearest 1/8"

Ordering Information	Order Code	Included with:	Options
Tiled Panel with Standard Base Raceway: 1. Pattern Number 2. Top cap type 3. Top cap finish 4. Raceway knockout option 5. Raceway finish 6. Tile Support profile 7. Panel fabric	Tiled Panel with Standard Base Raceway <i>Example:</i> DP7CTTRR3618 4/117/K/117/2/B191 <hr/> DP7 Dividends Horizon Panel <hr/> C Topway frame <hr/> TT Tiled both sides <hr/> RR Base raceway <hr/> 36 Height <hr/> 18 Width <hr/> 4 Radius Metal top cap <hr/> 117 Soft Grey top cap finish <hr/> K Base raceway with knockouts both sides <hr/> 117 Soft Grey base raceway finish <hr/> 2 D2 style tile supports <hr/> B191 Fairfield light fabric	Tiled Panel with Standard Base Raceway: <ul style="list-style-type: none"> Panel frame Acoustic panel inserts Base raceway covers Top cap Connection hardware 	Tiled Panels with Standard Base Raceway: Full View Frame Option: To specify full view frame for window or stacking applications, replace the "C" in pattern number with "V". No upcharge. Monolithic Side Option: For one side tiled, one side monolithic, change "TT" in pattern number to "MT" and deduct amount in far right column. Top Cap Options: (2) = Extruded Plastic (Smooth Radius) (3) = No Top Cap (4) = Radius Metal, add \$38 P1, \$40 P2, \$42 P3 paint grades (5) = Flat Metal, add \$38 P1, \$40 P2, \$42 P3 paint grades Raceway Knockout Options: (K) = Knockouts (N) = No knockouts Tile Support Options: (1) = D1 External Reveal (2) = D2 Recessed Reveal

Tiled Panels

Base Raceway

57", 64" and 78" High

description	h	w	d	pattern no.	grade								deduct for Monolithic One Side
					10	15	20	25	30	35	40	45	
 57" High Tiled Standard Base Raceway	56 ¹³ / ₁₆ "	15"	3"	DP7CTTRR5715	\$704.	\$723.	\$759.	\$773.	\$793.	\$808.	\$823.	\$844.	\$106.
	56 ¹³ / ₁₆ "	18"	3"	DP7CTTRR5718	704.	723.	759.	773.	793.	808.	823.	844.	106.
	56 ¹³ / ₁₆ "	24"	3"	DP7CTTRR5724	756.	778.	816.	831.	853.	869.	884.	907.	110.
	56 ¹³ / ₁₆ "	30"	3"	DP7CTTRR5730	800.	824.	865.	878.	904.	920.	936.	960.	113.
	56 ¹³ / ₁₆ "	36"	3"	DP7CTTRR5736	850.	875.	918.	936.	961.	978.	993.	1,021.	115.
	56 ¹³ / ₁₆ "	42"	3"	DP7CTTRR5742	900.	928.	972.	990.	1,018.	1,036.	1,054.	1,080.	117.
	56 ¹³ / ₁₆ "	48"	3"	DP7CTTRR5748	951.	980.	1,027.	1,046.	1,074.	1,093.	1,111.	1,142.	119.
	56 ¹³ / ₁₆ "	60"	3"	DP7CTTRR5760	1,142.	1,175.	1,232.	1,255.	1,289.	1,312.	1,335.	1,368.	121.
 64" High Tiled Standard Base Raceway	64 ¹ / ₁₆ "	15"	3"	DP7CTTRR6415	744.	768.	804.	819.	842.	855.	871.	894.	127.
	64 ¹ / ₁₆ "	18"	3"	DP7CTTRR6418	744.	768.	804.	819.	842.	855.	871.	894.	127.
	64 ¹ / ₁₆ "	24"	3"	DP7CTTRR6424	800.	822.	865.	877.	901.	918.	935.	960.	134.
	64 ¹ / ₁₆ "	30"	3"	DP7CTTRR6430	846.	872.	913.	931.	958.	971.	990.	1,016.	130.
	64 ¹ / ₁₆ "	36"	3"	DP7CTTRR6436	899.	928.	970.	989.	1,016.	1,035.	1,052.	1,079.	131.
	64 ¹ / ₁₆ "	42"	3"	DP7CTTRR6442	953.	981.	1,030.	1,049.	1,077.	1,096.	1,114.	1,144.	133.
	64 ¹ / ₁₆ "	48"	3"	DP7CTTRR6448	1,005.	1,035.	1,084.	1,103.	1,134.	1,155.	1,175.	1,204.	134.
	64 ¹ / ₁₆ "	60"	3"	DP7CTTRR6460	1,204.	1,241.	1,302.	1,326.	1,362.	1,386.	1,409.	1,447.	134.
 78" High Tiled Standard Base Raceway	78 ⁷ / ₁₆ "	15"	3"	DP7CTTRR7815	1,171.	1,204.	1,264.	1,287.	1,320.	1,345.	1,369.	1,404.	228.
	78 ⁷ / ₁₆ "	18"	3"	DP7CTTRR7818	1,171.	1,204.	1,264.	1,287.	1,320.	1,345.	1,369.	1,404.	228.
	78 ⁷ / ₁₆ "	24"	3"	DP7CTTRR7824	1,259.	1,295.	1,360.	1,383.	1,424.	1,448.	1,472.	1,511.	236.
	78 ⁷ / ₁₆ "	30"	3"	DP7CTTRR7830	1,335.	1,374.	1,438.	1,467.	1,506.	1,532.	1,561.	1,598.	230.
	78 ⁷ / ₁₆ "	36"	3"	DP7CTTRR7836	1,426.	1,469.	1,539.	1,567.	1,612.	1,640.	1,668.	1,710.	250.
	78 ⁷ / ₁₆ "	42"	3"	DP7CTTRR7842	1,511.	1,556.	1,630.	1,661.	1,707.	1,736.	1,768.	1,813.	255.
	78 ⁷ / ₁₆ "	48"	3"	DP7CTTRR7848	1,601.	1,651.	1,731.	1,764.	1,811.	1,843.	1,875.	1,922.	306.

Dimensions listed under h w d are actual to the nearest 1/8"



Ordering Information	Order Code	Included with:	Options
Tiled Panel with Standard Base Raceway: 1. Pattern Number 2. Top cap type 3. Top cap finish 4. Raceway knockout option 5. Raceway finish 6. Tile support profile 7. Tile support finish 8. Panel fabric	Tiled Panel with Standard Base Raceway <i>Example:</i> DP7CTTRR3618 4/117/K/117/2/B191 <hr/> DP7 Dividends Horizon Panel <hr/> C Topway frame <hr/> TT Tiled both sides <hr/> RR Base raceway <hr/> 36 Height <hr/> 18 Width <hr/> 4 Radius Metal top cap <hr/> 117 Soft Grey top cap finish <hr/> K Base raceway with knockouts both sides <hr/> 117 Soft Grey base raceway finish <hr/> 2 D2 style tile supports <hr/> B191 Fairfield light fabric	Tiled Panel with Standard Base Raceway: <ul style="list-style-type: none"> • Panel frame • Acoustic panel inserts • Base raceway covers • Top cap • Connection hardware 	Tiled Panels with Standard Base Raceway: Full View Frame Option: To specify full view frame for window or stacking applications, replace the "C" in pattern number with "V". No upcharge. Monolithic Side Option: For one side tiled, one side monolithic, change "TT" in pattern number to "MT" and deduct amount in far right column. Top Cap Options: (2) = Extruded Plastic (Smooth Radius) (3) = No Top Cap (4) = Radius Metal, add \$38 P1, \$40 P2, \$42 P3 paint grades (5) = Flat Metal, add \$38 P1, \$40 P2, \$42 P3 paint grades Raceway Knockout Options: (K) = Knockouts (N) = No knockouts Tile Support Options: (1) = D1 External Reveal (2) = D2 Recessed Reveal

Tiled Panels

Open Base

36", 42" and 50" High

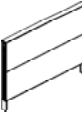
Dividends Horizon

description	h	w	d	pattern no.									Deduct for Monolithic One Side
					10	15	20	25	30	35	40	45	
36" High Tiled Open Base 	35 1/8"	18"	3"	DP7CTTLL3618	\$599.	\$599.	\$644.	\$654.	\$671.	\$681.	\$691.	\$708.	\$85.
	35 1/8"	24"	3"	DP7CTTLL3624	634.	634.	681.	692.	709.	720.	733.	750.	86.
	35 1/8"	30"	3"	DP7CTTLL3630	670.	670.	716.	731.	748.	763.	773.	792.	87.
	35 1/8"	36"	3"	DP7CTTLL3636	728.	728.	779.	796.	813.	829.	841.	861.	89.
	35 1/8"	42"	3"	DP7CTTLL3642	776.	776.	833.	846.	870.	885.	899.	922.	88.
	35 1/8"	48"	3"	DP7CTTLL3648	811.	811.	872.	888.	909.	925.	939.	963.	90.
	35 1/8"	60"	3"	DP7CTTLL3660	962.	962.	1,035.	1,052.	1,079.	1,097.	1,116.	1,142.	92.
42" High Tiled Open Base 	42 3/16"	18"	3"	DP7CTTLL4218	614.	614.	659.	671.	687.	697.	709.	726.	85.
	42 3/16"	24"	3"	DP7CTTLL4224	649.	649.	695.	708.	725.	737.	749.	767.	86.
	42 3/16"	30"	3"	DP7CTTLL4230	691.	691.	742.	757.	774.	788.	800.	821.	87.
	42 3/16"	36"	3"	DP7CTTLL4236	737.	737.	792.	805.	825.	838.	854.	872.	89.
	42 3/16"	42"	3"	DP7CTTLL4242	785.	785.	842.	858.	878.	894.	906.	929.	88.
	42 3/16"	48"	3"	DP7CTTLL4248	824.	824.	886.	901.	924.	937.	954.	978.	90.
	42 3/16"	60"	3"	DP7CTTLL4260	979.	979.	1,052.	1,071.	1,099.	1,117.	1,135.	1,162.	92.
50" High Tiled Open Base 	49 1/2"	18"	3"	DP7CTTLL5018	634.	634.	681.	692.	709.	720.	733.	750.	84.
	49 1/2"	24"	3"	DP7CTTLL5024	680.	680.	731.	741.	763.	773.	786.	804.	87.
	49 1/2"	30"	3"	DP7CTTLL5030	715.	715.	769.	781.	802.	814.	829.	846.	84.
	49 1/2"	36"	3"	DP7CTTLL5036	757.	757.	811.	827.	845.	861.	875.	897.	79.
	49 1/2"	42"	3"	DP7CTTLL5042	801.	801.	862.	876.	899.	915.	928.	952.	74.
	49 1/2"	48"	3"	DP7CTTLL5048	842.	842.	905.	923.	945.	961.	977.	1,000.	72.
	49 1/2"	60"	3"	DP7CTTLL5060	998.	998.	1,074.	1,093.	1,120.	1,140.	1,158.	1,187.	92.

Dimensions listed under h w d are actual to the nearest 1/8"

Ordering Information

Tiled Panel with Open Base:

1. Pattern Number
2. Top cap type
3. Top Cap finish
4. Base finish
5. Tile support profile
6. Panel fabric

Order Code

Tiled Panel with Open Base

Example: **DP7CTTLL3618**
4/117/117/2/B191

DP7	Dividends Horizon Panel
C	Topway frame
TT	Tiled both sides
LL	Open base
36	Height
18	Width
4	Radius Metal top cap
117	Soft Grey top cap finish
117	Soft Grey base finish
2	D2 style tile supports
B191	Fairfield light fabric

Included with:

Tiled Panel with Open Base:

- Panel frame
- Acoustic panel inserts
- Open base
- Top cap
- Connection hardware

Options

Tiled Panel with Open Base:

Full View Frame Option:

To specify full view frame for window or stacking applications, replace the "C" in pattern number with "V". No upcharge.

Monolithic Side Option:

For one side tiled, one side monolithic, change "TT" in pattern number to "MT" and deduct amount in far right column.

Top Cap Options:

- (2) = Extruded Plastic (Smooth Radius)
- (3) = No Top Cap
- (4) = Radius Metal, add \$38 P1, \$40 P2, \$42 P3 paint grades
- (5) = Flat Metal, add \$38 P1, \$40 P2, \$42 P3 paint grades



Tile Support Options:

- (1) = D1 External Reveal
- (2) = D2 Recessed Reveal

Tiled Panels

Open Base

57", 64" and 78" High

description	h	w	d	pattern no.	10	15	20	25	30	35	40	45	deduct for Monolithic One Side
57" High Tiled Open Base 	56 ¹³ / ₁₆ "	18"	3"	DP7CTTLL5718	\$759.	\$778.	\$814.	\$828.	\$848.	\$863.	\$878.	\$899.	\$106.
	56 ¹³ / ₁₆ "	24"	3"	DP7CTTLL5724	811.	833.	871.	886.	908.	924.	939.	962.	110.
	56 ¹³ / ₁₆ "	30"	3"	DP7CTTLL5730	855.	879.	920.	933.	959.	975.	991.	1,015.	113.
	56 ¹³ / ₁₆ "	36"	3"	DP7CTTLL5736	905.	930.	973.	991.	1,016.	1,033.	1,048.	1,076.	115.
	56 ¹³ / ₁₆ "	42"	3"	DP7CTTLL5742	955.	983.	1,027.	1,045.	1,073.	1,091.	1,109.	1,135.	117.
	56 ¹³ / ₁₆ "	48"	3"	DP7CTTLL5748	1,006.	1,035.	1,082.	1,101.	1,129.	1,148.	1,166.	1,197.	119.
	56 ¹³ / ₁₆ "	60"	3"	DP7CTTLL5760	1,197.	1,230.	1,287.	1,310.	1,344.	1,367.	1,390.	1,423.	121.
64" High Tiled Open Base 	64 ¹ / ₁₆ "	18"	3"	DP7CTTLL6418	799.	823.	859.	874.	897.	910.	926.	949.	127.
	64 ¹ / ₁₆ "	24"	3"	DP7CTTLL6424	855.	877.	920.	932.	956.	973.	990.	1,015.	134.
	64 ¹ / ₁₆ "	30"	3"	DP7CTTLL6430	901.	927.	968.	986.	1,013.	1,026.	1,045.	1,071.	130.
	64 ¹ / ₁₆ "	36"	3"	DP7CTTLL6436	954.	983.	1,025.	1,044.	1,071.	1,090.	1,107.	1,134.	131.
	64 ¹ / ₁₆ "	42"	3"	DP7CTTLL6442	1,008.	1,036.	1,085.	1,104.	1,132.	1,151.	1,169.	1,199.	133.
	64 ¹ / ₁₆ "	48"	3"	DP7CTTLL6448	1,060.	1,090.	1,139.	1,158.	1,189.	1,210.	1,230.	1,259.	134.
	64 ¹ / ₁₆ "	60"	3"	DP7CTTLL6460	1,259.	1,296.	1,357.	1,381.	1,417.	1,441.	1,464.	1,502.	134.
78" High Tiled Open Base 	78 ⁹ / ₁₆ "	18"	3"	DP7CTTLL7818	1,226.	1,259.	1,319.	1,342.	1,375.	1,400.	1,424.	1,459.	228.
	78 ⁹ / ₁₆ "	24"	3"	DP7CTTLL7824	1,314.	1,350.	1,415.	1,438.	1,479.	1,503.	1,527.	1,566.	236.
	78 ⁹ / ₁₆ "	30"	3"	DP7CTTLL7830	1,390.	1,429.	1,493.	1,522.	1,561.	1,587.	1,616.	1,653.	230.
	78 ⁹ / ₁₆ "	36"	3"	DP7CTTLL7836	1,481.	1,524.	1,594.	1,622.	1,667.	1,695.	1,723.	1,765.	250.
	78 ⁹ / ₁₆ "	42"	3"	DP7CTTLL7842	1,566.	1,611.	1,685.	1,716.	1,762.	1,791.	1,823.	1,868.	255.
	78 ⁹ / ₁₆ "	48"	3"	DP7CTTLL7848	1,656.	1,706.	1,786.	1,819.	1,866.	1,898.	1,930.	1,977.	306.

Dimensions listed under h w d are actual to the nearest 1/8"

Ordering Information

Tiled Panel with Open Base:

1. Pattern Number
2. Top cap type
3. Top Cap finish
4. Base finish
5. Tile support profile
6. Panel fabric

Order Code

Tiled Panel with Open Base

Example: **DP7CTTLL3618**
4/117/117/2/B191

DP7	Dividends Horizon Panel
C	Topway frame
TT	Tiled both sides
LL	Open base
36	Height
18	Width
4	Radius Metal top cap
117	Soft Grey top cap finish
117	Soft Grey base finish
2	D2 style tile supports
B191	Fairfield light fabric

Included with:

Tiled Panel with Open Base:

- Panel frame
- Acoustic panel inserts
- Open base
- Top cap
- Connection hardware

Options

Tiled Panel with Open Base:

Full View Frame Option:

To specify full view frame for window or stacking applications, replace the "C" in pattern number with "V". No upcharge.

Monolithic Side Option:

For one side tiled, one side monolithic, change "TT" in pattern number to "MT" and deduct amount in far right column.

Top Cap Options:

- (2) = Extruded Plastic (Smooth Radius)
- (3) = No Top Cap
- (4) = Radius Metal, add \$38 P1, \$40 P2, \$42 P3 paint grades
- (5) = Flat Metal, add \$38 P1, \$40 P2, \$42 P3 paint grades

Tile Support Options:

- (1) = D1 External Reveal
- (2) = D2 Recessed Reveal

Tiled Panels

Tile To Floor One Side

36" and 42" High

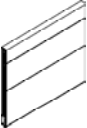
description	h	w	d	pattern no.									Deduct for
					10	15	20	25	30	35	40	45	Monolithic One Sideide 1
36" High Tiled Panel Tile to Floor One Side 	35 1/8"	15"	3"	DP7CTTFR3615	\$576.	\$592.	\$621.	\$631.	\$648.	\$658.	\$668.	\$685.	\$85.
	35 1/8"	18"	3"	DP7CTTFR3618	576.	592.	621.	631.	648.	658.	668.	685.	85.
	35 1/8"	24"	3"	DP7CTTFR3624	611.	629.	658.	669.	686.	697.	710.	727.	86.
	35 1/8"	30"	3"	DP7CTTFR3630	647.	664.	693.	708.	725.	740.	750.	769.	87.
	35 1/8"	36"	3"	DP7CTTFR3636	705.	722.	756.	773.	790.	806.	818.	838.	89.
	35 1/8"	42"	3"	DP7CTTFR3642	753.	775.	810.	823.	847.	862.	876.	899.	88.
	35 1/8"	48"	3"	DP7CTTFR3648	788.	810.	849.	865.	886.	902.	916.	940.	90.
	35 1/8"	60"	3"	DP7CTTFR3660	939.	967.	1,012.	1,029.	1,056.	1,074.	1,093.	1,119.	92.
42" High Tiled Panel Tile to Floor One Side 	42 3/16"	15"	3"	DP7CTTFR4215	591.	607.	636.	648.	664.	674.	686.	703.	85.
	42 3/16"	18"	3"	DP7CTTFR4218	591.	607.	636.	648.	664.	674.	686.	703.	85.
	42 3/16"	24"	3"	DP7CTTFR4224	626.	644.	672.	685.	702.	714.	726.	744.	86.
	42 3/16"	30"	3"	DP7CTTFR4230	668.	687.	719.	734.	751.	765.	777.	798.	87.
	42 3/16"	36"	3"	DP7CTTFR4236	714.	736.	769.	782.	802.	815.	831.	849.	89.
	42 3/16"	42"	3"	DP7CTTFR4242	762.	783.	819.	835.	855.	871.	883.	906.	88.
	42 3/16"	48"	3"	DP7CTTFR4248	801.	822.	863.	878.	901.	914.	931.	955.	90.
	42 3/16"	60"	3"	DP7CTTFR4260	956.	984.	1,029.	1,048.	1,076.	1,094.	1,112.	1,139.	92.

Dimensions listed under h w d are actual to the nearest 1/8"

Ordering Information	Order Code	Included with:	Options
Tiled Panel with Tile to Floor: 1. Pattern Number 2. Top cap type 3. Top cap finish 4. Base raceway finish 5. Tile support profile 6. Panel fabric	Tiled Panel with Tile to Floor <i>Example:</i> DP7CTTFR3618 4/117/K/117/2/B191 <hr/> DP7 Dividends Horizon Panel <hr/> C Topway frame <hr/> TT Tiled both sides <hr/> FR Tile to floor side one, raceway side two <hr/> 36 Height <hr/> 18 Width <hr/> 4 Radius Metal top cap <hr/> 117 Soft Grey top cap finish <hr/> K Knockouts for one-sided base raceway <hr/> 117 Soft Grey base raceway finish <hr/> 2 D2 style tile supports <hr/> B191 Fairfield light fabric	Tiled Panel with Tile to Floor: <ul style="list-style-type: none"> Panel frame Acoustic panel inserts Top cap Connection hardware Base raceway with knockout one side Tile to the floor one side 	Tiled Panels With Tile To Floor One Side: Full View Frame Option: To specify full view frame for window or stacking applications, replace the "C" in pattern number with "V". No upcharge. Monolithic Side Option: For side 1 monolithic, side 2 tiled, change "TT" in pattern number to "MT" and deduct amount in far right column. Tile to Floor Side Option: Tile to floor standard on side 2. To specify tile to floor on side 1, change "FR" in pattern number to "RF". Top Cap Options: (2) = Extruded Plastic (Smooth Radius) (3) = No Top Cap (4) = Radius Metal, add \$38 P1, \$40 P2, \$42 P3 paint grades (5) = Flat Metal, add \$38 P1, \$40 P2, \$42 P3 paint grades
		Raceway Knockout Options: (K) = Knockouts on raceway side (N) = No knockouts on raceway side	Tile Support Options: (1) = D1 External Reveal (2) = D2 Recessed Reveal

Tiled Panels

Tile To Floor One Side

50" and 57" High

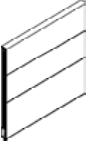
description	h	w	d	pattern no.	grade								deduct for Monolithic One Side
					10	15	20	25	30	35	40	45	
50" High Tiled Panel Tile to Floor One Side 	49 1/2"	15"	3"	DP7CTTFR5015	\$611.	\$629.	\$658.	\$669.	\$686.	\$697.	\$710.	\$727.	\$84.
	49 1/2"	18"	3"	DP7CTTFR5018	611.	629.	658.	669.	686.	697.	710.	727.	84.
	49 1/2"	24"	3"	DP7CTTFR5024	657.	674.	708.	718.	740.	750.	763.	781.	87.
	49 1/2"	30"	3"	DP7CTTFR5030	692.	714.	746.	758.	779.	791.	806.	823.	84.
	49 1/2"	36"	3"	DP7CTTFR5036	734.	753.	788.	804.	822.	838.	852.	874.	79.
	49 1/2"	42"	3"	DP7CTTFR5042	778.	802.	839.	853.	876.	892.	905.	929.	74.
	49 1/2"	48"	3"	DP7CTTFR5048	819.	844.	882.	900.	922.	938.	954.	977.	72.
	49 1/2"	60"	3"	DP7CTTFR5060	975.	1,003.	1,051.	1,070.	1,097.	1,117.	1,135.	1,164.	92.

57" High Tiled Panel Tile to Floor One Side 	56 13/16"	15"	3"	DP7CTTFR5715	736.	755.	791.	805.	825.	840.	855.	876.	106.
	56 13/16"	18"	3"	DP7CTTFR5718	736.	755.	791.	805.	825.	840.	855.	876.	106.
	56 13/16"	24"	3"	DP7CTTFR5724	788.	810.	848.	863.	885.	901.	916.	939.	110.
	56 13/16"	30"	3"	DP7CTTFR5730	832.	856.	897.	910.	936.	952.	968.	992.	113.
	56 13/16"	36"	3"	DP7CTTFR5736	882.	907.	950.	968.	993.	1,010.	1,025.	1,053.	115.
	56 13/16"	42"	3"	DP7CTTFR5742	932.	960.	1,004.	1,022.	1,050.	1,068.	1,086.	1,112.	117.
	56 13/16"	48"	3"	DP7CTTFR5748	983.	1,012.	1,059.	1,078.	1,106.	1,125.	1,143.	1,174.	119.
	56 13/16"	60"	3"	DP7CTTFR5760	1,174.	1,207.	1,264.	1,287.	1,321.	1,344.	1,367.	1,400.	121.

Dimensions listed under h w d are actual to the nearest 1/8"

Ordering Information

Tiled Panel with Tile to Floor:

1. Pattern Number
2. Top cap type
3. Top cap finish
4. Base raceway finish
5. Tile support profile
6. Panel fabric

Order Code

Tiled Panel with Tile to Floor

Example: **DP7CTTFR5018**
4/117/K/117/2/B191

DP7	Dividends Horizon Panel
C	Topway frame
TT	Tiled both sides
FR	Tile to floor side one, raceway side two
50	Height
18	Width
4	Radius Metal top cap
117	Soft Grey top cap finish
K	Knockouts for one-sided base raceway
117	Soft Grey base raceway finish
2	D2 style tile supports
B191	Fairfield light fabric

Included with:

Tiled Panel with Tile to Floor:

- Panel frame
- Acoustic panel inserts
- Top cap
- Connection hardware
- Base raceway with knockout one side
- Tile to the floor one side

Options

Tiled Panels With Tile To Floor One Side:

Full View Frame Option:

To specify full view frame for window or stacking applications, replace the "C" in pattern number with "V". No upcharge.

Monolithic Side Options:

For side 1 monolithic, side 2 tiled, change "TT" in pattern number to "MT" and deduct amount in far right column.

Tile to Floor Side Option:

Tile to floor standard on side 2. To specify tile to floor on side 1, change "FR" in pattern number to "RF".

Top Cap Options:

(2) = Extruded Plastic (Smooth Radius)
(3) = No Top Cap
(4) = Radius Metal, add \$38 P1, \$40 P2, \$42 P3 paint grades
(5) = Flat Metal, add \$38 P1, \$40 P2, \$42 P3 paint grades

Raceway Knockout Options:

(K) = Knockouts on raceway side
(N) = No knockouts on raceway side

Tile Support Options:

(1) = D1 External Reveal
(2) = D2 Recessed Reveal

Tiled Panels

Tile To Floor One Side

64" and 78" High

description	h	w	d	pattern no.	grade								deduct for Monolithic One Side
					10	15	20	25	30	35	40	45	
64" High Tiled Panel Tile to Floor One Side 	64 1/16"	15"	3"	DP7CTTFR6415	\$776.	\$800.	\$836.	\$851.	\$874.	\$887.	\$903.	\$926.	\$127.
	64 1/16"	18"	3"	DP7CTTFR6418	776.	800.	836.	851.	874.	887.	903.	926.	127.
	64 1/16"	24"	3"	DP7CTTFR6424	832.	854.	897.	909.	933.	950.	967.	992.	134.
	64 1/16"	30"	3"	DP7CTTFR6430	878.	904.	945.	963.	990.	1,003.	1,022.	1,048.	130.
	64 1/16"	36"	3"	DP7CTTFR6436	931.	960.	1,002.	1,021.	1,048.	1,067.	1,084.	1,111.	131.
	64 1/16"	42"	3"	DP7CTTFR6442	985.	1,013.	1,062.	1,081.	1,109.	1,128.	1,146.	1,176.	133.
	64 1/16"	48"	3"	DP7CTTFR6448	1,037.	1,067.	1,116.	1,135.	1,166.	1,187.	1,207.	1,236.	134.
	64 1/16"	60"	3"	DP7CTTFR6460	1,236.	1,273.	1,334.	1,358.	1,394.	1,418.	1,441.	1,479.	134.

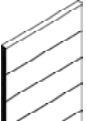
78" High Tiled Panel Tile to Floor One Side 	78 1/16"	15"	3"	DP7CTTFR7815	1,203.	1,236.	1,296.	1,319.	1,352.	1,377.	1,401.	1,436.	228.
	78 1/16"	18"	3"	DP7CTTFR7818	1,203.	1,236.	1,296.	1,319.	1,352.	1,377.	1,401.	1,436.	228.
	78 1/16"	24"	3"	DP7CTTFR7824	1,291.	1,327.	1,392.	1,415.	1,456.	1,480.	1,504.	1,543.	236.
	78 1/16"	30"	3"	DP7CTTFR7830	1,367.	1,406.	1,470.	1,499.	1,538.	1,564.	1,593.	1,630.	230.
	78 1/16"	36"	3"	DP7CTTFR7836	1,458.	1,501.	1,571.	1,599.	1,644.	1,672.	1,700.	1,742.	250.
	78 1/16"	42"	3"	DP7CTTFR7842	1,543.	1,588.	1,662.	1,693.	1,739.	1,768.	1,800.	1,845.	255.
	78 1/16"	48"	3"	DP7CTTFR7848	1,633.	1,683.	1,763.	1,796.	1,843.	1,875.	1,907.	1,954.	306.

Dimensions listed under h w d are actual to the nearest 1/8"

Ordering Information	Order Code	Included with:	Options
Tiled Panel with Tile to Floor: 1. Pattern Number 2. Top cap type 3. Top cap finish 4. Base raceway finish 5. Tile support profile 6. Panel fabric	Tiled Panel with Tile to Floor <i>Example:</i> DP7CTTFR6418 4/117/K/117/2/B191 <hr/> DP7 Dividends Horizon Panel <hr/> C Topway frame <hr/> TT Tiled both sides <hr/> FR Tile to floor side one, raceway side two <hr/> 64 Height <hr/> 18 Width <hr/> 4 Radius Metal top cap <hr/> 117 Soft Grey top cap finish <hr/> K Knockouts for one-sided base raceway <hr/> 117 Soft Grey base raceway finish <hr/> 2 D2 style tile supports <hr/> B191 Fairfield light fabric	Tiled Panel with Tile to Floor: <ul style="list-style-type: none"> Panel frame Acoustic panel inserts Top cap Connection hardware Base raceway with knockout one side Tile to the floor one side 	Tiled Panels With Tile To Floor One Side: Full View Frame Option: To specify full view frame for window or stacking applications, replace the "C" in pattern number with "V". No upcharge. Monolithic Side Options: For side 1 monolithic, side 2 tiled, change "TT" in pattern number to "MT" and deduct amount in far right column. Tile to Floor Side Option: Tile to floor standard on side 2. To specify tile to floor on side 1, change "FR" in pattern number to "RF". Top Cap Options: (2) = Extruded Plastic (Smooth Radius) (3) = No Top Cap (4) = Radius Metal, add \$38 P1, \$40 P2, \$42 P3 paint grades (5) = Flat Metal, add \$38 P1, \$40 P2, \$42 P3 paint grades Raceway Knockout Options: (K) = Knockouts on raceway side (N) = No knockouts on raceway side Tile Support Options: (1) = D1 External Reveal (2) = D2 Recessed Reveal

Tiled Panels

28" Lower Tile and Base Raceway

42" and 50" High

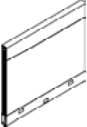
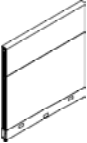
description	h	w	d	pattern no.	grade								Deduct for Monolithic One Side
					10	15	20	25	30	35	40	45	
42" High Tiled Panel with 28" Lower Tile and Base Raceway 	42 3/16"	15"	3"	DP7CPPRR4215	\$505.	\$520.	\$548.	\$561.	\$577.	\$588.	\$600.	\$616.	\$57.
	42 3/16"	18"	3"	DP7CPPRR4218	505.	520.	548.	561.	577.	588.	600.	616.	57.
	42 3/16"	24"	3"	DP7CPPRR4224	539.	557.	586.	599.	615.	628.	638.	657.	57.
	42 3/16"	30"	3"	DP7CPPRR4230	581.	601.	633.	647.	663.	678.	689.	711.	58.
	42 3/16"	36"	3"	DP7CPPRR4236	628.	649.	682.	696.	716.	729.	744.	761.	60.
	42 3/16"	42"	3"	DP7CPPRR4242	675.	697.	732.	748.	768.	783.	796.	820.	60.
	42 3/16"	48"	3"	DP7CPPRR4248	714.	735.	776.	791.	815.	827.	845.	868.	61.
	42 3/16"	60"	3"	DP7CPPRR4260	869.	896.	942.	961.	988.	1,007.	1,026.	1,053.	62.
50" High Tiled Panel with 28" Lower Tile and Base Raceway 	49 1/2"	15"	3"	DP7CPPRR5015	524.	542.	570.	582.	600.	611.	624.	639.	56.
	49 1/2"	18"	3"	DP7CPPRR5018	524.	542.	570.	582.	600.	611.	624.	639.	56.
	49 1/2"	24"	3"	DP7CPPRR5024	569.	588.	622.	632.	653.	662.	676.	695.	58.
	49 1/2"	30"	3"	DP7CPPRR5030	606.	628.	659.	671.	693.	705.	720.	736.	56.
	49 1/2"	36"	3"	DP7CPPRR5036	647.	665.	702.	718.	735.	751.	765.	787.	52.
	49 1/2"	42"	3"	DP7CPPRR5042	690.	716.	752.	766.	789.	805.	819.	843.	49.
	49 1/2"	48"	3"	DP7CPPRR5048	732.	756.	795.	814.	836.	850.	867.	890.	48.
	49 1/2"	60"	3"	DP7CPPRR5060	888.	917.	964.	983.	1,011.	1,031.	1,049.	1,077.	62.

Dimensions listed under h w d are actual to the nearest 1/8"

Ordering Information	Order Code	Included with:	Options
Tiled Panel with 28" Lower Tile and Base Raceway: 1. Pattern Number 2. Top cap type 3. Top cap finish 4. Raceway knockout option 5. Raceway trim finish 6. Tile support profile 7. Panel fabric	Tiled Panels with 28" Lower Tile and Base Raceway <i>Example:</i> DP7CPPRR4218 4/117/K/117/2/B191 <hr/> DP7 Dividends Horizon Panel <hr/> C Topway frame <hr/> PP Tiled both sides, 28" Lower Tile <hr/> RR Raceway both sides <hr/> 42 Height <hr/> 18 Width <hr/> 4 Radius Metal top cap <hr/> 117 Soft Grey top cap finish <hr/> K Base raceway with knockouts both sides <hr/> 117 Soft Grey base raceway finish <hr/> 2 D2 style tile supports <hr/> B191 Fairfield light fabric	Tiled Panel with Standard Base Raceway and 28" Base Tile: <ul style="list-style-type: none"> • Panel frame • Acoustic panel inserts • Base raceway covers • Top cap • Connection hardware 	Tiled Panel with 28" Lower Tile and Base Raceway: Full View Frame Option: To specify full view frame for window or stacking applications, replace the "C" in pattern number with "V". No upcharge. Monolithic Side Option: For side 1 monolithic, side 2 tiled, change "PP" in pattern number to "MP" and deduct amount in far right column. Top Cap Options: (2) = Extruded Plastic (Smooth Radius) (3) = No Top Cap (4) = Radius Metal, add \$38 P1, \$40 P2, \$42 P3 paint grades (5) = Flat Metal, add \$38 P1, \$40 P2, \$42 P3 paint grades Raceway Knockout Options: (K) = Knockouts on raceway side (N) = No knockouts Tile Support Options: (1) = D1 External Reveal (2) = D2 Recessed Reveal

Tiled Panels

28" Lower Tile and Base Raceway

57" and 64" High

Dividends Horizon

description	h	w	d	pattern no.	grade								Deduct for Monolithic One Side
					10	15	20	25	30	35	40	45	
57" High Tiled Panel with 28" Lower Tile and Base Raceway	56 ^{13/16"}	15"	3"	DP7CPPRR5715	\$649.	\$667.	\$705.	\$719.	\$739.	\$753.	\$768.	\$789.	\$71.
	56 ^{13/16"}	18"	3"	DP7CPPRR5718	649.	667.	705.	719.	739.	753.	768.	789.	71.
	56 ^{13/16"}	24"	3"	DP7CPPRR5724	702.	724.	760.	776.	799.	815.	829.	851.	74.
	56 ^{13/16"}	30"	3"	DP7CPPRR5730	745.	769.	811.	824.	848.	865.	881.	906.	76.
	56 ^{13/16"}	36"	3"	DP7CPPRR5736	795.	821.	863.	881.	907.	923.	939.	965.	77.
	56 ^{13/16"}	42"	3"	DP7CPPRR5742	846.	872.	918.	936.	963.	981.	999.	1,026.	79.
	56 ^{13/16"}	48"	3"	DP7CPPRR5748	895.	925.	971.	990.	1,019.	1,038.	1,057.	1,086.	80.
	56 ^{13/16"}	60"	3"	DP7CPPRR5760	1,086.	1,121.	1,176.	1,199.	1,235.	1,258.	1,280.	1,313.	83.



64" High Tiled Panel with 28" Lower Tile and Base Raceway	64 ^{1/16"}	15"	3"	DP7CPPRR6415	688.	713.	749.	764.	787.	801.	817.	840.	86.
	64 ^{1/16"}	18"	3"	DP7CPPRR6418	688.	713.	749.	764.	787.	801.	817.	840.	86.
	64 ^{1/16"}	24"	3"	DP7CPPRR6424	745.	767.	811.	823.	847.	863.	880.	906.	90.
	64 ^{1/16"}	30"	3"	DP7CPPRR6430	791.	818.	858.	875.	904.	917.	936.	961.	87.
	64 ^{1/16"}	36"	3"	DP7CPPRR6436	845.	872.	916.	935.	961.	980.	997.	1,025.	88.
	64 ^{1/16"}	42"	3"	DP7CPPRR6442	897.	927.	975.	993.	1,023.	1,041.	1,059.	1,088.	89.
	64 ^{1/16"}	48"	3"	DP7CPPRR6448	951.	980.	1,030.	1,049.	1,079.	1,100.	1,121.	1,150.	90.
	64 ^{1/16"}	60"	3"	DP7CPPRR6460	1,150.	1,186.	1,247.	1,271.	1,307.	1,332.	1,355.	1,391.	90.



Dimensions listed under h w d are actual to the nearest 1/8"

Ordering Information	Order Code	Included with:	Options
Tiled Panel with 28" Lower Tile and Base Raceway: 1. Pattern Number 2. Top cap type 3. Top cap finish 4. Raceway knockout option 5. Raceway trim finish 6. Tile support style 7. Panel fabric	Tiled Panels with 28" Lower Tile and Base Raceway <i>Example:</i> DP7CPPRR5718 4/117/K/117/2/B191 DP7 Dividends Horizon Panel C Topway frame PP Tiled both sides, 28" Lower Tile RR Raceway both sides 57 Height 18 Width 4 Radius Metal top cap 117 Soft Grey top cap finish K Base raceway with knockouts both sides 117 Soft Grey base raceway finish 2 D2 style tile support B191 Fairfield light fabric	Tiled Panel with Standard Base Raceway and 28" Base Tile: <ul style="list-style-type: none"> • Panel frame • Acoustic panel inserts • Base raceway covers • Top cap • Connection hardware 	Tiled Panels with 28" Lower Tile and Base Raceway: Full View Frame Option: To specify full view frame for window or stacking applications, replace the "C" in pattern number with "V". No upcharge. Monolithic Side Option: For side 1 monolithic, side 2 tiled, change "PP" in pattern number to "MP" and deduct amount in far right column. Top Cap Options: (2) = Extruded Plastic (Smooth Radius) (3) = No Top Cap (4) = Radius Metal, add \$38 P1, \$40 P2, \$42 P3 paint grades (5) = Flat Metal, add \$38 P1, \$40 P2, \$42 P3 paint grades Raceway Knockout Options: (K) = Knockouts on raceway side (N) = No knockouts Tile Support Options: (1) = D1 External Reveal (2) = D2 Recessed Reveal

Tiled Panels

28" Lower Tile and Base Raceway

78" High

description	h	w	d	pattern no.	grade								deduct for Monolithic One Side
					10	15	20	25	30	35	40	45	
78" High Tiled Panel with 28" Lower Tile and Base Raceway	78 ¹ / ₁₆ "	15"	3"	DP7CPRR7815	\$1,117.	\$1,150.	\$1,209.	\$1,233.	\$1,266.	\$1,290.	\$1,314.	\$1,350.	\$153.
	78 ¹ / ₁₆ "	18"	3"	DP7CPRR7818	1,117.	1,150.	1,209.	1,233.	1,266.	1,290.	1,314.	1,350.	153.
	78 ¹ / ₁₆ "	24"	3"	DP7CPRR7824	1,203.	1,241.	1,305.	1,329.	1,369.	1,392.	1,416.	1,457.	158.
	78 ¹ / ₁₆ "	30"	3"	DP7CPRR7830	1,280.	1,318.	1,383.	1,411.	1,452.	1,478.	1,505.	1,544.	155.
	78 ¹ / ₁₆ "	36"	3"	DP7CPRR7836	1,372.	1,413.	1,484.	1,511.	1,557.	1,586.	1,613.	1,656.	168.
	78 ¹ / ₁₆ "	42"	3"	DP7CPRR7842	1,457.	1,501.	1,575.	1,605.	1,652.	1,682.	1,713.	1,759.	171.
	78 ¹ / ₁₆ "	48"	3"	DP7CPRR7848	1,547.	1,596.	1,677.	1,709.	1,757.	1,788.	1,820.	1,868.	205.

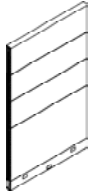

Dimensions listed under h w d are actual to the nearest 1/8"

Ordering Information	Order Code	Included with:	Options
Tiled Panel with 28" Lower Tile and Base Raceway: <ol style="list-style-type: none"> 1. Pattern Number 2. Top cap type 3. Top cap finish 4. Raceway knockout option 5. Raceway trim finish 6. Tile support style 7. Panel fabric 	Tiled Panels with 28" Lower Tile and Base Raceway <i>Example:</i> DP7CPRR7818 4/117/K/117/2/B191 <hr/> DP7 Dividends Horizon Panel <hr/> C Topway frame <hr/> PP Tiled both sides, 28" Lower Tile <hr/> RR Raceway both sides <hr/> 78 Height <hr/> 18 Width <hr/> 4 Radius Metal top cap <hr/> 117 Soft Grey top cap finish <hr/> K Base raceway with knockouts both sides <hr/> 117 Soft Grey base raceway finish <hr/> 2 D2 style tile support <hr/> B191 Fairfield light fabric	Tiled Panel with Standard Base Raceway and 28" Base Tile: <ul style="list-style-type: none"> • Panel frame • Acoustic panel inserts • Base raceway covers • Top cap • Connection hardware 	Tiled Panels with 28" Lower Tile and Base Raceway: Full View Frame Option: To specify full view frame for window or stacking applications, replace the "C" in pattern number with "V". No upcharge. Monolithic Side Option: For side 1 monolithic, side 2 tiled, change "PP" in pattern number to "MP" and deduct amount in far right column. Top Cap Options: (2) = Extruded Plastic (Smooth Radius) (3) = No Top Cap (4) = Radius Metal, add \$38 P1, \$40 P2, \$42 P3 paint grades (5) = Flat Metal, add \$38 P1, \$40 P2, \$42 P3 paint grades Raceway Knockout Options: (K) = Knockouts on raceway side (N) = No knockouts Tile Support Options: (1) = D1 External Reveal (2) = D2 Recessed Reveal

Tiled Panels

28" Lower Tile and Open Base

42" and 50" High

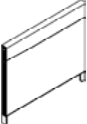
description	h	w	d	pattern no.	grade								Deduct for Monolithic One Side
					10	15	20	25	30	35	40	45	
42" High Tiled Panel with 28" Lower Tile and Open Base 	42 3/16"	18"	3"	DP7CPPLL4218	\$560.	\$575.	\$603.	\$616.	\$632.	\$643.	\$655.	\$671.	\$57.
	42 3/16"	24"	3"	DP7CPPLL4224	594.	612.	641.	654.	670.	683.	693.	712.	57.
	42 3/16"	30"	3"	DP7CPPLL4230	636.	656.	688.	702.	718.	733.	744.	766.	58.
	42 3/16"	36"	3"	DP7CPPLL4236	683.	704.	737.	751.	771.	784.	799.	816.	60.
	42 3/16"	42"	3"	DP7CPPLL4242	730.	752.	787.	803.	823.	838.	851.	875.	60.
	42 3/16"	48"	3"	DP7CPPLL4248	769.	790.	831.	846.	870.	882.	900.	923.	61.
	42 3/16"	60"	3"	DP7CPPLL4260	924.	951.	997.	1,016.	1,043.	1,062.	1,081.	1,108.	62.

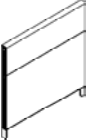
50" High Tiled Panel with 28" Lower Tile and Open Base 	49 1/2"	18"	3"	DP7CPPLL5018	579.	597.	625.	637.	655.	666.	679.	694.	56.
	49 1/2"	24"	3"	DP7CPPLL5024	624.	643.	677.	687.	708.	717.	731.	750.	58.
	49 1/2"	30"	3"	DP7CPPLL5030	661.	683.	714.	726.	748.	760.	775.	791.	56.
	49 1/2"	36"	3"	DP7CPPLL5036	702.	720.	757.	773.	790.	806.	820.	842.	52.
	49 1/2"	42"	3"	DP7CPPLL5042	745.	771.	807.	821.	844.	860.	874.	898.	49.
	49 1/2"	48"	3"	DP7CPPLL5048	787.	811.	850.	869.	891.	905.	922.	945.	48.
	49 1/2"	60"	3"	DP7CPPLL5060	943.	972.	1,019.	1,038.	1,066.	1,086.	1,104.	1,132.	62.

Dimensions listed under h w d are actual to the nearest 1/8"

Ordering Information	Order Code	Included with:	Options
Tiled Panels with 28" Lower Tile and Open Base: 1. Pattern Number 2. Top cap type 3. Top cap trim finish 4. Base support trim finish 5. Tile support style 6. Panel fabric	Tiled Panels with 28" Lower Tile and Open Base <i>Example:</i> DP7CPPLL4218 4/117/KK/117/2/B191 <hr/> DP7 Dividends Horizon Panel <hr/> C Topway frame <hr/> PP Tiled both sides, 28" Lower Tile <hr/> LL Open Base <hr/> 42 Height <hr/> 18 Width <hr/> 4 Radius Metal top cap <hr/> 117 Soft Grey top cap finish <hr/> 117 Soft Grey base support finish <hr/> 2 D2 style tile supports <hr/> B191 Fairfield light fabric	Tiled Panels with 28" Lower Tile and Open Base: <ul style="list-style-type: none"> Panel frame Acoustic panel inserts Open base Top cap Connection hardware 	Tiled Panels with 28" Lower Tile and Open Base: Full View Frame Option: To specify full view frames for window or stacking applications, replace the "C" in pattern number with "V". No upcharge. Monolithic Side Option: To specify monolithic on side one of panel, change "PP" in pattern number to "MP" and deduct amount in far right column. Top Cap Options: (2) = Extruded Plastic (Smooth Radius) (3) = No Top Cap (4) = Radius Metal, add \$38 P1, \$40 P2, \$42 P3 paint grades (5) = Flat Metal, add \$38 P1, \$40 P2, \$42 P3 paint grades Base Raceway Knockout Options: (K) = Knockouts on raceway side (N) = No knockouts Tile Support Options: (1) = D1 External Reveal (2) = D2 Recessed Reveal

Tiled Panels

28" Lower Tile and Open Base

57" and 64" High

description	h	w	d	pattern no.	grade								deduct for Monolithic One Side
					10	15	20	25	30	35	40	45	
57" High Tiled Panel with 28" Lower Tile and Open Base	56 ¹³ / ₁₆ "	18"	3"	DP7CPPLL5718	\$704.	\$722.	\$722.	\$774.	\$794.	\$808.	\$823.	\$844.	\$71.
	56 ¹³ / ₁₆ "	24"	3"	DP7CPPLL5724	757.	779.	779.	831.	854.	870.	884.	906.	74.
	56 ¹³ / ₁₆ "	30"	3"	DP7CPPLL5730	800.	824.	824.	879.	903.	920.	936.	961.	76.
	56 ¹³ / ₁₆ "	36"	3"	DP7CPPLL5736	850.	876.	876.	936.	962.	978.	994.	1,020.	77.
	56 ¹³ / ₁₆ "	42"	3"	DP7CPPLL5742	901.	927.	927.	991.	1,018.	1,036.	1,054.	1,081.	79.
	56 ¹³ / ₁₆ "	48"	3"	DP7CPPLL5748	950.	980.	980.	1,045.	1,074.	1,093.	1,112.	1,141.	80.
	56 ¹³ / ₁₆ "	60"	3"	DP7CPPLL5760	1,141.	1,176.	1,176.	1,254.	1,290.	1,313.	1,335.	1,368.	83.

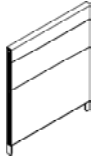

64" High Tiled Panel with 28" Lower Tile and Open Base	64 ¹ / ₁₆ "	18"	3"	DP7CPPLL6418	743.	768.	768.	819.	842.	856.	872.	895.	86.
	64 ¹ / ₁₆ "	24"	3"	DP7CPPLL6424	800.	822.	822.	878.	902.	918.	935.	961.	90.
	64 ¹ / ₁₆ "	30"	3"	DP7CPPLL6430	846.	873.	873.	930.	959.	972.	991.	1,016.	87.
	64 ¹ / ₁₆ "	36"	3"	DP7CPPLL6436	900.	927.	927.	990.	1,016.	1,035.	1,052.	1,080.	88.
	64 ¹ / ₁₆ "	42"	3"	DP7CPPLL6442	952.	982.	982.	1,048.	1,078.	1,096.	1,114.	1,143.	89.
	64 ¹ / ₁₆ "	48"	3"	DP7CPPLL6448	1,006.	1,035.	1,035.	1,104.	1,134.	1,155.	1,176.	1,205.	90.
	64 ¹ / ₁₆ "	60"	3"	DP7CPPLL6460	1,205.	1,241.	1,241.	1,326.	1,362.	1,387.	1,410.	1,446.	90.



Dimensions listed under h w d are actual to the nearest 1/8"

Ordering Information	Order Code	Included with:	Options
Tiled Panels with 28" Lower Tile and Open Base: 1. Pattern Number 2. Top cap type 3. Top cap trim finish 4. Base support trim finish 5. Tile support style 6. Panel fabric	Tiled Panels with 28" Lower Tile and Open Base <i>Example:</i> DP7CPPLL5718 4/117/KK/117/2/B191 <hr/> DP7 Dividends Horizon Panel <hr/> C Topway frame <hr/> PP Tiled both sides, 28" Lower Tile <hr/> LL Open Base <hr/> 57 Height <hr/> 18 Width <hr/> 4 Radius Metal top cap <hr/> 117 Soft Grey top cap finish <hr/> 117 Soft Grey base support finish <hr/> 2 D2 style tile support <hr/> B191 Fairfield light fabric	Tiled Panels with 28" Lower Tile and Open Base: <ul style="list-style-type: none"> Panel frame Acoustic panel inserts Open base Top cap Connection hardware 	Tiled Panels with 28" Lower Tile and Open Base: Full View Frame Option: To specify full view frames for window or stacking applications, replace the "C" in pattern number with "V". No upcharge. Monolithic Side Option: To specify monolithic on side one of panel, change "PP" in pattern number to "MP" and deduct amount in far right column. Top Cap Options: (2) = Extruded Plastic (Smooth Radius) (3) = No Top Cap (4) = Radius Metal, add \$38 P1, \$40 P2, \$42 P3 paint grades (5) = Flat Metal, add \$38 P1, \$40 P2, \$42 P3 paint grades Base Raceway Knockout Options: (K) = Knockouts on raceway side (N) = No knockouts Tile Support Options: (1) = D1 External Reveal (2) = D2 Recessed Reveal

Tiled Panels

28" Lower Tile and Open Base

78" High

description	h	w	d	pattern no.	grade								deduct for Monolithic One Side
					10	15	20	25	30	35	40	45	
78" High Tiled Panel with 28" Lower Tile and Open Base	78 ¹ / ₁₆ "	18"	3"	DP7CPPLL7818	\$1,172.	\$1,205.	\$1,264.	\$1,288.	\$1,321.	\$1,345.	\$1,369.	\$1,405.	\$153.
	78 ¹ / ₁₆ "	24"	3"	DP7CPPLL7824	1,258.	1,296.	1,360.	1,384.	1,424.	1,447.	1,471.	1,512.	158.
	78 ¹ / ₁₆ "	30"	3"	DP7CPPLL7830	1,335.	1,373.	1,438.	1,466.	1,507.	1,533.	1,560.	1,599.	155.
	78 ¹ / ₁₆ "	36"	3"	DP7CPPLL7836	1,427.	1,468.	1,539.	1,566.	1,612.	1,641.	1,668.	1,711.	168.
	78 ¹ / ₁₆ "	42"	3"	DP7CPPLL7842	1,512.	1,556.	1,630.	1,660.	1,707.	1,737.	1,768.	1,814.	171.
	78 ¹ / ₁₆ "	48"	3"	DP7CPPLL7848	1,602.	1,651.	1,732.	1,764.	1,812.	1,843.	1,875.	1,923.	205.

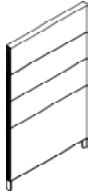

Dimensions listed under h w d are actual to the nearest 1/8"

Ordering Information	Order Code	Included with:	Options
Tiled Panels with 28" Lower Tile and Open Base: <ol style="list-style-type: none"> 1. Pattern Number 2. Top cap type 3. Top cap trim finish 4. Base support trim finish 5. Tile support style 6. Panel fabric 	Tiled Panels with 28" Lower Tile and Open Base <i>Example:</i> DP7CPPLL7818 4/117/KK/117/2/B191 <hr/> DP7 Dividends Horizon Panel <hr/> C Topway frame <hr/> PP Tiled both sides, 28" Lower Tile <hr/> LL Open Base <hr/> 78 Height <hr/> 18 Width <hr/> 4 Radius Metal top cap <hr/> 117 Soft Grey top cap finish <hr/> 117 Soft Grey base support finish <hr/> 2 D2 style tile support <hr/> B191 Fairfield light fabric	Tiled Panels with 28" Lower Tile and Open Base: <ul style="list-style-type: none"> • Panel frame • Acoustic panel inserts • Open base • Top cap • Connection hardware 	Tiled Panels with 28" Lower Tile and Open Base: <p>Full View Frame Option: To specify full view frames for window or stacking applications, replace the "C" in pattern number with "V". No upcharge.</p> <p>Monolithic Side Option: To specify monolithic on side one of panel, change "PP" in pattern number to "MP" and deduct amount in far right column.</p> <p>Top Cap Options: (2) = Extruded Plastic (Smooth Radius) (3) = No Top Cap (4) = Radius Metal, add \$38 P1, \$40 P2, \$42 P3 paint grades (5) = Flat Metal, add \$38 P1, \$40 P2, \$42 P3 paint grades</p> <p>Base Raceway Knockout Options:</p> <p>(K) = Knockouts on raceway side (N) = No knockouts</p> <p>Tile Support Options: (1) = D1 External Reveal (2) = D2 Recessed Reveal</p>

Tiled Panels

28" Lower Tile and Tile To Floor

42" and 50" High

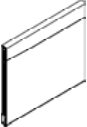
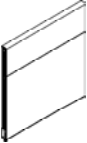
description	h	w	d	pattern no.	grade								Deduct for 1 side Monolithic
					10	15	20	25	30	35	40	45	
42" High Tiled Panel with 28" Lower Tile and Tile to Floor 	42 3/16"	15"	3"	DP7CPPFR4215	\$537.	\$552.	\$580.	\$593.	\$609.	\$620.	\$632.	\$648.	\$57.
	42 3/16"	18"	3"	DP7CPPFR4218	537.	552.	580.	593.	609.	620.	632.	648.	57.
	42 3/16"	24"	3"	DP7CPPFR4224	571.	589.	618.	631.	647.	660.	670.	689.	57.
	42 3/16"	30"	3"	DP7CPPFR4230	613.	633.	665.	679.	695.	710.	721.	743.	58.
	42 3/16"	36"	3"	DP7CPPFR4236	660.	681.	714.	728.	748.	761.	776.	793.	60.
	42 3/16"	42"	3"	DP7CPPFR4242	707.	729.	764.	780.	800.	815.	828.	852.	60.
	42 3/16"	48"	3"	DP7CPPFR4248	746.	767.	808.	823.	847.	859.	877.	900.	61.
	42 3/16"	60"	3"	DP7CPPFR4260	901.	928.	974.	993.	1,020.	1,039.	1,058.	1,085.	62.
50" High Tiled Panel with 28" Lower Tile and Tile to Floor 	49 1/2"	15"	3"	DP7CPPFR5015	556.	574.	602.	614.	632.	643.	656.	671.	56.
	49 1/2"	18"	3"	DP7CPPFR5018	556.	574.	602.	614.	632.	643.	656.	671.	56.
	49 1/2"	24"	3"	DP7CPPFR5024	601.	620.	654.	664.	685.	694.	708.	727.	58.
	49 1/2"	30"	3"	DP7CPPFR5030	638.	660.	691.	703.	725.	737.	752.	768.	56.
	49 1/2"	36"	3"	DP7CPPFR5036	679.	697.	734.	750.	767.	783.	797.	819.	52.
	49 1/2"	42"	3"	DP7CPPFR5042	722.	748.	784.	798.	821.	837.	851.	875.	49.
	49 1/2"	48"	3"	DP7CPPFR5048	764.	788.	827.	846.	868.	882.	899.	922.	48.
	49 1/2"	60"	3"	DP7CPPFR5060	920.	949.	996.	1,015.	1,043.	1,063.	1,081.	1,109.	62.

Dimensions listed under h w d are actual to the nearest 1/8"

Ordering Information	Order Code	Included with:	Options
Tiled Panels with 28" Lower Tile and Tile To Floor: 1. Pattern Number 2. Top cap type 3. Top cap finish 4. Knockout option 5. Base raceway finish 6. Tile support style 7. Panel fabric	Tiled Panels with 28" Lower Tile and Tile To Floor: <i>Example:</i> DP7CPPFF4218 4/117/K/117/2B191 <hr/> DP7CPP Pattern number <hr/> FF4218 <hr/> 4 Radius Metal top cap <hr/> 117 Soft Grey top cap finish <hr/> K Base raceway with knockouts <hr/> 117 Soft grey base raceway finish <hr/> 2 D2 style tile supports <hr/> B191 Fairfield light fabric	Tiled Panels with 28" Lower Tile and Tile To Floor: <ul style="list-style-type: none"> Panel frame Acoustic panel inserts Top cap Connection hardware Tile to floor side 1 Base raceway with knockout when required side 2 	Tiled Panels with 28" Lower Tile and Tile To Floor: Full View Frame Option: To specify full view frames for window or stacking applications, replace the "C" in pattern number with "V". No upcharge. Tile to Floor Side Option: Tile to Floor standard on side 2. To specify tile to floor on side 1, change "FR" in pattern number to "RF". Monolithic Side Option: To specify monolithic on side one of panel, change "PP" in pattern number to "MP" and deduct amount in far right column. Top Cap Options: (2) = Extruded Plastic (Smooth Radius) (3) = No Top Cap (4) = Radius Metal, add \$38 P1, \$40 P2, \$42 P3 paint grades (5) = Flat Metal, add \$38 P1, \$40 P2, \$42 P3 paint grades Raceway Knockout Options: (K) = Knockouts on raceway side (N) = No knockouts Tile Support Options: (1) = D1 External Reveal (2) = D2 Recessed Reveal

Tiled Panels

28" Lower Tile and Tile To Floor

57" and 64" High

description	h	w	d	pattern no.	grade								deduct for
					10	15	20	25	30	35	40	45	1 side Monolithic
57" High Tiled Panel with 28" Lower Tile and Tile to Floor	56 ¹³ / ₁₆ "	15"	3"	DP7CPPFR5715	\$681.	\$699.	\$737.	\$751.	\$771.	\$785.	\$800.	\$821.	\$71.
	56 ¹³ / ₁₆ "	18"	3"	DP7CPPFR5718	681.	699.	737.	751.	771.	785.	800.	821.	71.
	56 ¹³ / ₁₆ "	24"	3"	DP7CPPFR5724	734.	756.	792.	808.	831.	847.	861.	883.	74.
	56 ¹³ / ₁₆ "	30"	3"	DP7CPPFR5730	777.	801.	843.	856.	880.	897.	913.	938.	76.
	56 ¹³ / ₁₆ "	36"	3"	DP7CPPFR5736	827.	853.	895.	913.	939.	955.	971.	997.	77.
	56 ¹³ / ₁₆ "	42"	3"	DP7CPPFR5742	878.	904.	950.	968.	995.	1,013.	1,031.	1,058.	79.
	56 ¹³ / ₁₆ "	48"	3"	DP7CPPFR5748	927.	957.	1,003.	1,022.	1,051.	1,070.	1,089.	1,118.	80.
	56 ¹³ / ₁₆ "	60"	3"	DP7CPPFR5760	1,118.	1,153.	1,208.	1,231.	1,267.	1,290.	1,312.	1,345.	83.

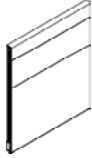

64" High Tiled Panel with 28" Lower Tile and Tile to Floor	64 ¹ / ₁₆ "	15"	3"	DP7CPPFR6415	720.	745.	781.	796.	819.	833.	849.	872.	86.
	64 ¹ / ₁₆ "	18"	3"	DP7CPPFR6418	720.	745.	781.	796.	819.	833.	849.	872.	86.
	64 ¹ / ₁₆ "	24"	3"	DP7CPPFR6424	777.	799.	843.	855.	879.	895.	912.	938.	90.
	64 ¹ / ₁₆ "	30"	3"	DP7CPPFR6430	823.	850.	890.	907.	936.	949.	968.	993.	87.
	64 ¹ / ₁₆ "	36"	3"	DP7CPPFR6436	877.	904.	948.	967.	993.	1,012.	1,029.	1,057.	88.
	64 ¹ / ₁₆ "	42"	3"	DP7CPPFR6442	929.	959.	1,007.	1,025.	1,055.	1,073.	1,091.	1,120.	89.
	64 ¹ / ₁₆ "	48"	3"	DP7CPPFR6448	983.	1,012.	1,062.	1,081.	1,111.	1,132.	1,153.	1,182.	90.
	64 ¹ / ₁₆ "	60"	3"	DP7CPPFR6460	1,182.	1,218.	1,279.	1,303.	1,339.	1,364.	1,387.	1,423.	90.



Dimensions listed under h w d are actual to the nearest 1/8"

Ordering Information	Order Code	Included with:	Options
Tiled Panels with 28" Lower Tile and Tile To Floor: 1. Pattern Number 2. Top cap type 3. Top cap finish 4. Knockout option 5. Base raceway finish 6. Tile support style 7. Panel fabric	Tiled Panels with 28" Lower Tile and Tile To Floor: <i>Example:</i> DP7CPPFF4218 4/117/K/117/2/B191 <hr/> DP7CPP Pattern number <hr/> FF4218 <hr/> 4 Radius Metal top cap <hr/> 117 Soft Grey top cap finish <hr/> K Base raceway with knockouts <hr/> 117 Soft Grey base raceway finish <hr/> 2 D2 style tile supports <hr/> B191 Fairfield light fabric	Tiled Panels with 28" Lower Tile and Tile To Floor: <ul style="list-style-type: none"> • Panel frame • Acoustic panel inserts • Top cap • Connection hardware • Tile to floor side 1 • Base raceway with knockout when required side 2 	Tiled Panels with 28" Lower Tile and Tile To Floor: Full View Frame Option: To specify full view frames for window or stacking applications, replace the "C" in pattern number with "V". No upcharge. Tile to Floor Side Option: Tile to Floor standard on side 2. To specify tile to floor on side 1, change "FR" in pattern number to "RF". Monolithic Side Option: To specify monolithic on side one of panel, change "PP" in pattern number to "MP" and deduct amount in far right column. Top Cap Options: (2) = Extruded Plastic (Smooth Radius) (3) = No Top Cap (4) = Radius Metal, add \$38 P1, \$40 P2, \$42 P3 paint grades (5) = Flat Metal, add \$38 P1, \$40 P2, \$42 P3 paint grades Raceway Knockout Options: (K) = Knockouts on raceway side (N) = No knockouts Tile Support Options: (1) = D1 External Reveal (2) = D2 Recessed Reveal

Tiled Panels

28" Lower Tile and Tile To Floor

78" High

description	h	w	d	pattern no.	grade							deduct for	
					10	15	20	25	30	35	40	45	1 side Monolithic
78" High Tiled Panel with 28" Lower Tile and Tile to Floor	78 ¹ / ₁₆ "	15"	3"	DP7CPPFR7815	\$1,149.	\$1,182.	\$1,241.	\$1,265.	\$1,298.	\$1,322.	\$1,346.	\$1,382.	\$153.
	78 ¹ / ₁₆ "	18"	3"	DP7CPPFR7818	1,149.	1,182.	1,241.	1,265.	1,298.	1,322.	1,346.	1,382.	153.
	78 ¹ / ₁₆ "	24"	3"	DP7CPPFR7824	1,235.	1,273.	1,337.	1,361.	1,401.	1,424.	1,448.	1,489.	158.
	78 ¹ / ₁₆ "	30"	3"	DP7CPPFR7830	1,312.	1,350.	1,415.	1,443.	1,484.	1,510.	1,537.	1,576.	155.
	78 ¹ / ₁₆ "	36"	3"	DP7CPPFR7836	1,404.	1,445.	1,516.	1,543.	1,589.	1,618.	1,645.	1,688.	168.
	78 ¹ / ₁₆ "	42"	3"	DP7CPPFR7842	1,489.	1,533.	1,607.	1,637.	1,684.	1,714.	1,745.	1,791.	171.
	78 ¹ / ₁₆ "	48"	3"	DP7CPPFR7848	1,579.	1,628.	1,709.	1,741.	1,789.	1,820.	1,852.	1,900.	205.

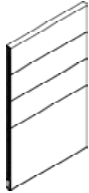

Ordering Information

Tiled Panels with 28" Lower Tile and Tile To Floor:

1. Pattern Number
2. Top cap type
3. Top cap finish
4. Knockout option
5. Base raceway finish
6. Tile support style
7. Panel fabric

Order Code

Tiled Panels with 28" Lower Tile and Tile To Floor:

Example: **DP7CPPFF4218**
4/117/K/117/2/B191

DP7CPP	Pattern number
FF4218	
4	Radius Metal top cap
117	Soft Grey top cap finish
K	Base raceway with knockouts
117	Soft Grey base raceway finish
2	D2 style tile supports
B191	Fairfield light fabric

Included with:

Tiled Panels with 28" Lower Tile and Tile To Floor:

- Panel frame
- Acoustic panel inserts
- Top cap
- Connection hardware
- Base raceway with knockout when required

Options

Tiled Panels with 28" Lower Tile and Tile To Floor:

Full View Frame Option:

To specify full view frames for window or stacking applications, replace the "C" in pattern number with "V". No upcharge.

Tile to Floor Side Option:

Tile to Floor standard on side 2. To specify tile to floor on side 1, change "FR" in pattern number to "RF".

Monolithic Side Option:

To specify monolithic on side one of panel, change "PP" in pattern number to "MP" and deduct amount in far right column.

Top Cap Options:

- (2)** = Extruded Plastic (Smooth Radius)
- (3)** = No Top Cap
- (4)** = Radius Metal, add \$38 P1, \$40 P2, \$42 P3 paint grades
- (5)** = Flat Metal, add \$38 P1, \$40 P2, \$42 P3 paint grades

Raceway Knockout Options:

- (K)** = Knockouts on raceway side
- (N)** = No knockouts

Tile Support Options:

- (1)** = D1 External Reveal
- (2)** = D2 Recessed Reveal

Beltway Panel Components

"Preconfigured" Dividends Horizon beltway panels ship completely assembled with a universal panel frame, choice of standard base raceway, open base or tiled to the floor base options, top cap, panel-to-panel connection hardware and beltway inserts.

Beltway panels may be ordered by component for "Build-to-Spec" applications. This includes when panel inserts are required on one side only or when a different fabric color or material is required on opposite panel sides.

Beltway Panel Insert Supports

All Dividends Horizon panel frames are pre-punched to accept beltway supports which span horizontally across the panel frame. Beltway panel inserts are mounted above and below the beltway and attach to the upper and lower panel frame and the beltway supports. Beltway supports are painted black.

Note: Slatwall tiles may not be specified or installed with beltway.

Beltway Panel Insert Construction

Fabric inserts are constructed of fabric laminated with a web adhesive and heat cured to 1/2" thick tackable acoustic board. Laminate inserts are constructed of a particle board core with laminate on the front and back. Steel tiles are constructed of formed steel that is painted in any Knoll core paint finish.

Beltway Cover Construction

Trim-colored plastic extrusion available in smooth finish.

Electrical

Panel base raceways 24" and wider will accept two duplex receptacles per panel side. 18" wide panels provide pass-through electrical only. Beltway raceways 30" and wider will accept two duplex receptacles per panel side. 18" and 24" wide beltways provide pass-through electrical only. All electrical components are ordered separately and must be field-installed.

One-Sided Beltway Panel

Beltway panels are available with one beltway per panel or per panel sides. Non-beltway side will have a monolithic insert.

Three Top Cap Options Available

- Smooth Radius Plastic
- Radius Metal
- Flat Metal

Top Cap Construction

Smooth radiused top caps are made from extruded plastic. Radius and flat metal top caps are made from extruded aluminum.

Top Cap Attachment

Snaps onto the trough of a topway panel frame. Retainer clips are included to attach top caps to full view frames.

Preconfigured Beltway Panel

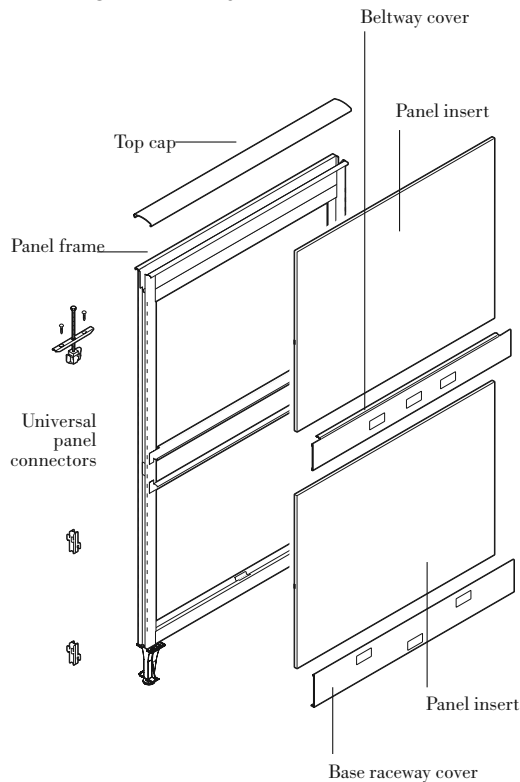

Panel Base Options

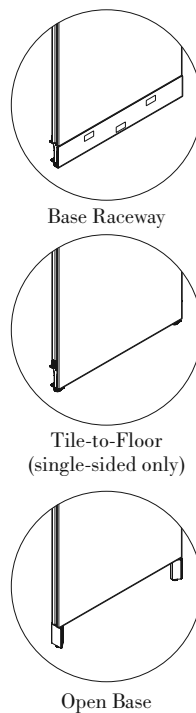

Beltway Panel Standard Configurations

42"H Panels

- One 7"H upper insert
- One 4"H beltway cover and insert support
- One 24"H lower insert

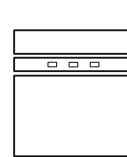

57"H Panels

- One 21"H upper insert
- One 4"H beltway cover and insert support
- One 24"H lower insert

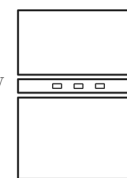

64"H Panels

- One 28"H upper insert
- One 4"H beltway cover and insert support
- One 24"H lower insert

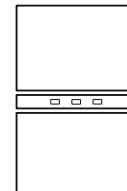

50"H Panels

- One 14"H upper panel insert
- One 4"H beltway cover and insert support
- One 24"H lower insert

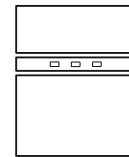

78"H Panels

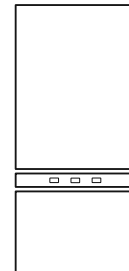

- One 50"H upper insert
- One 4"H beltway cover and insert support
- One 24"H lower panel insert



Beltway Panels

Standard Base Raceway

42" and 50" High

description	h	w	d	pattern no.	grade								Deduct for Monolithic on side 2
					10	15	20	25	30	35	40	45	
 42" Beltway Panels with Standard Base Raceway	42 ³ / ₁₆ "	18"	3"	DP7CBBRR4218	\$543.	\$559.	\$588.	\$597.	\$615.	\$625.	\$635.	\$652.	\$89.
	42 ³ / ₁₆ "	24"	3"	DP7CBBRR4224	618.	636.	665.	680.	697.	711.	721.	742.	111.
	42 ³ / ₁₆ "	30"	3"	DP7CBBRR4230	678.	698.	733.	745.	767.	779.	791.	814.	119.
	42 ³ / ₁₆ "	36"	3"	DP7CBBRR4236	743.	766.	803.	816.	840.	852.	869.	893.	132.
	42 ³ / ₁₆ "	42"	3"	DP7CBBRR4242	806.	831.	871.	885.	911.	928.	942.	966.	138.
	42 ³ / ₁₆ "	48"	3"	DP7CBBRR4248	861.	884.	930.	945.	970.	989.	1,006.	1,032.	149.
	42 ³ / ₁₆ "	60"	3"	DP7CBBRR4260	977.	1,006.	1,055.	1,075.	1,103.	1,124.	1,143.	1,172.	149.
 50" Beltway Panels with Standard Base Raceway	49 ¹ / ₂ "	18"	3"	DP7CBBRR5018	565.	581.	611.	622.	637.	650.	660.	678.	88.
	49 ¹ / ₂ "	24"	3"	DP7CBBRR5024	648.	665.	698.	712.	731.	744.	756.	776.	112.
	49 ¹ / ₂ "	30"	3"	DP7CBBRR5030	704.	722.	757.	773.	791.	807.	821.	843.	116.
	49 ¹ / ₂ "	36"	3"	DP7CBBRR5036	761.	783.	822.	838.	861.	875.	890.	913.	121.
	49 ¹ / ₂ "	42"	3"	DP7CBBRR5042	823.	849.	890.	907.	932.	948.	965.	990.	127.
	49 ¹ / ₂ "	48"	3"	DP7CBBRR5048	878.	906.	950.	967.	993.	1,012.	1,031.	1,057.	132.
	49 ¹ / ₂ "	60"	3"	DP7CBBRR5060	998.	1,028.	1,078.	1,098.	1,128.	1,148.	1,168.	1,197.	132.

Dimensions listed under h w d are actual to the nearest 1/16"



Ordering Information	Order Code	Included with:	Options
Beltway Panel with Standard Base Raceway: 1. Pattern Number 2. Top cap type 3. Top cap finish 4. Base raceway knockout option 5. Base raceway finish 6. Beltway finish 7. Panel fabric	Beltway Panel with Standard Base Raceway <i>Example:</i> DP7CBBRR4218 4/117/K/117/117/B191 <hr/> DP7CBB Pattern number <hr/> RR4218 <hr/> 4 Radius Metal top cap <hr/> 117 Soft Grey top cap finish <hr/> K Base Raceway with knockouts both sides <hr/> 117 Soft Grey base raceway finish <hr/> 117 Beltway finish <hr/> B191 Fairfield light fabric	Beltway Panel with Standard Base Raceway: <ul style="list-style-type: none"> Panel frame Acoustic panel inserts Base raceway covers Beltway covers Top cap Connection hardware 	Beltway Panel with Standard Raceway Options: Full View Frame Option: To specify full view frames for window or stacking applications, replace the "C" in pattern number with "V". No upcharge. Monolithic Side Option: To specify monolithic on side one of panel, change "BB" in pattern number to "MB" and deduct amount in far right column. Top Cap Options: (2) = Extruded Plastic (Smooth Radius) (3) = No Top Cap (4) = Radius Metal, add \$38 P1, \$40 P2, \$42 P3 paint grades (5) = Flat Metal, add \$38 P1, \$40 P2, \$42 P3 paint grades Raceway Knockout Options: (K) = Knockouts on raceway side (N) = No Knockouts

Beltway Panels

Standard Base Raceway

57", 64" and 78" High

Dividends Horizon

description	h	w	d	pattern no.	grade									Deduct for Monolithic on side 2
					10	15	20	25	30	35	40	45		
 57" Beltway Panels with Standard Base Raceway	56 ¹³ / ₁₆ "	18"	3"	DP7CBRR5718	\$604.	\$623.	\$652.	\$663.	\$682.	\$695.	\$707.	\$724.	\$88.	
	56 ¹³ / ₁₆ "	24"	3"	DP7CBRR5724	685.	707.	741.	755.	774.	788.	802.	823.	112.	
	56 ¹³ / ₁₆ "	30"	3"	DP7CBRR5730	741.	763.	800.	815.	838.	851.	867.	889.	116.	
	56 ¹³ / ₁₆ "	36"	3"	DP7CBRR5736	815.	839.	880.	896.	921.	937.	953.	977.	121.	
	56 ¹³ / ₁₆ "	42"	3"	DP7CBRR5742	874.	900.	944.	962.	988.	1,006.	1,023.	1,050.	127.	
	56 ¹³ / ₁₆ "	48"	3"	DP7CBRR5748	938.	965.	1,013.	1,032.	1,060.	1,078.	1,097.	1,126.	132.	
	56 ¹³ / ₁₆ "	60"	3"	DP7CBRR5760	1,056.	1,087.	1,141.	1,162.	1,193.	1,214.	1,236.	1,267.	132.	
 64" Beltway Panels with Standard Base Raceway	64 ¹ / ₁₆ "	18"	3"	DP7CBRR6418	641.	660.	693.	708.	723.	739.	750.	770.	95.	
	64 ¹ / ₁₆ "	24"	3"	DP7CBRR6424	722.	745.	780.	798.	817.	833.	846.	869.	117.	
	64 ¹ / ₁₆ "	30"	3"	DP7CBRR6430	777.	802.	840.	854.	877.	895.	909.	934.	117.	
	64 ¹ / ₁₆ "	36"	3"	DP7CBRR6436	867.	893.	935.	952.	977.	994.	1,012.	1,038.	134.	
	64 ¹ / ₁₆ "	42"	3"	DP7CBRR6442	927.	954.	999.	1,018.	1,046.	1,065.	1,082.	1,109.	142.	
	64 ¹ / ₁₆ "	48"	3"	DP7CBRR6448	995.	1,027.	1,076.	1,096.	1,126.	1,146.	1,165.	1,195.	154.	
	64 ¹ / ₁₆ "	60"	3"	DP7CBRR6460	1,125.	1,158.	1,214.	1,238.	1,271.	1,293.	1,315.	1,350.	154.	
 78" Beltway Panels with Standard Base Raceway	78 ⁹ / ₁₆ "	18"	3"	DP7CBRR7818	806.	831.	871.	885.	911.	928.	942.	966.	86.	
	78 ⁹ / ₁₆ "	24"	3"	DP7CBRR7824	904.	931.	976.	992.	1,019.	1,038.	1,057.	1,082.	99.	
	78 ⁹ / ₁₆ "	30"	3"	DP7CBRR7830	969.	998.	1,049.	1,068.	1,097.	1,115.	1,134.	1,165.	102.	
	78 ⁹ / ₁₆ "	36"	3"	DP7CBRR7836	1,074.	1,106.	1,159.	1,180.	1,214.	1,236.	1,258.	1,289.	119.	
	78 ⁹ / ₁₆ "	42"	3"	DP7CBRR7842	1,154.	1,189.	1,245.	1,268.	1,305.	1,327.	1,351.	1,383.	122.	
	78 ⁹ / ₁₆ "	48"	3"	DP7CBRR7848	1,271.	1,310.	1,374.	1,400.	1,436.	1,463.	1,490.	1,526.	151.	

Dimensions listed under h w d are actual to the nearest 1/16"

Ordering Information	Order Code	Included with:	Options
Beltway Panel with Standard Base Raceway: 1. Pattern Number 2. Top cap type 3. Top cap finish 4. Base raceway knockout option 5. Base raceway finish 6. Beltway finish 7. Panel fabric	Beltway Panel with Standard Base Raceway <i>Example:</i> DP7CBRR4218 4/117/K/117/117/B191 <hr/> DP7CBB Pattern number <hr/> RR4218 <hr/> 4 Radius Metal top cap <hr/> 117 Soft Grey top cap finish <hr/> K Base Raceway with knockouts both sides <hr/> 117 Soft Grey base raceway finish <hr/> 117 Beltway finish <hr/> B191 Fairfield light fabric	Beltway Panel with Standard Base Raceway: <ul style="list-style-type: none"> Panel frame Acoustic panel inserts Base raceway covers Beltway covers Top cap Connection hardware 	Beltway Panel with Standard Raceway Options: Full View Frame Option: To specify full view frames for window or stacking applications, replace the "C" in pattern number with "V". No upcharge. Monolithic Side Option: To specify monolithic on side one of panel, change "BB" in pattern number to "MB" and deduct amount in far right column. Top Cap Options: (2) = Extruded Plastic (Smooth Radius) (3) = No Top Cap (4) = Radius Metal, add \$38 P1, \$40 P2, \$42 P3 paint grades (5) = Flat Metal, add \$38 P1, \$40 P2, \$42 P3 paint grades Raceway Knockout Options: (K) = Knockouts on raceway side (N) = No Knockouts

Beltway Panels

Tile to the Floor

42" and 50" High

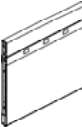
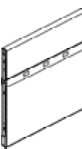
description	h	w	d	pattern no.	grade								Deduct for Monolithic side 1
					10	15	20	25	30	35	40	45	
 42" Beltway Panels with Tile to the Floor	42 ³ / ₁₆ "	18"	3"	DP7CBBFR4218	\$575.	\$591.	\$620.	\$629.	\$647.	\$657.	\$667.	\$684.	\$89.
	42 ³ / ₁₆ "	24"	3"	DP7CBBFR4224	650.	668.	697.	712.	729.	743.	753.	774.	111.
	42 ³ / ₁₆ "	30"	3"	DP7CBBFR4230	710.	730.	765.	777.	799.	811.	823.	846.	119.
	42 ³ / ₁₆ "	36"	3"	DP7CBBFR4236	775.	798.	835.	848.	872.	884.	901.	925.	132.
	42 ³ / ₁₆ "	42"	3"	DP7CBBFR4242	838.	863.	903.	917.	943.	960.	974.	998.	138.
	42 ³ / ₁₆ "	48"	3"	DP7CBBFR4248	893.	916.	962.	977.	1,002.	1,021.	1,038.	1,064.	149.
	42 ³ / ₁₆ "	60"	3"	DP7CBBFR4260	1,009.	1,038.	1,087.	1,107.	1,135.	1,156.	1,175.	1,204.	149.
 50" Beltway Panels with Tile to the Floor	49 ¹ / ₂ "	18"	3"	DP7CBBFR5018	597.	613.	643.	654.	669.	682.	692.	710.	88.
	49 ¹ / ₂ "	24"	3"	DP7CBBFR5024	680.	697.	730.	744.	763.	776.	788.	808.	112.
	49 ¹ / ₂ "	30"	3"	DP7CBBFR5030	736.	754.	789.	805.	823.	839.	853.	875.	116.
	49 ¹ / ₂ "	36"	3"	DP7CBBFR5036	793.	815.	854.	870.	893.	907.	922.	945.	121.
	49 ¹ / ₂ "	42"	3"	DP7CBBFR5042	855.	881.	922.	939.	964.	980.	997.	1,022.	127.
	49 ¹ / ₂ "	48"	3"	DP7CBBFR5048	910.	938.	982.	999.	1,025.	1,044.	1,063.	1,089.	132.
	49 ¹ / ₂ "	60"	3"	DP7CBBFR5060	1,030.	1,060.	1,110.	1,130.	1,160.	1,180.	1,200.	1,229.	132.

Dimensions listed under h w c are actual to the nearest 1/16"

Ordering Information	Order Code	Included with:	Options
Beltway Panel with Tile to the Floor: 1. Pattern Number 2. Top cap type 3. Top cap finish 4. Base raceway knockout option 5. Base raceway finish 6. Beltway finish 7. Panel fabric	Beltway Panel with Tile to the Floor: <i>Example:</i> DP7CBBFR4218 4/117/K/117/117/B191 <hr/> DP7CBB Pattern number <hr/> FR4218 <hr/> 4 Radius Metal top cap <hr/> 117 Soft Grey top cap finish <hr/> K Base raceway with knockouts both sides <hr/> 117 Soft Grey base raceway finish <hr/> 117 Soft Grey beltway cover finish <hr/> B191 Fairfield light fabric	Beltway Panel with Tile to the Floor: <ul style="list-style-type: none"> Panel frame Acoustic panel inserts Top cap Connection hardware Base raceway side 2 Beltway with covers Tile to the floor side 1 	Beltway Panel with Tile to the Floor: Full View Frame Option: To specify full view frames for window or stacking applications, replace the "C" in pattern number with "V". No upcharge. Monolithic Side Option: For side 1 monolithic, side 2 beltway, change "BB" in pattern number to "MB" and deduct amount in far right column. Tile to Floor Side Option: Panels are standard with tile to floor side 1, raceway side 2. To specify raceway side one and tile to floor side 2, change "FR" in pattern number to "RF". Top Cap Options: (2) = Extruded Plastic (Smooth Radius) (3) = No Top Cap (4) = Radius Metal, add \$38 P1, \$40 P2, \$42 P3 paint grades (5) = Flat Metal, add \$38 P1, \$40 P2, \$42 P3 paint grades Raceway Knockout Options: (K) = Knockouts on raceway side (N) = No Knockouts

Beltway Panels

Tile to the Floor

57" and 64" High

description	height	width	depth	pattern number									Deduct for Monolithic side 1
					10	15	20	25	30	35	40	45	
57" Beltway Panels with Tile to the Floor	56 ¹³ / ₁₆ "	18"	3"	DP7CBBFR5718	\$636.	\$655.	\$684.	\$695.	\$714.	\$727.	\$739.	\$756.	\$88.
	56 ¹³ / ₁₆ "	24"	3"	DP7CBBFR5724	717.	739.	773.	787.	806.	820.	834.	855.	112.
	56 ¹³ / ₁₆ "	30"	3"	DP7CBBFR5730	773.	795.	832.	847.	870.	883.	899.	921.	116.
	56 ¹³ / ₁₆ "	36"	3"	DP7CBBFR5736	847.	871.	912.	928.	953.	969.	985.	1,009.	121.
	56 ¹³ / ₁₆ "	42"	3"	DP7CBBFR5742	906.	932.	976.	994.	1,020.	1,038.	1,055.	1,082.	127.
	56 ¹³ / ₁₆ "	48"	3"	DP7CBBFR5748	970.	997.	1,045.	1,064.	1,092.	1,110.	1,129.	1,158.	132.
	56 ¹³ / ₁₆ "	60"	3"	DP7CBBFR5760	1,088.	1,119.	1,173.	1,194.	1,225.	1,246.	1,268.	1,299.	132.



64" Beltway Panels with Tile to the Floor	64 ¹ / ₁₆ "	18"	3"	DP7CBBFR6418	673.	692.	725.	740.	755.	771.	782.	802.	95.
	64 ¹ / ₁₆ "	24"	3"	DP7CBBFR6424	754.	777.	812.	830.	849.	865.	878.	901.	117.
	64 ¹ / ₁₆ "	30"	3"	DP7CBBFR6430	809.	834.	872.	886.	909.	927.	941.	966.	117.
	64 ¹ / ₁₆ "	36"	3"	DP7CBBFR6436	899.	925.	967.	984.	1,009.	1,026.	1,044.	1,070.	134.
	64 ¹ / ₁₆ "	42"	3"	DP7CBBFR6442	959.	986.	1,031.	1,050.	1,078.	1,097.	1,114.	1,141.	142.
	64 ¹ / ₁₆ "	48"	3"	DP7CBBFR6448	1,027.	1,059.	1,108.	1,128.	1,158.	1,178.	1,197.	1,227.	154.
	64 ¹ / ₁₆ "	60"	3"	DP7CBBFR6460	1,157.	1,190.	1,246.	1,270.	1,303.	1,325.	1,347.	1,382.	154.



Dimensions listed under h w c are actual to the nearest 1/16"

Ordering Information	Order Code	Included with:	Options
Beltway Panel with Tile to the Floor: 1. Pattern Number 2. Top cap type 3. Top cap finish 4. Base raceway knockout option 5. Base raceway finish 6. Beltway finish 7. Panel fabric	Beltway Panel with Tile to the Floor: <i>Example:</i> DP7CBBFR5718 4/117/K/117/117/B191 <hr/> DP7CBB Pattern number <hr/> FR5718 <hr/> 4 Radius Metal top cap <hr/> 117 Soft Grey top cap finish <hr/> K Base raceway with knockouts both sides <hr/> 117 Soft Grey base raceway finish <hr/> 117 Soft Grey beltway cover finish <hr/> B191 Fairfield light fabric	Beltway Panel with Tile to the Floor: <ul style="list-style-type: none"> • Panel frame • Acoustic panel inserts • Top cap • Connection hardware • Base raceway • Beltway with covers • Tile to the floor side 1 	Beltway Panel with Tile to the Floor: Full View Frame Option: To specify full view frames for window or stacking applications, replace the "C" in pattern number with "V". No upcharge. Monolithic Side Option: For side 1 monolithic, side 2 beltway, change "BB" in pattern number to "MB" and deduct amount in far right column. Tile to Floor Side Option: Panels are standard with tile to floor side 1, raceway side 2. To specify raceway side one and tile to floor side 2, change "FR" in pattern number to "RF". Top Cap Options: (2) = Extruded Plastic (Smooth Radius) (3) = No Top Cap (4) = Radius Metal, add \$38 P1, \$40 P2, \$42 P3 paint grades (5) = Flat Metal, add \$38 P1, \$40 P2, \$42 P3 paint grades Raceway Knockout Options: (K) = Knockouts on raceway side (N) = No Knockouts

Beltway Panels

Tile to the Floor

78" High

description	height	width	depth	pattern number									Deduct for Monolithic side 1
					10	15	20	25	30	35	40	45	
78" Beltway Panels with Tile to the Floor	78 ¹ / ₁₆ "	18"	3"	DP7CBBFR7818	\$833.	\$863.	\$903.	\$917.	\$943.	\$960.	\$974.	\$998.	\$86.
	78 ¹ / ₁₆ "	24"	3"	DP7CBBFR7824	936.	963.	1,008.	1,024.	1,051.	1,070.	1,089.	1,114.	99.
	78 ¹ / ₁₆ "	30"	3"	DP7CBBFR7830	1,001.	1,030.	1,081.	1,100.	1,129.	1,147.	1,166.	1,197.	102.
	78 ¹ / ₁₆ "	36"	3"	DP7CBBFR7836	1,106.	1,138.	1,191.	1,212.	1,246.	1,268.	1,290.	1,321.	119.
	78 ¹ / ₁₆ "	42"	3"	DP7CBBFR7842	1,186.	1,221.	1,277.	1,300.	1,337.	1,359.	1,383.	1,415.	122.
	78 ¹ / ₁₆ "	48"	3"	DP7CBBFR7848	1,303.	1,342.	1,406.	1,432.	1,468.	1,495.	1,522.	1,558.	151.



Dimensions listed under h w c are actual to the nearest 1/16"

Ordering Information	Order Code	Included with:	Options
Beltway Panel with Tile to the Floor: 1. Pattern Number 2. Top cap type 3. Top cap finish 4. Base raceway knockout option 5. Base raceway finish 6. Beltway finish 7. Panel fabric	Beltway Panel with Tile to the Floor: <i>Example:</i> DP7CBBFR7818 4/117/K/117/117/B191 <hr/> DP7CBB Pattern number <hr/> FR7818 <hr/> 4 Radius Metal top cap <hr/> 117 Soft Grey top cap finish <hr/> K Base raceway with knockouts both sides <hr/> 117 Soft Grey base raceway finish <hr/> 117 Soft Grey beltway cover finish <hr/> B191 Fairfield light fabric	Beltway Panel with Tile to the Floor: <ul style="list-style-type: none"> • Panel frame • Acoustic panel inserts • Top cap • Connection hardware • Base raceway • Beltway with covers • Tile to the floor side 1 	Beltway Panel with Tile to the Floor: Full View Frame Option: To specify full view frames for window or stacking applications, replace the "C" in pattern number with "V". No upcharge. Monolithic Side Option: For side 1 monolithic, side 2 beltway, change "BB" in pattern number to "MB" and deduct amount in far right column. Tile to Floor Side Option: Panels are standard with tile to floor side 1, raceway side 2. To specify raceway side one and tile to floor side 2, change "FR" in pattern number to "RF". Top Cap Options: (2) = Extruded Plastic (Smooth Radius) (3) = No Top Cap (4) = Radius Metal, add \$38 P1, \$40 P2, \$42 P3 paint grades (5) = Flat Metal, add \$38 P1, \$40 P2, \$42 P3 paint grades Raceway Knockout Options: (K) = Knockouts on raceway side (N) = No Knockouts

Panel Frame Options

Dividends Horizon offers two panel frame options, which are selected depending on customer's aesthetic and functional needs. Both frames are available in preconfigured and build-to-spec panels, and may also be specified in CAP.

Dividends Horizon panel frames may be specified separately for "Build-to-Spec" applications. These include when panel inserts are only required on one side or when a beltway is required on one side and tiled inserts are on the other.

Panel frames may be specified with a standard base raceway, an open base or a tile to the floor. Panel frames ship complete with the base components, top cap and universal connection hardware. Raceway cover knockouts are standard with standard base raceway. If not required raceway covers without knockouts may be specified.

Topway panel frames feature an integral top cable trough, and are used with D1 style stack panels.

Full View frames have no top trough, leaving a larger window opening in the top position. Full view panels frames are designed for use with windows in the top position. They are also required when stacking with D2 style stack frames or DP7 stacking screens.

Topway and full view panel frames are offered in worksurface height, 36", 42", 50", 57", 64" and 78" high.

Three Top Cap Options Available:

- Smooth Radius Plastic
- Radius Metal
- Flat Metal

Top Cap Construction

Smooth radiused plastic top caps are made from extruded plastic. Radius and flat metal top caps are made from steel.

Top Cap Attachment

Full view frames ordered with top caps include top cap attachment clips on the panel frame.

If top caps are ordered separately, top cap attachment clips ship with the top cap and must be field-installed to the panel frame.

Open Position Planner

Open Position Planner allows specifiers to design and order factory assembled panels in virtually any configuration. Open Position Planner is available only through CAP, and is not available in this price list.

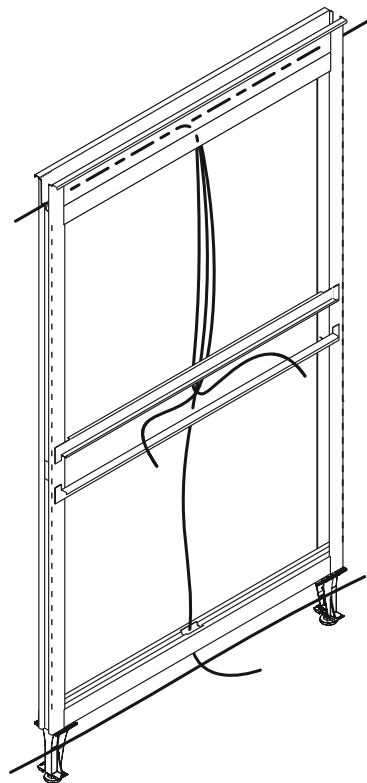

Topway Panel Frame

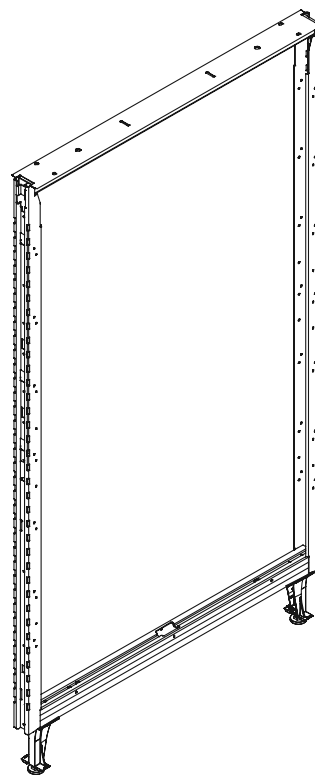

Full View Panel Frame

Panel Base Options

Dividends Horizon panels are available with three base options:

- Base Raceway
- Open Base
- Tile-to-Floor.

Overall panel heights, tile configurations and application rules are the same for all three base options.

Base Raceway

Provides duplex receptacle and data port access at base height. Base Raceway panels feature two roll formed steel raceway covers, which are available with or without electrical/data knockouts.

- Exterior dimension: 5"H x 2 15/16"D
- Interior dimension: 5"H x 2 7/8"D
- Dataport Knockout dimension: 1 3/8"H x 2 5/8"D
- Construction: Paint-colored 22-gauge roll-form steel cover
- Duplex access: 24" and wider base raceway covers have two duplex knockouts per panel side (18"W panels do not have duplex knockouts)
- Duplex location: 9" on center from each end

- Data access: All base raceway covers have one center-located data port knockout
- Additional data access: In panels 24" and wider, the outer knockouts can be used as additional data ports when the raceway is not used for duplex receptacles
- Power capacity: One power module or jumper

Note: Knockouts are standard unless specified without.

Open Base panels feature two extruded aluminum feet positioned at the end of each panel. A horizontal trim is located below the bottom tile.

Tile-To-Floor panels eliminate the raceway cover and access on one side, replaced by a fabric tile extended to the floor. A heavy gauge steel internal raceway cover protects the raceway contents and the tile from deflecting when hit by shoes or vacuum cleaners. The other side of the panel features a raceway cover, available with or without electrical/data knockouts. If needed, use one-sided electrical and one-sided base cable trays with this base option.

Panel Base Options

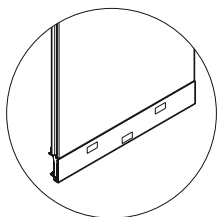

Base Raceway

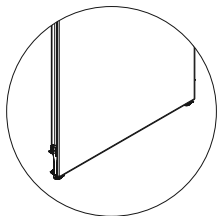

Tile-to-Floor
(single-sided only)

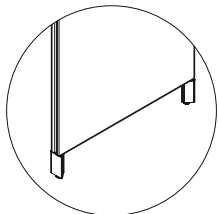

Open Base

Monolithic and Tiled Panel Standard Configuration

Worksurface Height



- Monolithic
- One worksurface height monolithic insert

36"H Panel Frames



- Monolithic
- One 28"H monolithic insert



- Tiled
- Two 14"H tiled inserts

42"H Panel Frames



- Monolithic
- One 42"H monolithic insert



- Tiled
- One 7"H tiled insert
 - Two 14"H tiled inserts



- Beltway
- One 7"H upper insert
 - One 4"H beltway cover
 - One 24"H lower insert

50"H Panel Frames



- Monolithic
- One 50"H monolithic insert

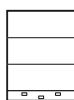

- Tiled
- Three 14"H tiled inserts



- Beltway
- One 14"H upper insert
 - One 4"H beltway cover
 - One 24"H lower insert

57"H Panel Frames



- Monolithic
- One 57"H monolithic insert



- Tiled
- One 7"H tiled inserts
 - Three 14"H tiled inserts

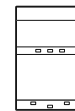

- Beltway
- One 7"H tiled insert
 - One 14"H tiled insert
 - One 4"H beltway cover
 - One 24"H lower insert

64"H Panel Frames



- Monolithic
- One 64"H monolithic insert

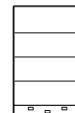

- Tiled
- Four 14" H tiled inserts

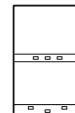

- Beltway
- One 28"H upper insert
 - One 4"H beltway cover
 - One 24"H lower insert

78"H Panel Frames



- Monolithic
- One 78"H monolithic insert

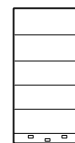

- Tiled
- Five 14"H tiled inserts

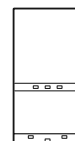



- Beltway
- One 50"H Upper insert
 - One 4"H Beltway cover
 - One 24"H Lower insert

Note: Insert dimensions are nominal. Inserts are for one side only.

Topway and Full View Panel Frame Assemblies

Worksurface Height, 36" and 42" High

Dividends Horizon

description	h	w	d	pattern no.	list
Worksurface Height	28 1/2"	15"	3"	DP7(J)RRWH15	\$203.
Panel Frame Assembly	28 1/2"	18"	3"	DP7(J)RRWH18	203.
Standard Base Raceway	28 1/2"	24"	3"	DP7(J)RRWH24	209.
	28 1/2"	30"	3"	DP7(J)RRWH30	217.
	28 1/2"	36"	3"	DP7(J)RRWH36	231.
	28 1/2"	42"	3"	DP7(J)RRWH42	258.
	28 1/2"	48"	3"	DP7(J)RRWH48	258.
	28 1/2"	60"	3"	DP7(J)RRWH60	298.
36" High Panel Frame Assembly	35 1/8"	15"	3"	DP7(J)RR3615	203.
Standard Base Raceway	35 1/8"	18"	3"	DP7(J)RR3618	203.
	35 1/8"	24"	3"	DP7(J)RR3624	209.
(topway and full view shown)	35 1/8"	30"	3"	DP7(J)RR3630	217.
	35 1/8"	36"	3"	DP7(J)RR3636	231.
	35 1/8"	42"	3"	DP7(J)RR3642	258.
	35 1/8"	48"	3"	DP7(J)RR3648	258.
	35 1/8"	60"	3"	DP7(J)RR3660	298.
42" High Panel Frame Assembly	42 3/16"	15"	3"	DP7(J)RR4215	181.
Standard Base Raceway	42 3/16"	18"	3"	DP7(J)RR4218	181.
	42 3/16"	24"	3"	DP7(J)RR4224	187.
(topway and full view shown)	42 3/16"	30"	3"	DP7(J)RR4230	203.
	42 3/16"	36"	3"	DP7(J)RR4236	217.
	42 3/16"	42"	3"	DP7(J)RR4242	235.
	42 3/16"	48"	3"	DP7(J)RR4248	246.
	42 3/16"	60"	3"	DP7(J)RR4260	283.

Dimensions listed under h w d are actual to the nearest 1/16"

Ordering Information	Order Code	Included with:	Options
Panel Frame Assembly 1. Pattern Number 2. Top cap type 3. Top cap trim finish 4. Raceway knockout option 5. Base raceway finish if required	Topway Panel Frame Assembly <i>Example:</i> DP7CRR6448 4/117K/117 <hr/> DP7CRR Topway Panel Frame 6448 Assemblies with Base Raceway <hr/> 4 Radius metal topcap <hr/> 117 Soft Grey top cap finish <hr/> K Raceway knockouts <hr/> 117 Soft Grey raceway finish	Panel Frame Assembly: <ul style="list-style-type: none"> • Panel frame • Top cap (optional) • Connection hardware • Base raceway Note: Worksurface Height panels do not connect to any other panel height. Note: Worksurface Height panel frame assemblies are not available with plastic top caps. Note: 15" wide panels are only available with standard base raceway or tile to floor.	Panel Frame Assembly: Option: (C) = Topway Panel Frame (V) = Full View Panel Frame Panel Base Options Open Panel Base Option: For open panel base, change 'RR' to 'LL' and add \$55 to list price. Title to Floor Option: For tile to floor on one side and base raceway on the other side change 'RR' to 'FR' and add \$32 to list price. Top Cap Options: (2) = Extruded Plastic (Smooth Radius) (3) = No Top Cap (4) = Radius Metal, add \$38 P1, \$40 P2, \$42 P3 paint grades (5) = Flat Metal, add \$38 P1, \$40 P2, \$42 P3 paint grades Base Raceway Knockout Options: (for RR and RF bases only) (K) = Knockouts on raceway side (N) = No knockouts

Topway and Full View Panel Frame Assemblies

50", 57" and 64" High

Dividends Horizon

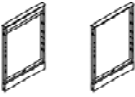
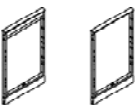
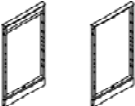
description	h	w	d	pattern no.	list
50" High Panel Frame Assembly Standard Base Raceway  (topway and full view shown)	49 1/2"	15"	3"	DP7()RR5015	\$187.
	49 1/2"	18"	3"	DP7()RR5018	187.
	49 1/2"	24"	3"	DP7()RR5024	196.
	49 1/2"	30"	3"	DP7()RR5030	211.
	49 1/2"	36"	3"	DP7()RR5036	222.
	49 1/2"	42"	3"	DP7()RR5042	240.
	49 1/2"	48"	3"	DP7()RR5048	252.
	49 1/2"	60"	3"	DP7()RR5060	274.
57" High Panel Frame Assembly Standard Base Raceway  (topway and full view shown)	56 13/16"	15"	3"	DP7()RR5715	187.
	56 13/16"	18"	3"	DP7()RR5718	187.
	56 13/16"	24"	3"	DP7()RR5724	196.
	56 13/16"	30"	3"	DP7()RR5730	207.
	56 13/16"	36"	3"	DP7()RR5736	220.
	56 13/16"	42"	3"	DP7()RR5742	234.
	56 13/16"	48"	3"	DP7()RR5748	247.
	56 13/16"	60"	3"	DP7()RR5760	261.
64" High Panel Frame Assembly Standard Base Raceway  (topway and full view shown)	64 1/16"	15"	3"	DP7()RR6415	198.
	64 1/16"	18"	3"	DP7()RR6418	198.
	64 1/16"	24"	3"	DP7()RR6424	214.
	64 1/16"	30"	3"	DP7()RR6430	222.
	64 1/16"	36"	3"	DP7()RR6436	237.
	64 1/16"	42"	3"	DP7()RR6442	252.
	64 1/16"	48"	3"	DP7()RR6448	266.
	64 1/16"	60"	3"	DP7()RR6460	307.

Dimensions listed under h w d are actual to the nearest 1/16"

Ordering Information	Order Code	Included with:	Options
Panel Frame Assembly 1. Pattern Number 2. Top cap type 3. Top cap trim finish 4. Raceway knockout option 5. Base raceway finish if required	Topway Panel Frame Assembly Example: DP7CRR6448 4/117K/117 <hr/> DP7CRR Topway Panel Frame 6448 Assembly with Base Raceway <hr/> 4 Radius metal topcap 117 Soft Grey top cap finish K Raceway knockouts 117 Soft Grey raceway finish	Panel Frame Assembly: <ul style="list-style-type: none"> Panel frame Top cap (optional) Connection hardware Base raceway Note: 15" wide panels are only available with a standard base raceway or tile to floor.	Panel Frame Assembly: Option: (C) = Topway Panel Frame (V) = Full View Panel Frame Panel Base Options Open Panel Base Option: For open panel base, change 'RR' to 'LL' and add \$55 to list price. Tile to Floor Option: For tile to floor on one side and base raceway on the other side change 'RR' to 'FR' and add \$32 to list price. Top Cap Options: (2) = Extruded Plastic (Smooth Radius) (3) = No Top Cap (4) = Radius Metal, add \$38 P1, \$40 P2, \$42 P3 paint grades (5) = Flat Metal, add \$38 P1, \$40 P2, \$42 P3 paint grades Base Raceway Knockout Options: (for RR and RF base only) (K) = Knockouts on raceway side (N) = No knockouts

Panels, Build-To-Spec

Topway and Full View Panel Frame Assemblies

78" High

Dividends Horizon

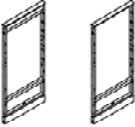
description	h	w	d	pattern no.	list
78" High Panel Frame Assembly Standard Base Raceway 	78 ⁹ / ₁₆ "	15"	3"	DP7()RR7815	\$303.
	78 ⁹ / ₁₆ "	18"	3"	DP7()RR7818	303.
	78 ⁹ / ₁₆ "	24"	3"	DP7()RR7824	321.
	78 ⁹ / ₁₆ "	30"	3"	DP7()RR7830	334.
	78 ⁹ / ₁₆ "	36"	3"	DP7()RR7836	359.
	78 ⁹ / ₁₆ "	42"	3"	DP7()RR7842	379.
	78 ⁹ / ₁₆ "	48"	3"	DP7()RR7848	395.

(topway and full view shown)

Dimensions listed under h w d are actual to the nearest 1/16"

Ordering Information	Order Code	Included with:	Options
Panel Frame Assembly 1. Pattern Number 2. Top cap type 3. Top cap trim finish 4. Raceway knockout option 5. Base raceway finish if required	Topway Panel Frame Assembly <i>Example:</i> DP7CRR7848 4/117K/117 <hr/> DP7CRR Topway Panel Frame 7848 Assembly with Base Raceway <hr/> 4 Radius metal topcap <hr/> 117 Soft Grey top cap finish <hr/> K Raceway knockouts <hr/> 117 Soft Grey raceway finish	Panel Frame Assembly: <ul style="list-style-type: none"> Panel frame Top cap (optional) Connection hardware Base raceway Note: 15" wide panels are only available with a standard base raceway or tile to floor.	Panel Frame Assembly: Option: (C) = Topway Panel Frame (V) = Full View Panel Frame Panel Base Options Open Panel Base Option: For open panel base, change 'RR' to 'LL' and add \$52 to list price. Tile to Floor Option: For tile to floor on one side and base raceway on the other side change 'RR' to 'FR' and add \$31 to list price. Top Cap Options: (2) = Extruded Plastic (Smooth Radius) (3) = No Top Cap (4) = Radius Metal, add \$38 P1, \$40 P2, \$42 P3 paint grades (5) = Flat Metal, add \$38 P1, \$40 P2, \$42 P3 paint grades Base Raceway Knockout Options: (for RR and RF base only) (K) = Knockouts on raceway side (N) = No knockouts

This page intentionally left blank

Stack Frames

Dividends Horizon stack frames provide the flexibility to increase the overall height of a standard Dividends Horizon panel.

Stack frames are available in three panel heights, 14", 21" and 28" all capable of attaching to any panel height. Maximum stacking height above the "base" standard panel is 28". This can be accomplished with one 28" high stack panel or by stacking two 14" high panels on each other.

21" stack panel frames may be attached to 42" standard Dividends Horizon panels allowing the overall panel height to be 64" or to 57" panels for an overall height of 78."

The 28" high stack panel frame is prepunched to accept tile insert support rails to provide a tiled look if required.

Stack Frame Options

Dividends Horizon offers two stack panel frame options, which are selected depending on customer's aesthetic and functional needs.

D1 Style Stack Frame Planning

D1 style stack frames feature a D1 style painted aluminum horizontal trim at the bottom of each stack frame. D1 style stack frames mount on top of Dividends Horizon topway panel frames only. D1 style stack panels are load bearing on the first tier only.

Note: When stacking (2) D1 style stack frames, the stack frame in the first tier position must have a topway to be able to accept the second tier stack frame.

D2 Style Stack Frame Planning

D2 style stack frames feature a D2 style black recessed horizontal reveal at the bottom of each stack frame. D2 style stack frames mount on top of Dividends Horizon DP7V full view panel frames only. D2 style stack frames are load bearing on the first or second tier, and are designed to align overhead storage components hung at 64" with overhead components hung off 64" full height panels. Components hung on stack panels at 50" or 57" will not align with components hung off 50" or 57" full height panels.

D2 style stack frames also have the option to be used with tiled or monolithic tiles on one or both side of the base/stack panel assembly. See options on panel pricing page.

Note: The single and double pane window insert kits are not compatible with the D2 style stack frame. Use D1 style stack frames with single or double pane window insert kits.

Note: D2 style stack frames are not compatible with slatwall tiles.

Stack Panel Dimensions

- Widths: 18", 24", 30", 36", 42", and 48"
- Heights: 14", 21" and 28"
- Thickness: 3"

Construction

The stack panel frame is an all-welded steel construction.

- Topway: 22-gauge roll-formed steel (if applicable)
- Vertical channels: 16-gauge roll-formed steel
- Horizontal rails: 16-gauge steel tubing

Panel Trim

When stack panels are installed, the "base" standard panel's top cap is utilized by attaching to the top of the stack panel.

Panel end trim is ordered separately from the stack panel. To specify panel end trim for the end of a panel run, simply add the stack panel and base panel frame height (i.e., a 50" high base panel frame with one 14" high stack panel will require a 64" high panel end trim kit).

In a high-to-low panel-to-panel application where stack panels are used, simply deduct the panel height difference between the two panels to determine size of the high-to-low panel end trim required.

Post Trim

Post trim covers must match the overall height of the "base" standard post and stack post.

Stack Post (Same-height panels)

When two or more stack panels are connected together in a 2-way "L", 3-way "T" or a 4-way "X" condition, and all the panel heights are of the same height, a stack panel post kit may be used.

The stack post kit attaches to the top of a base universal post and is available in a 14" or 28" height and ships with connecting hardware.

Stack Post (Multi-height panels)

When stack panels are used in a high-to-low panel-to-post applications, high-to-low post trim must be ordered separately.

Note: A universal post must match the height of the tallest base standard panel being connected.

Construction

Posts are 3" square extruded aluminum construction.

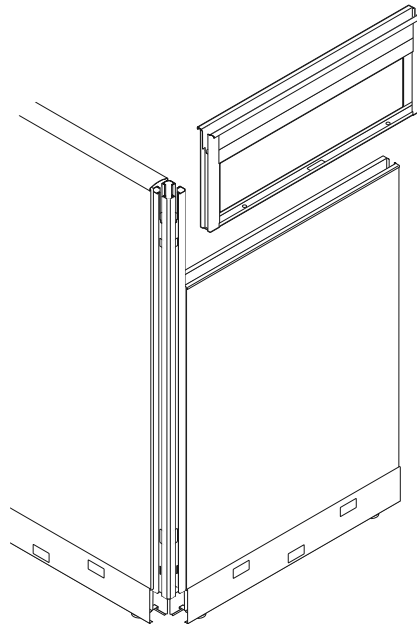

Stack Frame

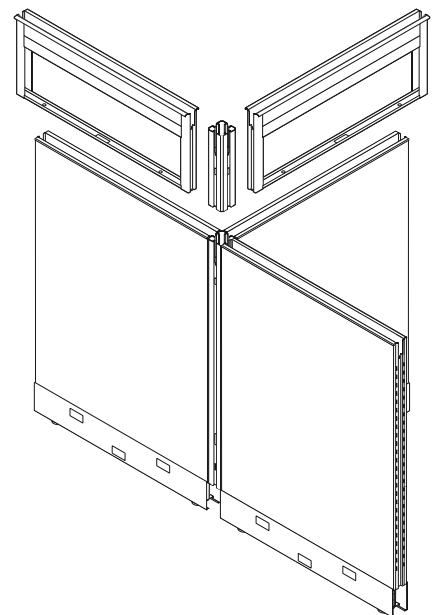

Stack Post (Same-Height Panels)

Stack Frames

D1 Style With External Reveal

(For Use With Topway Panels Only)

description	h	w	d	pattern no.	with topway	full view (without topway)
28" High Stack Panel Frame Only (full view shown)	29 1/4"	18"	3"	DP2S(T/N)F 2818	\$158.	\$189.
	29 1/4"	24"	3"	DP2S(T/N)F 2824	161.	200.
	29 1/4"	30"	3"	DP2S(T/N)F 2830	176.	212.
	29 1/4"	36"	3"	DP2S(T/N)F 2836	197.	229.
	29 1/4"	42"	3"	DP2S(T/N)F 2842	211.	247.
	29 1/4"	48"	3"	DP2S(T/N)F 2848	222.	256.
21" High Stack Panel Frame Only	21 7/8"	18"	3"	DP2STF 2118	162.	n/a
	21 7/8"	24"	3"	DP2STF 2124	174.	n/a
	21 7/8"	30"	3"	DP2STF 2130	187.	n/a
	21 7/8"	36"	3"	DP2STF 2136	205.	n/a
	21 7/8"	42"	3"	DP2STF 2142	225.	n/a
	21 7/8"	48"	3"	DP2STF 2148	235.	n/a
14" High Stack Panel, load bearing	14"	18"	3"	DP2 STFL1418	132.	n/a
	14"	24"	3"	DP2 STFL1424	137.	n/a
	14"	30"	3"	DP2 STFL1430	158.	n/a
	14"	36"	3"	DP2 STFL1436	175.	n/a
	14"	42"	3"	DP2 STFL1442	194.	n/a
	14"	48"	3"	DP2 STFL1448	208.	n/a
14" High Stack Panel non-load bearing	14"	18"	3"	DP2S(T/N)F 1418	132.	158.
	14"	24"	3"	DP2S(T/N)F 1424	137.	161.
	14"	30"	3"	DP2S(T/N)F 1430	158.	176.
	14"	36"	3"	DP2S(T/N)F 1436	175.	197.
	14"	42"	3"	DP2S(T/N)F 1442	194.	211.
	14"	48"	3"	DP2S(T/N)F 1448	208.	222.

NOTE: D1 Stack Frames may be used with Topway Panels only.

Ordering Information	Order Code	Included with:	Options
Stack Panel Frame 1. Pattern Number 2. Trim Finish	Stack Panel Frame <i>Example:</i> DP2STF 1448, 113 DP1STF Pattern Number 1448 113 Dark grey paint finish Stack Panel Post <i>Example:</i> DP2ASPO 14 DP2ASPO Pattern Number 14	Stack Panel Frame Note: When stacking (2) D1 style stack frames, the stack frame in the first tier position must have a topway trough to be able to accept the second tier stack frame.	Stack Panel Frame Stack frame option: (T) = with topway (N) = without topway Note: 21" stack panel frame not available without a topway. Note: D1 Stack Frames are load bearing on first tier only.

Stack Frames
D2 Style With Recessed Reveal
(For Use With DP7 Full View Panels Only)

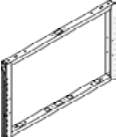
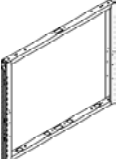
description	w	h	d	pattern no.	list
 14" High Dividends Stack Frame	18"	14 ⁵ / ₈ "	3"	DPS7V1418()	\$200.
	24"	14 ⁵ / ₈ "	3"	DPS7V1424()	203.
	30"	14 ⁵ / ₈ "	3"	DPS7V1430()	220.
	36"	14 ⁵ / ₈ "	3"	DPS7V1436()	240.
	42"	14 ⁵ / ₈ "	3"	DPS7V1442()	247.
	48"	14 ⁵ / ₈ "	3"	DPS7V1448()	255.
 21" High Dividends Stack Frame	18"	21 ⁷ / ₈ "	3"	DPS7V2118()	232.
	24"	21 ⁷ / ₈ "	3"	DPS7V2124()	244.
	30"	21 ⁷ / ₈ "	3"	DPS7V2130()	256.
	36"	21 ⁷ / ₈ "	3"	DPS7V2136()	272.
	42"	21 ⁷ / ₈ "	3"	DPS7V2142()	281.
	48"	21 ⁷ / ₈ "	3"	DPS7V2148()	290.
 28" High Dividends Stack Frame	18"	29 ¹ / ₄ "	3"	DPS7V2818()	221.
	24"	29 ¹ / ₄ "	3"	DPS7V2824()	234.
	30"	29 ¹ / ₄ "	3"	DPS7V2830()	248.
	36"	29 ¹ / ₄ "	3"	DPS7V2836()	268.
	42"	29 ¹ / ₄ "	3"	DPS7V2842()	281.
	48"	29 ¹ / ₄ "	3"	DPS7V2848()	291.

NOTE: D2 Stack Frames may be used with DP7 Full View Panels only.

Ordering Information	Order Code	Included with:	Options
Stack Frames: 1. Pattern Number 2. Tile Support Configuration	Stack Panel Frame Assembly <i>Example:</i> DPS7V1418TT <hr/> DPS7 Stack Panel Frame <hr/> V Full View <hr/> 14 Height <hr/> 18 Width <hr/> TT Segmented Tile Supports Both Side	Stack Panel Frame: <ul style="list-style-type: none"> Stack Frame <p>Note: Slatwall tiles, single pane and double pane window kits cannot be used with D2 stack frames.</p> <p>Note: D2 Stack Frames are load bearing on first and second tier.</p>	Tile Options/Pattern Number Suffix: <p>(TT) = Tile support located at the base of stacker to support segmented tiles on both sides of a panel.</p> <p>(TM) = Tile support located at the base of the stacker to support segmented tiles on one side and a monolithic tile on the other side of the panel.</p> <p>(MM) = Monolithic tiles on both sides of the panel.</p>

This page intentionally left blank

Monolithic Panel Fabric Inserts

Dividends Horizon monolithic inserts are available by component for use with panel frames for "Build-to-Spec" applications. These applications include when inserts are only required on one panel side or when a different fabric is required on each panel side.

Tile to floor option available in heights of 14", worksurface height, 24", 28", 42", 50", 57", 64" and 78".

Monolithic Panel Fabric Insert Construction

Fabric laminated with adhesive, heat-cured to 7/16" thick acoustical board.

Monolithic Panel Fabric Insert Ratings

Noise Reduction Coefficient (NRC) rating: .70
Sound Transmission Class (STC) rating: 11

The materials in Dividends Horizon panels meet the flame spread and smoke generation criteria established in UL1286 safety standard for office furniture.

Monolithic Panel Fabric Insert Attachment

Panel inserts flex to attach to the troughs in the upper and lower horizontal frame supports. Mounting clips are attached to panel inserts for connection to the vertical frame for additional support. No tools are required for insert attachment.

Note: If additional mid-span support for monolithic panel inserts is required, a beltway cable tray can be installed.

Note: Insert dimensions are nominal. Inserts are for one side only.

Monolithic Panel Fabric Insert

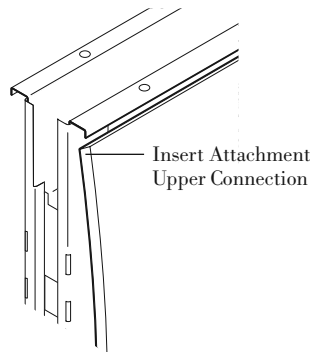
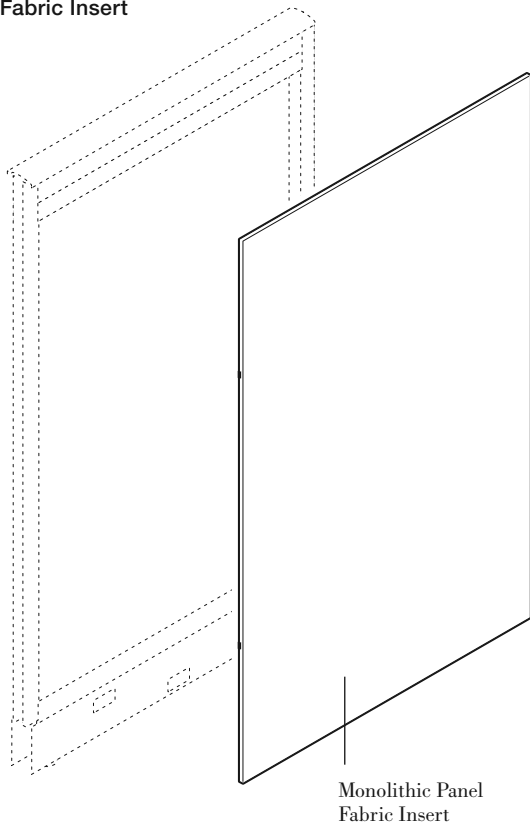

Monolithic Panel Fabric Insert Attachment

Monolithic Panel Fabric Insert Configurations



Worksurface Height
• One worksurface height monolithic insert



36"H Panel Frames
• One 28"H monolithic insert



42"H Panel Frames
• One 42"H monolithic insert



50"H Panel Frames
• One 50"H monolithic insert

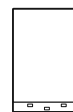

57"H Panel Frames
• One 57"H monolithic insert



64"H Panel Frames
• One 64"H monolithic insert







78"H Panel Frames
• One 78"H monolithic insert

Monolithic Panel Fabric Inserts

Worksurface Height, 28", 42" and 50" High

Dividends Horizon

description	w*	w	h	d	pattern no.	grade								
						10	15	20	25	30	35	40	45	
Worksurface Height Individual Monolithic Panel Fabric Insert 	15"	14 ³ / ₈ "	22 ¹ / ₂ "	3"	DP1 SOWH15	\$84.	\$92.	\$97.	\$102.	\$106.	\$110.	\$115.	\$119.	
	18"	17 ³ / ₈ "	22 ¹ / ₂ "	3"	DP1 SOWH18	84.	92.	97.	102.	106.	110.	115.	119.	
	24"	23 ³ / ₈ "	22 ¹ / ₂ "	3"	DP1 SOWH24	104.	108.	119.	125.	130.	133.	138.	148.	
	30"	29 ³ / ₈ "	22 ¹ / ₂ "	3"	DP1 SOWH30	113.	119.	130.	136.	141.	148.	152.	161.	
	36"	35 ³ / ₈ "	22 ¹ / ₂ "	3"	DP1 SOWH36	124.	130.	141.	149.	158.	164.	168.	174.	
	42"	41 ³ / ₈ "	22 ¹ / ₂ "	3"	DP1 SOWH42	129.	135.	143.	150.	160.	165.	172.	179.	
	48"	47 ³ / ₈ "	22 ¹ / ₂ "	3"	DP1 SOWH48	135.	141.	152.	161.	166.	173.	181.	191.	
	60"	59 ³ / ₈ "	22 ¹ / ₂ "	3"	DP1 SOWH60	153.	158.	165.	168.	174.	177.	185.	196.	
28" High Individual Monolithic Panel Fabric Insert (For 36"H Panel Frame) 	15"	14 ³ / ₈ "	29"	⁷ / ₁₆ "	DP1 SO2815	88.	92.	95.	100.	102.	107.	112.	116.	
	18"	17 ³ / ₈ "	29"	⁷ / ₁₆ "	DP1 SO2818	88.	92.	95.	100.	102.	107.	112.	116.	
	24"	23 ³ / ₈ "	29"	⁷ / ₁₆ "	DP1 SO2824	101.	107.	116.	121.	127.	130.	134.	143.	
	30"	29 ³ / ₈ "	29"	⁷ / ₁₆ "	DP1 SO2830	111.	116.	127.	132.	138.	143.	147.	156.	
	36"	35 ³ / ₈ "	29"	⁷ / ₁₆ "	DP1 SO2836	120.	127.	138.	144.	154.	160.	164.	169.	
	42"	41 ³ / ₈ "	29"	⁷ / ₁₆ "	DP1 SO2842	125.	131.	139.	146.	155.	161.	167.	174.	
	48"	47 ³ / ₈ "	29"	⁷ / ₁₆ "	DP1 SO2848	131.	138.	147.	156.	162.	168.	175.	187.	
	60"	59 ³ / ₈ "	29"	⁷ / ₁₆ "	DP1 SO2860	154.	158.	166.	169.	173.	177.	181.	185.	
42" High Individual Monolithic Panel Fabric Insert 	15"	14 ³ / ₈ "	36 ³ / ₈ "	⁷ / ₁₆ "	DP1 SO4215	98.	102.	111.	117.	122.	124.	130.	134.	
	18"	17 ³ / ₈ "	36 ³ / ₈ "	⁷ / ₁₆ "	DP1 SO4218	98.	102.	111.	117.	122.	124.	130.	134.	
	24"	23 ³ / ₈ "	36 ³ / ₈ "	⁷ / ₁₆ "	DP1 SO4224	111.	116.	125.	130.	136.	141.	144.	151.	
	30"	29 ³ / ₈ "	36 ³ / ₈ "	⁷ / ₁₆ "	DP1 SO4230	122.	130.	141.	144.	154.	157.	161.	167.	
	36"	35 ³ / ₈ "	36 ³ / ₈ "	⁷ / ₁₆ "	DP1 SO4236	136.	143.	156.	161.	163.	173.	177.	185.	
	42"	41 ³ / ₈ "	36 ³ / ₈ "	⁷ / ₁₆ "	DP1 SO4242	155.	161.	174.	181.	188.	193.	198.	207.	
	48"	47 ³ / ₈ "	36 ³ / ₈ "	⁷ / ₁₆ "	DP1 SO4248	163.	170.	187.	191.	201.	207.	212.	220.	
	60"	59 ³ / ₈ "	36 ³ / ₈ "	⁷ / ₁₆ "	DP1 SO4260	170.	175.	184.	188.	192.	195.	198.	204.	
50" High Individual Monolithic Panel Fabric Insert 	15"	14 ³ / ₈ "	43 ¹ / ₁₆ "	⁷ / ₁₆ "	DP1 SO5015	108.	113.	122.	125.	132.	136.	141.	146.	
	18"	17 ³ / ₈ "	43 ¹ / ₁₆ "	⁷ / ₁₆ "	DP1 SO5018	108.	113.	122.	125.	132.	136.	141.	146.	
	24"	23 ³ / ₈ "	43 ¹ / ₁₆ "	⁷ / ₁₆ "	DP1 SO5024	120.	127.	138.	141.	146.	154.	157.	163.	
	30"	29 ³ / ₈ "	43 ¹ / ₁₆ "	⁷ / ₁₆ "	DP1 SO5030	136.	143.	156.	161.	167.	173.	177.	184.	
	36"	35 ³ / ₈ "	43 ¹ / ₁₆ "	⁷ / ₁₆ "	DP1 SO5036	156.	163.	175.	181.	188.	192.	200.	208.	
	42"	41 ³ / ₈ "	43 ¹ / ₁₆ "	⁷ / ₁₆ "	DP1 SO5042	173.	182.	196.	201.	210.	215.	221.	230.	
	48"	47 ³ / ₈ "	43 ¹ / ₁₆ "	⁷ / ₁₆ "	DP1 SO5048	190.	201.	214.	221.	230.	236.	242.	253.	
	60"	59 ³ / ₈ "	43 ¹ / ₁₆ "	⁷ / ₁₆ "	DP1 SO5060	219.	226.	237.	241.	248.	252.	256.	263.	

w* = nominal width
 Dimensions listed under w h d are actual to the nearest ¹/₁₆"



Ordering Information	Order Code	Included with:	Options
Monolithic Panel Fabric Inserts 1. Pattern Number 2. Fabric	Monolithic Panel Fabric Inserts <i>Example:</i> DP1 SO6442, W351-3 DP1 Pattern Number SO6442 W351-3 Foundation Corn Silk Fabric	Monolithic Panel Fabric Inserts • Attachment clips	Monolithic Panel Fabric Inserts Tile to Floor Option: To Specify tile to floor, add an "F" suffix to the pattern number and add \$10 to the list price. Note: Tile to floor options available in heights of 14", Worksurface Height, 24", 28", 42", 50", 57", 64" and 78".

Panels, Build-To-Spec

Monolithic Panel Fabric Inserts

57", 64" and 78" High

Dividends Horizon

description	w*	w	h	d	pattern no.	grade								
						10	15	20	25	30	35	40	45	
57" High Individual Monolithic Panel Fabric Insert 	15"	14 ⁵ / ₈ "	56 ¹³ / ₁₆ "	7 ¹ / ₁₆ "	DP1 SO5715	\$119.	\$122.	\$130.	\$132.	\$136.	\$138.	\$140.	\$143.	
	18"	17 ³ / ₈ "	56 ¹³ / ₁₆ "	7 ¹ / ₁₆ "	DP1 SO5718	119.	122.	130.	132.	136.	138.	140.	143.	
	24"	23 ³ / ₈ "	56 ¹³ / ₁₆ "	7 ¹ / ₁₆ "	DP1 SO5724	133.	136.	142.	145.	149.	153.	156.	160.	
	30"	29 ³ / ₈ "	56 ¹³ / ₁₆ "	7 ¹ / ₁₆ "	DP1 SO5730	153.	157.	165.	167.	171.	175.	178.	183.	
	36"	35 ³ / ₈ "	56 ¹³ / ₁₆ "	7 ¹ / ₁₆ "	DP1 SO5736	171.	177.	186.	189.	193.	197.	201.	207.	
	42"	41 ³ / ₈ "	56 ¹³ / ₁₆ "	7 ¹ / ₁₆ "	DP1 SO5742	189.	194.	204.	208.	213.	217.	221.	227.	
	48"	47 ³ / ₈ "	56 ¹³ / ₁₆ "	7 ¹ / ₁₆ "	DP1 SO5748	207.	212.	220.	227.	232.	237.	240.	248.	
	60"	59 ³ / ₈ "	56 ¹³ / ₁₆ "	7 ¹ / ₁₆ "	DP1 SO5760	238.	245.	256.	262.	269.	275.	279.	285.	
64" High Individual Monolithic Panel Fabric Insert 	15"	14 ⁵ / ₈ "	58 ¹ / ₄ "	7 ¹ / ₁₆ "	DP1 SO6415	132.	139.	151.	156.	162.	167.	170.	178.	
	18"	17 ³ / ₈ "	58 ¹ / ₄ "	7 ¹ / ₁₆ "	DP1 SO6418	132.	139.	151.	156.	162.	167.	170.	178.	
	24"	23 ³ / ₈ "	58 ¹ / ₄ "	7 ¹ / ₁₆ "	DP1 SO6424	143.	151.	164.	168.	175.	182.	185.	193.	
	30"	29 ³ / ₈ "	58 ¹ / ₄ "	7 ¹ / ₁₆ "	DP1 SO6430	168.	177.	190.	197.	205.	210.	215.	224.	
	36"	35 ³ / ₈ "	58 ¹ / ₄ "	7 ¹ / ₁₆ "	DP1 SO6436	178.	197.	212.	216.	227.	231.	238.	247.	
	42"	41 ³ / ₈ "	58 ¹ / ₄ "	7 ¹ / ₁₆ "	DP1 SO6442	204.	213.	229.	236.	245.	250.	258.	269.	
	48"	47 ³ / ₈ "	58 ¹ / ₄ "	7 ¹ / ₁₆ "	DP1 SO6448	222.	231.	249.	257.	268.	275.	281.	292.	
	60"	59 ³ / ₈ "	58 ¹ / ₄ "	7 ¹ / ₁₆ "	DP1 SO6460	230.	237.	249.	253.	259.	265.	271.	277.	
78" High Individual Monolithic Panel Fabric Insert 	15"	14 ⁵ / ₈ "	72 ⁷ / ₈ "	7 ¹ / ₁₆ "	DP1 SO7815	154.	157.	164.	167.	173.	175.	178.	184.	
	18"	17 ³ / ₈ "	72 ⁷ / ₈ "	7 ¹ / ₁₆ "	DP1 SO7818	154.	157.	164.	167.	173.	175.	178.	184.	
	24"	23 ³ / ₈ "	72 ⁷ / ₈ "	7 ¹ / ₁₆ "	DP1 SO7824	181.	185.	193.	197.	202.	207.	210.	215.	
	30"	29 ³ / ₈ "	72 ⁷ / ₈ "	7 ¹ / ₁₆ "	DP1 SO7830	204.	210.	220.	224.	230.	235.	238.	244.	
	36"	35 ³ / ₈ "	72 ⁷ / ₈ "	7 ¹ / ₁₆ "	DP1 SO7836	227.	232.	244.	249.	256.	259.	267.	273.	
	42"	41 ³ / ₈ "	72 ⁷ / ₈ "	7 ¹ / ₁₆ "	DP1 SO7842	253.	261.	274.	279.	285.	292.	298.	304.	
	48"	47 ³ / ₈ "	72 ⁷ / ₈ "	7 ¹ / ₁₆ "	DP1 SO7848	277.	285.	300.	305.	313.	320.	324.	331.	

w* = nominal width

Dimensions listed under w h d are actual to the nearest 1/16"

Ordering Information	Order Code	Included with:	Options
Monolithic Panel Fabric Inserts	Monolithic Panel Fabric Inserts	Monolithic Panel Fabric Inserts	Monolithic Panel Fabric Inserts
1. Pattern Number	<i>Example:</i> DP1 SO6442, W351-3	• Attachment clips	Tile to Floor Option:
2. Fabric	DP1 Pattern Number		To Specify tile to floor, add an "F" suffix to the pattern number and add \$10 to the list price.
	SO6442		Note: Tile to floor options available in heights of 14", 24", 28", 42", 50", 57", 64" and 78".
	W351-3 Foundation Corn Silk Fabric		

This page intentionally left blank

Monolithic Panel Laminate Inserts

Dividends Horizon monolithic panel laminate inserts provide another material option for Dividends Horizon panels. Monolithic tile sizes are for use with frames from worksurface height to 57", and widths of up to 48" in tile to raceway, open base and tile to floor applications. Monolithic panel laminate inserts with matching surface and edge are available in the following finishes:

- (114) Folkstone Grey
- (117) Soft Grey
- (118) Bright White
- (119) Pumice

Legacy finishes are not available.

Monolithic Panel Laminate Insert Construction

Surface material: laminate on front and back surface

Edge material: .5mm edgeband

Core material: particle board

Thickness: 7/16 inches

Monolithic Panel Laminate Insert Attachment

Laminate tiles are installed on one side or both sides of a panel frame. Mounting clips are attached to laminate inserts for connection to the panel frame.

Note: Insert dimensions are nominal. Insert configurations shown below are for one side only.

Note: Laminate inserts are not compatible with the slotted standard coat hook (DP2CHTP).

Monolithic Panel Laminate Insert

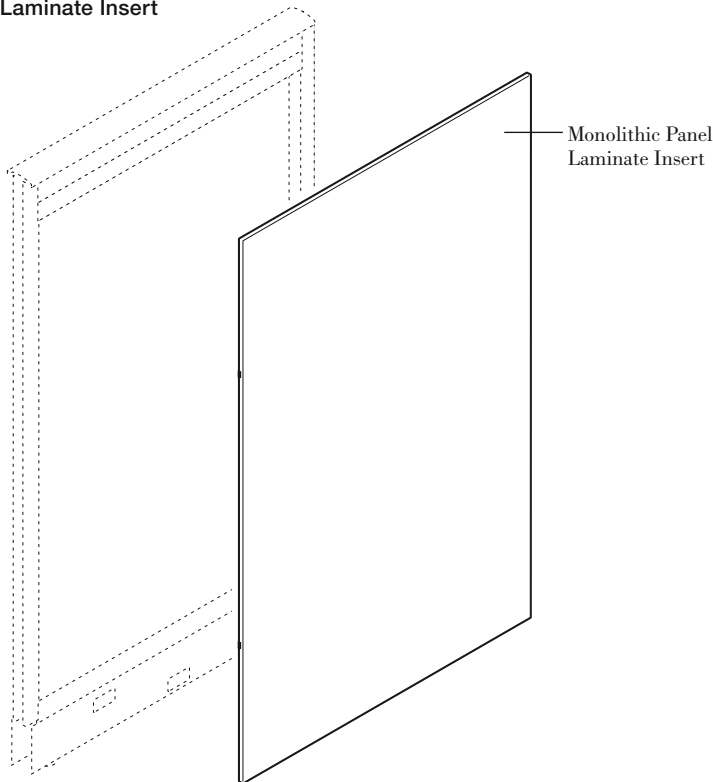

Monolithic Laminate Fabric Insert Configurations



Worksurface Height

- One worksurface height monolithic insert



36"H Panel Frames

- One 28"H monolithic insert



42"H Panel Frames

- One 42"H monolithic insert



50"H Panel Frames

- One 50"H monolithic insert



57"H Panel Frames





- One 57"H monolithic insert

Monolithic Panel Laminate Inserts

Worksurface Height, 28", 42", 50" and 57" High

Base Raceway or Open Base

Dividends Horizon

description	w*	w	h	d	pattern no.	List
 Worksurface Height Individual Monolithic Panel Laminate Insert Base Raceway or Open Base	15"	14 ⁵ / ₈ "	22 ¹ / ₂ "	7 ¹ / ₁₆ "	DP3L1WH15	\$150.
	18"	17 ⁵ / ₈ "	22 ¹ / ₂ "	7 ¹ / ₁₆ "	DP3L1WH18	159.
	24"	23 ⁵ / ₈ "	22 ¹ / ₂ "	7 ¹ / ₁₆ "	DP3L1WH24	182.
	30"	29 ⁵ / ₈ "	22 ¹ / ₂ "	7 ¹ / ₁₆ "	DP3L1WH30	213.
	36"	35 ⁵ / ₈ "	22 ¹ / ₂ "	7 ¹ / ₁₆ "	DP3L1WH36	230.
	42"	41 ⁵ / ₈ "	22 ¹ / ₂ "	7 ¹ / ₁₆ "	DP3L1WH42	275.
	48"	47 ⁵ / ₈ "	22 ¹ / ₂ "	7 ¹ / ₁₆ "	DP3L1WH48	279.
 28" High Individual Monolithic Panel Laminate Insert Base Raceway or Open Base	15"	14 ⁵ / ₈ "	29"	7 ¹ / ₁₆ "	DP3L12815	150.
	18"	17 ⁵ / ₈ "	29"	7 ¹ / ₁₆ "	DP3L12818	159.
	24"	23 ⁵ / ₈ "	29"	7 ¹ / ₁₆ "	DP3L12824	182.
	30"	29 ⁵ / ₈ "	29"	7 ¹ / ₁₆ "	DP3L12830	213.
	36"	35 ⁵ / ₈ "	29"	7 ¹ / ₁₆ "	DP3L12836	230.
	42"	41 ⁵ / ₈ "	29"	7 ¹ / ₁₆ "	DP3L12842	275.
	48"	47 ⁵ / ₈ "	29"	7 ¹ / ₁₆ "	DP3L12848	279.
 42" High Individual Monolithic Panel Laminate Insert Base Raceway or Open Base	15"	14 ⁵ / ₈ "	36 ³ / ₈ "	7 ¹ / ₁₆ "	DP3L14215	181.
	18"	17 ⁵ / ₈ "	36 ³ / ₈ "	7 ¹ / ₁₆ "	DP3L14218	199.
	24"	23 ⁵ / ₈ "	36 ³ / ₈ "	7 ¹ / ₁₆ "	DP3L14224	227.
	30"	29 ⁵ / ₈ "	36 ³ / ₈ "	7 ¹ / ₁₆ "	DP3L14230	272.
	36"	35 ⁵ / ₈ "	36 ³ / ₈ "	7 ¹ / ₁₆ "	DP3L14236	369.
	42"	41 ⁵ / ₈ "	36 ³ / ₈ "	7 ¹ / ₁₆ "	DP3L14242	388.
	48"	47 ⁵ / ₈ "	36 ³ / ₈ "	7 ¹ / ₁₆ "	DP3L14248	392.
 50" High Individual Monolithic Panel Laminate Insert Base Raceway or Open Base	15"	14 ⁵ / ₈ "	43 ¹¹ / ₁₆ "	7 ¹ / ₁₆ "	DP3L15015	186.
	18"	17 ⁵ / ₈ "	43 ¹¹ / ₁₆ "	7 ¹ / ₁₆ "	DP3L15018	215.
	24"	23 ⁵ / ₈ "	43 ¹¹ / ₁₆ "	7 ¹ / ₁₆ "	DP3L15024	240.
	30"	29 ⁵ / ₈ "	43 ¹¹ / ₁₆ "	7 ¹ / ₁₆ "	DP3L15030	277.
	36"	35 ⁵ / ₈ "	43 ¹¹ / ₁₆ "	7 ¹ / ₁₆ "	DP3L15036	373.
	42"	41 ⁵ / ₈ "	43 ¹¹ / ₁₆ "	7 ¹ / ₁₆ "	DP3L15042	393.
	48"	47 ⁵ / ₈ "	43 ¹¹ / ₁₆ "	7 ¹ / ₁₆ "	DP3L15048	397.
 57" High Individual Monolithic Panel Laminate Insert Base Raceway or Open Base	15"	14 ⁵ / ₈ "	56 ¹³ / ₁₆ "	7 ¹ / ₁₆ "	DP3L15715	217.
	18"	17 ⁵ / ₈ "	56 ¹³ / ₁₆ "	7 ¹ / ₁₆ "	DP3L15718	233.
	24"	23 ⁵ / ₈ "	56 ¹³ / ₁₆ "	7 ¹ / ₁₆ "	DP3L15724	278.
	30"	29 ⁵ / ₈ "	56 ¹³ / ₁₆ "	7 ¹ / ₁₆ "	DP3L15730	348.
	36"	35 ⁵ / ₈ "	56 ¹³ / ₁₆ "	7 ¹ / ₁₆ "	DP3L15736	378.
	42"	41 ⁵ / ₈ "	56 ¹³ / ₁₆ "	7 ¹ / ₁₆ "	DP3L15742	463.
	48"	47 ⁵ / ₈ "	56 ¹³ / ₁₆ "	7 ¹ / ₁₆ "	DP3L15748	467.

w* = nominal width
 Dimensions listed under w h d are actual to the nearest 1/16"





Ordering Information	Order Code	Included with:	Options
Monolithic Panel Laminate Inserts	Monolithic Panel Laminate Inserts	Monolithic Panel Laminate Inserts	Monolithic Panel Laminate Inserts
1. Pattern Number	<i>Example:</i> DP3L14224	• Attachment clips	Finish Options:
2. Laminate Finish	DP3L1 Pattern Number		
3. Edgeband Finish	4224		
	118 Bright White Laminate		
	118 Bright White Edgeband	114 Folkstone Grey	
		117 Soft Grey	
		118 Bright White	
		119 Pumice	

Panels, Build-To-Spec

Monolithic Panel Laminate Inserts

Worksurface Height, 28", 42", 50" and 57" High Tile To Floor

Dividends Horizon

description	w*	w	d	pattern no.	List
 Worksurface Height Individual Monolithic Panel Laminate Insert Tile To Floor	15"	14 ⁵ / ₈ "	⁷ / ₁₆ "	DP3L1WH15F	\$150.
	18"	17 ⁵ / ₈ "	⁷ / ₁₆ "	DP3L1WH18F	159.
	24"	23 ⁵ / ₈ "	⁷ / ₁₆ "	DP3L1WH24F	182.
	30"	29 ⁵ / ₈ "	⁷ / ₁₆ "	DP3L1WH30F	213.
	36"	35 ⁵ / ₈ "	⁷ / ₁₆ "	DP3L1WH36F	230.
	42"	41 ⁵ / ₈ "	⁷ / ₁₆ "	DP3L1WH42F	275.
	48"	47 ⁵ / ₈ "	⁷ / ₁₆ "	DP3L1WH48F	279.
 28" High Individual Monolithic Panel Laminate Insert Tile To Floor	15"	14 ⁵ / ₈ "	⁷ / ₁₆ "	DP3L12815F	150.
	18"	17 ⁵ / ₈ "	⁷ / ₁₆ "	DP3L12818F	159.
	24"	23 ⁵ / ₈ "	⁷ / ₁₆ "	DP3L12824F	182.
	30"	29 ⁵ / ₈ "	⁷ / ₁₆ "	DP3L12830F	213.
	36"	35 ⁵ / ₈ "	⁷ / ₁₆ "	DP3L12836F	230.
	42"	41 ⁵ / ₈ "	⁷ / ₁₆ "	DP3L12842F	275.
	48"	47 ⁵ / ₈ "	⁷ / ₁₆ "	DP3L12848F	279.
 42" High Individual Monolithic Panel Laminate Insert Tile To Floor	15"	14 ⁵ / ₈ "	⁷ / ₁₆ "	DP3L14215F	184.
	18"	17 ⁵ / ₈ "	⁷ / ₁₆ "	DP3L14218F	213.
	24"	23 ⁵ / ₈ "	⁷ / ₁₆ "	DP3L14224F	238.
	30"	29 ⁵ / ₈ "	⁷ / ₁₆ "	DP3L14230F	275.
	36"	35 ⁵ / ₈ "	⁷ / ₁₆ "	DP3L14236F	372.
	42"	41 ⁵ / ₈ "	⁷ / ₁₆ "	DP3L14242F	392.
	48"	47 ⁵ / ₈ "	⁷ / ₁₆ "	DP3L14248F	395.
 50" High Individual Monolithic Panel Laminate Insert Tile To Floor	15"	14 ⁵ / ₈ "	⁷ / ₁₆ "	DP3L15015F	216.
	18"	17 ⁵ / ₈ "	⁷ / ₁₆ "	DP3L15018F	231.
	24"	23 ⁵ / ₈ "	⁷ / ₁₆ "	DP3L15024F	276.
	30"	29 ⁵ / ₈ "	⁷ / ₁₆ "	DP3L15030F	346.
	36"	35 ⁵ / ₈ "	⁷ / ₁₆ "	DP3L15036F	376.
	42"	41 ⁵ / ₈ "	⁷ / ₁₆ "	DP3L15042F	460.
	48"	47 ⁵ / ₈ "	⁷ / ₁₆ "	DP3L15048F	464.
 57" High Individual Monolithic Panel Laminate Insert Tile To Floor	15"	14 ⁵ / ₈ "	⁷ / ₁₆ "	DP3L15715F	220.
	18"	17 ⁵ / ₈ "	⁷ / ₁₆ "	DP3L15718F	236.
	24"	23 ⁵ / ₈ "	⁷ / ₁₆ "	DP3L15724F	281.
	30"	29 ⁵ / ₈ "	⁷ / ₁₆ "	DP3L15730F	351.
	36"	35 ⁵ / ₈ "	⁷ / ₁₆ "	DP3L15736F	381.
	42"	41 ⁵ / ₈ "	⁷ / ₁₆ "	DP3L15742F	465.
	48"	47 ⁵ / ₈ "	⁷ / ₁₆ "	DP3L15748F	469.

w* = nominal width
Dimensions listed under w h d are actual to the nearest ¹/₁₆"

Ordering Information	Order Code	Included with:	Options
Monolithic Panel Laminate Inserts	Monolithic Panel Laminate Inserts	Monolithic Panel Laminate Inserts	Monolithic Panel Laminate Inserts
1. Pattern Number	<i>Example:</i> DP3L14224F	• Attachment clips	Finish Options:
2. Laminate Finish	DP3L1 Pattern Number		114 Folkstone Grey
3. Edgeband Finish	4224F		117 Soft Grey
	118 Bright White Laminate		118 Bright White
	118 Bright White Edgeband		119 Pumice

This page intentionally left blank

Tiled Panel Inserts

Dividends Horizon tiled inserts are available by component for use with panel frames for "Build-to-Spec" applications. These applications include when inserts are only required on one panel side and when fabrics are mixed tile-to-tile or side-to-side.

Tiled inserts are also included in "Preconfigured" tiled panel assemblies.

Tiled Panel Insert Construction

Fabric laminated with web adhesive, heat-cured to 7/16" thick acoustical board.

Tiled Panel Insert Supports

All Dividends Horizon panel frames are pre-punched to accept tiled panel insert supports which span horizontally across the panel frame.

Tiled panel insert supports are mounted above each tiled insert with the exception of the uppermost insert which attaches to the upper panel frame. D1 style insert supports are trim finish to match top caps and raceway covers.

D2 Tile Support Mounting Brackets

D2 tile supports require the use of D2 tile support mounting brackets. One pair of mounting brackets can be used to attach D2 tile supports on one or both sides of a panel at the installed height.

Tiled Panel Insert Attachment

Tiled panel inserts attach to the troughs in the horizontal panel frame and tiled insert supports. Mounting clips are attached to inserts for connection to the vertical frame for additional support. No tools are required for insert attachment.

Note: When attaching cantilevers to tiled panels, they can only be hung at the 28 1/2" worksurface height.

Note: Insert dimensions are nominal. Inserts and tiled supports are for one side only.

Note: Overheads can only be attached to the uppermost position of tiled panels. On 78" H panels the overhead may be positioned on the 4th or 5th tile location from the bottom, but not both locations of a single panel.

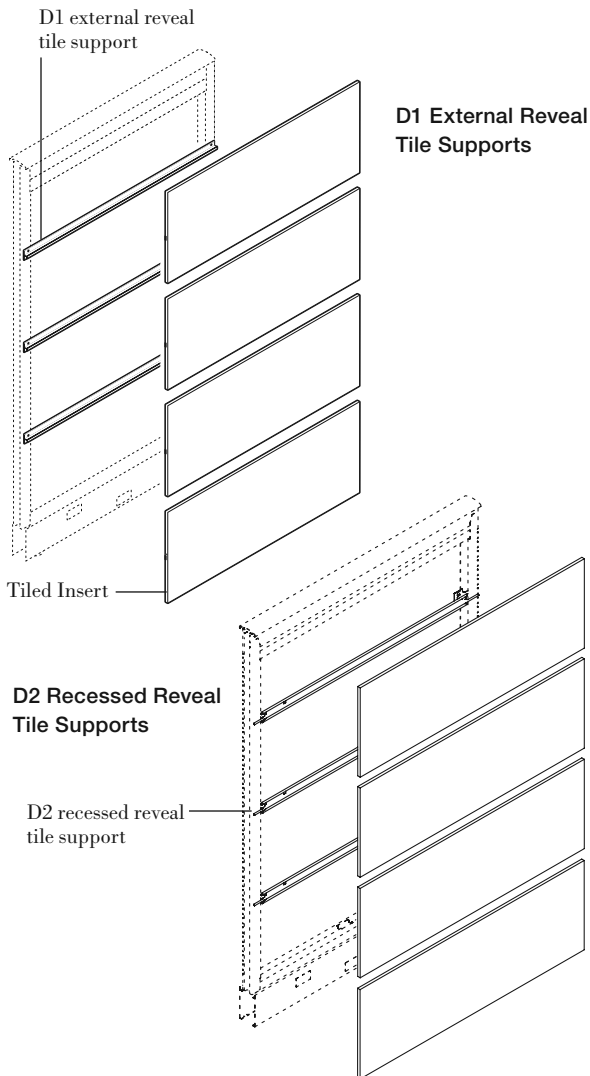

Tiled Panel Insert Configurations



36"H Panels

- Two 14"H tiled inserts
- One tile support

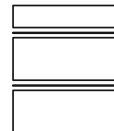

42"H Panels

- One 7"H tiled insert
- Two 14"H tiled inserts
- Two tile supports

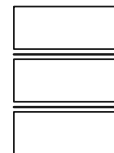

50"H Panels

- Three 14"H tiled inserts
- Two tile supports



57"H Panels

- One 7"H tiled insert
- Three 14"H tiled inserts
- Three tile supports



64"H Panels

- Four 14"H tiled inserts
- Three tile supports



78"H Panels

- Five 14"H tiled inserts
- Four tile supports

Tiled Panel Insert Attachment (D1 Style)

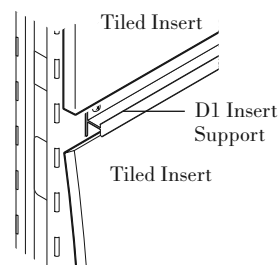

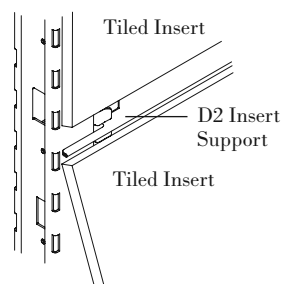

Tiled Panel Insert Attachment (D2 Style)



Tiled Panel Fabric Inserts

7", 14", 21", 28" High

Dividends Horizon

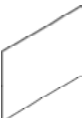
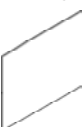
description	w*	w	h	d	pattern no.	grade							
						10	15	20	25	30	35	40	45
 7" High Individual Tiled Panel Fabric Insert	15"	14 ³ / ₈ "	7 ³ / ₁₆ "	⁷ / ₁₆ "	DP1SO715	\$39.	\$42.	\$46.	\$50.	\$55.	\$56.	\$58.	\$62.
	18"	17 ³ / ₈ "	7 ³ / ₁₆ "	⁷ / ₁₆ "	DP1SO718	39.	42.	46.	50.	55.	56.	58.	62.
	24"	23 ³ / ₈ "	7 ³ / ₁₆ "	⁷ / ₁₆ "	DP1SO724	42.	45.	53.	55.	57.	60.	61.	63.
	30"	29 ³ / ₈ "	7 ³ / ₁₆ "	⁷ / ₁₆ "	DP1SO730	48.	53.	58.	60.	63.	65.	68.	72.
	36"	35 ³ / ₈ "	7 ³ / ₁₆ "	⁷ / ₁₆ "	DP1SO736	55.	57.	63.	65.	68.	69.	72.	75.
	42"	41 ³ / ₈ "	7 ³ / ₁₆ "	⁷ / ₁₆ "	DP1SO742	58.	62.	67.	69.	73.	75.	77.	82.
	48"	47 ³ / ₈ "	7 ³ / ₁₆ "	⁷ / ₁₆ "	DP1SO748	62.	66.	70.	73.	77.	80.	88.	91.
60"	59 ³ / ₈ "	7 ³ / ₁₆ "	⁷ / ₁₆ "	DP1SO760	68.	70.	74.	75.	78.	79.	80.	82.	
 14" High Individual Tiled Panel Fabric Insert	15"	14 ³ / ₈ "	14 ³ / ₁₆ "	⁷ / ₁₆ "	DP1SO1415	56.	58.	62.	63.	66.	68.	69.	72.
	18"	17 ³ / ₈ "	14 ³ / ₁₆ "	⁷ / ₁₆ "	DP1SO1418	56.	58.	62.	63.	66.	68.	69.	72.
	24"	23 ³ / ₈ "	14 ³ / ₁₆ "	⁷ / ₁₆ "	DP1SO1424	60.	62.	67.	68.	70.	73.	75.	79.
	30"	29 ³ / ₈ "	14 ³ / ₁₆ "	⁷ / ₁₆ "	DP1SO1430	62.	65.	69.	72.	74.	77.	79.	82.
	36"	35 ³ / ₈ "	14 ³ / ₁₆ "	⁷ / ₁₆ "	DP1SO1436	66.	69.	74.	75.	80.	82.	90.	91.
	42"	41 ³ / ₈ "	14 ³ / ₁₆ "	⁷ / ₁₆ "	DP1SO1442	69.	72.	79.	80.	88.	91.	93.	95.
	48"	47 ³ / ₈ "	14 ³ / ₁₆ "	⁷ / ₁₆ "	DP1SO1448	74.	75.	84.	90.	93.	94.	96.	101.
60"	59 ³ / ₈ "	14 ³ / ₁₆ "	⁷ / ₁₆ "	DP1SO1460	79.	81.	85.	86.	89.	90.	92.	94.	
 21" High Individual Tiled Panel Inserts	15"	14 ³ / ₈ "	21 ³ / ₁₆ "	⁷ / ₁₆ "	DP1SO2115	81.	89.	94.	98.	102.	107.	111.	115.
	18"	17 ³ / ₈ "	21 ³ / ₁₆ "	⁷ / ₁₆ "	DP1SO2118	81.	89.	94.	98.	102.	107.	111.	115.
	24"	23 ³ / ₈ "	21 ³ / ₁₆ "	⁷ / ₁₆ "	DP1SO2124	100.	104.	115.	120.	125.	128.	133.	142.
	30"	29 ³ / ₈ "	21 ³ / ₁₆ "	⁷ / ₁₆ "	DP1SO2130	109.	115.	125.	131.	136.	142.	146.	155.
	36"	35 ³ / ₈ "	21 ³ / ₁₆ "	⁷ / ₁₆ "	DP1SO2136	119.	125.	136.	143.	151.	158.	163.	168.
	42"	41 ³ / ₈ "	21 ³ / ₁₆ "	⁷ / ₁₆ "	DP1SO2142	124.	130.	138.	144.	154.	160.	166.	173.
	48"	47 ³ / ₈ "	21 ³ / ₁₆ "	⁷ / ₁₆ "	DP1SO2148	130.	136.	146.	155.	161.	167.	174.	185.
60"	59 ³ / ₈ "	21 ³ / ₁₆ "	⁷ / ₁₆ "	DP1SO2160	142.	146.	154.	157.	162.	165.	167.	171.	
 28" High Individual Panel Insert	15"	14 ³ / ₈ "	29"	⁷ / ₁₆ "	DP1SO2815	88.	92.	95.	100.	102.	107.	112.	116.
	18"	17 ³ / ₈ "	29"	⁷ / ₁₆ "	DP1SO2818	88.	92.	95.	100.	102.	107.	112.	116.
	24"	23 ³ / ₈ "	29"	⁷ / ₁₆ "	DP1SO2824	101.	107.	116.	121.	127.	130.	134.	143.
	30"	29 ³ / ₈ "	29"	⁷ / ₁₆ "	DP1SO2830	111.	116.	127.	132.	138.	143.	147.	156.
	36"	35 ³ / ₈ "	29"	⁷ / ₁₆ "	DP1SO2836	120.	127.	138.	144.	154.	160.	164.	169.
	42"	42 ³ / ₈ "	29"	⁷ / ₁₆ "	DP1SO2842	125.	131.	139.	146.	155.	161.	167.	174.
	48"	47 ³ / ₈ "	29"	⁷ / ₁₆ "	DP1SO2848	131.	138.	147.	156.	162.	168.	175.	187.
60"	59 ³ / ₈ "	29"	⁷ / ₁₆ "	DP1SO2860	154.	158.	166.	169.	173.	177.	181.	185.	

w* = nominal width
 Dimensions listed under w h d are actual to the nearest ¹/₁₆"

Ordering Information

Tiled Panel Inserts

1. Pattern Number
2. Fabric

Order Code

Tiled Panel Inserts

Example: **DP1 SO1436, W234-5**

DP1 Pattern Number

SO1436

W234-5 Peano Sand fabric

Included with:

Tiled Panel Inserts

Note: Tiled panel insert supports must be ordered separately (see opposite page for quantities required).

Options

Tiled Panel Inserts

Tile to Floor Option:

To Specify tile to floor, add an "F" suffix to the pattern number and add \$10 to the list price.

Note: Tile to floor options available in heights of 14", 24", 28", 42", 50", 57", 64" and 78".

Panels, Build-To-Spec

Tiled Panel Fabric Inserts

Tile Supports

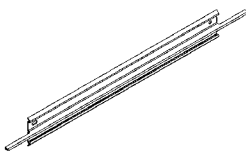
description	w*	d	pattern no.	list
 D1 Tile Support/ External Reveal	15"	5/8"	DP1SOS15	\$26.
	18"	5/8"	DP1SOS18	26.
	24"	5/8"	DP1SOS24	27.
	30"	5/8"	DP1SOS30	30.
	36"	5/8"	DP1SOS36	31.
	42"	5/8"	DP1SOS42	33.
	48"	5/8"	DP1SOS48	33.
	60"	5/8"	DP1SOS60	36.
 D2 Tile Support/ Recessed Reveal	15"		DP2SOS15	23.
	18"		DP2SOS18	23.
	24"		DP2SOS24	24.
	30"		DP2SOS30	26.
	36"		DP2SOS36	27.
	42"		DP2SOS42	30.
	48"		DP2SOS48	30.
	60"		DP2SOS60	33.
D2 Tile Support Mounting Brackets (pair)			DP2SOSC	7.

w* = nominal width
 Dimensions listed under w h d are actual to the nearest 1/16"

Ordering Information	Order Code	Included with:	Options
D1 Tile Support / External Reveal 1. Pattern Number 2. Trim Finish	D1 Tile Support / External Reveal Supports <i>Example:</i> DP1 SOS18, 117	Note: D2 insert supports require mounting brackets.	Tiled Insert Supports
D2 Tile Support / Recessed Reveal 1. Pattern Number	DP1 Pattern Number SOS18 117 Soft Grey trim finish		

This page intentionally left blank

Tiled Panel Laminate Inserts

Dividends Horizon tiled panel laminate inserts provide another material option for Dividends Horizon panels. Tiled panel sizes are for use with frames from 36" to 78" high, and widths of up to 48" in tile to raceway, open base and tile to floor applications. Tiled panel laminate inserts with matching surface and edge are available in the following finishes:

- (114) Folkstone Grey
- (117) Soft Grey
- (118) Bright White
- (119) Pumice

Legacy finishes are not available.

Tiled Panel Laminate Insert Construction

- Surface material: laminate on front and back surface
- Edge material: .5 mm edgeband
- Core material: particle board
- Thickness: 7/16"

Tiled Panel Insert Supports

All Dividends Horizon panel frames are pre-punched to accept tiled panel insert supports, which span horizontally across the panel frame. Tiled panel insert supports are mounted above each tiled insert with the exception of the uppermost insert which attaches to the upper panel frame. D1 style insert supports are trim finish to match top caps and raceway covers.

D2 Tile Support Mounting Brackets

D2 tile supports require the use of D2 tile support mounting brackets. One pair of mounting brackets can be used to attach D2 tile supports on one or both sides of a panel at the installed height.

Tiled Panel Laminate Insert Attachment

Laminate tiles are installed on one side or both sides of a panel frame. Mounting clips are attached to laminate inserts for connection to the panel frame.

Tiled Panel Laminate Insert Planning Guidelines

Insert dimensions are nominal. Insert configurations shown below are for one side only. Laminate inserts are not compatible with the slotted standard coat hook (DP2CHTP). When attaching cantilevers to tiled panels, they can only be hung at 28-1/2" worksurface height. Overheads can only be attached to the uppermost position of tiled panels. On 78"-high panels the overhead may be positioned on the 4th or 5th tile location from the bottom, but not both locations of a single panel.

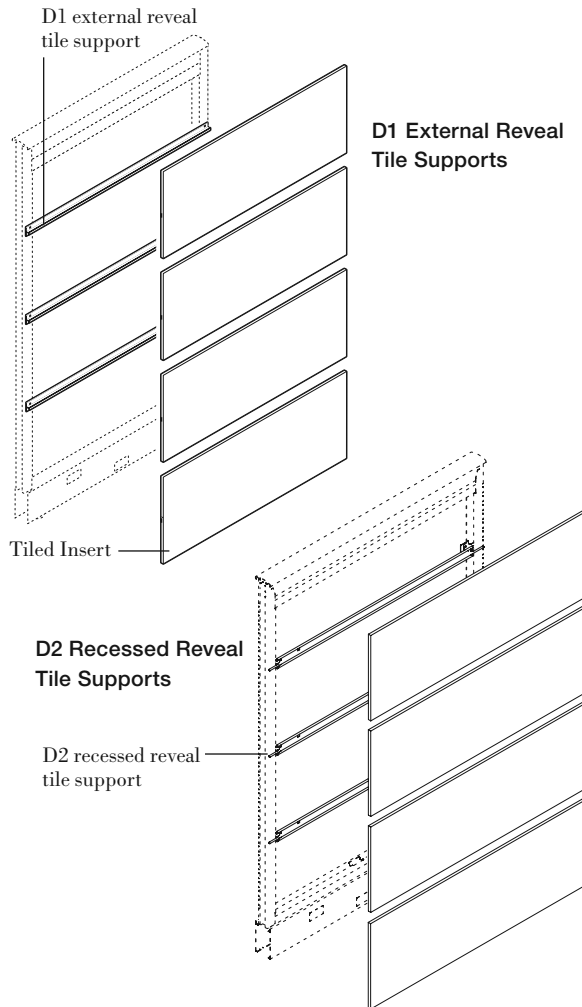

Tiled Panel Insert Configurations



36"H Panels

- Two 14"H tiled inserts
- One tile support

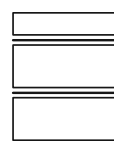

42"H Panels

- One 7"H tiled insert
- Two 14"H tiled inserts
- Two tile supports



50"H Panels

- Three 14"H tiled inserts
- Two tile supports



57"H Panels

- One 7"H tiled insert
- Three 14"H tiled inserts
- Three tile supports



64"H Panels

- Four 14"H tiled inserts
- Three tile supports



78"H Panels





- Five 14"H tiled inserts
- Four tile supports

Tiled Panel Laminate Inserts

7", 10", 14", 21" and 28" High

Base Raceway or Open Base

Dividends Horizon

description	w*	w	h	d	pattern no.	list
 7" High Individual Tiled Panel Laminate Insert Base Raceway or Open Base	15"	14 ⁵ / ₈ "	7 ³ / ₁₆ "	⁷ / ₁₆ "	DP3L10715	\$100.
	18"	17 ⁵ / ₈ "	7 ³ / ₁₆ "	⁷ / ₁₆ "	DP3L10718	102.
	24"	23 ⁵ / ₈ "	7 ³ / ₁₆ "	⁷ / ₁₆ "	DP3L10724	105.
	30"	29 ⁵ / ₈ "	7 ³ / ₁₆ "	⁷ / ₁₆ "	DP3L10730	109.
	36"	35 ⁵ / ₈ "	7 ³ / ₁₆ "	⁷ / ₁₆ "	DP3L10736	123.
	42"	41 ⁵ / ₈ "	7 ³ / ₁₆ "	⁷ / ₁₆ "	DP3L10742	127.
	48"	47 ⁵ / ₈ "	7 ³ / ₁₆ "	⁷ / ₁₆ "	DP3L10748	131.
 10" High Individual Tiled Panel Laminate Insert Base Raceway or Open Base	15"	14 ⁵ / ₈ "	10 ³ / ₁₆ "	⁷ / ₁₆ "	DP3L11015	103.
	18"	17 ⁵ / ₈ "	10 ³ / ₁₆ "	⁷ / ₁₆ "	DP3L11018	105.
	24"	23 ⁵ / ₈ "	10 ³ / ₁₆ "	⁷ / ₁₆ "	DP3L11024	109.
	30"	29 ⁵ / ₈ "	10 ³ / ₁₆ "	⁷ / ₁₆ "	DP3L11030	120.
	36"	35 ⁵ / ₈ "	10 ³ / ₁₆ "	⁷ / ₁₆ "	DP3L11036	138.
	42"	41 ⁵ / ₈ "	10 ³ / ₁₆ "	⁷ / ₁₆ "	DP3L11042	142.
	48"	47 ⁵ / ₈ "	10 ³ / ₁₆ "	⁷ / ₁₆ "	DP3L11048	146.
 14" High Individual Tiled Panel Laminate Insert Base Raceway or Open Base	15"	14 ⁵ / ₈ "	14 ³ / ₁₆ "	⁷ / ₁₆ "	DP3L11415	105.
	18"	17 ⁵ / ₈ "	14 ³ / ₁₆ "	⁷ / ₁₆ "	DP3L11418	107.
	24"	23 ⁵ / ₈ "	14 ³ / ₁₆ "	⁷ / ₁₆ "	DP3L11424	117.
	30"	29 ⁵ / ₈ "	14 ³ / ₁₆ "	⁷ / ₁₆ "	DP3L11430	130.
	36"	35 ⁵ / ₈ "	14 ³ / ₁₆ "	⁷ / ₁₆ "	DP3L11436	152.
	42"	41 ⁵ / ₈ "	14 ³ / ₁₆ "	⁷ / ₁₆ "	DP3L11442	156.
	48"	47 ⁵ / ₈ "	14 ³ / ₁₆ "	⁷ / ₁₆ "	DP3L11448	159.
 21" High Individual Tiled Panel Laminate Insert Base Raceway or Open Base	15"	14 ⁵ / ₈ "	21 ³ / ₁₆ "	⁷ / ₁₆ "	DP3L12115	115.
	18"	17 ⁵ / ₈ "	21 ³ / ₁₆ "	⁷ / ₁₆ "	DP3L12118	127.
	24"	23 ⁵ / ₈ "	21 ³ / ₁₆ "	⁷ / ₁₆ "	DP3L12124	149.
	30"	29 ⁵ / ₈ "	21 ³ / ₁₆ "	⁷ / ₁₆ "	DP3L12130	153.
	36"	35 ⁵ / ₈ "	21 ³ / ₁₆ "	⁷ / ₁₆ "	DP3L12136	220.
	42"	41 ⁵ / ₈ "	21 ³ / ₁₆ "	⁷ / ₁₆ "	DP3L12142	223.
	48"	47 ⁵ / ₈ "	21 ³ / ₁₆ "	⁷ / ₁₆ "	DP3L12148	227.
 28" High Individual Tiled Panel Laminate Insert Base Raceway or Open Base	15"	14 ⁵ / ₈ "	29"	⁷ / ₁₆ "	DP3L12815	150.
	18"	17 ⁵ / ₈ "	29"	⁷ / ₁₆ "	DP3L12818	159.
	24"	23 ⁵ / ₈ "	29"	⁷ / ₁₆ "	DP3L12824	182.
	30"	29 ⁵ / ₈ "	29"	⁷ / ₁₆ "	DP3L12830	213.
	36"	35 ⁵ / ₈ "	29"	⁷ / ₁₆ "	DP3L12836	230.
	42"	41 ⁵ / ₈ "	29"	⁷ / ₁₆ "	DP3L12842	275.
	48"	47 ⁵ / ₈ "	29"	⁷ / ₁₆ "	DP3L12848	279.

w* = nominal width
Dimensions listed under w h d are actual to the nearest ¹/₁₆"

Ordering Information	Order Code	Included with:	Options
Tiled Panel Laminate Inserts	Tiled Panel Laminate Inserts	Tiled Panel Laminate Inserts	Tiled Panel Laminate Inserts
1. Pattern Number	<i>Example:</i> DP3L10724	• Attachment clips	Finish Options:
2. Laminate Finish	DP3L1 Pattern Number		114 Folkstone Grey
3. Edgeband Finish	0724		117 Soft Grey
	118 Bright White Laminate		118 Bright White
	118 Bright White Edgeband		119 Pumice

Panels, Build-To-Spec

Tiled Panel Laminate Inserts
 14" and 28" High
 Tile To Floor

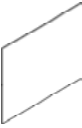
description	w*	w	d	pattern no.	list
14" High Individual Tiled Panel Laminate Insert Tile to Floor 	15"	14 ⁵ / ₈ "	⁷ / ₁₆ "	DP3L11415F	\$111.
	18"	17 ⁵ / ₈ "	⁷ / ₁₆ "	DP3L11418F	118.
	24"	23 ⁵ / ₈ "	⁷ / ₁₆ "	DP3L11424F	129.
	30"	29 ⁵ / ₈ "	⁷ / ₁₆ "	DP3L11430F	145.
	36"	35 ⁵ / ₈ "	⁷ / ₁₆ "	DP3L11436F	173.
	42"	41 ⁵ / ₈ "	⁷ / ₁₆ "	DP3L11442F	185.
	48"	47 ⁵ / ₈ "	⁷ / ₁₆ "	DP3L11448F	188.
28" High Individual Tiled Panel Laminate Insert Tile to Floor 	15"	14 ⁵ / ₈ "	⁷ / ₁₆ "	DP3L12815F	150.
	18"	17 ⁵ / ₈ "	⁷ / ₁₆ "	DP3L12818F	159.
	24"	23 ⁵ / ₈ "	⁷ / ₁₆ "	DP3L12824F	182.
	30"	29 ⁵ / ₈ "	⁷ / ₁₆ "	DP3L12830F	213.
	36"	35 ⁵ / ₈ "	⁷ / ₁₆ "	DP3L12836F	230.
	42"	41 ⁵ / ₈ "	⁷ / ₁₆ "	DP3L12842F	275.
	48"	47 ⁵ / ₈ "	⁷ / ₁₆ "	DP3L12848F	279.

w* = nominal width
 Dimensions listed under w h d are actual to the nearest ¹/₁₆"

Ordering Information	Order Code	Included with:	Options
Tiled Panel Laminate Inserts	Tiled Panel Laminate Inserts	Tiled Panel Laminate Inserts	Tiled Panel Laminate Inserts
1. Pattern Number	<i>Example:</i> DP3L11424F	• Attachment clips	Finish Options: 114 Folkstone Grey 117 Soft Grey 118 Bright White 119 Pumice
2. Laminate Finish	DP3L1 Pattern Number		
3. Edgeband Finish	1424F		
	118 Bright White Laminate		
	118 Bright White Edgeband		

This page intentionally left blank

Beltway Panel Inserts

Lower Inserts Specifications

Beltway Panel Inserts

Dividends Horizon beltway panel inserts are available by component for use with panel frames for "build-to-spec" applications. These applications include when inserts are only required on one panel side and when fabrics or materials are mixed insert-to-insert or side-to-side.

Beltway inserts are also included in "Preconfigured" beltway panel assemblies.

Beltway Panel Insert Construction

Fabric inserts are constructed of fabric laminated with web adhesive and heat-cured to $\frac{7}{16}$ " thick acoustical board. Laminate inserts are constructed of a particle laminate on the front and back. Steel tiles are constructed of formed steel that is painted in any Knoll core paint finish.

Beltway Panel Insert Attachment

Beltway panel inserts attach to the troughs in the upper and lower horizontal frame supports and beltway insert supports. Beltway top and bottom panel inserts require beltway cover and insert supports. Mounting clips attach to panel inserts and connect to vertical frame for additional support. No tools are required for insert attachment.

Note: Slatwall tiles may not be specified or installed with beltway.

Beltway Cover

Beltway covers snap into the beltway supports and are constructed of extruded plastic. Beltway covers include knockouts with covers for duplex receptacles centered 12" from each panel end (except for 18 and 24" wide). A single communications knockout cover in the center of the beltway is included on all beltways except for 30" wide. Electrical knockouts are the same size as communications

knockouts and can be used for communications cables and data ports if terminal blocks are not installed within the beltway.

Beltway covers and insert supports can be installed on one or both sides of panels. Beltway cover and insert supports require top and bottom beltway panel inserts.

Beltway Cover Construction

Color injected plastic extrusion that is available in smooth finish.

Electrical

Beltways 30" and wider accept two duplex receptacles per beltway. 18" and 24" wide beltways provide pass-through electrical only. All electrical components are ordered separately and must be field-installed.

One-Sided Beltway Panel

Beltway panels are available with one beltway per panel or per panel side.

Note: Insert dimensions are nominal. Inserts and beltway cover/supports are for one side only.

Beltway Panel Insert Locations

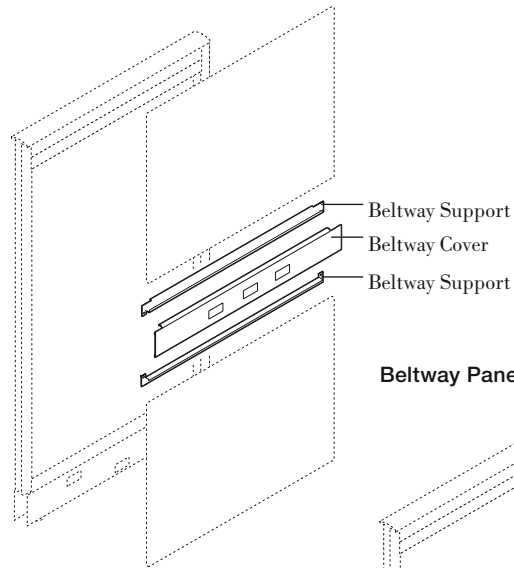

Beltway Panel Insert Locations

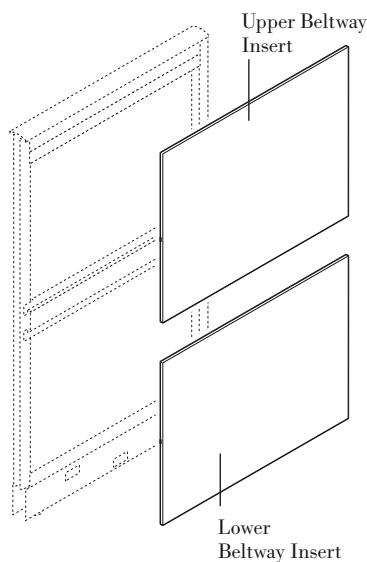

Beltway Panel Insert Attachment

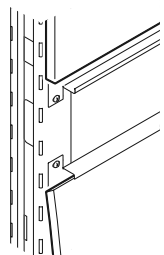

Beltway Panel Insert Configurations

42"H Panels

- One 7"H upper insert
- One 4"H beltway cover and insert support
- One 24"H lower insert

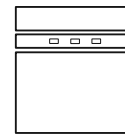

50"H Panels

- One 14"H upper panel insert
- One 4"H beltway cover and insert support
- One 24"H lower insert

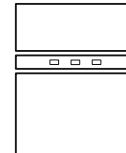

57"H Panels

- One 21"H upper insert
- One 4"H beltway cover and insert support
- One 24"H lower insert

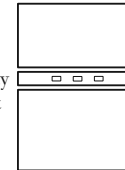

78"H Panels

- One 50"H upper insert
- One 4"H beltway cover and insert support
- One 24"H lower panel insert

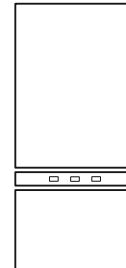

64"H Panels

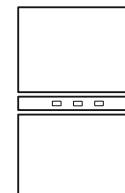

- One 28"H upper insert
- One 4"H beltway cover and insert support
- One 24"H lower insert



Beltway Panel Inserts

Lower Fabric Inserts

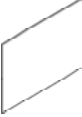
Beltway Cover and Insert Supports

description	w*	w	h	d	pattern no.	grade									
						10	15	20	25	30	35	40	45		
24" High Fabric Beltway Panel Lower Insert, For All Beltway Panels 	18"	17 ⁵ / ₈ "	25 ¹ / ₂ "	7 ¹ / ₁₆ "	DP1SO2418	\$84.	\$92.	\$97.	\$102.	\$106.	\$110.	\$115.	\$119.		
	24"	23 ⁵ / ₈ "	25 ¹ / ₂ "	7 ¹ / ₁₆ "	DP1SO2424	104.	108.	119.	125.	130.	133.	138.	148.		
	30"	29 ⁵ / ₈ "	25 ¹ / ₂ "	7 ¹ / ₁₆ "	DP1SO2430	113.	119.	130.	136.	141.	148.	152.	161.		
	36"	35 ⁵ / ₈ "	25 ¹ / ₂ "	7 ¹ / ₁₆ "	DP1SO2436	124.	130.	141.	149.	158.	164.	168.	174.		
	42"	41 ⁵ / ₈ "	25 ¹ / ₂ "	7 ¹ / ₁₆ "	DP1SO2442	129.	135.	143.	150.	160.	165.	172.	179.		
	48"	47 ⁵ / ₈ "	25 ¹ / ₂ "	7 ¹ / ₁₆ "	DP1SO2448	135.	141.	152.	161.	166.	173.	181.	191.		
	60"	59 ⁵ / ₈ "	25 ¹ / ₂ "	7 ¹ / ₁₆ "	DP1SO2460	153.	158.	165.	168.	174.	177.	185.	196.		
Beltway Cover and Insert Supports 	18"			7 ¹ / ₁₆ "	DP2BC18K	92.	n/a	n/a	n/a	n/a	n/a	n/a	n/a		
	24"			7 ¹ / ₁₆ "	DP2BC24K	106.	n/a	n/a	n/a	n/a	n/a	n/a	n/a		
	30"			7 ¹ / ₁₆ "	DP2BC30K	117.	n/a	n/a	n/a	n/a	n/a	n/a	n/a		
	36"			7 ¹ / ₁₆ "	DP2BC36K	129.	n/a	n/a	n/a	n/a	n/a	n/a	n/a		
	42"			7 ¹ / ₁₆ "	DP2BC42K	143.	n/a	n/a	n/a	n/a	n/a	n/a	n/a		
	48"			7 ¹ / ₁₆ "	DP2BC48K	160.	n/a	n/a	n/a	n/a	n/a	n/a	n/a		
	60"			7 ¹ / ₁₆ "	DP2BC60K	186.	n/a	n/a	n/a	n/a	n/a	n/a	n/a		
Beltway Knockout Replacement Cover for Electrical and Data 	Pkg of 10				DE1 KCBW	42.	n/a	n/a	n/a	n/a	n/a	n/a	n/a		

Panels, Build-To-Spec

w* = nominal width
 Dimensions listed under w h d are actual to the nearest 1/16"

Ordering Information	Order Code	Included with:	Options
Beltway Cover/Insert Supports 1. Pattern Number 2. Beltway Cover/Trim Finish Beltway Panel Inserts 1. Pattern Number 2. Fabric	Beltway Panel Inserts <i>Example:</i> DP1 SO2442, W257-6 DP1 Pattern Number SO2442 W257-6 Solid Crepe Blue Pine fabric Beltway Cover/Insert Supports <i>Example:</i> DP2 BC42K, 117 DP2 Pattern Number BC42K 117 Soft Grey Beltway Cover Trim	Beltway Panel Inserts Beltway Cover/Insert Supports <ul style="list-style-type: none"> Individual beltway cover Insert supports (top and bottom rail) Attachment hardware Beltway knockout covers 	Beltway Panel Inserts Beltway Cover/Insert Supports Beltway cover has a smooth finish Tile to Floor Option: To Specify tile to floor, add an "F" suffix to the pattern number and add \$10 to the list price. Note: Tile to floor options available in heights of 14", 24", 28", 42", 50", 57", 64" and 78".

Beltway Panel Inserts

Lower Steel Inserts

Dividends Horizon

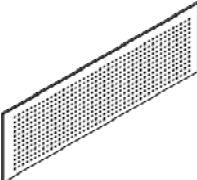
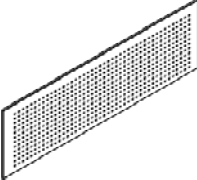
description	w*	w	h	d	pattern no.	1 pack P1	1 pack P2	1 pack P3	2 pack P1	2 pack P2	2 pack P3
 D3 24" High Solid Steel Insert	18"	17 ⁵ / ₈ "	25 ¹ / ₂ "	⁷ / ₁₆ "	DP3SS()2418	\$93.	\$111.	\$119.	\$161.	\$189.	\$207.
	24"	23 ⁵ / ₈ "	25 ¹ / ₂ "	⁷ / ₁₆ "	DP3SS()2424	115.	132.	144.	202.	230.	251.
	30"	29 ⁵ / ₈ "	25 ¹ / ₂ "	⁷ / ₁₆ "	DP3SS()2430	122.	143.	155.	215.	251.	272.
	36"	35 ⁵ / ₈ "	25 ¹ / ₂ "	⁷ / ₁₆ "	DP3SS()2436	138.	156.	174.	239.	272.	302.
	42"	41 ⁵ / ₈ "	25 ¹ / ₂ "	⁷ / ₁₆ "	DP3SS()2442	142.	157.	175.	249.	276.	306.
	48"	47 ⁵ / ₈ "	25 ¹ / ₂ "	⁷ / ₁₆ "	DP3SS()2448	145.	167.	182.	258.	296.	322.
 D3 24" High Perforated Steel Insert	18"	17 ⁵ / ₈ "	25 ¹ / ₂ "	⁷ / ₁₆ "	DP3PSB()2418	140.	166.	181.	242.	285.	308.
	24"	23 ⁵ / ₈ "	25 ¹ / ₂ "	⁷ / ₁₆ "	DP3PSB()2424	173.	198.	217.	302.	346.	379.
	30"	29 ⁵ / ₈ "	25 ¹ / ₂ "	⁷ / ₁₆ "	DP3PSB()2430	186.	215.	232.	324.	379.	408.
	36"	35 ⁵ / ₈ "	25 ¹ / ₂ "	⁷ / ₁₆ "	DP3PSB()2436	208.	234.	261.	359.	408.	453.
	42"	41 ⁵ / ₈ "	25 ¹ / ₂ "	⁷ / ₁₆ "	DP3PSB()2442	214.	236.	262.	374.	415.	460.
	48"	47 ⁵ / ₈ "	25 ¹ / ₂ "	⁷ / ₁₆ "	DP3PSB()2448	219.	250.	273.	389.	443.	483.
 D3 24" High Embossed Steel Insert	18"	17 ⁵ / ₈ "	25 ¹ / ₂ "	⁷ / ₁₆ "	DP3ESB()2418	140.	166.	181.	242.	285.	308.
	24"	23 ⁵ / ₈ "	25 ¹ / ₂ "	⁷ / ₁₆ "	DP3ESB()2424	173.	198.	217.	302.	346.	379.
	30"	29 ⁵ / ₈ "	25 ¹ / ₂ "	⁷ / ₁₆ "	DP3ESB()2430	186.	215.	232.	324.	379.	408.
	36"	35 ⁵ / ₈ "	25 ¹ / ₂ "	⁷ / ₁₆ "	DP3ESB()2436	208.	234.	261.	359.	408.	453.
	42"	41 ⁵ / ₈ "	25 ¹ / ₂ "	⁷ / ₁₆ "	DP3ESB()2442	214.	236.	262.	374.	415.	460.
	48"	47 ⁵ / ₈ "	25 ¹ / ₂ "	⁷ / ₁₆ "	DP3ESB()2448	219.	250.	273.	389.	443.	483.

w* = nominal width

Dimensions listed under w h d are actual to the nearest ¹/₁₆"

Ordering Information

Solid Steel Insert

1. Pattern number
2. Paint finish

Order Code

Solid Steel Insert

Example: **DP3SS()2418 115**

DP3 Pattern number

SS22418

115 Medium Grey paint

Included with:

Solid Steel Insert

Options

Solid Steel Insert

Insert pack quantity into parenthesis in pattern number



Tile to Floor Option:

Tile to Floor available in heights of 14", 24" and 28". To specify tile to floor, add an 'F' suffix to the pattern number and add \$16 for a single pack or \$31 for a double pack.

Beltway Panel Inserts

Lower Laminate Inserts

Dividends Horizon

description	w*	w	d	pattern no.	list
24" High Laminate Beltway Panel Lower Insert Base Raceway or Open Base 	15"	14 ⁷ / ₈ "	⁷ / ₁₆ "	DP3L12415	\$127.
	18"	17 ⁷ / ₈ "	⁷ / ₁₆ "	DP3L12418	136.
	24"	23 ⁷ / ₈ "	⁷ / ₁₆ "	DP3L12424	151.
	30"	29 ⁷ / ₈ "	⁷ / ₁₆ "	DP3L12430	181.
	36"	35 ⁷ / ₈ "	⁷ / ₁₆ "	DP3L12436	222.
	42"	41 ⁷ / ₈ "	⁷ / ₁₆ "	DP3L12442	226.
	48"	47 ⁷ / ₈ "	⁷ / ₁₆ "	DP3L12448	229.
24" High Laminate Beltway Panel Lower Insert Tile to Floor 	15"	14 ⁷ / ₈ "	⁷ / ₁₆ "	DP3L12415F	127.
	18"	17 ⁷ / ₈ "	⁷ / ₁₆ "	DP3L12418F	136.
	24"	23 ⁷ / ₈ "	⁷ / ₁₆ "	DP3L12424F	151.
	30"	29 ⁷ / ₈ "	⁷ / ₁₆ "	DP3L12430F	181.
	36"	35 ⁷ / ₈ "	⁷ / ₁₆ "	DP3L12436F	222.
	42"	41 ⁷ / ₈ "	⁷ / ₁₆ "	DP3L12442F	226.
	48"	47 ⁷ / ₈ "	⁷ / ₁₆ "	DP3L12448F	229.

Panels, Build-To-Spec

w* = nominal width
 Dimensions listed under w h d are actual to the nearest 1/16"

Ordering Information	Order Code	Included with:	Options:
Beltway Panel Laminate Inserts 1. Pattern Number 2. Laminate Finish 3. Edgeband Finish	Beltway Panel Laminate Inserts <i>Example:</i> DP3L12436 <hr/> DP3L1 Pattern Number <hr/> 2436 <hr/> 118 Bright White Laminate <hr/> 118 Bright White Edgeband	Beltway Panel Laminate Inserts • Attachment clips	Beltway Panel Laminate Inserts Finish Options: 114 Folkstone Grey 117 Soft Grey 118 Bright White 119 Pumice

High Acoustic Core Inserts and Sound Transmission Septum Inserts

Optional high acoustic core inserts or sound transmission septum inserts combine with tiles to provide enhanced acoustics.

High acoustic core inserts can be installed in monolithic and tiled panels but must be field-cut to be installed in beltway panels.

Sound transmission septum inserts can be installed in monolithic and tiled panels and single-sided beltway panels.

High Acoustic Core Insert Construction

1 1/2" thick, three-ply insert with an inner septum and outer fiberglass with polywrap.

Sound Transmission Septum Insert Construction

1/16" thick chipboard.

Core Insert Attachment

High acoustic core inserts and sound transmission septum inserts are inserted into the center of the panel frame. Core inserts are sized to fit into the panel frame without the use of fasteners. In-field installation is required.

High Acoustic Core Insert Panel Ratings

Noise Reduction Coefficient (NRC) rating: .80 when combined with tiles.

Sound Transmission Class (STC) rating: 26 when combined with tiles.

Sound Transmission Septum Insert Panel Ratings

Noise Reduction Coefficient (NRC) rating: .60 when combined with tiles.

Sound Transmission Class (STC) rating: 17 when combined with tiles.

Available Sizes

High acoustic core inserts and sound transmission septum inserts are available for all widths of 50", 64" and 78" high monolithic and tiled panels.

Beltway electrical panels require the high acoustic core inserts or the sound transmission septum inserts to be field-cut prior to installation.

Packaging

High acoustic cores and sound transmission septum inserts are shipped in separate containers.

High Acoustic Core Insert

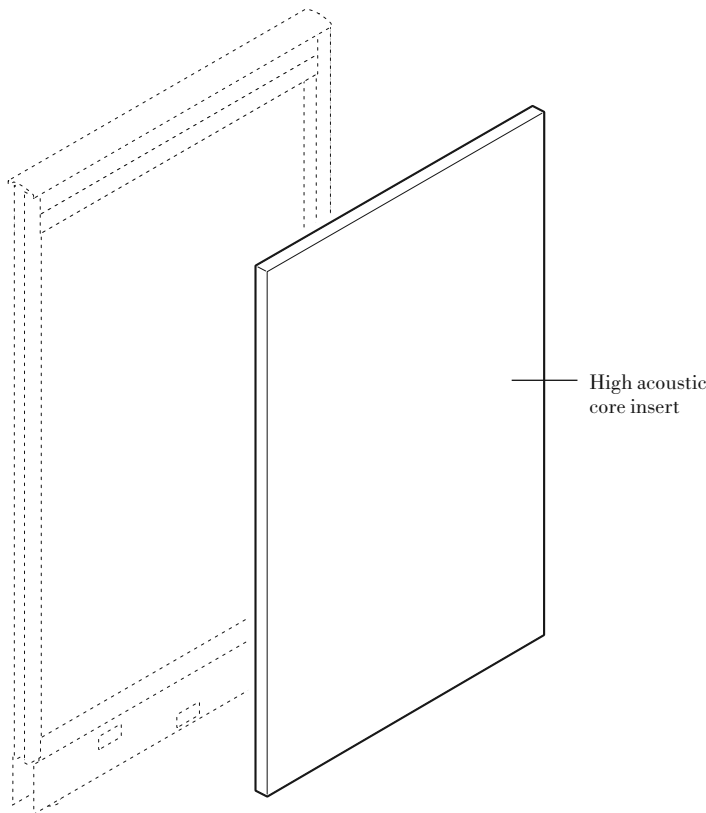

High Acoustic Core Insert Construction

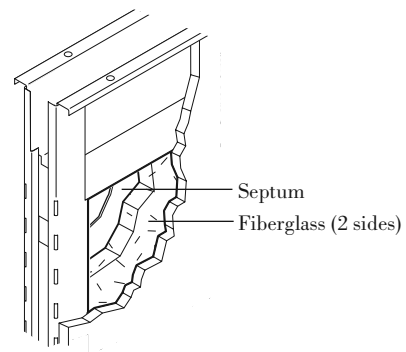

Sound Transmission Septum Insert Construction

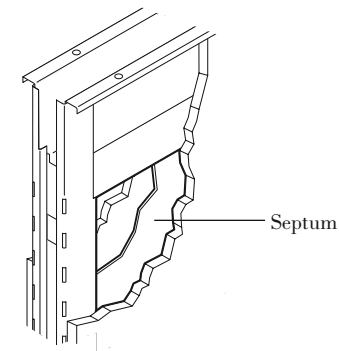

High Acoustic Core Inserts

Sound Transmission Septum Inserts

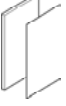
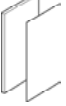
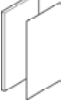
description	type	pattern no.	High Acoustic Core Insert	Sound Transmission Septum Insert
 50" High	For 18" panel width	DP1() 5018	\$25.	\$13.
	For 24" panel width	DP1() 5024	30.	13.
	For 30" panel width	DP1() 5030	33.	13.
	For 36" panel width	DP1() 5036	37.	20.
	For 42" panel width	DP1() 5042	42.	20.
	For 48" panel width	DP1() 5048	50.	20.
 64" High	For 18" panel width	DP1() 6418	34.	13.
	For 24" panel width	DP1() 6424	39.	13.
	For 30" panel width	DP1() 6430	45.	13.
	For 36" panel width	DP1() 6436	53.	20.
	For 42" panel width	DP1() 6442	61.	20.
	For 48" panel width	DP1() 6448	68.	20.
 78" High	For 18" panel width	DP1() 7818	45.	23.
	For 24" panel width	DP1() 7824	53.	23.
	For 30" panel width	DP1() 7830	60.	23.
	For 36" panel width	DP1() 7836	66.	25.
	For 42" panel width	DP1() 7842	75.	25.
	For 48" panel width	DP1() 7848	88.	25.

Panels, Build-To-Spec

Ordering Information

Inserts

1. Pattern Number

Order Code

Inserts

Example: **DP1(AC) 6448**
DP1(AC) Pattern Number
6448

Included with:

Inserts

- High Acoustic Core Insert
- Sound Transmission Septum Insert

Options

Inserts

Insert the appropriate letters for insert required within the parentheses of the pattern number.
(AC) = High Acoustic
(ST) = Sound Transmission

Single Pane Window Insert Kit

Single pane windows are available for three applications:

- Top position, with topway - for use in the top position of panels and D1 style stack frame with a topway trough.
- Top position, full view - for use in the top position of full view panels and D1 style stack frames.
- Middle position - for use in the middle positions of topway and full view panels.

Note: Window insert kits may not be specified in the bottom position of panels. Specify D2 tile supports and insert support mounting brackets separately.

Note: Single and double pane window insert kits are not compatible with the D2 style stack frame. Use D1 style stack frames with top position single or double pane window insert kits.

Construction

Single pane windows are shipped in two components - an "open" frame, and a "window" frame. Each frame snaps onto a Dividends Horizon panel frame. Both frames are constructed of extruded, then robotically-welded aluminum. Single pane windows have 1/4" clear tempered glass inserts with PVC glazing strip or frosted acrylic.

Single Pane Window Insert Kit

Available Sizes

- Heights: 14", 21" and 28"
- Widths: 24", 30", 36", 42", and 48"

Double Pane Window Insert Kits

Double pane window insert kits are available in three applications:

- 14" high topway window kit (used at the top position of a topway panel frame and topway D1 stack frame)
- 14" high full view/middle position window kit (used in the middle position of a topway panel, at top and middle positions of a full view panel frame and a full view D1 stack frame)
- 21" high topway window kit (used at the top position of a 64" topway panel frame and a 21" topway D1 stack frame)

Construction

The double pane window construction consists of clear double pane Plexiglas with a silk-screened dot-matrix pattern frame. The kits consist of two Plexiglas panes and vertical/horizontal trim pieces. Frosted Plexiglas does not have the dot-matrix silk screen pattern.

Tiled insert supports must be ordered separately per panel side to support the window kit. Double pane windows must use D1 tile supports, and are not compatible with D2 tile supports.

Note: When cleaning Plexiglas, only use a lint free cotton cloth (not paper towels or any other wood-based product) with warm water and a mild dish detergent. Do not use ammonia or any alcohol based cleaning products because they will break down the protective layer on the outside of the Plexiglas products.

Plexiglas is susceptible to scratching and marring if it is not handled and cleaned properly. Handle Plexiglas with extreme care! Wear cotton gloves when handling Plexiglas to avoid fingerprints.

Double Window Insert Kit

Available Sizes

- Heights: 14" and 21" (64" high panels only)
- Widths: 24", 30", 36", 42", and 48"

Attachment

Window insert kits are installed on each side of a panel frame. Glazed insert kits consist of two inserts. Individual tile support rails must be ordered separately.

Note: Knoll's three window types are aesthetically different, and are not designed to be mixed together within a single installation.

Single Pane Window Insert Kit

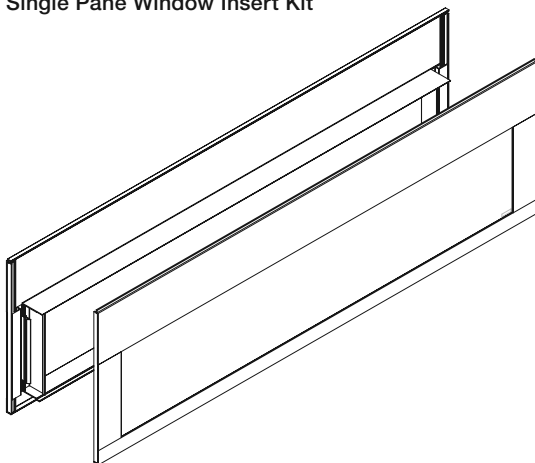

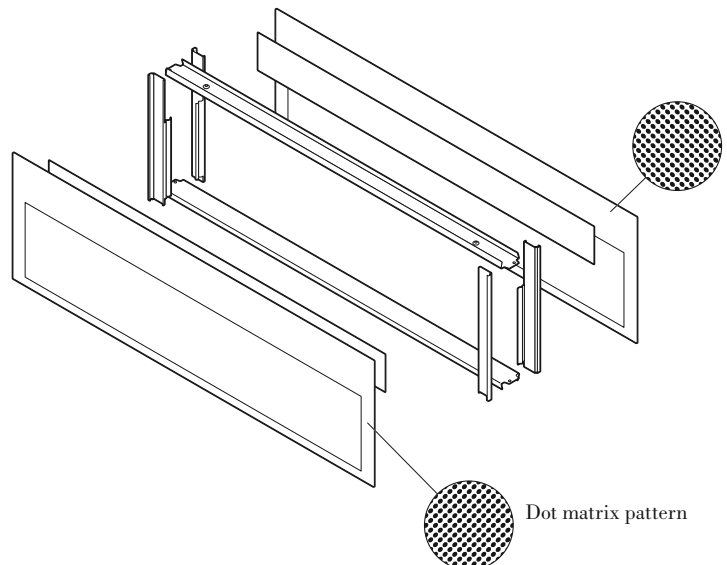

Double Pane Window Insert Kit



Window Insert Kits

Single Pane Windows

Dividends Horizon

description	h	w	pattern no.	P1	P2	P3
Window, top position with topway 	14"	24"	D2P1()T1424	\$355.	\$376.	\$393.
	14"	30"	D2P1()T1430	413.	432.	454.
	14"	36"	D2P1()T1436	465.	489.	512.
	14"	42"	D2P1()T1442	552.	580.	608.
	14"	48"	D2P1()T1448	565.	594.	623.
	21"	24"	D2P1()T2124	415.	436.	456.
	21"	30"	D2P1()T2130	489.	513.	538.
	21"	36"	D2P1()T2136	525.	552.	578.
	21"	42"	D2P1()T2142	628.	660.	690.
	21"	48"	D2P1()T2148	699.	736.	770.
	28"	24"	D2P1()T2824	456.	479.	503.
	28"	30"	D2P1()T2830	538.	565.	593.
	28"	36"	D2P1()T2836	578.	608.	636.
	28"	42"	D2P1()T2842	690.	726.	761.
28"	48"	D2P1()T2848	770.	808.	847.	
Window, top position full view 	14"	24"	D2P1()VT1424	355.	376.	393.
	14"	30"	D2P1()VT1430	413.	432.	454.
	14"	36"	D2P1()VT1436	465.	489.	512.
	14"	42"	D2P1()VT1442	552.	580.	608.
	14"	48"	D2P1()VT1448	565.	594.	623.
	21"	24"	D2P1()VT2124	415.	436.	456.
	21"	30"	D2P1()VT2130	489.	513.	538.
	21"	36"	D2P1()VT2136	525.	552.	578.
	21"	42"	D2P1()VT2142	628.	660.	690.
	21"	48"	D2P1()VT2148	699.	736.	770.
	28"	24"	D2P1()VT2824	456.	479.	503.
	28"	30"	D2P1()VT2830	538.	565.	593.
	28"	36"	D2P1()VT2836	578.	608.	636.
	28"	42"	D2P1()VT2842	690.	726.	761.
28"	48"	D2P1()VT2848	770.	808.	847.	
Window, middle position 	14"	24"	D2P1()VL1424	355.	376.	393.
	14"	30"	D2P1()VL1430	413.	432.	454.
	14"	36"	D2P1()VL1436	465.	489.	512.
	14"	42"	D2P1()VL1442	552.	580.	608.
	14"	48"	D2P1()VL1448	565.	594.	623.

Panels, Build-To-Spec

Ordering Information

Single Pane Window Kit

1. Pattern number
2. Paint finish

Order Code

Single Pane Window Kit

Example:	D2P1GT1448, 117
D2P1	Single Pane Window w/
GT1448	Clear Glass
117	Soft Grey Paint

Included with:

Single Pane Window Kit

Note: The single pane window insert kit is not compatible with the D2 style stack frame. Use D1 style stack frames with single pane window insert kits.

Note: Use top position window insert kits when using with D1 style stack frames.

Options

Single Pane Window Kit

Note: Single Pane Window Kit must be used with D2 Style Supports

Glass Options:
(G) = Clear Tempered Glass
(F) = Frosted Acrylic

Window Insert Kits

Double Pane Windows

Dividends Horizon

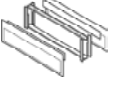
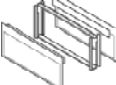
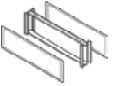
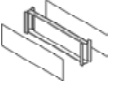
description	h	w	pattern no.	list
14"H Topway Window Insert Kit (2 acrylic inserts) 	14 ⁷ / ₁₆ "	23 ⁷ / ₁₆ "	DP1GT 1424	\$409.
	14 ⁷ / ₁₆ "	29 ⁷ / ₁₆ "	DP1GT 1430	475.
	14 ⁷ / ₁₆ "	35 ⁷ / ₁₆ "	DP1GT 1436	535.
	14 ⁷ / ₁₆ "	41 ⁷ / ₁₆ "	DP1GT 1442	636.
	14 ⁷ / ₁₆ "	47 ⁷ / ₁₆ "	DP1GT 1448	650.
21"H Topway Window Insert Kit (2 acrylic inserts) 	21 ¹¹ / ₁₆ "	23 ⁷ / ₁₆ "	DP1GT 2124	477.
	21 ¹¹ / ₁₆ "	29 ⁷ / ₁₆ "	DP1GT 2130	562.
	21 ¹¹ / ₁₆ "	35 ⁷ / ₁₆ "	DP1GT 2136	604.
	21 ¹¹ / ₁₆ "	41 ⁷ / ₁₆ "	DP1GT 2142	722.
	21 ¹¹ / ₁₆ "	47 ⁷ / ₁₆ "	DP1GT 2148	806.
14"H Full View Middle Position / Full View Insert Kit (2 acrylic inserts) 	14 ⁷ / ₁₆ "	23 ⁷ / ₁₆ "	DP1GL 1424	409.
	14 ⁷ / ₁₆ "	29 ⁷ / ₁₆ "	DP1GL 1430	475.
	14 ⁷ / ₁₆ "	35 ⁷ / ₁₆ "	DP1GL 1436	535.
	14 ⁷ / ₁₆ "	41 ⁷ / ₁₆ "	DP1GL 1442	636.
	14 ⁷ / ₁₆ "	47 ⁷ / ₁₆ "	DP1GL 1448	650.
14" Frosted Full View Middle Position Insert Kit (2 acrylic inserts) 	14 ⁷ / ₁₆ "	23 ⁷ / ₁₆ "	DP1FL 1424	316.
	14 ⁷ / ₁₆ "	29 ⁷ / ₁₆ "	DP1FL 1430	369.
	14 ⁷ / ₁₆ "	35 ⁷ / ₁₆ "	DP1FL 1436	427.
	14 ⁷ / ₁₆ "	41 ⁷ / ₁₆ "	DP1FL 1442	517.
	14 ⁷ / ₁₆ "	47 ⁷ / ₁₆ "	DP1FL 1448	531.

Ordering Information

Topway Window Insert Kit
1. Pattern Number

Order Code

Topway Window Insert Kit
Example: **DP1GT 2142**
DP1GT2 Pattern Number
2142

Included with:

Topway Window Insert Kit

- 2 Plexiglas inserts
- Horizontal top trim piece
- Horizontal bottom trim piece
- 4 vertical trim pieces

Options

Topway Window Insert Kit
Note: Double Pane Window Kits must be used with D1 tile supports.

This page intentionally left blank

Markerboard Tiles

Markerboard tiles may be attached to any Dividends Horizon universal panel frame.

Construction

Markerboard tiles are constructed of 20 gauge steel, powder coated with paint suitable for use with standard dry erase markers.

Available Sizes

- Heights: 7", 10", 14", 21", 24" and 28"
- Widths: 18", 24", 30", 36", 42", and 48"

Attachment

Markerboard tiles are installed on one side of a panel frame. Individual D1 or D2 tile support rails must be ordered separately.

Markerboard Trays

Markerboard trays are positioned directly below markerboard tiles, and are designed to hold dry erase markers and erasers.

Trays mount to the outside of tile frames, and replace a D1 or D2 tile support.

Markerboard trays may not be positioned directly above or below a beltway raceway and may not be used with stack frames.

Note: Markerboard tiles can use D1 or D2 tile supports. Legacy D1 and D2 Markerboard tiles use D1 tile supports only.



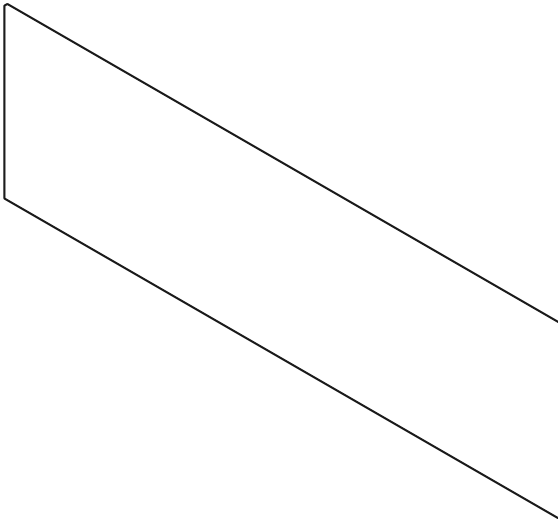

Markerboard Tile



Markerboard Tiles

7", 10", 14" and 21" High

Dividends Horizon

description	h	w	pattern no.	1 pack	6 pack
 D3 7" Markerboard tile	7"	18"	DP3MB()718	\$68.	\$300.
	7"	24"	DP3MB()724	72.	319.
	7"	30"	DP3MB()730	79.	354.
	7"	36"	DP3MB()736	94.	412.
	7"	42"	DP3MB()742	101.	440.
	7"	48"	DP3MB()748	104.	467.
 D3 10" Markerboard tile	10"	18"	DP3MB()1018	94.	420.
	10"	24"	DP3MB()1024	101.	447.
	10"	30"	DP3MB()1030	102.	467.
	10"	36"	DP3MB()1036	113.	496.
	10"	42"	DP3MB()1042	117.	523.
	10"	48"	DP3MB()1048	124.	560.
 D3 14" Markerboard tile	14"	18"	DP3MB()1418	94.	420.
	14"	24"	DP3MB()1424	101.	447.
	14"	30"	DP3MB()1430	102.	467.
	14"	36"	DP3MB()1436	113.	496.
	14"	42"	DP3MB()1442	117.	523.
	14"	48"	DP3MB()1448	124.	560.
 D3 21" Markerboard tile	21"	18"	DP3MB()2118	120.	627.
	21"	24"	DP3MB()2124	149.	784.
	21"	30"	DP3MB()2130	161.	842.
	21"	36"	DP3MB()2136	181.	935.
	21"	42"	DP3MB()2142	186.	970.
	21"	48"	DP3MB()2148	190.	1,010.

Panels, Build-To-Spec

Ordering Information

Markerboard Tiles
1. Pattern Number

Order Code

Markerboard Tiles
Example: **DP3MB(1) 1436**
DP3MB(1) Pattern Number
1436

Included with:



Markerboard Tiles

Options

Markerboard Tiles
(1) = 1 Pack
(6) = 6 Pack

Markerboard Tiles

24" and 28" High and Markerboard Tray

description	height	width	pattern number	1 pack	2 pack	P1	P2	P3
 D3 24" Markerboard tile	24"	18"	DP3MB()2418	\$120.	\$209.			
	24"	24"	DP3MB()2424	149.	261.			
	24"	30"	DP3MB()2430	161.	280.			
	24"	36"	DP3MB()2436	181.	311.			
	24"	42"	DP3MB()2442	186.	324.			
	24"	48"	DP3MB()2448	190.	336.			
 D3 28" Markerboard tile	28"	18"	DP3MB()2818	131.	228.			
	28"	24"	DP3MB()2824	151.	265.			
	28"	30"	DP3MB()2830	162.	286.			
	28"	36"	DP3MB()2836	181.	317.			
	28"	42"	DP3MB()2842	186.	327.			
	28"	48"	DP3MB()2848	190.	338.			
 Markerboard Tray		24"	DP1MBT24			104.	110.	114.
		30"	DP1MBT30			107.	112.	117.
		36"	DP1MBT36			109.	114.	119.
		42"	DP1MBT42			111.	116.	121.
		48"	DP1MBT48			113.	118.	124.

Ordering Information

Markerboard Tiles

1. Pattern Number

Markerboard Tray

1. Pattern Number
2. Paint Finish

Order Code

Markerboard Tiles

Example: **DP3MB(1) 1436**

DP3MB(1) Pattern Number
1436

Included with:

Markerboard Tiles

Options

Markerboard Tiles

(1) = 1 Pack
(2) = 2 Pack

This page intentionally left blank

Solid Steel Tiles

Solid steel tiles are painted solid steel formed inserts that may be inserted into any Dividends Horizon universal panel frame.

Construction

Steel tiles are made of 20-gauge formed steel that is painted in any Dividends Horizon paint color.

Embossed Steel Tiles

Embossed steel tiles are painted embossed steel formed inserts that may be inserted into any Dividends Horizon universal panel frame.

Construction

Embossed steel tiles are made of 18-gauge formed steel that is painted in any Dividends Horizon paint color

Perforated Steel Tiles

Perforated steel tiles are painted perforated steel formed inserts that may be inserted into any Dividends Horizon universal panel frame.

Construction

Perforated steel tiles are made of 18-gauge formed steel that is painted in any Dividends Horizon paint color.

Available Sizes

- Height: 7", 10", 14", 21", 24" and 28"
- Widths: 15", 18", 24", 30", 36", 42" and 48"

Attachment

Steel tiles are installed on one side or both sides of a panel frame. Individual D1 or D2 tile support rails must be ordered separately.

One-sided Attachment

For applications with perforated inserts on one side of panel only, specify sound transmission septums.

Tile-to-Floor Option

14", 24" and 28" high steel tiles are available to be specified Tile-to-Floor.

Solid Steel Tile Insert

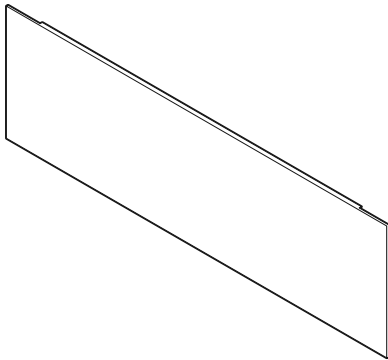



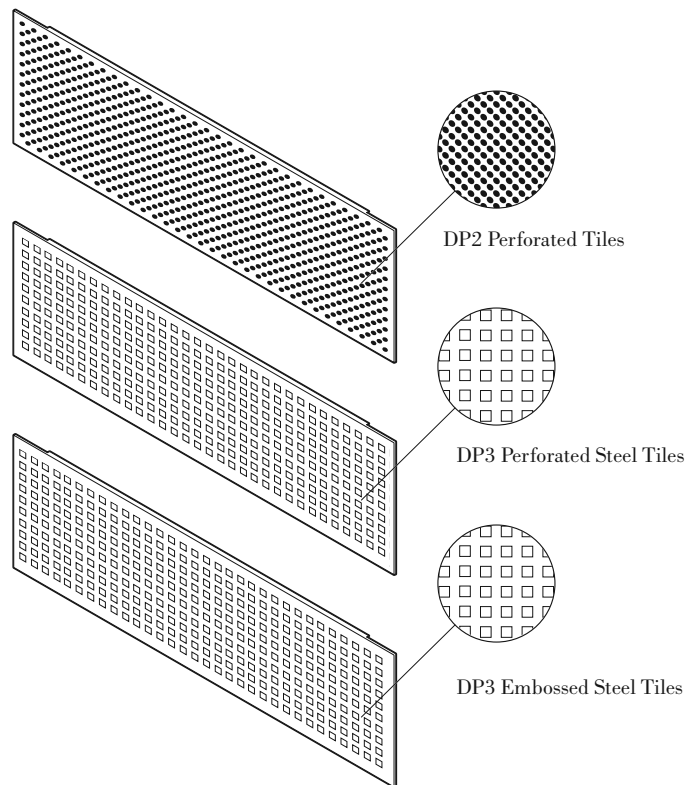

Perforated and Embossed Steel Tile Inserts



Steel Tile Insert Kits

7", 10", 14" and 21" High Solid Steel Insert

Dividends Horizon

description	w*	w	h	d	pattern no.	1 pack P1	1 pack P2	1 pack P3	6 pack P1	6 pack P2	6 pack P3
 D3 7" High Solid Steel Insert	15"	14 5/8"	7 3/16"	7/16"	DP3SS()715	\$52.	\$61.	\$72.	\$230.	\$267.	\$318.
	18"	17 5/8"	7 3/16"	7/16"	DP3SS()718	52.	61.	72.	230.	267.	318.
	24"	23 5/8"	7 3/16"	7/16"	DP3SS()724	55.	68.	74.	244.	302.	330.
	30"	29 5/8"	7 3/16"	7/16"	DP3SS()730	62.	76.	83.	274.	337.	366.
	36"	35 5/8"	7 3/16"	7/16"	DP3SS()736	73.	86.	91.	318.	366.	395.
	42"	41 5/8"	7 3/16"	7/16"	DP3SS()742	78.	89.	97.	337.	389.	423.
	48"	47 5/8"	7 3/16"	7/16"	DP3SS()748	81.	92.	99.	359.	411.	445.
 D3 10" High Solid Steel Insert	15"	14 5/8"	10 3/16"	7/16"	DP3SS()1015	73.	84.	87.	324.	366.	382.
	18"	17 5/8"	10 3/16"	7/16"	DP3SS()1018	73.	84.	87.	324.	366.	382.
	24"	23 5/8"	10 3/16"	7/16"	DP3SS()1024	78.	88.	91.	346.	395.	411.
	30"	29 5/8"	10 3/16"	7/16"	DP3SS()1030	79.	91.	95.	359.	417.	431.
	36"	35 5/8"	10 3/16"	7/16"	DP3SS()1036	87.	99.	104.	382.	439.	460.
	42"	41 5/8"	10 3/16"	7/16"	DP3SS()1042	90.	102.	113.	402.	460.	503.
	48"	47 5/8"	10 3/16"	7/16"	DP3SS()1048	95.	114.	118.	431.	517.	539.
 D3 14" High Solid Steel Insert	15"	14 5/8"	14 3/16"	7/16"	DP3SS()1415	73.	84.	87.	324.	366.	382.
	18"	17 5/8"	14 3/16"	7/16"	DP3SS()1418	73.	84.	87.	324.	366.	382.
	24"	23 5/8"	14 3/16"	7/16"	DP3SS()1424	78.	88.	91.	346.	395.	411.
	30"	29 5/8"	14 3/16"	7/16"	DP3SS()1430	79.	91.	95.	359.	417.	431.
	36"	35 5/8"	14 3/16"	7/16"	DP3SS()1436	87.	99.	104.	382.	439.	460.
	42"	41 5/8"	14 3/16"	7/16"	DP3SS()1442	90.	102.	113.	402.	460.	503.
	48"	47 5/8"	14 3/16"	7/16"	DP3SS()1448	95.	114.	118.	431.	517.	539.
 D3 21" High Solid Steel Insert	15	14 5/8"	21 3/16"	7/16"	DP3SS()2115	93.	111.	119.	483.	568.	619.
	18"	17 5/8"	21 3/16"	7/16"	DP3SS()2118	93.	111.	119.	483.	568.	619.
	24"	23 5/8"	21 3/16"	7/16"	DP3SS()2124	115.	132.	144.	604.	689.	755.
	30"	29 5/8"	21 3/16"	7/16"	DP3SS()2130	122.	143.	155.	648.	755.	813.
	36"	35 5/8"	21 3/16"	7/16"	DP3SS()2136	138.	156.	174.	719.	813.	906.
	42"	41 5/8"	21 3/16"	7/16"	DP3SS()2142	142.	157.	175.	747.	827.	921.
	48"	47 5/8"	21 3/16"	7/16"	DP3SS()2148	145.	167.	182.	776.	884.	963.

Panels, Build-To-Spec

Ordering Information	Order Code	Included with:	Options
Solid Steel Insert 1. Pattern number 2. Paint finish	Solid Steel Insert Example: DP3SS()1418 115 DP3 Pattern number SS21418 115 Medium Grey paint	Solid Steel Insert	Insert pack quantity into parenthesis in pattern number Tile to Floor Option: Tile to Floor available in heights of 14", 24" and 28". To specify tile to floor, add an 'F' suffix to the pattern number and add \$16 for a single pack, \$31 for a double pack and \$95 for a 6 pack to the list price.

Worksurface Height and 28" High Solid Steel Insert

description	w*	w	h	d	pattern no.	1 pack P1	1 pack P2	1 pack P3	2 pack P1	2 pack P2	2 pack P3
D3 Worksurface Height Solid Steel Insert 	15"	14 5/8"	22 1/2"	7/16"	DP3SS()WH15	\$93.	\$111.	\$119.	\$161.	\$189.	\$207.
	18"	17 5/8"	22 1/2"	7/16"	DP3SS()WH18	93.	111.	119.	161.	189.	207.
	24"	23 5/8"	22 1/2"	7/16"	DP3SS()WH24	115.	132.	144.	202.	230.	251.
	30"	29 5/8"	22 1/2"	7/16"	DP3SS()WH30	122.	143.	155.	215.	251.	272.
	36"	35 5/8"	22 1/2"	7/16"	DP3SS()WH36	138.	156.	174.	239.	272.	302.
	42"	41 5/8"	22 1/2"	7/16"	DP3SS()WH42	142.	157.	175.	249.	276.	306.
	48"	47 5/8"	22 1/2"	7/16"	DP3SS()WH48	145.	167.	182.	258.	296.	322.

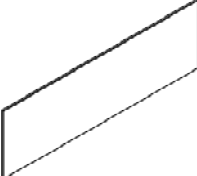
description	w*	w	h	d	pattern no.	1 pack P1	1 pack P2	1 pack P3	2 pack P1	2 pack P2	2 pack P3
D3 28" High Solid Steel Insert 	15"	14 5/8"	29"	7/16"	DP3SS()2815	100.	100.	118.	175.	191.	207.
	18"	17 5/8"	29"	7/16"	DP3SS()2818	100.	100.	118.	175.	191.	207.
	24"	23 5/8"	29"	7/16"	DP3SS()2824	116.	116.	144.	204.	232.	253.
	30"	29 5/8"	29"	7/16"	DP3SS()2830	124.	143.	156.	220.	253.	276.
	36"	35 5/8"	29"	7/16"	DP3SS()2836	138.	156.	174.	242.	276.	306.
	42"	41 5/8"	29"	7/16"	DP3SS()2842	142.	158.	174.	251.	278.	308.
	48"	47 5/8"	29"	7/16"	DP3SS()2848	145.	167.	183.	261.	298.	324.

Ordering Information

Solid Steel Insert

1. Pattern number
2. Paint finish

Order Code

Solid Steel Insert

Example: **DP3SS()2118 115**

DP3	Pattern number
SS22118	
115	Medium Grey paint

Included with:

Solid Steel Insert

Options

Solid Steel Insert

Insert pack quantity into parenthesis in pattern number

Tile to Floor Option:

Tile to Floor available in heights of 14", Worksurface Height, 24" and 28". To specify tile to floor, add an 'F' suffix to the pattern number and add \$16 for a single pack, \$31 for a double pack and \$95 for a 6 pack to the list price.

Steel Tile Insert Kits

7", 10", 14" and 21" High Perforated Steel Insert

Dividends Horizon

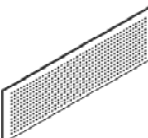
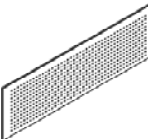
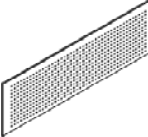
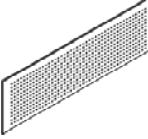
description	w*	w	h	d	pattern no.	1 pack P1	1 pack P2	1 pack P3	6 pack P1	6 pack P2	6 pack P3
 D3 7" High Perforated Steel Insert	15"	14 ⁵ / ₈ "	7 ³ / ₁₆ "	⁷ / ₁₆ "	DP3PSB()715	\$79.	\$90.	\$109.	\$346.	\$402.	\$474.
	18"	17 ⁵ / ₈ "	7 ³ / ₁₆ "	⁷ / ₁₆ "	DP3PSB()718	79.	90.	109.	346.	402.	474.
	24"	23 ⁵ / ₈ "	7 ³ / ₁₆ "	⁷ / ₁₆ "	DP3PSB()724	84.	102.	112.	366.	453.	497.
	30"	29 ⁵ / ₈ "	7 ³ / ₁₆ "	⁷ / ₁₆ "	DP3PSB()730	92.	114.	121.	411.	511.	553.
	36"	35 ⁵ / ₈ "	7 ³ / ₁₆ "	⁷ / ₁₆ "	DP3PSB()736	111.	128.	137.	474.	553.	597.
	42"	41 ⁵ / ₈ "	7 ³ / ₁₆ "	⁷ / ₁₆ "	DP3PSB()742	117.	133.	145.	511.	581.	639.
	48"	47 ⁵ / ₈ "	7 ³ / ₁₆ "	⁷ / ₁₆ "	DP3PSB()748	120.	139.	149.	539.	619.	667.
 D3 10" High Perforated Steel Insert	15"	14 ⁵ / ₈ "	10 ³ / ₁₆ "	⁷ / ₁₆ "	DP3PSB()1015	111.	124.	130.	489.	553.	575.
	18"	17 ⁵ / ₈ "	10 ³ / ₁₆ "	⁷ / ₁₆ "	DP3PSB()1018	111.	124.	130.	489.	553.	575.
	24"	23 ⁵ / ₈ "	10 ³ / ₁₆ "	⁷ / ₁₆ "	DP3PSB()1024	117.	132.	137.	517.	597.	619.
	30"	29 ⁵ / ₈ "	10 ³ / ₁₆ "	⁷ / ₁₆ "	DP3PSB()1030	118.	137.	143.	539.	626.	648.
	36"	35 ⁵ / ₈ "	10 ³ / ₁₆ "	⁷ / ₁₆ "	DP3PSB()1036	130.	149.	157.	575.	661.	689.
	42"	41 ⁵ / ₈ "	10 ³ / ₁₆ "	⁷ / ₁₆ "	DP3PSB()1042	136.	155.	169.	604.	689.	755.
	48"	47 ⁵ / ₈ "	10 ³ / ₁₆ "	⁷ / ₁₆ "	DP3PSB()1048	143.	171.	180.	648.	776.	813.
 D3 14" High Perforated Steel Insert	15"	14 ⁵ / ₈ "	14 ³ / ₁₆ "	⁷ / ₁₆ "	DP3PSB()1415	111.	124.	130.	489.	553.	575.
	18"	17 ⁵ / ₈ "	14 ³ / ₁₆ "	⁷ / ₁₆ "	DP3PSB()1418	111.	124.	130.	489.	553.	575.
	24"	23 ⁵ / ₈ "	14 ³ / ₁₆ "	⁷ / ₁₆ "	DP3PSB()1424	117.	132.	137.	517.	597.	619.
	30"	29 ⁵ / ₈ "	14 ³ / ₁₆ "	⁷ / ₁₆ "	DP3PSB()1430	118.	137.	143.	539.	626.	648.
	36"	35 ⁵ / ₈ "	14 ³ / ₁₆ "	⁷ / ₁₆ "	DP3PSB()1436	130.	149.	157.	575.	661.	689.
	42"	41 ⁵ / ₈ "	14 ³ / ₁₆ "	⁷ / ₁₆ "	DP3PSB()1442	136.	155.	169.	604.	689.	755.
	48"	47 ⁵ / ₈ "	14 ³ / ₁₆ "	⁷ / ₁₆ "	DP3PSB()1448	143.	171.	180.	648.	776.	813.
 D3 21" High Perforated Steel Insert	15"	14 ⁵ / ₈ "	21 ³ / ₁₆ "	⁷ / ₁₆ "	DP3PSB()2115	140.	166.	181.	726.	855.	928.
	18"	17 ⁵ / ₈ "	21 ³ / ₁₆ "	⁷ / ₁₆ "	DP3PSB()2118	140.	166.	181.	726.	855.	928.
	24"	23 ⁵ / ₈ "	21 ³ / ₁₆ "	⁷ / ₁₆ "	DP3PSB()2124	173.	198.	217.	906.	1,036.	1,135.
	30"	29 ⁵ / ₈ "	21 ³ / ₁₆ "	⁷ / ₁₆ "	DP3PSB()2130	186.	215.	232.	969.	1,135.	1,223.
	36"	35 ⁵ / ₈ "	21 ³ / ₁₆ "	⁷ / ₁₆ "	DP3PSB()2136	208.	234.	261.	1,078.	1,223.	1,359.
	42"	41 ⁵ / ₈ "	21 ³ / ₁₆ "	⁷ / ₁₆ "	DP3PSB()2142	214.	236.	262.	1,122.	1,244.	1,380.
	48"	47 ⁵ / ₈ "	21 ³ / ₁₆ "	⁷ / ₁₆ "	DP3PSB()2148	219.	250.	273.	1,165.	1,330.	1,446.

Panels, Build-To-Spec

Ordering Information

Perforated Steel Insert

1. Pattern number
2. Paint finish

Order Code

Perforated Steel Insert

Example: **DP3PSB21430 117**

DP3	Pattern number
PSB21430	
117	Soft Grey paint

Included with:

Perforated Steel Insert

Options

Perforated Steel Insert

Insert pack quantity into parenthesis in pattern number

Tile to Floor Option:

Tile to Floor available in heights of 14", Worksurface Height, 24" and 28". To specify tile to floor, add an 'F' suffix to the pattern number and add \$16 for a single pack, \$31 for a double pack and \$95 for a 6 pack to the list price.

Tile to Floor Option not available on DP2 perforated steel tile insert.

14", Worksurface Height and 28" High Perforated Steel Insert

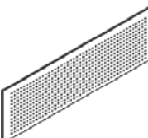
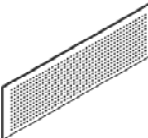
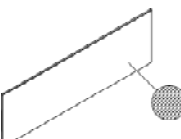
description	w*	w	h	d	pattern no.	1 pack P1	1 pack P2	1 pack P3	2 pack P1	2 pack P2	2 pack P3
 <p>D3 Worksurface Height Perforated Steel Insert</p>	15"	14 5/8"	22 1/2"	7/16"	DP3PSB()WH15	\$140.	\$166.	\$181.	\$242.	\$285.	\$308.
	18"	17 5/8"	22 1/2"	7/16"	DP3PSB()WH18	140.	166.	181.	242.	285.	308.
	24"	23 5/8"	22 1/2"	7/16"	DP3PSB()WH24	173.	198.	217.	302.	346.	379.
	30"	29 5/8"	22 1/2"	7/16"	DP3PSB()WH30	186.	215.	232.	324.	379.	408.
	36"	35 5/8"	22 1/2"	7/16"	DP3PSB()WH36	208.	234.	261.	359.	408.	453.
	42"	41 5/8"	22 1/2"	7/16"	DP3PSB()WH42	214.	236.	262.	374.	415.	460.
	48"	47 5/8"	22 1/2"	7/16"	DP3PSB()WH48	219.	250.	273.	389.	443.	483.
 <p>D3 28" High Perforated Steel Insert</p>	15"	14 5/8"	29"	7/16"	DP3PSB()2815	151.	151.	180.	263.	289.	308.
	18"	17 5/8"	29"	7/16"	DP3PSB()2818	151.	151.	180.	263.	289.	308.
	24"	24 5/8"	29"	7/16"	DP3PSB()2824	175.	175.	217.	306.	350.	382.
	30"	29 5/8"	29"	7/16"	DP3PSB()2830	187.	215.	234.	330.	382.	415.
	36"	35 5/8"	29"	7/16"	DP3PSB()2836	208.	234.	261.	364.	415.	460.
	42"	41 5/8"	29"	7/16"	DP3PSB()2842	214.	237.	261.	379.	417.	465.
	48"	47 5/8"	29"	7/16"	DP3PSB()2848	219.	250.	274.	393.	445.	487.
 <p>D2 14" High Perforated Steel Insert</p>	18"	17 5/8"	14 3/16"	7/16"	DP2PS()1418	97.	107.	112.	181.	196.	205.
	24"	23 5/8"	14 3/16"	7/16"	DP2PS()1424	128.	139.	147.	240.	267.	278.
	30"	29 5/8"	14 3/16"	7/16"	DP2PS()1430	130.	142.	149.	245.	269.	281.
	36"	35 5/8"	14 3/16"	7/16"	DP2PS()1436	132.	144.	153.	248.	273.	283.
	42"	41 5/8"	14 3/16"	7/16"	DP2PS()1442	132.	146.	153.	251.	277.	290.
	48"	47 5/8"	14 3/16"	7/16"	DP2PS()1448	136.	149.	156.	256.	281.	295.

Ordering Information

Perforated Steel Insert

1. Pattern number
2. Paint finish

Order Code

Perforated Steel Insert

Example: **DP3PSB21430 117**

DP3 Pattern number

PSB21430

117 Soft Grey paint

Included with:

Perforated Steel Insert

Options

Perforated Steel Insert

Insert pack quantity into parenthesis in pattern number

Tile to Floor Option:

Tile to Floor available in heights of 14", 24" and 28". To specify tile to floor, add an 'F' suffix to the pattern number and add \$16 for a single pack, \$31 for a double pack and \$95 for a 6 pack to the list price.

Tile to Floor Option not available on DP2 perforated steel tile insert.

Steel Tile Insert Kits

7", 10", 14" and 21" High Embossed Steel Insert

Dividends Horizon

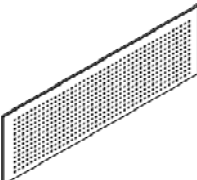
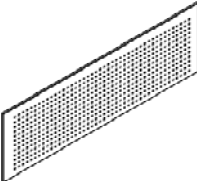
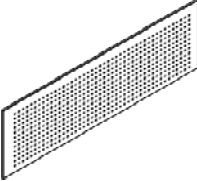
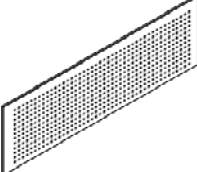
description	w*	w	h	d	pattern no.	1 pack P1	1 pack P2	1 pack P3	6 pack P1	6 pack P2	6 pack P3
 D3 7" High Embossed Steel Insert	15"	14 ⁵ / ₈ "	7 ³ / ₁₆ "	⁷ / ₁₆ "	DP3ESB()715	\$79.	\$90.	\$109.	\$346.	\$402.	\$474.
	18"	17 ⁵ / ₈ "	7 ³ / ₁₆ "	⁷ / ₁₆ "	DP3ESB()718	79.	90.	109.	346.	402.	474.
	24"	23 ⁵ / ₈ "	7 ³ / ₁₆ "	⁷ / ₁₆ "	DP3ESB()724	84.	102.	112.	366.	453.	497.
	30"	30 ⁵ / ₈ "	7 ³ / ₁₆ "	⁷ / ₁₆ "	DP3ESB()730	92.	114.	121.	411.	511.	553.
	36"	35 ⁵ / ₈ "	7 ³ / ₁₆ "	⁷ / ₁₆ "	DP3ESB()736	111.	128.	137.	474.	553.	597.
	42"	41 ⁵ / ₈ "	7 ³ / ₁₆ "	⁷ / ₁₆ "	DP3ESB()742	117.	133.	145.	511.	581.	639.
	48"	47 ⁵ / ₈ "	7 ³ / ₁₆ "	⁷ / ₁₆ "	DP3ESB()748	120.	139.	149.	539.	619.	667.
 D3 10" High Embossed Steel Insert	15"	14 ⁵ / ₈ "	10 ³ / ₁₆ "	⁷ / ₁₆ "	DP3ESB()1015	111.	124.	130.	489.	553.	575.
	18"	17 ⁵ / ₈ "	10 ³ / ₁₆ "	⁷ / ₁₆ "	DP3ESB()1018	111.	124.	130.	489.	553.	575.
	24"	23 ⁵ / ₈ "	10 ³ / ₁₆ "	⁷ / ₁₆ "	DP3ESB()1024	117.	132.	137.	517.	597.	619.
	30"	29 ⁵ / ₈ "	10 ³ / ₁₆ "	⁷ / ₁₆ "	DP3ESB()1030	118.	137.	143.	539.	626.	648.
	36"	35 ⁵ / ₈ "	10 ³ / ₁₆ "	⁷ / ₁₆ "	DP3ESB()1036	130.	149.	157.	575.	661.	689.
	42"	41 ⁵ / ₈ "	10 ³ / ₁₆ "	⁷ / ₁₆ "	DP3ESB()1042	136.	155.	169.	604.	689.	755.
	48"	47 ⁵ / ₈ "	10 ³ / ₁₆ "	⁷ / ₁₆ "	DP3ESB()1048	143.	171.	180.	648.	776.	813.
 D3 14" High Embossed Steel Insert	15"	14 ⁵ / ₈ "	14 ³ / ₁₆ "	⁷ / ₁₆ "	DP3ESB()1415	111.	124.	130.	489.	553.	575.
	18"	17 ⁵ / ₈ "	14 ³ / ₁₆ "	⁷ / ₁₆ "	DP3ESB()1418	111.	124.	130.	489.	553.	575.
	24"	23 ⁵ / ₈ "	14 ³ / ₁₆ "	⁷ / ₁₆ "	DP3ESB()1424	117.	132.	137.	517.	597.	619.
	30"	29 ⁵ / ₈ "	14 ³ / ₁₆ "	⁷ / ₁₆ "	DP3ESB()1430	118.	137.	143.	539.	626.	648.
	36"	35 ⁵ / ₈ "	14 ³ / ₁₆ "	⁷ / ₁₆ "	DP3ESB()1436	130.	149.	157.	575.	661.	689.
	42"	41 ⁵ / ₈ "	14 ³ / ₁₆ "	⁷ / ₁₆ "	DP3ESB()1442	136.	155.	169.	604.	689.	755.
	48"	47 ⁵ / ₈ "	14 ³ / ₁₆ "	⁷ / ₁₆ "	DP3ESB()1448	143.	171.	180.	648.	776.	813.
 D3 21" Embossed Steel Insert	15"	14 ⁵ / ₈ "	21"	⁷ / ₁₆ "	DP3ESB()2115	140.	166.	181.	726.	855.	928.
	18"	17 ⁵ / ₈ "	21"	⁷ / ₁₆ "	DP3ESB()2118	140.	166.	181.	726.	855.	928.
	24"	23 ⁵ / ₈ "	21"	⁷ / ₁₆ "	DP3ESB()2124	173.	198.	217.	906.	1,036.	1,135.
	30"	29 ⁵ / ₈ "	21"	⁷ / ₁₆ "	DP3ESB()2130	186.	215.	232.	969.	1,135.	1,223.
	36"	35 ⁵ / ₈ "	21"	⁷ / ₁₆ "	DP3ESB()2136	208.	234.	261.	1,078.	1,223.	1,359.
	42"	41 ⁵ / ₈ "	21"	⁷ / ₁₆ "	DP3ESB()2142	214.	236.	262.	1,122.	1,244.	1,380.
	48"	47 ⁵ / ₈ "	21"	⁷ / ₁₆ "	DP3ESB()2148	219.	250.	273.	1,165.	1,330.	1,446.

Panels, Build-To-Spec

Ordering Information

Embossed Steel Insert

1. Pattern number
2. Paint finish

Order Code

Embossed Steel Insert

Example: **DP3ESB21430 117**

DP3 Pattern number

ESB21430

117 Soft Grey paint

Included with:

Embossed Steel Insert

Options

Embossed Steel Insert

Insert pack quantity into parenthesis in pattern number

Tile to Floor Option:

Tile to Floor available in heights of 14", 24" and 28". To specify tile to floor, add an 'F' suffix to the pattern number and add \$16 for a single pack, \$31 for a double pack and \$95 for a 6 pack to the list price.

Worksurface Height and 28" High Embossed Steel Insert

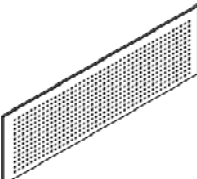
description	w*	w	h	d	pattern no.	1 pack P1	1 pack P2	1 pack P3	2 pack P1	2 pack P2	2 pack P3
 D3 Worksurface Height Embossed Steel Insert	15"	14 5/8"	22 1/2"	7/16"	DP3ESB()WH15	\$140.	\$166.	\$181.	\$242.	\$285.	\$308.
	18"	17 5/8"	22 1/2"	7/16"	DP3ESB()WH18	140.	166.	181.	242.	285.	308.
	24"	23 5/8"	22 1/2"	7/16"	DP3ESB()WH24	173.	198.	217.	302.	346.	379.
	30"	39 5/8"	22 1/2"	7/16"	DP3ESB()WH30	186.	215.	232.	324.	379.	408.
	36"	35 5/8"	22 1/2"	7/16"	DP3ESB()WH36	208.	234.	261.	359.	408.	453.
	42"	41 5/8"	22 1/2"	7/16"	DP3ESB()WH42	214.	236.	262.	374.	415.	460.
	48"	47 5/8"	22 1/2"	7/16"	DP3ESB()WH48	219.	250.	273.	389.	443.	483.

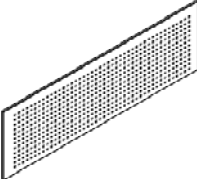
description	w*	w	h	d	pattern no.	1 pack P1	1 pack P2	1 pack P3	2 pack P1	2 pack P2	2 pack P3
 D3 28" High Embossed Steel Insert	15"	14 5/8"	29"	7/16"	DP3ESB()2815	151.	151.	180.	263.	289.	308.
	18"	17 5/8"	29"	7/16"	DP3ESB()2818	151.	151.	180.	263.	289.	308.
	24"	23 5/8"	29"	7/16"	DP3ESB()2824	175.	175.	217.	306.	350.	382.
	30"	29 5/8"	29"	7/16"	DP3ESB()2830	187.	215.	234.	330.	382.	415.
	36"	35 5/8"	29"	7/16"	DP3ESB()2836	208.	234.	261.	364.	415.	460.
	42"	41 5/8"	29"	7/16"	DP3ESB()2842	214.	237.	261.	379.	417.	465.
	48"	47 5/8"	29"	7/16"	DP3ESB()2848	219.	250.	274.	393.	445.	487.

Ordering Information

Embossed Steel Insert

1. Pattern number
2. Paint finish

Order Code

Embossed Steel Insert

Example: **DP3ESB22130 117**

DP3 Pattern number

ESB22130

117 Soft Grey paint

Included with:

Embossed Steel Insert

Options

Embossed Steel Insert

Insert pack quantity into parenthesis in pattern number

Tile to Floor Option:

Tile to Floor available in heights of 14", Worksurface Height, 24" and 28". To specify tile to floor, add an 'F' suffix to the pattern number and add \$16 for a single pack, \$31 for a double pack and \$95 for a 6 pack to the list price.

This page intentionally left blank

Slatwall Tiles

Slatwall tiles are designed to support KnollExtra Orchestra work tools. Slatwall tiles will support flat panel monitor arms with varying weight limitations based on mounting and application. Please refer to the KnollExtra price list for comprehensive mounting and weight limitation information by application. Slatwall kits include all mounting brackets and hardware for installation, and are fully assembled. SLATWALL TILES INCLUDE INTEGRAL TILE SUPPORT(S).

Slatwall tiles are field installed on Dividends Horizon DP7 panel frames. To specify, select the slatwall width to match the width of the panel frame, in either top or middle position locations.

Specify slatwall tiles along with built-to-spec panel frames and other tiles for a complete panel. Slatwall tiles may not be specified directly above or below other slatwall tiles, beltway, stack frames, or stacking screens. Slatwall tiles may not be specified on stack frames

Construction

Slatwall is constructed of heat treated extruded aluminum, powder coated in any Knoll Core paint color. 16 gauge steel reinforcements with integral hooks and tri-lobular screws on the back of slatwall provide reinforcement for heavy loads.

Note: Due to design improvements with the slatwall tile, monitor arm reinforcements are no longer required when hanging monitor arms from Dividends Horizon slatwall.

Top Position Slatwall Tiles

Top position slatwall tiles may be installed at the top of any Dividends Horizon DP7 panel frame, and include all required hardware. Top position slatwall is available in heights of 7, 14, 21 and 28 inches.

TOP POSITION SLATWALL TILES FEATURE AN INTEGRAL TILE SUPPORT AT THE BOTTOM, REPLACING THE SEPARATE D1 OR D2 TILE SUPPORT TYPICALLY REQUIRED BETWEEN TILES.

Middle Position Slatwall Tiles

Middle position slatwall tiles may be installed at the middle of any Dividends Horizon DP7 panel frame, and include all necessary hardware. Middle position slatwall is available in heights of 7, 14 and 21 inches.

MIDDLE POSITION SLATWALL TILES FEATURE AN INTEGRAL TILE SUPPORT AT THE TOP AND BOTTOM, REPLACING D1 OR D2 TILE SUPPORT TYPICALLY REQUIRED BETWEEN TILES.

Top Position Slatwall

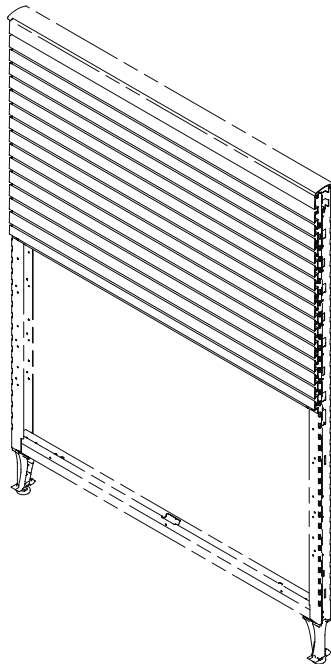



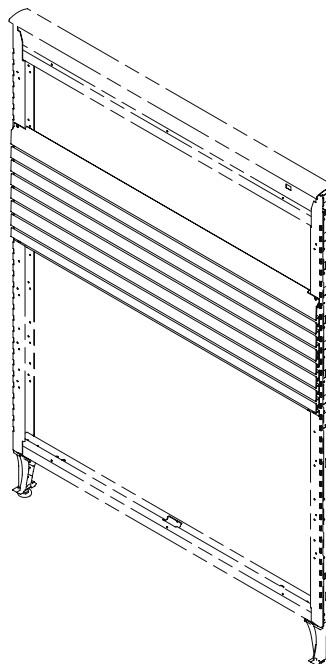

Middle Position Slatwall



Slatwall Tiles

7", 14", 21" and 28" High

Dividends Horizon

description	w	h	d	pattern no.	P1	P2	P3
7" High Slatwall Tile 	24"	7"	7/16"	DP1SW0724()	\$194.	\$213.	\$222.
	30"	7"	7/16"	DP1SW0730()	207.	229.	238.
	36"	7"	7/16"	DP1SW0736()	222.	244.	254.
	42"	7"	7/16"	DP1SW0742()	235.	258.	269.
	48"	7"	7/16"	DP1SW0748()	248.	273.	284.
14" High Slatwall Tile 	24"	14"	7/16"	DP1SW1424()	260.	287.	313.
	30"	14"	7/16"	DP1SW1430()	306.	337.	366.
	36"	14"	7/16"	DP1SW1436()	351.	386.	422.
	42"	14"	7/16"	DP1SW1442()	383.	422.	459.
	48"	14"	7/16"	DP1SW1448()	416.	457.	500.
21" High Slatwall Tile 	24"	21"	7/16"	DP1SW2124()	344.	379.	414.
	30"	21"	7/16"	DP1SW2130()	415.	455.	497.
	36"	21"	7/16"	DP1SW2136()	484.	533.	580.
	42"	21"	7/16"	DP1SW2142()	534.	587.	641.
	48"	21"	7/16"	DP1SW2148()	582.	642.	700.
28" Top Position Slatwall Tile 	24"	28"	7/16"	DP1SW2824()	428.	472.	514.
	30"	28"	7/16"	DP1SW2830()	521.	573.	625.
	36"	28"	7/16"	DP1SW2836()	615.	675.	737.
	42"	28"	7/16"	DP1SW2842()	682.	748.	817.
	48"	28"	7/16"	DP1SW2848()	747.	823.	898.

Panels, Build-To-Spec

Ordering Information

Post Assemblies

1. Pattern Number
2. Paint Finish

Order Code

Post Assemblies

Example: **DP1 S2824T, 111**
DP1 S2824Pattern Number
T
111 Jet Black Paint

Included with:

Note: Middle position slatwall tiles are able to be used on topway or full view panels.
 28" High Slatwall tiles are available for the top position only.

Options

Panel Options:

- (T)** = for topway panel top position
- (F)** = for full view panel top position
- (M)** = for middle position

Technology Tile

Dividends Horizon technology tiles are 14" or 28" high fabric or painted steel tiles with a factory installed technology port for above worksurface power and/or data access. Technology ports may be specified on the left, right, or both sides of technology tiles.

Each technology port has two openings: duplex power receptacles are positioned to the outside of the panel, while data ports may be positioned in either of the two positions. For applications where only one of the two openings is used, a knockout filler is included with each data port to fill this opening.

Technology tiles with one port accommodate one power and one data or two data outlets. Technology tiles with two ports accommodate up to two power receptacles and two data outlets, or four data outlets.

Specify vertical power modules, power receptacles, and data components separately.

Construction

Steel inserts are made of 20-gauge formed painted steel. Fabric inserts are made with a roll-coat adhesive, heat-cured to $\frac{7}{16}$ " thick acoustical board.

Available Sizes

Heights: 14", 28"
Widths: 18", 24", 30", 42", 48" and 60" (14" only)

Note: Steel technology tiles are only available in Knoll Core finishes

Note: Technology tiles are not able to be specified in the top position of 36" high topway panel.

14" High Technology Tile

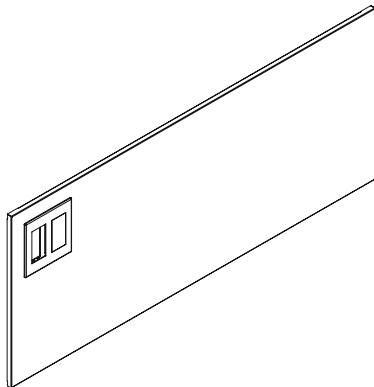

28" High Technology Tile

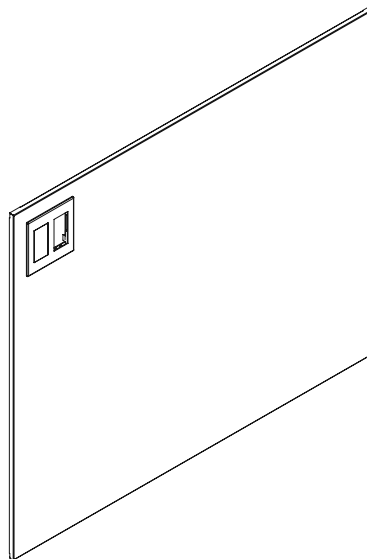

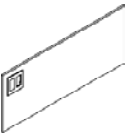
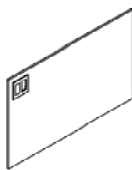
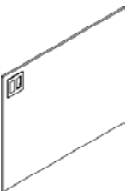
description	h	w	pattern no.	grade							
				10	15	20	25	30	35	40	45
14" High, Technology Tile Fabric 	14"	18"	DP6TF()1418	\$144.	\$147.	\$153.	\$154.	\$157.	\$160.	\$161.	\$165.
	14"	24"	DP6TF()1424	150.	153.	158.	160.	162.	167.	169.	174.
	14"	30"	DP6TF()1430	153.	155.	161.	165.	168.	171.	174.	178.
	14"	36"	DP6TF()1436	157.	161.	168.	169.	175.	178.	188.	189.
	14"	42"	DP6TF()1442	161.	165.	174.	175.	185.	189.	192.	195.
	14"	48"	DP6TF()1448	168.	169.	181.	188.	192.	193.	196.	202.
	14"	60"	DP6TF()1460	174.	176.	182.	183.	186.	188.	190.	193.
	Worksurface Height, Technology Tile Fabric 	22 1/2"	18"	DP6TF()WH18	189.	195.	199.	206.	209.	214.	221.
22 1/2"		24"	DP6TF()WH24	207.	214.	227.	234.	242.	245.	251.	263.
22 1/2"		30"	DP6TF()WH30	220.	227.	242.	248.	256.	263.	269.	280.
22 1/2"		36"	DP6TF()WH36	232.	242.	256.	265.	277.	284.	290.	297.
22 1/2"		42"	DP6TF()WH42	239.	246.	258.	267.	279.	286.	294.	304.
22 1/2"		48"	DP6TF()WH48	246.	256.	269.	280.	287.	295.	305.	321.
22 1/2"		60"	DP6TF()WH60	260.	270.	282.	295.	297.	306.	320.	345.
28" High, Technology Tile Fabric 		28"	18"	DP6TF()2818	189.	195.	199.	206.	209.	214.	221.
	28"	24"	DP6TF()2824	207.	214.	227.	234.	242.	245.	251.	263.
	28"	30"	DP6TF()2830	220.	227.	242.	248.	256.	263.	269.	280.
	28"	36"	DP6TF()2836	232.	242.	256.	265.	277.	284.	290.	297.
	28"	42"	DP6TF()2842	239.	246.	258.	267.	279.	286.	294.	304.
	28"	48"	DP6TF()2848	246.	256.	269.	280.	287.	295.	305.	321.

Panels, Build-To-Spec

Ordering Information

Technology Tile Fabric:

1. Pattern Number
2. Fabric
3. Bezel location

Order Code

Technology Tile Fabric

Example: **DP3TFL1418/ W352-4**

DP3TF Technology Tile Fabric

L Left Hand Bezel Location

14 Height

18 Width

W352-4 Labrynth Sage Fabric

Included with:

Technology Tile Fabric

- Fabric Technology Tile
- Bezel

Options

Technology Tile Fabric

Bezel Location Options:

- (L)** = Left Hand Bezel
- (R)** = Right Hand Bezel
- (D)** = Double Bezel - add \$43

Tile to Floor Options:

Tile to Floor available in heights of 14", Worksurface Height, and 28". To specify tile to floor, add an "F" suffix to the pattern number and add \$10 to the list price.

Technology Tiles Steel

Dividends Horizon

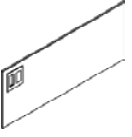
description	h	w	pattern no.	P1	P2	P3
 14" High, Technology Tile Steel	14"	18"	DP6TS()1418	\$126.	\$134.	\$137.
	14"	24"	DP6TS()1424	132.	139.	143.
	14"	30"	DP6TS()1430	133.	140.	144.
	14"	36"	DP6TS()1436	140.	148.	154.
	14"	42"	DP6TS()1442	143.	153.	157.
	14"	48"	DP6TS()1448	148.	159.	163.
	14"	60"	DP6TS()1460	158.	168.	172.

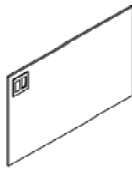
description	h	w	pattern no.	P1	P2	P3
 Worksurface Height, Technology Tile Steel	22 1/2"	18"	DP6TS()WH18	154.	163.	168.
	22 1/2"	24"	DP6TS()WH24	169.	182.	187.
	22 1/2"	30"	DP6TS()WH30	178.	189.	195.
	22 1/2"	36"	DP6TS()WH36	191.	206.	212.
	22 1/2"	42"	DP6TS()WH42	195.	210.	217.
	22 1/2"	48"	DP6TS()WH48	199.	213.	220.
	22 1/2"	60"	DP6TS()WH60	199.	213.	220.

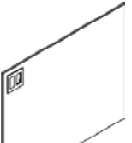
description	h	w	pattern no.	P1	P2	P3
 28" High, Technology Tile Steel	28"	18"	DP6TS()2818	154.	163.	168.
	28"	24"	DP6TS()2824	169.	182.	187.
	28"	30"	DP6TS()2830	178.	189.	195.
	28"	36"	DP6TS()2836	191.	206.	212.
	28"	42"	DP6TS()2842	195.	210.	217.
	28"	48"	DP6TS()2848	199.	213.	220.

Ordering Information

Technology Tile Steel

1. Pattern Number
2. Paint
3. Bezel location

Order Code

Technology Tile Steel

Example: **DP3TSL1418/ 113**

DPSTS Technology Tile Steel

L Left Hand Bezel Location

14 Height

18 Width

113 Dark Grey Paint Finish

Included with:

Technology Tile Steel

- Steel Technology Tile
- Bezel

Note: Steel technology tiles are only available in Knoll core finishes.

Options

Technology Tile Steel

Bezel Location Options:

- (L)** = Left Hand Bezel
- (R)** = Right Hand Bezel
- (D)** = Double Bezel - add \$43

Tile to Floor Options:

Tile to Floor available in heights of 14", Worksurface Height, and 28". To specify tile to floor, add an "F" suffix to the pattern number and add \$16 to the list price.

This page intentionally left blank

Open Weave Screens

Open Weave screens are designed to allow light and transparency into the workstation, while providing limited visual privacy.

When combined with Dividends Horizon freestanding components, open weave screen provide a layered aesthetic to the office.

Open Weave Screen Construction

Open weave screens feature Warp Net, a new open textile structure designed by Suzanne Tick. Warp net is constructed of 100% Earthtex, made from Olefin. Earthtex has passed the prestigious McDonough Braungart Design Chemistry Sustainability Protocol, and is fully recyclable.

Open weave screens have a triangular profile frame, made from extruded aluminum frame members, powder coated in any Knoll Core paint finish.

Open Weave Screen Dimensions:

Widths: 24, 30, 36, 42, and 48 inches
Heights: 36, 42, 50, 57, and 64 inches
Thickness: 3 inches

Glass Screens

Glass Screens, available in both triangular and rectangular profile frames, provide territorial privacy, while transmitting light into the office.

Glass Screen Construction

Glass screens are available in both triangular and rectangular frame profiles, made from extruded aluminum frame members, powder coated in any Knoll Core paint finish. Clear glass is 4mm thick tempered glass. Frosted acrylic is 6mm thick acrylic.

Glass Screen Dimensions

Widths: 24, 30, 36, 42 and 48 inches
Heights: 42, 50, 57 and 64 inches
Thickness: 3 inches

Planning With Screens

Dividends Horizon open weave and glass screens are primarily designed to divide space and let light into the office. Screens do not have a slotted standard, and do not support overhead storage components. Screens feature slots to allow use of a mid-span worksurface support at the standard 28 1/2" H worksurface height.

Screens attach to Dividends Horizon panels or connecting posts of the same or greater height, or other screens of the same height. In a "high/low" situation, screens do not attach to higher or lower screens, or lower panels. Screens ship with attachment hardware and topcap, if specified.

Open Weave Screen with Triangular Frame and Open Base Option

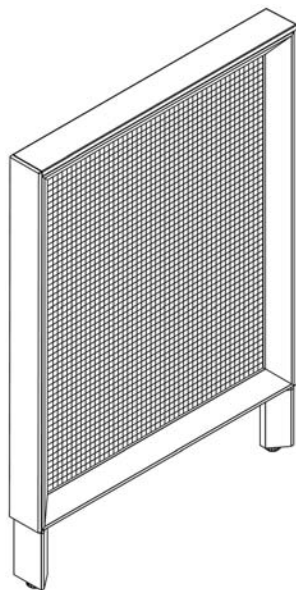

Glass Screen with Rectangular Frame and Open Base Option

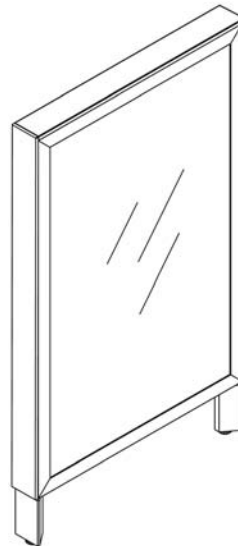

Screen Base Options

Open weave screens are available with three base options: base raceway, open base, or frame to floor. Triangular frame glass screens are available with three base options: base raceway, open base, or frame to floor. Rectangular frame glass screens are available with two base options: base raceway or open base. All bases feature leveling glides with 2" of vertical travel. Raceway covers are standard without knockouts. Screens support electrical pass-thru's, but do not support power modules or electrical receptacles.

Note: 36"H screen may not be connected to a Legacy post.

Note: 64" open weave screen "L" or "U" configurations require minimum 36" wide panel return(s).

Note: Raceway covers are not available with knockouts.

Note: Screens are only available in Knoll core finishes.

Freestanding Open Weave Screen Kits

When used with Open Weave Screens with frame-to-floor (FF) option, new Freestanding Open Weave Screen kits allow open weave screens to be used in freestanding applications, creating a sense of enclosure without the need for conventional panel or screen planning.

Freestanding Open Weave Screen Kits may be used with open weave screens only, and are not compatible with panels or glass screens.

A single open weave screen of any height or width may become freestanding by specifying the appropriately sized freestanding open weave screen kit. Freestanding open weave screen kits for single screen applications include (2) flat steel feet and (1) ballast plate. The width of the screen determines which freestanding open weave screen kit is specified. For example, a 48" wide open weave screen would use DP7SWTFK48.

Two open weave screens of the same height and width may be attached together to create a double freestanding open weave screen. There is a single pattern number (DP7SWTFKD) for the freestanding open weave screen kit that should be specified to create a double freestanding open weave screen. The double freestanding open weave screen kit includes (3) flat steel feet.

Note: Freestanding open weave screen kits are finished with textured paint, including 613 silver.

Freestanding Open Weave Screen Kit Dimensions

Flat Steel Feet

Width: 4 inches

Thickness: 7/16 inches

Depth: 20 inches



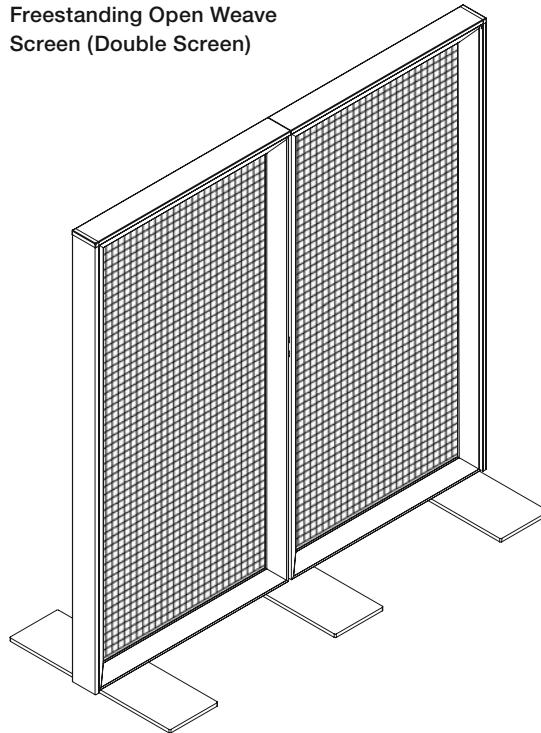

Freestanding Open Weave Screen (Double Screen)

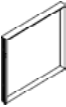

Open Weave and Glass Screens

Dividends Horizon

Open Weave Screens 36", 42", 50" and 57" High



description	h	w	t	pattern no.	P1	P2	P3
 36" High Open Weave Screen	36"	24"	3"	DP7SWT()3624	\$901.	\$919.	\$938.
	36"	30"	3"	DP7SWT()3630	992.	1,012.	1,032.
	36"	36"	3"	DP7SWT()3636	993.	1,013.	1,033.
	36"	42"	3"	DP7SWT()3642	1,039.	1,059.	1,081.
	36"	48"	3"	DP7SWT()3648	1,084.	1,106.	1,128.
 42" High Open Weave Screen	42"	24"	3"	DP7SWT()4224	973.	992.	1,012.
	42"	30"	3"	DP7SWT()4230	1,036.	1,057.	1,078.
	42"	30"	3"	DP7SWT()4236	1,101.	1,121.	1,144.
	42"	42"	3"	DP7SWT()4242	1,110.	1,133.	1,155.
	42"	48"	3"	DP7SWT()4248	1,120.	1,143.	1,165.
 50" High Open Weave Screen	50"	24"	3"	DP7SWT()5024	1,045.	1,064.	1,086.
	50"	30"	3"	DP7SWT()5030	1,081.	1,103.	1,125.
	50"	36"	3"	DP7SWT()5036	1,116.	1,139.	1,161.
	50"	42"	3"	DP7SWT()5042	1,183.	1,206.	1,230.
	50"	48"	3"	DP7SWT()5048	1,248.	1,273.	1,299.
 57" High Open Weave Screen	57"	24"	3"	DP7SWT()5724	1,064.	1,086.	1,107.
	57"	30"	3"	DP7SWT()5730	1,132.	1,155.	1,177.
	57"	36"	3"	DP7SWT()5736	1,199.	1,223.	1,247.
	57"	42"	3"	DP7SWT()5742	1,223.	1,248.	1,272.
	57"	48"	3"	DP7SWT()5748	1,248.	1,273.	1,299.

*Note: Frame to the floor shown

Ordering Information	Order Code	Included with:	Options
Open Weave Screen: 1. Pattern number 2. Frame finish 3. Top cap style 4. Top cap finish 5. Base finish 6. Fabric finish	Open Weave Screen: <i>Example:</i> DP7SWTFF3636 117/4/117/117/W1113-1 DP7SWT Triangular open weave screen FF Screen to Floor 117 Frame finish 4 Radius metal top cap 117 Top cap finish 117 Raceway finish W1113-1 Warp Net White	Open Weave Screen Note: 36" h screens are not compatible with Legacy post connectors. Note: Screens are only available in Knoll core finishes.	Open Weave Screen Top Cap Options: (2) = Extruded Plastic (Smooth Radius) (3) = No Top Cap (4) = Radius Metal, add \$38 P1, \$40 P2, \$42 P3 (5) = Flat Metal, add \$38 P1, \$40 P2, \$42 P3 paint grade Raceway Type: (FF) = Frame to the Floor both sides (RR) = Raceway covers no knockouts (LL) = Open base Note: Raceway covers are not available with knockouts.

Open Weave Screens

64" High and Freestanding Open Weave Screen Kits

description	type	h	w	d	pattern no.	P1	P2	P3
 <p>64" High Open Weave Screen</p>		64"	24"	3"	DP7SWT()6424	\$1,084.	\$1,106.	\$1,128.
		64"	30"	3"	DP7SWT()6430	1,184.	1,207.	1,231.
		64"	36"	3"	DP7SWT()6436	1,247.	1,272.	1,297.
		64"	42"	3"	DP7SWT()6442	1,264.	1,289.	1,314.
		64"	48"	3"	DP7SWT()6448	1,281.	1,307.	1,332.
 <p>Freestanding Open Weave Screen Kit</p> <p>(single screen kit shown)</p>	For use with 2 open weave screens				DP7SWTFKD	420.	462.	480.
	For use with 24" wide open weave screen				DP7SWTFK24	392.	431.	448.
	For use with 30" wide open weave screen				DP7SWTFK30	397.	437.	454.
	For use with 36" wide open weave screen				DP7SWTFK36	407.	448.	466.
	For use with 42" wide open weave screen				DP7SWTFK42	420.	462.	480.
	For use with 48" wide open weave screen				DP7SWTFK48	420.	462.	480.

Panels, Build-To-Spec

Ordering Information

Open Weave Screen:

1. Pattern number
2. Frame finish
3. Top cap style
4. Top cap finish
5. Base finish
6. Fabric finish

Freestanding Open Weave Screen Kits

1. Pattern number
2. Paint finish

Order Code

Open Weave Screen:

Example: **DP7SWTFF3636**
117/4/117/117/W1113-1

DP7SWT	Triangular open weave screen
FF	Screen to Floor
117	Frame finish
4	Radius metal top cap
117	Top cap finish
117	Raceway finish
W1113-1	Warp Net White

Included with:

Open Weave Screen

Note: Freestanding open weave screen kits are finished with textured paint, including 613 Silver.

Note: Freestanding open weave screen kits only work with open weave screens with frame-to-floor (FF) base option.

Options:

Open Weave Screen

Top Cap Options:
(2) = Extruded Plastic (Smooth Radius)
(3) = No Top Cap
(4) = Radius Metal, add \$38 P1, \$40 P2, \$42 P3
(5) = Flat Metal, add \$38 P1, \$40 P2, \$42 P3 paint grade

Raceway Type:
(FF) = Frame to the Floor both sides
(RR) = Raceway covers no knockouts
(LL) = Open base

Note: Raceway covers are not available with knockouts.

Open Weave and Glass Screens

Triangular Frame Screen with Glass or Frosted Acrylic 42" and 50" High

Dividends Horizon

description	h	w	t	pattern no.	P1	P2	P3
42" High Triangular Frame Screen with Glass 	42"	24"	3"	DP7S()T()4224	\$915.	\$934.	\$952.
	42"	30"	3"	DP7S()T()4230	969.	989.	1,008.
	42"	36"	3"	DP7S()T()4236	1,025.	1,046.	1,065.
	42"	42"	3"	DP7S()T()4242	1,047.	1,068.	1,088.
	42"	48"	3"	DP7S()T()4248	1,068.	1,088.	1,109.

50" High Triangular Frame Screen with Glass 	50"	24"	3"	DP7S()T()5024	984.	1,004.	1,024.
	50"	30"	3"	DP7S()T()5030	1,010.	1,030.	1,050.
	50"	36"	3"	DP7S()T()5036	1,035.	1,055.	1,076.
	50"	42"	3"	DP7S()T()5042	1,121.	1,143.	1,165.
	50"	48"	3"	DP7S()T()5048	1,204.	1,229.	1,253.

*Note: Frame with raceway covers shown

Ordering Information	Order Code	Included with:	Options
Triangular Frame Screen with Glass: 1. Pattern number 2. Frame finish 3. Glass type 4. Top cap style 5. Top cap finish 6. Raceway finish	Triangular Frame with Glass: <i>Example:</i> DP7SGTRR4236 117/4/117/117 <hr/> DP7SGT Triangular frame with clear glass <hr/> RR Raceway type <hr/> 117 Frame finish <hr/> 4 Radius metal top cap <hr/> 117 Top cap finish <hr/> 117 Raceway finish	Triangular Frame with Glass <ul style="list-style-type: none"> • Topcap (when specified) • Connecting hardware Note: Screens are only available in Knoll core finishes.	Glass Options: (G) = Clear Tempered Glass (F) = Frosted Acrylic Top Cap Options: (2) = Extruded Plastic (Smooth Radius) (3) = No Top Cap (4) = Radius Metal, add \$38 P1, \$40 P2, \$42 P3 (5) = Flat Metal, add \$38 P1, \$40 P2, \$42 P3 paint grades

Raceway Type:
(FF) = Frame to the Floor both sides
(RR) = Raceway covers no knockouts
(LL) = Open base

Frame to floor option not available on Triangular glass screens.

Note: Raceway covers are not available with knockouts.

Open Weave and Glass Screens

Triangular Frame Screen with Glass or Frosted Acrylic

57" and 64" High

description	h	w	t	pattern no.	P1	P2	P3
57" High Triangular Frame Screen with Glass	57"	24"	3"	DP7S()T()5724	\$1,010.	\$1,030.	\$1,050.
	57"	30"	3"	DP7S()T()5730	1,065.	1,086.	1,107.
	57"	36"	3"	DP7S()T()5736	1,122.	1,144.	1,167.
	57"	42"	3"	DP7S()T()5742	1,167.	1,189.	1,213.
	57"	48"	3"	DP7S()T()5748	1,210.	1,235.	1,259.



64" High Triangular Frame Screen with Glass	64"	24"	3"	DP7S()T()6424	1,034.	1,054.	1,075.
	64"	30"	3"	DP7S()T()6430	1,121.	1,143.	1,165.
	64"	36"	3"	DP7S()T()6436	1,206.	1,232.	1,256.
	64"	42"	3"	DP7S()T()6442	1,211.	1,236.	1,260.
	64"	48"	3"	DP7S()T()6448	1,215.	1,240.	1,264.



Panels, Build-To-Spec

*Note: Frame to the floor shown

Ordering Information	Order Code	Included with:	Options
Triangular Frame Screen with Glass: 1. Pattern number 2. Frame finish 3. Glass type 4. Top cap style 5. Top cap finish 6. Raceway finish	Triangular Frame with Glass: <i>Example:</i> DP7SGTTRR5736 117/4/117/117 <hr/> DP7SGT Triangular frame with clear glass <hr/> RR Raceway type <hr/> 117 Frame finish <hr/> 4 Radius metal top cap <hr/> 117 Top cap finish <hr/> 117 Raceway finish	Triangular Frame with Glass <ul style="list-style-type: none"> • Topcap (when specified) • Connecting hardware Note: Screens are only available in Knoll core finishes.	Glass Options: (G) = Clear Tempered Glass (F) = Frosted Acrylic Top Cap Options: (2) = Extruded Plastic (Smooth Radius) (3) = No Top Cap (4) = Radius Metal, add \$38 P1, \$40 P2, \$42 P3 (5) = Flat Metal, add \$38 P1, \$40 P2, \$42 P3 paint grades Raceway Type: (FF) = Frame to the Floor both sides (RR) = Raceway covers no knockouts (LL) = Open base Note: Raceway covers are not available with knockouts.

Open Weave and Glass Screens

Rectangular Frame Screen with Glass or Frosted Acrylic

42" and 50" High

description	h	w	t	pattern no.	P1	P2	P3
42" High Rectangular Frame Screen with Glass	42"	24"	3"	DP7S()R()4224	\$921.	\$939.	\$958.
	42"	30"	3"	DP7S()R()4230	977.	995.	1,016.
	42"	36"	3"	DP7S()R()4236	1,033.	1,053.	1,074.
	42"	42"	3"	DP7S()R()4242	1,054.	1,075.	1,096.
	42"	48"	3"	DP7S()R()4248	1,076.	1,098.	1,120.



50" High Rectangular Frame Screen with Glass	50"	24"	3"	DP7S()R()5024	992.	1,013.	1,033.
	50"	30"	3"	DP7S()R()5030	1,019.	1,040.	1,060.
	50"	36"	3"	DP7S()R()5036	1,045.	1,065.	1,086.
	50"	42"	3"	DP7S()R()5042	1,131.	1,154.	1,176.
	50"	48"	3"	DP7S()R()5048	1,217.	1,242.	1,266.



Ordering Information

Rectangular Frame Screen with Glass:

1. Pattern number
2. Frame finish
3. Glass type
4. Top cap style
5. Top cap finish
6. Raceway finish

Order Code

Rectangular Frame with Glass:

Example: **DP7SGRRR4236**
117/4/117/117

DP7SGR	Rectangular frame screen with clear glass
RR	Raceway type
117	Frame finish
4	Radius metal top cap
117	Top cap finish
117	Raceway finish

Included with:

Rectangular Frame Glass

- Topcap (when specified)
- Connecting hardware

Note: Screens are only available in Knoll core finishes.

Options

Glass Options:

- (G)** = Clear Tempered Glass
(F) = Frosted Acrylic

Top Cap Options:

- (2)** = Extruded Plastic (Smooth Radius)
(3) = No Top Cap
(4) = Radius Metal, add \$38 P1, \$40 P2, \$42 P3
(5) = Flat Metal, add \$38 P1, \$40 P2, \$42 P3 paint grades

Raceway Type:

- (RR)** = Raceway covers no knockouts
(LL) = Open base

Frame to floor option not available on Rectangular glass screens.

Note: Raceway covers are not available with knockouts.

Open Weave and Glass Screens

Rectangular Frame Screen with Glass or Frosted Acrylic

57" and 64" High

description	h	w	t	pattern no.	P1	P2	P3
57" High Rectangular Frame Screen with Glass	57"	24"	3"	DP7S()R()5724	\$1,017.	\$1,038.	\$1,058.
	57"	30"	3"	DP7S()R()5730	1,075.	1,097.	1,119.
	57"	36"	3"	DP7S()R()5736	1,132.	1,155.	1,177.
	57"	42"	3"	DP7S()R()5742	1,177.	1,200.	1,225.
	57"	48"	3"	DP7S()R()5748	1,223.	1,246.	1,271.



64" High Rectangular Frame Screen with Glass	64"	24"	3"	DP7S()R()6424	1,041.	1,062.	1,082.
	64"	30"	3"	DP7S()R()6430	1,130.	1,153.	1,175.
	64"	36"	3"	DP7S()R()6436	1,218.	1,243.	1,267.
	64"	42"	3"	DP7S()R()6442	1,223.	1,246.	1,271.
	64"	48"	3"	DP7S()R()6448	1,226.	1,250.	1,274.



Ordering Information

Rectangular Frame Screen with Glass:

1. Pattern number
2. Frame finish
3. Glass type
4. Top cap style
5. Top cap finish
6. Raceway finish

Order Code

Rectangular Frame with Glass:

Example: **DP7SGRRR5736**
117/4/117/117

DP7SGR	Rectangular frame screen with clear glass
RR	Raceway type
117	Frame finish
4	Radius metal top cap
117	Top cap finish
117	Raceway finish

Included with:

Rectangular Frame Glass

- Topcap (when specified)
- Connecting hardware

Note: Screens are only available in Knoll core finishes.

Options

Glass Options:

- (G)** = Clear Tempered Glass
- (F)** = Frosted Acrylic

Top Cap Options:

- (2)** = Extruded Plastic (Smooth Radius)
- (3)** = No Top Cap
- (4)** = Radius Metal, add \$38 P1, \$40 P2, \$42 P3
- (5)** = Flat Metal, add \$38 P1, \$40 P2, \$42 P3 paint grades

Raceway Type:

- (RR)** = Raceway covers no knockouts
- (LL)** = Open base

Frame to floor option not available on Rectangular glass screens.

Note: Raceway covers are not available with knockouts.

Stacking Open Weave Screens

Stacking open weave screens are designed to allow light and transparency into the workstation, while providing limited visual privacy. When combined with Dividends Horizon freestanding components, open weave screens provide a layered aesthetic to the office.

Stacking Open Weave Screen Construction

Open weave screens feature Warp Net, a new open textile structure designed by Suzanne Tick. Warp Net is constructed of 100% Earthtex, made from Olefin. Earthtex has passed the prestigious McDonough Braungart Design Chemistry Sustainability Protocol, and is fully recyclable.

Open weave screens have a triangular profile frame, made from extruded aluminum frame members, powder coated in any Knoll Core paint finish.

Stacking Glass Screens

Stacking glass screens, available in both triangular and rectangular profile frames, provide territorial privacy, while transmitting light into the office.

Stacking Glass Screen Construction

Stacking glass screens are constructed of extruded aluminum frame members, powder coated in any Knoll Core paint finish. Clear glass is 4mm tempered glass. Frosted material is 6mm acrylic.

Stacking Screen Dimensions:

Widths: 24, 30, 36, 42, and 48 inches
Heights: 14, 21 and 28 inches
Thickness: 3 inches

Planning With Stacking Screens

Dividends Horizon open weave and glass screens are primarily designed to divide space and let light into the office. Screens do not have a slotted standard, and do not support overhead storage components.

Stacking screens attach to any Dividends Horizon DP7V series full view panel frame, and may be stacked one tier high. Stacking screens do not stack on topway panel frames.

Stacking screens attach to Dividends Horizon DP7V panels or connecting posts of the same or greater height, or other screens of the same height.

Note: Stacking screens may be used with DP7 full view panel frames only.

Note: Screens are only available in Knoll core finishes.

Note: Knoll's three window types are aesthetically and functionally different, and are not designed to be mixed together within a single installation.

Triangular Stack Panel Screen with Open Weave Fabric insert

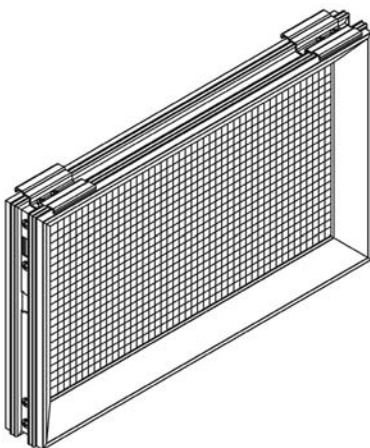

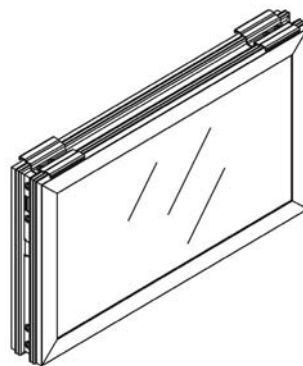

Rectangular Stack Panel Screen with Glass insert



Open Weave and Glass Stacking Screens

Triangular Frame Stacking Screen with Open Weave Fabric

Dividends Horizon

description	h	w	t	pattern no.	P1	P2	P3
14" High Triangular Frame Stacking Screen with Open Weave Fabric 	14"	24"	3"	DP7SSWT1424	\$521.	\$532.	\$542.
	14"	30"	3"	DP7SSWT1430	551.	563.	573.
	14"	36"	3"	DP7SSWT1436	582.	594.	605.
	14"	42"	3"	DP7SSWT1442	605.	618.	629.
	14"	48"	3"	DP7SSWT1448	627.	639.	652.
21" High Triangular Frame Stacking Screen with Open Weave Fabric 	21"	24"	3"	DP7SSWT2124	559.	570.	581.
	21"	30"	3"	DP7SSWT2130	595.	606.	619.
	21"	36"	3"	DP7SSWT2136	631.	644.	656.
	21"	42"	3"	DP7SSWT2142	656.	671.	683.
	21"	48"	3"	DP7SSWT2148	680.	694.	708.
28" High Triangular Frame Stacking Screen with Open Weave Fabric 	28"	24"	3"	DP7SSWT2824	596.	607.	620.
	28"	30"	3"	DP7SSWT2830	638.	651.	663.
	28"	36"	3"	DP7SSWT2836	680.	694.	708.
	28"	42"	3"	DP7SSWT2842	708.	721.	736.
	28"	48"	3"	DP7SSWT2848	734.	748.	764.

Panels, Build-To-Spec

Ordering Information

Triangular Frame Stacking Screen with Open Weave Fabric:

1. Pattern number
2. Frame finish
3. Fabric finish

Order Code

Triangular Frame Stacking Screen with Open Weave Fabric:

Example: **DP7SSWT1436**
117/W1113-1

DP7SSWT Stack, triangular frame, open weave

117 Frame finish

W1113-1 Fabric finish

Included with:



Triangular Frame Stacking Screen with Open Weave Fabric

- Attachment hardware

Note: Screens are only available in Knoll core finishes.

NOTE: Stacking screens are compatible with DP7 Full View panels only.

Triangular Frame Stacking Screen with Glass or Frosted Acrylic

description	h	w	t	pattern no.	P1	P2	P3
14" High Triangular Frame Stacking Screen with Glass or Frosted Acrylic 	14"	24"	3"	DP7SS()T1424	\$522.	\$533.	\$543.
	14"	30"	3"	DP7SS()T1430	548.	559.	570.
	14"	36"	3"	DP7SS()T1436	575.	586.	599.
	14"	42"	3"	DP7SS()T1442	602.	613.	626.
	14"	48"	3"	DP7SS()T1448	628.	639.	653.
21" High Triangular Frame Stacking Screen with Glass or Frosted Acrylic 	21"	24"	3"	DP7SS()T2124	564.	575.	587.
	21"	30"	3"	DP7SS()T2130	596.	608.	620.
	21"	36"	3"	DP7SS()T2136	627.	638.	652.
	21"	42"	3"	DP7SS()T2142	658.	671.	684.
	21"	48"	3"	DP7SS()T2148	689.	705.	718.
28" High Triangular Frame Stacking Screen with Glass or Frosted Acrylic 	28"	24"	3"	DP7SS()T2824	606.	618.	630.
	28"	30"	3"	DP7SS()T2830	642.	656.	667.
	28"	36"	3"	DP7SS()T2836	678.	690.	706.
	28"	42"	3"	DP7SS()T2842	716.	730.	744.
	28"	48"	3"	DP7SS()T2848	752.	768.	782.

Ordering Information

Triangular Frame Stacking Screen

1. Pattern number
2. Frame finish
3. Glass

Order Code

Triangular Frame Stacking Screen

Example: **DP7SSGT1424 / 117**
DP7SSGT Stack, Triangular Frame,
w/ clear tempered glass
117 Frame finish

Included with:

Triangular Frame Stacking Screen



- Attachment hardware
- Note:** Screens are only available in Knoll core finishes.

Options

NOTE: Stacking screens are compatible with DP7 Full View panels only.

Glass Options:
(G) = Clear Tempered Glass
(F) = Frosted Acrylic

Rectangular Frame Stacking Screen with Glass or Frosted Acrylic

description	h*	w	t	pattern no.	P1	P2	P3
14" High Rectangular Frame Stacking Screen with Glass or Frosted Acrylic 	14"	24"	3"	DP7SS()R1424	\$514.	\$523.	\$534.
	14"	30"	3"	DP7SS()R1430	541.	552.	563.
	14"	36"	3"	DP7SS()R1436	567.	578.	591.
	14"	42"	3"	DP7SS()R1442	595.	607.	619.
	14"	48"	3"	DP7SS()R1448	622.	633.	647.
21" High Rectangular Frame Stacking Screen with Glass or Frosted Acrylic 	21"	24"	3"	DP7SS()R2124	556.	567.	578.
	21"	30"	3"	DP7SS()R2130	588.	601.	611.
	21"	36"	3"	DP7SS()R2136	620.	632.	646.
	21"	42"	3"	DP7SS()R2142	653.	665.	679.
	21"	48"	3"	DP7SS()R2148	684.	698.	712.
28" High Rectangular Frame Stacking Screen with Glass or Frosted Acrylic 	28"	24"	3"	DP7SS()R2824	600.	611.	624.
	28"	30"	3"	DP7SS()R2830	635.	649.	660.
	28"	36"	3"	DP7SS()R2836	673.	685.	701.
	28"	42"	3"	DP7SS()R2842	711.	725.	740.
	28"	48"	3"	DP7SS()R2848	748.	764.	777.

Panels, Build-To-Spec

Ordering Information

Rectangular Frame Stacking Screen:

1. Pattern number
2. Frame finish
3. Glass

Order Code

Rectangular Frame Stacking Screen:

Example: **DP7SSGR1424/117**

DP7SSGR Stack, Rectangular Frame, w/clear tempered glass

117 Raceway finish

Included with:

Rectangular Frame Stacking Screen:

- Attachment hardware

Note: Screens are only available in Knoll core finishes.

Options

NOTE: Stacking screens are compatible with DP7 Full View panels only.

Glass Options:
(G) = Clear Tempered Glass
(F) = Frosted Acrylic

Frameless Add Up

Frameless add ups provide additional privacy between workstations, while creating a lighter and more transparent space. Combining frameless glass add ups with Dividends Horizon panels provides a clean, light aesthetic.

Frameless add ups are available in clear or powder glass. 7" and 14" heights are available, which is consistent with Dividends Horizon panel frame height increments.

Frameless add ups replace flat top caps on panels, bolting onto the panel frame. Add ups are not available in radius profile.

Frameless Glass Add Up Construction

Frameless glass add ups feature an extruded aluminum base and are available in any Knoll Core paint finish. Legacy finishes are not available.

Clear tempered or powder glass is ½" thick with polished edge.

Frameless Glass Add Up Dimensions

- Widths: 15, 18, 24, 30, 36, 42, 48, 54, 60, 66, and 72 inches
- Heights: 7 and 14 inches
- Thickness: 3 inches

Planning with Frameless Add Ups

Frameless add ups attach to the top of any height Dividends or Dividends Horizon topway or full view panel frame or stack frame, regardless of production date.

Frameless add ups replace the panel top cap and can span over one or more panels up to 72" wide.

Dividends Horizon frameless add ups are designed for use in same-height panel applications, and also support change of height applications involving a post connection.

Frameless add ups do not currently support change of height applications in straight line panel-to-panel conditions.

End caps are specified for each end of a run of add ups. End caps must be specified separately and are available in packages of ten.

Frameless Add Up Alignment Clip

A clear polycarbonate alignment clip maintains alignment between frameless add up inserts. One alignment clip is included with every frameless add up. Alignment clips do not need to be specified separately.

14" High Frameless Add Up

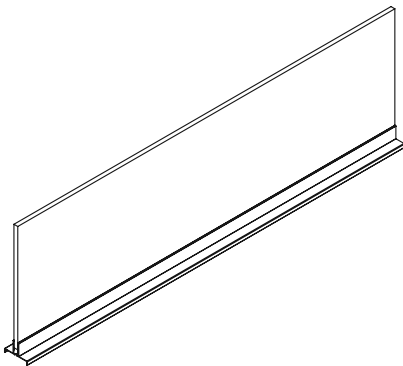

7" High Frameless Add Up

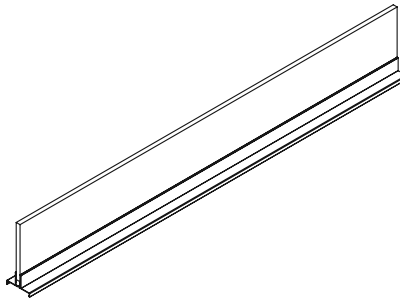

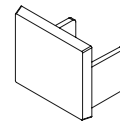

Frameless Add Up End Cap



Frameless Add Up

Clear and Powder Glass

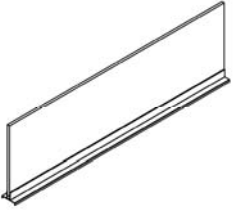
Dividends Horizon

description	w	d	h	pattern no.	list	Clear (TEMP)	Powder (GL13)
Frameless Add Up, 7" High 	15"	1/2"	7"	DP1AU0715()G		\$194.	\$208.
	18"	1/2"	7"	DP1AU0718()G		216.	234.
	24"	1/2"	7"	DP1AU0724()G		237.	261.
	30"	1/2"	7"	DP1AU0730()G		259.	287.
	36"	1/2"	7"	DP1AU0736()G		293.	326.
	42"	1/2"	7"	DP1AU0742()G		326.	365.
	48"	1/2"	7"	DP1AU0748()G		360.	404.
	54"	1/2"	7"	DP1AU0754()G		391.	441.
	60"	1/2"	7"	DP1AU0760()G		423.	477.
	66"	1/2"	7"	DP1AU0766()G		454.	514.
	72"	1/2"	7"	DP1AU0772()G		485.	551.
Frameless Add Up, 14" High 	15"	1/2"	14"	DP1AU1415()G		240.	267.
	18"	1/2"	14"	DP1AU1418()G		277.	313.
	24"	1/2"	14"	DP1AU1424()G		314.	360.
	30"	1/2"	14"	DP1AU1430()G		351.	406.
	36"	1/2"	14"	DP1AU1436()G		403.	469.
	42"	1/2"	14"	DP1AU1442()G		454.	531.
	48"	1/2"	14"	DP1AU1448()G		506.	594.
	54"	1/2"	14"	DP1AU1454()G		556.	654.
	60"	1/2"	14"	DP1AU1460()G		605.	715.
	66"	1/2"	14"	DP1AU1466()G		655.	775.
	72"	1/2"	14"	DP1AU1472()G		704.	836.
End Cap 	Package of Ten			DP1AUECTP	34.		

Panels, Build-To-Spec

Ordering Information	Order Code	Included with:	Options
Frameless Add Up with Clear Glass 1. Pattern number 2. Frame finish 3. Glass finish End Cap 1. Pattern number 2. Paint finish	Frameless Add Up with Clear Glass <i>Example:</i> DP1AU0736VG DP1AU Frameless Add Up 07 7" High 36 36" Wide V Full view G Glass 117 Frame finish TEMP Clear glass finish	Frameless Add Up with Clear Glass <ul style="list-style-type: none"> Attachment hardware Topway Trough Spacer (Topway only) Alignment Clip 	Frame Options: (V) = Full view (C) = Topway Glass Options: (TEMP) = Clear (GL13) = Powder

Dividends Horizon DP7 Post Assemblies

Post assemblies are required for all "L", "T", and "X" applications involving same-height panels. Included with post assemblies are the appropriate post, post cover, top cap and inside corner raceway filler.

Posts use the universal panel connection hardware, which is included with the post, for attachment.

For high-low and post-to-panel applications, posts and covers must be ordered separately by component.

Dividends Horizon Post and Trim Construction

Posts are 3" square extruded aluminum construction. Post covers are powder-coated 20 gauge steel.

Posts have cut-outs for electrical and data access that match the wire and cable channels provided by panel frames. This allows cables to be routed through the post at the topway and base raceway. Refer to the Beltway Electrical Specification page for cable routing information.

The illustrations that follow are common same-height post assembly configurations. Choose the post assembly that matches the required application.

Post "L" Configuration

"L" post assembly includes:

- Universal post
- Two-way top cap
- Corner post cover
- Inside corner raceway filler

Post "T" Configuration

"T" post assembly includes:

- Universal post
- Three-way top cap
- Straight post cover
- Inside corner raceway filler

Post "X" Configuration

"X" post assembly includes:

- Universal post
- Four-way top cap
- Inside corner raceway filler

Post "X" Configuration

Trim options available:

- Radius
- Flat

Two-way Post Connection

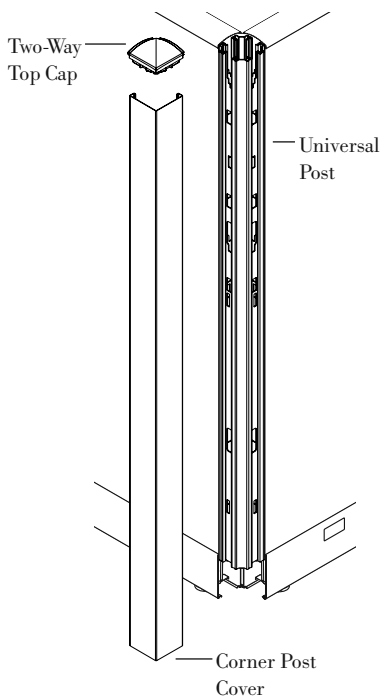

Post and Cover Plan Views

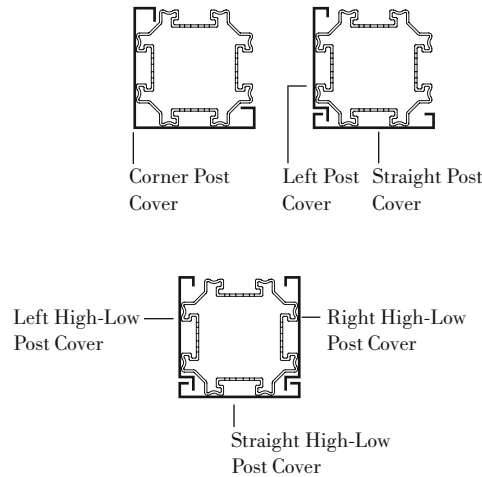

Post "L" Configuration

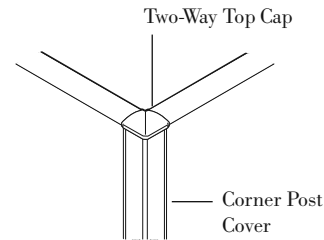

Post "T" Configuration

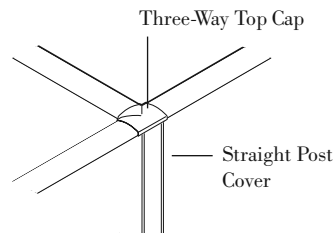

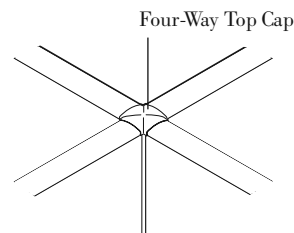

Post "X" Configuration



Dividends Horizon DP7 Post Assemblies

L, T and X Configurations

Dividends Horizon

description	h	w	d	pattern no.	P1	P2	P3
 Dividends Horizon Two-Way Post Assembly ("L")	28 1/2"	3"	3"	DP7PAWH2()	\$136.	\$143.	\$151.
	36"	3"	3"	DP7PA362()	136.	143.	151.
	42"	3"	3"	DP7PA422()	136.	143.	151.
	50"	3"	3"	DP7PA502()	147.	156.	163.
	57"	3"	3"	DP7PA572()	174.	184.	191.
	64"	3"	3"	DP7PA642()	174.	184.	191.
	78"	3"	3"	DP7PA782()	252.	267.	279.
 Dividends Horizon Three-Way Post Assembly ("T")	28 1/2"	3"	3"	DP7PAWH3()	141.	149.	156.
	36"	3"	3"	DP7PA363()	141.	149.	156.
	42"	3"	3"	DP7PA423()	141.	149.	156.
	50"	3"	3"	DP7PA503()	151.	158.	166.
	57"	3"	3"	DP7PA573()	174.	185.	191.
	64"	3"	3"	DP7PA643()	174.	185.	191.
	78"	3"	3"	DP7PA783()	250.	262.	277.
 Dividends Horizon Four-Way Post Assembly ("X")	28 1/2"	3"	3"	DP7PAWH4()	131.	138.	144.
	36"	3"	3"	DP7PA364()	131.	138.	144.
	42"	3"	3"	DP7PA424()	131.	138.	144.
	50"	3"	3"	DP7PA504()	138.	146.	154.
	57"	3"	3"	DP7PA574()	158.	167.	175.
	64"	3"	3"	DP7PA644()	158.	167.	175.
	78"	3"	3"	DP7PA784()	229.	240.	252.

Post Connectors/End Trim

Ordering Information

Post Assemblies

1. Pattern Number
2. Finish

Order Code

Post Assemblies

Example: **DP7PA362,5,113**
613 Silver Paint Finish

Included with:

Post Assemblies

- Post
- Post top cap
- Post cover
- Connecting hardware
- Base inside corner fillers

Note: Worksurface Height panels do not connect to any other panel height.

Options

Post Assemblies

- (4)** = Radius
- (5)** = Flat Profile

Note: Plastic and veneer versions not available.

High-Low Post Components

High-Low panel-to-post configurations require ordering the post covers by components.

Shown are common high-low panel-to-post configurations. Choose the high-low panel-to-post configuration that matches the required application.

Posts use the universal panel connection hardware for attachment, which is included with the post.

High-Low "L" Post Connector Configuration (see Figure 1)

High-Low "L" components required:

- 1 One, universal post that matches height of tallest panel DP7PO(64)
- 2 One, "one-way" post top cap DP7PT1(5)
- 3 One corner post covers that match height of tallest panel. DP7PC(64)2
- 4 One, high-low right hand post cover that matches high-low panel-to-post dimension. DP7PC(14)(R)H - Mirrored configuration would require left hand cover DP7PC(14)(L)H

High-Low "T" Post Connector Configuration A (see Figure 2)

High-Low "T" components required:

- 1 One, universal post that matches height of tallest panel DP7PO(64)
- 2 One, "two-way" top cap DP7PT2(5)
- 3 One, straight post cover that matches height of tallest panel DP7PC(64)
- 4 One, high-low right hand post cover that matches high-low panel-to-post dimension DP7PC(14)(R)H - Mirrored configuration would require a left hand cover DP7PC(14)(L)H

High-Low "T" Post Connector Configuration B (see Figure 3)

High-Low "T" components required:

- 1 One, universal post that matches height of tallest panel DP7PO(64)
- 2 One, "in-line" top cap DP7PTS(5)
- 3 One, straight post cover that matches height of tallest panel DP7PC(64)
- 4 One, high-low straight post cover that matches high-low panel-to-post dimension DP7PC(14)H

Hi-Low "T" Post Connector Configuration C (see Figure 4)

High-Low "T" components required:

- 1 One, universal post that matches height of tallest panel DP7PO(64)
- 2 One, "one-way" top cap DP7PT1(5)
- 3 One, straight post cover that matches height of tallest panel DP7PC(64)
- 4 Two, high-low right hand post covers that match high-low panel-to-post dimension DP7PC(14)(R)H - Mirrored configuration would require left hand covers DP7PC(14)(L)H

Figure 1

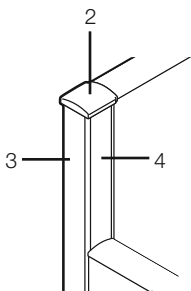

Figure 2

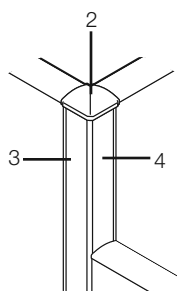

Figure 3

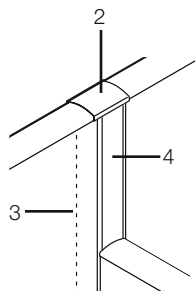
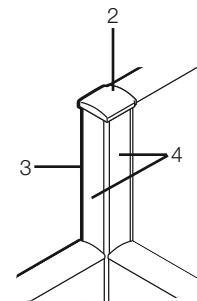

Figure 4



Post Top Caps



High-Low "X" Post Connector Configuration A (see Figure 5)

High-Low "X" components required (best method of various options):

- 1 One universal post that matches height of tallest panel DP7PO(64)
- 2 One, "one-way" top cap DP7PT1(5)
- 3 One, high-low straight post cover that matches high-low panel-to-post dimensions DP7PC(14)H
- 4 Two, high-low right hand post covers that match high-low panel-to-post dimensions DP7PC(14)(R)H - Mirrored configuration would require left hand covers DP7PC(14)(L)H

High-Low "X" Post Connector Configuration B (see Figure 6)

High-Low "X" components required:

- 1 One, universal post that matches height of tallest panel DP7PO(64)
- 2 One, "in-line" top cap DP7PTS(5)
- 3 Two, high-low straight post covers that match high-low panel-to-post dimensions DP7PC(14)H

High-Low "X" Post Connector Configuration C (see Figure 7)

High-Low "X" components required:

- 1 One, universal post that matches height of tallest panel DP7PO(64)
- 2 One, "two-way" top cap DP7PT2(5)
- 3 One, high-low straight post cover that matches high-low panel-to-post dimension. DP7PC(14)H
- 4 One, high-low right hand post cover that matches high-low panel-to-post dimension. DP7PC(14)(R)H - Mirrored configuration would require left hand cover DP7PC(14)(L)H

High-Low "X" Post Connector Configuration D (see Figure 8)

High-Low "X" components required:

- 1 One, universal post that matches height of tallest panel DP7PO(64)
- 2 One, "three-way" top cap DP7PT3(5)
- 3 One, high-low straight post cover that matches high-low panel-to-post dimension DP7PC(14)H

Figure 5

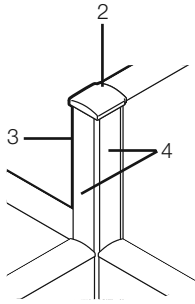

Figure 6

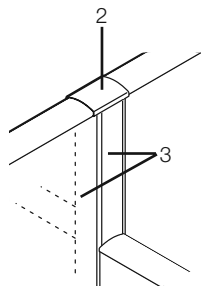

Figure 7

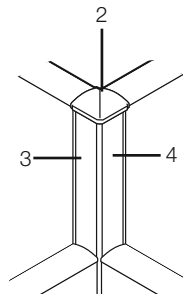
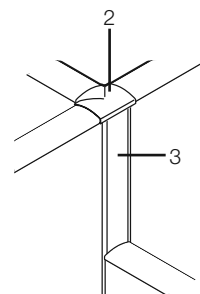
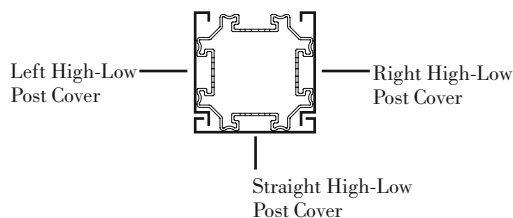











Figure 8



Post Plan View



Post, Stack Panel Post, Post Top Caps and Inside Corner Raceway Filler

description	type	h	w	d	pattern no.	list price	P1	P2	P3
Dividends Horizon Universal Post 		28 1/2"	3"	3"	DP7POWH	\$73.			
		36"	3"	3"	DP7PO36	73.			
		42"	3"	3"	DP7PO42	73.			
		42"	3"	3"	DP7PO50	84.			
		57"	3"	3"	DP7PO57	100.			
		64"	3"	3"	DP7PO64	100.			
	78"	3"	3"	DP7PO78	173.				
14" High Dividends Horizon Stack Panel Post		14 5/8"	3"	3"	DP7SPO14	76.			
									
21" High Dividends Horizon Stack Panel Post		21 15/16"	3"	3"	DP7SPO21	77.			
									
28" High Dividends Horizon Stack Panel Post		29 1/4"	3"	3"	DP7SPO28	87.			
									
Dividends Horizon Post Top Caps  Four-way  In-line  One-way  Two-way  Three-way	Four-Way	1/2"	3"	3"	DP7PT4()	8.	9.	9.	
	In-line Straght	1/2"	3"	3"	DP7PTS()	8.	9.	9.	
	One-Way	1/2"	3"	3"	DP7PT1()	8.	9.	9.	
	Three-Way	1/2"	3"	3"	DP7PT3()	8.	9.	9.	
	Two-Way	1/2"	3"	3"	DP7PT2()	8.	9.	9.	
	Inside Corner Raceway Filler					DP7BF	10.	n/a	n/a
									

Ordering Information

Post Top Cap

1. Pattern number
2. Finish

Order Code

Post Top Caps

Example: **DP7PT45**
 013 Silver Paint Finish

Included with:

Note: Worksurface Height panels do not connect to any other panel height.

Options

Post Top Caps Options

- (4) = Radius
- (5) = Flat Profile

An inside corner raceway filler is used to block the light leak created when two raceway covers meet at a 90° connection.

Dividends Horizon DP7 Post Components

Post Covers and High Low Post Covers

Dividends Horizon

description	h	pattern no.	P1	P2	P3
<div data-bbox="105 346 121 483" style="display: inline-block; vertical-align: middle;"> </div> Dividends Horizon Post Covers Full Height "T"	28 1/2"	DP7PCWH	\$43.	\$46.	\$58.
	36"	DP7PC36	43.	46.	58.
	42"	DP7PC42	43.	46.	58.
	50"	DP7PC50	44.	48.	51.
	57"	DP7PC57	50.	52.	54.
	64"	DP7PC64	50.	52.	55.
	78"	DP7PC78	55.	60.	62.
<div data-bbox="105 619 121 756" style="display: inline-block; vertical-align: middle;"> </div> Dividends Horizon Post Covers Full Height "L"	28 1/2"	DP7PCWH2	65.	68.	71.
	36"	DP7PC362	65.	68.	71.
	42"	DP7PC422	65.	68.	71.
	50"	DP7PC502	68.	72.	76.
	57"	DP7PC572	74.	79.	85.
	64"	DP7PC642	74.	79.	85.
	78"	DP7PC782	85.	89.	92.
<div data-bbox="105 882 121 934" style="display: inline-block; vertical-align: middle;"> </div> Dividends Horizon Straight High Low Post Covers	14"/15"	DP7PC14H	15.	19.	20.
	21"/22"	DP7PC21H	21.	22.	23.
	28"	DP7PC28H	34.	37.	38.
	36"	DP7PC36H	46.	50.	52.
	42"	DP7PC42H	51.	54.	56.
	7" / 8"	DP7PC07H	9.	11.	11.
<div data-bbox="105 1092 121 1144" style="display: inline-block; vertical-align: middle;"> </div> Dividends Horizon High Low Left Hand Post Covers	7" / 8"	DP7PC07LH	9.	11.	11.
	14"/15"	DP7PC14LH	15.	19.	20.
	21"/22"	DP7PC21LH	21.	22.	23.
	28"	DP7PC28LH	34.	37.	38.
	36"	DP7PC36LH	46.	50.	52.
	42"	DP7PC42LH	51.	54.	56.
<div data-bbox="105 1302 121 1354" style="display: inline-block; vertical-align: middle;"> </div> Dividends Horizon High Low Right Hand Post Covers	7" / 8"	DP7PC07RH	9.	11.	11.
	14"/15"	DP7PC14RH	15.	19.	20.
	21"/22"	DP7PC21RH	21.	22.	23.
	28"	DP7PC28RH	34.	37.	38.
	36"	DP7PC36RH	46.	50.	52.
	42"	DP7PC42RH	51.	54.	56.

Post Connectors/End Trim

Ordering Information

Post Top Cap

1. Pattern number
2. Finish

Order Code

Post Top Caps

Example: **DP7PT45**
 013 Silver Paint Finish

Included with:

Note: Worksurface Height panels do not connect to any other panel height.

Options

Post Top Caps Options

- (4)** = Radius
- (5)** = Flat Profile

An inside corner raceway filler is used to block the light leak created when two raceway covers meet at a 90° connection.

Legacy Post Assemblies

Post assemblies are required for all "L", "T", and "X" applications involving same-height panels. Included with post assemblies are the appropriate post, post cover and top cap.

Post connectors use the universal panel connection hardware for attachment, which is included with the post.

For high-low and post-to-panel applications, posts and covers must be ordered separately by component.

NOTE: LEGACY POSTS ARE FOR EXISTING CUSTOMERS ONLY.

Legacy Post and Trim Construction

Posts are 3" square extruded aluminum construction. Post covers are flat or radius profile, metal or smooth textured plastic extrusion with softly-radiused molded plastic top cap. Metal post covers are powder-coated 20 ga. steel.

Posts have cut-outs for electrical and data access that match the wire and cable channels provided by panel frames. This allows cables to be routed through the post at the topway and base raceway. Refer to the Beltway Electrical Specification page for cable routing information.

The illustrations that follow are common same-height post assembly configurations. Choose the post assembly that matches the required application.

Post "L" Configuration

"L" assembly includes:

- Universal post
- Two-way top cap
- Corner post cover

Post "L" Configuration

"L" post assembly includes:

- Universal post
- Two-way top cap
- Corner post cover

Post "T" Configuration

"T" post assembly includes:

- Universal post
- Three-way top cap
- Straight post cover

Trim options available:

- Smooth Radius Plastic
- Radius Metal
- Flat Metal

Note: Not available with fabric covered post covers.

Through-Post Access for Power and Data

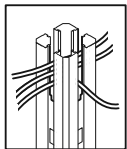

Topway Cable Access

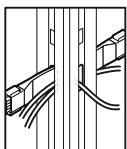

Beltway Power and Cable

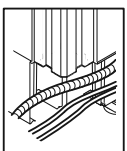

Base Raceway Power and Cable

Two-Way Post Connection

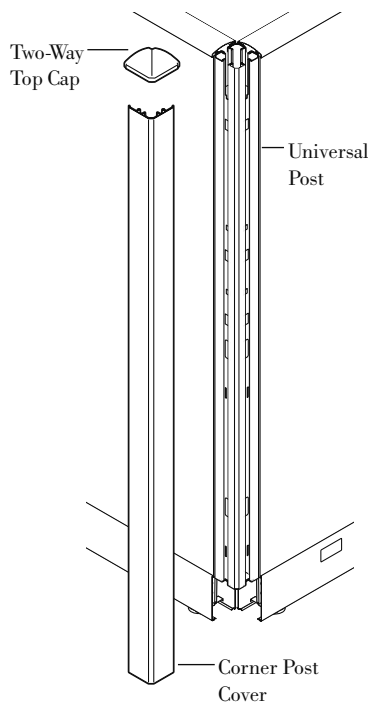

Post Top Cap for Enhanced Smooth Trim

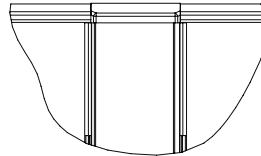

Post and Cover Top Views

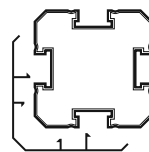

Corner Post Cover

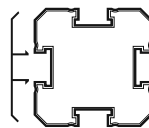

Straight Post Cover

Post "L" Configurations

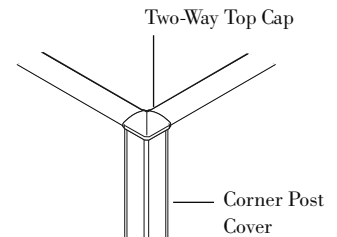

Post "T" Configurations

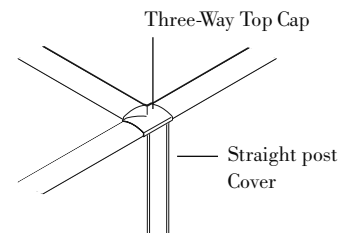

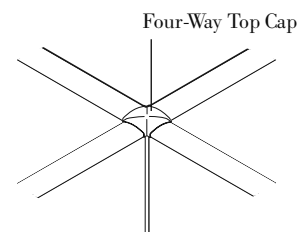

Post "X" Configurations



Legacy Post Assemblies L, T and X Configurations

Dividends Horizon

description	h *	w	d	pattern no.	Plastic list	Metal P1	Metal P2	Metal P3
 Two-Way Post Assembly ("L")	36"	3"	3"	DP()PA362	\$110.	\$141.	\$149.	\$158.
	42"	3"	3"	DP()PA422	110.	141.	149.	158.
	50"	3"	3"	DP()PA502	124.	153.	162.	168.
	57"	3"	3"	DP()PA572	152.	181.	190.	198.
	64"	3"	3"	DP()PA642	152.	181.	190.	198.
	78"	3"	3"	DP()PA782	244.	261.	277.	289.
 Three-Way Post Assembly ("T")	36"	3"	3"	DP()PA363	102.	147.	155.	162.
	42"	3"	3"	DP()PA423	102.	147.	155.	162.
	50"	3"	3"	DP()PA503	112.	158.	164.	172.
	57"	3"	3"	DP()PA573	138.	181.	190.	198.
	64"	3"	3"	DP()PA643	138.	181.	190.	198.
	78"	3"	3"	DP()PA783	226.	259.	272.	287.
 Four-Way Post Assembly ("X")	36"	3"	3"	DP()PA364	90.	136.	143.	150.
	42"	3"	3"	DP()PA424	90.	136.	143.	150.
	50"	3"	3"	DP()PA504	100.	143.	152.	160.
	57"	3"	3"	DP()PA574	121.	164.	173.	182.
	64"	3"	3"	DP()PA644	121.	164.	173.	182.
	78"	3"	3"	DP()PA784	202.	237.	249.	261.

Post Connectors/End Trim

h = nominal height

Ordering Information

Post Assemblies

1. Pattern Number
2. Trim Finish

Order Code

Post Assemblies

Example: **DP(2A)PA 642, 113**
DP(2A)PA Pattern Number
642
113 Dark grey trim finish

Included with:

Post Assemblies

- Post assemblies
- Post top cap
- Post cover
- Connecting hardware

Options

Post Assemblies

Post Assembly Trim Options
(2A) = Plastic, Enhanced Smooth Radius
(4) = Metal, Radius
(5) = Metal, Flat

High-Low Post Components

High-Low panel-to-post configurations require ordering the post covers by components.

Shown are common high-low panel-to-post configurations. Choose the high-low panel-to-post configuration that matches the required application.

Post connectors use the universal panel connection hardware for attachment, which is included with the post.

Universal Post and High-Low Trim Construction

- Posts: 3" square extruded aluminum.
- Post covers: Flat-profile, plastic extrusion with a smooth finish
- Top cap: Softly-radiused injection molded plastic

High-Low "L" Post Connector Configuration (see Figure 1)

High-Low "L" components required:

- 1 One, universal post that matches height of tallest panel
- 2 One, "one-way" post top cap

- 3 Two straight post covers that match height of tallest panel

- 4 One, high-low straight post cover that matches high-low panel-to-post dimension

High-Low "T" Post Connector Configuration A (see Figure 2)

High-Low "T" components required:

- 1 One, universal post that matches height of tallest panel
- 2 One, "two-way" top cap
- 3 One, straight post cover that matches height of tallest panel
- 4 One, high-low straight post cover that matches high-low panel-to-post dimension

High-Low "T" Post Connector Configuration B (see Figure 3)

High-Low "T" components required:

- 1 One, universal post that matches height of tallest panel
- 2 One, "in-line" top cap
- 3 One, straight post cover that matches height of tallest panel

- 4 One, high-low straight post cover that matches high-low panel-to-post dimension

Hi-Lo "T" Post Connector Configuration C (see Figure 4)

High-Low "T" components required:

- 1 One, universal post that matches height of tallest panel
- 2 One, "one-way" top cap
- 3 One, straight post cover that matches height of tallest panel
- 4 Two, high-low straight post covers that match high-low panel-to-post dimensions

High-Low "X" Post Connector Configuration A (see Figure 5)

High-Low "X" components required:

- 1 One universal post that matches height of tallest panel
- 2 One, "one-way" top cap
- 3 Three, high-low straight post covers that match high-low panel-to-post dimensions

High-Low "X" Post Connector Configuration B (see Figure 6)

High-Low "X" components required:

- 1 One, universal post that matches height of tallest panel
- 2 One, "in-line" top cap
- 3 Two, high-low straight post covers that match high-low panel-to-post dimensions

High-Low "X" Post Connector Configuration C (see Figure 7)

High-Low "X" components required:

- 1 One, universal post that matches height of tallest panel
- 2 One, "two-way" top cap
- 3 Two, high-low straight post covers that match high-low panel-to-post dimensions

High-Low "X" Post Connector Configuration D (see Figure 8)

High-Low "X" components required:

- 1 One, universal post that matches height of tallest panel
- 2 One, "three-way" top cap
- 3 One, high-low straight post cover that matches high-low panel to-post dimension

Figure 1

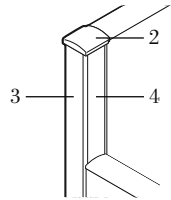

Figure 2

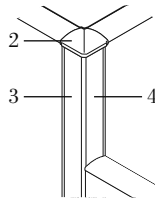

Figure 3

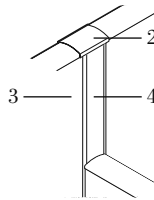

Figure 4

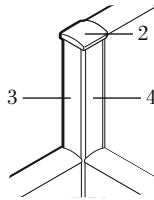

Figure 5

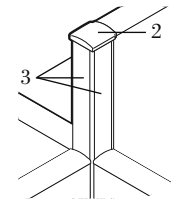

Figure 6

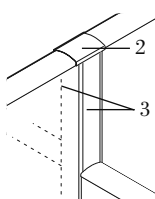

Figure 7

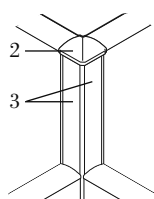
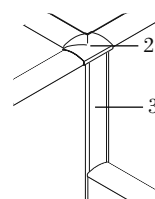

Figure 8



Post Top Caps



One-Way

Two-Way

Three-Way





Four-Way

Inline

Legacy Post Components

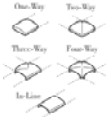
Post, Post Top Caps and Post Covers

Dividends Horizon

description	type	h	w	d	pattern no.	Price list	Metal P1	Metal P2	Metal P3
Universal Post (Post Only) 		36"	3"	3"	DP2APO36	\$83.			
		42"	3"	3"	DP2APO42	83.			
		50"	3"	3"	DP2APO50	95.			
		57"	3"	3"	DP2APO57	114.			
		64"	3"	3"	DP2APO64	114.			
		78"	3"	3"	DP2APO78	197.			
Post Top Caps 	One-Way	1/2"	3"	3"	DP()PT1	5.	9.	10.	10.
	Two-Way	1/2"	3"	3"	DP()PT2	5.	9.	10.	10.
	Three-Way	1/2"	3"	3"	DP()PT3	5.	9.	10.	10.
	Four-Way	1/2"	3"	3"	DP()PT4	5.	9.	10.	10.
	In-Line (Straight)	1/2"	3"	3"	DP()PTS	5.	9.	10.	10.
Post Covers (Straight) 		36"			DP()PC36SF	10.	45.	48.	53.
		42"			DP()PC42S	10.	45.	48.	53.
		50"			DP()PC50S	11.	46.	50.	54.
		57"			DP()PC57S	17.	53.	55.	57.
		64"			DP()PC64S	17.	53.	55.	57.
		78"			DP()PC78S	25.	57.	61.	63.
Post Covers (Corner) 		36"			DP()PC36L	23.	67.	70.	73.
		42"			DP()PC42L	23.	67.	70.	73.
		50"			DP()PC50L	26.	70.	74.	79.
		57"			DP()PC57L	32.	77.	82.	88.
		64"			DP()PC64L	32.	77.	82.	88.
		78"			DP()PC78L	41.	88.	92.	95.
Post Covers (Straight) High-Low Connection 	36" - 42"	8"			DP()PC08S	4.	10.	12.	12.
	42" - 50"	8"			DP()PC08S	4.	10.	12.	12.
	36" - 50"	14"			DP()PC14S	5.	15.	20.	21.
	50" - 64"	14"			DP()PC14S	5.	15.	20.	21.
	64" - 78"	14"			DP()PC14S	5.	15.	20.	21.
	42" - 64"	22"			DP()PC22S	6.	22.	23.	24.
	36" - 64"	28"			DP()PC28S	11.	36.	38.	39.
	50" - 78"	28"			DP()PC28S	11.	36.	38.	39.
	42" - 78"	36"			DP()PC36S	17.	48.	53.	55.
	36" - 78"	42"			DP()PC42SH	22.	54.	56.	58.



Post Connectors/End Trim

Ordering Information	Order Code	Included with:	Options
Universal Post 1. Pattern Number	Universal Post <i>Example:</i> DP2A P050	Universal Post Connecting hardware	Universal Post Panel Top Cap and Post Cover Options: (2A)= Plastic, Enhanced Smooth Radius (4) = Metal, Radius (5) = Metal, Flat
Post Top Cap 1. Pattern Number 2. Trim finish	DP2A Pattern Number P050 Post Top Cap <i>Example:</i> DP2A PT4, V04	Panel Top Cap Post Covers	
Post Covers 1. Pattern Number 2. Trim finish	DP2A PT4 Pattern Number 117 Soft grey Post Covers <i>Example:</i> DP2A PC50S, 117		
	DP(2A) Pattern Number PC50S 117 Soft grey		

Legacy Post Components

Stack Panel Posts

Dividends Horizon

description	h	w	d	pattern no.	List Price
14" High Stack Panel Posts 	14 ⁵ / ₈ "	3"	3"	DP2ASPO 14	\$79.
21" High Stack Panel Posts 	21 ¹⁵ / ₁₆ "	3"	3"	DP2ASPO 21	80.
28" High Stack Panel Posts 	29 ¹ / ₄ "	3"	3"	DP2ASPO 28	90.

Ordering Information	Order Code	Included with:	Options
Stack Panel Frame	Stack Panel Frame	Stack Panel Frame	Stack Panel Post
1. Pattern Number	<i>Example:</i> DP2STF 1448, 113	Stack Panel Post	
2. Trim Finish	DP1STF Pattern Number		
Stack Panel Post	1448		
1. Pattern Number	113 Dark grey paint finish		
	Stack Panel Post		
	<i>Example:</i> DP2ASPO 14		
	DP2ASPO Pattern Number		
	14		

This page intentionally left blank

Panel End Trim

Panel end trim in one of three trim types ends a panel run.

Trim options available:

- Smooth Radius Plastic
- Metal Radius
- Metal Flat

Metal trim is constructed of extruded aluminum, powder coated.

End trim includes the appropriate attachment hardware and the panel end cap for transition to panel top cap.

Thin Profile Panel End Trim

The thin profile panel end trim is an extruded aluminum end cover that is designed to attach to panel ends to provide a smooth end condition for the end of panel runs. The thin profile end trim and high low end trims are constructed of extruded aluminum with a powder coated finish. Thin profile panel end trim may only be used with panels that have been selected with the number 5 (flat metal) trim option.

High-Low Panel-to-Panel End Trim

High-low panel-to-panel end trim is used to complete straight, high-low panel-to-panel connections.

Construction and attachment is identical to panel end trim and includes attachment hardware and top/bottom end caps.

Up to ten, category 5 cables can be laid-in to carry data from the upper panel topway to the lower panel topway.

High-Low Thin Profile End Trim

High-low panel to panel end trim is used to complete straight, high-low panel to panel connections. Construction and attachment is identical to the thin profile panel end trim and includes attachment hardware. High-low thin profile end trim may only be used with panels that have been selected with the number 5 (flat metal) trim option.

Note: When using the high-low thin profile end trim, the higher and lower panels continue to use the standard full-width top cap.

Panel Top Caps

Smooth plastic and metal panel top caps are available in all panel widths.

Construction: Plastic top caps are constructed of injection molded colored plastic. Metal caps are powder coated steel.

Top caps with retainer clips must be ordered when using top caps on full view panels.

Shortened High-Low Panel Top Caps

When specifying the enhanced smooth or metal panel trim for a high-low panel end trim condition, the top cap on the lower panel must be shortened by 1 inch. Panel top caps can be field cut to the new length, or shortened top caps may be ordered separately.

Note: Thin profile end trim and high low end trim are available in Knoll core finishes only.

Panel End Trim

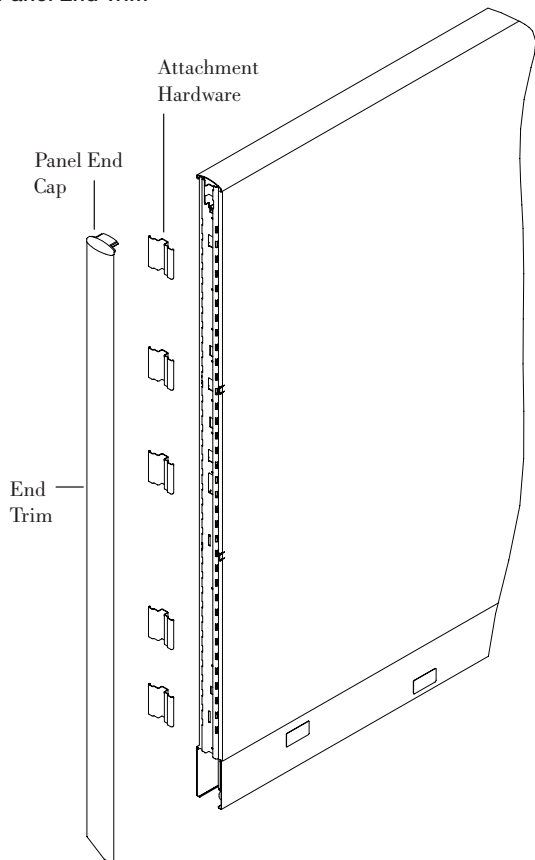

Enhanced High-Low Panel End Trim

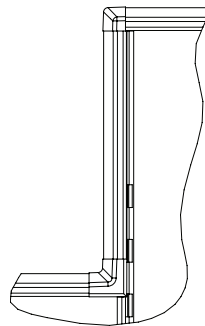

Thin Profile End Trim

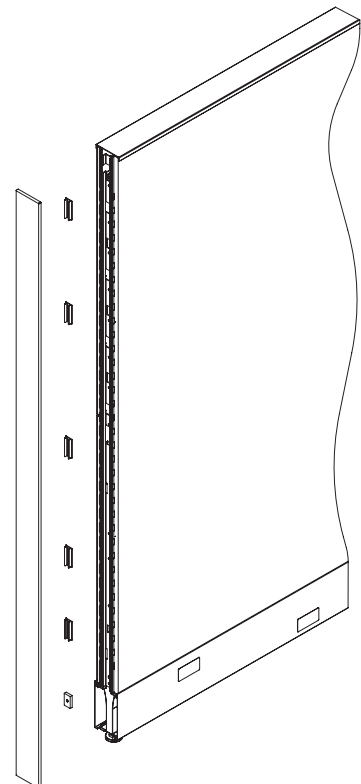

Panel End Trim and Panel Top Caps

Panel End and High-Low Panel End

Dividends Horizon



description	type	h *	w	d	pattern no.	Plastic list	Metal P1	Metal P2	Metal P3
Panel End		28 1/2"	3"	5/8"	DP()PEWH	\$19.	\$56.	\$61.	\$63.
		36"	3"	5/8"	DP()PE36F	19.	56.	61.	63.
		42"	3"	5/8"	DP()PE42	20.	58.	62.	64.
		50"	3"	5/8"	DP()PE50	21.	60.	63.	65.
		57"	3"	5/8"	DP()PE57	23.	62.	65.	67.
		64"	3"	5/8"	DP()PE64	23.	62.	65.	67.
		78"	3"	5/8"	DP()PE78	28.	67.	71.	74.
Panel End, High-Low	36" - 42"	6"			DP()PE08	7.	34.	37.	38.
	36" - 50"	14"			DP()PE14	9.	37.	39.	40.
	36" - 57"	21"			DP()PE22	13.	39.	42.	44.
	36" - 64"	28"			DP()PE28	23.	48.	51.	54.
	36" - 78"	42"			DP()PE42H	30.	58.	62.	64.
	42" - 50"	8"			DP()PE08	7.	34.	37.	38.
	42" - 57"	15"			DP()PE14	9.	37.	39.	40.
	42" - 64"	22"			DP()PE22	13.	39.	42.	44.
	42" - 78"	36"			DP()PE36	29.	56.	61.	63.
	50" - 57"	7"			DP()PE08	7.	34.	37.	38.
	50" - 64"	14"			DP()PE14	9.	37.	39.	40.
	50" - 78"	28"			DP()PE28	23.	48.	51.	54.
	57" - 64"	7"			DP()PE08	7.	34.	37.	38.
	57" - 78"	21"			DP()PE22	13.	39.	42.	44.
	64" - 78"	14"			DP()PE14	9.	37.	39.	40.

h* = Nominal height
Dimensions listed under h w d are actual to the nearest 1/16"

Ordering Information	Order Code	Included with:	Options
Panel End 1. Pattern Number 2. Trim Finish	Panel End <i>Example:</i> DP2A PE42, 117 DP2A Pattern Number PE42	Panel End • Panel end cover • Connecting hardware	Panel End, High-Low Panel End and Top Caps
High-Low Panel End 1. Pattern Number 2. Trim Finish	High-Low Panel End <i>Example:</i> DP2A PE42 117 DP2A Pattern Number PE42 117 Soft Grey	High-Low Panel End • Panel end cover • Connecting hardware • Lower transition cap Note: Worksurface Height panels do not connect to any other panel height.	Trim options (2A) = Plastic, Enhanced Smooth Radius (4) = Metal, Radius (5) = Metal, Flat

Post Connectors/End Trim

Thin Profile Panel End Trim and High-Low Panel End

description	type	h	w	d	pattern no.	P1	P2	P3
Thin Profile Panel End		28 1/2"	3"	5/8"	DP6PEWH	\$87.	\$87.	\$87.
		36"	3"	5/8"	DP6PE36F	87.	87.	87.
		42"	3"	5/8"	DP6PE42	94.	94.	94.
		50"	3"	5/8"	DP6PE50	103.	103.	103.
		57"	3"	5/8"	DP6PE57	112.	112.	112.
		64"	3"	5/8"	DP6PE64	121.	121.	121.
		78"	3"	5/8"	DP6PE78	141.	141.	141.
Thin Profile Panel End High-Low	36"-42"	6"	3"	5/8"	DP6PE08	44.	46.	46.
	36"-50"	14"	3"	5/8"	DP6PE14	55.	58.	58.
	36"-57"	21"	3"	5/8"	DP6PE22	66.	70.	70.
	36"-64"	28"	3"	5/8"	DP6PE28	77.	81.	81.
	36"-78"	42"	3"	5/8"	DP6PE42H	94.	100.	100.
	42"-50"	8"	3"	5/8"	DP6PE08	44.	46.	46.
	42"-57"	15"	3"	5/8"	DP6PE14	55.	58.	58.
	42"-64"	22"	3"	5/8"	DP6PE22	66.	70.	70.
	42"-78"	36"	3"	5/8"	DP6PE36	87.	91.	91.
	50"-57"	7"	3"	5/8"	DP6PE08	44.	46.	46.
	50"-64"	14"	3"	5/8"	DP6PE14	55.	58.	58.
	50"-78"	28"	3"	5/8"	DP6PE28	77.	81.	81.
	57"-64"	7"	3"	5/8"	DP6PE08	44.	46.	46.
	57"-78"	21"	3"	5/8"	DP6PE22	66.	70.	70.
	64"-78"	14"	3"	5/8"	DP6PE14	55.	58.	58.

Ordering Information

Thin Profile End Trim

1. Pattern Number
2. Finish

Order Code

Thin Profile End Trim

Example: **DP6PE42 117**

DP	Dividends Panel
6	Thin Profile
PE	Panel End
42	Height
117	Finish

Included with:

Thin Panel End Trim

Attachment hardware

Note: This profile end trim is only available in Knoll core finishes.

Note: Worksurface Height panels do not connect to any other panel height.

Panel End Trim and Panel Top Caps

Topway and Full View Frame Top Caps

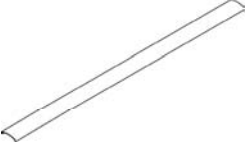
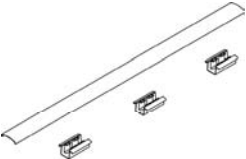
description	w	pattern no.	list	Metal P1	Metal P2	Metal P3
Panel Top Caps for use with Topway Frames 	15"	DP()PT15	\$13.	\$38.	\$40.	\$42.
	18"	DP()PT18	13.	38.	40.	42.
	24"	DP()PT24	15.	38.	40.	42.
	30"	DP()PT30	19.	38.	40.	42.
	36"	DP()PT36	20.	38.	40.	42.
	42"	DP()PT42	20.	38.	40.	42.
	48"	DP()PT48	21.	38.	40.	42.
	54"	DP()PT54	n/a	42.	44.	46.
	60"	DP()PT60	25.	45.	47.	49.
	66"	DP()PT66	n/a	49.	52.	55.
	72"	DP()PT72	n/a	54.	58.	61.
	78"	DP()PT78	n/a	60.	63.	66.
	84"	DP()PT84	n/a	65.	68.	72.
	90"	DP()PT90	n/a	71.	75.	78.
96"	DP()PT96	n/a	76.	81.	85.	
Panel Top Caps for use with Full View Frames 	15"	DP()PT15F	13.	38.	40.	42.
	18"	DP()PT18F	13.	38.	40.	42.
	24"	DP()PT24F	15.	38.	40.	42.
	30"	DP()PT30F	19.	38.	40.	42.
	36"	DP()PT36F	20.	38.	40.	42.
	42"	DP()PT42F	20.	38.	40.	42.
	48"	DP()PT48F	21.	38.	40.	42.
	54"	DP()PT54F	n/a	42.	44.	46.
	60"	DP()PT60F	25.	45.	47.	49.
	66"	DP()PT66F	n/a	49.	52.	55.
	72"	DP()PT72F	n/a	54.	58.	61.
	78"	DP()PT78F	n/a	60.	63.	66.
	84"	DP()PT84F	n/a	65.	68.	72.
	90"	DP()PT90F	n/a	71.	75.	78.
96"	DP()PT96F	n/a	76.	81.	85.	

Post Connectors/End Trim

Ordering Information

Panel Top Cap

1. Pattern Number
2. Trim Finish

Order Code

Panel Top Cap

Example: **DP5PT18, 117**

DP5PT18 Pattern number

117 Soft Grey trim finish

Included with:

Panel Top Cap

- Panel Top Cap
- Attachment brackets (for Full View Frame only)

Options

Panel Top Caps

Trim options

- (2A)** = Plastic, Enhanced Smooth Radius
- (4)** = Metal, Radius
- (5)** = Metal, Flat

Panel End Trim and Panel Top Caps

Shortened Panel Top Caps

Dividends Horizon

description	w	pattern no.	list	Metal P1	Metal P2	Metal P3
Shortened Panel Top Caps (for lower panel on high-low panel to panel application) Not for use with DP6 Thin profile panel ends	14"	DP()PT14	\$13.	\$38.	\$40.	\$42.
	17"	DP()PT17	13.	38.	40.	42.
	23"	DP()PT23	15.	38.	40.	42.
	29"	DP()PT29	19.	38.	40.	42.
	35"	DP()PT35	20.	38.	40.	42.
	41"	DP()PT41	20.	38.	40.	42.
	47"	DP()PT47	21.	38.	40.	42.
	53"	DP()PT53	n/a	42.	44.	46.
	59"	DP()PT59	n/a	45.	47.	49.
	65"	DP()PT65	n/a	49.	52.	55.
	71"	DP()PT71	n/a	54.	58.	61.
	77"	DP()PT77	n/a	60.	63.	66.
	83"	DP()PT83	n/a	65.	68.	72.
	89"	DP()PT89	n/a	71.	75.	78.
95"	DP()PT95	n/a	76.	81.	85.	



Shortened Panel Top Caps for use with Full View Frames (for lower panel on high-low panel to panel application) Not for use with DP6 thin profile panel end	14"	DP()PT14F	13.	38.	40.	42.
	17"	DP()PT17F	13.	38.	40.	42.
	23"	DP()PT23F	15.	38.	40.	42.
	29"	DP()PT29F	19.	38.	40.	42.
	35"	DP()PT35F	20.	38.	40.	42.
	41"	DP()PT41F	20.	38.	40.	42.
	47"	DP()PT47F	21.	38.	40.	42.
	53"	DP()PT53F	n/a	42.	44.	46.
	59"	DP()PT59F	n/a	45.	47.	49.
	65"	DP()PT65F	n/a	49.	52.	55.
	71"	DP()PT71F	n/a	54.	58.	61.
	77"	DP()PT77F	n/a	60.	63.	66.
	83"	DP()PT83F	n/a	65.	68.	72.
	89"	DP()PT89F	n/a	71.	75.	78.
95"	DP()PT95F	n/a	76.	81.	85.	

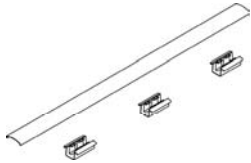

h* = Nominal height

Dimensions listed under h w d are actual to the nearest 1/16"

Ordering Information	Order Code	Included with:	Options
Panel Top Cap	Panel Top Cap	Panel Top Cap	Panel Top Caps
1. Pattern Number	<i>Example:</i> DP5PT18, 117	• Panel Top Cap	Trim options
2. Trim Finish	DP5PT18 Pattern number	• Attachment brackets (For Full View Frame only)	(2A) = Plastic, Enhanced Smooth Radius
Panel-to-Panel Top Cap Transition	117 Soft Grey trim finish		(4) = Metal, Radius
1. Pattern Number			(5) = Metal, Flat
2. Trim Finish			

This page intentionally left blank

Panel Wall Starter, Panel-to-Panel Top Cap Transition

Off-Module Panel Connector

Specifications

Panel Wall Starter

Panel wall starters mount to reinforced building walls to begin a perpendicular topway or full view panel run. Wall starters consist of a wall bracket and upper and lower panel-mounting brackets. Wall fasteners are not included or supplied by Knoll. Choice of wall fasteners is critical and must be selected to match the wall construction, wall surface and loading conditions.

Wall starters are available in all Dividends Horizon panel heights. Black finish only.

NOTE: KNOLL, INC. ASSUMES NO RESPONSIBILITY FOR WALL CONSTRUCTION OR PERFORMANCE OF FASTENERS USED.

Off-Module Panel Connector

The off-module connector allows for panel attachment anywhere along the width of the perpendicular panel. The off-module connector can be used with same height topway or full view panels only. The connector consists of a height specific connector and attaching hardware. The 3-way (DP1PT3) or 4-way (DP1PT4) post top cap must be ordered separately when radius metal top caps are being used. Specify connector height to match panel height. Black finish only.

When using the off-module panel connector, the attached connector will deface the perpendicular fabric panel insert.

Electrical components and data cables cannot be routed through the off-module panel.

Panel-to-Panel Top Cap Transition

Top cap transitions fill the gap between panel top cap sections in straight panel-to-panel configurations.

- Construction: Trim-colored, softly-radiused molded plastic
- Size: 1" wide by 3" deep
- Attachment: Snaps between top cap sections in straight, same-height panel configurations

NOTE: PANEL-TO-PANEL TOP CAP TRANSITIONS ARE ORDERED SEPARATELY FROM PANELS.

Panel Wall Starter Connection

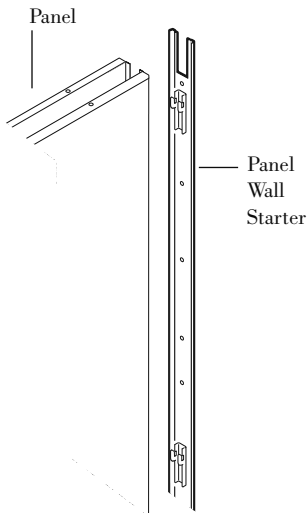

Off-Module Panel Connector

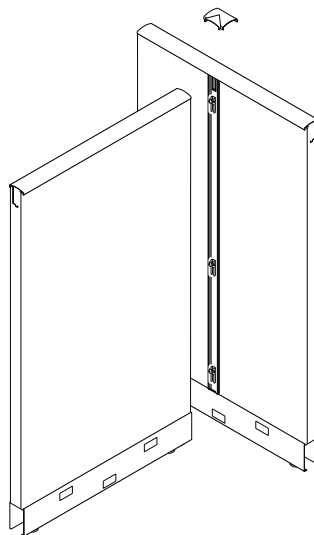

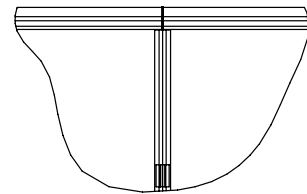

Panel-To-Panel Transition for Enhanced Smooth Panel Trim



Panel Wall Starter, Panel-to-Panel Top Cap Transition and Off-Module Panel Connector

Dividends Horizon

description	type	h *	h	w	d	pattern no.	Single pack list	10 pack list
 Panel Wall Starter		36"	28"	2"	3/4"	DP2PWS36	\$42.	n/a
		42"	35 3/8"	2"	3/4"	DP2PWS42	42.	n/a
		50"	42 11/16"	2"	3/4"	DP2PWS50	50.	n/a
		57"	50"	2"	3/4"	DP2PWS57	55.	n/a
		64"	57 1/4"	2"	3/4"	DP2PWS64	58.	n/a
		78"	71 7/8"	2"	3/4"	DP2PWS78	70.	n/a
Panel-to-Panel Top Cap Transition		3/4"	1"	3"		DP() TCT()	3.	23.
 Off-Module Panel Connector		36"	28"	2"	3/4"	DP2PMS36	58.	n/a
		42"	35 3/8"	2"	3/4"	DP2PMS42	58.	n/a
		50"	42 11/16"	2"	3/4"	DP2PMS50	65.	n/a
		57"	50"	2"	3/4"	DP2PMS57	68.	n/a
		64"	57 1/4"	2"	3/4"	DP2PMS64	70.	n/a
		78"	71 7/8"	2"	3/4"	DP2PMS78	84.	n/a
Radius Post Top Cap (for use with off-module panel connector when radius metal top caps are used)	three-way		1/2"	3"	3"	DP1PT3	5.	n/a
	four-way		1/2"	3"	3"	DP1PT4	5.	n/a

Post Connectors/End Trim

h* = nominal height
 Dimensions listed under h w d are actual to the nearest 1/16"

Ordering Information	Order Code	Included with:	Options
Panel Wall Starter 1. Pattern Number	Panel Wall Starter <i>Example:</i> DP1 PWS 64	Panel Wall Starter	Panel Wall Starter
Off-Module Panel Connector 1. Pattern Number	DP1 PW Pattern Number 64	Off-Module Panel Connector	Off-Module Panel Connector
Panel-to-Panel Top Cap Transition 1. Pattern Number 2. Trim Finish	Off-Module Panel Connector <i>Example:</i> DP1 PMS50 DP1 Pattern Number PMS50 Panel-to-Panel Top Cap Transition <i>Example:</i> DP1 TCT, 117 DP1 TCT Pattern Number 117 Soft Grey	Panel-to-Panel Top Cap Transition Note: Three-way or four-way post top cap must be ordered separately when radius metal panel top caps are being used.	Panel-to-Panel Top Cap Transition Trim Option: (2A) =Plastic, Enhanced Smooth Radius (4) =Metal, Radius (5) =Metal, Flat Panel-to-Panel Top Cap Transition Add an 'SP' suffix to the base pattern number for single pack or 'TP' suffix for a 10 pack.

Panel Rigidizer Brackets

Panel rigidizer brackets are used to reduce panel connection flex where panel to worksurface brackets cannot be used.

Panel rigidizer brackets are unnecessary if a panel can be properly secured with the use of a panel to worksurface bracket.

Rigidizer brackets are available for inline (straight), 2-way (L), 3-way (T) and 4-way (X) panel conditions.

High-low panel to post conditions cannot accommodate the panel rigidizer brackets. Full view panel frames without a topway cannot accommodate a panel rigidizer bracket.

Carpet grippers are recommended for use with panel rigidizer brackets.

Specify panel rigidizer brackets for appropriate panel attachment condition.

- 2-way (L) for panels of the same height in a 90 degree application

- 3-way (T) for 3 panels of the same height attached to a universal post.
- 4-way (X) for 4 panels of the same height attached to a universal post.

Carpet Grippers

Carpet grippers should be specified to increase rigidity of unsupported panel runs. The carpet grippers snap onto leveling glides to prevent panel runs from shifting on carpet. The glides rotate in carpet grippers to permit leveling. Available in black finish only.

Panel-Mounted Coat Hook

The Dividends Horizon panel-mounted coat hook is made of extruded aluminum and is available in an anodized black finish or matte aluminum finish. The coat hook attaches to any Dividends Horizon panel by connecting over the top of the Dividends Horizon radius plastic and metal panel top caps only.

Slotted Standard Coat Hook

Independent of the top cap, the slotted standard coat hook attaches to the left or right vertical slotted standard of any Dividends Horizon panel. The die cast slotted standard

coat hook is available in any of the Knoll Core paint finishes. The slotted standard coat hook is sold in packages of ten and is not compatible with laminate tiles or screens.

Panel Reveal Fillers

Panel reveal filler strips are used to cover unused vertical panel slots. Panel reveal fillers are designed to only be used with Legacy post panel applications. Panel reveal fillers should not be used with panel applications that are using DP7 posts. Panel reveal fillers are available in two thickness:

- 1/2" for panel-to-panel and panel to end trim attachment.
- 1/4" for panel-to-post attachment.

Panel reveal fillers are offered in a 74" length and are field cut to install into any Dividends Horizon panel height.

To determine the correct amount of reveal fillers to be specified, use the following formulas: For panels and end trim-2 x the number of straight panel connections plus the number of panel end trims. For panel to post connections, 4x the number of posts.

Panel Rigidizer Brackets

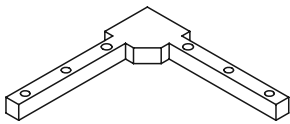

Two-way "L"

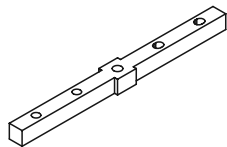

Inline (straight)

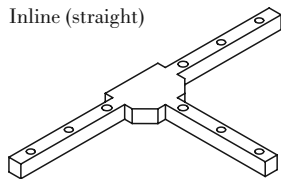

Three-way "T"

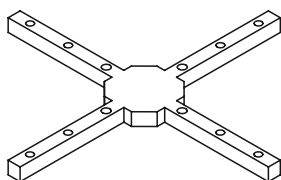

Four-way "X"

Carpet Gripper



Panel-Mounted Coat Hook (for radius plastic and metal trim only)

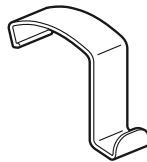

Slotted Standard Coat Hook

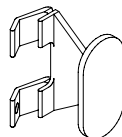

Panel Reveal Fillers

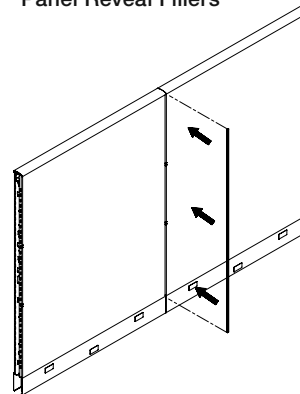



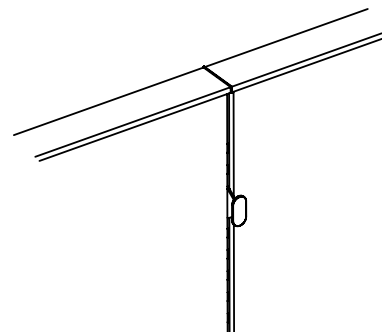

Slotted Standard Coat Hook Application

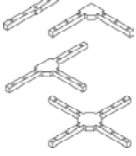

Panel Rigidizer Brackets, Coat Hooks and Reveal Fillers Carpet Grippers

Dividends Horizon

description	type	h	w	d	pattern no.	list	P1	P2	P3
Carpet Grippers 	Package of 10				DP1 CG	\$13.			
Coat Hook (For Panel Slotted Standard) 	Package of 10				DP2CHTP		131.	131.	131.
Coat Hook (For radius metal and plastic trim only) (Package of 4) 	Anodized Black Finish				DP1 CHB	113.			
	Matte Aluminum Finish				DP1 CHP	108.			
Panel Rigidizer Brackets 	2-way-L	1/2"	5 1/2"	5 1/2"	DP1PRBL	84.			
	3-way-T	1/2"	5 1/2"	5 1/2"	DP1PRBT	100.			
	4-way-X	1/2"	5 1/2"	5 1/2"	DP1PRBX	168.			
	Straight	1/2"	5 1/2"	5/8"	DP1PRBS	72.			
Panel Reveal Filler (for panel-to-panel and panel-to-end trim attachment) 	15 Fillers	74"			DP1PRFW15	54.			
	250 Fillers	74"			DP1PRFW250	465.			
	70 Fillers	74"			DP1PRFW70	155.			
Panel Reveal Filler (for panel-to-post attachment) 	15 Fillers	74"			DP1PRFN15	42.			
	250 Fillers	74"			DP1PRFN250	305.			
	70 Fillers	74"			DP1PRFN70	109.			

Post Connectors/End Trim

Ordering Information	Order Code	Included with:	Options
Panel Rigidizer Bracket 1. Pattern Number	Panel Rigidizer Bracket <i>Example:</i> DP1 PRBL	Panel Rigidizer Bracket • Rigidizer Bracket • Set Screws	Panel Rigidizer Bracket Panel Reveal Filler
Panel Reveal Filler 1. Pattern Number	Panel Reveal Filler <i>Example:</i> DP1PRF N15	Panel Reveal Filler • Reveal Fillers (15 qty)	
Slotted Standard Coat Hook 1. Pattern Number 2. Paint Finish	Slotted Standard Coat Hook <i>Example:</i> DP2CH 118 Bright White	Note: Panel reveal fillers are for use with legacy post panel applications and should not be used with panel applications that are using DP7 posts.	

Concealed Post Planning Guidelines Specifications

Concealed Post

Concealed posts eliminate visible post covers, creating a seamless aesthetic at three-way post connections. Larger widths of fabric or laminate tile-to-floor tiles are used to hide the concealed post. Panel top caps, up to 99" long, span concealed posts, which eliminate the need for post top caps. Concealed post applications are specified by individual components through "Build-to-Spec".

Planning with Concealed Posts

Concealed posts are to be used in three-way post conditions where straight post covers want to be eliminated. The concealed post should be specified in place of a standard Dividends Horizon DP7 or Legacy post. Concealed post fabric or laminate tiles must be specified in the tile location that is covering the post. (See illustration below) Concealed post, half post or centered fabric and laminate tiles are designed to cover the concealed post with the edge

of the tile ending in the center of the concealed post. Only concealed post fabric and laminate tile sizes are compatible with concealed posts.

A high low condition may be created by having a perpendicular panel at a lower height than the concealed post. Specify the height of the concealed post to be at the same height as the higher panels. A concealed post high low top cap must be specified in this situation. Panel top caps that span concealed posts are not designed for use in high-low concealed post applications, standard width panel top caps and a concealed post high low top cap should be used instead. A DP7 straight high low post cover should be specified in a concealed post high low application.

The two panels on the straight side of the three-way concealed post intersection must always be the same height. The concealed post is not designed to change height on the concealed post side of the three-way connection.

Concealed post panel top caps and frameless add ups are 3" wider than standard sizes, for applications wanting to span the concealed post. Panel top caps are available in lengths up to 99". Any concealed post application requiring panel top caps longer than 99" must specify panel top caps equal to the width of a panel or combination of panels and a concealed post same height top cap. Concealed post fabric and laminate tiles, post top caps, panel top caps, and frameless add ups are designed for use with the concealed post only.

Note: Concealed posts and corresponding components are not compatible with Dividends Horizon DP7 posts, Legacy posts, standard post top caps, or standard fabric or laminate tile sizes.

Concealed Post Connection Plan View

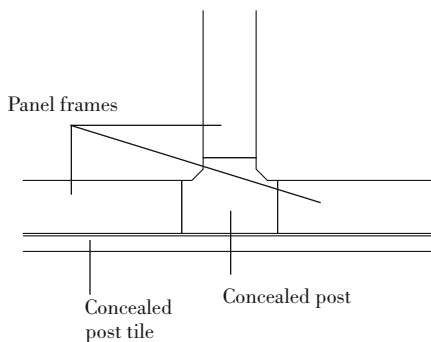

Concealed Post Application

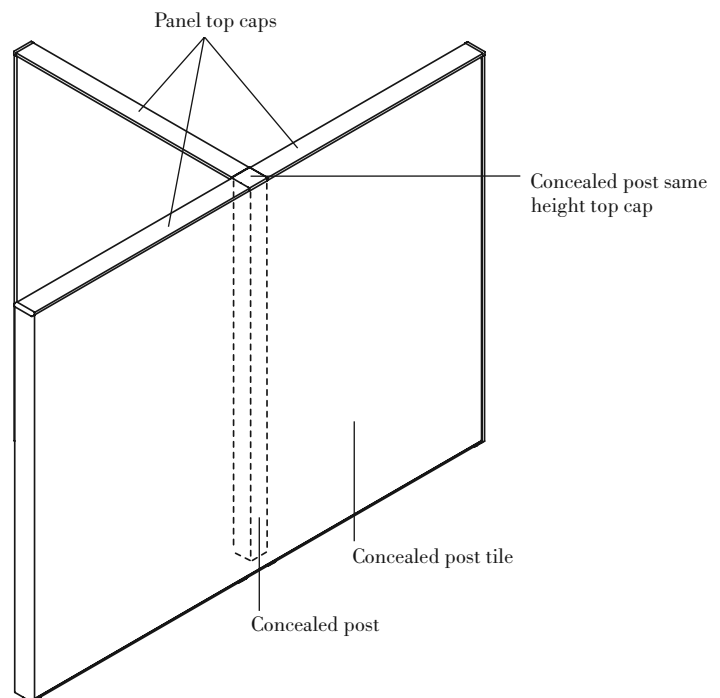

Concealed Post Construction

Concealed posts are a square extruded aluminum construction. They have cut-outs for electrical and data access that match the wire and cable channels provided by panel frames. This allows cables to be routed through the post at the topway and base raceway.

Concealed Post Same Height Top Cap

When all three panels in a concealed post application are the same height and standard length panel top caps are used, a concealed post same height top cap must be specified. A concealed post same height top cap covers the top of a concealed post and connects three panel top caps at the same height. (See illustration below)

Concealed Post High Low Top Cap

When the perpendicular panel in a three-way concealed post application is a lower height than the concealed post, a concealed post high low top cap must be specified. A concealed post high low top

cap covers the top of the concealed post and connects the two same height panel top caps. (See illustration below) A DP7 high low straight post cover should be specified in a concealed post high low application.

Concealed Post Top Cap Construction

Concealed post flat profile top caps are constructed of injection molded colored plastic.

Concealed Post Panel Top Caps

Concealed post panel top caps are 3" longer than standard panel top cap widths, so they can span over a concealed post. Panel top caps must be specified according to the panel type, either full view or topway, they are attaching to. Concealed post panel top caps are available in flat profile metal. Concealed post panel top caps are not compatible with a Dividends Horizon DP7 or Legacy post. Concealed post panel top caps that span a concealed post must be used in same height applications only. High low concealed post conditions must use concealed post high low top caps. (See illustration below)

Concealed Post Shortened Panel Top Caps

Concealed post shortened panel tops are 3" longer than standard shortened panel top cap widths, so they can span over a concealed post. A concealed post shortened panel top cap must be specified for the lower panel in a high low panel-to-panel condition when the panel top cap of the lower panel is spanning over the concealed post. (See illustration below) When the lower panel top cap is not spanning over the concealed post because a concealed post top cap is being used, specify standard shortened panel top cap widths. Standard DP5 high low panel end trim should be specified with concealed post shortened panel top caps in high low panel-to-panel applications.

Concealed Post Panel Top Cap Construction

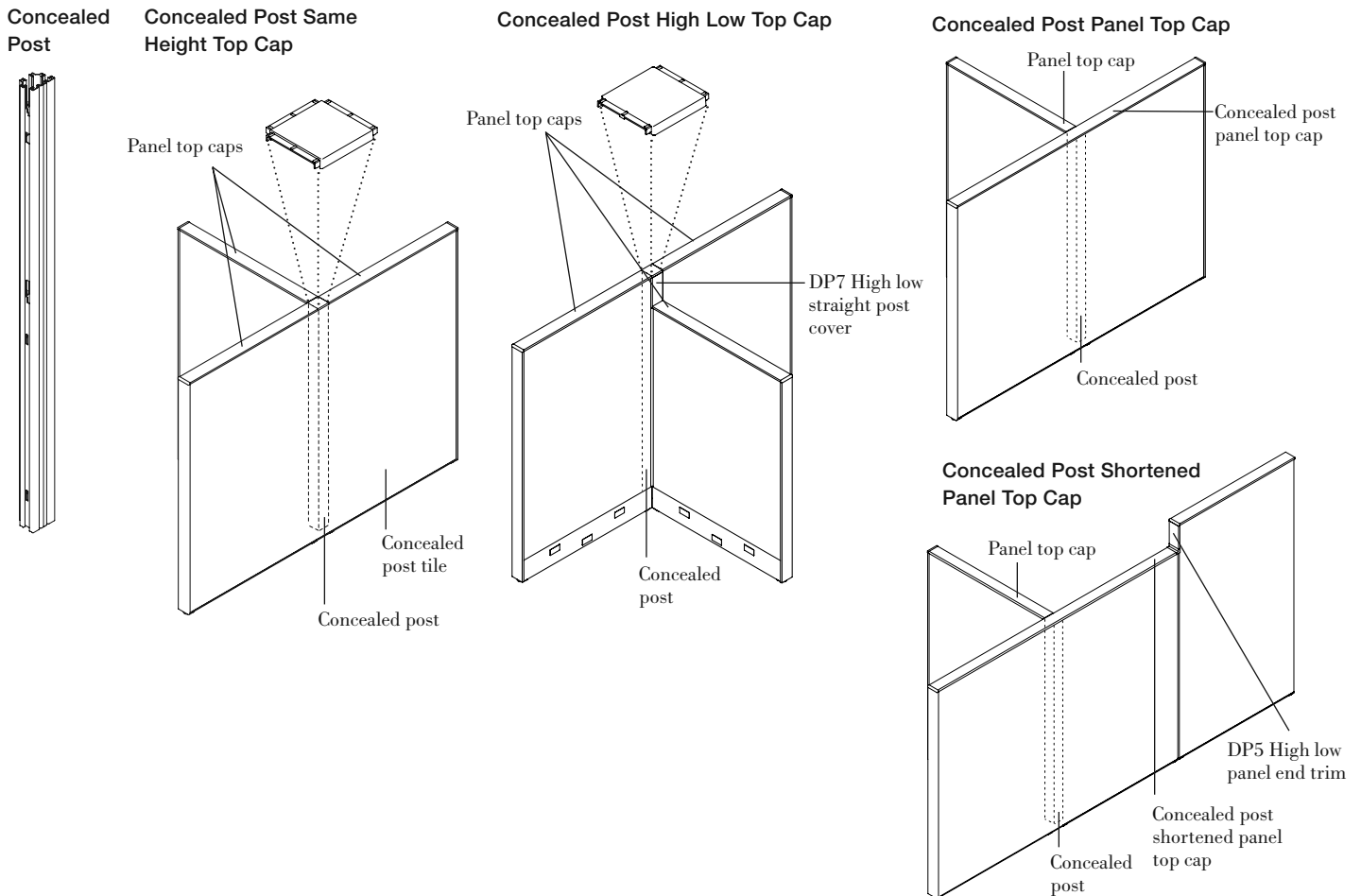

Concealed post panel top caps are constructed of roll-formed steel.



Concealed Post

Post Components

Post and Post Top Caps

description	w	h	d	pattern no.	list	P1	P2	P3
 Concealed Post	3"	28 1/2"	3"	DP7POWHCPF	\$118.			
	3"	36"	3"	DP7PO36CPF	134.			
	3"	42"	3"	DP7PO42CPF	144.			
	3"	50"	3"	DP7PO50CPF	156.			
	3"	57"	3"	DP7PO57CPF	169.			
	3"	64"	3"	DP7PO64CPF	188.			
 Concealed Post Same Height Top Caps	3"	1/2"	3"	DP7PTCP()		12.	13.	14.
 Concealed Post High Low Top Caps	3"	1/2"	3"	DP7PTCPH()		12.	13.	14.

Ordering Information

Concealed Post

1. Pattern Number

Concealed Post Top Caps

1. Pattern Number
2. Paint Finish Code

Order Code

Concealed Post

Example: **DP7PO42CPF**

DP7PO42 Pattern Number
CPF

Concealed Post Top Caps

Example: **DP7PTCP5**

DP7PTCP Pattern Number

5 Flat profile

613 Silver paint finish

Included with:

Concealed Post

- Tile to floor filler

Concealed Post Top Caps

Options:

Post Top Cap Option:

(5) = Flat Profile

Concealed Post Post Components Panel Top Caps

description	w	h	d	pattern no.	P1	P2	P3
Concealed Post Panel Top Caps for use with Topway Frames	33"	1/2"	3"	DP()PT30CP	\$58.	\$64.	\$67.
	39"	1/2"	3"	DP()PT36CP	59.	65.	68.
	51"	1/2"	3"	DP()PT48CP	60.	66.	69.
	63"	1/2"	3"	DP()PT60CP	61.	67.	70.
	75"	1/2"	3"	DP()PT72CP	63.	69.	72.
	87"	1/2"	3"	DP()PT84CP	65.	72.	75.
	99"	1/2"	3"	DP()PT96CP	66.	73.	76.

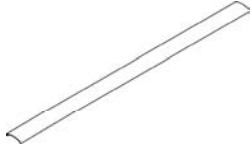

Concealed Post Panel Top Caps for use with Full View Frames	33"	1/2"	3"	DP()PT30CPF	58.	64.	67.
	39"	1/2"	3"	DP()PT36CPF	59.	65.	68.
	51"	1/2"	3"	DP()PT48CPF	60.	66.	69.
	63"	1/2"	3"	DP()PT60CPF	61.	67.	70.
	75"	1/2"	3"	DP()PT72CPF	63.	69.	72.
	87"	1/2"	3"	DP()PT84CPF	65.	72.	75.
	99"	1/2"	3"	DP()PT96CPF	66.	73.	76.

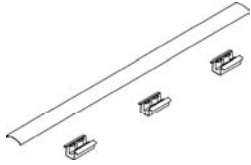

Concealed Post Shortened Panel Top Caps for use with Topway Frames	32"	1/2"	3"	DP()PT29CP	58.	64.	67.
	38"	1/2"	3"	DP()PT35CP	59.	65.	68.
	50"	1/2"	3"	DP()PT47CP	60.	66.	69.
	62"	1/2"	3"	DP()PT59CP	61.	67.	70.
	74"	1/2"	3"	DP()PT71CP	63.	69.	72.
	86"	1/2"	3"	DP()PT83CP	65.	72.	75.
	98"	1/2"	3"	DP()PT95CP	66.	73.	76.

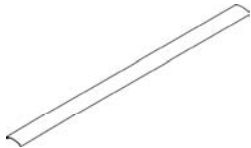

Concealed Post Shortened Panel Top Caps for use with Full View Frames	32"	1/2"	3"	DP()PT29CPF	58.	64.	67.
	38"	1/2"	3"	DP()PT35CPF	59.	65.	68.
	50"	1/2"	3"	DP()PT47CPF	60.	66.	69.
	62"	1/2"	3"	DP()PT59CPF	61.	67.	70.
	74"	1/2"	3"	DP()PT71CPF	63.	69.	72.
	86"	1/2"	3"	DP()PT83CPF	65.	72.	75.
	98"	1/2"	3"	DP()PT95CPF	66.	73.	76.

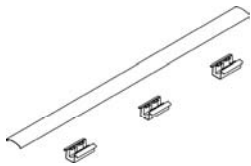

Ordering Information

Concealed Post Panel Top Caps

1. Pattern Number
2. Paint Finish Code

Order Code

Concealed Post Panel Top Caps

Example: **DP5PT48CP**
DP5PT48 Pattern Number
CP
117 Soft Grey paint finish

Included with:

Concealed Post Panel Top Caps

- Panel Top Caps
- Attachment Brackets (for Full View Frame only)

Options:

Trim Option:

(5) = Metal, Flat

Concealed Post *Monolithic Panel Fabric Inserts* Specifications

Concealed Post Monolithic Fabric Inserts

Concealed post monolithic fabric inserts are designed to cover a concealed post and eliminate the need for a post cover. Concealed post monolithic tile-to-floor fabric inserts create a seamless aesthetic at a three-way connection. There are three types of concealed post monolithic tiles: half post, centered, and double with post. Concealed post monolithic fabric inserts are only available tile-to-floor. Concealed post applications are specified by individual components through "Build-to-Spec".

Concealed Post Monolithic Fabric Insert Construction

Fabric laminated with adhesive and heat-cured to 7/18" thick acoustical board.

Concealed Post Monolithic Fabric Insert Attachment

Panel inserts flex to attach to the troughs in the upper and lower horizontal frame supports. Mounting clips are attached to panel inserts for connection to the vertical frame for additional support. No tools are required for insert attachment.

Planning with Concealed Post Half Post Fabric Tiles

Half post fabric tiles attach to a panel frame or combination of panel frames that are connected to a concealed post. This type of tile covers the entire width of the panel frame(s) and half of the concealed post. Half post fabric tiles are 1-1/2" wider than standard tile widths to cover half of the concealed post. Half post fabric tiles are handed, either left or right.

The left edge of a left half post fabric tile ends in the middle of a concealed post and the right edge of the tile ends on the furthest right edge of the panel(s). The right edge of a right half post fabric tile ends in the middle of a concealed post and the left edge of the tile ends on the left side of the panel(s). (See illustration below) A half post fabric tile must be used with either another half post tile or a centered tile, so the other half of the post is concealed by a tile.

Half Post Fabric Tile Application

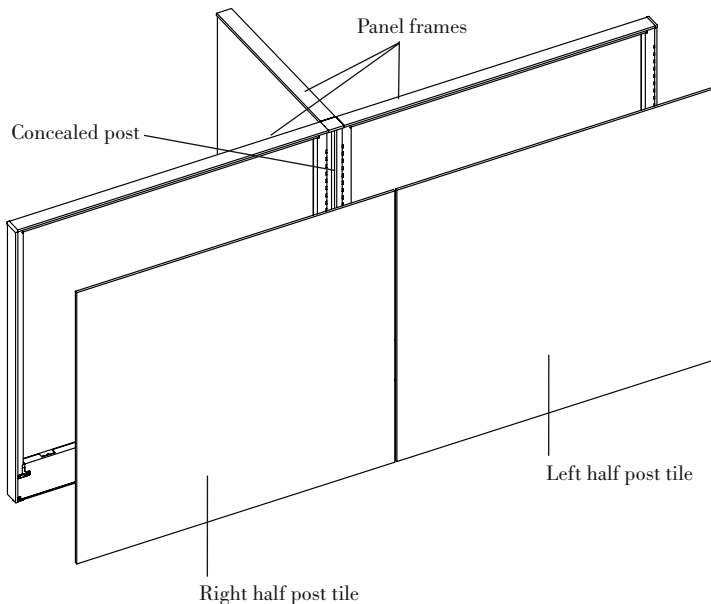

Half Post Fabric Tile Plan View

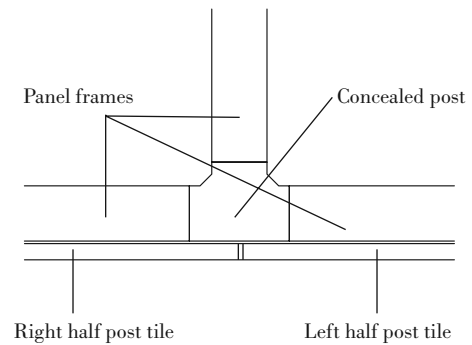

Concealed Post

Monolithic Panel Fabric Inserts and Frameless Add Ups Specifications

Planning with Concealed Post Centered Fabric Tiles

Centered fabric tiles attach to a panel frame or combination of panel frames that are connected to concealed posts. Centered fabric tiles are centered on a panel frame(s) between two concealed posts. The left and right edge of the fabric tile ends in the center of a concealed post. A centered fabric tile is 3" wider than standard tile widths. Centered fabric tiles must be centered on the panel frame(s) between the concealed posts. Neither the right nor left edge of a centered fabric tile is able to end anywhere other than the center of a concealed post. (See illustration below) A centered fabric tile must be used with either a half post tile or another centered tile, so the other half of the post is concealed by a tile.

Planning with Concealed Post Double with Post Fabric Tiles

A double with post fabric tile attaches to two panel frames that are connected by a concealed post. The tile attaches to the panels and hides the concealed post connection. The concealed post must be between the panel frames. Double with post fabric tiles are 3" wider than standard tile widths, so that they are able to cover a concealed post. (See illustration below) Neither the right nor left edge of a double with post fabric tile is able to end anywhere other than the right or left edge of a panel frame.

Concealed Post Frameless Add Ups

Concealed post frameless add ups are 3" longer than standard frameless add up lengths, so they can span over a concealed post. Concealed post frameless add ups are not compatible with Dividends Horizon DP7 or Legacy posts.

Note: Concealed posts and corresponding components are not compatible with Dividends Horizon DP7 posts, Legacy posts, standard post top caps, or standard fabric or laminate tile sizes.

Double With Post Fabric Tile Application

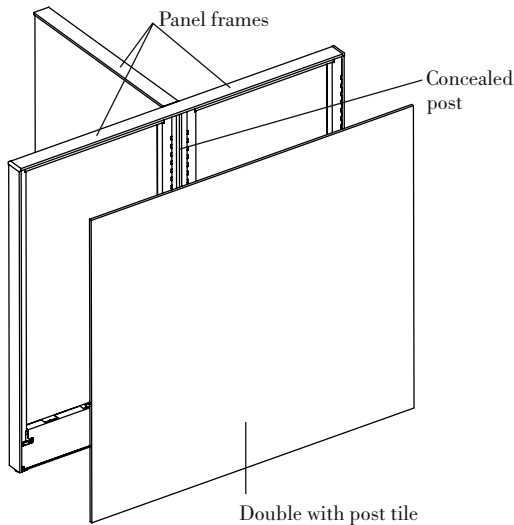

Double With Post Fabric Tile Plan View

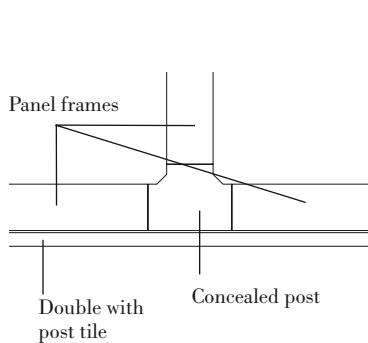

Centered Fabric Tile Application

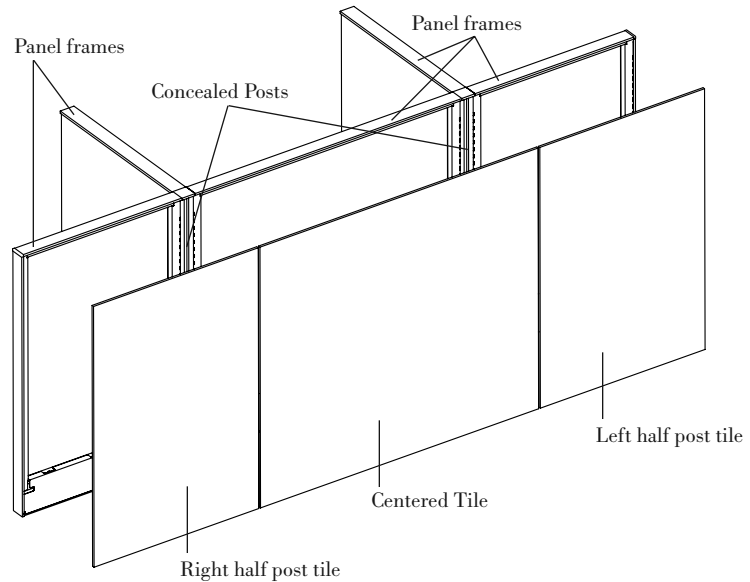

Centered Fabric Tile Plan View

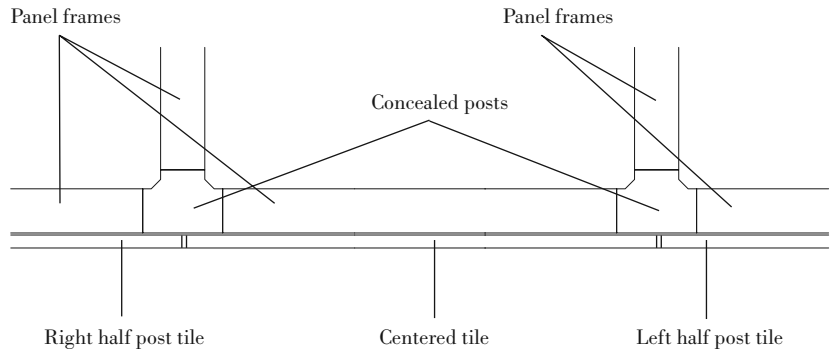



Concealed Post

Monolithic Panel Half Post Fabric Inserts

Worksurface Height, 28" and 42" High

Dividends Horizon

description	w*	w	d	pattern no.	10	15	20	25	30	35	40	45
Worksurface Height Concealed Post	15"	16 1/2"	7/16"	DP1SOWH15()F	\$94.	\$97.	\$101.	\$104.	\$105.	\$108.	\$109.	\$112.
Monolithic Panel Half Post	18"	19 1/2"	7/16"	DP1SOWH18()F	105.	108.	113.	116.	117.	120.	122.	125.
Fabric Inserts	24"	25 1/2"	7/16"	DP1SOWH24()F	115.	119.	124.	127.	130.	133.	134.	138.
	30"	31 1/2"	7/16"	DP1SOWH30()F	126.	130.	136.	139.	142.	145.	147.	151.
	36"	37 1/2"	7/16"	DP1SOWH36()F	137.	141.	148.	151.	154.	157.	160.	164.
	42"	43 1/2"	7/16"	DP1SOWH42()F	147.	152.	159.	162.	167.	170.	172.	177.
	48"	49 1/2"	7/16"	DP1SOWH48()F	158.	163.	171.	174.	179.	182.	185.	190.
	60"	61 1/2"	7/16"	DP1SOWH60()F	167.	172.	180.	184.	189.	192.	195.	200.
28" High Concealed Post	15"	16 1/2"	7/16"	DP1SO2815()F	95.	98.	82.	84.	87.	89.	89.	91.
Monolithic Panel Half Post	18"	19 1/2"	7/16"	DP1SO2818()F	108.	112.	103.	106.	109.	111.	112.	115.
Fabric Inserts	24"	25 1/2"	7/16"	DP1SO2824()F	122.	125.	125.	127.	131.	134.	135.	138.
(For 36"H Panel Frame)	30"	31 1/2"	7/16"	DP1SO2830()F	135.	139.	146.	149.	153.	156.	158.	162.
	36"	37 1/2"	7/16"	DP1SO2836()F	148.	153.	167.	171.	175.	178.	181.	186.
	42"	43 1/2"	7/16"	DP1SO2842()F	162.	166.	189.	192.	197.	201.	204.	209.
	48"	49 1/2"	7/16"	DP1SO2848()F	175.	180.	210.	214.	219.	223.	227.	233.
	60"	61 1/2"	7/16"	DP1SO2860()F	186.	191.	224.	228.	234.	239.	243.	249.
42" High Concealed Post	15"	16 1/2"	7/16"	DP1SO4215()F	98.	100.	106.	106.	111.	113.	115.	117.
Monolithic Panel Half Post	18"	19 1/2"	7/16"	DP1SO4218()F	114.	117.	123.	124.	129.	131.	134.	136.
Fabric Inserts	24"	25 1/2"	7/16"	DP1SO4224()F	130.	133.	141.	142.	147.	150.	152.	156.
	30"	31 1/2"	7/16"	DP1SO4230()F	146.	150.	158.	160.	165.	168.	171.	175.
	36"	37 1/2"	7/16"	DP1SO4236()F	162.	167.	175.	178.	183.	186.	190.	194.
	42"	43 1/2"	7/16"	DP1SO4242()F	178.	183.	193.	196.	201.	205.	208.	214.
	48"	49 1/2"	7/16"	DP1SO4248()F	194.	200.	210.	214.	219.	223.	227.	233.
	60"	61 1/2"	7/16"	DP1SO4260()F	207.	214.	224.	228.	234.	239.	243.	249.

w* = nominal width

Dimensions listed under w h d are actual to the nearest 1/16"

Ordering Information	Order Code	Included with:	Options
Concealed Post Monolithic Panel Fabric Inserts	Concealed Post Monolithic Panel Fabric Inserts	Concealed Post Monolithic Panel Fabric Inserts	Concealed Post Monolithic Panel Fabric Inserts
1. Pattern Number	<i>Example:</i> DP1SO2818CEF	• Attachment Clips	Configuration:
2. Fabric	DP1SO Pattern Number		(CE) = Left Half Post: Tile ends in the center of the post on the left and at the right side of the panel frame.
	2818		(EC) = Right Half Post: Tile ends in the center of the post on the right and at the left side of the panel frame.
	CE Center left, End Right		
	F Tile to Floor		
	W351-3 Foundation Corn Silk Fabric		

Concealed Post

Monolithic Panel Half Post Fabric Inserts

50", 57" and 64" High

Dividends Horizon

description	w*	w	d	pattern no.	10	15	20	25	30	35	40	45
50" High Concealed Post Monolithic Panel Half Post Fabric Inserts	15"	16 1/2"	7/16"	DP1SO5015()F	\$101.	\$103.	\$108.	\$110.	\$113.	\$115.	\$117.	\$120.
	18"	19 1/2"	7/16"	DP1SO5018()F	120.	122.	128.	131.	134.	137.	139.	143.
	24"	25 1/2"	7/16"	DP1SO5024()F	138.	142.	149.	151.	156.	158.	161.	165.
	30"	31 1/2"	7/16"	DP1SO5030()F	157.	161.	169.	172.	177.	180.	183.	188.
	36"	37 1/2"	7/16"	DP1SO5036()F	176.	180.	189.	193.	198.	202.	205.	211.
	42"	43 1/2"	7/16"	DP1SO5042()F	194.	200.	210.	213.	220.	223.	227.	233.
	48"	49 1/2"	7/16"	DP1SO5048()F	213.	219.	230.	234.	241.	245.	249.	256.
60"	61 1/2"	7/16"	DP1SO5060()F	229.	235.	247.	251.	258.	263.	267.	274.	
57" High Concealed Post Monolithic Panel Half Post Fabric Inserts	15"	16 1/2"	7/16"	DP1SO5715()F	104.	107.	112.	113.	116.	119.	121.	124.
	18"	19 1/2"	7/16"	DP1SO5718()F	125.	129.	135.	137.	140.	144.	146.	150.
	24"	25 1/2"	7/16"	DP1SO5724()F	147.	151.	158.	160.	165.	168.	171.	175.
	30"	31 1/2"	7/16"	DP1SO5730()F	168.	173.	181.	184.	189.	193.	196.	201.
	36"	37 1/2"	7/16"	DP1SO5736()F	189.	195.	204.	208.	213.	218.	221.	227.
	42"	43 1/2"	7/16"	DP1SO5742()F	211.	217.	227.	231.	238.	242.	246.	252.
	48"	49 1/2"	7/16"	DP1SO5748()F	232.	239.	250.	255.	262.	267.	271.	278.
60"	61 1/2"	7/16"	DP1SO5760()F	250.	257.	270.	275.	282.	287.	292.	300.	
64" High Concealed Post Monolithic Panel Half Post Fabric Inserts	15"	16 1/2"	7/16"	DP1SO6415()F	105.	107.	113.	116.	118.	121.	122.	127.
	18"	19 1/2"	7/16"	DP1SO6418()F	129.	132.	139.	143.	146.	149.	151.	156.
	24"	25 1/2"	7/16"	DP1SO6424()F	154.	158.	166.	169.	173.	177.	179.	185.
	30"	31 1/2"	7/16"	DP1SO6430()F	178.	183.	192.	196.	201.	205.	208.	214.
	36"	37 1/2"	7/16"	DP1SO6436()F	202.	208.	218.	223.	229.	233.	237.	243.
	42"	43 1/2"	7/16"	DP1SO6442()F	227.	234.	245.	249.	256.	261.	265.	272.
	48"	49 1/2"	7/16"	DP1SO6448()F	251.	259.	271.	276.	284.	289.	294.	301.
60"	61 1/2"	7/16"	DP1SO6460()F	272.	280.	293.	299.	307.	312.	318.	326.	



w* = nominal width
Dimensions listed under w h d are actual to the nearest 1/16"

Ordering Information	Order Code	Included with:	Options
Concealed Post Monolithic Panel Fabric Inserts 1. Pattern Number 2. Fabric	Concealed Post Monolithic Panel Fabric Inserts <i>Example:</i> DP1SO5718CEF DP1SO Pattern Number 5718 CE Center left, End Right F Tile to Floor W351-3 Foundation Corn Silk Fabric	Concealed Post Monolithic Panel Fabric Inserts • Attachment Clips	Concealed Post Monolithic Panel Fabric Inserts Configuration: (CE) = Left Half Post: Tile ends in the center of the post on the left and at the right side of the panel frame. (EC) = Right Half Post: Tile ends in the center of the post on the right and at the left side of the panel frame.

Alternative Planning

Concealed Post
Monolithic Panel Centered Fabric Inserts
Worksurface Height, 28" and 42" High

Dividends Horizon

description	w*	w	d	pattern no.	10	15	20	25	30	35	40	45
Worksurface Height Concealed Post	15"	18"	7/16"	DP1SOWH15CCF	\$131.	\$134.	\$142.	\$143.	\$149.	\$151.	\$154.	\$158.
Monolithic Panel Centered Fabric Insert	18"	21"	7/16"	DP1SOWH18CCF	135.	139.	147.	148.	154.	156.	169.	163.
	24"	27"	7/16"	DP1SOWH24CCF	140.	143.	151.	153.	158.	161.	164.	168.
	30"	33"	7/16"	DP1SOWH30CCF	144.	148.	156.	158.	163.	166.	169.	173.
	36"	39"	7/16"	DP1SOWH36CCF	148.	153.	161.	163.	168.	171.	174.	178.
	42"	45"	7/16"	DP1SOWH42CCF	153.	157.	165.	168.	172.	176.	179.	183.
	48"	51"	7/16"	DP1SOWH48CCF	157.	162.	170.	173.	177.	181.	184.	188.
	60"	63"	7/16"	DP1SOWH60CCF	166.	171.	179.	183.	188.	191.	194.	199.
28" High Concealed Post	15"	18"	7/16"	DP1SO2815CCF	141.	146.	154.	156.	161.	163.	166.	171.
Monolithic Panel Centered Fabric Insert	18"	21"	7/16"	DP1SO2818CCF	147.	152.	160.	162.	167.	169.	172.	177.
(For 36"H Panel Frame)	24"	27"	7/16"	DP1SO2824CCF	152.	157.	165.	168.	173.	176.	179.	184.
	30"	33"	7/16"	DP1SO2830CCF	158.	163.	171.	174.	179.	182.	185.	190.
	36"	39"	7/16"	DP1SO2836CCF	164.	169.	177.	180.	185.	188.	191.	196.
	42"	45"	7/16"	DP1SO2842CCF	169.	174.	182.	186.	191.	195.	198.	203.
	48"	51"	7/16"	DP1SO2848CCF	175.	180.	188.	192.	197.	201.	204.	209.
	60"	63"	7/16"	DP1SO2860CCF	185.	191.	200.	204.	209.	213.	217.	222.
42" High Concealed Post	15"	18"	7/16"	DP1SO4215CCF	154.	158.	166.	168.	173.	177.	179.	185.
Monolithic Panel Centered Fabric Insert	18"	21"	7/16"	DP1SO4218CCF	161.	165.	173.	176.	181.	185.	187.	193.
	24"	27"	7/16"	DP1SO4224CCF	167.	172.	181.	183.	188.	192.	195.	201.
	30"	33"	7/16"	DP1SO4230CCF	174.	179.	188.	191.	196.	200.	203.	209.
	36"	39"	7/16"	DP1SO4236CCF	181.	186.	195.	199.	204.	208.	211.	217.
	42"	45"	7/16"	DP1SO4242CCF	187.	193.	203.	206.	211.	215.	219.	225.
	48"	51"	7/16"	DP1SO4248CCF	194.	200.	210.	214.	219.	223.	227.	233.
	60"	63"	7/16"	DP1SO4260CCF	207.	214.	224.	228.	234.	239.	243.	249.

w* = nominal width
Dimensions listed under w h d are actual to the nearest 1/16"



Ordering Information	Order Code	Included with:	Options
Concealed Post Monolithic Panel Fabric Inserts	Concealed Post Monolithic Panel Fabric Inserts	Concealed Post Monolithic Panel Fabric Inserts	Concealed Post Monolithic Panel Fabric Inserts
1. Pattern Number	<i>Example:</i> DP1SO2818CCF	• Attachment Clips	
2. Fabric	DP1SO Pattern Number		
	2818		
	CC Center Left, Center Right		
	F Tile to Floor		
	W351-3 Foundation Corn Silk Fabric		

Concealed Post

Monolithic Panel Centered Fabric Inserts

50", 57" and 64" High

Dividends Horizon

description	w*	w	d	pattern no.	10	15	20	25	30	35	40	45
50" High Concealed Post	15"	18"	7/16"	DP1SO5015CCF	\$167.	\$170.	\$180.	\$183.	\$187.	\$191.	\$194.	\$200.
Monolithic Panel Centered Fabric Insert	18"	21"	7/16"	DP1SO5018CCF	175.	178.	188.	192.	196.	200.	203.	209.
	24"	27"	7/16"	DP1SO5024CCF	182.	187.	197.	200.	205.	209.	213.	219.
	30"	33"	7/16"	DP1SO5030CCF	190.	195.	205.	209.	214.	218.	222.	228.
	36"	39"	7/16"	DP1SO5036CCF	198.	203.	213.	218.	223.	227.	231.	237.
	42"	45"	7/16"	DP1SO5042CCF	205.	212.	222.	226.	232.	236.	241.	247.
	48"	45"	7/16"	DP1SO5048CCF	213.	220.	230.	235.	241.	245.	250.	256.
	60"	63"	7/16"	DP1SO5060CCF	229.	236.	247.	252.	259.	263.	268.	275.
57" High Concealed Post	15"	18"	7/16"	DP1SO5715CCF	177.	183.	193.	196.	201.	205.	208.	213.
Monolithic Panel Centered Fabric Insert	18"	21"	7/16"	DP1SO5718CCF	186.	192.	203.	206.	211.	215.	219.	224.
	24"	27"	7/16"	DP1SO5724CCF	196.	202.	212.	216.	222.	226.	229.	235.
	30"	33"	7/16"	DP1SO5730CCF	205.	211.	222.	226.	232.	236.	240.	246.
	36"	39"	7/16"	DP1SO5736CCF	214.	220.	232.	236.	242.	246.	251.	257.
	42"	45"	7/16"	DP1SO5742CCF	224.	230.	241.	246.	253.	257.	261.	268.
	48"	51"	7/16"	DP1SO5748CCF	233.	239.	251.	256.	263.	267.	272.	279.
	60"	63"	7/16"	DP1SO5760CCF	251.	258.	271.	276.	283.	288.	293.	301.
64" High Concealed Post	15"	18"	7/16"	DP1SO6415CCF	192.	196.	206.	211.	215.	220.	223.	230.
Monolithic Panel Centered Fabric Insert	18"	21"	7/16"	DP1SO6418CCF	202.	207.	217.	222.	227.	232.	235.	242.
	24"	27"	7/16"	DP1SO6424CCF	212.	217.	228.	233.	238.	243.	247.	254.
	30"	33"	7/16"	DP1SO6430CCF	222.	228.	239.	244.	250.	255.	259.	266.
	36"	39"	7/16"	DP1SO6436CCF	232.	239.	250.	255.	262.	267.	271.	278.
	42"	45"	7/16"	DP1SO6442CCF	242.	249.	261.	266.	273.	278.	283.	290.
	48"	51"	7/16"	DP1SO6448CCF	252.	260.	272.	277.	285.	290.	295.	302.
	60"	63"	7/16"	DP1SO6460CCF	272.	281.	294.	300.	308.	313.	319.	327.

w* = nominal width
 Dimensions listed under w h d are actual to the nearest 1/16"

Ordering Information	Order Code	Included with:	Options
Concealed Post Monolithic Panel Fabric Inserts	Concealed Post Monolithic Panel Fabric Inserts	Concealed Post Monolithic Panel Fabric Inserts	Concealed Post Monolithic Panel Fabric Inserts
1. Pattern Number	<i>Example:</i> DP1SO5718CCF	• Attachment Clips	
2. Fabric	DP1SO Pattern Number		
	5718		
	CC Center Left, Center Right		
	F Tile to Floor		
	W351-3 Foundation Corn Silk Fabric		

Alternative Planning

Monolithic Panel Double with Post Fabric Inserts
Worksurface Height, 28" and 42" High

description	w*	w	d	pattern no.	10	15	20	25	30	35	40	45
Worksurface Height Concealed Post	30"	33"	7/16"	DP1SOWH30EPEF	\$131.	\$136.	\$142.	\$144.	\$149.	\$151.	\$153.	\$157.
Monolithic Panel Double with	36"	39"	7/16"	DP1SOWH36EPEF	146.	151.	158.	160.	165.	168.	170.	175.
Post Fabric Insert	48"	51"	7/16"	DP1SOWH48EPEF	160.	165.	173.	176.	181.	184.	187.	192.
	60"	63"	7/16"	DP1SOWH60EPEF	175.	180.	189.	192.	197.	201.	204.	210.



28" High Concealed Post	30"	33"	7/16"	DP1SO2830EPEF	103.	105.	111.	114.	116.	119.	120.	123.
Monolithic Panel Double with	36"	39"	7/16"	DP1SO2836EPEF	140.	143.	151.	154.	158.	161.	163.	167.
Post Fabric Insert	48"	51"	7/16"	DP1SO2848EPEF	176.	181.	190.	194.	199.	203.	206.	211.
(For 36" h panel frame)	60"	63"	7/16"	DP1SO2860EPEF	213.	219.	230.	234.	241.	245.	249.	255.



42" High Concealed Post	30"	33"	7/16"	DP1SO4230EPEF	128.	132.	139.	142.	144.	147.	149.	153.
Monolithic Panel Double with	36"	39"	7/16"	DP1SO4236EPEF	163.	168.	176.	180.	183.	187.	190.	195.
Post Fabric Insert	48"	51"	7/16"	DP1SO4248EPEF	197.	203.	213.	217.	222.	226.	230.	236.
	60"	63"	7/16"	DP1SO4260EPEF	232.	239.	250.	255.	261.	266.	271.	278.



w* = nominal width

Dimensions listed under w h d are actual to the nearest 1/16"

Ordering Information	Order Code	Included with:	Options
Concealed Post Monolithic Panel Fabric Inserts	Concealed Post Monolithic Panel Fabric Inserts	Concealed Post Monolithic Panel Fabric Inserts	Concealed Post Monolithic Panel Fabric Inserts
1. Pattern Number	<i>Example:</i> DP1SO2836EPEF	• Attachment Clips	
2. Fabric	DP1SO Pattern Number		
	2836		
	EPE End, Post, End		
	F Tile to Floor		
	W351-3 Foundation Corn Silk Fabric		

Concealed Post

Monolithic Panel Double with Post Fabric Inserts

50", 57" and 64" High

description	w*	w	d	pattern no.	10	15	20	25	30	35	40	45
50" High Concealed Post	30"	33"	7/16"	DP1SO5030EPEF	\$152.	\$155.	\$163.	\$168.	\$171.	\$174.	\$178.	\$182.
Monolithic Panel Double with	36"	39"	7/16"	DP1SO5036EPEF	184.	189.	198.	203.	208.	211.	216.	221.
Post Fabric Insert	48"	51"	7/16"	DP1SO5048EPEF	216.	222.	233.	238.	244.	248.	253.	259.
	60"	63"	7/16"	DP1SO5060EPEF	248.	256.	268.	273.	281.	285.	291.	298.



57" High Concealed Post	30"	33"	7/16"	DP1SO5730EPEF	176.	181.	190.	194.	199.	201.	206.	211.
Monolithic Panel Double with	36"	39"	7/16"	DP1SO5736EPEF	206.	212.	222.	227.	233.	236.	241.	247.
Post Fabric Insert	48"	51"	7/16"	DP1SO5748EPEF	235.	242.	254.	259.	266.	270.	275.	282.
	60"	51"	7/16"	DP1SO5760EPEF	265.	273.	286.	292.	300.	305.	310.	318.



64" High Concealed Post	30"	33"	7/16"	DP1SO6430EPEF	224.	230.	242.	246.	253.	257.	262.	268.
Monolithic Panel Double with	36"	39"	7/16"	DP1SO6436EPEF	239.	246.	259.	263.	271.	275.	280.	287.
Post Fabric Insert	48"	51"	7/16"	DP1SO6448EPEF	254.	262.	275.	280.	288.	293.	298.	305.



w* = nominal width
 Dimensions listed under w h d are actual to the nearest 1/16"

Ordering Information	Order Code	Included with:	Options
Concealed Post Monolithic Panel Fabric Inserts	Concealed Post Monolithic Panel Fabric Inserts	Concealed Post Monolithic Panel Fabric Inserts	Concealed Post Monolithic Panel Fabric Inserts
1. Pattern Number	<i>Example:</i> DP1SO5736EPEF	• Attachment Clips	
2. Fabric	DP1SO Pattern Number		
	5736		
	EPE End, Post, End		
	F Tile to Floor		
	W351-3 Foundation Corn Silk Fabric		

Concealed Post
 Frameless Add Up
 Clear and Powder Glass

description	w	d	h	pattern no.	list	Clear (TEMP)	Powder (GL13)
Frameless Add Up, 7" High (For use with concealed post only)	51"	3/4"	7"	DP1AU0751()G		\$376.	\$422.
	57"	3/4"	7"	DP1AU0757()G		407.	459.
	63"	3/4"	7"	DP1AU0763()G		438.	496.
	69"	3/4"	7"	DP1AU0769()G		470.	532.
	75"	3/4"	7"	DP1AU0775()G		501.	569.



Frameless Add Up, 14" High (For use with concealed post only)	51"	3/4"	14"	DP1AU1451()G		531.	624.
	57"	3/4"	14"	DP1AU1457()G		580.	685.
	63"	3/4"	14"	DP1AU1463()G		630.	745.
	69"	3/4"	14"	DP1AU1469()G		679.	806.
	75"	3/4"	14"	DP1AU1475()G		729.	866.

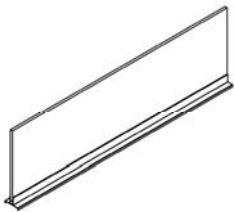

End Cap				DP1AUECTP	34.		
---------	--	--	--	------------------	-----	--	--



Ordering Information

Frameless Add Up with Glass

1. Pattern number
2. Frame finish
3. Glass finish

End Cap

1. Pattern number
2. Paint finish

Order Code

Frameless Add Up with Glass

Example: **DP1AU0757VG**

DP1AU	Frameless Add Up
07	7" High
57	57" Wide
V	Full view
G	Glass
117	Frame finish
TEMP	Clear glass finish

Included with:

Frameless Add Up with Glass

- Attachment hardware
- Topway Trough Spacer (Topway only)
- Alignment Clip

Options

Frame Options:

- (V)** = Full view
(C) = Topway

Glass Options:

- (TEMP)** = Clear
(GL13) = Powder

This page intentionally left blank

The 120-degree planning model provides comparable or greater square footage per workstation than typical cubicle layouts (comparisons are illustrated on this page). At the same time, Dividends Horizon 120° allows for a more natural space, creating a more comfortable place to work. Maintaining a consistent 48" module promotes improved asset management and a reduction of reconfiguration costs.

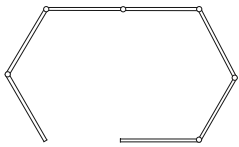

Big House
Sq. Feet = 69.8'
7 Panels

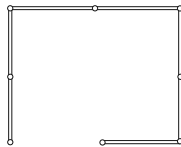

8' x 8'
Sq. Feet = 64'
7 Panels

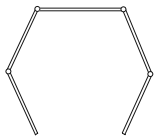

Full House
Sq. Feet = 42.1'
5 Panels

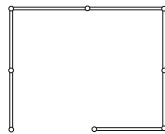

6' x 7'
Sq. Feet = 42'
7 Panels

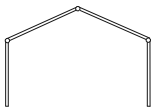

Open House
Sq. Feet = 35.5'
4 Panels



6' x 6'
Sq. Feet = 36'
6 Panels

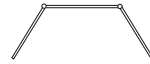

Townhouse
Sq. Feet = 34.1'
3 Panels

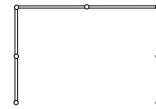

6' x 6'
Sq. Feet = 36'
6 Panels

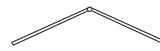

Apartment
Sq. Feet = 32.1'
2 Panels

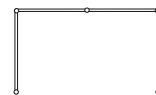

4' x 6'
Sq. Feet = 24'
4 Panels

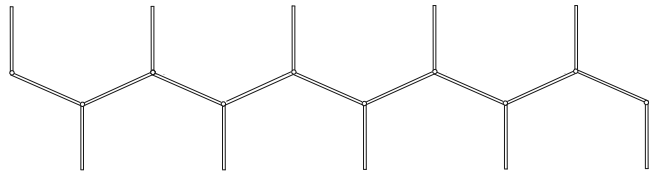

8 Open House Stations
Sq. Feet = 284'
19 Panels

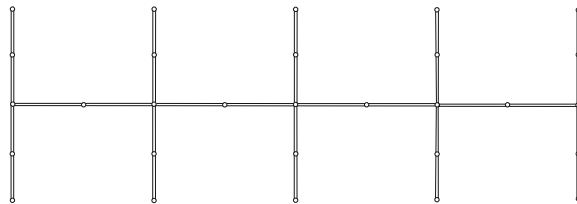

8 Station Cluster
Each station 6' x 6'
Sq. Feet = 288'
28 Panels

These worksurfaces are designed specifically for Dividends Horizon 120. The (L/R) suffix at the end of a pattern number indicates a defined pedestal location. If the worksurface has no defined pedestal location, the (L/R) represents the curved side of the top. All tops and tables are available with 2mm edge band or a 1" ergonomic edge.

Worksurface: W3

This worksurface, combined with the T3 Transition top, works best with the "apartment" layout. This application allows for stations on both sides of the spine, and is ideal for high density layouts. Available in extended versions for placement directly next to another worksurface.

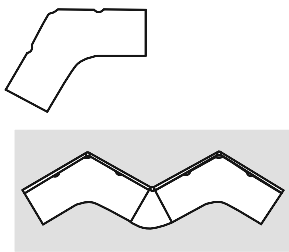

Worksurface: W3

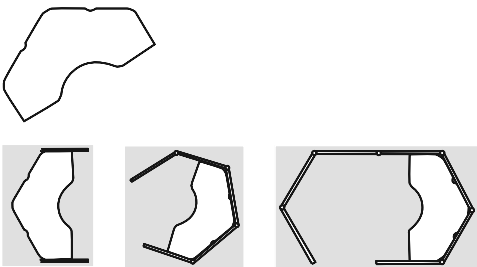

Worksurface: W4

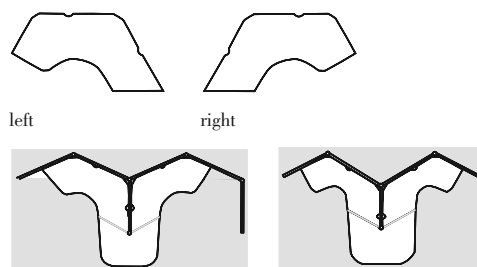

Worksurface: W5 (L/R)

Worksurface: W4

This top works well in the "open house," "full house," and "big house" layouts for call center, professional, and managerial applications.

Worksurface: W5 (L/R)

With transition top T5 and this worksurface, teaming is made easy using the "townhouse" or "open house" layout. The shared space allows for call center, professional, or technical applications.

Worksurface: W6 (L/R)

In the "big house," "full house" or "open house", this worksurface allows for a pedestal on one side (determined by the L/R). Applications for this top include a call center with the "open house," technical applications with the "full house," and managerial layouts with the "big house."

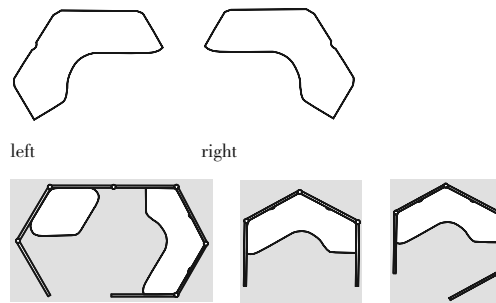

Worksurface: W6 (L/R)

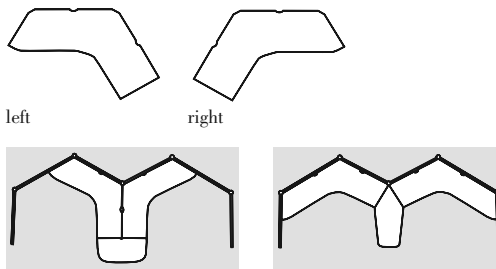

Worksurface: W7 (L/R)

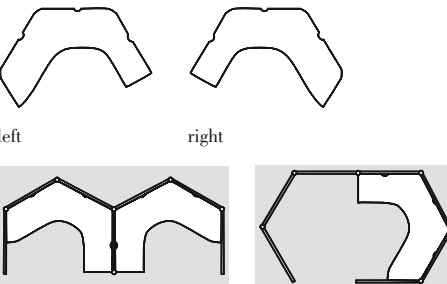

Worksurface: W11 / W1118 (L/R)

Worksurface: W7 (L/R)

Used in conjunction with a T4 transition top, the W7 worksurface provides a great teaming space when the "townhouse" layout is used. The "open house" layout incorporates the T2 transition top for professional or technical stations with shared space for conferencing. Available in extended versions for placement directly next to another worksurface.

Worksurface: W11 /W1118 (L/R)

This top is a spacious option for a technical station in the "open house" layout. Adding a T2 transition top provides additional teaming space. The W11 surface also fits nicely in a private managerial office or a "full house" professional application.

Worksurface: W12 / W1218 (L/R)

This top, with the T5/T518 transition top provides a technical office with shared conferencing space in the “open house” layout. The 18” return allows ample space in the supervisory application of the “full house.”

Worksurface: W13 / W1318 (L/R)

This surface provides a teaming space with the T2/T218 transition in the “open house” layout. The W13/W1318 creates generous worksurface space in the “full house” as well as the management layout of the “big house.”

Transition Tops

Transition tops require columns (not included) for support. Flat brackets (not included) are required to attach transition tops to adjacent worksurfaces.

Application Notes

Dividends Horizon 120° worksurfaces use cantilevers as their main form of support. A cantilever must be used at each post location to support worksurfaces properly. A pedestal may be used for support, where applicable, in conjunction with cantilevers.

Worksurface: W12 / W1218 (L/R)

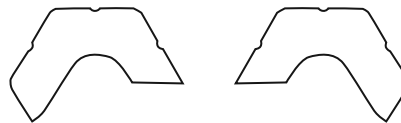

left

right



Worksurface: W13 / W1318 (L/R)

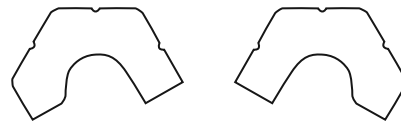

left

right

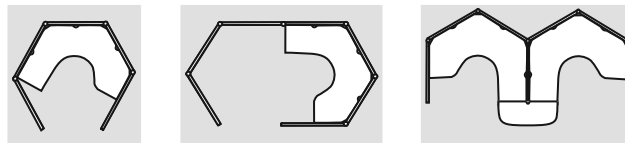

Transition Tops



Transition top: T2



Transition top: T218

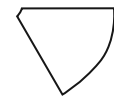

Transition top: T3



Transition top: T4







Transition top: T5



Transition top: T518

120° Planning

120° Post Assemblies

description	h*	w	d	pattern no.	Black	Metal P1	Metal P2	Metal P3
 120° Two-Way Post Assembly	36"	3"	3"	DP()120PA362		\$245.	\$253.	\$261.
	42"	3"	3"	DP()120PA422		245.	253.	261.
	50"	3"	3"	DP()120PA502		257.	265.	273.
	57"	3"	3"	DP()120PA572		284.	294.	301.
	64"	3"	3"	DP()120PA642		284.	294.	301.
	78"	3"	3"	DP()120PA782		361.	377.	389.
 120° Three-Way Post Assembly	36"	3"	3"	DP()120PA363		251.	259.	265.
	42"	3"	3"	DP()120PA423		251.	259.	265.
	50"	3"	3"	DP()120PA503		261.	268.	276.
	57"	3"	3"	DP()120PA573		284.	294.	301.
	64"	3"	3"	DP()120PA643		284.	294.	301.
	78"	3"	3"	DP()120PA783		359.	373.	386.
 14" High 120° Stack Panel Posts	14 ^{5/8} "	3"	3"	DP120SPO 14	76.			
 21" High 120° Stack Panel Posts	21 ^{15/16} "	3"	3"	DP120SPO 21	77.			
 28" High 120° Stack Panel Posts	29 ^{1/4} "	3"	3"	DP120SPO 28	87.			

h = nominal height

Ordering Information

- Post Assemblies**
1. Pattern Number
 2. Trim Finish

Order Code

Post Assemblies
Example: **DP(4)120PA 642, 113**
DP(4)120 Pattern Number
PA 642
113 Dark grey trim finish

Included with:

- Post Assemblies**
- Post assemblies
 - Post top cap
 - Post cover
 - Connecting hardware





Options

- Post assembly trim options**
- (4)** = Metal, Radius
 - (5)** = Metal, Flat

120° Planning

120° Post Components

Dividends Horizon

description	type	h	w	d	pattern no.	Metal P1	Metal P2	Metal P3
Post Covers (Straight) High-Low Connection 	36" - 42"	8"			DP120PC08S	\$9.	\$11.	\$11.
	36" - 50"	14"			DP120PC14S	15.	19.	20.
	36" - 64"	28"			DP120PC28S	34.	37.	38.
	36" - 78"	42"			DP120PC42SH	51.	54.	56.
	42" - 50"	8"			DP120PC08S	9.	11.	11.
	42" - 64"	22"			DP120PC22S	21.	22.	23.
	42" - 78"	36"			DP120PC36S	46.	50.	52.
	50" - 64"	14"			DP120PC14S	15.	19.	20.
	50" - 78"	28"			DP120PC28S	34.	37.	38.
	64" - 78"	14"			DP120PC14S	15.	19.	20.
Post Top Caps 	One-Way	1/2"	3"	3"	DP()120PT1	8.	9.	9.
	Three-Way	1/2"	3"	3"	DP()120PT3	8.	9.	9.
	Two-Way	1/2"	3"	3"	DP()120PT2	8.	9.	9.
Post Covers (Straight) 	36"				DP120PC36SF	43.	46.	50.
	42"				DP120PC42S	43.	46.	50.
	50"				DP120PC50S	44.	48.	51.
	57"				DP120PC57S	50.	52.	55.
	64"				DP120PC64S	50.	52.	55.
	78"				DP120PC78S	55.	60.	62.
Universal Post (Post Only) 	36"	3"	3"		DP120PO36	183.		
	42"	3"	3"		DP120PO42	183.		
	50"	3"	3"		DP120PO50	193.		
	57"	3"	3"		DP120PO57	210.		
	64"	3"	3"		DP120PO64	210.		
	78"	3"	3"		DP120PO78	283.		
Inside Panel Shroud for 120° posts 	5"				DP120S	10.	13.	15.

Ordering Information	Order Code	Included with:	Options
Universal Post 1. Pattern Number	Universal Post <i>Example:</i> DP2A P050	Universal Post Connecting hardware	120° Post Panel Top Cap and Post Covers
Panel Top Cap 1. Pattern Number 2. Trim finish	DP2A Pattern Number P050	Panel Top Cap Post Covers	(4) = Metal, Radius (5) = Metal, Flat
Post Covers 1. Pattern Number 2. Trim finish	<i>Example:</i> DPV1 PT4, V04 DPV1 PT4 Pattern Number V04 Maple trim finish		
	Post Covers <i>Example:</i> DP2A PC50S, 117 DP(2A) Pattern Number PC50S 117 Soft grey trim finish		

This page intentionally left blank

Grain Direction

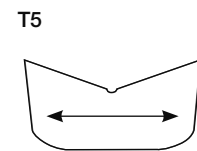
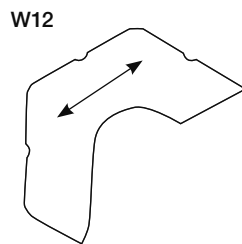
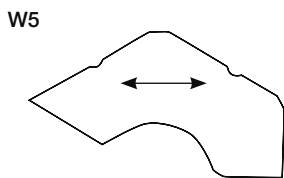
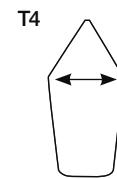
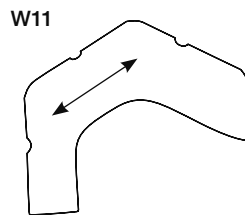
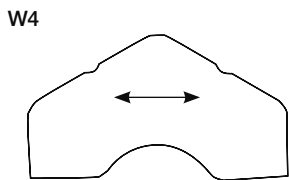
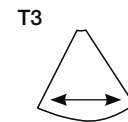
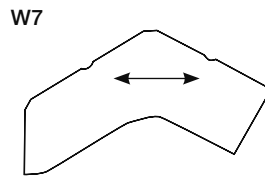
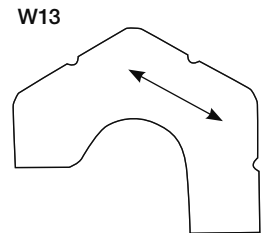
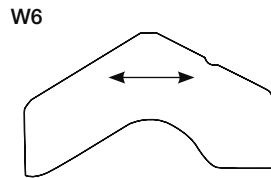
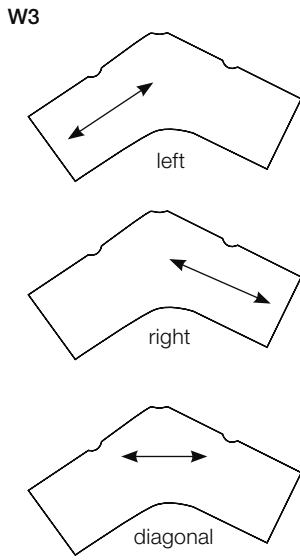

120° Planning

120° Worksurface and Transition Tops

Dividends Horizon

description	top name	w	return depth	d	pattern no.	2 mm	woodgrain edge	metal edge
Worksurface	W11L	48"	18"L-24"R		D1WW11481824	\$976.	\$1,072.	\$1,170.
	W11R	48"	24"L-18"R		D1WW11482418	976.	1,072.	1,170.
	W12L	48"	24"		D1WW124824L	1,019.	1,122.	1,223.
	W12R	48"	24"		D1WW124824R	1,019.	1,122.	1,223.
	W1318L	48"	24"L-18"R		D1WW13482418	976.	1,072.	1,170.
	W1318R	48"	18"L-24"R		D1WW13481824	976.	1,072.	1,170.
	W13L	48"	24"		D1WW134824L	976.	1,072.	1,170.
	W13R	48"	24"		D1WW134824R	976.	1,072.	1,170.
	W218L	48"	24"L-18"R		D1WW12482418	1,019.	1,122.	1,223.
	W218R	48"	18"L-24"R		D1WW12481824	1,019.	1,122.	1,223.
	W3	48"	24"		D1WW34824	743.	817.	890.
	W4	48"	24"		D1WW44824	764.	841.	917.
	W5L	48"	24"		D1WW54824L	615.	677.	740.
	W5R	48"	24"		D1WW54824R	615.	677.	740.
	W6L	48"	24"		D1WW64824L	826.	908.	990.
	W6R	48"	24"		D1WW64824R	826.	908.	990.
	W7L	48"	24"		D1WW74824L	823.	906.	987.
	W7R	48"	24"		D1WW74824R	823.	906.	987.
Transition tops	T2	50"	24"		D1WT224	496.	545.	596.
	T218	37 1/2"	18"		D1WT218	464.	512.	557.
	T3	26"	24"		D1WT324	472.	521.	569.
	T4	26"	24"		D1WT424	568.	625.	681.
	T5	50"	24"		D1WT524	575.	633.	688.
	T518	37 1/2"	18"		D1WT518	515.	566.	616.

Alternative Planning

Ordering Information

Worksurface

1. Pattern number
2. Finish

Order Code

Example:	D1WW134824L, 118, 118
D1W	Dividends 120 w/s 2mm edge
W13	Worksurface #13
4824	Side width/return depth
L	Pedestal on left side
118	Bright White laminate
118	Bright White edge

Included with:

Worksurface

- Worksurface

Worksurface supports must be ordered separately.

For all tops, specify laminate and edge color.

Transition and peninsula tops require a column base for support.

Note: An upcharge applies when specifying Legacy laminates. See Legacy finish page.

Options

Refer to the worksurface planning page for worksurface drawings and applications.

Note: W3 worksurfaces have a grain direction option. Specify left, right or diagonal. Add \$25 to the list price when specifying diagonal.

3+1 Circuit Electrical

The Dividends Horizon 3+1 electrical system is designed for areas where power usage is significant and sensitive electronic equipment requiring a single isolated circuit is required.

The wire configuration of the 8-wire/4 circuit electrical system is (see chart):

- Hot "A" (black)
- Hot "B" (red)
- Hot "C" (blue)
- Shared neutral "N1" (white/black) for circuits #1, 2 and 3
- Shared ground "G1" (green) for circuits #1, 2 and 3
- Hot "X" (pink)
- Isolated neutral "N2" (white/ red) for circuit 4
- Isolated ground "G2" (green/ yellow) for circuit 4

Circuits 1, 2 and 3 have shared neutral and grounds for convenience power while circuit 4 has a separate ground and neutral for designated/isolated power or to support uninterrupted power supply (UPS).

Compatibility

All Dividends Horizon power systems use components that appear similar. However, components from the three different power systems are not functionally, fully interchangeable. 3+1 components can be connected to 3+3 wire systems, however only 3+1 will function.

3+1 Duplex Receptacles

Duplex receptacles used in 3+1 electrical systems are:

- Convenience duplex circuit number 1 (pattern number DE1DR1)
- Convenience duplex circuit number 2 (pattern number DE1DR2)
- Convenience duplex circuit number 3 (pattern number DE1DR3)
- Isolated duplex circuit number 4 (pattern number DE1DR4)

Isolated duplex receptacle number 4 has an orange-colored triangle on black background to identify an isolated duplex.

An optional orange-colored isolated duplex is also available. It has the isolated identifying triangle outlined in black.

- Isolated orange-colored duplex circuit number 4 (pattern number DE1DOR4)

3+1 Electrical System Technical Specifications

The 3+1 electrical system consists of four 20 amp, 120 volt, 60-Hertz circuits. The circuits will accommodate 120 volt single phase, 120/240 volt split phase and 120/208 volt three phase power. System components are 20 amp capacity. The National Electric Code (NEC) limits continuous loads to 80% of capacity or 16 amps.

Typically, each circuit can power 8-10 duplex convenience outlets with normal loads. In heavier load situations, such as computer systems, each circuit will power 3-5 duplex outlets. If each workstation has two convenience duplex outlets and one protected duplex, the 8-wire (4-circuit) system can supply a cluster of 6 -10 workstations from each infeed.

Surge Suppressors

Dividends Horizon surge suppressors (pattern number DE1SS) plug into any terminal block position to provide surge protection for all duplexes on that circuit.

Note: When connected, surge suppressors take the place of a duplex receptacle resulting in the elimination of one duplex position from the circuit.

Independent Neutral Electrical Systems

Dividends Horizon offers a 2+1 electrical system with independent neutrals as a standard special. It is our belief that independent neutrals are not required. However, if a customer desires an independent neutral electrical system, a Dividends Horizon solution can be provided. For further information, list pricing and schematic drawings, contact Knoll Customer Service.

SPECIFYING ELECTRICAL COMPONENTS

Panel Power Module

Specify one panel power module per panel that matches the width of the panel where duplexes or infeeds are required.

Power Connector

Specify one power connector (with or without post) to connect panel power modules in adjacent panels.

Power Jumper

Specify one power jumper that matches the width of the panel(s) being passed through to connect to panel power modules in nonadjacent panels.

Wiring Diagram (3+1)

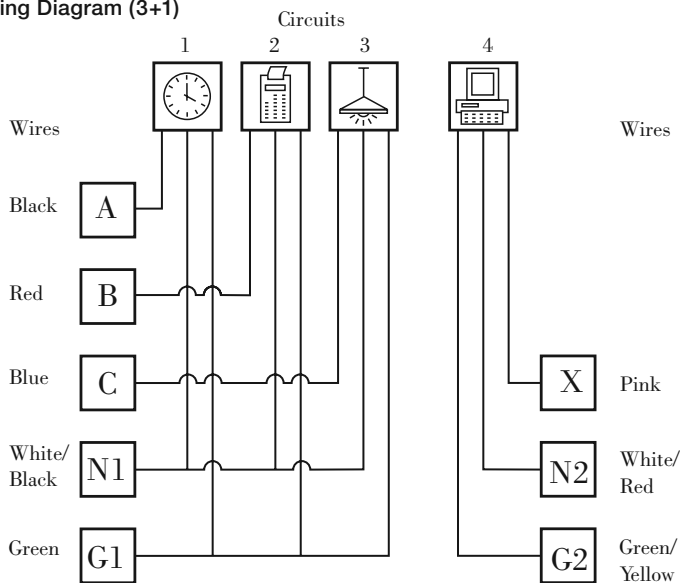

2+2 Electrical System

The Dividends Horizon 2+2 electrical system is designed for areas where power usage is significant and sensitive electronic equipment requiring two isolated circuits are required.

The wiring configuration of the (2+2) electrical system is (see chart):

- Hot "A" (black)
- Hot "B" (red)
- Shared neutral "N1" (white/black) for circuits #1 and 2
- Shared ground "G1" (green) for circuits #1 and 2
- Hot "Y" (tan)
- Hot "X" (pink)
- Isolated Shared Neutral "N2" (white/red) for circuits #4 and 5
- Isolated Shared ground "G2" (green/yellow) for circuits #4 and 5

Circuits 1 and 2 share common neutral and ground. Circuits 4 and 5 share a separate common neutral and ground.

Compatibility

All Dividends Horizon power systems use components that appear similar. However, components from the three different power systems are not functionally, fully interchangeable.

2+2 Duplex Receptacles

Duplex receptacles used in 8-wire (2+2) electrical systems are:

- Convenience duplex circuit number 1 (pattern number DE1DR1)
- Convenience duplex circuit number 2 (pattern number DE1DR2)
- Isolated duplex circuit number 4 (pattern number DE1DR4)
- Isolated duplex circuit number 5 (pattern number DE1DR5)

2+2 Electrical System Technical Specifications

The 2+2 electrical system consists of four 20 amp, 120 volt, 60-Hertz circuits. The circuits will accommodate 120 volt single phase, 120/240 volt split phase, and 120/208 volt three phase power. System components are 20 amp capacity. The National Electric

Code (NEC) limits continuous loads up to 80% of capacity or 16 amps. Typically, each circuit can power 8-10 duplex convenience outlets with normal loads. In heavier load situations, such as computer systems, each circuit will power 3-5 duplex outlets.

Surge Suppressors

Dividends Horizon surge suppressors (pattern number DE1 SS) plug into any terminal block position to provide surge protection for all duplexes on that circuit.

Note: When connected, surge suppressors take the place of a duplex receptacle resulting in the elimination of one duplex position from the circuit.

SPECIFYING ELECTRICAL COMPONENTS

Panel Power Module

Specify one panel power module per panel that matches the width of the panel where duplexes or infeeds are required.

Power Connector

Specify one power connector (with or without post) to connect power modules in adjacent panels.

Power Jumper

Specify one power jumper that matches the width of the panel(s) being passed through to connect to panel power modules in nonadjacent panels.

Wiring Diagram (2+2)

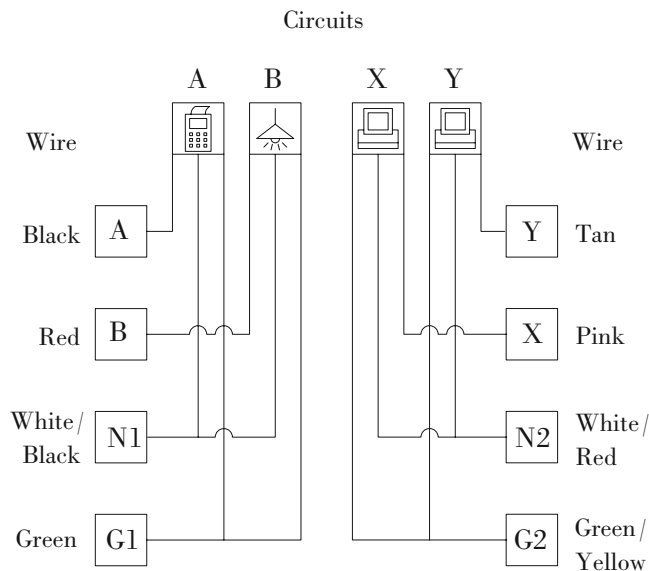

3+3 Electrical System

The Dividends Horizon 3+3 electrical system is designed for areas where power usage is significant and sensitive electronic equipment requiring multiple isolated circuits is required.

The wiring configuration of the 3+3 electrical system is (see chart):

- Hot "A" (black)
- Hot "B" (red)
- Hot "C" (blue)
- Shared neutral "N1" (white/black) for circuits #1, 2 and 3
- Shared ground "G1" (green) for circuits #1, 2 and 3
- Hot "Z" (orange)
- Hot "X" (pink)
- Hot "Y" (tan)
- Isolated neutral "N2" (white/ red) for circuits 4, 5 and 6
- Isolated ground "G2" (green/yellow) for circuits 4, 5 and 6

Circuits 1, 2 and 3 are for convenience power while circuits 4, 5 and 6 are for designated/ isolated power or for supporting uninterrupted power supply (UPS).

Compatibility

All Dividends Horizon power systems use components that appear similar. However, components from the three different power systems are not functionally, fully interchangeable. 3+3 components can be connected to 3+1 systems, however only 8-wires will function.

Wiring Diagram (3+3)

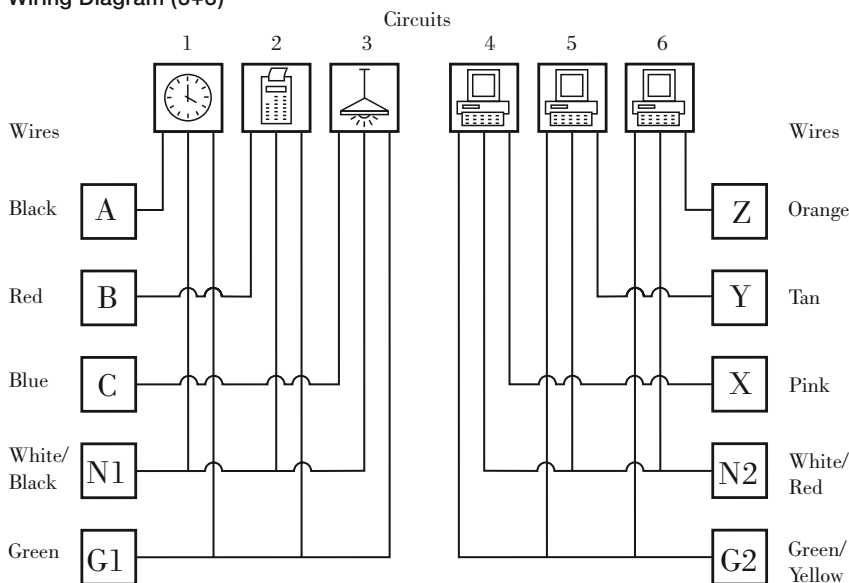

3+3 Duplex Receptacles

Duplex receptacles used in 3+3 electrical systems are:

- Convenience duplex circuit number 1 (pattern number DE1DR1)
- Convenience duplex circuit number 2 (pattern number DE1DR2)
- Convenience duplex circuit number 3 (pattern number DE1DR3)
- Isolated duplex circuit number 4 (pattern number DE1DR4)
- Isolated duplex circuit number 5 (pattern number DE1DR5)
- Isolated duplex circuit number 6 (pattern number DE1DR6)

Isolated duplex receptacles number 4, 5 and 6 have an orange-colored triangle on black background to signify as an isolated duplex.

Optional orange-colored isolated duplexes are also available. They have the isolated identifying triangle outlined in black.

- Isolated orange-colored duplex circuit number 4 (pattern number DE1DOR4)
- Isolated orange-colored duplex circuit number 5 (pattern number DE1DOR5)
- Isolated orange-colored duplex circuit number 6 (pattern number DE1DOR6)

3+3 Electrical System Technical Specifications

The 3+3 electrical system consists of six 20 amp, 120 volt, 60-Hertz circuits. The circuits will accommodate 120 volt single phase, 120/240 volt split phase and 120/208 volt three phase power. System components are 20 amp capacity. The National Electric Code (NEC) limits continuous loads to 80% of capacity or 16 amps. Typically, each circuit can power 8-10 duplex convenience outlets with normal loads. In heavier load situations, such as computer systems, each circuit will power 3-5 duplex outlets. If each workstation has two convenience duplex outlets and one protected duplex, the 10-wire (6-circuit) system can supply a cluster of 9 -15 workstations from each infeed.

Surge Suppressors

Dividends Horizon surge suppressors (pattern number DE1SS) plug into any terminal block position to provide surge protection for all duplexes on that circuit.

Note: When connected, surge suppressors take the place of a duplex receptacle resulting in the elimination of one duplex position from the circuit.

Independent Neutral Electrical Systems

Dividends Horizon offers a 10-wire/2+2 electrical system with independent neutrals as a standard special. It is our belief that independent neutrals are not required. However, if a customer desires an independent neutral electrical system, a Dividends Horizon solution can be provided. For further information, list pricing and schematic drawings, contact Knoll Customer Service.

SPECIFYING ELECTRICAL COMPONENTS

Panel Power Module

Specify one panel power module per panel that matches the width of the panel where duplexes or infeeds are required.

Power Connector

Specify one power connector (with or without post) to connect panel power modules in adjacent panels.

Power Jumper

Specify one power jumper that matches the width of the panel(s) being passed through to connect to panel power modules in nonadjacent panels.

Base Raceway Electrical

Power Modules, Power Jumpers

Specifications

Base Raceway Electrical

Power can be distributed through the base raceway.

Three systems are available:

- 3 + 1
- 2 + 2
- 3 + 3

Modular components are used to distribute power through the base raceway and consist of:

- Power modules
- Power connectors
- Power jumpers
- Duplex receptacles
- Power infeeds

All electrical components and data cables are field-installed.

CAUTION: DO NOT CONNECT POWER UNTIL INSTALLATION IS COMPLETE. CONNECTION TO THE BUILDING POWER SOURCE MUST BE PERFORMED BY A LICENSED ELECTRICIAN.

Power Modules

Power modules are the primary electrical components for distributing electrical within panels. They are also the only components that accept duplex receptacles and power infeeds for access.

Panels 24" and wider can accept power modules. 18" wide panels only accept power jumpers.

Power modules consist of terminal blocks at each end connected by a hard-wired metal conduit. The terminal blocks accept duplex receptacles or power infeeds. Power modules snap into integral channels in base raceways and can be accessed on one or both panel sides.

Power Jumpers

Power jumpers connect between power modules in non-adjacent panels. Power jumpers take the place of power modules in panels not requiring duplexes to provide pass-through power.

Three versions are available:

- Single panel power jumpers
- Single panel power jumpers with post
- Multiple panel power jumpers

Single panel power jumpers carry power from a panel with a power module through a single non-electrified panel to an adjacent panel with a power module when a post connector is not involved.

Single panel power jumpers with post carry power from a panel with a power module through a single non-electrified panel and post connector to an adjacent panel with a power module.

Multiple panel power jumpers carry power from a panel with a power module through multiple panels with or without a post to the next available power module.

Base Raceway Electrical

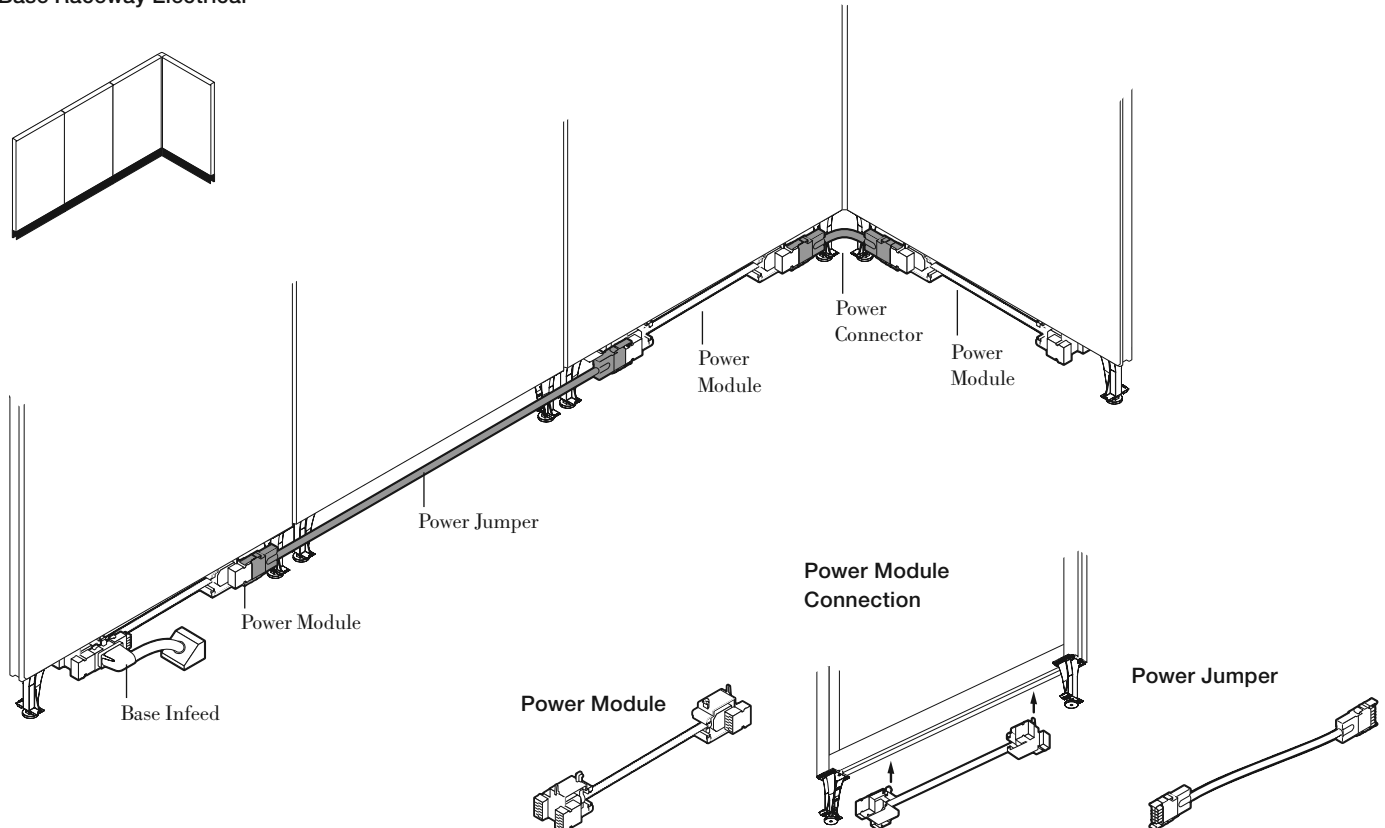

Base Raceway Electrical 3+1, 2+2 and 3+3 Systems Specifications

Power Connectors

Power connectors carry power from power module to power module in adjacent panels.

Two versions are available:

- 12" no post
- 15" with post

12" power connectors connect adjacent power modules in straight configurations when no post connector is involved.

15" power connectors are used in applications involving adjacent power modules separated by post connectors.

Duplex Receptacles

Duplex receptacles provide access to power along the base raceway.

Two duplex receptacles can be installed per panel side in base raceways 24" and wider. 18" wide panels cannot accept duplex receptacles.

Receptacles insert into terminal blocks in outlet positions at either end of power modules and attach with a single screw.

Duplexes are available in (3+1), (2+2) and (3+3) systems. Each system engages a different combination of circuit wiring within the power module. For detailed wiring diagrams, refer to the electrical system required:

- 3 + 1
- 2 + 2
- 3 + 3

3+1, 2+2 and 3+3 Electrical Systems

Each electrical system is designed for different usage.

The (2+2) electrical system is for areas requiring 2 circuits for standard power usage and 2 circuits for isolated power usage.

The (3+1) electrical system is for areas requiring significant power usage and an isolated circuit.

The (3+3) electrical system is for areas with significant power usage and a need for multiple isolated circuits.

Base Power Infeeds

Base power infeeds route power from the building's electrical source to the panel base raceway.

Power infeeds plug into any terminal block position on panel power modules.

Power Connector

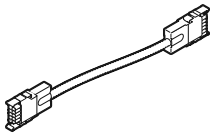

Duplex Receptacle

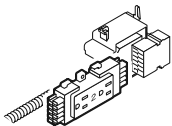

Base Infeed

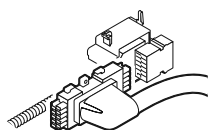

Legend

- Power Module
- ⋯ Power Jumper
- Power Connector

Note: Power connectors or power jumpers can only plug into power modules

Power Connectors

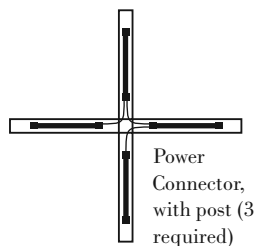
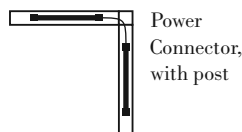
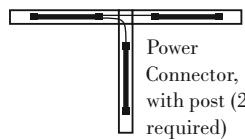
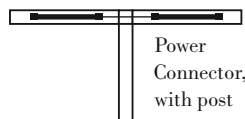

Single Panel Power Jumpers

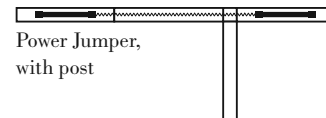
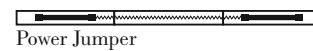

Multiple Panel Power Jumpers

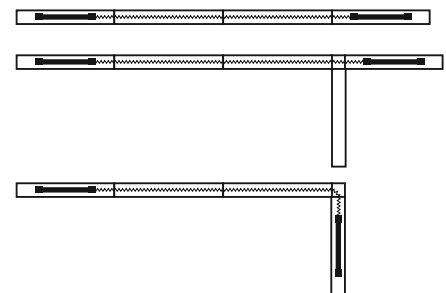

Multiple Panel Power Jumper and Power Connector

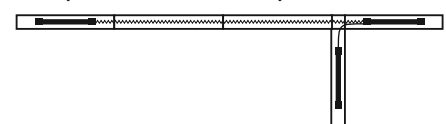





Base Raceway Electrical

Power Modules, Connectors and Jumpers

(3+1), (2+2) and (3+3)

Dividends Horizon

description	type	pattern no.	E	8	T
Power Module - Double sided for raceway on both sides 	24"W Panel	DE1(E,8,T) PM24	\$101.	\$112.	\$115.
	30"W Panel	DE1(E,8,T) PM30	108.	119.	119.
	36"W Panel	DE1(E,8,T) PM36	112.	122.	125.
	42"W Panel	DE1(E,8,T) PM42	120.	132.	131.
	48"W Panel	DE1(E,8,T) PM48	127.	139.	138.
	60"W Panel	DE1(E,8,T) PM60	142.	156.	156.
Power Module - Single sided for raceway on one side 	24"W Panel	DE1(E,8,T) PMS24	101.	112.	115.
	30"W Panel	DE1(E,8,T) PMS30	108.	119.	119.
	36"W Panel	DE1(E,8,T) PMS36	112.	122.	125.
	42"W Panel	DE1(E,8,T) PMS42	120.	132.	131.
	48"W Panel	DE1(E,8,T) PMS48	127.	139.	138.
	60"W Panel	DE1(E,8,T) PMS60	142.	156.	156.
Power Connector - (power module-to-power module) 	12" no post	DE1(E,8,T) PCNP	66.	72.	81.
	15" with post	DE1(E,8,T) PCWP	68.	74.	87.
Power Jumper 	15" Panel	DE1(E,8,T) PJ15NP	77.	89.	112.
	18" Panel	DE1(E,8,T) PJ18NP	77.	89.	112.
	24" Panel	DE1(E,8,T) PJ24NP	88.	94.	117.
	30" Panel	DE1(E,8,T) PJ30NP	91.	99.	121.
	36" Panel	DE1(E,8,T) PJ36NP	94.	102.	128.
	42" Panel	DE1(E,8,T) PJ42NP	99.	109.	132.
	48" Panel	DE1(E,8,T) PJ48NP	104.	116.	138.
Power Jumper (with post) 	15" Panel + Post	DE1(E,8,T) PJ15WP	85.	92.	115.
	18" Panel + Post	DE1(E,8,T) PJ18WP	85.	92.	115.
	24" Panel + Post	DE1(E,8,T) PJ24WP	89.	97.	120.
	30" Panel + Post	DE1(E,8,T) PJ30WP	92.	100.	124.
	36" Panel + Post	DE1(E,8,T) PJ36WP	97.	107.	131.
	42" Panel + Post	DE1(E,8,T) PJ42WP	101.	112.	134.
	48" Panel + Post	DE1(E,8,T) PJ48WP	108.	119.	141.

Ordering Information

Power Jumper
1. Pattern Number

Order Code

Power Jumper
Example: **DE1E PJ42NP**
DE1E Pattern Number
PJ42NP

Included with:

Power Jumper

Options

Power Jumper

Options
(E) = 3+1
(8) = 2+2
(T) = 3+3

Note: Double-sided power module will not fit in a panel base raceway with tile to the floor on one side.

Base Raceway Electrical
Power Modules, Connectors and Jumpers
(3+1), (2+2) and (3+3)

Dividends Horizon

description	type	pattern no.	E	8	T
Multiple Panel Power Jumper (with or without post) 	54" Panel Run	DE1(E,8,T) PJ54WP	\$113.	\$124.	\$146.
	60" Panel Run	DE1(E,8,T) PJ60WP	116.	128.	146.
	66" Panel Run	DE1(E,8,T) PJ66WP	122.	134.	157.
	72" Panel Run	DE1(E,8,T) PJ72WP	125.	138.	162.
	78" Panel Run	DE1(E,8,T) PJ78WP	131.	144.	166.
	84" Panel Run	DE1(E,8,T) PJ84WP	136.	151.	170.
	96" Panel Run	DE1(E,8,T) PJ96WP	143.	158.	182.

Ordering Information

Power Jumper

1. Pattern Number

Order Code

Power Jumper

Example: **DE1E PJ42NP**

DE1E Pattern Number

PJ42NP

Included with:

Power Jumper

Options

Power Jumper

Options

(E) = 3+1

(8) = 2+2

(T) = 3+3

Note: Double-sided power module will not fit in a panel base raceway with tile to the floor on one side.

This page intentionally left blank

Duplex Receptacles

Duplexes are field-installed into power modules within beltway and base raceways. Duplex receptacles insert into panel power module terminal block positions and attach with a single screw.

Identification of Duplexes

Duplexes are clearly marked to indicate which circuits they access. Convenience duplex receptacles are black in color with the circuit identification in white.

Isolated duplexes are black in color with the circuit identification in white and an orange triangle located in the lower right corner.

Orange isolated duplexes are also available for ease of identification. In orange-colored duplexes the identifying triangle is outlined in black.

Types of Duplex Receptacles

Several types of duplex outlets are available. Each is specific to the circuit it accesses and is listed by power system.

Specify the duplex receptacle related to the power system being used (example: 8-wire) and circuit accessed (example: circuit 4). Black or orange finish.

3+1 Duplex Receptacles

Receptacles in a 3+1 electrical system can access circuits 1, 2 and 3 (convenience power) and circuit 4 (isolated power)

2+2 Duplex Receptacles

Receptacles in a 2+2 electrical system can access circuits 1 and 2 (convenience power) and circuits 4 and 5 (isolated power)

Please note that circuit 3 is not available in a 2+2 electrical system.

3+3 Duplex Receptacles

Receptacles in a 3+3 electrical system can access circuits 1, 2 and 3 (convenience power) and circuits 4, 5 and 6 (isolated power)

Power Capacity

Each duplex circuit has a capacity of 20 amps. The National Electrical Code (NEC) requires that each circuit does not exceed 80% of capacity or 16 amps continuous use on each 20 amp circuit.

Duplex Receptacle Dimensions

- Overall dimensions: 4 ⁵/₈" wide, 2 ¹/₁₆" high, 1" deep
- Face dimensions: 2 ⁵/₈" wide, 1 ¹/₄" high

Access

Non-electrified panels can accept data ports in any raceway cover knockout. Panels with power modules can only accept data ports in the center knockout due to the location of the terminal block.

Typical Power Requirements of Various Equipment

Equipment	Amp (approx.)
Calculator	.25
Coffee maker*	8.5-15
Desktop copier*	10-15
Fan	1
Fax (plain paper)	5-8
Heater*	8.5-15
Laser printer	6-10
Lighting	.5-1.5
Microwave*	10-20
PC	4-8
Refrigerator*	10-15
Terminal	1-3
Typewriter	1-2
Scanner	.25-.5

*Requires separate circuit

Note: The above amperage chart is based on the estimated average amount of power required and is intended as a general guide only. For precise amperage requirements, refer to the equipment manufacturer's amperage specifications and compare to the available amperage on each circuit.

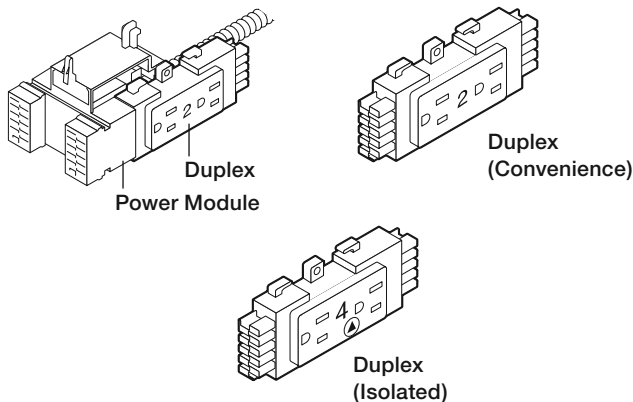

Base Raceway Covers (knockout locations)

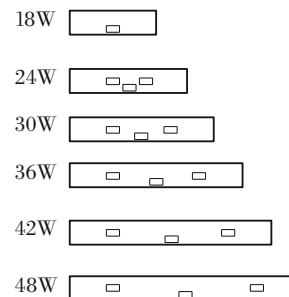



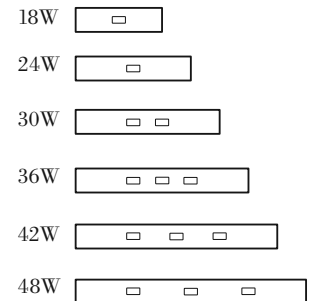

Beltway Covers (knockout locations)



Receptacles

Knockout Replacement Covers

description	type	pattern no.	Single pack list	Ten pack list
Receptacle, (3+1)(Black) 	Duplex circuit 1	DE1DR1 ()	\$35.	\$281.
	Duplex circuit 2	DE1DR2 ()	35.	281.
	Duplex circuit 3	DE1DR3 ()	35.	281.
	Duplex circuit 4	DE1DR4 ()	35.	281.
Receptacle, (2+2)(Black) 	Duplex circuit 1	DE1DR1 ()	35.	281.
	Duplex circuit 2	DE1DR2 ()	35.	281.
	Duplex circuit 4	DE1DR4 ()	35.	281.
	Duplex circuit 5	DE1DR5 ()	35.	281.
Receptacle, (3+3)(Black) 	Duplex circuit 1	DE1DR1 ()	35.	281.
	Duplex circuit 2	DE1DR2 ()	35.	281.
	Duplex circuit 3	DE1DR3 ()	35.	281.
	Duplex circuit 4	DE1DR4 ()	35.	281.
	Duplex circuit 5	DE1DR5 ()	35.	281.
	Duplex circuit 6	DE1DR6 ()	35.	281.
Receptacle, (Orange) 	Duplex circuit 4	DE1DOR4()	35.	281.
	Duplex circuit 5	DE1DOR5()	35.	281.
	Duplex circuit 6	DE1DOR6()	35.	281.
Base Raceway Knockout Replacement Cover (for electrical or data) 	Package of 10	DE1KC	n/a	38.

Ordering Information	Order Code	Included with:	Options
Receptacle 1. Pattern Number	Receptacle <i>Example:</i> DE1 DR4 DE1 DR4 Pattern Number	Receptacle	Receptacle Quantity Option: (SP) = Single Pack (TP) = Ten Pack

Vertical Electrical

Power Module, Electrical Receptacle and Trim Plate Specifications

Vertical Power Module

A vertical power module is an alternative to using beltway electrical. The use of a vertical power module allows for electrical access within a panel without having to order a beltway panel. Vertical power modules can be installed below a worksurface, at desk height or even within a panel-mounted overhead cabinet.

A panel's left-hand or right-hand vertical rail (see below) allows for installation of a vertical power module. Vertical power modules may be installed with 1-sided or 2-sided access, allowing users of both panel faces access to an electrical receptacle.

Base Power Jumpers

Base raceway power jumpers are used to connect the adjacent panel's base power module to the vertical power module.

Additional vertical power modules may be "daisy-chained" together with base power jumpers. If one vertical power module is installed, an additional vertical power module may be added within the same panel. A base power jumper connects between the two vertical power modules.

Vertical power modules can also be daisy-chained in adjacent panels. A base power jumper passes through the beltway panel frame opening to connect to the additional vertical power module.

Vertical Electrical Receptacle

Please note that base raceway receptacles are not compatible with vertical power modules.

Vertical electrical receptacles must be ordered separately from the vertical power module. Vertical electrical receptacles consist of one vertical receptacle. One vertical power module can also accommodate back-to-back vertical electrical receptacles.

To provide back-to-back vertical electrical power, two vertical receptacles must be specified. Vertical electrical receptacles must be ordered separately.

Specify the vertical receptacle that relates to the circuit specified.

Note: Vertical Electrical Receptacles are not available for Circuits 5 or 6.

Compatibility

The Dividends Horizon (3+1) electrical system and (3+3) electrical system can use the vertical power module. Vertical power modules may be used with the Dividends Horizon 8-wire (2+2) electrical systems on circuits 1, 2 and 4 only. The power module can accommodate circuits 1-4 based on the Dividends Horizon electrical system being used.

Desktop Power module

Desktop power modules (DE3WSME) provide two low-profile outlets at worksurface height. The desktop power module also helps meet ADA requirements regarding power access at worksurface height.

A mounting bracket and attachment screw allow the desktop power module to be installed at any point along the rear of a worksurface without tools or the removal of the worksurface. An 8 1/2' power cord plugs into any duplex receptacle in the base raceway and accesses the circuit it is connected to. Desktop power module dimensions are 3 3/4" wide and 4 1/2" high.

Base Raceway Power Jumpers

To specify a base power jumper that connects a desk height vertical power module to an adjacent panel's base power module, specify a 48" base power jumper for panel widths of 36" or less. Use a 54" base power jumper for panel widths of 42" or 48". If a vertical power module is to be installed higher than worksurface height within a 64" high panel, a 66" base power jumper is required and an 84" base power jumper is required for 78" high panels.

To specify a base power jumper to span the width of two vertical power modules within two adjacent panels, identify the base power jumper length by combining the panel widths and height differences between the two vertical power modules.

Note: The base power jumper passes through the panel's beltway opening that is at a height of 33".

The panel's beltway opening (at 33" high) must not be obstructed as to allow for the base power jumper to pass through.

Note: 36" high panel frames do not have beltway openings and do not support horizontal power pass through at 33".

Note: Vertical electrical components can be used with a technology tile or field installed into a fabric tile.

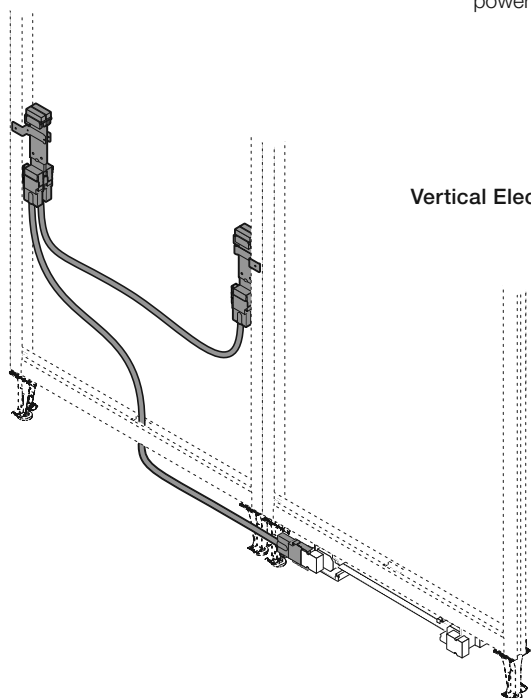

Vertical Electrical Power Jumpers

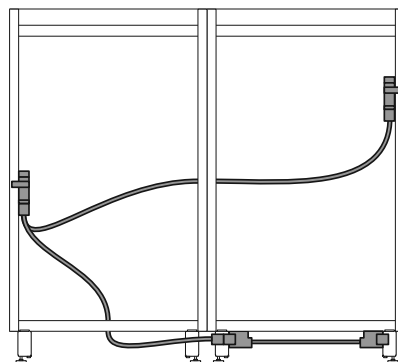

Desktop Power Module

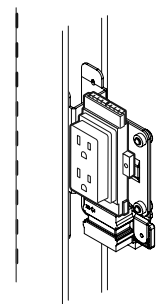

Vertical Power Module and Electrical Receptacle

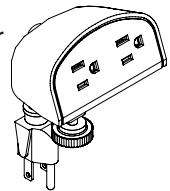

Vertical Electrical

Power Module, Electrical Receptacle and Trim Plate Specifications

Communications and Data Distribution

Dividends Horizon panels can accommodate communications and data cables horizontally in three ways:

- Along the top cableway
- Along the beltway (with optional cable tray)
- Along the base raceway (with optional cable tray)

Vertical cable distribution is through the panel's internal panel cavity which is accessed by cable slots located in both the upper and lower horizontal panel frame. Since cables are distributed internally within Dividends Horizon panels, no external cable managers are required.

Raceway cover data knockouts have an opening of 1³/₈" high x 2¹/₁₆" wide. Data port covers are no longer available from Knoll and must be supplied from a communications vendor.

Data Port Access

Non-electrified panels can accept data ports in any raceway cover knockout.

Panels with power modules can only accept data ports in the center knockout due to the location of the terminal blocks.

Single Floating Data Port

Dividends Horizon floating data ports allow data and communications to be mounted in any location on the panel surface.

Floating data ports include front and back mounting plates and attachment screws. All data port kits must be specified separately for floating data ports. Floating data ports involve field-cutting the panel insert for installation.

Includes front and back mounting plates and two mounting screws. Data ports kits or data port components must be specified separately from a communications vendor. Black finish.

Desktop Modules

The desktop data module provides up to two data/communication ports at worksurface height. The desktop power module provides two convenient electrical outlets at worksurface height. The desktop power and data module includes two data/communication ports and two electrical outlets at worksurface height. The thumbscrew on the bracket allows user adjustability if desired. Black finish.

Data modules do not include data jacks. Data jacks need to be purchased separately. This data module has two openings that can accept most standard jack sizes. The data module comes with adapter pieces that can accommodate most standard data jacks.

Topway Panel Cable Routing

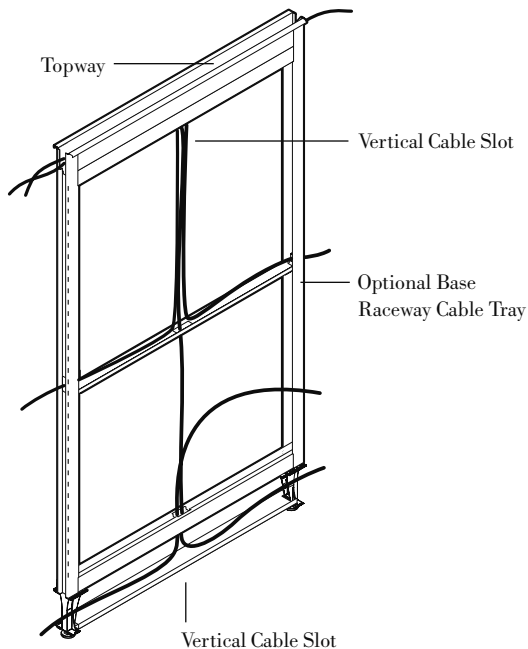

Floating Data Port

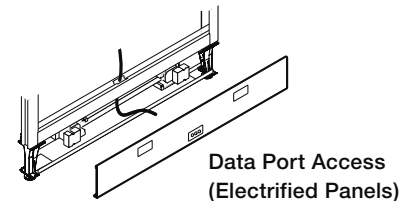
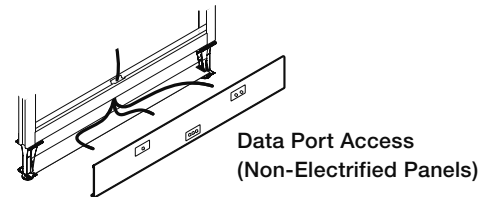
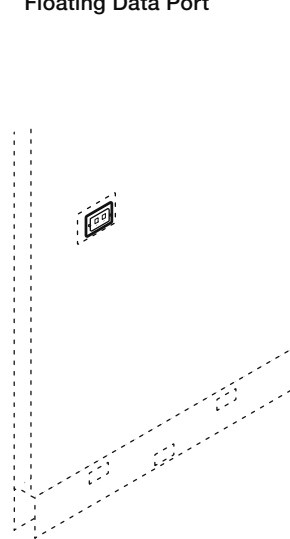

Desktop Data Module

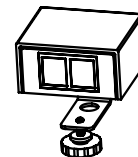

Desktop Power and Data Module

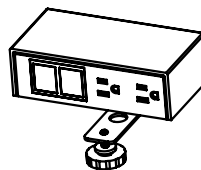

Desktop Power Module

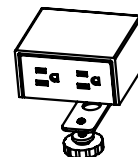

Vertical Electrical

Power Module, Electrical Receptacle and Trim Plate

Double and Single Ports

description	type	pattern no.	Single pack	Ten pack	3+1	2+2	3+3
Technology Tile Trim Plate (field install kit)	Faceplate, backplate filler and hardware	DE6 FDP	\$48.	n/a			

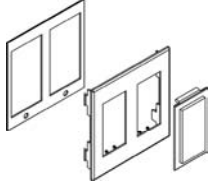

Trim Plate Filler	Package of 10	DE6 FDPF	n/a	37.			
-------------------	---------------	-----------------	-----	-----	--	--	--

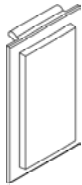

Single Floating Data Port Trim Plate (field install kit)	Faceplate, backplate and hardware	DE1 FDP	44.	n/a			
---	--------------------------------------	----------------	-----	-----	--	--	--

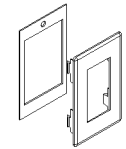

Vertical Power Module	Vertical Power Module	DE6 VPM	183.	n/a			
-----------------------	-----------------------	----------------	------	-----	--	--	--

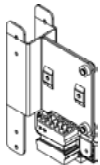



Ordering Information	Order Code	Included with:	Options
Vertical Power Module 1. Pattern Number	Vertical Power Module <i>Example:</i> DE5 VPM	Vertical Power Module	Vertical Power Module
Base Raceway Power Jumper 1. Pattern Number	DE5 VPM Pattern Number Base Raceway Power Jumper <i>Example:</i> DE1(E) BPJ30 DE1(E) Pattern Number BPJ30	Base Raceway Power Jumper	Base Raceway Power Jumper Insert appropriate letter for type of wiring required within the parentheses of the pattern number. (E) = 3+1 (8) = 2+2 (T) = 3+3 Receptacle Quantity Option: (SP) = Single Pack (TP) = Ten Pack Note: Trim plate filler for use with technology tile trim plate only.

Vertical Electrical

Power Module, Electrical Receptacle and Trim Plate

Double and Single Ports

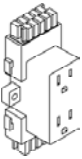
Dividends Horizon

description	type	pattern no.	Single pack	Ten pack	3+1	2+2	3+3
 Vertical Electrical Receptacle	Duplex circuit 1	DE6 VDR1()	\$35.	\$281.			
	Duplex circuit 2	DE6 VDR2()	35.	281.			
	Duplex circuit 3	DE6 VDR3()	35.	281.			
	Duplex circuit 4	DE6 VDR4()	35.	281.			
 Base Raceway Power Jumpers	48" Jumper	DE1(E,8,T) PJ48WP			108.	119.	141.
	54" Jumper	DE1(E,8,T) PJ54WP			113.	124.	146.
	60" Jumper	DE1(E,8,T) PJ60WP			116.	128.	146.
	66" Jumper	DE1(E,8,T) PJ66WP			122.	134.	157.
	72" Jumper	DE1(E,8,T) PJ72WP			125.	138.	162.
	78" Jumper	DE1(E,8,T) PJ78WP			131.	144.	166.
	84" Jumper	DE1(E,8,T) PJ84WP			136.	151.	170.

Electrical/Data Components

Ordering Information	Order Code	Included with:	Options
Vertical Power Module 1. Pattern Number	Vertical Power Module <i>Example:</i> DE5 VPM DE5 VPM Pattern Number	Vertical Power Module Base Raceway Power Jumper	Vertical Power Module Base Raceway Power Jumper Insert appropriate letter for type of wiring required within the parentheses of the pattern number. (E) = 3+1 (8) = 2+2 (T) = 3+3
Base Raceway Power Jumper 1. Pattern Number	Base Raceway Power Jumper <i>Example:</i> DE1(E) BPJ30 DE1(E) Pattern Number BPJ30		Receptacle Quantity Option: (SP) = Single Pack (TP) = Ten Pack Note: Trim plate filler for use with technology tile trim plate only.

description	type	w	d	h	pattern no.	list
Desktop Power Module, clamp mount	With 108" Cord	3 3/4"	2 1/2"	4 1/2"	DE4WSME108	\$127.
	With 72" Cord	3 3/4"	2 1/2"	4 1/2"	DE4WSME72	102.



Desktop Power + Data Module, clamp mount	With 108" Cord	3 3/4"	2 1/2"	4 1/2"	DE4WSMED108	273.
	With 72" Cord	3 3/4"	2 1/2"	4 1/2"	DE4WSMED72	247.



Desktop Data Module, clamp mount		3 3/4"	2 1/2"	4 1/2"	DE4WSMC	90.
-------------------------------------	--	--------	--------	--------	----------------	-----



Ordering Information	Order Code	Included with	Options
Desktop Power Module	Desktop Power Module		
1. Pattern Number	<i>Example:</i> DE4 WSME108		

This page intentionally left blank

Beltway Electrical

Power can be distributed through the beltway

Three systems are available:

- 3+1
- 2+2
- 3+3

Modular components are used to distribute power within beltways and consist of:

- Beltway power modules
- Beltway power connectors
- Beltway power jumpers
- Beltway vertical power jumpers
- Duplex receptacles

All electrical components and data cables are field-installed.

WARNING: DO NOT CONNECT POWER UNTIL INSTALLATION IS COMPLETE. CONNECTING TO THE BUILDING POWER SOURCE MUST BE PERFORMED BY A LICENSED ELECTRICIAN.

Beltway modules accept duplex receptacles and vertical power jumpers for bringing the power to the beltway from the base raceway. Another alternative for desk height electrical is a vertical power module.

Depending on the number of desk height receptacles required in each panel, consider the list price of both beltway electrical and vertical power module in each application.

Beltway Power Modules

Power modules are the primary electrical components for distributing power within beltways. Beltway power modules are also components that accept duplex receptacles and vertical power jumpers for bringing the power to the beltway from the base raceway.

Beltway raceways 30" and wider can accept beltway power modules while 18" and 24" wide panels can accept power jumpers for pass-through power only.

Beltway power modules screw into the vertical channels of panel frames and include a steel horizontal mounting support.

Specify one beltway power module per panel that matches the width of the panel where duplexes are required. Available one- or two-sided.

Just like base raceway power modules, beltway power modules consist of a terminal block at each end connected by a hard-wired metal conduit.

Beltway power modules are one- or two-sided. This allows planning options such as beltway one side and monolithic or tiled inserts on the other, or beltway one side and no inserts on the other for against-the-wall applications. The terminal blocks accept either duplex receptacles or vertical power jumpers.

Beltway Power Connectors

Beltway power connectors carry power from power module to power module in adjacent panels.

Two versions are available:

- no post
- with post.

Beltway power connectors, no post, connect adjacent power modules in straight configurations when a post connector is not involved.

Beltway power connectors, with post, are used in applications involving adjacent power modules separated by post connectors in straight through post configurations only.

Specify one beltway power connector (with or without post) to connect beltway power module or beltway power jumper in adjacent panels. In straight line configurations only.

Beltway Electrical

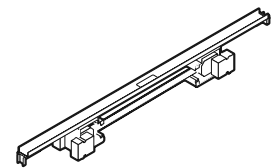
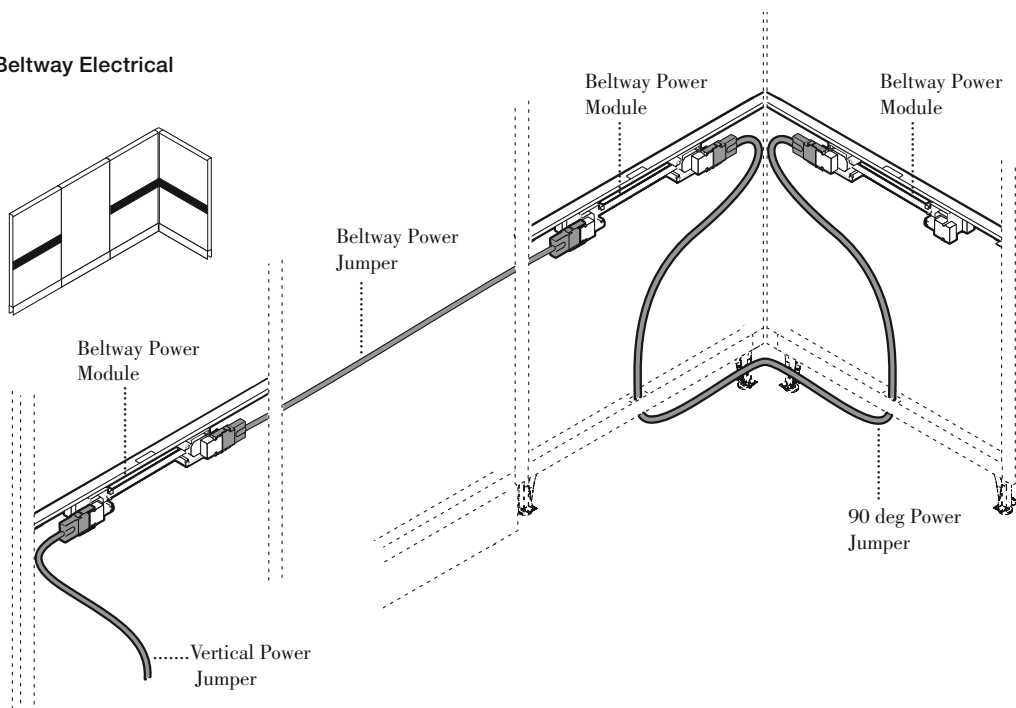

Beltway Power Module

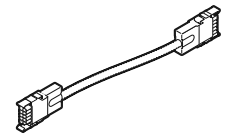

Beltway Power Connector

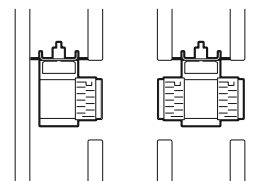

One-Sided Beltway Two-Sided Beltway

Beltway Profiles

Beltway Power Jumpers

Beltway power jumpers connect between power modules in nonadjacent panels. Beltway power jumpers take the place of power modules in panels not requiring duplexes to provide pass-through power.

Three versions are available:

- Single panel jumpers
- Single panel jumpers with post
- Multiple panel jumpers

Single panel beltway jumpers carry power from a panel with a beltway power module through a single non-electrified panel to an adjacent panel with a beltway power module when a post is not involved in straight line configurations only.

Single beltway panel jumpers with post carry power from a panel with a power module through a single non-electrified panel and post connector to an adjacent panel with a beltway power module in straight through post configurations only.

Multiple beltway panel jumpers carry power from a panel with a power module through multiple panels with or without a post to the next available beltway power module in straight line configurations only.

Specify one beltway power jumper per panel that matches the width of the panel for pass-through electrical where duplexes are not required for straight line configurations only.

90° Beltway Power Jumper

A 90° beltway power jumper connects adjacent beltway power modules at a 90° “L” panel connection.

The following illustrations outline the various components required for beltway applications with a post.

Note: A 90° beltway power jumper can only be used with adjacent panels in a “X”, “T” or “L” conditions. The 90° jumper cannot be used to span multiple panels.

To specify correct jumper length, determine the largest panel width between the two adjacent corner panels in which jumper is to be installed.

Vertical Power Jumpers

To carry power from the base raceway to the beltway located in the same panel requires a vertical power jumper. Vertical power jumpers function as an extension of the base raceway power system.

Attachment is from any unused outlet position in the base raceway to the end terminal block connection in the beltway power module. The vertical power jumper cable is concealed in the cavity of the panel frame.

Power can also be carried to a beltway run from the base raceway of an adjacent panel with a power module. This is accomplished by using a panel power jumper.

Specify one vertical power jumper per beltway electrical run not to exceed the electrical systems capacity. See the technical specifications for the electrical system being utilized.

Note: Length of power jumper allows for connections with or without post conditions.

Power Infeeds

A ceiling infeed may also be used to bring power directly to the beltway power module without having to go directly to a base raceway power module.

Duplex Receptacles

Duplex receptacles provide access to power along the beltway. Duplexes used in the beltway are the same as the duplexes used in the base raceway.

Two duplex receptacles can be installed per panel side in beltway raceways 30" and wider. 24"W panels will accept beltway power jumpers for pass-through power only.



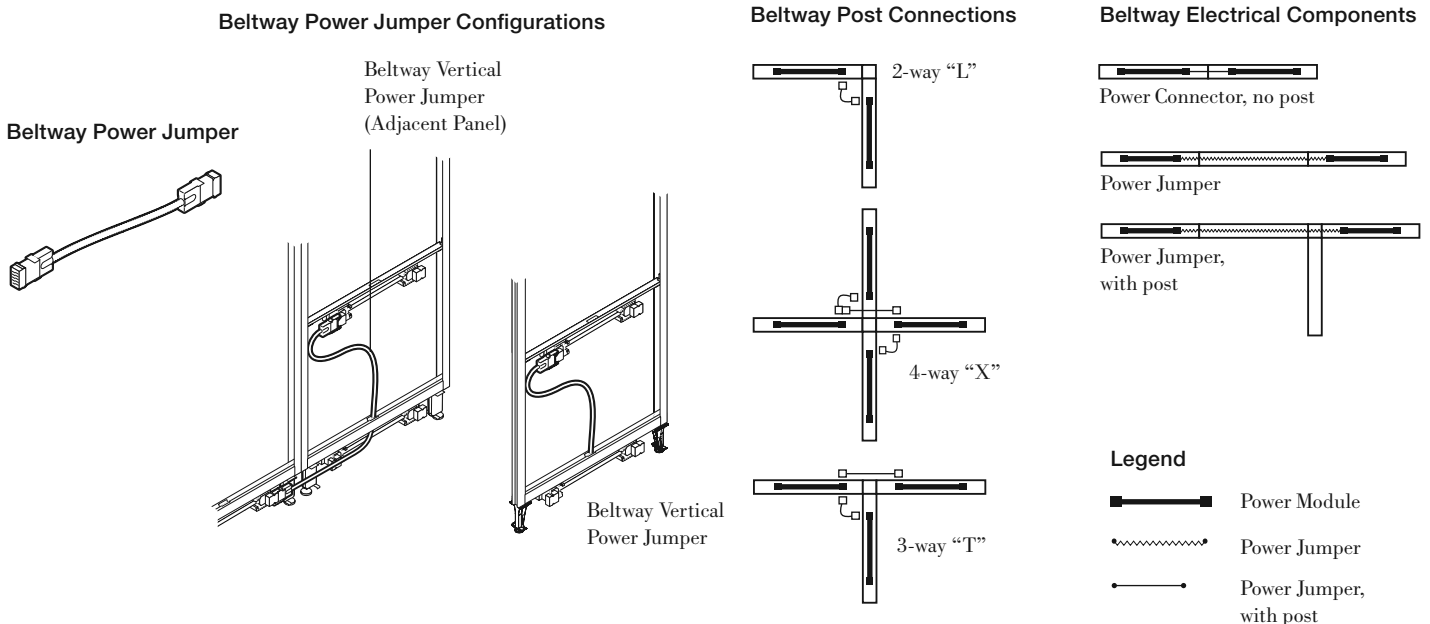



Receptacles insert into terminal blocks in outlet positions at either end of power modules and attach with a single screw.



Beltway Electrical

Power Modules, Power Connectors and Power Jumpers

Dividends Horizon



description	type	length	pattern no.	3+1	2+2	3+3
 Beltway Power Module - 1-Side		30"	DE1() BPM301	\$142.	\$157.	\$157.
		36"	DE1() BPM361	149.	164.	160.
		42"	DE1() BPM421	157.	170.	168.
		48"	DE1() BPM481	164.	182.	175.
		60"	DE1() BPM601	185.	190.	190.
 Beltway Power Module - 2-Side		30"	DE1() BPM302	142.	157.	157.
		36"	DE1() BPM362	149.	164.	160.
		42"	DE1() BPM422	157.	170.	168.
		48"	DE1() BPM482	164.	182.	175.
		60"	DE1() BPM602	185.	190.	190.
 Beltway Power Connector	17" No Post		DE2() BPCNP	71.	77.	88.
	20" With Post		DE2() BPCWP	73.	84.	91.
 Beltway Power Jumper (No post)		18"	DE2() BPJ18NP	88.	94.	117.
		24"	DE2() BPJ24NP	91.	99.	121.
		30"	DE2() BPJ30NP	94.	102.	128.
		36"	DE2() BPJ36NP	99.	109.	132.
		42"	DE2() BPJ42NP	104.	116.	138.
		48"	DE2() BPJ48NP	108.	119.	141.
 Beltway Power Jumper (With post)		18"	DE2() BPJ18WP	89.	97.	120.
		24"	DE2() BPJ24WP	92.	100.	124.
		30"	DE2() BPJ30WP	97.	107.	131.
		36"	DE2() BPJ36WP	101.	113.	134.
		42"	DE2() BPJ42WP	108.	119.	141.
		48"	DE2() BPJ48WP	116.	121.	143.
 Multiple Panel Power Jumper (with or without post)		54" Panel Run	DE2() BPJ54WP	116.	128.	146.
		60" Panel Run	DE2() BPJ60WP	122.	134.	157.
		66" Panel Run	DE2() BPJ66WP	125.	137.	162.
		72" Panel Run	DE2() BPJ72WP	131.	143.	166.
		78" Panel Run	DE2() BPJ78WP	136.	149.	170.
		84" Panel Run	DE2() BPJ84WP	143.	160.	182.
		96" Panel Run	DE2() BPJ96WP	154.	167.	189.

Ordering Information	Order Code	Included with:	Options
Beltway Power Jumper 1. Pattern Number Note: Insert appropriate letter for type of wiring required within the parentheses of the pattern number.	Beltway Power Jumper <i>Example:</i> DE1(E) BPJ30 DE1(E) Pattern Number BPJ30	Beltway Power Jumper	Beltway Power Jumper Insert appropriate letter for type of wiring required within the parentheses of the pattern number. <ul style="list-style-type: none"> • E= 3+1 • 8= 2+2 • T= 3+3

Beltway Electrical

Power Modules, Power Connectors and Power Jumpers

Dividends Horizon

description	type	length	pattern no.	3+1	2+2	3+3
90° Beltway Power Jumper 		30" Beltway Panel	DE1() PJ120WP	\$187.	\$205.	\$235.
		36" Beltway Panel	DE1() PJ126WP	193.	213.	244.
		42" Beltway Panel	DE1() PJ138WP	202.	222.	253.
		48" Beltway Panel	DE1() PJ144WP	209.	230.	262.
Vertical Power Jumper (Within Same Panel)			DE1() VPJ	160.	175.	166.
Vertical Power Jumper (From Adjacent Panel) 		30" Beltway Panel	DE1(E,8,T) PJ48WP	108.	119.	141.
		36" Beltway Panel	DE1(E,8,T) PJ54WP	113.	124.	146.
		42" Beltway Panel	DE1(E,8,T) PJ54WP	113.	124.	146.
		48" Beltway Panel	DE1(E,8,T) PJ60WP	116.	128.	146.

Ordering Information	Order Code	Included with:	Options
Beltway Power Jumper 1. Pattern Number Note: Insert appropriate letter for type of wiring required within the parentheses of the pattern number.	Beltway Power Jumper <i>Example:</i> DE1(E) BPJ30 DE1(E) Pattern Number BPJ30	Beltway Power Jumper	Beltway Power Jumper Insert appropriate letter for type of wiring required within the parentheses of the pattern number. <ul style="list-style-type: none"> • E= 3+1 • 8= 2+2 • T= 3+3

Power Infeeds

Power infeeds carry power from the building's electrical source to the panel system's base raceway. Two styles are available:

- Base power infeeds
- Ceiling infeeds

Base Power Infeed

Dividends Horizon base power infeeds route power from floor monuments or electrical boxes to any terminal block duplex position on base raceway power modules. Two screws secure the base power infeed to the power module.

Note: When connected, a base power infeed takes the place of one duplex outlet.

Base power infeeds have a 56" long liquid tight conduit and pigtail for connection to the building's power supply.

Infeeds are specified either right- or left-handed. This allows the conduit to enter the outlet position from either the left or right side.

In addition to right- or left handed base power infeeds is a reversible base power infeed with a 56" long liquid tight conduit. The reversible infeed rotates to provide either a right- or left-hand power entry.

Specify the base infeed that matches the power system accessed and left or right cable entry (example: (3+1), left-hand entry).

Ceiling Infeeds

Raceway-to-ceiling infeeds route power from a ceiling-located power source to the panel system's base raceway. Unlike base infeeds which plug into any terminal block outlet position, ceiling infeeds must plug into the end of a base raceway power module. Ceiling infeeds have a 19 1/2' long metal conduit and pigtail.

Two components are required for installation:

- Raceway to ceiling infeed
- Power pole

Ceiling infeed may be installed directly into a beltway power module for beltway electrical only.

Specify the ceiling infeed that matches the power system accessed.

Power Poles

Power poles can accommodate one raceway-to-ceiling infeed along with data cables. The power pole can also be used to route data cables only, if required. Cable capacity for power poles with the electrical conduit installed is 30, category 5 cables and without an electrical conduit is 40, category 5 cables.

Power poles integrate within the panel system footprint by mounting atop existing post connectors in "L", "T" or "X" configurations.

Power poles are available in three lengths in order to accommodate all three heights of post connectors. All power poles measure 126" or 144" when added to the height of the post connector. For ceilings less than 126" or 144" high, field-cut the power pole to the required height. Power poles include ceiling trim plate, connecting hardware and post/power pole trim covers.

Legacy Power Pole Construction

Power pole is extruded aluminum powder coated, with four PVC trim covers.

Dividends Horizon DP7 Power Pole Construction

Power pole is extruded aluminum, with removable cover, powder coated in any Knoll Core or Dividends Horizon Legacy finish. One side of the power pole is open, allowing cables to be inserted or removed when the cover is removed.

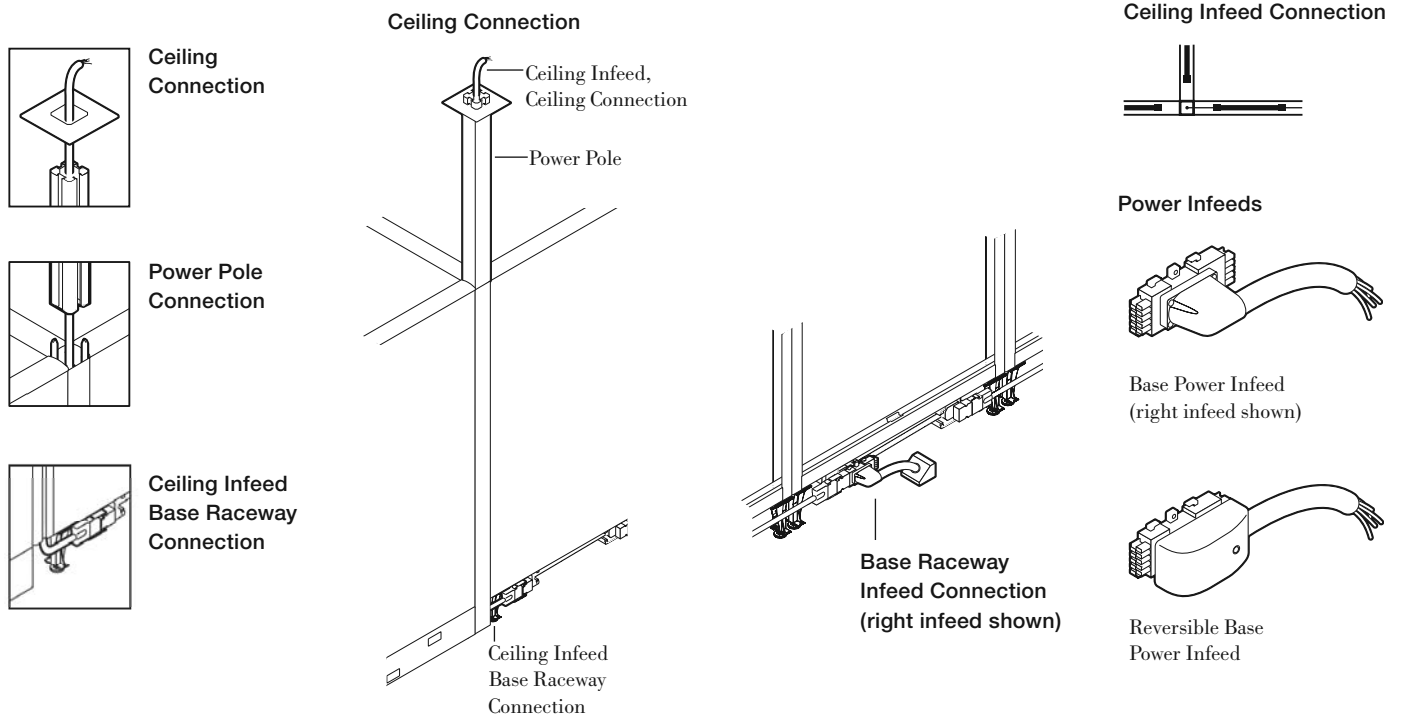

CAUTION: DO NOT CONNECT POWER UNTIL INSTALLATION IS COMPLETE. CONNECTION TO BUILDING POWER SOURCE MUST BE PERFORMED BY A LICENSED ELECTRICIAN.



Electrical Infeeds and Power Poles

Base Power and Raceway-to-Ceiling Infeeds

Dividends Horizon

description	type	length	pattern no.	list	P1	P2	P3
Base Power Infeed (specify left or right) (right shown) 	2+2	56"	DE18 BI56(L/R)	\$200.			
	3+1	56"	DE1E BI56(L/R)	182.			
	3+3	56"	DE1T BI56(L/R)	235.			
Base Power Infeed (reversible) 	2+2	56"	DE18 RBI56	242.			
	3+1	56"	DE1E RBI56	221.			
	3+3	56"	DE1T RBI56	291.			
Raceway-to-Ceiling Infeed 	2+2	19 1/2'	DE18 CI144	294.			
	3+1	19 1/2'	DE1E CI144	266.			
	3+3	19 1/2'	DE1T CI144	338.			

Ordering Information

Base Power Infeed (L/R)

1. Pattern Number

Power Pole

1. Pattern Number
2. Trim Finish

Note: Power poles mount atop existing post connectors in "L", "T" and "X" configurations

Order Code

Base Power Infeed (L/R)

Example: **DE18 BI56(L)**

DE18 Pattern Number (left entry)
BI56(L)

Power Pole

Example: **DE(1) PP64S, 117**

DE(1) Pattern Number

PP64S

117 Soft Grey trim finish

Included with:

Base Power Infeed (L/R)

Power Pole

- Power pole
- Ceiling trim plate
- Connecting hardware
- Post/power pole trim cover

Note: Power pole does not include raceway-to-ceiling infeed which must be ordered separately.

Options

Base Power Infeed (L/R)

- To specify direction of entry, add either an "L" or "R" suffix to the pattern number.

Legacy Power Pole

- Post cover

(1)= Grooved
(2)= Smooth
Insert appropriate number for post cover option within the parentheses of the pattern number

Dividends Horizon Power Pole

- Post cover

Electrical Infeeds and Power Poles

DP7 and Legacy Power Poles

Dividends Horizon

description	type	length	pattern no.	list	P1	P2	P3
Dividends Horizon Power Pole for use with DP7 Series Posts only (does not include Raceway-to-Ceiling Infeed) For 126" ceiling height	For 36"H DP7 Post	90"	DP7PP36S		\$377.	\$396.	\$415.
	For 42"H DP7 Post	84"	DP7PP42S		346.	362.	381.
	For 50"H DP7 Post	76"	DP7PP50S		319.	334.	350.
	For 57"H DP7 Post	69"	DP7PP57S		282.	297.	310.
	For 64"H DP7 Post	62"	DP7PP64S		277.	291.	305.
	For 78"H DP7 Post	48"	DP7PP78S		277.	291.	305.
Dividends Horizon Power Pole for use with DP7 Series Posts only (does not include Raceway-to-Ceiling Infeed) For 144" ceiling height	For 36"H DP7 Post	108"	DP7PP36T		384.	404.	422.
	For 42"H DP7 Post	102"	DP7PP42T		352.	371.	389.
	For 50"H DP7 Post	94"	DP7PP50T		319.	334.	350.
	For 57"H DP7 Post	86"	DP7PP57T		282.	297.	310.
	For 64"H DP7 Post	80"	DP7PP64T		277.	291.	305.
	For 78"H DP7 Post	66"	DP7PP78T		277.	291.	305.
Legacy Power Pole for use with Legacy Posts only (does not include Raceway-to-Ceiling Infeed) For 126" ceiling height	For 36"H Post	90"	DE2PP36S	377.			
	For 42"H Post	84"	DE2PP42S	346.			
	For 50"H Post	76"	DE2PP50S	319.			
	For 64"H Post	62"	DE2PP64S	282.			
	For 78"H Post	48"	DE2PP78S	277.			
Legacy Power Pole for use with Legacy Posts only (does not include Raceway-to-Ceiling Infeed) For 144" ceiling height	For 36"H Post	108"	DE2PP36T	284.			
	For 42"H Post	102"	DE2PP42T	252.			
	For 50"H Post	94"	DE2PP50T	326.			
	For 64"H Post	80"	DE2PP64T	291.			
	For 78"H Post	66"	DE2PP78T	282.			

Ordering Information	Order Code	Included with:	Options
Base Power Infeed (L/R)	Base Power Infeed (L/R)	Base Power Infeed (L/R)	Base Power Infeed (L/R)
1. Pattern Number	<i>Example:</i> DE18 BI56(L)	Power Pole	<ul style="list-style-type: none"> To specify direction of entry, add either an "L" or "R" suffix to the pattern number.
Power Pole	DE18 Pattern Number (left entry)	<ul style="list-style-type: none"> Power pole Ceiling trim plate Connecting hardware Post/power pole trim cover 	Legacy Power Pole
1. Pattern Number	BI56(L)	Note: Power pole does not include raceway-to-ceiling infeed which must be ordered separately.	<ul style="list-style-type: none"> Post cover has a smooth finish
2. Trim Finish	Power Pole	Note: Power poles mount atop existing post connectors in "L", "T" and "X" configurations	Dividends Horizon Power Pole
	<i>Example:</i> DE2 PP64S, 117		
	DE2 Pattern Number		
	PP64S		
	117 Soft Grey trim finish		

This page intentionally left blank

New York City Hardwire Infeeds

The New York City hardwire infeed is comprised of a junction box and a power connector exiting from one side.

New York City infeeds are available in one size which mount within any base raceway 24" or wider.

The New York City infeed takes the place of a power module and prevents the installation of duplex receptacles in the panel housing the infeed. The hardwire infeed's power connector plugs into a power module which must be located in the adjacent panel.

The New York City infeed can be rotated to either the right or left side of the base raceway to provide power to either the adjacent left or right panel.

If power is required in both directions, specify a separate power jumper the length of the panel containing the infeed. The power jumper connects panel power modules located at either side of the panel containing the NYC hardwire infeed and is routed within the same raceway as the NYC hardwire infeed.

The power jumper is then routed in the opposite direction and connects to a power module located in the adjacent panel on the panel's other side (refer to the diagram below).

The panel containing the NYC hardwire infeed must be specified without base raceway cover knockouts.

A template for drilling the base raceway cover to accept the NYC hardwire infeed conduit is included.

Chicago Hardwire

Pre-wired modular electrical systems are not permitted in the City of Chicago. All electrical must be hard-wired by a qualified electrician.

In order to conform to City of Chicago electrical codes, a hardwire receptacle raceway kit(s) must be installed in all panel base raceways that require duplex receptacles. In order to conform to the City of Chicago electrical code for base power infeed, the hardwire infeed raceway kit must be installed within the panel base raceway. Hardwire receptacle raceway kit(s) and hardwire infeed raceway kit(s) mount in the base raceway between the panel feet and are available in 24" to 48" widths.

Hardwire receptacle raceway kits are secured by four screws. In addition, the base raceway covers on both sides of a panel with hardwire receptacle raceway kits must be secured with two screws each. A template for drilling attachment holes in base raceway covers is included with the hardwire receptacle raceway kit.

Optional Chicago base raceway covers can be ordered separately to replace existing covers if pre-drilled covers are desired.

When passing (jumping) hardwired power through panels, panels must be specified without knockouts in the base raceway to conform to the City of Chicago electrical code. All panels containing hardwire receptacle raceway kits must be specified with base raceway knockouts.

Note: Dividends Horizon beltway electrical is not available with Chicago hardwire.

New York Electrical Configurations

NYC Infeeds are reversible and one direction

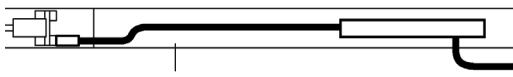

NYC Infeeds (positioned at left side of raceway)



NYC Infeeds (positioned at right side of raceway)

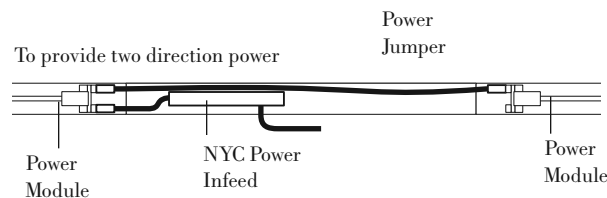

To provide two direction power

Power Jumper

Power Module

NYC Power Infeed

Power Module

New York Electrical

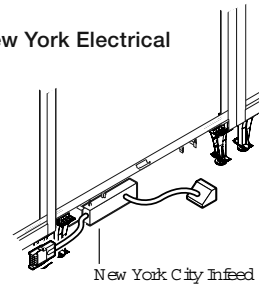

New York City Infeed

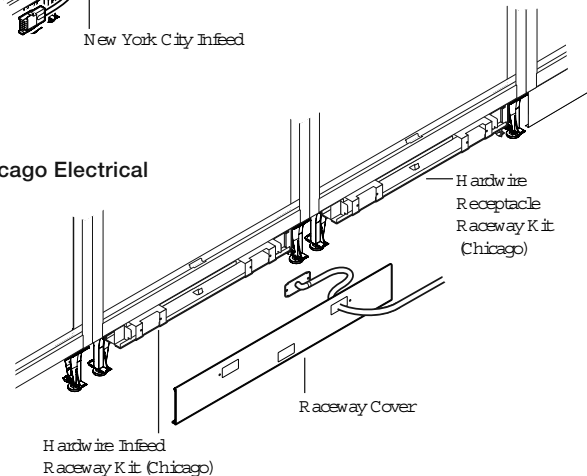

Chicago Electrical



Hardwire Infeed Raceway Kit (Chicago)

Hardwire Receptacle Raceway Kit (Chicago)



Raceway Cover

description	type	l	pattern no.	list
 Hardwire Infeed (NYC) - 1 Direction	2+2		DE18 B1NY1	\$552.
	3+1		DE1E B1NY1	480.
	3+3		DE1T B1NY1	618.
 Base Power Infeed (San Francisco)	2+2	56"	DE18 BI56()SF	189.
	3+1	56"	DE1E BI56()SF	172.
	3+3	56"	DE1T BI56()SF	223.
 Reversible Base Power Infeed (San Francisco)	2+2	56"	DE18 RBI56SF	230.
	3+1	56"	DE1E RBI56SF	210.
	3+3	56"	DE1T RBI56SF	276.
Electrical Retrofit Kit (Chicago) (for electrical on new panel base raceway)			DP7CERK	60.

Ordering Information	Order Code	Included with:	Options
Hardwire Infeed (NYC) 1. Pattern Number	Hardwire Infeed (NYC) Example: DE1E B1NY1 DE1E Pattern Number B1NY1	Hardwire Infeed (NYC) <ul style="list-style-type: none"> • Junction box with power connector and infeed • Ceiling trim plate • Attachment screws 	Hardwire Infeed (NYC) Power System <ul style="list-style-type: none"> • 3+1 • 2+2 • 3+3 San Francisco Infeed direction option (L) = Left (R) = Right Note: The electrical retrofit kit provides brackets that connect Chicago Electrical components that were manufactured prior to June 2008 to DP7 panel base raceways.

New York City, San Francisco and Chicago Electrical Infeeds, Receptacle Kits and Replacement Kits

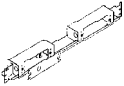
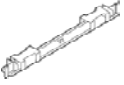
Dividends Horizon

description	type	l	pattern no.	list
 Hardwire Infeed Raceway Kit (Chicago)	Double Sided	24"	DP7HIRKD24	\$339.
	Double Sided	30"	DP7HIRKD30	575.
	Double Sided	36"	DP7HIRKD36	580.
	Double Sided	42"	DP7HIRKD42	583.
	Double Sided	48"	DP7HIRKD48	587.
	Double Sided	60"	DP7HIRKD60	598.
	Single Sided	24"	DP7HIRKS24	477.
	Single Sided	30"	DP7HIRKS30	678.
	Single Sided	36"	DP7HIRKS36	683.
	Single Sided	42"	DP7HIRKS42	686.
	Single Sided	48"	DP7HIRKS48	690.
Single Sided	60"	DP7HIRKS60	700.	
 Hardwire Receptacle Raceway Kit (Chicago)	Double Sided	24"	DP7HRRKD24	261.
	Double Sided	30"	DP7HRRKD30	437.
	Double Sided	36"	DP7HRRKD36	442.
	Double Sided	42"	DP7HRRKD42	445.
	Double Sided	48"	DP7HRRKD48	450.
	Double Sided	60"	DP7HRRKD60	461.
	Single Sided	24"	DP7HRRKS24	301.
	Single Sided	30"	DP7HRRKS30	425.
	Single Sided	36"	DP7HRRKS36	430.
	Single Sided	42"	DP7HRRKS42	430.
	Single Sided	48"	DP7HRRKS48	435.
Single Sided	60"	DP7HRRKS60	444.	
 Pre-Drilled Replacement Covers, Pair (Chicago)	24" Wide Panel	24"	DP7RCCH24	37.
	30" Wide Panel	30"	DP7RCCH30	41.
	36" Wide Panel	36"	DP7RCCH36	44.
	42" Wide Panel	42"	DP7RCCH42	50.
	48" Wide Panel	48"	DP7RCCH48	52.
	60" Wide Panel	60"	DP7RCCH60	60.

Ordering Information

Hardwire Infeed (NYC)

1. Pattern Number

Order Code

Hardwire Infeed (NYC)

Example: DE1E B1NY1

DE1E Pattern Number
B1NY1

Included with:

Hardwire Infeed (NYC)

- Junction box with power connector and infeed
- Ceiling trim plate
- Attachment screws

Options

Hardwire Infeed (NYC)

Power System

- 3+1
- 2+2
- 3+3

San Francisco Infeed direction option

(L) = Left
(R) = Right

Note: The electrical retrofit kit provides brackets that connect Chicago Electrical components that were manufactured prior to June 2008 to DP7 panel base raceways.

This page intentionally left blank

Base Raceway Cable Tray

Optional steel cable trays are available for installations requiring the use of data and communications cables within the base raceway. The cable tray mounts between the panel feet.

Cable trays are field-installed and accessible from either side of the base raceway. A single sided base raceway cable tray should be specified when attaching to a tile-to-floor panel base.

Note: Cables should not be installed in base raceways without cable trays.

Beltway Cable Tray

An optional cable tray is available for data and communications cables within the beltway. Beltway cable trays should be used when wires are being routed horizontally from panel-to-panel at the beltway. The cable tray mounts into slots located on the vertical panel frame.

Cable trays are 1¹/₄" high, 1⁵/₁₆" deep and are field-installed. Construction is 20-gauge steel with black finish.

Note: Beltway cable trays can be installed in monolithic panels to provide additional mid span insert support when required.

Worksurface Cable Management Basket

Constructed of black finished steel wire, the worksurface cable management basket mounts to the underside of worksurfaces to provide management of excess cords and cables. Once installed, the cable management basket slides forward to a position abutting the panel face to allow the passage of cords and cables.

Specify by width available between worksurface supports. Black finish.

Worksurface cable management baskets are 1¹/₂" high, 3¹/₂" deep and 19¹/₂" to 41¹/₂" wide.

Vertical Wire Pathway Grommet

An optional plastic grommet that snaps into the vertical wire pathway on the horizontal panel frame to separate cables from the panel frame. Located in center of topway and base raceway.

Topway Cable Grommet

The primary location for cable management for Dividends Horizon is in the topway. In order to utilize the topway channel effectively, the outside knockouts must be removed by using pliers. When the knockouts are removed the cables can be easily managed in the channel.

If required, a topway knockout grommet may be installed inside of the topway channel. Four grommets would be required per panel topway





Worksurface Cable Management Clip

An optional cable management clip. 3/4" x 1/2" (internal dimension) plastic clip manages cables on the underside of worksurfaces.

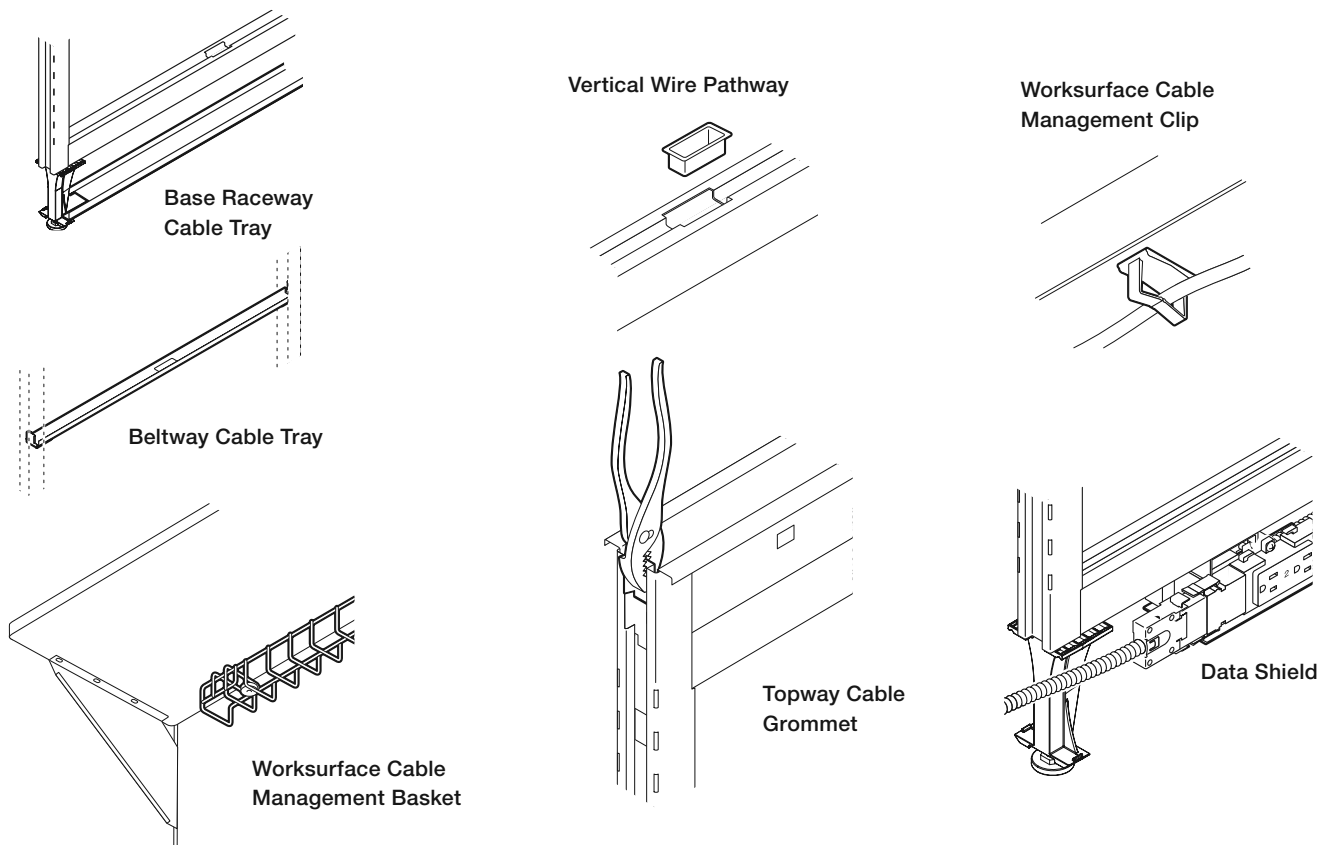
Data Shield

If separation of cabling and electrical wires is required within the base raceway, a data shield can be attached below a base raceway power module at either end. Data shields are field-installed. The data shield should be used with base raceway panels only.



description	type	pattern no.	list
 Worksurface Cable Management Basket	19 1/2" wide	D1 WB20	\$38.
	25 1/2" wide	D1 WB26	40.
	31 1/2" wide	D1 WB32	50.
	35" wide	D1 WB36	55.
	41" wide	D1 WB42	58.
 Vertical Wire Pathway Grommet (optional)	Package of 10	DP1 VWG	160.
 Topway Cable Grommet	Package of 40	DP1 TKC	56.
 Worksurface Cable Management Clip	Package of 10	D1 WC	36.
 Data Shield	1 Pair	DE1 DATSHD	28.

Ordering Information

Base Raceway Cable Tray

1. Pattern Number

Order Code

Base Raceway Cable Tray

Example: **DP1 RCT24**

DP1 Pattern Number
RCT24

Included with:

Base Raceway Cable Tray

Options



Base Raceway Cable Tray

Note: DP7 cable trays are for use with all DP7 series panels and all panels produced prior to November 2007.

Note: Data Shield is for use with panels that have base raceway on both sides only. It is not compatible with tile to floor or open base panels.

Cable Management

Base Raceway and Beltway Cable Trays

description	type	pattern no.	list
Base Raceway Cable Tray - double sided for use with raceway on both sides (optional) 	18" Panel Width	DP72 RCT18	\$22.
	24" Panel Width	DP72 RCT24	24.
	30" Panel Width	DP72 RCT30	28.
	36" Panel Width	DP72 RCT36	30.
	42" Panel Width	DP72 RCT42	32.
	48" Panel Width	DP72 RCT48	36.
	60" Panel Width	DP72 RCT60	39.
Base Raceway Cable Tray - single sided for use with raceway on one side (optional) 	18" Panel Width	DP71 RCT18	22.
	24" Panel Width	DP71 RCT24	24.
	30" Panel Width	DP71 RCT30	28.
	36" Panel Width	DP71 RCT36	30.
	42" Panel Width	DP71 RCT42	32.
	48" Panel Width	DP71 RCT48	36.
	60" Panel Width	DP71 RCT60	39.
Beltway Cable Tray (optional) 	18" Panel Width	DP1 BCT18	24.
	24" Panel Width	DP1 BCT24	25.
	30" Panel Width	DP1 BCT30	29.
	36" Panel Width	DP1 BCT36	31.
	42" Panel Width	DP1 BCT42	34.
	48" Panel Width	DP1 BCT48	37.
	60" Panel Width	DP1 BCT60	54.

Ordering Information

Base Raceway Cable Tray
1. Pattern Number

Order Code

Base Raceway Cable Tray
Example: **DP1 RCT24**
DP1 Pattern Number
RCT24

Included with:

Base Raceway Cable Tray

Options

Base Raceway Cable Tray
Note: DP7 cable trays are for use with all DP7 series panels and all panels produced prior to November 2007.

This page intentionally left blank

Panel-Mounted

Dividends Series 1, Series 2 and Series 3 Overheads - Specifications

Flip-Up Door Overheads

Flip-up overheads mount to the integral vertical channels on Dividends Horizon panels to provide overhead storage within workstations.

Flip-up overhead cabinets consist of a top, shelf, end panels, overhead door with or without lock and required assembly screws. 30" to 48" wide cabinets have single doors while cabinets 54", 60", 66" and 72" wide have double doors. 54" wide overhead cabinets will ship with one 24" and one 30" door. 66" wide overhead cabinets will ship with one 30" and one 36" door. 54" and 66" overhead doors may be removed and reversed.

Overheads must match the width of single or multiple panels and cannot be mounted off-module. All cabinets are shipped knocked-down.

Series 1 Flip-up Door Overhead

Series 1 flip-up overhead cabinets match the aesthetics of the original Dividends Horizon system. The radiused fronts and molded plastic end trim match the radiused profile trim used on panel topcaps and end trim. Series 1 cabinets are offered with steel doors.

Series 2 Flip-up Door Overhead

Series 2 overhead cabinets offer an alternative aesthetic to the original Dividends Horizon Series 1 overhead. Unlike the radiused door profile of the Series 1 overhead door, the Series 2 door profile is rectilinear with soft radiused corners (see door profile drawing below). The Series 2 overhead offers a painted steel or veneer overhead door front.

Series 3 Flip-up Door Overhead

Series 3 cabinets offer a third aesthetic choice for flip-up overhead cabinets. The series 3 door profile is similar to the rectilinear door of the Series 2 cabinet, but the corners have a sharper radius to complement Dividends Horizon flat profile trim. Series 3 cabinets are offered with steel, laminate or veneer doors.

Note: Horizon Series 3 overheads are designed to complement and work next to other Series 3 overheads only.

Available Sizes

- Height: 15"
- Depth: 14¹/₈"
- Widths: 24", 30", 36", 42", 48", 54", 60", 66" and 72"

Construction:

- **Horizontal top and shelf:** 18-gauge (30" to 48" wide), 16-gauge (60" to 72" wide) painted roll-formed steel
- **Overhead door:**
 - Steel: 20-gauge painted steel
 - Laminate: 3/4" particle board with high pressure laminate on the outside and a paper backer on the inside. 1mm edgeband.
 - Veneer: 3/4" thick particle board with 0.6mm thick veneer on the top and edge.
- **Overhead door end trim:** Color injected, molded plastic (on Series 1 only)
- **End panels:** 16-gauge painted steel with integral mounting hooks
- **Overhead door suspension:** Steel ball bearing

Interior Dimensions

The interior dimensions of overhead cabinets and shelves are:

- Depth: 12"
- Usable interior height: 12⁵/₈"
- Width: 1/8" shorter than the exterior width

Cabinet Door Clearance

Cabinet doors open over the tops of cabinets. Required clearance is 16¹/₄" total height (height of cabinet plus top clearance required).

Touchdown Overhead Cabinets

Touchdown overhead cabinets are equipped with hydraulic assist cylinders that allow the overhead cabinet front to gently fall to a closed position.

Retrofit mechanisms may be field added to any flip-up overhead cabinet with a steel door.

Note: Touchdown mechanisms are not compatible with laminate or veneer doors.

Task Lights

All Dividends cabinets and shelves will accept task lights. Task lights must be specified separately.

Locks

Locks are standard on overhead cabinets and keyed randomly unless otherwise specified. Other keying options include keyed alike or keyed with lock cores K001-K250. All locks are factory-installed and are black finish. Cabinets can also be specified without locks if required. When locks are not specified on Series 1 and Series 2 overheads, a plug is located in the lock position. Lock retrofit kits are available for field installation at a later date for Series 1 and Series 2 overheads only.

Note: Horizon Series 3 flip-up overheads are only available in Knoll Core finishes.

Flip-up Door Overhead Configurations

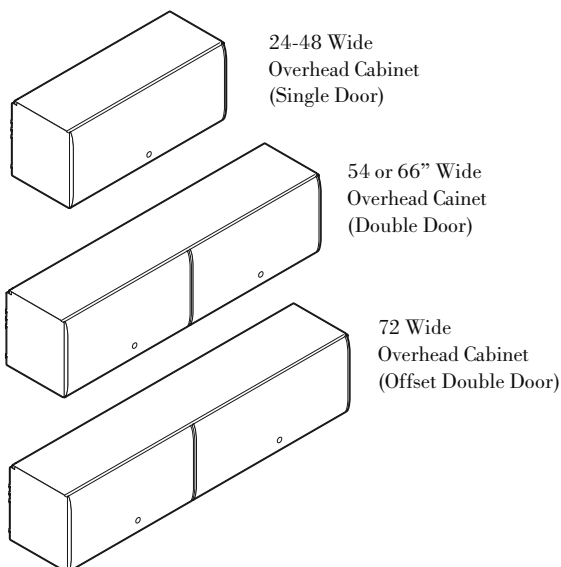

Interior Dimensions

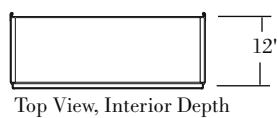
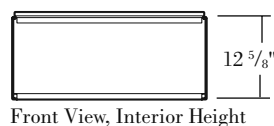

Cabinet Door Clearance

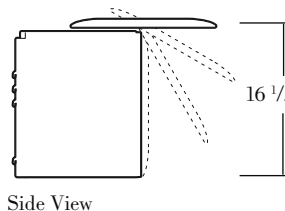

Flip-up Door Overhead Profiles

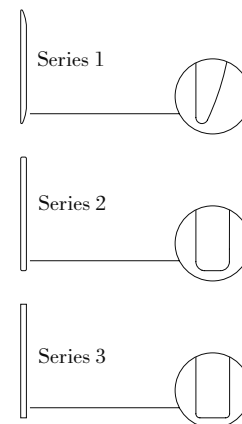

Flip-Up Door Overheads

Panel-Mounted

Dividends Series 1, Series 2 and Horizon Series 3

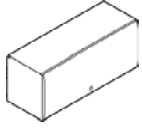
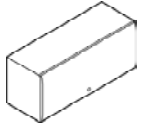
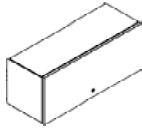
description	w*	w	d	h	pattern no.	P1	P2	P3	V1-P1	V1-P2	V1-P3
Dividends Series 1 Flip-Up Overhead w/Steel Door 	24"	23 7/8"	14 1/8"	15"	DS1O24L	\$347.	\$381.	\$397.	n/a	n/a	n/a
	30"	29 7/8"	14 1/8"	15"	DS1O30L	347.	381.	397.	n/a	n/a	n/a
	36"	35 7/8"	14 1/8"	15"	DS1O36L	366.	401.	420.	n/a	n/a	n/a
	42"	41 7/8"	14 1/8"	15"	DS1O42L	387.	427.	446.	n/a	n/a	n/a
	48"	47 7/8"	14 1/8"	15"	DS1O48L	400.	443.	461.	n/a	n/a	n/a
	54"	53 7/8"	14 1/8"	15"	DS1O54L	590.	648.	678.	n/a	n/a	n/a
	60"	59 7/8"	14 1/8"	15"	DS1O60L	590.	648.	678.	n/a	n/a	n/a
	66"	65 7/8"	14 1/8"	15"	DS1O66L	609.	671.	700.	n/a	n/a	n/a
	72"	71 7/8"	14 1/8"	15"	DS1O72L	609.	671.	700.	n/a	n/a	n/a
Series 2 Flip-Up Overhead w/ Steel or Veneer Door 	24"	23 7/8"	14 1/8"	15"	DS2PM24L	450.	519.	542.	705.	775.	795.
	30"	29 7/8"	14 1/8"	15"	DS2PM30L	450.	519.	542.	705.	775.	795.
	36"	35 7/8"	14 1/8"	15"	DS2PM36L	490.	564.	587.	713.	786.	812.
	42"	41 7/8"	14 1/8"	15"	DS2PM42L	535.	614.	639.	730.	813.	839.
	48"	47 7/8"	14 1/8"	15"	DS2PM48L	587.	675.	705.	784.	872.	902.
	54"	53 7/8"	14 1/8"	15"	DS2PM54L	698.	803.	839.	1,116.	1,220.	1,257.
	60"	59 7/8"	14 1/8"	15"	DS2PM60L	698.	803.	839.	1,116.	1,220.	1,257.
	66"	65 7/8"	14 1/8"	15"	DS2PM66L	778.	895.	933.	1,169.	1,286.	1,325.
	72"	71 7/8"	14 1/8"	15"	DS2PM72L	778.	895.	933.	1,169.	1,286.	1,325.
Dividends "touchdown" retro-fit (two kits required for 54"w - 72"w)					DS1EAKIT	238.					
Series 3 Flip-Up Overhead w/ Steel Door 	30"		14 1/2"	15"	DS3PMS30L	444.	490.	512.			
	36"		14 1/2"	15"	DS3PMS36L	458.	503.	526.			
	42"		14 1/2"	15"	DS3PMS42L	471.	519.	543.			
	48"		14 1/2"	15"	DS3PMS48L	488.	536.	560.			
	60"		14 1/2"	15"	DS3PMS60L	614.	676.	707.			
	66"		14 1/2"	15"	DS3PMS66L	669.	736.	770.			
	72"		14 1/2"	15"	DS3PMS72L	669.	736.	770.			

w* = nominal width

Dimensions listed under w h d are actual to the nearest 1/16"

Ordering Information	Order Code	Included with:	Options
Dividends Series 1 Flip-Up Door Overhead 1. Pattern Number 2. Paint Finish 3. Door End Cap Finish Series 2 Flip-Up Door Overhead 1. Pattern Number 2. Paint Finish 3. Door Finish (veneer door only) Series 3 Flip-Up Door Overhead 1. Pattern Number 2. Paint Finish case 3. Door Finish (laminated and veneer door only) 4. Door Edge Finish (laminated door only)	Dividends Series 1 Flip-Up Door Overhead <i>Example:</i> DS1O 30L, 113, 113 DS1O 30L Pattern Number 113 Dark grey paint finish 113 Dark grey End cap finish Series 2 Flip-Up Overhead w/ Steel Door <i>Example:</i> DS2PM 30L, 115 DS2PM 30L Pattern Number 115 Medium grey paint finish	Dividends Series 1 Flip-Up Door Overhead Series 2 Flip-Up Overhead Series 3 Flip-Up Overhead Note: Touchdown mechanism not available on veneer or laminate front Flip-Up overheads. Note: Series 3 Horizon overheads are only available in Knoll core finishes.	Flip-Up Door Door Overhead To specify overhead cabinet without locks replace the "L" suffix from the pattern number with "N" Deduct \$20. For 54", 60", 66" and 72" overhead cabinets Deduct \$40 To specify Touchdown overhead cabinet, add "E" as the 2nd to last digit of the pattern number <i>Example:</i> DS3PML48EL (Add \$150 for cabinet widths of 48" or less. Add \$300 for cabinet widths of 54" or greater). Series 2 Flip-Up Door Overhead Finish Option: Add a "Y" to the end of the pattern number to specify a different finish for the door versus the case. Use P3 pricing for this dual finish option.

Flip-Up Door Overheads

Dividends Horizon

Panel-Mounted

Dividends Series 1, Series 2 and Horizon Series 3

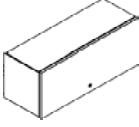
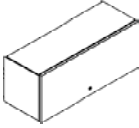
description	w*	w	d	h	pattern no.	P1	P2	P3	V1-P1	V1-P2	V1-P3
Series 3 Flip-Up Overhead w/ Laminate Door 		30"	14 1/2"	15"	DS3PML30L	\$671.	\$748.	\$780.			
		36"	14 1/2"	15"	DS3PML36L	701.	768.	802.			
		42"	14 1/2"	15"	DS3PML42L	722.	791.	826.			
		48"	14 1/2"	15"	DS3PML48L	766.	840.	877.			
		60"	14 1/2"	15"	DS3PML60L	1,146.	1,256.	1,310.			
		66"	14 1/2"	15"	DS3PML66L	1,162.	1,277.	1,342.			
		72"	14 1/2"	15"	DS3PML72L	1,196.	1,315.	1,374.			
Series 3 Flip-Up Overhead w/ Veneer Door 		30"	14 1/2"	15"	DS3PMV30L	927.	1,017.	1,062.			
		36"	14 1/2"	15"	DS3PMV36L	948.	1,041.	1,087.			
		42"	14 1/2"	15"	DS3PMV42L	971.	1,066.	1,114.			
		48"	14 1/2"	15"	DS3PMV48L	1,014.	1,101.	1,150.			
		60"	14 1/2"	15"	DS3PMV60L	1,634.	1,794.	1,873.			
		66"	14 1/2"	15"	DS3PMV66L	1,678.	1,845.	1,937.			
		72"	14 1/2"	15"	DS3PMV72L	1,693.	1,857.	1,940.			

w* = nominal width

Dimensions listed under w h d are actual to the nearest 1/16"

Ordering Information	Order Code	Included with:	Options
Dividends Series 1 Flip-Up Door Overhead 1. Pattern Number 2. Paint Finish 3. Door End Cap Finish Series 2 Flip-Up Door Overhead 1. Pattern Number 2. Paint Finish 3. Door Finish (veneer door only) Series 3 Flip-Up Door Overhead 1. Pattern Number 2. Paint Finish case 3. Door Finish (laminated and veneer door only) 4. Door Edge Finish (laminated door only)	Dividends Series 1 Flip-Up Door Overhead Example: DS1O 30L, 113, 113 <hr/> DS1O 30L Pattern Number 113 Dark grey paint finish <hr/> 113 Dark grey End cap finish <hr/> Series 2 Flip-Up Overhead w/ Steel Door Example: DS2PM 30L, 115 <hr/> DS2PM 30L Pattern Number <hr/> 115 Medium grey paint finish	Dividends Series 1 Flip-Up Door Overhead Series 2 Flip-Up Overhead Series 3 Flip-Up Overhead Note: Touchdown mechanism not available on veneer or laminate front Flip-Up overheads. Note: Series 3 Horizon overheads are only available in Knoll core finishes.	Flip-Up Door Door Overhead To specify overhead cabinet without locks replace the "L" suffix from the pattern number with "N" Deduct \$20. For 54", 60", 66" and 72" overhead cabinets Deduct \$40 To specify Touchdown overhead cabinet, add "E" as the 2nd to last digit of the pattern number Example: DS3PML48EL (Add \$150 for cabinet widths of 48" or less. Add \$300 for cabinet widths of 54" or greater). Series 2 Flip-Up Door Overhead Finish Option: Add a "Y" to the end of the pattern number to specify a different finish for the door versus the case. Use P3 pricing for this dual finish option.

This page intentionally left blank

Sliding Door Overheads

Panel-Mounted Specifications

Sliding Door Overheads

Sliding door overheads complement the aesthetic of the Dividends Horizon system. The rectilinear door profile was designed to match Dividends Horizon flat profile trim details.

Dividends Horizon sliding door overhead cabinets mount to integral vertical channels on Dividends Horizon panels to provide overhead storage within workstations.

Sliding door overhead cabinets consist of a top, shelf, mid cabinet septum, end panels and a door with handle. Units are available with or without locks.

Overheads must match the width of single or multiple panels and cannot be mounted off-module. All cabinets are shipped knocked-down.

Note: Series 3 overheads are designed to complement and work next to other Series 3 overheads only.

Available Sizes

- Height: 14" and 21"
- Depth: 13 1/2"
- Widths: 30", 36", 42", 48", 54", 60", 66" and 72"

Construction:

- **Horizontal top and shelf:** 18-gauge (30" to 48" wide), 16-gauge (60" to 72" wide) painted roll-formed steel
- **Sliding door:**
 - Steel: 20-gauge painted steel
 - Laminate: 3/4" particle board with high pressure laminate on the outside and a paper backer on the inside. 1mm edgeband.
 - Veneer: 3/4" thick particle board with 0.6mm thick veneer on the top and edge.
- **Fixed shelf:** 16-gauge painted steel
- **End panels:** 16-gauge painted steel with integral mounting hooks
- **Sliding door mechanism:** Integral track in top and bottom shelves with full length abs plastic extrusion. Door brackets are injection molded nylon.
- **Door handle:** painted aluminum (same color as case)

Interior Dimensions

The interior dimensions of overhead cabinets and shelves are:

- Depth: 12 1/4"
- Usable interior height: 12 5/8"
- Width: 1/8" shorter than the exterior width

Task Lights

All Dividends Horizon cabinets and shelves will accept task lights. Task lights must be ordered separately.

Locks

Locks are standard on overhead cabinets and keyed randomly unless otherwise specified. All locks are factory-installed and are black finish. Cabinets can also be specified without locks if required.

Note: Horizon sliding door overheads are only available in Knoll Core finishes.

Sliding Door Overhead Configurations

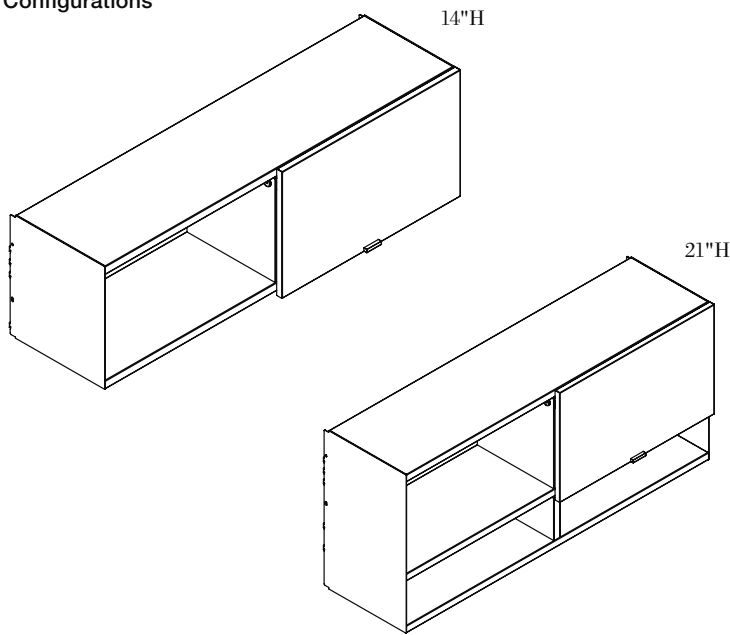

Interior Dimensions for 14"H Overhead

Front View, Interior Height

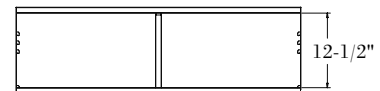

Top View, Interior Height



Interior Dimensions for 21"H Overhead

Front View, Interior Height

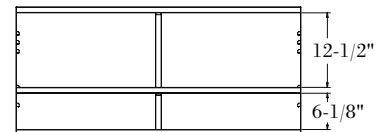

Top View, Interior Height

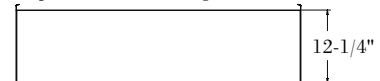

Sliding Door Overheads

Panel-Mounted

14" Tall Case

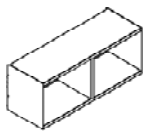
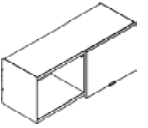
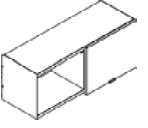
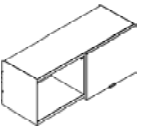
description	d	w	h	pattern no.	P1	P2	P3
 Overhead without Doors	12 1/2"	30"	14"	DS3PMNS3014	\$264.	\$291.	\$304.
	12 1/2"	36"	14"	DS3PMNS3614	275.	302.	317.
	12 1/2"	42"	14"	DS3PMNS4214	283.	311.	326.
	12 1/2"	48"	14"	DS3PMNS4814	294.	323.	336.
	12 1/2"	60"	14"	DS3PMNS6014	334.	368.	385.
	12 1/2"	66"	14"	DS3PMNS6614	345.	379.	396.
	12 1/2"	72"	14"	DS3PMNS7214	354.	390.	407.
 Sliding Door Overhead w/ Steel Door	13 1/2"	30"	14"	DS3PMSS3014L	437.	482.	502.
	13 1/2"	36"	14"	DS3PMSS3614L	449.	495.	518.
	13 1/2"	42"	14"	DS3PMSS4214L	464.	511.	533.
	13 1/2"	48"	14"	DS3PMSS4814L	471.	519.	543.
	13 1/2"	60"	14"	DS3PMSS6014L	533.	587.	613.
	13 1/2"	66"	14"	DS3PMSS6614L	547.	603.	630.
	13 1/2"	72"	14"	DS3PMSS7214L	556.	612.	639.
 Sliding Door Overhead w/ Laminate Door	13 1/2"	30"	14"	DS3PMSL3014L	755.	829.	866.
	13 1/2"	36"	14"	DS3PMSL3614L	776.	852.	890.
	13 1/2"	42"	14"	DS3PMSL4214L	798.	875.	915.
	13 1/2"	48"	14"	DS3PMSL4814L	819.	898.	938.
	13 1/2"	60"	14"	DS3PMSL6014L	840.	922.	962.
	13 1/2"	66"	14"	DS3PMSL6614L	861.	945.	986.
	13 1/2"	72"	14"	DS3PMSL7214L	882.	967.	1,011.
 Sliding Door Overhead w/ Veneer Door	13 1/2"	30"	14"	DS3PMSV3014L	834.	915.	956.
	13 1/2"	36"	14"	DS3PMSV3614L	861.	944.	986.
	13 1/2"	42"	14"	DS3PMSV4214L	887.	974.	1,017.
	13 1/2"	48"	14"	DS3PMSV4814L	914.	1,003.	1,048.
	13 1/2"	60"	14"	DS3PMSV6014L	941.	1,033.	1,079.
	13 1/2"	66"	14"	DS3PMSV6614L	967.	1,062.	1,109.
	13 1/2"	72"	14"	DS3PMSV7214L	994.	1,092.	1,141.

Ordering Information	Order Code	Included with:	Options
Sliding Door Overheads: 1. Pattern number 2. Paint finish case 3. Door finish (laminated and veneer door only) 4. Door edge finish (laminated door only)	Sliding Door Overhead w/ Steel Door <i>Example:</i> DS3PMSS3014L /117/117 DS3PMSS Pattern Number 3014L 117 Dark grey paint finish case 117 Dark grey paint finish door	Sliding Door Overhead Note: Sliding door overheads are only available in Knoll core finishes.	Sliding Door Overhead Lock/No lock For non-locking units substitute the "L" suffix with a "N" and deduct \$21.00 from the list price.

Sliding Door Overheads

Panel-Mounted

21" Tall Case (Full Height Door)

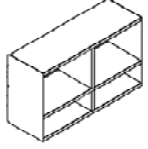
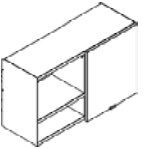
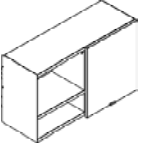
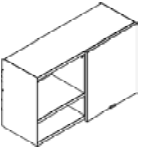
description	d	w	h	pattern no.	P1	P2	P3
 Overhead without Door	12 1/2"	30"	21"	DS3PMNS3021	\$365.	\$402.	\$420.
	12 1/2"	36"	21"	DS3PMNS3621	380.	418.	437.
	12 1/2"	42"	21"	DS3PMNS4221	393.	432.	451.
	12 1/2"	48"	21"	DS3PMNS4821	407.	447.	468.
	12 1/2"	60"	21"	DS3PMNS6021	464.	511.	533.
	12 1/2"	66"	21"	DS3PMNS6621	379.	417.	436.
	12 1/2"	72"	21"	DS3PMNS7221	492.	541.	565.
 Sliding Door Overhead w/ Steel Door	13 1/2"	30"	21"	DS3PMSS3021FL	568.	626.	654.
	13 1/2"	36"	21"	DS3PMSS3621FL	587.	647.	675.
	13 1/2"	42"	21"	DS3PMSS4221FL	607.	666.	698.
	13 1/2"	48"	21"	DS3PMSS4821FL	623.	684.	716.
	13 1/2"	60"	21"	DS3PMSS6021FL	713.	784.	821.
	13 1/2"	66"	21"	DS3PMSS6621FL	733.	806.	843.
	13 1/2"	72"	21"	DS3PMSS7221FL	747.	822.	859.
 Sliding Door Overhead w/ Laminate Door	13 1/2"	30"	21"	DS3PMSL3021FL	941.	1,033.	1,078.
	13 1/2"	36"	21"	DS3PMSL3621FL	968.	1,063.	1,110.
	13 1/2"	42"	21"	DS3PMSL4221FL	997.	1,094.	1,144.
	13 1/2"	48"	21"	DS3PMSL4821FL	1,026.	1,126.	1,175.
	13 1/2"	60"	21"	DS3PMSL6021FL	1,053.	1,156.	1,208.
	13 1/2"	66"	21"	DS3PMSL6621FL	1,081.	1,187.	1,241.
	13 1/2"	72"	21"	DS3PMSL7221FL	1,109.	1,218.	1,272.
 Sliding Door Overhead w/ Veneer Door	13 1/2"	30"	21"	DS3PMSV3021FL	1,024.	1,124.	1,174.
	13 1/2"	36"	21"	DS3PMSV3621FL	1,061.	1,166.	1,217.
	13 1/2"	42"	21"	DS3PMSV4221FL	1,100.	1,208.	1,262.
	13 1/2"	48"	21"	DS3PMSV4821FL	1,139.	1,250.	1,306.
	13 1/2"	60"	21"	DS3PMSV6021FL	1,177.	1,293.	1,351.
	13 1/2"	66"	21"	DS3PMSV6621FL	1,215.	1,336.	1,394.
	13 1/2"	72"	21"	DS3PMSV7221FL	1,255.	1,378.	1,439.

Ordering Information	Order Code	Included with:	Options
Sliding Door Overheads: 1. Pattern number 2. Paint finish case 3. Door finish (laminate and veneer door only) 4. Door edge finish (laminate door only)	Sliding Door Overhead w/ Steel Door <i>Example:</i> DS3PMSS3021FL /117/117 DS3PMSS Pattern Number 3021FL 117 Dark grey paint finish case 117 Dark grey paint finish door	Sliding Door Overhead Note: Sliding door overheads are only available in Knoll core finishes.	Sliding Door Overhead Lock/No lock For non-locking units substitute the "L" suffix with a "N" and deduct \$21.00 from the list price.

Sliding Door Overheads

Panel-Mounted

21" Tall Case (Partial Height Door)

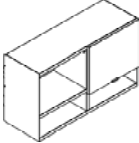
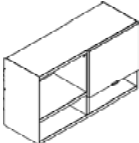
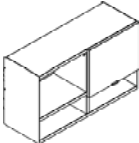
description	d	w	h	pattern no.	P1	P2	P3
Sliding Door Overhead w/ Steel Door 	13 1/2"	30"	21"	DS3PMSS3021PL	\$565.	\$623.	\$650.
	13 1/2"	36"	21"	DS3PMSS3621PL	583.	641.	671.
	13 1/2"	42"	21"	DS3PMSS4221PL	602.	661.	690.
	13 1/2"	48"	21"	DS3PMSS4821PL	616.	678.	709.
	13 1/2"	60"	21"	DS3PMSS6021PL	683.	751.	786.
	13 1/2"	66"	21"	DS3PMSS6621PL	704.	773.	808.
	13 1/2"	72"	21"	DS3PMSS7221PL	717.	788.	824.
Sliding Door Overhead w/ Laminate Door 	13 1/2"	30"	21"	DS3PMSL3021PL	933.	1,024.	1,069.
	13 1/2"	36"	21"	DS3PMSL3621PL	960.	1,054.	1,100.
	13 1/2"	42"	21"	DS3PMSL4221PL	987.	1,084.	1,133.
	13 1/2"	48"	21"	DS3PMSL4821PL	1,016.	1,115.	1,165.
	13 1/2"	60"	21"	DS3PMSL6021PL	1,044.	1,146.	1,196.
	13 1/2"	66"	21"	DS3PMSL6621PL	1,071.	1,176.	1,229.
	13 1/2"	72"	21"	DS3PMSL7221PL	1,099.	1,206.	1,261.
Sliding Door Overhead w/ Veneer Door 	13 1/2"	30"	21"	DS3PMSV3021PL	1,024.	1,124.	1,173.
	13 1/2"	36"	21"	DS3PMSV3621PL	1,054.	1,157.	1,209.
	13 1/2"	42"	21"	DS3PMSV4221PL	1,085.	1,192.	1,245.
	13 1/2"	48"	21"	DS3PMSV4821PL	1,117.	1,226.	1,281.
	13 1/2"	60"	21"	DS3PMSV6021PL	1,148.	1,261.	1,316.
	13 1/2"	66"	21"	DS3PMSV6621PL	1,178.	1,294.	1,353.
	13 1/2"	72"	21"	DS3PMSV7221PL	1,210.	1,330.	1,388.

Ordering Information

Sliding Door Overheads:

1. Pattern number
2. Paint finish case
3. Door finish
(laminated and veneer door only)
4. Door edge finish
(laminated door only)

Order Code

Sliding Door Overhead w/ Steel Door

Example: **DS3PMSS3021PL**
/117/117

DS3PMSS Pattern Number
3021PL

117 Dark grey paint finish case

117 Dark grey paint finish door

Included with:

Sliding Door Overhead

Note: Sliding door overheads are only available in Knoll core finishes.

Options

Sliding Door Overhead

Lock/No lock
For non-locking units substitute the "L" suffix with a "N" and deduct \$21.00 from the list price.

Panel Up Mounted Overhead Cabinets

Up mounted cabinets mount to 50" or 57" high panels only to provide overhead storage within workstations and are an alternative to overheads panel-mounted on 64" high panels. Up mounted cabinets have full finished backs and require up mount brackets for mounting.

When installed on 50" high panels, up mounted cabinets match up to the overall 64" height of panel-mounted overhead cabinets and freestanding overdesks to provide a consistent height within the facility.

Overhead cabinets consist of a top, shelf, end panels, enclosed back, overhead door with or without lock and required assembly screws. 30" to 48" wide cabinets have single doors while cabinets 54", 60", 66" and 72" wide have double doors. 54" wide overhead cabinets will ship with one 24" and one 30" door. 66" wide overhead cabinets will ship with one 30" and one 36" door. 54" and 66" overhead doors may be removed and reversed.

Up mounted cabinets are shipped knocked-down.

Up mounted overheads must match the width of single or multiple panels and cannot be mounted off module.

Series 1 Flip-up Overhead Cabinets

Series 1 flip-up overhead cabinets match the aesthetics of the original Dividends Horizon system. The radiused fronts and molded plastic end trim match the radiused profile trim used on panel topcaps and end trim. Series 1 cabinets are offered with steel doors.

Series 2 Flip-up Overhead Cabinets

Series 2 overhead cabinets offer an alternative aesthetic to the Dividends Horizon Series 1 overhead. Unlike the radiused door profile of the Series 1 overhead door, the Series 2 door profile is rectilinear with soft radiused corners (see door profile drawing below). The Series 2 overhead offers a painted steel or veneer overhead door front.

Available Sizes

- Height: 15"
- Depth: 13 $\frac{1}{2}$ "
- Widths: 30", 36", 42", 48", 54", 60", 66" and 72"

Construction:

- Horizontal top and shelf: 18-gauge (30" to 48" wide), 16-gauge (60" to 72" wide) painted roll-formed steel
- Overhead door: 20-gauge painted
- Overhead door suspension: Steel ball-bearing
- Overhead door end trim: Color injected, molded plastic (Series 1 only)
- End panels: 16-gauge painted steel with integral mounting hooks
- Up mount brackets: 14-gauge steel

Interior Dimensions

Up mounted cabinet interiors measure:

- Depth 12"
- Usable interior height: 12 $\frac{5}{8}$ "
- Width: $\frac{1}{8}$ " shorter than the exterior width.

Cabinet Door Clearance

Cabinet doors open over the tops of cabinets. Required clearance is: 16 $\frac{1}{4}$ " total height (height of cabinet plus top clearance required).

Panel Up Mounted Overhead for Stack Frames

Dividends Horizon non-load bearing stacking frames do not allow for panel-mount hanging components. To provide overhead storage, a panel up mounted overhead cabinet with enclosed back can be utilized. As a lower price option, the panel up mounted overhead cabinet without enclosed back can be substituted.

Up mount brackets

Cabinet up mount brackets are required for up mounted applications.

Up mount brackets are ordered separately in pairs. Up mount brackets can be used on both Dividends Horizon Series 1 and Series 2 up mounted cabinets.

Touchdown Overhead Cabinets

Touchdown overhead cabinets are equipped with hydraulic assist cylinders that allows the overhead cabinet front to gently fall to a closed position.

Retrofit mechanisms may be field added to any flip-up overhead cabinet with a steel door.

Note: Touchdown mechanisms are not compatible with laminate or veneer doors.

Locks

Locks are standard on overhead cabinets and keyed randomly unless otherwise specified. Other keying options include keyed alike or keyed with lock cores K001-K250. All locks are factory-installed and are black finish. Cabinets can also be specified without locks if required.

When locks are not specified a plug is located in the lock position.

Optional lock retrofit kits are available for field-installation at a later date if required.

Task Lights

All Dividends up mounted cabinets will accept task lights. Task lights must be ordered separately.

Panel Up Mounted Cabinet

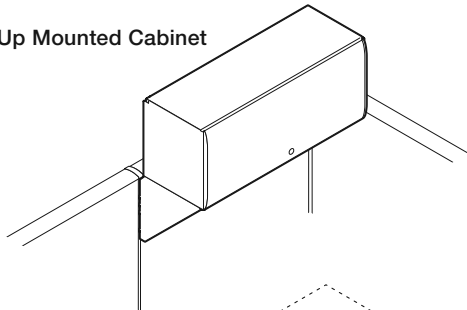

Up Mount Brackets

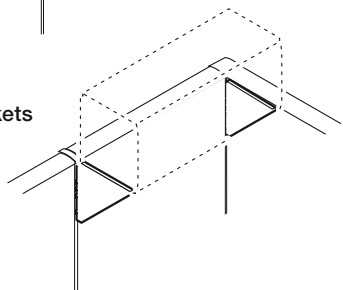

Interior Dimensions

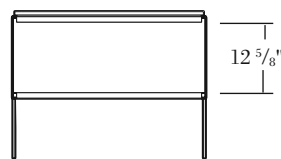

Front View, Interior Height

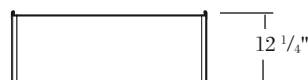

Top View, Interior Depth



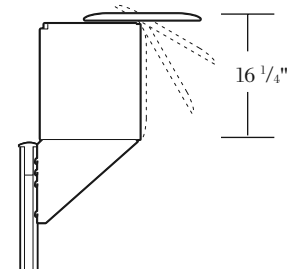

Cabinet Door Clearance



Up Mounted Overheads

Dividends and Series 2

Dividends Horizon

description	w*	w	d	h	pattern no.	P1	P2	P3	V1-P1	V1-P2	V1-P3
Dividends Overhead Cabinet with Enclosed Back and Lock 	30"	29 ⁷ / ₈ "	14 ¹ / ₈ "	15"	DS1E30L	\$461.	\$509.	\$531.	n/a	n/a	n/a
	36"	35 ⁷ / ₈ "	14 ¹ / ₈ "	15"	DS1E36L	479.	528.	550.	n/a	n/a	n/a
	42"	41 ⁷ / ₈ "	14 ¹ / ₈ "	15"	DS1E42L	517.	569.	595.	n/a	n/a	n/a
	48"	47 ⁷ / ₈ "	14 ¹ / ₈ "	15"	DS1E48L	540.	595.	621.	n/a	n/a	n/a
	54"	53 ⁷ / ₈ "	14 ¹ / ₈ "	15"	DS1E54L	707.	776.	812.	n/a	n/a	n/a
	60"	59 ⁷ / ₈ "	14 ¹ / ₈ "	15"	DS1E60L	707.	776.	812.	n/a	n/a	n/a
	66"	65 ⁷ / ₈ "	14 ¹ / ₈ "	15"	DS1E66L	729.	803.	840.	n/a	n/a	n/a
	72"	71 ⁷ / ₈ "	14 ¹ / ₈ "	15"	DS1E72L	729.	803.	840.	n/a	n/a	n/a
Dividends Overhead Cabinet Without Enclosed Back and Lock 	24"	23 ⁷ / ₈ "	14 ¹ / ₈ "	15"	DS1UE24L	347.	381.	397.	n/a	n/a	n/a
	30"	29 ⁷ / ₈ "	14 ¹ / ₈ "	15"	DS1UE30L	347.	381.	397.	n/a	n/a	n/a
	36"	35 ⁷ / ₈ "	14 ¹ / ₈ "	15"	DS1UE36L	366.	401.	420.	n/a	n/a	n/a
	42"	41 ⁷ / ₈ "	14 ¹ / ₈ "	15"	DS1UE42L	387.	427.	446.	n/a	n/a	n/a
	48"	47 ⁷ / ₈ "	14 ¹ / ₈ "	15"	DS1UE48L	400.	443.	461.	n/a	n/a	n/a
Series 2 Overhead Cabinet With Enclosed Back and Lock 	30"	29 ⁷ / ₈ "	14 ¹ / ₈ "	15"	DS2UM30L	613.	705.	735.	828.	920.	952.
	36"	35 ⁷ / ₈ "	14 ¹ / ₈ "	15"	DS2UM36L	632.	728.	760.	854.	850.	983.
	42"	41 ⁷ / ₈ "	14 ¹ / ₈ "	15"	DS2UM42L	654.	750.	784.	887.	986.	1,017.
	48"	47 ⁷ / ₈ "	14 ¹ / ₈ "	15"	DS2UM48L	665.	765.	797.	934.	1,035.	1,067.
	54"	53 ⁷ / ₈ "	14 ¹ / ₈ "	15"	DS2UM54L	895.	1,028.	1,072.	1,306.	1,442.	1,484.
	60"	59 ⁷ / ₈ "	14 ¹ / ₈ "	15"	DS2UM60L	895.	1,028.	1,072.	1,306.	1,442.	1,484.
	66"	65 ⁷ / ₈ "	14 ¹ / ₈ "	15"	DS2UM66L	934.	1,074.	1,121.	1,364.	1,506.	1,551.
	72"	71 ⁷ / ₈ "	14 ¹ / ₈ "	15"	DS2UM72L	934.	1,074.	1,121.	1,364.	1,506.	1,551.
Overhead Upmount Brackets (Pair)		⁷ / ₈ "	12 ³ / ₁₆ "	11 ³ / ₄ "	DB1U18	67.	73.	78.	n/a	n/a	n/a
											
	Reuter Upmount Brackets (Pair)		⁷ / ₈ "	12 ³ / ₁₆ "	11 ³ / ₄ "	DB1RU18	91.	98.	103.	n/a	n/a
											

w* = nominal width

Dimensions listed under w h d are actual to the nearest ¹/₁₆"

Ordering Information

Upmount Overhead Cabinet

1. Pattern Number
2. Paint Finish
3. Door End Cap Finish

Series 2 Overhead Cabinet

1. Pattern Number
2. Paint Finish

Order Code

Upmount Overhead Cabinet

Example: **DS1E 30L, 113, 113**

DS1E 30L Pattern Number

113 Dark grey paint finish

113 Dark grey end cap finish

Series 2 Overhead Cabinet

Example: **DS2UM 30L, 115**

DS2UM Pattern Number

30L

115 Medium grey paint finish

Included with:

Upmount Overhead Cabinet

Series 2 Overhead Cabinet

Up Mount overheads include an enclosed back.

Up Mount brackets are required and must be ordered separately.

Options

Upmount Overhead Cabinet

To specify overhead cabinet without locks, replace the "L" suffix from the pattern number with "N"
Deduct \$20 For 54", 60", 66" and 72" overhead cabinets **Deduct \$40**

To specify Touchdown overhead cabinet, add "E" as the 2nd to last digit of the pattern number
Example: **DS3PML48EL**
(Add \$150 for cabinet widths of 48" or less. Add \$300 for cabinet widths of 54" or greater).

Series 2 Up Mount Overhead Finish Option:

Add a "Y" to the end of the pattern number to specify a front color that is different than the case color. Use P3 pricing for this dual finish option.

Overhead Book Shelves

Dividends Horizon bookshelves mount to the integral vertical channels on Dividends Horizon panels to provide overhead storage within workstations.

Bookshelves include a shelf, end panels, open back and required assembly screws.

Shelves must match the width of single or multiple panels and cannot be mounted off-module.

All book shelves are shipped knocked-down.

Available Sizes

- Height: shelf 8"
- Depth: 14¹/₈"
- Widths: 24", 30", 36", 42", 48", 54", 60", 66" and 72"

Construction:

- Horizontal shelf: 18-gauge (24" to 48" wide), 16-gauge (60" to 72" wide) painted roll-formed steel
- End panels: 16-gauge painted steel with integral mounting hooks

Corner Shelf

Dividends Horizon corner shelves mount to the integral vertical channels of Dividends Horizon panels to provide overhead storage in corner applications. Panels supporting the corner shelf must be of the same width. Corner shelf consists of shelf, end panels and rear corner support bracket.

Note: Corner shelves do not accept task lights.

Note: Corner shelves may not be mounted on load bearing stack frames.

Available Sizes

- Height: 8"
- Depth: 12"
- Widths: 36", 42", and 48"

Construction:

- Shelf: 7/8" wood core construction with laminate on both sides and t-mold edge
- End panels: 16-gauge painted steel with integral mounting hooks

Task Lights

All Dividends Horizon shelves will accept task lights. Task lights must be ordered separately.

Bookshelf

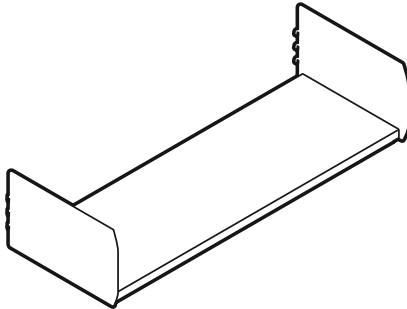

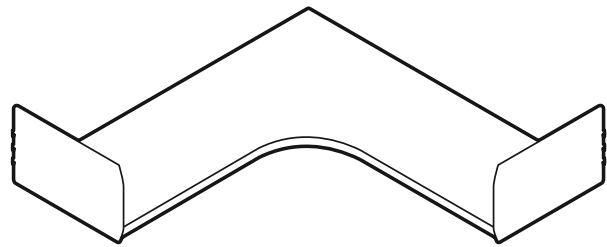

Corner Shelf

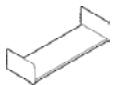

Overhead Bookshelf and Corner Shelf

7 1/4" High

description	w *	w	d	h	pattern no.	P1	P2	P3
 Overhead Bookshelf	24"	23 7/8"	14 1/8"	7 1/4"	DS1S 24	\$140.	\$155.	\$162.
	30"	29 7/8"	14 1/8"	7 1/4"	DS1S 30	140.	155.	162.
	36"	35 7/8"	14 1/8"	7 1/4"	DS1S 36	147.	155.	163.
	42"	41 7/8"	14 1/8"	7 1/4"	DS1S 42	154.	163.	170.
	48"	47 7/8"	14 1/8"	7 1/4"	DS1S 48	161.	169.	177.
	54"	53 7/8"	14 1/8"	7 1/4"	DS1S 54	173.	183.	192.
	60"	59 7/8"	14 1/8"	7 1/4"	DS1S 60	173.	183.	192.
	66"	65 7/8"	14 1/8"	7 1/4"	DS1S 66	188.	198.	209.
	72"	71 7/8"	14 1/8"	7 1/4"	DS1S 72	188.	198.	209.
 Overhead Corner Shelf	36"	35 7/8"	12"	7 1/4"	DS1CS 36	364.	385.	400.
	42"	41 7/8"	12"	7 1/4"	DS1CS 42	396.	418.	438.
	48"	47 7/8"	12"	7 1/4"	DS1CS 48	431.	456.	477.

w* = nominal width
 Dimensions listed under w h d are actual to the nearest 1/16"

Ordering Information

Overhead Bookshelf

1. Pattern Number
2. Paint Finish

Overhead Corner Shelf

1. Pattern Number
2. Laminate Finish
3. Edge Band Finish
4. Paint Finish

Order Code

Overhead Bookshelf

Example: **DS1S 60, 113**

DS1S 60 Pattern Number

113 Dark Grey Finish

Overhead Corner Shelf

Example: **DS1CS36, M42, 117, 117**

DS1CS36 Pattern Number

M42 Soft Grey Laminate

117 Soft Grey Edge Band

117 Soft Grey Paint

Included with:

Overhead Bookshelf

Overhead Corner Shelf

- Rear Corner Support Bracket

Note: An upcharge applies when specifying a Legacy laminate. See Legacy finish page for more information.

Mounting Brackets and Accessories

Backstop, Wall-Mount and Panel Mount Specifications

Optional Overhead Back Stop

Panel-mounted overhead cabinet and bookshelf backs are open and use the panel face as the back. When required, an optional field-installed back stop is available. Attachment can be made to an assembled unit. Construction is dark grey extruded plastic.

Specify the overhead back stop width to match the width of the shelf or overhead cabinet.

Overhead Cabinet Wall-Mount Brackets

Wall-mount brackets allow Dividends Horizon panel-mounted overheads to be wall-mounted to dry-wall construction. Wall-mounting brackets are available in sizes 30", 36", 42" and 48".

Specify the width of wall-mount bracket to match the width of the panel-mounted overhead cabinet. If cabinet width is 60" or 72" wide, specify two 30" or two 36" wall-mount brackets respectively.

If a 60" cabinet is desired, two (2) 30" wide wall-mount brackets may be installed side-by-side to support the overhead cabinet. When a 72" cabinet is used, two (2) 36" wall-mount brackets may be used.

Shelf Wall-Mount Brackets

Wall-mount brackets allow Dividends Horizon panel-mounted shelves to be wall-mounted to dry-wall construction. Wallmounting brackets are painted black, and are available in sizes 30", 42" and 48".

Specify the width of wall-mount bracket to match the width of the panel-mounted overhead shelf. Specify paint finish to match the shelf paint finish.

A metal shelf back will ship with the wall-mount bracket, which is painted to match the shelf color. Overhead shelves that are 60" and 72" wide cannot be wall mounted using the Dividends Horizon wall-mount bracket.

NOTE: WALL-MOUNT BRACKETS MUST ONLY BE USED WITH STRUCTURAL WALLS. TO ENSURE PROPER INSTALLATION, PLEASE FOLLOW THE INSTALLATION INSTRUCTIONS ENCLOSED WITH THE BRACKETS.

Up mount brackets

Cabinet up mount brackets are required for up mounted applications.

Up mount brackets are ordered separately in pairs. Up mount brackets can be used on both Dividends Horizon Series 1 and Series 2 up mounted cabinets.

Currents Downmount Bracket

This downmount bracket allows for Dividends Horizon or Series 2 panel mounted overhead cabinets to be mounted into Currents spine wall. This downmount bracket can only be used with Currents 64"H spine wall only.

Specify to match the overhead cabinet width. Specify paint finish to match the overhead cabinet finish.

Reuter Panel-Mount Brackets

Reuter panel-mount brackets are available to allow Reuter overheads and shelves to be panel-mounted on Dividends Horizon 57" or 64" high panels. Reuter overhead panel-mount brackets allow overhead sizes up to 72" to be panel-mounted. Reuter shelf panel-mount brackets allow shelves up to 48" to be panel-mounted. Finish black.

Vertical Dividers

Optional vertical dividers attach to the shelves within overhead cabinets and bookshelves to provide inner cabinet organization. Construction is 18-gauge steel with dark grey finish.

Overhead Cabinet Lock Retrofit Kit

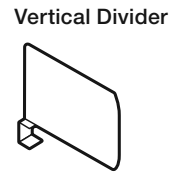
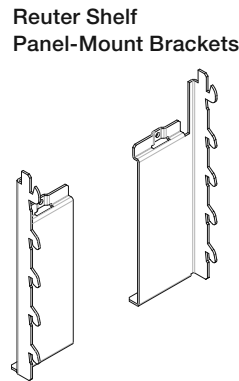
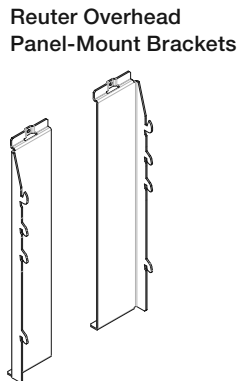
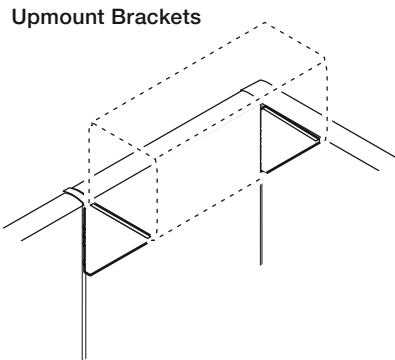
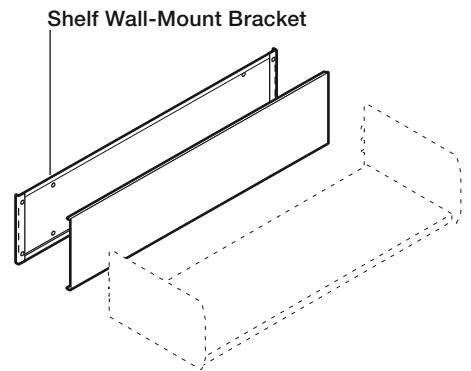
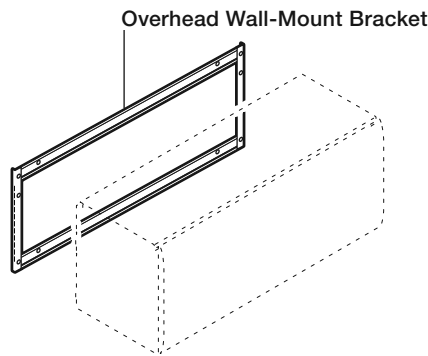
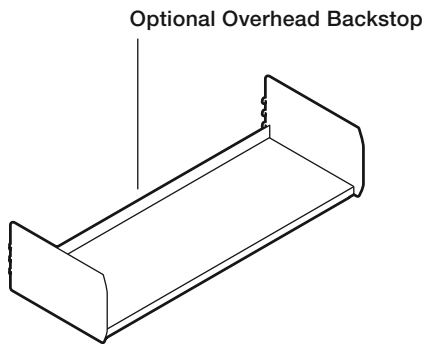

The overhead cabinet lock retrofit kit allows non-locking Series 1 and Series 2 flip-up overhead cabinets to be converted to locking overhead cabinets.



Mounting Brackets and Accessories

Overhead Backstop, Wall-mount Brackets and Currents Downmount Brackets

Dividends Horizon

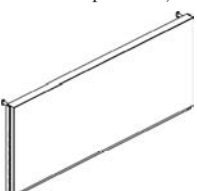
description	w*	w	d	h	pattern no.	black	P1	P2	P3
 Overhead Back Stop (Dark Grey Only)	24"	23 ¹¹ / ₁₆ "	5/8"	1 7/16"	DS1BS 24		\$4.	n/a	n/a
	30"	29 ¹¹ / ₁₆ "	5/8"	1 7/16"	DS1BS 30		4.	n/a	n/a
	36"	35 ¹¹ / ₁₆ "	5/8"	1 7/16"	DS1BS 36		4.	n/a	n/a
	42"	41 ¹¹ / ₁₆ "	5/8"	1 7/16"	DS1BS 42		7.	n/a	n/a
	48"	47 ¹¹ / ₁₆ "	5/8"	1 7/16"	DS1BS 48		7.	n/a	n/a
	54"	53 ¹¹ / ₁₆ "	5/8"	1 7/16"	DS1BS 54		10.	n/a	n/a
	60"	59 ¹¹ / ₁₆ "	5/8"	1 7/16"	DS1BS 60		10.	n/a	n/a
	72"	71 ¹¹ / ₁₆ "	5/8"	1 7/16"	DS1BS 72		10.	n/a	n/a
14" H Overhead Wall-Mount Bracket	24"	24"	1/2"	1 4 1/4"	DS1WM 24	68.	71.	75.	78.
	30"	30"	1/2"	1 4 1/4"	DS1WM 30	68.	71.	75.	78.
	36"	36"	1/2"	1 4 1/4"	DS1WM 36	72.	76.	79.	83.
	42"	42"	1/2"	1 4 1/4"	DS1WM 42	80.	84.	88.	92.
	48"	48"	1/2"	1 4 1/4"	DS1WM 48	86.	91.	95.	99.
 Overhead Shelf-Mount Bracket	30"	30"	1/2"	7"	DS1SWM 30		68.	74.	80.
	36"	36"	1/2"	7"	DS1SWM 36		72.	81.	84.
	42"	42"	1/2"	7"	DS1SWM 42		80.	88.	91.
	48"	48"	1/2"	7"	DS1SWM 48		86.	94.	97.
 Dividends Series 2 Downmount Brackets (For Currents spine use)	24"				DSCSWDB24		224.	n/a	n/a
	30"				DSCSWDB30		231.	n/a	n/a
	36"				DSCSWDB36		237.	n/a	n/a
	42"				DSCSWDB42		244.	n/a	n/a
	48"				DSCSWDB48		249.	n/a	n/a







w* = nominal width
 Dimensions listed under w h d are actual to the nearest 1/16"

Ordering Information	Order Code	Included with:	Options
Overhead Wall-Mount Bracket	Overhead Wall-Mount Bracket	Overhead Wall-Mount Bracket	Overhead Wall-Mount Bracket
1. Pattern Number	<i>Example:</i> DS1WM 30	Overhead Back Stop	Overhead Back Stop
Overhead Back Stop	DS1WM Pattern Number		
1. Pattern Number	30		
	Overhead Back Stop		
	<i>Example:</i> DB1BS 30		
	DB1BS 30 Pattern Number		

Mounting Brackets and Accessories

Upmount Brackets, Vertical Dividers and Lock Retrofit Kit

Dividends Horizon

description	pattern no.	black	P1	P2	P3
Vertical Dividers Package of 4 	DS1 VD	\$88.	\$92.	\$97.	\$101.
Overhead Cabinet Lock Retrofit Kit 	DS1 OHL	52.	n/a	n/a	n/a
Overhead Upmount Brackets (Pair) 	DB1U18	n/a	67.	73.	78.
Reuter Upmount Brackets (Pair) 	DB1RU18	n/a	91.	98.	103.
Reuter Overhead Panel Bracket (pair) 	RO1 DPB	52.	n/a	n/a	n/a
Reuter Shelf Panel-Mount Bracket (pair) 	RS1 DPB	52.	n/a	n/a	n/a

Ordering Information

Vertical Dividers

1. Pattern Number

Reuter Overhead Panel-Mount Bracket

1. Pattern Number

Order Code

Vertical Dividers

Example: **DS1 VD**

Reuter Overhead Panel-Mount Bracket

Example: **RO1 DPB**

Included with:

Vertical Dividers
(4) Vertical dividers

Reuter Overhead Panel-Mount Bracket
Brackets (pair)

Options

Vertical Dividers
Reuter Overhead Panel-Mount Bracket

Overhead cabinet lock retrofit kit is for Dividends Series 1 and Series 2 Flip-up Overhead only.

This page intentionally left blank

Task Lights

Dividends task lights are available in standard and advanced models. Task lights must be ordered separately from shelves, overhead cabinets, and overdesk units.

Tasklights include T5 cool white (4100K) fluorescent lamp, electronic ballast, 9 foot grounded cordset, prismatic lens, rocker switch, one cord exit management clip and mounting hardware.

Task light cordset is center exit. On smaller units cord exit is off-center but still not handed. This allows the cordset to be positioned either to the right or left of the task light to access the closest available duplex. Task lights are TCLP compliant and meet requirements of California Title 20 and Title 24.

Advanced task lights are fitted with ballast and lamp compliant with LEED requirements. All task lights include mounting hardware for attachment to overhead cabinets, shelves, up mounted cabinets and freestanding overdesks. Task light housings are painted black.

Specify task light one size or less than the overall cabinet or overdesk width.

Task Light Mounting Positions

Task lights have adjustable mounting brackets that lock into integral channels in the underside of the cabinet's lower shelf. The spring steel adjustable mounting brackets flex to install without requiring tools and allow the light to be positioned at any position side-to-side and front-to-back.

Cord Management Clips

Cord management clips attach to the integral slotted channels on panel frames to manage task light cordsets. Clips are $\frac{3}{8}$ " high black molded plastic construction.

New York City Applications

Task lights are approved for New York City installations.

City of Chicago Applications

City of Chicago task lights have a 9 foot power cord with a resettable circuit breaker built into the plug. To specify City of Chicago task lights, add a "CH" suffix to the end of the pattern number.

Task Light Specifications						
Standard Task Lights						
Model Number	Fixture Length	Lamp Length	Lamp Part Number	Line Current AMP	Lamp Watts	Input Watts
DL3T5E19S	19"	12"	FULHAM F8T5/CW	.12	8	8
DL3T5E25S	25"	21.6"	FULHAM F14T5/41K	.24	14	15
DL3T5E37S	37"	33.4"	FULHAM F21T5/41K	.36	21	24
DL3T5E49S	49"	45.2"	FULHAM F28T5/41K	.45	28	31
Advanced Fixtures						
DL3T5E25A	25"	22.2"	PHILIPS F14T5/841/ALTO	.15	14	18
DL3T5E37A	37"	33.98"	PHILIPS F21T5/841/ALTO	.21	21	24
DL3T5E49A	49"	45.8"	PHILIPS F28T5/841/ALTO	.26	28	31

Task Light

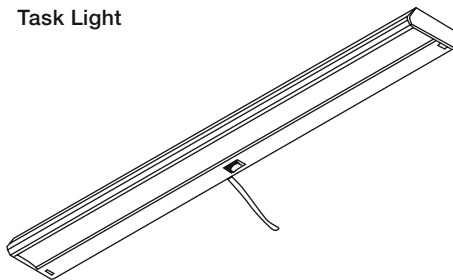

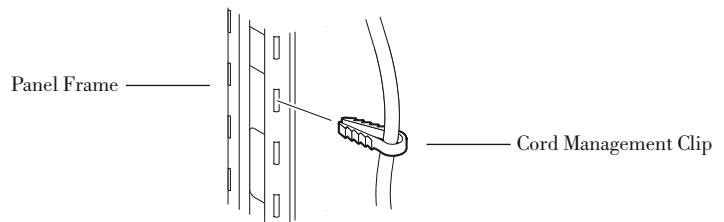

Cord Management Clip Attachment



T5 Task Lights

Cord Management Clip

description	type	w	d	h	pattern no.	standard	advanced
	Use with 24" and wider overhead	19"	4"	1 1/2"	DL3T5E19S	\$170.	n/a
	Use with 30" and wider overhead	25"	4"	1 1/2"	DL3T5E25 ()	183.	430.
	Use with 42" and wider overhead	37"	4"	1 1/2"	DL3T5E37 ()	187.	453.
	Use with 60" and wider overhead	49"	4"	1 1/2"	DL3T5E49 ()	213.	470.
Cord management clip	(package of 50)				DL3TC	43.	



Order Code	Specification Information	Application Notes
Example: DL3T5E25S <hr/> DL3 Task Light <hr/> T5 T5 lamp <hr/> E Electronic ballast <hr/> 25 Width <hr/> S Standard	<p><i>Specify:</i></p> <p>Width - Task Lights mount in cabinets and shelves at least 5" wider than light width.</p> <p><i>Type:</i></p> <p>(S) Standard (A) Advanced</p> <p>Specify suffix -CH and add \$45 list for City of Chicago installations. Example: DL3T5E25S-CH</p> <p>All housings are black.</p>	<p>Task lights mount into the recess in the underside of overhead cabinets and shelves at least 6" wider than task light width.</p> <p>All task lights are 120v and include T5 cool white (4100K) fluorescent lamp, electronic ballast, 9' grounded cordset, prismatic lens, rocker switch, one cord exit management clip and mounting hardware.</p> <p>Additional cord management clips must be ordered separately.</p> <p>Task light cordset is center exit. On smaller units cord exit is off-center, but still not handed.</p> <p>Task lights are TCLP compliant and meet requirements of California Title 20 and Title 24.</p> <p>Advanced task lights are fitted with ballasts and lamps compliant with LEED requirements, meeting the LEED EB standard for mercury content.</p>

Dividends Floorstanding, Doublewide and Mobile Specifications

Floorstanding Pedestals

Dividends Series 1 floorstanding pedestals are used to support worksurfaces in both panel-wrap and freestanding desk applications. No cantilevers or other supports are required at the end of the worksurface supported by a pedestal.

For panel-wrap applications, three depths are available in order to mount beneath 18", 24" and 30" deep worksurfaces.

In floorstanding desks, pedestals can either be specified "Preconfigured" with floorstanding desks or ordered by component for "Build-to-Spec" applications.

Two drawer configurations are available: box/box/file and file/file. Pedestals can be specified with or without locks.

Mobile Pedestals

Dividends Series 1 mobile pedestals provide moveable storage within workstations and tuck beneath worksurfaces when not in use. Available drawer configurations are box/box/file, box/file, and file/file.

Mobile pedestals roll on four corner-mounted swivel casters and one bottom drawer-mounted caster for stability when the lower drawer is in the open position. The front corner casters are locking.

Mobile pedestals may be specified with an optional handle allowing easy mobility. All mobile pedestals include 13-gauge finished tops. All other construction and drawer dimensions are the same as freestanding pedestals.

Mobile pedestals measure 20⁵/₈" and 26⁵/₈" high, 15" wide and 18" or 24" deep. All mobile pedestals include locks.

Available Sizes

Depths: 18", 24" and 30"
Width: 15"
Height: 20⁵/₈" and 26⁷/₈"

Doublewide Pedestals

The doublewide pedestal incorporates two 12" high drawers in a 30" width (18³/₄" depth) and is intended for below worksurface applications only. The doublewide's design allows for side-to-side letter or legal filing and front-to-back letter filing.

Doublewide pedestal can be used below 19", 24", or 36" deep worksurfaces, not 18" deep worksurfaces.

Available Size

Depth: 18³/₄" (floorstanding pedestal only)
Width: 30"
Height: 26⁷/₈"

Construction

Floorstanding mobile and doublewide pedestals match the aesthetics and dimensions of Dividends Horizon panel components.

- Outer wrapper: 20-gauge seamless steel wrapper, includes finished back and full dust pan
- Inner frame: 20-gauge steel uprights and 16-gauge cross rails
- Drawer front: 20-gauge steel, gently radiused (double wide front: 18-gauge)
- Drawer top cap trim: Color injected, molded plastic
- Box drawer suspension (floorstanding pedestal only): 3/4" extension, ball-bearing slides

- File drawer suspension: Full extension, ball-bearing slides
- Drawer pulls: Color injected, molded plastic
- Leveling glides: 3/8" diameter steel stem with 1 1/2" of height adjustment (double wide pedestal: 5/16" diameter steel stem with a 1 9/16" of height adjustment)

Internal Drawer Dimensions

Box drawer

- Internal height: 4⁵/₁₆"
- Internal width: 12⁹/₁₆"
- Internal depths: 18" = 15¹⁵/₁₆", 24" = 21¹/₄", 30" = 27¹/₄"

File drawer

- Internal height: 9¹/₄"
- Internal width: 12⁹/₁₆"
- Internal depths: 18" = 15¹⁵/₁₆", 24" = 21¹/₄", 30" = 27¹/₄"

File drawer (doublewide pedestal)

- Internal height: 9³/₄"
- Internal width: 26³/₄"
- Internal depth: 15³/₄"

Locks

Pedestals can be ordered with or without locks. When specified without locks, a lock plug is included. An optional lock retrofit kit is available for field installation of locks at a later date if required.

Locks are keyed randomly unless otherwise specified. Other keying options include keyed alike or keyed with lock cores K001-K250. All random keyed locks are factory-installed and have a black finish.

Pedestal Accessories

A hanging file bar for front-to-back or side-to-side filing is included with Series 1 pedestals.

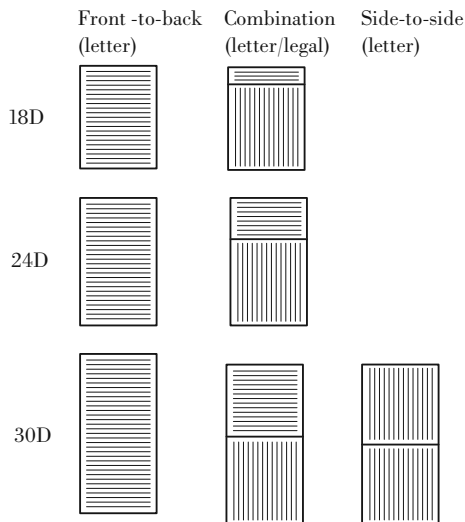

Pedestal Filing Configurations

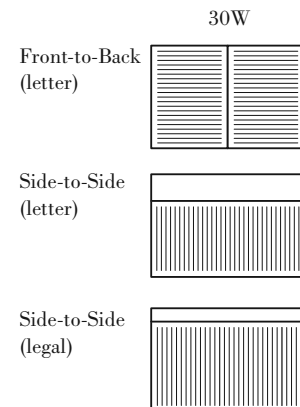

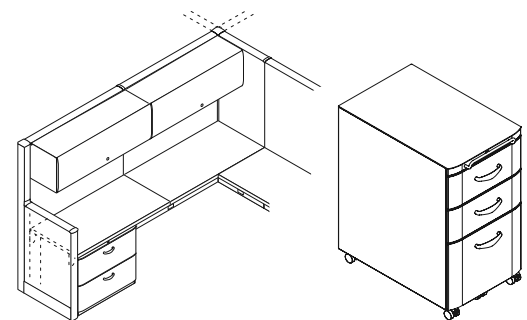

Doublewide Pedestal Filing Configurations



Doublewide Pedestal

Mobile Pedestal

*Dividends Floorstanding, Doublewide and Mobile
18", 24" and 30" Depths*

description	type	d*	d	w	h	pattern no.	P1	P2	P3
 <p>Floorstanding Pedestals with Locks</p>	6/6/12	18"	17 1/2"	14 7/8"	26 7/8"	DS1PF L18A	\$544.	\$598.	\$626.
	12/12	18"	17 1/2"	14 7/8"	26 7/8"	DS1PF L18B	523.	575.	602.
	6/6/12	24"	23 1/2"	14 7/8"	26 7/8"	DS1PF L24A	598.	658.	688.
	12/12	24"	23 1/2"	14 7/8"	26 7/8"	DS1PF L24B	574.	632.	659.
	6/6/12	30"	29 1/2"	14 7/8"	26 7/8"	DS1PF L30A	628.	690.	722.
	12/12	30"	29 1/2"	14 7/8"	26 7/8"	DS1PF L30B	601.	659.	689.
 <p>Mobile Pedestals with Locks</p>	6/6/12	18"	16 3/4"	14 7/8"	26 3/8"	DS1PM L18A	899.	924.	1,033.
	12/12	18"	16 3/4"	14 7/8"	26 3/8"	DS1PM L18B	871.	959.	1,003.
	6/12	18"	17 1/2"	14 7/8"	20 5/8"	DS1PM L18F	799.	879.	920.
	6/6/12	24"	22 3/4"	14 7/8"	26 3/8"	DS1PM L24A	967.	1,065.	1,113.
	12/12	24"	22 3/4"	14 7/8"	26 3/8"	DS1PM L24B	940.	1,033.	1,081.
	6/12	24"	22 3/4"	14 7/8"	20 5/8"	DS1PM L24F	865.	952.	994.
 <p>Doublewide Pedestals with Locks</p>	12/12	19"	18 3/4"	30"	26 7/8"	DS1DW 30L	826.	909.	950.

d* = nominal depth
Dimensions listed under d w h are actual to the nearest 1/16"

Ordering Information	Order Code	Included with:	Options
Floorstanding Pedestals 1. Pattern Number 2. Paint Finish 3. Pull Finish 4. Drawer Top Cap Finish Mobile Pedestals 1. Pattern Number 2. Paint Finish 3. Pull Finish 4. Drawer Top Cap Finish Doublewide Pedestals 1. Pattern Number 2. Paint Finish 3. Pull Finish 4. Drawer Top Cap Finish	Floorstanding Pedestals <i>Example:</i> DS1PF L24A, 117, 117, 117 <hr/> DS1PF Pattern Number 24A <hr/> 117 Soft Grey paint finish <hr/> 117 Soft Grey pull finish <hr/> 117 Soft Grey top cap finish <hr/> Doublewide Pedestals <i>Example:</i> DS1DW 30L, 117, 117, 117 <hr/> DS1DW Pattern Number 30L <hr/> 117 Soft Grey paint finish <hr/> 117 Soft Grey pull finish <hr/> 117 Soft Grey top cap finish <hr/> Mobile Pedestals <i>Example:</i> DS1PM L24A, 117, 117, 117 <hr/> DS1PM Pattern Number L24A <hr/> 117 Soft Grey paint finish <hr/> 117 Soft Grey pull finish <hr/> 117 Soft Grey drawer top cap finish	Floorstanding Pedestals <ul style="list-style-type: none"> Hanging file bar (file drawer) Mobile Pedestals <ul style="list-style-type: none"> Hanging file bar (file drawer) Doublewide Pedestals <ul style="list-style-type: none"> Hanging file bar (front-to-back) Hanging file rail (side-to-side) Doublewide pedestals are not intended for freestanding use and must be secured beneath a panel supported worksurface	Floorstanding Pedestals <ul style="list-style-type: none"> To specify pedestals without locks, replace the "L" (6th character) in the pattern number with an "N". Deduct \$21 Doublewide Pedestals <ul style="list-style-type: none"> To specify pedestals without locks, replace the "L" (6th character) in the pattern number with an "N". Deduct \$21 Mobile Pedestals Mobile pedestals are available with lock only. To specify a Dividends mobile pedestal with a handle, add "P" as the 7th character of the pattern number ie. DS1PML(P)24 add \$53

Pedestals

Series 2 Floorstanding, Doublewide and Mobile Specifications

Series 2 Floorstanding Pedestals

Series 2 floorstanding pedestals are used to support worksurfaces in both panel wrapped and freestanding applications. No cantilevers or other supports are required at the end of the worksurface supported by a pedestal.

Two drawer configurations are available: box/box/file and file/ file. Mobile pedestals are not available without locks.

The Series 2 24" deep pedestal design offers case without a back. In panel applications or in freestanding desking applications where the desk is against the wall, a back is not necessary.

In desking applications where the back of the case is exposed, an optional back is used to conceal the pedestals contents.

The 18" and 30" deep Series 2 pedestals include a back with each case.

Mobile Pedestals

Series 2 mobile pedestals provide moveable storage within a workstation and tuck beneath worksurfaces when not in use. Available drawer configurations are box/file, box/box/file and file/file.

Mobile pedestals roll on four corner-mounted swivel casters and one bottom drawer-mounted caster for stability when the lower drawer is in the open position. The front corner casters are locking.

Mobile pedestals may be specified with an optional handle allowing easy mobility.

All mobile pedestals include 13-gauge finished tops. A back is included with all Series 2 mobile pedestals.

Pedestals may be specified without the top for attachment of a pedestal cushion. Pedestal cushion may be ordered through the Knoll Currents product line.

Available Sizes

Depths: 18", 24" and 30" (Floorstanding pedestal only)

Width: 15"

Height: 26 ⁷/₈"

Series 2 Doublewide Pedestals

The doublewide pedestal incorporates two 12" high drawers in a 30" or 36" width (18 ³/₄" depth) and is intended for below worksurface applications only. The doublewide's design allows for side-to-side letter or legal filing and front-to-back letter filing.

Doublewide pedestals can be used below 19", 24", 30" or 36" deep worksurfaces, not 18" deep worksurfaces.

Available Sizes

Depth: 18 ³/₄" (floorstanding pedestal only)

Width: 30" and 36"

Height: 26 ⁷/₈"

Construction:

- Outer wrapper: 20-gauge steel
- Drawer front: 20-gauge steel (double wide front: 18-gauge)
- Pedestal back: 20-gauge
- ³/₄" extension ball bearing slides on 6" box drawers

- Full extension ball bearing slides on 12" file drawers
- Leveling glides: ³/₈" diameter steel stem with 1 ¹/₂" of height adjustment (double wide ped: ⁵/₁₆" diameter steel stem with a 1 ⁹/₁₆" of height adjustment

Internal Drawer Dimensions

Box drawer

- Internal height: 4 ⁵/₁₆"
- Internal width: 12 ¹/₁₆"
- Internal depths: 18 ³/₈"

File drawer

- Internal height: 9 ¹/₂"
- Internal width: 12 ¹/₁₆"
- Internal depths: 18 ³/₈"

File drawer (doublewide pedestal)

- Internal height: 9 ³/₄"
- Internal width: 26 ³/₄" and 32 ³/₄"
- Internal depth: 15 ³/₄"

Locks

Series 2 mobile pedestals are available not available without locks. Series 2 doublewide pedestals can be ordered with or without locks.

Locks are randomly keyed unless otherwise specified. Other keying options include keyed alike or keyed with lock cores K001-K250. All locks are factory-installed and have a black finish.

Pedestal Accessories

All Series 2 pedestal accessories including the hanging file bar must be specified separately.

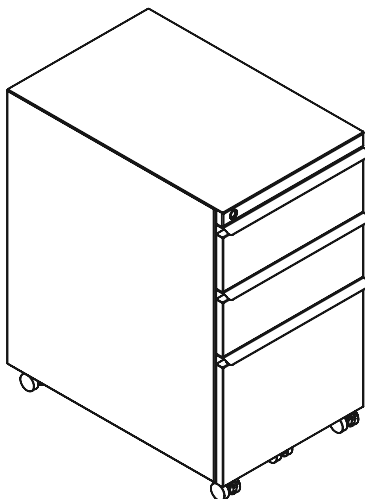

Mobile Pedestal

Pedestals

Series 2 Floorstanding, Doublewide and Mobile

18", 24" and 30" Depths

description	type	d*	d	w	h	pattern no.	P1	P2	P3
	6/6/12 w/back	18"	17 1/2"	14 7/8"	26 7/8"	DS2PF L18A	\$548.	\$631.	\$658.
	12/12 w/back	18"	17 1/2"	14 7/8"	26 7/8"	DS2PF L18B	527.	607.	633.
	6/6/12 no back	24"	23 1/2"	14 7/8"	26 7/8"	DS2PF L24A	470.	541.	564.
	12/12 no back	24"	23 1/2"	14 7/8"	26 7/8"	DS2PF L24B	445.	513.	534.
	6/6/12 w/back	30"	24 1/2"	14 7/8"	26 7/8"	DS2PF L30A	633.	728.	763.
	12/12 w/back	30"	29 1/2"	14 7/8"	26 7/8"	DS2PF L30B	606.	695.	725.

Series 2 Floorstanding Case Back (For 24" deep units only)				14 7/8"	26 7/8"	DS2XPB	81.	91.	94.
--	--	--	--	---------	---------	---------------	-----	-----	-----



	6/6/12	18"	16 3/4"	14 7/8"	26 3/8"	DS2PM L18A	906.	1,041.	1,086.
	12/12	18"	16 3/4"	14 7/8"	26 3/8"	DS2PM L18B	878.	1,011.	1,054.
	6/12	18"	16 3/4"	14 7/8"	20 5/8"	DS2PM L18F	805.	927.	967.
	6/6/12	24"	22 3/4"	14 7/8"	26 3/8"	DS2PM L24A	643.	741.	773.
	12/12	24"	22 3/4"	14 7/8"	26 3/8"	DS2PM L24B	643.	741.	773.
	6/12	24"	22 3/4"	14 7/8"	20 5/8"	DS2PM L24F	577.	663.	691.

	12/12	19"	18 3/4"	30"	26 7/8"	DS2DW 30L	832.	957.	998.
	12/12	19"	18 3/4"	36"	26 7/8"	DS2DW 36L	879.	1,012.	1,055.

d* = nominal depth
 Dimensions listed under d w h are actual to the nearest 1/16"

Ordering Information	Order Code	Included with:	Options
Pedestals 1. Pattern Number 2. Paint Finish	Floorstanding Pedestals <i>Example:</i> DS2PF L24A, 117 <hr/> DS2PF Pattern Number L24A 117 Soft Grey paint finish <hr/> Doublewide Pedestals <i>Example:</i> DS2DW 30L, 113 <hr/> DS2DW Pattern Number 30L 113 Dark grey paint finish	Floorstanding Pedestals <ul style="list-style-type: none"> Hanging file bar not included Note: 24" deep floorstanding pedestals do not include a back panel. Back panels must be ordered separately. 18" and 30" deep floorstanding pedestals have backs.	Floorstanding Pedestals <ul style="list-style-type: none"> To specify pedestals without locks, replace the "L" suffix with an "N". Deduct \$15 Doublewide Pedestals <ul style="list-style-type: none"> To specify pedestals without locks, replace the "L" suffix with an "N". Deduct \$21 Mobile Pedestals <ul style="list-style-type: none"> To specify a Series 2 mobile pedestal without a steel top, replace "M" character with "O" in the pattern number ie. DS2P(O)L24A Deduct \$35 Add \$50 list for mobile handle. Add a "P" between the "L" lock code and the case size to designate the handle option, example (DS2PMLP24A) Finish Option: Add a "Y" to the end of the pattern number to specify a different finish for the door versus the case. Use P3 pricing for this dual finish option.
		Mobile Pedestals <ul style="list-style-type: none"> Hanging file bar not included Doublewide Pedestals <ul style="list-style-type: none"> Hanging File Bar (front-to-back) Hanging file rail (side-to-side) Doublewide pedestals are not intended for freestanding use and must be secured beneath a panel supported worksurface.	

Pencil Tray

Five section tray rides on drawer sides of box drawers. Plastic injection molded construction. 13¹/₄" wide, 5⁷/₁₆" deep and 7/8" high. Black or clear finish available.

Hanging File Bar

Allows for side-to-side hanging folders. 20-gauge steel construction. Set of two. Black finish.

A hanging file bar is included with each file drawer when ordering Series 1 desks or pedestals. Hanging file bars are not included with Series 2 pedestals or desks - order separately.

Drawer Dividers

Two styles available: box drawer and file drawer sizes. 18-gauge steel construction. Black finish.

Stationery Inserts

Set of four trays for use in box drawers. 18-gauge steel construction. Can accommodate letter-and legal-sized stationery. Black finish.

Pencil Drawer

For use with freestanding desks or panel-mounted worksurfaces with depths of 24" or more. 24" wide, 17 5/8" deep and 2" high. Black finish.

Attachment: Mounts on underside of worksurface with included mounting hardware

Pedestal Lock Retrofit Kit

Allows existing nonlocking pedestals to be field-retrofitted with locks. Includes lock housing, lock core and lock rod assembly (must be specified box/box/file or file/file).

Worksurface Edge Grommet

Available factory-installed when ordering worksurfaces or as a kit for field installation. Can be installed in any location along the rear edge of worksurfaces. Includes a cutting template, grommet and cover. Dark grey finish.

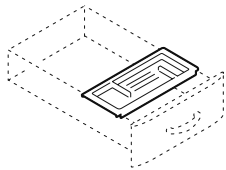

Pencil Tray

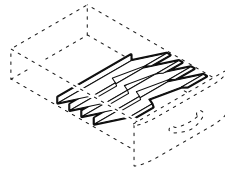

Stationery Inserts

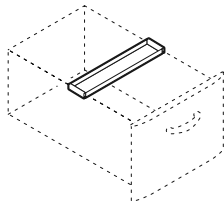

Hanging File Bar

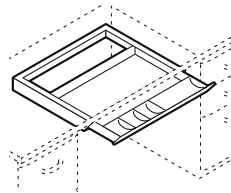

Pencil Drawer

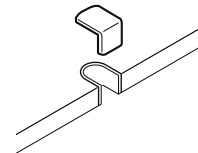

Worksurface Edge Grommet

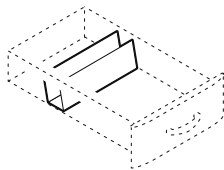



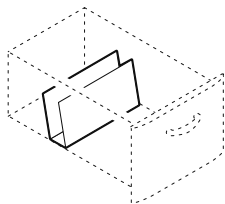



Drawer Divider, Box



Drawer Divider, File Drawer

Accessories

Drawer Organizers, Grommet Kits and Lock Retrofit Kits

description	type	w	d	h	pattern no.	list
 Pencil Tray	Black finish	13 1/4"	5 7/8"	7/8"	DS2PPTN	\$35.
	Clear finish	13 1/4"	5 7/8"	7/8"	DS2PPTC	42.
 Hanging File Bar		12 3/16"	2 15/16"	1/2"	DS1PFS	30.
 Drawer Divider, Box		12 3/8"	3"	3 1/8"	DS1PBD	30.
 Drawer Divider, File		10	3 5/8"	6 3/8"	DS1PFD	30.
 Stationary Inserts, box (4 trays)		13	15 1/16"	8 7/8"	DS1PST	160.
 Pencil Drawer		24"	17 5/8"	2"	DS1PCD	218.
 Worksurface Grommet Kit (Dark Grey)		2 3/16"	2 3/16"	1 3/8"	D1WSG	21.
Dividends Floorstanding Pedestal Lock Retrofit Kit					DS1LKKT	67.
Series 2 Floorstanding Pedestal Lock Retrofit Kit					DS2LKKT	55.
Dividends Doublewide Pedestal Lock Retrofit Kit					DS1DWDPL	60.
Series 2 Doublewide Pedestal Lock Retrofit Kit		30"			DS2DWDPL30	58.
		36"			DS2DWDPL36	60.

Ordering Information

Pencil Tray
1. Pattern Number

Order Code

Pencil Tray
Example: **DS2PPT**
DS2PPT Pattern Number

Included with:

Pencil Tray

Options

Pencil Tray Finish Options:
N = Black
C = Clear

Single Depth Credenzas

Dividends Horizon single depth credenzas increase planning and design options by blending residential furniture attributes within systems furniture applications. Credenzas offer a practical solution for functional under worksurface storage, while increasing the overall aesthetics of an office.

Credenzas consist of a metal, laminate, or veneer top option with a shelf and binder storage area. Single depth credenzas have four configuration options: sliding door only, drawer only, sliding door and drawer combination, and open shelves without a sliding door or a drawer.

The sliding door is a single steel, laminate, or veneer door with a handle that conceals half the width of the binder storage area. A single drawer may be specified for the location above the shelf. The drawer may be installed in either the right or left location, the drawer location does not need to be specified when ordered. When a drawer is specified along with a sliding door, the drawer front and sliding door finishes are the same. Units that include a drawer have a full back and those without a drawer have a partial back that encloses the binder storage area below the shelf.

Shorter width credenzas, 24, 30, and 36 inches wide, are available with a laminate or veneer top only. 24 inch wide credenzas do not include a center vertical septum and are only available as open shelf units, without a sliding door or drawer. Units are shipped knocked down and may be specified with or without locks. Dividends Horizon credenzas are available in all Knoll Core finishes. Legacy finishes are not available.

Available Sizes

Heights: 24 inches
Depth: 13-5/16 inches
Widths: 24 – 72 inches

Construction

- **Top:**
 - Steel: 16-gauge painted steel
 - Laminate: 1-1/4 inch thick particle board with high pressure laminate on top and a paper backer on the underside with 2mm edgeband
 - Veneer: 1-1/4 inch thick particle board with 0.6mm veneer on top and edge.
- **End Panels:** 16-gauge painted steel
- **Back Panel:** 20-gauge painted steel

• **Door:**

- Steel: 20-gauge panted steel
- Laminate: 3/4 inch thick particle board with high pressure laminate on the outside and a paper backer on the inside with 1mm edgeband
- Veneer 3/4 inch thick particle board with 0.6mm thick veneer on top and edge

• **Fixed Shelf:** 16-gauge painted steel

• **Door Handle:** painted aluminum (same color as case)

Interior Dimensions

Heights: 12-1/2 inches for the lower section, 5-7/8 inches for the upper section
Depth: 12-1/16 inches

Locks

Locks are standard on credenzas with doors and/or drawers and are keyed randomly unless otherwise specified. All locks are factory installed and have a black finish. Credenzas can also be specified without locks if required.

Single Depth Credenza with Open Shelves

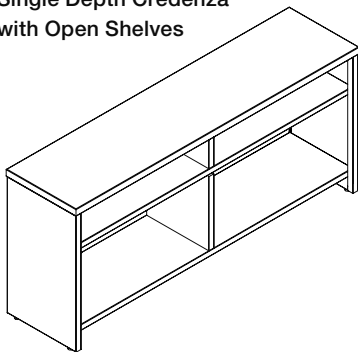

Single Depth Credenza with a Drawer

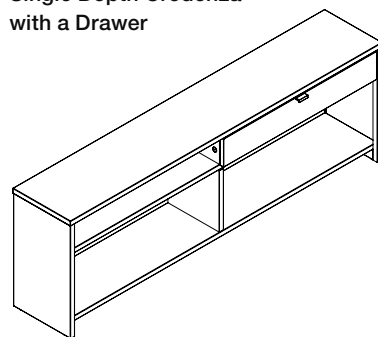

Single Depth Credenza with a Sliding Door

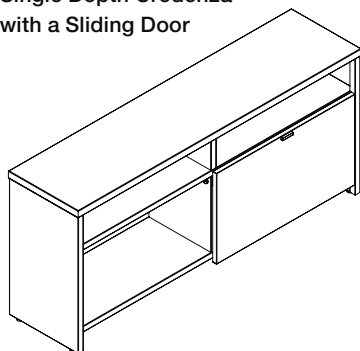

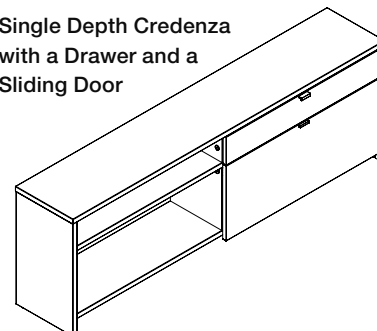

Single Depth Credenza with a Drawer and a Sliding Door



Credenzas

Single Depth with Steel Top

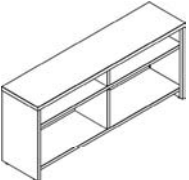

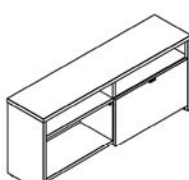
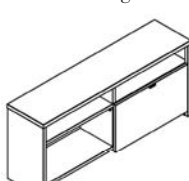
With or Without a Sliding Door

description	w	h	d	pattern no.	P1	P2	P3
 Credenza without Door	42"	24"	13 ⁵ / ₁₆ "	DS4LC1ANS42N	\$603.	\$662.	\$693.
	48"	24"	13 ⁵ / ₁₆ "	DS4LC1ANS48N	618.	679.	710.
	54"	24"	13 ⁵ / ₁₆ "	DS4LC1ANS54N	689.	759.	793.
	60"	24"	13 ⁵ / ₁₆ "	DS4LC1ANS60N	697.	767.	801.
	66"	24"	13 ⁵ / ₁₆ "	DS4LC1ANS66N	717.	788.	824.
	72"	24"	13 ⁵ / ₁₆ "	DS4LC1ANS72N	745.	820.	857.
 Credenza with Steel Sliding Door	42"	24"	13 ⁵ / ₁₆ "	DS4LC1BSS42L	744.	819.	855.
	48"	24"	13 ⁵ / ₁₆ "	DS4LC1BSS48L	760.	836.	874.
	54"	24"	13 ⁵ / ₁₆ "	DS4LC1BSS54L	845.	930.	971.
	60"	24"	13 ⁵ / ₁₆ "	DS4LC1BSS60L	850.	936.	978.
	66"	24"	13 ⁵ / ₁₆ "	DS4LC1BSS66L	876.	964.	1,008.
	72"	24"	13 ⁵ / ₁₆ "	DS4LC1BSS72L	905.	993.	1,040.
 Credenza with Laminate Sliding Door	42"	24"	13 ⁵ / ₁₆ "	DS4LC1BLS42L	1,209.	1,329.	1,387.
	48"	24"	13 ⁵ / ₁₆ "	DS4LC1BLS48L	1,239.	1,360.	1,421.
	54"	24"	13 ⁵ / ₁₆ "	DS4LC1BLS54L	1,267.	1,391.	1,454.
	60"	24"	13 ⁵ / ₁₆ "	DS4LC1BLS60L	1,296.	1,424.	1,487.
	66"	24"	13 ⁵ / ₁₆ "	DS4LC1BLS66L	1,325.	1,456.	1,521.
	72"	24"	13 ⁵ / ₁₆ "	DS4LC1BLS72L	1,355.	1,487.	1,554.
 Credenza with Veneer Sliding Door	42"	24"	13 ⁵ / ₁₆ "	DS4LC1BVS42L	1,289.	1,416.	1,480.
	48"	24"	13 ⁵ / ₁₆ "	DS4LC1BVS48L	1,325.	1,456.	1,520.
	54"	24"	13 ⁵ / ₁₆ "	DS4LC1BVS54L	1,361.	1,495.	1,562.
	60"	24"	13 ⁵ / ₁₆ "	DS4LC1BVS60L	1,397.	1,533.	1,602.
	66"	24"	13 ⁵ / ₁₆ "	DS4LC1BVS66L	1,431.	1,573.	1,643.
	72"	24"	13 ⁵ / ₁₆ "	DS4LC1BVS72L	1,468.	1,612.	1,685.

Dimensions listed under w h d are actual to the nearest 1/16"

Ordering Information	Order Code	Included with:	Options
Credenza with Sliding Door: 1. Pattern number 2. Paint finish 3. Door finish (laminated and veneer only) 4. Door edge finish (laminated only)	Credenza with Sliding Door: <i>Example:</i> DS4LC1BSS42L/117 DS4LC1B Pattern Number SS42L 117 Dark grey paint	Credenza with or without Sliding Door: Note: Credenzas are only available in Knoll core finishes.	Credenza with or without Sliding Door: Lock/No lock option For non-locking credenzas with a sliding door or a drawer, substitute the "L" suffix with an "N" and deduct \$21 from the list price.
Credenza without Sliding Door: 1. Pattern number 2. Paint finish	Credenza without a Sliding Door: <i>Example:</i> DS4LC1ANS42N/117 DS4LC1A Pattern Number NS42N 117 Dark grey paint		Note: Credenzas with a drawer have a full back. Credenzas without a drawer have a partial back that encloses the binder storage area below the shelf.

*Single Depth with Steel Top
Without a Sliding Door and with a Drawer*

description	w	h	d	pattern no.	P1	P2	P3
 <p>Credenza with Steel Drawer</p>	42"	24"	13 ⁵ / ₁₆ "	DS4LC1CSS42L	\$903.	\$962.	\$993.
	48"	24"	13 ⁵ / ₁₆ "	DS4LC1CSS48L	918.	979.	1,010.
	54"	24"	13 ⁵ / ₁₆ "	DS4LC1CSS54L	989.	1,059.	1,093.
	60"	24"	13 ⁵ / ₁₆ "	DS4LC1CSS60L	997.	1,067.	1,101.
	66"	24"	13 ⁵ / ₁₆ "	DS4LC1CSS66L	1,017.	1,088.	1,124.
	72"	24"	13 ⁵ / ₁₆ "	DS4LC1CSS72L	1,045.	1,120.	1,157.
 <p>Credenza with Laminate Drawer</p>	42"	24"	13 ⁵ / ₁₆ "	DS4LC1CLS42L	1,071.	1,130.	1,161.
	48"	24"	13 ⁵ / ₁₆ "	DS4LC1CLS48L	1,086.	1,147.	1,178.
	54"	24"	13 ⁵ / ₁₆ "	DS4LC1CLS54L	1,157.	1,227.	1,261.
	60"	24"	13 ⁵ / ₁₆ "	DS4LC1CLS60L	1,165.	1,235.	1,269.
	66"	24"	13 ⁵ / ₁₆ "	DS4LC1CLS66L	1,185.	1,256.	1,292.
	72"	24"	13 ⁵ / ₁₆ "	DS4LC1CLS72L	1,213.	1,288.	1,325.
 <p>Credenza with Veneer Drawer</p>	42"	24"	13 ⁵ / ₁₆ "	DS4LC1CVS42L	1,107.	1,166.	1,197.
	48"	24"	13 ⁵ / ₁₆ "	DS4LC1CVS48L	1,122.	1,183.	1,214.
	54"	24"	13 ⁵ / ₁₆ "	DS4LC1CVS54L	1,193.	1,263.	1,297.
	60"	24"	13 ⁵ / ₁₆ "	DS4LC1CVS60L	1,201.	1,271.	1,305.
	66"	24"	13 ⁵ / ₁₆ "	DS4LC1CVS66L	1,221.	1,292.	1,328.
	72"	24"	13 ⁵ / ₁₆ "	DS4LC1CVS72L	1,249.	1,324.	1,361.

Dimensions listed under w h d are actual to the nearest 1/16"

Ordering Information	Order Code	Included with:	Options
<p>Credenza with a Drawer:</p> <ol style="list-style-type: none"> 1. Pattern number 2. Paint finish 3. Drawer front finish (laminite and veneer only) 4. Drawer front edge finish (laminite only) 	<p>Credenza with a Drawer:</p> <p><i>Example:</i> DS4LC1CLS42L /117/118/118</p> <hr/> <p>DS4LC1C Pattern Number LS42L</p> <hr/> <p>117 Dark grey paint</p> <hr/> <p>118 Bright white drawer front</p> <hr/> <p>118 Bright white drawer front edge</p> <hr/>	<p>Credenza with a Drawer:</p> <p>Note: Credenzas are only available in Knoll core finishes.</p>	<p>Credenza with a Drawer:</p> <p>Lock/No lock option For non-locking credenzas with a sliding door or a drawer, substitute the "L" suffix with an "N" and deduct \$21 from the list price.</p> <p>Note: Credenzas with a drawer have a full back. Credenzas without a drawer have a partial back that encloses the binder storage area below the shelf.</p>

*Single Depth with Steel Top
With a Sliding Door and with a Drawer*

description	w	h	d	pattern no.	P1	P2	P3
Credenza with Steel Sliding Door and Drawer	42"	24"	13 ⁵ / ₁₆ "	DS4LC1DSS42L	\$1,044.	\$1,119.	\$1,155.
	48"	24"	13 ⁵ / ₁₆ "	DS4LC1DSS48L	1,060.	1,136.	1,174.
	54"	24"	13 ⁵ / ₁₆ "	DS4LC1DSS54L	1,145.	1,230.	1,271.
	60"	24"	13 ⁵ / ₁₆ "	DS4LC1DSS60L	1,150.	1,236.	1,278.
	66"	24"	13 ⁵ / ₁₆ "	DS4LC1DSS66L	1,176.	1,264.	1,308.
	72"	24"	13 ⁵ / ₁₆ "	DS4LC1DSS72L	1,205.	1,293.	1,340.



Credenza with Laminate Sliding Door and Drawer	42"	24"	13 ⁵ / ₁₆ "	DS4LC1DLS42L	1,509.	1,629.	1,687.
	48"	24"	13 ⁵ / ₁₆ "	DS4LC1DLS48L	1,539.	1,660.	1,721.
	54"	24"	13 ⁵ / ₁₆ "	DS4LC1DLS54L	1,567.	1,691.	1,754.
	60"	24"	13 ⁵ / ₁₆ "	DS4LC1DLS60L	1,596.	1,724.	1,787.
	66"	24"	13 ⁵ / ₁₆ "	DS4LC1DLS66L	1,625.	1,756.	1,821.
	72"	24"	13 ⁵ / ₁₆ "	DS4LC1DLS72L	1,655.	1,787.	1,854.



Credenza with Veneer Sliding Door and Drawer	42"	24"	13 ⁵ / ₁₆ "	DS4LC1DVS42L	1,589.	1,716.	1,780.
	48"	24"	13 ⁵ / ₁₆ "	DS4LC1DVS48L	1,625.	1,756.	1,820.
	54"	24"	13 ⁵ / ₁₆ "	DS4LC1DVS54L	1,661.	1,795.	1,862.
	60"	24"	13 ⁵ / ₁₆ "	DS4LC1DVS60L	1,697.	1,833.	1,902.
	66"	24"	13 ⁵ / ₁₆ "	DS4LC1DVS66L	1,731.	1,873.	1,943.
	72"	24"	13 ⁵ / ₁₆ "	DS4LC1DVS72L	1,768.	1,912.	1,985.





Dimensions listed under w h d are actual to the nearest 1/16"

Ordering Information	Order Code	Included with:	Options
Credenza with a Sliding Door and a Drawer: 1. Pattern number 2. Paint finish 3. Drawer/Door finish (laminates and veneer only) 4. Drawer/Door edge finish (laminates only)	Credenza with a Sliding Door and a Drawer: <i>Example:</i> DS4LC1DSS42L/117 DS4LC1D Pattern Number SS42L 117 Dark grey paint	Credenza with a Sliding Door and a Drawer: Note: Credenzas are only available in Knoll core finishes.	Credenza with a Sliding Door and a Drawer: Lock/No lock option For non-locking credenzas with a sliding door or a drawer, substitute the "L" suffix with an "N" and deduct \$42 from the list price. Note: Credenzas with a drawer have a full back. Credenzas without a drawer have a partial back that encloses the binder storage area below the shelf.

Credenzas

Single Depth with Laminate Top

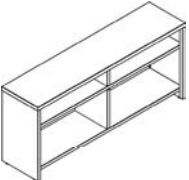
With or without a Sliding Door

description	w	h	d	pattern no.	P1	P2	P3
 <p>Credenza without Door</p>	24"	24"	13 ³ / ₁₆ "	DS4LC1ANL24N	\$811.	\$890.	\$932.
	30"	24"	13 ³ / ₁₆ "	DS4LC1ANL30N	811.	890.	932.
	36"	24"	13 ³ / ₁₆ "	DS4LC1ANL36N	811.	890.	932.
	42"	24"	13 ³ / ₁₆ "	DS4LC1ANL42N	811.	890.	932.
	48"	24"	13 ³ / ₁₆ "	DS4LC1ANL48N	833.	916.	958.
	54"	24"	13 ³ / ₁₆ "	DS4LC1ANL54N	898.	988.	1,034.
	60"	24"	13 ³ / ₁₆ "	DS4LC1ANL60N	899.	989.	1,035.
	66"	24"	13 ³ / ₁₆ "	DS4LC1ANL66N	930.	1,023.	1,069.
	72"	24"	13 ³ / ₁₆ "	DS4LC1ANL72N	961.	1,058.	1,104.
 <p>Credenza with Steel Sliding Door</p>	30"	24"	13 ³ / ₁₆ "	DS4LC1BSL30L	942.	1,037.	1,084.
	36"	24"	13 ³ / ₁₆ "	DS4LC1BSL36L	942.	1,037.	1,084.
	42"	24"	13 ³ / ₁₆ "	DS4LC1BSL42L	942.	1,037.	1,084.
	48"	24"	13 ³ / ₁₆ "	DS4LC1BSL48L	966.	1,063.	1,111.
	54"	24"	13 ³ / ₁₆ "	DS4LC1BSL54L	1,049.	1,154.	1,205.
	60"	24"	13 ³ / ₁₆ "	DS4LC1BSL60L	1,050.	1,155.	1,208.
	66"	24"	13 ³ / ₁₆ "	DS4LC1BSL66L	1,084.	1,192.	1,246.
	72"	24"	13 ³ / ₁₆ "	DS4LC1BSL72L	1,114.	1,226.	1,281.
 <p>Credenza with Laminate Sliding Door</p>	30"	24"	13 ³ / ₁₆ "	DS4LC1BLL30L	1,313.	1,443.	1,507.
	36"	24"	13 ³ / ₁₆ "	DS4LC1BLL36L	1,313.	1,443.	1,507.
	42"	24"	13 ³ / ₁₆ "	DS4LC1BLL42L	1,313.	1,443.	1,507.
	48"	24"	13 ³ / ₁₆ "	DS4LC1BLL48L	1,355.	1,487.	1,555.
	54"	24"	13 ³ / ₁₆ "	DS4LC1BLL54L	1,396.	1,532.	1,601.
	60"	24"	13 ³ / ₁₆ "	DS4LC1BLL60L	1,437.	1,578.	1,649.
	66"	24"	13 ³ / ₁₆ "	DS4LC1BLL66L	1,478.	1,623.	1,696.
	72"	24"	13 ³ / ₁₆ "	DS4LC1BLL72L	1,519.	1,669.	1,743.

Dimensions listed under w h d are actual to the nearest 1/16"

Ordering Information	Order Code	Included with:	Options
<p>Credenza with Sliding Door:</p> <ol style="list-style-type: none"> 1. Pattern number 2. Paint finish 3. Top finish 4. Top edge finish 5. Door finish (laminated and veneer only) 6. Door edge finish (laminated only) 	<p>Credenza with Sliding Door:</p> <p><i>Example:</i> DS4LC1BLL42L /117/118/117/118/118</p> <hr/> <p>DS4LC1B Pattern Number</p> <hr/> <p>LL42L</p> <hr/> <p>117 Dark grey paint</p> <hr/> <p>118 Bright white top</p> <hr/> <p>117 Dark grey top edge</p> <hr/> <p>118 Bright white door</p> <hr/> <p>118 Bright white door edge</p> <hr/> <p>Credenza without a Sliding Door:</p> <p><i>Example:</i> DS4LC1ANL42N /117</p> <hr/> <p>DS4LC1A Pattern Number</p> <hr/> <p>NL42N</p> <hr/> <p>117 Dark grey paint</p> <hr/> <p>118 Bright white top</p> <hr/> <p>117 Dark grey top edge</p>	<p>Credenza with or without Sliding Door:</p> <p>Note: Credenzas are only available in Knoll core finishes.</p>	<p>Credenza with or without Sliding Door:</p> <p>Lock/No lock option For non-locking credenzas with sliding door or a drawer, substitute the "L" suffix with a "N" and deduct \$21. from the list price.</p> <p>Note: Credenzas with a drawer have a full back. Credenzas without a drawer have a partial back that encloses the binder storage area below the shelf.</p>

Credenzas

Single Depth with Laminate Top

With or without a Sliding Door

Dividends Horizon



description	w	h	d	pattern no.	P1	P2	P3
 Credenza with Veneer Sliding Door	30"	24"	13 ⁵ / ₁₆ "	DS4LC1BVL30L	\$1,396.	\$1,532.	\$1,602.
	36"	24"	13 ⁵ / ₁₆ "	DS4LC1BVL36L	1,396.	1,532.	1,602.
	42"	24"	13 ⁵ / ₁₆ "	DS4LC1BVL42L	1,396.	1,532.	1,602.
	48"	24"	13 ⁵ / ₁₆ "	DS4LC1BVL48L	1,444.	1,586.	1,657.
	54"	24"	13 ⁵ / ₁₆ "	DS4LC1BVL54L	1,491.	1,637.	1,711.
	60"	24"	13 ⁵ / ₁₆ "	DS4LC1BVL60L	1,538.	1,690.	1,766.
	66"	24"	13 ⁵ / ₁₆ "	DS4LC1BVL66L	1,586.	1,741.	1,821.
	72"	24"	13 ⁵ / ₁₆ "	DS4LC1BVL72L	1,633.	1,795.	1,875.

Dimensions listed under w h d are actual to the nearest 1/16"

Ordering Information	Order Code	Included with:	Options
Credenza with Sliding Door: 1. Pattern number 2. Paint finish 3. Top finish 4. Top edge finish 5. Door finish (laminated and veneer only) 6. Door edge finish (laminated only)	Credenza with Sliding Door: Example: DS4LC1BLL42L /117/118/117/118/118 DS4LC1B Pattern Number LL42L 117 Dark grey paint 118 Bright white top 117 Dark grey top edge 118 Bright white door 118 Bright white door edge	Credenza with or without Sliding Door: Note: Credenzas are only available in Knoll core finishes.	Credenza with or without Sliding Door: Lock/No lock option For non-locking credenzas with sliding door or a drawer, substitute the "L" suffix with a "N" and deduct \$21. from the list price. Note: Credenzas with a drawer have a full back. Credenzas without a drawer have a partial back that encloses the binder storage area below the shelf.
Credenza without Sliding Door: 1. Pattern number 2. Paint finish 3. Top finish 4. Top edge finish	Credenza without a Sliding Door: Example: DS4LC1ANL42N/117 DS4LC1A Pattern Number NL42N 117 Dark grey paint 118 Bright white top 117 Dark grey top edge		

Storage Components

*Single Depth with Laminate Top
Without a Sliding Door and with a Drawer*

description	w	h	d	pattern no.	P1	P2	P3
 Credenza with Steel Drawer	30"	24"	13 ⁵ / ₁₆ "	DS4LC1CSL30L	\$1,111.	\$1,190.	\$1,232.
	36"	24"	13 ⁵ / ₁₆ "	DS4LC1CSL36L	1,111.	1,190.	1,232.
	42"	24"	13 ⁵ / ₁₆ "	DS4LC1CSL42L	1,111.	1,190.	1,232.
	48"	24"	13 ⁵ / ₁₆ "	DS4LC1CSL48L	1,133.	1,216.	1,258.
	54"	24"	13 ⁵ / ₁₆ "	DS4LC1CSL54L	1,198.	1,288.	1,334.
	60"	24"	13 ⁵ / ₁₆ "	DS4LC1CSL60L	1,199.	1,289.	1,335.
	66"	24"	13 ⁵ / ₁₆ "	DS4LC1CSL66L	1,230.	1,323.	1,369.
	72"	24"	13 ⁵ / ₁₆ "	DS4LC1CSL72L	1,261.	1,358.	1,404.
 Credenza with Laminate Drawer	30"	24"	13 ⁵ / ₁₆ "	DS4LC1CLL30L	1,279.	1,358.	1,400.
	36"	24"	13 ⁵ / ₁₆ "	DS4LC1CLL36L	1,279.	1,358.	1,400.
	42"	24"	13 ⁵ / ₁₆ "	DS4LC1CLL42L	1,279.	1,358.	1,400.
	48"	24"	13 ⁵ / ₁₆ "	DS4LC1CLL48L	1,301.	1,384.	1,426.
	54"	24"	13 ⁵ / ₁₆ "	DS4LC1CLL54L	1,366.	1,456.	1,502.
	60"	24"	13 ⁵ / ₁₆ "	DS4LC1CLL60L	1,367.	1,457.	1,503.
	66"	24"	13 ⁵ / ₁₆ "	DS4LC1CLL66L	1,398.	1,491.	1,537.
	72"	24"	13 ⁵ / ₁₆ "	DS4LC1CLL72L	1,429.	1,526.	1,572.
 Credenza with Veneer Drawer	30"	24"	13 ⁵ / ₁₆ "	DS4LC1CVL30L	1,315.	1,394.	1,436.
	36"	24"	13 ⁵ / ₁₆ "	DS4LC1CVL36L	1,315.	1,394.	1,436.
	42"	24"	13 ⁵ / ₁₆ "	DS4LC1CVL42L	1,315.	1,394.	1,436.
	48"	24"	13 ⁵ / ₁₆ "	DS4LC1CVL48L	1,337.	1,420.	1,462.
	54"	24"	13 ⁵ / ₁₆ "	DS4LC1CVL54L	1,402.	1,492.	1,538.
	60"	24"	13 ⁵ / ₁₆ "	DS4LC1CVL60L	1,403.	1,493.	1,539.
	66"	24"	13 ⁵ / ₁₆ "	DS4LC1CVL66L	1,434.	1,527.	1,573.
	72"	24"	13 ⁵ / ₁₆ "	DS4LC1CVL72L	1,465.	1,562.	1,608.

Dimensions listed under w h d are actual to the nearest 1/16"

Ordering Information

Credenza with a Drawer:

1. Pattern number
2. Paint finish
3. Top finish
4. Top edge finish
5. Drawer finish (laminite and veneer only)
6. Drawer edge finish (laminite only)

Order Code

Credenza with a Drawer:

Example: **DS4LC1CSL42L**
/117/118/117

DS4LC1C Pattern Number
SL42L

117 Dark grey paint

118 Bright white top

117 Dark grey top edge

Included with:

Credenza with a Drawer:

Note: Credenzas are only available in Knoll core finishes.

Options

Credenza with a Drawer:

Lock/No lock option

For non-locking credenzas with a sliding door or a drawer, substitute the "L" suffix with an "N" and deduct \$21 from the list price.

Note: Credenzas with a drawer have a full back. Credenzas without a drawer have a partial back that encloses the binder storage area below the shelf.

Single Depth with Laminate Top
With a Sliding Door and with a Drawer

description	w	d	h	pattern no.	P1	P2	P3
 Credenza with Steel Sliding Door and Drawer	30"	13 3/16"	24"	DS4LC1DSL30L	\$1,242.	\$1,337.	\$1,384.
	36"	13 3/16"	24"	DS4LC1DSL36L	1,242.	1,337.	1,384.
	42"	13 3/16"	24"	DS4LC1DSL42L	1,242.	1,337.	1,384.
	48"	13 3/16"	24"	DS4LC1DSL48L	1,266.	1,363.	1,411.
	54"	13 3/16"	24"	DS4LC1DSL54L	1,349.	1,454.	1,505.
	60"	13 3/16"	24"	DS4LC1DSL60L	1,350.	1,455.	1,508.
	66"	13 3/16"	24"	DS4LC1DSL66L	1,384.	1,492.	1,546.
	72"	13 3/16"	24"	DS4LC1DSL72L	1,414.	1,526.	1,581.

 Credenza with Laminate Sliding Door and Drawer	30"	13 3/16"	24"	DS4LC1DLL30L	1,613.	1,743.	1,807.
	36"	13 3/16"	24"	DS4LC1DLL36L	1,613.	1,743.	1,807.
	42"	13 3/16"	24"	DS4LC1DLL42L	1,613.	1,743.	1,807.
	48"	13 3/16"	24"	DS4LC1DLL48L	1,655.	1,787.	1,855.
	54"	13 3/16"	24"	DS4LC1DLL54L	1,696.	1,832.	1,901.
	60"	13 3/16"	24"	DS4LC1DLL60L	1,737.	1,878.	1,949.
	66"	13 3/16"	24"	DS4LC1DLL66L	1,778.	1,923.	1,996.
	72"	13 3/16"	24"	DS4LC1DLL72L	1,819.	1,969.	2,043.

 Credenza with Veneer Sliding Door and Drawer	30"	13 3/16"	24"	DS4LC1DVL30L	1,696.	1,832.	1,902.
	36"	13 3/16"	24"	DS4LC1DVL36L	1,696.	1,832.	1,902.
	42"	13 3/16"	24"	DS4LC1DVL42L	1,696.	1,832.	1,902.
	48"	13 3/16"	24"	DS4LC1DVL48L	1,744.	1,886.	1,957.
	54"	13 3/16"	24"	DS4LC1DVL54L	1,791.	1,937.	2,011.
	60"	13 3/16"	24"	DS4LC1DVL60L	1,838.	1,990.	2,066.
	66"	13 3/16"	24"	DS4LC1DVL66L	1,886.	2,041.	2,121.
	72"	13 3/16"	24"	DS4LC1DVL72L	1,933.	2,095.	2,175.

Dimensions listed under w h d are actual to the nearest 1/16"



Ordering Information	Order Code	Included with:	Options
Credenza with a Sliding Door and a Drawer: 1. Pattern number 2. Paint finish 3. Top finish 4. Top edge finish 5. Drawer/Door finish (laminite and veneer only) 6. Drawer/Door edge finish (laminite only)	Credenza with a Sliding Door and a Drawer: <i>Example:</i> DS4LC1DSL42L /117/118/117 DS4LC1D Pattern Number SL42L 117 Dark grey paint 118 Bright white top 117 Dark grey top edge	Credenza with a Sliding Door and a Drawer: Note: Credenzas are only available in Knoll core finishes.	Credenza with a Sliding Door and a Drawer: Lock/No lock option For non-locking credenzas with a sliding door or a drawer substitute the "L" suffix with an "N" and deduct \$42 from the list price. Note: Credenzas with a drawer have a full back. Credenzas without a drawer have a partial back that encloses the binder storage area below the shelf.

Credenzas

Single Depth with Veneer Top

With or without a Sliding Door

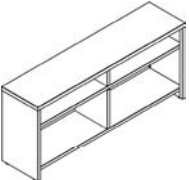
Dividends Horizon

description	w	h	d	pattern no.	P1	P2	P3
 <p>Credenza without Door</p>	24"	24"	13 ⁵ / ₁₆ "	DS4LC1ANV24N	\$1,241.	\$1,365.	\$1,427.
	30"	24"	13 ⁵ / ₁₆ "	DS4LC1ANV30N	1,241.	1,365.	1,427.
	36"	24"	13 ⁵ / ₁₆ "	DS4LC1ANV36N	1,241.	1,365.	1,427.
	42"	24"	13 ⁵ / ₁₆ "	DS4LC1ANV42N	1,241.	1,365.	1,427.
	48"	24"	13 ⁵ / ₁₆ "	DS4LC1ANV48N	1,270.	1,398.	1,461.
	54"	24"	13 ⁵ / ₁₆ "	DS4LC1ANV54N	1,300.	1,430.	1,496.
	60"	24"	13 ⁵ / ₁₆ "	DS4LC1ANV60N	1,331.	1,463.	1,529.
	66"	24"	13 ⁵ / ₁₆ "	DS4LC1ANV66N	1,360.	1,496.	1,565.
	72"	24"	13 ⁵ / ₁₆ "	DS4LC1ANV72N	1,390.	1,528.	1,598.
 <p>Credenza with Steel Sliding Door</p>	30"	24"	13 ⁵ / ₁₆ "	DS4LC1BSV30L	1,309.	1,438.	1,502.
	36"	24"	13 ⁵ / ₁₆ "	DS4LC1BSV36L	1,309.	1,438.	1,502.
	42"	24"	13 ⁵ / ₁₆ "	DS4LC1BSV42L	1,309.	1,438.	1,502.
	48"	24"	13 ⁵ / ₁₆ "	DS4LC1BSV48L	1,341.	1,473.	1,538.
	54"	24"	13 ⁵ / ₁₆ "	DS4LC1BSV54L	1,373.	1,507.	1,575.
	60"	24"	13 ⁵ / ₁₆ "	DS4LC1BSV60L	1,404.	1,543.	1,612.
	66"	24"	13 ⁵ / ₁₆ "	DS4LC1BSV66L	1,436.	1,577.	1,648.
	72"	24"	13 ⁵ / ₁₆ "	DS4LC1BSV72L	1,468.	1,612.	1,685.
 <p>Credenza with Laminate Sliding Door</p>	30"	24"	13 ⁵ / ₁₆ "	DS4LC1BLV30L	1,590.	1,747.	1,825.
	36"	24"	13 ⁵ / ₁₆ "	DS4LC1BLV36L	1,590.	1,747.	1,825.
	42"	24"	13 ⁵ / ₁₆ "	DS4LC1BLV42L	1,590.	1,747.	1,825.
	48"	24"	13 ⁵ / ₁₆ "	DS4LC1BLV48L	1,622.	1,782.	1,862.
	54"	24"	13 ⁵ / ₁₆ "	DS4LC1BLV54L	1,655.	1,818.	1,899.
	60"	24"	13 ⁵ / ₁₆ "	DS4LC1BLV60L	1,687.	1,853.	1,937.
	66"	24"	13 ⁵ / ₁₆ "	DS4LC1BLV66L	1,718.	1,889.	1,974.
	72"	24"	13 ⁵ / ₁₆ "	DS4LC1BLV72L	1,751.	1,924.	2,011.

Dimensions listed under w h d are actual to the nearest 1/16"

Ordering Information	Order Code	Included with:	Options
<p>Credenza with Sliding Door:</p> <ol style="list-style-type: none"> 1. Pattern number 2. Paint finish 3. Top finish 4. Door finish (laminated and veneer) 5. Door edge finish (laminated only) 	<p>Credenza with Sliding Door:</p> <p><i>Example:</i> DS4LC1BSV42L /117/Y319</p> <hr/> <p>DS4LC1B Pattern Number</p> <hr/> <p>SV42L</p> <hr/> <p>117 Dark grey paint</p> <hr/> <p>Y319 Cherry Techwood top</p>	<p>Credenza with or without Sliding Door:</p> <p>Note: Credenzas are only available in Knoll core finishes.</p>	<p>Credenza with or without a Sliding Door:</p> <p>Lock/No lock option</p> <p>For non-locking credenzas with a sliding door or a drawer, substitute the "L" suffix with an "N" and deduct \$21 from the list price.</p> <p>Note: Credenzas with a drawer have a full back. Credenzas without a drawer have a partial back that encloses the binder storage area below the shelf.</p>
<p>Credenza without a Sliding Door:</p> <ol style="list-style-type: none"> 1. Pattern number 2. Paint finish 3. Top finish 	<p>Credenza without a Sliding Door:</p> <p><i>Example:</i> DS4LC1ANV42N /117/Y319</p> <hr/> <p>DS4LC1A Pattern Number</p> <hr/> <p>NV42N</p> <hr/> <p>117 Dark grey paint</p> <hr/> <p>Y319 Cherry Techwood top</p>		



Credenzas
Single Depth with Veneer Top
With or without a Sliding Door

description	w	h	d	pattern no.	P1	P2	P3
 Credenza with Veneer Sliding Door	30"	24"	13 ⁵ / ₁₆ "	DS4LC1BVV30L	\$1,673.	\$1,837.	\$1,921.
	36"	24"	13 ⁵ / ₁₆ "	DS4LC1BVV36L	1,673.	1,837.	1,921.
	42"	24"	13 ⁵ / ₁₆ "	DS4LC1BVV42L	1,673.	1,837.	1,921.
	48"	24"	13 ⁵ / ₁₆ "	DS4LC1BVV48L	1,711.	1,881.	1,965.
	54"	24"	13 ⁵ / ₁₆ "	DS4LC1BVV54L	1,750.	1,923.	2,010.
	60"	24"	13 ⁵ / ₁₆ "	DS4LC1BVV60L	1,789.	1,965.	2,054.
	66"	24"	13 ⁵ / ₁₆ "	DS4LC1BVV66L	1,827.	2,008.	2,099.
	72"	24"	13 ⁵ / ₁₆ "	DS4LC1BVV72L	1,867.	2,050.	2,142.

Dimensions listed under w h d are actual to the nearest 1/16"

Ordering Information	Order Code	Included with:	Options
Credenza with Sliding Door: 1. Pattern number 2. Paint finish 3. Top finish 4. Door finish (laminate and veneer) 5. Door edge finish (laminate only)	Credenza with Sliding Door: <i>Example:</i> DS4LC1BSV42L /117/Y319 <hr/> DS4LC1B Pattern Number SV42L <hr/> 117 Dark grey paint <hr/> Y319 Cherry Techwood top	Credenza with or without Sliding Door: Note: Credenzas are only available in Knoll core finishes.	Credenza with or without a Sliding Door: Lock/No lock option For non-locking credenzas with a sliding door or a drawer, substitute the "L" suffix with an "N" and deduct \$21 from the list price. Note: Credenzas with a drawer have a full back. Credenzas without a drawer have a partial back that encloses the binder storage area below the shelf.
Credenza without a Sliding Door: 1. Pattern number 2. Paint finish 3. Top finish	Credenza without a Sliding Door: <i>Example:</i> DS4LC1ANV42N /117/Y319 <hr/> DS4LC1A Pattern Number NV42N <hr/> 117 Dark grey paint <hr/> Y319 Cherry Techwood top		

*Single Depth with Veneer Top
Without a Sliding Door and with a Drawer*

description	w	h	d	pattern no.	P1	P2	P3
 <p>Credenza with Steel Door</p>	30"	24"	13 5/16"	DS4LC1CSV30L	\$1,541.	\$1,665.	\$1,727.
	36"	24"	13 5/16"	DS4LC1CSV36L	1,541.	1,665.	1,727.
	42"	24"	13 5/16"	DS4LC1CSV42L	1,541.	1,665.	1,727.
	48"	24"	13 5/16"	DS4LC1CSV48L	1,570.	1,698.	1,761.
	54"	24"	13 5/16"	DS4LC1CSV54L	1,600.	1,730.	1,796.
	60"	24"	13 5/16"	DS4LC1CSV60L	1,631.	1,763.	1,829.
	66"	24"	13 5/16"	DS4LC1CSV66L	1,660.	1,796.	1,865.
	72"	24"	13 5/16"	DS4LC1CSV72L	1,690.	1,828.	1,898.
 <p>Credenza with Laminate Door</p>	30"	24"	13 5/16"	DS4LC1CLV30L	1,709.	1,833.	1,895.
	36"	24"	13 5/16"	DS4LC1CLV36L	1,709.	1,833.	1,895.
	42"	24"	13 5/16"	DS4LC1CLV42L	1,709.	1,833.	1,895.
	48"	24"	13 5/16"	DS4LC1CLV48L	1,738.	1,866.	1,929.
	54"	24"	13 5/16"	DS4LC1CLV54L	1,768.	1,898.	1,964.
	60"	24"	13 5/16"	DS4LC1CLV60L	1,799.	1,931.	1,997.
	66"	24"	13 5/16"	DS4LC1CLV66L	1,828.	1,964.	2,033.
	72"	24"	13 5/16"	DS4LC1CLV72L	1,858.	1,996.	2,066.
 <p>Credenza with Veneer Door</p>	30"	24"	13 5/16"	DS4LC1CVV30L	1,745.	1,869.	1,931.
	36"	24"	13 5/16"	DS4LC1CVV36L	1,745.	1,869.	1,931.
	42"	24"	13 5/16"	DS4LC1CVV42L	1,745.	1,869.	1,931.
	48"	24"	13 5/16"	DS4LC1CVV48L	1,774.	1,902.	1,965.
	54"	24"	13 5/16"	DS4LC1CVV54L	1,804.	1,934.	2,000.
	60"	24"	13 5/16"	DS4LC1CVV60L	1,835.	1,967.	2,033.
	66"	24"	13 5/16"	DS4LC1CVV66L	1,864.	2,000.	2,069.
	72"	24"	13 5/16"	DS4LC1CVV72L	1,894.	2,032.	2,102.

Dimensions listed under w h d are actual to the nearest 1/16"

Ordering Information	Order Code	Included with:	Options
<p>Credenza with a Drawer:</p> <ol style="list-style-type: none"> 1. Pattern number 2. Paint finish 3. Top finish 4. Door finish (laminated and veneer only) 5. Door edge finish (laminated only) 	<p>Credenza with a Drawer:</p> <p><i>Example:</i> DS4LC1CSV42L /117/ Y319</p> <hr/> <p>DS4LC1C Pattern Number</p> <hr/> <p>SV42L</p> <hr/> <p>117 Dark grey paint</p> <hr/> <p>Y319 Cherry Techwood top</p>	<p>Credenza with a Drawer:</p> <p>Note: Credenzas are only available in Knoll core finishes.</p>	<p>Credenza with a Drawer:</p> <p>Lock/No lock option For non-locking credenzas with a sliding door or a drawer, substitute the "L" suffix with an "N" and deduct \$21 from the list price.</p> <p>Note: Credenzas with a drawer have a full back. Credenzas without a drawer have a partial back that encloses the binder storage area below the shelf.</p>

Single Depth with Veneer Top
With a Sliding Door and with a Drawer

description	w	h	d	pattern no.	P1	P2	P3
	30"	24"	13 ⁵ / ₁₆ "	DS4LC1DSV30L	\$1,609.	\$1,738.	\$1,802.
	36"	24"	13 ⁵ / ₁₆ "	DS4LC1DSV36L	1,609.	1,738.	1,802.
	42"	24"	13 ⁵ / ₁₆ "	DS4LC1DSV42L	1,609.	1,738.	1,802.
	48"	24"	13 ⁵ / ₁₆ "	DS4LC1DSV48L	1,641.	1,773.	1,838.
	54"	24"	13 ⁵ / ₁₆ "	DS4LC1DSV54L	1,673.	1,807.	1,875.
	60"	24"	13 ⁵ / ₁₆ "	DS4LC1DSV60L	1,704.	1,843.	1,912.
	66"	24"	13 ⁵ / ₁₆ "	DS4LC1DSV66L	1,736.	1,877.	1,948.
	72"	24"	13 ⁵ / ₁₆ "	DS4LC1DSV72L	1,768.	1,912.	1,985.

	30"	24"	13 ⁵ / ₁₆ "	DS4LC1DLV30L	1,890.	2,047.	2,125.
	36"	24"	13 ⁵ / ₁₆ "	DS4LC1DLV36L	1,890.	2,047.	2,125.
	42"	24"	13 ⁵ / ₁₆ "	DS4LC1DLV42L	1,890.	2,047.	2,125.
	48"	24"	13 ⁵ / ₁₆ "	DS4LC1DLV48L	1,922.	2,082.	2,162.
	54"	24"	13 ⁵ / ₁₆ "	DS4LC1DLV54L	1,955.	2,118.	2,199.
	60"	24"	13 ⁵ / ₁₆ "	DS4LC1DLV60L	1,987.	2,153.	2,237.
	66"	24"	13 ⁵ / ₁₆ "	DS4LC1DLV66L	2,018.	2,189.	2,274.
	72"	24"	13 ⁵ / ₁₆ "	DS4LC1DLV72L	2,051.	2,224.	2,311.

	30"	24"	13 ⁵ / ₁₆ "	DS4LC1DVV30L	1,973.	2,137.	2,221.
	36"	24"	13 ⁵ / ₁₆ "	DS4LC1DVV36L	1,973.	2,137.	2,221.
	42"	24"	13 ⁵ / ₁₆ "	DS4LC1DVV42L	1,973.	2,137.	2,221.
	48"	24"	13 ⁵ / ₁₆ "	DS4LC1DVV48L	2,011.	2,181.	2,265.
	54"	24"	13 ⁵ / ₁₆ "	DS4LC1DVV54L	2,050.	2,223.	2,310.
	60"	24"	13 ⁵ / ₁₆ "	DS4LC1DVV60L	2,089.	2,265.	2,354.
	66"	24"	13 ⁵ / ₁₆ "	DS4LC1DVV66L	2,127.	2,308.	2,399.
	72"	24"	13 ⁵ / ₁₆ "	DS4LC1DVV72L	2,167.	2,350.	2,442.

Dimensions listed under w h d are actual to the nearest 1/16"

Ordering Information	Order Code	Included with:	Options
Credenza with a Sliding Door and a Drawer: 1. Pattern number 2. Paint finish 3. Top finish 4. Drawer/Door finish (laminated and veneer only) 5. Drawer/Door edge finish (laminated only)	Credenza with a Sliding Door and a Drawer: <i>Example:</i> DS4LC1SV42L /117/Y319 <hr/> DS4LC1 Pattern Number SV42L <hr/> 117 Dark grey paint <hr/> Y319 Cherry Techwood top	Credenza with a Sliding Door and a Drawer: Note: Credenzas are only available in Knoll core finishes.	Credenza with a Sliding Door and a Drawer: Lock/No lock option For non-locking credenzas with a sliding door or a drawer, substitute the "L" suffix with an "N" and deduct \$42 from the list price. Note: Credenzas with a drawer have a full back. Credenzas without a drawer have a partial back that encloses the binder storage area below the shelf.

Double Depth Credenzas

Dividends Horizon double depth credenzas are designed for use in various applications, including personal storage in shared workstations, space division in the open plan, and impromptu collaboration areas. Double depth credenzas offer a more unified aesthetic option, with the seamless top and end panels, when back-to-back credenzas are required.

Double depth credenzas consist of a seamless laminate or veneer top option with a shelf and binder storage area. Credenzas have four configuration options: sliding door only, drawer only, sliding door and drawer combination, and open shelves without a sliding door or a drawer. Double depth credenzas have the same configuration on both sides.

The sliding door is a single steel, laminate, or veneer door with a handle that conceals half the width of the binder storage area. A single drawer may be specified for the location above the shelf. The drawer may be installed in either the right or left location, the drawer location does not need to be specified when ordered. When a drawer is specified along with a sliding door, the drawer front and sliding door finishes are the same. A single full back panel divides the front and back sections of the credenza.

24 inch wide credenzas do not include a center vertical septum and are only available as open shelf units, without a sliding door or drawer. Units are shipped knocked down and may be specified with or without locks. Dividends Horizon credenzas are available in all Knoll Core finishes. Legacy finishes are not available.

Available Sizes

Heights: 24 inches
 Depth: 26-5/8 inches
 Widths: 24 – 72 inches

Construction

- **Top:**
 - Laminate: 1-1/4 inch thick particle board with high pressure laminate on top and a paper backer on the underside with 2mm edgeband
 - Veneer: 1-1/4 inch thick particle board with 0.6mm veneer on top and edge.
- **End Panels:** 16-gauge painted steel
- **Back Panel:** 20-gauge painted steel

• **Door:**

- Steel: 20-gauge panted steel
- Laminate: 3/4 inch thick particle board with high pressure laminate on the outside and a paper backer on the inside with 1mm edgeband
- Veneer 3/4 inch thick particle board with 0.6mm thick veneer on top and edge

• **Fixed Shelf:** 16-gauge painted steel

• **Door Handle:** painted aluminum (same color as case)

Interior Dimensions

Heights: 12-1/2 inches for the lower section, 5-7/8 inches for the upper section
 Depth: 12-1/16 inches

Locks

Locks are standard on credenzas with doors and/or drawers and are keyed randomly unless otherwise specified. All locks are factory installed and have a black finish. Credenzas can also be specified without locks if required.

Double Depth Credenza with Open Shelves

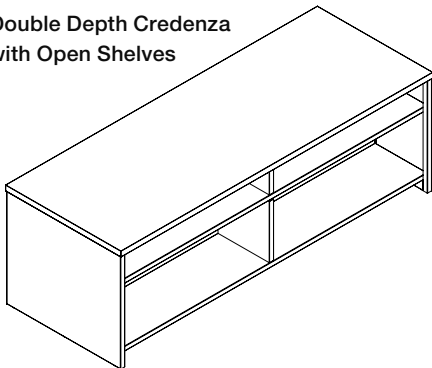

Double Depth Credenza with a Drawer

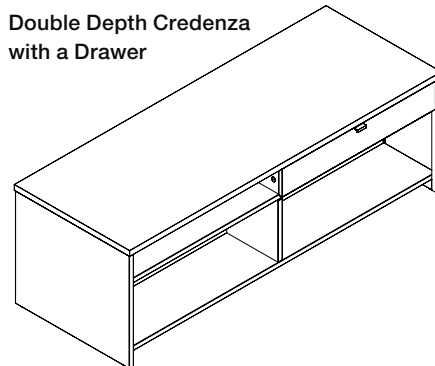

Double Depth Credenza with a Sliding Door

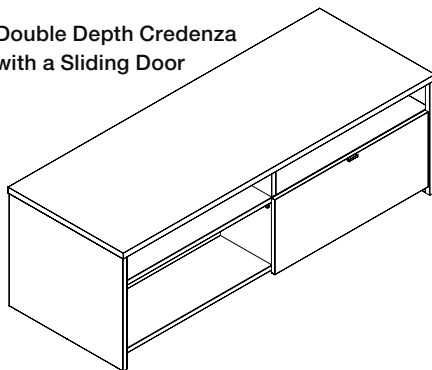

Double Depth Credenza with a Drawer and a Sliding Door

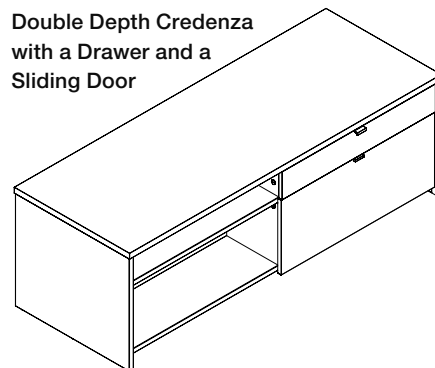



Credenzas

Double Depth with Laminate Top

With or without a Sliding Door

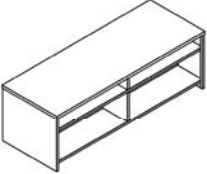
Dividends Horizon

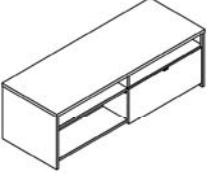
description	w	h	d	pattern no.	P1	P2	P3
 Credenza without Door	24"	24"	26 ⁵ / ₈ "	DS4LC2ANL24N	\$1,622.	\$1,780.	\$1,864.
	30"	24"	26 ⁵ / ₈ "	DS4LC2ANL30N	1,622.	1,780.	1,864.
	36"	24"	26 ⁵ / ₈ "	DS4LC2ANL36N	1,622.	1,780.	1,864.
	42"	24"	26 ⁵ / ₈ "	DS4LC2ANL42N	1,622.	1,780.	1,864.
	48"	24"	26 ⁵ / ₈ "	DS4LC2ANL48N	1,666.	1,832.	1,916.
	54"	24"	26 ⁵ / ₈ "	DS4LC2ANL54N	1,796.	1,976.	2,068.
	60"	24"	26 ⁵ / ₈ "	DS4LC2ANL60N	1,798.	1,978.	2,070.
	66"	24"	26 ⁵ / ₈ "	DS4LC2ANL66N	1,860.	2,046.	2,138.
	72"	24"	26 ⁵ / ₈ "	DS4LC2ANL72N	1,922.	2,116.	2,208.
 Credenza with Steel Sliding Door	30"	24"	26 ⁵ / ₈ "	DS4LC2BSL30L	1,884.	2,074.	2,168.
	36"	24"	26 ⁵ / ₈ "	DS4LC2BSL36L	1,884.	2,074.	2,168.
	42"	24"	26 ⁵ / ₈ "	DS4LC2BSL42L	1,884.	2,074.	2,168.
	48"	24"	26 ⁵ / ₈ "	DS4LC2BSL48L	1,932.	2,126.	2,222.
	54"	24"	26 ⁵ / ₈ "	DS4LC2BSL54L	2,098.	2,308.	2,410.
	60"	24"	26 ⁵ / ₈ "	DS4LC2BSL60L	2,100.	2,310.	2,416.
	66"	24"	26 ⁵ / ₈ "	DS4LC2BSL66L	2,168.	2,384.	2,492.
	72"	24"	26 ⁵ / ₈ "	DS4LC2BSL72L	2,228.	2,452.	2,562.
 Credenza with Laminate Sliding Door	30"	24"	26 ⁵ / ₈ "	DS4LC2BLL30L	2,626.	2,886.	3,014.
	36"	24"	26 ⁵ / ₈ "	DS4LC2BLL36L	2,626.	2,886.	3,014.
	42"	24"	26 ⁵ / ₈ "	DS4LC2BLL42L	2,626.	2,886.	3,014.
	48"	24"	26 ⁵ / ₈ "	DS4LC2BLL48L	2,710.	2,974.	3,110.
	54"	24"	26 ⁵ / ₈ "	DS4LC2BLL54L	2,792.	3,064.	3,202.
	60"	24"	26 ⁵ / ₈ "	DS4LC2BLL60L	2,874.	3,156.	3,298.
	66"	24"	26 ⁵ / ₈ "	DS4LC2BLL66L	2,956.	3,246.	3,392.
	72"	24"	26 ⁵ / ₈ "	DS4LC2BLL72L	3,038.	3,338.	3,486.

Dimensions listed under w h d are actual to the nearest 1/16"

Ordering Information	Order Code	Included with:	Options
Credenza with a Sliding Door: 1. Pattern number 2. Paint finish 3. Top finish 4. Top edge finish 5. Door finish (laminite and veneer only) 6. Door edge finish (laminite only)	Credenza with a Sliding Door: Example: DS4LC2BSL42L /117/118/117 <hr/> DS4LC2B Pattern Number LL42L <hr/> 117 Dark grey paint <hr/> 118 Bright white top <hr/> 117 Dark grey top edge	Credenza with a Sliding Door: Note: Credenzas are only available in Knoll core finishes.	Credenza with a Sliding Door: Lock/No lock option For non-locking credenzas with a sliding door or a drawer, substitute the "L" suffix with a "N" and deduct \$42 from the list price.
Credenza without a Sliding Door: 1. Pattern number 2. Paint finish 3. Top finish 4. Top edge finish	Credenza without a Sliding Door: Example: DS4LC2ANL42N /117/118/117 <hr/> DS4LC2A Pattern Number NL42N <hr/> 117 Dark grey paint <hr/> 118 Bright white top <hr/> 117 Dark grey top edge		



Credenzas
Double Depth with Laminate Top
With or without a Sliding Door

description	w	h	d	pattern no.	P1	P2	P3
 Credenza with Veneer Sliding Door	30"	24"	26 ⁵ / ₈ "	DS4LC2BVL30L	\$2,792.	\$3,064.	\$3,204.
	36"	24"	26 ⁵ / ₈ "	DS4LC2BVL36L	2,792.	3,064.	3,204.
	42"	24"	26 ⁵ / ₈ "	DS4LC2BVL42L	2,792.	3,064.	3,204.
	48"	24"	26 ⁵ / ₈ "	DS4LC2BVL48L	2,888.	3,172.	3,314.
	54"	24"	26 ⁵ / ₈ "	DS4LC2BVL54L	2,982.	3,274.	3,422.
	60"	24"	26 ⁵ / ₈ "	DS4LC2BVL60L	3,076.	3,380.	3,532.
	66"	24"	26 ⁵ / ₈ "	DS4LC2BVL66L	3,172.	3,482.	3,642.
	72"	24"	26 ⁵ / ₈ "	DS4LC2BVL72L	3,266.	3,590.	3,750.

Dimensions listed under w h d are actual to the nearest 1/16"

Ordering Information	Order Code	Included with:	Options
Credenza with a Sliding Door: 1. Pattern number 2. Paint finish 3. Top finish 4. Top edge finish 5. Door finish (laminates and veneer only) 6. Door edge finish (laminates only)	Credenza with a Sliding Door: <i>Example:</i> DS4LC2BSL42L /117/118/117 <hr/> DS4LC2B Pattern Number LL42L <hr/> 117 Dark grey paint <hr/> 118 Bright white top <hr/> 117 Dark grey top edge	Credenza with a Sliding Door: Note: Credenzas are only available in Knoll core finishes.	Credenza with a Sliding Door: Lock/No lock option For non-locking credenzas with a sliding door or a drawer, substitute the "L" suffix with a "N" and deduct \$42 from the list price.
Credenza without a Sliding Door: 1. Pattern number 2. Paint finish 3. Top finish 4. Top edge finish	Credenza without a Sliding Door: <i>Example:</i> DS4LC2ANL42N /117/118/117 <hr/> DS4LC2A Pattern Number NL42N <hr/> 117 Dark grey paint <hr/> 118 Bright white top <hr/> 117 Dark grey top edge		

*Double Depth with Laminate Top
Without a Sliding Door and with a Drawer*

description	w	h	d	pattern no.	P1	P2	P3
 <p>Credenza with Steel Drawer</p>	30"	24"	26 ⁵ / ₈ "	DS4LC2CSL30L	\$2,222.	\$2,380.	\$2,464.
	36"	24"	26 ⁵ / ₈ "	DS4LC2CSL36L	2,222.	2,380.	2,464.
	42"	24"	26 ⁵ / ₈ "	DS4LC2CSL42L	2,222.	2,380.	2,464.
	48"	24"	26 ⁵ / ₈ "	DS4LC2CSL48L	2,266.	2,432.	2,516.
	54"	24"	26 ⁵ / ₈ "	DS4LC2CSL54L	2,396.	2,576.	2,668.
	60"	24"	26 ⁵ / ₈ "	DS4LC2CSL60L	2,398.	2,578.	2,670.
	66"	24"	26 ⁵ / ₈ "	DS4LC2CSL66L	2,460.	2,646.	2,738.
	72"	24"	26 ⁵ / ₈ "	DS4LC2CSL72L	2,522.	2,716.	2,808.
 <p>Credenza with Laminate Drawer</p>	30"	24"	26 ⁵ / ₈ "	DS4LC2CLL30L	2,558.	2,716.	2,800.
	36"	24"	26 ⁵ / ₈ "	DS4LC2CLL36L	2,558.	2,716.	2,800.
	42"	24"	26 ⁵ / ₈ "	DS4LC2CLL42L	2,558.	2,716.	2,800.
	48"	24"	26 ⁵ / ₈ "	DS4LC2CLL48L	2,602.	2,768.	2,852.
	54"	24"	26 ⁵ / ₈ "	DS4LC2CLL54L	2,732.	2,912.	3,004.
	60"	24"	26 ⁵ / ₈ "	DS4LC2CLL60L	2,734.	2,914.	3,006.
	66"	24"	26 ⁵ / ₈ "	DS4LC2CLL66L	2,796.	2,982.	3,074.
	72"	24"	26 ⁵ / ₈ "	DS4LC2CLL72L	2,858.	3,052.	3,144.
 <p>Credenza with Veneer Drawer</p>	30"	24"	26 ⁵ / ₈ "	DS4LC2CVL30L	2,630.	2,788.	2,872.
	36"	24"	26 ⁵ / ₈ "	DS4LC2CVL36L	2,630.	2,788.	2,872.
	42"	24"	26 ⁵ / ₈ "	DS4LC2CVL42L	2,630.	2,788.	2,872.
	48"	24"	26 ⁵ / ₈ "	DS4LC2CVL48L	2,674.	2,840.	2,924.
	54"	24"	26 ⁵ / ₈ "	DS4LC2CVL54L	2,804.	2,984.	3,076.
	60"	24"	26 ⁵ / ₈ "	DS4LC2CVL60L	2,806.	2,986.	3,078.
	66"	24"	26 ⁵ / ₈ "	DS4LC2CVL66L	2,868.	3,054.	3,146.
	72"	24"	26 ⁵ / ₈ "	DS4LC2CVL72L	2,930.	3,124.	3,216.

Dimensions listed under w h d are actual to the nearest 1/16"

Ordering Information	Order Code	Included with:	Options
<p>Credenza with a Drawer:</p> <ol style="list-style-type: none"> 1. Pattern number 2. Paint finish 3. Top finish 4. Top edge finish 5. Drawer finish (laminated and veneer only) 6. Drawer edge finish (laminated only) 	<p>Credenza with a Drawer:</p> <p><i>Example:</i> DS4LC2CSL42L /117/118/117</p> <hr/> <p>DS4LC2C Pattern Number</p> <p>SL42L</p> <hr/> <p>117 Dark grey paint</p> <hr/> <p>118 Bright white top</p> <hr/> <p>117 Dark grey top edge</p>	<p>Credenza with a Drawer:</p> <p>Note: Credenzas are only available in Knoll core finishes.</p>	<p>Credenza with a Drawer:</p> <p>Lock/No lock option</p> <p>For non-locking credenzas with a sliding door or a drawer, substitute the "L" suffix with a "N" and deduct \$42 from the list price.</p>

*Double Depth with Laminate Top
With a Sliding Door and with a Drawer*

description	w	h	d	pattern no.	P1	P2	P3
	30"	24"	26 ⁵ / ₈ "	DS4LC2DSL30L	\$2,484.	\$2,674.	\$2,768.
	36"	24"	26 ⁵ / ₈ "	DS4LC2DSL36L	2,484.	2,674.	2,768.
	42"	24"	26 ⁵ / ₈ "	DS4LC2DSL42L	2,484.	2,674.	2,768.
	48"	24"	26 ⁵ / ₈ "	DS4LC2DSL48L	2,532.	2,726.	2,822.
	54"	24"	26 ⁵ / ₈ "	DS4LC2DSL54L	2,698.	2,908.	3,010.
	60"	24"	26 ⁵ / ₈ "	DS4LC2DSL60L	2,700.	2,910.	3,016.
	66"	24"	26 ⁵ / ₈ "	DS4LC2DSL66L	2,768.	2,984.	3,092.
	72"	24"	26 ⁵ / ₈ "	DS4LC2DSL72L	2,828.	3,052.	3,162.

	30"	24"	26 ⁵ / ₈ "	DS4LC2DLL30L	3,226.	3,486.	3,614.
	36"	24"	26 ⁵ / ₈ "	DS4LC2DLL36L	3,226.	3,486.	3,614.
	42"	24"	26 ⁵ / ₈ "	DS4LC2DLL42L	3,226.	3,486.	3,614.
	48"	24"	26 ⁵ / ₈ "	DS4LC2DLL48L	3,310.	3,574.	3,710.
	54"	24"	26 ⁵ / ₈ "	DS4LC2DLL54L	3,392.	3,664.	3,802.
	60"	24"	26 ⁵ / ₈ "	DS4LC2DLL60L	3,474.	3,756.	3,898.
	66"	24"	26 ⁵ / ₈ "	DS4LC2DLL66L	3,556.	3,846.	3,992.
	72"	24"	26 ⁵ / ₈ "	DS4LC2DLL72L	3,638.	3,938.	4,086.

	30"	24"	26 ⁵ / ₈ "	DS4LC2DVL30L	3,392.	3,664.	3,804.
	36"	24"	26 ⁵ / ₈ "	DS4LC2DVL36L	3,392.	3,664.	3,804.
	42"	24"	26 ⁵ / ₈ "	DS4LC2DVL42L	3,392.	3,664.	3,804.
	48"	24"	26 ⁵ / ₈ "	DS4LC2DVL48L	3,488.	3,772.	3,914.
	54"	24"	26 ⁵ / ₈ "	DS4LC2DVL54L	3,582.	3,874.	4,022.
	60"	24"	26 ⁵ / ₈ "	DS4LC2DVL60L	3,676.	3,980.	4,132.
	66"	24"	26 ⁵ / ₈ "	DS4LC2DVL66L	3,772.	4,082.	4,242.
	72"	24"	26 ⁵ / ₈ "	DS4LC2DVL72L	3,866.	4,190.	4,350.

Dimensions listed under w h d are actual to the nearest 1/16"



Ordering Information	Order Code	Included with:	Options
Credenza with a Sliding Door and a Drawer: 1. Pattern number 2. Paint finish 3. Top finish 4. Top edge finish 5. Drawer/Door finish (laminated and veneer only) 6. Drawer/Door edge finish (laminated only)	Credenza with a Sliding Door and a Drawer: <i>Example:</i> DS4LC2DSL42L /117/118/117 DS4LC2D Pattern Number SL42L 117 Dark grey paint 118 Bright white top 117 Dark grey top edge	Credenza with a Sliding Door and a Drawer: Note: Credenzas are only available in Knoll core finishes.	Credenza with a Sliding Door and a Drawer: Lock/No lock option For non-locking credenzas with a sliding door or a drawer, substitute the "L" suffix with a "N" and deduct \$84 from the list price.

Credenzas

Double Depth with Veneer Top

With or without a Sliding Door

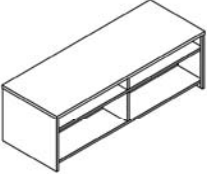
Dividends Horizon

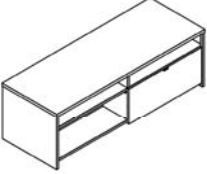
description	w	h	d	pattern no.	P1	P2	P3
 Credenza without Door	24"	24"	26 ³ / ₈ "	DS4LC2ANV24N	\$2,482.	\$2,730.	\$2,854.
	30"	24"	26 ³ / ₈ "	DS4LC2ANV30N	2,482.	2,730.	2,854.
	36"	24"	26 ³ / ₈ "	DS4LC2ANV36N	2,482.	2,730.	2,854.
	42"	24"	26 ³ / ₈ "	DS4LC2ANV42N	2,482.	2,730.	2,854.
	48"	24"	26 ³ / ₈ "	DS4LC2ANV48N	2,540.	2,796.	2,922.
	54"	24"	26 ³ / ₈ "	DS4LC2ANV54N	2,600.	2,860.	2,922.
	60"	24"	26 ³ / ₈ "	DS4LC2ANV60N	2,662.	2,926.	3,058.
	66"	24"	26 ³ / ₈ "	DS4LC2ANV66N	2,720.	2,992.	3,130.
	72"	24"	26 ³ / ₈ "	DS4LC2ANV72N	2,780.	3,056.	3,196.
 Credenza with Steel Sliding Door	30"	24"	26 ³ / ₈ "	DS4LC2BSV30L	2,618.	2,876.	3,004.
	36"	24"	26 ³ / ₈ "	DS4LC2BSV36L	2,618.	2,876.	3,004.
	42"	24"	26 ³ / ₈ "	DS4LC2BSV42L	2,618.	2,876.	3,004.
	48"	24"	26 ³ / ₈ "	DS4LC2BSV48L	2,682.	2,946.	3,076.
	54"	24"	26 ³ / ₈ "	DS4LC2BSV54L	2,746.	3,014.	3,150.
	60"	24"	26 ³ / ₈ "	DS4LC2BSV60L	2,808.	3,086.	3,224.
	66"	24"	26 ³ / ₈ "	DS4LC2BSV66L	2,872.	3,154.	3,296.
	72"	24"	26 ³ / ₈ "	DS4LC2BSV72L	2,936.	3,224.	3,370.
 Credenza with Laminate Sliding Door	30"	24"	26 ³ / ₈ "	DS4LC2BLV30L	3,180.	3,494.	3,650.
	36"	24"	26 ³ / ₈ "	DS4LC2BLV36L	3,180.	3,494.	3,650.
	42"	24"	26 ³ / ₈ "	DS4LC2BLV42L	3,180.	3,494.	3,650.
	48"	24"	26 ³ / ₈ "	DS4LC2BLV48L	3,244.	3,564.	3,724.
	54"	24"	26 ³ / ₈ "	DS4LC2BLV54L	3,310.	3,636.	3,798.
	60"	24"	26 ³ / ₈ "	DS4LC2BLV60L	3,374.	3,706.	3,874.
	66"	24"	26 ³ / ₈ "	DS4LC2BLV66L	3,436.	3,778.	3,948.
	72"	24"	26 ³ / ₁₆ "	DS4LC2BLV72L	3,502.	3,848.	4,022.

Dimensions listed under w h d are actual to the nearest 1/16"

Ordering Information	Order Code	Included with:	Options
Credenza with a Sliding Door: 1. Pattern number 2. Paint finish 3. Top finish 4. Door finish (laminated and veneer) 5. Door edge finish (laminated only)	Credenza with a Sliding Door: <i>Example:</i> DS4LC2BSV42L /117/Y319 <hr/> DS4LC2B Pattern Number SV42L <hr/> 117 Dark grey paint <hr/> Y319 Cherry Techwood top	Credenza with or without Sliding Door: Note: Credenzas are only available in Knoll core finishes.	Credenza with or without a Sliding Drawer: Lock/No lock option For non-locking credenzas with a sliding door or a drawer, substitute the "L" suffix with a "N" and deduct \$42 from the list price.
Credenza without a Sliding Door: 1. Pattern number 2. Paint finish 3. Top finish	Credenza without a Sliding Door: <i>Example:</i> DS4LC2ASV42L /117/Y319 <hr/> DS4LC2A Pattern Number SV42L <hr/> 117 Dark grey paint <hr/> Y319 Cherry Techwood top		

Storage Components



Credenzas
Double Depth with Veneer Top
With or without a Sliding Door

description	w	h	d	pattern no.	P1	P2	P3
	30"	24"	26 5/8"	DS4LC2BVV30L	\$3,346.	\$3,674.	\$3,842.
	36"	24"	26 5/8"	DS4LC2BVV36L	3,346.	3,674.	3,842.
	42"	24"	26 5/8"	DS4LC2BVV42L	3,346.	3,674.	3,842.
	48"	24"	26 5/8"	DS4LC2BVV48L	3,422.	3,762.	3,930.
	54"	24"	26 5/8"	DS4LC2BVV54L	3,500.	3,846.	4,020.
	60"	24"	26 5/8"	DS4LC2BVV60L	3,578.	3,930.	4,108.
	66"	24"	26 5/8"	DS4LC2BVV66L	3,654.	4,016.	4,198.
	72"	24"	26 5/8"	DS4LC2BVV72L	3,734.	4,100.	4,284.

Dimensions listed under w h d are actual to the nearest 1/16"

Ordering Information	Order Code	Included with:	Options
Credenza with a Sliding Door: 1. Pattern number 2. Paint finish 3. Top finish 4. Door finish (laminate and veneer) 5. Door edge finish (laminate only)	Credenza with a Sliding Door: <i>Example:</i> DS4LC2BSV42L /117/Y319 <hr/> DS4LC2B Pattern Number SV42L <hr/> 117 Dark grey paint <hr/> Y319 Cherry Techwood top	Credenza with or without Sliding Door: Note: Credenzas are only available in Knoll core finishes.	Credenza with or without a Sliding Drawer: Lock/No lock option For non-locking credenzas with a sliding door or a drawer, substitute the "L" suffix with a "N" and deduct \$42 from the list price.
Credenza without a Sliding Door: 1. Pattern number 2. Paint finish 3. Top finish	Credenza without a Sliding Door: <i>Example:</i> DS4LC2ASV42L /117/Y319 <hr/> DS4LC2A Pattern Number SV42L <hr/> 117 Dark grey paint <hr/> Y319 Cherry Techwood top		

*Double Depth with Veneer Top
Without a Sliding Door and with a Drawer*

description	w	h	d	pattern no.	P1	P2	P3
 <p>Credenza with Steel Drawer</p>	30"	24"	26 5/8"	DS4LC2CSV30L	\$3,082.	\$3,330.	\$3,454.
	36"	24"	26 5/8"	DS4LC2CSV36L	3,082.	3,330.	3,454.
	42"	24"	26 5/8"	DS4LC2CSV42L	3,082.	3,330.	3,454.
	48"	24"	26 5/8"	DS4LC2CSV48L	3,140.	3,396.	3,522.
	54"	24"	26 5/8"	DS4LC2CSV54L	3,200.	3,460.	3,592.
	60"	24"	26 5/8"	DS4LC2CSV60L	3,262.	3,526.	3,658.
	66"	24"	26 5/8"	DS4LC2CSV66L	3,320.	3,592.	3,730.
	72"	24"	26 5/8"	DS4LC2CSV72L	3,380.	3,656.	3,796.
 <p>Credenza with Laminate Drawer</p>	30"	24"	26 5/8"	DS4LC2CLV30L	3,418.	3,666.	3,790.
	36"	24"	26 5/8"	DS4LC2CLV36L	3,418.	3,666.	3,790.
	42"	24"	26 5/8"	DS4LC2CLV42L	3,418.	3,666.	3,790.
	48"	24"	26 5/8"	DS4LC2CLV48L	3,476.	3,732.	3,858.
	54"	24"	26 5/8"	DS4LC2CLV54L	3,536.	3,796.	3,928.
	60"	24"	26 5/8"	DS4LC2CLV60L	3,598.	3,862.	3,994.
	66"	24"	26 5/8"	DS4LC2CLV66L	3,656.	3,928.	4,066.
	72"	24"	26 5/8"	DS4LC2CLV72L	3,716.	3,992.	4,132.
 <p>Credenza with Veneer Drawer</p>	30"	24"	26 5/8"	DS4LC2CVV30L	3,490.	3,738.	3,862.
	36"	24"	26 5/8"	DS4LC2CVV36L	3,490.	3,738.	3,862.
	42"	24"	26 5/8"	DS4LC2CVV42L	3,490.	3,738.	3,862.
	48"	24"	26 5/8"	DS4LC2CVV48L	3,548.	3,804.	3,930.
	54"	24"	26 5/8"	DS4LC2CVV54L	3,608.	3,868.	4,000.
	60"	24"	26 5/8"	DS4LC2CVV60L	3,670.	3,934.	4,066.
	66"	24"	26 5/8"	DS4LC2CVV66L	3,728.	4,000.	4,138.
	72"	24"	26 5/8"	DS4LC2CVV72L	3,788.	4,064.	4,204.

Dimensions listed under w h d are actual to the nearest 1/16"

Ordering Information	Order Code	Included with:	Options
<p>Credenza with a Drawer:</p> <ol style="list-style-type: none"> 1. Pattern number 2. Paint finish 3. Top finish 4. Door finish (laminated and veneer only) 5. Door edge finish (laminated only) 	<p>Credenza with a Drawer:</p> <p><i>Example:</i> DS4LC2CSV42L /117/Y319</p> <hr/> <p>DS4LC2C Pattern Number SV42L</p> <hr/> <p>117 Dark grey paint Y319 Cherry Techwood top</p>	<p>Credenza with a Drawer:</p> <p>Note: Credenzas are only available in Knoll core finishes.</p>	<p>Credenza with a Drawer:</p> <p>Lock/No lock option For non-locking credenzas with a sliding door or a drawer, substitute the "L" suffix with a "N" and deduct \$42 from the list price.</p>

*Double Depth with Veneer Top
With a Sliding Door and with a Drawer*

description	w	h	d	pattern no.	P1	P2	P3
	30"	24"	26 ⁵ / ₈ "	DS4LC2DSV30L	\$3,218.	\$3,476.	\$3,604.
	36"	24"	26 ⁵ / ₈ "	DS4LC2DSV36L	3,218.	3,476.	3,604.
	42"	24"	26 ⁵ / ₈ "	DS4LC2DSV42L	3,218.	3,476.	3,604.
	48"	24"	26 ⁵ / ₈ "	DS4LC2DSV48L	3,282.	3,546.	3,676.
	54"	24"	26 ⁵ / ₈ "	DS4LC2DSV54L	3,346.	3,614.	3,750.
	60"	24"	26 ⁵ / ₈ "	DS4LC2DSV60L	3,408.	3,686.	3,824.
	66"	24"	26 ⁵ / ₈ "	DS4LC2DSV66L	3,472.	3,754.	3,896.
	72"	24"	26 ⁵ / ₈ "	DS4LC2DSV72L	3,536.	3,824.	3,970.

	30"	24"	26 ⁵ / ₈ "	DS4LC2DLV30L	3,780.	4,094.	4,250.
	36"	24"	26 ⁵ / ₈ "	DS4LC2DLV36L	3,780.	4,094.	4,250.
	42"	24"	26 ⁵ / ₈ "	DS4LC2DLV42L	3,780.	4,094.	4,250.
	48"	24"	26 ⁵ / ₈ "	DS4LC2DLV48L	3,844.	4,164.	4,324.
	54"	24"	26 ⁵ / ₈ "	DS4LC2DLV54L	3,910.	4,236.	4,398.
	60"	24"	26 ⁵ / ₈ "	DS4LC2DLV60L	3,974.	4,306.	4,474.
	66"	24"	26 ⁵ / ₈ "	DS4LC2DLV66L	4,036.	4,378.	4,548.
	72"	24"	26 ⁵ / ₈ "	DS4LC2DLV72L	4,102.	4,448.	4,622.

	30"	24"	26 ⁵ / ₈ "	DS4LC2DVV30L	3,946.	4,274.	4,442.
	36"	24"	26 ⁵ / ₈ "	DS4LC2DVV36L	3,946.	4,274.	4,442.
	42"	24"	26 ⁵ / ₈ "	DS4LC2DVV42L	3,946.	4,274.	4,442.
	48"	24"	26 ⁵ / ₈ "	DS4LC2DVV48L	4,022.	4,362.	4,530.
	54"	24"	26 ⁵ / ₈ "	DS4LC2DVV54L	4,100.	4,446.	4,620.
	60"	24"	26 ⁵ / ₈ "	DS4LC2DVV60L	4,178.	4,530.	4,708.
	66"	24"	26 ⁵ / ₈ "	DS4LC2DVV66L	4,254.	4,616.	4,798.
	72"	24"	26 ⁵ / ₈ "	DS4LC2DVV72L	4,334.	4,700.	4,884.

Dimensions listed under w h d are actual to the nearest 1/16"

Ordering Information	Order Code	Included with:	Options
Credenza with a Sliding Door and a Drawer: 1. Pattern number 2. Paint finish 3. Top finish 4. Drawer/Door finish (laminated and veneer only) 5. Drawer/Door edge finish (laminated only)	Credenza with a Sliding Door and a Drawer: <i>Example:</i> DS4LC2SV42L /117/Y319 DS4LC2D Pattern Number SV42L 117 Dark grey paint Y319 Cherry Techwood top	Credenza with a Sliding Door and a Drawer: Note: Credenzas are only available in Knoll core finishes.	Credenza with a Sliding Door and a Drawer: Lock/No lock option For non-locking credenzas with a sliding door or a drawer, substitute the "L" suffix with a "N" and deduct \$84 from the list price.

This page intentionally left blank

Flip-up Door Overdesk Units

Series 1 and Series 2 freestanding flip-up door overdesk units mount atop freestanding desks to provide overhead storage.

Pass-through communications or visual privacy can be obtained with a removeable privacy screen. When installed on freestanding desks, overdesks match up to 64" high panels to provide a consistent height within the facility.

Flip-up door overdesk units consist of an overhead cabinet with or without lock and enclosed back along with desk-mount stanchions. Tackable privacy screens are optional and mount between the stanchions. Overdesks 30" to 48" wide have single overhead doors while units 60" and 72" wide have double doors.

Available Sizes

- Height: 37 $\frac{1}{2}$ "
- Depth: 13 $\frac{1}{2}$ "
- Widths: 36", 42", 48", 54", 60", 66" and 72"

Flip-up Door Overdesk Attachment

Flip-up door overdesks can be mounted to both single and double pedestal desks. The stanchion design provides attachment directly through the top of the worksurface. In addition, overdesks can be attached virtually anywhere along the worksurface provided that proper floorstanding worksurface support is used.

NOTE: ATTACHMENT REQUIRES DRILLING TOP OF WORKSURFACES.

Construction

- Outer cabinet: 20-gauge steel
- Cabinet top and lower shelf: 18-gauge for 36", 42" and 48" widths and 16-gauge for 60" and 72" widths
- Overhead doors: 20-gauge painted steel
- Door end trim: Color injected, molded plastic
- Overhead door suspension: Steel ball-bearing
- Outer stanchions: 14-gauge steel
- Inner stanchions: 20-gauge steel

Wire Management

Vertical wire management channels for task light wires are located inside stanchions and are concealed by the inner stanchion.

Locks

Locks are standard on overdesks and keyed randomly unless otherwise specified. Other keying options include keyed alike or keyed with lock cores (K001-K250). All locks are factory-installed and are black finish. Overdesks can also be specified without locks if required.

Optional lock retrofit kits are available for field installation in flip-up door overdesks without locks at a later date if required.

Tackable Privacy Screen

Flip-up door overdesk privacy screen provides visual privacy and a tackable surface. Privacy screens mount between flip-up door overdesk stanchions and are available in all overdesk widths.

Privacy screen construction is similar to the fabric insert used on Dividends panel frames. Two fabric wrapped inserts sandwich a honeycomb core providing both tackable and acoustic features.

Note: Tackable privacy screens are for use with Series 1 and Series 2 flip-up door overdesks only. They are not compatible with sliding door overdesks.

“Touchdown” Overhead Cabinets

Touchdown overhead cabinets are equipped with hydraulic assist cylinders that allows the overhead cabinet front to gently fall to a closed position.

Retrofit mechanisms may be field added to any flip-up door overdesk.

Task Lights

Series 1 and 2 flip-up door overdesks will accept task lights. Task lights must be ordered separately.

Flip-Up Door Overdesk Applications

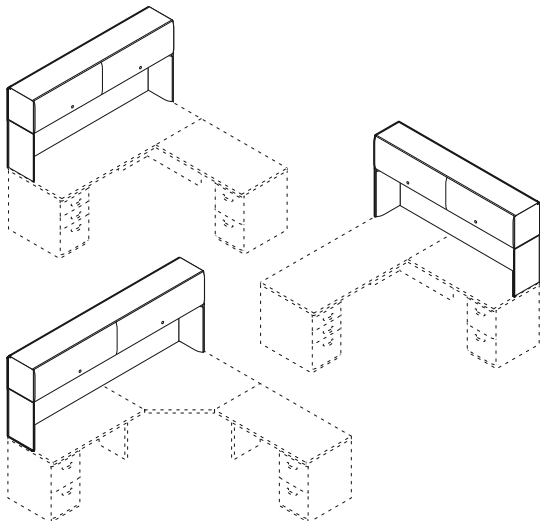

Overdesk units can span a single worksurface or two worksurfaces in “L” configuration.

Flip-Up Door Overdesk Unit Components

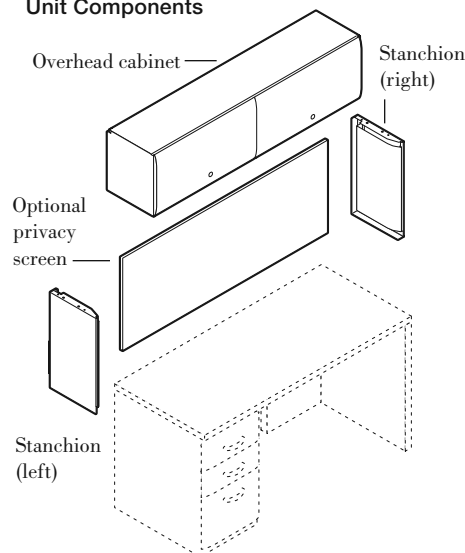

Flip-Up Door Overdesk Size Configurations

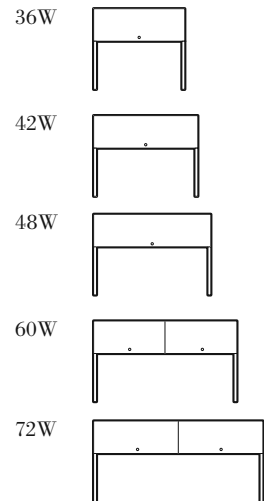

Flip-up Door Overdesk and Tackboards

Dividends and Series 2

Dividends Horizon

description	w	d	h	pattern no.	black	P1	P2	P3	V1-P1	V1-P2	V1-P3
Flip-Up Door Overdesk with Enclosed Back and Lock (includes Stanchions)	36"	13 1/2"	15"	DD2OD 36L	n/a	\$711.	\$787.	\$824.	n/a	n/a	n/a
	42"	13 1/2"	15"	DD2OD 42L	n/a	749.	826.	866.	n/a	n/a	n/a
	48"	13 1/2"	15"	DD2OD 48L	n/a	772.	852.	894.	n/a	n/a	n/a
	54"	13 1/2"	15"	DD2OD 54L	n/a	942.	1,036.	1,089.	n/a	n/a	n/a
	60"	13 1/2"	15"	DD2OD 60L	n/a	942.	1,036.	1,089.	n/a	n/a	n/a
	66"	13 1/2"	15"	DD2OD 66L	n/a	967.	1,064.	1,118.	n/a	n/a	n/a
	72"	13 1/2"	15"	DD2OD 72L	n/a	967.	1,064.	1,118.	n/a	n/a	n/a

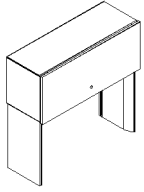

Series 2 Flip-Up Door Overdesk with Enclosed Back and Lock (includes Stanchions)	36"	13 1/2"	15"	DS2OD 36L	n/a	1,009.	1,160.	1,212.	1,231.	1,385.	1,434.
	42"	13 1/2"	15"	DS2OD 42L	n/a	1,029.	1,183.	1,235.	1,265.	1,418.	1,471.
	48"	13 1/2"	15"	DS2OD 48L	n/a	1,043.	1,198.	1,249.	1,310.	1,469.	1,517.
	54"	13 1/2"	15"	DS2OD 54L	n/a	1,270.	1,460.	1,526.	1,683.	1,875.	1,937.
	60"	13 1/2"	15"	DS2OD 60L	n/a	1,270.	1,460.	1,526.	1,683.	1,875.	1,937.
	66"	13 1/2"	15"	DS2OD 66L	n/a	1,310.	1,508.	1,572.	1,741.	1,939.	2,003.
	72"	13 1/2"	15"	DS2OD 72L	n/a	1,310.	1,508.	1,572.	1,741.	1,939.	2,003.

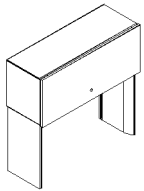

Vertical Dividers Package of 4				DS1 VD	88.	92.	97.	101.			
-----------------------------------	--	--	--	---------------	-----	-----	-----	------	--	--	--



Ordering Information	Order Code	Included with:	Options
Overdesk Cabinet 1. Pattern Number 2. Paint Finish 3. Door End Cap Finish	Overdesk Cabinet <i>Example:</i> DD2OD 48L, 613, 113 DD2OD Pattern Number 48L <hr/> 613 Silver paint finish <hr/> 113 Dark grey door end cap finish	Overdesk Cabinet Stanchion mount overdesk cabinets include an enclosed back.	Overdesk Cabinet To specify overhead cabinet without locks, replace the "L" suffix from the pattern number with "N". For 30" to 48" wide overdesk units, Deduct \$20 For 54", 60", 66" and 72" wide overdesk units, Deduct \$40 To specify Touchdown overhead cabinet, add "E" as the 2nd to last digit of the pattern number <i>Example:</i> DS3PML48EL (Add \$150 for cabinet widths of 48" or less. Add \$300 for cabinet widths of 54" or greater). Add a "Y" to the end of the pattern number to specify a different finish for the door versus the case. Use P3 pricing for this dual finish option.

Flip-up Door Overdesk and Tackboards

Dividends and Series 2 Tackboard

Dividends Horizon

description	w	d	h	pattern no.	grade							
					10	15	20	25	30	35	40	45
Flip-Up Door Overdesk	36"	18"	20"	DD3 PS36	\$254.	\$261.	\$275.	\$279.	\$286.	\$291.	\$297.	\$304.
Tackable Privacy Screen	42"	24"	20"	DD3 PS42	265.	275.	287.	292.	301.	306.	310.	319.
(for Dividends and Series 2 Overdesks)	48"	30"	20"	DD3 PS48	276.	284.	297.	303.	310.	317.	322.	330.
	54"	36"	20"	DD3 PS54	296.	304.	319.	325.	333.	338.	346.	353.
	60"	42"	20"	DD3 PS60	296.	304.	319.	325.	333.	338.	346.	353.
	66"	42"	20"	DD3 PS66	319.	327.	344.	349.	359.	365.	374.	381.
	72"	48"	20"	DD3 PS72	319.	327.	344.	349.	359.	365.	374.	381.

Ordering Information

Overdesk Tackable Privacy Screen

1. Pattern Number
2. Fabric

Order Code

Overdesk Tackable Privacy Screen

Example: **DD3 PS48, W351-3**

DD3 PS48 Pattern Number

W351-3 Foundation Corn Silk

Included with:

Overdesk Tackable Privacy Screen

Options

Note: Flip-up Door overdesk tackable privacy screen is for use with Dividends and Series 2 Flip-up door overheads.

This page intentionally left blank

Sliding Door Overdesks

The rectilinear door profile of the sliding door overdesk was designed to complement the flat profile trim details of the Dividends Horizon system. Sliding door overdesks can be used in paneled workstation configurations or freestanding office applications.

Sliding door overdesks mount atop worksurfaces to provide overhead storage. When installed on a worksurface, sliding door overdesks match up to 57" and 64" high panels to provide a consistent height within the facility. 14" or 21" high sliding door overdesks consist of a top, shelf, mid cabinet septum, end panels/stanchions, and a door with a handle.

14" high cabinets and 21" high cabinets with full doors are standard with fully enclosed backs. No door units and 21" high cabinets with partial doors have a partial or full back option available. Partial backs cover the upper section of the cabinet. Full backs enclose both the upper and lower section of the cabinet.

21" high cabinets are able to be specified with a full or partial door. A partial door covers the upper section of the cabinet. A full door covers both the upper and lower section of the cabinet.

Available Sizes

- Height: 14" and 21"
- Depth: 13-1/2"
- Widths: 30", 36", 42", 48", 60", 66", and 72"

Sliding Door Overdesks

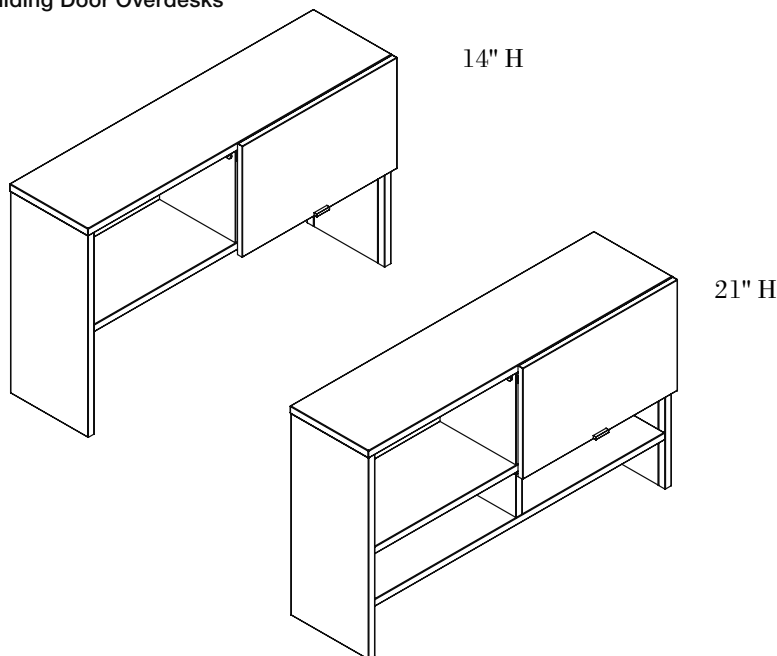

Construction

- **Horizontal top and shelf:** 18-gauge (30" to 48" wide), 16-gauge (60" to 72" wide) painted steel
- **Sliding door:**
 - Steel: 20-gauge painted steel
 - Laminate: 3/4" particle board with high pressure laminate on the outside and a paper backer on the inside. 1mm edgeband.
 - Veneer: 3/4" thick particle board with 0.6mm thick veneer on top and edge.
- **End panels/stanchions:** 16-gauge painted steel
- **Sliding door mechanism:** integral track in top and bottom shelves with full length abs plastic extrusion. Door brackets are injection molded nylon.
- **Fixed Shelf:** 16-gauge painted steel
- **Door handle:** painted aluminum (same color as case)
- **Back panel:** 20-gauge painted steel

Interior Dimensions

The interior dimensions of sliding door overdesks are:

- Depth: 12 1/4"
- Usable interior height: 12-1/2" high for 14"H cabinets and upper portion of 21"H cabinets; 6-1/8"H for lower portion of 21"H cabinets.
- Width: 1" shorter than exterior width

Overdesk Attachment

Overdesks can be mounted to both single and double pedestal desks as well as panel hung worksurfaces. The stanchion design provides attachment directly through the top of the worksurface. In addition, overdesks can be attached virtually anywhere along the worksurface provided that proper worksurface support is used.

Dividends Horizon Series 3 Overdesk units are sized to the nominal dimension, and are designed for use on the width dimension of Dividends Horizon rectangular worksurfaces.

Series 3 overheads are not compatible with use on extended corner worksurfaces, or a combination of other worksurfaces that are less than the nominal dimension.

NOTE: ATTACHMENT REQUIRES DRILLING TOP OF WORKSURFACES.

Task Lights

Sliding door overdesks will accept task lights. Task lights must be ordered separately.

Locks

Locks are standard on overhead cabinets and keyed randomly unless otherwise specified. All locks are factory-installed and are a black finish. Overdesks can also be specified without locks if required.

Note: Sliding door overdesks are only available in Knoll Core finishes.

Interior Dimensions for 14"H Overhead

Front View, Interior Height

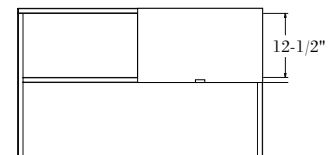

Top View, Interior Height

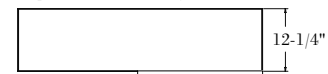

Interior Dimensions for 21"H Overhead

Front View, Interior Height

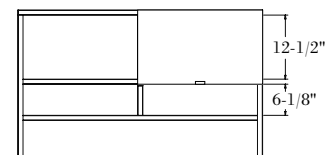

Top View, Interior Height

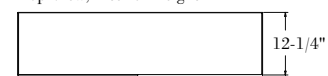

Sliding Door Overdesks

57" High Cabinet with 14" High Storage, 14" High Door

Dividends Horizon

description	w	pattern no.	P1	P2	P3
57" h Overdesk without Door with 14" Tall Cabinet	30"	DS3ODNS1573014	\$847.	\$932.	\$972.
	36"	DS3ODNS1573614	863.	950.	992.
	42"	DS3ODNS1574214	880.	967.	1,012.
	48"	DS3ODNS1574814	911.	1,000.	1,047.
	60"	DS3ODNS1576014	988.	1,087.	1,136.
	66"	DS3ODNS1576614	1,012.	1,114.	1,164.
	72"	DS3ODNS1577214	1,027.	1,130.	1,180.

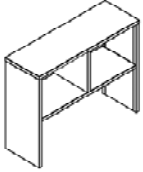

57" h Overdesk with Steel Sliding Door and 14" Tall Cabinet	30"	DS3ODSS1573014L	915.	1,005.	1,049.
	36"	DS3ODSS1573614L	936.	1,027.	1,073.
	42"	DS3ODSS1574214L	957.	1,050.	1,097.
	48"	DS3ODSS1574814L	987.	1,084.	1,132.
	60"	DS3ODSS1576014L	1,080.	1,187.	1,240.
	66"	DS3ODSS1576614L	1,107.	1,216.	1,271.
	72"	DS3ODSS1577214L	1,122.	1,232.	1,286.

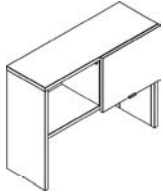

57" h Overdesk with Laminate Sliding Door and 14" Tall Cabinet	30"	DS3ODSL1573014L	1,209.	1,327.	1,387.
	36"	DS3ODSL1573614L	1,241.	1,363.	1,424.
	42"	DS3ODSL1574214L	1,272.	1,398.	1,460.
	48"	DS3ODSL1574814L	1,305.	1,432.	1,497.
	60"	DS3ODSL1576014L	1,337.	1,469.	1,533.
	66"	DS3ODSL1576614L	1,368.	1,503.	1,571.
	72"	DS3ODSL1577214L	1,400.	1,538.	1,608.

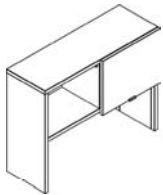

57" h Overdesk with Veneer Sliding Door and 14" Tall Cabinet	30"	DS3ODSV1573014L	1,273.	1,399.	1,461.
	36"	DS3ODSV1573614L	1,311.	1,440.	1,504.
	42"	DS3ODSV1574214L	1,349.	1,481.	1,548.
	48"	DS3ODSV1574814L	1,386.	1,522.	1,591.
	60"	DS3ODSV1576014L	1,424.	1,565.	1,634.
	66"	DS3ODSV1576614L	1,461.	1,605.	1,678.
	72"	DS3ODSV1577214L	1,499.	1,646.	1,720.

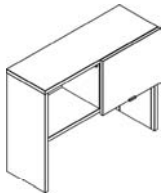

Ordering Information

Sliding Door Overdesk

1. Pattern number
2. Case finish
3. Door finish

Order Code

Sliding Door Overdesk

Example: **DS3ODSS 1573014FL, 613**

DS3ODSS Pattern Number
1573014FL

613 Silver Paint Finish

Included with:

Sliding Door Overdesk

Note: Overheads are only available in Knoll core finishes.

No lock - substitute "N" for "L" at the end of pattern number, subtract \$21.

Sliding Door Overdesks

Dividends Horizon

57" High Cabinet with 21" High Storage (Full Height Door)

description	w	pattern no.	P1	P2	P3
57" h without Sliding Door Overdesk with 21" Tall Cabinet	30"	DS3ODNS()573021	\$912.	\$1,004.	\$1,049.
	36"	DS3ODNS()573621	934.	1,027.	1,074.
	42"	DS3ODNS()574221	956.	1,051.	1,098.
	48"	DS3ODNS()574821	992.	1,093.	1,143.
	60"	DS3ODNS()576021	1,086.	1,195.	1,250.
	66"	DS3ODNS()576621	1,115.	1,227.	1,282.
	72"	DS3ODNS()577221	1,133.	1,246.	1,304.

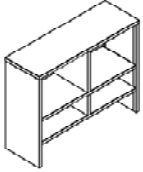

57" h Steel Sliding Door Overdesk with 21" Tall Cabinet	30"	DS3ODSS2573021FL	1,042.	1,145.	1,195.
	36"	DS3ODSS2573621FL	1,062.	1,167.	1,218.
	42"	DS3ODSS2574221FL	1,093.	1,199.	1,253.
	48"	DS3ODSS2574821FL	1,152.	1,265.	1,321.
	60"	DS3ODSS2576021FL	1,266.	1,390.	1,453.
	66"	DS3ODSS2576621FL	1,307.	1,434.	1,500.
	72"	DS3ODSS2577221FL	1,335.	1,464.	1,530.

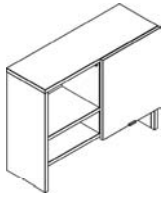

57" h Laminate Sliding Door Overdesk with 21" Tall Cabinet	30"	DS3ODSL2573021FL	1,366.	1,500.	1,568.
	36"	DS3ODSL2573621FL	1,412.	1,552.	1,621.
	42"	DS3ODSL2574221FL	1,459.	1,602.	1,674.
	48"	DS3ODSL2574821FL	1,504.	1,654.	1,727.
	60"	DS3ODSL2576021FL	1,551.	1,704.	1,781.
	66"	DS3ODSL2576621FL	1,597.	1,756.	1,833.
	72"	DS3ODSL2577221FL	1,643.	1,806.	1,888.



57" h Veneer Sliding Door Overdesk with 21" Tall Cabinet	30"	DS3ODSV2573021FL	1,436.	1,577.	1,648.
	36"	DS3ODSV2573621FL	1,492.	1,639.	1,713.
	42"	DS3ODSV2574221FL	1,549.	1,702.	1,778.
	48"	DS3ODSV2574821FL	1,604.	1,763.	1,842.
	60"	DS3ODSV2576021FL	1,662.	1,825.	1,907.
	66"	DS3ODSV2576621FL	1,717.	1,888.	1,972.
	72"	DS3ODSV2577221FL	1,774.	1,949.	2,037.

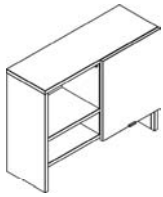

Ordering Information

Sliding Door Overdesk

1. Pattern number
2. Case finish
3. Door finish

Order Code

Sliding Door Overdesk

Example: **DS3ODSS 2573021FL, 613**

DS3ODSS Pattern Number
2573021FL

613 Silver Paint Finish

Included with:

Sliding Door Overdesk

Note: Overheads are only available in Knoll core finishes.

Options

No lock - substitute "N" for "L" at the end of pattern number, subtract \$21.

Back option for No Door units
(1)= Back covering overhead only
(2)= Back covering overhead and shelf section

Sliding Door Overdesks 57" High Cabinet with 21" High Storage (Partial Height Door)

Dividends Horizon

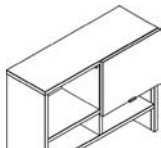
description	w	pattern no.	P1	P2	P3
 57" h Steel Sliding Door Overdesk with 21" Tall Cabinet	30"	DS3ODSS()573021PL	\$1,042.	\$1,145.	\$1,195.
	36"	DS3ODSS()573621PL	1,062.	1,167.	1,218.
	42"	DS3ODSS()574221PL	1,093.	1,199.	1,253.
	48"	DS3ODSS()574821PL	1,152.	1,265.	1,321.
	60"	DS3ODSS()576021PL	1,266.	1,390.	1,453.
	66"	DS3ODSS()576621PL	1,307.	1,434.	1,500.
	72"	DS3ODSS()577221PL	1,335.	1,464.	1,530.

 57" h Laminate Sliding Door Overdesk with 21" Tall Cabinet	30"	DS3ODSL()573021PL	1,358.	1,492.	1,558.
	36"	DS3ODSL()573621PL	1,404.	1,543.	1,611.
	42"	DS3ODSL()574221PL	1,450.	1,592.	1,664.
	48"	DS3ODSL()574821PL	1,495.	1,642.	1,716.
	60"	DS3ODSL()576021PL	1,542.	1,693.	1,769.
	66"	DS3ODSL()576621PL	1,587.	1,743.	1,822.
	72"	DS3ODSL()577221PL	1,633.	1,794.	1,875.

 57" h Veneer Sliding Door Overdesk with 21" Tall Cabinet	30"	DS3ODSV()573021PL	1,425.	1,566.	1,635.
	36"	DS3ODSV()573621PL	1,476.	1,621.	1,694.
	42"	DS3ODSV()574221PL	1,527.	1,679.	1,754.
	48"	DS3ODSV()574821PL	1,579.	1,735.	1,813.
	60"	DS3ODSV()576021PL	1,631.	1,791.	1,873.
	66"	DS3ODSV()576621PL	1,683.	1,848.	1,931.
	72"	DS3ODSV()577221PL	1,733.	1,905.	1,991.

Storage Components

Ordering Information

Sliding Door Overdesk

1. Pattern number
2. Case finish
3. Door finish

Order Code

Sliding Door Overdesk

Example: **DS3ODSS 2573021PL, 613**

DS3ODSS Pattern Number
2573021PL

613 Silver Paint Finish

Included with:

Sliding Door Overdesk

Note: Overheads are only available in Knoll core finishes.

Options

No lock - substitute "N" for "L" at the end of pattern number, subtract \$21.

Back option

(1) = Back covering overhead only
(2) = Back covering overhead and shelf section

Sliding Door Overdesks 64" High Cabinet with 14" High Storage

Dividends Horizon

description	w	pattern no.	P1	P2	P3
64"h without Sliding Door Overdesk with 14" Tall Cabinet	30"	DS3ODNS1643014	\$877.	\$963.	\$1,006.
	36"	DS3ODNS1643614	885.	971.	1,015.
	42"	DS3ODNS1644214	912.	1,000.	1,045.
	48"	DS3ODNS1644814	991.	1,088.	1,136.
	60"	DS3ODNS1646014	1,021.	1,121.	1,171.
	66"	DS3ODNS1646614	1,045.	1,147.	1,198.
	72"	DS3ODNS1647214	1,059.	1,162.	1,213.



64"h Steel Sliding Door Overdesk with 14" Tall Cabinet	30"	DS3ODSS1643014L	924.	1,014.	1,059.
	36"	DS3ODSS1643614L	944.	1,037.	1,082.
	42"	DS3ODSS1644214L	965.	1,059.	1,105.
	48"	DS3ODSS1644814L	995.	1,094.	1,143.
	60"	DS3ODSS1646014L	1,089.	1,196.	1,250.
	66"	DS3ODSS1646614L	1,118.	1,227.	1,282.
	72"	DS3ODSS1647214L	1,130.	1,241.	1,295.

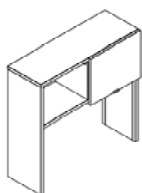

64"h Laminate Sliding Door Overdesk with 14" Tall Cabinet	30"	DS3ODSL1643014L	1,218.	1,338.	1,398.
	36"	DS3ODSL1643614L	1,251.	1,374.	1,434.
	42"	DS3ODSL1644214L	1,284.	1,409.	1,473.
	48"	DS3ODSL1644814L	1,315.	1,446.	1,510.
	60"	DS3ODSL1646014L	1,349.	1,481.	1,548.
	66"	DS3ODSL1646614L	1,381.	1,517.	1,586.
	72"	DS3ODSL1647214L	1,413.	1,553.	1,622.

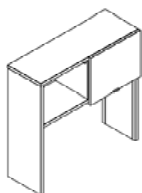

Ordering Information

Sliding Door Overdesk

1. Pattern number
2. Case finish
3. Door finish

Order Code

Sliding Door Overdesk

Example: **DS3ODSS 2643014FL,**
613

DS3ODSS Pattern Number
2643014FL

613 Silver Paint Finish

Included with:

Sliding Door Overdesk

Note: Overheads are only available
in Knoll core finishes.

Options

No lock - substitute "N" for "L" at
the end of pattern number, subtract
\$21.

Sliding Door Overdesks 64" High Cabinet with 14" High Storage

Dividends Horizon

description	w	pattern no.	P1	P2	P3
64" h Veneer Sliding Door Overdesk with 14" Tall Cabinet	30"	DS3ODSV1643014L	\$1,284.	\$1,410.	\$1,474.
	36"	DS3ODSV1643614L	1,321.	1,453.	1,517.
	42"	DS3ODSV1644214L	1,361.	1,495.	1,562.
	48"	DS3ODSV1644814L	1,399.	1,536.	1,605.
	60"	DS3ODSV1646014L	1,438.	1,578.	1,650.
	66"	DS3ODSV1646614L	1,476.	1,620.	1,694.
	72"	DS3ODSV1647214L	1,514.	1,662.	1,738.

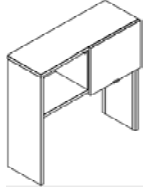

Ordering Information

Sliding Door Overdesk

1. Pattern number
2. Case finish
3. Door finish

Order Code

Sliding Door Overdesk

Example: **DS3ODSS 2643014FL,**
613

DS3ODSS Pattern Number
2643014FL

613 Silver Paint Finish

Included with:

Sliding Door Overdesk

Note: Overheads are only available
in Knoll core finishes.

Options

No lock - substitute "N" for "L" at
the end of pattern number, subtract
\$21.

Sliding Door Overdesks 64" High Cabinet with 21" High Storage (Full Height Door)

Dividends Horizon

description	w	pattern no.	P1	P2	P3
64"h without Sliding Door Overdesk with 21" Tall Cabinet	30"	DS3ODNS()643021	\$932.	\$1,025.	\$1,071.
	36"	DS3ODNS()643621	947.	1,042.	1,089.
	42"	DS3ODNS()644221	971.	1,070.	1,119.
	48"	DS3ODNS()644821	1,034.	1,136.	1,188.
	60"	DS3ODNS()646021	1,134.	1,247.	1,305.
	66"	DS3ODNS()646621	1,171.	1,287.	1,346.
	72"	DS3ODNS()647221	1,197.	1,317.	1,377.



64"h Steel Sliding Door Overdesk with 21" Tall Cabinet	30"	DS3ODSS2643021FL	1,049.	1,151.	1,202.
	36"	DS3ODSS2643621FL	1,070.	1,174.	1,227.
	42"	DS3ODSS2644221FL	1,099.	1,206.	1,261.
	48"	DS3ODSS2644821FL	1,158.	1,272.	1,330.
	60"	DS3ODSS2646021FL	1,272.	1,398.	1,460.
	66"	DS3ODSS2646621FL	1,313.	1,444.	1,507.
	72"	DS3ODSS2647221FL	1,341.	1,473.	1,538.

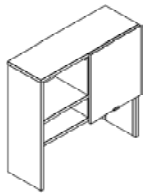

64"h Laminate Sliding Door Overdesk with 21" Tall Cabinet	30"	DS3ODSL2643021FL	1,379.	1,515.	1,583.
	36"	DS3ODSL2643621FL	1,425.	1,566.	1,635.
	42"	DS3ODSL2644221FL	1,472.	1,616.	1,689.
	48"	DS3ODSL2644821FL	1,517.	1,667.	1,741.
	60"	DS3ODSL2646021FL	1,564.	1,718.	1,796.
	66"	DS3ODSL2646621FL	1,610.	1,769.	1,848.
	72"	DS3ODSL2647221FL	1,657.	1,820.	1,902.

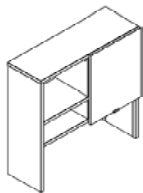

Ordering Information

Sliding Door Overdesk

1. Pattern number
2. Case finish
3. Door finish

Order Code

Sliding Door Overdesk

Example: **DS3ODSS 2643021FL,**
613

DS3ODSS Pattern Number
2643021FL

613 Silver Paint Finish

Included with:

Sliding Door Overdesk

Note: Overheads are only available in Knoll core finishes.

Options

No lock - substitute "N" for "L" at the end of pattern number, subtract \$21.

Back option for No Door units
(1)= Back covering overhead only
(2)= Back covering overhead and shelf section

Sliding Door Overdesks

64" High Cabinet with 21" High Storage (Full Height Door)

Dividends Horizon

description	w	pattern no.	P1	P2	P3
64"h Veneer Sliding Door	30"	DS3ODSV2643021FL	\$1,449.	\$1,591.	\$1,663.
Overdesk with 21" Tall Cabinet	36"	DS3ODSV2643621FL	1,504.	1,654.	1,727.
	42"	DS3ODSV2644221FL	1,562.	1,715.	1,792.
	48"	DS3ODSV2644821FL	1,617.	1,778.	1,856.
	60"	DS3ODSV2646021FL	1,674.	1,838.	1,922.
	66"	DS3ODSV2646621FL	1,730.	1,901.	1,987.
	72"	DS3ODSV2647221FL	1,786.	1,963.	2,050.

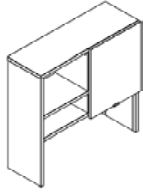

Ordering Information

Sliding Door Overdesk

1. Pattern number
2. Case finish
3. Door finish

Order Code

Sliding Door Overdesk

Example: **DS3ODSS 2643021FL,**
613

DS3ODSS Pattern Number
2643021FL

613 Silver Paint Finish

Included with:

Sliding Door Overdesk

Note: Overheads are only available in Knoll core finishes.

Options

No lock - substitute "N" for "L" at the end of pattern number, subtract \$21.

Back option for No Door units
(1)= Back covering overhead only
(2) = Back covering overhead and shelf section

Sliding Door Overdesks 64" High Cabinet with 21" High Storage (Partial Height Door)

Dividends Horizon

description	w	pattern no.	P1	P2	P3
64"h Steel Sliding Door Overdesk with 21" Tall Cabinet	30"	DS3ODSS()643021PL	\$1,049.	\$1,151.	\$1,202.
	36"	DS3ODSS()643621PL	1,070.	1,174.	1,227.
	42"	DS3ODSS()644221PL	1,099.	1,206.	1,261.
	48"	DS3ODSS()644821PL	1,158.	1,272.	1,330.
	60"	DS3ODSS()646021PL	1,272.	1,398.	1,460.
	66"	DS3ODSS()646621PL	1,313.	1,444.	1,507.
	72"	DS3ODSS()647221PL	1,341.	1,473.	1,538.

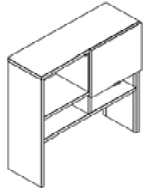

64"h Laminate Sliding Door Overdesk with 21" Tall Cabinet	30"	DS3ODSL()643021PL	1,370.	1,505.	1,573.
	36"	DS3ODSL()643621PL	1,416.	1,556.	1,625.
	42"	DS3ODSL()644221PL	1,462.	1,607.	1,679.
	48"	DS3ODSL()644821PL	1,507.	1,657.	1,731.
	60"	DS3ODSL()646021PL	1,554.	1,707.	1,784.
	66"	DS3ODSL()646621PL	1,599.	1,758.	1,836.
	72"	DS3ODSL()647221PL	1,645.	1,808.	1,890.

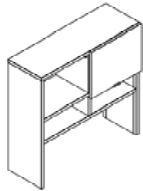

64"h Veneer Sliding Door Overdesk with 21" Tall Cabinet	30"	DS3ODSV()643021PL	1,438.	1,579.	1,650.
	36"	DS3ODSV()643621PL	1,488.	1,636.	1,709.
	42"	DS3ODSV()644221PL	1,540.	1,692.	1,768.
	48"	DS3ODSV()644821PL	1,592.	1,749.	1,827.
	60"	DS3ODSV()646021PL	1,643.	1,806.	1,886.
	66"	DS3ODSV()646621PL	1,695.	1,862.	1,946.
	72"	DS3ODSV()647221PL	1,745.	1,919.	2,006.

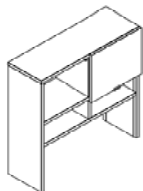

Ordering Information

Sliding Door Overdesk

1. Pattern number
2. Case finish
3. Door finish

Order Code

Sliding Door Overdesk

Example: DS3ODSS 2643021PL,
613

DS3ODSS Pattern Number
2643021PL

613 Silver Paint Finish

Included with:

Sliding Door Overdesk

Note: Overheads are only available
in Knoll core finishes.

Options

No lock - substitute "N" for "L" at
the end of pattern number, subtract
\$21.

Back option

(1)= Back covering overhead only
(2)= Back covering overhead and
shelf section

This page intentionally left blank

Available Worksurface Styles

- Rectangular
- Rectilinear corner
- Split top corner
- Curvilinear corner
- Trapezoid
- Smooth wave
- Curvilinear wave end
- Half-round
- Quarter-round
- Blended "D" shape
- "D" shape peninsula
- "P" and "G" shape peninsula
- Counter Worksurfaces
- Transition

Universal Applications

The undersides of worksurfaces are pre-drilled to accept various panel-hung and freestanding supports.

All supports must be ordered separately.

In panel-hung applications, worksurfaces are supported by:

- Cantilevers
- Pedestals
- Panel-to-worksurface brackets
- Flat brackets
- Panel-mounted C-leg support
- Open support legs

In peninsula applications, worksurfaces are supported by panels on one end and the other end is supported by:

- Support column
- A leg
- T support base

For freestanding applications, worksurface support is provided by:

- Pedestals
- End units
- Flat brackets

Construction

Laminate

- Surface material: .028 high-pressure laminate on top surface with a paper backer on under side
- Edge material: 2mm PVC on straight and curved surfaces
- Core material: 45 lb. density particle board
- Thickness: 1 1/4"

Techwood

- Surface material: 0.6mm veneer
- Edge material: 0.6mm veneer on straight and curved surfaces
- Core material: 45 lb. density particle board
- Thickness: 1 1/4"

For available sizes, refer to the individual worksurface categories within this section.

Optional Edge Grommets

Edge grommets are optional and can be specified factory-installed centered along the

rear edge of rectangular, rectilinear corner, curvilinear wave end, and curvilinear corner worksurfaces. Grommets can also be retrofitted to worksurfaces by ordering an edge grommet kit (pattern number D1WSG). The edge grommet kit allows grommets to be field-installed in any location along the rear edge of worksurfaces.

Note: Edge grommets on 'D', 'G', and 'P' peninsula worksurfaces are located on the panel hung side.

Cable Management

A 1/2" reveal is provided between the worksurface and panel for cable management. When edge grommets are specified, the grommet works in conjunction with the 1/2" reveal to allow plugs to be inserted through the grommet and cables to be positioned anywhere along the rear edge of the worksurface.

Loading Capacities

Maximum weight allowed for worksurfaces:

- 24"-42" wide: 200 lbs.
- 48" wide: 216 lbs.
- 54" wide: 243 lbs.
- 60" wide: 270 lbs.
- 66" wide: 297 lbs.
- 72" wide: 324 lbs.
- 78" wide: 351 lbs.
- 84" wide: 378 lbs.
- 90" wide: 405 lbs.
- 96" wide: 432 lbs.

Note: Installations which violate these requirements will not be covered by the Knoll, Inc. warranty.

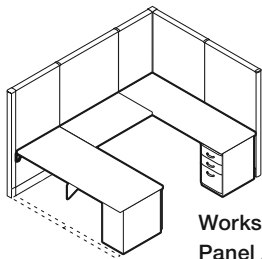

Worksurfaces and Supports,
Panel Application

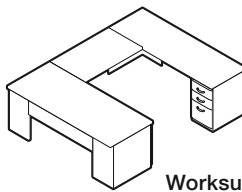

Worksurfaces and Supports,
Freestanding Application

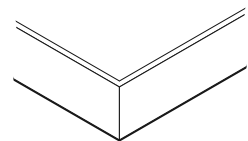

2mm Vinyl Edge Detail

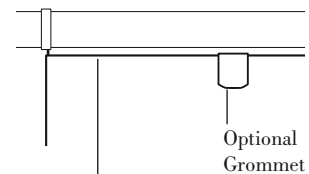
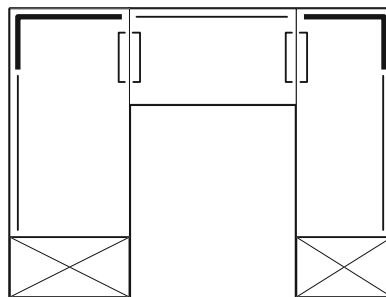
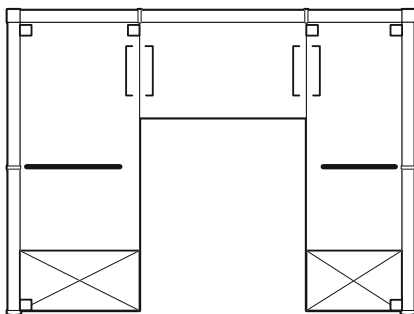

1/2" Cable
Management Reveal

Worksurface Cable Management

Laminate Worksurface Grain Direction

The standard grain direction for wood grain or brushed laminates for each worksurface shape is shown below.

When wood grain or brushed laminates are specified on Dividends Horizon corner worksurfaces, a left, right or diagonal grain direction option must be specified as shown below. Insert the desired grain direction option (L, R or D) after the laminate finish code. The diagonal option is an upcharge. This option applies only to corner worksurfaces with the same dimension on each rear side.

Techwood Worksurface Grain Direction

The standard grain direction for Techwood worksurfaces for each worksurface shape is shown below.

Techwood corner worksurfaces with the same dimension on each rear side have a diagonal grain direction.

Laminate Worksurface Grain Direction

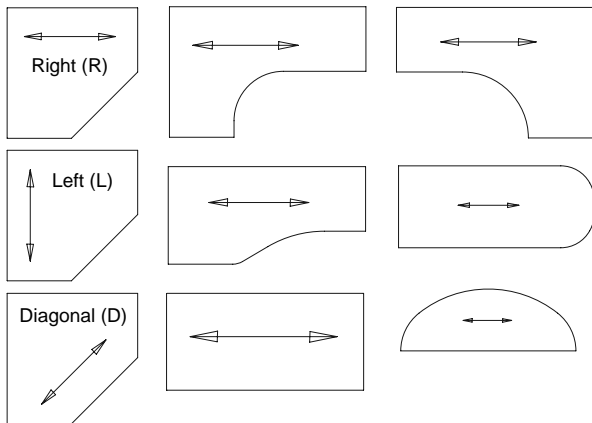

Techwood Worksurface Grain Direction

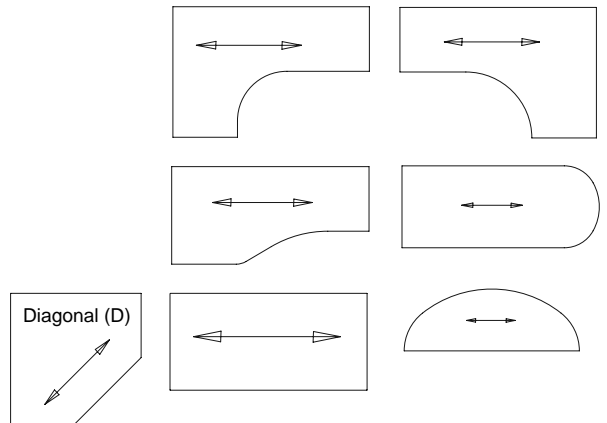

Panel-Hung Worksurface Support

All worksurfaces require support every 48" in width. In panel-hung applications, mid-span support must be provided by cantilevers, panel-mounted C-legs or open support legs.

When worksurfaces are mounted perpendicular to panels, the worksurface depth must equal the width of the panel when using panel-to-worksurface brackets.

Cantilevers are available in three depths to match worksurface depths.

- 18" deep worksurfaces are supported by 18" deep cantilevers.
- 24" deep worksurfaces are supported by 24" deep cantilevers.
- 30" deep worksurfaces are not recommended to be supported by cantilevers. 30" deep cantilevers are used for mid-span support.
- 36" deep worksurfaces cannot be supported by cantilevers.

Panel-mounted C-leg supports are available to support 24" and 30" worksurface depths in heavier worksurface load applications.

Open support legs are available to support 18", 24" and 30" worksurfaces depths.

Freestanding Worksurface Support

For freestanding desk applications, specify freestanding pedestals, end units and/or intermediate support every 48" in width.

- 18" deep worksurfaces can be supported by 18" deep pedestals and end units only
- 24" deep worksurfaces can be supported by either 18" or 24" deep pedestals or end units
- 30" deep worksurfaces can be supported by either 24" or 30" deep pedestals or end units
- 36" deep worksurfaces can only be supported by 30" deep pedestals or end units and provide a 6" front overhang for desk applications.

Maximum Width Between Panel-Hung Worksurface Supports

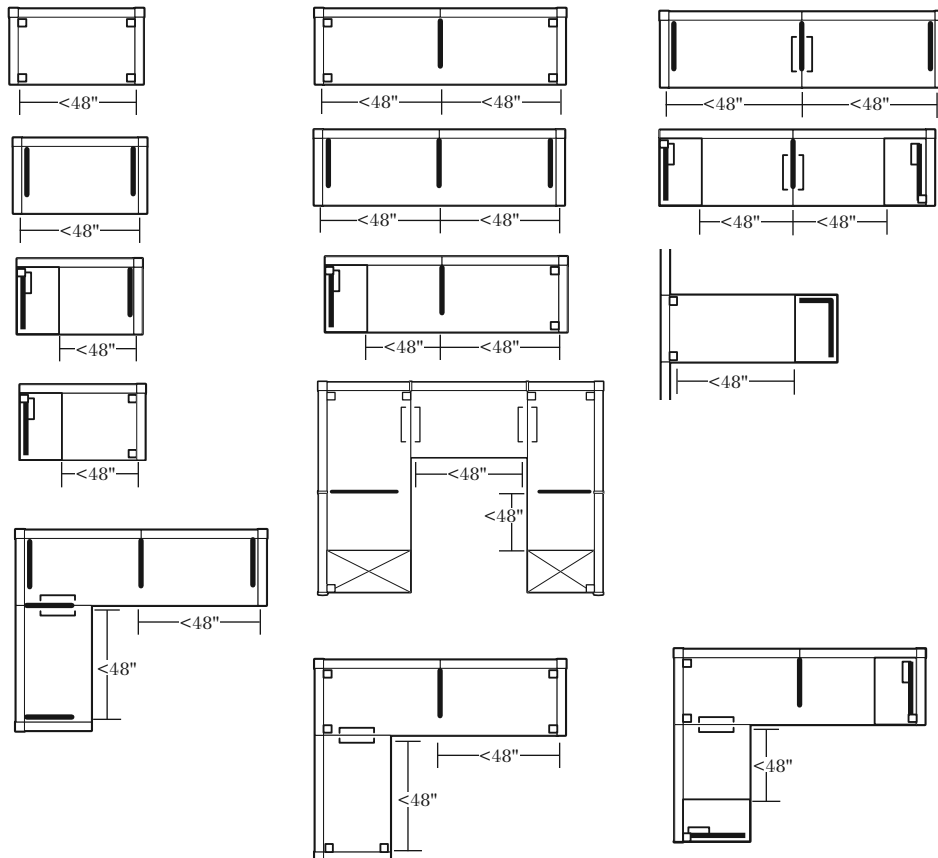

Maximum Width Between Freestanding Worksurface Supports

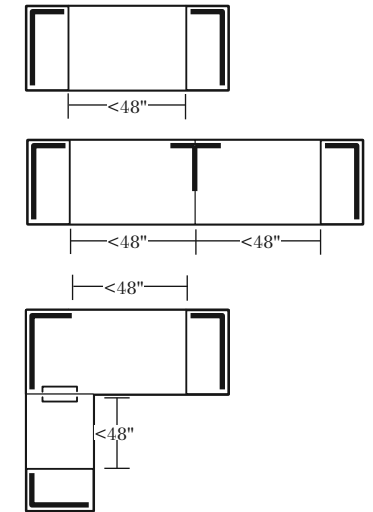









Worksurface Reinforcement

Worksurface reinforcements are required for worksurface spans greater than 48 inches. This includes freestanding desk worksurfaces over 48 inches using desk end units. Worksurface reinforcements have a black paint finish.

Notes:

- Whenever using pedestals they should be connected to panels with panel-to-worksurface brackets
- Panel runs must be floor-supported every 8 feet (i.e., pedestal with panel-to-worksurface brackets or panel-mounted C-leg)
- When a panel mounted C-leg is used, unsupported worksurface span is not to exceed 48".

Legend

-  Pedestal or End Unit
-  Panel Mounted C-leg Support
-  Cantilever or C-leg
-  Flat Bracket
-  Flat Bracket with Cantilever or Shared C-leg
-  Panel-to-worksurface Bracket
-  Pedestal or C-leg
-  End Unit
-  Intermediate

Worksurface Reinforcement Panel Hung Application

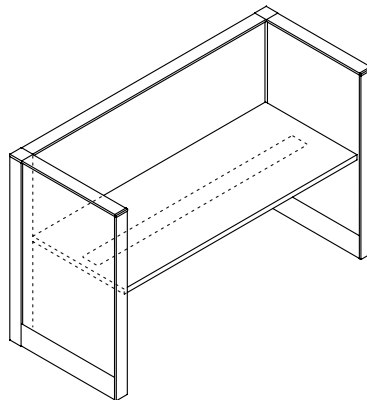
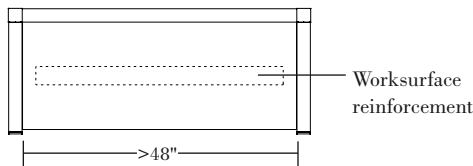

Worksurface Reinforcement Freestanding Desk Application

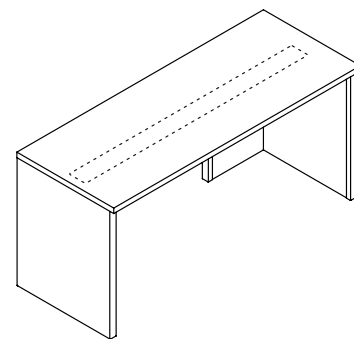
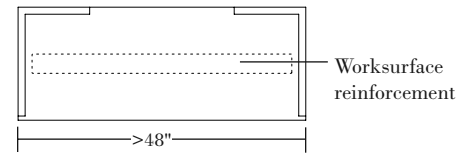

Rectangular Worksurfaces 18" and 24" Deep Specifications

Rectangular Worksurfaces

Dividends Horizon rectangular worksurfaces are universal and may be used in:

- Panel-hung applications
- Freestanding applications

Available Sizes

- Depths: 18" and 24"
- Widths: 24" to 96"

Panel-Hung Applications

When a worksurface spans multiple panels a cantilever or freestanding support is required every 48" of width.

Freestanding Applications

Rectangular worksurfaces in "build-to-spec" applications use pedestals and end units as the primary support for freestanding desks. Back panels are optional and can be specified as required.

The most common freestanding applications involve desks, returns and bridge units in "L" and "U" configurations.

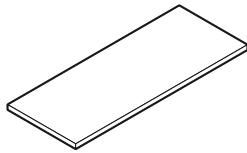

24"D Rectangular Worksurface

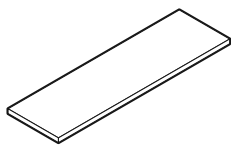

18"D Rectangular Worksurface

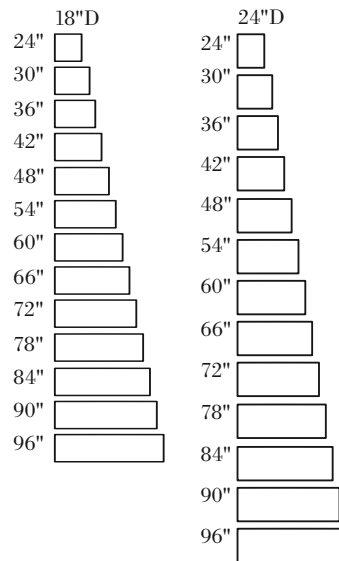

Rectangular Sizes Available

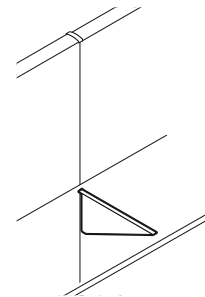

Worksurfaces over 48" W require mid-span support

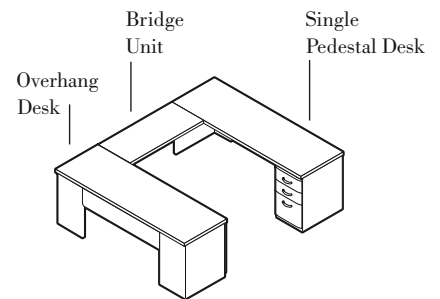
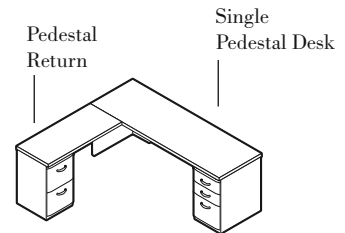



Freestanding Desk Applications

Rectangular Worksurfaces

18" and 24" Deep

Dividends Horizon

description	w *	w	d	t	pattern no.	laminate w/ PVC edge	laminate w/ woodgrain edge	laminate w/ metal edge	techwood w/ techwood edge
18" Deep Rectangular No Grommets 	24"	23 13/16"	17 1/2"	1 1/4"	D1R 2418N	\$147.	\$163.	\$178.	\$364.
	30"	29 13/16"	17 1/2"	1 1/4"	D1R 3018N	156.	173.	188.	383.
	36"	35 13/16"	17 1/2"	1 1/4"	D1R 3618N	175.	193.	211.	402.
	42"	41 13/16"	17 1/2"	1 1/4"	D1R 4218N	203.	222.	242.	421.
	48"	47 13/16"	17 1/2"	1 1/4"	D1R 4818N	225.	248.	272.	439.
	54"	53 13/16"	17 1/2"	1 1/4"	D1R 5418N	240.	264.	289.	455.
	60"	59 13/16"	17 1/2"	1 1/4"	D1R 6018N	261.	287.	312.	472.
	66"	65 13/16"	17 1/2"	1 1/4"	D1R 6618N	281.	308.	337.	490.
	72"	71 13/16"	17 1/2"	1 1/4"	D1R 7218N	297.	326.	355.	507.
	78"	77 13/16"	17 1/2"	1 1/4"	D1R 7818N	318.	349.	381.	528.
	84"	83 13/16"	17 1/2"	1 1/4"	D1R 8418N	335.	368.	401.	548.
	90"	89 13/16"	17 1/2"	1 1/4"	D1R 9018N	373.	411.	445.	569.
96"	95 13/16"	17 1/2"	1 1/4"	D1R 9618N	413.	453.	495.	590.	
24" Deep Rectangular No Grommets 	24"	23 13/16"	23 1/2"	1 1/4"	D1R 2424N	157.	174.	190.	376.
	30"	29 13/16"	23 1/2"	1 1/4"	D1R 3024N	181.	198.	216.	398.
	36"	35 13/16"	23 1/2"	1 1/4"	D1R 3624N	201.	220.	240.	419.
	42"	41 13/16"	23 1/2"	1 1/4"	D1R 4224N	230.	252.	278.	441.
	48"	47 13/16"	23 1/2"	1 1/4"	D1R 4824N	257.	284.	309.	462.
	54"	53 13/16"	23 1/2"	1 1/4"	D1R 5424N	279.	306.	334.	487.
	60"	59 13/16"	23 1/2"	1 1/4"	D1R 6024N	301.	330.	360.	510.
	66"	65 13/16"	23 1/2"	1 1/4"	D1R 6624N	325.	357.	390.	533.
	72"	71 13/16"	23 1/2"	1 1/4"	D1R 7224N	339.	374.	407.	556.
	78"	77 13/16"	23 1/2"	1 1/4"	D1R 7824N	364.	400.	436.	582.
	84"	83 13/16"	23 1/2"	1 1/4"	D1R 8424N	385.	426.	463.	608.
	90"	89 13/16"	23 1/2"	1 1/4"	D1R 9024N	435.	477.	521.	633.
96"	95 13/16"	23 1/2"	1 1/4"	D1R 9624N	473.	522.	570.	658.	

w* = nominal width
Dimensions listed under w d t are actual to the nearest 1/16"

Ordering Information

Worksurfaces

1. Pattern Number
2. Top Finish Type
3. Edge Finish

Order Code

Worksurfaces

Example: **D1R 4818N, 114, 114**

D1R Pattern Number
4818N

114 Folkstone Grey
Laminate

114 Folkstone Grey Edge
Band

Included with:

Worksurfaces

Note: An upcharge applies when specifying Legacy laminates. See Legacy finish page.

Options

Worksurfaces

- Center-Located Edge Grommet
- Woodgrain PVC edge
- Metal edge
- Techwood edge

To specify edge grommet, replace the "N" suffix from the pattern number with "G".
Add \$18.

Rectangular Worksurfaces

19" Deep Specifications

Rectangular Worksurfaces

The 19" deep rectangular worksurface aligns with the depth of a doublewide pedestal. Dividends Horizon worksurfaces provide a 1/2" reveal between the worksurface and panel for cable management.

Dividends Horizon 19" deep rectangular worksurfaces are universal and may be used in:

- Panel-hung applications
- Freestanding applications

Available Sizes

- Depths: 19"
- Widths: 24" to 96"

Panel-Hung Applications

When a worksurface spans multiple panels, a cantilever or freestanding support is required every 48" of width.

Freestanding Applications

Rectangular worksurfaces in "build-to-spec" applications use pedestals and end units as the primary support for freestanding desks. Back panels are optional and can be specified as required.

The most common freestanding applications involve desks, returns and bridge units in "L" and "U" configurations.

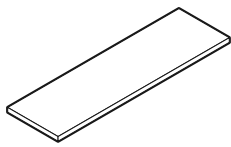

19"D Rectangular Worksurface

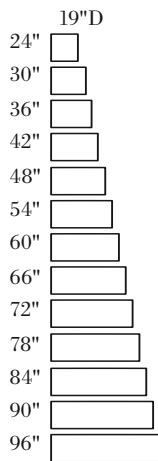

Rectangular Sizes Available

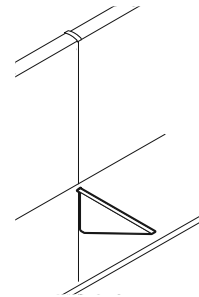

Worksurfaces over 48" W require mid-span support

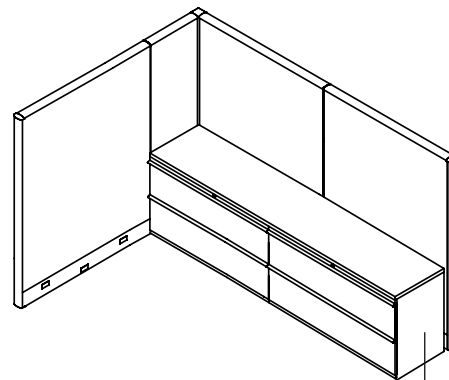

19" Deep Worksurface Application

Doublewide Pedestal

Rectangular Worksurfaces

19" Deep

Dividends Horizon

description	w*	w	d	t	pattern no.	laminate w/ PVC edge	laminate w/ woodgrain edge	laminate w/ metal edge	techwood w/ techwood edge
19" Deep Rectangular - No Grommets (for use with doublewide pedestals) 	24"	23 ^{13/16"}	18 ^{3/4"}	1 ^{1/4"}	D1R2419N	\$149.	\$165.	\$180.	\$266.
	30"	29 ^{13/16"}	18 ^{3/4"}	1 ^{1/4"}	D1R3019N	161.	177.	192.	285.
	36"	35 ^{13/16"}	18 ^{3/4"}	1 ^{1/4"}	D1R3619N	180.	197.	215.	405.
	42"	41 ^{13/16"}	18 ^{3/4"}	1 ^{1/4"}	D1R4219N	207.	228.	248.	424.
	48"	47 ^{13/16"}	18 ^{3/4"}	1 ^{1/4"}	D1R4819N	230.	253.	277.	443.
	54"	53 ^{13/16"}	18 ^{3/4"}	1 ^{1/4"}	D1R5419N	247.	272.	297.	461.
	60"	59 ^{13/16"}	18 ^{3/4"}	1 ^{1/4"}	D1R6019N	268.	295.	322.	479.
	66"	65 ^{13/16"}	18 ^{3/4"}	1 ^{1/4"}	D1R6619N	288.	317.	346.	497.
	72"	71 ^{13/16"}	18 ^{3/4"}	1 ^{1/4"}	D1R7219N	304.	334.	365.	515.
	78"	77 ^{13/16"}	18 ^{3/4"}	1 ^{1/4"}	D1R7819N	325.	357.	391.	537.
	84"	83 ^{13/16"}	18 ^{3/4"}	1 ^{1/4"}	D1R8419N	344.	379.	413.	558.
	90"	89 ^{13/16"}	18 ^{3/4"}	1 ^{1/4"}	D1R9019N	383.	421.	460.	580.
	96"	95 ^{13/16"}	18 ^{3/4"}	1 ^{1/4"}	D1R9619N	423.	465.	508.	602.

w* = nominal width

Dimensions listed under w d t are actual to the nearest 1/16"

Ordering Information

Worksurfaces

1. Pattern Number
2. Top Finish Type
3. Edge Finish

Order Code

Worksurfaces

Example: **D1R 4819N, 114, 114**

D1R Pattern Number
4819N

114 Folkstone Grey
Laminate

114 Folkstone Grey Edge
Band

Included with:

Worksurfaces

Note: An upcharge applies when specifying Legacy laminates. See Legacy finish page.

Options

Worksurfaces

- Center-Located Edge Grommet
- Woodgrain PVC edge
- Metal edge
- Techwood edge

To specify edge grommet, replace the "N" suffix from the pattern number with "G".
Add \$18.

Rectangular Worksurfaces

Dividends Horizon rectangular worksurfaces are universal and can be used in:

- Panel-hung applications
- Freestanding applications

See page 166 for the following:

- Worksurface construction
- Optional edge grommets
- Loading capacities

Available Sizes

- Depths: 30" and 36"
- Widths: 24" to 96" (30"D), 60" to 72" (36"D)

Panel-Hung Applications

When a worksurface spans multiple panels a cantilever or freestanding floor support is required every 48". 36" deep worksurfaces cannot be supported by cantilevers. Worksurfaces over 48" W require mid-span support

Freestanding Applications

Refer to the freestanding desk section for "preconfigured" applications. Rectangular worksurfaces in "build-to-spec" applications use pedestals and end units as the primary support for freestanding desks. Back panels are optional and can be specified as required.

The most common freestanding applications involve desks, returns and bridge units in "L" and "U" configurations.

Overhang Desks

Overhang desks can be ordered by component by specifying desk supports and worksurfaces separately. To specify, select either a 30" or 36" deep worksurface in 60", 66" or 72" widths. Back panels should be specified to match the worksurface width while supports (pedestals or end units) should be one size smaller than the worksurface depth to provide a 6" front overhang. Example: 36" deep worksurface with 30" deep pedestals or end units.

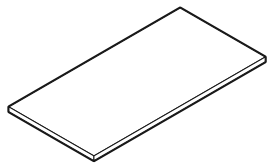

30"D Rectangular Worksurface

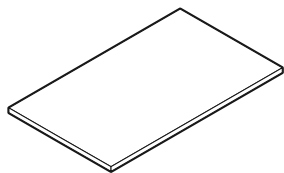

36"D Rectangular Worksurface

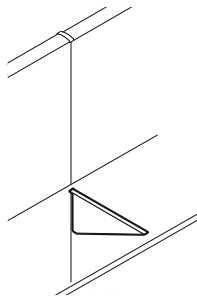

Worksurfaces over 48"W require mid-span support

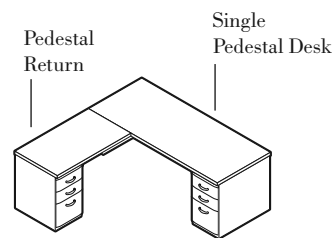
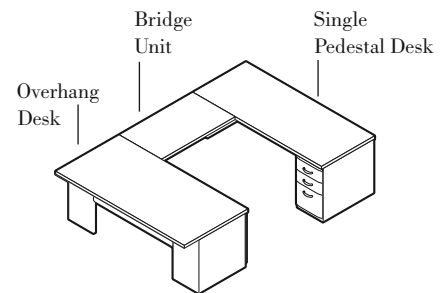



Freestanding Desk Applications

Rectangular Worksurfaces

30" and 36" Deep

Dividends Horizon

description	w	w	d	t	pattern no.	lamine w/ PVC edge	lamine w/ woodgrain edge	lamine w/ metal edge	techwood w/ techwood edge
30" Deep Rectangular No Grommets 	24"	23 ^{13/16} "	29 ^{1/2} "	1 ^{1/4} "	D1R 2430N	\$202.	\$221.	\$241.	\$390.
	30"	29 ^{13/16} "	29 ^{1/2} "	1 ^{1/4} "	D1R 3030N	225.	248.	272.	420.
	36"	35 ^{13/16} "	29 ^{1/2} "	1 ^{1/4} "	D1R 3630N	249.	275.	300.	449.
	42"	41 ^{13/16} "	29 ^{1/2} "	1 ^{1/4} "	D1R 4230N	272.	299.	324.	479.
	48"	47 ^{13/16} "	29 ^{1/2} "	1 ^{1/4} "	D1R 4830N	301.	330.	360.	509.
	54"	53 ^{13/16} "	29 ^{1/2} "	1 ^{1/4} "	D1R 5430N	341.	375.	409.	531.
	60"	59 ^{13/16} "	29 ^{1/2} "	1 ^{1/4} "	D1R 6030N	376.	414.	450.	553.
	66"	65 ^{13/16} "	29 ^{1/2} "	1 ^{1/4} "	D1R 6630N	418.	460.	502.	575.
	72"	71 ^{13/16} "	29 ^{1/2} "	1 ^{1/4} "	D1R 7230N	435.	477.	521.	596.
	78"	77 ^{13/16} "	29 ^{1/2} "	1 ^{1/4} "	D1R 7830N	464.	512.	558.	624.
	84"	83 ^{13/16} "	29 ^{1/2} "	1 ^{1/4} "	D1R 8430N	493.	541.	592.	651.
	90"	89 ^{13/16} "	29 ^{1/2} "	1 ^{1/4} "	D1R 9030N	530.	582.	636.	678.
96"	95 ^{13/16} "	29 ^{1/2} "	1 ^{1/4} "	D1R 9630N	568.	625.	682.	705.	
36" Deep Rectangular No Grommets 	60"	59 ^{13/16} "	35 ^{1/2} "	1 ^{1/4} "	D1R 6036N	482.	529.	577.	657.
	66"	65 ^{13/16} "	35 ^{1/2} "	1 ^{1/4} "	D1R 6636N	532.	586.	638.	679.
	72"	71 ^{13/16} "	35 ^{1/2} "	1 ^{1/4} "	D1R 7236N	586.	646.	703.	704.

w* = nominal width
Dimensions listed under w h t are actual to the nearest 1/16"

Ordering Information

Worksurfaces

1. Pattern Number
2. Top Finish Type
3. Edge Finish

Order Code

Worksurfaces

Example: **D1R 6030N, 114, 114**

D1R Pattern Number
6030N

114 Folkstone Grey
Laminate

114 Folkstone Grey Edge
Band

Included with:

Worksurfaces

Note: An upcharge applies when specifying Legacy laminates. See Legacy finish page.

Options

Worksurfaces

- Center-Located Edge Grommet
- Woodgrain PVC edge
- Metal edge
- Techwood edge

To specify edge grommet, replace the "N" suffix from the pattern number with "G".
Add \$18.

Curvilinear Wave End Worksurfaces

Dividends Horizon curvilinear wave end worksurfaces are primarily used in panel-hung applications.

Available Sizes

Curvilinear wave end worksurfaces are handed with one side deeper than the other.

- Depths: 24"/30", 18"/30", 24"/36"
- Widths: 36" to 72"

Curvilinear Wave End Applications

36" to 48" wide wave ends are generally used as worksurface returns attached to curvilinear corners.

72" wide wave ends are used as primary worksurfaces with returns attached at the deep end.

Note: Only 18" and 24" deep returns can be attached to 72" wide wave end worksurfaces.

Curvilinear Wave End Support

In applications where worksurface ends are mounted perpendicular to panels, panel-to-worksurface brackets or a cantilever and a panel-to-worksurface bracket can be used as shown below.

72" wide curvilinear wave ends always require mid-span cantilever support including applications involving pedestal support at one end.

Pedestal Support Applications

Pedestals can be used as supports in the following locations:

- The deep end of all curvilinear wave ends
- The shallow end of all 48" and 72" wide curvilinear wave end worksurfaces

Recommended Pedestal Depths

- 18" deep wave ends require 18" deep pedestals
- 24" deep wave ends can use either a 18" or 24" deep pedestal
- 30" deep wave ends can use either a 24" or 30" deep pedestal
- 36" deep wave ends require a 30" deep pedestal

Note: When the pedestal depth is less than the worksurface depth, a panel-to-worksurface bracket must be used in the rear corner of the worksurface to the panel.

Freestanding Applications

Curvilinear wave end worksurfaces can be used to create unique freestanding workstations supported by pedestals and end units. The most common application is a 72" wide wave end worksurface with a single pedestal and end unit attached to a freestanding return.

Curvilinear Wave End Worksurface

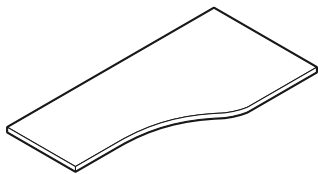

Curvilinear Wave End Worksurface Sizes

72"W	30"/18"D	18"/30"D
72"W	30"/24"D	24"/30"D
72"W	36"/24"D	24"/36"D

Curvilinear Wave End Applications

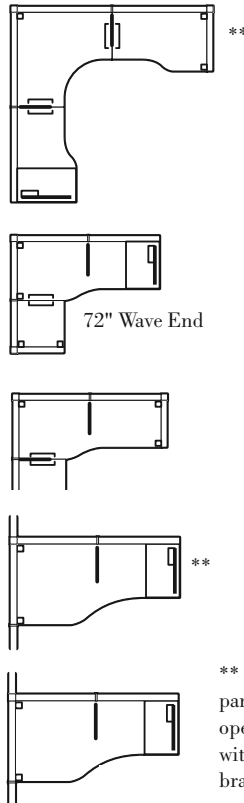

** Requires a return panel, panel-mounted C-leg support, open support leg, or a pedestal with a panel-to-worksurface bracket for support.

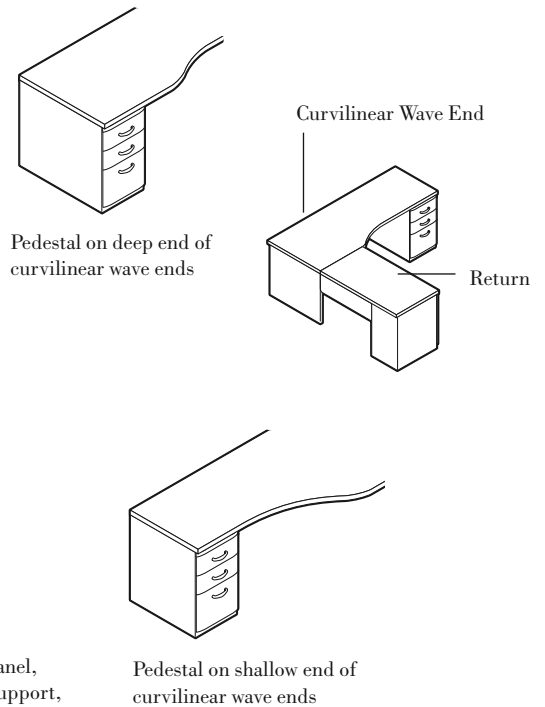

Pedestal Support Applications



Curvilinear Wave End Worksurfaces

Mixed Depths

Dividends Horizon

description	w*	1	2	3	A	B	t	pattern no.	laminate w/ PVC edge	laminate w/ woodgrain edge	laminate w/ metal edge	techwood w/ techwood edge
Curvilinear Wave End Left No Grommets 	36"	35 13/16"	23 1/2"	29 1/2"	14 15/16"	2 15/16"	1 1/4"	D1W 363024N	\$424.	\$465.	\$510.	\$813.
	42"	41 13/16"	23 1/2"	29 1/2"	14 15/16"	8 15/16"	1 1/4"	D1W 423024N	444.	491.	533.	837.
	48"	47 13/16"	23 1/2"	29 1/2"	14 15/16"	14 15/16"	1 1/4"	D1W 483024N	474.	523.	571.	860.
	72"	71 13/16"	17 1/2"	29 1/2"	23 7/16"	14 15/16"	1 1/4"	D1W 723018N	588.	647.	705.	884.
	72"	71 13/16"	23 1/2"	29 1/2"	23 7/16"	30 7/16"	1 1/4"	D1W 723024N	606.	665.	728.	908.
	72"	71 13/16"	23 1/2"	35 1/2"	23 7/16"	14 15/16"	1 1/4"	D1W 723624N	626.	687.	750.	932.
Curvilinear Wave End Right No Grommets 	36"	35 13/16"	29 1/2"	23 1/2"	2 15/16"	14 15/16"	1 1/4"	D1W 362430N	424.	465.	510.	813.
	42"	41 13/16"	29 1/2"	23 1/2"	8 15/16"	14 15/16"	1 1/4"	D1W 422430N	444.	491.	533.	837.
	48"	47 13/16"	29 1/2"	23 1/2"	14 15/16"	14 15/16"	1 1/4"	D1W 482430N	474.	523.	571.	860.
	72"	71 13/16"	29 1/2"	17 1/2"	14 15/16"	23 7/16"	1 1/4"	D1W 721830N	588.	647.	705.	884.
	72"	71 13/16"	29 1/2"	23 1/2"	30 7/16"	23 7/16"	1 1/4"	D1W 722430N	606.	665.	728.	908.
	72"	71 13/16"	35 1/2"	23 1/2"	14 15/16"	23 7/16"	1 1/4"	D1W 722436N	626.	687.	750.	932.

w* = nominal width

A and B = straight edge length

Dimensions listed under 1, 2 and 3 are actual to nearest 1/16"

Ordering Information

Worksurfaces

1. Pattern Number
2. Top Finish Type
3. Edge Finish

Order Code

Worksurfaces

Example: **D1R 6030N, 114, 114**

D1R Pattern Number
6030N

114 Folkstone
Grey Laminate

114 Folkstone Grey Edge
Band

Included with:

Worksurfaces

Note: An upcharge applies when specifying Legacy laminates. See Legacy finish page.

Options

Worksurfaces

- Center-Located Edge Grommet
- Woodgrain PVC edge
- Metal edge
- Techwood edge

To specify edge grommet, replace the "N" suffix from the pattern number with "G".
Add \$18.

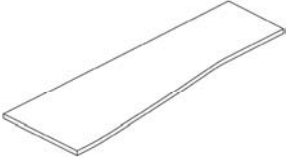
description	w*	w	depth left	depth right	t	pattern no.	laminates w/	laminates w/	laminates w/	techwood w/
							PVC edge	woodgrain edge	metal edge	techwood edge
Smooth Wave 	48"	47 ^{13/16} "	17 ^{1/2} "	23 ^{1/2} "	1 ^{1/4} "	D1W S481824N	\$474.	\$523.	\$571.	\$827.
	48"	47 ^{13/16} "	17 ^{1/2} "	29 ^{1/2} "	1 ^{1/4} "	D1W S481830N	474.	523.	571.	830.
	48"	47 ^{13/16} "	23 ^{1/2} "	17 ^{1/2} "	1 ^{1/4} "	D1W S482418N	474.	523.	571.	835.
	48"	47 ^{13/16} "	23 ^{1/2} "	29 ^{1/2} "	1 ^{1/4} "	D1W S482430N	474.	523.	571.	838.
	48"	47 ^{13/16} "	29 ^{1/2} "	17 ^{1/2} "	1 ^{1/4} "	D1W S483018N	474.	523.	571.	842.
	48"	47 ^{13/16} "	29 ^{1/2} "	23 ^{1/2} "	1 ^{1/4} "	D1W S483024N	474.	523.	571.	845.
	60"	59 ^{13/16} "	17 ^{1/2} "	23 ^{1/2} "	1 ^{1/4} "	D1W S601824N	550.	606.	660.	849.
	60"	59 ^{13/16} "	17 ^{1/2} "	29 ^{1/2} "	1 ^{1/4} "	D1W S601830N	550.	606.	660.	852.
	60"	59 ^{13/16} "	23 ^{1/2} "	17 ^{1/2} "	1 ^{1/4} "	D1W S602418N	550.	606.	660.	857.
	60"	59 ^{13/16} "	23 ^{1/2} "	29 ^{1/2} "	1 ^{1/4} "	D1W S602430N	550.	606.	660.	860.
	60"	59 ^{13/16} "	29 ^{1/2} "	17 ^{1/2} "	1 ^{1/4} "	D1W S603018N	550.	606.	660.	864.
	60"	59 ^{13/16} "	29 ^{1/2} "	23 ^{1/2} "	1 ^{1/4} "	D1W S603024N	550.	606.	660.	867.
	66"	65 ^{13/16} "	17 ^{1/2} "	23 ^{1/2} "	1 ^{1/4} "	D1W S661824N	588.	648.	706.	871.
	66"	65 ^{13/16} "	17 ^{1/2} "	29 ^{1/2} "	1 ^{1/4} "	D1W S661830N	588.	648.	706.	874.
	66"	65 ^{13/16} "	23 ^{1/2} "	17 ^{1/2} "	1 ^{1/4} "	D1W S662418N	588.	648.	706.	878.
	66"	65 ^{13/16} "	23 ^{1/2} "	29 ^{1/2} "	1 ^{1/4} "	D1W S662430N	588.	648.	706.	882.
	66"	65 ^{13/16} "	29 ^{1/2} "	17 ^{1/2} "	1 ^{1/4} "	D1W S663018N	588.	648.	706.	886.
	66"	65 ^{13/16} "	29 ^{1/2} "	23 ^{1/2} "	1 ^{1/4} "	D1W S663024N	588.	648.	706.	889.
	72"	71 ^{13/16} "	17 ^{1/2} "	23 ^{1/2} "	1 ^{1/4} "	D1W S721824N	626.	687.	750.	893.
	72"	71 ^{13/16} "	17 ^{1/2} "	29 ^{1/2} "	1 ^{1/4} "	D1W S721830N	626.	687.	750.	896.
	72"	71 ^{13/16} "	23 ^{1/2} "	17 ^{1/2} "	1 ^{1/4} "	D1W S722418N	626.	687.	750.	900.
	72"	71 ^{13/16} "	23 ^{1/2} "	29 ^{1/2} "	1 ^{1/4} "	D1W S722430N	626.	687.	750.	905.
	72"	71 ^{13/16} "	29 ^{1/2} "	17 ^{1/2} "	1 ^{1/4} "	D1W S723018N	626.	687.	750.	909.
	72"	71 ^{13/16} "	29 ^{1/2} "	23 ^{1/2} "	1 ^{1/4} "	D1W S723024N	626.	687.	750.	912.
	78"	77 ^{13/16} "	17 ^{1/2} "	23 ^{1/2} "	1 ^{1/4} "	D1W S781824N	662.	729.	795.	916.
	78"	77 ^{13/16} "	17 ^{1/2} "	29 ^{1/2} "	1 ^{1/4} "	D1W S781830N	662.	729.	795.	918.
	78"	77 ^{13/16} "	23 ^{1/2} "	17 ^{1/2} "	1 ^{1/4} "	D1W S782418N	662.	729.	795.	919.
	78"	77 ^{13/16} "	23 ^{1/2} "	29 ^{1/2} "	1 ^{1/4} "	D1W S782430N	662.	729.	795.	923.
	78"	77 ^{13/16} "	29 ^{1/2} "	17 ^{1/2} "	1 ^{1/4} "	D1W S783018N	662.	729.	795.	927.
	78"	77 ^{13/16} "	29 ^{1/2} "	23 ^{1/2} "	1 ^{1/4} "	D1W S783024N	662.	729.	795.	931.
84"	83 ^{13/16} "	17 ^{1/2} "	23 ^{1/2} "	1 ^{1/4} "	D1W S841824N	701.	770.	841.	934.	
84"	83 ^{13/16} "	17 ^{1/2} "	29 ^{1/2} "	1 ^{1/4} "	D1W S841830N	701.	770.	841.	938.	
84"	83 ^{13/16} "	23 ^{1/2} "	17 ^{1/2} "	1 ^{1/4} "	D1W S842418N	701.	770.	841.	941.	
84"	83 ^{13/16} "	23 ^{1/2} "	29 ^{1/2} "	1 ^{1/4} "	D1W S842430N	701.	770.	841.	945.	
84"	83 ^{13/16} "	29 ^{1/2} "	17 ^{1/2} "	1 ^{1/4} "	D1W S843018N	701.	770.	841.	948.	
84"	83 ^{13/16} "	29 ^{1/2} "	23 ^{1/2} "	1 ^{1/4} "	D1W S843024N	701.	770.	841.	953.	

Ordering Information

Worksurfaces

1. Pattern Number
2. Top Finish Type
3. Edge Finish

Order Code

Worksurfaces

Example: **D1R 6030N, 114, 114**

D1W	Dividends Worksurface
S	Smooth Wave Shape
72	Overall width in inches
30	Nominal depth at user's left side
24	Nominal depth at user's right side
N	No grommet
114	Folkstone Grey Laminate
114	Folkstone Grey Edge Band

Included with:

Worksurfaces

Note: An upcharge applies when specifying Legacy laminates. See Legacy finish page.

Options

Worksurfaces

- 2 Center-Located Edge Grommets
- Woodgrain PVC edge
- Metal edge
- Techwood edge

To specify edge grommets, replace the "N" suffix from the pattern number with a "G".

Add \$28

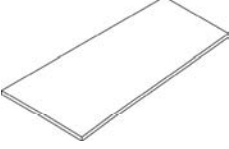
description	w*	w	depth left	depth right	t	pattern no.	laminate w/ PVC edge	laminate w/ woodgrain edge	laminate w/ metal edge	techwood w/ techwood edge
Trapezoidal 	48"	47 ^{13/16} "	23 ^{1/2} "	29 ^{1/2} "	1 ^{1/4} "	D1W T482430N	\$474.	\$523.	\$571.	\$592.
	48"	47 ^{13/16} "	29 ^{1/2} "	23 ^{1/2} "	1 ^{1/4} "	D1W T483024N	474.	523.	571.	592.
	60"	59 ^{13/16} "	23 ^{1/2} "	29 ^{1/2} "	1 ^{1/4} "	D1W T602430N	550.	606.	660.	626.
	60"	59 ^{13/16} "	29 ^{1/2} "	23 ^{1/2} "	1 ^{1/4} "	D1W T603024N	550.	606.	660.	626.
	66"	65 ^{13/16} "	23 ^{1/2} "	29 ^{1/2} "	1 ^{1/4} "	D1W T662430N	588.	648.	706.	659.
	66"	65 ^{13/16} "	29 ^{1/2} "	23 ^{1/2} "	1 ^{1/4} "	D1W T663024N	588.	648.	706.	659.
	72"	71 ^{13/16} "	23 ^{1/2} "	29 ^{1/2} "	1 ^{1/4} "	D1W T722430N	626.	687.	750.	693.
	72"	71 ^{13/16} "	29 ^{1/2} "	23 ^{1/2} "	1 ^{1/4} "	D1W T723024N	626.	687.	750.	693.

Ordering Information

Worksurfaces

1. Pattern Number
2. Top Finish Type
3. Edge Finish

Order Code

Worksurfaces

Example: **D1W T482430N**

D1W	Dividends Worksurface
T	Trapezoidal Shape
48	Overall Width, inches
24	Nominal depth at user's left side
30	Nominal depth at user's right side
N	No grommet
114	Folkstone Grey Laminate
114	Folkstone Grey Edge Band

Included with:

Worksurface

Note: An upcharge applies when specifying Legacy laminates. See Legacy finish page.

Options

Worksurfaces

- 2 Center-Located Edge Grommets
- Woodgrain PVC edge
- Metal edge
- Techwood edge

To specify edge grommets replace the "N" suffix from the pattern number with a "G".

Add \$28

Corner Worksurfaces

Rectilinear and Split Top Corner Specifications

Rectilinear Corner Worksurfaces

Dividends Horizon rectilinear corner worksurfaces are used in panel-hung and freestanding applications.

Split Top Corner Worksurfaces

Split top corner worksurfaces allow for height and angle adjustment on the front work surface.

The depth of the front keyboard work surface is 10 5/8". The front surface adjusts from a - 5 3/4" below the work surface to a + 7" above. The mechanism has a tilt feature of ±10 degrees.

Included with the split top work surface is the back corner work surface, the front corner work surface, the split top mechanism, one rear corner panel-to-work surface bracket and two flat brackets for attachment to return work surfaces. Cantilevers must be ordered separately and are specified to the size return

work surface depth (i.e 24" cantilevers for 24" deep return work surfaces). Panel-mounted C-leg or Open Leg work surface supports may be used in place of cantilevers.

Available Sizes

- Widths: 36", 42" and 48"
- Returns: 18", 24" and 30"
- Thickness: 1 1/4"

Corner Worksurface Support

Corner worksurfaces must be supported by cantilevers at each end and a panel-to-work surface bracket at the rear corner. Panel-mounted C-leg or Open Leg work surface supports may be used instead of cantilevers for corner work surface support. Cantilevers and panel-mounted C-leg or Open Leg supports are ordered separately. Panel-to-work surface bracket is included.

Corner Worksurface Applications

Corner worksurfaces attach to adjacent work surfaces with cantilevers and flat brackets. Suggested applications are illustrated below.

Note: All dimensions are nominal except for front edge dimension.

Note: Series 3 overdesk units are not compatible with corner work surfaces.

Rectilinear Corner Worksurface

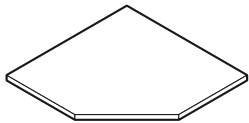

Rectilinear Split-Top Corner Worksurface

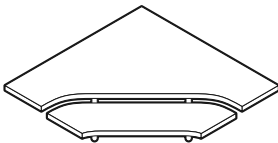

Rectilinear and Split Top Corner Worksurface Sizes Available

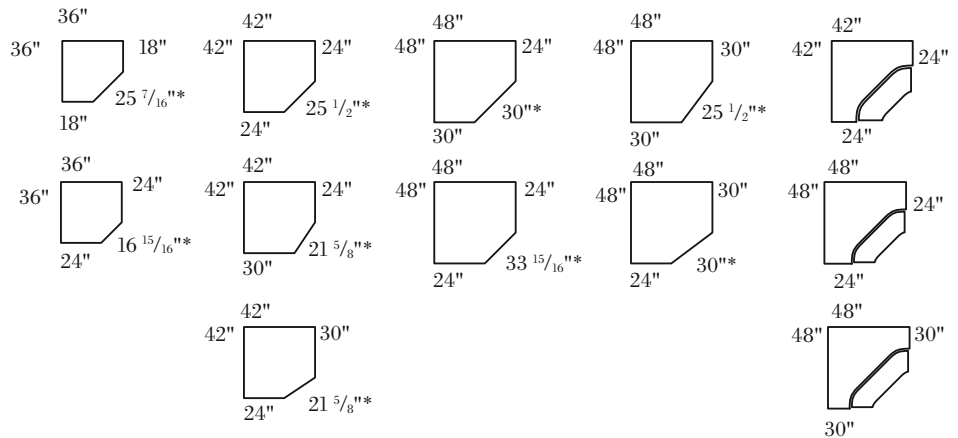

Corner Worksurface Support

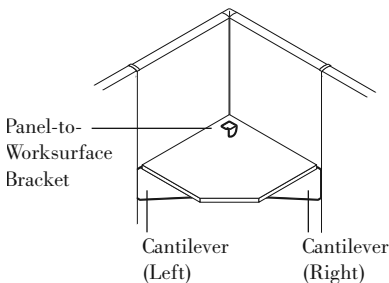

Corner Worksurface Applications

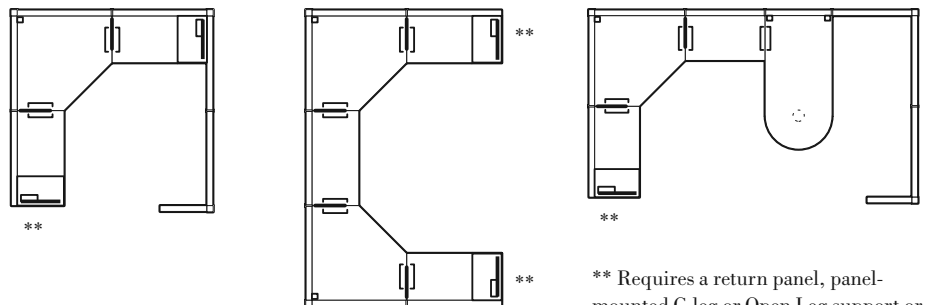





** Requires a return panel, panel-mounted C-leg or Open Leg support or a pedestal with a panel-to-work surface bracket for support.

Corner Worksurfaces

Rectilinear and Split Top Corner

Mixed Depths

description	1	2	3	4	t	pattern no.	laminate w/ PVC edge	laminate w/ woodgrain edge	laminate w/ metal edge	techwood w/ techwood edge
Rectilinear Corner Worksurface No Grommets 	36"	36"	18"	18"	1 1/4"	D1C 3618N	\$362.	\$399.	\$435.	\$736.
	36"	36"	24"	24"	1 1/4"	D1C 3624N	369.	407.	443.	805.
	42"	42"	24"	24"	1 1/4"	D1C 4224N	416.	458.	499.	873.
	48"	48"	24"	24"	1 1/4"	D1C 4824N	475.	524.	572.	942.
	48"	48"	30"	30"	1 1/4"	D1C 4830N	491.	539.	588.	1,012.
Rectilinear Corner Worksurface. 24" Deep Return Left 30" Deep Return Right No Grommets 	42"	42"	24"	30"	1 1/4"	D1C 422430N	436.	479.	523.	948.
	48"	48"	24"	30"	1 1/4"	D1C 482430N	495.	544.	595.	1,012.
Rectilinear Corner Worksurface. 30" Deep Return Left 24" Deep Return Right No Grommets 	42"	42"	30"	24"	1 1/4"	D1C 423024N	436.	479.	523.	948.
	48"	48"	30"	24"	1 1/4"	D1C 483024N	495.	544.	595.	1,012.
Split Top Corner Worksurface No Grommets 	42"	42"	24"	24"	1 1/4"	D1CS 4224N	1,478.	1,625.	1,775.	2,512.
	48"	48"	24"	24"	1 1/4"	D1CS 4824N	1,523.	1,673.	1,826.	2,597.
	48"	48"	30"	30"	1 1/4"	D1CS 4830N	1,533.	1,686.	1,841.	2,681.

Note: Above 1, 2, 3, and 4 dimensions are all nominal
Actual dimensions are 1/2" less than shown above.

Ordering Information	Order Code	Included with:	Options
Worksurfaces 1. Pattern Number 2. Top Finish Type 3. Edge Finish	Worksurfaces <i>Example:</i> D1C 423024N, 117, 115 D1C Pattern Number 423024N	Worksurfaces <ul style="list-style-type: none"> • Worksurface • Panel-to-Worksurface Bracket 	Worksurfaces <ul style="list-style-type: none"> • 2 Center-Located Edge Grommets • Woodgrain PVC edge • Metal edge • Techwood edge
Split Top Corner Worksurfaces 1. Pattern Number 2. Top Finish Type 3. Edge Finish	117 Soft Grey Laminate 115 Medium Grey Edge Band Split Top Corner Worksurfaces <i>Example:</i> D1CS 4224N, 117, 117 D1CS Pattern Number 4224N 117 Soft Grey Laminate 117 Soft Grey Edge Band	Split Top Corner Worksurfaces <ul style="list-style-type: none"> • Front Worksurface • Back Worksurface • Split Top Mechanism • Flat Brackets • Panel-to-Worksurface Bracket <p>Note: When wood grain or brushed laminates are specified on corner worksurfaces where side 1 and 2 are of equal length, one of three grain direction options must be specified. Insert the desired grain direction option (L,R or D) after the laminate code. Please add \$25 to the list price for diagonal grain (D) selection.</p> <p>Note: Techwood corner worksurfaces with the same dimension on side 1 and side 2 have a diagonal grain direction. See grain direction page for more information.</p> <p>Note: An upcharge applies when specifying Legacy laminates. See Legacy finish page.</p>	<p>To specify edge grommets, replace the "N" suffix from the pattern number with a "G". Add \$28</p> <p>Split Top Corner Worksurfaces</p> <ul style="list-style-type: none"> • 2 Center-Located Edge Grommets • Woodgrain PVC edge • Metal edge • Techwood edge <p>Note: Overdesk units are not compatible with corner worksurfaces.</p>

Corner Worksurfaces

Curvilinear Corner "L" Shape - 24" Depths Specifications

Curvilinear Corner L Shape Worksurfaces

Dividends Horizon curvilinear corner "L" shape worksurfaces are specified for panel-hung applications only and provide a continuous flow when used in conjunction with other curvilinear worksurfaces.

Curvilinear Corner Worksurface Support

Curvilinear corner "L" shape worksurfaces must be supported by cantilevers at each end and a panel-to-worksurface bracket at the rear corner. Panel-mounted C-leg or open leg worksurface supports may be used instead of cantilevers for corner worksurface support.

Cantilevers, panel-mounted c-leg and open support legs are ordered separately. A panel-to-worksurface bracket is included.

Note: Worksurfaces greater than 48" wide require an additional mid-span cantilever support along the 60" or 72" side.

Note: A pedestal, panel-mounted C-leg or Open Leg Support can be substituted for a cantilever in the following locations:

- The long end of 60" and 72" wide curvilinear "L" shape corner worksurfaces

Note: Series 3 overdesk units are not compatible with corner worksurfaces.

Curvilinear Corner Worksurface

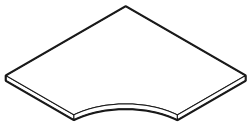

Curvilinear Corner Worksurface Support Options

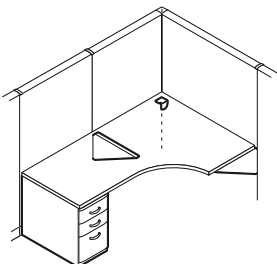
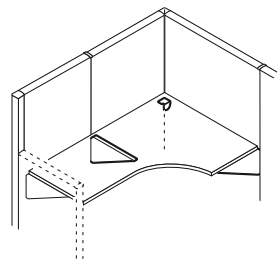
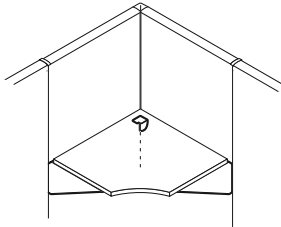

Curvilinear Corner "L" Shape Worksurface

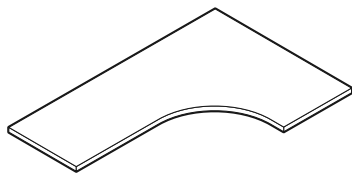

Curvilinear Corner Worksurface Applications

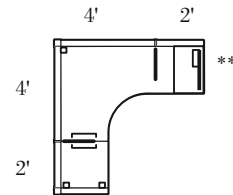
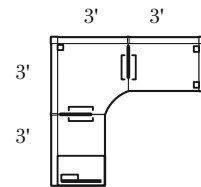



** Requires a return panel or pedestal/panel-mounted C-leg or Open Support Leg with panel-to-worksurface bracket for support

Corner Worksurfaces

Curvilinear Corner "L" Shape - 24" Depths

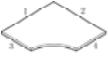
24" Depths

description	1	2	3	4	t	pattern no.	laminated w/ PVC edge	laminated w/ woodgrain edge	laminated w/ metal edge	techwood w/ techwood edge
Curvilinear Corner "L" Shape Worksurface 24" Deep Returns Left and Right	36"	36"	24"	24"	1 1/4"	D1L 3636SSN	\$394.	\$432.	\$471.	\$906.
	42"	42"	24"	24"	1 1/4"	D1L 4242SSN	473.	522.	570.	962.
	42"	60"	24"	24"	1 1/4"	D1L 4260SSN	653.	718.	782.	1,075.
	42"	66"	24"	24"	1 1/4"	D1L 4266SSN	670.	741.	806.	1,102.
	42"	72"	24"	24"	1 1/4"	D1L 4272SSN	696.	765.	836.	1,157.
	42"	78"	24"	24"	1 1/4"	D1L 4278SSN	703.	774.	844.	1,212.
	48"	48"	24"	24"	1 1/4"	D1L 4848SSN	533.	588.	639.	1,018.
	48"	60"	24"	24"	1 1/4"	D1L 4860SSN	660.	726.	791.	1,130.
	48"	66"	24"	24"	1 1/4"	D1L 4866SSN	684.	752.	820.	1,185.
	48"	72"	24"	24"	1 1/4"	D1L 4872SSN	709.	779.	848.	1,240.
	48"	78"	24"	24"	1 1/4"	D1L 4878SSN	782.	860.	938.	1,267.
	48"	84"	24"	24"	1 1/4"	D1L 4884SSN	878.	966.	1,054.	1,294.
	60"	42"	24"	24"	1 1/4"	D1L 6042SSN	653.	718.	782.	1,075.
	60"	48"	24"	24"	1 1/4"	D1L 6048SSN	660.	726.	791.	1,130.
	66"	42"	24"	24"	1 1/4"	D1L 6642SSN	670.	741.	806.	1,102.
	66"	48"	24"	24"	1 1/4"	D1L 6648SSN	684.	752.	820.	1,185.
	72"	42"	24"	24"	1 1/4"	D1L 7242SSN	696.	765.	836.	1,157.
	72"	48"	24"	24"	1 1/4"	D1L 7248SSN	709.	779.	848.	1,240.
	78"	42"	24"	24"	1 1/4"	D1L 7842SSN	703.	774.	844.	1,212.
	78"	48"	24"	24"	1 1/4"	D1L 7848SSN	782.	860.	938.	1,267.
	84"	48"	24"	24"	1 1/4"	D1L 8448SSN	878.	966.	1,054.	1,294.

Note: Above 1, 2, 3, and 4 dimensions are all nominal
Actual dimensions are 1/2" less than shown above.

Ordering Information

1. Worksurfaces
2. Pattern Number
3. Top Finish Type
4. Edge Finish

Order Code

Worksurfaces	
<i>Example:</i> D1L 4860SSN, 117, 117	
D1L	Pattern Number
4860SSN	
117	Soft Grey laminate
117	Soft Grey Edge Band

Included with:

- Worksurfaces**
- Worksurface
 - Panel-to-Worksurface Bracket
- Note:** When wood grain or brushed laminates are specified on corner worksurfaces where side 1 and 2 are of equal length, one of three grain direction options must be specified. Insert the desired grain direction option (L,R or D) after the laminate code. Please add \$25 to the list price for diagonal grain (D) selection.
- Note:** Techwood corner worksurfaces with the same dimension on side 1 and side 2 have a diagonal grain direction. See grain direction page for more information.
- Note:** An upcharge applies when specifying Legacy laminates. See Legacy finish page.

Options

- Worksurfaces**
- 2 center-located edge grommets
 - Woodgrain PVC edge
 - Metal edge
 - Techwood
- To specify edge grommets, replace the "N" suffix from the pattern number with "G"
Add \$28
- Note:** Overdesk units are not compatible with corner worksurfaces.

Corner Worksurfaces

Curvilinear Corner "L" shape-Mixed Depths Specifications

Curvilinear Corner "L" Shape Worksurfaces

Dividends Horizon curvilinear corner, "L" shape worksurfaces are specified for panel-hung applications only and provide a continuous flow when used in conjunction with other curvilinear worksurfaces.

Curvilinear Corner Worksurface Support

Curvilinear corner "L" shape worksurfaces must be supported by cantilevers at each end and a panel-to-worksurface bracket at the rear corner. Panel-mounted C-leg or open leg worksurface supports may be used instead of cantilevers for corner worksurface support.

Cantilevers and panel-mounted C-leg or open leg supports are ordered separately. A panel-to-worksurface bracket is included.

Note: 60" and 72" wide curvilinear corners require an additional mid-span cantilever support along the 60" or 72" side.

Note: A pedestal or panel-mounted C-leg can be substituted for a cantilever in the following locations:

- The long end of 60" and 72" wide curvilinear "L" shape corner worksurfaces

Curvilinear Corner Worksurface Applications

Curvilinear "L" shape corner worksurfaces are primarily used with wave end and rectangular worksurface returns.

Curvilinear Corner Worksurface

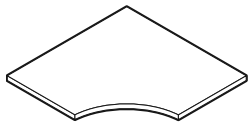

Curvilinear Corner Worksurface Support Options

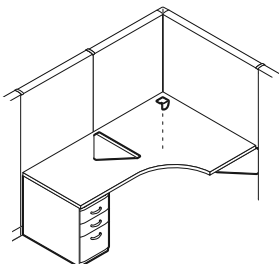
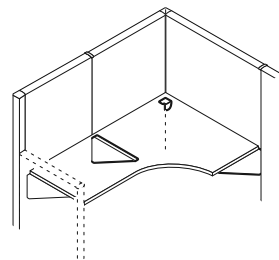
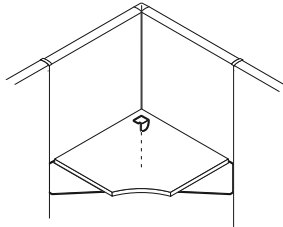

Curvilinear Corner "L" Shape Worksurface

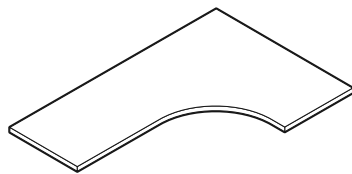

Curvilinear Corner Worksurface Applications

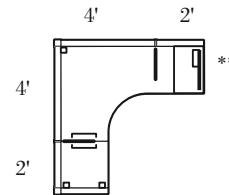
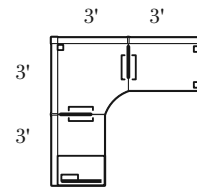

** Requires a return panel or pedestal/panel-mounted C-leg or Open Leg Support with panel-to-worksurface bracket for support

Corner Worksurfaces

Curvilinear Corner "L" shape-Mixed Depths

Mixed Depths

Dividends Horizon

description	1	2	3	4	t	pattern no.	laminate w/ PVC edge	laminate w/ woodgrain edge	laminate w/ metal edge	techwood w/ techwood edge
Curvilinear Corner "L" Shape Worksurface. 30" Deep Returns Left and Right	48"	48"	30"	30"	1 1/4"	D1L 4848DDN	\$575.	\$633.	\$689.	\$1,029.
Curvilinear Corner "L" Shape Worksurface 24" Deep Return Left 30" Deep Return Right	48"	48"	24"	30"	1 1/4"	D1L 4848SDN	568.	625.	682.	1,029.
	48"	60"	24"	30"	1 1/4"	D1L 4860SDN	649.	714.	776.	1,056.
	48"	66"	24"	30"	1 1/4"	D1L 4866SDN	681.	748.	817.	1,083.
	48"	72"	24"	30"	1 1/4"	D1L 4872SDN	714.	784.	855.	1,110.
	60"	48"	24"	30"	1 1/4"	D1L 6048SDN	636.	699.	763.	1,139.
	66"	48"	24"	30"	1 1/4"	D1L 6648SDN	667.	734.	804.	1,166.
	72"	48"	24"	30"	1 1/4"	D1L 7248SDN	701.	772.	842.	1,193.
Curvilinear Corner "L" Shape Worksurface 30" Deep Return Left 24" Deep Return Right	48"	48"	30"	24"	1 1/4"	D1L 4848DSN	568.	625.	682.	1,029.
	48"	60"	30"	24"	1 1/4"	D1L 4860DSN	636.	699.	763.	1,056.
	48"	66"	30"	24"	1 1/4"	D1L 4866DSN	667.	734.	804.	1,083.
	48"	72"	30"	24"	1 1/4"	D1L 4872DSN	701.	772.	842.	1,110.
	60"	48"	30"	24"	1 1/4"	D1L 6048DSN	649.	714.	776.	1,139.
	66"	48"	30"	24"	1 1/4"	D1L 6648DSN	681.	748.	817.	1,166.
	72"	48"	30"	24"	1 1/4"	D1L 7248DSN	714.	784.	855.	1,193.



Note: Above 1, 2, 3, and 4 dimensions are all nominal
Actual dimensions are 1/2" less than shown above.

Ordering Information	Order Code	Included with:	Options
Worksurfaces	Worksurfaces	Worksurfaces	Worksurfaces
1. Pattern Number	<i>Example:</i> D1L 4860SDN, 117, 117	• Worksurface	• 2 center-located edge grommets
2. Top Finish Type	D1L Pattern Number	• Panel-to-worksurface bracket	• Woodgrain PVC edge
3. Edge Band Finish	4860SDN	Note: An upcharge applies when specifying Legacy laminates. See Legacy finish page.	• Metal edge
	117 Soft Grey Laminate		• Techwood
	117 Soft Grey edge band		

To specify edge grommets, replace the "N" suffix from the pattern number with "G"

Add \$28

Note: An overdesk unit will not align with the width of a corner worksurface due to the 1/2" wire drop gap. The overdesk will be 1/2" too wide.

Peninsula Worksurfaces

"D", "P", "9" and Blended "D" Specifications

"D", Blended "D", Conferencing, "P" and "9" Shape Peninsula Worksurfaces

Dividends Horizon peninsula worksurfaces mount perpendicular to panels of the same width to provide conferencing area within a workstation.

"D", "P" and "9" tops are supported by panel-to-worksurface brackets on the flat end and a support column, T leg or A leg support at the free end. Adjacent worksurfaces can attach to peninsula tops with flat brackets.

All brackets and supports are ordered separately. "D", "P" and "9" shape peninsula worksurfaces may be used in freestanding applications.

"D" Shaped Peninsula

Available Sizes

- Depths: 24", 30" and 36"
- Widths: 48", 60", 66" and 72"
- Thickness: 1 1/4"

"P" and "9" Shaped Peninsula

Available Sizes

- Depth: 30" panel depth
- Widths: 66", 72" and 78"
- Conferencing diameter: 36" and 42"
- Thickness: 1 1/4"

Blended "D" Peninsula

Available Sizes

- Depths: 48"
- Widths: 72" and 66"
- Thickness: 1 1/4"

Conferencing Worksurfaces

- Depth: 48"
- Width: 60"
- Thickness: 1 1/4"

"D" and "P" Shape Peninsula Worksurfaces

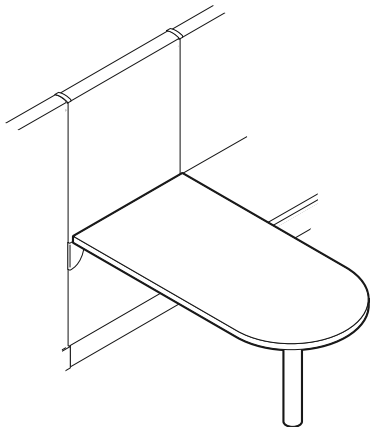

Blended "D" Shape Peninsula Worksurface

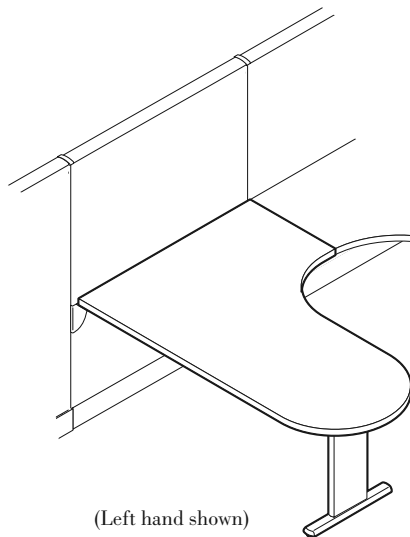

Conferencing Worksurface Dimensions

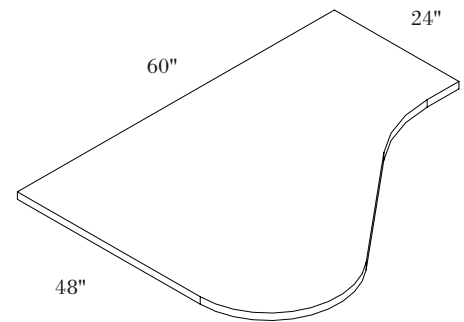





Peninsula Worksurfaces

“D”, “P”, “9” and Blended “D”

Mixed Depths

Dividends Horizon

description	type	w *	w	d	dia.	t	pattern no.	laminata w/	laminata w/	laminata w/	techwood w/	
								PVC edge	woodgrain edge	metal edge	techwood edge	
“D” Peninsula Worksurface Laminate No Grommets 		48"	47 ^{13/16} "	23 ^{13/16} "	1 ^{1/4} "		D1D 4824N	\$390.	\$430.	\$468.	\$967.	
		48"	47 ^{13/16} "	29 ^{13/16} "	1 ^{1/4} "		D1D 4830N	430.	471.	516.	999.	
		60"	59 ^{13/16} "	29 ^{13/16} "	1 ^{1/4} "		D1D 6030N	548.	604.	659.	1,031.	
		66"	65 ^{13/16} "	29 ^{13/16} "	1 ^{1/4} "		D1D 6630N	599.	658.	718.	1,063.	
		72"	71 ^{13/16} "	29 ^{13/16} "	1 ^{1/4} "		D1D 7230N	630.	693.	756.	1,095.	
		72"	71 ^{13/16} "	35 ^{13/16} "	1 ^{1/4} "		D1D 7236N	689.	758.	827.	1,127.	
Blended “D” Peninsula Worksurface (Left hand shown) 	LH w/ 24" return depth	66"	65 ^{13/16} "	47 ^{13/16} "	1 ^{1/4} "		D1BD6648SL	637.	701.	764.	2,257.	
		72"	71 ^{13/16} "	47 ^{13/16} "	1 ^{1/4} "		D1BD7248SL	651.	717.	780.	2,278.	
	LH w/ 30" return depth	66"	65 ^{13/16} "	47 ^{13/16} "	1 ^{1/4} "		D1BD6648DL	670.	741.	806.	2,257.	
		72"	71 ^{13/16} "	47 ^{13/16} "	1 ^{1/4} "		D1BD7248DL	695.	764.	835.	2,278.	
	RH w/ 24" return depth	66"	65 ^{13/16} "	47 ^{13/16} "	1 ^{1/4} "		D1BD6648SR	637.	701.	764.	2,257.	
		72"	71 ^{13/16} "	47 ^{13/16} "	1 ^{1/4} "		D1BD7248SR	651.	717.	780.	2,278.	
	RH w/ 30" return depth	66"	65 ^{13/16} "	47 ^{13/16} "	1 ^{1/4} "		D1BD6648DR	670.	741.	806.	2,257.	
		72"	71 ^{13/16} "	47 ^{13/16} "	1 ^{1/4} "		D1BD7248DR	695.	764.	835.	2,278.	
	Conferencing worksurface (left hand shown) 		60"	59 ^{13/16} "	48"	24"	1 ^{1/4} "	DB1BD48SL	877.	965.	1,053.	2,234.
			60"	59 ^{13/16} "	48"	24"	1 ^{1/4} "	DB1BD48SR	877.	965.	1,053.	2,234.
	Peninsula Worksurface-Laminate No Grommets (9-shaped shown) 	P-shaped	66"	65 ^{13/16} "	29 ^{13/16} "	36"	1 ^{1/4} "	D1P 6630N	626.	687.	750.	1,445.
			72"	71 ^{13/16} "	29 ^{13/16} "	42"	1 ^{1/4} "	D1P 7230N	638.	702.	765.	1,486.
78"			77 ^{13/16} "	29 ^{13/16} "	42"	1 ^{1/4} "	D1P 7830N	716.	786.	857.	1,528.	
9-shaped		66"	65 ^{13/16} "	29 ^{13/16} "	36"	1 ^{1/4} "	D19 6630N	626.	687.	750.	1,445.	
		72"	71 ^{13/16} "	29 ^{13/16} "	42"	1 ^{1/4} "	D19 7230N	638.	702.	765.	1,486.	
		78"	77 ^{13/16} "	29 ^{13/16} "	42"	1 ^{1/4} "	D19 7830N	716.	786.	857.	1,528.	

w* = nominal width
 Dimensions listed under w d t are actual to the nearest 1/16"

Ordering Information	Order Code	Included with:	Options
“D” Worksurface 1. Pattern Number 2. Top Finish Type 3. Edge Finish	“D” Worksurface <i>Example:</i> D1H 6030, 114, 114 D1H 6030 Pattern Number 114 Folkstone Grey Laminate 114 Folkstone Grey Edge Band	Worksurface Note: Support column and panel-to-worksurface brackets must be ordered separately. Note: An upcharge applies when specifying Legacy laminates. See Legacy finish page.	Worksurfaces <ul style="list-style-type: none"> • Woodgrain PVC edge • Metal edge • Techwood edge To specify an edge grommet, replace “N” suffix from pattern number with “G”. Add \$18.

Curvilinear Half-Round Worksurfaces

Curvilinear half-round worksurfaces are sized to match up to the width of two back-to-back 24" deep or two back-to-back 30" deep freestanding desks.

Panel-supported half-round worksurfaces are notched along the flat end to accommodate the panel end trim.

Attachment is with a column support, T leg or A leg (must be ordered separately) at the free end of the worksurface and with flat brackets on the flat end of the half-round worksurface. The flat brackets attach to the adjacent freestanding desks. Flat brackets are black.

Available Sizes

- Depths: 18" and 24"
- Widths: 48" and 63"
- Thickness: 1 1/4"

Note: All Dividends Horizon worksurfaces include a 1/2" wire drop at the rear edge. When used back to back with Half-Round worksurface, these two 1/2" wire drops will meet to form a 1" space between worksurfaces.

Transition Worksurfaces

Attachment is with a column support, T leg or A leg (must be ordered separately) at the free end of the worksurface and with flat brackets on the flat end of the transition worksurface. The flat brackets attach to the adjacent freestanding desks. Flat brackets are black.

Available Sizes

- Depths: 24", 36", 48"
- Widths: 48"
- Thickness: 1 1/4"

Corner Round Worksurfaces

Corner-round worksurfaces are designed to "finish" a run of panel-mounted worksurfaces. Corner-round may be specified in two ways.

In a 90° "L" configuration, a notched corner-round worksurface is used to wrap around the panels. Two cantilevers and flat brackets (must be ordered separately) support the corner-round worksurface.

In an end run configuration, the corner-round worksurface is handed and must be specified as a left-hand or a right-hand top. One cantilever with a flat bracket and one panel-to-worksurface bracket (must be ordered separately) support the corner-round top.

Available Sizes

- Depth: 24"
- Width: 24"
- Thickness: 1 1/4"

Optional Edge Grommets

Grommets are not available for worksurfaces on this page.

Curvilinear Half-Round Worksurfaces (without panels)

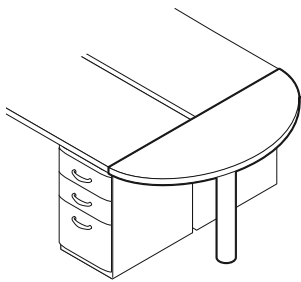

Curvilinear Half-Round Worksurfaces (with panels)

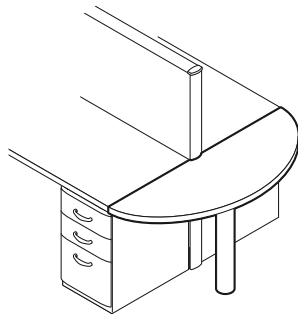

Corner-Round Worksurface

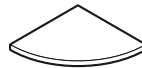

Notched Corner Worksurfae



Corner-Round Applications

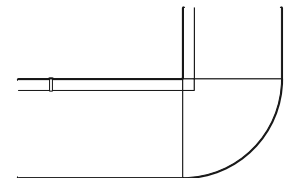

Corner-Round - Notched "L" Configuration

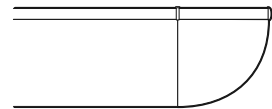



Corner-Round - End Run Configuration (right-hand shown) Quarter-round Surface

Curvilinear Half- and Corner-Round Worksurfaces

Mixed Depths

Dividends Horizon

description	type	w	return depth	t	pattern no.	laminate w/ PVC edge	laminate w/ woodgrain edge	laminate w/ metal edge	techwood w/ techwood edge
 Curvilinear Half-Round Worksurface	w/o panels	48"	18"	1 1/4"	D1H4818	\$339.	\$374.	\$407.	\$930.
	w/o panels	60"	24"	1 1/4"	D1H6024	467.	514.	561.	1,012.
	w/panels	51"	18"	1 1/4"	D1H5118P	345.	380.	414.	970.
	w/panels	63"	24"	1 1/4"	D1H6324P	472.	521.	569.	1,053.
 Transition Worksurface	w panels	51"	24"	1 1/4"	D2H5124P	416.	458.	499.	1,081.
	w panels	51"	36"	1 1/4"	D2H5136P	424.	465.	510.	1,117.
	w panels	51"	48"	1 1/4"	D2H5148P	432.	474.	519.	1,151.
	w/o panels	48"	24"	1 1/4"	D2H4824	411.	450.	492.	977.
	w/o panels	48"	36"	1 1/4"	D2H4836	417.	459.	501.	1,012.
	w/o panels	48"	48"	1 1/4"	D2H4848	427.	468.	512.	1,047.
 Corner Round Worksurface	left	23 13/16"	23 1/2"	1 1/4"	D1CRL24	181.	198.	216.	792.
	notched	23 1/2"	23 1/2"	1 1/4"	D1CRN24	181.	198.	216.	792.
	right	23 13/16"	23 1/2"	1 1/4"	D1CRR24	181.	198.	216.	792.

Ordering Information

Half-Round Worksurface

1. Pattern Number
2. Top Finish Type
3. Edge Finish

Transition Worksurface

1. Pattern Number
2. Top Finish Type
3. Edge Finish

Corner-Round Worksurface

1. Pattern Number
2. Top Finish Type
3. Edge Finish

Order Code

Half-Round Worksurface

Example: **D1H 5118P, 118, 118**

D1H Pattern Number
5118P

118 Bright White Laminate

118 Bright White Edge Band

Transition Worksurface

Example: **D2H 5136P, 117, 117**

D2H Pattern Number
5136P

117 Soft Grey Laminate

117 Soft Grey Edge Band

Included with:

Half-Round Worksurface

- Worksurface
- 2 flat brackets

Note: Support column must be ordered separately.

Transition Worksurface

- Worksurface
- 2 flat brackets

Note: Support column must be ordered separately.

Corner Round Worksurface

- Worksurface

Note: 2 cantilevers must be ordered separately.

Note: An upcharge applies when specifying Legacy laminates. See Legacy finish page.

Options

Half-Round Worksurface

- Woodgrain PVC edge
- Metal edge
- Techwood edge

Transition Worksurface

- Woodgrain PVC edge
- Metal edge
- Techwood edge

Corner-Round Worksurface

- Woodgrain PVC edge
- Metal edge
- Techwood edge

Transaction Counter Worksurfaces

15" Deep Specifications

15"D Counter Worksurfaces

Dividends Horizon 15"D counter worksurfaces attach to the tops of 42" high panels to provide a transaction area within workstations. Three types are available:

- Straight
- Square corner
- Quarter-round corner

Available Sizes

- Depth: 15"
- Widths: 24" to 96"
- Thickness: 1 1/4"

Straight Counter Worksurface Support

Straight counter worksurfaces can span single or multiple panels. Counter worksurfaces are supported by four counter worksurface brackets which are included with the straight counter worksurfaces. Counter worksurface brackets are required at panel or post junctions for proper support.

Note: High-low panel end trim must be field cut when using countertops in a high-low straight panel run application.

Note: Counter worksurfaces may NOT be used with on any screens or 36H panels.

Square and Quarter-Round Corner Counter Worksurfaces

Square corners allow rectilinear "L", "T" and "X" configurations while quarter-round corners allow radiused "L" configurations. When using corner counter worksurfaces, all adjoining straight counter worksurfaces must be 6" less than panel(s) width dimension. Square and quarter-round counter worksurfaces are supported by flat brackets which are included with corner worksurfaces. Additional support is provided by counter worksurface brackets from the adjoining straight counter worksurfaces.

Square-corner counter worksurfaces include three flat brackets while quarter-round counters include two flat brackets. Flat brackets are dark grey finish.

Counter Worksurface Corner Applications

Suggested applications and configurations are illustrated below.

Note: When connecting a 15" deep counter worksurface with either corner counter worksurface, specify 6" shorter than the required width to accommodate the width of the corner counter worksurface.

Counter Worksurface Supports

Straight counter worksurfaces 24" to 48" wide include four counter worksurface brackets while straight counters 54" to 96" wide include six counter worksurface brackets.

15"D Counter Worksurface

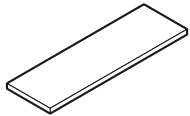

15"D Square-Shape Counter Worksurface



15"D Quarter Round Counter Worksurface



15"D Counter Worksurface Sizes Available

15D	
24	
30	
36	
42	
48	
54	
60	
66	
72	
78	
84	
90	
96	
15	
15	

15"D Counter Worksurface Applications

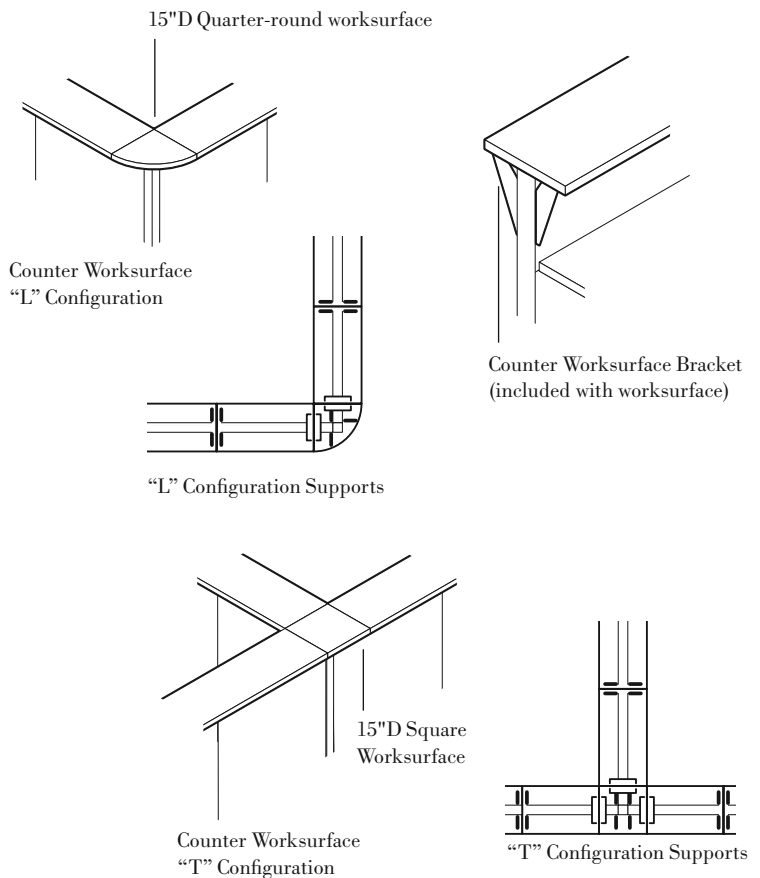



Transaction Counter Worksurfaces

Rectangular, Square Corner and Quarter-round Corner

15" Deep

Dividends Horizon

description	w *	w	d	t	pattern no.	laminates w/ PVC edge	laminates w/ woodgrain edge	laminates w/ metal edge	techwood w/ techwood edge
15" Deep Quarter-Round Shape Corner Counter Worksurface 	15"	14 ^{13/16"}	15"	1 ^{1/4"}	D1R 1515C	\$179.	\$198.	\$217.	\$725.
15" Deep Square-Shape Corner Counter Worksurface 	15"	14 ^{13/16"}	15"	1 ^{1/4"}	D1R 1515S	164.	182.	198.	455.
15" Deep Rectangular Counter Worksurface 	24"	23 ^{13/16"}	15"	1 ^{1/4"}	D1R 2415	206.	226.	247.	469.
	30"	29 ^{13/16"}	15"	1 ^{1/4"}	D1R 3015	222.	245.	266.	490.
	36"	35 ^{13/16"}	15"	1 ^{1/4"}	D1R 3615	228.	251.	274.	512.
	42"	41 ^{13/16"}	15"	1 ^{1/4"}	D1R 4215	229.	252.	275.	533.
	48"	47 ^{13/16"}	15"	1 ^{1/4"}	D1R 4815	229.	252.	275.	554.
	54"	54 ^{13/16"}	15"	1 ^{1/4"}	D1R 5415	238.	261.	288.	574.
	60"	59 ^{13/16"}	15"	1 ^{1/4"}	D1R 6015	252.	278.	303.	596.
	66"	65 ^{13/16"}	15"	1 ^{1/4"}	D1R 6615	261.	289.	314.	617.
	72"	71 ^{13/16"}	15"	1 ^{1/4"}	D1R 7215	287.	314.	342.	638.
	78"	77 ^{13/16"}	15"	1 ^{1/4"}	D1R 7815	303.	333.	364.	659.
	84"	83 ^{13/16"}	15"	1 ^{1/4"}	D1R 8415	318.	351.	382.	680.
	90"	89 ^{13/16"}	15"	1 ^{1/4"}	D1R 9015	335.	369.	401.	701.
	96"	95 ^{13/16"}	15"	1 ^{1/4"}	D1R 9615	351.	386.	420.	722.

w* = nominal width

Dimensions listed under w d are actual to the nearest 1/16"

Ordering Information	Order Code	Included with:	Options
15"D Counter Worksurface 1. Pattern Number 2. Top Finish Type 3. Edge Finish 4. Counter Worksurface Bracket Finish Square-Shape Corner Counter Worksurface 1. Pattern Number 2. Top Finish Type 3. Edge Finish Quarter-Round Shape Counter Worksurface 1. Pattern Number 2. Top Finish Type 3. Edge Finish	15"D Counter Worksurface <i>Example:</i> D1R 3615, 117, 117, 117 D1R 3615 Pattern Number 117 Soft Grey Laminate 117 Soft Grey Edge Band 117 Soft Grey Bracket Finish Square-Shape Counter Worksurface <i>Example:</i> D1R 1515S, 117, 117 D1R Pattern Number 1515S 117 Soft Grey Laminate 117 Soft Grey Edge Band Quarter-Round Shape Counter Worksurface <i>Example:</i> D1R 1515C, 117, 117 D1R Pattern Number 1515C 117 Soft Grey Laminate 117 Soft Grey Edge Band	15"D Counter Worksurface <ul style="list-style-type: none"> Four counter worksurface brackets Attachment hardware Square-Shape Counter Worksurface <ul style="list-style-type: none"> Three counter worksurface flat brackets Attachment hardware Quarter-Round Shape Counter Worksurface <ul style="list-style-type: none"> Two counter worksurface flat brackets Attachment hardware <p>Note: An upcharge applies when specifying Legacy laminates. See Legacy finish page.</p>	15"D Counter Worksurface <ul style="list-style-type: none"> Woodgrain PVC edge Metal edge Techwood edge Square-Shape Counter Worksurface <ul style="list-style-type: none"> Woodgrain PVC edge Metal edge Techwood edge Quarter-Round Shape Counter Worksurface <ul style="list-style-type: none"> Woodgrain PVC edge Metal edge Techwood edge

Rectangular with Cascade Edge 24" and 30" Deep

Dividends Horizon

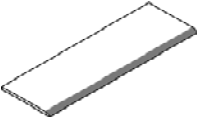
description	w	d	t	pattern no.	Solid	Woodgrain
24" D Rectangular 	24"	24"	1 1/4"	DCE1R2424N	\$195.	\$224.
	30"	24"	1 1/4"	DCE1R3024N	224.	258.
	36"	24"	1 1/4"	DCE1R3624N	248.	286.
	42"	24"	1 1/4"	DCE1R4224N	286.	329.
	48"	24"	1 1/4"	DCE1R4824N	321.	369.
	54"	24"	1 1/4"	DCE1R5424N	345.	396.
	60"	24"	1 1/4"	DCE1R6024N	374.	430.
	66"	24"	1 1/4"	DCE1R6624N	404.	464.
	72"	24"	1 1/4"	DCE1R7224N	422.	486.
	78"	24"	1 1/4"	DCE1R7824N	453.	521.
	84"	24"	1 1/4"	DCE1R8424N	479.	550.
	90"	24"	1 1/4"	DCE1R9024N	540.	621.
96"	24"	1 1/4"	DCE1R9624N	590.	678.	
30" D Rectangular 	24"	30"	1 1/4"	DCE1R2430N	249.	287.
	30"	30"	1 1/4"	DCE1R3030N	279.	321.
	36"	30"	1 1/4"	DCE1R3630N	310.	357.
	42"	30"	1 1/4"	DCE1R4230N	337.	387.
	48"	30"	1 1/4"	DCE1R4830N	374.	430.
	54"	30"	1 1/4"	DCE1R5430N	423.	487.
	60"	30"	1 1/4"	DCE1R6030N	465.	535.
	66"	30"	1 1/4"	DCE1R6630N	519.	596.
	72"	30"	1 1/4"	DCE1R7230N	540.	621.
	78"	30"	1 1/4"	DCE1R7830N	577.	663.
	84"	30"	1 1/4"	DCE1R8430N	613.	705.
	90"	30"	1 1/4"	DCE1R9030N	659.	758.
96"	30"	1 1/4"	DCE1R9630N	705.	810.	

Ordering Information

1. Pattern Number
2. Top Finish Type

Order Code

Worksurfaces	
Example: DCE1R4824N, 118	
DCE1	Dividends Cascade Edge Worksurface
R	Rectangular
48	Width
24	Depth
N	No Grommet
118	Bright White finish

Included with:

Specify worksurface supports separately.

Available Colors:

Solid:

- 114 Folkstone Grey
- 117 Soft Grey
- 118 Bright White
- 119 Pumice

Woodgrain:



- 124 Medium Cherry
- 125 Natural Maple
- 126 Natural Cherry
- 127 Walnut

Options

Worksurfaces

- Center-Located Edge Grommet
To specify, replace the "N" suffix from the pattern number with "G".
Add \$21.

Shaded area on worksurface drawings represents cascade edge detail.

description	A	B	C	pattern no.	Solid	Woodgrain
Blended “D”  right hand shown	66"	48"	24"	DCE1BD6648S(L/R)	\$791.	\$909.
	66"	48"	30"	DCE1BD6648D(L/R)	831.	957.
	72"	48"	24"	DCE1BD7248S(L/R)	808.	931.
	72"	48"	30"	DCE1BD7248D(L/R)	862.	992.
	78"	48"	24"	DCE1BD7848S(L/R)	934.	1,074.
	78"	48"	30"	DCE1BD7848D(L/R)	965.	1,109.
	84"	48"	24"	DCE1BD8448S(L/R)	959.	1,103.
	84"	48"	30"	DCE1BD8448D(L/R)	1,020.	1,172.
Blended “L” 	36"	24"	24"	DCE1L3636SSN	489.	563.
	42"	24"	24"	DCE1L4242SSN	590.	678.
	42"	24"	30"	DCE1L4242SDN	701.	805.
	42"	30"	24"	DCE1L4242DSN	701.	805.
	48"	24"	24"	DCE1L4848SSN	663.	763.
	48"	24"	30"	DCE1L4848SDN	793.	912.
	48"	30"	24"	DCE1L4848DSN	793.	912.
	48"	30"	30"	DCE1L4848DDN	712.	819.

Ordering Information

1. Pattern Number
2. Top Finish Type

Order Code

Worksurfaces

Example: **DCE1BD7248SL, 118**

DCE1	Dividends Cascade Edge worksurface
BD	Blended “D”
72	Width
48	Depth
S	24”d return
L	Extended Left
118	Bright White

Included with:

Available Colors:

Solid:

114	Folkstone Grey
117	Soft Grey
118	Bright White
119	Pumice

Woodgrain:

124	Medium Cherry
125	Natural Maple
126	Natural Cherry
127	Walnut

Options

Worksurfaces

- Center-Located Edge Grommet (Blended “L” only)To specify, replace the “N” suffix from the pattern number with “G”.
Add \$42.

Note: Support column and panel-to-worksurface brackets must be ordered separately.

Shaded area on worksurface drawings represents cascade edge detail.

Note: When wood grain or brushed laminates are specified on Cascade corner worksurfaces with two “A” sides of equal length, one of three grain direction options must be specified. Insert the desired grain direction option (L,R or D) after the laminate code. Please add \$25 to the list price for diagonal grain (D) selection.

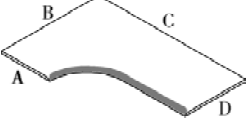
description	Width B	Width C	Width A	Width D	t	pattern no.	Solid	Woodgrain
Blended “L” 	42"	60"	24"	24"	1 1/4"	DCE1L4260SSN	\$810.	\$932.
	42"	66"	24"	24"	1 1/4"	DCE1L4266SSN	831.	957.
	42"	72"	24"	24"	1 1/4"	DCE1L4272SSN	863.	993.
	42"	78"	24"	24"	1 1/4"	DCE1L4278SSN	873.	1,003.
	48"	60"	24"	24"	1 1/4"	DCE1L4860SSN	821.	943.
	48"	60"	24"	30"	1 1/4"	DCE1L4860SDN	805.	927.
	48"	60"	30"	24"	1 1/4"	DCE1L4860DSN	805.	927.
	48"	66"	24"	24"	1 1/4"	DCE1L4866SSN	850.	977.
	48"	66"	24"	30"	1 1/4"	DCE1L4866SDN	847.	974.
	48"	66"	30"	24"	1 1/4"	DCE1L4866DSN	847.	974.
	48"	72"	24"	24"	1 1/4"	DCE1L4872SSN	881.	1,013.
	48"	72"	24"	30"	1 1/4"	DCE1L4872SDN	886.	1,020.
	48"	72"	30"	24"	1 1/4"	DCE1L4872DSN	886.	1,020.
	48"	78"	24"	24"	1 1/4"	DCE1L4878SSN	971.	1,117.
	48"	84"	24"	24"	1 1/4"	DCE1L4884SSN	1,092.	1,256.
	60"	42"	24"	24"	1 1/4"	DCE1L6042SSN	810.	932.
	60"	48"	24"	24"	1 1/4"	DCE1L6048SSN	821.	943.
	60"	48"	24"	30"	1 1/4"	DCE1L6048SDN	805.	927.
	60"	48"	30"	24"	1 1/4"	DCE1L6048DSN	805.	927.
	66"	42"	24"	24"	1 1/4"	DCE1L6642SSN	831.	957.
	66"	48"	24"	24"	1 1/4"	DCE1L6648SSN	850.	977.
	66"	48"	24"	30"	1 1/4"	DCE1L6648SDN	847.	974.
	66"	48"	30"	24"	1 1/4"	DCE1L6648DSN	847.	974.
	72"	42"	24"	24"	1 1/4"	DCE1L7242SSN	863.	993.
	72"	48"	24"	24"	1 1/4"	DCE1L7248SSN	881.	1,013.
	72"	48"	24"	30"	1 1/4"	DCE1L7248SDN	886.	1,020.
	72"	48"	30"	24"	1 1/4"	DCE1L7248DSN	886.	1,020.
	78"	42"	24"	24"	1 1/4"	DCE1L7842SSN	873.	1,003.
78"	48"	24"	24"	1 1/4"	DCE1L7848SSN	971.	1,117.	
84"	48"	24"	24"	1 1/4"	DCE1L8448SSN	1,092.	1,256.	

Ordering Information

1. Pattern Number
2. Top Finish Type

Order Code





Worksurfaces	
Example:	DCE1L4872SDG,114
DCE1	Dividends Cascade Edge worksurface
L	Blended “L”
48	Width
72	Depth
S	24”d, left side
D	30”d, right side
G	Grommet
114	Folkstone Grey

Included with:

Available Colors:	
Solid:	
114	Folkstone Grey
117	Soft Grey
118	Bright White
119	Pumice
Woodgrain:	
124	Medium Cherry
125	Natural Maple
126	Natural Cherry
127	Walnut

Options

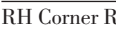
- Worksurfaces**
- Center-Located Edge Grommet
To specify, replace the “N” suffix from the pattern number with “G”.
Add \$42.
- Note:** Specify the panel-to-worksurface brackets separately.
- Shaded area on worksurface drawings represents cascade edge detail.

description	w	d	t	pattern no.	Solid	Woodgrain
	48"	18"	1 1/4"	DCE1H4818	\$422.	\$486.
	48"	18"	1 1/4"	DCE1H4818P	422.	486.
	60"	24"	1 1/4"	DCE1H6024	581.	670.
	60"	24"	1 1/4"	DCE1H6024P	581.	670.
LH Corner Round	24"	24"	1 1/4"	DCE1CR24L	224.	258.
						
RH Corner Round	24"	24"	1 1/4"	DCE1CR24R	224.	258.
						
Notched Corner Round	24"	24"	1 1/4"	DCE1CR24N	224.	258.
						

Ordering Information

1. Pattern Number
2. Top Finish Type

Order Code

Worksurfaces	
Example:	DCE1H4818P,117
DCE1	Dividends Cascade Edge worksurface
H	Half Round
48	Width
18	Depth
P	Notched for panel
117	Soft Grey

Included with:

Available Colors:	
Solid:	
114	Folkstone Grey
117	Soft Grey
118	Bright White
119	Pumice
Woodgrain:	
124	Medium Cherry
125	Natural Maple
126	Natural Cherry
127	Walnut

Options

P= Notched for panel

Note: Specify all support brackets separately.

Shaded area on worksurface drawings represents cascade edge detail.

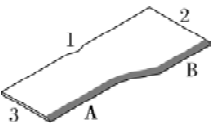
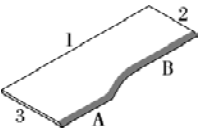
description	1	2	3	A	B	t	pattern no.	Solid	Woodgrain
Wave End, RH 	36"	30"	24"	3"	15"	1 1/4"	DCE1W362430N	\$525.	\$604.
	42"	30"	24"	9"	15"	1 1/4"	DCE1W422430N	551.	635.
	48"	30"	24"	15"	15"	1 1/4"	DCE1W482430N	591.	679.
	72"	30"	24"	30 1/2"	23 1/2"	1 1/4"	DCE1W722430N	752.	864.
<i>shown with grommet</i>									
Wave End, LH 	36"	24"	30"	15"	3"	1 1/4"	DCE1W363024N	525.	604.
	42"	24"	30"	15"	9"	1 1/4"	DCE1W423024N	551.	635.
	48"	24"	30"	15"	15"	1 1/4"	DCE1W483024N	591.	679.
	72"	24"	30"	23 1/2"	30 1/2"	1 1/4"	DCE1W723024N	752.	864.

Ordering Information

1. Pattern Number
2. Top Finish Type

Order Code

Worksurfaces	
Example:	DCE1W483024N,118
DCE1	Dividends Cascade Edge worksurface
W	Wave End
48	Width
30	30"d, left side
24	24"d, right side
N	No grommet
118	Bright White

Included with:

Available Colors:	
Solid:	
114	Folkstone Grey
117	Soft Grey
118	Bright White
119	Pumice
Woodgrain:	
124	Medium Cherry
125	Natural Maple
126	Natural Cherry
127	Walnut

Options

- Worksurfaces**
- Center-Located Edge Grommet
To specify, replace the "N" suffix from the pattern number with "G".
Add \$21.
- Note:** Specify all support brackets separately.
- Shaded area on worksurface drawings represents cascade edge detail.

This page intentionally left blank

Worksurface Supports

Worksurfaces are shipped without supports which must be ordered separately.

A variety of worksurface supports are available. They include:

- Cantilevers
- Flat brackets
- Panel-to-worksurface brackets

In addition, freestanding pedestals and end units can also be used for worksurface support.

Cantilevers and panel-to-worksurface brackets are used strictly in panel-mount applications while flat brackets, pedestals and end units can be used in both panel-mounted and freestanding applications.

Cantilevers

Cantilevers provide panel-hung worksurface support when the worksurface width runs parallel to the panel run.

Primary cantilever applications include:

- Corner worksurfaces
- Worksurface mid-span support
- 18" and 24" deep rectangular worksurface support in moderate load situations

Note: For heavy load applications, panel-to-worksurface brackets, freestanding pedestal, panel-mount C-leg, or open support leg is recommended. In applications involving 30" deep worksurfaces, cantilevers are only recommended for mid-span support.

Cantilevers are left- and right-handed and are available in three depths (18", 24" and 30") to support 18", 24" and 30" deep worksurfaces.

Note: 36" deep worksurfaces cannot be supported by cantilevers.

- **Attachment:** Cantilevers lock into the panel's slotted standard and adjust vertically in 1 1/2" increments. Cantilevers are left- or right-handed
- **Construction:** 14-gauge, black painted steel

Flat Brackets

Flat brackets are used to join a primary worksurface with an adjacent return or bridge unit worksurface at the same height.

Flat brackets are available in three depths to support 18", 24" and 30" deep worksurface returns.

- **Attachment:** Flat brackets attach to pre-drilled positions on the undersides of worksurfaces with provided screws
- **Construction:** 14-gauge painted steel

Shared Cantilevers

Adjacent worksurfaces can share a single cantilever if the appropriate flat bracket is used in conjunction with the appropriate cantilever (i.e. 18" cantilever with 18" flat bracket).

Panel-to-Worksurface Brackets, Worksurface Support

Panel-to-worksurface brackets are used to:

- Mount worksurfaces perpendicular to panels
- Anchor the rear corner of corner worksurfaces to panels
- Secure a panel to a pedestal

Panel-to-worksurface brackets provide the most secure panel-hung support for heavily loaded worksurfaces.

Panel worksurface brackets are handed left or right.

Note: The panel width must match the worksurface depth for panel-to-worksurface brackets to connect worksurfaces perpendicular to panels.

- **Attachment:** Panel-to-worksurface brackets lock into the panel's slotted standard and adjust vertically in 1 1/2" increments
- **Construction:** 14-gauge painted steel

Panel-to-Worksurface Brackets, Stabilizing Support

Panel-to-worksurface brackets are also used in conjunction with pedestals to stabilize panel runs.

In applications where the worksurface is "wrapped" with a return panel and a pedestal is installed below the worksurface at the "wrapped" end, a panel-to-worksurface bracket is used at the front corner of the worksurface. In pedestal applications, the panel-to-worksurface bracket connects the pedestal at the rear corner of the pedestal to the panel (as shown in the illustration below) or front corner of the pedestal to the panel when a return wing panel is used.

Panel-to-Worksurface Brackets, Off-Module Support

For applications where the width of the panel exceeds the depth of the worksurface, specify off-module panel-to-worksurface brackets which allow off module worksurface support.

Worksurface Reinforcement

Worksurface reinforcements are required for worksurface spans greater than 48 inches. This includes freestanding desk worksurfaces over 48 inches using desk end units. Worksurface reinforcements have a black paint finish.

Panel Mounted Worksurface Bracket Application

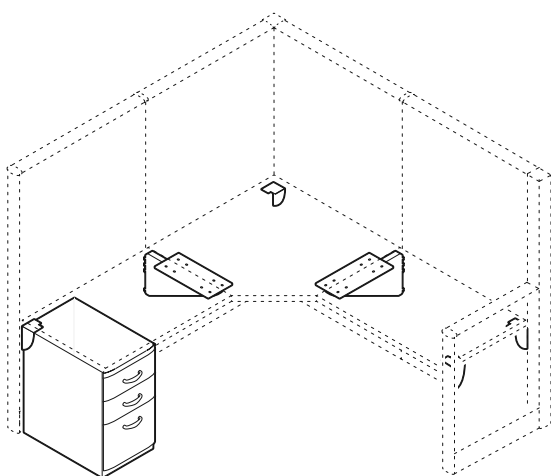

Flat Bracket Application

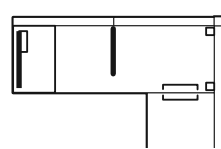

Shared Cantilever Application

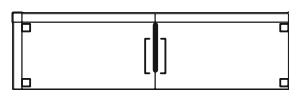

Stabilizing Support

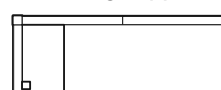

Off-Module Support

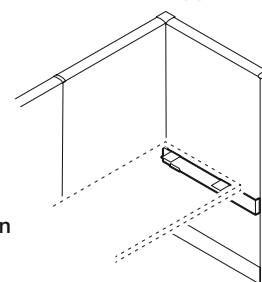



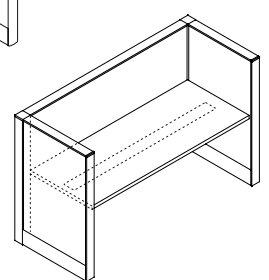



Worksurface Reinforcement Panel Hung Application



Panel Mounted Worksurface Brackets

Cantilevers, Flat Brackets and Panel-to-Worksurface Brackets

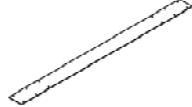
Dividends Horizon

description	type	w	d	h	pattern no.	black	P1	P2	P3
Cantilever Bracket Left or Right (Left Shown) (package of 10) 	For 18"D WS	1 ⁵ / ₁₆ "	12 ³ / ₁₆ "	11 ¹³ / ₁₆ "	DB1C 18 (L or R) 10	\$356.	\$374.	\$392.	\$409.
	For 24"D WS	1 ⁵ / ₁₆ "	20 ⁵ / ₈ "	10 ¹ / ₂ "	DB1C 24 (L or R) 10	444.	466.	488.	511.
	For 30"D WS	1 ⁵ / ₁₆ "	26 ¹⁵ / ₁₆ "	10 ¹ / ₂ "	DB1C 30 (L or R) 10	634.	666.	697.	729.
Cantilever Brackets, Left or Right (Left Shown) (single pack) 	For 18"D WS	1 ⁵ / ₁₆ "	12 ³ / ₁₆ "	11 ¹³ / ₁₆ "	DB1C 18 (L or R)	36.	38.	40.	41.
	For 24"D WS	1 ⁵ / ₁₆ "	20 ⁵ / ₈ "	10 ¹ / ₂ "	DB1C 24 (L or R)	47.	49.	52.	54.
	For 30"D WS	1 ⁵ / ₁₆ "	26 ¹⁵ / ₁₆ "	10 ¹ / ₂ "	DB1C 30 (L or R)	65.	68.	72.	75.
Cantilever Brackets for 120° Planning (Left Shown)(single pack) 		20 ⁵ / ₈ "		1 ⁵ / ₁₆ "	DB120C (L or R)	47.	49.	52.	54.
Flat Bracket (single pack) 	For 18"D WS	3 ³ / ₄ "	8 ⁵ / ₁₆ "		DB1F 18SP	15.	n/a	n/a	n/a
	For 24"D WS	3 ³ / ₄ "	14 ⁵ / ₈ "		DB1F 24SP	25.	n/a	n/a	n/a
	For 30"D WS	3 ³ / ₄ "	20 ¹⁵ / ₁₆ "		DB1F 30SP	29.	n/a	n/a	n/a
Flat Bracket (package of 10) 	For 18"D WS	3 ³ / ₄ "	8 ⁵ / ₁₆ "		DB1F18TP	120.	n/a	n/a	n/a
	For 24"D WS	3 ³ / ₄ "	14 ³ / ₁₆ "		DB1F24TP	200.	n/a	n/a	n/a
	For 30"D WS	3 ³ / ₄ "	20 ⁵ / ₁₆ "		DB1F30TP	230.	n/a	n/a	n/a
Worksurface Reinforcement 		54"	4"		DB1WR54	58.	n/a	n/a	n/a
		60"	4"		DB1WR60	59.	n/a	n/a	n/a
		66"	4"		DB1WR66	61.	n/a	n/a	n/a
		72"	4"		DB1WR72	63.	n/a	n/a	n/a
Panel-to-Worksurface Brackets (Individual) 	Left (Shown)	3"	3"	4 ¹¹ / ₁₆ "	DB1P WS L	6.	6.	7.	7.
	Right	3"	3"	4 ¹¹ / ₁₆ "	DB1P WS R	6.	6.	7.	7.

Worksurface Supports

Ordering Information

Panel-to-Worksurface Bracket, Off Module

1. Pattern Number
2. Trim Finish

Order Code

Panel-to-Worksurface Bracket, Off Module

Example: **DB1P WS36, 113**

DB1P	Pattern Number
WS36	
113	Dark Grey Finish

Included with:

Panel-to-Worksurface Bracket, Off Module

- Trim finish mounting rail
- Worksurface brackets

Options

Panel-to-Worksurface Bracket, Off Module

Cantilevers, Flat Brackets and Panel-to-Worksurface Brackets

description	type	w	d	h	pattern no.	black	P1	P2	P3
Panel-to-Worksurface Brackets (Pair)	Left/Right	3"	3"	4 ^{11/16} "	DB1P WS P	\$13.	\$14.	\$14.	\$15.
Panel-to-Worksurface Brackets (Off Module)	For 24" Wide Panel				DB1P WS24	n/a	61.	66.	68.
	For 30" Wide Panel				DB1P WS30	n/a	64.	70.	74.
	For 36" Wide Panel				DB1P WS36	n/a	67.	74.	78.
	For 42" Wide Panel				DB1P WS42	n/a	72.	81.	86.
	For 48" Wide Panel				DB1P WS48	n/a	78.	86.	89.

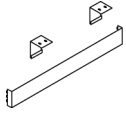

Ordering Information

Panel-to-Worksurface Bracket, Off Module

1. Pattern Number
2. Trim Finish

Order Code

Panel-to-Worksurface Bracket, Off Module

Example: **DB1P WS36, 113**

DB1P Pattern Number

WS36

113 Dark Grey Finish

Included with:

Panel-to-Worksurface Bracket, Off Module

- Trim finish mounting rail
- Worksurface brackets

Options

Panel-to-Worksurface Bracket, Off Module

This page intentionally left blank

Screen-to-Worksurface Brackets, Worksurface Support

Screen-to-worksurface brackets are used to:

- Mount worksurfaces perpendicular to screens
- Anchor the rear corner of corner worksurfaces to screens

Screen-to-worksurface brackets provide the most secure screen-hung support for heavily loaded worksurfaces.

Screen worksurface brackets are handed left or right.

Note: The screen width must match the worksurface depth for screen-to-worksurface brackets to connect worksurfaces perpendicular to screens.

- **Attachment:** Screen-to-worksurface brackets lock into the screen's slotted standard and adjust vertically in 1 1/2" increments
- **Construction:** 14-gauge painted steel

Screen-to-Worksurface Support Application

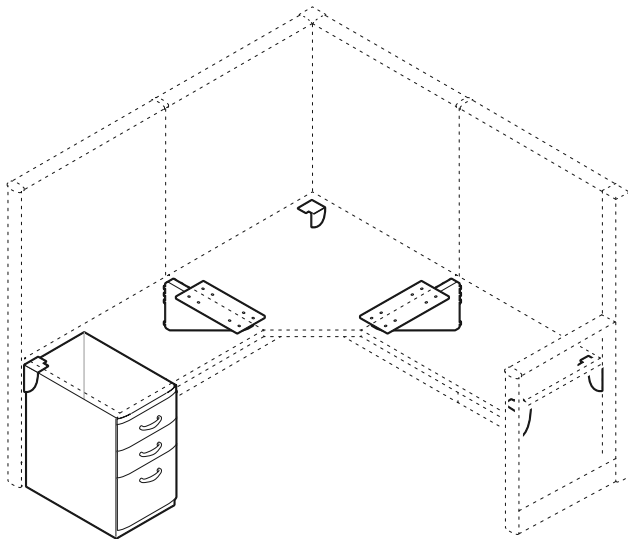

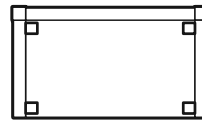

Screen-to-Worksurface Brackets



Screen-to-Worksurface Brackets

Screen mid-span worksurface support

description	type	w	d	h	pattern no.	P1	P2	P3
Screen-to-Worksurface Brackets (Individual)	Left				DB1SWSL	\$6.	\$8.	\$10.
	Right				DB1SWSR	6.	8.	10.
								
Screen-to-Worksurface Brackets (Pair)	Left/Right				DB1SWSP	13.	17.	21.
Screen Mid-Span Worksurface Support	left hand				DBSMLH	22.	23.	24.
	right hand				DBSMRH	22.	23.	24.
								

Ordering Information

Panel-to-Worksurface Bracket, Off Module

1. Pattern Number
2. Trim Finish

Order Code

Panel-to-Worksurface Bracket, Off Module

Example: **DB1P WS36, 113**

DB1P Pattern Number

WS36

113 Dark Grey Finish

Included with:

Panel-to-Worksurface Bracket, Off Module

- Trim finish mounting rail
- Worksurface brackets

Options

Panel-to-Worksurface Bracket, Off Module

Panel-Mounted C-Leg and Open Leg Worksurface Support

Panel-mounted C-leg and Open Leg worksurface supports provide panel-hung worksurface support when the worksurface width runs parallel to the panel run.

Primary panel-mounted C-leg and Open Leg support applications include:

- Rectangular worksurface end support for 24" and 30" depth worksurfaces
- Mid span worksurface support for 24" and 30" depth worksurfaces
- Corner and split top corner worksurface support
- Support for heavier worksurface load applications
- Shared support between two adjacent worksurfaces

Note: 18" deep and 36" worksurface may not be used with panel-mounted C-leg worksurface support.

Construction

C-leg support specifications:

- Support foot: die cast aluminum
- Support leg: extruded aluminum
- Mounting bracket: $\frac{3}{16}$ " steel plate

Construction

Open Support Leg specifications

- Vertical members: extruded aluminum
- Top plate and spanner bar: 0.025" cold rolled steel
- Mounting brackets: $\frac{3}{16}$ " steel plate

Note: Open support legs are only available in Knoll Core finishes

Note: Shared P-leg is designed for use where 2 panels meet. It cannot be used on the end of a panel run.

Panel-Mounted C-Leg Support

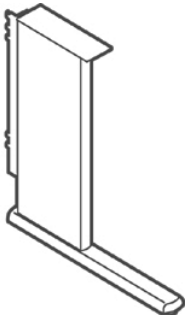

Panel-Mounted C-Leg Support (radiused foot)

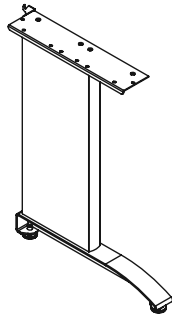

Open Support Leg

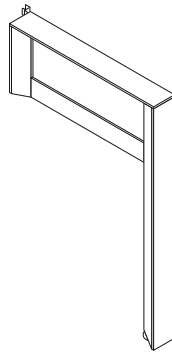

Panel Mounted Worksurface Supports

Open Support Leg and C-Leg

Dividends Horizon

description	type	w	d	h	pattern no.	P1	P2	P3
Panel Mounted C-Leg Worksurface Support (Left-hand shown)	Left-hand C-Leg			26 ⁷ / ₈ "	DB1CL24L	\$307.	\$338.	\$353.
	Right-hand C-Leg			26 ⁷ / ₈ "	DB1CL 24R	307.	338.	353.
	Shared C-Leg			26 ⁷ / ₈ "	DB1CL24S	326.	358.	376.
Panel Mounted C-Leg Worksurface Support Radiused Foot (Right-hand shown)	LH Shared Worksurface C-Leg			26 ⁷ / ₈ "	DB2CL24LS	386.	427.	444.
	LH Single Worksurface C-Leg			26 ⁷ / ₈ "	DB2CL24L	366.	402.	421.
	RH Shared Worksurface C-Leg			26 ⁷ / ₈ "	DB2CL24RS	386.	427.	444.
	RH Single Worksurface C-Leg			26 ⁷ / ₈ "	DB2CL24R	366.	402.	421.
Open Support Leg Panel Attachment		3"	15"	26 ⁷ / ₈ "	DB1LSP15()	295.	311.	325.
		3"	18"	26 ⁷ / ₈ "	DB1LSP18()	295.	311.	325.
		3"	24"	26 ⁷ / ₈ "	DB1LSP24()	291.	306.	321.
		3"	30"	26 ⁷ / ₈ "	DB1LSP30()	304.	318.	335.
		3"	36"	26 ⁷ / ₈ "	DB1LSP36()	322.	338.	353.
Open Support Leg Screen Attachment		3"	15"	26 ⁷ / ₈ "	DB1LSS15()	295.	311.	325.
		3"	18"	26 ⁷ / ₈ "	DB1LSS18()	295.	311.	325.
		3"	24"	26 ⁷ / ₈ "	DB1LSS24()	291.	306.	321.
		3"	30"	26 ⁷ / ₈ "	DB1LSS30()	304.	318.	335.
		3"	36"	26 ⁷ / ₈ "	DB1LSS36()	322.	338.	353.

Worksurface Supports

Ordering Information

Cantilever Bracket

1. Pattern Number

Panel-Mounted C-Leg Worksurface Support

1. Pattern Number
2. Paint Finish

Order Code

Cantilever Bracket

Example: **DB1C 24L**

DB1C 24L Pattern Number

Panel Mounted C-Leg Worksurface Support

Example: **DB1 CL24R, 117**

DB1 Pattern Number

CL24R

117 Soft Grey finish

Included with:

Cantilever Bracket

- Attachment hardware

Panel-Mounted C-Leg Worksurface Support

- C-leg foot
- C-leg column
- Panel attachment
- C-leg flat bracket
- Leveling feet

Note: Open Support Legs are only available in Knoll core finishes.

Note: The shared open support leg is designed for use where 2 panels meet. It cannot be used at the end of a panel run.

Options

Cantilever Bracket

Note: Specify "L" (left-handed) or "R" (right-handed).

Panel-Mounted C-Leg Worksurface Support

Open Leg Support Option

(R) = Right-hand leg
(L) = Left-hand leg
(S) = Shared leg

Round Support Column

4" diameter round column may be used to support the rounded end of panel-mounted curvilinear half-round, "D", "P", "9", and blended "D" peninsula tops. Column is available in dark grey paint only.

Construction

- Material: 4" diameter steel tube
- Mounting bracket: heavy gauge steel plate, 6 x 6

T-Support Column

The T-support column may be used to support the rounded end of a panel-mounted curvilinear half-round, "D", "P", "9", and blended "D" peninsula tops. The T-support column is recommended for use with "D" peninsula worksurfaces used in freestanding applications. The T-support column is available in all Dividends paint finishes.

Construction

T-support column specifications:

- Support foot: die cast aluminum
- Support leg: extruded aluminum
- Mounting bracket: heavy gauge steel plate

T-End Unit

The T-end unit is used on the end of a freestanding "D" peninsula worksurface top. The T-end is available in a depth of 24" and 30" for use with "D", "P" and "9" top depths of 24" and 30".

Construction

- Outer skin: 21-gauge steel
- Inner frame: 20-gauge steel
- Mounting brackets: 11-gauge steel

A Leg

An A leg may be used to support panel mounted curvilinear half-round, "D", "P", "9" and blended "D" peninsula tops. A legs are available in any Knoll Core paint finish.

Construction

- Vertical members: extruded aluminum
- Top plate and spanner bar: 0.025" cold rolled steel
- Mounting brackets: 14 gauge steel

Note: A legs are only available in Knoll Core finishes

Round Column with Panel
"D" Worksurface

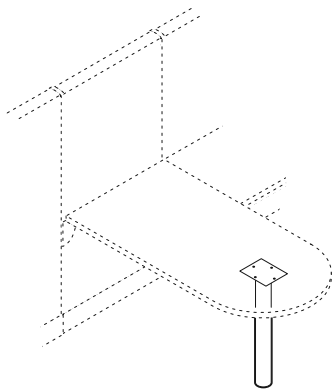

T-Support Base with Panel
"D" Worksurface

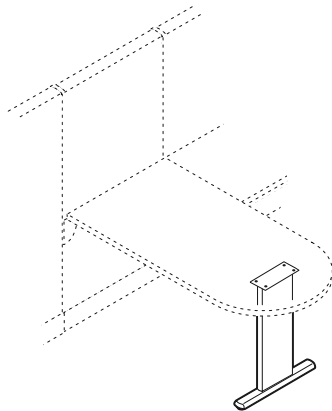

T-End Unit with Freestanding
"D" Worksurface

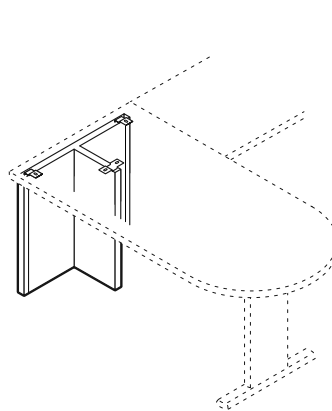

A-Leg with Panel
"D" Worksurface

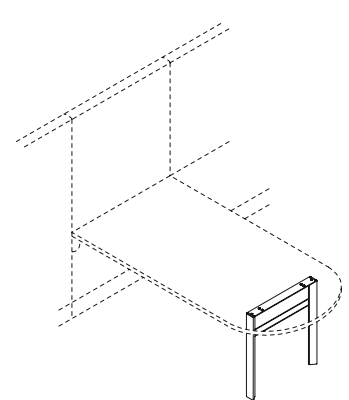



Peninsula Worksurface Supports

Round Column, T-Support Column and T-End Unit

Dividends Horizon

Worksurface Supports

description	w	d	h	pattern no.	P1	P2	P3
 T-End Unit	21 ¹³ / ₁₆ "	12"	26 ⁷ / ₈ "	DD1TEU24	\$291.	\$320.	\$335.
	27 ¹³ / ₁₆ "	12"	26 ⁷ / ₈ "	DD1TEU30	318.	349.	365.
 T-Support Base	23 ¹ / ₂ "	12"	26 ⁷ / ₈ "	DB1TB	274.	301.	313.
 Support Column (Round)	4"	4"	26 ⁷ / ₈ "	DB1S CR	215.	n/a	n/a
 A Leg	3"	15"	26 ⁷ / ₈ "	DB1LS15A	310.	341.	355.
	3"	18"	26 ⁷ / ₈ "	DB1LS18A	321.	353.	367.
	3"	24"	26 ⁷ / ₈ "	DB1LS24A	331.	364.	379.
	3"	30"	26 ⁷ / ₈ "	DB1LS30A	342.	376.	391.
	3"	36"	26 ⁷ / ₈ "	DB1LS36A	351.	386.	401.

Dimensions listed under w d t are actual to the nearest ¹/₁₆"

Ordering Information	Order Code	Included with:	Options
T-End Unit 1. Pattern Number 2. Paint Finish	T-End Unit <i>Example:</i> DD1TEU24, 115 DD1TEU24 Pattern Number 115 Medium Grey Paint Finish	T-End Unit • Worksurface T-Support Base Note: The A leg is for use in peninsula worksurface applications only. It is not to be used in freestanding applications. Note: A Legs are only available in Knoll core finishes.	T-End Unit T-Support Base
T-Support Base 1. Pattern Number 2. Paint Finish	T-Support Base <i>Example:</i> DB1TB, 115 DB1TB Pattern Number 115 Medium Grey Paint Finish		
A Leg 1. Pattern Number 2. Paint Finish			

Y Leg Tables

Freestanding and Credenza Supported Specifications

Dividends Horizon Tables

The design details of Dividends Horizon tables are consistent with the scale and visual language of the Dividends Horizon system. This design consistency makes Dividends Horizon tables appropriate for use in conference, meeting, private office and open plan office applications.

Dividends Horizon Y Leg tables are available in two versions:

- Freestanding Y Leg
- Credenza Supported Y Leg

Freestanding Y Leg Tables

Freestanding Y Leg tables include a worksurface and base assembly. All freestanding table sizes are available with two Y legs and a horizontal stretcher connecting the two columns.

In addition, 24 and 30 inch deep tables are available without a stretcher. Tables without stretcher include an integral worksurface support plate. 36 and 42 inch deep tables are available only with a stretcher.

Available Sizes

- Width: 60-96 inches
- Depth: 24-42 inches
- Height: 28-1/2 inches

Credenza Supported Y Leg Tables

The unique Dividends Horizon Credenza Supported Y Leg tables are designed to be used in concert with Dividends Horizon low credenzas, specified separately.

Credenza Supported Tables include one Y Leg, credenza support spacer, and a worksurface with integral stiffening plate.

Note: Credenza supported tables may be used with laminate or veneer top credenzas only, and are not compatible with steel top credenzas.

Available Sizes

- Width: 60-96 inches
- Depth: 24-36 inches
- Height: 28-1/2 inches

Optional Edge Grommet

Edge grommets are optional and can be factory installed centered along the rear edge of rectangular or racetrack freestanding or credenza supported Y Leg tables.

Construction

- Worksurface:
 - Material: 0.028 inch thick high pressure laminate or 0.6mm thick veneer on 1-1/8" particle board core
 - Edge: plastic laminate tops have a 2mm edgeband; Techwood tops have a 3/16 inch thick Techwood edge
- Bases:
 - Stretcher: extruded aluminum
 - Stiffening plate: 4 inch deep 12 gauge steel plate (length varies)
 - Foot: die cast aluminum
 - Column: extruded aluminum with 3/16 inch thick structural plate
 - Credenza support spacer: 2-15/16 inches high x 9-5/8 inches wide x 1-9/16 inches deep steel box with a flat bracket on top

Note: Dividends Horizon tables are only available in Knoll Core paint, laminate, and Techwood finishes. Legacy finishes are not available. All paint finishes have the Dividends Horizon textured paint finish; this includes 613 Silver, which is a smooth paint on all other Dividends Horizon products.

Note: The stiffening plate on tables without a stretcher prevents the field installation of a grommet or plexus box. (see illustration below)

24" Deep Freestanding Racetrack Y Leg Table with Stretcher



24" Deep Credenza Supported Racetrack Y Leg Table

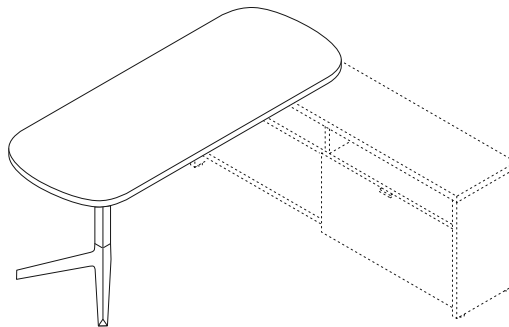

24" Deep Freestanding Racetrack Y Leg Table without Stretcher

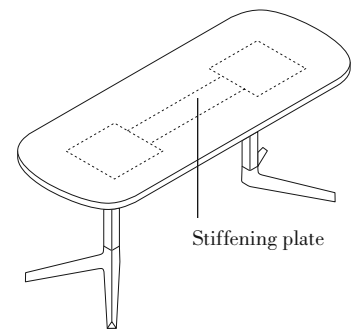

Y Leg Tables

Freestanding Rectangular Table Top

24" and 30" Deep

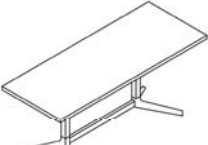
description	w*	w	d	t	h	pattern no.	Laminate	Laminate	Laminate	Techgrain	Techgrain	Techgrain
							Top P1 Paint	Top P2 Paint	Top P3 Paint	Top P1 Paint	Top P2 Paint	Top P3 Paint
 24" Deep Rectangular with (2) Y-Legs, No Grommet	60"	59 ^{13/16"}	23 ^{1/2"}	1 ^{1/4"}	28 ^{1/2"}	DT1ARY6024NS	\$1,458.	\$1,604.	\$1,668.	\$1,670.	\$1,837.	\$1,911.
	66"	65 ^{13/16"}	23 ^{1/2"}	1 ^{1/4"}	28 ^{1/2"}	DT1ARY6624NS	1,474.	1,622.	1,686.	1,697.	1,868.	1,942.
	72"	71 ^{13/16"}	23 ^{1/2"}	1 ^{1/4"}	28 ^{1/2"}	DT1ARY7224NS	1,490.	1,639.	1,705.	1,725.	1,898.	1,974.
	78"	77 ^{13/16"}	23 ^{1/2"}	1 ^{1/4"}	28 ^{1/2"}	DT1ARY7824NS	1,506.	1,657.	1,723.	1,753.	1,929.	2,006.
	84"	83 ^{13/16"}	23 ^{1/2"}	1 ^{1/4"}	28 ^{1/2"}	DT1ARY8424NS	1,534.	1,687.	1,755.	1,781.	1,959.	2,038.
	90"	89 ^{13/16"}	23 ^{1/2"}	1 ^{1/4"}	28 ^{1/2"}	DT1ARY9024NS	1,561.	1,718.	1,786.	1,808.	1,990.	2,069.
	96"	95 ^{13/16"}	23 ^{1/2"}	1 ^{1/4"}	28 ^{1/2"}	DT1ARY9624NS	1,589.	1,748.	1,818.	1,836.	2,020.	2,101.

(with stretcher shown)

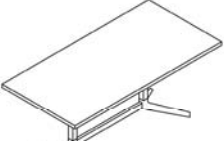
 30" Deep Rectangular with (2) Y-Legs, No Grommet	60"	59 ^{13/16"}	29 ^{1/2"}	1 ^{1/4"}	28 ^{1/2"}	DT1ARY6030NS	1,495.	1,645.	1,711.	1,706.	1,877.	1,952.
	66"	65 ^{13/16"}	29 ^{1/2"}	1 ^{1/4"}	28 ^{1/2"}	DT1ARY6630NS	1,516.	1,668.	1,735.	1,739.	1,912.	1,989.
	72"	71 ^{13/16"}	29 ^{1/2"}	1 ^{1/4"}	28 ^{1/2"}	DT1ARY7230NS	1,536.	1,690.	1,758.	1,771.	1,948.	2,026.
	78"	77 ^{13/16"}	29 ^{1/2"}	1 ^{1/4"}	28 ^{1/2"}	DT1ARY7830NS	1,557.	1,713.	1,782.	1,804.	1,984.	2,063.
	84"	83 ^{13/16"}	29 ^{1/2"}	1 ^{1/4"}	28 ^{1/2"}	DT1ARY8430NS	1,587.	1,746.	1,816.	1,836.	2,020.	2,101.
	90"	89 ^{13/16"}	29 ^{1/2"}	1 ^{1/4"}	28 ^{1/2"}	DT1ARY9030NS	1,616.	1,778.	1,849.	1,869.	2,055.	2,138.
	96"	95 ^{13/16"}	29 ^{1/2"}	1 ^{1/4"}	28 ^{1/2"}	DT1ARY9630NS	1,646.	1,811.	1,883.	1,901.	2,091.	2,175.

(with stretcher shown)

w* = nominal width
 Dimensions listed under w d t h are actual to the nearest 1/16"

Ordering Information	Order Code	Included with:	Options
Freestanding Y Leg Table: 1. Pattern number 2. Base/Stretcher Paint Finish 3. Top Finish 4. Edge Finish	Freestanding Y Leg Table: Example: DT1ARY6024NS, 114, 114 <hr/> DT1 Dividends Horizon Table <hr/> A 2 Leg table assembly <hr/> R Rectangular shape <hr/> Y Y Leg Base <hr/> 60 Overall width in inches <hr/> 24 Overall depth in inches <hr/> N No grommet <hr/> S Stretcher <hr/> 114 Base/ stretcher paint finish <hr/> 114 Laminate top finish <hr/> 114 Edgeband finish	Freestanding Y Leg Table: <ul style="list-style-type: none"> (2) Y Legs Hardware kit Table top Stretcher or stiffening plate Note: Y Leg tables are finished with textured paint, including 613 Silver. Note: Y Leg Tables are only available in Knoll core finishes.	Grommet Option: <ul style="list-style-type: none"> To specify an edge grommet, replace the "N" suffix from the pattern number with an "E" and add \$17. Stretcher Option: <ul style="list-style-type: none"> A stretcher is optional on 24" and 30" deep tables ONLY. To specify a table without a stretcher replace the "S" suffix from the pattern number with an "N". Stretchers are required on 36" and 42" depths.

Y Leg Tables

Freestanding Rectangular Table Top

36" and 42" Deep

description	w*	w	d	t	h	pattern no.	Laminate	Laminate	Laminate	Techgrain	Techgrain	Techgrain
							Top P1 Paint	Top P2 Paint	Top P3 Paint	Top P1 Paint	Top P2 Paint	Top P3 Paint
36" Deep Rectangular with (2) Y-Legs, No Grommet	60"	59 ^{13/16"}	35 ^{1/2"}	1 ^{1/4"}	28 ^{1/2"}	DT1ARY6036N	\$1,544.	\$1,698.	\$1,766.	\$1,782.	\$1,960.	\$2,038.
	66"	65 ^{13/16"}	35 ^{1/2"}	1 ^{1/4"}	28 ^{1/2"}	DT1ARY6636N	1,571.	1,728.	1,797.	1,817.	1,999.	2,078.
	72"	71 ^{13/16"}	35 ^{1/2"}	1 ^{1/4"}	28 ^{1/2"}	DT1ARY7236N	1,598.	1,758.	1,829.	1,852.	2,037.	2,118.
	78"	77 ^{13/16"}	35 ^{1/2"}	1 ^{1/4"}	28 ^{1/2"}	DT1ARY7836N	1,625.	1,788.	1,860.	1,887.	2,076.	2,158.
	84"	83 ^{13/16"}	35 ^{1/2"}	1 ^{1/4"}	28 ^{1/2"}	DT1ARY8436N	1,652.	1,818.	1,891.	1,922.	2,114.	2,198.
	90"	89 ^{13/16"}	35 ^{1/2"}	1 ^{1/4"}	28 ^{1/2"}	DT1ARY9036N	1,679.	1,847.	1,921.	1,957.	2,153.	2,238.
	96"	95 ^{13/16"}	35 ^{1/2"}	1 ^{1/4"}	28 ^{1/2"}	DT1ARY9636N	1,706.	1,877.	1,952.	1,992.	2,191.	2,278.



42" Deep Rectangular with (2) Y-Legs, No Grommet	84"	83 ^{13/16"}	42 ^{1/2"}	1 ^{1/4"}	28 ^{1/2"}	DT1ARY8442N	1,695.	1,865.	1,940.	2,151.	2,366.	2,461.
	90"	89 ^{13/16"}	42 ^{1/2"}	1 ^{1/4"}	28 ^{1/2"}	DT1ARY9042N	1,731.	1,904.	1,980.	2,181.	2,399.	2,495.
	96"	95 ^{13/16"}	42 ^{1/2"}	1 ^{1/4"}	28 ^{1/2"}	DT1ARY9642N	1,757.	1,933.	2,010.	2,210.	2,431.	2,528.



w* = nominal width
Dimensions listed under w d t h are actual to the nearest 1/16"

Ordering Information	Order Code	Included with:	Options
Freestanding Y Leg Table: 1. Pattern number 2. Base/Stretcher Paint Finish 3. Top Finish 4. Edge Finish	Freestanding Y Leg Table: <i>Example:</i> DT1ARY6024NS, 114, 114 <hr/> DT1 Dividends Horizon Table <hr/> A 2 Leg table assembly <hr/> R Rectangular shape <hr/> Y Y Leg Base <hr/> 60 Overall width in inches <hr/> 24 Overall depth in inches <hr/> N No grommet <hr/> S Stretcher <hr/> 114 Base/ stretcher paint finish <hr/> 114 Laminate top finish <hr/> 114 Edgeband finish	Freestanding Y Leg Table: <ul style="list-style-type: none"> • (2) Y Legs • Hardware kit • Table top • Stretcher or stiffening plate Note: Y Leg tables are finished with textured paint, including 613 Silver. Note: Y Leg Tables are only available in Knoll core finishes.	Grommet Option: <ul style="list-style-type: none"> • To specify an edge grommet, replace the "N" suffix from the pattern number with an "E" and add \$17. Stretcher Option: <ul style="list-style-type: none"> • A stretcher is optional on 24" and 30" deep tables ONLY. To specify a table without a stretcher replace the "S" suffix from the pattern number with an "N". Stretchers are required on 36" and 42" depths.

Y Leg Tables

Freestanding Racetrack Table Top

24" and 30" Deep

description	w*	w	d	t	h	pattern number	Laminate	Laminate	Laminate	Techgrain	Techgrain	Techgrain
							Top P1 Paint	Top P2 Paint	Top P3 Paint	Top P1 Paint	Top P2 Paint	Top P3 Paint
 24" Deep Racetrack with (2) Y-Legs, No Grommet	60"	59 ¹³ / ₁₆ "	23 ¹ / ₂ "	1 ¹ / ₄ "	28 ¹ / ₂ "	DT1ATY6024NS	\$1,457.	\$1,603.	\$1,667.	\$2,600.	\$2,861.	\$2,976.
	66"	65 ¹³ / ₁₆ "	23 ¹ / ₂ "	1 ¹ / ₄ "	28 ¹ / ₂ "	DT1ATY6624NS	1,502.	1,652.	1,718.	2,624.	2,887.	3,003.
	72"	71 ¹³ / ₁₆ "	23 ¹ / ₂ "	1 ¹ / ₄ "	28 ¹ / ₂ "	DT1ATY7224NS	1,546.	1,701.	1,769.	2,648.	2,914.	3,031.
	78"	77 ¹³ / ₁₆ "	23 ¹ / ₂ "	1 ¹ / ₄ "	28 ¹ / ₂ "	DT1ATY7824NS	1,591.	1,750.	1,820.	2,672.	2,940.	3,058.
	84"	83 ¹³ / ₁₆ "	23 ¹ / ₂ "	1 ¹ / ₄ "	28 ¹ / ₂ "	DT1ATY8424NS	1,619.	1,780.	1,852.	2,696.	2,966.	3,085.
	90"	89 ¹³ / ₁₆ "	23 ¹ / ₂ "	1 ¹ / ₄ "	28 ¹ / ₂ "	DT1ATY9024NS	1,646.	1,811.	1,883.	2,720.	2,993.	3,113.
	96"	95 ¹³ / ₁₆ "	23 ¹ / ₂ "	1 ¹ / ₄ "	28 ¹ / ₂ "	DT1ATY9624NS	1,674.	1,841.	1,915.	2,744.	3,019.	3,140.

(with stretcher shown)

 30" Deep Racetrack with (2) Y-Legs, No Grommet	60"	59 ¹³ / ₁₆ "	29 ¹ / ₂ "	1 ¹ / ₄ "	28 ¹ / ₂ "	DT1ATY6030NS	1,514.	1,665.	1,732.	2,639.	2,903.	3,020.
	66"	65 ¹³ / ₁₆ "	29 ¹ / ₂ "	1 ¹ / ₄ "	28 ¹ / ₂ "	DT1ATY6630NS	1,556.	1,712.	1,780.	2,665.	2,932.	3,050.
	72"	71 ¹³ / ₁₆ "	29 ¹ / ₂ "	1 ¹ / ₄ "	28 ¹ / ₂ "	DT1ATY7230NS	1,599.	1,758.	1,829.	2,691.	2,960.	3,079.
	78"	77 ¹³ / ₁₆ "	29 ¹ / ₂ "	1 ¹ / ₄ "	28 ¹ / ₂ "	DT1ATY7830NS	1,641.	1,805.	1,877.	2,717.	2,989.	3,109.
	84"	83 ¹³ / ₁₆ "	29 ¹ / ₂ "	1 ¹ / ₄ "	28 ¹ / ₂ "	DT1ATY8430NS	1,672.	1,839.	1,912.	2,743.	3,018.	3,139.
	90"	89 ¹³ / ₁₆ "	29 ¹ / ₂ "	1 ¹ / ₄ "	28 ¹ / ₂ "	DT1ATY9030NS	1,702.	1,872.	1,947.	2,769.	3,046.	3,168.
	96"	95 ¹³ / ₁₆ "	29 ¹ / ₂ "	1 ¹ / ₄ "	28 ¹ / ₂ "	DT1ATY9630NS	1,733.	1,906.	1,982.	2,795.	3,075.	3,198.

(with stretcher shown)

w* = nominal width
 Dimensions listed under w d t h are actual to the nearest 1/16"

Ordering Information	Order Code	Included with:	Options
Freestanding Y Leg Table: 1. Pattern number 2. Base/Stretcher Paint Finish 3. Top Finish 4. Edge Finish	Freestanding Y Leg Table: Example: DT1ATY6024NS, 114, 114 <hr/> DT1 Dividends Horizon Table <hr/> A 2 Leg table assembly <hr/> T Racetrack shape <hr/> Y Y Leg Base <hr/> 60 Overall width in inches <hr/> 24 Overall depth in inches <hr/> N No grommet <hr/> S Stretcher <hr/> 114 Base/ stretcher paint finish <hr/> 114 Laminate top finish <hr/> 114 Edgeband finish	Freestanding Y Leg Table: <ul style="list-style-type: none"> (2) Y Legs Hardware kit Table top Stretcher or stiffening plate Note: Y Leg tables are finished with textured paint, including 613 Silver. Note: Y Leg Tables are only available in Knoll core finishes.	Grommet Option: <ul style="list-style-type: none"> To specify an edge grommet, replace the "N" suffix from the pattern number with an "E" and add \$17. Stretcher Option: <ul style="list-style-type: none"> A stretcher is optional on 24" and 30" deep tables ONLY. To specify a table without a stretcher replace the "S" suffix from pattern number with an "N". Stretchers are required on 36" and 42" depths.

Y Leg Tables

Freestanding Racetrack Table Top

36" and 42" Deep

Dividends Horizon

description	w*	w	d	t	h	pattern no.	Laminate	Laminate	Laminate	Techgrain	Techgrain	Techgrain
							Top P1 Paint	Top P2 Paint	Top P3 Paint	Top P1 Paint	Top P2 Paint	Top P3 Paint
 36" Deep Racetrack with (2) Y-Legs, No Grommet	60"	59 ^{13/16"}	35 ^{1/2"}	1 ^{1/4"}	28 ^{1/2"}	DT1ATY6036N	\$1,566.	\$1,723.	\$1,792.	\$2,678.	\$2,945.	\$3,064.
	66"	65 ^{13/16"}	35 ^{1/2"}	1 ^{1/4"}	28 ^{1/2"}	DT1ATY6636N	1,615.	1,776.	1,847.	2,706.	2,976.	3,096.
	72"	71 ^{13/16"}	35 ^{1/2"}	1 ^{1/4"}	28 ^{1/2"}	DT1ATY7236N	1,663.	1,830.	1,903.	2,734.	3,007.	3,128.
	78"	77 ^{13/16"}	35 ^{1/2"}	1 ^{1/4"}	28 ^{1/2"}	DT1ATY7836N	1,712.	1,883.	1,958.	2,762.	3,038.	3,160.
	84"	83 ^{13/16"}	35 ^{1/2"}	1 ^{1/4"}	28 ^{1/2"}	DT1ATY8436N	1,739.	1,913.	1,989.	2,790.	3,069.	3,192.
	90"	89 ^{13/16"}	35 ^{1/2"}	1 ^{1/4"}	28 ^{1/2"}	DT1ATY9036N	1,767.	1,943.	2,021.	2,818.	3,100.	3,224.
	96"	95 ^{13/16"}	35 ^{1/2"}	1 ^{1/4"}	28 ^{1/2"}	DT1ATY9636N	1,794.	1,973.	2,052.	2,846.	3,131.	3,256.

 42" Deep Racetrack with (2) Y-Legs, No Grommet	84"	83 ^{13/16"}	42 ^{1/2"}	1 ^{1/4"}	28 ^{1/2"}	DT1ATY8442N	1,780.	1,958.	2,036.	2,839.	3,123.	3,248.
	90"	89 ^{13/16"}	42 ^{1/2"}	1 ^{1/4"}	28 ^{1/2"}	DT1ATY9042N	1,815.	1,997.	2,077.	2,869.	3,156.	3,282.
	96"	95 ^{13/16"}	42 ^{1/2"}	1 ^{1/4"}	28 ^{1/2"}	DT1ATY9642N	1,847.	2,032.	2,113.	2,898.	3,188.	3,316.

w* = nominal width

Dimensions listed under w d t h are actual to the nearest 1/16"

Ordering Information	Order Code	Included with:	Options
Freestanding Y Leg Table: 1. Pattern number 2. Base/Stretcher Paint Finish 3. Top Finish 4. Edge Finish	Freestanding Y Leg Table: <i>Example:</i> DT1ATY6024NS, 114, 114 <hr/> DT1 Dividends Horizon Table <hr/> A 2 Leg table assembly <hr/> T Racetrack shape <hr/> Y Y Leg Base <hr/> 60 Overall width in inches <hr/> 24 Overall depth in inches <hr/> N No grommet <hr/> S Stretcher <hr/> 114 Base/ stretcher paint finish <hr/> 114 Laminate top finish <hr/> 114 Edgeband finish	Freestanding Y Leg Table: <ul style="list-style-type: none"> • (2) Y Legs • Hardware kit • Table top • Stretcher or stiffening plate Note: Y Leg tables are finished with textured paint, including 613 Silver. Note: Y Leg Tables are only available in Knoll core finishes.	Grommet Option: <ul style="list-style-type: none"> • To specify an edge grommet, replace the "N" suffix from the pattern number with an "E" and add \$17. Stretcher Option: <ul style="list-style-type: none"> • A stretcher is optional on 24" and 30" deep tables ONLY. To specify a table without a stretcher replace the "S" suffix from pattern number with an "N". Stretchers are required on 36" and 42" depths.

Y Leg Tables

Credenza Supported Rectangular Table Top

24", 30" and 36" Deep

description	w*	w	d	t	h	pattern no"	Laminate	Laminate	Laminate	Techgrain	Techgrain	Techgrain
							Top P1 Paint	Top P2 Paint	Top P3 Paint	Top P1 Paint	Top P2 Paint	Top P3 Paint
24" Deep Rectangular with (1) Y-Leg and (1) Spacer - No Grommet	60"	59 ¹³ / ₁₆ "	23 ¹ / ₂ "	1 ¹ / ₄ "	28 ¹ / ₂ "	DT1CRY6024N	\$1,218.	\$1,340.	\$1,394.	\$1,428.	\$1,570.	\$1,633.
	66"	65 ¹³ / ₁₆ "	23 ¹ / ₂ "	1 ¹ / ₄ "	28 ¹ / ₂ "	DT1CRY6624N	1,234.	1,357.	1,412.	1,455.	1,601.	1,664.
	72"	71 ¹³ / ₁₆ "	23 ¹ / ₂ "	1 ¹ / ₄ "	28 ¹ / ₂ "	DT1CRY7224N	1,249.	1,375.	1,430.	1,483.	1,631.	1,696.
	78"	77 ¹³ / ₁₆ "	23 ¹ / ₂ "	1 ¹ / ₄ "	28 ¹ / ₂ "	DT1CRY7824N	1,265.	1,392.	1,448.	1,511.	1,662.	1,728.
	84"	83 ¹³ / ₁₆ "	23 ¹ / ₂ "	1 ¹ / ₄ "	28 ¹ / ₂ "	DT1CRY8424N	1,293.	1,423.	1,480.	1,539.	1,692.	1,760.
	90"	89 ¹³ / ₁₆ "	23 ¹ / ₂ "	1 ¹ / ₄ "	28 ¹ / ₂ "	DT1CRY9024N	1,321.	1,453.	1,511.	1,566.	1,723.	1,791.
	96"	95 ¹³ / ₁₆ "	23 ¹ / ₂ "	1 ¹ / ₄ "	28 ¹ / ₂ "	DT1CRY9624N	1,349.	1,484.	1,543.	1,594.	1,753.	1,823.

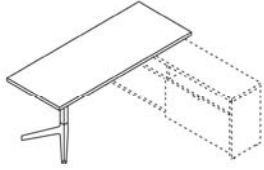

(credenza not included)

30" Deep Rectangular with (1) Y-Leg and (1) Spacer - No Grommet	60"	59 ¹³ / ₁₆ "	29 ¹ / ₂ "	1 ¹ / ₄ "	28 ¹ / ₂ "	DT1CRY6030N	1,253.	1,378.	1,433.	1,465.	1,611.	1,675.
	66"	65 ¹³ / ₁₆ "	29 ¹ / ₂ "	1 ¹ / ₄ "	28 ¹ / ₂ "	DT1CRY6630N	1,274.	1,401.	1,457.	1,497.	1,647.	1,712.
	72"	71 ¹³ / ₁₆ "	29 ¹ / ₂ "	1 ¹ / ₄ "	28 ¹ / ₂ "	DT1CRY7230N	1,294.	1,424.	1,481.	1,529.	1,682.	1,749.
	78"	77 ¹³ / ₁₆ "	29 ¹ / ₂ "	1 ¹ / ₄ "	28 ¹ / ₂ "	DT1CRY7830N	1,315.	1,447.	1,505.	1,561.	1,718.	1,786.
	84"	83 ¹³ / ₁₆ "	29 ¹ / ₂ "	1 ¹ / ₄ "	28 ¹ / ₂ "	DT1CRY8430N	1,345.	1,480.	1,539.	1,594.	1,753.	1,823.
	90"	89 ¹³ / ₁₆ "	29 ¹ / ₂ "	1 ¹ / ₄ "	28 ¹ / ₂ "	DT1CRY9030N	1,375.	1,513.	1,574.	1,626.	1,789.	1,860.
	96"	95 ¹³ / ₁₆ "	29 ¹ / ₂ "	1 ¹ / ₄ "	28 ¹ / ₂ "	DT1CRY9630N	1,405.	1,546.	1,608.	1,658.	1,824.	1,897.

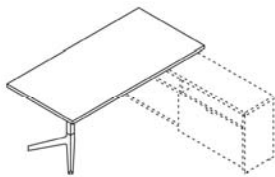

(credenza not included)

36" Deep Rectangular with (1) Y-Leg and (1) Spacer - No Grommet	60"	59 ¹³ / ₁₆ "	35 ¹ / ₂ "	1 ¹ / ₄ "	28 ¹ / ₂ "	DT1CRY6036N	1,329.	1,462.	1,520.	1,565.	1,722.	1,791.
	66"	65 ¹³ / ₁₆ "	35 ¹ / ₂ "	1 ¹ / ₄ "	28 ¹ / ₂ "	DT1CRY6636N	1,354.	1,489.	1,549.	1,598.	1,758.	1,828.
	72"	71 ¹³ / ₁₆ "	35 ¹ / ₂ "	1 ¹ / ₄ "	28 ¹ / ₂ "	DT1CRY7236N	1,379.	1,517.	1,577.	1,630.	1,793.	1,865.
	78"	77 ¹³ / ₁₆ "	35 ¹ / ₂ "	1 ¹ / ₄ "	28 ¹ / ₂ "	DT1CRY7836N	1,404.	1,544.	1,606.	1,663.	1,829.	1,902.
	84"	83 ¹³ / ₁₆ "	35 ¹ / ₂ "	1 ¹ / ₄ "	28 ¹ / ₂ "	DT1CRY8436N	1,439.	1,583.	1,646.	1,695.	1,864.	1,939.
	90"	89 ¹³ / ₁₆ "	35 ¹ / ₂ "	1 ¹ / ₄ "	28 ¹ / ₂ "	DT1CRY9036N	1,474.	1,621.	1,686.	1,728.	1,900.	1,976.
	96"	95 ¹³ / ₁₆ "	35 ¹ / ₂ "	1 ¹ / ₄ "	28 ¹ / ₂ "	DT1CRY9636N	1,509.	1,660.	1,726.	1,760.	1,935.	2,013.

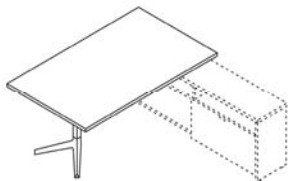

(credenza not included)

w* = nominal width

Dimensions listed under w d t h are actual to the nearest¹/₁₆"

Ordering Information	Order Code	Included with:	Options
Credenza Supported Y Leg Table:	Credenza Supported Y Leg Table:	Credenza Supported Y leg Table:	Grommet Option:
1. Pattern number	<i>Example:</i> DT1CRY6024N, 114, 114	<ul style="list-style-type: none"> (1) Y Leg (1) Credenza support spacer Hardware kit Table top Stiffening plate 	<ul style="list-style-type: none"> To specify an edge grommet, replace the "N" suffix from the pattern number with an "E" and add \$17.
2. Base/Stretcher Paint Finish	DT1 Dividends Horizon Table	Credenza must be specified separately	Note: Credenza supported tables may be used with laminate or veneer top credenzas only and are not compatible with steel top credenzas.
3. Top Finish	C Credenza support assembly	Note: Y Leg tables are finished with textured paint, including 613 Silver.	
4. Edge Finish	R Rectangular shape	Note: Y Leg Tables are only available in Knoll core finishes.	
	Y Y Leg Base		
	60 Overall width in inches		
	24 Overall depth in inches		
	N No grommet		
	114 Base/ stretcher paint finish		
	114 Laminate top finish		
	114 Edgeband finish		

Y Leg Tables

Credenza Supported Racetrack Table Top

24", 30" and 36" Deep

Dividends Horizon

description	w*	w	d	h	pattern no.	Laminate	Laminate	Laminate	Techgrain	Techgrain	Techgrain
						Top P1 Paint	Top P2 Paint	Top P3 Paint	Top P1 Paint	Top P2 Paint	Top P3 Paint
24" Deep Racetrack with (1) Y-Leg and (1) Spacer - No Grommet	60"	59 ^{13/16"}	23 ^{1/2"}	28 ^{1/2"}	DT1CTY6024N	\$1,216.	\$1,338.	\$1,392.	\$2,380.	\$2,619.	\$2,690.
	66"	65 ^{13/16"}	23 ^{1/2"}	28 ^{1/2"}	DT1CTY6624N	1,261.	1,387.	1,443.	2,393.	2,634.	2,711.
	72"	71 ^{13/16"}	23 ^{1/2"}	28 ^{1/2"}	DT1CTY7224N	1,306.	1,437.	1,494.	2,407.	2,648.	2,731.
	78"	77 ^{13/16"}	23 ^{1/2"}	28 ^{1/2"}	DT1CTY7824N	1,351.	1,486.	1,545.	2,420.	2,663.	2,752.
	84"	83 ^{13/16"}	23 ^{1/2"}	28 ^{1/2"}	DT1CTY8424N	1,366.	1,502.	1,562.	2,433.	2,678.	2,773.
	90"	89 ^{13/16"}	23 ^{1/2"}	28 ^{1/2"}	DT1CTY9024N	1,380.	1,519.	1,579.	2,447.	2,692.	2,793.
	96"	95 ^{13/16"}	23 ^{1/2"}	28 ^{1/2"}	DT1CTY9624N	1,395.	1,535.	1,596.	2,460.	2,707.	2,814.

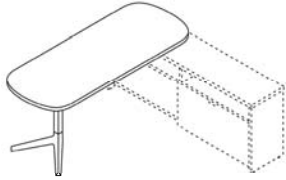

(credenza not included)

30" Deep Racetrack with (1) Y-Leg and (1) Spacer - No Grommet	60"	59 ^{13/16"}	29 ^{1/2"}	28 ^{1/2"}	DT1CTY6030N	1,274.	1,401.	1,457.	2,395.	2,635.	2,723.
	66"	65 ^{13/16"}	29 ^{1/2"}	28 ^{1/2"}	DT1CTY6630N	1,316.	1,448.	1,506.	2,422.	2,664.	2,756.
	72"	71 ^{13/16"}	29 ^{1/2"}	28 ^{1/2"}	DT1CTY7230N	1,359.	1,494.	1,554.	2,448.	2,694.	2,790.
	78"	77 ^{13/16"}	29 ^{1/2"}	28 ^{1/2"}	DT1CTY7830N	1,401.	1,541.	1,603.	2,475.	2,723.	2,823.
	84"	83 ^{13/16"}	29 ^{1/2"}	28 ^{1/2"}	DT1CTY8430N	1,431.	1,574.	1,638.	2,502.	2,752.	2,856.
	90"	89 ^{13/16"}	29 ^{1/2"}	28 ^{1/2"}	DT1CTY9030N	1,462.	1,608.	1,672.	2,528.	2,782.	2,890.
	96"	95 ^{13/16"}	29 ^{1/2"}	28 ^{1/2"}	DT1CTY9630N	1,492.	1,641.	1,707.	2,555.	2,811.	2,923.

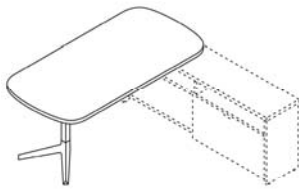

(credenza not included)

36" Deep Racetrack with (1) Y-Leg and (1) Spacer - No Grommet	60"	59 ^{13/16"}	35 ^{1/2"}	28 ^{1/2"}	DT1CTY6036N	1,348.	1,483.	1,542.	2,410.	2,651.	2,756.
	66"	65 ^{13/16"}	35 ^{1/2"}	28 ^{1/2"}	DT1CTY6636N	1,395.	1,535.	1,596.	2,450.	2,695.	2,802.
	72"	71 ^{13/16"}	35 ^{1/2"}	28 ^{1/2"}	DT1CTY7236N	1,443.	1,587.	1,651.	2,490.	2,739.	2,848.
	78"	77 ^{13/16"}	35 ^{1/2"}	28 ^{1/2"}	DT1CTY7836N	1,490.	1,639.	1,705.	2,530.	2,783.	2,894.
	84"	83 ^{13/16"}	35 ^{1/2"}	28 ^{1/2"}	DT1CTY8436N	1,524.	1,677.	1,744.	2,570.	2,827.	2,940.
	90"	89 ^{13/16"}	35 ^{1/2"}	28 ^{1/2"}	DT1CTY9036N	1,559.	1,714.	1,783.	2,610.	2,871.	2,986.
	96"	95 ^{13/16"}	35 ^{1/2"}	28 ^{1/2"}	DT1CTY9636N	1,593.	1,752.	1,822.	2,650.	2,915.	3,032.

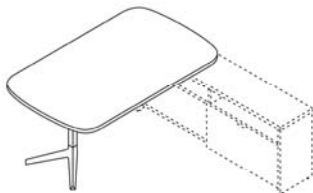

(credenza not included)

w* = nominal width

Dimensions listed under w d t h are actual to the nearest 1/16"

Ordering Information	Order Code	Included with:	Options
Credenza Supported Y Leg Table:	Credenza Supported Y Leg Table:	Credenza Supported Y Leg Table:	Grommet Option:
1. Pattern number	<i>Example:</i> DT1CTY6024N, 114, 114	<ul style="list-style-type: none"> (1) Y Leg (1) Credenza support spacer Hardware kit Table top Stiffening plate 	<ul style="list-style-type: none"> To specify an edge grommet, replace the "N" suffix from the pattern number with an "E" and add \$17.
2. Base/Stretcher Paint Finish	DT1 Dividends Horizon Table	Credenza must be specified separately	Note: Credenza supported tables may be used with laminate or veneer top credenzas only and are not compatible with steel top credenzas.
3. Top Finish	C Credenza support assembly	Note: Y Leg tables are finished with textured paint, including 613 Silver.	
4. Edge Finish	T Racetrack shape	Note: Y Leg Tables are only available in Knoll core finishes.	
	Y Y Leg Base		
	60 Overall width in inches		
	24 Overall depth in inches		
	N No grommet		
	114 Base/ stretcher paint finish		
	114 Laminate top finish		
	114 Edgeband finish		

This page intentionally left blank

X Base Tables

Dividends Horizon X base tables are designed to be used along with the Dividends Horizon system to create a consistent aesthetic throughout the entire office. With various height and width options, X base tables can be used in a multitude of applications, including collaboration areas in the open plan, break rooms, and lounge areas.

Available with a round, square or rounded square top shape with either a laminate or veneer finish, a Dividends Horizon X base table is appropriate for use in a vast array of applications from the private office to the open plan and even to lounge areas. The five height options allow for the same table base to be used in various applications while maintaining visual consistency throughout the space.

X base tables include a top, support column, and X base.

Available Sizes

- Width: 30 - 48 inches
- Depth: 30 - 48 inches
- Heights: 17, 21, 28-1/2, 36, and 42 inches

Construction

• Worksurface:

- Material: 0.028" thick high pressure laminate or 0.6mm thick veneer on 1-1/8" particle board core
- Edge: plastic laminate tops have a 2mm edgeband; Techwood tops have a 3/16" thick Techwood edge.

• Base:

- Foot: die cast aluminum
- Column: extruded aluminum with 3/16" thick structural plate

Table Supports

X bases may be specified separately for use with an alternative table top. The appropriate X base size must be selected according to the width of the table top being used. X bases are available in five heights and may be used with table tops that are 30 to 48 inches wide.

Available Sizes

Heights: 17, 21, 28-1/2, 36, and 42 inches

Construction

• Base:

- Foot: die cast aluminum
- Column: extruded aluminum with 3/16" thick structural plate

Note: Dividends Horizon tables are only available in Knoll Core paint and laminate finishes. Legacy finishes are not available. All paint finishes have the Dividends Horizon textured paint finish; this includes 613 Silver, which is a smooth paint on all other Dividends Horizon products.

Square X Base Table

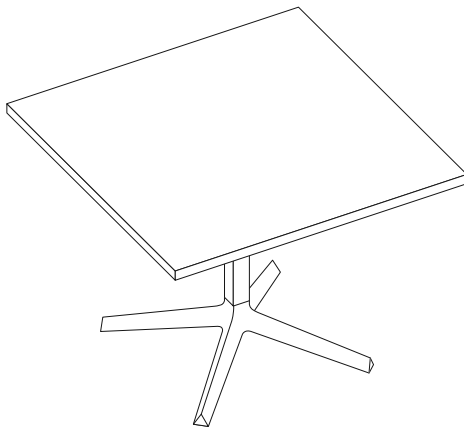

Round X Base Table



Rounded Square X Base Table





X Base Tables

Square Table Tops

17", 21", 28", 36" and 42" High

description	w*	w	d	t	h	pattern no.	Laminate	Laminate	Laminate	Techgrain	Techgrain	Techgrain
							Top P1 Paint	Top P2 Paint	Top P3 Paint	Top P1 Paint	Top P2 Paint	Top P3 Paint
 17" High Square X Base Table	30"	29 ^{13/16"}	29 ^{13/16"}	1 ^{1/4"}	17"	DT1ASX303017	\$887.	\$978.	\$1,018.	\$1,309.	\$1,447.	\$1,504.
	36"	35 ^{13/16"}	35 ^{13/16"}	1 ^{1/4"}	17"	DT1ASX363617	925.	1,020.	1,062.	1,383.	1,523.	1,585.
	42"	41 ^{13/16"}	41 ^{13/16"}	1 ^{1/4"}	17"	DT1ASX424217	1,026.	1,131.	1,177.	1,464.	1,612.	1,677.
	48"	47 ^{13/16"}	47 ^{13/16"}	1 ^{1/4"}	17"	DT1ASX484817	1,077.	1,187.	1,235.	1,522.	1,676.	1,744.

 21" High Square X Base Table	30"	29 ^{13/16"}	29 ^{13/16"}	1 ^{1/4"}	21"	DT1ASX303021	887.	978.	1,018.	1,309.	1,447.	1,504.
	36"	35 ^{13/16"}	35 ^{13/16"}	1 ^{1/4"}	21"	DT1ASX363621	925.	1,020.	1,062.	1,383.	1,523.	1,585.
	42"	41 ^{13/16"}	41 ^{13/16"}	1 ^{1/4"}	21"	DT1ASX424221	1,026.	1,131.	1,177.	1,464.	1,612.	1,677.
	48"	47 ^{13/16"}	47 ^{13/16"}	1 ^{1/4"}	21"	DT1ASX484821	1,077.	1,187.	1,235.	1,522.	1,676.	1,744.

 28" High Square X Base Table	30"	29 ^{13/16"}	29 ^{13/16"}	1 ^{1/4"}	28 ^{1/2"}	DT1ASX3030	907.	998.	1,038.	1,329.	1,467.	1,524.
	36"	35 ^{13/16"}	35 ^{13/16"}	1 ^{1/4"}	28 ^{1/2"}	DT1ASX3636	945.	1,040.	1,082.	1,403.	1,543.	1,605.
	42"	41 ^{13/16"}	41 ^{13/16"}	1 ^{1/4"}	28 ^{1/2"}	DT1ASX4242	1,046.	1,151.	1,197.	1,484.	1,632.	1,697.
	48"	47 ^{13/16"}	47 ^{13/16"}	1 ^{1/4"}	28 ^{1/2"}	DT1ASX4848	1,097.	1,207.	1,255.	1,542.	1,696.	1,764.

 36" High Square X Base Table	30"	29 ^{13/16"}	29 ^{13/16"}	1 ^{1/4"}	36"	DT1ASX303036	957.	1,048.	1,088.	1,379.	1,517.	1,574.
	36"	35 ^{13/16"}	35 ^{13/16"}	1 ^{1/4"}	36"	DT1ASX363636	995.	1,090.	1,132.	1,453.	1,593.	1,655.
	42"	41 ^{13/16"}	41 ^{13/16"}	1 ^{1/4"}	36"	DT1ASX424236	1,096.	1,201.	1,247.	1,534.	1,682.	1,747.

 42" High Square X Base Table	30"	29 ^{13/16"}	29 ^{13/16"}	1 ^{1/4"}	42"	DT1ASX303042	977.	1,068.	1,108.	1,399.	1,537.	1,594.
	36"	35 ^{13/16"}	35 ^{13/16"}	1 ^{1/4"}	42"	DT1ASX363642	1,015.	1,110.	1,152.	1,473.	1,613.	1,675.
	42"	41 ^{13/16"}	41 ^{13/16"}	1 ^{1/4"}	42"	DT1ASX424242	1,116.	1,221.	1,267.	1,554.	1,702.	1,767.

w* = nominal width
 Dimensions listed under w d t h are actual to the nearest 1/16"





Ordering Information	Order Code	Included with:	Options
X Base Table: 1. Pattern number 2. Base Paint Finish 3. Top Finish 4. Edge Finish	X Base Table: <i>Example:</i> DT1ASX3030, 114, 114, 114 <hr/> DT1 Dividends Horizon Table <hr/> A Table assembly <hr/> S Square shape <hr/> X X Base <hr/> 30 Overall width in inches <hr/> 30 Overall depth in inches <hr/> 114 Base finish <hr/> 114 Laminate top finish <hr/> 114 Edgeband finish	X Base Table: <ul style="list-style-type: none"> • (1) X Base • Hardware kit • Table top Note: X Base Tables are finished with textured paint, including 613 Silver. Note: X Base Tables are only available in Knoll core finishes.	

X Base Tables

Round Table Tops

17", 21", 28", 36" and 42" High

Dividends Horizon

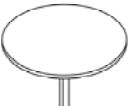
description	w*	w	d	t	h	pattern no.	Laminate Top P1 Paint	Laminate Top P2 Paint	Laminate Top P3 Paint	Techgrain Top P1 Paint	Techgrain Top P2 Paint	Techgrain Top P3 Paint
 17" High Round X Base Table	30"	29 ^{13/16"}	29 ^{13/16"}	1 ^{1/4"}	17"	DT1ACX3017	\$896.	\$988.	\$1,028.	\$2,000.	\$2,200.	\$2,290.
	36"	35 ^{13/16"}	35 ^{13/16"}	1 ^{1/4"}	17"	DT1ACX3617	932.	1,027.	1,069.	2,079.	2,289.	2,381.
	42"	41 ^{13/16"}	41 ^{13/16"}	1 ^{1/4"}	17"	DT1ACX4217	1,031.	1,136.	1,182.	2,179.	2,399.	2,496.
	48"	47 ^{13/16"}	47 ^{13/16"}	1 ^{1/4"}	17"	DT1ACX4817	1,082.	1,192.	1,240.	2,238.	2,464.	2,563.
 21" High Round X Base Table	30"	29 ^{13/16"}	29 ^{13/16"}	1 ^{1/4"}	21"	DT1ACX3021	896.	988.	1,028.	2,000.	2,200.	2,290.
	36"	35 ^{13/16"}	35 ^{13/16"}	1 ^{1/4"}	21"	DT1ACX3621	932.	1,027.	1,069.	2,079.	2,289.	2,381.
	42"	41 ^{13/16"}	41 ^{13/16"}	1 ^{1/4"}	21"	DT1ACX4221	1,031.	1,136.	1,182.	2,179.	2,399.	2,496.
	48"	47 ^{13/16"}	47 ^{13/16"}	1 ^{1/4"}	21"	DT1ACX4821	1,082.	1,192.	1,240.	2,238.	2,464.	2,563.
 28" High Round X Base Table	30"	29 ^{13/16"}	29 ^{13/16"}	1 ^{1/4"}	28 ^{1/2"}	DT1ACX30	916.	1,008.	1,048.	2,020.	2,220.	2,310.
	36"	35 ^{13/16"}	35 ^{13/16"}	1 ^{1/4"}	28 ^{1/2"}	DT1ACX36	952.	1,047.	1,089.	2,099.	2,309.	2,401.
	42"	41 ^{13/16"}	41 ^{13/16"}	1 ^{1/4"}	28 ^{1/2"}	DT1ACX42	1,051.	1,156.	1,202.	2,199.	2,419.	2,516.
	48"	47 ^{13/16"}	47 ^{13/16"}	1 ^{1/4"}	28 ^{1/2"}	DT1ACX48	1,102.	1,212.	1,260.	2,258.	2,484.	2,583.
 36" High Round X Base Table	30"	29 ^{13/16"}	29 ^{13/16"}	1 ^{1/4"}	36"	DT1ACX3036	966.	1,058.	1,098.	2,070.	2,270.	2,360.
	36"	35 ^{13/16"}	35 ^{13/16"}	1 ^{1/4"}	36"	DT1ACX3636	1,002.	1,097.	1,139.	2,149.	2,359.	2,451.
	42"	41 ^{13/16"}	41 ^{13/16"}	1 ^{1/4"}	36"	DT1ACX4236	1,101.	1,206.	1,252.	2,249.	2,469.	2,566.
 42" High Round X Base Table	30"	29 ^{13/16"}	29 ^{13/16"}	1 ^{1/4"}	42"	DT1ACX3042	986.	1,078.	1,118.	2,090.	2,290.	2,380.
	36"	35 ^{13/16"}	35 ^{13/16"}	1 ^{1/4"}	42"	DT1ACX3642	1,022.	1,117.	1,159.	2,169.	2,379.	2,471.
	42"	41 ^{13/16"}	41 ^{13/16"}	1 ^{1/4"}	42"	DT1ACX4242	1,121.	1,226.	1,272.	2,269.	2,489.	2,586.

w* = nominal width

Dimensions listed under w d t h are actual to the nearest^{1/16"}

Ordering Information

X Base Table:

1. Pattern number
2. Base Paint Finish
3. Top Finish
4. Edge Finish

Order Code

X Base Table:

Example: **DT1ACX3030, 114, 114, 114**

DT1	Dividends Horizon Table
A	Table assembly
C	Round shape
X	X Base
30	Overall width in inches
30	Overall depth in inches
114	Base finish
114	Laminate top finish
114	Edgeband finish

Included with:

X Base Table:

- (1) X Base
- Hardware kit
- Table top

Note: X Base Tables are finished with textured paint, including 613 Silver.

Note: X Base Tables are only available in Knoll core finishes.





Options

X Base Tables

Rounded Square Table Tops

17", 21", 28", 36" and 42" High

Dividends Horizon

description	w*	w	d	t	h	pattern no.	Laminate	Laminate	Laminate	Techgrain	Techgrain	Techgrain
							Top P1 Paint	Top P2 Paint	Top P3 Paint	Top P1 Paint	Top P2 Paint	Top P3 Paint
 17" High Rounded Square X Base Table	30"	29 ^{13/16"}	29 ^{13/16"}	1 ^{1/4"}	17"	DT1ADX303017	\$896.	\$988.	\$1,028.	\$2,000.	\$2,200.	\$2,290.
	36"	35 ^{13/16"}	35 ^{13/16"}	1 ^{1/4"}	17"	DT1ADX363617	932.	1,027.	1,069.	2,079.	2,289.	2,381.
	42"	41 ^{13/16"}	41 ^{13/16"}	1 ^{1/4"}	17"	DT1ADX424217	1,031.	1,136.	1,182.	2,179.	2,399.	2,496.
	48"	47 ^{13/16"}	47 ^{13/16"}	1 ^{1/4"}	17"	DT1ADX484817	1,082.	1,192.	1,240.	2,238.	2,464.	2,563.
 21" High Rounded Square X Base Table	30"	29 ^{13/16"}	29 ^{13/16"}	1 ^{1/4"}	21"	DT1ADX303021	896.	988.	1,028.	2,000.	2,200.	2,290.
	36"	35 ^{13/16"}	35 ^{13/16"}	1 ^{1/4"}	21"	DT1ADX363621	932.	1,027.	1,069.	2,079.	2,289.	2,381.
	42"	41 ^{13/16"}	41 ^{13/16"}	1 ^{1/4"}	21"	DT1ADX424221	1,031.	1,136.	1,182.	2,179.	2,399.	2,496.
	48"	47 ^{13/16"}	47 ^{13/16"}	1 ^{1/4"}	21"	DT1ADX484821	1,082.	1,192.	1,240.	2,238.	2,464.	2,563.
 28" High Rounded Square X Base Table	30"	29 ^{13/16"}	29 ^{13/16"}	1 ^{1/4"}	28 ^{1/2"}	DT1ADX3030	916.	1,008.	1,048.	2,020.	2,220.	2,310.
	36"	35 ^{13/16"}	35 ^{13/16"}	1 ^{1/4"}	28 ^{1/2"}	DT1ADX3636	952.	1,047.	1,089.	2,099.	2,309.	2,401.
	42"	41 ^{13/16"}	41 ^{13/16"}	1 ^{1/4"}	28 ^{1/2"}	DT1ADX4242	1,051.	1,156.	1,202.	2,199.	2,419.	2,510.
	48"	47 ^{13/16"}	47 ^{13/16"}	1 ^{1/4"}	28 ^{1/2"}	DT1ADX4848	1,102.	1,212.	1,260.	2,258.	2,484.	2,583.
 36" High Rounded Square X Base Table	30"	29 ^{13/16"}	29 ^{13/16"}	1 ^{1/4"}	36"	DT1ADX303036	966.	1,058.	1,098.	2,070.	2,270.	2,360.
	36"	35 ^{13/16"}	35 ^{13/16"}	1 ^{1/4"}	36"	DT1ADX363636	1,002.	1,097.	1,139.	2,149.	2,359.	2,451.
	42"	41 ^{13/16"}	41 ^{13/16"}	1 ^{1/4"}	36"	DT1ADX424236	1,101.	1,206.	1,252.	2,249.	2,469.	2,566.

Tables

w* = nominal width
 Dimensions listed under w d t h are actual to the nearest 1/16"

Ordering Information	Order Code	Included with:	Options
X Base Table: 1. Pattern number 2. Base Paint Finish 3. Top Finish 4. Edge Finish	X Base Table: <i>Example:</i> DT1ADX3030, 114, 114, 114 <hr/> DT1 Dividends Horizon Table <hr/> A Table assembly <hr/> D Rounded Square shape <hr/> X X Base <hr/> 30 Overall width in inches <hr/> 30 Overall depth in inches <hr/> 114 Base finish <hr/> 114 Laminate top finish <hr/> 114 Edgeband finish	X Base Table: <ul style="list-style-type: none"> (1) X Base Hardware kit Table top Note: X Base Tables are finished with textured paint, including 613 Silver. Note: X Base Tables are only available in Knoll core finishes.	

X Base Tables

Rounded Square Table Tops

17", 21", 28", 36" and 42" High

description	w*	w	d	t	h	pattern no.	Laminate	Laminate	Laminate	Techgrain	Techgrain	Techgrain
							Top P1 Paint	Top P2 Paint	Top P3 Paint	Top P1 Paint	Top P2 Paint	Top P3 Paint
42" High Rounded Square X Base Table	30"	29 ^{13/16"}	29 ^{13/16"}	1 ^{1/4"}	42"	DT1ADX303042	\$986.	\$1,078.	\$1,118.	\$2,090.	\$2,290.	\$2,380.
	36"	35 ^{13/16"}	35 ^{13/16"}	1 ^{1/4"}	42"	DT1ADX363642	1,022.	1,117.	1,159.	2,169.	2,379.	2,471.
	42"	41 ^{13/16"}	41 ^{13/16"}	1 ^{1/4"}	42"	DT1ADX424242	1,121.	1,226.	1,272.	2,269.	2,489.	2,586.



w* = nominal width



Dimensions listed under w d t h are actual to the nearest 1/16"

Ordering Information	Order Code	Included with:	Options
X Base Table:	X Base Table:	X Base Table:	
1. Pattern number	<i>Example:</i> DT1ADX3030, 114, 114,	<ul style="list-style-type: none"> (1) X Base Hardware kit Table top 	
2. Base Paint Finish	114		
3. Top Finish	DT1 Dividends Horizon	Note: X Base Tables are finished with textured paint, including 613 Silver.	
4. Edge Finish	A Table assembly		
	D Rounded Square shape	Note: X Base Tables are only available in Knoll core finishes.	
	X X Base		
	30 Overall width in inches		
	30 Overall depth in inches		
	114 Base finish		
	114 Laminate top finish		
	114 Edgeband finish		

Table Supports

X Bases

Credenza Support Spacer

description	w	h	d	pattern no.	P1	P2	P3
Small X-Base, for use with 30" or 36" wide round, square or rounded square table tops 		17"		DT1BXS17	\$476.	\$526.	\$548.
		21"		DT1BXS21	476.	526.	548.
		28"		DT1BXS	496.	546.	568.
		36"		DT1BXS36	546.	596.	618.
		42"		DT1BXS42	566.	616.	638.
Large X Base, for use with 42" or 48" wide round, square or rounded square table tops 		17"		DT1BXL17	525.	580.	604.
		21"		DT1BXL21	525.	580.	604.
		28"		DT1BXL	545.	600.	624.
		36"		DT1BXL36	595.	650.	674.
		42"		DT1BXL42	615.	670.	694.
Credenza Support Spacer For use with Dividends Horizon Credenza 	9 ⁵ / ₈ "	2 ¹⁵ / ₁₆ "	1 ⁹ / ₁₆ "	DT1S	132.	145.	151.

Tables

Ordering Information	Order Code	Included with:	Options
Table Supports: 1. Pattern number 2. Paint Finish	X Base: <i>Example:</i> DT1BXS, 114 DT1 Dividends Horizon Table B Base S X Shape 114 Paint finish Credenza Support Spacer: <i>Example:</i> DT1S, 114 DT1 Dividends Horizon Table S Support Spacer 114 Paint finish	X Base: <ul style="list-style-type: none"> X Base Hardware kit Credenza Support spacer: <ul style="list-style-type: none"> Support spacer Hardware Kit Note: X bases are painted with textured paint, including 613 Silver. Note: Table supports are only available in Knoll core finishes.	

Dividends Horizon Conference Tables

Dividends Horizon conference tables are designed with a scale and visual language consistent with the full scope of Dividends Horizon products. This design consistency makes Dividends Horizon tables appropriate for use in conference, meeting, private office and open plan office applications.

Dividends Horizon conference tables are available in racetrack, rectangular, or boat shape and in all standard Dividends Horizon finishes.

Conference tables include a table top and base assembly. A conference table base assembly includes two Y legs, one center support T base, and two horizontal stretchers that connect the three bases. Top sizes up to 120 inches are produced in one piece, while tops longer than 120 inches are produced in two pieces.

Available Sizes

Width: 102- 144 inches

Depth: 36- 48 inches

Height: 28-1/2 inches

Construction

Worksurface:

- Material: 0.028 inch thick high pressure laminate or 0.6mm thick veneer on 1-1/8 inch thick particle board core
- Edge: plastic laminate tops have a 2mm edgeband; Techwood tops have a 3/16" thick Techwood edge

Base:

- Stretcher: extruded aluminum
- Foot: die cast aluminum
- Column: extruded aluminum with 3/16 inch thick structural plate

Note: Dividends Horizon conference tables are only available in Knoll Core paint, laminate, and Techwood finishes. Legacy finishes are not available. All paint finishes have the Dividends Horizon textured paint finish; this includes 613 Silver, which is a smooth paint on all other Dividends Horizon products.

Note: Grain patterns on woodgrain laminate and veneer tops will not match at the seam in the middle of tables longer than 120 inches.

Rectangular Conference Table

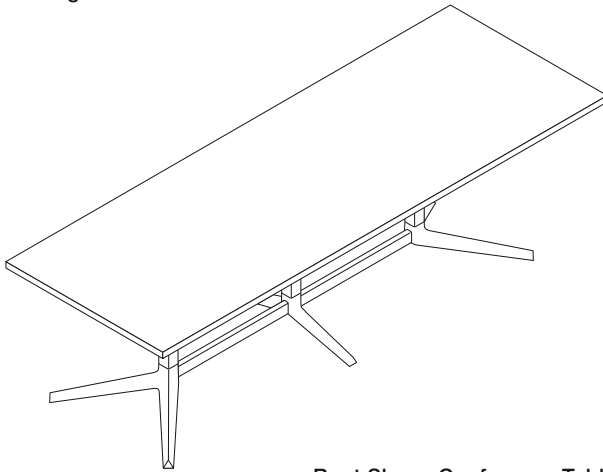

Racetrack Conference Table

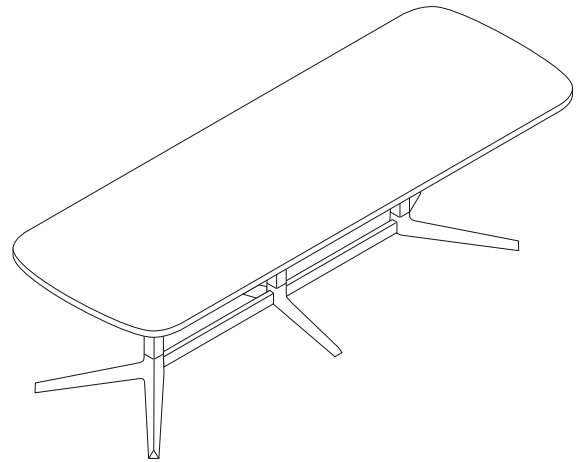

Boat Shape Conference Table



Conference Tables

Rectangular Table Top

36", 42" and 48" Deep

description	w*	w	d	t	h	pattern no.	Laminate	Laminate	Laminate	Techgrain	Techgrain	Techgrain
							Top P1 Paint	Top P2 Paint	Top P3 Paint	Top P1 Paint	Top P2 Paint	Top P3 Paint
36" Deep Rectangular Conference Table	102"	101 ^{13/16"}	35 ^{1/2"}	1 ^{1/4"}	28 ^{1/2"}	DT1ARY10236N	\$2,100.	\$2,150.	\$2,200.	\$2,400.	\$2,500.	\$2,700.
	108"	107 ^{13/16"}	35 ^{1/2"}	1 ^{1/4"}	28 ^{1/2"}	DT1ARY10836N	2,150.	2,200.	2,250.	2,450.	2,695.	2,803.

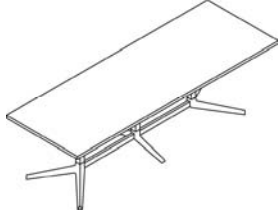

42" Deep Rectangular Conference Table	102"	101 ^{13/16"}	41 ^{1/2"}	1 ^{1/4"}	28 ^{1/2"}	DT1ARY10242N	2,150.	2,200.	2,250.	2,450.	2,550.	2,750.
	108"	107 ^{13/16"}	41 ^{1/2"}	1 ^{1/4"}	28 ^{1/2"}	DT1ARY10842N	2,200.	2,250.	2,300.	2,475.	2,750.	2,887.
	120"	119 ^{13/16"}	41 ^{1/2"}	1 ^{1/4"}	28 ^{1/2"}	DT1ARY12042N	2,352.	2,402.	2,452.	2,571.	2,828.	2,941.
	132"	131 ^{13/16"}	41 ^{1/2"}	1 ^{1/4"}	28 ^{1/2"}	DT1ARY13242N	2,452.	2,502.	2,552.	2,989.	3,288.	3,420.
	144"	143 ^{13/16"}	41 ^{1/2"}	1 ^{1/4"}	28 ^{1/2"}	DT1ARY14442N	2,552.	2,602.	2,652.	3,407.	3,748.	3,898.



48" Deep Rectangular Conference Table	102"	101 ^{13/16"}	47 ^{1/2"}	1 ^{1/4"}	28 ^{1/2"}	DT1ARY10248N	2,200.	2,250.	2,300.	2,500.	2,650.	2,850.
	108"	107 ^{13/16"}	47 ^{1/2"}	1 ^{1/4"}	28 ^{1/2"}	DT1ARY10848N	2,250.	2,300.	2,350.	2,575.	2,825.	2,950.
	120"	119 ^{13/16"}	47 ^{1/2"}	1 ^{1/4"}	28 ^{1/2"}	DT1ARY12048N	2,409.	2,459.	2,509.	2,646.	2,911.	3,027.
	132"	131 ^{13/16"}	47 ^{1/2"}	1 ^{1/4"}	28 ^{1/2"}	DT1ARY13248N	2,509.	2,559.	2,609.	3,072.	3,379.	3,514.
	144"	143 ^{13/16"}	47 ^{1/2"}	1 ^{1/4"}	28 ^{1/2"}	DT1ARY14448N	2,609.	2,659.	2,709.	3,497.	3,847.	4,001.

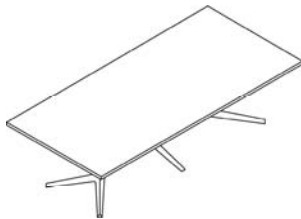

w* = nominal width
 Dimensions listed under w d t h are actual to the nearest 1/16"

Ordering Information	Order Code	Included with:	Options
Conference Tables:	Conference Table:	Conference Table:	Conference Tables
1. Pattern number	<i>Example:</i> DT1ARY10836N	• (2) Y Legs	
2. Base/Stretcher Paint Finish	DT1 Dividends Horizon Table	• (1) T leg	
3. Top Finish	A Table Assembly	• (2) Stretchers	
4. Edge Finish	R Rectangular shape	• Table Top	
	Y Y Leg Base	• Hardware Kit	
	108 Overall width in inches		
	36 Overall depth in inches		
	N No grommet		
	114 Base/ stretcher paint finish		
	114 Laminate top finish		
	114 Edgeband finish		

Conference Tables

Racetrack Table Top

36", 42" and 48" Deep

description	w	w	d	t	h	pattern no.	Laminate	Laminate	Laminate	Techgrain	Techgrain	Techgrain
							Top P1 Paint	Top P2 Paint	Top P3 Paint	Top P1 Paint	Top P2 Paint	Top P3 Paint
36" Deep Racetrack Conference Table	102"	101 ^{13/16"}	35 ^{1/2"}	1 ^{1/4"}	28 ^{1/2"}	DT1ATY10236N	\$2,100.	\$2,150.	\$2,200.	\$3,100.	\$3,400.	\$3,500.
	108"	107 ^{13/16"}	35 ^{1/2"}	1 ^{1/4"}	28 ^{1/2"}	DT1ATY10836N	2,150.	2,200.	2,250.	3,145.	3,460.	3,598.



42" Deep Racetrack Conference Table	102"	101 ^{13/16"}	41 ^{1/2"}	1 ^{1/4"}	28 ^{1/2"}	DT1ATY10242N	2,150.	2,200.	2,250.	3,125.	3,450.	3,600.
	108"	107 ^{13/16"}	41 ^{1/2"}	1 ^{1/4"}	28 ^{1/2"}	DT1ATY10842N	2,200.	2,250.	2,300.	3,200.	3,500.	3,650.
	120"	119 ^{13/16"}	41 ^{1/2"}	1 ^{1/4"}	28 ^{1/2"}	DT1ATY12042N	2,352.	2,402.	2,452.	3,266.	3,593.	3,737.
	132"	131 ^{13/16"}	41 ^{1/2"}	1 ^{1/4"}	28 ^{1/2"}	DT1ATY13242N	2,452.	2,502.	2,552.	3,750.	4,125.	4,290.
	144"	143 ^{13/16"}	41 ^{1/2"}	1 ^{1/4"}	28 ^{1/2"}	DT1ATY14442N	2,552.	2,602.	2,652.	4,233.	4,656.	4,842.



48" Deep Racetrack Conference Table	102"	101 ^{13/16"}	47 ^{1/2"}	1 ^{1/4"}	28 ^{1/2"}	DT1ATY10248N	2,200.	2,250.	2,300.	3,200.	3,475.	3,625.
	108"	107 ^{13/16"}	47 ^{1/2"}	1 ^{1/4"}	28 ^{1/2"}	DT1ATY10848N	2,250.	2,300.	2,350.	3,300.	3,550.	3,700.
	120"	119 ^{13/16"}	47 ^{1/2"}	1 ^{1/4"}	28 ^{1/2"}	DT1ATY12048N	2,409.	2,459.	2,509.	3,339.	3,673.	3,820.
	132"	131 ^{13/16"}	47 ^{1/2"}	1 ^{1/4"}	28 ^{1/2"}	DT1ATY13248N	2,509.	2,559.	2,609.	3,831.	4,214.	4,383.
	144"	143 ^{13/16"}	47 ^{1/2"}	1 ^{1/4"}	28 ^{1/2"}	DT1ATY14448N	2,609.	2,659.	2,709.	4,323.	4,755.	4,945.



w* = nominal width
 Dimensions listed under w d t h are actual to the nearest 1/16"

Ordering Information	Order Code	Included with:	Options
Conference Tables:	Conference Table:	Conference Table:	Conference Tables
1. Pattern number	<i>Example:</i> DT1ARY10836N	• (2) Y Legs	
2. Base/Stretcher Paint Finish	DT1 Dividends Horizon Table	• (1) T leg	
3. Top Finish	A Table Assembly	• (2) Stretchers	
4. Edge Finish	R Rectangular shape	• Table Top	
	Y Y Leg Base	• Hardware Kit	
	108 Overall width in inches		
	36 Overall depth in inches		
	N No grommet		
	114 Base/ stretcher paint finish		
	114 Laminate top finish		
	114 Edgeband finish		

Conference Tables

Boat Shape Table Top

42" and 48" Deep

description	w*	w	d	t	h	pattern no.	Laminate	Laminate	Laminate	Techgrain	Techgrain	Techgrain
							Top P1 Paint	Top P2 Paint	Top P3 Paint	Top P1 Paint	Top P2 Paint	Top P3 Paint
42" Deep Boat Shape Conference Table	102"	101 13/16"	41 1/2"	1 1/4"	28 1/2"	DT1ABY10242N	\$2,150.	\$2,200.	\$2,250.	\$3,125.	\$3,450.	\$3,600.
	108"	107 13/16"	41 1/2"	1 1/4"	28 1/2"	DT1ABY10842N	2,200.	2,250.	2,300.	3,200.	3,500.	3,650.
	120"	119 13/16"	41 1/2"	1 1/4"	28 1/2"	DT1ABY12042N	2,352.	2,402.	2,452.	3,266.	3,593.	3,737.
	132"	131 13/16"	41 1/2"	1 1/4"	28 1/2"	DT1ABY13242N	2,452.	2,502.	2,552.	3,750.	4,125.	4,290.
	144"	143 13/16"	41 1/2"	1 1/4"	28 1/2"	DT1ABY14442N	2,552.	2,602.	2,652.	4,233.	4,656.	4,842.



48" Deep Boat Shape Conference Table	102"	101 13/16"	47 1/2"	1 1/4"	28 1/2"	DT1ABY10248N	2,200.	2,250.	2,300.	3,200.	3,475.	3,625.
	108"	107 13/16"	47 1/2"	1 1/4"	28 1/2"	DT1ABY10848N	2,250.	2,300.	2,350.	3,300.	3,550.	3,700.
	120"	119 13/16"	47 1/2"	1 1/4"	28 1/2"	DT1ABY12048N	2,409.	2,459.	2,509.	3,339.	3,673.	3,820.
	132"	131 13/16"	47 1/2"	1 1/4"	28 1/2"	DT1ABY13248N	2,509.	2,559.	2,609.	3,831.	4,214.	4,383.
	144"	143 13/16"	47 1/2"	1 1/4"	28 1/2"	DT1ABY14448N	2,609.	2,659.	2,709.	4,323.	4,755.	4,945.



Tables

w* = nominal width
Dimensions listed under w d t h are actual to the nearest 1/16"

Ordering Information	Order Code	Included with:	Options
Conference Tables:	Conference Table:	Conference Table:	Conference Tables
1. Pattern number	<i>Example:</i> DT1ARY10836N	• (2) Y Legs	
2. Base/Stretcher Paint Finish	DT1 Dividends Horizon Table	• (1) T leg	
3. Top Finish	A Table Assembly	• (2) Stretchers	
4. Edge Finish	R Rectangular shape	• Table Top	
	Y Y Leg Base	• Hardware Kit	
	108 Overall width in inches		
	36 Overall depth in inches		
	N No grommet		
	114 Base/ stretcher paint finish		
	114 Laminate top finish		
	114 Edgeband finish		

Preconfigured Desks

Series 2 Single and Double Pedestal Specifications

Series 2 Single and Double Pedestal Desks

Series 2 freestanding single and double pedestal desks can be specified "Preconfigured" or by component for "Build-to-Spec" applications. These applications include when a different pedestal drawer configuration is required, or when back panels are not needed.

"Preconfigured" single pedestal desks consist of a worksurface, Series 2 box/box/file pedestal, "L" shaped end panel and full height back panel.

"Preconfigured" double pedestal desks consist of a worksurface, two pedestals (file/file and box/ box/file) and full height back panel.

Available Sizes

- Height: 28½"
- Depths: 24", 30" and 36"
(double pedestal desk only)
- Widths: 60", 66" and 72"
- Worksurface thickness: 1¼"

"Build-to-Spec" Desks

For "Build-to-Spec" desks specify by component. Refer to individual component category for information.

Construction

All freestanding desks match the aesthetics and dimensions of Dividends Horizon panel components.

Drawers overlay the cabinet front and feature softly-radiused integral pulls, drawer fronts and drawer trim. Series 2 desks include full-height modesty panels.

Worksurface support is provided by pedestals and end units which are non-handed and shipped knocked down. This allows pedestals and end units to be positioned at either end of worksurfaces.

Optional Edge Grommets

Edge grommets are optional for all desks except overhang desks and can be specified factory-installed, centered along the rear edge of worksurfaces. Grommets can also be ordered as a kit (pattern number D1WSG) for field installation in any position along the rear edge of the worksurface. When grommets are specified, a reveal of ½" is provided between the rear of the worksurface and the back panel for repositioning cables anywhere along the back panel.

Locks

Desk pedestals can be ordered with or without locks. When specified without locks, a lock plug is included. An optional lock retrofit kit is available for field-installation of locks at a later date if required. Locks are keyed randomly unless otherwise specified. Other keying options include keyed alike or keyed with lock cores K001-K250.

All locks are factory-installed and have a black finish.

Desk Accessory

All Series 2 pedestal accessories including the hanging file bar must be specified separately.

Series 2 Single Pedestal Desk

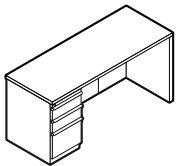

Series 2 Double Pedestal Desk

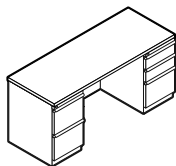

Series 2 Desk Components

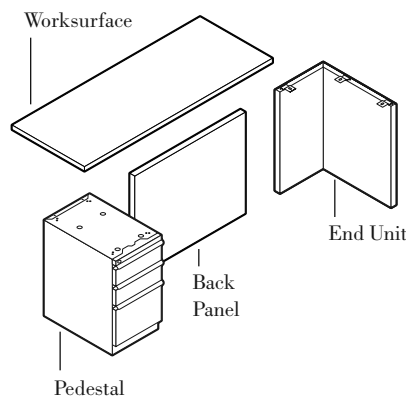

Optional Edge Grommet

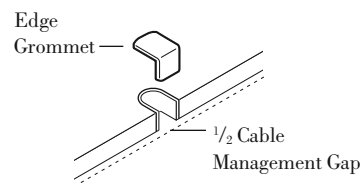

Series 2 Freestanding Desk Configurations

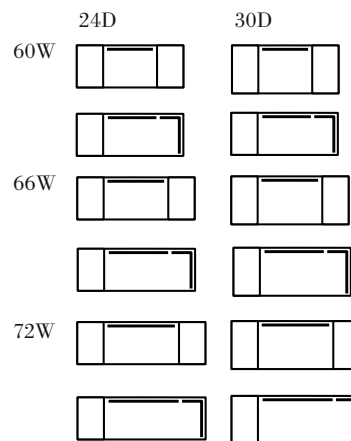

Preconfigured Desks

Series 2 Single and Double Pedestal

24", 30" and 36" Deep

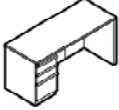
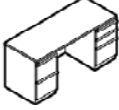
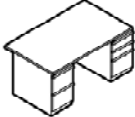
description	w*	w	d	h	pattern no.	P1	P2	P3
 Single Pedestal Desk with Locks	60"	59 ^{13/16"}	23 ^{1/2"}	28 ^{1/2"}	DD2S L6024N	\$1,456.	\$1,572.	\$1,628.
	60"	59 ^{13/16"}	29 ^{1/2"}	28 ^{1/2"}	DD2S L6030N	1,596.	1,716.	1,777.
	66"	65 ^{13/16"}	23 ^{1/2"}	28 ^{1/2"}	DD2S L6624N	1,492.	1,608.	1,666.
	66"	65 ^{13/16"}	29 ^{1/2"}	28 ^{1/2"}	DD2S L6630N	1,649.	1,772.	1,832.
	72"	71 ^{13/16"}	23 ^{1/2"}	28 ^{1/2"}	DD2S L7224N	1,516.	1,634.	1,693.
	72"	71 ^{13/16"}	29 ^{1/2"}	28 ^{1/2"}	DD2S L7230N	1,675.	1,800.	1,861.
 Double Pedestal Desk with Locks	60"	59 ^{13/16"}	23 ^{1/2"}	28 ^{1/2"}	DD2D L6024N	1,674.	1,812.	1,881.
	60"	59 ^{13/16"}	29 ^{1/2"}	28 ^{1/2"}	DD2D L6030N	1,807.	1,949.	2,020.
	66"	65 ^{13/16"}	23 ^{1/2"}	28 ^{1/2"}	DD2D L6624N	1,710.	1,848.	1,918.
	66"	65 ^{13/16"}	29 ^{1/2"}	28 ^{1/2"}	DD2D L6630N	1,861.	2,005.	2,077.
	72"	71 ^{13/16"}	23 ^{1/2"}	28 ^{1/2"}	DD2D L7224N	1,734.	1,874.	1,944.
	72"	71 ^{13/16"}	29 ^{1/2"}	28 ^{1/2"}	DD2D L7230N	1,889.	2,031.	2,106.
 Double Pedestal Desk with Locks and 6" Front Overhang	60"	59 ^{13/16"}	35 ^{1/2"}	28 ^{1/2"}	DD2O L6036N	1,916.	2,057.	2,129.
	66"	65 ^{13/16"}	35 ^{1/2"}	28 ^{1/2"}	DD2O L6636N	1,978.	2,121.	2,193.
	72"	71 ^{13/16"}	35 ^{1/2"}	28 ^{1/2"}	DD2O L7236N	2,044.	2,188.	2,258.

w* = nominal width
 Dimensions listed under w d h are actual to the nearest 1/16"

Ordering Information	Order Code	Included with:	Options
Single Pedestal Desk 1. Pattern Number 2. Laminate Finish 3. Edge Band Finish 4. Paint Finish	Single Pedestal Desk <i>Example:</i> DD2S L7230N, 117, 117, 117 <hr/> DD2S Pattern Number L7230N <hr/> 117 Soft Grey laminate <hr/> 117 Soft Grey edge finish <hr/> 117 Soft Grey paint finish <hr/> Double Pedestal Desk <i>Example:</i> DD2D L7230N, 117, 117, 117 <hr/> DD2D Pattern Number L7230N <hr/> 117 Soft Grey laminate <hr/> 117 Soft Grey edge finish <hr/> 117 Soft Grey paint finish	Single Pedestal Desk Double Pedestal Desk Note: An upcharge applies when specifying Legacy laminates. See Legacy finish page.	Single Pedestal Desk <ul style="list-style-type: none"> To specify desk with center located edge grommet, replace the suffix letter "N" with a "G". Add \$18 (Grommets not available for overhang desks) <ul style="list-style-type: none"> To specify pedestals without locks, replace the fifth character "L" with an "N". Deduct \$21 Double Pedestal Desk <ul style="list-style-type: none"> To specify desk with center located edge grommet, replace the suffix letter "N" with a "G". Add \$18 (Grommets not available for overhang desks) <ul style="list-style-type: none"> To specify pedestals without locks, replace the fifth character "L" with an "N". Deduct \$42

Preconfigured Desks

Single and Double Pedestal Specifications

Single and Double Pedestal Desks

Dividends freestanding single and double pedestal desks can be specified "Preconfigured" or by component for "Build-to-Spec" applications. These applications include when a different pedestal drawer configuration is required, or when back panels are not needed. "Preconfigured" single pedestal desks consist of a worksurface, box/box/file pedestal, "L" shaped end panel and half-height back panel. "Preconfigured" double pedestal desks consist of a worksurface, two pedestals (file/file and box/ box/file) and half-height back panel.

Available Sizes

- Height: 28½"
- Depths: 24", 30" and 36"
(Double pedestal desk only)
- Widths: 60", 66" and 72"
- Worksurface thickness: 1¼"

"Build-to-Spec" Desks

For "Build-to-Spec" desks specify by component. Refer to individual component category for information.

Construction

All freestanding desks match the aesthetics and dimensions of Dividends panel components.

Drawers overlay the cabinet front and feature softly-radiused pulls, drawer fronts and drawer trim.

Half-height back panels extend 11" from the bottom of the worksurface, are inset ¾" from the pedestal backs and match the softly-radiused aesthetics of other Dividends components.

Worksurface support is provided by pedestals and end units which are non-handed and shipped knocked down. This allows pedestals and end units to be positioned at either end of worksurfaces.

Locks

Desk pedestals can be ordered with or without locks. When specified without locks, a lock plug is included. An optional lock retrofit kit is available for field-installation of locks at a later date if required. Locks are keyed randomly unless otherwise specified. Other keying options include keyed alike or keyed with lock cores K001-K250 All locks are factory-installed and have a black finish.

Accessory

Hanging file bars for front-to-back or side-to-side filing are included with pedestals.

Single Pedestal Desk

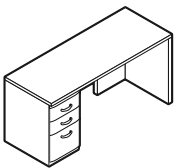

Double Pedestal Desk

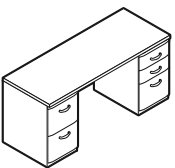

Desk Components

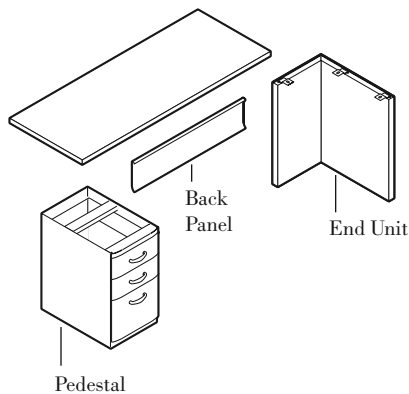

Freestanding Desk Configurations

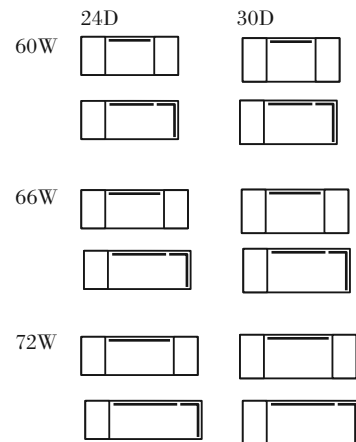

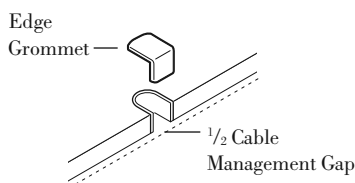

Optional Edge Grommet



Preconfigured Desks

Single and Double Pedestal

24", 30" and 36" Deep

description	w*	w	d	h	pattern no.	P1	P2	P3
 Single Pedestal Desk with Locks	60"	59 ^{13/16"}	23 ^{1/2"}	28 ^{1/2"}	DD1S L6024N	\$1,456.	\$1,572.	\$1,628.
	60"	59 ^{13/16"}	29 ^{1/2"}	28 ^{1/2"}	DD1S L6030N	1,592.	1,716.	1,777.
	66"	65 ^{13/16"}	23 ^{1/2"}	28 ^{1/2"}	DD1S L6624N	1,492.	1,608.	1,666.
	66"	65 ^{13/16"}	29 ^{1/2"}	28 ^{1/2"}	DD1S L6630N	1,649.	1,772.	1,832.
	72"	71 ^{13/16"}	23 ^{1/2"}	28 ^{1/2"}	DD1S L7224N	1,516.	1,634.	1,693.
	72"	71 ^{13/16"}	29 ^{1/2"}	28 ^{1/2"}	DD1S L7230N	1,675.	1,800.	1,861.
 Double Pedestal Desk with Locks	60"	59 ^{13/16"}	23 ^{1/2"}	28 ^{1/2"}	DD1D L6024N	1,674.	1,812.	1,881.
	60"	59 ^{13/16"}	29 ^{1/2"}	28 ^{1/2"}	DD1D L6030N	1,807.	1,949.	2,020.
	66"	65 ^{13/16"}	23 ^{1/2"}	28 ^{1/2"}	DD1D L6624N	1,710.	1,848.	1,918.
	66"	65 ^{13/16"}	29 ^{1/2"}	28 ^{1/2"}	DD1D L6630N	1,861.	2,005.	2,077.
	72"	71 ^{13/16"}	23 ^{1/2"}	28 ^{1/2"}	DD1D L7224N	1,734.	1,874.	1,944.
	72"	71 ^{13/16"}	29 ^{1/2"}	28 ^{1/2"}	DD1D L7230N	1,889.	2,031.	2,106.
 Double Pedestal Desk with Locks and 6" Front Overhang	60"	59 ^{13/16"}	35 ^{1/2"}	28 ^{1/2"}	DD1O L6036N	1,916.	2,057.	2,129.
	66"	65 ^{13/16"}	35 ^{1/2"}	28 ^{1/2"}	DD1O L6636N	1,978.	2,121.	2,193.
	72"	71 ^{13/16"}	35 ^{1/2"}	28 ^{1/2"}	DD1O L7236N	2,044.	2,188.	2,258.

w* = nominal width
 Dimensions listed under w d h are actual to the nearest 1/16"

Ordering Information	Order Code	Included with:	Options
Single Pedestal Desk 1. Pattern Number 2. Laminate Finish 3. Edge Band Finish 4. Paint Finish 5. Pull Finish 6. Drawer Top Cap Finish	Single Pedestal Desk <i>Example:</i> DD1S L7230N, 117, 117, 117, 117, 117 <hr/> DD1S Pattern Number L7230N <hr/> 117 Soft Grey laminate <hr/> 117 Soft Grey edge finish <hr/> 117 Soft Grey paint finish <hr/> 117 Soft Grey pull finish <hr/> Y3 Dark Grey top cap finish	Single Pedestal Desk Double Pedestal Desk Note: An upcharge applies when specifying Legacy laminates. See Legacy finish page.	Single Pedestal Desk <ul style="list-style-type: none"> To specify desk with center located edge grommet, replace the suffix letter "N" with a "G". Add \$18 (Grommets not available for overhang desks) <ul style="list-style-type: none"> To specify pedestals without locks, replace the fifth character "L" with an "N". Deduct \$21
Double Pedestal Desk 1. Pattern Number 2. Laminate Finish 3. Edge Band Finish 4. Paint Finish 5. Pull Finish 6. Drawer Top Cap Finish	Double Pedestal Desk <i>Example:</i> DD1D L7230N, 117, 117, 117, 117, 117 <hr/> DD1D Pattern Number L7230N <hr/> 117 Soft Grey laminate <hr/> 117 Soft Grey edge finish <hr/> 117 Soft Grey paint finish <hr/> 117 Soft Grey pull finish <hr/> 117 Soft Grey top cap finish	Double Pedestal Desk <ul style="list-style-type: none"> To specify desk with center located edge grommet, replace the suffix letter "N" with a "G". Add \$18 (Grommets not available for overhang desks) <ul style="list-style-type: none"> To specify pedestals without locks, replace the fifth character "L" with an "N". Deduct \$42	

Preconfigured Desks

Series 2 Freestanding Corner Unit Specifications

Series 2 Freestanding Corner Units (Assembly)

Dividends Horizon Series 2 freestanding corner units are available "Preconfigured" and can also be specified by component for "Build-to-Spec" applications.

"Preconfigured" freestanding corners consist of a worksurface, three "L" shaped end units and two full height back panels.

Available Sizes

- Height: 28½"
- Widths: 36", 42" and 48"
- Returns: 24" depth

Construction

Corner Unit:

- Worksurface: 1¼" thick, 45 lb. density particle board core with high pressure laminate surface and 2mm vinyl edge banding
- Back panels: 20-gauge steel
- Series 2 Freestanding Corner Units include full height back panels

Rear Corner End Unit

- Outer skin: 21-gauge steel
- Inner frame: 20-gauge steel
- Leveling glide: ¾" 16-gauge steel with 1½" of height adjustment
- Attachment bracket: 11-gauge steel

Side Corner End Unit

- Outer skin: 21-gauge
- Inner frame: 20-gauge
- Leveling glide: ¾" 16-gauge steel with 1½" of height adjustment
- Attachment bracket: 11-gauge steel

Freestanding Corner End Units (Components)

Freestanding corner end units have mounting brackets that allow attachment to corner worksurfaces. A 6" wide rear corner end unit is used in the rear corner to support the worksurface top. A 12" wide non-handed side corner end unit is attached to both sides of a corner worksurface for support.

Optional Edge Grommets

Edge grommets are optional and can be specified factory-installed on center on both edges along the rear edge of the worksurface. Grommets can also be ordered as a kit (pattern number D1WSG) for field installation in any position along the rear edge of the worksurface.

Series 2 Freestanding Corner Unit Components

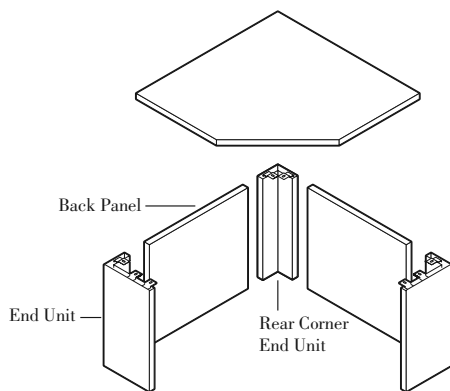

Edge Grommet Locations

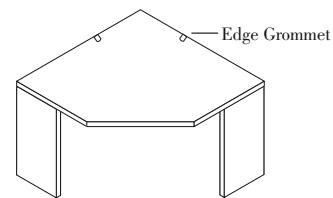

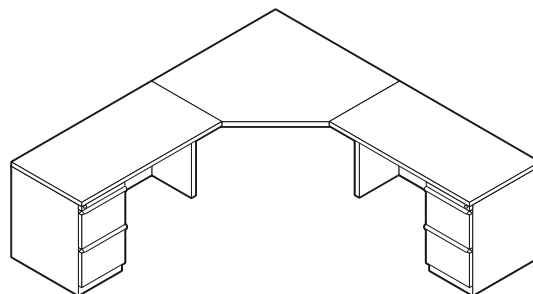

Series 2 Freestanding Corner Unit Attached to Return to Form a "L" Shaped Workstation



Preconfigured Desks

Series 2 Freestanding Corner Unit

24" Deep

description	type	w*	w	d	h	pattern no.	P1	P2	P3
 Freestanding Corner Unit (Assembly)		36"	35 1/2"	23 1/2"	28 1/2"	DD2VD 3624 N	\$1,230.	\$1,354.	\$1,416.
		42"	41 1/2"	23 1/2"	28 1/2"	DD2VD 4224 N	1,272.	1,399.	1,462.
		48"	47 1/2"	23 1/2"	28 1/2"	DD2VD 4824 N	1,335.	1,467.	1,534.
 Freestanding Curved Corner Unit (Assembly)		36"	35 1/2"	23 1/2"	28 1/2"	DD2VL 3624 N	1,257.	1,382.	1,447.
		42"	41 1/2"	23 1/2"	28 1/2"	DD2VL 4224 N	1,334.	1,466.	1,533.
		48"	47 1/2"	23 1/2"	28 1/2"	DD2VL 4824 N	1,392.	1,533.	1,601.
 Freestanding Corner End Unit (Component)			6 9/16"	6 9/16"	26 7/8"	DD1R CU6	259.	286.	299.

w* = nominal width

Dimensions listed under w d h are actual to the nearest 1/16"

Ordering Information	Order Code	Included with:	Options
Freestanding Corner 1. Pattern Number 2. Laminate Finish 3. Edge Band Finish 4. Paint Finish	Freestanding Corner <i>Example:</i> DD2VD 3624 N, 117, 117 <hr/> DD2VD Pattern Number 3624 <hr/> N No Grommets <hr/> 117 Soft Grey laminate <hr/> 117 Soft Grey edge finish <hr/> 117 Soft Grey paint finish <hr/> Freestanding Corner End Unit <i>Example:</i> DD1RCU6, 117 <hr/> DD1RCU6 Pattern Number <hr/> 117 Soft Grey paint finish	Freestanding Corner <ul style="list-style-type: none"> • Corner supports (3) • Back panels (2) • Corner worksurface • Connecting hardware Freestanding Corner End Unit Note: Series 2 freestanding corner units have full height modesty panels. Note: An upcharge applies when specifying Legacy laminates. See Legacy finish page.	Freestanding Corner <ul style="list-style-type: none"> • To specify two center-mounted edge grommets, replace the suffix letter "N" with a "G". Add \$28. Freestanding Corner End Unit

Preconfigured Desks

Freestanding Corner Unit Specifications

Freestanding Corner Units (Assembly)

Dividends freestanding corner units are available "Preconfigured" and can also be specified by component for "Build-to-Spec" applications. "Preconfigured" freestanding corners consist of a worksurface, three "L" shaped end units and two 11" high back panels.

Available Sizes

- Height: 28½"
- Widths: 36", 42" and 48"
- Returns: 24" depth

Construction

Corner Unit Specifications

- Worksurface: 1¼" thick, 45 lb. density particle board core with high pressure laminate surface and 2mm vinyl edge banding
- Back panels: 20-gauge steel

Rear Corner End Unit

- Outer skin: 21-gauge steel
- Inner frame: 20-gauge steel
- Leveling glide: ¾" 16-gauge steel with 1½" of height adjustment
- Attachment bracket: 11-gauge steel

Side Corner End Unit

- Outer skin: 21-gauge
- Inner frame: 20-gauge
- Leveling glide: ¾" 16-gauge steel
- Attachment bracket: 11-gauge steel

Freestanding Corner End Units (Components)

Freestanding corner end units have mounting brackets that allow attachment to corner worksurfaces. A 6" wide rear corner end unit is used in the rear corner to support the worksurface top. A 12" wide non-handed side corner end unit is attached to both sides of a corner worksurface for support.

Optional Edge Grommets

Edge grommets are optional and can be specified factory-installed on center on both edges along the rear edge of the worksurface. Grommets can also be ordered as a kit (pattern number D1WSG) for field installation in any position along the rear edge of the worksurface.

Freestanding Corner Unit Components

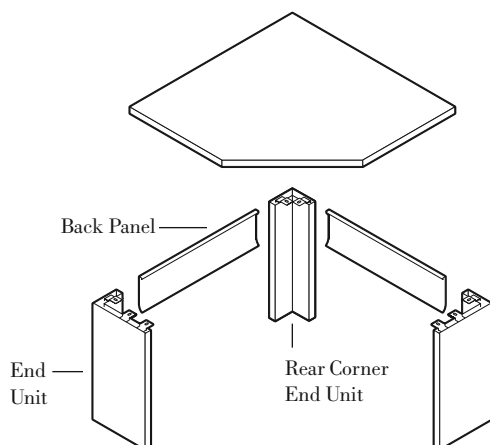

Edge Grommet Locations

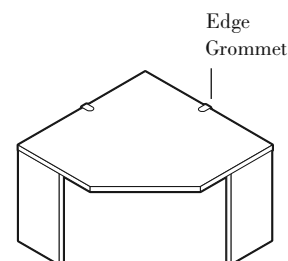

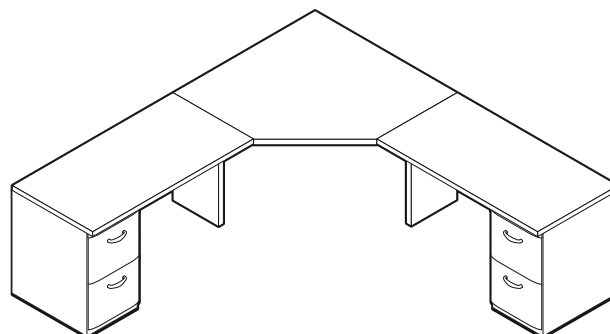

Freestanding Corner Unit attached to returns to form an "L" shaped workstation



Preconfigured Desks

Freestanding Corner Unit

24" Deep

description	type	w*	w	d	h	pattern no.	P1	P2	P3
 Freestanding Corner Unit (Assembly)		36"	35 1/2"	23 1/2"	28 1/2"	DD1VD 3624 N	\$1,230.	\$1,354.	\$1,416.
		42"	41 1/2"	23 1/2"	28 1/2"	DD1VD 4224 N	1,272.	1,399.	1,462.
		48"	47 1/2"	23 1/2"	28 1/2"	DD1VD 4824 N	1,335.	1,467.	1,534.
 Freestanding Curved Corner Unit (Assembly)		36"	35 1/2"	23 1/2"	28 1/2"	DD1VL 3624 N	1,257.	1,382.	1,447.
		42"	41 1/2"	23 1/2"	28 1/2"	DD1VL 4224 N	1,334.	1,466.	1,533.
		48"	47 1/2"	23 1/2"	28 1/2"	DD1VL 4824 N	1,392.	1,533.	1,601.
Freestanding Corner End Unit (Component)			6 9/16"	6 9/16"	26 7/8"	DD1R CU6	259.	286.	299.
Freestanding Corner Unit (Component)			6 9/16"	12 9/16"	26 7/8"	DD1S CU12	304.	334.	350.
 Back Panels for Freestanding Corner Unit (Component)	full height	36"	20 15/16"	26 5/8"		DD1 FBPV36	183.	200.	210.
	full height	42"	26 15/16"	26 5/8"		DD1 FBPV42	185.	203.	213.
	full height	48"	32 15/16"	26 5/8"		DD1 FBPV48	188.	207.	216.
	half height	36"	20 15/16"	11"		DD1 BPV36	153.	168.	175.
	half height	42"	26 15/16"	11"		DD1 BPV42	161.	178.	185.
	half height	48"	32 15/16"	11"		DD1 BPV48	169.	187.	195.

w* = nominal width
 Dimensions listed under w d h are actual to the nearest 1/16"

Ordering Information	Order Code	Included with:	Options
Freestanding Corner 1. Pattern Number 2. Laminate Finish 3. Edge Band Finish 4. Paint Finish	Freestanding Corner <i>Example:</i> DD1VD 3624 N, 117, 117 DD1VD Pattern Number 3624	Freestanding Corner <ul style="list-style-type: none"> • Corner supports (3) • Back panels (2) • Corner worksurface • Connecting hardware 	Freestanding Corner <ul style="list-style-type: none"> • To specify two center-mounted edge grommets, replace the suffix letter "N" with a "G". Add \$28.
Freestanding Corner End Unit 1. Pattern Number 2. Paint Finish	N No Grommets 117 Soft Grey laminate 117 Soft Grey edge finish	Freestanding Corner End Unit	Freestanding Corner End Unit
Freestanding Corner Back Panel 1. Pattern Number 2. Paint Finish	117 Soft Grey paint finish Freestanding Corner End Unit <i>Example:</i> DD1R CU6, 117 DD1R Pattern Number CU6 117 Soft Grey paint finish Freestanding Corner Back Panel <i>Example:</i> DD1 BPV42, 115 DD1 Pattern Number BPV42 115 Medium grey paint finish	Freestanding Corner Back Panel Note: Series 1 freestanding corner units have a curved half modesty panel. Note: An upcharge applies when specifying Legacy laminates. See Legacy finish page.	Freestanding Corner Back Panel

Preconfigured Desks

Series 2 Returns and Bridge Units

Specifications

Series 2 End Panel and Pedestal Returns

Dividends Horizon freestanding returns can be specified "Preconfigured" or can be ordered by component for "Build-to-Spec" applications. These applications include when a different pedestal drawer combination is required or when back panels are not needed.

"Preconfigured" pedestal returns consist of a worksurface, file/file pedestal, and full-height back panel. "Preconfigured" end panel returns consist of a worksurface, "L" shaped end panel and full height back panel.

Available Sizes

- Height: 28 1/2"
- Widths: 36", 42" and 48"
- Depths: 18" and 24"

Attachment

Returns attach to adjacent desks or freestanding corner units with flat brackets, which are included.

Construction

All freestanding returns match the aesthetics of the Dividends Horizon panel system.

Drawers overlay the cabinet front and feature softly-radiused integral pulls, drawer fronts and drawer trim. Series 2 Desk components include full-height back panels.

Worksurface support is provided by pedestals and end units which are non-handed and shipped knocked down.

This allows pedestals and end units to be positioned at either end of worksurfaces.

"Build-to-Spec" Returns and Bridges

For "Build-to-Spec" returns and bridges, specify by component. Refer to the individual component categories for information.

Accessory

Hanging file bars for front-to-back or side-to-side filing are included with pedestals.

Bridge Units

Bridge units are used to form freestanding "U" shaped workstations.

Bridge units consist of a worksurface and back panel and connect to adjacent freestanding components with flat brackets which are included.

Available Sizes

- Height: 28 1/2"
- Widths: 30", 36", 42" and 48"
- Depths: 18" and 24"

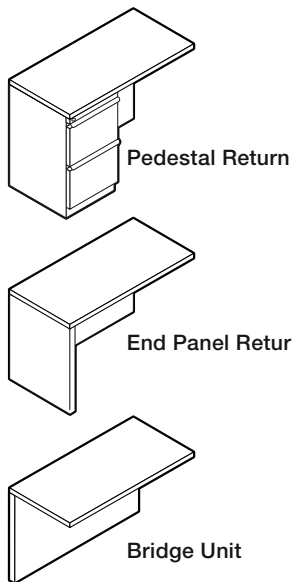

Series 2 Return Sizes Available

	18"D	24"D
30"W		
42"W		
48"W		

Series 2 Bridge Unit Sizes Available

30"W	
42"W	
42"W	
48"W	

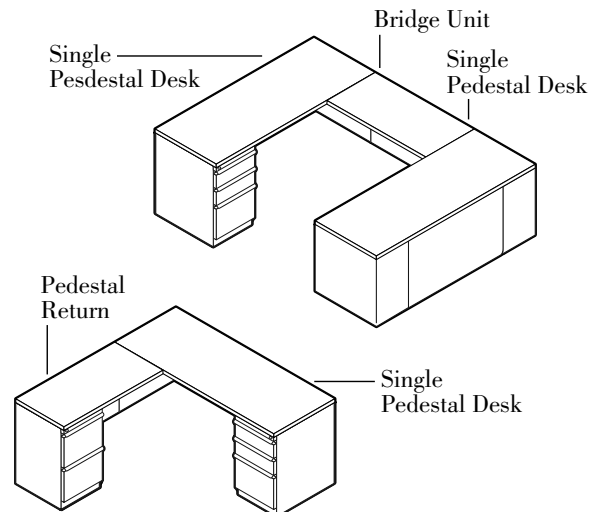

Series 2 Desk Configurations



Preconfigured Desks

Series 2 Returns and Bridge Units

18" and 24" Deep

description	w*	w	d	h	pattern no.	P1	P2	P3
 End Panel Return	36"	35 ¹³ / ₁₆ "	17 ¹ / ₂ "	28 ¹ / ₂ "	DD2E 3618N	\$679.	\$730.	\$750.
	36"	35 ¹³ / ₁₆ "	23 ¹ / ₂ "	28 ¹ / ₂ "	DD2E 3624N	741.	793.	821.
	42"	41 ¹³ / ₁₆ "	17 ¹ / ₂ "	28 ¹ / ₂ "	DD2E 4218N	714.	765.	791.
	42"	41 ¹³ / ₁₆ "	23 ¹ / ₂ "	28 ¹ / ₂ "	DD2E 4224N	777.	831.	859.
 Pedestal Return	36"	35 ¹³ / ₁₆ "	17 ¹ / ₂ "	28 ¹ / ₂ "	DD2P (L)3618N	878.	948.	982.
	36"	35 ¹³ / ₁₆ "	23 ¹ / ₂ "	28 ¹ / ₂ "	DD2P (L)3624N	959.	1,032.	1,069.
	42"	41 ¹³ / ₁₆ "	17 ¹ / ₂ "	28 ¹ / ₂ "	DD2P (L)4218N	916.	985.	1,019.
	42"	41 ¹³ / ₁₆ "	23 ¹ / ₂ "	28 ¹ / ₂ "	DD2P (L)4224N	997.	1,072.	1,108.
	48"	47 ¹³ / ₁₆ "	17 ¹ / ₂ "	28 ¹ / ₂ "	DD2P (L)4818N	950.	1,019.	1,054.
	48"	47 ¹³ / ₁₆ "	23 ¹ / ₂ "	28 ¹ / ₂ "	DD2P (L)4824N	1,036.	1,111.	1,149.
 Bridge Unit	30"	29 ¹³ / ₁₆ "	17 ¹ / ₂ "	28 ¹ / ₂ "	DD2B 3018N	331.	346.	352.
	36"	35 ¹³ / ₁₆ "	17 ¹ / ₂ "	28 ¹ / ₂ "	DD2B 3618N	365.	381.	390.
	36"	35 ¹³ / ₁₆ "	23 ¹ / ₂ "	28 ¹ / ₂ "	DD2B 3624N	392.	407.	415.
	42"	41 ¹³ / ₁₆ "	17 ¹ / ₂ "	28 ¹ / ₂ "	DD2B 4218N	396.	413.	421.
	42"	41 ¹³ / ₁₆ "	23 ¹ / ₂ "	28 ¹ / ₂ "	DD2B 4224N	429.	446.	454.
	48"	47 ¹³ / ₁₆ "	17 ¹ / ₂ "	28 ¹ / ₂ "	DD2B 4818N	429.	446.	454.
	48"	47 ¹³ / ₁₆ "	23 ¹ / ₂ "	28 ¹ / ₂ "	DD2B 4824N	468.	486.	494.

w* = nominal width
 Dimensions listed under w d h are actual to the nearest 1/16"

Ordering Information	Order Code	Included with:	Options
Pedestal Return 1. Pattern Number 2. Laminate Finish 3. Edge Band Finish 4. Paint Finish	Pedestal Return <i>Example:</i> DD2P L4824N, 117, 117, 117 <hr/> DP2P Pattern Number L4824N <hr/> 117 Soft Grey laminate <hr/> 117 Soft Grey edge finish <hr/> 117 Soft Grey paint finish <hr/> End Panel Return or Bridge Unit <i>Example:</i> DD2B 4224N, 117, 117, 117 <hr/> DD2B Pattern Number 4424 <hr/> 117 Soft Grey laminate <hr/> 117 Soft Grey finish <hr/> 117 Soft Grey finish	Pedestal Return <ul style="list-style-type: none"> • Worksurface • Pedestal • Back panel • Half height flat bracket (1) • Connecting hardware End Panel Return or Bridge Unit <ul style="list-style-type: none"> • Worksurface • Back panel • Half height flat brackets (2) • Connecting hardware Note: An upcharge applies when specifying Legacy laminates. See Legacy finish page.	Pedestal Return <ul style="list-style-type: none"> • To specify center-mounted edge grommet, replace the "N" suffix from the pattern number with "G". Add \$18 • To specify pedestal without locks, replace the 5th digit "L" from the pattern number with "N". Deduct \$21 End Panel Return or Bridge Unit <ul style="list-style-type: none"> • To specify center-mounted edge grommet, replace the "N" suffix from the pattern number with "G". Add \$18

Preconfigured Desks

Returns and Bridge Units

Specifications

End Panel and Pedestal Returns

Dividends freestanding returns can be specified "Preconfigured" or can be ordered by component for "Build-to-Spec" applications. These applications include when a different pedestal drawer combination is required or when back panels are not needed.

"Preconfigured" pedestal returns consist of a worksurface, file/file pedestal, and half-height back panel. "Preconfigured" end panel returns consist of a worksurface, "L" shaped end panel and half-height back panel.

Available Sizes

- Height: 28 1/2"
- Widths: 36", 42" and 48"
- Depths: 18" and 24"

Attachment

Returns attach to adjacent desks or freestanding corner units with flat brackets, which are included.

Construction

All freestanding returns match the aesthetics of the Dividends panel system.

Drawers overlay the cabinet front and feature softly-radiused pulls, drawer fronts and drawer trim.

Half-height back panels extend 11" from the bottom of the worksurface, are inset 3/4" from the pedestal backs and match the softly radiused aesthetics of other Dividends components.

Worksurface support is provided by pedestals and end units which are non-handed and shipped knocked down. This allows pedestals and end units to be positioned at either end of worksurfaces.

"Build-to-Spec" Returns and Bridges

For "Build-to-Spec" returns and bridges, specify by component. Refer to the individual component categories for information.

Accessory

Hanging file bars for front-to-back or side-to-side filing are included with pedestals.

Bridge Units

Bridge units are used to form freestanding "U" shaped workstations.

Bridge units consist of a worksurface and back panel and connect to adjacent freestanding components with flat brackets which are included.

Available Sizes

- Height: 28 1/2"
- Widths: 30", 36", 42" and 48"
- Depths: 18" and 24"

Pedestal Return

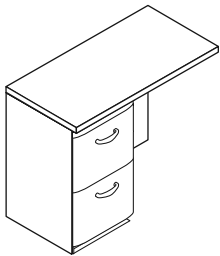

End Panel Return

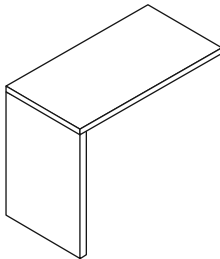

Bridge Unit

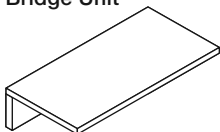

Return Sizes Available

	18D	24D
30W		
30W		
42W		
42W		
48W		

Bridge Unit Sizes Available

30W		
42W		
42W		
48W		

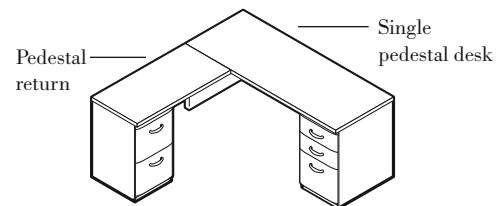
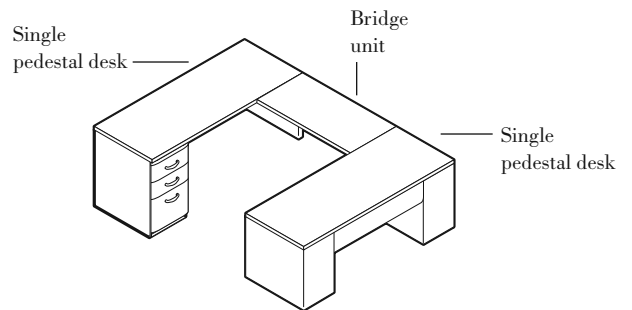

Freestanding Configuration



Preconfigured Desks

Returns and Bridge Units

18" and 24" Deep

description	w*	w	d	h	pattern no.	P1	P2	P3
 End Panel Return	36"	35 ¹³ / ₁₆ "	17 ¹ / ₂ "	28 ¹ / ₂ "	DD1E 3618N	\$679.	\$730.	\$750.
	36"	35 ¹³ / ₁₆ "	23 ¹ / ₂ "	28 ¹ / ₂ "	DD1E 3624N	741.	793.	821.
	42"	41 ¹³ / ₁₆ "	17 ¹ / ₂ "	28 ¹ / ₂ "	DD1E 4218N	714.	765.	791.
	42"	41 ¹³ / ₁₆ "	23 ¹ / ₂ "	28 ¹ / ₂ "	DD1E 4224N	777.	831.	859.
 Pedestal Return	36"	35 ¹³ / ₁₆ "	17 ¹ / ₂ "	28 ¹ / ₂ "	DD1P (L)3618N	878.	948.	982.
	36"	35 ¹³ / ₁₆ "	23 ¹ / ₂ "	28 ¹ / ₂ "	DD1P (L)3624N	959.	1,032.	1,069.
	42"	41 ¹³ / ₁₆ "	17 ¹ / ₂ "	28 ¹ / ₂ "	DD1P (L)4218N	916.	985.	1,019.
	42"	41 ¹³ / ₁₆ "	23 ¹ / ₂ "	28 ¹ / ₂ "	DD1P (L)4224N	997.	1,072.	1,108.
	48"	47 ¹³ / ₁₆ "	17 ¹ / ₂ "	28 ¹ / ₂ "	DD1P (L)4818N	950.	1,019.	1,054.
	48"	47 ¹³ / ₁₆ "	23 ¹ / ₂ "	28 ¹ / ₂ "	DD1P (L)4824N	1,036.	1,111.	1,149.
 Bridge Unit	30"	29 ¹³ / ₁₆ "	17 ¹ / ₂ "	28 ¹ / ₂ "	DD1B 3018N	331.	346.	352.
	36"	35 ¹³ / ₁₆ "	17 ¹ / ₂ "	28 ¹ / ₂ "	DD1B 3618N	365.	381.	390.
	36"	35 ¹³ / ₁₆ "	23 ¹ / ₂ "	28 ¹ / ₂ "	DD1B 3624N	392.	407.	415.
	42"	41 ¹³ / ₁₆ "	17 ¹ / ₂ "	28 ¹ / ₂ "	DD1B 4218N	396.	413.	421.
	42"	41 ¹³ / ₁₆ "	23 ¹ / ₂ "	28 ¹ / ₂ "	DD1B 4224N	429.	446.	454.
	48"	47 ¹³ / ₁₆ "	17 ¹ / ₂ "	28 ¹ / ₂ "	DD1B 4818N	429.	446.	454.
	48"	47 ¹³ / ₁₆ "	23 ¹ / ₂ "	28 ¹ / ₂ "	DD1B 4824N	468.	486.	494.

w* = nominal width
 Dimensions listed under w d h are actual to the nearest 1/16"

Ordering Information	Order Code	Included with:	Options
Pedestal Return 1. Pattern Number 2. Laminate Finish 3. Edge Band Finish 4. Paint Finish 5. Pull Finish 6. Drawer Top Cap Finish End Panel Return or Bridge Unit 1. Pattern Number 2. Laminate Finish 3. Edge Band Finish 4. Paint Finish	Pedestal Return <i>Example:</i> DD1P L4824N, 117, 117, 117, 117, 117 <hr/> DP1P Pattern Number <hr/> L4824N <hr/> 117 Soft Grey laminate <hr/> 117 Soft Grey edge finish <hr/> 117 Soft Grey paint finish <hr/> 117 Soft Grey pull finish <hr/> 117 Soft Grey top cap finish <hr/> End Panel Return or Bridge Unit <i>Example:</i> DD1B 4224N, 117, 117, 117 <hr/> DD1B Pattern Number <hr/> 4424 <hr/> 117 Soft Grey laminate <hr/> 117 Soft Grey edge band <hr/> 117 Soft Grey finish	Pedestal Return <ul style="list-style-type: none"> • Worksurface • Pedestal • Back panel • Half height flat bracket (1) • Connecting hardware End Panel Return or Bridge Unit <ul style="list-style-type: none"> • Worksurface • Back panel • Half height flat brackets (2) • Connecting hardware Note: An upcharge applies when specifying Legacy laminates. See Legacy finish page.	Pedestal Return <ul style="list-style-type: none"> • To specify center-mounted edge grommet, replace the "N" suffix from the pattern number with "G". Add \$18 • To specify pedestal without locks, replace the 5th digit "L" from the pattern number with "N". Deduct \$21 End Panel Return or Bridge Unit <ul style="list-style-type: none"> • To specify center-mounted edge grommet, replace the "N" suffix from the pattern number with "G". Add \$18

Desk Components

End Units

Planning Guidelines

Desk End Units

Dividends desk end units are an "L" shaped, non-handed design that can be used on either end of a worksurface in freestanding and panel applications. Desk end units have the same footprint (outside dimension) as pedestals and can be interchanged with pedestals.

End units are used in "Preconfigured" single pedestal desks and end panel returns.

They can also be specified by component for "Build-to-Spec" applications.

These include when an end panel is required on one end and a desk integration unit is required on the other, or when an end unit is required on both ends of the worksurface.

Available Sizes

Depths: 18", 24" and 30"

Width: 15"

Height: 26⁷/₈"

Desk End Unit Attachment

Desk end units have mounting brackets that allow attachment to worksurfaces with supplied screws. Dividends worksurfaces are pre-drilled for end unit attachment.

Construction

End unit specifications:

- Outer skin: 21-gauge steel
- Inner frame: 20-gauge steel
- Leveling glides: ³/₈" 16-gauge steel with 1¹/₂" of height adjustment
- Attachment bracket: 11-gauge steel

Desk Integration End Units

If a back panel (modesty) is required in a systems application, a desk integration end unit can be used in place of an end unit.

Panel-to-worksurface brackets are included and make the connection between the worksurface and Dividends Horizon panels. Desk integration end units are 15" wide.

Note: The desk integration end unit is a non-structural support. Panel-to-work surface brackets provide the actual support for the worksurface.

Note: Panel width must match the depth of the connecting worksurface.

Construction

Desk integration end unit specifications:

- Outer skin: 20-gauge steel
- Panel-to-worksurface brackets: 14-gauge steel

Intermediate End Units

Intermediate end units are freestanding "T" shaped end units used to support two desks in an in-line configuration.

Units attach to 18", 24" and 30" deep worksurfaces in place of desk end units. Mounting brackets and a front worksurface alignment plate are included with intermediate end units.

Available Size

- Depth: 14"
- Width: 30"
- Height: 26⁷/₈"

Construction

Intermediate end unit specifications:

- Outer skin: 20-gauge steel
- Inner frame: 20-gauge steel
- Mounting brackets: 11-gauge steel

Desk End Unit

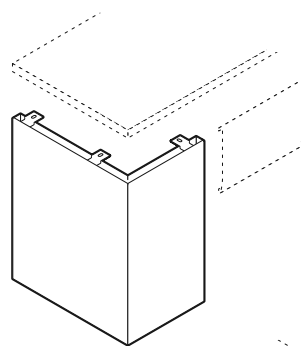

Intermediate End Unit

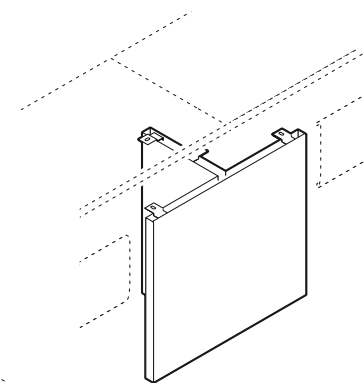

Desk Integration End Unit (Non-structural)

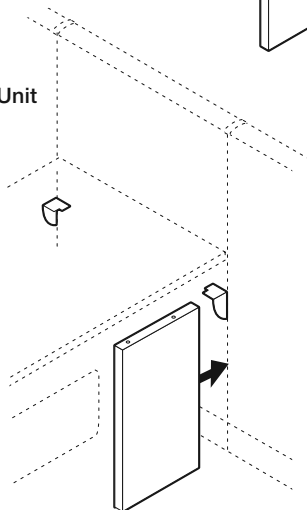

Desk End Unit Available Sizes

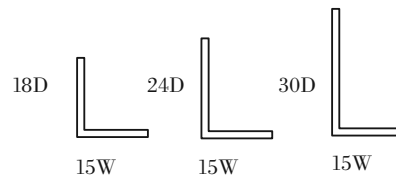

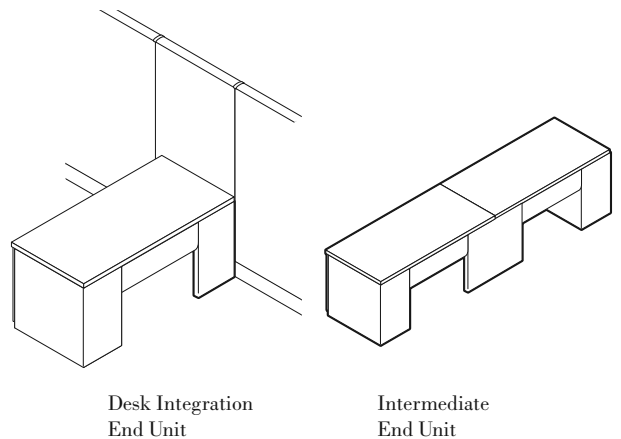

End Unit Configurations



End Units

Desk End, Desk Integration and Intermediate

description	d*	d	w	h	pattern no.	P1	P2	P3
 Desk End Unit	18"	16 ³ / ₈ "	14 ⁷ / ₈ "	26 ⁷ / ₈ "	DD1 EU18	\$325.	\$357.	\$375.
	24"	22 ³ / ₈ "	14 ⁷ / ₈ "	26 ⁷ / ₈ "	DD1 EU24	358.	394.	412.
	30"	28 ³ / ₈ "	14 ⁷ / ₈ "	26 ⁷ / ₈ "	DD1 EU30	391.	428.	449.
 Desk Integration End Unit (Non-structural)	1 ¹ / ₂ "	1 ¹ / ₂ "	14 ⁷ / ₈ "	26 ⁷ / ₈ "	DD1 DIEU	180.	196.	205.
 Intermediate End Unit	14"	12"	31 ⁹ / ₁₆ "	26 ⁷ / ₈ "	DD1 IE30	325.	357.	375.

d* = nominal depth
 Dimensions listed under d w h are actual to the nearest 1/16"

Ordering Information	Order Code	Included with:	Options
Desk End Unit 1. Pattern Number 2. Paint Finish	Desk End Unit <i>Example: DD1 EU18, 117</i> <hr/> DD1 EU18 Pattern Number <hr/> 117 Soft Grey Paint Finish	Desk End Unit Desk Integration End Unit • Panel-to-Worksurface Brackets (2) Intermediate End Unit	Desk End Unit Desk Integration End Unit Intermediate End Unit
Desk Integration End Unit 1. Pattern Number 2. Paint Finish	Desk Integration End Unit <i>Example: DD1 DIEU, 117</i> <hr/> DD1 DIEU Pattern Number <hr/> 117 Soft Grey Paint Finish		
Intermediate End Unit 1. Pattern Number 2. Paint Finish	Intermediate End Unit <i>Example: DD1 IE30, 117</i> <hr/> DD1 IE30 Pattern Number <hr/> 117 Soft Grey Paint Finish		

Desk Components

Half Height Back Panels

Planning Guidelines

Half Height Back Panels

Dividends back panels extend between pedestals, end units or desk integration end units in freestanding desks. They also extend between end units in returns and along the rear surface of bridge units. Back panels are softly-radiused to match the aesthetics of the Dividends Horizon system and extend 11" down from the worksurface to provide a half-height modesty.

Back panels are used in "Preconfigured" desks or can be specified separately by component for "Build-to-Spec" applications.

Available Sizes

- Widths: 19⁵/₈" to 48¹/₄" see compatibility chart (below)
- Height: 11"

Back Panel Attachment

Back panels attach to the undersides of worksurfaces with mounting brackets and do not require attachment to adjacent pedestals or end units. Dividends Horizon worksurfaces are pre-drilled for back panel attachment.

Construction

Back panel specifications:

- Outer skin: 22-gauge steel
- Mounting Brace: 16-gauge

Back Panel Compatibility

The chart below shows which back panels are specified for various configurations.

Optional Grommets/Wire Management

When installed, back panels provide a 1/2" reveal between the back panel and worksurface for wire management. Optional edge grommets are required to provide access.

Desk Configurations

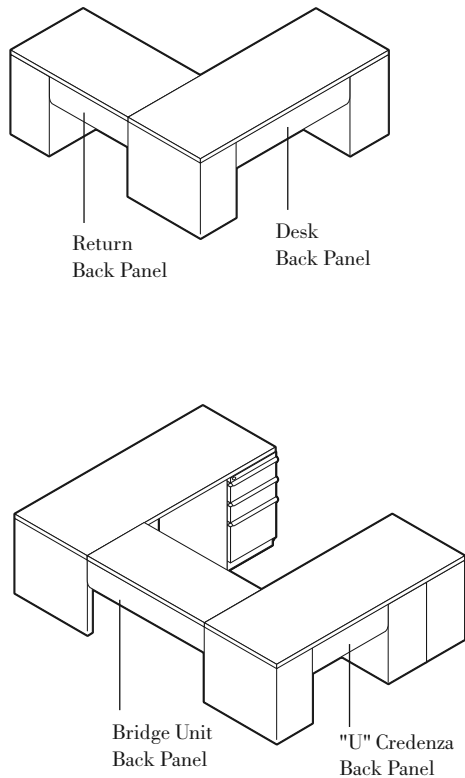

Back Panel Compatibility

Product	Work-surface Width	Back Panel Width	Back Panel Pattern No.	No. of Required Peds/End Units
Desks	54	23 ⁷ / ₈ "	DD1 BPD54	2
	60	29 ⁷ / ₈ "	DD1 BPD60	2
	66	35 ⁷ / ₈ "	DD1 BPD66	2
	72	41 ⁷ / ₈ "	DD1 BPD72	2
Returns	36	21 ⁵ / ₈ "	DD1 BPR36	1
	42	27 ⁵ / ₈ "	DD1 BPR42	1
	48	33 ⁵ / ₈ "	DD1 BPR48	1
	60	45 ⁵ / ₈ "	DD1 BPR60	1
Bridge Units	30	31 ³ / ₈ "	DD1 BPB30	0
	36	37 ³ / ₈ "	DD1 BPB36	0
	42	43 ³ / ₈ "	DD1 BPB42	0
	48	49 ³ / ₈ "	DD1 BPB48	0
"U" Credenza w/2 peds	72	26 ¹⁵ / ₁₆ "	DD1 BPU72	3
Freestanding Corner Unit (needs two back panels)	36	20 ¹⁵ / ₁₆ "	DD1 BPV36	3
	42	26 ¹⁵ / ₁₆ "	DD1 BPV42	3
	48	32 ¹⁵ / ₁₆ "	DD1 BPV48	3





Note: Specify "desk" back panels from category (above) for use with desk integration end units and intermediate end units.

Desk Components

Half Height Back Panels

For Desks, Returns, Bridges and 2 Pedestal Configuration

Dividends Horizon

description	top width	w *	h	pattern no.	P1	P2	P3
 Half Height Back panels for Desks	54"	29 ⁷ / ₈ "	11"	DD1 BPD54	\$181.	\$197.	\$207.
	60"	29 ⁷ / ₈ "	11"	DD1 BPD60	190.	210.	218.
	66"	35 ⁷ / ₈ "	11"	DD1 BPD66	200.	220.	229.
	72"	41 ⁷ / ₈ "	11"	DD1 BPD72	211.	230.	243.
 Half Height Back panels for Returns	36"	21 ⁵ / ₈ "	11"	DD1 BPR36	161.	178.	185.
	42"	27 ⁵ / ₈ "	11"	DD1 BPR42	168.	185.	194.
	48"	33 ³ / ₈ "	11"	DD1 BPR48	180.	196.	205.
	60"	45 ³ / ₈ "	11"	DD1 BPR60	200.	220.	229.
 Half Height Back panels for Bridges	30"	31 ³ / ₈ "	11"	DD1 BPB30	142.	156.	165.
	36"	37 ³ / ₈ "	11"	DD1 BPB36	153.	168.	175.
	42"	43 ³ / ₈ "	11"	DD1 BPB42	161.	178.	185.
	48"	49 ³ / ₈ "	11"	DD1 BPB48	171.	188.	196.
 Half Height Back panels for 2 Pedestal "U" Credenza	72"	26 ¹⁵ / ₁₆ "	11"	DD1 BPU72	161.	178.	185.

Dimensions listed under w h are actual to the nearest¹/₁₆"

Ordering Information	Order Code	Included with:	Options
Back Panels for Bridges 1. Pattern Number 2. Paint Finish	Back Panels for Bridges <i>Example:</i> DD1 BPB36 , 117 <hr/> DD1 Pattern Number BPB36 <hr/> 117 Soft Grey Paint Finish	Back Panels for Bridges • Attachment Hardware	Back Panels for Bridges

Desk Components

Full Back Panels

Planning Guidelines

Full Back Panels

Dividends full back panels extend between pedestals, end units or desk integration end units in freestanding desks. They also extend between end units in returns and along the rear surface of bridge units.

Full back panels are specified separately by component for "Build-to-Spec" applications.

Available Sizes

- Widths: 19⁵/₈" to 48¹/₄" see compatibility chart (above)
- Height: 26⁵/₈"

Full Back Panel Attachment

Back panels attach to the undersides of pedestals or end units with mounting brackets.

Construction

Back panel specifications:

- Outer skin: 20-gauge steel
- Mounting Brace: 16-gauge

Back Panel Compatibility

The chart below shows which back panels are specified for various configurations.

Optional Grommets/Wire Management

When installed, back panels provide a 1/2" reveal between the back panel and worksurface for wire management. Optional edge grommets are required to provide access.

Desk Configurations

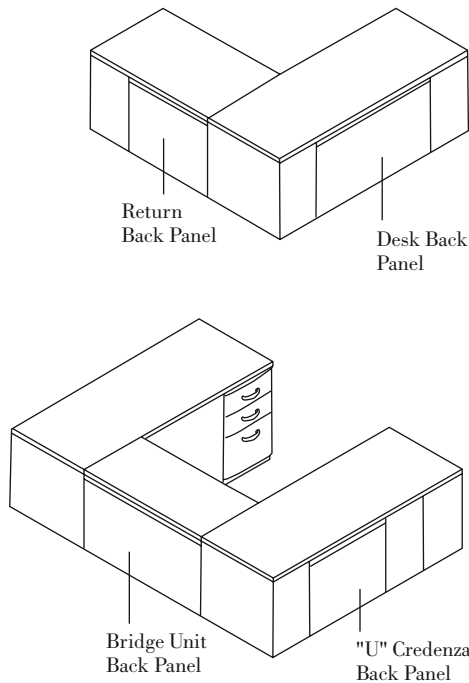





Back Panel Compatibility

Product	Work-surface Width	Back Panel Width	Back Panel Pattern No.	No. of Required Peds/End Units
Desks	54	23 ⁷ / ₈ "	DD1 FFBDP54	2
	60	29 ⁷ / ₈ "	DD1 FFBDP60	2
	66	35 ⁷ / ₈ "	DD1 FBPD66	2
	72	41 ⁷ / ₈ "	DD1 FBPD72	2
Returns	36	21 ⁵ / ₈ "	DD1 FBPR36	1
	42	27 ⁵ / ₈ "	DD1 FBPR42	1
	48	33 ⁵ / ₈ "	DD1 FBPR48	1
	60	45 ⁵ / ₈ "	DD1 FBPR60	1
Bridge Units	30	31 ⁵ / ₈ "	DD1 FBPB30	0
	36	37 ⁵ / ₈ "	DD1 FBPB36	0
	42	43 ⁵ / ₈ "	DD1 FBPB42	0
	48	49 ⁵ / ₈ "	DD1 FBPB48	0
"U" Credenza w/2 peds	72	26 ¹⁵ / ₁₆ "	DD1 FBPU72	3
Freestanding Corner Unit (needs two back panels)	36	20 ¹⁵ / ₁₆ "	DD1 FBPV36	3
	42	26 ¹⁵ / ₁₆ "	DD1 FBPV42	3
	48	32 ¹⁵ / ₁₆ "	DD1 FBPV48	3

Note: Specify "desk" back panels from category (above) for use with desk integration end units and intermediate end units.

Full Back Panels

For Desks, Returns, Bridges and 2 Pedestal Configuration

description	top width	w *	h	pattern no.	P1	P2	P3
Full Back panels for Desks 	54"	23 ⁷ / ₈ "	26 ⁵ / ₈ "	DD1 FBPD54	\$215.	\$236.	\$247.
	60"	29 ⁷ / ₈ "	26 ⁵ / ₈ "	DD1 FBPD60	219.	241.	253.
	66"	35 ⁷ / ₈ "	26 ⁵ / ₈ "	DD1 FBPD66	225.	248.	257.
	72"	41 ⁷ / ₈ "	26 ⁵ / ₈ "	DD1 FBPD72	232.	255.	267.
Full Back panels for Returns 	36"	21 ⁵ / ₈ "	26 ⁵ / ₈ "	DD1 FBPR36	202.	221.	232.
	42"	27 ⁵ / ₈ "	26 ⁵ / ₈ "	DD1 FBPR42	207.	227.	237.
	48"	33 ⁵ / ₈ "	26 ⁵ / ₈ "	DD1 FBPR48	216.	237.	248.
	60"	45 ⁵ / ₈ "	26 ⁵ / ₈ "	DD1 FBPR60	236.	258.	273.
Full Back panels for Bridges 	30"	31 ³ / ₈ "	26 ⁵ / ₈ "	DD1 FBPB30	189.	208.	217.
	36"	37 ³ / ₈ "	26 ⁵ / ₈ "	DD1 FBPB36	198.	219.	228.
	42"	43 ³ / ₈ "	26 ⁵ / ₈ "	DD1 FBPB42	216.	237.	248.
	48"	49 ³ / ₈ "	26 ⁵ / ₈ "	DD1 FBPB48	221.	244.	255.
Full Back panels for 2 Pedestal "U" Credenza 	72"	26 ¹⁵ / ₁₆ "	26 ⁵ / ₈ "	DD1 FBPU72	207.	227.	237.

Dimensions listed under w h are actual to the nearest¹/₁₆"

Ordering Information	Order Code	Included with:	Options
Back Panels for Bridges 1. Pattern Number 2. Paint Finish	Back Panels for Bridges <i>Example:</i> DD1 FBPB36 , 117 <hr/> DD1 Pattern Number FBPB36 <hr/> 117 Soft Grey Paint Finish	Back Panels for Bridges • Attachment Hardware	Back Panels for Bridges

Pencil Tray

Five section tray rides on drawer sides of box drawers. Plastic injection molded construction. 13¹/₄ wide, 5⁷/₁₆ deep and ⁷/₈ high. Black or clear finish available.

Hanging File Bar

Allows for side-to-side hanging folders. 20-gauge steel construction. Set of two. Black finish.

Note: A hanging file bar is included with each file drawer when ordering desks or pedestals.

Drawer Dividers

Two styles available: box drawer and file drawer sizes. 18-gauge steel construction. Black finish.

Stationery Inserts

Set of four trays for use in box drawers. 18-gauge steel construction. Can accommodate letter- and legal-sized stationery. Black finish.

Pencil Drawer

For use with freestanding desks or panel-mounted worksurfaces with depths of 24 or more. 24 wide, 17 ⁵/₈ deep and 2 high. Black finish.

Attachment: Mounts on underside of worksurface with included mounting hardware

Pedestal Lock Retrofit Kit

Allows existing nonlocking pedestals to be field-retrofitted with locks. Includes lock housing, lock core (keyed randomly unless specified keyed alike) and lock rod assembly (must be specified box/box/file or file/file).

Flat Brackets

Allow same-height worksurfaces to be joined in perpendicular configurations. All flat brackets are 3³/₄ wide. Black finish.

Three sizes available to support the following worksurface depths:

- 18 deep worksurfaces
- 24 deep worksurfaces
- 30 deep worksurfaces
- Construction: 14-gauge steel
- Attachment: Mounts on underside of worksurfaces in pre-drilled locations with included mounting hardware

Worksurface Cable Management Clips

Self-adhesive, injection-molded clips adhere to any flat, nonporous surface to route cables along and beneath worksurfaces. ³/₄ x ¹/₂ internal dimension.

Worksurface Cable Management Basket

Steel wire basket attaches to the underside of worksurfaces to provide management of excess cords and cables. Once installed, the cable basket slides forward to a position abutting the panel face to allow the passage of cords and cables. Black finish.

Worksurface Edge Grommet

Available factory-installed when ordering worksurfaces or as a kit for field installation. Can be installed in any location along the rear edge of worksurfaces. Includes a cutting template, grommet and cover. Dark grey finish.

Worksurface Reinforcement

Worksurface reinforcements are required for worksurface spans greater than 48 inches. This includes freestanding desk worksurfaces over 48 inches using desk end units. Worksurface reinforcements have a black paint finish.

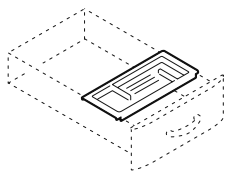

Pencil Tray

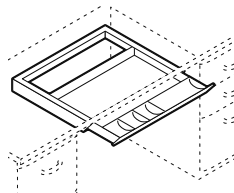

Pencil Drawer

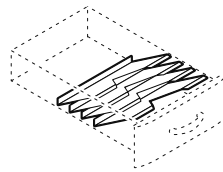

Stationery Inserts

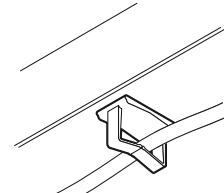

Worksurface Cable Management Clip

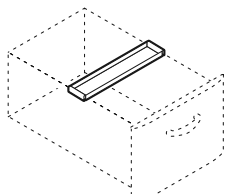

Hanging File Bar

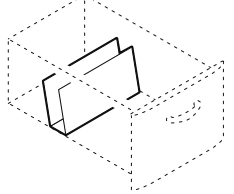

Drawer Divider, File Drawer

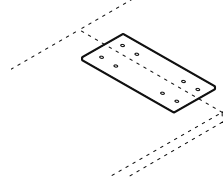

Flat Bracket

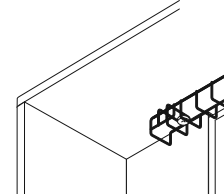

Worksurface Cable Management Basket

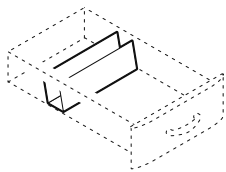

Drawer Divider, Box Drawer

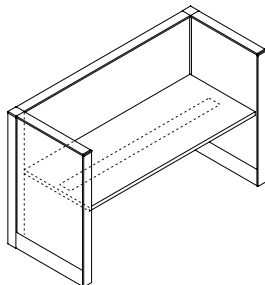



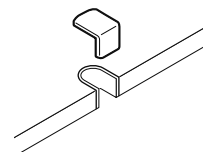





Worksurface Reinforcement Panel Hung Application



Worksurface Edge Grommet

Drawer Organizers, Cable Management and Grommet Kits

description	type	w	d	h	pattern no.	list
 Pencil Tray	Black finish	13 1/4"	5 7/8"	7/8"	DS2PPTN	\$35.
	Clear finish	13 1/4"	5 7/8"	7/8"	DS2PPTC	42.
 Hanging File Bar		12 3/16"	2 15/16"	1/2"	DS1PFS	30.
 Drawer Divider, Box		12 3/8"	3"	3 1/8"	DS1PBD	30.
 Drawer Divider, File		10	3 5/8"	6 3/8"	DS1PFD	30.
 Stationary Inserts, box (4 trays)		13	15 1/16"	8 7/8"	DS1PST	160.
 Pencil Drawer		24"	17 3/8"	2"	DS1PCD	218.
 Worksurface Cable Management Clip	Package of 10	3/4"	1/2"		D1 WC	36.
 Worksurface Cable Management Basket	19 1/2" wide	16 1/2"	3 1/2"	1 1/2"	D1 WB20	38.
	25 1/2" wide	25 1/2"	3 1/2"	1 1/2"	D1 WB26	40.
	31 1/2" wide	31 1/2"	3 1/2"	1 1/2"	D1 WB32	50.
	35" wide	35"	3 1/2"	1 1/2"	D1 WB36	55.
	41" wide	41"	3 1/2"	1 1/2"	D1 WB42	58.
 Worksurface Grommet Kit (Dark Grey)		2 3/16"	2 5/16"	1 3/8"	D1WSG	21.



Freestanding Desks

Ordering Information	Order Code	Included with:	Options
Pencil Tray 1. Pattern Number	Pencil Tray <i>Example:</i> DS1 PPT DS1 PPT Pattern Number	Pencil Tray	

Desk Accessories

Flat Brackets and Worksurface Reinforcements

Dividends Horizon

description	w	d	pattern no.	list
Flat Bracket (single pack) 	$3\frac{3}{4}''$	$8\frac{5}{16}''$	DB1F 18SP	\$15.
	$3\frac{3}{4}''$	$14\frac{7}{8}''$	DB1F 24SP	25.
	$3\frac{3}{4}''$	$20\frac{15}{16}''$	DB1F 30SP	29.
Flat Bracket (package of 10) 	$3\frac{3}{4}''$	$8\frac{5}{16}''$	DB1F18TP	120.
	$3\frac{3}{4}''$	$14\frac{7}{8}''$	DB1F24TP	200.
	$3\frac{3}{4}''$	$20\frac{15}{16}''$	DB1F30TP	230.
Worksurface Reinforcement 	54"	4"	DB1WR54	58.
	60"	4"	DB1WR60	59.
	66"	4"	DB1WR66	61.
	72"	4"	DB1WR72	63.

Ordering Information

Flat Bracket
1. Pattern Number

Order Code

Flat Bracket
Example: **DB1PWSP**
DB1PWSP Pattern Number

Included with:

Flat Bracket

Options

Flat Bracket

Alpha-Numeric Index

<i>pattern no.</i>	<i>page</i>	<i>pattern no.</i>	<i>page</i>	<i>pattern no.</i>	<i>page</i>	<i>pattern no.</i>	<i>page</i>
D1 WB20	187, 329	D1L 4878SSN	267	DIR 7815	275	D1W S722418N	262
D1 WB26	187, 329	D1L 4884SSN	267	DIR 7818N	255	D1W S722430N	262
D1 WB32	187, 329	D1L 6042SSN	267	DIR 7824N	255	D1W S723018N	262
D1 WB36	187, 329	D1L 6048DSN	269	DIR 7830N	259	D1W S723024N	262
D1 WB42	187, 329	D1L 6048SDN	269	DIR 8415	275	D1W S781824N	262
D1 WC	187, 329	D1L 6048SSN	267	DIR 8418N	255	D1W S781830N	262
D19 6630N	271	D1L 6642SSN	267	DIR 8424N	255	D1W S782418N	262
D19 7230N	271	D1L 6648DSN	269	DIR 8430N	259	D1W S782430N	262
D19 7830N	271	D1L 6648SDN	269	DIR 9015	275	D1W S783018N	262
D1BD6648DL	271	D1L 6648SSN	267	DIR 9018N	255	D1W S783024N	262
D1BD6648DR	271	D1L 7242SSN	267	DIR 9024N	255	D1W S841824N	262
D1BD6648SL	271	D1L 7248DSN	269	DIR 9030N	259	D1W S841830N	262
D1BD6648SR	271	D1L 7248SDN	269	DIR 9615	275	D1W S842418N	262
D1BD7248DL	271	D1L 7248SSN	267	DIR 9618N	255	D1W S842430N	262
D1BD7248DR	271	D1L 7842SSN	267	DIR 9624N	255	D1W S843018N	262
D1BD7248SL	271	D1L 7848SSN	267	DIR 9630N	259	D1W S843024N	262
D1BD7248SR	271	D1L 8448SSN	267	DIR2419N	257	D1W T482430N	263
D1C 3618N	265	D1P 6630N	271	DIR3019N	257	D1W T483024N	263
D1C 3624N	265	D1P 7230N	271	DIR3619N	257	D1W T602430N	263
D1C 422430N	265	D1P 7830N	271	DIR4219N	257	D1W T603024N	263
D1C 4224N	265	DIR 1515C	275	DIR4819N	257	D1W T662430N	263
D1C 423024N	265	DIR 1515S	275	DIR5419N	257	D1W T663024N	263
D1C 482430N	265	DIR 2415	275	DIR6019N	257	D1W T722430N	263
D1C 4824N	265	DIR 2418N	255	DIR6619N	257	D1W T723024N	263
D1C 483024N	265	DIR 2424N	255	DIR7219N	257	D1W5C	213, 329
D1C 4830N	265	DIR 2430N	259	DIR7819N	257	D1WT218	157
D1CRL24	273	DIR 3015	275	DIR8419N	257	D1WT224	157
D1CRN24	273	DIR 3018N	255	DIR9019N	257	D1WT324	157
D1CRR24	273	DIR 3024N	255	DIR9619N	257	D1WT424	157
D1CS 4224N	265	DIR 3030N	259	D1W 362430N	261	D1WT518	157
D1CS 4824N	265	DIR 3615	275	D1W 363024N	261	D1WT524	157
D1CS 4830N	265	DIR 3618N	255	D1W 422430N	261	D1WW11481824	157
D1D 4824N	271	DIR 3624N	255	D1W 423024N	261	D1WW11482418	157
D1D 4830N	271	DIR 3630N	259	D1W 482430N	261	D1WW12481824	157
D1D 6030N	271	DIR 4215	275	D1W 483024N	261	D1WW12482418	157
D1D 6630N	271	DIR 4218N	255	D1W 721830N	261	D1WW124824L	157
D1D 7230N	271	DIR 4224N	255	D1W 722430N	261	D1WW124824R	157
D1D 7236N	271	DIR 4230N	259	D1W 722436N	261	D1WW13481824	157
D1H4818	273	DIR 4815	275	D1W 723018N	261	D1WW13482418	157
D1H5118P	273	DIR 4818N	255	D1W 723024N	261	D1WW134824L	157
D1H6024	273	DIR 4824N	255	D1W 723624N	261	D1WW134824R	157
D1H6324P	273	DIR 4830N	259	D1W S481824N	262	D1WW34824	157
D1L 3636SSN	267	DIR 5415	275	D1W S481830N	262	D1WW44824	157
D1L 4242SSN	267	DIR 5418N	255	D1W S482418N	262	D1WW54824L	157
D1L 4260SSN	267	DIR 5424N	255	D1W S482430N	262	D1WW54824R	157
D1L 4266SSN	267	DIR 5430N	259	D1W S483018N	262	D1WW64824L	157
D1L 4272SSN	267	DIR 6015	275	D1W S483024N	262	D1WW64824R	157
D1L 4278SSN	267	DIR 6018N	255	D1W S601824N	262	D1WW74824L	157
D1L 4848DDN	269	DIR 6024N	255	D1W S601830N	262	D1WW74824R	157
D1L 4848DSN	269	DIR 6030N	259	D1W S602418N	262	D2H4824	273
D1L 4848SDN	269	DIR 6036N	259	D1W S602430N	262	D2H4836	273
D1L 4848SSN	267	DIR 6615	275	D1W S603018N	262	D2H4848	273
D1L 4860DSN	269	DIR 6618N	255	D1W S603024N	262	D2H5124P	273
D1L 4860SDN	269	DIR 6624N	255	D1W S661824N	262	D2H5136P	273
D1L 4860SSN	267	DIR 6630N	259	D1W S661830N	262	D2H5148P	273
D1L 4866DSN	269	DIR 6636N	259	D1W S662418N	262	D2P1	79
D1L 4866SDN	269	DIR 7215	275	D1W S662430N	262	DB120C (L or R)	283
D1L 4866SSN	267	DIR 7218N	255	D1W S663018N	262	DB1BD48SL	271
D1L 4872DSN	269	DIR 7224N	255	D1W S663024N	262	DB1BD48SR	271
D1L 4872SDN	269	DIR 7230N	259	D1W S721824N	262	DB1C 18 (L or R)	283
D1L 4872SSN	267	DIR 7236N	259	D1W S721830N	262	DB1C 18 (L or R) 10	283

<i>pattern no.</i>	<i>page</i>	<i>pattern no.</i>	<i>page</i>	<i>pattern no.</i>	<i>page</i>	<i>pattern no.</i>	<i>page</i>
DB1C 24 (L or R)	283	DCE1H4818P	279	DCE1R9624N	276	DD10 L6636N	313
DB1C 24 (L or R) 10	283	DCE1H6024	279	DCE1R9630N	276	DD10 L7236N	313
DB1C 30 (L or R)	283	DCE1H6024P	279	DCE1W362430N	280	DD1P (L)3618N	321
DB1C 30 (L or R) 10	283	DCE1L3636SSN	277	DCE1W363024N	280	DD1P (L)3624N	321
DB1CL 24R	289	DCE1L4242DSN	277	DCE1W422430N	280	DD1P (L)4218N	321
DB1CL24L	289	DCE1L4242SDN	277	DCE1W423024N	280	DD1P (L)4224N	321
DB1CL24S	289	DCE1L4242SSN	277	DCE1W482430N	280	DD1P (L)4818N	321
DB1F 18SP	283, 330	DCE1L4260SSN	278	DCE1W483024N	280	DD1P (L)4824N	321
DB1F 24SP	283, 330	DCE1L4266SSN	278	DCE1W722430N	280	DD1R CU6	315, 317
DB1F 30SP	283, 330	DCE1L4272SSN	278	DCE1W723024N	280	DD1S CU12	317
DB1F18TP	283, 330	DCE1L4278SSN	278	DD1 BPB30	325	DD1S L6024N	313
DB1F24TP	283, 330	DCE1L4848DDN	277	DD1 BPB36	325	DD1S L6030N	313
DB1F30TP	283, 330	DCE1L4848DSN	277	DD1 BPB42	325	DD1S L6624N	313
DB1LS15A	291	DCE1L4848SDN	277	DD1 BPB48	325	DD1S L6630N	313
DB1LS18A	291	DCE1L4848SSN	277	DD1 BPD54	325	DD1S L7224N	313
DB1LS24A	291	DCE1L4860DSN	278	DD1 BPD60	325	DD1S L7230N	313
DB1LS30A	291	DCE1L4860SDN	278	DD1 BPD66	325	DD1TEU24	291
DB1LS36A	291	DCE1L4860SSN	278	DD1 BPD72	325	DD1TEU30	291
DB1LSP15	289	DCE1L4866DSN	278	DD1 BPR36	325	DD1VD 3624 N	317
DB1LSP18	289	DCE1L4866SDN	278	DD1 BPR42	325	DD1VD 4224 N	317
DB1LSP24	289	DCE1L4866SSN	278	DD1 BPR48	325	DD1VD 4824 N	317
DB1LSP30	289	DCE1L4872DSN	278	DD1 BPR60	325	DD1VL 3624 N	317
DB1LSP36	289	DCE1L4872SDN	278	DD1 BPU72	325	DD1VL 4224 N	317
DB1LSS15	289	DCE1L4872SSN	278	DD1 BPV36	317	DD1VL 4824 N	317
DB1LSS18	289	DCE1L4878SSN	278	DD1 BPV42	317	DD2B 3018N	319
DB1LSS24	289	DCE1L4884SSN	278	DD1 BPV48	317	DD2B 3618N	319
DB1LSS30	289	DCE1L6042SSN	278	DD1 DIEU	323	DD2B 3624N	319
DB1LSS36	289	DCE1L6048DSN	278	DD1 EU18	323	DD2B 4218N	319
DB1P WS L	283	DCE1L6048SDN	278	DD1 EU24	323	DD2B 4224N	319
DB1P WS P	284	DCE1L6048SSN	278	DD1 EU30	323	DD2B 4818N	319
DB1P WS R	283	DCE1L6642SSN	278	DD1 FBPB30	327	DD2B 4824N	319
DB1P WS24	284	DCE1L6648DSN	278	DD1 FBPB36	327	DD2D L6024N	311
DB1P WS30	284	DCE1L6648SDN	278	DD1 FBPB42	327	DD2D L6030N	311
DB1P WS36	284	DCE1L6648SSN	278	DD1 FBPB48	327	DD2D L6624N	311
DB1P WS42	284	DCE1L7242SSN	278	DD1 FBPD54	327	DD2D L6630N	311
DB1P WS48	284	DCE1L7248DSN	278	DD1 FBPD60	327	DD2D L7224N	311
DB1RU18	199, 204	DCE1L7248SDN	278	DD1 FBPD66	327	DD2D L7230N	311
DB1S CR	291	DCE1L7248SSN	278	DD1 FBPD72	327	DD2E 3618N	319
DB1SWSL	287	DCE1L7842SSN	278	DD1 FBPR36	327	DD2E 3624N	319
DB1SWSP	287	DCE1L7848SSN	278	DD1 FBPR42	327	DD2E 4218N	319
DB1SWSR	287	DCE1L8448SSN	278	DD1 FBPR48	327	DD2E 4224N	319
DB1TB	291	DCE1R2424N	276	DD1 FBPR60	327	DD2O L6036N	311
DB1U18	199, 204	DCE1R2430N	276	DD1 FBPU72	327	DD2O L6636N	311
DB1WR54	283, 330	DCE1R3024N	276	DD1 FBPV36	317	DD2O L7236N	311
DB1WR60	283, 330	DCE1R3030N	276	DD1 FBPV42	317	DD2OD 36L	237
DB1WR66	283, 330	DCE1R3624N	276	DD1 FBPV48	317	DD2OD 42L	237
DB1WR72	283, 330	DCE1R3630N	276	DD1 IE30	323	DD2OD 48L	237
DB2CL24L	289	DCE1R4224N	276	DD1B 3018N	321	DD2OD 54L	237
DB2CL24LS	289	DCE1R4230N	276	DD1B 3618N	321	DD2OD 60L	237
DB2CL24R	289	DCE1R4824N	276	DD1B 3624N	321	DD2OD 66L	237
DB2CL24RS	289	DCE1R4830N	276	DD1B 4218N	321	DD2OD 72L	237
DBSMLH	287	DCE1R5424N	276	DD1B 4224N	321	DD2P (L)3618N	319
DBSMRH	287	DCE1R5430N	276	DD1B 4818N	321	DD2P (L)3624N	319
DCE1BD6648D(L/R)	277	DCE1R6024N	276	DD1B 4824N	321	DD2P (L)4218N	319
DCE1BD6648S(L/R)	277	DCE1R6030N	276	DD1D L6024N	313	DD2P (L)4224N	319
DCE1BD7248D(L/R)	277	DCE1R6624N	276	DD1D L6030N	313	DD2P (L)4818N	319
DCE1BD7248S(L/R)	277	DCE1R6630N	276	DD1D L6624N	313	DD2P (L)4824N	319
DCE1BD7848D(L/R)	277	DCE1R7224N	276	DD1D L6630N	313	DD2S L6024N	311
DCE1BD7848S(L/R)	277	DCE1R7230N	276	DD1D L7224N	313	DD2S L6030N	311
DCE1BD8448D(L/R)	277	DCE1R7824N	276	DD1D L7230N	313	DD2S L6624N	311
DCE1BD8448S(L/R)	277	DCE1R7830N	276	DD1E 3618N	321	DD2S L6630N	311
DCE1CR24L	279	DCE1R8424N	276	DD1E 3624N	321	DD2S L7224N	311
DCE1CR24N	279	DCE1R8430N	276	DD1E 4218N	321	DD2S L7230N	311
DCE1CR24R	279	DCE1R9024N	276	DD1E 4224N	321	DD2VD 3624 N	315
DCE1H4818	279	DCE1R9030N	276	DD1O L6036N	313	DD2VD 4224 N	315

<i>pattern no.</i>	<i>page</i>	<i>pattern no.</i>	<i>page</i>	<i>pattern no.</i>	<i>page</i>	<i>pattern no.</i>	<i>page</i>
DD2VD 4824 N	315	DE1(E,8,T) PMS24	163	DP1 S04236	57	DP1AU0748	113
DD2VL 3624 N	315	DE1(E,8,T) PMS30	163	DP1 S04242	57	DP1AU0751	148
DD2VL 4224 N	315	DE1(E,8,T) PMS36	163	DP1 S04248	57	DP1AU0754	113
DD2VL 4824 N	315	DE1(E,8,T) PMS42	163	DP1 S04260	57	DP1AU0757	148
DD3 PS36	238	DE1(E,8,T) PMS48	163	DP1 S05015	57	DP1AU0760	113
DD3 PS42	238	DE1(E,8,T) PMS60	163	DP1 S05018	57	DP1AU0763	148
DD3 PS48	238	DE1KC	167	DP1 S05024	57	DP1AU0766	113
DD3 PS54	238	DE1T B1NY1	183	DP1 S05030	57	DP1AU0769	148
DD3 PS60	238	DE1T BI56	183	DP1 S05036	57	DP1AU0772	113
DD3 PS66	238	DE1T BI56(L/R)	179	DP1 S05042	57	DP1AU0775	148
DD3 PS72	238	DE1T CI144	179	DP1 S05048	57	DP1AU1415	113
DE1	176, 177	DE1T RBI56	179	DP1 S05060	57	DP1AU1418	113
DE1 DATSHD	187	DE1T RBI56SF	183	DP1 S05715	58	DP1AU1424	113
DE1 FDP	170	DE2	176	DP1 S05718	58	DP1AU1430	113
DE1 KCBW	73	DE2PP36S	180	DP1 S05724	58	DP1AU1436	113
DE18 B1NY1	183	DE2PP36T	180	DP1 S05730	58	DP1AU1442	113
DE18 BI56	183	DE2PP42S	180	DP1 S05736	58	DP1AU1448	113
DE18 BI56(L/R)	179	DE2PP42T	180	DP1 S05742	58	DP1AU1451	148
DE18 CI144	179	DE2PP50S	180	DP1 S05748	58	DP1AU1454	113
DE18 RBI56	179	DE2PP50T	180	DP1 S05760	58	DP1AU1457	148
DE18 RBI56SF	183	DE2PP64S	180	DP1 S06415	58	DP1AU1460	113
DE1DOR4	167	DE2PP64T	180	DP1 S06418	58	DP1AU1463	148
DE1DOR5	167	DE2PP78S	180	DP1 S06424	58	DP1AU1466	113
DE1DOR6	167	DE2PP78T	180	DP1 S06430	58	DP1AU1469	148
DE1DR1	167	DE4WSMC	172	DP1 S06436	58	DP1AU1472	113
DE1DR2	167	DE4WSME108	172	DP1 S06442	58	DP1AU1475	148
DE1DR3	167	DE4WSME72	172	DP1 S06448	58	DP1AUECTP	113, 148
DE1DR4	167	DE4WSMED108	172	DP1 S06460	58	DP1FL 1424	80
DE1DR5	167	DE4WSMED72	172	DP1 S07815	58	DP1FL 1430	80
DE1DR6	167	DE6 FDP	170	DP1 S07818	58	DP1FL 1436	80
DE1E B1NY1	183	DE6 FDPF	170	DP1 S07824	58	DP1FL 1442	80
DE1E BI56	183	DE6 VDR1	171	DP1 S07830	58	DP1FL 1448	80
DE1E BI56(L/R)	179	DE6 VDR2	171	DP1 S07836	58	DP1GL 1424	80
DE1E CI144	179	DE6 VDR3	171	DP1 S07842	58	DP1GL 1430	80
DE1E RBI56	179	DE6 VDR4	171	DP1 S07848	58	DP1GL 1436	80
DE1E RBI56SF	183	DE6 VPM	170	DP1 TKC	187	DP1GL 1442	80
DE1(E,8,T) PCNP	163	DL3T5E19S	207	DP1 VWG	187	DP1GL 1448	80
DE1(E,8,T) PCWP	163	DL3T5E25	207	DP120PC08S	154	DP1GT 1424	80
DE1(E,8,T) PJ15NP	163	DL3T5E37	207	DP120PC14S	154	DP1GT 1430	80
DE1(E,8,T) PJ15WP	163	DL3T5E49	207	DP120PC22S	154	DP1GT 1436	80
DE1(E,8,T) PJ18NP	163	DL3TC	207	DP120PC28S	154	DP1GT 1442	80
DE1(E,8,T) PJ18WP	163	DP 121, 123, 127, 129, 130, 133, 139, 153, 154		DP120PC36S	154	DP1GT 1448	80
DE1(E,8,T) PJ24NP	163	DP1	77	DP120PC36SF	154	DP1GT 2124	80
DE1(E,8,T) PJ24WP	163	DP1 BCT18	188	DP120PC42S	154	DP1GT 2130	80
DE1(E,8,T) PJ30NP	163	DP1 BCT24	188	DP120PC42SH	154	DP1GT 2136	80
DE1(E,8,T) PJ30WP	163	DP1 BCT30	188	DP120PC50S	154	DP1GT 2142	80
DE1(E,8,T) PJ36NP	163	DP1 BCT36	188	DP120PC57S	154	DP1GT 2148	80
DE1(E,8,T) PJ36WP	163	DP1 BCT42	188	DP120PC64S	154	DP1MBT24	84
DE1(E,8,T) PJ42NP	163	DP1 BCT48	188	DP120PC78S	154	DP1MBT30	84
DE1(E,8,T) PJ42WP	163	DP1 BCT60	188	DP120PO36	154	DP1MBT36	84
DE1(E,8,T) PJ48NP	163	DP1 CG	135	DP120PO42	154	DP1MBT42	84
DE1(E,8,T) PJ48WP	163, 171, 177	DP1 CHB	135	DP120PO50	154	DP1MBT48	84
DE1(E,8,T) PJ54WP	164, 171, 177	DP1 CHP	135	DP120PO57	154	DP1PRBL	135
DE1(E,8,T) PJ60WP	164, 171, 177	DP1 S02815	57	DP120PO64	154	DP1PRBS	135
DE1(E,8,T) PJ66WP	164, 171	DP1 S02818	57	DP120PO78	154	DP1PRBT	135
DE1(E,8,T) PJ72WP	164, 171	DP1 S02824	57	DP120S	154	DP1PRBX	135
DE1(E,8,T) PJ78WP	164, 171	DP1 S02830	57	DP120SPO 14	153	DP1PRFN15	135
DE1(E,8,T) PJ84WP	164, 171	DP1 S02836	57	DP120SPO 21	153	DP1PRFN250	135
DE1(E,8,T) PJ96WP	164	DP1 S02842	57	DP120SPO 28	153	DP1PRFN70	135
DE1(E,8,T) PM24	163	DP1 S02848	57	DP1AU0715	113	DP1PRFW15	135
DE1(E,8,T) PM30	163	DP1 S02860	57	DP1AU0718	113	DP1PRFW250	135
DE1(E,8,T) PM36	163	DP1 S04215	57	DP1AU0724	113	DP1PRFW70	135
DE1(E,8,T) PM42	163	DP1 S04218	57	DP1AU0730	113	DP1PT3	133
DE1(E,8,T) PM48	163	DP1 S04224	57	DP1AU0736	113	DP1PT4	133
DE1(E,8,T) PM60	163	DP1 S04230	57	DP1AU0742	113	DP1SO1415	65

<i>pattern no.</i>	<i>page</i>	<i>pattern no.</i>	<i>page</i>	<i>pattern no.</i>	<i>page</i>	<i>pattern no.</i>	<i>page</i>
DP1SO1418	65	DP1SO5018CCF	145	DP1SOS18	66	DP2BC36K	73
DP1SO1424	65	DP1SO5024	143	DP1SOS24	66	DP2BC42K	73
DP1SO1430	65	DP1SO5024CCF	145	DP1SOS30	66	DP2BC48K	73
DP1SO1436	65	DP1SO5030	143	DP1SOS36	66	DP2BC60K	73
DP1SO1442	65	DP1SO5030CCF	145	DP1SOS42	66	DP2CHTP	135
DP1SO1448	65	DP1SO5030EPEF	147	DP1SOS48	66	DP2PMS36	133
DP1SO1460	65	DP1SO5036	143	DP1SOS60	66	DP2PMS42	133
DP1SO2115	65	DP1SO5036CCF	145	DP1SOWH15	57, 142	DP2PMS50	133
DP1SO2118	65	DP1SO5036EPEF	147	DP1SOWH15CCF	144	DP2PMS57	133
DP1SO2124	65	DP1SO5042	143	DP1SOWH18	57, 142	DP2PMS64	133
DP1SO2130	65	DP1SO5042CCF	145	DP1SOWH18CCF	144	DP2PMS78	133
DP1SO2136	65	DP1SO5048	143	DP1SOWH24	57, 142	DP2PS	90
DP1SO2142	65	DP1SO5048CCF	145	DP1SOWH24CCF	144	DP2PWS36	133
DP1SO2148	65	DP1SO5048EPEF	147	DP1SOWH30	57, 142	DP2PWS42	133
DP1SO2160	65	DP1SO5060	143	DP1SOWH30CCF	144	DP2PWS50	133
DP1SO2418	73	DP1SO5060CCF	145	DP1SOWH30EPEF	146	DP2PWS57	133
DP1SO2424	73	DP1SO5060EPEF	147	DP1SOWH36	57, 142	DP2PWS64	133
DP1SO2430	73	DP1SO5715	143	DP1SOWH36CCF	144	DP2PWS78	133
DP1SO2436	73	DP1SO5715CCF	145	DP1SOWH36EPEF	146	DP2SOS15	66
DP1SO2442	73	DP1SO5718	143	DP1SOWH42	57, 142	DP2SOS18	66
DP1SO2448	73	DP1SO5718CCF	145	DP1SOWH42CCF	144	DP2SOS24	66
DP1SO2460	73	DP1SO5724	143	DP1SOWH48	57, 142	DP2SOS30	66
DP1SO2815	65, 142	DP1SO5724CCF	145	DP1SOWH48CCF	144	DP2SOS36	66
DP1SO2815CCF	144	DP1SO5730	143	DP1SOWH48EPEF	146	DP2SOS42	66
DP1SO2818	65, 142	DP1SO5730CCF	145	DP1SOWH60	57, 142	DP2SOS48	66
DP1SO2818CCF	144	DP1SO5730EPEF	147	DP1SOWH60CCF	144	DP2SOS60	66
DP1SO2824	65, 142	DP1SO5736	143	DP1SOWH60EPEF	146	DP2SOSC	66
DP1SO2824CCF	144	DP1SO5736CCF	145	DP1SW0724	95	DP2STF 2118	53
DP1SO2830	65, 142	DP1SO5736EPEF	147	DP1SW0730	95	DP2STF 2124	53
DP1SO2830CCF	144	DP1SO5742	143	DP1SW0736	95	DP2STF 2130	53
DP1SO2830EPEF	146	DP1SO5742CCF	145	DP1SW0742	95	DP2STF 2136	53
DP1SO2836	65, 142	DP1SO5748	143	DP1SW0748	95	DP2STF 2142	53
DP1SO2836CCF	144	DP1SO5748CCF	145	DP1SW1424	95	DP2STF 2148	53
DP1SO2836EPEF	146	DP1SO5748EPEF	147	DP1SW1430	95	DP2S(T/N)F 1418	53
DP1SO2842	65, 142	DP1SO5760	143	DP1SW1436	95	DP2S(T/N)F 1424	53
DP1SO2842CCF	144	DP1SO5760CCF	145	DP1SW1442	95	DP2S(T/N)F 1430	53
DP1SO2848	65, 142	DP1SO5760EPEF	147	DP1SW1448	95	DP2S(T/N)F 1436	53
DP1SO2848CCF	144	DP1SO6415	143	DP1SW2124	95	DP2S(T/N)F 1442	53
DP1SO2848EPEF	146	DP1SO6415CCF	145	DP1SW2130	95	DP2S(T/N)F 1448	53
DP1SO2860	65, 142	DP1SO6418	143	DP1SW2136	95	DP2S(T/N)F 2318	53
DP1SO2860CCF	144	DP1SO6418CCF	145	DP1SW2142	95	DP2S(T/N)F 2824	53
DP1SO2860EPEF	146	DP1SO6424	143	DP1SW2148	95	DP2S(T/N)F 2830	53
DP1SO4215	142	DP1SO6424CCF	145	DP1SW2824	95	DP2S(T/N)F 2836	53
DP1SO4215CCF	144	DP1SO6430	143	DP1SW2830	95	DP2S(T/N)F 2842	53
DP1SO4218	142	DP1SO6430CCF	145	DP1SW2836	95	DP2S(T/N)F 2848	53
DP1SO4218CCF	144	DP1SO6430EPEF	147	DP1SW2842	95	DP3ESB	74, 91, 92
DP1SO4224	142	DP1SO6436	143	DP1SW2848	95	DP3L10715	69
DP1SO4224CCF	144	DP1SO6436CCF	145	DP2 STFL1418	53	DP3L10718	69
DP1SO4230	142	DP1SO6436EPEF	147	DP2 STFL1424	53	DP3L10724	69
DP1SO4230CCF	144	DP1SO6442	143	DP2 STFL1430	53	DP3L10730	69
DP1SO4230EPEF	146	DP1SO6442CCF	145	DP2 STFL1436	53	DP3L10736	69
DP1SO4236	142	DP1SO6448	143	DP2 STFL1442	53	DP3L10742	69
DP1SO4236CCF	144	DP1SO6448CCF	145	DP2 STFL1448	53	DP3L10748	69
DP1SO4236EPEF	146	DP1SO6448EPEF	147	DP2APO36	123	DP3L11015	69
DP1SO4242	142	DP1SO6460	143	DP2APO42	123	DP3L11018	69
DP1SO4242CCF	144	DP1SO6460CCF	145	DP2APO50	123	DP3L11024	69
DP1SO4248	142	DP1SO715	65	DP2APO57	123	DP3L11030	69
DP1SO4248CCF	144	DP1SO718	65	DP2APO64	123	DP3L11036	69
DP1SO4248EPEF	146	DP1SO724	65	DP2APO78	123	DP3L11042	69
DP1SO4260	142	DP1SO730	65	DP2ASPO 14	124	DP3L11048	69
DP1SO4260CCF	144	DP1SO736	65	DP2ASPO 21	124	DP3L11415	69
DP1SO4260EPEF	146	DP1SO742	65	DP2ASPO 28	124	DP3L11415F	70
DP1SO5015	143	DP1SO748	65	DP2BC18K	73	DP3L11418	69
DP1SO5015CCF	145	DP1SO760	65	DP2BC24K	73	DP3L11418F	70
DP1SO5018	143	DP1SOS15	66	DP2BC30K	73	DP3L11424	69

<i>pattern no.</i>	<i>page</i>	<i>pattern no.</i>	<i>page</i>	<i>pattern no.</i>	<i>page</i>	<i>pattern no.</i>	<i>page</i>
DP7CMMMLL3630	17	DP7CMMRR5030	15	DP7CPPFR6442	38	DP7CPPRR5742	32
DP7CMMMLL3636	17	DP7CMMRR5036	15	DP7CPPFR6448	38	DP7CPPRR5748	32
DP7CMMMLL3642	17	DP7CMMRR5042	15	DP7CPPFR6460	38	DP7CPPRR5760	32
DP7CMMMLL3648	17	DP7CMMRR5048	15	DP7CPPFR7815	39	DP7CPPRR6415	32
DP7CMMMLL3660	17	DP7CMMRR5060	15	DP7CPPFR7818	39	DP7CPPRR6418	32
DP7CMMMLL4218	17	DP7CMMRR5715	16	DP7CPPFR7824	39	DP7CPPRR6424	32
DP7CMMMLL4224	17	DP7CMMRR5718	16	DP7CPPFR7830	39	DP7CPPRR6430	32
DP7CMMMLL4230	17	DP7CMMRR5724	16	DP7CPPFR7836	39	DP7CPPRR6436	32
DP7CMMMLL4236	17	DP7CMMRR5730	16	DP7CPPFR7842	39	DP7CPPRR6442	32
DP7CMMMLL4242	17	DP7CMMRR5736	16	DP7CPPFR7848	39	DP7CPPRR6448	32
DP7CMMMLL4248	17	DP7CMMRR5742	16	DP7CPPLL4218	34	DP7CPPRR6460	32
DP7CMMMLL4260	17	DP7CMMRR5748	16	DP7CPPLL4224	34	DP7CPPRR7815	33
DP7CMMMLL5018	17	DP7CMMRR5760	16	DP7CPPLL4230	34	DP7CPPRR7818	33
DP7CMMMLL5024	17	DP7CMMRR6415	16	DP7CPPLL4236	34	DP7CPPRR7824	33
DP7CMMMLL5030	17	DP7CMMRR6418	16	DP7CPPLL4242	34	DP7CPPRR7830	33
DP7CMMMLL5036	17	DP7CMMRR6424	16	DP7CPPLL4248	34	DP7CPPRR7836	33
DP7CMMMLL5042	17	DP7CMMRR6430	16	DP7CPPLL4260	34	DP7CPPRR7842	33
DP7CMMMLL5048	17	DP7CMMRR6436	16	DP7CPPLL5018	34	DP7CPPRR7848	33
DP7CMMMLL5060	17	DP7CMMRR6442	16	DP7CPPLL5024	34	DP7CTTFR3615	28
DP7CMMMLL5718	18	DP7CMMRR6448	16	DP7CPPLL5030	34	DP7CTTFR3618	28
DP7CMMMLL5724	18	DP7CMMRR6460	16	DP7CPPLL5036	34	DP7CTTFR3624	28
DP7CMMMLL5730	18	DP7CMMRR7815	16	DP7CPPLL5042	34	DP7CTTFR3630	28
DP7CMMMLL5736	18	DP7CMMRR7818	16	DP7CPPLL5048	34	DP7CTTFR3636	28
DP7CMMMLL5742	18	DP7CMMRR7824	16	DP7CPPLL5060	34	DP7CTTFR3642	28
DP7CMMMLL5748	18	DP7CMMRR7830	16	DP7CPPLL5718	35	DP7CTTFR3648	28
DP7CMMMLL5760	18	DP7CMMRR7836	16	DP7CPPLL5724	35	DP7CTTFR3660	28
DP7CMMMLL6418	18	DP7CMMRR7842	16	DP7CPPLL5730	35	DP7CTTFR4215	28
DP7CMMMLL6424	18	DP7CMMRR7848	16	DP7CPPLL5736	35	DP7CTTFR4218	28
DP7CMMMLL6430	18	DP7CMMRRWH15	15	DP7CPPLL5742	35	DP7CTTFR4224	28
DP7CMMMLL6436	18	DP7CMMRRWH18	15	DP7CPPLL5748	35	DP7CTTFR4230	28
DP7CMMMLL6442	18	DP7CMMRRWH24	15	DP7CPPLL5760	35	DP7CTTFR4236	28
DP7CMMMLL6448	18	DP7CMMRRWH30	15	DP7CPPLL6418	35	DP7CTTFR4242	28
DP7CMMMLL6460	18	DP7CMMRRWH36	15	DP7CPPLL6424	35	DP7CTTFR4248	28
DP7CMMMLL7818	18	DP7CMMRRWH42	15	DP7CPPLL6430	35	DP7CTTFR4260	28
DP7CMMMLL7824	18	DP7CMMRRWH48	15	DP7CPPLL6436	35	DP7CTTFR5015	29
DP7CMMMLL7830	18	DP7CMMRRWH60	15	DP7CPPLL6442	35	DP7CTTFR5018	29
DP7CMMMLL7836	18	DP7CPPFR4215	37	DP7CPPLL6448	35	DP7CTTFR5024	29
DP7CMMMLL7842	18	DP7CPPFR4218	37	DP7CPPLL6460	35	DP7CTTFR5030	29
DP7CMMMLL7848	18	DP7CPPFR4224	37	DP7CPPLL7818	36	DP7CTTFR5036	29
DP7CMMMLLWH18	17	DP7CPPFR4230	37	DP7CPPLL7824	36	DP7CTTFR5042	29
DP7CMMMLLWH24	17	DP7CPPFR4236	37	DP7CPPLL7830	36	DP7CTTFR5048	29
DP7CMMMLLWH30	17	DP7CPPFR4242	37	DP7CPPLL7836	36	DP7CTTFR5060	29
DP7CMMMLLWH36	17	DP7CPPFR4248	37	DP7CPPLL7842	36	DP7CTTFR5715	29
DP7CMMMLLWH42	17	DP7CPPFR4260	37	DP7CPPLL7848	36	DP7CTTFR5718	29
DP7CMMMLLWH48	17	DP7CPPFR5015	37	DP7CPPRR4215	31	DP7CTTFR5724	29
DP7CMMMLLWH60	17	DP7CPPFR5018	37	DP7CPPRR4218	31	DP7CTTFR5730	29
DP7CMMRR3615	15	DP7CPPFR5024	37	DP7CPPRR4224	31	DP7CTTFR5736	29
DP7CMMRR3618	15	DP7CPPFR5030	37	DP7CPPRR4230	31	DP7CTTFR5742	29
DP7CMMRR3624	15	DP7CPPFR5036	37	DP7CPPRR4236	31	DP7CTTFR5748	29
DP7CMMRR3630	15	DP7CPPFR5042	37	DP7CPPRR4242	31	DP7CTTFR5760	29
DP7CMMRR3636	15	DP7CPPFR5048	37	DP7CPPRR4248	31	DP7CTTFR6415	30
DP7CMMRR3642	15	DP7CPPFR5060	37	DP7CPPRR4260	31	DP7CTTFR6418	30
DP7CMMRR3648	15	DP7CPPFR5715	38	DP7CPPRR5015	31	DP7CTTFR6424	30
DP7CMMRR3660	15	DP7CPPFR5718	38	DP7CPPRR5018	31	DP7CTTFR6430	30
DP7CMMRR4215	15	DP7CPPFR5724	38	DP7CPPRR5024	31	DP7CTTFR6436	30
DP7CMMRR4218	15	DP7CPPFR5730	38	DP7CPPRR5030	31	DP7CTTFR6442	30
DP7CMMRR4224	15	DP7CPPFR5736	38	DP7CPPRR5036	31	DP7CTTFR6448	30
DP7CMMRR4230	15	DP7CPPFR5742	38	DP7CPPRR5042	31	DP7CTTFR6460	30
DP7CMMRR4236	15	DP7CPPFR5748	38	DP7CPPRR5048	31	DP7CTTFR7815	30
DP7CMMRR4242	15	DP7CPPFR5760	38	DP7CPPRR5060	31	DP7CTTFR7818	30
DP7CMMRR4248	15	DP7CPPFR6415	38	DP7CPPRR5715	32	DP7CTTFR7824	30
DP7CMMRR4260	15	DP7CPPFR6418	38	DP7CPPRR5718	32	DP7CTTFR7830	30
DP7CMMRR5015	15	DP7CPPFR6424	38	DP7CPPRR5724	32	DP7CTTFR7836	30
DP7CMMRR5018	15	DP7CPPFR6430	38	DP7CPPRR5730	32	DP7CTTFR7842	30
DP7CMMRR5024	15	DP7CPPFR6436	38	DP7CPPRR5736	32	DP7CTTFR7848	30

<i>pattern no.</i>	<i>page</i>	<i>pattern no.</i>	<i>page</i>	<i>pattern no.</i>	<i>page</i>	<i>pattern no.</i>	<i>page</i>
DP7CTTLL3618	26	DP7CTTRR5715	25	DP7PAWH2	115	DP7PTCPH	138
DP7CTTLL3624	26	DP7CTTRR5718	25	DP7PAWH3	115	DP7PTS	118
DP7CTTLL3630	26	DP7CTTRR5724	25	DP7PAWH4	115	DP7RCCH24	184
DP7CTTLL3636	26	DP7CTTRR5730	25	DP7PC07H	119	DP7RCCH30	184
DP7CTTLL3642	26	DP7CTTRR5736	25	DP7PC07LH	119	DP7RCCH36	184
DP7CTTLL3648	26	DP7CTTRR5742	25	DP7PC07RH	119	DP7RCCH42	184
DP7CTTLL3660	26	DP7CTTRR5748	25	DP7PC14H	119	DP7RCCH48	184
DP7CTTLL4218	26	DP7CTTRR5760	25	DP7PC14LH	119	DP7RCCH60	184
DP7CTTLL4224	26	DP7CTTRR6415	25	DP7PC14RH	119	DP7S	104, 105, 106, 107
DP7CTTLL4230	26	DP7CTTRR6418	25	DP7PC21H	119	DP7SPO14	118
DP7CTTLL4236	26	DP7CTTRR6424	25	DP7PC21LH	119	DP7SPO21	118
DP7CTTLL4242	26	DP7CTTRR6430	25	DP7PC21RH	119	DP7SPO28	118
DP7CTTLL4248	26	DP7CTTRR6436	25	DP7PC28H	119	DP7SS	110, 111
DP7CTTLL4260	26	DP7CTTRR6442	25	DP7PC28LH	119	DP7SSWT1424	109
DP7CTTLL5018	26	DP7CTTRR6448	25	DP7PC28RH	119	DP7SSWT1430	109
DP7CTTLL5024	26	DP7CTTRR6460	25	DP7PC36	119	DP7SSWT1436	109
DP7CTTLL5030	26	DP7CTTRR7815	25	DP7PC362	119	DP7SSWT1442	109
DP7CTTLL5036	26	DP7CTTRR7818	25	DP7PC36H	119	DP7SSWT1448	109
DP7CTTLL5042	26	DP7CTTRR7824	25	DP7PC36LH	119	DP7SSWT2124	109
DP7CTTLL5048	26	DP7CTTRR7830	25	DP7PC36RH	119	DP7SSWT2130	109
DP7CTTLL5060	26	DP7CTTRR7836	25	DP7PC42	119	DP7SSWT2136	109
DP7CTTLL5718	27	DP7CTTRR7842	25	DP7PC422	119	DP7SSWT2142	109
DP7CTTLL5724	27	DP7CTTRR7848	25	DP7PC42H	119	DP7SSWT2148	109
DP7CTTLL5730	27	DP7HIRKD24	184	DP7PC42LH	119	DP7SSWT2824	109
DP7CTTLL5736	27	DP7HIRKD30	184	DP7PC42RH	119	DP7SSWT2830	109
DP7CTTLL5742	27	DP7HIRKD36	184	DP7PC50	119	DP7SSWT2836	109
DP7CTTLL5748	27	DP7HIRKD42	184	DP7PC502	119	DP7SSWT2842	109
DP7CTTLL5760	27	DP7HIRKD48	184	DP7PC57	119	DP7SSWT2848	109
DP7CTTLL6418	27	DP7HIRKD60	184	DP7PC572	119	DP7SWT	102, 103
DP7CTTLL6424	27	DP7HIRKS24	184	DP7PC64	119	DP7SWTFK24	103
DP7CTTLL6430	27	DP7HIRKS30	184	DP7PC642	119	DP7SWTFK30	103
DP7CTTLL6436	27	DP7HIRKS36	184	DP7PC78	119	DP7SWTFK36	103
DP7CTTLL6442	27	DP7HIRKS42	184	DP7PC782	119	DP7SWTFK42	103
DP7CTTLL6448	27	DP7HIRKS48	184	DP7PCWH	119	DP7SWTFK48	103
DP7CTTLL6460	27	DP7HIRKS60	184	DP7PCWH2	119	DP7SWTFKD	103
DP7CTTLL7818	27	DP7HRRKD24	184	DP7PO36	118	DPS7V1418	54
DP7CTTLL7824	27	DP7HRRKD30	184	DP7PO36CPF	138	DPS7V1424	54
DP7CTTLL7830	27	DP7HRRKD36	184	DP7PO42	118	DPS7V1430	54
DP7CTTLL7836	27	DP7HRRKD42	184	DP7PO42CPF	138	DPS7V1436	54
DP7CTTLL7842	27	DP7HRRKD48	184	DP7PO50	118	DPS7V1442	54
DP7CTTLL7848	27	DP7HRRKD60	184	DP7PO50CPF	138	DPS7V1448	54
DP7CTTRR3615	24	DP7HRRKS24	184	DP7PO57	118	DPS7V2118	54
DP7CTTRR3618	24	DP7HRRKS30	184	DP7PO57CPF	138	DPS7V2124	54
DP7CTTRR3624	24	DP7HRRKS36	184	DP7PO64	118	DPS7V2130	54
DP7CTTRR3630	24	DP7HRRKS42	184	DP7PO64CPF	138	DPS7V2136	54
DP7CTTRR3636	24	DP7HRRKS48	184	DP7PO78	118	DPS7V2142	54
DP7CTTRR3642	24	DP7HRRKS60	184	DP7POWH	118	DPS7V2148	54
DP7CTTRR3648	24	DP7PA362	115	DP7POWHCPF	138	DPS7V2818	54
DP7CTTRR3660	24	DP7PA363	115	DP7PP36S	180	DPS7V2824	54
DP7CTTRR4215	24	DP7PA364	115	DP7PP36T	180	DPS7V2830	54
DP7CTTRR4218	24	DP7PA422	115	DP7PP42S	180	DPS7V2836	54
DP7CTTRR4224	24	DP7PA423	115	DP7PP42T	180	DPS7V2842	54
DP7CTTRR4230	24	DP7PA424	115	DP7PP50S	180	DP87V2848	54
DP7CTTRR4236	24	DP7PA502	115	DP7PP50T	180	DS1 OHL	204
DP7CTTRR4242	24	DP7PA503	115	DP7PP57S	180	DS1 VD	204, 237
DP7CTTRR4248	24	DP7PA504	115	DP7PP57T	180	DS1BS 24	203
DP7CTTRR4260	24	DP7PA572	115	DP7PP64S	180	DS1BS 30	203
DP7CTTRR5015	24	DP7PA573	115	DP7PP64T	180	DS1BS 36	203
DP7CTTRR5018	24	DP7PA574	115	DP7PP78S	180	DS1BS 42	203
DP7CTTRR5024	24	DP7PA642	115	DP7PP78T	180	DS1BS 48	203
DP7CTTRR5030	24	DP7PA643	115	DP7PT1	118	DS1BS 54	203
DP7CTTRR5036	24	DP7PA644	115	DP7PT2	118	DS1BS 60	203
DP7CTTRR5042	24	DP7PA782	115	DP7PT3	118	DS1BS 66	203
DP7CTTRR5048	24	DP7PA783	115	DP7PT4	118	DS1BS 72	203
DP7CTTRR5060	24	DP7PA784	115	DP7PTCP	138	DS1CS 36	201

<i>pattern no.</i>	<i>page</i>	<i>pattern no.</i>	<i>page</i>	<i>pattern no.</i>	<i>page</i>	<i>pattern no.</i>	<i>page</i>
DS1CS 42	201	DS2DWDPL30	213	DS3ODSL1643014L	244	DS3ODSV2573021FL	242
DS1CS 48	201	DS2DWDPL36	213	DS3ODSL1643614L	244	DS3ODSV2573621FL	242
DS1DW 30L	209	DS2LKKT	213	DS3ODSL1644214L	244	DS3ODSV2574221FL	242
DS1DWDPL	213	DS2OD 36L	237	DS3ODSL1644814L	244	DS3ODSV2574821FL	242
DS1E30L	199	DS2OD 42L	237	DS3ODSL1646014L	244	DS3ODSV2576021FL	242
DS1E36L	199	DS2OD 48L	237	DS3ODSL1646614L	244	DS3ODSV2576621FL	242
DS1E42L	199	DS2OD 54L	237	DS3ODSL1647214L	244	DS3ODSV2577221FL	242
DS1E48L	199	DS2OD 60L	237	DS3ODSL2573021FL	242	DS3ODSV2643021FL	247
DS1E54L	199	DS2OD 66L	237	DS3ODSL2573621FL	242	DS3ODSV2643621FL	247
DS1E60L	199	DS2OD 72L	237	DS3ODSL2574221FL	242	DS3ODSV2644221FL	247
DS1E66L	199	DS2PF L18A	211	DS3ODSL2574821FL	242	DS3ODSV2644821FL	247
DS1E72L	199	DS2PF L18B	211	DS3ODSL2576021FL	242	DS3ODSV2646021FL	247
DS1EAKIT	191	DS2PF L24A	211	DS3ODSL2576621FL	242	DS3ODSV2646621FL	247
DS1LKKT	213	DS2PF L24B	211	DS3ODSL2577221FL	242	DS3ODSV2647221FL	247
DS1O24L	191	DS2PF L30A	211	DS3ODSL2643021FL	246	DS3PML30L	192
DS1O30L	191	DS2PF L30B	211	DS3ODSL2643621FL	246	DS3PML36L	192
DS1O36L	191	DS2PM L18A	211	DS3ODSL2644221FL	246	DS3PML42L	192
DS1O42L	191	DS2PM L18B	211	DS3ODSL2644821FL	246	DS3PML48L	192
DS1O48L	191	DS2PM L18F	211	DS3ODSL2646021FL	246	DS3PML60L	192
DS1O54L	191	DS2PM L24A	211	DS3ODSL2646621FL	246	DS3PML66L	192
DS1O60L	191	DS2PM L24B	211	DS3ODSL2647221FL	246	DS3PML72L	192
DS1O66L	191	DS2PM L24F	211	DS3ODSS	243, 248	DS3PMNS3014	195
DS1O72L	191	DS2PM24L	191	DS3ODSS1573014L	241	DS3PMNS3021	196
DS1PBD	213, 329	DS2PM30L	191	DS3ODSS1573614L	241	DS3PMNS3614	195
DS1PCD	213, 329	DS2PM36L	191	DS3ODSS1574214L	241	DS3PMNS3621	196
DS1PF L18A	209	DS2PM42L	191	DS3ODSS1574814L	241	DS3PMNS4214	195
DS1PF L18B	209	DS2PM48L	191	DS3ODSS1576014L	241	DS3PMNS4221	196
DS1PF L24A	209	DS2PM54L	191	DS3ODSS1576614L	241	DS3PMNS4814	195
DS1PF L24B	209	DS2PM60L	191	DS3ODSS1577214L	241	DS3PMNS4821	196
DS1PF L30A	209	DS2PM66L	191	DS3ODSS1643014L	244	DS3PMNS6014	195
DS1PF L30B	209	DS2PM72L	191	DS3ODSS1643614L	244	DS3PMNS6021	196
DS1PFD	213, 329	DS2PPTC	213, 329	DS3ODSS1644214L	244	DS3PMNS6614	195
DS1PFS	213, 329	DS2PPTN	213, 329	DS3ODSS1644814L	244	DS3PMNS6621	196
DS1PM L18A	209	DS2UM30L	199	DS3ODSS1646014L	244	DS3PMNS7214	195
DS1PM L18B	209	DS2UM36L	199	DS3ODSS1646614L	244	DS3PMNS7221	196
DS1PM L18F	209	DS2UM42L	199	DS3ODSS1647214L	244	DS3PMS30L	191
DS1PM L24A	209	DS2UM48L	199	DS3ODSS2573021FL	242	DS3PMS36L	191
DS1PM L24B	209	DS2UM54L	199	DS3ODSS2573621FL	242	DS3PMS42L	191
DS1PM L24F	209	DS2UM60L	199	DS3ODSS2574221FL	242	DS3PMS48L	191
DS1PST	213, 329	DS2UM66L	199	DS3ODSS2574821FL	242	DS3PMS60L	191
DS1S 24	201	DS2UM72L	199	DS3ODSS2576021FL	242	DS3PMS66L	191
DS1S 30	201	DS2XPB	211	DS3ODSS2576621FL	242	DS3PMS72L	191
DS1S 36	201	DS3ODNS	242, 246	DS3ODSS2577221FL	242	DS3PMSL3014L	195
DS1S 42	201	DS3ODNS1573014	241	DS3ODSS2643021FL	246	DS3PMSL3021FL	196
DS1S 48	201	DS3ODNS1573614	241	DS3ODSS2643621FL	246	DS3PMSL3021PL	197
DS1S 54	201	DS3ODNS1574214	241	DS3ODSS2644221FL	246	DS3PMSL3614L	195
DS1S 60	201	DS3ODNS1574814	241	DS3ODSS2644821FL	246	DS3PMSL3621FL	196
DS1S 66	201	DS3ODNS1576014	241	DS3ODSS2646021FL	246	DS3PMSL3621PL	197
DS1S 72	201	DS3ODNS1576614	241	DS3ODSS2646621FL	246	DS3PMSL4214L	195
DS1SWM 30	203	DS3ODNS1577214	241	DS3ODSS2647221FL	246	DS3PMSL4221FL	196
DS1SWM 36	203	DS3ODNS1643014	244	DS3ODSV	243, 248	DS3PMSL4221PL	197
DS1SWM 42	203	DS3ODNS1643614	244	DS3ODSV1573014L	241	DS3PMSL4814L	195
DS1SWM 48	203	DS3ODNS1644214	244	DS3ODSV1573614L	241	DS3PMSL4821FL	196
DS1UE24L	199	DS3ODNS1644814	244	DS3ODSV1574214L	241	DS3PMSL4821PL	197
DS1UE30L	199	DS3ODNS1646014	244	DS3ODSV1574814L	241	DS3PMSL6014L	195
DS1UE36L	199	DS3ODNS1646614	244	DS3ODSV1576014L	241	DS3PMSL6021FL	196
DS1UE42L	199	DS3ODNS1647214	244	DS3ODSV1576614L	241	DS3PMSL6021PL	197
DS1UE48L	199	DS3ODSL	243, 248	DS3ODSV1577214L	241	DS3PMSL6614L	195
DS1WM 24	203	DS3ODSL1573014L	241	DS3ODSV1643014L	245	DS3PMSL6621FL	196
DS1WM 30	203	DS3ODSL1573614L	241	DS3ODSV1643614L	245	DS3PMSL6621PL	197
DS1WM 36	203	DS3ODSL1574214L	241	DS3ODSV1644214L	245	DS3PMSL7214L	195
DS1WM 42	203	DS3ODSL1574814L	241	DS3ODSV1644814L	245	DS3PMSL7221FL	196
DS1WM 48	203	DS3ODSL1576014L	241	DS3ODSV1646014L	245	DS3PMSL7221PL	197
DS2DW 30L	211	DS3ODSL1576614L	241	DS3ODSV1646614L	245	DS3PMSS3014L	195
DS2DW 36L	211	DS3ODSL1577214L	241	DS3ODSV1647214L	245	DS3PMSS3021FL	196

<i>pattern no.</i>	<i>page</i>	<i>pattern no.</i>	<i>page</i>	<i>pattern no.</i>	<i>page</i>	<i>pattern no.</i>	<i>page</i>
DS3PMSS3021PL	197	DS4LC1ANV42N	222	DS4LC1BVV36L	223	DS4LC1CVV30L	224
DS3PMSS3614L	195	DS4LC1ANV48N	222	DS4LC1BVV42L	223	DS4LC1CVV36L	224
DS3PMSS3621FL	196	DS4LC1ANV54N	222	DS4LC1BVV48L	223	DS4LC1CVV42L	224
DS3PMSS3621PL	197	DS4LC1ANV60N	222	DS4LC1BVV54L	223	DS4LC1CVV48L	224
DS3PMSS4214L	195	DS4LC1ANV66N	222	DS4LC1BVV60L	223	DS4LC1CVV54L	224
DS3PMSS4221FL	196	DS4LC1ANV72N	222	DS4LC1BVV66L	223	DS4LC1CVV60L	224
DS3PMSS4221PL	197	DS4LC1BLL30L	218	DS4LC1BVV72L	223	DS4LC1CVV66L	224
DS3PMSS4814L	195	DS4LC1BLL36L	218	DS4LC1CLL30L	220	DS4LC1CVV72L	224
DS3PMSS4821FL	196	DS4LC1BLL42L	218	DS4LC1CLL36L	220	DS4LC1DLL30L	221
DS3PMSS4821PL	197	DS4LC1BLL48L	218	DS4LC1CLL42L	220	DS4LC1DLL36L	221
DS3PMSS6014L	195	DS4LC1BLL54L	218	DS4LC1CLL48L	220	DS4LC1DLL42L	221
DS3PMSS6021FL	196	DS4LC1BLL60L	218	DS4LC1CLL54L	220	DS4LC1DLL48L	221
DS3PMSS6021PL	197	DS4LC1BLL66L	218	DS4LC1CLL60L	220	DS4LC1DLL54L	221
DS3PMSS6614L	195	DS4LC1BLL72L	218	DS4LC1CLL66L	220	DS4LC1DLL60L	221
DS3PMSS6621FL	196	DS4LC1BLS42L	215	DS4LC1CLL72L	220	DS4LC1DLL66L	221
DS3PMSS6621PL	197	DS4LC1BLS48L	215	DS4LC1CLS42L	216	DS4LC1DLL72L	221
DS3PMSS7214L	195	DS4LC1BLS54L	215	DS4LC1CLS48L	216	DS4LC1DLS42L	217
DS3PMSS7221FL	196	DS4LC1BLS60L	215	DS4LC1CLS54L	216	DS4LC1DLS48L	217
DS3PMSS7221PL	197	DS4LC1BLS66L	215	DS4LC1CLS60L	216	DS4LC1DLS54L	217
DS3PMSV3014L	195	DS4LC1BLS72L	215	DS4LC1CLS66L	216	DS4LC1DLS60L	217
DS3PMSV3021FL	196	DS4LC1BLV30L	222	DS4LC1CLS72L	216	DS4LC1DLS66L	217
DS3PMSV3021PL	197	DS4LC1BLV36L	222	DS4LC1CLV30L	224	DS4LC1DLS72L	217
DS3PMSV3614L	195	DS4LC1BLV42L	222	DS4LC1CLV36L	224	DS4LC1DLV30L	225
DS3PMSV3621FL	196	DS4LC1BLV48L	222	DS4LC1CLV42L	224	DS4LC1DLV36L	225
DS3PMSV3621PL	197	DS4LC1BLV54L	222	DS4LC1CLV48L	224	DS4LC1DLV42L	225
DS3PMSV4214L	195	DS4LC1BLV60L	222	DS4LC1CLV54L	224	DS4LC1DLV48L	225
DS3PMSV4221FL	196	DS4LC1BLV66L	222	DS4LC1CLV60L	224	DS4LC1DLV54L	225
DS3PMSV4221PL	197	DS4LC1BLV72L	222	DS4LC1CLV66L	224	DS4LC1DLV60L	225
DS3PMSV4814L	195	DS4LC1BSL30L	218	DS4LC1CLV72L	224	DS4LC1DLV66L	225
DS3PMSV4821FL	196	DS4LC1BSL36L	218	DS4LC1CSL30L	220	DS4LC1DLV72L	225
DS3PMSV4821PL	197	DS4LC1BSL42L	218	DS4LC1CSL36L	220	DS4LC1DSL30L	221
DS3PMSV6014L	195	DS4LC1BSL48L	218	DS4LC1CSL42L	220	DS4LC1DSL36L	221
DS3PMSV6021FL	196	DS4LC1BSL54L	218	DS4LC1CSL48L	220	DS4LC1DSL42L	221
DS3PMSV6021PL	197	DS4LC1BSL60L	218	DS4LC1CSL54L	220	DS4LC1DSL48L	221
DS3PMSV6614L	195	DS4LC1BSL66L	218	DS4LC1CSL60L	220	DS4LC1DSL54L	221
DS3PMSV6621FL	196	DS4LC1BSL72L	218	DS4LC1CSL66L	220	DS4LC1DSL60L	221
DS3PMSV6621PL	197	DS4LC1BSS42L	215	DS4LC1CSL72L	220	DS4LC1DSL66L	221
DS3PMSV7214L	195	DS4LC1BSS48L	215	DS4LC1CSS42L	216	DS4LC1DSL72L	221
DS3PMSV7221FL	196	DS4LC1BSS54L	215	DS4LC1CSS48L	216	DS4LC1DSS42L	217
DS3PMSV7221PL	197	DS4LC1BSS60L	215	DS4LC1CSS54L	216	DS4LC1DSS48L	217
DS3PMV30L	192	DS4LC1BSS66L	215	DS4LC1CSS60L	216	DS4LC1DSS54L	217
DS3PMV36L	192	DS4LC1BSS72L	215	DS4LC1CSS66L	216	DS4LC1DSS60L	217
DS3PMV42L	192	DS4LC1BSV30L	222	DS4LC1CSS72L	216	DS4LC1DSS66L	217
DS3PMV48L	192	DS4LC1BSV36L	222	DS4LC1CSV30L	224	DS4LC1DSS72L	217
DS3PMV60L	192	DS4LC1BSV42L	222	DS4LC1CSV36L	224	DS4LC1DSV30L	225
DS3PMV66L	192	DS4LC1BSV48L	222	DS4LC1CSV42L	224	DS4LC1DSV36L	225
DS3PMV72L	192	DS4LC1BSV54L	222	DS4LC1CSV48L	224	DS4LC1DSV42L	225
DS4LC1ANL24N	218	DS4LC1BSV60L	222	DS4LC1CSV54L	224	DS4LC1DSV48L	225
DS4LC1ANL30N	218	DS4LC1BSV66L	222	DS4LC1CSV60L	224	DS4LC1DSV54L	225
DS4LC1ANL36N	218	DS4LC1BSV72L	222	DS4LC1CSV66L	224	DS4LC1DSV60L	225
DS4LC1ANL42N	218	DS4LC1BVL30L	219	DS4LC1CSV72L	224	DS4LC1DSV66L	225
DS4LC1ANL48N	218	DS4LC1BVL36L	219	DS4LC1CVL30L	220	DS4LC1DSV72L	225
DS4LC1ANL54N	218	DS4LC1BVL42L	219	DS4LC1CVL36L	220	DS4LC1DVL30L	221
DS4LC1ANL60N	218	DS4LC1BVL48L	219	DS4LC1CVL42L	220	DS4LC1DVL36L	221
DS4LC1ANL66N	218	DS4LC1BVL54L	219	DS4LC1CVL48L	220	DS4LC1DVL42L	221
DS4LC1ANL72N	218	DS4LC1BVL60L	219	DS4LC1CVL54L	220	DS4LC1DVL48L	221
DS4LC1ANS42N	215	DS4LC1BVL66L	219	DS4LC1CVL60L	220	DS4LC1DVL54L	221
DS4LC1ANS48N	215	DS4LC1BVL72L	219	DS4LC1CVL66L	220	DS4LC1DVL60L	221
DS4LC1ANS54N	215	DS4LC1BVS42L	215	DS4LC1CVL72L	220	DS4LC1DVL66L	221
DS4LC1ANS60N	215	DS4LC1BVS48L	215	DS4LC1CVS42L	216	DS4LC1DVL72L	221
DS4LC1ANS66N	215	DS4LC1BVS54L	215	DS4LC1CVS48L	216	DS4LC1DVS42L	217
DS4LC1ANS72N	215	DS4LC1BVS60L	215	DS4LC1CVS54L	216	DS4LC1DVS48L	217
DS4LC1ANV24N	222	DS4LC1BVS66L	215	DS4LC1CVS60L	216	DS4LC1DVS54L	217
DS4LC1ANV30N	222	DS4LC1BVS72L	215	DS4LC1CVS66L	216	DS4LC1DVS60L	217
DS4LC1ANV36N	222	DS4LC1BVV30L	223	DS4LC1CVS72L	216	DS4LC1DVS66L	217

<i>pattern no.</i>	<i>page</i>	<i>pattern no.</i>	<i>page</i>	<i>pattern no.</i>	<i>page</i>	<i>pattern no.</i>	<i>page</i>
DS4LC1DV572L	217	DS4LC2BVL66L	228	DS4LC2DLL72L	230	DT1ACX3642	302
DS4LC1DVV30L	225	DS4LC2BVL72L	228	DS4LC2DLV30L	234	DT1ACX42	302
DS4LC1DVV36L	225	DS4LC2BVV30L	232	DS4LC2DLV36L	234	DT1ACX4217	302
DS4LC1DVV42L	225	DS4LC2BVV36L	232	DS4LC2DLV42L	234	DT1ACX4221	302
DS4LC1DVV48L	225	DS4LC2BVV42L	232	DS4LC2DLV48L	234	DT1ACX4236	302
DS4LC1DVV54L	225	DS4LC2BVV48L	232	DS4LC2DLV54L	234	DT1ACX4242	302
DS4LC1DVV60L	225	DS4LC2BVV54L	232	DS4LC2DLV60L	234	DT1ACX48	302
DS4LC1DVV66L	225	DS4LC2BVV60L	232	DS4LC2DLV66L	234	DT1ACX4817	302
DS4LC1DVV72L	225	DS4LC2BVV66L	232	DS4LC2DLV72L	234	DT1ACX4821	302
DS4LC2ANL24N	227	DS4LC2BVV72L	232	DS4LC2DSL30L	230	DT1ADX3030	303
DS4LC2ANL30N	227	DS4LC2CLL30L	229	DS4LC2DSL36L	230	DT1ADX303017	303
DS4LC2ANL36N	227	DS4LC2CLL36L	229	DS4LC2DSL42L	230	DT1ADX303021	303
DS4LC2ANL42N	227	DS4LC2CLL42L	229	DS4LC2DSL48L	230	DT1ADX303036	303
DS4LC2ANL48N	227	DS4LC2CLL48L	229	DS4LC2DSL54L	230	DT1ADX303042	304
DS4LC2ANL54N	227	DS4LC2CLL54L	229	DS4LC2DSL60L	230	DT1ADX3636	303
DS4LC2ANL60N	227	DS4LC2CLL60L	229	DS4LC2DSL66L	230	DT1ADX363617	303
DS4LC2ANL66N	227	DS4LC2CLL66L	229	DS4LC2DSL72L	230	DT1ADX363621	303
DS4LC2ANL72N	227	DS4LC2CLL72L	229	DS4LC2DSV30L	234	DT1ADX363636	303
DS4LC2ANV24N	231	DS4LC2CLV30L	233	DS4LC2DSV36L	234	DT1ADX363642	304
DS4LC2ANV30N	231	DS4LC2CLV36L	233	DS4LC2DSV42L	234	DT1ADX4242	303
DS4LC2ANV36N	231	DS4LC2CLV42L	233	DS4LC2DSV48L	234	DT1ADX424217	303
DS4LC2ANV42N	231	DS4LC2CLV48L	233	DS4LC2DSV54L	234	DT1ADX424221	303
DS4LC2ANV48N	231	DS4LC2CLV54L	233	DS4LC2DSV60L	234	DT1ADX424236	303
DS4LC2ANV54N	231	DS4LC2CLV60L	233	DS4LC2DSV66L	234	DT1ADX424242	304
DS4LC2ANV60N	231	DS4LC2CLV66L	233	DS4LC2DSV72L	234	DT1ADX4848	303
DS4LC2ANV66N	231	DS4LC2CLV72L	233	DS4LC2DVL30L	230	DT1ADX484817	303
DS4LC2ANV72N	231	DS4LC2CSL30L	229	DS4LC2DVL36L	230	DT1ADX484821	303
DS4LC2BLL30L	227	DS4LC2CSL36L	229	DS4LC2DVL42L	230	DT1ARY10236N	307
DS4LC2BLL36L	227	DS4LC2CSL42L	229	DS4LC2DVL48L	230	DT1ARY10242N	307
DS4LC2BLL42L	227	DS4LC2CSL48L	229	DS4LC2DVL54L	230	DT1ARY10248N	307
DS4LC2BLL48L	227	DS4LC2CSL54L	229	DS4LC2DVL60L	230	DT1ARY10836N	307
DS4LC2BLL54L	227	DS4LC2CSL60L	229	DS4LC2DVL66L	230	DT1ARY10842N	307
DS4LC2BLL60L	227	DS4LC2CSL66L	229	DS4LC2DVL72L	230	DT1ARY10848N	307
DS4LC2BLL66L	227	DS4LC2CSL72L	229	DS4LC2DVV30L	234	DT1ARY12042N	307
DS4LC2BLL72L	227	DS4LC2CSV30L	233	DS4LC2DVV36L	234	DT1ARY12048N	307
DS4LC2BLV30L	231	DS4LC2CSV36L	233	DS4LC2DVV42L	234	DT1ARY13242N	307
DS4LC2BLV36L	231	DS4LC2CSV42L	233	DS4LC2DVV48L	234	DT1ARY13248N	307
DS4LC2BLV42L	231	DS4LC2CSV48L	233	DS4LC2DVV54L	234	DT1ARY14442N	307
DS4LC2BLV48L	231	DS4LC2CSV54L	233	DS4LC2DVV60L	234	DT1ARY14448N	307
DS4LC2BLV54L	231	DS4LC2CSV60L	233	DS4LC2DVV66L	234	DT1ARY6024NS	293
DS4LC2BLV60L	231	DS4LC2CSV66L	233	DS4LC2DVV72L	234	DT1ARY6030NS	293
DS4LC2BLV66L	231	DS4LC2CSV72L	233	DSCSWDB24	203	DT1ARY6036N	294
DS4LC2BLV72L	231	DS4LC2CVL30L	229	DSCSWDB30	203	DT1ARY6624NS	293
DS4LC2BSL30L	227	DS4LC2CVL36L	229	DSCSWDB36	203	DT1ARY6630NS	293
DS4LC2BSL36L	227	DS4LC2CVL42L	229	DSCSWDB42	203	DT1ARY6636N	294
DS4LC2BSL42L	227	DS4LC2CVL48L	229	DSCSWDB48	203	DT1ARY7224NS	293
DS4LC2BSL48L	227	DS4LC2CVL54L	229	DT1ABY10242N	309	DT1ARY7230NS	293
DS4LC2BSL54L	227	DS4LC2CVL60L	229	DT1ABY10248N	309	DT1ARY7236N	294
DS4LC2BSL60L	227	DS4LC2CVL66L	229	DT1ABY10842N	309	DT1ARY7824NS	293
DS4LC2BSL66L	227	DS4LC2CVL72L	229	DT1ABY10848N	309	DT1ARY7830NS	293
DS4LC2BSL72L	227	DS4LC2CVV30L	233	DT1ABY12042N	309	DT1ARY7836N	294
DS4LC2BSV30L	231	DS4LC2CVV36L	233	DT1ABY12048N	309	DT1ARY8424NS	293
DS4LC2BSV36L	231	DS4LC2CVV42L	233	DT1ABY13242N	309	DT1ARY8430NS	293
DS4LC2BSV42L	231	DS4LC2CVV48L	233	DT1ABY13248N	309	DT1ARY8436N	294
DS4LC2BSV48L	231	DS4LC2CVV54L	233	DT1ABY14442N	309	DT1ARY8442N	294
DS4LC2BSV54L	231	DS4LC2CVV60L	233	DT1ABY14448N	309	DT1ARY9024NS	293
DS4LC2BSV60L	231	DS4LC2CVV66L	233	DT1ACX30	302	DT1ARY9030NS	293
DS4LC2BSV66L	231	DS4LC2CVV72L	233	DT1ACX3017	302	DT1ARY9036N	294
DS4LC2BSV72L	231	DS4LC2DLL30L	230	DT1ACX3021	302	DT1ARY9042N	294
DS4LC2BVL30L	228	DS4LC2DLL36L	230	DT1ACX3036	302	DT1ARY9624NS	293
DS4LC2BVL36L	228	DS4LC2DLL42L	230	DT1ACX3042	302	DT1ARY9630NS	293
DS4LC2BVL42L	228	DS4LC2DLL48L	230	DT1ACX36	302	DT1ARY9636N	294
DS4LC2BVL48L	228	DS4LC2DLL54L	230	DT1ACX3617	302	DT1ARY9642N	294
DS4LC2BVL54L	228	DS4LC2DLL60L	230	DT1ACX3621	302	DT1ASX3030	301
DS4LC2BVL60L	228	DS4LC2DLL66L	230	DT1ACX3636	302	DT1ASX303017	301

<i>pattern no.</i>	<i>page</i>	<i>pattern no.</i>	<i>page</i>
DT1ASX303021	301	DT1CRY6624N	297
DT1ASX303036	301	DT1CRY6630N	297
DT1ASX303042	301	DT1CRY6636N	297
DT1ASX3636	301	DT1CRY7224N	297
DT1ASX363617	301	DT1CRY7230N	297
DT1ASX363621	301	DT1CRY7236N	297
DT1ASX363636	301	DT1CRY7824N	297
DT1ASX363642	301	DT1CRY7830N	297
DT1ASX4242	301	DT1CRY7836N	297
DT1ASX424217	301	DT1CRY8424N	297
DT1ASX424221	301	DT1CRY8430N	297
DT1ASX424236	301	DT1CRY8436N	297
DT1ASX424242	301	DT1CRY9024N	297
DT1ASX4848	301	DT1CRY9030N	297
DT1ASX484817	301	DT1CRY9036N	297
DT1ASX484821	301	DT1CRY9624N	297
DT1ATY10236N	308	DT1CRY9630N	297
DT1ATY10242N	308	DT1CRY9636N	297
DT1ATY10248N	308	DT1CTY6024N	298
DT1ATY10836N	308	DT1CTY6030N	298
DT1ATY10842N	308	DT1CTY6036N	298
DT1ATY10848N	308	DT1CTY6624N	298
DT1ATY12042N	308	DT1CTY6630N	298
DT1ATY12048N	308	DT1CTY6636N	298
DT1ATY13242N	308	DT1CTY7224N	298
DT1ATY13248N	308	DT1CTY7230N	298
DT1ATY14442N	308	DT1CTY7236N	298
DT1ATY14448N	308	DT1CTY7824N	298
DT1ATY6024NS	295	DT1CTY7830N	298
DT1ATY6030NS	295	DT1CTY7836N	298
DT1ATY6036N	296	DT1CTY8424N	298
DT1ATY6624NS	295	DT1CTY8430N	298
DT1ATY6630NS	295	DT1CTY8436N	298
DT1ATY6636N	296	DT1CTY9024N	298
DT1ATY7224NS	295	DT1CTY9030N	298
DT1ATY7230NS	295	DT1CTY9036N	298
DT1ATY7236N	296	DT1CTY9624N	298
DT1ATY7824NS	295	DT1CTY9630N	298
DT1ATY7830NS	295	DT1CTY9636N	298
DT1ATY7836N	296	DT1S	305
DT1ATY8424NS	295	RO1 DPB	204
DT1ATY8430NS	295	RS1 DPB	204
DT1ATY8436N	296		
DT1ATY8442N	296		
DT1ATY9024NS	295		
DT1ATY9030NS	295		
DT1ATY9036N	296		
DT1ATY9042N	296		
DT1ATY9624NS	295		
DT1ATY9630NS	295		
DT1ATY9636N	296		
DT1ATY9642N	296		
DT1BXL	305		
DT1BXL17	305		
DT1BXL21	305		
DT1BXL36	305		
DT1BXL42	305		
DT1BXS	305		
DT1BXS17	305		
DT1BXS21	305		
DT1BXS36	305		
DT1BXS42	305		
DT1CRY6024N	297		
DT1CRY6030N	297		
DT1CRY6036N	297		

Selling Policy

	<p>This Selling Policy supercedes all previous selling policies. Prices, discounts and product offerings are subject to change without notice.</p>
Terms & Conditions of Sales	<p>Sales by Knoll, Inc. or Knoll North America Corp. ("Seller") of Knoll Product Lines (hereinafter "Products") within the United States and Canada are made only on the terms which are contained in this Selling Policy. Seller hereby gives notice of its objection to any different or additional terms and conditions. This sale is expressly conditional upon Purchaser's assent to the terms and conditions set forth below. Additional terms and conditions may apply to KnollStudio and KnollTextiles orders. These terms and conditions may be modified or supplemented only by a written document signed by an authorized representative of Seller. These terms and conditions supercede any prior and/or contemporaneous agreements or correspondence between Purchaser and Seller. Written quotations expire thirty (30) days from the date of issuance and can be withdrawn by written notice anytime during that period. Where Purchaser and Seller have entered into the Knoll Electronic Terms and Conditions, all orders, acknowledgements, invoices and other business communications placed or transmitted in accordance with the Knoll Electronic Terms and Conditions shall be deemed to be in writing and signed and shall be valid for all purposes as if they were originated and maintained in documentary form.</p>
Ordering Information	<p>All orders must be in writing. The product pattern number(s) contained on Seller's order acknowledgement shall be the final expression of the order.</p>
Order Confirmation	<p>A purchase order is not binding on Seller until Purchaser has received Seller's order confirmation or acknowledgment.</p>
Pricing Policies	<p>List prices are subject to change without notice.</p> <p>List prices shall be those prices in effect on the date of receipt of a complete purchase order unless shipment is requested more than ninety (90) days after order entry in which case prices in effect on the date of shipment apply. List prices include specified freight costs. Unless specified in writing by Seller, no other charges are included in Seller's list prices.</p>
Taxes	<p>All sales, use, excise and other taxes applicable to the sale of the Products shall be paid by Purchaser. If Purchaser claims an exemption from any tax, Purchaser shall submit to Seller the appropriate exemption certificates.</p>
Terms of Payment	<p>Payment for one hundred percent (100%) of the net order amount is due within thirty (30) days of the date of invoice, which is issued upon shipment. In case of any discrepancies, such as shortages, and Seller is notified in writing within ten (10) days of receipt of Product, only that portion may be deducted and the balance paid. For orders greater than \$100,000 net, a fifty percent (50%) deposit is due at the time of order placement, with the remainder due within thirty (30) days of the date of invoice.</p> <p>KnollStudio orders less than \$2,000 require payment for one hundred percent (100%) of the net order amount (including any applicable sales tax and charges for inside delivery, special packaging, etc.), due at time of order placement. For KnollStudio orders greater than \$2,000, a one-half (50%) deposit is due at time of order placement with the remainder (including any applicable sales tax and charges for inside delivery, special packaging, etc.) due prior to shipment.</p> <p>If, in the judgment of Seller, Purchaser's financial condition does not justify the terms of the payment, Seller may require full or partial payment in advance.</p> <p>Past due accounts shall be charged one and one-half percent (1.5%) per month, or the highest rate permitted by law, whichever is less, and will be added to the outstanding balance. In the event Purchaser defaults on payment, Purchaser shall be liable for all collection costs, including reasonable attorney's fees and costs.</p>
Changes and Cancellation	<p>Purchase orders may not be changed or cancelled, in whole or in part, without prior written consent of Seller. Changes may effect delivery dates. Expenses incurred because of changes shall be charged to Purchaser. In the event of cancellations, Purchaser will be liable for reasonable cancellation charges established by Seller. Orders for special Product, orders including "COM" (hereinafter defined) material and orders pursuant to expedited delivery programs, may not be canceled.</p>
Freight Prepaid	<p>Freight is prepaid and included in the price of all Products, except KnollTextiles, within the 48 contiguous United States for orders placed with Knoll, Inc. and within Canada, excluding the Yukon, Northwest Territories, Nunavut and Newfoundland for orders placed with Knoll North America Corp. Packing is tested for rigorous motion and transportation but is not guaranteed to protect furniture from conditions over which the Seller has no control. If special packaging is required for any reason, please consult with your sales representative or dealer. Seller shall select the method of shipment and routing. All shipments shall be tailgate deliveries. Freight for all KnollTextiles orders is prepaid and added to the invoice.</p>
Delivery/Freight Charges	<p>Shipments outside the contiguous 48 United States and Canada shall be shipped F.O.B. Origin.</p> <p>For shipments outside the contiguous United States and Canada, Purchaser is responsible for the cost of freight from point of embarkation, including any handling and transportation charges incidental to loading at the point of departure and unloading at the final destination.</p> <p>Conditions beyond the control of Seller, including weather, available facilities and traffic conditions, may affect exact time of delivery. Seller shall not be responsible for specific carrier delivery date or time unless it has made a specific delivery commitment, in writing.</p> <p>Nonstandard methods of shipment and/or additional services are available upon request. Purchaser will be billed for the differential cost of any special services in excess of standard surface carrier freight costs. Premium charges, at Purchaser's request, will be added for airfreight, exclusive use of vehicle and extra, export or special packaging. Accessorial charges will be added for inside delivery, extra labor, reconsignment and redelivery.</p> <p>Partial shipments may be made and invoiced by Seller.</p>
Claims	<p>All shipments for all Knoll Products within the contiguous United States and Canada are F.O.B. Origin. Risk of loss passes to Purchaser at time of delivery to carrier. Purchaser shall inspect all Products upon receipt and notify Seller within ten (10) working days after receipt of any damage or defects which are, or should be, apparent from an inspection of the Product and its packaging. Failure of Purchaser to make a claim against carrier or notify Seller during the ten (10) working day period shall constitute acceptance of the Products and waiver of any apparent defects, errors or shortages. Seller will agree to repair or replace Product damaged in shipment if Purchaser has notified Seller of freight damage within ten (10) working days after receipt and assigns its rights against the carrier.</p>
Seller's Security Interest	<p>Until Seller receives the full payment for the Product, Seller shall have a security interest in the Product. Purchaser agrees to perform all acts, including but not limited to the execution and filing of documentation, which may be necessary to perfect and assure the security interest of Seller.</p>
Returns	<p>The return of Products without a written authorization by Seller shall not be accepted. To receive authorization for Product return, please call Customer Service. All Products that are returned pursuant to a valid authorization shall be subject to a twenty-five percent (25%) of list restocking charge. Products not currently offered for sale by Seller (including COM) shall not be authorized for return. All returned Products must be unused, in original condition and in the original Seller packing cartons. No refund or credit shall be given for damaged Products.</p>
Held Orders/Storage	<p>If Purchaser requests that an order be held or delayed, prices and terms and conditions in effect at the time of shipment shall apply. If Purchaser requests a delay after the time when Seller can defer production, Purchaser will be invoiced for the Product, payable in accordance with standard terms, when the order is ready for shipment. Seller may transfer the Product to storage, in which case all expenses incurred in connection with storage, including demurrage, preparation for storage, storage charges and handling shall be payable by Purchaser upon submission of invoices by Seller. Risk of loss to the Product shall pass to the Purchaser upon delivery of the Product into storage.</p>

Selling Policy

Customer's Own Material	<p>A Purchaser who requests a fabric or other surface material not standard to Seller's line of Products ("COM") must submit samples of the requested material to Seller prior to entry of a purchaser order. Seller shall determine if the material is suitable to its manufacturing processes and meets any requirements of Underwriters Laboratories. If the COM is acceptable, Seller will then establish a price for using the COM or the Product in question. For a description of the procedures for submitting samples and testing, contact customer resources or your sales representative. Seller shall have no responsibility for the appearance, condition, performance, durability, colorfastness or any other physical attribute of the COM. Purchaser shall indemnify and hold Seller harmless for any damages, injuries or losses arising out of or related to use of the COM on the Product.</p>
Warranty	<p>Seller warrants to the original Purchaser only that the Products Seller manufactures and sells to Purchaser are free of defects in workmanship and materials, during the applicable warranty period set forth below.</p> <p>Warranty period set forth below is for 24-hour, 7 days a week, multi shift use.</p> <p>Should any failure to conform with this limited warranty appear to a Product listed below during the applicable warranty period from the date of shipment, Seller shall, upon prompt written notice, repair or replace, at its option and costs, the affected part or parts.</p> <p><i>Product and Period of Warranty</i></p> <p><i>Lifetime: AutoStrada, Calibre, Crinion Open Table, Currents, Dividends Horizon, Equity, Morrison, Reff laminate, Series 2 Storage, Template and other non-wood components (except cascade edge worksurfaces, operational parts, controls, electrical, Lighting, Series 2 Veneer Front Storage, special or custom products, see below)</i></p> <p><i>10 Years: AutoStrada, Crinion Open Table, Reff wood components, Series 2 Veneer Front Storage, Wood Casegoods (Magnusson, The Graham Collection) (except wood casegoods upholstered surfaces, see below), Interaction tables (except height adjustment mechanisms for Counterforce, crank-adjustable, and split-top tables and worksurfaces, see below), Reuter overheads, Reuter vertical storage, KnollExtra Sapper Monitor Arm Collection, Adjustable keyboard mechanisms and platforms, Communication Boards (except fabric board textiles, see below), Smokador collection (except leathers, see below), and Orchestra Universal Systems Accessories, Bulldog, Chadwick, Essentials Work Chairs, Generation by Knoll work chair, Life, Moment, RPM and Sapper seating structural and operational parts, controls, casters, pneumatic cylinders, seat and back suspension material (except seating upholstery, textiles and leathers, finishes and labor, see below). Labor to repair Generation by Knoll work chair.</i></p> <p><i>5 Years: Operational parts, controls, electrical, Lighting (except light ballasts, bulbs and power supply, see below), cascade edge worksurfaces, special or custom product, wood veneer products, Currents handcrank, Interaction Counterforce, Interaction crank-adjustable, and split-top mechanisms, KnollStudio, KnollExtra Wishbone and Zorro monitor supports, CPU storage and all universal storage drawers, Spark Series seating structural parts, (except seating upholstery, textiles, finishes and labor, see below).</i></p> <p><i>3 Years: Bulldog, Chadwick, Essentials Work Chairs, Life, Moment, RPM, Sapper seating upholstery, textiles and leathers, finishes and labor to repair, Generation by Knoll work chair seating upholstery, textiles and leathers, and finishes, Spark Series seating upholstery and textiles. Fabric boards textiles and Smokador Collection leathers.</i></p> <p><i>2 Years: All other KnollExtra product</i></p> <p><i>1 Year: Light ballasts, bulbs and power supply, seating upholstered arm pads and soft arm pads, Spark Series seating finishes and labor to repair, wood casegoods upholstered surfaces.</i></p> <p>This warranty does not apply to:</p> <ul style="list-style-type: none">• Damage caused by a carrier other than the Seller.• Normal wear and tear or acts or omissions of parties other than Seller (including user modification, improper use or installation of Products).• COM or other third party materials applied to Products.• Products not installed by or under the auspices of a Knoll Dealer.• Dramatic temperature variations or exposure to unusual conditions.• Except as specifically noted above, textiles and upholstery supplied by <i>KnollTextiles</i> (consult current <i>KnollTextiles</i> price list for applicable warranty). <p>Natural variations occurring in wood, marble, and leather shall not be considered defects, and the Seller does not guarantee the colorfastness or matching of the colors, grains or textures, or surface hardness of such materials. The Seller also does not guarantee the colorfastness of fiberglass panel surfaces.</p> <p>THE EXPRESS WARRANTIES CONTAINED HEREIN ARE IN LIEU OF ALL OTHER WARRANTIES, EXPRESS OR IMPLIED, INCLUDING ANY WARRANTIES OF MERCHANTABILITY AND FITNESS FOR PARTICULAR PURPOSE AND ALL OTHER WARRANTIES ARISING FROM COURSE OF DEALING OR USAGE OF TRADE.</p> <p>The remedies provided above are the Purchaser's sole remedies for any failure of Seller to comply with its obligations regarding the workmanship of its Products. Correction of any nonconformity in the manner and for the period of time provided shall constitute complete fulfillment of all liabilities of Seller, with respect to or arising out of the Product furnished hereunder.</p>
Delay/Force Majeure	<p>Seller shall not be liable for failure to perform or for delay in performance due to fire, flood, strike or other labor difficulty, act of God, act of any governmental authority or of the Purchaser, riot, embargo, fuel or energy shortage, wrecks or delay in transportation, inability to obtain necessary labor, materials or manufacturing facilities from usual sources or failure of suppliers to meet their contractual obligations, or due to any cause beyond its reasonable control. If any such event occurs, Seller may extend delivery dates by a period of time necessary to overcome the effect of such delay, allocate available Product or cancel any purchase order.</p>
Compliance with Law	<p>PURCHASER IS SOLELY RESPONSIBLE FOR COMPLIANCE WITH ALL APPLICABLE FEDERAL, STATE AND LOCAL LAWS, ORDINANCES, REGULATIONS, RULES AND STANDARDS RELATING TO THE INSTALLATION, MAINTENANCE, USE AND OPERATION OF THE PRODUCTS.</p>
Patents	<p>Subject to the following provisions, Seller shall, at its own expense, defend or, at its option, settle any claim, suit or proceeding brought against the Purchaser, and/or its vendees, mediate and immediate, so far as based on an allegation that any Product or any part thereof furnished hereunder constitutes a direct or a contributory infringement of any claim of any patent of the United States or Canada. This obligation shall be effective only if Purchaser shall have made all payments then due hereunder and if Seller is notified promptly in writing and given authority, information and assistance for the defense of said claim, suit or proceeding. Seller shall pay all damages and costs awarded in such suit or proceedings so defended.</p> <p>The foregoing indemnity does not apply to the following:</p> <ul style="list-style-type: none">• Products supplied according to a design other than that of Seller, and which is required by the Purchaser.• Combination of the Product with another product not furnished hereunder unless Seller is a contributory infringer.• Any settlements of a suit or proceeding made without Seller's written consent.
Limitations of Liability	<p>SELLER, ITS CONTRACTORS, AUTHORIZED DEALERS AND SUBCONTRACTORS OR SUPPLIERS OF ANY TIER SHALL NOT BE LIABLE TO PURCHASER FOR ANY SPECIAL, INDIRECT, INCIDENTAL OR CONSEQUENTIAL DAMAGES ARISING FROM A BREACH OF THIS AGREEMENT.</p> <p>Purchaser's remedies set forth herein are exclusive and the liability of Seller with respect to the breach of this agreement or any contract entered into between the parties pursuant hereto shall not exceed the price of the Product or part on which such liability is based.</p>

KnollKey Lock Program

KnollKey Lock Program General Information

Following is the KnollKey lock policy, applicable to all products.

Knoll furniture can be ordered keyed-alike or random keyed. Key-alike and random keying instructions cannot be mixed on any single order. Only one of the two instructions can be used on an individual order. When an order is submitted with mixed (key-alike and random) instructions, Knoll will release the order as key-alike only and lock cores will have to be specified separately.

Key-alike

For the convenience of the user, furniture may be keyed alike at no charge. Write "Key-alike" in the description of your purchase order for any pedestal, overhead, file or other item you wish to have keyed alike.

Using the key-alike instructions, order cores and keys as line items on your purchase order. Do NOT submit a key-alike form. The Knoll East Greenville Lock Center will select key numbers from the standard range of K 001 - K 250. Key numbers will not be repeated unless over 250 sets are ordered. Lock cores keyed-alike will ship separately from the product, ready for field installation.

There is no charge for key-alike orders if placed with the furniture order.

IF THE KEY-ALIKE ORDER IS NOT PLACED AT LEAST TWO WEEKS PRIOR TO THE FURNITURE SHIP DATE, A \$50 HANDLING CHARGE AND AIR FREIGHT CHARGES WILL APPLY.

If product is ordered and shipped random-keyed, additional lock cores for key-alike are billable.

Random-Keying

To specify product keyed-random, write "key-random" in the product description. Random-keyed product is shipped with the lock core factory installed. A shrouded key is included. Random means no effort has been made to match key numbers, or to make them different.

Keys

A Knoll shrouded key is shipped with every lock core. 250 Key numbers are available. For numbers above 250, contact Custom Product Development. Additional keys and key blanks are available. See service parts for more information.

Master Keying

Knoll locks can be controlled by means of a master key. There is no additional per-lock charge for master keying. A letter of approval from the client must accompany orders for master keys.

Installing Lock Cores

Lock cores can be installed or removed in the field by using a change key. Cores must be in the unlocked position to be removed. See service parts for change key pattern number and pricing.

Lock Distribution

All orders for key-alike lock cores/keys are packaged and shipped from the East Greenville Lock Center, regardless of where the pedestals, overhead, or other units are produced. Random keyed product will have cores factory-installed.

How to Specify Key-Alike

Following is an example of how to specify key-alike for a cluster of 10 workstations.

Step 1 - Using the project floorplan, count the number of locks in each workstation.

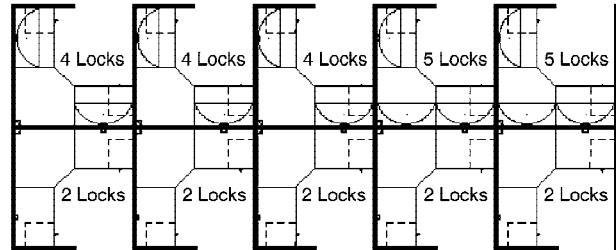

Step 2 - Count the number of workstations with the same quantity of locks. Group together the workstations with a like number of locks.

5 workstations with 2 locks per station
3 workstations with 4 locks per station
2 workstations with 5 locks per station

Step 3 - For the first group (5 sets of 2 locks), enter the number of workstations in the quantity column.

Qty	Pattern #	Description	Unit List	Ext. List
5				

Step 4 - Then enter the pattern number "KSPEC_ _" and add a suffix for the number of locks for that group (i.e., for 2 locks per station, add the suffix "2"). Up to 30 lock cores are available in a set (i.e., KSPEC 30).

Qty	Pattern #	Description	Unit List	Ext. List
5	KSPEC 2	Set of 2 cores/keys	N / C	N / C

Step 5 - Repeat for other groups.

Qty	Pattern #	Description	Unit List	Ext. List
5	KSPEC 2	Set of 2 cores/keys	N / C	N / C
3	KSPEC 4	Set of 4 cores/keys	N / C	N / C
2	KSPEC 5	Set of 5 cores/keys	N / C	N / C

Your Key instructions are complete.

Knoll will select key numbers for each set from 250 available numbers. Additional key numbers are available through Custom Product Development. **For additions to existing installations, specify desired key numbers in the description.**

Service Parts

Pattern #	Description	List Price
KKEY_ _ _	Shrouded Key Specify key number desired	\$5
KBLANK	Shrouded Key Blank	\$5
KSPECB_ _ _	Retrofit Universal Core/Key Specify key number desired	\$18
KCHANGE	Change Key	\$5
KMASTER*	Master Key	\$5

*Note: A letter of approval on company letterhead from the client must accompany all orders for master keys.

General Ordering Information

The Products

This guide encompasses all standard products for this product group.

Sizes

Dimensions listed in this guide are indicated as:

H = height

W = width

D = depth

Dia. = diameter

Rad. = radius

Pricing

All prices shown are list.

How to Order

Select pattern numbers and quantities required for your complete installation. Product questions can be addressed in the specific sections of this guide or by contacting your sales representative or customer resource representative at 1-800-343-5665.

Next, select options (if required), along with colors and finishes appropriate to each product. Reference the Finishes and Fabrics pages for color designations.

On large installations, an item's "designated area" can be specified to assist in product organization and handling.

To expedite complete / correct entry of your order, be certain all pattern numbers, quantities, colors and area identifications are completely specified. Also, include complete purchase order numbers, bill-to and ship-to addresses, a contact name and specific factory shipping dates required.

Mail all orders to:

Knoll, Inc.

1235 Water Street

P.O. Box 157

East Greenville, PA 18041

Attention: Order Entry

Once your order is entered at Knoll, an acknowledgment will be mailed to you. You will be advised of your scheduled shipping date within five days of the original acknowledgment. If it is necessary to revise your order, please contact your customer resource representative.

Sustainability Statement

Sustainable design is a key component of Knoll's environmental focus. Our commitment to social responsibility and a healthy environment has prompted us to further articulate our longstanding environmental programs and, with encouragement and support from our colleagues in the industry, we have re-energized our focus on such "green" initiatives as life cycle analysis and LEED™ certification. Knoll is proud to have contributed to projects that have received LEED certification from the U.S. Green Building Council.

For the latest information on Knoll products that help our customers achieve LEED certification, log on to knoll.com, click on "About Knoll" and then "Environmental Focus."