

AutoStrada

Price List
July 2015

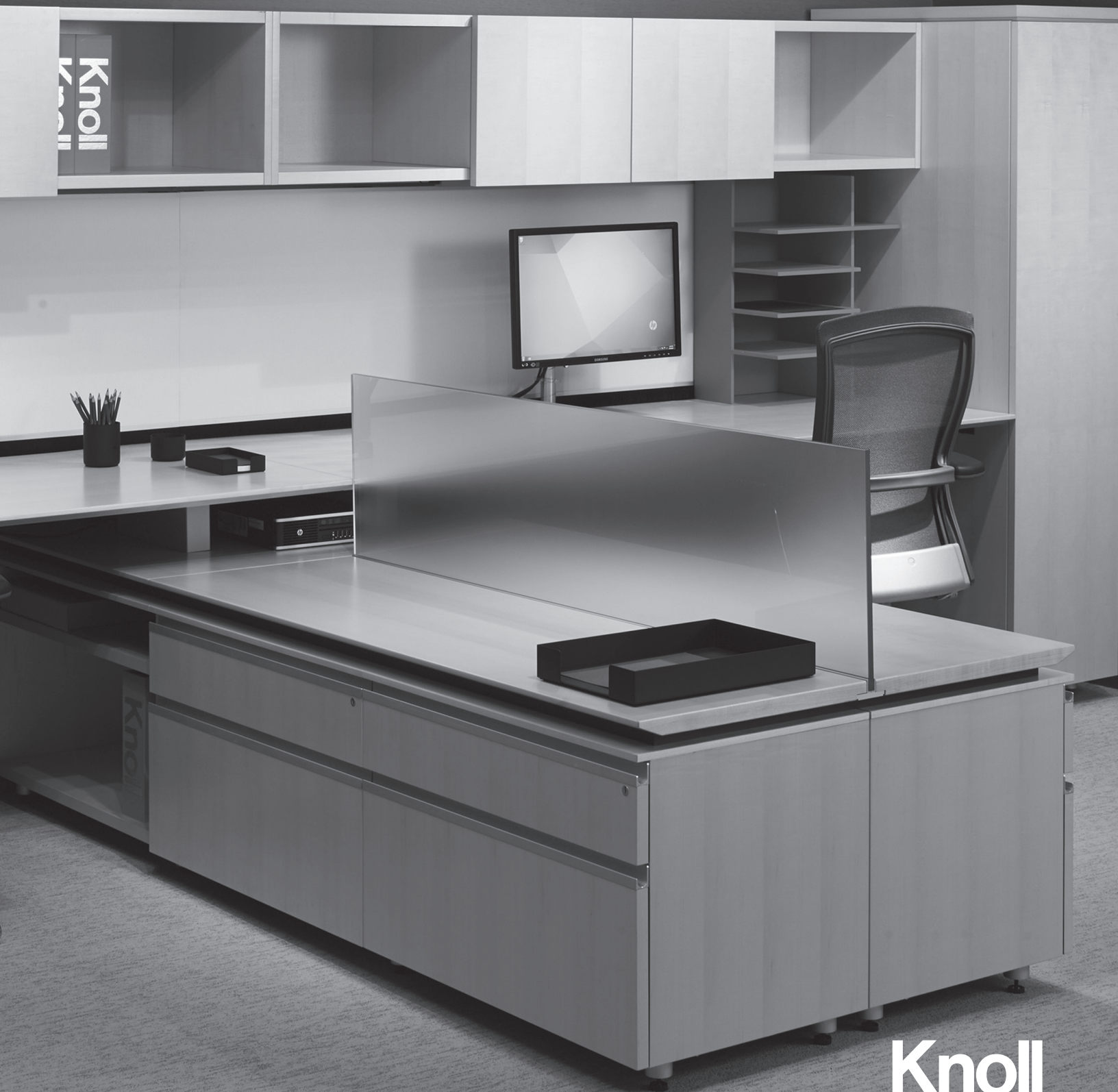

Knoll

Introduction	Knoll and Sustainable Design	4
	AutoStrada Basics	5
	AutoStrada Materials and Details	6
	AutoStrada Finishes	7
	AutoStrada Fabric Options	9
	AutoStrada Paint and Laminate Finishes Matrix	10
Applied Wall	Introduction	11
	Planning the applied wall system	12
	Specifying the applied wall system	13
	Applied wall frames	14
	Horizontal channels	15
	Wall trim and corners	20
	Wall covers	22
	Display shelves	36
	Glass shelves	37
	Bookshelves	38
	Open overhead cabinets	39
	Sliding door overhead cabinets with glass doors	40
	Sliding door overhead cabinets with laminate or veneer doors	41
	Hinged door overhead cabinets	42
	Overhead storage mounting kits	43
	Power and wire management	44
	Accessories	46
Spine and linkable screens	Service Wall frames	47
	Wall crown and base trim covers	48
	Structural base cover kits	51
	Access covers	53
	Spine ends and connectors	58
	End Starters	66
	Panel system starters and T-ends	70
	Power components, spine	78
	Add up glass panels, for spine	81
	Linkable screens and windows	82
	Gallery Screens	88
	Glass Gallery Screens	89
	Panels	Tiled/Monolithic - mono side only with base raceway
Mono/Mono - exterior hard side no raceway		96
Tiled/Monolithic - both sides with base raceway		100
Tiled one side/Slatwall combo other		106
Slatwall/Fabric combo both sides - both sides with base raceway		110
Frameless glass add-ups for panels		111
Glass Gallery Screens		113
Posts, panels		114
Trim, panels		126
Power distribution components for one side raceway panels		130
Power distribution components		131
AutoStrada Ported Panel Components		138

Medians	42" Medians with binder depth top shelf	142
	42" Medians with binder depth top shelf cont'd	143
	42" Medians with legal depth top shelf	144
	42" Medians with legal depth top shelf cont'd	145
	42" Medians with double end gable	146
	42" Medians with double end gable cont'd	147
	42" Median storage, binder depth	148
	42" Median storage, legal depth	149
	49" Medians with binder depth top shelf	150
	49" Medians with binder depth top shelf cont'd	151
	49" Medians with legal depth top shelf	152
	49" Medians with legal depth top shelf cont'd	153
	49" Medians with double end gable	154
	49" Medians with double end gable cont'd	155
	49" Median storage, binder depth	156
	49" Median storage, legal depth	157
	Bridges	42" Bridge units
49" Bridge units		159
Top shelves for bridges		160
Window kits for bridges		162
Cabinets	Storage Anchored Cabinets, w/BBF and FF configurations	163
	Storage Anchored Cabinets, with hinged door configurations	165
	Storage Anchored Cabinets, w/ Wardrobe and BBF	167
	Storage Anchored Cabinets, w/ Wardrobe and FF	168
	Storage Anchored Cabinets w/front and back access	169
	Storage Anchored Cabinets, front access	175
	Storage Anchored brackets	178
	Storage anchored cabinet trim	179
	Freestanding Cabinets for private office	180
	Freestanding Cabinets for open plan use with metal case pedestals	184
Lower Storage	Metal case	185
	Wood or laminate case	190
	Box shelf	199
Overhead Storage	Overhead storage, wood cases	200
	Reuter flat front overhead cabinet	219
	Reuter overhead cabinet mounting options	220
	Task Lights for Reuter Overhead Storage	221
	Task Lights	222
	Reuter T5 mounting kit	223
Worksurfaces	Credenza Top Glass Divider	225
	Flush, user edge tapered	226
	Cord drop, user edge tapered	229
	Rectilinear, user and approach edges tapered	232
	Rectilinear for C-Leg and T-Leg bases	234
	Wedge, user and approach edges tapered	235
	Peninsula, user and approach edges tapered	236
	Peninsulas	237
	Tables	243
	Open Frame Legs Infill Options	246
	Table desks	247
	Transaction tops	249
	Transaction Top Brackets	250
Support Components	Spine-based support	251
	Linkable screen mounted worksurface support	252
	Panel hung worksurface support	253
	Worksurface support	254
	Stiffeners	262
Accessories	Tackboard sections for medians and bridges	263
	Slatwall sections for medians and bridges	264
	Wall hung tackboards	265
	Worksurface stand-offs and cabinet feet	266

Elevations	Side Elevation	268	
Crinion Open Table	Introduction	270	
	Specifications	271	
	Crinion Open Table Finishes	272	
	Worksurfaces with center hinged power access	273	
	Worksurfaces with edge grommet	274	
	Worksurfaces with cord drop	275	
	End counters	276	
	Extended end counters	277	
	File tops	279	
	Complete base assemblies fixed height 24" D dual	280	
	Complete base assemblies fixed height 24" D single sided	281	
	Complete base assemblies fixed height 30" D dual	282	
	Complete base assemblies fixed height 30" D single sided	283	
	Complete base assemblies adjustable height 30" D dual	284	
	Complete base assemblies adjustable height 30" D single sided	285	
	Complete base assemblies fixed height 36" D dual	286	
	Complete base assemblies fixed height 36" D single sided	287	
	Complete base assemblies adjustable height 36" D dual	288	
	Complete base assemblies adjustable height 36" D single sided	289	
	Top channels	290	
	Beams for single sided or dual tables	291	
	Beams for dual tables	292	
	Beams for single sided tables	293	
	End legs, intermediate leg sets for dual tables	294	
	End legs, intermediate leg sets for single sided tables	296	
	End panels for dual tables and single sided tables, painted	297	
	End panels for dual tables and single sided tables, laminate and veneer	298	
	Beam trusses	299	
	Worksurface support	300	
	Modular Raceway	302	
	Hardwire Raceway	308	
	Cable tray and cable clips	309	
	Beam mounted cable trays and cable baskets	310	
	Center screens	311	
	Shelves, adapters and buttresses for slatwall screens	313	
	Side screens	314	
	Return screens	316	
	Dual end screens	318	
	Single sided end screen	320	
	Frameless glass Add up	322	
	Morrison Network privacy screens	323	
	Wall Mounting of Knoll Products		324
	Alpha-Numeric Index		326
Selling Policy		344	
KnollKey Lock Program		346	
General Ordering Information		347	

Knoll and Sustainable Design

Each year Knoll sets key initiatives in our journey to sustainability. We are members of a global consortium on energy, have adopted a scientific, metrics-based approach to sustainable product design, and maintain a leadership position in establishing universal, verifiable, sustainability standards for our industry.

Knoll promotes independent third-party certification because it provides the most impartial and trustworthy foundation for industry-wide environmental compliance. Certification by established and respected third parties ensures that all manufacturers are held to the same high standards and that customers can trust a company's declaration about the environmental benefits of its products. Knoll third-party partners include: the International Standards Organization (ISO); Forest Stewardship Council (FSC®); Rainforest Alliance; GREENGUARD® Environmental Institute; and The Business and Institutional Furniture Manufacturer's Association (BIFMA) level® certification from Scientific Certification Systems (SCS).

In addition, Knoll is aligned with the U.S. Green Building Council and can help companies, healthcare organizations and educational institutions achieve Leadership in Energy and Environmental Design (LEED®) workplace certification.

Global Climate Change

- Knoll is a sponsor of the Clinton Global Initiative, which brings together a community of global leaders to devise and implement solutions to some of the world's most pressing challenges, including environmental change.
- Knoll has a comprehensive Energy Management Program to increase energy efficiency in products and processes.

Life Cycle Assessment (LCA) Tool

- Life Cycle Assessment is a science-based measurement of a product's environmental impacts throughout its life cycle, from raw materials sourcing through manufacture, shipping, use and re-use or end-of-life. LCA enables cradle-to-cradle implementation of sustainable practices.
- Knoll has partnered with The Green Standard.org to develop an affordable, universal ISO-compliant computer-based LCA tool that can be used by the entire contract furniture industry and is partnering on the development of an Environmental Product Declaration System (EPDs) for Knoll products. EPDs are verified documents containing LCA results and additional environmental performance information about a product.

Setting Industry Standards

- Knoll partners with MTS (The Institute for Market Transformation to Sustainability) to develop the SMaRT® Consensus Sustainable Products Standards, a set of consensus-based sustainable product standards based on the LEED® model, for all building products, fabric, apparel, flooring and carpet. MTS, the developer of SMaRT®, is an accredited American National Standards Institute (ANSI) standard developer.
- Knoll also partners with BIFMA (Business and Institutional Furniture Manufacturers Association) to promote level® sustainability standards for the contract furniture industry.
- Knoll has established FSC® (Forest Stewardship Council) certified wood as the standard for general office open plan office systems, casegoods and tables.
- Knoll has launched Full Circle, a resource recovery program developed with ANEW, to help customers extend the life cycle of surplus furniture, fixtures and equipment (FF&E) in an economically, socially and environmentally responsible manner.
- Our goal is to encourage all manufacturers in the contract furniture industry and related industries to adopt standards that will lead to sustainable products and practices.

For more information about Knoll and sustainable design, visit knoll.com/environment.

Introduction

With a commitment to innovation and modern aesthetics, Knoll sets the standard for the environment in which people work. AutoStrada is one of the most comprehensive office concepts to be developed by Knoll. Evolving workplace needs are met with innovative design, from private offices to collaborative spaces for team interaction.

AutoStrada addresses any office combination with a consistent aesthetic of high quality materials and carefully detailed design. Whether an office requires a high-performance open plan system, refined architectural case goods, progressive private office furniture, or a collaborative “big table” concept, AutoStrada provides a solution.

AutoStrada is a planning approach that combines furniture and interior architecture for both open plan and private offices spaces.

AutoStrada is a premium, one-source design.

AutoStrada is the definition of the most advanced technology management capabilities.

AutoStrada is modern. It is absolute design with a strong, basic design premise.

The Planning Models

Four AutoStrada planning models offer one set of continuous, intelligent, solutions-oriented capabilities.

Four ways AutoStrada redefines space:

- Spine-based planning
- Storage-anchored planning
- Collaborative table-based planning
- Architectural office planning

Any one environment could include solutions provided by any mix or all of the four planning models. Diverse planning models meet cross-cultural workplace environments everywhere.

AS1 AutoStrada spine based planning

AutoStrada spine based planning provides wall-like architectural order to office interiors and offers high performance technological support. The spine supports continuous off-module attachment of workspaces, storage components, KnollExtra accessories, and perpendicular linkable screens or panels to define workstations. The spine also manages and distributes power and communications throughout clusters of workstations, enabling convenient outlets at desk height and unobstructed access to cabling.

Spines can be built to any one foot increment of length and can be freestanding with outriggers to support cantilevered workspaces and overhead storage. Spines may also be integrated with attached panels or screens for support and enclosure. T-ends enable the spine to extend to absorb the dimensional gain of attached panels.

Spine covers include veneer, laminate, dry-erase marker, tackable fabric, integral shelves, slat wall and integral cable tray surfaces. Spines are available in three horizons--39”H, 48”H and 64”H--and may be fitted with frameless glass add ups for additional privacy above any of four crown profiles.

Linkable screens are available in tackable upholstered or glazed panels and windows, with a complete range of connectors that also support workspaces and storage.

AS2 AutoStrada storage anchored planning

AutoStrada storage anchored planning redefines the open office architecture with aesthetic and functional alternatives to conventional panel-based systems. Storage anchored planning begins with the anchor cabinet to which either AutoStrada panels or wood or laminate surrounds are attached to create individual or shared work areas. Storage anchored planning combines the performance of systems furniture with elegant details more like custom millwork.

AutoStrada panels feature a laminate or veneer tiled grid to the floor, with aluminum reveals between tiles on the exterior, and fabric or fabric and slat wall surfaces on the inside of the workstation. Interior base raceway distributes power and communications throughout a cluster with outlets only on the inside of the panels. AutoStrada panel heights enable seated access (42”H), seated privacy (49”H) or standing privacy (64”H). Frameless glass add ups can be added to panels for additional privacy. Connectors support workspaces, overhead storage or shelves and KnollExtra paper management and technology support tools.

AutoStrada surrounds, in veneer or laminate surface, are ideal for raised floor environments and a visual alternative to panels. Median surrounds or median storage form the backbone to which bridges and anchor cabinets are attached. Medians include a back panel, one or two end gables, a counter surface and a workspace or shelves. Bridges include a back panel and workspace. AutoStrada surrounds typically describe workstation boundaries at a 49” horizon.

AS3 AutoStrada wall based planning

AutoStrada wall based planning integrates freestanding and wall supported storage, desks and tables to build distinctive workspaces in private offices and walled collaborative areas.

AutoStrada Applied Walls add systems performance to built walls, enabling various surface materials and off module support for shelves, overheads and workspaces. Applied wall is either 69”H or 84”H, in any 6” increment of width. Horizontal channels contain interchangeable inserts like veneer, marker surface, fabric, glass, slat wall or recessed covers, and accept brackets for a variety of accessories at any point. Wall frames transfer most of the supported load directly to the floor.

AutoStrada overheads and tackboards can also be directly attached to most built walls. Freestanding AutoStrada cabinets for private offices are available in 70” and 84” horizons.

AS4 AutoStrada collaborative planning

AutoStrada collaborative planning is based on the Crinion Open Table, which creates open shared workspaces for groups from two to ten or more at a continuous workspace “bench”. Designed to support teams of people Crinion Open Table is ideal for trading rooms, libraries and conference rooms.

Crinion Open Table offers a unique alternative to traditional workstations, with continuous cantilevered workspaces, unobstructed kneespace, convenient, capable power and communications distribution, and optional desktop privacy screens. An extremely strong structure supports workspaces up to 36”d each side and virtually unlimited in length.

Crinion Open Table may be complemented with AutoStrada metal or wood storage, or Calibre files and cabinets as parallel file banks or as returns.

Materials

AutoStrada offers a range of exceptional materials and finishes, including premium grade hardwood veneers, Techwood, laminate, clear anodized aluminum, and architectural glass.

Veneers are all hand selected to best showcase the beauty of natural grain. Every effort is made to ensure that Knoll veneers are the best that can be sourced in quality of color, consistency and size. Natural variations of wood are not considered to be defects. The natural process of color change in real wood products is part of the beauty and unique character of the material. Knoll expects wood to patina over time.

Techwood is a genuine wood veneer which has been enhanced by technology to provide color and grain consistency.

High recycled content aluminum is used in the manufacture of aluminum components.

High-pressure laminate surface materials have been selected for their durability and low maintenance.

FSC (Forest Stewardship Council) certified materials are available by request.

Construction details

All AutoStrada worksurfaces are 1 1/4" thick and are a 3 ply solid construction. Worksurfaces are available in rectilinear and wedge shapes. The distinctive 3/8" tapered edge can be specified on just the user side or also on the approach side. Worksurfaces can be specified "full depth" with or without grommets, or with a 3/8" cord drop along the back with a centered edge grommet.

Worksurfaces appear to "float" 1" above lower storage components. Pedestals and legs can support a worksurface height of 28 1/4"H (typically in open plan) or 29 5/8" (in private offices). The higher worksurface height requires wood pedestals equipped with cabinet feet.

Pedestals and overhead storage are available in either metal or wood case. Wood pedestals have full extension file drawer slides with bottom-loadable steel floor and 3/4 extension slides all wood construction box drawers.

Wood or laminate case cabinets with hinged doors and adjustable shelves require doors to be removed to adjust shelving; alternatively a special request 170° hinge package is available to retrofit cabinets in the field.

Metal pedestals and Reuter overhead storage cabinets with flat front are durable steel construction with painted, laminate or veneer drawer fronts.

Metal pedestals feature full width protruding aluminum pull. Metal pedestals have all full extension personal, data and file drawer slides.

Wood cases incorporate 3 ply construction and components are finished on all sides. Core material is 45lb density particleboard. Wood drawers feature dovetail joinery details. File drawers have steel floor and are bottom loadable. Wood drawers feature full width anodized aluminum recessed or protruding pull. File drawers include file bars to support letter or legal suspended filing in either direction.

Freestanding private office cabinets are supported by cylindrical extruded aluminum feet which match an optional worksurface standoff detail.

Spine, linkable screens, panels, legs and metal storage offer 1" or greater levelling capacity. Wood storage has 1/2" levelling.

Cable management

AutoStrada incorporates discreet and concealed wire management as well as four or six circuit power distribution in all four planning models, supporting low to very high technology requirements. Storage anchored surrounds, designed for raised floor environments, are the only planning type that does not have power distribution capability.

Leg design

AutoStrada support legs are a refined shape in clear anodized aluminum finish. Legs feature either lockable casters or a unique glide sleeve that allows leveling without exposed glide threads. A pair of straight legs or one 9" wide leg can support one end of a worksurface when the other end is spine-supported, panel-supported or joined to a perpendicular worksurface with AT2TB brackets. If distance between support spans over 48", additional support is required.

Two pairs of straight legs may also be specified to create a freestanding table in combination with an AutoStrada worksurface not to exceed 72" x 30" with a corresponding stiffener.

Locks

All pedestals and cabinets with drawers are supplied with a ganglock mechanism in place. In addition, cabinets 30" wide and over with drawers have an interlock anti-tip feature to prevent the opening of a second drawer when one is already open. Drawer fronts and door fronts where applicable are routed to receive the lock itself. Keying instructions for key alike must accompany all orders and are field installed. Products are shipped from the factory with random locks or lock plugs for key-alike orders.

Representative Dimensions

All dimensions in this price list are nominal and for representative purposes only. For specific build dimensions please consult specification planning tools or contact your Customer Service representative.

Line drawings in this price list are strictly for quick product identification.

Wood Finishes

V1 Techwood

Natural Edge	Synthetic Edge	Finish
Y316	S316	Maple
Y319	S319	Cherry
Y323	S323	Medium Walnut
Y326	S326	Dark Mahogany
Y329	S329	Medium Oak
Y342	S342	Medium Teak *
Y344	S344	Espresso
Y811	S811	Natural
Y821	S821	Blond Maple
Y831	S831	Light Cherry
Y851	S851	Black Oak
Y881	S881	Light Walnut
Y882	S882	Dove Grey *
Y883	S883	Pangar Wenge

V2 Natural Veneers / Premium Techwood

Natural Edge	Synthetic Edge	Finish
V312	R312	Bronze Cherry
V316	R316	Maple
V319	R319	Medium Cherry
V411	R411	Light Walnut
V412	R412	Natural Cherry
V413	R413	Sand Oak (Open pore)
V414	R414	Natural Oak
V415	R415	Peacock Green Walnut
V417	R417	Old English Walnut
V421	R421	Chalk Oak
V423	R423	Light Oak
V433	R433	Light Fawn Cherry
V436	R436	Medium Brown Cherry
V439	R439	Straight Anigre

V2 Natural Veneers / Premium Techwood (cont.)

Natural Edge	Synthetic Edge	Finish
V440	R440	Natural Hemlock (QC)
Y841	S841	Ebony (Open pore)*
Y861	S861	Grigio (Open pore)*
Y884	S884	White Pine (Open pore)*

V3 Premium Veneer

Natural Edge	Synthetic Edge	Finish
V512	R512	Figured Anigre
V514	R514	Makore
V515	R515	Figured Sycamore
V517	R517	Natural Sapele
V518	R518	Natural Chestnut

***Note:**

- Finishes with * are NOT available on Reff Optional Edges.
- All finishes shift in color over time, this natural aging process varies by material.
- Synthetic Edge option is available on worksurfaces, only.

Laminates

Core Laminate Surface / Edge

111	Jet Black
114	Folkstone Grey
115	Medium Grey
117	Soft Grey
118	Bright White
119	Pumice
121	Micro Grey *
122	Brushed Sand *
123	Brushed Grey *
128	Fog
129	Micro Sand *

*121, 122, 123, 129 Not available with matching edge option, and only available on worksurfaces.

*121, 122, 123, 129 Not available for Panel post covers, post caps, top trims, end trims.

LW Marker Board - Available for panels, Task panels and sliding display boards.

Note: All core Laminate worksurfaces are available with optional edge finish. (unless otherwise noted)
ie; A worksurface in 118, can have 139 edge finish.

Wood Grain Laminates Surface / Edge

124	Medium Chery
125	Natural Maple
126	Natural Cherry
127	Walnut
139	Light Ash
140	Warm Ash
141	Whitened Ash
142	Grey Ash
143	Classic Oak
144	Graphite Pear
145	Zebra

Wood Grain Laminates are NOT available on the following components:

- Storage with J Pull option
- Administrative and Reception products
- Worksurfaces with optional edge profiles
- Panel post covers, post caps, top trims, end trims and panels with beltway options

Impact Resistant Laminate

Core & Wood Grain Laminates Surface / Edge

911	Jet Black
914	Folkstone Grey
917	Soft Grey
918	Bright White
919	Pumice
924	Medium Cherry
925	Natural Maple
926	Natural Cherry
927	Walnut
928	Fog

Note: The Rules of Core and Wood grain Laminates, applies to the Impact Resistant Laminates.

*25% Upcharge applies to the laminate pricing for the Impact Resistant Laminates.

Important Note:

Wood grain direction depends on the width of the product.

For any vertical surface, ie; modesty panels, overheads and hutches, **up to 60"** wide, the grain direction will be **vertical**. For any vertical surface **greater than 60"** wide, the grain direction is **horizontal**.

up to 60" (vertical)



60" greater (horizontal)



Note: Pedestals and Cabinets with metal interior, when specified in "Wood Grain Laminate" or "Veneer", the shelves are painted black.

Mixed Finishes: For Laminate worksurfaces with Laminate or Veneer Edge Options, specify mixed finish worksurfaces using separate top finish & edge finish.

For Example:

Top finish: 114 Folkstone Grey Laminate

Edge finish: 115 Medium Grey Laminate, or Y882 Dove Grey Techwood

Paint

P1

111 Jet Black
 112 Brown
 113 Dark Grey
 114 Folkstone Grey
 115 Medium Grey
 116 Sandstone
 117 Soft Grey
 118 Bright White

Forbo

851 Biscuit
 852 Sky Blue
 853 Stone
 854 Cinnamon
 855 Heather Blue

P2

611 Beige Mist Metallic
 612 Medium Metallic Grey

P3

613 Silver

Anodized

AA Anodized Aluminum

Plated

PT Brushed Pewter

G1

Glass

TEMP Clear Tempered

G2

Architectural Glass

GL6 Block Matrix
 GL13 Powder

G3

Back Painted Glass 4mm

GL11 Back Painted Black
 GL14 Folkstone Grey
 GL15 Back Painted Medium Grey
 GL17 Back Painted Soft Grey
 GL18 Back Painted White

Colored Glass

GL25 Bronze
 GL35 Grey

Fabric Options*Grade 10*

Annex (W1360) ●
 Broadcloth II (W1619)
 Circuit (W1754)
 Element (W1077) ●
 Foundation (W351)
 Growth Spurt (W692)
 Pivot (W1926)
 Skylark (W1718)
 Symbolic Detail (W693)
 Tailor made II (W1610)
 Twister (W1923)
 Versatility (W432)

Grade 20

Bauhaus Block (W296A)
 Circle Line (W1146)
 Criss Cross (W305)
 Logic (W1318)
 Neamtic II (W1620)
 Photon II (W1695)
 Reflect (W884) ∅
 Resolution (W280)
 Weave Three (W298)

Grade 30

Basket Draft (W249)
 Flow (W565)
 Harmony (W232)
 Interknit (W1090)
 Match Point (W1145)
 Micro (W465)*
 Relay (W1020) ▲

Grade 40

Amplify (W1215) ●
 Bandwidth (W1219) ●
 Clarkson (W1218)
 Ornament (W1078)
 Palladium (W1030)

Grade 45

Monarch (K1149) - (not available on Linkable Screens)

Grade 50

Presto (K1000) ●
 Trophy (K1709) ●
 versa (K1698)

Grade 55

Ransom (K1298) ●
 Transition (W816)

**with backing only*

▲ Monolithic panels, linkable screens and tackboards only

● Linkable screens and add ups only

∅ May not be available in all colors.

Customers Own Material

Prices for panels that are to be manufactured with a customer supplied fabric will follow Grade 10 panel pricing. Customer's Own Material is subject to an application testing fee of \$750 per fabric and a \$2500 fee for UL testing. Panels bearing COM fabrics are subject to extended leadtimes. It is the responsibility of the customer's purchasing agent to ensure COM fabric is supplied for testing and manufacturing. Delays in receiving COM fabric for manufacturing will result in rescheduled delivery dates.

Fabric Options For Cushions

♣ = Cal 133 Pre-approved

A

Alignment (K349) ♣
 Basket Draft (W249)
 Beacon (W1597)
 Bocce (K1255) ♣
 Cats Cradle (K1290) ♣
 Chance (K1552)
 Common Ground (K448) ♣
 Distri (K872)
 Hourglass (K1523)
 Mariner (K642)
 Monarch (K1149) ♣
 Prep (K1076) ♣
 Presto (K1000) ♣
 Reflect (W884)
 Soliloquy (K1458)
 Sonnet (K1460) ♣
 Stacks (K528)
 Trophy (K1709) ♣

B

Abacus (K715) ♣
 Bank Shot (K134) ♣
 Belize (K1165)
 Bistro (K1775)
 Boundary (K1828)
 Cameo (K1443)
 Chroma (K345) ♣

B cont.

Chronicle (K1525) ♣
 Close Knit (K201)
 Dovetail (K1150) ♣
 Ferry (K1697)
 Framework (K1447) ♣
 Keaton (K1596)
 Gala II (K1520) ♣
 Grande (K180)
 Grandview (K1463)
 Knoll Felt (K1207) ♣
 Knoll Hopsack (K1206) ♣
 Lyric (K698)
 Mini Stitch (K1130) ♣
 Night Life (K181)
 Nonchalant CR (HC198)
 Paradigm (K1101)
 Pogo (K1100) ♣
 Pop (K782)
 Prairie (K1925)
 Prim (K1884)
 Ransom (K1298) ♣
 Ricochet (K498) ♣
 Roam (K1657)
 Spark (K1075) ♣
 Spotlight (K772)
 Sutton (K1750) ♣
 Utmost (K1325)

B cont.

Venue (K1558)
 Wide Angle (K244) ♣
 Zephyr (K724)
 Zipline (K1448) ♣

C

Atlas (K1236)
 Baxter (K1557)
 Biota (K1297) ♣
 Charm (K1049)
 Circa (K1054)
 Classic Boucle (K162) ♣
 Cricket (HC1279)
 Dahlia CR (HC1660)
 Durand (K1885)
 Earthwork (K1238) ♣
 Echo (K1019)
 Empire Stripe (K1025)
 Enmesh (K1092) ♣
 Entourage (K1389)
 Fable CR (HC1122)
 Fibra (K1105)
 Fox Trot CR (HC777)
 Greenwich (K1753)
 Highline CR (HC1064)
 Hudson (K1765)
 Hula Hoop (K753)
 Kora CR (HC1010)
 Legend CR (W432)

C cont.

Lore CR (HC1123)
 Metro (K1018)
 Milestone (K1886)
 Moto CR (HC1002)
 Noble (K1556)
 Panache CR (HC1047)
 Parasol (HC1257)
 Pony Up (K1323) ♣
 Quark (K781)
 Regard CR (HC1063)
 Rio (K1164)
 Roundtrip (K1430) ♣
 Sahara (HC1269)
 Sandpiper CR (HC1258)
 Sequin CR (HC1009)
 Sinclair (K1555)
 Smart (K1268)
 Spectator (K1391) ♣
 Spot On (K1324)
 Star Struck (K1048)
 Stepping Stones (K346)
 Swing (K479)
 Tight Rope (K1798)
 Tower Grid (K1887)
 Transition (K816)
 Treble CR (HC1062)
 Vibe (K1029)
 Zari CR (HC1008)

D

Cavalier (K217)
 Compass CR (HC1183)
 Eclat Weave (K1104)
 Harrison (K1084)
 Hologram (K500)
 Masquerade (K806)
 Menagerie (K1322)
 Obi (K1175)
 Satellite (K503)
 Zoom (K113)

E

Cross Stitch (K1026) ♣
 Katazome (K1459)
 Kimono (K1174)
 Mamba (K549)
 Marquee (K1608)
 Sherman (K1789)
 Tryst (K1522)
 Whip (K1386)

F

Biscayne (K1771)
 Century (K1051)
 Coco (K1024)
 Cornaro (K1320)
 Cuddle Cloth (K231)
 Glider (K1717)
 Groove Line (K488)
 Icon (K1028)

F cont.

Intrigue (K1551)
 Jubilee (K1445)
 Kinship (K1465) ♣
 Mod Plaid (K1630)
 Rivington (K1080)
 Soon (K1787)
 Topography (K1052)
 Totem (K1561)
 Tweed Frieze (K754)

G

Gibson (K1086)
 Haze (K109)
 Kinabalu (K1800)
 Rattan (K138)
 Serendipity (K1528)
 Ultrasuede®(K1021) ♣
 Utrillo (K1807)

H

Arno (K128) ♣
 Haiku (K1479)

I

Dynamic (K1617)

	All standard Paint Finishes	AA or all paints except Silver	Laminate Horizontal Surfaces	Laminate Vertical Surfaces	Anodized Aluminum Only
AS1 Spine Based	standard crown covers	spine base trim covers	worksurfaces	structural base covers	
	structural base covers	slat wall covers	tables	access covers	
	outlet covers	integral shelves		fronts for metal pedestals	
	spine connectors	flat crown covers		fronts for Reuter overheads	
	metal pedestals and fronts	flat crown covers		box shelves	
	Reuter cases and fronts	straight legs			
		wide legs			
AS2 Storage Anchored	slat wall, panel	panel top trim	worksurfaces	all laminate pedestals	top trim wider than 96"
	panel raceway covers	panel reveals		anchor cabinets	
		storage reveals		medians	
		pulls		bridges	
				tiles, panels	
AS3 Applied Wall & private office components	wall covers	horizontal channels up to 96"	worksurfaces	all laminate overheads	horizontal channels wider than 96"
	coat hook	slat wall covers	tables	freestanding storage	
	picture hook	recess covers	applied wall shelves	wall hung overheads	
	bookends	end trim			
		cable tray			
		marker tray			
		display shelf			
AS4 Crinion Open Table	end legs	hinged access	worksurfaces, tapered edge and post formed		beams
	intermediate legs	top channel up to 96"			top channel longer than 96"
	cantilevers	screen frames			

Finish code	Finish name	Paint grade	All standard Paint Finishes	AA or all paints except Silver	Laminate Horizontal Surfaces	Laminate Vertical Surfaces	Anodized Aluminum Only
611	Beige Mist Metallic	P2	•	•			
118	Bright White	P1	•	•	•	•	
112	Brown	P1	•	•			
123	Brushed Grey				▲		
122	Brushed Sand				▲		
113	Dark Grey	P1	•	•			
128	Fog				•	•	
114	Folkstone Grey	P1	•	•	•	•	
111	Jet Black	P1	•	•	•	•	
115	Medium Grey	P1	•	•			
612	Medium Metallic Grey	P2	•	•			
121	Micro Grey				▲		
129	Micro Sand				▲		
119	Pumice				•	•	
116	Sandstone	P1	•	•			
613	Silver	P3	•				
117	Soft Grey	P1	•	•	•	•	
812	Easy Grey*						
813	Trim Grey*						
AA	Anodized Aluminum			•			•
LW	Markerboard White **						

Notes:

▲ All laminates have matching edge bands except:
 123 Brushed Grey has 128 Fog edge
 122 Brushed Sand has 119 Pumice edge
 121 Micro Grey has 114 Folkstone grey edge
 129 Micro Sand has 119 Pumice edge

* Easy Grey and Trim grey integral colors only available for
 Compact crown covers
 Linkable screen trim
 Linkable screen top caps
 Spine end connector top caps

** Markerboard white is available only on AS1 spine access covers, AS3 Applied Wall covers and AS4 screens.

Introduction

AutoStrada Applied Wall System is designed for systems performance in built wall environments. Applied Wall enables a variety of interchangeable wall surface materials, continuous support for worksurfaces, shelves and overhead storage, power distribution and integrated wire management. Applied Wall System supports AutoStrada components in private offices and collaborative work spaces, while transmitting much of the weight load directly to the floor.

Applied Wall System includes:

- wall mount frames which stand on leveling glides and are secured to built walls
- horizontal channels that are attached to the frames
- covers that insert between the channels
- shelves and overhead storage components that can be engaged anywhere along the channels
- cable tray, worksurface support brackets and accessories

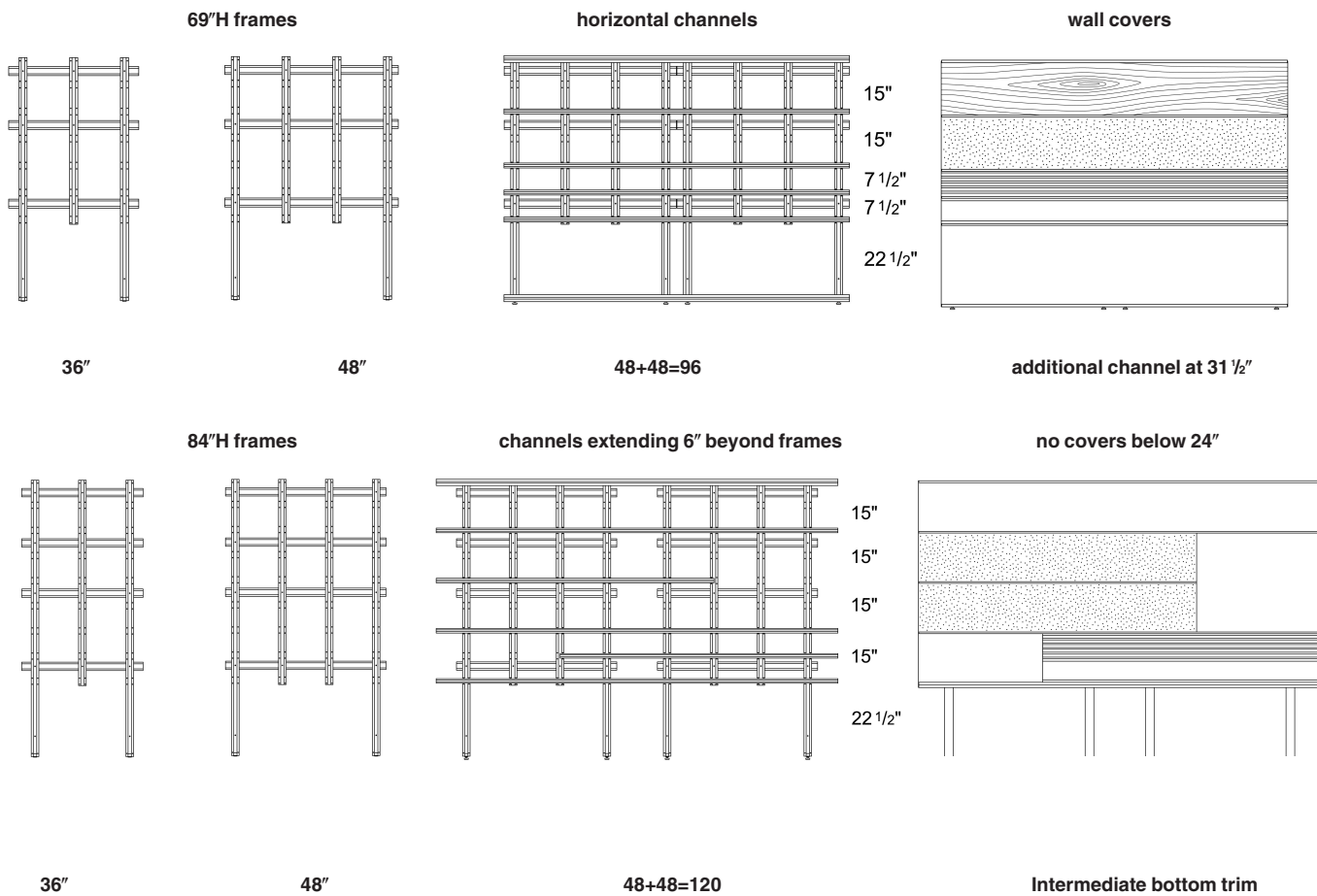

Frames

Wall mount frames are available in 69" and 84" horizons, 36" or 48" wide. Frames are steel weldments that include two or three horizontal rails through which frames are bolted to the vertical structure of the built wall. Adjacent frames can be leveled and shims enable each frame to be made plumb. At each side are vertical frame members with leveling glides. Between the side frame members are one or two intermediate studs that extend from approximately 24" above the floor to the top of the frame.

Channels

Channels are painted or natural anodized aluminum extrusions that hold covers and feature a continuous curved slot into which components and brackets are inserted. Channels are attached to the frames at each side member and stud with a bracket above and below. Channels do not need to align with frame widths and can extend up to 6" beyond the side of a frame.

Top channels, 36"-144" in width in 6" increments, attach only at the top of the frame and finish off the top of the assembly. Intermediate channels, 24"-144" in 6" increments of width, attach typically every 15" below the top channel, but may also be set at 7 1/2" or 22 1/2" increments to accommodate specific purpose covers such as slat wall or markerboards. Bottom channels, 36"-144" in 6" increments of width, attach only at the base of a wall frame to support covers below worksurface height (between 1 1/2" and 24" above the floor). If no covers are planned below 24" no bottom channel is required but intermediate bottom trim cover and vertical frame covers are recommended to enclose the structural frame.

Covers

Wall covers are designed to insert between channels and may be interchanged without removing channels. Covers are optional and not required behind overhead storage cabinets or below worksurface height, for example. The scope of wall covers includes:

- 7 1/2"H recess covers for surface-mounted plugmold and voice/data outlets, normally mounted just below worksurface height, with optional cable trays
- 7 1/2"H slat wall covers to support KnollExtra accessories
- 15" and 22 1/2"H tackable linoleum covers
- 7 1/2", 15", 22 1/2" and 30"H veneer, laminate, paint, fabric, tackable fabric covers
- 7 1/2", 15", 22 1/2", 30", 45" H marker.

All covers are available from 24"-96" in 6" increments of width except laminate and marker, 24"-72".

Components

- 5 1/2" deep display shelves in painted or clear anodized aluminum, 24"-72" wide in 6" increments
- 9" deep, 1/2" thick glass shelves and 12" deep plastic laminate or wood veneer bookshelves, 24"-72" wide, designed to align with the bottom of an adjacent cabinet,
- 9" deep glass and 12" deep plastic or veneer bookshelves to align with the top of an adjacent cabinet,
- open overhead storage units in plastic laminate or wood veneer, 18"-96" wide
- overhead storage units with solid or glass sliding doors, 42"-96" wide in 6" increments
- fully enclosed overhead storage units with hinged doors, 18"-96" wide,
- Reuter overhead storage, task lights and fascias for wood overhead storage,
- grommets for wall covers, surface mounted plugmold raceway and cable trays,
- support brackets for the back or end of a worksurface, and
- accessories such as coat hook, picture hook, marker tray, notepad, and horizontal/vertical wire manager clips.

Other cover sets

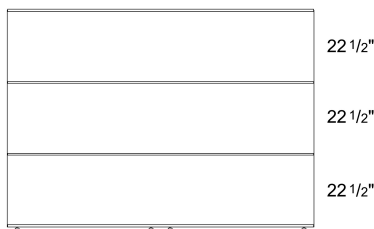

69" frames

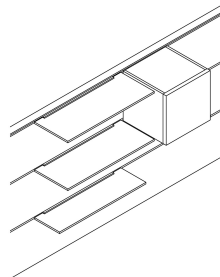

Upper shelf, lower shelf, glass shelf and overhead

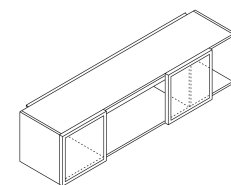

sliding doors

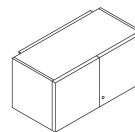

hinged doors

display wall with marker surface

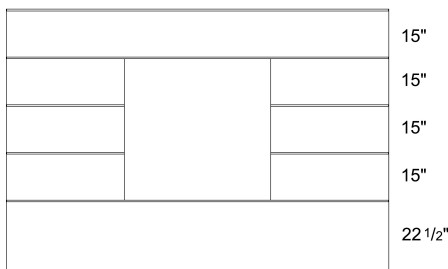

84" frames

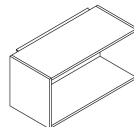

open overhead

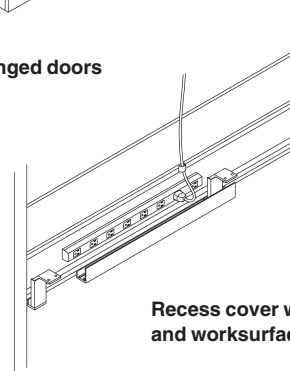

Recess cover with cable tray and worksurface brackets

How to specify Applied Wall

1. Plan frames to support the height and width of the intended overall wall system. Frames can be installed side-by-side or as much as 12" apart to provide adequate structure for horizontal channels up to 6" wider than the frame on each side. For example, a 10' length of channels and wall covers can be supported by three 36" wide frames or by two 48" wide frames.
2. Specify horizontal channels at each level required for covers and overhead storage or shelves. A top channel is always required and intermediate channels may be attached to the frame at any 7 1/2" increment above 24", 31 1/2", 39", 46 1/2", 54", 61 1/2", or 69" above the floor.
3. Typically intermediate channels are planned at 24", 39" and 54" to support 15"h covers. An additional channel at 31 1/2" will enable 7 1/2"h covers above and below worksurface height for slat wall and power/wire management. Horizontal channels can be planned the full width of the wall or may be segmented to allow taller covers such as a markerboard in specific locations. Alternatively intermediate channels may be planned at 24" and 46 1/2" on a 69"H frame to support all 22 1/2" H covers.
4. Specify bottom channel to support 22 1/2"H covers between floor and 24". Specify intermediate bottom trim and vertical frame covers if leaving the frame open below 24".
5. Specify end trim if end of wall is visible and specify corner connectors, if any.
6. Specify functional covers such as recess cover, the mounting location for surface mounted power distribution and voice/data outlets, and slat wall covers. Also specify tackable or marker surface covers. Then fill in the wall with decorative covers such as wood veneer, plastic laminate, non-tackable fabric, or backpainted glass. If planning a bookshelf the cover below the shelf cannot be glass. Covers are not required behind overhead storage cabinets.
7. Specify overhead storage: display shelves at 31 1/2" or 39", lower bookshelves at 54" and upper bookshelves at 69" to align with adjacent overhead storage cabinets. Specify open, partially open or fully enclosed overhead storage in veneer or laminate surface. Overhead storage cabinets usually hang from a channel at 69" and bear against a channel at 54" above the floor.
8. Specify power and cable trays. Power is distributed by a surface mounted plugmold raceway with ten simplex outlets, available in three configurations: one- circuit three-wire, two-circuit four wire, or two-circuit six wire. A 24" wide plugmold with eight simplex outlets is also available. Raceways are always hardwired to the building power supply by an electrical contractor. Contractor will punch a hole through the recess cover behind the plugmold to connect from the wall to the plugmold. Recess cover also accommodates voice/data outlets and cable grommets are available to line a punched hole.
9. Specify worksurface supports. Worksurface support brackets can be attached to the channel at 24" above the floor or may be attached within a cable tray at the same level.
10. Add accessories.

Customer's Responsibility:**Attachment of AutoStrada Applied Wall System to built walls**



It is the responsibility of the customer and their structural engineer/architect to verify that the permanent built wall (studs, blocks, solid masonry, or other) to which the Applied Wall System is intended to be attached is designed to support the load bearing standards set forth below. It is also the responsibility of the customer and their structural engineer/architect to specify the fasteners and method for attaching the frames to the built wall and confirm that the installers have followed these specifications. For local standards and additional requirements such as seismic the customer should consult local building and safety codes.

Design loads:

69"H Applied wall: 240#/foot of width. Assume four 60 lb. vertical loads spaced evenly between 24" and 69" above the floor, with the load centered 11" from the built wall.
 84"H Applied wall: 300#/foot of width. Assume five 60 lb. vertical loads spaced evenly between 24" and 84" above the floor, with the load centered 11" from the built wall.

Warning/Disclaimer

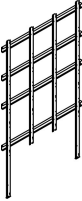
Knoll is not responsible for the attachment method of the Applied Wall System product, which is the responsibility of the customer and its structural engineer/architect. Knoll is not responsible for the cost of preparing an existing wall nor the additional cost for a new wall to make them appropriate for the installation of the Applied Wall System product. Failure to properly attach the Applied Wall System to a wall capable of supporting the loads listed above can lead to property damage and/or personal injury.

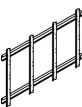
description	h	w	d	pattern number	black
69"H frames 	69"	36"	1 1/4"	AAWS F6936	\$559.
	69"	48"	1 1/4"	AAWS F6948	695.
84"H frames 	84"	36"	1 1/4"	AAWS F8436	627.
	84"	48"	1 1/4"	AAWS F8448	764.
22 1/2" add on frames 	22 1/2"	36"	1 1/4"	AAWS F2236	304.
	22 1/2"	48"	1 1/4"	AAWS F2248	354.
30" add on frames 	30"	36"	1 1/4"	AAWS F3036	334.
	30"	48"	1 1/4"	AAWS F3048	372.

Order Code

Example: AAWS F6936
A AutoStrada
AWS Applied wall system
F Wall frame
69 Height
36 Width

Specification Information

Applied wall frames are painted black

Application Notes

Wall frames attach to built walls to provide level, vertical structure for complete applied wall system assemblies. Wall frames include two leveling glides, studs on 14" centers, and horizontal beams.

Add on frames add 22 1/2" or 30" of height to 69" or 84" frames (or other add on frames). Add on frames include stacking hardware.

Knoll does not supply or recommend specific hardware to fasten frame to built wall.

Horizontal channels

Top channels

description	h	w	d	pattern number	painted	aluminum
Top channel 	1"	36"	1"	AAWS TC 036 ()	\$76.	\$76.
	1"	42"	1"	AAWS TC 042 ()	87.	87.
	1"	48"	1"	AAWS TC 048 ()	100.	100.
	1"	54"	1"	AAWS TC 054 ()	122.	122.
	1"	60"	1"	AAWS TC 060 ()	127.	127.
	1"	66"	1"	AAWS TC 066 ()	134.	134.
	1"	72"	1"	AAWS TC 072 ()	139.	139.
	1"	78"	1"	AAWS TC 078 ()	153.	153.
	1"	84"	1"	AAWS TC 084 ()	165.	165.
	1"	90"	1"	AAWS TC 090 ()	178.	178.
	1"	96"	1"	AAWS TC 096 ()	185.	185.
	1"	102"	1"	AAWS TC 102 ()	n/a	190.
	1"	108"	1"	AAWS TC 108 ()	n/a	203.
	1"	114"	1"	AAWS TC 114 ()	n/a	211.
	1"	120"	1"	AAWS TC 120 ()	n/a	216.
	1"	126"	1"	AAWS TC 126 ()	n/a	221.
	1"	132"	1"	AAWS TC 132 ()	n/a	241.
	1"	138"	1"	AAWS TC 138 ()	n/a	247.
	1"	144"	1"	AAWS TC 144 ()	n/a	252.

Order Code

Example:	AAWS TC 036 AA
A	AutoStrada
AWS	Applied wall system
TC	Top channel
036	Width
AA	Finish

Specification Information

AA- Anodized Aluminum.
 All standard painted finishes except 613 Silver also available for channels up to 96" wide.

Application Notes

Top channel attaches only at the top of wall frames to provide continuous slot for component support and retention for top of wall covers. Top channel encloses top of frames to within 1/4" of the built wall for cord passage.
 Specify top channel in length to match overall length of applied wall covers, or in shorter segments. Top channel can extend past wall frame up to 6" on each end.

Horizontal channels

Top Up channels

description	h	w	d	pattern number	painting	aluminum
Top Up channel	1"	36"	1"	AAWS TU 036 ()	\$183.	\$183.
	1"	42"	1"	AAWS TU 042 ()	214.	214.
	1"	48"	1"	AAWS TU 048 ()	243.	243.
	1"	54"	1"	AAWS TU 054 ()	292.	292.
	1"	60"	1"	AAWS TU 060 ()	304.	304.
	1"	66"	1"	AAWS TU 066 ()	317.	317.
	1"	72"	1"	AAWS TU 072 ()	328.	328.
	1"	78"	1"	AAWS TU 078 ()	339.	339.
	1"	84"	1"	AAWS TU 084 ()	549.	549.
	1"	90"	1"	AAWS TU 090 ()	549.	549.
	1"	96"	1"	AAWS TU 096 ()	549.	549.
	1"	102"	1"	AAWS TU 102 ()	n/a	577.
	1"	108"	1"	AAWS TU 108 ()	n/a	577.
	1"	114"	1"	AAWS TU 114 ()	n/a	577.
	1"	120"	1"	AAWS TU 120 ()	n/a	577.
	1"	126"	1"	AAWS TU 126 ()	n/a	592.
	1"	132"	1"	AAWS TU 132 ()	n/a	592.
	1"	138"	1"	AAWS TU 138 ()	n/a	592.
	1"	144"	1"	AAWS TU 144 ()	n/a	592.

Order Code	Specification Information	Application Notes
Example: AAWS TU 073 AA	AA- Anodized Aluminum.	Top Up channels are an alternative to top channels at the top of wall frames or add on frames.
A AutoStrada	All standard painted finishes except Silver also available for channels up to 96" wide.	Top Up channel enables covers to be mounted above the applied wall. Specify ceiling channel separately to retain top of covers mounted above frames.
AWS Applied wall system		Top Up channel provides continuous slot for component support, retains top of covers on frame and bottom of covers mounted above frame.
TU Top Up channel		Top Up channel encloses top of frames to within 1/4" of the built wall for cord passage. Specify Top Up channel in length to match overall length of applied wall covers, or in shorter segments. Top Up channel can extend past wall frame up to 6" on each end.
072 Width		
AA Finish		

Horizontal channels

Ceiling channels

description	h	w	d	pattern number	painting	aluminum
Ceiling channel	1"	36"	1"	AAWS CC 036 ()	\$153.	\$153.
	1"	42"	1"	AAWS CC 042 ()	171.	171.
	1"	48"	1"	AAWS CC 048 ()	189.	189.
	1"	54"	1"	AAWS CC 054 ()	207.	207.
	1"	60"	1"	AAWS CC 060 ()	226.	226.
	1"	66"	1"	AAWS CC 066 ()	243.	243.
	1"	72"	1"	AAWS CC 072 ()	261.	261.
	1"	78"	1"	AAWS CC 078 ()	292.	292.
	1"	84"	1"	AAWS CC 084 ()	426.	426.
	1"	90"	1"	AAWS CC 090 ()	426.	426.
	1"	96"	1"	AAWS CC 096 ()	426.	426.
	1"	102"	1"	AAWS CC 102 ()	n/a	451.
	1"	108"	1"	AAWS CC 108 ()	n/a	451.
	1"	114"	1"	AAWS CC 114 ()	n/a	451.
	1"	120"	1"	AAWS CC 120 ()	n/a	451.
	1"	126"	1"	AAWS CC 126 ()	n/a	476.
	1"	132"	1"	AAWS CC 132 ()	n/a	476.
	1"	138"	1"	AAWS CC 138 ()	n/a	476.
	1"	144"	1"	AAWS CC 144 ()	n/a	476.

Order Code

Example:	AAWS CC 036 AA
A	AutoStrada
AWS	Applied wall system
CC	Ceiling channel
036	Width
AA	Finish

Specification Information

AA- Anodized Aluminum.
 All standard painted finishes except Silver also available for channels up to 96" wide.

Application Notes

Ceiling channels are fastened directly to the building wall to retain the top of covers up to 30"H mounted above wall frames with Top Up channel.
 Ceiling channels do not accept brackets for applied wall storage, shelves or accessories.
 Specify ceiling channels in lengths to match overall width of covers mounted above frames or in shorter segments.

Knoll does not supply or recommend specific hardware for fastening ceiling channel to building wall.

Horizontal channels
Intermediate channels

description	h	w	d	pattern number	painted	aluminum
Intermediate channel 	1"	24"	1"	AAWS IC 024 ()	\$64.	\$64.
	1"	30"	1"	AAWS IC 030 ()	71.	71.
	1"	36"	1"	AAWS IC 036 ()	76.	76.
	1"	42"	1"	AAWS IC 042 ()	87.	87.
	1"	48"	1"	AAWS IC 048 ()	94.	94.
	1"	54"	1"	AAWS IC 054 ()	113.	113.
	1"	60"	1"	AAWS IC 060 ()	122.	122.
	1"	66"	1"	AAWS IC 066 ()	127.	127.
	1"	72"	1"	AAWS IC 072 ()	134.	134.
	1"	78"	1"	AAWS IC 078 ()	148.	148.
	1"	84"	1"	AAWS IC 084 ()	171.	171.
	1"	90"	1"	AAWS IC 090 ()	178.	178.
	1"	96"	1"	AAWS IC 096 ()	185.	185.
	1"	102"	1"	AAWS IC 102 ()	n/a	190.
	1"	108"	1"	AAWS IC 108 ()	n/a	195.
	1"	114"	1"	AAWS IC 114 ()	n/a	203.
	1"	120"	1"	AAWS IC 120 ()	n/a	216.
	1"	126"	1"	AAWS IC 126 ()	n/a	229.
	1"	132"	1"	AAWS IC 132 ()	n/a	241.
	1"	138"	1"	AAWS IC 138 ()	n/a	247.
1"	144"	1"	AAWS IC 144 ()	n/a	252.	

Order Code

Example: AAWS IC 024 AA
A AutoStrada
AWS Applied wall system
IC Intermediate channel
024 Width
AA Finish

Specification Information

AA- Anodized Aluminum or any painted finish except 613 silver. Painted finish is not available on channels wider than 96".

Application Notes

Intermediate channels attach to wall frames to provide continuous slot for component support and retention for top and bottom of wall covers. Horizontal channels attach to wall frames at predetermined mounting locations depending on what height covers and overhead storage are planned on wall surface: 24", 31 1/2", 39", 46 1/2", 54", 61 1/2", 69" above the floor.

Specify channels in length to match overall length of applied wall covers, or in shorter segments. Intermediate channels can extend past wall frame up to 6" on each end. Channels include mounting hardware to attach to wall frame studs.

Horizontal channels

Bottom channels

description	h	w	d	pattern number	painting	aluminum
Bottom channel	1"	36"	1"	AAWS BC 036 ()	\$64.	\$64.
	1"	42"	1"	AAWS BC 042 ()	71.	71.
	1"	48"	1"	AAWS BC 048 ()	76.	76.
	1"	54"	1"	AAWS BC 054 ()	87.	87.
	1"	60"	1"	AAWS BC 060 ()	94.	94.
	1"	66"	1"	AAWS BC 066 ()	100.	100.
	1"	72"	1"	AAWS BC 072 ()	107.	107.
	1"	78"	1"	AAWS BC 078 ()	113.	113.
	1"	84"	1"	AAWS BC 084 ()	127.	127.
	1"	90"	1"	AAWS BC 090 ()	134.	134.
	1"	96"	1"	AAWS BC 096 ()	139.	139.
	1"	102"	1"	AAWS BC 102 ()	n/a	148.
	1"	108"	1"	AAWS BC 108 ()	n/a	153.
	1"	114"	1"	AAWS BC 114 ()	n/a	158.
	1"	120"	1"	AAWS BC 120 ()	n/a	165.
	1"	126"	1"	AAWS BC 126 ()	n/a	171.
	1"	132"	1"	AAWS BC 132 ()	n/a	178.
	1"	138"	1"	AAWS BC 138 ()	n/a	185.
	1"	138"	1"	AAWS BC 144 ()	n/a	190.

Order Code

Example:	AAWS BC 036 AA
A	AutoStrada
AWS	Applied wall system
BC	Bottom channel
036	Width
AA	Finish

Specification Information

AA - Anodized Aluminum or any painted finish except 613 Silver.

Painted finish is not available on channels wider than 96".

Application Notes

Bottom channels attach to bottom of wall frames to retain bottom of wall covers planned below 24". Specify channels in length to match overall length of applied wall covers, or in shorter segments. Bottom channels can extend past wall frame up to 6" on each end.



Includes hardware.

Bottom channel is not required if no covers are planned below intermediate channel mounted at 24" above floor. Specify intermediate bottom trim and vertical frame covers to cover exposed studs at bottom of each wall frame.

Wall trim and corners

End trims, intermediate trim

AutoStrada

description	type	h	w	d	pattern no.	painting or easy grey	painting or aluminum
	69"H frame	69"	1/8"	2 1/4"	AAWS ET 69 ()		\$113.
	84"H frame	84"	1/8"	2 1/4"	AAWS ET 84 ()		153.
	69"H + 22" add on	91 1/2"	1/8"	2 1/4"	AAWS ET 91 ()		177.
	69"H + 30" add on	99"	1/8"	2 1/4"	AAWS ET 99 ()		189.
	84"H + 22" add on	106 1/2"	1/8"	2 1/4"	AAWS ET 106 ()		214.
	84"H + 30" add on	114"	1/8"	2 1/4"	AAWS ET 114 ()		226.
	Field Modifiable	144"	1/8"	2 1/4"	AAWS ET 144 ()		261.
Wall end trim for frames open below 24"	69"H frame, open base	69"	1/8"	2 1/4"	AAWS ETO 69 ()		87.
	84"H frame, open base	84"	1/8"	2 1/4"	AAWS ETO 84 ()		107.
Intermediate trim cover		1 1/8"	144"	3/4"	AAWS IBT ()	111.	
							
	Vertical frame covers (pair)		21"	2 1/2"	2"	AAWS VFC ()	49.
							

Order Code	Specification Information	Application
Example: AAWS ET 69 AA		
A AutoStrada	Intermediate bottom trim and Vertical frame covers are available in Easy Grey (812) or any standard painted finish except 613 Silver.	Wall end trim encloses exposed end of applied wall frame and add on frames. If no wall covers are planned below 24" datum specify corresponding wall end trims for open base: 48"h for 69" h frames or 63"h for 84" h frames.
AWS Applied wall system	All end trim inside and outside covers are available in AA anodized aluminum or any standard paint finish except 613 Silver.	If no covers are planned below 24" datum specify optional intermediate bottom trim, which may be cut on site to overall width of applied wall, and one pair of vertical frame covers to cover exposed studs of each wall frame.
ET End trim		
69 Width	All standard painted finishes except silver are also available for all end trims up to 91"H.	
AA Finish		

Wall trim and corners

Inside and outside corners

description	type	h	w	d	pattern no.	list	aluminum
Inside corner	69"H frame	69"	2 1/4"	2 1/4"	AAWSIL69 ()		\$153.
	84"H frame	84"	2 1/4"	2 1/4"	AAWSIL84 ()		195.
	69"H + 22 1/2" add on	91 1/2"	2 1/4"	2 1/4"	AAWSIL91 ()		268.
	69"H + 30" add on	99"	2 1/4"	2 1/4"	AAWSIL99 ()		268.
	84"H + 22 1/2" add on	106 1/2"	2 1/4"	2 1/4"	AAWSIL106 ()		268.
	84"H + 30" add on	114"	2 1/4"	2 1/4"	AAWSIL114 ()		268.
	Field Modifiable	144"	2 1/4"	2 1/4"	AAWSIL144 ()		268.
Inside corner for frames open below 24"	69"H frame, open base	48"	2 1/4"	2 1/4"	AAWSILO69 ()		122.
	84"H frame, open base	63"	2 1/4"	2 1/4"	AAWSILO84 ()		148.





Outside corner	69"H frame	69"	2 1/4"	2 1/4"	AAWSOL69 ()		241.
	84"H frame	84"	2 1/4"	2 1/4"	AAWSOL84 ()		304.
	69"H + 22 1/2"H add on	91 1/2"	2 1/4"	2 1/4"	AAWSOL91 ()		456.
	69"H + 30"H add on	99"	2 1/4"	2 1/4"	AAWSOL99 ()		456.
	84"H + 22 1/2"H add on	106 1/2"	2 1/4"	2 1/4"	AAWSOL106 ()		456.
	84"H + 30"H add on	114"	2 1/4"	2 1/4"	AAWSOL114 ()		456.
	Field modifiable	144"	2 1/4"	2 1/4"	AAWSOL144 ()		456.
Outside corner for frames open below 24"	69"H frame, open base	48"	2 1/4"	2 1/4"	AAWSOLO69 ()		178.
	84"H frame, open base	63"	2 1/4"	2 1/4"	AAWSOLO84 ()		221.



Order Code	Specification Information	Application Notes
Example: AAWS IL 69 AA	AA - Anodized Aluminum.	Inside corners and outside corners align and enclose the 90° junction of two wall frames or wall frames plus add on frames.
A AutoStrada	All standard painted finishes except silver are also available for all end trims up to 91"H.	Frames must match in height.
AWS Applied wall system		Inside and outside corners require 2 1/4" square planning footprint.
IL Inside corner		
69 Width		
AA Finish		

Wall covers

Recess surface

description	h	w	d	pattern no.	easy grey	or painted	aluminum	or painted
Recess cover 	7 1/2"	24"	3/4"	AAWS C0724 R ()				\$87.
	7 1/2"	30"	3/4"	AAWS C0730 R ()				100.
	7 1/2"	36"	3/4"	AAWS C0736 R ()				113.
	7 1/2"	42"	3/4"	AAWS C0742 R ()				127.
	7 1/2"	48"	3/4"	AAWS C0748 R ()				137.
	7 1/2"	54"	3/4"	AAWS C0754 R ()				159.
	7 1/2"	60"	3/4"	AAWS C0760 R ()				171.
	7 1/2"	66"	3/4"	AAWS C0766 R ()				183.
	7 1/2"	72"	3/4"	AAWS C0772 R ()				193.
	7 1/2"	78"	3/4"	AAWS C0778 R ()				205.
	7 1/2"	84"	3/4"	AAWS C0784 R ()				217.
	7 1/2"	90"	3/4"	AAWS C0790 R ()				240.
	7 1/2"	96"	3/4"	AAWS C0796 R ()				250.
Recess end trim (pair) 	6 1/2"	1/2"	3/4"	AAWS RET ()				34.

Order Code	Specification Information	Application
Example: AAWS C0724 R AA A AutoStrada AWS Applied wall system C Cover 07 Height 24 Width R Recess cover AA Finish	Recess covers are available in AA anodized aluminum or any standard painted finish except 613 Silver. Recess end trim is 812 Easy Grey or any standard painted finish except 613 Silver.	Recess covers provide mounting location for continuous, surface-mounted plugmold strip or voice/data outlets. Recess covers are typically mounted below or just above desk height (24"-35 1/2" above floor). Recess covers insert between intermediate channels and are secured in position with screws. Recess covers are extruded, clear anodized aluminum surface.

Recess cover should be at least 6" wider than 60" plugmold or 24" plugstrip to be mounted.

Recess end trim encloses the ends of a recess cover where it meets any other cover type.

Recess end trim kit includes one left hand and one right hand trim.

Recess end trim is not required where recess cover meets wall end trim, corner connector or another recess cover.

Wall covers

Slatwall surface

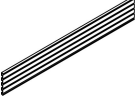
description	h	w	d	pattern no.	painting or aluminum
Slatwall cover	7 1/2"	24"	1/2"	AAWS C0724 S ()	\$100.
	7 1/2"	30"	1/2"	AAWS C0730 S ()	113.
	7 1/2"	36"	1/2"	AAWS C0736 S ()	127.
	7 1/2"	42"	1/2"	AAWS C0742 S ()	139.
	7 1/2"	48"	1/2"	AAWS C0748 S ()	153.
	7 1/2"	54"	1/2"	AAWS C0754 S ()	178.
	7 1/2"	60"	1/2"	AAWS C0760 S ()	190.
	7 1/2"	66"	1/2"	AAWS C0766 S ()	203.
	7 1/2"	72"	1/2"	AAWS C0772 S ()	216.
	7 1/2"	78"	1/2"	AAWS C0778 S ()	229.
	7 1/2"	84"	1/2"	AAWS C0784 S ()	241.
	7 1/2"	90"	1/2"	AAWS C0790 S ()	265.
	7 1/2"	96"	1/2"	AAWS C0796 S ()	279.

Order Code

Example:	AAWS C0724 S AA
A	AutoStrada
AWS	Applied wall system
C	Cover
07	Height
24	Width
S	Slatwall cover
AA	Finish

Specification Information

AA - Anodized Aluminum only.
Slatwall covers are available in AA anodized aluminum or any standard painted finish except 613 Silver.



Application

Slatwall covers provide four continuous, horizontal slots to accept a variety of KnollExtra paper management accessories and flat screen monitor arms. Slatwall covers are typically installed just above desk height (31 1/2 - 39" above floor).
Slatwall covers insert between intermediate channels and are secured in position with screws. Slatwall covers are extruded, clear anodized aluminum surface.

Slatwall covers will support flat panel monitor arms with varying weight limitations based on mounting and application. Please refer to the KnollExtra price list for comprehensive mounting and weight limitation information by application.

Wall covers

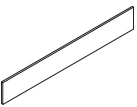
Marker surface

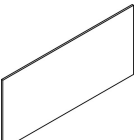
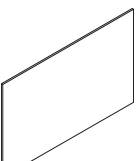
description	h	w	d	pattern no.	list
Marker cover, 7 1/2"H 	7 1/2"	24"	1/2"	AAWS C0724 M ()	\$76.
	7 1/2"	30"	1/2"	AAWS C0730 M ()	83.
	7 1/2"	36"	1/2"	AAWS C0736 M ()	88.
	7 1/2"	42"	1/2"	AAWS C0742 M ()	96.
	7 1/2"	48"	1/2"	AAWS C0748 M ()	100.
	7 1/2"	54"	1/2"	AAWS C0754 M ()	106.
	7 1/2"	60"	1/2"	AAWS C0760 M ()	111.
	7 1/2"	66"	1/2"	AAWS C0766 M ()	117.
Marker cover, 15"H 	15"	24"	1/2"	AAWS C1524 M ()	99.
	15"	30"	1/2"	AAWS C1530 M ()	110.
	15"	36"	1/2"	AAWS C1536 M ()	122.
	15"	42"	1/2"	AAWS C1542 M ()	131.
	15"	48"	1/2"	AAWS C1548 M ()	145.
	15"	54"	1/2"	AAWS C1554 M ()	157.
	15"	60"	1/2"	AAWS C1560 M ()	167.
	15"	66"	1/2"	AAWS C1566 M ()	178.
Marker cover, 22 1/2"H 	22 1/2"	24"	1/2"	AAWS C2224 M ()	124.
	22 1/2"	30"	1/2"	AAWS C2230 M ()	138.
	22 1/2"	36"	1/2"	AAWS C2236 M ()	161.
	22 1/2"	42"	1/2"	AAWS C2242 M ()	177.
	22 1/2"	48"	1/2"	AAWS C2248 M ()	191.
	22 1/2"	54"	1/2"	AAWS C2254 M ()	206.
	22 1/2"	60"	1/2"	AAWS C2260 M ()	240.
	22 1/2"	66"	1/2"	AAWS C2266 M ()	246.
Marker cover, 30"H 	30"	24"	1/2"	AAWS C3024 M ()	145.
	30"	30"	1/2"	AAWS C3030 M ()	167.
	30"	36"	1/2"	AAWS C3036 M ()	191.
	30"	42"	1/2"	AAWS C3042 M ()	212.
	30"	48"	1/2"	AAWS C3048 M ()	232.
	30"	54"	1/2"	AAWS C3054 M ()	255.
	30"	60"	1/2"	AAWS C3060 M ()	277.
	30"	66"	1/2"	AAWS C3066 M ()	295.
30"	72"	1/2"	AAWS C3072 M ()	316.	

Order Code	
Example: AAWS C0724 M LW	
A	AutoStrada
AWS	Applied wall system
C	Cover
07	Height
24	Width
M	Marker cover
LW	Finish

Specification Information
LW - Markerboard surface

Application
Markerboard cover is a white, dry-erase surface that fits flush with adjacent wall covers. Marker covers insert between channels set at the corresponding height differences.

Wall covers

Marker surface

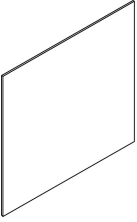
description	h	w	d	pattern no.	list
Marker cover, 45"H 	45"	24"	1/2"	AAWS C4524 M ()	\$192.
	45"	30"	1/2"	AAWS C4530 M ()	220.
	45"	36"	1/2"	AAWS C4536 M ()	268.
	45"	42"	1/2"	AAWS C4542 M ()	296.
	45"	48"	1/2"	AAWS C4548 M ()	326.
	45"	54"	1/2"	AAWS C4554 M ()	359.
	45"	60"	1/2"	AAWS C4560 M ()	384.
	45"	66"	1/2"	AAWS C4566 M ()	415.
	45"	72"	1/2"	AAWS C4572 M ()	446.

Order Code

Example:	AAWS C0724 M LW
A	AutoStrada
AWS	Applied wall system
C	Cover
07	Height
24	Width
M	Marker cover
LW	Finish

Specification Information

LW - Markerboard surface

Application

Markerboard cover is a white, dry-erase surface that fits flush with adjacent wall covers. Marker covers insert between channels set at the corresponding height differences.

Wall covers

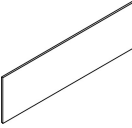
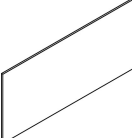

Tackable linoleum

description	h	w	d	pattern no.	list
Linoleum cover, 15"H 	15"	24"	1/2"	AAWS C1524 L ()	\$161.
	15"	30"	1/2"	AAWS C1530 L ()	192.
	15"	36"	1/2"	AAWS C1536 L ()	231.
	15"	42"	1/2"	AAWS C1542 L ()	260.
	15"	48"	1/2"	AAWS C1548 L ()	297.
	15"	54"	1/2"	AAWS C1554 L ()	334.
	15"	60"	1/2"	AAWS C1560 L ()	373.
	15"	66"	1/2"	AAWS C1566 L ()	405.
	15"	72"	1/2"	AAWS C1572 L ()	442.
	15"	78"	1/2"	AAWS C1578 L ()	479.
	15"	84"	1/2"	AAWS C1584 L ()	516.
	15"	90"	1/2"	AAWS C1590 L ()	545.
15"	96"	1/2"	AAWS C1596 L ()	583.	
Linoleum cover, 22 1/2"H 	22 1/2"	24"	1/2"	AAWS C2224 L ()	224.
	22 1/2"	30"	1/2"	AAWS C2230 L ()	272.
	22 1/2"	36"	1/2"	AAWS C2236 L ()	323.
	22 1/2"	42"	1/2"	AAWS C2242 L ()	373.
	22 1/2"	48"	1/2"	AAWS C2248 L ()	428.
	22 1/2"	54"	1/2"	AAWS C2254 L ()	484.
	22 1/2"	60"	1/2"	AAWS C2260 L ()	540.
	22 1/2"	66"	1/2"	AAWS C2266 L ()	583.
	22 1/2"	72"	1/2"	AAWS C2272 L ()	640.
	22 1/2"	78"	1/2"	AAWS C2278 L ()	690.
	22 1/2"	84"	1/2"	AAWS C2284 L ()	744.
	22 1/2"	90"	1/2"	AAWS C2290 L ()	795.
22 1/2"	96"	1/2"	AAWS C2296 L ()	857.	

Order Code	Specification Information	Application
Example: AAWS C0724 L 851	851 Forbo #2186	Linoleum covers insert between horizontal channels to provide tackable, non-upholstered surface. Linoleum covers are tackable with 1/2" pushpins. Linoleum surface is firm enough to permit open shelf brackets to bear against face of cover.
A AutoStrada	852 Forbo #2162	
AWS Applied wall system	853 Forbo #2182	
C Cover	854 Forbo #2166	
07 Height	855 Forbo #2204	
24 Width	856 Forbo #2202	
L Tackable linoleum		
851 Finish		

Wall covers

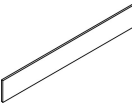
Tackable upholstered

description	h	w	d	pattern no.	Grade								
					10	15	20	30	35	40	45	50	55
Tackable upholstered cover, 7 1/2"H 	7 1/2"	24"	1/2"	AAWS C0724 A ()	\$85.	\$87.	\$89.	\$97.	\$99.	\$102.	\$105.	\$111.	\$119.
	7 1/2"	30"	1/2"	AAWS C0730 A ()	92.	96.	98.	104.	106.	108.	110.	119.	125.
	7 1/2"	36"	1/2"	AAWS C0736 A ()	99.	102.	105.	109.	111.	113.	117.	125.	131.
	7 1/2"	42"	1/2"	AAWS C0742 A ()	113.	117.	119.	121.	123.	126.	127.	131.	137.
	7 1/2"	48"	1/2"	AAWS C0748 A ()	129.	131.	133.	134.	136.	138.	140.	144.	149.
	7 1/2"	54"	1/2"	AAWS C0754 A ()	141.	144.	146.	148.	149.	152.	153.	157.	161.
	7 1/2"	60"	1/2"	AAWS C0760 A ()	156.	157.	158.	160.	161.	166.	167.	171.	176.
	7 1/2"	66"	1/2"	AAWS C0766 A ()	168.	171.	172.	174.	176.	178.	180.	183.	188.
	7 1/2"	72"	1/2"	AAWS C0772 A ()	181.	183.	186.	187.	188.	191.	192.	195.	201.
Tackable upholstered cover, 15"H 	15"	24"	1/2"	AAWS C1524 A ()	130.	131.	133.	134.	136.	138.	140.	141.	151.
	15"	30"	1/2"	AAWS C1530 A ()	154.	156.	157.	158.	160.	163.	166.	167.	176.
	15"	36"	1/2"	AAWS C1536 A ()	179.	180.	181.	183.	186.	188.	190.	191.	199.
	15"	42"	1/2"	AAWS C1542 A ()	204.	205.	206.	209.	211.	214.	215.	216.	225.
	15"	48"	1/2"	AAWS C1548 A ()	230.	231.	232.	234.	235.	239.	240.	241.	249.
	15"	54"	1/2"	AAWS C1554 A ()	252.	254.	255.	258.	259.	262.	264.	265.	273.
	15"	60"	1/2"	AAWS C1560 A ()	278.	281.	282.	285.	286.	289.	290.	292.	298.
	15"	66"	1/2"	AAWS C1566 A ()	304.	305.	308.	309.	310.	314.	315.	317.	324.
	15"	72"	1/2"	AAWS C1572 A ()	328.	329.	330.	331.	332.	336.	337.	340.	351.

Order Code	Specification Information	Application
Example: AAWS C0724 A 288-6	See finish page for Knoll textile selections.	Tackable upholstered covers insert between horizontal channels to provide tackable, fabric surface. Covers are tackable with 1/2" pushpins.
A AutoStrada		
AWS Applied wall system	Fabric is railroaded.	Open shelves cannot be positioned immediately above tackable fabric covers. Tackable core is not firm enough to permit open shelf brackets to bear against face of cover.
C Cover		
07 Height		
24 Width		
A Tackable upholstered		
288-6 Fabric		

Wall covers

Tackable upholstered

AutoStrada

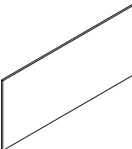
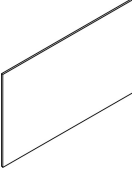
description	h	w	d	pattern no.	Grade								
					10	15	20	30	35	40	45	50	55
Tackable upholstered cover, 22½"H 	22½"	24"	½"	AAWS C2224 A ()	\$183.	\$188.	\$191.	\$194.	\$199.	\$204.	\$209.	\$216.	\$230.
	22½"	30"	½"	AAWS C2230 A ()	222.	228.	232.	235.	239.	243.	247.	255.	268.
	22½"	36"	½"	AAWS C2236 A ()	260.	265.	269.	272.	278.	284.	287.	294.	308.
	22½"	42"	½"	AAWS C2242 A ()	299.	304.	310.	314.	317.	322.	325.	332.	345.
	22½"	48"	½"	AAWS C2248 A ()	337.	342.	346.	353.	359.	363.	366.	373.	384.
	22½"	54"	½"	AAWS C2254 A ()	378.	381.	388.	392.	395.	401.	405.	412.	424.
	22½"	60"	½"	AAWS C2260 A ()	417.	422.	426.	429.	436.	439.	444.	451.	462.
	22½"	66"	½"	AAWS C2266 A ()	456.	460.	465.	470.	475.	479.	482.	490.	502.
	22½"	72"	½"	AAWS C2272 A ()	496.	500.	503.	507.	514.	517.	521.	529.	541.
Tackable upholstered cover, 30"H 	30"	24"	½"	AAWS C3024 A ()	332.	337.	340.	344.	353.	359.	364.	368.	388.
	30"	30"	½"	AAWS C3030 A ()	403.	408.	410.	414.	419.	424.	429.	436.	454.
	30"	36"	½"	AAWS C3036 A ()	473.	477.	479.	482.	487.	492.	498.	502.	523.
	30"	42"	½"	AAWS C3042 A ()	539.	543.	545.	551.	557.	561.	565.	570.	593.
	30"	48"	½"	AAWS C3048 A ()	609.	612.	614.	618.	624.	631.	636.	640.	659.
	30"	54"	½"	AAWS C3054 A ()	678.	682.	684.	688.	692.	696.	702.	707.	728.
	30"	60"	½"	AAWS C3060 A ()	743.	746.	749.	755.	761.	765.	771.	775.	796.
	30"	66"	½"	AAWS C3066 A ()	811.	817.	819.	824.	829.	834.	842.	845.	865.
	30"	72"	½"	AAWS C3072 A ()	880.	884.	887.	891.	896.	902.	909.	912.	934.

Order Code

Example:	AAWS C0724 A 288-6
A	AutoStrada
AWS	Applied wall system
C	Cover
07	Height
24	Width
A	Tackable upholstered
288-6	Fabric

Specification Information

See finish page for Knoll textile selections.

Application



Tackable upholstered covers insert between horizontal channels to provide tackable, fabric surface. Covers are tackable with ½" pushpins.

Fabric is railroaded.

Open shelves cannot be positioned immediately above tackable fabric covers. Tackable core is not firm enough to permit open shelf brackets to bear against face of cover.

Wall covers

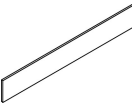
Non-tackable upholstered

description	h	w	d	pattern no.	Grade									
					10	15	20	30	35	40	45	50	55	
Non-tackable upholstered cover, 7½"H 	7½"	24"	½"	AAWS C0724 F ()	\$85.	\$87.	\$89.	\$97.	\$99.	\$102.	\$105.	\$111.	\$119.	
	7½"	30"	½"	AAWS C0730 F ()	92.	96.	98.	104.	106.	108.	110.	119.	125.	
	7½"	36"	½"	AAWS C0736 F ()	99.	102.	105.	109.	111.	113.	117.	125.	131.	
	7½"	42"	½"	AAWS C0742 F ()	106.	108.	110.	114.	119.	122.	124.	131.	137.	
	7½"	48"	½"	AAWS C0748 F ()	111.	113.	117.	123.	125.	127.	130.	137.	144.	
	7½"	54"	½"	AAWS C0754 F ()	119.	122.	124.	129.	131.	134.	136.	144.	150.	
	7½"	60"	½"	AAWS C0760 F ()	125.	127.	130.	135.	137.	139.	141.	150.	156.	
	7½"	66"	½"	AAWS C0766 F ()	131.	134.	136.	140.	144.	146.	149.	156.	161.	
	7½"	72"	½"	AAWS C0772 F ()	137.	139.	141.	148.	150.	152.	154.	161.	168.	
	7½"	78"	½"	AAWS C0778 F ()	144.	146.	149.	153.	156.	158.	160.	168.	175.	
	7½"	84"	½"	AAWS C0784 F ()	150.	152.	154.	159.	161.	165.	167.	175.	180.	
	7½"	90"	½"	AAWS C0790 F ()	156.	158.	160.	166.	168.	171.	174.	180.	187.	
7½"	96"	½"	AAWS C0796 F ()	161.	165.	167.	172.	175.	177.	179.	187.	192.		
Non-tackable upholstered cover, 15"H 	15"	24"	½"	AAWS C1524 F ()	108.	111.	113.	123.	125.	127.	131.	134.	139.	
	15"	30"	½"	AAWS C1530 F ()	122.	125.	127.	135.	137.	139.	144.	146.	152.	
	15"	36"	½"	AAWS C1536 F ()	134.	137.	139.	148.	150.	152.	156.	158.	165.	
	15"	42"	½"	AAWS C1542 F ()	146.	150.	152.	159.	161.	165.	168.	171.	177.	
	15"	48"	½"	AAWS C1548 F ()	158.	161.	165.	172.	175.	177.	180.	183.	189.	
	15"	54"	½"	AAWS C1554 F ()	171.	175.	177.	184.	187.	189.	192.	194.	201.	
	15"	60"	½"	AAWS C1560 F ()	183.	187.	189.	195.	198.	201.	205.	207.	214.	
	15"	66"	½"	AAWS C1566 F ()	194.	198.	201.	209.	212.	214.	218.	220.	228.	
	15"	72"	½"	AAWS C1572 F ()	207.	212.	214.	221.	224.	228.	231.	233.	239.	
	15"	78"	½"	AAWS C1578 F ()	220.	224.	228.	234.	236.	239.	242.	244.	250.	
	15"	84"	½"	AAWS C1584 F ()	233.	236.	239.	246.	248.	250.	254.	257.	262.	
	15"	90"	½"	AAWS C1590 F ()	244.	248.	250.	258.	260.	262.	267.	269.	275.	
15"	96"	½"	AAWS C1596 F ()	257.	260.	262.	270.	272.	275.	281.	284.	289.		

Order Code	Specification Information	Application
Example: AAWS C0724 F 288-6	See finish page for Knoll textile selections.	Non-tackable upholstered covers insert between horizontal channels to provide fabric surface. Fabric is railroaded. Wood core is firm enough to permit open shelf brackets to bear against face of cover.
A AutoStrada		
AWS Applied wall system		
C Cover		
07 Height		
24 Width		
F Non-tackable upholstered		
288-6 Fabric		

Wall covers

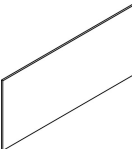
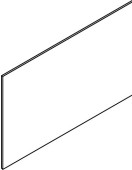

Non-tackable upholstered

description	h	w	d	pattern no.	Grade									
					10	15	20	30	35	40	45	50	55	
Non-tackable upholstered cover, 22 1/2"H 	22 1/2"	24"	1/2"	AAWS C2224 F ()	\$148.	\$153.	\$157.	\$168.	\$175.	\$180.	\$187.	\$198.	\$218.	
	22 1/2"	30"	1/2"	AAWS C2230 F ()	161.	171.	175.	186.	191.	197.	204.	216.	235.	
	22 1/2"	36"	1/2"	AAWS C2236 F ()	179.	188.	191.	203.	209.	215.	221.	234.	251.	
	22 1/2"	42"	1/2"	AAWS C2242 F ()	195.	205.	209.	220.	228.	233.	239.	250.	269.	
	22 1/2"	48"	1/2"	AAWS C2248 F ()	214.	222.	228.	237.	243.	249.	255.	268.	288.	
	22 1/2"	54"	1/2"	AAWS C2254 F ()	232.	240.	243.	254.	260.	267.	272.	287.	304.	
	22 1/2"	60"	1/2"	AAWS C2260 F ()	248.	257.	260.	271.	278.	286.	291.	302.	322.	
	22 1/2"	66"	1/2"	AAWS C2266 F ()	265.	273.	278.	290.	295.	300.	309.	320.	337.	
	22 1/2"	72"	1/2"	AAWS C2272 F ()	285.	292.	295.	308.	314.	319.	325.	336.	359.	
	22 1/2"	78"	1/2"	AAWS C2278 F ()	299.	310.	314.	324.	329.	335.	341.	357.	374.	
	22 1/2"	84"	1/2"	AAWS C2284 F ()	318.	326.	329.	340.	346.	356.	363.	373.	392.	
	22 1/2"	90"	1/2"	AAWS C2290 F ()	334.	342.	346.	362.	367.	372.	377.	391.	409.	
22 1/2"	96"	1/2"	AAWS C2296 F ()	354.	364.	367.	376.	381.	389.	395.	408.	426.		
Non-tackable upholstered cover, 30"H 	30"	24"	1/2"	AAWS C3024 F ()	168.	177.	180.	192.	205.	212.	218.	224.	242.	
	30"	30"	1/2"	AAWS C3030 F ()	190.	198.	203.	215.	229.	234.	240.	246.	264.	
	30"	36"	1/2"	AAWS C3036 F ()	213.	221.	226.	237.	249.	255.	261.	268.	288.	
	30"	42"	1/2"	AAWS C3042 F ()	235.	243.	247.	259.	271.	278.	286.	291.	310.	
	30"	48"	1/2"	AAWS C3048 F ()	257.	265.	269.	284.	294.	299.	308.	314.	330.	
	30"	54"	3/4"	AAWS C3054 F ()	281.	289.	292.	304.	317.	323.	328.	334.	356.	
	30"	60"	1/2"	AAWS C3060 F ()	300.	311.	315.	326.	337.	344.	353.	361.	376.	
	30"	66"	1/2"	AAWS C3066 F ()	324.	331.	335.	351.	364.	369.	374.	379.	400.	
	30"	72"	1/2"	AAWS C3072 F ()	345.	357.	362.	372.	382.	391.	398.	403.	420.	
	30"	78"	1/2"	AAWS C3078 F ()	370.	377.	380.	394.	407.	412.	418.	424.	445.	
	30"	84"	1/2"	AAWS C3084 F ()	392.	401.	405.	416.	428.	436.	442.	448.	465.	
	30"	90"	1/2"	AAWS C3090 F ()	414.	422.	426.	439.	451.	456.	462.	470.	487.	
	30"	96"	1/2"	AAWS C3096 F ()	437.	446.	449.	460.	475.	480.	485.	491.	510.	

Order Code	Specification Information	Application
Example: AAWS C0724 F 288-6	See finish page for Knoll textile selections.	Non-tackable upholstered covers insert between horizontal channels to provide fabric surface.
A AutoStrada		
AWS Applied wall system		
C Cover		Fabric is railroaded.
07 Height		Wood core is firm enough to permit open shelf brackets to bear against face of cover.
24 Width		
F Non-tackable upholstered		
288-6 Fabric		

Wall covers

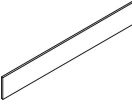
Laminate or Veneer surface

description	h	w	d	pattern no.	L	V1	V2	V3
Laminate or Veneer cover, 7 1/2"H 	7 1/2"	24"	1/2"	AAWS C0724 ()	\$71.	\$159.	\$193.	\$261.
	7 1/2"	30"	1/2"	AAWS C0730 ()	78.	168.	197.	273.
	7 1/2"	36"	1/2"	AAWS C0736 ()	81.	171.	199.	296.
	7 1/2"	42"	1/2"	AAWS C0742 ()	85.	177.	209.	322.
	7 1/2"	48"	1/2"	AAWS C0748 ()	89.	181.	215.	341.
	7 1/2"	54"	1/2"	AAWS C0754 ()	95.	188.	222.	367.
	7 1/2"	60"	1/2"	AAWS C0760 ()	100.	192.	232.	391.
	7 1/2"	66"	1/2"	AAWS C0766 ()	104.	195.	237.	411.
	7 1/2"	72"	1/2"	AAWS C0772 ()	108.	199.	244.	435.
	7 1/2"	78"	1/2"	AAWS C0778 ()	n/a	205.	251.	458.
	7 1/2"	84"	1/2"	AAWS C0784 ()	n/a	210.	259.	480.
	7 1/2"	90"	1/2"	AAWS C0790 ()	n/a	216.	268.	503.
	7 1/2"	96"	1/2"	AAWS C0796 ()	n/a	220.	273.	526.
Laminate or Veneer cover, 15"H 	15"	24"	1/2"	AAWS C1524 ()	87.	180.	214.	337.
	15"	30"	1/2"	AAWS C1530 ()	97.	190.	230.	384.
	15"	36"	1/2"	AAWS C1536 ()	106.	197.	242.	427.
	15"	42"	1/2"	AAWS C1542 ()	116.	207.	257.	474.
	15"	48"	1/2"	AAWS C1548 ()	126.	219.	273.	521.
	15"	54"	1/2"	AAWS C1554 ()	136.	232.	295.	564.
	15"	60"	1/2"	AAWS C1560 ()	145.	240.	305.	611.
	15"	66"	1/2"	AAWS C1566 ()	154.	249.	319.	655.
	15"	72"	1/2"	AAWS C1572 ()	161.	257.	331.	696.
	15"	78"	1/2"	AAWS C1578 ()	n/a	267.	346.	741.
	15"	84"	1/2"	AAWS C1584 ()	n/a	275.	364.	783.
	15"	90"	1/2"	AAWS C1590 ()	n/a	286.	376.	830.
	15"	96"	1/2"	AAWS C1596 ()	n/a	295.	391.	875.

Order Code

Example:	AAWS C0724 118
A	AutoStrada
AWS	Applied wall system
C	Cover
07	Height
24	Width
118	Finish

Specification Information

See finish page for laminate and veneer finish codes.

Product on this page will accept wood grain laminate where laminate is currently an option.

Application

Veneer or laminate covers insert between horizontal channels.

Techwood and natural veneer grain direction is horizontal.

Wall covers

Laminate or Veneer surface

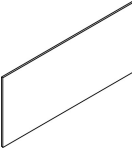
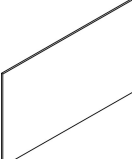
description	h	w	d	pattern no.	L	V1	V2	V3
Laminate or Veneer cover, 22 1/2"H 	22 1/2"	24"	1/2"	AAWS C2224 ()	\$108.	\$201.	\$246.	\$432.
	22 1/2"	30"	1/2"	AAWS C2230 ()	122.	215.	262.	484.
	22 1/2"	36"	1/2"	AAWS C2236 ()	141.	237.	295.	570.
	22 1/2"	42"	1/2"	AAWS C2242 ()	154.	249.	317.	638.
	22 1/2"	48"	1/2"	AAWS C2248 ()	165.	262.	336.	699.
	22 1/2"	54"	1/2"	AAWS C2254 ()	176.	274.	361.	764.
	22 1/2"	60"	1/2"	AAWS C2260 ()	205.	291.	380.	836.
	22 1/2"	66"	1/2"	AAWS C2266 ()	209.	302.	401.	895.
	22 1/2"	72"	1/2"	AAWS C2272 ()	213.	316.	420.	959.
	22 1/2"	78"	1/2"	AAWS C2278 ()	n/a	328.	444.	1,025.
	22 1/2"	84"	1/2"	AAWS C2284 ()	n/a	341.	462.	1,093.
	22 1/2"	90"	1/2"	AAWS C2290 ()	n/a	358.	484.	1,160.
22 1/2"	96"	1/2"	AAWS C2296 ()	n/a	371.	504.	1,222.	
Laminate or Veneer cover, 30"H 	30"	24"	1/2"	AAWS C3024 ()	126.	219.	273.	522.
	30"	30"	1/2"	AAWS C3030 ()	144.	240.	304.	611.
	30"	36"	1/2"	AAWS C3036 ()	166.	262.	336.	700.
	30"	42"	1/2"	AAWS C3042 ()	181.	278.	367.	788.
	30"	48"	1/2"	AAWS C3048 ()	196.	297.	393.	874.
	30"	54"	1/2"	AAWS C3054 ()	218.	321.	426.	965.
	30"	60"	1/2"	AAWS C3060 ()	233.	336.	454.	1,055.
	30"	66"	1/2"	AAWS C3066 ()	247.	358.	482.	1,138.
	30"	72"	1/2"	AAWS C3072 ()	264.	374.	509.	1,185.
	30"	78"	1/2"	AAWS C3078 ()	n/a	388.	538.	1,311.
	30"	84"	1/2"	AAWS C3084 ()	n/a	409.	564.	1,395.
	30"	90"	1/2"	AAWS C3090 ()	n/a	425.	595.	1,483.
30"	96"	1/2"	AAWS C3096 ()	n/a	443.	619.	1,569.	

Order Code

Example:	AAWS C0724 118
A	AutoStrada
AWS	Applied wall system
C	Cover
07	Height
24	Width
118	Finish

Specification Information

See finish page for laminate and veneer finish codes.

Product on this page will accept wood grain laminate where laminate is currently an option.



Application

Veneer or laminate covers insert between horizontal channels.

Techwood and natural veneer grain direction is horizontal.

Wall covers

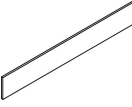
Painted surface

description	h	w	d	pattern no.	paint
Painted cover, 7 1/2"H 	7 1/2"	24"	1/2"	AAWS C0724 P ()	\$134.
	7 1/2"	30"	1/2"	AAWS C0730 P ()	135.
	7 1/2"	36"	1/2"	AAWS C0736 P ()	136.
	7 1/2"	42"	1/2"	AAWS C0742 P ()	168.
	7 1/2"	48"	1/2"	AAWS C0748 P ()	171.
	7 1/2"	54"	1/2"	AAWS C0754 P ()	172.
	7 1/2"	60"	1/2"	AAWS C0760 P ()	204.
	7 1/2"	66"	1/2"	AAWS C0766 P ()	206.
	7 1/2"	72"	1/2"	AAWS C0772 P ()	207.
	7 1/2"	78"	1/2"	AAWS C0778 P ()	211.
	7 1/2"	84"	1/2"	AAWS C0784 P ()	243.
	7 1/2"	90"	1/2"	AAWS C0790 P ()	246.
7 1/2"	96"	1/2"	AAWS C0796 P ()	247.	
Painted cover, 15"H 	15"	24"	1/2"	AAWS C1524 P ()	141.
	15"	30"	1/2"	AAWS C1530 P ()	146.
	15"	36"	1/2"	AAWS C1536 P ()	150.
	15"	42"	1/2"	AAWS C1542 P ()	185.
	15"	48"	1/2"	AAWS C1548 P ()	188.
	15"	54"	1/2"	AAWS C1554 P ()	190.
	15"	60"	1/2"	AAWS C1560 P ()	226.
	15"	66"	1/2"	AAWS C1566 P ()	230.
	15"	72"	1/2"	AAWS C1572 P ()	233.
	15"	78"	1/2"	AAWS C1578 P ()	236.
	15"	84"	1/2"	AAWS C1584 P ()	271.
	15"	90"	1/2"	AAWS C1590 P ()	275.
15"	96"	1/2"	AAWS C1596 P ()	281.	

Order Code

Example:	AAWS C0724 P 118
A	AutoStrada
AWS	Applied wall system
C	Cover
07	Height
24	Width
P	Painted surface
118	Finish

Specification Information

See finish page for painted finish codes.

Application

Painted wood covers insert between horizontal channels.
 Painted covers are powder coat or wet spray on medium density fiberboard.

Wall covers

Painted surface

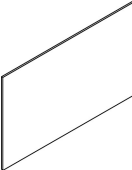
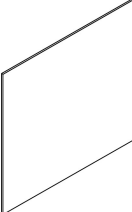
description	h	w	d	pattern no.	paint
Painted cover, 22 1/2"H 	22 1/2"	24"	1/2"	AAWS C2224 P ()	\$150.
	22 1/2"	30"	1/2"	AAWS C2230 P ()	156.
	22 1/2"	36"	1/2"	AAWS C2236 P ()	160.
	22 1/2"	42"	1/2"	AAWS C2242 P ()	195.
	22 1/2"	48"	1/2"	AAWS C2248 P ()	201.
	22 1/2"	54"	1/2"	AAWS C2254 P ()	207.
	22 1/2"	60"	1/2"	AAWS C2260 P ()	243.
	22 1/2"	66"	1/2"	AAWS C2266 P ()	248.
	22 1/2"	72"	1/2"	AAWS C2272 P ()	254.
	22 1/2"	78"	1/2"	AAWS C2278 P ()	259.
	22 1/2"	84"	1/2"	AAWS C2284 P ()	297.
	22 1/2"	90"	1/2"	AAWS C2290 P ()	302.
22 1/2"	96"	1/2"	AAWS C2296 P ()	309.	
Painted cover, 30"H 	30"	24"	1/2"	AAWS C3024 P ()	157.
	30"	30"	1/2"	AAWS C3030 P ()	165.
	30"	36"	1/2"	AAWS C3036 P ()	172.
	30"	42"	1/2"	AAWS C3042 P ()	211.
	30"	48"	1/2"	AAWS C3048 P ()	216.
	30"	54"	1/2"	AAWS C3054 P ()	224.
	30"	60"	1/2"	AAWS C3060 P ()	261.
	30"	66"	1/2"	AAWS C3066 P ()	269.
	30"	72"	1/2"	AAWS C3072 P ()	275.
	30"	78"	1/2"	AAWS C3078 P ()	285.
	30"	84"	1/2"	AAWS C3084 P ()	324.
	30"	90"	1/2"	AAWS C3090 P ()	329.
30"	96"	1/2"	AAWS C3096 P ()	336.	

Order Code

Example:	AAWS C0724 P 118
A	AutoStrada
AWS	Applied wall system
C	Cover
07	Height
24	Width
P	Painted surface
118	Finish

Specification Information

See finish page for painted finish codes.

Application

Painted wood covers insert between horizontal channels.
Painted covers are powder coat or wet spray on medium density fiberboard.

Wall covers

Backpainted glass surface

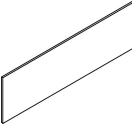
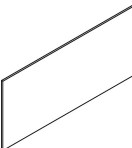
description	h	w	pattern no.	881	882
Backpainted glass, 15"H 	15"	24"	AAWS C1524 G ()	\$297.	\$363.
	15"	30"	AAWS C1530 G ()	346.	410.
	15"	36"	AAWS C1536 G ()	399.	459.
	15"	42"	AAWS C1542 G ()	448.	509.
	15"	48"	AAWS C1548 G ()	497.	559.
	15"	54"	AAWS C1554 G ()	545.	610.
	15"	60"	AAWS C1560 G ()	598.	658.
	15"	66"	AAWS C1566 G ()	646.	707.
Backpainted glass, 22 1/2"H 	22 1/2"	24"	AAWS C2224 G ()	392.	474.
	22 1/2"	30"	AAWS C2230 G ()	465.	540.
	22 1/2"	36"	AAWS C2236 G ()	534.	610.
	22 1/2"	42"	AAWS C2242 G ()	610.	685.
	22 1/2"	48"	AAWS C2248 G ()	679.	770.
	22 1/2"	54"	AAWS C2254 G ()	744.	857.
	22 1/2"	60"	AAWS C2260 G ()	820.	943.
	22 1/2"	66"	AAWS C2266 G ()	888.	1,030.
	22 1/2"	72"	AAWS C2272 G ()	956.	1,119.

Order Code

Example:	AAWS C1524 G 881
A	AutoStrada
AWS	Applied wall system
C	Cover
15	Height
24	Width
G	Backpainted glass
881	Finish

Specification Information

Backpainted glass is 4mm thick.
 Specify glass surface:
 881 sea glass white
 882 star white
 Sea glass has natural glass tint.
 Star glass has low lead content for pure white appearance.

Application

Backpainted glass covers insert between horizontal channels to provide nearly opaque glass surface. Glass covers may be used as dry-erase marker surface.

Bookshelves cannot be mounted in channel directly above glass cover.

description	h	w	d	pattern no.	price	finished or aluminum
Display shelf 	1"	6"	5 1/2"	AAWS DS0605 ()	\$85.	
	1"	24"	5 1/2"	AAWS DS2405 ()	224.	
	1"	30"	5 1/2"	AAWS DS3005 ()	236.	
	1"	36"	5 1/2"	AAWS DS3605 ()	254.	
	1"	42"	5 1/2"	AAWS DS4205 ()	281.	
	1"	48"	5 1/2"	AAWS DS4805 ()	297.	
	1"	54"	5 1/2"	AAWS DS5405 ()	323.	
	1"	60"	5 1/2"	AAWS DS6005 ()	334.	
	1"	66"	5 1/2"	AAWS DS6605 ()	346.	
	1"	72"	5 1/2"	AAWS DS7205 ()	363.	

Order Code



Example: AAWS DS2405 AA	
A	AutoStrada
AWS	Applied wall system
DS	Display shelf
24	Width
05	Depth
AA	Finish

Specification Information

AA - Anodized Aluminum or any standard painted finish except 613 Silver.

Application

Display shelf is natural anodized aluminum extrusion with integral bracket detail that engages into horizontal channel at any point. Display shelves are typically mounted in channels at 31 1/2" or 39" above the floor. Display shelf can be mounted in channel between glass covers.

description	h	w	d	pattern no.	list	glass
Powder glass lower shelf 	1 1/2"	24"	9"	AAWS LS2409 G ()()		\$522.
	1 1/2"	30"	9"	AAWS LS3009 G ()()		559.
	1 1/2"	36"	9"	AAWS LS3609 G ()()		605.
	1 1/2"	42"	9"	AAWS LS4209 G ()()		652.
	1 1/2"	48"	9"	AAWS LS4809 G ()()		701.
	1 1/2"	54"	9"	AAWS LS5409 G ()()		757.
	1 1/2"	60"	9"	AAWS LS6009 G ()()		806.
	1 1/2"	66"	9"	AAWS LS6609 G ()()		864.
	1 1/2"	72"	9"	AAWS LS7209 G ()()		920.
Powder glass upper shelf 	1 1/2"	24"	9"	AAWS US2409 G ()()		522.
	1 1/2"	30"	9"	AAWS US3009 G ()()		559.
	1 1/2"	36"	9"	AAWS US3609 G ()()		605.
	1 1/2"	42"	9"	AAWS US4209 G ()()		652.
	1 1/2"	48"	9"	AAWS US4809 G ()()		701.
	1 1/2"	54"	9"	AAWS US5409 G ()()		757.
	1 1/2"	60"	9"	AAWS US6009 G ()()		806.
	1 1/2"	66"	9"	AAWS US6609 G ()()		864.
	1 1/2"	72"	9"	AAWS US7209 G ()()		920.
Book ends (pair)	7"	5"	7"	AAWS BE ()	69.	

Order Code

Example:	AAWS LS2409 G GL13 AA
A	AutoStrada
AWS	Applied wall system
LS	Shelf
24	Width
09	Depth
G	Glass
GL13	Glass finish
AA	Support finish

Specification Information

GL13 - Powder glass only.
 Glass platform is available in AA anodized aluminum or any standard painted finish except Silver.
 Bookends are available in any standard painted finish.

Application



Glass shelves are supported by a 5 1/2" deep aluminum platform with integral bracket detail that engages into horizontal channel at any point.
 Specify lower shelf for most applications to align with bottom of adjacent overhead storage cabinet. Specify upper shelf only to align with top of adjacent overhead storage cabinet.
 Shelf bracket bears against surface of cover below so it cannot be positioned above glass or tackable fabric covers.

Book ends rest on glass shelf at any point to contain books or binders.

Bookshelves

lamine and veneer

AutoStrada

description	h	w	d	pattern no.	list	L	V1	V2	V3
Laminate or veneer lower shelf 	1 1/2"	24"	12"	AAWS LS2412 () ()		\$230.	\$308.	\$354.	\$477.
	1 1/2"	30"	12"	AAWS LS3012 () ()		252.	337.	391.	525.
	1 1/2"	36"	12"	AAWS LS3612 () ()		278.	372.	427.	574.
	1 1/2"	42"	12"	AAWS LS4212 () ()		301.	405.	463.	625.
	1 1/2"	48"	12"	AAWS LS4812 () ()		324.	437.	501.	678.
	1 1/2"	54"	12"	AAWS LS5412 () ()		399.	533.	613.	826.
	1 1/2"	60"	12"	AAWS LS6012 () ()		373.	500.	574.	777.
	1 1/2"	66"	12"	AAWS LS6612 () ()		399.	533.	613.	826.
	1 1/2"	72"	12"	AAWS LS7212 () ()		423.	564.	649.	876.
Laminate or veneer upper shelf 	1 1/2"	24"	12"	AAWS US2412 () ()		230.	308.	354.	477.
	1 1/2"	30"	12"	AAWS US3012 () ()		252.	337.	391.	525.
	1 1/2"	36"	12"	AAWS US3612 () ()		278.	372.	427.	574.
	1 1/2"	42"	12"	AAWS US4212 () ()		301.	405.	463.	625.
	1 1/2"	48"	12"	AAWS US4812 () ()		324.	437.	501.	678.
	1 1/2"	54"	12"	AAWS US5412 () ()		399.	533.	613.	826.
	1 1/2"	60"	12"	AAWS US6012 () ()		373.	500.	574.	777.
	1 1/2"	66"	12"	AAWS US6612 () ()		399.	533.	613.	826.
	1 1/2"	72"	12"	AAWS US7212 () ()		423.	564.	649.	876.
Book ends (pair)	7"	5"	7"	AAWS BE ()	69.				

Order Code

Example:	AAWS LS2412 118 AA
A	Autostrada
AWS	Applied wall system
LS	Shelf
24	Width
12	Depth
118	Shelf finish
AA	Support finish

Specification Information

Shelf platform is available in AA anodized aluminum or any standard painted finish except 613 Silver.

Bookends are available in any standard painted finish.

See finish page for laminate and veneer finish codes.

Product on this page will accept wood grain laminate where laminate is currently an option.

Application

Laminate and veneer bookshelves are supported by a 5 1/2" deep aluminum platform with integral bracket detail that engages into horizontal channel at any point. Specify lower shelf for most applications to align with bottom of adjacent overhead storage cabinet. Specify upper shelf only to align with top of adjacent overhead storage cabinet.

Shelf bracket bears against surface of cover below so it cannot be positioned above glass or tackable fabric covers.

Book ends rest on bookshelf at any point to contain books or binders.

Open overhead cabinets

Laminate or wood veneer

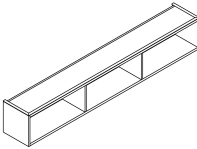
description	h	w	d	pattern no.	L	V1	V2	V3
Open overhead, binder depth  96" w shown	15"	18"	14 1/4"	AAWS OBO 18 ()()	\$1,614.	\$1,724.	\$1,989.	\$2,584.
	15"	24"	14 1/4"	AAWS OBO 24 ()()	1,657.	1,769.	2,038.	2,648.
	15"	30"	14 1/4"	AAWS OBO 30 ()()	1,704.	1,816.	2,087.	2,715.
	15"	36"	14 1/4"	AAWS OBO 36 ()()	1,750.	1,864.	2,142.	2,783.
	15"	42"	14 1/4"	AAWS OBO 42 ()()	1,794.	1,910.	2,197.	2,857.
	15"	48"	14 1/4"	AAWS OBO 48 ()()	1,843.	1,961.	2,257.	2,935.
	15"	54"	14 1/4"	AAWS OBO 54 ()()	1,939.	2,061.	2,375.	3,085.
	15"	60"	14 1/4"	AAWS OBO 60 ()()	2,036.	2,162.	2,491.	3,240.
	15"	66"	14 1/4"	AAWS OBO 66 ()()	2,091.	2,229.	2,559.	3,329.
	15"	72"	14 1/4"	AAWS OBO 72 ()()	2,150.	2,293.	2,630.	3,420.
	15"	78"	14 1/4"	AAWS OBO 78 ()()	2,255.	2,407.	2,762.	3,591.
	15"	84"	14 1/4"	AAWS OBO 84 ()()	2,322.	2,478.	2,845.	3,699.
	15"	90"	14 1/4"	AAWS OBO 90 ()()	2,393.	2,554.	2,933.	3,810.
	15"	96"	14 1/4"	AAWS OBO 96 ()()	2,463.	2,629.	3,020.	4,239.
	Open overhead, legal depth	15"	18"	17 1/4"	AAWS OGO 18 ()()	1,744.	1,864.	2,143.
15"		24"	17 1/4"	AAWS OGO 24 ()()	1,790.	1,913.	2,198.	2,860.
15"		30"	17 1/4"	AAWS OGO 30 ()()	1,840.	1,962.	2,256.	2,934.
15"		36"	17 1/4"	AAWS OGO 36 ()()	1,889.	2,014.	2,312.	3,008.
15"		42"	17 1/4"	AAWS OGO 42 ()()	1,938.	2,061.	2,374.	3,085.
15"		48"	17 1/4"	AAWS OGO 48 ()()	1,990.	2,117.	2,436.	3,169.
15"		54"	17 1/4"	AAWS OGO 54 ()()	2,093.	2,227.	2,565.	3,333.
15"		60"	17 1/4"	AAWS OGO 60 ()()	2,200.	2,338.	2,692.	3,497.
15"		66"	17 1/4"	AAWS OGO 66 ()()	2,257.	2,407.	2,766.	3,597.
15"		72"	17 1/4"	AAWS OGO 72 ()()	2,319.	2,476.	2,843.	3,695.
15"		78"	17 1/4"	AAWS OGO 78 ()()	2,437.	2,600.	2,986.	3,880.
15"		84"	17 1/4"	AAWS OGO 84 ()()	2,509.	2,676.	3,074.	3,996.
15"		90"	17 1/4"	AAWS OGO 90 ()()	2,585.	2,755.	3,167.	4,114.
15"		96"	17 1/4"	AAWS OGO 96 ()()	2,663.	2,840.	3,262.	4,239.

Order Code	Specification Information	Application
Example: AAWS OBO 18 118 115 A AutoStrada AWS Applied wall system OBO Open overhead cabinet 18 Width 118 Laminate or veneer 115 Trim finish	See finish page for laminate and veneer finish codes. Product on this page will accept wood grain laminate where laminate is currently an option. Top trim may be specified in AA anodized aluminum or any standard painted finish except Silver. Mounting extrusions and anti dislodgement brackets match the AA trim or are black paint with any painted finish trim.	Open overhead cabinets include continuous mounting extrusion that engages into top or intermediate channel at any point. Overhead cabinets also include anti-dislodgement brackets that engage into intermediate channel below cabinet. Overhead cabinets normally mount between 54" and 69" above the floor.

Sliding door overhead cabinets with glass doors

Laminate or wood veneer

AutoStrada

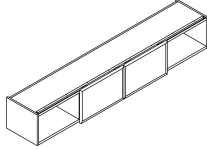
description	h	w	d	pattern no.	L	V1	V2	V3
 <p>96" w shown</p>	15"	42"	15 1/4"	AAWS OBR 42 () ()	\$3,334.	\$3,583.	\$4,495.	\$5,393.
	15"	48"	15 1/4"	AAWS OBR 48 () ()	3,437.	3,700.	4,633.	5,563.
	15"	54"	15 1/4"	AAWS OBR 54 () ()	3,539.	3,818.	4,769.	5,725.
	15"	60"	15 1/4"	AAWS OBR 60 () ()	3,643.	3,938.	4,907.	5,889.
	15"	66"	15 1/4"	AAWS OBR 66 () ()	3,742.	4,056.	5,046.	6,056.
	15"	72"	15 1/4"	AAWS OBR 72 () ()	3,844.	4,173.	5,182.	6,222.
	15"	78"	15 1/4"	AAWS OBR 78 () ()	4,038.	4,382.	5,444.	6,533.
	15"	84"	15 1/4"	AAWS OBR 84 () ()	4,158.	4,513.	5,608.	6,727.
	15"	90"	15 1/4"	AAWS OBR 90 () ()	4,283.	4,647.	5,776.	6,931.
	15"	96"	15 1/4"	AAWS OBR 96 () ()	4,415.	4,788.	5,949.	7,140.
Open/Sliding door(s) glass, legal depth	15"	42"	18 1/4"	AAWS OGR 42 () ()	3,599.	3,872.	4,852.	5,819.
	15"	48"	18 1/4"	AAWS OGR 48 () ()	3,707.	3,999.	5,001.	6,000.
	15"	54"	18 1/4"	AAWS OGR 54 () ()	3,819.	4,431.	5,152.	6,181.
	15"	60"	18 1/4"	AAWS OGR 60 () ()	3,929.	4,254.	5,301.	6,361.
	15"	66"	18 1/4"	AAWS OGR 66 () ()	4,044.	4,380.	5,449.	6,537.
	15"	72"	18 1/4"	AAWS OGR 72 () ()	4,152.	4,504.	5,600.	6,720.
	15"	78"	18 1/4"	AAWS OGR 78 () ()	4,360.	4,732.	5,880.	7,056.
	15"	84"	18 1/4"	AAWS OGR 84 () ()	4,493.	4,875.	6,056.	7,268.
	15"	90"	18 1/4"	AAWS OGR 90 () ()	4,625.	5,019.	6,237.	7,488.
	15"	96"	18 1/4"	AAWS OGR 96 () ()	4,765.	5,170.	6,426.	7,710.

Order Code	Specification Information	Application
Example: AAWS OBR 42 118 GL13 AA	See finish page for laminate, veneer and glass finish codes.	Sliding door overhead cabinets include continuous mounting extrusion that engages into top or intermediate channel at any point. Overhead cabinets also include anti-dislodgement brackets that engage into intermediate channel below cabinet. Overhead cabinets normally mount between 54" and 69" above the floor.
A AutoStrada	Product on this page will accept wood grain laminate where laminate is currently an option.	Overhead cabinets are binder height.
AWS Applied wall system	Trim finish is AA anodized aluminum or any standard painted finish except 613 Silver.	No locks.
OBR Sliding glass door binder depth overhead	Mounting extrusion and anti dislodgement brackets match the AA trim or are black paint with any painted finish trim.	
42 Width		
118 Case finish		
GL13 Glass finish		
AA Trim finish		

Sliding door overhead cabinets with laminate or veneer doors

Laminate or wood veneer

AutoStrada

Applied Wall

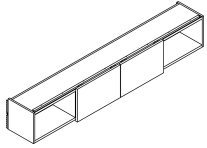
description	h	w	d	pattern no.	L	V1	V2	V3
Open/Sliding door(s) laminate or veneer, binder depth  96" w shown	15"	42"	15 1/4"	AAWS OBS 42 () ()	\$2,792.	\$3,016.	\$3,832.	\$4,983.
	15"	48"	15 1/4"	AAWS OBS 48 () ()	2,880.	3,116.	3,950.	5,135.
	15"	54"	15 1/4"	AAWS OBS 54 () ()	2,966.	3,213.	4,068.	5,289.
	15"	60"	15 1/4"	AAWS OBS 60 () ()	3,049.	3,311.	4,185.	5,442.
	15"	66"	15 1/4"	AAWS OBS 66 () ()	3,139.	3,408.	4,303.	5,594.
	15"	72"	15 1/4"	AAWS OBS 72 () ()	3,223.	3,507.	4,421.	5,748.
	15"	78"	15 1/4"	AAWS OBS 78 () ()	3,384.	3,684.	4,643.	6,037.
	15"	84"	15 1/4"	AAWS OBS 84 () ()	3,484.	3,792.	4,785.	6,217.
	15"	90"	15 1/4"	AAWS OBS 90 () ()	3,590.	3,909.	4,925.	6,402.
	15"	96"	15 1/4"	AAWS OBS 96 () ()	3,696.	4,024.	5,073.	6,597.
Open/Sliding door(s) laminate or veneer, legal depth	15"	42"	18 1/4"	AAWS OGS 42 () ()	3,017.	3,253.	4,150.	5,379.
	15"	48"	18 1/4"	AAWS OGS 48 () ()	3,113.	3,361.	4,272.	5,545.
	15"	54"	18 1/4"	AAWS OGS 54 () ()	3,203.	3,469.	4,396.	5,711.
	15"	60"	18 1/4"	AAWS OGS 60 () ()	3,294.	3,575.	4,519.	5,875.
	15"	66"	18 1/4"	AAWS OGS 66 () ()	3,389.	3,684.	4,647.	6,043.
	15"	72"	18 1/4"	AAWS OGS 72 () ()	3,480.	3,786.	4,779.	6,208.
	15"	78"	18 1/4"	AAWS OGS 78 () ()	3,655.	3,976.	5,016.	6,519.
	15"	84"	18 1/4"	AAWS OGS 84 () ()	3,763.	4,098.	5,165.	6,713.
	15"	90"	18 1/4"	AAWS OGS 90 () ()	3,877.	4,219.	5,319.	6,917.
	15"	96"	18 1/4"	AAWS OGS 96 () ()	3,993.	4,346.	5,481.	7,123.

Order Code	Specification Information	Application
Example: AAWS OBS 42 118 AA A AutoStrada AWS Applied wall system OBS Sliding solid door binder depth overhead 42 Width 118 Finish AA Trim finish	See finish page for laminate and veneer finish codes. Product on this page will accept wood grain laminate where laminate is currently an option. Trim finish is AA anodized aluminum or any standard painted finish except 613 Silver. Mounting extrusion and anti dislodgement bracket match the AA trim or are black paint with any painted finish trim.	Sliding door overhead cabinets include continuous mounting extrusion that engages into top or intermediate channel at any point. Overhead cabinets also include anti-dislodgement brackets that engage into intermediate channel below cabinet. Overhead cabinets normally mount between 54" and 69" above the floor. Sliding door overheads are not available with locks.
		Overhead cabinets are binder height. No locks.

Hinged door overhead cabinets

Laminate or wood veneer

AutoStrada

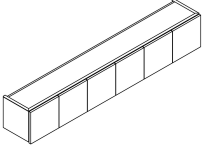
description	h	w	d	#drs/locks	pattern no.	L	V1	V2	V3
Hinged door overhead binder depth  96" w shown	15"	18"	15 1/4"	1/1	AAWS OBD 18L () ()	\$2,218.	\$2,362.	\$2,710.	\$3,525.
	15"	18"	15 1/4"	1/1	AAWS OBD 18R () ()	2,218.	2,362.	2,710.	3,525.
	15"	24"	15 1/4"	2/1	AAWS OBD 24 () ()	2,345.	2,495.	2,863.	3,727.
	15"	30"	15 1/4"	2/1	AAWS OBD 30 () ()	2,478.	2,638.	3,031.	3,943.
	15"	36"	15 1/4"	2/1	AAWS OBD 36 () ()	2,619.	2,789.	3,209.	4,172.
	15"	42"	15 1/4"	3/2	AAWS OBD 42 () ()	2,638.	2,813.	3,232.	4,199.
	15"	48"	15 1/4"	3/2	AAWS OBD 48 () ()	2,689.	2,861.	3,296.	4,283.
	15"	54"	15 1/4"	3/2	AAWS OBD 54 () ()	2,830.	3,011.	3,467.	4,506.
	15"	60"	15 1/4"	4/2	AAWS OBD 60 () ()	2,965.	3,154.	3,628.	4,717.
	15"	66"	15 1/4"	4/2	AAWS OBD 66 () ()	3,050.	3,252.	3,738.	4,863.
	15"	72"	15 1/4"	4/2	AAWS OBD 72 () ()	3,135.	3,338.	3,840.	4,989.
	15"	78"	15 1/4"	5/3	AAWS OBD 78 () ()	3,294.	3,514.	4,033.	5,246.
	15"	84"	15 1/4"	5/3	AAWS OBD 84 () ()	3,392.	3,620.	4,155.	5,403.
	15"	90"	15 1/4"	6/3	AAWS OBD 90 () ()	3,491.	3,728.	4,281.	5,566.
	15"	96"	15 1/4"	6/3	AAWS OBD 96 () ()	3,600.	3,840.	4,409.	5,732.
Hinged door overhead legal depth	15"	18"	18 1/4"	1/1	AAWS OGD 18L () ()	2,396.	2,549.	2,925.	3,805.
	15"	18"	18 1/4"	1/1	AAWS OGD 18R () ()	2,396.	2,549.	2,925.	3,805.
	15"	24"	18 1/4"	2/1	AAWS OGD 24 () ()	2,531.	2,695.	3,095.	4,025.
	15"	30"	18 1/4"	2/1	AAWS OGD 30 () ()	2,675.	2,848.	3,275.	4,257.
	15"	36"	18 1/4"	2/1	AAWS OGD 36 () ()	2,829.	3,012.	3,466.	4,503.
	15"	42"	18 1/4"	3/2	AAWS OGD 42 () ()	2,850.	3,049.	3,490.	4,536.
	15"	48"	18 1/4"	3/2	AAWS OGD 48 () ()	2,905.	3,088.	3,557.	4,628.
	15"	54"	18 1/4"	3/2	AAWS OGD 54 () ()	3,059.	3,251.	3,740.	4,867.
	15"	60"	18 1/4"	4/2	AAWS OGD 60 () ()	3,201.	3,407.	3,920.	5,095.
	15"	66"	18 1/4"	4/2	AAWS OGD 66 () ()	3,296.	3,513.	4,040.	5,250.
	15"	72"	18 1/4"	4/2	AAWS OGD 72 () ()	3,387.	3,604.	4,148.	5,390.
	15"	78"	18 1/4"	5/3	AAWS OGD 78 () ()	3,560.	3,796.	4,355.	5,665.
	15"	84"	18 1/4"	5/3	AAWS OGD 84 () ()	3,665.	3,910.	4,487.	5,834.
	15"	90"	18 1/4"	6/3	AAWS OGD 90 () ()	3,775.	4,026.	4,625.	6,008.
	15"	96"	18 1/4"	6/3	AAWS OGD 96 () ()	3,887.	4,148.	4,761.	6,190.

Order Code	Specification Information	Application
Example: AAWS OBD 24 L 118 AA A AutoStrada AWS Applied wall system OBD Hinged door binder depth overhead 24 Width L Lock 118 Case & matching door finish AA Trim finish	See finish page for laminate and veneer finish codes. Product on this page will accept wood grain laminate where laminate is currently an option. Trim finish is AA anodized aluminum or any standard painted finish except 613 Silver. Mounting extrusion and anti dislodgement brackets match the AA trim or are black paint with any painted finish trim.	Hinged door overhead cabinets include continuous mounting extrusion that engages into top or intermediate channel at any point. Overhead cabinets also include anti-dislodgement brackets that engage into intermediate channel below cabinet. Overhead cabinets normally mount between 54" and 69" above the floor. Overhead cabinets are binder height.

Overhead storage mounting kits

Adapters for Reuter and wall-attached wood overheads

description	type	w	pattern no.	finished	black or AA
Reuter overhead storage downmount kit	Applied Wall		AAWS RO MK ()	\$199.	

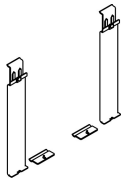

Adapter kit for wood overhead storage	Length	Depth	Pattern No.	Price
	18"	16 1/2"	AAWS WOMK 18 ()	96.
	24"	22 1/2"	AAWS WOMK 24 ()	101.
	30"	28 1/2"	AAWS WOMK 30 ()	106.
	36"	34 1/2"	AAWS WOMK 36 ()	113.
	42"	40 1/2"	AAWS WOMK 42 ()	121.
	48"	46 1/2"	AAWS WOMK 48 ()	126.
	54"	52 1/2"	AAWS WOMK 54 ()	131.
	60"	58 1/2"	AAWS WOMK 60 ()	137.
	66"	64 1/2"	AAWS WOMK 66 ()	142.
	72"	70 1/2"	AAWS WOMK 72 ()	160.
	78"	76 1/2"	AAWS WOMK 78 ()	170.
	84"	82 1/2"	AAWS WOMK 84 ()	177.
	90"	88 1/2"	AAWS WOMK 90 ()	183.
	96"	94 1/2"	AAWS WOMK 96 ()	189.

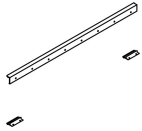



Order Code	Specification Information	Application
Example: AAWS WOMK 18 AA		
A AutoStrada	For Reuter overhead downmount brackets - see finish page for painted finish code options.	Reuter overhead storage downmount kit adapts Reuter flat front or curved front cabinets to attach to top or intermediate channel. Kit includes two anti-dislodgement brackets that engage into intermediate channel below the cabinet.
AWS Applied wall system	Adapter kits for wood overheads are available in AA anodized aluminum or 111 black only.	Adapter kit for wood overhead storage converts AutoStrada wall-attached single-high overhead cabinets to mount on the applied wall system.
WOMK Wall mount bracket kit		
18 Width		
AA Finish		

Power and wire management

Cable trays and worksurface supports



AutoStrada

description	application	h	w	d	pattern no.	list	painting or aluminum
		2 1/4"	24"	1 3/4"	AAWS CT24 ()		\$76.
		2 1/4"	30"	1 3/4"	AAWS CT30 ()		82.
		2 1/4"	36"	1 3/4"	AAWS CT36 ()		94.
		2 1/4"	42"	1 3/4"	AAWS CT42 ()		107.
		2 1/4"	48"	1 3/4"	AAWS CT48 ()		122.
		2 1/4"	54"	1 3/4"	AAWS CT54 ()		139.
		2 1/4"	60"	1 3/4"	AAWS CT60 ()		148.
		2 1/4"	66"	1 3/4"	AAWS CT66 ()		153.
		2 1/4"	72"	1 3/4"	AAWS CT72 ()		158.
	28 3/8"H worksurface	3"	2"		AAWS BE27 ()	127.	
	29 5/8"H worksurface	4"	2"		AAWS BE28 ()	127.	

Order Code	Specification Information	Application
<p>Example: AAWS CT24 AA</p> <p>A AutoStrada</p> <p>AWS Applied Wall System</p> <p>CT Cable tray</p> <p>24 Width</p> <p>AA Finish</p>	<p>Cable trays are available in AA - Anodized Aluminum or any standard painted finish except 613 Silver.</p> <p>End support brackets are available in all standard paint finishes.</p>	<p>Cable trays mount anywhere along any intermediate channel, and are typically installed below worksurface height in the channel 24" above the floor.</p> <p>When combined with recess cover above cable tray is effectively expanded from 1 3/4" to 2 1/2" deep.</p> <p>End support brackets include a flat base plate to engage into a slot in the base of the cable tray.</p>
		<p>End support brackets also directly engage into intermediate channel at 24" above floor to support back edge or one end of worksurface.</p>

Power and wire management

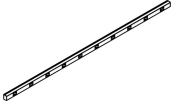
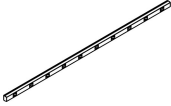
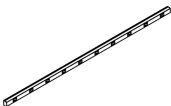
Surface mounted plugmold raceway

description	h	w	d	pattern no.	aluminum
Plugmold, single circuit (3 wire, grey outlets) 	1 1/2"	60"	1 1/8"	AAWS RPM1 05 ()	\$439.
Plugmold, two circuits (4 wire, grey outlets shared neutral and ground) 	1 1/2"	60"	1 1/8"	AAWS RPM2 05 ()	549.
Plugmold, isolated (6 wire, gray + orange outlets independent neutral and ground) 	1 1/2"	60"	1 1/8"	AAWS RPM2I 05 ()	549.
Plugstrip, two circuits (4 wire, grey + orange outlets shared neutral and ground) 	1 1/2"	28"	1 1/8"	AAWS RPM2 02 ()	268.

Order Code

Example:	AAWS RPM1 05 AA
A	AutoStrada
AWS	Applied Wall System
RPM1	Plugmold raceway, one circuit
05	width
AA	Finish, Aluminum

Specification Information

AA - Aluminum only available finish.

Plugmold is 60" wide with outlets every 6" (ten simplex outlets total).

Plugstrip is 28" wide with outlets every 3" (eight outlets total).

Application

Plugmold is surface mounted raceway for one or two circuits. Plugmold includes ten simplex outlets, anodized aluminum covers and end caps. Plugmold may be linked or trimmed to length on site.

Plugstrip includes eight simplex outlets.

Plugstrip mounts to 30" or wider recess cover.

Power supply must be made by an electrical contractor, including hardwire connection from junction box in building to back side of plugmold raceway. Typically contractor punches a hole for connection through a recess cover positioned just above a junction box in the building wall.

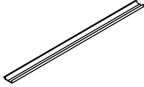
description	h	w	d	pattern no.	list	paint	black or AA only
Marker tray 	3/4"	24"	2 1/2"	AAWS MT24 ()		Painted aluminum	
	3/4"	30"	2 1/2"	AAWS MT30 ()		Painted aluminum	
	3/4"	36"	2 1/2"	AAWS MT36 ()		Painted aluminum	
	3/4"	42"	2 1/2"	AAWS MT42 ()		Painted aluminum	
	3/4"	48"	2 1/2"	AAWS MT48 ()		Painted aluminum	
	3/4"	54"	2 1/2"	AAWS MT54 ()		Painted aluminum	
	3/4"	60"	2 1/2"	AAWS MT60 ()		Painted aluminum	
	3/4"	66"	2 1/2"	AAWS MT66 ()		Painted aluminum	
	3/4"	72"	2 1/2"	AAWS MT72 ()		Painted aluminum	
Easel pad holder	2"	28"	1 1/8"	AAWS EASEL ()		Painted aluminum	104.
Picture hook	1"	1 1/4"	1"	AAWS PH ()		Painted aluminum	23.
Coat hook	2"	2 1/2"	1 1/2"	AAWS CH ()		Painted aluminum	23.
Wire manager clips (10/pk)	3/4"	3/8"	3/4"	AAWS WMC	12.		
Cable grommet (10/pk)	1 1/4"		1 1/4"	AAWS CG	10.		

Order Code

Example:	AAWS MT24 AA
A	AutoStrada
AWS	Applied wall system
MT	Marker tray
24	Width
AA	Finish

Specification Information

- Markertray is available in AA anodized aluminum or any standard painted finish except 613 Silver.
- Easel pad holder is available in AA anodized aluminum or 111 black only.
- Picture hook and Coat hook are available in all standard painted finishes.
- Wire manager clips are easy grey plastic.
- Cable grommets are black plastic.

Application Notes

Applied wall system accessories include integral bracket detail that engages into top or intermediate channels at any point.

Easel pad holder includes three studs to hang standard 27"x34" easel pads on inside and outside face of bracket.

Wire manager clips may be used for horizontal or vertical wire management of lamp cords on the face of the applied wall.



Cable grommet is 1 1/4" diameter trim ring for 1" diameter hole which may be punched in recess covers to route data/communications cables from inside of applied wall to the surface.

Service Wall frames

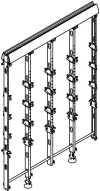
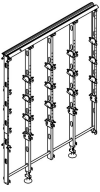

Standard and compact crown

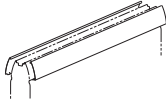
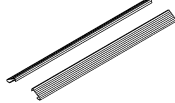
description	type	w	d	h	pattern number	black	list
 Wall frame, standard crown	39"H	48"	5"	43"	APF1 3948	\$554.	
		60"	5"	43"	APF1 3960	637.	
		72"	5"	43"	APF1 3972	789.	
	48"H	48"	5"	52"	APF1 4848	610.	
		60"	5"	52"	APF1 4860	697.	
		72"	5"	52"	APF1 4872	870.	
	64"H	48"	5"	68"	APF1 6448	725.	
		60"	5"	68"	APF1 6460	829.	
		72"	5"	68"	APF1 6472	1,038.	
 Wall frame, compact crown	39"H	48"	5"	40"	APFA1 3948	444.	
		60"	5"	40"	APFA1 3960	509.	
		72"	5"	40"	APFA1 3972	628.	
	48"H	48"	5"	49"	APFA1 4848	486.	
		60"	5"	49"	APFA1 4860	557.	
		72"	5"	49"	APFA1 4872	696.	
	64"H	48"	5"	65"	APFA1 6448	580.	
		60"	5"	65"	APFA1 6460	662.	
		72"	5"	65"	APFA1 6472	829.	
Acoustical inserts	39"H		2"	34"	APA 39		32.
	48"H		2"	43"	APA 48		38.
	64"H		2"	59"	APA 64		51.

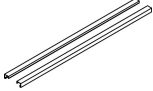
Order Code	Specification Information	Application
Example: APFA1 3948	Wall frame pattern numbers begin with APF (standard crown) and APFA (compact crown) prefixes.	Service Wall frames are the structural component of spine-based planning. Specify frames in any combination of widths to create the overall wall length required.
APF Spine frame		Crown is bored to accept stackable add-up panels at 3" increments.
A compact crown		Service Wall frames include two levelling feet with 2" travel, 12" from each side edge.
1 Generation	<i>Specify:</i>	
39 Height	<i>Fifth position: height</i>	
48 Width	39 39"H	Frames include vertical studs every 12" on center, with cover mounting clips and cable manager inserts on both sides. Frames also include 4"H or 1" top crown with continuous channel for add-up panels. 4"H standard crown frames include shaped crowns for upmounting shelves or overhead storage cabinets, canopy lighting at any point. Compact crown frames feature a slim profile crown with downmounting capability only.
	48 48"H	
	64 64"H	
	<i>Seventh position: width</i>	
	48 48"W	
	60 60"W	
	72 72"W	
	All Service Wall frames include 3" diameter, 2" levelling glides and one set of connectors to adjacent frame or wall connector. Frames are black painted finish.	Acoustical inserts fit between studs in Service Wall frame to increase control of sound transmission. Inserts are bagged in heights corresponding to wall frame. Specify four inserts for 48"W frame, five for 60"W frame, and six for 72"W frame. Service Walls with acoustical inserts have been tested to STC 33. Inserts do not affect the NRC rating of the wall which is .40.
		Specify crown covers, raceway covers, structural base covers, and wall covers for each face of Service Wall frame, and specify power components separately.

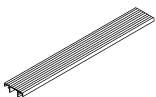
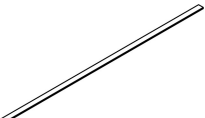

description	type	w	d	h	pattern number	paint	list	anodized alum
Crown covers (pair)		48"	5"	4"	APT 48 ()	\$39.		
		60"	5"	4"	APT 60 ()	47.		
		72"	5"	4"	APT 72 ()	52.		
		(specify painted finish)						
compact crown, integral color		48"	5"	1"	APTA 48 ()		61.	
		60"	5"	1"	APTA 60 ()		74.	
		72"	5"	1"	APTA 72 ()		126.	
flat, low profile		48"	5"	1"	APTL 48 ()	87.		87.
		60"	5"	1"	APTL 60 ()	110.		110.
		72"	5"	1"	APTL 72 ()	132.		132.
		96"	5"	1"	APTL 96 ()	177.		177.
		120"	5"	1"	APTL 120 ()	n/a		220.
(finish default AA, anodized aluminum)								
flat, high profile		48"	5"	1 1/4"	APTH 48 ()	87.		87.
		60"	5"	1 1/4"	APTH 60 ()	110.		110.
		72"	5"	1 1/4"	APTH 72 ()	132.		132.
		96"	5"	1 1/4"	APTH 96 ()	177.		177.
		120"	5"	1 1/4"	APTH 120 ()	n/a		220.
(finish default AA, anodized aluminum)								

Order Code	Specification Information	Application
Example: APRA 480 AA		
APR A Base trim	Service Wall crown pattern numbers begin with APT- (standard) and APTA- (compact) prefix, then frame width.	Crown, base trim, and structural base covers are required for every wall frame in corresponding widths. Covers are specified in pairs to cover both sides of a frame.
48 Width		
0 Outlet openings	Standard crown covers are available in painted finish. Please specify painted finish from paint options listed on page 8.	Crown top caps are optional fillers for the crown where no add-up panels are planned. Standard crown end caps are included with all connectors. Compact crown end caps must be ordered individually or in kits of 10.
AA Finish	Compact crown covers are available in Integral light grey (812 Easy grey) or dark grey (813 Trim grey) plastic.	Specify painted finish for standard crown end caps.
	Flat crown covers are available in clear anodized aluminum or painted finish options listed on page 8 excluding silver.	Specify light grey (812 Easy Grey) or dark grey (813 Trim Grey) integral color for crown top cap and Sloped compact crown end cap.
	Base trim covers begin with APRA- prefix, then frame width. Base trim covers are available in clear anodized aluminum or painted finish options listed on page 8 excluding silver.	Flat crown end caps in corresponding low or high profile are ordered separately as individual units.
		Flat crown end caps are required for all connectors except flat ends.

description	type	w	d	h	pattern number	paint	list	anodized alum
	no outlets	48"	–	4"	APRA 480 ()	\$149.		\$149.
		60"	–	4"	APRA 600 ()	178.		178.
		72"	–	4"	APRA 720 ()	214.		214.
		24"	2"	–	APT1 C24 ()		9.	
		36"	2"	–	APT1 C36 ()		17.	
		48"	2"	–	APT1 C48 ()		29.	
		60"	2"	–	APT1 C60 ()		32.	
		72"	2"	–	APT1 C72 ()		39.	
integral color only, plastic								
		24"	2"	–	APTA C24 ()	32.		32.
		36"	2"	–	APTA C36 ()	39.		39.
		48"	2"	–	APTA C48 ()	47.		47.
		60"	2"	–	APTA C60 ()	53.		53.
		72"	2"	–	APTA C72 ()	65.		65.
default finish AA, anodized aluminum								
	standard (replacement part)				APT ()		5.	
		compact			APTA CC1 ()		15.	
		compact (kit of 10)				APTA CC ()		127.

Spine and linkable screens

Order Code	Specification Information	Application
Example: APRA 480 AA APR A Base trim 48 Width 0 Outlet openings AA Finish	<p>Service Wall crown pattern numbers begin with APT- (standard) and APTA- (compact) prefix, then frame width.</p> <p>Standard crown covers are available in painted finish. Please specify painted finish from paint options listed on page 8.</p> <p>Compact crown covers are available in Integral light grey (812 Easy grey) or dark grey (813 Trim grey) plastic.</p> <p>Flat crown covers are available in clear anodized aluminum or painted finish options listed on page 8 excluding silver.</p> <p>Base trim covers begin with APRA- prefix, then frame width. Base trim covers are available in clear anodized aluminum or painted finish options listed on page 8 excluding silver.</p>	<p>Crown, base trim, and structural base covers are required for every wall frame in corresponding widths. Covers are specified in pairs to cover both sides of a frame.</p> <p>Crown top caps are optional fillers for the crown where no add-up panels are planned. Standard crown end caps are included with all connectors. Compact crown end caps must be ordered individually or in kits of 10.</p> <p>Specify painted finish for standard crown end caps.</p> <p>Specify light grey (812 Easy Grey) or dark grey (813 Trim Grey) integral color for crown top cap and Sloped compact crown end cap.</p>
		<p>Flat crown covers in high profile are designed for 48" h spine to align with attached AutoStrada 49" h panels. In all other applications, specify low profile crown covers.</p> <p>Flat crown end caps in corresponding low or high profile are ordered separately as individual units.</p> <p>Flat crown end caps are required for all connectors except flat ends.</p>

description	type	w	d	h	pattern number	paint	list	anodized alum
Crown end cap, metal	flat, low profile				APTL ()		\$37.	
						specify painted finish		
	flat, high profile				APTH ()		\$37.	
						specify painted finish		

Order Code	Specification Information	Application
Example: APRA 480 AA		
APR A Base trim	Service Wall crown pattern numbers begin with APT- (standard) and APTA- (compact) prefix, then frame width.	Crown, base trim, and structural base covers are required for every wall frame in corresponding widths. Covers are specified in pairs to cover both sides of a frame.
48 Width		
0 Outlet openings	Standard crown covers are available in painted finish. Please specify painted finish from paint options listed on page 8.	Crown top caps are optional fillers for the crown where no add-up panels are planned. Standard crown end caps are included with all connectors. Compact crown end caps must be ordered individually or in kits of 10.
AA Finish	Compact crown covers are available in Integral light grey (812 Easy grey) or dark grey (813 Trim grey) plastic. Flat crown covers are available in clear anodized aluminum or painted finish options listed on page 8 excluding silver. Base trim covers begin with APRA- prefix, then frame width. Base trim covers are available in clear anodized aluminum or painted finish options listed on page 8 excluding silver.	Specify painted finish for standard crown end caps. Specify light grey (812 Easy Grey) or dark grey (813 Trim Grey) integral color for crown top cap and Sloped compact crown end cap.

Structural base cover kits

Painted steel surface (pair)

description	type	width	depth	height	pattern number	paint
Structural base covers (pair)	painted steel	48"	1"	16"	APCA AZ48S()	\$295.
		60"	1"	16"	APCA AZ60S()	343.
		72"	1"	16"	APCA AZ72S()	406.

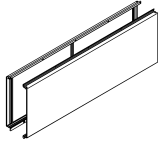

Order Code

Example: APCA AZ48S 118	
APCA	Autostrada wall cover
AZ	Attachment zone
48	Width
S	Steel
118	Finish

Specification Information

Structural base cover kit pattern numbers begin with APCA AZ prefix, then cover width.

Starting at tenth position specify paint finish

Please specify painted finish for structural base covers from paint options listed on page 8.

Application Notes

Structural base covers are required for every wall frame in corresponding widths. Covers are specified in pairs to cover both sides of a frame.

Structural base covers bolt to each side of the wall frame up to 21"H for structure and continuous attachment capability.

Structural base cover kits

Veneer and laminate surface (pair)

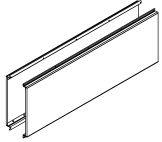

description	type	width	depth	height	pattern number	L	V1	V2	V3
Structural base covers (pair)	anodized aluminum or painted trim	48"	1"	16"	APCA AZ48 () ()	\$837.	\$943.	\$1,024.	\$1,392.
		60"	1"	16"	APCA AZ60 () ()	925.	1,030.	1,125.	1,575.
		72"	1"	16"	APCA AZ72 () ()	961.	1,054.	1,182.	1,715.



Order Code	Specification Information	Application Notes
Example: APCA AZ48 V312 AA		
APCA AutoStrada wall cover	Structural base cover kit pattern numbers begin with APCA AZ prefix, then cover width.	Please specify laminate, V1, V2 or V3 finish from finish options listed on page 8.
AZ Attachment zone	Starting at ninth position specify laminate, veneer or techwood finish	
48 Width	Product on this page will accept wood grain laminate where laminate is currently an option.	Structural base covers are required for every Service Wall frame in corresponding widths. Covers are specified in pairs to cover both sides of a Service Wall. Structural base covers bolt to each side of the Service Wall frame up to 21"H for structure and continuous attachment capability.
V312 Cover finish	Laminated and veneer covers have an anodized aluminum or painted trim at the top and bottom of each cover. Painted finish options listed on page 8 excluding silver.	
AA Trim finish		

Access covers

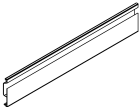
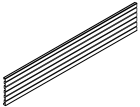
Slatwall, cable tray and outlets covers

description	height	depth	width	pattern number	list	textured
9"H cable tray covers 	9"	1"	12"	APCA 0912 C ()	\$84.	
		1"	24"	APCA 0924 C ()	101.	
		1"	36"	APCA 0936 C ()	116.	
		1"	48"	APCA 0948 C ()	153.	
		1"	60"	APCA 0960 C ()	195.	
		1"	72"	APCA 0972 C ()	237.	
9"H slatwall covers 	9"	1"	12"	APCA 0912 S ()	74.	
		1"	24"	APCA 0924 S ()	86.	
		1"	36"	APCA 0936 S ()	104.	
		1"	48"	APCA 0948 S ()	133.	
		1"	60"	APCA 0960 S ()	169.	
		1"	72"	APCA 0972 S ()	206.	
Outlets cover 	9"	1"	12"	APCA OC () ()		83.

Order Code	Specification Information	Application Notes
Example: APCA 0948C AA APCA Autostrada wall cover 09 Height 48 Width C Type AA Finish	<p>Cable tray and slatwall covers are aluminum with an anodized or painted finish.</p> <p>Outlets covers are painted plastic with anodized aluminum or painted extrusion on the top and bottom.</p> <p>Please specify painted finish for outlets cover face from paint options listed on page 8.</p>	<p>Cable tray mounts from 21" - 30" only on any Service Wall frame. Adjacent trays form continuous, easily accessible cable management at worksurface or table height. Shorter segments provide local cable management below outlet modules. Covers may span across a straight Service Wall frame connection.</p> <p>Bottom half of cable tray cover permits cables to be managed on surface of studs with one cable holder (55 CAT5 cables) or two clips (28 cables).</p> <p>Slatwall supports KnollExtra task lights, monitor arms, paper trays, file holders and other accessories.</p> <p>Slatwall covers will support flat panel monitor arms with varying weight limitations based on mounting and application. Please refer to the KnollExtra price list for comprehensive mounting and weight limitation information by application.</p>
		<p>Locate outlets covers on Service Wall frames before specifying other Service Wall covers.</p> <p>Outlets cover mounts between 21" and 30" (below standard desk height), 30" - 39" (above desk height) or 39" - 48" on Service Wall frame.</p> <p>Outlets cover is 12" wide, and mounts anywhere on Service Wall frame between 21" and 48" above the floor. Outlets cover corresponds to power components (specified separately) mounted on Service Wall frame.</p> <p>Outlets covers have four openings for power or PDC outlets. Specify outlet fillers for unused outlet openings in cover.</p>

Access covers

Hardwire outlets and covers

description	height	depth	width	pattern number	list
Hardwire outlets cover	9"	1"	12"	APCA HOC () ()	\$81.

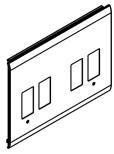

Hardwire outlet box, desk height				AR1 HOB	226.
				AR1 HOB2	298.

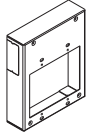

Order Code	Specification Information	Application Notes
Example: APCA HOC 613 AA		
APCA AutoStrada wall cover	Hardwire outlets covers are painted steel with anodized aluminum or painted extrusion top and bottom.	For hardwire power applications (required in City of Chicago) specify hardwire outlets cover and hardwire outlets box, instead of standard outlets covers and modular power components. Do not specify cable tray covers at same level as hardwire power.
H Hardwire		
OC Outlets cover	Please specify painted finish for outlets cover face from paint options listed on page 8.	Hardwire outlet box accepts two Decora-style duplex outlets, and includes mounting brackets for one face of Service Wall between 21" and 48"H. Two quad hardwire outlet box accepts four duplex outlets on one face.
613 Cover Finish		
AA Trim Finish	Painted finish option for hardwire outlets cover trim listed on page 8 excluding silver.	Outlet boxes include openings to permit continuous lay-in wiring with Wiremold® raceway. Electrical contractor supplies infeed cable, Wiremold 2400®, and duplex outlets. Outlet boxes can be planned back to back, with distribution on one side of Service Wall.
		NOTE: Currents cable tray access covers and all AutoStrada access covers cannot be used in the same 9"H zone as the Wiremold raceway as the Wiremold will not fit behind the covers.
		Outlets covers have four openings for power or PDC outlets. Specify outlet fillers for unused outlet openings in cover.

Access covers

Integral shelf

Spine and linkable screens

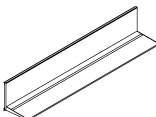
description	height	width of shelf	pattern number	list	L	V1	V2	V3
Integral shelf covers 	9"	21"	APSA 0921 ()()		\$643.	\$708.	\$722.	\$770.
		24"	APSA 0924 ()()		643.	708.	722.	770.
		33"	APSA 0933 ()()		729.	796.	811.	878.
		36"	APSA 0936 ()()		729.	796.	811.	878.
		45"	APSA 0945 ()()		781.	853.	873.	957.
		48"	APSA 0948 ()()		781.	853.	873.	957.
		57"	APSA 0957 ()()		864.	939.	960.	1,061.
		60"	APSA 0960 ()()		864.	939.	960.	1,061.
		69"	APSA 0969 ()()		930.	1,008.	1,031.	1,149.
	72"	APSA 0972 ()()		930.	1,008.	1,031.	1,149.	
	16"	21"	APSA 1621 ()()		658.	720.	738.	819.
		24"	APSA 1624 ()()		658.	720.	738.	819.
		33"	APSA 1633 ()()		740.	808.	833.	945.
		36"	APSA 1636 ()()		740.	808.	833.	945.
		45"	APSA 1645 ()()		804.	875.	902.	1,047.
		48"	APSA 1648 ()()		804.	875.	902.	1,047.
		57"	APSA 1657 ()()		891.	966.	998.	1,177.
		60"	APSA 1660 ()()		891.	966.	998.	1,177.
		69"	APSA 1669 ()()		958.	1,036.	1,074.	1,281.
72"	APSA 1672 ()()		958.	1,036.	1,074.	1,281.		

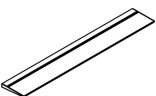
Integral shelves 	21"	ADS 0821 ()	377.
	24"	ADS 0824 ()	377.
	33"	ADS 0833 ()	432.
	36"	ADS 0836 ()	432.
	45"	ADS 0845 ()	477.
	48"	ADS 0848 ()	477.
	57"	ADS 0857 ()	535.
	60"	ADS 0860 ()	535.
	69"	ADS 0869 ()	582.
72"	ADS 0872 ()	582.	

Order Code	Specification Information	Application Notes
Example: APSA 0948 118 AA		
APSA Autostrada integral shelf cover	Please specify laminate, V1, V2 or V3 finish for Service Wall cover from finish options listed on page 8.	Service Wall covers enclose frames between 21"H and the top crown. Covers may be specified in any combination of widths corresponding to the total Service Wall length. Covers may span across a straight Service Wall frame connection.
09 Height	Product on this page will accept wood grain laminate where laminate is currently an option.	Integral shelves may be added to any laminate, marker or veneer spine cover. Holes for fasteners must be drilled through bottom extrusion and cover on site.
48 Width	Shelf is extruded aluminum with an anodized or painted finish.	
118 Cover Ffinish	Painted finish option for integral shelf cover trim and integral shelf listed on page 8excluding silver.	The integral shelf cover features a full width 8" deep display shelf crafted in anodized or painted aluminum. The cover is also available with a shelf that is 3" less wide than full module to accommodate a panel connected to the Service Wall.
AA Shelf and Trim Finish		

Access covers
Laminate, marker and veneer

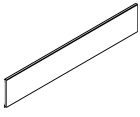
description	height	width	pattern number	L	V1	V2	V3
Access covers 	9"	12"	APCA 0912 () ()	\$300.	\$353.	\$368.	\$407.
		24"	APCA 0924 () ()	318.	371.	388.	464.
		36"	APCA 0936 () ()	352.	404.	428.	531.
		48"	APCA 0948 () ()	365.	418.	448.	577.
		60"	APCA 0960 () ()	394.	448.	486.	644.
		72"	APCA 0972 () ()	412.	470.	508.	695.
	16"	12"	APCA 1612 () ()	305.	361.	381.	452.
		24"	APCA 1624 () ()	331.	384.	412.	537.
		36"	APCA 1636 () ()	368.	421.	459.	629.
		48"	APCA 1648 () ()	388.	441.	487.	708.
		60"	APCA 1660 () ()	429.	482.	536.	806.
		72"	APCA 1672 () ()	452.	505.	569.	888.
	18"	12"	APCA 1812 () ()	311.	362.	382.	462.
		24"	APCA 1824 () ()	338.	387.	419.	559.
		36"	APCA 1836 () ()	372.	425.	467.	661.
		48"	APCA 1848 () ()	399.	451.	501.	747.
		60"	APCA 1860 () ()	437.	488.	547.	852.
		72"	APCA 1872 () ()	463.	521.	587.	947.
	27"	12"	APCA 2712 () ()	321.	377.	400.	521.
		24"	APCA 2724 () ()	355.	411.	451.	651.
		36"	APCA 2736 () ()	406.	462.	519.	801.
48"		APCA 2748 () ()	436.	489.	556.	918.	
60"		APCA 2760 () ()	485.	539.	620.	1,068.	
72"		APCA 2772 () ()	519.	572.	665.	1,196.	

Order Code	Specification Information	Application Notes
Example: APCA 0948 V312 AA APCA Autostrada wall cover 09 Height 48 Width V312 Cover Finish AA Trim Finish	Please specify laminate, V1, V2 or V3 finish for access covers from finish options listed on page 8. Product on this page will accept wood grain laminate where laminate is currently an option. Specify finish code: LW for markerboard surface. Painted finish option for trim listed on page 8 excluding silver.	Service Wall covers enclose frames between 21"H and the top crown. Covers may be specified in any combination of widths corresponding to the total Service Wall length. Covers may span across a straight Service Wall frame connection. For active surfaces with access to cables and power/data/communications outlets, specify 9" and 16"H segmented covers as described in Specification Information.

Access covers

Tackable upholstered

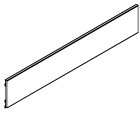



description	height	depth	width	pattern number	10	15	20	30	35	40	45	50	55
	9"	1"	12"	APCA 0912 A () ()	\$126.	\$128.	\$129.	\$133.	\$137.	\$141.	\$146.	\$153.	\$161.
		1"	24"	APCA 0924 A () ()	154.	156.	157.	161.	163.	169.	170.	175.	189.
		1"	36"	APCA 0936 A () ()	170.	174.	175.	181.	183.	188.	189.	193.	204.
		1"	48"	APCA 0948 A () ()	192.	196.	197.	199.	204.	206.	207.	215.	225.
		1"	60"	APCA 0960 A () ()	206.	209.	214.	217.	221.	225.	230.	232.	243.
		1"	72"	APCA 0972 A () ()	n/a	231.	n/a	n/a	n/a	n/a	n/a	n/a	n/a
	16"	1"	12"	APCA 1612 A () ()	135.	140.	142.	153.	158.	162.	169.	178.	199.
		1"	24"	APCA 1624 A () ()	174.	181.	182.	192.	199.	205.	207.	220.	243.
		1"	36"	APCA 1636 A () ()	193.	199.	203.	209.	220.	225.	231.	240.	264.
		1"	48"	APCA 1648 A () ()	216.	222.	224.	234.	242.	247.	250.	262.	286.
		1"	60"	APCA 1660 A () ()	237.	242.	243.	252.	261.	270.	273.	283.	305.
		1"	72"	APCA 1672 A () ()	n/a	262.	n/a	n/a	n/a	n/a	n/a	n/a	n/a
	18"	1"	12"	APCA 1812 A () ()	151.	155.	157.	168.	174.	182.	186.	196.	220.
		1"	24"	APCA 1824 A () ()	176.	182.	186.	196.	203.	207.	214.	222.	246.
		1"	36"	APCA 1836 A () ()	197.	203.	205.	215.	222.	231.	233.	242.	268.
		1"	48"	APCA 1848 A () ()	241.	244.	247.	259.	265.	274.	275.	286.	313.
		1"	60"	APCA 1860 A () ()	241.	244.	247.	259.	265.	274.	275.	286.	313.
		1"	72"	APCA 1872 A () ()	n/a	268.	n/a	n/a	n/a	n/a	n/a	n/a	n/a
	27"	1"	12"	APCA 2712 A () ()	169.	177.	182.	197.	206.	217.	222.	239.	274.
		1"	24"	APCA 2724 A () ()	198.	206.	214.	225.	239.	247.	250.	268.	303.
1"		36"	APCA 2736 A () ()	221.	232.	237.	247.	261.	273.	275.	290.	328.	
1"		48"	APCA 2748 A () ()	246.	256.	262.	275.	286.	295.	300.	317.	353.	
1"		60"	APCA 2760 A () ()	272.	282.	284.	298.	312.	319.	325.	339.	374.	
1"		72"	APCA 2772 A () ()	n/a	300.	n/a	n/a	n/a	n/a	n/a	n/a	n/a	

Spine and linkable screens

Order Code	Specification Information	Application Notes
<p>Example: APCA 0948A W210 AA</p> <p>APCA Autostrada wall cover</p> <p>09 Height</p> <p>48 Width</p> <p>A Surface type</p> <p>W210 Fabric</p> <p>AA Trim Finish</p>	<p>For active face of 39"H Service Wall frame, specify two 9"H covers. For passive face (along corridor or wall) specify one 18" cover.</p> <p>For active face of 48"H Service Wall frame, specify three 9"H covers or one 9"H and one 18"H cover. For passive face, specify 27"H cover.</p> <p>For active face of 64"H Service Wall frame, specify three 9"H covers and one 16"H cover or one 9"H, one 18"H, and one 16"H cover. For passive face, specify one 27" and one 16"H cover.</p> <p>For full fabric surface between 5" and 21", order upholstered attachment zone cover.</p> <p>Surface type: A tackable upholstered</p>	<p>Tackable upholstered Service Wall covers enclose Service Wall frames between 21" and the top crown. Covers incorporate a tackable, acoustical core in the same outward profile as other upholstered covers. Specify widths corresponding to Service Wall frame width, or in any 12" increment to accommodate 12"W outlets covers or slatwall covers. Covers may span across a straight Service Wall frame connection. For active surfaces with access to cables and power/data/communications outlets, specify 9" and 16"H segmented covers as described in Specification Information.</p> <p>For passive Service Wall surfaces (corridors or conference areas) specify 18"H or 27"H covers in place of two or three 9"H covers.</p> <p>18"H covers may also be specified above 9"H covers including outlets covers below desk height on 48" or 64"H Service Walls.</p> <p>Service Wall with upholstered tackable covers has been tested to NRC .40 and STC 22.</p> <p>When ordering 60" or wider covers, please check width of fabric specified. In which cases fabric will need to be applied railroaded. Contact CPD.</p>

Spine ends and connectors





Flat ends

description	type	height	depth	pattern no.	painting
Flat end	standard crown 	39"	5"	AX1A F39 () ()	\$121.
		48"	5"	AX1A F48 () ()	137.
		64"	5"	AX1A F64 () ()	153.
	compact crown 	39"	5"	AX1A C39 ()	121.
		48"	5"	AX1A C48 ()	137.
		64"	5"	AX1A C64 ()	153.
	low profile flat crown 	39"	5"	AX1A EL39 ()	121.
		48"	5"	AX1A EL48 ()	137.
		64"	5"	AX1A EL64 ()	151.
high profile flat crown 	39"	5"	AX1A EH39 ()	121.	
	48"	5"	AX1A EH48 ()	137.	
	64"	5"	AX1A EH64 ()	151.	

Order Code	Specification Information	Application Notes
Example: AX1A C48 118	For flat ends specify:	Flat end finishes end of corresponding height Service Wall when end of Service Wall is supported by outriggers or perpendicular screens or panels. Flat ends include end cover for compact crown or standard crown, as specified.
AX1A AutoStrada connector	<i>Starting seventh position:</i> painted finish for outside trim cover and raceway cover	
C Type	<i>Starting eleventh position:</i> painted finish for crown end cap	
48 Height	Please specify painted finishes from paint finish options listed on page 8.	High-low straight connectors join Service Wall of different heights in a straight line.
118 vertical cover finish		Straight connector is replacement hardware kit to join Service Wall frames of the same height end to end. Kit includes four barrel-shape connectors and hardware.

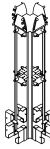
Spine ends and connectors

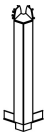
Corner, T, X, V and Y connections

description	type	height	width	depth	pattern number	list
90° connector	T connector 	39"	6"	7"	AX1A T39 () ()	\$393.
		48"	6"	7"	AX1A T48 () ()	471.
		64"	6"	7"	AX1A T64 () ()	551.
	X connector 	39"	7"	7"	AX1A X39 ()	393.
		48"	7"	7"	AX1A X48 ()	428.
		64"	7"	7"	AX1A X64 ()	472.
	L connector 	39"	6"	6"	AX1A L39 () ()	393.
		48"	6"	6"	AX1A L48 () ()	472.
		64"	6"	6"	AX1A L64 () ()	551.
120° connector	V connector 	39"	5 1/2"	5 1/2"	AX1A V39 () ()	393.
		48"	5 1/2"	5 1/2"	AX1A V48 () ()	472.
		64"	5 1/2"	5 1/2"	AX1A V64 () ()	551.
	Y connector 	39"	6 1/2"	5 1/2"	AX1A Y39 () ()	393.
		48"	6 1/2"	5 1/2"	AX1A Y48 () ()	472.
		64"	6 1/2"	5 1/2"	AX1A Y64 () ()	551.

Order Code

Example: AX1A L48 118
AX1A AutoStrada connector
L Type
48 Height
118 vertical cover finish

Specification Information

For L, T, V and Y connectors specify:

Seventh position:
painted finish for vertical trim cover and raceway cover

Eighth position, and X connectors:
painted finish for top cap and standard crown end caps

Please specify painted finish as applicable from paint options listed on page 8.

Application Notes

L, T, and X connectors join Service Wall frames at 90° angles and include vertical trim covers, top cap and standard crown end caps, and one spare set of straight connectors.

When ordering connectors for the Service Wall with compact crown, specify crown end caps separately.

V and Y connectors join Service Wall frames at 120° angles and include vertical trim covers, topcap and standard crown end caps.

Spine ends and connectors

Outriggers and spine starters

description	type	height	width	depth	pattern number	list
Outrigger 	deep	21"	3"	15"	AA1ORD()	\$186.
	standard	21"	3"	8"	AA1OR()	135.
Service Wall starter	39"	39"		2"	AX1 SWS39 ()	121.
	48"	48"		2"	AX1 SWS48 ()	135.
	64"	64"		2"	AX1 SWS64 ()	155.
Straight connector kit (replacement)		–	–	–	AX1 S	25.
High low straight connector for spine with standard crown only	48 - 39"	48"		5"	AX1 HLS4839 ()()	214.
	64 - 39"	64"		5"	AX1 HLS6439 ()()	363.
	64 - 48"	64"		5"	AX1 HLS6448 ()()	244.

Order Code

Example: AA1 ORD 118
AA1 Accessory
ORD Outrigger deep
118 Finish

Specification Information

Please specify painted finish as applicable from finish options listed on page 8.



Application Notes

Outrigger connects to structural base cover at any point. Outriggers (or perpendicular systems panels) are required every 8' and adjacent to flat end for adequate support. Specify deep outriggers when cantilevering 24"D worksurfaces without adjacent perpendicular systems panels or spine wall connectors.

Service Wall starter connects Service Wall to building wall.

Spine end connectors for linkable screens and Morrison panels

Spine and linkable screens

description	application	h	w	d	pattern no.	list
 Spine end connector	39"h spine	39"	5"	1/2"	AX1SEC3939 () () ()	\$259.
	48"h spine	48"	5"	1/2"	AX1SEC4848 () () ()	272.
	64"h spine	64"	5"	1/2"	AX1SEC6464 () () ()	325.
Spine end connector to top of compact 1"h crown	39"h spine	40"	5"	1/2"	AX1SEC4039 L () ()	259.
	48"h spine	49"	5"	1/2"	AX1SEC4948 L () ()	272.
	64"h spine	65"	5"	1/2"	AX1SEC6564 L () ()	325.
 Spine end connector to top of Currents 4"h crown	39"h spine	43"	5"	1/2"	AX1SEC4339 C () ()	259.
	48"h spine	52"	5"	1/2"	AX1SEC5248 C () ()	272.
	64"h spine	68"	5"	1/2"	AX1SEC6864 C () ()	325.
Inside base trim cover for Currents raceway		4"	5"		AX1SECBT ()	51.

Order Code	Specification Information	Application Notes
Example: AX1 SEC 3939 L 613 613 812 AX1 Spine connector SEC Type 39 Connector height 39 Spine height L Crown type 613 Crown end cap finish 613 Vertical cover finish 812 Top cap finish	For spine end connectors specify: 1.Crown type C=Currents standard 4"h L=low profile flat 1" H=high profile flat 1 1/4" F=compact crown 1" 2.Crown end cap finish Standard, low and high profile flat and compact crown end caps are available in all standard paint finishes and 813 Trim Grey. Compact crown end caps are also available in 812 Easy Grey. 3.Vertical cover finish: All standard paint finishes 4.Top cap for vertical cover: 812=Easy Grey 813=Trim Grey And all standard paint finishes Spine end connectors on this page align with spine base covers ^{13/16"} above the floor.	Spine end connectors are complete vertical cover and top trim for the end of an AutoStrada or Currents spine. Side edges of end connectors accept end starters for linkable screens and other systems panels of the same height or lower. Spine end connectors include painted aluminum cover with beveled top cap and the specified flat, compact, or standard crown end cap. Spine end connectors to top of compact crown are a visual alternative that replaces the crown end cap with a taller aluminum end cover and flat top cap. Spine end connectors to top of Currents crown are recommended when attaching any end started panel that is between the nominal height of the spine and the actual height with crown, such as 42"h panel to 39"h spine with 4"h crown. Spine end connectors to top of Currents crown enclose the end of spine and standard crown and include flat top cap and inside top trim cover.

Spine ends and connectors
*High-low spine end connectors
 for linkable screens and Morrison panels*

description	application	h	w	d	pattern no.	list
 Spine end connector	42" h panel/39" h spine	39"	5"	1/2"	AX1SEC4239 () ()	\$259.
	48" h panel/39" h spine	48"	5"	1/2"	AX1SEC4839 () ()	272.
	56" h panel/39" h spine	56"	5"	1/2"	AX1SEC5639 () ()	313.
	64" h panel/39" h spine	64"	5"	1/2"	AX1SEC6439 () ()	325.
	56" h panel/48" h spine	56"	5"	1/2"	AX1SEC5648 () ()	313.
	64" h panel/48" h spine	64"	5"	1/2"	AX1SEC6448 () ()	325.
	80" h panel/48" h spine	80"	5"	1/2"	AX1SEC8048 () ()	494.
	80" h panel/64" h spine	80"	5"	1/2"	AX1SEC8064 () ()	473.
Inside base trim cover for Currents raceway		4"	5"		AX1SECBT ()	51.

Order Code

Example:	AX1 SEC 6448 613 812
AX1	Spine connector
SEC	Type
64	Panel height
48	Spine height
613	Painted finish
613	Trim finish

Specification Information

For spine end connectors specify:

- Vertical cover finish:
All standard paint finishes
- Top cap for vertical cover
812=Easy Grey
813=Trim Grey
And all standard painted finishes

Spine end connectors on this page align with spine base covers $1\frac{3}{16}$ " above the floor.

Application Notes

High low spine end connectors are complete end cover and trim for an AutoStrada or Currents spine, when attached panels are taller than the spine. High low spine end connectors match the height of the attached linkable screen or Morrison panel. Side edges of spine end connectors accept end starters for linkable screens and Morrison panels of the same height or lower.

High low spine end connectors include painted aluminum outside cover with flat top cap and inside cover over the end of the spine.

Inside base trim for Currents raceway is recommended to finish inside of any spine end connector when combined with standard Currents recessed base raceway covers. Base trim is not required with AutoStrada spine base covers.

Note: 42" h panel/39" h spine combination (AX1SEC4239) can only be specified with compact or flat crown versions of the spine. For combination of 39" h spine with standard 4" h crown and 42" h panels specify AX1SEC4339C () ().

Spine end connectors for AutoStrada and Reff panels and Gallery screens

description	application	h	w	d	pattern no.	list
Spine end connector	34" panel or 39" screen/39"h spine	39"	5"	1/2"	AX1SEA3939 () () ()	\$259.
	34"-42" panel or 39"-49" screen/48"h spine	48"	5"	1/2"	AX1SEA4848 () () ()	272.
	34"-49" panel or screen/64"h spine	64"	5"	1/2"	AX1SEA4964 () () ()	325.
	42" panel/39"h spine + 1 1/4" crown	42"	5"	1/2"	AX1SEA4239 () ()	259.
	42" panel/39"h spine + 4" crown	43"	5"	1/2"	AX1SEA4339 C () ()	259.
	49" panel /39" spine	49"	5"	1/2"	AX1SEA4939 () ()	272.
	49" panel or screen/48"h spine + 1 1/4" crown	49"	5"	1/2"	AX1SEA4948 () ()	286.
	49" panel or screen/48"h spine + 4" crown	52"	5"	1/2"	AX1SEA5248 C () ()	272.
	64" panel/39"h spine	64"	5"	1/2"	AX1SEA6439 () ()	325.
	64" panel/48"h spine	64"	5"	1/2"	AX1SEA6448 () ()	325.
	64" panel/64"h spine + 1 1/4" crown	65"	5"	1/2"	AX1SEA6464 () ()	325.
	64" panel/64"h spine + 4" crown	68"	5"	1/2"	AX1SEA6864 C () ()	325.
	79" panel/48"h spine	79"	5"	1/2"	AX1SEA7948 () ()	494.
	79" panel/64"h spine	79"	5"	1/2"	AX1SEA7964 () ()	473.
Inside base trim cover for Currents raceway		4"	5"		AX1SECBT ()	51.

Spine and linkable screens

Order Code	Specification Information	Application Notes
Example: AX1 SEA 4239 613 613 812 <hr/> AX1 Spine connector <hr/> SEA Type <hr/> 42 Panel height <hr/> 39 Spine height <hr/> 613 Painted finish <hr/> 613 Trim finish <hr/> 812 Top trim finish	For spine end connectors when panels are lower than spine specify crown type and finish for crown end cap. 1. Crown type: C=Currents standard 4"h L=low profile flat 1"h H=high profile flat 1 1/4"h F=compact 1"h 2. All crown end caps are available in all painted finishes. For all spine end connectors specify vertical cover and top trim finish. 3. Vertical cover finish: All standard paint finishes 4. Top trim for vertical cover: 812=Easy Grey 813=Trim Grey And all standard paint finishes End connectors on this page begin 1/2" above floor.	Spine end connectors are complete end cover and trim for an AutoStrada or Currents spine. Side edges of spine end connectors accept end starters for AutoStrada or Reff panels or Gallery screens. In most cases spine end connectors match the height of the attached panel. When attached panel is lower than the spine, the spine end connector is as high as the nominal height of the spine and the crown requires an end cap. When attached panel is between the nominal height of the spine and the top of the Currents 4"h crown, spine end connector must cover the entire height of the spine with crown. Spine end connectors include painted outside cover with flat top cap and inside cover (where applicable) over the end of the spine. Inside base trim for Currents raceway is recommended to finish inside when combined with standard Currents recessed base raceway covers. Base trim is not required with AutoStrada spine base covers.

Spine end connectors for Dividends Horizon panels and screens

description	application	h	w	d	pattern no.	list
Spine end connector	36"h panel/39"h spine	39"	5"	1/2"	AX1SED3939 () () ()	\$259.
	36"h-42"h panel/ 48"h spine	48"	5"	1/2"	AX1SED4848 () () ()	272.
	36"h-64"h panel/ 64"h spine	64"	5"	1/2"	AX1SED6464 () () ()	325.
	42"h panel/ 39"h spine + 1" crown	42"	5"	1/2"	AX1SED4239 () ()	259.
	42"h panel/ 39"h spine + 4" crown	43"	5"	1/2"	AX1SED4339C () ()	259.
	50"h panel/ 39"h spine	50"	5"	1/2"	AX1SED5039 () ()	272.
	50"h panel/ 48"h spine + 1" crown	50"	5"	1/2"	AX1SED5048 () ()	286.
	50"h panel/ 48"h spine + 4" crown	52"	5"	1/2"	AX1SED5248C () ()	272.
	57"h panel/ 39"h spine	57"	5"	1/2"	AX1SED5739 () ()	313.
	57"h panel/ 48"h spine	57"	5"	1/2"	AX1SED5748 () ()	313.
	64"h panel/ 39"h spine	64"	5"	1/2"	AX1SED6439 () ()	325.
	64"h panel/ 48"h spine	64"	5"	1/2"	AX1SED6448 () ()	325.
	78"h panel/ 48"h spine	78"	5"	1/2"	AX1SED7848 () ()	494.
78"h panel/ 64"h spine	78"	5"	1/2"	AX1SED7864 () ()	473.	
Inside base trim cover for Currents raceway		4"	5"		AX1SECBT ()	51.

Order Code	Specification Information	Application Notes
Example: AX1 SED 6448 613 812	For spine end connectors with panel lower than spine specify crown type and finish for crown end cap. 1. Crown type: C=Currents standard 4"h L=low profile flat 1"h H=high profile flat 1 1/4"h F=compact 1"h 2. All crown end caps are available in all painted finishes. For all spine end connectors specify vertical cover and top trim finish: 3. Vertical cover finish: All standard paint finishes 4. Top cap for vertical cover: 812=Easy Grey 813=Trim Grey And all standard painted finishes	Spine end connectors are complete end cover and trim for an AutoStrada or Currents spine. Side edges of spine end connectors accept end starters for Dividends Horizon panels and screens. In most cases spine end connectors match the height of the attached Dividends Horizon panel/screen. When attached panel/screen is lower than the spine, the spine end connector is as high as the nominal height of the spine and the crown requires an end cap. Specify low profile flat metal crown covers to align with a 50"h Dividends Horizon panel/screen.
AX1 Spine connector		
SED Type		
64 Panel height		
48 Spine height		
613 Vertical cover finish		
812 Top cap finish	When attached panel/screen is between the nominal height of the spine and the top of the Currents 4"h crown, spine end connector must cover the entire height of the spine with crown. Spine end connectors include painted aluminum outside cover with flat top cap and inside cover (where applicable) over the end of the spine. Inside base trim for Currents raceway is recommended to finish inside when combined with standard Currents recessed base raceway covers. Base trim is not required with AutoStrada spine base covers.	



End connectors on this page begin 1/2" above floor.

3 1/2" spine extender kit for use with ceiling infeed or panels

description	application	h	w	d	pattern no.	list
Spine extender kit for use with Currents Spine	39"h spine	39"	5"	4"	AX1SX39 C (L/C/P)() ()	\$532.
	48"h spine	48"	5"	4"	AX1SX48 C (L/C/P)() ()	550.
	64"h spine	64"	5"	4"	AX1SX64 C (L/C/P)() ()	650.
Spine extender kit for use with AutoStrada Spine	39"h spine	39"	5"	4"	AX1SX39 A (L/C/P)() ()	650.
	48"h spine	48"	5"	4"	AX1SX48 A (L/C/P)() ()	667.
	64"h spine	64"	5"	4"	AX1SX64 A (L/C/P)() ()	774.

Order Code	Specification Information	Application Notes
Example: AX1 SX 48 AL 613 613	For all 3 1/2" spine extenders specify spine base type:	Spine extenders include brackets, side and top trim covers between the end of a spine and any spine end connector to add 3 1/2" to the length of a spine.
AX1 Spine connector	A AutoStrada C Currents	This extension can also make up for the dimensional gain of one Dividends Horizon panel or screen in the middle of a cluster of workstations.
SX Type		
48 Spine height	Then specify crown end type.	Spine end connector must be specified separately to finish off face of spine extender.
A Spine type	L=Flat low/high profile metal crown end cap C=Standard and compact sloped end cap	
L Crown end type	P=Power Pole	Spine extender dimension matches that of the Currents 3 1/2" x 5" ceiling infeed panel which may be added between nominal spine height and ceiling for connection to building power, data and communications supply.
613 Vertical finish	Then specify finish for vertical trim covers, all standard painted finishes.	In most cases the spine end connector matches the height of the attached Dividends Horizon panel or screen, but the extending area is only as high as the nominal height of the spine (bottom of crown) so the crown always requires an end cap.
613 Base trim finish		
613 Top cap finish	Then specify base cover finish. AutoStrada spine base covers are clear anodized aluminum (AA) or painted finish excluding silver. Currents spine raceway covers are available in any painted finish only.	When attached panel or screen is lower than the spine, the spine end connector should be the same height as the nominal height of the spine.
	Then specify top cap finish (if applicable).	

To attach linkable screens or Morrison panels to spine end connector

description	application	h	w	d	pattern no.	00	02	04
End starters for linkable screens 	30" h screen	25"	1"	1/2" - 4 1/2"	AX1LES30 () ()	\$156.	\$169.	\$181.
	39" h screen	34"	1"	1/2" - 4 1/2"	AX1LES39 () ()	169.	181.	202.
	48" h screen	43"	1"	1/2" - 4 1/2"	AX1LES48 () ()	195.	220.	246.
	64" h screen	59"	1"	1/2" - 4 1/2"	AX1LES64 () ()	229.	265.	304.
End starters for Morrison panels 	30" h panel	30"	1"	1/2" - 4 1/2"	AX1MES30 () ()	162.	169.	181.
	39" h panel	39"	1"	1/2" - 4 1/2"	AX1MES39 () ()	195.	202.	220.
	42" h panel	42"	1"	1/2" - 4 1/2"	AX1MES42 () ()	195.	202.	229.
	48" h panel	48"	1"	1/2" - 4 1/2"	AX1MES48 () ()	202.	207.	236.
	56" h panel	56"	1"	1/2" - 4 1/2"	AX1MES56 () ()	236.	259.	293.
	64" h panel	64"	1"	1/2" - 4 1/2"	AX1MES64 () ()	236.	259.	293.
	80" h panel	80"	1"	1/2" - 4 1/2"	AX1MES80 () ()	337.	388.	467.
End starter top cap for Morrison panel with linkable screen trim	00, 02 or 04 offset		1"	2 1/4"	AX1LES E ()	11.	11.	n/a

Order Code	Specification Information	Application Notes
Example: AX1 LES48 02 613 812	For spine end starters specify:	End starters connect a linkable screen or panel to either side of a spine end connector of the same height or taller.
AX1 Spine connector	1.Configuration	End starters for linkable screens and Morrison panels include connector track and top cap.
L for linkable screens	00=Flush	For Morrison panels that have linkable screen trim also specify end starter linkable screen end cap.
ES End starter	02=Offset one panel	End starters are available in three configurations: flush with end of spine or offset one or two screen/panel thickness beyond end of spine.
48 Panel height	04=Offset two panels	
02 Offset	2.Paint finish for end starter: All standard paint finishes	
613 Painted finish	3.Trim finish for top cap: 812=Easy Grey 813=Trim Grey Or all standard paint finishes for Morrison top cap.	
812 Trim finish	End starters on this page align with spine base covers 13/16" above the floor.	
		For full access to entire width of spine surface specify end starters offset one panel thickness (02 suffix).
		For a cluster of two workstations with one screen or panel between specify one end starter offset two panel thicknesses (04 suffix) and one offset one thickness (02 suffix).
		For a cluster of three workstations (two intermediate panels) specify two end starters offset two panel thicknesses (04 suffix).
		For a cluster of four workstations (three intermediate panels) extend the spine 12" and specify two flush end starters (00 suffix).
		When specifying an end starter top cap for a Morrison panel with linkable screen trim, note that the 02 offset top cap will also work in an 04 offset application.

To attach AutoStrada or Reff panels to spine end connector

description	application	h	w	d	pattern no.	00	02	04
End starters for AutoStrada or Reff panels	34" h panel	34"	1"	1/2" - 4 1/2"	AX1AES34 () () () ()	\$420.	\$420.	\$459.
	42" h panel	42"	1"	1/2" - 4 1/2"	AX1AES42 () () () ()	529.	529.	579.
	49" h panel	49"	1"	1/2" - 4 1/2"	AX1AES49 () () () ()	547.	547.	599.
	64" h panel	64"	1"	1/2" - 4 1/2"	AX1AES64 () () () ()	662.	662.	725.
	79" h panel	79"	1"	1/2" - 4 1/2"	AX1AES79 () () () ()	1,012.	1,012.	1,140.

Spine and linkable screens

Order Code	Specification Information	Application Notes
Example: AX1 AES49 02 24 E 812 AA	For spine end starters specify:	
AX1 Spine connector	1. Configuration 00=Inset flush 02=Offset one panel 04=Offset two panels	End starters connect a panel to either side of a spine end connector of the same height or taller. End starters include hookstrip and top cap. Specify first adjacent panel top cap width and type.
A for AutoStrada panels	2. Adjoining panel width (18, 20, 24, 30, 36, 42, 48)	End starters are available in two configurations: inset flush with end of spine (00) or offset one panel thickness (02) or offset two panel thicknesses (04) beyond end of spine.
ES End starter	3. Trim profile A=Flat B=Square C=Bullnose E=AutoStrada	For a cluster of two workstations (one intermediate panel) specify one end starter offset two panel thicknesses (04 suffix). For a cluster of three workstations (two intermediate panels) specify two end starters offset two panel thicknesses (04). For a cluster of four workstations (three intermediate panels) extend the spine 12" and specify two inset end starters (00 suffix).
49 Panel height	4. Vertical cover finish All standard paint finishes	End starters on this page start 1/2" above the floor.
02 Offset	5. Top trim AutoStrada: AA Clear anodized aluminum and all core paint finishes except silver.	
24 Panel width	Reff: All core paint finishes	
E Trim profile		
812 Vertical cover finish		
AA Top trim finish		

To attach Gallery screens to spine end connector

description	application	height	width	depth	pattern no.	00	01	02
End starters for Gallery screens	39"h or 49"h screen	39"	1"	1/2" - 3"	AX1GES39 () ()	\$192.	\$159.	\$159.
	49"h screen	48"	1"	1/2" - 3"	AX1GES48 () ()	217.	165.	179.

Order Code	Specification Information	Application Notes
Example: AX1GES 48 02 613	For spine end starters specify:	End starters connect a 1" thick Gallery screen to either side of spine end connector of the same height or taller.
AX1 Spine connector	1.Configuration	End starters are available in three configurations: flush with end of spine or offset one or two screen thicknesses beyond end of spine.
G Thin screens	00=Flush	
ES End starter	01=Offset one panel	Offset end starters compensate for the dimensional gain of Gallery screens attached to the spine.
48 Panel height	02=Offset two panels	
02 Offset	2.Finish:	
613 Painted finish	All standard paint finishes	
	End starters on this page start 1/2" above the floor.	

To attach Dividends Horizon panels and screens to spine end connector

description	application	h	w	d	pattern no.	list
End starters for Dividends Horizon panels and screens	36"h panel, flush, left end of Service Wall	36"	1"	3"	AX1DHES3600L(5)()	\$206.
	36"h panel, flush, right end of Service Wall	36"	1"	3"	AX1DHES3600R(5)()	206.
	36"h panel, offset 1 panel thickness, left end of Service Wall	36"	1"	3"	AX1DHES3603L(5)()	206.
	36"h panel, offset 1 panel thickness, right end of Service Wall	36"	1"	3"	AX1DHES3603R(5)()	206.
	42"h panel, flush, left end of Service Wall	42"	1"	3"	AX1DHES4200L(5)()	206.
	42"h panel, flush, right end of Service Wall	42"	1"	3"	AX1DHES4200R(5)()	206.
	42"h panel, offset 1 panel thickness, left end of Service Wall	42"	1"	3"	AX1DHES4203L(5)()	206.
	42"h panel, offset 1 panel thickness, right end of Service Wall	42"	1"	3"	AX1DHES4203R(5)()	206.
	50"h panel, flush, left end of Service Wall	50"	1"	3"	AX1DHES5000L(5)()	206.
	50"h panel, flush, right end of Service Wall	50"	1"	3"	AX1DHES5000R(5)()	206.
	50"h panel, offset 1 panel thickness, left end of Service Wall	50"	1"	3"	AX1DHES5003L(5)()	206.
	50"h panel, offset 1 panel thickness, right end of Service Wall	50"	1"	3"	AX1DHES5003R(5)()	206.
	57"h panel, flush, left end of Service Wall	57"	1"	3"	AX1DHES5700L(5)()	206.
	57"h panel, flush, right end of Service Wall	57"	1"	3"	AX1DHES5700R(5)()	206.
	57"h panel, offset 1 panel thickness, left end of Service Wall	57"	1"	3"	AX1DHES5703L(5)()	206.
	57"h panel, offset 1 panel thickness, right end of Service Wall	57"	1"	3"	AX1DHES5703R(5)()	206.
	64"h panel, flush, left end of Service Wall	64"	1"	3"	AX1DHES6400L(5)()	206.
	64"h panel, flush, right end of Service Wall	64"	1"	3"	AX1DHES6400R(5)()	206.
	64"h panel, offset 1 panel thickness, left end of Service Wall	64"	1"	3"	AX1DHES6403L(5)()	206.
	64"h panel, offset 1 panel thickness, right end of Service Wall	64"	1"	3"	AX1DHES6403R(5)()	206.

Spine and linkable screens

Order Code	Specification Information	Application Notes
Example: AX1 DHES 36 00 L (5)	1. Offset	End starters connect a Dividends Horizon panel or screen to either side of a same height or taller spine end connector. End starters for Dividends Horizon panels and screens include specified end top cap.
AX1 Spine connector	00=Flush	
DH Dividends Horizon	03=Offset 1 panel thickness	End starters may be positioned in either of two configurations: flush with end of spine or offset one panel thickness beyond end of spine. For full access to entire width of spine surface, position end starters offset one panel thickness.
ES End starter	2. Top cap type	
36 Panel height	5=Metal flat	For a single workstation (0 intermediate panels), specify 2 spine end connectors and 2 end starters positioned offset by 1 panel thickness. For a cluster of 2 workstations (1 intermediate panel), specify 1 panel starter, 2 spine end connectors, 1 spine extender, and 2 end starters positioned offset by 1 panel thickness. For a cluster of 3 workstations, (2 intermediate panels), extend the spine another 12", specify 2 panel starters, 2 spine end connectors, and 2 end starters positioned flush. For a cluster of 4 workstations (3 intermediate panels), extend the spine 12" and specify 3 panel starters, 2 spine end connectors, and 2 end starters (1 end starter flush and the other offset by 1 panel thickness). For a cluster of 5 workstations (4 intermediate panels) extend the spine by 12" and specify 4 panel starters, 2 spine end connectors, and 2 end starters positioned offset by 1 panel thickness.
00 Offset	3. Paint finish	
5 Top cap type	All standard paint finishes	
613 Painted finish		

Panel system starters and T-ends

Linkable screen panel starters

description	type	width	depth	height	pattern number	paint	
	Morrison and linkable screen panel starters	30"H panel	4"	1"	26"	AA1MPS30()	\$121.
	39"H panel/screen	4"	1"	35"	AA1MPS39()	121.	
	42"H panel	4"	1"	38"	AA1MPS42()	121.	
	48"H panel/screen	4"	1"	44"	AA1MPS48()	127.	
	56"H panel	4"	1"	52"	AA1MPS56()	132.	
	64"H panel/screen	4"	1"	60"	AA1MPS64()	137.	
	74"H panel	4"	1"	70"	AA1MPS74()	142.	
	80"H panel	4"	1"	76"	AA1MPS80()	142.	
	Morrison raceway shroud	2 1/4"	3"	4"	AA1MRS()	51.	
	panel/screen top clip				AA2 MTC ()	60.	
Linkable screen starter fillers	39"H linkable screen	1"	2"	18"	AA1CET39 ()	43.	
48"H linkable screen	1"	2"	27"	AA1CET48 ()	48.		
64"H linkable screen	1"	2"	43"	AA1CET64 ()	60.		

Order Code

Example:	AA1 MPS48 3
AA1	Accessory
M	Morrison
PS	Panel starter
48	Panel height
V3	Finish

Specification Information

Please specify painted finish for panel starters, Morrison raceway shroud and end trim from paint finish options listed on page 8.

Linkable screen fillers are trim grey or easy grey integral color.

Application Notes

Panel starters attach perpendicular panels or linkable screens to Service Wall structural base covers (5" - 21"H).

Panel starters include clamp bracket to any height Service Wall and full height connector track with modified top wedge block.

Top clip connects panel connector track to Service Wall crown. Specify top clip for added stiffness of panels higher than 48" or whenever cantilevering components from panel. Top clip is not compatible with end trim.

Specify raceway shroud if connecting power from Service Wall to Morrison panel.

Linkable screen fillers are optional fillers for linkable screen starters. End trims may interfere with easy access to Service Wall covers.

Panel system starters and T-ends

Morrison panel/linkable screen T-ends

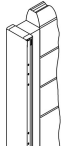
description	type	width	depth	height	pattern number	extension, 0 or 1 1/8	extension, 3 1/2
 T ends for Currents screens and linkable screens	39" screen/39" spine	2 1/4"-5 3/4"	7"	39"	AX2 C3939 () ()	\$822.	\$923.
	48" screen/39" spine	2 1/4"-5 3/4"	7"	48"	AX2 C4839 () ()	955.	1,054.
	48" screen/48" spine	2 1/4"-5 3/4"	7"	48"	AX2 C4848 () ()	889.	987.
	64" screen/39" spine	2 1/4"-5 3/4"	7"	64"	AX2 C6439 () ()	1,089.	1,185.
	64" screen/48" spine	2 1/4"-5 3/4"	7"	64"	AX2 C6448 () ()	1,022.	1,119.
	64" screen/64" spine	2 1/4"-5 3/4"	7"	64"	AX2 C6464 () ()	1,022.	1,119.

description	type	width	depth	height	pattern number	extension, 0 or 1 1/8	extension, 3 1/2
 T ends for Morrison panels	39" panel/39" spine	6"	7"	39"	AX1 M3939 () ()	822.	923.
	42" panel/39" spine	6"	7"	42"	AX1 M4239 () ()	889.	987.
	48" panel/39" spine	6"	7"	48"	AX1 M4839 () ()	955.	1,054.
	48" panel/48" spine	6"	7"	48"	AX1 M4848 () ()	889.	987.
	56" panel/39" spine	6"	7"	56"	AX1 M5639 () ()	1,022.	1,119.
	56" panel/48" spine	6"	7"	56"	AX1 M5648 () ()	955.	1,054.
	64" panel/39" spine	6"	7"	64"	AX1 M6439 () ()	1,089.	1,185.
	64" panel/48" spine	6"	7"	64"	AX1 M6448 () ()	1,022.	1,119.
	64" panel/64" spine	6"	7"	64"	AX1 M6464 () ()	1,022.	1,119.
	80" panel/39" spine	6"	7"	80"	AX1 M8039 () ()	1,316.	1,448.
	80" panel/48" spine	6"	7"	80"	AX1 M8048 () ()	1,316.	1,448.
	80" panel/64" spine	6"	7"	80"	AX1 M8064 () ()	1,316.	1,448.

description	type	extension, 0 or 1 1/8	extension, 3 1/2
 T-end raceway adapter kit	1 1/8" extension	AX1 RF1 ()	52.
	3 1/2" extension	AX1 RF3 ()	77.

description	type	extension, 0 or 1 1/8	extension, 3 1/2
 T-end raceway end cover	AA1 ARE ()	30.	30.

Order Code	Specification Information	Application Notes
Example: AX1 M6448 3 613 613 AX1 Spine connector M Morrison 64 Morrison height 48 Spine height 3 Extension 613 Top cap finish 613 Vertical trim cover	T ends begin with AX1-prefix. Fourth position indicates attached panel system: C Linkable screen M Morrison panel Fifth position: height of panel. Seventh position: height of service wall. Ninth position: extension at end of spine. 0 0" extension 1 1 1/8" extension 3 3 1/2" extension Please specify painted finish for Morrison top cap, crown end, vertical trim cover, raceway cover and T end vertical cover from from paint finish options listed on page 8. When ordering T-ends for the Service Wall, specify crown end caps separately.	T-end encloses the end of a Service Wall and connects to linkable screens or panels on one or both sides. T-ends include Morrison-style top trim for the 7" wide connection to panels or screens. Currents T-end includes 5" and 6" wide trim and two end caps. Morrison T-end includes 7" wide trim. Use 5" wide trim and two end caps when connecting Currents screens on both sides. Use 6" wide trim and one end cap when connecting to Currents screens on one side only. Specify Morrison end connector separately to finish side edge without a connected screen. Use 7" wide trim when connecting to Morrison panels. Specify Morrison end counter, top cap and raceway cover kits separately to finish side edge of Morrison T-ends without a connected panel. T-ends for linkable screens and Morrison panels capture the end of the Service Wall (no extension) or extend the Service Wall 1 1/8" or 3 1/2". This extension enables precise planning of multiple workstations and intermediate screens or panels between workstations. Specify two 0" T-ends for a single workstation on each side (no intermediate screens). Specify two 1 1/8" T-ends for one intermediate screen, one 1 1/8" and one 3 1/2" for two screens, and two 3 1/2" for three intermediate screens. T-ends with 3 1/2" extension have removable inside covers and accept ceiling infeed panel. The Raceway Adapter kit finishes the bottom of a T-end with the Autostrada base trim profile. No adapter kit is necessary for 0" T-ends.

Panel system starters and T-ends

AutoStrada and Reff panel starters and T-ends

AutoStrada

description	type	pattern number	list	extension, 0 or 1 1/8	extension, 3 1/2
 AutoStrada or Reff panel starter	34"H (includes AA1RTC bracket)	AA1RPS34 ()()	\$138.		
	42"H (includes AA1RTC bracket)	AA1RPS42 ()()	241.		
	49"H (includes AA1RTC bracket)	AA1RPS49 ()()	247.		
	64"H (includes AA1RTC bracket)	AA1RPS64 ()()	263.		
	79"H (includes AA1RTC bracket)	AA1RPS79 ()()	274.		

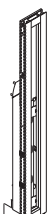
description	type	pattern number	list	extension, 0 or 1 1/8	extension, 3 1/2
 T-end frame for AutoStrada or Reff panels	42" panel to 39" spine frame	AX1 R34239 ()()		987.	1,089.
	49" panel to 39" spine frame	AX1 R34939 ()()		998.	1,100.
	49" panel to 48" spine frame	AX1 R34948 ()()		936.	1,033.
	64" panel to 39" spine frame	AX1 R36439 ()()		1,104.	1,202.
	64" panel to 48" spine frame	AX1 R36448 ()()		1,039.	1,140.
	64" panel to 64" spine frame	AX1 R36464 ()()		1,039.	1,140.
	79" panel to 39" spine frame	AX1 R37939 ()()		1,113.	1,214.
	79" panel to 48" spine frame	AX1 R37948 ()()		1,047.	1,146.
	79" panel to 64" spine frame	AX1 R37964 ()()		1,014.	1,113.

description	type	pattern number	list	extension, 0 or 1 1/8	extension, 3 1/2
T-end frame for AutoStrada panel without base raceway	42" panel to 39" spine frame	AX1 A34239 ()()		987.	1,089.
	49" panel to 39" spine frame	AX1 A34939 ()()		998.	1,100.
	49" panel to 48" spine frame	AX1 A34948 ()()		936.	1,033.
	64" panel to 39" spine frame	AX1 A36439 ()()		1,104.	1,202.

Order Code	Specification Information	Application Notes
Example: AA1-RPS6448E613AA AA1 Accessory R Reff/AutoStrada PS Panel starter 64 Panel height 48 Adjoining panel width E Panel top trim profile 613 Finish, panel starter AA Panel top trim finish	For T-end specify extension at end of spine, then paint finish. Extension at end of spine: 0 0" extension 1 1 1/8" extension 3 3 1/2" extensions <i>Specify following for panel starter:</i> 1. Adjoining panel width (panel starter includes extended panel top trim for panel attached to starter) 2. Top trim profile of adjoining panel E = Extruded aluminum top trim 3. Painted finish for panel starter 4. Top trim finish Anodized aluminum or painted finish Please specify painted finish for panel starters and inside covers of T-end from paint finish options listed on page 8.	Panel starters attach perpendicular AutoStrada panels to Service Wall. Panel starter includes clamp bracket to structural base cover, top clip, and vertical extrusion corresponding to AutoStrada panel height. T-end encloses the end of a Service Wall and connects to perpendicular AutoStrada panels on one or both sides. Specify AutoStrada end connector to finish side edge without a connected wall. Specify T-end with 0", 1 1/8", or 3 1/2" of extension to accommodate the "creep" of panels between workstations on each side of Service Wall. Specify two 0" T-ends for a single workstation on each side (no intermediate panels). Specify two 1 1/8" T-ends for one intermediate panel, one 1 1/8" and one 3 1/2" for two panels, and two 3 1/2" for three intermediate panels. T-ends with 3 1/2" extension have removable inside covers and accept ceiling infeed panel. Finish options for AA1RTC() top clip: 118 White 111 Black 613 Silver To complete T - end solution, must specify frame, crown end cap, raceway extender and cover set.

Panel system starters and T-ends

AutoStrada and Reff panel starters and T-ends

AutoStrada

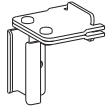

description	type	pattern number	list	extension, 0 or 1 1/8	extension, 3 1/2
T-end frame for AutoStrada panel without base raceway	64" panel to 48" spine frame	AX1 A36448()		\$1,039.	\$1,140.
	64" panel to 64" spine frame	AX1 A36464()		1,039.	1,140.
Top clip (replacement part)		AA1RTC()	98.		



Spine and linkable screens

Order Code	Specification Information	Application Notes
Example: AA1-RPS6448E613AA	For T-end specify extension at end of spine, then paint finish.	Panel starters attach perpendicular AutoStrada panels to Service Wall.
AA1 Accessory	Extension at end of spine:	Panel starter includes clamp bracket to structural base cover, top clip, and vertical extrusion corresponding to AutoStrada panel height.
R Reff/AutoStrada	0 0" extension	
PS Panel starter	1 1 1/8" extension	T-end encloses the end of a Service Wall and connects to perpendicular AutoStrada panels on one or both sides.
64 Panel height	3 3 1/2" extensions	Specify AutoStrada end connector to finish side edge without a connected wall.
48 Adjoining panel width	<i>Specify following for panel starter:</i>	Specify T-end with 0", 1 1/8", or 3 1/2" of extension to accommodate the "creep" of panels between workstations on each side of Service Wall.
E Panel top trim profile	1. Adjoining panel width (panel starter includes extended panel top trim for panel attached to starter)	
613 Finish, panel starter	2. Top trim profile of adjoining panel E = Extruded aluminum top trim	Finish options for AA1RTC() top clip: 118 White 111 Black 613 Silver
AA Panel top trim finish	3. Painted finish for panel starter 4. Top trim finish Anodized aluminum or painted finish	To complete T - end solution, must specify frame, crown end cap, raceway extender and cover set.
	Please specify painted finish for panel starters and inside covers of T-end from paint finish options listed on page 8.	

T-end fabric and wood cover sets (AutoStrada or Reff panels)

description	type	height	pattern number	list
 Monolithic cover set	Fabric	42"	R3B0P0F4207	\$153.
		49"	R3B0P0F4907	174.
		64"	R3B0P0F6407	204.
		79"	R3B0P0F7907	234.
	L/V1/V2/V3	42"	R3B0P0H4207	157.
		49"	R3B0P0H4907	178.
		64"	R3B0P0H6407	210.
		79"	R3B0P0H7907	239.
 Tiled cover set	Fabric	42"	R3B0T0F4207	153.
		49"	R3B0T0F4907	174.
		64"	R3B0T0F6407	204.
		79"	R3B0T0F7907	234.
	L/V1/V2/V3	42"	R3B0T0H4207	157.
		49"	R3B0T0H4907	178.
		64"	R3B0T0H6407	210.
		79"	R3B0T0H7907	239.
 Tiled cover set, no base raceway	L/V1/V2/V3	42"	R3R0T0H4207	181.
		49"	R3R0T0H4907	206.
		64"	R3R0T0H6407	241.

Order Code

Example: R3B0P0F4207 E 4
R3B Generation 3
0P0F Monolithic
42 Panel height
07 Width
E Top trim profile
4 4" base height
W359- Fabric
AA Trim finish
111 Outside base finish
111 Inside base finish

Specification Information

See Reff System for full selection of painted finishes, fabrics and wood veneers for T-end cover sets.

Specify:

1. Top trim profile
2. Panel finishes
3. Top trim finish
4. Base finish

Top trim profile:

E Extruded Aluminum

Base height:

4 4" base height

Application Notes

Specify covers in monolithic or tiled sets to complete T-end frames for AutoStrada or Reff panel.

Monolithic cover sets include a raceway cover and a single snap-in panel above.

Tiled sets include raceway cover and segmented tiles corresponding to adjacent AutoStrada or Reff tiled panels.

AutoStrada or Reff tiled module horizontal reveals are at nominal 19", 34", 49" and 64" above the floor and do not align with service wall cover reveals.

Please see page 8 for list of applicable finishes.

Panel system starters and T-ends

Gallery screen starters

description	h	w	d	pattern no.	list
Gallery screen starter	21"	3"	1"	AA1GPS ()	\$139.
Screen-to-worksurface bracket				AG1B	34.

Order Code

Example:	AA1 GPS 613
AA1	Accessory
G	For thin screens
PS	Panel starter
613	Painted finish

Specification Information

For intermediate gallery screen starters specify any standard painted finish.

Screen to worksurface bracket is black painted finish.

Application Notes

Gallery screen starter attaches thin screen to structural base cover of AutoStrada spine or Currents service wall. Specify Gallery screen to have through holes for starter bracket.

Screen-to-worksurface bracket is required to stabilize Gallery screens by connecting to adjacent worksurface. Specify one bracket for each screen.

Panel system starters and T-ends



Dividends Horizon panel and screen starters

description	application	h	w	d	pattern no.	list
Service Wall starters for Dividends Horizon panels and screens	36" high Dividends Horizon Panel or Screen	36"	1"	3"	AA1DHPS36(5)()	\$337.
	42" high Dividends Horizon Panel or Screen	42"	1"	3"	AA1DHPS42(5)()	337.
	50" high Dividends Horizon Panel or Screen	50"	1"	3"	AA1DHPS50(5)()	337.
	57" high Dividends Horizon Panel or Screen	57"	1"	3"	AA1DHPS57(5)()	337.
	64" high Dividends Horizon Panel or Screen	64"	1"	3"	AA1DHPS64(5)()	337.
Top clip for Dividends Horizon panels and screens to lower Service Wall	Top clip for Dividends Horizon Panel/Screen to Service Wall				AA1DHTC()	88.

Order Code	Specification Information	Application Notes
Example: AA1 DHPS 36 (5)	1.Top cap type 5=Metal flat	Panel/screen starter includes a clamp bracket that attaches to the structural base cover of the Service Wall to start a Dividends panel/screen run perpendicular to the face of the Service Wall anywhere other than at the end of the Service Wall.
AA1 Accessory	2.Paint finish All standard paint finishes	
DH Dividends Horizon		Top clip, which secures top edge of panel to underside of Service Wall crown, is required in addition to panel starter for stability of 57" or higher panels or 50"H panels with cantilevered shelves overhead storage.
PS Panel starter		
36 Panel height		
5 Top cap type		
613 Painted finish		

Panel system starters and T-ends

Universal panel starter and T-end

description	width	depth	height	pattern number	paint
 Universal T-end adapter	2-6"	7"	39"	AA1UA39()	\$85.
	2-6"	7"	48"	AA1UA48()	104.
	2-6"	7"	64"	AA1UA64()	114.
 Universal panel starters	3"	1"	39"	AA1UPS39()	192.
	3"	1"	48"	AA1UPS48()	207.
	3"	1"	64"	AA1UPS64()	220.
 Universal top clip				AA2 UTC ()	83.

Order Code

Example:	AA1 UPS48 111
AA1	Accessory
UPS	Panel starter
48	Panel height
111	Finish

Specification Information

Please specify painted finish for universal end and panel starters from paint finish options listed on page 8.

Application Notes

Universal adapters and starters integrate other panel systems with the Service Wall. Vertical surface accepts architectural wall starter of most other systems.

T-end adapters include connector to corresponding height T-end for linkable screen (specified separately).

Panel starter includes clamp bracket to structural base cover on Service Wall.

Top clip gives added stability to attached panels of the same height or higher than the Service Wall.

Power components, spine

2+2 power components

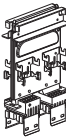
description	type	w	d	h	pattern number	black	orange (-O) or orange triangle (-T)	no finish
Desk height outlet module	21-48"H	5"	-	6"	AR1 EOM			\$176.
								
Central switch	21-48"H				AR1-ELS-B			490.
Duplex outlet	Circuit A				AR1 DA	43.		
	Circuit B				AR1 DB	43.		
	Circuit X				AR1 DX	43.		48.
	Circuit Y				AR1 DY	43.		48.
Power infeeds, modular	Desk height power	85"			AR1 EPI5			203.
	Ceiling infeed	145"			AR1 EPIC			252.
Hardwire base infeeds (NYC)	One connector				AR1 EPH1			337.
	Two connectors				AR1 EPH2			505.
Transitional connectors for Morrison or Reff	12"	61"			AR1 ET1			186.
	36"	85"			AR1 ET3			236.
	60"	109"			AR1 ET5			270.
	96"	133"			AR1 ET8			300.
Jumper cable	12"	37"			AR1 EJ1			101.
	24"	49"			AR1 EJ2			133.
	36"	61"			AR1 EJ3			153.
	48"	73"			AR1 EJ4			166.
	60"	85"			AR1 EJ5			186.
	72"	97"			AR1 EJ6			203.
	96"	121"			AR1 EJ8			236.
	120"	145"			AR1 EJ10			269.
	144"	169"			AR1 EJ12			300.

Order Code

Example: AR1 EOM	
AR1	Power component
E	2+2
OM	Outlet module

Application Notes

Autostrada power components distribute four 20-amp circuits at desk height: two convenience circuits and two protected circuits, with separate grounds and heavy duty #10 neutrals. Power may be distributed point-to-point between outlet modules at or below desk height. Outlet modules accept two duplex outlets on each face and four jumper cables to connect to other modules or infeed power.

Modular desk-height outlet module mounts between frame studs at any height from 21" - 48", above or below adjacent worksurfaces. Each 12"W Service Wall frame bay can accept two outlet housings (up to four duplex outlets on each side) side by side.

Central switch controls three outlets inside Service Wall frame for task or ambient lights. Switch occupies right-hand outlet opening in outlets cover on one side of wall.

Switches cannot be positioned back-to-back in combination with an outlet module. Central switch includes white rocker switch, connector to adjacent outlet module, and three simplex outlets on circuit B (2+2 or 3+3).

Outlet modules accept two duplex outlets on each face. Specify outlets with black face for convenience circuits. Specify orange face or black with orange triangle for protected circuits with separate ground and neutral in building power supply.

Desk height power infeed connects from floor box to outlets module in Service Wall. Infeed includes 85" conduit with a 6" pigtail. Ceiling infeed connects from ceiling mounted box to desk height outlet module. Specify ceiling infeed panel separately.

Hardwire base infeed is approved for installations in the City of New York. Infeed includes junction box for base raceway and connector to outlet module.

Jumper cables join power from outlet module to outlet module. Application dimension is distance between modules.

Transitional connectors connect power from Service Wall to powered Morrison or Reff panels attached to the Service Wall. Application dimension suggests distance from outlet to panel. Transitional connectors have watertight conduit between modular ends. Do not specify transitional connectors in City of New York installations.

Power components, spine

3+3 power components

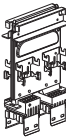
description	type	w	d	h	pattern number	black	orange (-O) or orange triangle (-T)	no finish
Desk-height outlet module	21"-48"H	6"	1"	9"	AR1 TOM			\$203.
								
Central switch	21-48"H				AR1-ELS-B			490.
Duplex outlet	Circuit A				AR1 DA	43.		
	Circuit B				AR1 DB	43.		
	Circuit C				AR1 DC	43.		
	Circuit X				AR1 DX	43.	48.	
	Circuit Y				AR1 DY	43.	48.	
	Circuit Z				AR1 DZ	43.	48.	
Power infeeds	Desk height power	85"			AR1 TPI5			236.
	Ceiling infeed	145"			AR1 TPIC			287.
Hardwire base infeeds (NYC)	One connector				AR1 TPH1			372.
	Two connectors				AR1 TPH2			575.
Transitional connectors for Morrison or Reff	12"	61"			AR1 TT1			219.
	36"	85"			AR1 TT3			270.
	60"	109"			AR1 TT5			300.
	96"	133"			AR1 TT8			337.
Jumper cable	120"				AR1 TJ10			300.
	12"	37"			AR1 TJ1			116.
	24"	49"			AR1 TJ2			153.
	36"	61"			AR1 TJ3			186.
	48"	73"			AR1 TJ4			203.
	60"	85"			AR1 TJ5			219.
	72"	97"			AR1 TJ6			236.
	96"	121"			AR1 TJ8			269.
	144" wall	169"			AR1 TJ12			336.

Spine and linkable screens

Order Code

Example:	AR1 TOM
AR1	Power component
T	3+3
OM	Outlet module

Application Notes

AutoStrada power components distribute six 20-amp circuits at desk height or wall base: three convenience circuits and three protected circuits, with separate grounds and heavy-duty #10 neutrals.

Service Wall power may be distributed point-to-point between outlet modules at desk height or in the base raceway. Outlet modules and power rails accept two duplex outlets on each face and four connector/jumper cables.

Modular desk-height outlet module mounts between Service Wall frame studs at any height from 21" - 48", above or below adjacent worksurfaces. Each 12"W frame bay can accept two outlet housings (up to four duplex outlets on each side.)

Central switch controls three outlets inside Service Wall frame for task or ambient lights. Switch occupies right-hand outlet opening in outlets cover on one side of Service Wall.

Central switch includes white rocker switch, connector to adjacent outlet module, and three simplex outlets on circuit B (2+2 or 3+3).

Outlet modules and power rails accept two duplex outlets on each face. Specify outlets with black face for convenience circuits. Specify orange face or black with orange triangle for protected circuits with separate ground and neutral in building power supply.

description	width	depth	height	pattern number	no finish	paint
High capacity cable holders (10)	1"	3/4"	2 1/2"	AR1 HCC H10	\$35.	



Cable clips for wall studs (100)	1/4"	1/2"	1 1/2"	AR1 PCC 100	84.	
----------------------------------	------	------	--------	--------------------	-----	--



Ceiling infeed panel for stabilizer end cabinet or T-end with 3 1/2" extension		5"	48"	APX CIP4 ()		515.
		5"	72"	APX CIP6 ()		602.
		5"	96"	APX CIP8 ()		688.

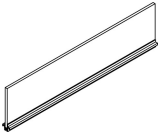
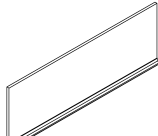
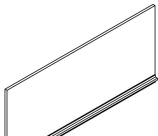

Order Code	Specification Information	Application Notes
Example: AR1 PCC 100	Cable clips and cable managers are black plastic.	Specify cable clips, approximately 50 per Service Wall frame to support and manage cables on the face of studs in the Service Wall frame.
AR1 Raceway	Cable holders are light grey plastic.	Each clip manages up to 14 Category 5 or fiber optic cables; four clips attach between 21"-30", 30"-39", 39"-48"; six between 48"-64"H. Only two clips fit behind a cable tray cover at the 21"-30" height.
PCC Cable clip	Please specify painted finish for ceiling infeed panel from paint finish options listed on page 8.	Specify high capacity cable holders approximately 20 per Service Wall frame to support and manage larger bundles of cables. Each holds up to 55 Cat 5 cables; two holders attach to studs at each 9" level; three holders at the 16" level of a 64"H wall. Only one holder fits behind a cable tray cover at the 21"-30" height (upside down).
100 Size/Quantity		Raceway cable managers are U-shape cable supports that snap into the underside of the Service Wall frame. Plan one per foot foot to contain data cables or power jumpers in the base raceway. Ceiling infeed panel attaches to end of Service Wall adjacent to Currents, Morrison, or Reff T-end panel with 3 1/2" extension. Center channel, 2" x 2 1/2", accommodates one or two power infeed cables. Each side channel is 1 1/2" x 3 1/2" lay-in cable raceway, for continuous lay-in cabling from ceiling to Service Wall surface. Specify ceiling infeed separately.

description	type	width	depth	height	pattern number	clear tempered	powder
Add up panels	 frameless glass, 8"h	24"	1/2"	8"	AUA1 0824 G () ()	\$276.	\$336.
		36"	1/2"	8"	AUA1 0836 G () ()	314.	450.
		48"	1/2"	8"	AUA1 0848 G () ()	406.	562.
		60"	1/2"	8"	AUA1 0860 G () ()	499.	724.
		72"	1/2"	8"	AUA1 0872 G () ()	562.	874.
	 frameless glass, 12"h	24"	1/2"	12"	AUA1 1224 G () ()	330.	379.
		36"	1/2"	12"	AUA1 1236 G () ()	468.	536.
		48"	1/2"	12"	AUA1 1248 G () ()	596.	688.
		60"	1/2"	12"	AUA1 1260 G () ()	727.	841.
		72"	1/2"	12"	AUA1 1272 G () ()	862.	990.
	 frameless glass, 15"h	24"	1/2"	15"	AUA1 1524 G () ()	336.	591.
		36"	1/2"	15"	AUA1 1536 G () ()	468.	655.
		48"	1/2"	15"	AUA1 1548 G () ()	599.	942.
		60"	1/2"	15"	AUA1 1560 G () ()	737.	1,062.
		72"	1/2"	15"	AUA1 1572 G () ()	868.	1,243.

Order Code	Specification Information	Application Notes
Example: AUA1 1248 G TEMP AA AUA1 Autostrada add up panel 12 Height 48 Width G Type TEMP Glass Finish AA Trim Finish	Add up type: G Glass Glass add-ups are available with the following glass options: TEMP Clear tempered GL13 Powder Specify wide add-up panels for use on long Service Wall and Fence runs.	Add-up panels add acoustical privacy and light control above any height Service Wall. Anodized aluminum or painted base frame inserts in center of any Service Wall crown and is secured by bolts within crown. Frameless glass add-ups can be positioned at any 3" increment in standard or compact crown with any cover type.

- Any height add up can be used on any height AutoStrada or Currents Service Wall or Fence.
- 8"h Add ups are designed primarily for use on 39"h spine with 1"h crown to create a 48"h horizon.
 - 12"h Add ups are designed for use on 48"h spine for a 61" horizon with 1"h crown or a 64" horizon with 4"h crown.
 - 15"h Add ups are designed primarily for use on 48"h spine with 1"h crown for a 64" horizon.

Linkable screens and windows

Upholstered

description	type	height	depth	width	pattern number	10	15	20	30	35	40	45	50	55
	30"H	30"	2 1/4"	18"	AP1L 3018 N () ()	\$268.	\$303.	\$323.	\$375.	\$393.	\$420.	\$420.	\$470.	\$524.
		30"	2 1/4"	24"	AP1L 3024 N () ()	310.	351.	372.	433.	452.	485.	538.	566.	598.
		30"	2 1/4"	30"	AP1L 3030 N () ()	338.	384.	406.	474.	495.	528.	589.	620.	654.
		30"	2 1/4"	36"	AP1L 3036 N () ()	387.	438.	460.	535.	558.	597.	662.	699.	737.
		30"	2 1/4"	42"	AP1L 3042 N () ()	445.	498.	527.	612.	638.	685.	757.	797.	837.
		30"	2 1/4"	48"	AP1L 3048 N () ()	488.	550.	577.	669.	698.	748.	828.	872.	918.
		30"	2 1/4"	60"	AP1L 3060 N () ()	576.	647.	684.	784.	876.	969.	n/a	n/a	n/a
		30"	2 1/4"	72"	AP1L 3072 N () ()	n/a	806.	n/a	n/a	n/a	n/a	n/a	n/a	n/a
39"H	39"	2 1/4"	18"	AP1L 3918 N () ()	324.	361.	376.	432.	450.	476.	526.	551.	577.	
	39"	2 1/4"	24"	AP1L 3924 N () ()	367.	405.	426.	488.	506.	539.	593.	622.	654.	
	39"	2 1/4"	30"	AP1L 3930 N () ()	395.	442.	460.	528.	551.	583.	643.	678.	709.	
	39"	2 1/4"	36"	AP1L 3936 N () ()	444.	491.	517.	590.	614.	652.	720.	755.	792.	
	39"	2 1/4"	42"	AP1L 3942 N () ()	498.	555.	582.	664.	693.	738.	815.	852.	892.	
	39"	2 1/4"	48"	AP1L 3948 N () ()	542.	603.	633.	724.	754.	801.	883.	928.	972.	
	39"	2 1/4"	60"	AP1L 3960 N () ()	632.	700.	737.	838.	875.	932.	1,025.	n/a	n/a	
	39"	2 1/4"	72"	AP1L 3972 N () ()	n/a	847.	n/a	n/a	n/a	n/a	n/a	n/a	n/a	
48"H	48"	2 1/4"	18"	AP1L 4818 N () ()	378.	420.	443.	503.	526.	559.	616.	647.	682.	
	48"	2 1/4"	24"	AP1L 4824 N () ()	428.	476.	500.	572.	596.	634.	696.	730.	768.	
	48"	2 1/4"	30"	AP1L 4830 N () ()	465.	518.	543.	620.	648.	690.	757.	794.	834.	
	48"	2 1/4"	36"	AP1L 4836 N () ()	524.	580.	610.	695.	724.	772.	849.	890.	935.	
	48"	2 1/4"	42"	AP1L 4842 N () ()	587.	651.	686.	782.	818.	868.	955.	1,002.	1,052.	
	48"	2 1/4"	48"	AP1L 4848 N () ()	639.	709.	746.	851.	887.	942.	1,037.	1,091.	1,145.	
	48"	2 1/4"	60"	AP1L 4860 N () ()	743.	827.	868.	992.	1,032.	1,098.	1,208.	n/a	n/a	
	48"	2 1/4"	72"	AP1L 4872 N () ()	n/a	1,008.	n/a	n/a	n/a	n/a	n/a	n/a	n/a	
64"H	64"	2 1/4"	18"	AP1L 6418 A () ()	492.	549.	575.	655.	686.	726.	799.	838.	883.	
	64"	2 1/4"	24"	AP1L 6424 A () ()	542.	603.	633.	724.	754.	801.	883.	928.	972.	
	64"	2 1/4"	30"	AP1L 6430 A () ()	610.	679.	710.	816.	847.	899.	992.	1,038.	1,092.	
	64"	2 1/4"	36"	AP1L 6436 A () ()	657.	732.	771.	880.	917.	974.	1,072.	1,125.	1,182.	
	64"	2 1/4"	42"	AP1L 6442 A () ()	726.	806.	849.	969.	1,012.	1,075.	1,182.	1,244.	1,304.	
	64"	2 1/4"	48"	AP1L 6448 A () ()	779.	865.	906.	1,035.	1,082.	1,148.	1,264.	1,328.	1,392.	
	64"	2 1/4"	60"	AP1L 6460 A () ()	883.	979.	1,028.	1,175.	1,223.	1,302.	1,432.	n/a	n/a	

Order Code	Specification Information	Application Notes
Example: AP1L 3948N 15 812 AA		
AP1 AutoStrada	Linkable screens include top cap and 4"H x 2 1/2"W extruded aluminum legs with levellers.	Linkable screens divide workstations perpendicular to Service Wall where base raceway is not required. Linkable screens connect to the Service Wall with screen starters and to each other with screen connectors. Specify starters and connectors separately.
L Linkable screen	Top cap is integral color trim grey or easy grey.	Linkable screens with connectors can end support or cantilever work surfaces, upmount or downmount overhead storage, with brackets designed for Morrison panel mounting.
39 Height	Legs are available in clear anodized aluminum or painted finish options list on page 8 excluding silver.	30"H upholstered screens are primarily intended for use in combination with 18"H windows, connected to other 48"H screens with 48"H screen connectors.
48 Width		39"H screens align with the underside of either compact or standard crown on 39"H Service Wall. 39"H screens enable seated visual access.
N Core		48"H screens align with the underside of either compact or standard crown on 48"H Service Wall. 48"H screens provide some seated privacy.
15 Fabric Grade		64"H screens align with the underside of either compact or standard crown on 64"H Service Wall. 64"H screens provide seated privacy, and include a high-acoustical core for improved sound absorption.
812 Trim Color		
AA Leg Finish		

Linkable screens and windows

Glazed

description	type	width	depth	height	pattern number	clear tempered	architectural
 Linkable screen	39"H	18"	2 1/4"	39"	AP1L 3918G () ()	\$613.	\$753.
		24"	2 1/4"	39"	AP1L 3924G () ()	659.	847.
		30"	2 1/4"	39"	AP1L 3930G () ()	737.	972.
		36"	2 1/4"	39"	AP1L 3936G () ()	757.	1,046.
		42"	2 1/4"	39"	AP1L 3942G () ()	817.	1,153.
		48"	2 1/4"	39"	AP1L 3948G () ()	845.	1,231.
	48"H	18"	2 1/4"	48"	AP1L 4818G () ()	664.	842.
		24"	2 1/4"	48"	AP1L 4824G () ()	715.	955.
		30"	2 1/4"	48"	AP1L 4830G () ()	784.	1,089.
		36"	2 1/4"	48"	AP1L 4836G () ()	827.	1,191.
		42"	2 1/4"	48"	AP1L 4842G () ()	888.	1,316.
		48"	2 1/4"	48"	AP1L 4848G () ()	925.	1,412.
	64"H	18"	2 1/4"	64"	AP1L 6418G () ()	764.	1,009.
		24"	2 1/4"	64"	AP1L 6424G () ()	831.	1,162.
		30"	2 1/4"	64"	AP1L 6430G () ()	910.	1,323.
		36"	2 1/4"	64"	AP1L 6436G () ()	953.	1,458.
		42"	2 1/4"	64"	AP1L 6442G () ()	1,032.	1,623.
		48"	2 1/4"	64"	AP1L 6448G () ()	1,078.	1,752.

Spine and linkable screens

Order Code	Specification Information	Application Notes
Example: AP1L 3948G GL6 AA 812 AA <hr/> AP1 AutoStrada <hr/> L Linkable screen <hr/> 39 Height <hr/> 48 Width <hr/> G Glazed <hr/> GL6 Glass Type <hr/> AA Frame Finish <hr/> 812 Trim Color <hr/> AA Leg Finish	<p>Glazed linkable screens include top cap and two 4"H x 2 1/2"W extruded aluminum legs with levellers. Top cap is integral color trim grey or easy grey. Window frame is anodized aluminum or painted extrusions.</p> <p>Frame and legs are available in clear anodized aluminum or painted finish options listed on page 8 excluding silver.</p> <p>Glass is tempered clear. Architectural glass is available in powder or block matrix finishes.</p> <p>TEMP Clear Tempered GL6 Block Matrix GLI3 Powder</p>	<p>Linkable screens divide workstations perpendicular to Service Wall where base raceway is not required. Linkable screens connect to the Service Wall with screen starters and to each other with screen connectors. Specify starters and connectors separately.</p> <p>Glazed linkable screens feature nearly flush glazing on one surface and a perimeter frame of anodized or painted aluminum. Glazed linkable screens with connectors can end support or cantilever worksurfaces with brackets designed for Morrison panel mounting.</p> <p>39"H screens align with the underside of either compact or standard crown on 39"H Service Wall. 39"H screens enable seated visual access.</p> <p>48"H screens align with the underside of either compact or standard crown on 48"H Service Wall. 48"H screens provide some seated privacy.</p> <p>64"H screens align with the underside of either compact or standard crown on 64"H Service Wall.</p>

Linkable screens and windows

Windows for linkable screens

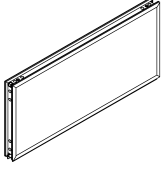
description	type	width	height	pattern number	clear tempered	architectural
Window 	16"H	24"	16"	AP1W 1624G () ()	\$499.	\$519.
		30"	16"	AP1W 1630G () ()	551.	571.
		36"	16"	AP1W 1636G () ()	616.	640.
		42"	16"	AP1W 1642G () ()	663.	692.
		48"	16"	AP1W 1648G () ()	737.	766.
		60"	16"	AP1W 1660G () ()	815.	846.
		72"	16"	AP1W 1672G () ()	930.	966.
	18"H	24"	18"	AP1W 1824G () ()	518.	538.
		30"	18"	AP1W 1830G () ()	570.	593.
		36"	18"	AP1W 1836G () ()	639.	663.
		42"	18"	AP1W 1842G () ()	691.	717.
		48"	18"	AP1W 1848G () ()	762.	792.
		60"	18"	AP1W 1860G () ()	883.	918.
		72"	18"	AP1W 1872G () ()	1,083.	1,125.
	22"H	24"	22"	AP1W 2224G () ()	536.	557.
		30"	22"	AP1W 2230G () ()	590.	613.
		36"	22"	AP1W 2236G () ()	661.	690.
		42"	22"	AP1W 2242G () ()	714.	742.
		48"	22"	AP1W 2248G () ()	785.	819.
		60"	22"	AP1W 2260G () ()	912.	948.
		72"	22"	AP1W 2272G () ()	1,126.	1,172.
25"H	24"	25"	AP1W 2524G () ()	555.	575.	
	30"	25"	AP1W 2530G () ()	610.	633.	
	36"	25"	AP1W 2536G () ()	686.	712.	
	42"	25"	AP1W 2542G () ()	739.	768.	
	48"	25"	AP1W 2548G () ()	814.	845.	
	60"	25"	AP1W 2560G () ()	940.	977.	
	72"	25"	AP1W 2572G () ()	1,172.	1,219.	

Order Code	Specification Information	Application Notes
Example: AP1W 1624G GL6 AA AP1 AutoStrada linkable screen W Window 16 Height 24 Width G Surface Type GL6 Glass Finish AA Frame Finish	Window frame is anodized aluminum or painted extrusions. Painted finish option listed on page 8 excluding silver. Glass is tempered clear. Architectural glass is available in powder or block matrix finishes. TEMP Clear Tempered GL6 Block Matrix GL13 Powder	Windows add on to linkable screens to build partially glazed screens. Linkable screens with windows connect to the Service Wall with screen starters and to each other with screen connectors. Specify starters and connectors in the same height as the combination of screen and window. Windows feature nearly flush glazing on one surface and a perimeter frame of anodized or painted aluminum.

Specify 16"H windows on 48"H linkable screens and connect with 64"H connectors.

Specify 18"H windows on 30"H linkable screens and connect with 48"H connectors.

Specify 25"H windows on 39"H linkable screens and connect with 64"H connectors.

Linkable screens and windows

Connectors and trim

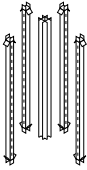
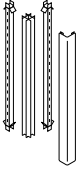
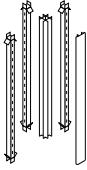
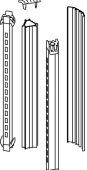
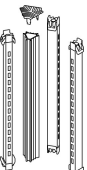
description	type	height	depth	width	pattern number	no finish	integral color	list
90° connector	4-way X 	39"	2 1/4"	2 1/4"	AC1 39X4 ()	\$245.		
		48"	2 1/4"	2 1/4"	AC1 48X4 ()	273.		
		64"	2 1/4"	2 1/4"	AC1 64X4 ()	304.		
	2-way L 	39"	2"		AC1 39L2 ()			165.
		48"	2"		AC1 48L2 ()			174.
		64"	2"		AC1 64L2 ()			187.
	3-way T 	39"	2"		AC1 39T3 ()			210.
		48"	2"		AC1 48T3 ()			220.
		64"	2"		AC1 64T3 ()			237.
120° connector	2-way V 	39"			AC1 39V2 ()			183.
		48"			AC1 48V2 ()			191.
		64"			AC1 64V2 ()			209.
	3-way Y 	39"			AC1 39Y3 ()			223.

Order Code

Example: AC1 39L2 812
AC1 Linkable screen connector
39 Height
L2 90° 2-way L
812 Finish

Specification Information

All top and vertical trim is easy grey (812) or trim grey (813) integral color surface.

Connector post is painted black extrusion.

Carpet grips are black integral color surface.

Linkable screen feet are anodized aluminum or painted finish option listed on page 8 excluding silver.

Application Notes

Connectors join linkable screens in straight, 90° or 120° post configurations.

Linkable screen connectors include connector tracks, universal posts and top and vertical trim (where required).

Connector tracks have cantilever slots for worksurface and storage support.

L, T and X connectors include a universal post and 2, 3 or 4 connector tracks and top cap.





End trim may be specified instead of an end connector if cantilever capability is not required.

Carpet grips snap into linkable screen glides to prevent components from sliding. Glide rotates in carpet grip to permit levelling.

Non-skid grips snap into glides to prevent sliding on hard surface floors.

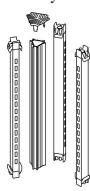
Linkable screens and windows

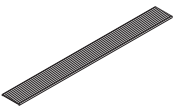

Connectors and trim

description	type	height	depth	width	pattern number	no finish	integral color	list
120° connector	3-way Y	48"			AC1 48Y3 ()			\$233.
		64"			AC1 64Y3 ()			249.
								
Connector track	No trim	39"	–	–	MC1-39S1	57.		
		48"	–	–	MC1-48S1	66.		
		64"	–	–	MC1-64S1	70.		
								
End connector	with connector track	30"			ACA1 30E1 ()		71.	
		39"			ACA1 39E1 ()		74.	
		48"			ACA1 48E1 ()		86.	
		64"			ACA1 64E1 ()		100.	
								
linkable screen end trim (no connector)		30"			AA1 30E ()			44.
		39"			AA1 39E ()			46.
		48"			AA1 48E ()			48.
		64"			AA1 64E ()			49.
								
top trim, linkable screen (replacement)				18"	AA1 T18 ()			12.
				24"	AA1 T24 ()			15.
				30"	AA1 T30 ()			25.
				36"	AA1 T36 ()			27.
				42"	AA1 T42 ()			28.
				48"	AA1 T48 ()			30.
				6"	AA1 T06 ()			9.
				60"	AA1 T60 ()			33.
								

Order Code	Specification Information	Application Notes
Example: AC1 39L2 812		
AC1 Linkable screen connector	All top and vertical trim is easy grey (812) or trim grey (813) integral color surface.	Connectors join linkable screens in straight, 90° or 120° post configurations.
39 Height	Connector post is painted black extrusion.	Linkable screen connectors include connector tracks, universal posts and top and vertical trim (where required).
L2 90° 2-way L	Carpet grips are black integral color surface.	Connector tracks have cantilever slots for worksurface and storage support.
812 Finish	Linkable screen feet are anodized aluminum or painted finish option listed on page 8 excluding silver.	L, T and X connectors include a universal post and 2, 3 or 4 connector tracks and top cap.
		End trim may be specified instead of an end connector if cantilever capability is not required.
		Carpet grips snap into linkable screen glides to prevent components from sliding. Glide rotates in carpet grip to permit levelling.
		Non-skid grips snap into glides to prevent sliding on hard surface floors.

Linkable screens and windows

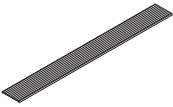
Connectors and trim

description	type	height	depth	width	pattern number	no finish	integral color	list
top trim, linkable screen (replacement)				72"	AA1 T72 ()			\$36.
								
linkable screen feet, pair	replacement part				APA1 LF ()			73.
								
Raceway cover for Currents end connector or end trim on Morrison panel					AA1RE()			32.
Non-skid pads (set of 10)					AA1NSK			38.
Carpet grips (set of 10)					MM2-CG			25.

Order Code	Specification Information	Application Notes
Example: AC1 39L2 812		
AC1 Linkable screen connector	All top and vertical trim is easy grey (812) or trim grey (813) integral color surface.	Connectors join linkable screens in straight, 90° or 120° post configurations.
39 Height	Connector post is painted black extrusion.	Linkable screen connectors include connector tracks, universal posts and top and vertical trim (where required).
L2 90° 2-way L	Carpet grips are black integral color surface.	Connector tracks have cantilever slots for worksurface and storage support.
812 Finish	Linkable screen feet are anodized aluminum or painted finish option listed on page 8 excluding silver.	L, T and X connectors include a universal post and 2, 3 or 4 connector tracks and top cap.
		End trim may be specified instead of an end connector if cantilever capability is not required.
		Carpet grips snap into linkable screen glides to prevent components from sliding. Glide rotates in carpet grip to permit levelling.
		Non-skid grips snap into glides to prevent sliding on hard surface floors.

description	application	h	w	d	pattern no.	L	V1	V2	V3
Gallery screens	39" high	39"	20"	1"	AG1B3920 () () ()	\$350.	\$438.	\$562.	\$948.
	39" high	39"	24"	1"	AG1B3924 () () ()	393.	477.	628.	1,098.
	39" high	39"	30"	1"	AG1B3930 () () ()	438.	517.	692.	1,267.
	39" high	39"	36"	1"	AG1B3936 () () ()	481.	557.	756.	1,436.
	39" high	39"	42"	1"	AG1B3942 () () ()	525.	597.	821.	1,605.
	39" high	39"	48"	1"	AG1B3948 () () ()	568.	637.	885.	1,773.
	39" high	39"	54"	1"	AG1B3954 () () ()	612.	678.	952.	1,942.
	39" high	39"	60"	1"	AG1B3960 () () ()	655.	716.	1,016.	2,110.
	39" high	39"	66"	1"	AG1B3966 () () ()	699.	756.	1,082.	2,277.
	39" high	39"	72"	1"	AG1B3972 () () ()	742.	796.	1,146.	2,448.
	39" high	39"	78"	1"	AG1B3978 () () ()	785.	836.	1,210.	2,614.
	39" high	39"	84"	1"	AG1B3984 () () ()	831.	876.	1,277.	2,783.
	39" high	39"	90"	1"	AG1B3990 () () ()	874.	916.	1,341.	2,953.
	39" high	39"	96"	1"	AG1B3996 () () ()	917.	956.	1,405.	3,120.
	49" high	49"	20"	1"	AG1B4920 () () ()	455.	530.	693.	1,167.
	49" high	49"	24"	1"	AG1B4924 () () ()	499.	570.	768.	1,317.
	49" high	49"	30"	1"	AG1B4930 () () ()	542.	611.	843.	1,523.
	49" high	49"	36"	1"	AG1B4936 () () ()	587.	650.	917.	1,729.
	49" high	49"	42"	1"	AG1B4942 () () ()	631.	691.	992.	1,936.
	49" high	49"	48"	1"	AG1B4948 () () ()	674.	730.	1,067.	2,139.
	49" high	49"	54"	1"	AG1B4954 () () ()	718.	771.	1,142.	2,346.
	49" high	49"	60"	1"	AG1B4960 () () ()	762.	808.	1,217.	2,553.
	49" high	49"	66"	1"	AG1B4966 () () ()	804.	850.	1,290.	2,756.
	49" high	49"	72"	1"	AG1B4972 () () ()	849.	889.	1,365.	2,964.
	49" high	49"	78"	1"	AG1B4978 () () ()	891.	930.	1,441.	3,169.
	49" high	49"	84"	1"	AG1B4984 () () ()	937.	969.	1,516.	3,377.
	49" high	49"	90"	1"	AG1B4990 () () ()	980.	1,011.	1,590.	3,582.
	49" high	49"	96"	1"	AG1B4996 () () ()	1,023.	1,050.	1,667.	3,789.

Order Code	Specification Information	Application Notes
Example: AG1 B 4948L N 115	For Gallery screens specify:	Gallery screens attach to AutoStrada or Currents Service Wall and adjacent worksurfaces to define workspaces. Gallery screens are 1" thick, solid wood core, self-edged in laminate, Techwood or natural veneer. 39"H screens correspond in height to 39"H Service Wall (underside of any crown). 49"H screens correspond in height to 49"H Anchor cabinet and to 48"H Service Wall with compact or flat crown.
AG1 Gallery screen	1.Planning application, L=Screen at left end of Service Wall (from inside face of screen) R=Screen at right end of Service Wall	Other end of 39"H screen is always "N", no attachment. Other end of 49"H screen can have provisions for attachment to 49"H Anchor cabinet or no attachment.
B Back screen	S=Intermediate screen attached to face of Service Wall	Gallery screens must be stabilized by screen-to-worksurface bracket or attachment to Anchor cabinet.
49 Height	2.Then specify other end application: A=Attach to anchor cabinet (49"H screen only) N=No attachment	
48 Width	3.Then specify finish, all standard laminates for vertical applications, all standard Techwoods and natural veneers.	
L End starter	Gallery screens include black leveling glides with 1" range. Starting point for screens is 1/2" above floor.	
N No attachment		
115 Finish		

description	application	pattern no.	AA	P1	P2	P3	G2	G3
Panel attachment kit for glass gallery screen	for 42" h panel attachment	A1GGPC4234(L/R) ()	\$775.	\$659.	\$659.	\$698.		
	for 46" h panel attachment	A1GGPC4934(L/R) ()	775.	659.	659.	698.		
Spine attachment kit for glass gallery screen	mid span/ off modular	A1GGSPSC30(L/R) ()	808.	687.	687.	726.		
	spine end starter	A1GGSE30(L/R) () ()	785.	668.	668.	708.		
Glass, for panel based	for 42" h x 60" w	A1PGG4260 ()					1,410.	1,899.
	for 42" h x 72" w	A1PGG4272 ()					1,636.	2,265.
	for 49" h x 60" w	A1PGG4960 ()					1,620.	2,204.
	for 49" h x 72" w	A1PGG4972 ()					1,887.	2,585.
Glass, for spine based	for 48" h x 60" w	A1SGG4860 ()					1,567.	2,127.
	for 48" h x 72" w	A1SGG4872 ()					1,823.	2,496.

Spine and linkable screens

Order Code	Specification Information	Application Notes
Example: A1GGPC4234		
A AutoStrada	1.L/R- Left or right hand connection If left hand, worksurface on right side of glass If right hand, worksurface on left side of glass	Glass Gallery Screen Panel attachment kit includes finished connection to panel post and end capture for glass.
1 Generation 1		
GG Gallery screen, glass		Glass Gallery Screen Spine attachment kit includes finished connection to spine and end capture for glass.
PC Panel post connector		
42 42" h panel attachment (includes Hi/low trim)	2.Finish divider capture AA and all core paint options except 613	
34 34" high nominal		Glass to align top of panel insert, below top trim for panel base.
(L/R) Left or right hand connection	<i>Glass Finish</i> G2=Architectural G3=Color	Glass to align top of Service Wall cover, below crown or at horizontal channel at nominal 48" high if 64" Service Wall.
() Finish divider, capture		

Tiled/Monolithic - mono side only with base raceway
Tiled one side - Laminate/Monolithic side - fabric

description	h	w	pattern no.	Grade							
				10	15	20	30	35	40	45	
Tiled laminate one side, fabric monolithic other side (tiled side without base raceway)	34"	18"	R3R1AFL3418 () () () () () ()	\$738.	\$750.	\$785.	\$833.	\$864.	\$921.	\$949.	
		24"	R3R1AFL3424 () () () () () ()	785.	802.	838.	882.	916.	971.	1,001.	
		30"	R3R1AFL3430 () () () () () ()	845.	859.	897.	939.	972.	1,030.	1,060.	
		36"	R3R1AFL3436 () () () () () ()	899.	911.	949.	992.	1,024.	1,082.	1,109.	
		42"	R3R1AFL3442 () () () () () ()	1,033.	1,048.	1,083.	1,128.	1,160.	1,216.	1,245.	
		48"	R3R1AFL3448 () () () () () ()	1,068.	1,083.	1,119.	1,163.	1,195.	1,252.	1,281.	
		42"	18"	R3R1AFL4218 () () () () () ()	819.	842.	887.	949.	988.	1,057.	1,097.
		24"	R3R1AFL4224 () () () () () ()	875.	899.	947.	1,006.	1,047.	1,111.	1,154.	
		30"	R3R1AFL4230 () () () () () ()	938.	961.	1,008.	1,069.	1,108.	1,176.	1,218.	
		36"	R3R1AFL4236 () () () () () ()	998.	1,021.	1,069.	1,131.	1,171.	1,234.	1,279.	
42"	R3R1AFL4242 () () () () () ()	1,122.	1,146.	1,192.	1,253.	1,294.	1,361.	1,402.			
48"	R3R1AFL4248 () () () () () ()	1,185.	1,211.	1,255.	1,316.	1,358.	1,421.	1,466.			
49"	18"	R3R1AFL4918 () () () () () ()	910.	932.	988.	1,055.	1,102.	1,185.	1,227.		
24"	R3R1AFL4924 () () () () () ()	972.	993.	1,050.	1,115.	1,166.	1,247.	1,292.			
30"	R3R1AFL4930 () () () () () ()	1,049.	1,069.	1,124.	1,191.	1,240.	1,324.	1,366.			
36"	R3R1AFL4936 () () () () () ()	1,109.	1,135.	1,189.	1,254.	1,305.	1,384.	1,428.			
42"	R3R1AFL4942 () () () () () ()	1,251.	1,273.	1,328.	1,395.	1,443.	1,525.	1,570.			
48"	R3R1AFL4948 () () () () () ()	1,320.	1,340.	1,398.	1,465.	1,514.	1,597.	1,638.			
64"	18"	R3R1AFL6418 () () () () () ()	1,041.	1,071.	1,146.	1,232.	1,303.	1,408.	1,467.		
24"	R3R1AFL6424 () () () () () ()	1,111.	1,144.	1,216.	1,305.	1,369.	1,477.	1,540.			
30"	R3R1AFL6430 () () () () () ()	1,196.	1,227.	1,304.	1,390.	1,454.	1,565.	1,624.			
36"	R3R1AFL6436 () () () () () ()	1,271.	1,304.	1,375.	1,464.	1,527.	1,637.	1,696.			
42"	R3R1AFL6442 () () () () () ()	1,447.	1,476.	1,552.	1,637.	1,704.	1,813.	1,873.			
48"	R3R1AFL6448 () () () () () ()	1,521.	1,552.	1,624.	1,711.	1,780.	1,887.	1,946.			

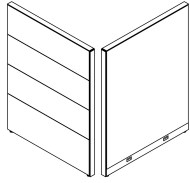

both sides 64x48 shown, 49" h with three tiles; 34" h with two tiles; 42" h 3 tiles/ top tile 7" h

Order Code	Specification Information	Application Notes
Example: R3R1AFL3418EAA4K 613W359-118N	<i>To order please specify pattern number including:</i>	Monolithic side with base raceway only. Tiled side inserts extended to the floor. Be sure to specify power rails for panels with one sided base raceways.
R3	1. Height	
	2. Width	
R1	3. Extruded Aluminum Top Trim <i>E - default</i>	Tiled side includes panel reveals between laminate inserts. Aluminum vertical hookstrip cover ordered separately.
A	4. Finish, Aluminum trim (top trim and tile dividers/reveals) <i>Anodized aluminum or painted finish options listed on page 10 excluding silver.</i>	Panels are not for use with medians, storage medians or bridges.
F	5. Base raceway height <i>4 = 4" h, default</i>	Black PVC hookstrip reveals should be ordered for monolithic side from Reff price list.
L	6. Knock-out option <i>K = with knock-outs</i> <i>N = no knock-outs</i>	Panels on this page will accept standard Reff System stacking window modules.
34	7. Base raceway finish <i>Painted or plated finish options only</i>	Product on this page will accept marker board and wood grain laminate where laminate is currently an option.
18	8. Fabric selection	
E	9. Finish, L = Laminate LW = Marker board	
AA	10. Milled for ported components <i>M = milled for (\$15 list upcharge applicable)</i> <i>N = not milled for</i>	
4		
K		
613		
W359-		
118		
N	See page 8 for finish options applicable.	

Tiled/Monolithic - mono side only with base raceway
Tiled one side - V1 Techwood/Monolithic - fabric

description	h	w	pattern no.	Grade						
				10	15	20	30	35	40	45
Tiled V1 techwood one side, fabric monolithic other side (tiled side without base raceway)	34"	18"	R3R1AF13418 () () () () () () ()	\$757.	\$773.	\$810.	\$856.	\$887.	\$941.	\$974.
		24"	R3R1AF13424 () () () () () () ()	815.	828.	867.	910.	941.	1,000.	1,029.
	30"	R3R1AF13430 () () () () () () ()	871.	886.	924.	967.	1,001.	1,058.	1,088.	
	36"	R3R1AF13436 () () () () () () ()	924.	938.	975.	1,019.	1,051.	1,109.	1,140.	
	42"	R3R1AF13442 () () () () () () ()	1,069.	1,080.	1,117.	1,162.	1,194.	1,252.	1,281.	
	48"	R3R1AF13448 () () () () () () ()	1,100.	1,116.	1,154.	1,197.	1,232.	1,286.	1,317.	
	42"	18"	R3R1AF14218 () () () () () () ()	842.	864.	912.	972.	1,013.	1,080.	1,122.
		24"	R3R1AF14224 () () () () () () ()	903.	926.	972.	1,033.	1,074.	1,142.	1,184.
		30"	R3R1AF14230 () () () () () () ()	969.	993.	1,040.	1,100.	1,142.	1,205.	1,249.
		36"	R3R1AF14236 () () () () () () ()	1,029.	1,052.	1,098.	1,158.	1,200.	1,265.	1,310.
42"		R3R1AF14242 () () () () () () ()	1,158.	1,184.	1,231.	1,294.	1,334.	1,398.	1,442.	
48"		R3R1AF14248 () () () () () () ()	1,217.	1,241.	1,289.	1,349.	1,389.	1,458.	1,498.	
49"		18"	R3R1AF14918 () () () () () () ()	935.	958.	1,014.	1,080.	1,131.	1,212.	1,258.
		24"	R3R1AF14924 () () () () () () ()	1,001.	1,022.	1,077.	1,146.	1,193.	1,280.	1,323.
	30"	R3R1AF14930 () () () () () () ()	1,076.	1,098.	1,155.	1,224.	1,272.	1,353.	1,397.	
	36"	R3R1AF14936 () () () () () () ()	1,145.	1,164.	1,224.	1,286.	1,339.	1,420.	1,465.	
	42"	R3R1AF14942 () () () () () () ()	1,294.	1,316.	1,369.	1,434.	1,485.	1,570.	1,615.	
	48"	R3R1AF14948 () () () () () () ()	1,363.	1,384.	1,439.	1,508.	1,557.	1,640.	1,685.	
64"	18"	R3R1AF16418 () () () () () () ()	1,075.	1,105.	1,179.	1,267.	1,337.	1,445.	1,505.	
	24"	R3R1AF16424 () () () () () () ()	1,148.	1,178.	1,249.	1,340.	1,408.	1,520.	1,576.	
	30"	R3R1AF16430 () () () () () () ()	1,234.	1,263.	1,339.	1,427.	1,491.	1,606.	1,665.	
	36"	R3R1AF16436 () () () () () () ()	1,307.	1,339.	1,412.	1,502.	1,569.	1,680.	1,740.	
	42"	R3R1AF16442 () () () () () () ()	1,489.	1,521.	1,594.	1,684.	1,751.	1,860.	1,919.	
	48"	R3R1AF16448 () () () () () () ()	1,569.	1,597.	1,671.	1,760.	1,828.	1,939.	2,000.	

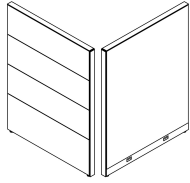

both sides 64x48 shown, 49" h with three tiles; 34" h with two tiles; 42" h 3 tiles/ top tile 7" h

Panels

Order Code	Specification Information	Application Notes
Example: R3R1AF13418EAA4K 613W359-Y319N	<i>To order please specify pattern number including:</i>	Monolithic side with base raceway only. Tiled side inserts extended to the floor. Be sure to specify power rails for panels with one sided base raceways.
R3	1. Height	
	2. Width	
R1	3. Extruded Aluminum Top Trim <i>E - default</i>	Tiled side includes panel reveals between V1 inserts. Aluminum vertical hookstrip cover ordered separately.
A	4. Finish, Aluminum trim (top trim and tile dividers/reveals) <i>Anodized aluminum or painted finish options listed on page 10 excluding silver.</i>	Panels are not for use with medians, storage medians or bridges.
F	5. Base raceway height <i>4 = 4" h, default</i>	Black PVC hookstrip reveals should be ordered for monolithic side from Reff price list.
1	6. Knock-out option <i>K = with knock-outs</i> <i>N = no knock-outs</i>	Panels on this page will accept standard Reff System stacking window modules.
34	7. Base raceway finish <i>painted or plated finish options only</i>	
18	8. Fabric selection	
E	9. Finish, V1 Techwood	
AA	10. Milled for ported components <i>M = milled for (\$15 list upcharge applicable)</i> <i>N = not milled for</i>	
4		
K		
613		
W359-		
Y319		
N	See page 8 for finish options applicable.	

Tiled/Monolithic - mono side only with base raceway
Tiled one side - V2 Natural/Monolithic - fabric

description	h	w	pattern no.	Grade							
				10	15	20	30	35	40	45	
Tiled V2 natural one side, fabric monolithic other side (tiled side without base raceway)	34"	18"	R3R1AF23418 (X)(X)(X)(X)(X)	\$774.	\$791.	\$827.	\$871.	\$906.	\$959.	\$988.	
		24"	R3R1AF23424 (X)(X)(X)(X)(X)	829.	847.	884.	928.	959.	1,016.	1,047.	
		30"	R3R1AF23430 (X)(X)(X)(X)(X)	887.	904.	939.	984.	1,017.	1,074.	1,102.	
		36"	R3R1AF23436 (X)(X)(X)(X)(X)	940.	957.	995.	1,039.	1,072.	1,126.	1,156.	
		42"	R3R1AF23442 (X)(X)(X)(X)(X)	1,087.	1,098.	1,138.	1,180.	1,212.	1,271.	1,302.	
		48"	R3R1AF23448 (X)(X)(X)(X)(X)	1,123.	1,140.	1,175.	1,220.	1,253.	1,308.	1,339.	
		42"	18"	R3R1AF24218 (X)(X)(X)(X)(X)	859.	882.	928.	988.	1,030.	1,096.	1,141.
			24"	R3R1AF24224 (X)(X)(X)(X)(X)	921.	942.	992.	1,052.	1,093.	1,157.	1,201.
			30"	R3R1AF24230 (X)(X)(X)(X)(X)	985.	1,011.	1,058.	1,118.	1,157.	1,227.	1,267.
			36"	R3R1AF24236 (X)(X)(X)(X)(X)	1,052.	1,076.	1,122.	1,184.	1,226.	1,292.	1,336.
		42"	R3R1AF24242 (X)(X)(X)(X)(X)	1,182.	1,203.	1,252.	1,312.	1,353.	1,420.	1,463.	
		48"	R3R1AF24248 (X)(X)(X)(X)(X)	1,243.	1,265.	1,315.	1,377.	1,416.	1,482.	1,525.	
	49"	18"	R3R1AF24918 (X)(X)(X)(X)(X)	957.	979.	1,033.	1,099.	1,150.	1,234.	1,280.	
		24"	R3R1AF24924 (X)(X)(X)(X)(X)	1,019.	1,043.	1,098.	1,164.	1,216.	1,300.	1,344.	
		30"	R3R1AF24930 (X)(X)(X)(X)(X)	1,100.	1,123.	1,180.	1,247.	1,299.	1,380.	1,423.	
		36"	R3R1AF24936 (X)(X)(X)(X)(X)	1,166.	1,190.	1,245.	1,315.	1,363.	1,445.	1,489.	
		42"	R3R1AF24942 (X)(X)(X)(X)(X)	1,316.	1,338.	1,392.	1,459.	1,510.	1,593.	1,636.	
		48"	R3R1AF24948 (X)(X)(X)(X)(X)	1,388.	1,411.	1,465.	1,534.	1,581.	1,667.	1,710.	
	64"	18"	R3R1AF26418 (X)(X)(X)(X)(X)	1,097.	1,126.	1,201.	1,292.	1,358.	1,466.	1,527.	
		24"	R3R1AF26424 (X)(X)(X)(X)(X)	1,170.	1,200.	1,273.	1,363.	1,430.	1,539.	1,599.	
		30"	R3R1AF26430 (X)(X)(X)(X)(X)	1,257.	1,286.	1,361.	1,450.	1,515.	1,627.	1,686.	
		36"	R3R1AF26436 (X)(X)(X)(X)(X)	1,338.	1,365.	1,439.	1,528.	1,595.	1,708.	1,765.	
		42"	R3R1AF26442 (X)(X)(X)(X)(X)	1,523.	1,553.	1,626.	1,713.	1,782.	1,892.	1,952.	
		48"	R3R1AF26448 (X)(X)(X)(X)(X)	1,597.	1,627.	1,702.	1,790.	1,857.	1,969.	2,028.	

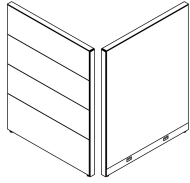

both sides 64x48 shown, 49" h with three tiles; 34" h with two tiles; 42" h 3 tiles/ top tile 7" h

Order Code	Specification Information	Application Notes
Example: R3R1AF23418EAA4K613W359-V316N	<i>To order please specify pattern number including:</i>	Monolithic side with base raceway only. Tiled side inserts extended to the floor. Be sure to specify power rails for panels with one sided base raceways.
R3 AutoStrada w/generation 3 frame	1. Height	
R1 Base raceway monolithic side only	2. Width	
A Tiled one side, Monolithic other	3. Extruded Aluminum Top Trim <i>E - default</i>	Tiled side includes panel reveals between V2 inserts. Aluminum vertical hookstrip cover ordered separately.
F Fabric, monolithic side	4. Finish, Aluminum trim (top trim and tile dividers/reveals) <i>Anodized aluminum or painted finish options listed on page 10 excluding silver.</i>	Panels are not for use with medians, storage medians or bridges.
2 V2 Natural, tiled side	5. Base raceway height <i>4 = 4" h, default</i>	Black PVC hookstrip reveals should be ordered for monolithic side from Reff price list.
34 34" high	6. Knock-out option <i>K = with knock-outs</i> <i>N = no knock-outs</i>	Panels on this page will accept standard Reff System stacking window modules.
18 18" wide	7. Base raceway finish <i>painted or plated finish options only</i>	
E Extruded Aluminum top trim	8. Fabric selection	
AA Top Trim anodized aluminum finish	9. Finish, V2 Natural	
4 4" high base raceway	10. Milled for ported components <i>M = milled for (\$15 list upcharge applicable)</i> <i>N = not milled for</i>	
K Knock-outs in base raceway		
613 Finish, base raceway		
W359- Finish, fabric		
V316 Finish, Maple		
N Not milled for ported components	See page 8 for finish options applicable.	

Tiled/Monolithic - mono side only with base raceway
 Tiled one side - V3 Exotic/Monolithic - fabric

description	h	w	pattern no.	Grade							
				10	15	20	30	35	40	45	
Tiled V3 exotic one side, fabric monolithic other side (tiled side without base raceway)	34"	18"	R3R1AF33418 () () () () () ()	\$1,030.	\$1,049.	\$1,097.	\$1,156.	\$1,200.	\$1,272.	\$1,308.	
		24"	R3R1AF33424 () () () () () ()	1,100.	1,120.	1,171.	1,229.	1,272.	1,344.	1,382.	
		30"	R3R1AF33430 () () () () () ()	1,178.	1,194.	1,244.	1,304.	1,347.	1,418.	1,458.	
		36"	R3R1AF33436 () () () () () ()	1,247.	1,265.	1,316.	1,370.	1,415.	1,488.	1,527.	
		42"	R3R1AF33442 () () () () () ()	1,432.	1,451.	1,498.	1,557.	1,601.	1,672.	1,711.	
		48"	R3R1AF33448 () () () () () ()	1,482.	1,504.	1,553.	1,608.	1,650.	1,724.	1,762.	
		42"	18"	R3R1AF34218 () () () () () ()	1,171.	1,194.	1,242.	1,304.	1,344.	1,411.	1,456.
		24"	R3R1AF34224 () () () () () ()	1,254.	1,279.	1,326.	1,387.	1,425.	1,492.	1,536.	
		30"	R3R1AF34230 () () () () () ()	1,345.	1,369.	1,416.	1,476.	1,518.	1,583.	1,628.	
		36"	R3R1AF34236 () () () () () ()	1,433.	1,459.	1,505.	1,567.	1,607.	1,673.	1,715.	
42"	R3R1AF34242 () () () () () ()	1,608.	1,631.	1,677.	1,740.	1,781.	1,846.	1,889.			
48"	R3R1AF34248 () () () () () ()	1,691.	1,715.	1,763.	1,825.	1,863.	1,933.	1,974.			
49"	18"	R3R1AF34918 () () () () () ()	1,275.	1,305.	1,378.	1,463.	1,528.	1,636.	1,694.		
24"	R3R1AF34924 () () () () () ()	1,359.	1,388.	1,462.	1,548.	1,614.	1,721.	1,781.			
30"	R3R1AF34930 () () () () () ()	1,465.	1,493.	1,568.	1,651.	1,717.	1,828.	1,885.			
36"	R3R1AF34936 () () () () () ()	1,553.	1,577.	1,650.	1,738.	1,803.	1,911.	1,970.			
42"	R3R1AF34942 () () () () () ()	1,741.	1,769.	1,842.	1,926.	1,993.	2,102.	2,161.			
48"	R3R1AF34948 () () () () () ()	1,839.	1,866.	1,937.	2,026.	2,089.	2,196.	2,255.			
64"	18"	R3R1AF36418 () () () () () ()	1,468.	1,509.	1,606.	1,718.	1,805.	1,952.	2,028.		
24"	R3R1AF36424 () () () () () ()	1,566.	1,601.	1,699.	1,814.	1,899.	2,047.	2,123.			
30"	R3R1AF36430 () () () () () ()	1,677.	1,714.	1,809.	1,926.	2,015.	2,161.	2,237.			
36"	R3R1AF36436 () () () () () ()	1,782.	1,818.	1,916.	2,031.	2,117.	2,262.	2,340.			
42"	R3R1AF36442 () () () () () ()	2,021.	2,059.	2,158.	2,272.	2,358.	2,502.	2,581.			
48"	R3R1AF36448 () () () () () ()	2,122.	2,161.	2,255.	2,369.	2,457.	2,601.	2,679.			

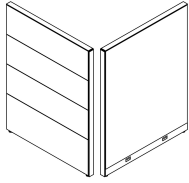

both sides 64x48 shown, 49" h with three tiles; 34" h with two tiles; 42" h 3 tiles/ top tile 7" h

Panels

Order Code	Specification Information	Application Notes
Example: R3R1AF33418EAA4K 613W359-V515N	To order please specify pattern number including:	Monolithic side with base raceway only. Tiled side inserts extended to the floor. Be sure to specify power rails for panels with one sided base raceways.
R3	AutoStrada w/generation 3 frame	
R1	Base raceway monolithic side only	Tiled side includes panel reveals between V3
A	Tiled one side, Monolithic other	inserts. Aluminum vertical hookstrip cover ordered separately.
F	Fabric, monolithic side	
3	V3 Exotic, tiled side	Panels are not for use with medians, storage medians or bridges.
34	34" high	
18	18" wide	Black PVC hookstrip reveals should be ordered for monolithic side from Reff price list.
E	Extruded Aluminum top trim	
AA	Top Trim anodized aluminum finish	Panels on this page will accept standard Reff System stacking window modules.
4	4" high base raceway	
K	Knock-outs in base raceway	
613	Finish, base raceway	
W359-	Finish, fabric	
V515	Finish, Quartered Clear Figured Sycamore	
N	Not milled for ported components	

See page 8 for finish options applicable.

Tiled/Monolithic - mono side only with base raceway
 Tiled one side - Laminate / Laminate
 34" and 42"h

description	h	w	pattern no.	L
Tiled/Monolithic - tiled side no raceway	34"	18"	R3R1ALL3418 () () () () () ()	\$654.
Laminate outside/Laminate inside		24"	R3R1ALL3424 () () () () () ()	712.
		30"	R3R1ALL3430 () () () () () ()	796.
		36"	R3R1ALL3436 () () () () () ()	861.
		42"	R3R1ALL3442 () () () () () ()	886.
		48"	R3R1ALL3448 () () () () () ()	930.
	42"	18"	R3R1ALL4218 () () () () () ()	691.
		24"	R3R1ALL4224 () () () () () ()	751.
		30"	R3R1ALL4230 () () () () () ()	844.
		36"	R3R1ALL4236 () () () () () ()	910.
		42"	R3R1ALL4242 () () () () () ()	1,001.
		48"	R3R1ALL4248 () () () () () ()	1,121.

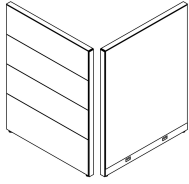

both sides 64x48 shown, 49"h with three tiles; 34"h with two tiles; 42"h 3 tiles/ top tile 7"h

Order Code	Specification Information	Application Notes
Example: R3R1ALL4218EAA4K 613W359-118N	To order please specify pattern number including:	Laminate finish insert extended to the floor. Be sure to specify power rails for panels with one sided base raceways.
R3 AutoStrada w/generation 3 frame	1. Height	
R1 Base raceway monolithic side only	2. Width	
A Monolithic	3. Extruded Aluminum Top Trim <i>E - default</i>	Aluminum vertical hookstrip cover ordered separately.
L Laminate, interior side	4. Finish, Aluminum top trim <i>Anodized aluminum or painted finish options listed on page 10 excluding silver.</i>	Panels are not for use with medians, storage medians or bridges.
L Laminate, exterior side	5. Base raceway height <i>4 = 4"h, default</i>	Black PVC hookstrip reveals should be ordered for fabric side from Reff price list.
42 42" high	6. Knock-out option <i>K = with knock-outs N = no knock-outs</i>	Panels on this page will accept standard Reff System stacking window modules.
18 18" wide	7. Base raceway finish <i>painted or plated finish options only</i>	
E Extruded Aluminum top trim	8. Finish, L = Laminate LW = Marker board	These panels will accept all core laminates; including marker board and wood grain laminate.
AA Top Trim anodized aluminum finish	9. Finish, L = Laminate LW = Marker board	
4 4" high base raceway	10. Milled for ported components <i>M = milled for (\$15 list upcharge applicable) N = not milled for</i>	
K Knock-outs in base raceway		
613 Finish, base raceway	See page 8 for finish options applicable.	
118 Finish, Bright White		
118 Finish, Bright White		
N Not milled for ported components		

Tiled/Monolithic - mono side only with base raceway

Tiled one side - Laminate / Laminate

49" and 64"h

description	h	w	pattern no.	L
Tiled/Monolithic - tiled side no raceway	49"	18"	R3R1ALL4918 () () () () () ()	\$821.
Laminate outside/Laminate inside		24"	R3R1ALL4924 () () () () () ()	895.
		30"	R3R1ALL4930 () () () () () ()	1,000.
		36"	R3R1ALL4936 () () () () () ()	1,082.
		42"	R3R1ALL4942 () () () () () ()	1,189.
		48"	R3R1ALL4948 () () () () () ()	1,331.
	64"	18"	R3R1ALL6418 () () () () () ()	912.
		24"	R3R1ALL6424 () () () () () ()	994.
		30"	R3R1ALL6430 () () () () () ()	1,114.
		36"	R3R1ALL6436 () () () () () ()	1,203.
		42"	R3R1ALL6442 () () () () () ()	1,324.
		48"	R3R1ALL6448 () () () () () ()	1,482.

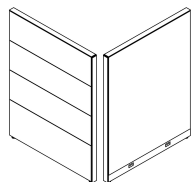

both sides 64x48 shown, 49"h with three tiles; 34"h with two tiles; 42"h 3 tiles/ top tile 7"h

Panels

Order Code	Specification Information	Application Notes
Example: R3R1ALL4218EAA4K 613W359-118N	To order please specify pattern number including:	Laminate finish insert extended to the floor. Be sure to specify power rails for panels with one sided base raceways.
R3 AutoStrada w/generation 3 frame	1. Height	
R1 Base raceway monolithic side only	2. Width	
A Monolithic	3. Extruded Aluminum Top Trim <i>E - default</i>	Aluminum vertical hookstrip cover ordered separately.
L Laminate, interior side	4. Finish, Aluminum top trim <i>Anodized aluminum or painted finish options listed on page 10 excluding silver.</i>	Panels are not for use with medians, storage medians or bridges.
L Laminate, exterior side	5. Base raceway height <i>4 = 4"h, default</i>	Black PVC hookstrip reveals should be ordered for fabric side from Reff price list.
42 42" high	6. Knock-out option <i>K = with knock-outs</i>	
18 18" wide	<i>N = no knock-outs</i>	
E Extruded Aluminum top trim	7. Base raceway finish <i>painted or plated finish options only</i>	Panels on this page will accept standard Reff System stacking window modules.
AA Top Trim anodized aluminum finish	8. Finish, L = Laminate	
4 4" high base raceway	LW = Marker board	These panels will accept all core laminates; including marker board and wood grain laminate.
K Knock-outs in base raceway	9. Finish, L = Laminate	
613 Finish, base raceway	LW = Marker board	
118 Finish, Bright White	10. Milled for ported components <i>M = milled for (\$15 list upcharge applicable)</i>	
118 Finish, Bright White	<i>N = not milled for</i>	
N Not milled for ported components	See page 8 for finish options applicable.	

Mono/Mono - exterior hard side no raceway Laminate outside / Fabric inside

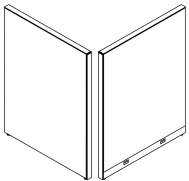
description	h	w	pattern no.	Grade						
				10	15	20	30	35	40	45
Monolithic laminate exterior no raceway, interior fabric with raceway  <i>both sides 49x48 shown</i>	42"	18"	R3R1PFL4218 () () () () () ()	\$516.	\$528.	\$550.	\$597.	\$632.	\$673.	\$702.
		24"	R3R1PFL4224 () () () () () ()	524.	534.	557.	604.	639.	681.	710.
		30"	R3R1PFL4230 () () () () () ()	629.	638.	663.	709.	744.	784.	818.
		36"	R3R1PFL4236 () () () () () ()	681.	690.	713.	761.	796.	838.	867.
		42"	R3R1PFL4242 () () () () () ()	765.	774.	796.	847.	882.	925.	953.
		48"	R3R1PFL4248 () () () () () ()	832.	842.	864.	912.	950.	991.	1,021.
	49"	18"	R3R1PFL4918 () () () () () ()	571.	588.	614.	671.	709.	756.	789.
		24"	R3R1PFL4924 () () () () () ()	627.	641.	668.	725.	765.	815.	847.
		30"	R3R1PFL4930 () () () () () ()	709.	725.	749.	810.	848.	898.	930.
		36"	R3R1PFL4936 () () () () () ()	766.	780.	809.	864.	904.	954.	986.
	42"	R3R1PFL4942 () () () () () ()	845.	859.	886.	945.	984.	1,035.	1,067.	
	48"	R3R1PFL4948 () () () () () ()	951.	965.	993.	1,055.	1,092.	1,144.	1,176.	

Order Code	Specification Information	Application Notes
Example: R3R1PFL4218EAA4K 613W359-118N	<i>To order please specify pattern number including:</i>	Interior fabric side with base raceway, exterior monolithic laminate finish insert extended to the floor. Be sure to specify power rails for panels with one sided base raceways.
R3 AutoStrada w/generation 3 frame	1. Height	Aluminum vertical hookstrip cover ordered separately.
R1 Base raceway monolithic side only	2. Width	
P Monolithic	3. Extruded Aluminum Top Trim <i>E - default</i>	Panels are not for use with medians, storage medians or bridges.
F Fabric, interior side	4. Finish, Aluminum top trim <i>Anodized aluminum or painted finish options listed on page 10 excluding silver.</i>	
L Laminate, exterior side	5. Base raceway height <i>4 = 4" h, default</i>	Black PVC hookstrip reveals should be ordered for fabric side from Reff price list.
42 42" high	6. Knock-out option <i>K = with knock-outs N = no knock-outs</i>	
18 18" wide	7. Base raceway finish <i>painted or plated finish options only</i>	Panels on this page will accept standard Reff System stacking window modules.
E Extruded Aluminum top trim	8. Fabric selection	
AA Top Trim anodized aluminum finish	9. Finish, L = Laminate LW = Marker board	Product on this page will accept marker board and wood grain laminate where laminate is currently an option.
4 4" high base raceway	10. Milled for ported components <i>M = milled for (\$15 list upcharge applicable) N = not milled for</i>	
K Knock-outs in base raceway		
613 Finish, base raceway		
W359- Finish, fabric		
118 Finish, Bright White		
N Not milled for ported components	See page 8 for finish options applicable.	

Mono/Mono - exterior hard side no raceway

VI Techwood outside / Fabric inside

description	h	w	pattern no.	Grade							
				10	15	20	30	35	40	45	
Monolithic VI techwood exterior no raceway, interior fabric with raceway	42"	18"	R3R1PF14218 () () () () () () ()	\$613.	\$628.	\$652.	\$705.	\$749.	\$796.	\$830.	
		24"	R3R1PF14224 () () () () () () ()	619.	633.	659.	712.	754.	802.	836.	
		30"	R3R1PF14230 () () () () () () ()	747.	757.	785.	842.	884.	932.	965.	
		36"	R3R1PF14236 () () () () () () ()	809.	821.	849.	903.	943.	994.	1,029.	
		42"	R3R1PF14242 () () () () () () ()	909.	921.	950.	1,003.	1,048.	1,096.	1,131.	
		48"	R3R1PF14248 () () () () () () ()	988.	1,000.	1,029.	1,083.	1,128.	1,175.	1,211.	
		49"	18"	R3R1PF14918 () () () () () () ()	682.	698.	729.	794.	841.	896.	934.
			24"	R3R1PF14924 () () () () () () ()	745.	763.	792.	860.	905.	961.	1,000.
			30"	R3R1PF14930 () () () () () () ()	849.	865.	896.	964.	1,010.	1,068.	1,105.
			36"	R3R1PF14936 () () () () () () ()	908.	927.	958.	1,023.	1,071.	1,126.	1,165.
		42"	R3R1PF14942 () () () () () () ()	1,005.	1,022.	1,056.	1,122.	1,167.	1,227.	1,263.	
		48"	R3R1PF14948 () () () () () () ()	1,131.	1,149.	1,182.	1,248.	1,296.	1,353.	1,392.	

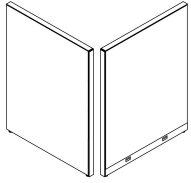

both sides 49x48 shown

Order Code	Specification Information	Application Notes
Example: R3R1PF14218EAA4K 613W359-Y319N	<i>To order please specify pattern number including:</i>	Interior fabric side with base raceway, exterior monolithic V1 insert extended to the floor. Be sure to specify power rails for panels with one sided base raceways.
R3	AutoStrada w/generation 3 frame	
R1	Base raceway monolithic side only	
P	Monolithic, both sides	Aluminum vertical hookstrip cover ordered separately.
F	Fabric, inside	Panels are not for use with medians, storage medians or bridges.
1	VI Techwood, outside	
42	42" high	Black PVC hookstrip reveals should be ordered for fabric side from Reff price list.
18	18" wide	
E	Extruded Aluminum top trim	Panels on this page will accept standard Reff System stacking window modules.
AA	Top Trim anodized aluminum finish	
4	4" high base raceway	
K	Knock-outs in base raceway	
613	Finish, base raceway	
W359-	Finish, fabric	
Y319	Finish, Cherry	
N	Not milled for ported components	

1. Height
2. Width
3. Extruded Aluminum Top Trim
E - default
4. Finish, Aluminum top trim
Anodized aluminum or painted finish options listed on page 10 excluding silver.
5. Base raceway height
4 = 4" h, default
6. Knock-out option
K = with knock-outs
N = no knock-outs
7. Base raceway finish
painted or plated finish options only
8. Fabric selection
9. Finish, VI Techwood
10. Milled for ported components
M = milled for (\$15 list upcharge applicable)
N = not milled for

See page 8 for finish options applicable.

Mono/Mono - exterior hard side no raceway
V2 Natural veneer outside / Fabric inside

description	h	w	pattern no.	Grade						
				10	15	20	30	35	40	45
Monolithic V2 natural veneer exterior no raceway, interior fabric with raceway	42"	18"	R3R1PF24218 () () () () () ()	\$627.	\$638.	\$665.	\$716.	\$762.	\$809.	\$844.
		24"	R3R1PF24224 () () () () () ()	634.	646.	673.	726.	770.	818.	851.
		30"	R3R1PF24230 () () () () () ()	763.	773.	801.	857.	901.	945.	981.
		36"	R3R1PF24236 () () () () () ()	824.	835.	864.	918.	961.	1,010.	1,043.
		42"	R3R1PF24242 () () () () () ()	928.	938.	967.	1,021.	1,068.	1,113.	1,149.
		48"	R3R1PF24248 () () () () () ()	1,011.	1,021.	1,051.	1,107.	1,150.	1,197.	1,233.
	49"	18"	R3R1PF24918 () () () () () ()	694.	710.	743.	809.	853.	909.	947.
		24"	R3R1PF24924 () () () () () ()	757.	775.	806.	874.	920.	975.	1,014.
		30"	R3R1PF24930 () () () () () ()	861.	879.	910.	977.	1,021.	1,078.	1,117.
		36"	R3R1PF24936 () () () () () ()	927.	942.	975.	1,042.	1,089.	1,146.	1,185.
	42"	R3R1PF24942 () () () () () ()	1,023.	1,042.	1,075.	1,144.	1,188.	1,244.	1,284.	
	48"	R3R1PF24948 () () () () () ()	1,155.	1,173.	1,204.	1,273.	1,320.	1,379.	1,417.	

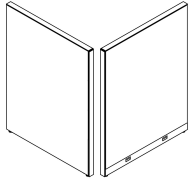

both sides 49x48 shown

Order Code	Specification Information	Application Notes
Example: R3R1PF24218EAA4K 613W359-V316N	To order please specify pattern number including:	Interior fabric side with base raceway, exterior monolithic V2 finish insert extended to the floor. Be sure to specify power rails for panels with one sided base raceways.
R3 AutoStrada w/generation 3 frame	1. Height	
R1 Base raceway monolithic side only	2. Width	
P Monolithic	3. Extruded Aluminum Top Trim <i>E - default</i>	Aluminum vertical hookstrip cover ordered separately.
F Fabric, monolithic interior	4. Finish, Aluminum top trim <i>Anodized aluminum or painted finish options listed on page 10 excluding silver.</i>	Panels are not for use with medians, storage medians or bridges.
2 V2 Natural, monolithic exterior	5. Base raceway height <i>4 = 4" h, default</i>	Black PVC hookstrip reveals should be ordered for fabric side from Reff price list.
42 42" high	6. Knock-out option <i>K = with knock-outs</i> <i>N = no knock-outs</i>	Panels on this page will accept standard Reff System stacking window modules.
18 18" wide	7. Base raceway finish <i>painted or plated finish options only</i>	
E Extruded Aluminum top trim	8. Fabric selection	
AA Top Trim anodized aluminum finish	9. Finish, V2 Natural	
4 4" high base raceway	10. Milled for ported components <i>M = milled for (\$15 list upcharge applicable)</i> <i>N = not milled for</i>	
K Knock-outs in base raceway		
613 Finish, base raceway	See page 8 for finish options applicable.	
W359- Finish, fabric		
V316 Finish, Maple		
N Not milled for ported components		

Mono/Mono - exterior hard side no raceway
V3 Exotic veneer outside / Fabric inside

description	h	w	pattern no.	Grade							
				10	15	20	30	35	40	45	
Monolithic V3 exotic veneer exterior no raceway, interior fabric with raceway	42"	18"	R3R1PF34218 () () () () () () ()	\$845.	\$857.	\$883.	\$936.	\$980.	\$1,024.	\$1,062.	
		24"	R3R1PF34224 () () () () () () ()	858.	868.	896.	948.	993.	1,040.	1,074.	
		30"	R3R1PF34230 () () () () () () ()	1,031.	1,043.	1,072.	1,124.	1,167.	1,216.	1,249.	
		36"	R3R1PF34236 () () () () () () ()	1,116.	1,128.	1,156.	1,210.	1,254.	1,303.	1,338.	
		42"	R3R1PF34242 () () () () () () ()	1,260.	1,272.	1,302.	1,355.	1,398.	1,446.	1,481.	
		48"	R3R1PF34248 () () () () () () ()	1,377.	1,388.	1,417.	1,470.	1,516.	1,563.	1,598.	
		49"	18"	R3R1PF34918 () () () () () () ()	935.	954.	983.	1,050.	1,095.	1,152.	1,191.
			24"	R3R1PF34924 () () () () () () ()	1,023.	1,043.	1,074.	1,142.	1,187.	1,243.	1,282.
			30"	R3R1PF34930 () () () () () () ()	1,165.	1,185.	1,216.	1,283.	1,328.	1,385.	1,423.
			36"	R3R1PF34936 () () () () () () ()	1,257.	1,274.	1,306.	1,375.	1,419.	1,476.	1,516.
		42"	R3R1PF34942 () () () () () () ()	1,393.	1,411.	1,442.	1,511.	1,557.	1,614.	1,651.	
		48"	R3R1PF34948 () () () () () () ()	1,571.	1,590.	1,623.	1,689.	1,736.	1,793.	1,834.	

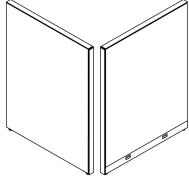

both sides 49x48 shown

Order Code	Specification Information	Application Notes
Example: R3R1PF34218EAA4K 613W359-V515N	<i>To order please specify pattern number including:</i>	Interior fabric side with base raceway, exterior monolithic V3 finish insert extended to the floor. Be sure to specify power rails for panels with one sided base raceways.
R3 AutoStrada w/generation 3 frame	1. Height	
R1 Base raceway monolithic side only	2. Width	
P Monolithic	3. Extruded Aluminum Top Trim <i>E - default</i>	Aluminum vertical hookstrip cover ordered separately.
F Fabric, interior side	4. Finish, Aluminum top trim <i>Anodized aluminum or painted finish options listed on page 10 excluding silver.</i>	Panels are not for use with medians, storage medians or bridges.
3 V3 Exotic, exterior side	5. Base raceway height <i>4 = 4" h, default</i>	Black PVC hookstrip reveals should be ordered for fabric side from Reff price list.
42 42" high	6. Knock-out option <i>K = with knock-outs N = no knock-outs</i>	Panels on this page will accept standard Reff System stacking window modules.
18 18" wide	7. Base raceway finish <i>painted or plated finish options only</i>	
E Extruded Aluminum top trim	8. Fabric selection	
AA Top Trim anodized aluminum finish	9. Finish, V3 Exotic	
4 4" high base raceway	10. Milled for ported components <i>M = milled for (\$15 list upcharge applicable) N = not milled for</i>	
K Knock-outs in base raceway		
613 Finish, base raceway		
W359- Finish, fabric		
V515 Finish, Quartered Clear Figured Sycamore	See page 8 for finish options applicable.	
N Not milled for ported components		

Tiled/Monolithic - both sides with base raceway
 Tiled one side - Laminate/Monolithic side - fabric

description	h	w	pattern no.	Grade						
				10	15	20	30	35	40	45
Tiled laminate one side, fabric monolithic other side (both sides w/ base raceway)	34"	18"	R3R2AFL3418 () () () () () ()	\$738.	\$750.	\$785.	\$833.	\$864.	\$921.	\$949.
		24"	R3R2AFL3424 () () () () () ()	785.	802.	838.	882.	916.	971.	1,001.
		30"	R3R2AFL3430 () () () () () ()	845.	859.	897.	939.	972.	1,030.	1,060.
		36"	R3R2AFL3436 () () () () () ()	899.	911.	949.	992.	1,024.	1,082.	1,109.
		42"	R3R2AFL3442 () () () () () ()	1,033.	1,048.	1,083.	1,128.	1,160.	1,216.	1,245.
		48"	R3R2AFL3448 () () () () () ()	1,068.	1,083.	1,119.	1,163.	1,195.	1,252.	1,281.
	49"	18"	R3R2AFL4918 () () () () () ()	910.	932.	988.	1,055.	1,102.	1,185.	1,227.
		24"	R3R2AFL4924 () () () () () ()	972.	993.	1,050.	1,115.	1,166.	1,247.	1,292.
		30"	R3R2AFL4930 () () () () () ()	1,049.	1,069.	1,124.	1,191.	1,240.	1,324.	1,366.
		36"	R3R2AFL4936 () () () () () ()	1,109.	1,135.	1,189.	1,254.	1,305.	1,384.	1,428.
		42"	R3R2AFL4942 () () () () () ()	1,251.	1,273.	1,328.	1,395.	1,443.	1,525.	1,570.
		48"	R3R2AFL4948 () () () () () ()	1,320.	1,340.	1,398.	1,465.	1,514.	1,597.	1,638.
64"	18"	R3R2AFL6418 () () () () () ()	1,041.	1,071.	1,146.	1,232.	1,303.	1,408.	1,467.	
	24"	R3R2AFL6424 () () () () () ()	1,111.	1,144.	1,216.	1,305.	1,369.	1,477.	1,540.	
	30"	R3R2AFL6430 () () () () () ()	1,196.	1,227.	1,304.	1,390.	1,454.	1,565.	1,624.	
	36"	R3R2AFL6436 () () () () () ()	1,271.	1,304.	1,375.	1,464.	1,527.	1,637.	1,696.	
	42"	R3R2AFL6442 () () () () () ()	1,447.	1,476.	1,552.	1,637.	1,704.	1,813.	1,873.	
	48"	R3R2AFL6448 () () () () () ()	1,521.	1,552.	1,624.	1,711.	1,780.	1,887.	1,946.	

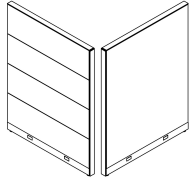

both sides 64x48 shown, 49" h with three tiles; 34" h with two tiles

Order Code	Specification Information	Application Notes
Example: R3R2AFL3418EAA4K 613W359-118N	<i>To order please specify pattern number including:</i>	Tiled side includes aluminum panel reveals between laminate inserts. Aluminum vertical hookstrip cover ordered separately.
R3	AutoStrada w/generation 3 frame	
R2	Base raceway both sides	Panels are not for use with medians, storage medians or bridges.
A	Tiled one side, Monolithic other	Black PVC hookstrip reveals should be ordered for monolithic side from Reff price list.
F	Fabric, monolithic side	
L	Laminate, tiled side	
34	34" high	
18	18" wide	
E	Extruded Aluminum top trim	Panels on this page will accept standard Reff System stacking window modules.
AA	Top Trim anodized aluminum finish	Product on this page will accept marker board and wood grain laminate where laminate is currently an option.
4	4" high base raceway	
K	Knock-outs in base raceway	
613	Finish, base raceway	
W359-	Finish, fabric	
118	Finish, laminate tile side	
N	Not milled for ported components	

- Height
- Width
- Extruded Aluminum Top Trim *E - default*
- Finish, Aluminum trim (top trim and tile dividers/reveals) *Anodized aluminum or painted finish options listed on page 10 excluding silver.*
- Base raceway height *4 = 4" h, default*
- Knock-out option *K = with knock-outs*
N = no knock-outs
- Base raceway finish *painted or plated finish options only*
- Fabric selection
- Finish, L= Laminate
LW = Marker board
- Milled for ported components *M = milled for (\$15 list upcharge applicable)*
N = not milled for

See page 8 for finish options applicable.

Tiled/Monolithic - both sides with base raceway
 Tiled one side - V1 Techwood/Monolithic - fabric

description	h	w	pattern no.	Grade						
				10	15	20	30	35	40	45
Tiled V1 techwood one side, fabric monolithic other side (both sides w/ base raceway)	34"	18"	R3R2AF13418 () () () () () () ()	\$757.	\$773.	\$810.	\$856.	\$887.	\$941.	\$974.
		24"	R3R2AF13424 () () () () () () ()	815.	828.	867.	910.	941.	1,000.	1,029.
		30"	R3R2AF13430 () () () () () () ()	871.	886.	924.	967.	1,001.	1,058.	1,088.
		36"	R3R2AF13436 () () () () () () ()	924.	938.	975.	1,019.	1,051.	1,109.	1,140.
		42"	R3R2AF13442 () () () () () () ()	1,069.	1,080.	1,117.	1,162.	1,194.	1,252.	1,281.
		48"	R3R2AF13448 () () () () () () ()	1,100.	1,116.	1,154.	1,197.	1,232.	1,286.	1,317.
		49"	18"	R3R2AF14918 () () () () () () ()	935.	958.	1,014.	1,080.	1,131.	1,212.
		24"	R3R2AF14924 () () () () () () ()	1,001.	1,022.	1,077.	1,146.	1,193.	1,280.	1,323.
		30"	R3R2AF14930 () () () () () () ()	1,076.	1,098.	1,155.	1,224.	1,272.	1,353.	1,397.
		36"	R3R2AF14936 () () () () () () ()	1,145.	1,164.	1,224.	1,286.	1,339.	1,420.	1,465.
		42"	R3R2AF14942 () () () () () () ()	1,294.	1,316.	1,369.	1,434.	1,485.	1,570.	1,615.
		48"	R3R2AF14948 () () () () () () ()	1,363.	1,384.	1,439.	1,508.	1,557.	1,640.	1,685.
	64"	18"	R3R2AF16418 () () () () () () ()	1,075.	1,105.	1,179.	1,267.	1,337.	1,445.	1,505.
		24"	R3R2AF16424 () () () () () () ()	1,148.	1,178.	1,249.	1,340.	1,408.	1,520.	1,576.
		30"	R3R2AF16430 () () () () () () ()	1,234.	1,263.	1,339.	1,427.	1,491.	1,606.	1,665.
		36"	R3R2AF16436 () () () () () () ()	1,307.	1,339.	1,412.	1,502.	1,569.	1,680.	1,740.
		42"	R3R2AF16442 () () () () () () ()	1,489.	1,521.	1,594.	1,684.	1,751.	1,860.	1,919.
		48"	R3R2AF16448 () () () () () () ()	1,569.	1,597.	1,671.	1,760.	1,828.	1,939.	2,000.

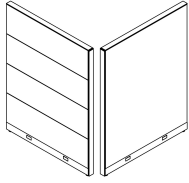

both sides 64x48 shown, 49" h with three tiles; 34" h with two tiles

Panels

Order Code	Specification Information	Application Notes
Example: R3R2AF13418EAA4K 613W359-Y319N	To order please specify pattern number including:	Tiled side includes panel reveals between V1 inserts. Aluminum vertical hookstrip cover ordered separately.
R3 AutoStrada w/generation 3 frame	1. Height	
R2 Base raceway both sides	2. Width	
A Tiled one side, Monolithic other	3. Extruded Aluminum Top Trim <i>E - default</i>	Panels are not for use with medians, storage medians or bridges.
F Fabric, monolithic side	4. Finish, Aluminum trim (top trim and tile dividers/reveals)	Black PVC hookstrip reveals should be ordered for monolithic side from Reff price list.
1 V1 Techwood, tiled side	<i>Anodized aluminum or painted finish options listed on page 10 excluding silver.</i>	
34 34" high	5. Base raceway height <i>4 = 4" h, default</i>	Panels on this page will accept standard Reff System stacking window modules.
18 18" wide	6. Knock-out option <i>K = with knock-outs N = no knock-outs</i>	
E Extruded Aluminum top trim	7. Base raceway finish <i>painted or plated finish options only</i>	
AA Top Trim anodized aluminum finish	8. Fabric selection	
4 4" high base raceway	9. Finish, V1 Techwood	
K Knock-outs in base raceway	10. Milled for ported components <i>M = milled for (\$15 list upcharge applicable) N = not milled for</i>	
613 Finish, base raceway		
W359- Finish, fabric		
Y319 Finish, Cherry		
N Not milled for ported components	See page 8 for finish options applicable.	

Tiled/Monolithic - both sides with base raceway
 Tiled one side - V2 Natural/Monolithic - fabric

description	h	w	pattern no.	Grade							
				10	15	20	30	35	40	45	
Tiled V2 natural one side, fabric monolithic other side (both sides w/ base raceway)	34"	18"	R3R2AF23418 (X)(X)(X)(X)(X)	\$774.	\$791.	\$827.	\$871.	\$906.	\$959.	\$988.	
		24"	R3R2AF23424 (X)(X)(X)(X)(X)	829.	847.	884.	928.	959.	1,016.	1,047.	
		30"	R3R2AF23430 (X)(X)(X)(X)(X)	887.	904.	939.	984.	1,017.	1,074.	1,102.	
		36"	R3R2AF23436 (X)(X)(X)(X)(X)	940.	957.	995.	1,039.	1,072.	1,126.	1,156.	
		42"	R3R2AF23442 (X)(X)(X)(X)(X)	1,087.	1,098.	1,138.	1,180.	1,212.	1,271.	1,302.	
		48"	R3R2AF23448 (X)(X)(X)(X)(X)	1,123.	1,140.	1,175.	1,220.	1,253.	1,308.	1,339.	
		49"	18"	R3R2AF24918 (X)(X)(X)(X)(X)	957.	979.	1,033.	1,099.	1,150.	1,234.	1,280.
			24"	R3R2AF24924 (X)(X)(X)(X)(X)	1,019.	1,043.	1,098.	1,164.	1,216.	1,300.	1,344.
			30"	R3R2AF24930 (X)(X)(X)(X)(X)	1,100.	1,123.	1,180.	1,247.	1,299.	1,380.	1,423.
			36"	R3R2AF24936 (X)(X)(X)(X)(X)	1,166.	1,190.	1,245.	1,315.	1,363.	1,445.	1,489.
		42"	R3R2AF24942 (X)(X)(X)(X)(X)	1,316.	1,338.	1,392.	1,459.	1,510.	1,593.	1,636.	
		48"	R3R2AF24948 (X)(X)(X)(X)(X)	1,388.	1,411.	1,465.	1,534.	1,581.	1,667.	1,710.	
	64"	18"	R3R2AF26418 (X)(X)(X)(X)(X)	1,097.	1,126.	1,201.	1,292.	1,358.	1,466.	1,527.	
		24"	R3R2AF26424 (X)(X)(X)(X)(X)	1,170.	1,200.	1,273.	1,363.	1,430.	1,539.	1,599.	
		30"	R3R2AF26430 (X)(X)(X)(X)(X)	1,257.	1,286.	1,361.	1,450.	1,515.	1,627.	1,686.	
		36"	R3R2AF26436 (X)(X)(X)(X)(X)	1,338.	1,365.	1,439.	1,528.	1,595.	1,708.	1,765.	
		42"	R3R2AF26442 (X)(X)(X)(X)(X)	1,523.	1,553.	1,626.	1,713.	1,782.	1,892.	1,952.	
		48"	R3R2AF26448 (X)(X)(X)(X)(X)	1,597.	1,627.	1,702.	1,790.	1,857.	1,969.	2,028.	

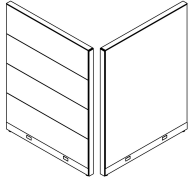

both sides 64x48 shown, 49" h with three tiles; 34" h with two tiles

Order Code	Specification Information	Application Notes
Example: R3R2AF23418EAA4K 613W359-V316N	To order please specify pattern number including:	Tiled side includes panel reveals between V2 inserts. Aluminum vertical hookstrip cover ordered separately.
R3 AutoStrada w/generation 3 frame	1. Height	
R2 Base raceway both sides	2. Width	
A Tiled one side, Monolithic other	3. Extruded Aluminum Top Trim <i>E - default</i>	Panels are not for use with medians, storage medians or bridges.
F Fabric, monolithic side	4. Finish, Aluminum trim (top trim and tile dividers/reveals)	Black PVC hookstrip reveals should be ordered for monolithic side from Reff price list.
2 V2 Natural, tiled side	<i>Anodized aluminum or painted finish options listed on page 10 excluding silver.</i>	
34 34" high	5. Base raceway height <i>4 = 4" h, default</i>	Panels on this page will accept standard Reff System stacking window modules.
18 18" wide	6. Knock-out option <i>K = with knock-outs N = no knock-outs</i>	
E Extruded Aluminum top trim	7. Base raceway finish <i>painted or plated finish options only</i>	
AA Top Trim anodized aluminum finish	8. Fabric selection	
4 4" high base raceway	9. Finish, V2 Natural	
K Knock-outs in base raceway	10. Milled for ported components <i>M = milled for (\$15 list upcharge applicable) N = not milled for</i>	
613 Finish, base raceway		
W359- Finish, fabric		
V316 Finish, Maple		
N Not milled for ported components	See page 8 for finish options applicable.	

Tiled/Monolithic - both sides with base raceway
 Tiled one side - V3 Exotic/Monolithic - fabric

description	h	w	pattern no.	Grade						
				10	15	20	30	35	40	45
Tiled V3 exotic one side, fabric monolithic other side (both sides w/ base raceway)	34"	18"	R3R2AF33418 () () () () () ()	\$1,030.	\$1,049.	\$1,097.	\$1,156.	\$1,200.	\$1,272.	\$1,308.
		24"	R3R2AF33424 () () () () () ()	1,100.	1,120.	1,171.	1,229.	1,272.	1,344.	1,382.
		30"	R3R2AF33430 () () () () () ()	1,178.	1,194.	1,244.	1,304.	1,347.	1,418.	1,458.
		36"	R3R2AF33436 () () () () () ()	1,247.	1,265.	1,316.	1,370.	1,415.	1,488.	1,527.
		42"	R3R2AF33442 () () () () () ()	1,432.	1,451.	1,498.	1,557.	1,601.	1,672.	1,711.
		48"	R3R2AF33448 () () () () () ()	1,482.	1,504.	1,553.	1,608.	1,650.	1,724.	1,762.
	49"	18"	R3R2AF34918 () () () () () ()	1,275.	1,305.	1,378.	1,463.	1,528.	1,636.	1,694.
		24"	R3R2AF34924 () () () () () ()	1,359.	1,388.	1,462.	1,548.	1,614.	1,721.	1,781.
		30"	R3R2AF34930 () () () () () ()	1,465.	1,493.	1,568.	1,651.	1,717.	1,828.	1,885.
		36"	R3R2AF34936 () () () () () ()	1,553.	1,577.	1,650.	1,738.	1,803.	1,911.	1,970.
		42"	R3R2AF34942 () () () () () ()	1,741.	1,769.	1,842.	1,926.	1,993.	2,102.	2,161.
		48"	R3R2AF34948 () () () () () ()	1,839.	1,866.	1,937.	2,026.	2,089.	2,196.	2,255.
64"	18"	R3R2AF36418 () () () () () ()	1,468.	1,509.	1,606.	1,718.	1,805.	1,952.	2,028.	
	24"	R3R2AF36424 () () () () () ()	1,566.	1,601.	1,699.	1,814.	1,899.	2,047.	2,123.	
	30"	R3R2AF36430 () () () () () ()	1,677.	1,714.	1,809.	1,926.	2,015.	2,161.	2,237.	
	36"	R3R2AF36436 () () () () () ()	1,782.	1,818.	1,916.	2,031.	2,117.	2,262.	2,340.	
	42"	R3R2AF36442 () () () () () ()	2,021.	2,059.	2,158.	2,272.	2,358.	2,502.	2,581.	
	48"	R3R2AF36448 () () () () () ()	2,122.	2,161.	2,255.	2,369.	2,457.	2,601.	2,679.	

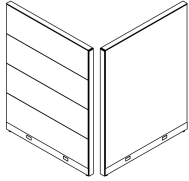

both sides 64x48 shown, 49" h with three tiles; 34" h with two tiles

Panels

Order Code	Specification Information	Application Notes
Example: R3R2AF33418EAA4K 613W359-V515N	<i>To order please specify pattern number including:</i>	Tiled side includes panel reveals between V3 inserts. Aluminum vertical hookstrip cover ordered separately.
R3 AutoStrada w/generation 3 frame	1. Height	
R2 Base raceway both sides	2. Width	
A Tiled one side, Monolithic other	3. Extruded Aluminum Top Trim <i>E - default</i>	Panels are not for use with medians, storage medians or bridges.
F Fabric, monolithic side	4. Finish, Aluminum trim (top trim and tile dividers/reveals) <i>Anodized aluminum or painted finish options listed on page 10 excluding silver.</i>	Black PVC hookstrip reveals should be ordered for monolithic side from Reff price list.
3 V3 Exotic, tiled side	5. Base raceway height <i>4 = 4" h, default</i>	Panels on this page will accept standard Reff System stacking window modules.
34 34" high	6. Knock-out option <i>K = with knock-outs</i>	
18 18" wide	<i>N = no knock-outs</i>	
E Extruded Aluminum top trim	7. Base raceway finish <i>painted or plated finish options only</i>	
AA Top Trim anodized aluminum finish	8. Fabric selection	
4 4" high base raceway	9. Finish, V3 Exotic	
K Knock-outs in base raceway	10. Milled for ported components <i>M = milled for (\$15 list upcharge applicable)</i>	
613 Finish, base raceway	<i>N = not milled for</i>	
W359- Finish, fabric		
V515 Finish, Quartered Clear Figured Sycamore		
N Not milled for ported components	See page 8 for finish options applicable.	

Tiled/Monolithic - both sides with base raceway
 Tiled one side - Laminate/Laminate
 34" and 42"h

description	h	w	pattern no.	L
Tiled/Monolithic - both sides with base raceway	34"	18"	R3R2ALL3418 () () () () () ()	\$802.
Laminate outside/Laminate inside		24"	R3R2ALL3424 () () () () () ()	874.
		30"	R3R2ALL3430 () () () () () ()	977.
		36"	R3R2ALL3436 () () () () () ()	1,058.
		42"	R3R2ALL3442 () () () () () ()	1,089.
		48"	R3R2ALL3448 () () () () () ()	1,120.
	42"	18"	R3R2ALL4218 () () () () () ()	966.
		20"	R3R2ALL4220 () () () () () ()	966.
		24"	R3R2ALL4224 () () () () () ()	1,055.
		30"	R3R2ALL4230 () () () () () ()	1,179.
		36"	R3R2ALL4236 () () () () () ()	1,274.
		42"	R3R2ALL4242 () () () () () ()	1,311.
		48"	R3R2ALL4248 () () () () () ()	1,353.

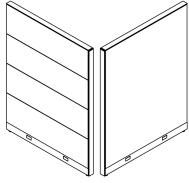

both sides 64x48 shown, 49"h with three tiles; 34"h with two tiles

Order Code	Specification Information	Application Notes
Example: R3R2ALL3418EAA4K 613W359-V515N	<i>To order please specify pattern number including:</i>	Panels are not for use with medians, storage medians or bridges.
R3 AutoStrada w/generation 3 frame	1. Height	Black PVC hookstrip reveals should be ordered for monolithic side from Reff price list.
R2 Base raceway both sides	2. Width	
A Tiled one side, Monolithic other	3. Extruded Aluminum Top Trim <i>E - default</i>	Panels on this page will accept standard Reff System stacking window modules.
L Laminate	4. Finish, Aluminum trim (top trim and tile dividers/reveals) <i>Anodized aluminum or painted finish options listed on page 10 excluding silver.</i>	
L Laminate	5. Base raceway height <i>4 = 4"h, default</i>	These panels will accept all core laminate; including marker board and wood grain laminates.
34 34" high	6. Knock-out option <i>K = with knock-outs N = no knock-outs</i>	
18 18" wide	7. Base raceway finish <i>painted or plated finish options only</i>	
E Extruded Aluminum top trim	8. Finish, L = Laminate LW = Marker board	
AA Top Trim anodized aluminum finish	9. Finish, L = Laminate LW = Marker board	
4 4" high base raceway	10. Milled for ported components <i>M = milled for (\$15 list upcharge applicable) N = not milled for</i>	
K Knock-outs in base raceway		
613 Finish, base raceway		
118 Finish, Laminate		
118 Finish, Laminate		
N Not milled for ported components		

See page 8 for finish options applicable.

Tiled/Monolithic - both sides with base raceway
 Tiled one side - Laminate/Laminate
 49" and 64"h

description	h	w	pattern no.	L
Tiled/Monolithic - both sides with base raceway	49"	18"	R3R2ALL4918 (X)(X)(X)(X)(X)	\$1,009.
Laminate outside/Laminate inside		24"	R3R2ALL4924 (X)(X)(X)(X)(X)	1,100.
		30"	R3R2ALL4930 (X)(X)(X)(X)(X)	1,231.
		36"	R3R2ALL4936 (X)(X)(X)(X)(X)	1,330.
		42"	R3R2ALL4942 (X)(X)(X)(X)(X)	1,370.
		48"	R3R2ALL4948 (X)(X)(X)(X)(X)	1,411.
	64"	18"	R3R2ALL6418 (X)(X)(X)(X)(X)	1,255.
		24"	R3R2ALL6424 (X)(X)(X)(X)(X)	1,368.
		30"	R3R2ALL6430 (X)(X)(X)(X)(X)	1,533.
		36"	R3R2ALL6436 (X)(X)(X)(X)(X)	1,654.
		42"	R3R2ALL6442 (X)(X)(X)(X)(X)	1,704.
		48"	R3R2ALL6448 (X)(X)(X)(X)(X)	1,774.

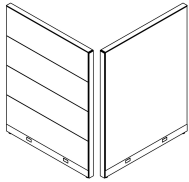

both sides 64x48 shown, 49"h with three tiles; 34"h with two tiles

Order Code	Specification Information	Application Notes
Example: R3R2ALL3418EAA4K 613W359-V515N	To order please specify pattern number including:	Panels are not for use with medians, storage medians or bridges.
R3 AutoStrada w/generation 3 frame	1. Height	Black PVC hookstrip reveals should be ordered for monolithic side from Reff price list.
R2 Base raceway both sides	2. Width	Panels on this page will accept standard Reff System stacking window modules.
A Tiled one side, Monolithic other	3. Extruded Aluminum Top Trim <i>E - default</i>	These panels will accept all core laminate; including marker board and wood grain laminates.
L Laminate	4. Finish, Aluminum trim (top trim and tile dividers/reveals) <i>Anodized aluminum or painted finish options listed on page 10 excluding silver.</i>	See page 8 for finish options applicable.
L Laminate	5. Base raceway height <i>4 = 4"h, default</i>	
34 34" high	6. Knock-out option <i>K = with knock-outs</i> <i>N = no knock-outs</i>	
18 18" wide	7. Base raceway finish <i>painted or plated finish options only</i>	
E Extruded Aluminum top trim	8. Finish, L = Laminate LW = Marker board	
AA Top Trim anodized aluminum finish	9. Finish, L = Laminate LW = Marker board	
4 4" high base raceway	10. Milled for ported components <i>M = milled for (\$15 list upcharge applicable)</i> <i>N = not milled for</i>	
K Knock-outs in base raceway		
613 Finish, base raceway		
118 Finish, Laminate		
118 Finish, Laminate		
N Not milled for ported components		

Tiled one side/Slatwall combo other
Tiled one side - Laminate/Slatwall and Fabric other side

description	h	w	pattern no.	Grade							
				10	15	20	30	35	40	45	
Tiled laminate one side, slatwall/fabric other side (tiled side without base raceway)	42"	18"	R3R1CXL4218 () () () () () () () ()	\$1,103.	\$1,119.	\$1,158.	\$1,216.	\$1,251.	\$1,309.	\$1,340.	
		24"	R3R1CXL4224 () () () () () () () ()	1,221.	1,235.	1,277.	1,331.	1,368.	1,425.	1,462.	
		30"	R3R1CXL4230 () () () () () () () ()	1,336.	1,355.	1,394.	1,447.	1,483.	1,543.	1,577.	
		36"	R3R1CXL4236 () () () () () () () ()	1,454.	1,470.	1,511.	1,565.	1,601.	1,659.	1,694.	
		42"	R3R1CXL4242 () () () () () () () ()	1,572.	1,589.	1,627.	1,683.	1,720.	1,779.	1,810.	
		48"	R3R1CXL4248 () () () () () () () ()	1,691.	1,707.	1,745.	1,802.	1,838.	1,897.	1,928.	
		49"	18"	R3R1CXL4918 () () () () () () () ()	1,265.	1,285.	1,331.	1,388.	1,431.	1,504.	1,541.
			24"	R3R1CXL4924 () () () () () () () ()	1,401.	1,419.	1,467.	1,523.	1,566.	1,637.	1,677.
			30"	R3R1CXL4930 () () () () () () () ()	1,539.	1,555.	1,603.	1,659.	1,702.	1,775.	1,811.
			36"	R3R1CXL4936 () () () () () () () ()	1,673.	1,693.	1,740.	1,797.	1,839.	1,913.	1,950.
			42"	R3R1CXL4942 () () () () () () () ()	1,809.	1,828.	1,874.	1,933.	1,974.	2,046.	2,084.
			48"	R3R1CXL4948 () () () () () () () ()	1,946.	1,965.	2,013.	2,071.	2,112.	2,184.	2,222.
		64"	18"	R3R1CXL6418 () () () () () () () ()	1,400.	1,424.	1,489.	1,563.	1,621.	1,715.	1,766.
			24"	R3R1CXL6424 () () () () () () () ()	1,583.	1,608.	1,672.	1,748.	1,806.	1,899.	1,951.
		30"	R3R1CXL6430 () () () () () () () ()	1,766.	1,791.	1,855.	1,929.	1,989.	2,082.	2,133.	
		36"	R3R1CXL6436 () () () () () () () ()	1,951.	1,974.	2,038.	2,114.	2,171.	2,265.	2,318.	
		42"	R3R1CXL6442 () () () () () () () ()	2,133.	2,158.	2,222.	2,297.	2,354.	2,450.	2,501.	
		48"	R3R1CXL6448 () () () () () () () ()	2,318.	2,341.	2,405.	2,482.	2,539.	2,634.	2,686.	

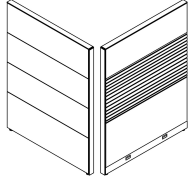

both sides 64x48 shown, 42" & 49" h do not have insert above slatwall section

Order Code	Specification Information	Application Notes
Example: R3R1CXL4218EAA4K613W359-118AA	<i>To order please specify pattern number including:</i>	Tiled side includes panel reveals between laminate inserts. Aluminum vertical hookstrip cover ordered separately. Tiled side inserts extend to the floor, there is no base raceway on this panel side. Be sure to specify power rails for panels with one sided base raceways.
R3 AutoStrada w/generation 3 frame	1. Height	Panels with slatwall one or both sides do not accommodate ported power or data modules
R1 Base raceway slatwall combo side only	2. Width	42" and 49" h panels on this page will not accept frameless glass add-ups.
C Tiled one side, Slatwall combo other	3. Extruded Aluminum Top Trim <i>E - default</i>	Slatwall stiffener bracket recommended when installing multiple Wishbone monitor arms. See page 110.
X Fabric/Slatwall combo side	4. Finish, Aluminum trim (top trim and tile dividers/reveals) <i>Anodized aluminum or painted finish options listed on page 10 excluding silver.</i>	Product on this page will accept marker board and wood grain laminate where laminate is currently an option.
L Laminate, tiled side	5. Base raceway height <i>4 = 4" h, default</i>	
42 42" high	6. Knock-out option <i>K = with knock-outs</i> <i>N = no knock-outs</i>	
18 18" wide	7. Base raceway finish <i>painted or plated finish options only</i>	
E Extruded Aluminum top trim	8. Fabric selection	
AA Top Trim anodized aluminum finish	9. Finish, L = Laminate LW = Marker board	Black PVC hookstrip reveals should be ordered for panel side with slatwall.
4 4" high base raceway	10. Finish, Slatwall <i>Anodized aluminum or painted finish options listed on page 10 excluding silver</i>	Panels on this page will accept standard Reff System stacking window modules.
K Knock-outs in base raceway		
613 Finish, base raceway		
W359- Finish, Fabric (combo side)		
118 Finish, Bright white (tiled side)	See page 8 for finish options applicable.	
AA Finish, Slatwall		

Tiled one side - V1 Techwood/Slatwall and Fabric other side

description	h	w	pattern no.	Grade							
				10	15	20	30	35	40	45	
Tiled V1 techwood one side, slatwall/fabric other side (tiled side without base raceway)	42"	18"	R3R1CX14218 (X)(X)(X)(X)(X)(X)	\$1,571.	\$1,588.	\$1,627.	\$1,684.	\$1,718.	\$1,781.	\$1,811.	
		24"	R3R1CX14224 (X)(X)(X)(X)(X)(X)	1,693.	1,709.	1,750.	1,804.	1,842.	1,899.	1,935.	
		30"	R3R1CX14230 (X)(X)(X)(X)(X)(X)	1,814.	1,830.	1,871.	1,925.	1,964.	2,021.	2,055.	
		36"	R3R1CX14236 (X)(X)(X)(X)(X)(X)	1,936.	1,952.	1,992.	2,048.	2,084.	2,141.	2,175.	
		42"	R3R1CX14242 (X)(X)(X)(X)(X)(X)	2,057.	2,075.	2,114.	2,168.	2,207.	2,265.	2,298.	
		48"	R3R1CX14248 (X)(X)(X)(X)(X)(X)	2,174.	2,189.	2,232.	2,287.	2,323.	2,382.	2,415.	
		49"	18"	R3R1CX14918 (X)(X)(X)(X)(X)(X)	1,736.	1,757.	1,803.	1,860.	1,901.	1,975.	2,015.
			24"	R3R1CX14924 (X)(X)(X)(X)(X)(X)	1,876.	1,895.	1,942.	2,002.	2,046.	2,116.	2,155.
			30"	R3R1CX14930 (X)(X)(X)(X)(X)(X)	2,017.	2,035.	2,084.	2,140.	2,185.	2,257.	2,296.
			36"	R3R1CX14936 (X)(X)(X)(X)(X)(X)	2,160.	2,175.	2,226.	2,282.	2,324.	2,396.	2,435.
		42"	R3R1CX14942 (X)(X)(X)(X)(X)(X)	2,298.	2,319.	2,364.	2,424.	2,466.	2,538.	2,575.	
		48"	R3R1CX14948 (X)(X)(X)(X)(X)(X)	2,441.	2,459.	2,507.	2,565.	2,608.	2,680.	2,718.	
	64"	18"	R3R1CX16418 (X)(X)(X)(X)(X)(X)	1,989.	2,015.	2,078.	2,155.	2,211.	2,307.	2,358.	
		24"	R3R1CX16424 (X)(X)(X)(X)(X)(X)	2,185.	2,210.	2,274.	2,350.	2,409.	2,505.	2,554.	
		30"	R3R1CX16430 (X)(X)(X)(X)(X)(X)	2,380.	2,405.	2,471.	2,547.	2,604.	2,701.	2,752.	
		36"	R3R1CX16436 (X)(X)(X)(X)(X)(X)	2,577.	2,602.	2,667.	2,742.	2,801.	2,898.	2,949.	
		42"	R3R1CX16442 (X)(X)(X)(X)(X)(X)	2,775.	2,800.	2,863.	2,941.	2,996.	3,093.	3,145.	
		48"	R3R1CX16448 (X)(X)(X)(X)(X)(X)	2,970.	2,994.	3,060.	3,135.	3,194.	3,287.	3,337.	

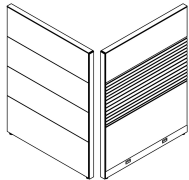

both sides 64x48 shown, 42" & 49" h do not have insert above slatwall section

Panels

Order Code	Specification Information	Application Notes	
Example: R3R1CX14218EAA4K 613W359-Y319AA	To order please specify pattern number including:	Tiled side includes panel reveals between V1 inserts. Aluminum vertical hookstrip cover ordered separately. Tiled side inserts extend to the floor, there is no base raceway on this panel side. Be sure to specify power rails for panels with one sided base raceways.	
R3 AutoStrada w/generation 3 frame	1. Height	Slatwall/fabric side combination: Slatwall above worksurface is nominally 15" h for 42" high panels, and 22 1/2" h for both 49" and 64" high panels. Fabric insert begins at just below worksurface height to the base raceway. (64" high panels also have a fabric insert above the slatwall section).	
R1 Base raceway slatwall combo side only	2. Width		
C Tiled one side, Slatwall combo other	3. Extruded Aluminum Top Trim		
X Fabric/Slatwall combo side	<i>E - default</i>		
1 V1 Techwood, tiled side	4. Finish, Aluminum trim (top trim and tile dividers/reveals)		
42 42" high	<i>Anodized aluminum or painted finish options listed on page 10 excluding silver.</i>		
18 18" wide	5. Base raceway height		
E Extruded Aluminum top trim	<i>4 = 4" h, default</i>		
AA Top Trim anodized aluminum finish	6. Knock-out option		
4 4" high base raceway	<i>K = with knock-outs</i>		
K Knock-outs in base raceway	<i>N = no knock-outs</i>		
613 Finish, base raceway	7. Base raceway finish	Panels with slatwall one or both sides do not accommodate ported power or data modules 42" and 49" h panels on this page will not accept frameless glass add-ups. Slatwall stiffener bracket recommended when installing multiple Wishbone monitor arms. See page 110.	
W359- Finish, Fabric (combo side)	<i>Painted or plated finish options only</i>		
Y319 Finish, Cherry (tiled side)	8. Fabric selection		
AA Finish, Slatwall	9. Finish, V1 Techwood		
	10. Finish, Slatwall		
	<i>Anodized aluminum or painted finish options listed on page 10 excluding silver</i>		
	See page 8 for finish options applicable.		
			Panels on this page will accept standard Reff System stacking window modules.

Tiled one side - V2 Natural/Slatwall and Fabric other side

description	h	w	pattern no.	Grade						
				10	15	20	30	35	40	45
Tiled V2 natural one side, slatwall/fabric other side (tiled side without base raceway)	42"	18"	R3R1CX24218 () () () () () () () ()	\$1,635.	\$1,650.	\$1,691.	\$1,748.	\$1,785.	\$1,843.	\$1,876.
		24"	R3R1CX24224 () () () () () () () ()	1,773.	1,789.	1,829.	1,885.	1,920.	1,979.	2,015.
		30"	R3R1CX24230 () () () () () () () ()	1,910.	1,925.	1,966.	2,021.	2,058.	2,117.	2,151.
		36"	R3R1CX24236 () () () () () () () ()	2,048.	2,062.	2,103.	2,161.	2,195.	2,255.	2,288.
		42"	R3R1CX24242 () () () () () () () ()	2,185.	2,203.	2,241.	2,297.	2,335.	2,393.	2,426.
	48"	R3R1CX24248 () () () () () () () ()	2,322.	2,338.	2,378.	2,434.	2,471.	2,530.	2,564.	
	49"	18"	R3R1CX24918 () () () () () () () ()	1,808.	1,829.	1,876.	1,935.	1,977.	2,049.	2,086.
		24"	R3R1CX24924 () () () () () () () ()	1,970.	1,989.	2,035.	2,094.	2,135.	2,209.	2,246.
		30"	R3R1CX24930 () () () () () () () ()	2,128.	2,149.	2,195.	2,253.	2,297.	2,367.	2,405.
		36"	R3R1CX24936 () () () () () () () ()	2,289.	2,308.	2,354.	2,414.	2,457.	2,530.	2,569.
42"		R3R1CX24942 () () () () () () () ()	2,450.	2,469.	2,514.	2,574.	2,617.	2,688.	2,728.	
48"	R3R1CX24948 () () () () () () () ()	2,610.	2,629.	2,679.	2,735.	2,778.	2,851.	2,889.		
64"	18"	R3R1CX26418 () () () () () () () ()	2,086.	2,114.	2,175.	2,253.	2,311.	2,405.	2,457.	
	24"	R3R1CX26424 () () () () () () () ()	2,308.	2,336.	2,397.	2,477.	2,534.	2,628.	2,680.	
	30"	R3R1CX26430 () () () () () () () ()	2,531.	2,555.	2,621.	2,698.	2,756.	2,851.	2,902.	
	36"	R3R1CX26436 () () () () () () () ()	2,754.	2,778.	2,842.	2,919.	2,976.	3,073.	3,124.	
	42"	R3R1CX26442 () () () () () () () ()	2,975.	3,000.	3,063.	3,142.	3,198.	3,293.	3,349.	
	48"	R3R1CX26448 () () () () () () () ()	3,197.	3,222.	3,284.	3,363.	3,420.	3,515.	3,568.	

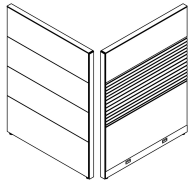

both sides 64x48 shown, 42" & 49" h do not have insert above slatwall section

Order Code	Specification Information	Application Notes
Example: R3R1CX24218EAA4K 613W359-V316AA	<i>To order please specify pattern number including:</i>	Tiled side includes panel reveals between V2 inserts. Aluminum vertical hookstrip cover ordered separately. Tiled side inserts extend to the floor, there is no base raceway on this panel side. Be sure to specify power rails for panels with one sided base raceways.
R3 AutoStrada w/generation 3 frame	1. Height	Panels with slatwall one or both sides do not accommodate ported power or data modules
R1 Base raceway slatwall combo side only	2. Width	
C Tiled one side, Slatwall combo other	3. Extruded Aluminum Top Trim	42" and 49" h panels on this page will not accept frameless glass add-ups.
X Fabric/Slatwall combo side	<i>E - default</i>	
2 V2 Natural, tiled side	4. Finish, Aluminum trim (top trim and tile dividers/reveals)	Slatwall stiffener bracket recommended when installing multiple Wishbone monitor arms. See page 110.
42 42" high	<i>Anodized aluminum or painted finish options listed on page 10 excluding silver.</i>	
18 18" wide	5. Base raceway height	Black PVC hookstrip reveals should be ordered for panel side with slatwall.
E Extruded Aluminum top trim	<i>4 = 4" h, default</i>	
AA Top Trim anodized aluminum finish	6. Knock-out option	Panels on this page will accept standard Reff System stacking window modules.
4 4" high base raceway	<i>K = with knock-outs</i>	
K Knock-outs in base raceway	7. Base raceway finish	
613 Finish, base raceway	<i>Painted or plated finish options only</i>	
W359- Finish, Fabric (combo side)	8. Fabric selection	
V316 Finish, Maple (tiled side)	9. Finish, V2 Natural	
AA Finish, Slatwall	10. Finish, Slatwall	
	<i>Anodized aluminum or painted finish options listed on page 10 excluding silver</i>	
	See page 8 for finish options applicable.	

Tiled one side/Slatwall combo other
 Tiled one side - V3 Exotic/Slatwall and Fabric other side

description	h	w	pattern no.	Grade							
				10	15	20	30	35	40	45	
Tiled V3 exotic one side, slatwall/fabric other side (tiled side without base raceway)	42"	18"	R3R1CX34218 () () () () () () () ()	\$2,155.	\$2,174.	\$2,227.	\$2,299.	\$2,347.	\$2,425.	\$2,467.	
		24"	R3R1CX34224 () () () () () () () ()	2,333.	2,351.	2,403.	2,478.	2,526.	2,601.	2,646.	
		30"	R3R1CX34230 () () () () () () () ()	2,509.	2,531.	2,584.	2,656.	2,704.	2,780.	2,825.	
		36"	R3R1CX34236 () () () () () () () ()	2,688.	2,712.	2,762.	2,833.	2,881.	2,958.	3,002.	
		42"	R3R1CX34242 () () () () () () () ()	2,870.	2,889.	2,941.	3,014.	3,061.	3,140.	3,181.	
		48"	R3R1CX34248 () () () () () () () ()	3,047.	3,065.	3,120.	3,193.	3,241.	3,316.	3,361.	
		49"	18"	R3R1CX34918 () () () () () () () ()	2,384.	2,410.	2,472.	2,546.	2,602.	2,697.	2,744.
			24"	R3R1CX34924 () () () () () () () ()	2,591.	2,617.	2,680.	2,754.	2,811.	2,903.	2,952.
			30"	R3R1CX34930 () () () () () () () ()	2,800.	2,825.	2,888.	2,959.	3,018.	3,109.	3,163.
			36"	R3R1CX34936 () () () () () () () ()	3,009.	3,034.	3,096.	3,172.	3,225.	3,321.	3,370.
		42"	R3R1CX34942 () () () () () () () ()	3,217.	3,242.	3,305.	3,379.	3,435.	3,526.	3,580.	
		48"	R3R1CX34948 () () () () () () () ()	3,428.	3,449.	3,513.	3,589.	3,646.	3,738.	3,787.	
	64"	18"	R3R1CX36418 () () () () () () () ()	2,757.	2,789.	2,873.	2,973.	3,047.	3,172.	3,239.	
		24"	R3R1CX36424 () () () () () () () ()	3,045.	3,077.	3,164.	3,261.	3,334.	3,460.	3,525.	
		30"	R3R1CX36430 () () () () () () () ()	3,333.	3,367.	3,448.	3,550.	3,625.	3,747.	3,815.	
		36"	R3R1CX36436 () () () () () () () ()	3,623.	3,655.	3,738.	3,838.	3,913.	4,034.	4,106.	
		42"	R3R1CX36442 () () () () () () () ()	3,910.	3,946.	4,028.	4,127.	4,203.	4,328.	4,394.	
		48"	R3R1CX36448 () () () () () () () ()	4,200.	4,233.	4,315.	4,416.	4,490.	4,616.	4,680.	

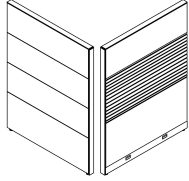

both sides 64x48 shown, 42" & 49" h do not have insert above slatwall section

Order Code	Specification Information	Application Notes
Example: R3R1CX34218EAA4K 613W359-V515AA	To order please specify pattern number including:	Tiled side includes panel reveals between V3 inserts.
R3	1. Height	Aluminum vertical hookstrip cover ordered separately. Tiled side inserts extend to the floor, there is no base raceway on this panel side.
R1	2. Width	Be sure to specify power rails for panels with one sided base raceways.
R1	3. Extruded Aluminum Top Trim <i>E - default</i>	Slatwall/fabric side combination: Slatwall above worksurface is nominally 15" h for 42" high panels, and 22 1/2" h for both 49" and 64" high panels. Fabric insert begins at just below worksurface height to the base raceway. (64" high panels also have a fabric insert above the slatwall section).
C	4. Finish, Aluminum trim (top trim and tile dividers/reveals)	Black PVC hookstrip reveals should be ordered for panel side with slatwall.
X	<i>Anodized aluminum or painted finish options listed on page 10 excluding silver.</i>	Panels on this page will accept standard Reff System stacking window modules.
3	5. Base raceway height <i>4 = 4" h, default</i>	
42	6. Knock-out option <i>K = with knock-outs N = no knock-outs</i>	
18	7. Base raceway finish <i>painted or plated finish options only</i>	
E	8. Fabric selection	
AA	9. Finish, V3 Exotic	
4	10. Finish, Slatwall <i>Anodized aluminum or painted finish options listed on page 10 excluding silver</i>	
K	See page 8 for finish options applicable.	
613		
W359-		
V515		
AA		

Slatwall/Fabric combo both sides - both sides with base raceway

description	h	w	pattern no.	Grade						list
				10	15	20	30	35	40	
Slatwall/Fabric both sides (base raceway both sides)	42"	18"	R3R2SXX4218 () () () () () () () ()	\$1,244.	\$1,275.	\$1,354.	\$1,466.	\$1,541.	\$1,659.	\$1,726.
	24"		R3R2SXX4224 () () () () () () () ()	1,359.	1,392.	1,470.	1,581.	1,654.	1,775.	1,842.
	30"		R3R2SXX4230 () () () () () () () ()	1,475.	1,508.	1,585.	1,696.	1,771.	1,889.	1,955.
	36"		R3R2SXX4236 () () () () () () () ()	1,590.	1,622.	1,701.	1,811.	1,887.	2,004.	2,073.
	42"		R3R2SXX4242 () () () () () () () ()	1,704.	1,736.	1,815.	1,926.	2,002.	2,118.	2,186.
	48"		R3R2SXX4248 () () () () () () () ()	1,823.	1,855.	1,935.	2,047.	2,118.	2,239.	2,304.
	49"	18"	R3R2SXX4918 () () () () () () () ()	1,536.	1,573.	1,670.	1,786.	1,872.	2,016.	2,091.
	24"		R3R2SXX4924 () () () () () () () ()	1,680.	1,715.	1,811.	1,926.	2,015.	2,160.	2,235.
	30"		R3R2SXX4930 () () () () () () () ()	1,819.	1,858.	1,954.	2,071.	2,158.	2,299.	2,377.
	36"		R3R2SXX4936 () () () () () () () ()	1,964.	2,002.	2,096.	2,211.	2,298.	2,442.	2,517.
	42"		R3R2SXX4942 () () () () () () () ()	2,105.	2,141.	2,240.	2,352.	2,441.	2,584.	2,662.
	48"		R3R2SXX4948 () () () () () () () ()	2,246.	2,285.	2,380.	2,496.	2,583.	2,725.	2,803.
	64"	18"	R3R2SXX6418 () () () () () () () ()	1,576.	1,629.	1,758.	1,910.	2,026.	2,217.	2,320.
	24"		R3R2SXX6424 () () () () () () () ()	1,726.	1,779.	1,903.	2,058.	2,173.	2,364.	2,467.
	30"		R3R2SXX6430 () () () () () () () ()	1,874.	1,925.	2,052.	2,208.	2,322.	2,511.	2,616.
	36"		R3R2SXX6436 () () () () () () () ()	2,022.	2,076.	2,205.	2,353.	2,471.	2,663.	2,763.
	42"		R3R2SXX6442 () () () () () () () ()	2,171.	2,222.	2,350.	2,505.	2,619.	2,811.	2,913.
	48"		R3R2SXX6448 () () () () () () () ()	2,320.	2,369.	2,497.	2,650.	2,765.	2,957.	3,060.
Slatwall Stiffener Bracket	42"		ASWRB42							369.
	49"		ASWRB49							465.
	64"		ASWRB64							492.
	79"		ASWRB79							518.

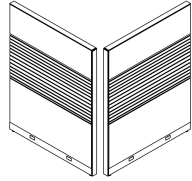

both sides 64x48 shown, 42" h and 49" h do not have inserts above slatwall sections

Order Code	Specification Information	Application Notes
Example: R3R2SXX4218EAA4K613W359-W359-AA	To order please specify pattern number including:	Slatwall/fabric combination: Panels with slatwall one or both sides do not accommodate ported power or data modules.
R3 AutoStrada w/generation 3 frame	1. Height	42" and 49" h panels on this page will not accept frameless glass add-ups.
R2 Base raceway both sides	2. Width	
S Slatwall/Fabric combo both sides	3. Extruded Aluminum Top Trim <i>E - default</i>	
X Fabric/Slatwall combo side 1	4. Finish, Aluminum trim (top trim and tile dividers/reveals) <i>Anodized aluminum or painted finish options listed on page 10 excluding silver.</i>	
X Fabric/Slatwall combo side 2	5. Base raceway height <i>4 = 4" h, default</i>	
42 42" high	6. Knock-out option <i>K = with knock-outs</i>	Black PVC hookstrip reveals should be ordered for both panel sides with slatwall.
18 18" wide	7. Base raceway finish <i>N = no knock-outs</i>	Panels on this page will accept standard Reff System stacking window modules.
E Extruded Aluminum top trim	8. Fabric selection (side 1)	
AA Top Trim anodized aluminum finish	9. Fabric selection (side 2)	
4 4" high base raceway	10. Finish, Slatwall <i>Anodized aluminum or painted finish options listed on page 10 excluding silver</i>	
K Knock-outs in base raceway		
613 Finish, base raceway		
W359- Finish, Fabric (side 1)		
W359- Finish, Fabric (side 2)		
AA Finish, Slatwall	See page 8 for finish options applicable.	

description	w	d	pattern no.	G1	G2/G3	list
Frameless glass add-up 8"h, for panels	18"		R3GAU0818 () ()	\$303.	\$379.	
	20"		R3GAU0820 () ()	323.	410.	
	24"		R3GAU0824 () ()	342.	445.	
	30"		R3GAU0830 () ()	380.	504.	
	36"		R3GAU0836 () ()	417.	565.	
	42"		R3GAU0842 () ()	481.	655.	
	48"		R3GAU0848 () ()	497.	698.	
Frameless glass add-up 12"h, for panels	18"		R3GAU1218 () ()	331.	454.	
	20"		R3GAU1220 () ()	361.	498.	
	24"		R3GAU1224 () ()	381.	545.	
	30"		R3GAU1230 () ()	427.	631.	
	36"		R3GAU1236 () ()	475.	715.	
	42"		R3GAU1242 () ()	549.	830.	
	48"		R3GAU1248 () ()	575.	901.	
Frameless glass add-up 15"h, for panels	18"		R3GAU1518 () ()	342.	483.	
	20"		R3GAU1520 () ()	372.	535.	
	24"		R3GAU1524 () ()	399.	585.	
	30"		R3GAU1530 () ()	447.	682.	
	36"		R3GAU1536 () ()	496.	775.	
	42"		R3GAU1542 () ()	574.	903.	
	48"		R3GAU1548 () ()	608.	979.	
Frameless glass add-up 8"h, for panels for hi/lo condition no post involved	18"		R3GAUHL0818 () ()	303.	379.	
	20"		R3GAUHL0820 () ()	323.	410.	
	24"		R3GAUHL0824 () ()	342.	445.	
	30"		R3GAUHL0830 () ()	380.	504.	
	36"		R3GAUHL0836 () ()	417.	565.	
	42"		R3GAUHL0842 () ()	481.	655.	
	48"		R3GAUHL0848 () ()	497.	698.	

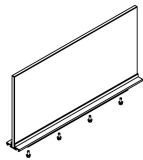

Order Code	Specification Information	Application Notes
Example: R3GAU0818GL13AA R3 AutoStrada w/generation 3 frame GAU Glass add-up 08 height 18 width GL13 glass finish, powder AA finish, capture/trim	To order please specify pattern number including: 1. Height 08 = 42"h panel with add-up will align with top of 49"h panel 12 = 49"h panel with add-up will align with 48"h spine with spine add-up (overall height 61" nominal) 15 = add-up will align with tile segments of 34"h, 49"h or 64"h panels (ie: 34"h panel with add-up align to 49"h panel) 2. Width 3. Glass Finish TEMP = clear tempered glass GL13 = powder GL25 = Bronze GL35 = Grey 4. Finish, capture/trim Anodized aluminum or painted finish options listed on page 8 excluding silver	Frameless glass add-ups only for use with non-progressive tile construction panels with at least one side fabric tiles. Panel frames are not pre-drilled to accept frameless glass add-ups. Frame requires drilling on site for installation. Frameless glass add-ups must correspond to width of panel securing to. Do not span multiple panels with one longer glass add-up. Frameless glass add-ups can not be installed on panel when panel attached to storage anchored cabinet.
		To order please specify pattern number including configuration condition: Finish: Anodized aluminum or painted finish options as listed on page 8 excluding silver. Note: Spacer kits are for use with fabric or veneer stacking modules ONLY. Not for use with stacking windows. Installation instruction sheets for the Spacer kit, available on Knoll Exchange. Refer to reference number 6TR16HO.

description	w	d	pattern no.	G1	G2/G3	list
Frameless glass add-up 12"h, for panels for hi/lo condition no post involved	18"		R3GAUHL1218 ()()	\$331.	\$454.	
	20"		R3GAUHL1220 ()()	361.	498.	
	24"		R3GAUHL1224 ()()	381.	545.	
	30"		R3GAUHL1230 ()()	427.	631.	
	36"		R3GAUHL1236 ()()	475.	715.	
	42"		R3GAUHL1242 ()()	549.	830.	
	48"		R3GAUHL1248 ()()	575.	901.	
Frameless glass add-up 15"h, for panels for hi/lo condition no post involved	18"		R3GAUHL1518 ()()	342.	483.	
	20"		R3GAUHL1520 ()()	372.	535.	
	24"		R3GAUHL1524 ()()	399.	585.	
	30"		R3GAUHL1530 ()()	447.	682.	
	36"		R3GAUHL1536 ()()	496.	775.	
	42"		R3GAUHL1542 ()()	574.	903.	
	48"		R3GAUHL1548 ()()	608.	979.	
Attachment Kit, to install frameless glass to 15"h or 8"h stacking module			R3SKIT			57.
Spacer Kit includes 2 spacers and 2 washers.						
Add-up Alignment Clip, pack of 10			R3AUAC10			32.
Alignment clips recommended to ensure glass alignment of add-up modules in side by side applications						

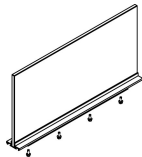

Order Code	Specification Information	Application Notes
Example: R3GAU0818GL13AA	<i>To order please specify pattern number including:</i>	Frameless glass add-ups only for use with non-progressive tile construction panels with at least one side fabric tiles.
R3 AutoStrada w/generation 3 frame	1. Height 08 = 42"h panel with add-up will align with top of 49"h panel 12 = 49"h panel with add-up will align with 48"h spine with spine add-up (overall height 61" nominal) 15 = add-up will align with tile segments of 34"h, 49"h or 64"h panels (ie: 34"h panel with add-up align to 49"h panel)	<i>To order please specify pattern number including configuration condition:</i>
GAU Glass add-up	2. Width	Finish: Anodized aluminum or painted finish options as listed on page 8 excluding silver.
08 height	3. Glass Finish <i>TEMP</i> = clear tempered glass <i>GL13</i> = powder <i>GL25</i> = Bronze <i>GL35</i> = Grey	Note: Spacer kits are for use with fabric or veneer stacking modules ONLY. Not for use with stacking windows.
18 width	4. Finish, capture/trim <i>Anodized aluminum or painted finish options listed on page 8 excluding silver</i>	Installation instruction sheets for the Spacer kit, available on Knoll Exchange. Refer to reference number 6TR16HO.
GL13 glass finish, powder		
AA finish, capture/trim		

description	application	pattern no.	AA	P1	P2	P3	G1	G2	G3
Panel attachment kit for glass gallery screen	for 42" h panel attachment	A1GGPC4234(L/R)()	\$775.	\$659.	\$659.	\$698.			
	for 46" h panel attachment	A1GGPC4934(L/R)()	775.	659.	659.	698.			
Spine attachment kit for glass gallery screen	mid span/ off modular	A1GGSPSC30(L/R)()	808.	687.	687.	726.			
	spine end starter	A1GGSE30(L/R)() ()	785.	668.	668.	708.			
Glass, for panel based	for 42" h x 60" w	A1PGG4260()					935.	1,410.	1,899.
	for 42" h x 72" w	A1PGG4272()					1,071.	1,636.	2,265.
	for 49" h x 60" w	A1PGG4960()					1,058.	1,620.	2,204.
	for 49" h x 72" w	A1PGG4972()					1,216.	1,887.	2,585.
Glass, for spine based	for 48" h x 60" w	A1SGG4860()					1,029.	1,567.	2,127.
	for 48" h x 72" w	A1SGG4872()					1,180.	1,823.	2,496.

Example:	A1GGPC4234
A	AutoStrada
1	Generation 1
GG	Gallery screen, glass
PC	Panel post connector
42	42" h panel attachment (includes Hi/low trim)
34	34" high nominal
(L/R)	Left or right hand connection
()	Finish divider, capture

1.L/R- Left or right hand connection
 If left hand, worksurface on right side of glass
 If right hand, worksurface on left side of glass

2.Finish divider capture
 AA and all core paint options except 613

Glass Finish
 G1=Clear Temp glass
 G2=Architectural
 G3=Color

Glass Gallery Screen Panel attachment kit includes finished connection to panel post and end capture for glass.

Glass Gallery Screen Spine attachment kit includes finished connection to spine and end capture for glass.

Glass to align top of panel insert, below top trim for panel base.

Glass to align top of spine cover, below crown or at horizontal channel at nominal 48" high if 64" spine.

Posts, panels

T post

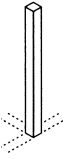
description	h	pattern no.	list
 T post, tiled laminate (no base plate)	34"	R3R0TTL34 () () ()	\$239.
	42"	R3R0TTL42 () () ()	263.
	49"	R3R0TTL49 () () ()	297.
	64"	R3R0TTL64 () () ()	329.
T post, tiled V1 techwood (no base plate)	34"	R3R0TT134 () () ()	252.
	42"	R3R0TT142 () () ()	276.
	49"	R3R0TT149 () () ()	313.
	64"	R3R0TT164 () () ()	346.
T post, tiled V2 natural (no base plate)	34"	R3R0TT234 () () ()	277.
	42"	R3R0TT242 () () ()	303.
	49"	R3R0TT249 () () ()	341.
	64"	R3R0TT264 () () ()	379.
T post, tiled V3 exotic (no base plate)	34"	R3R0TT334 () () ()	363.
	42"	R3R0TT342 () () ()	396.
	49"	R3R0TT349 () () ()	448.
	64"	R3R0TT364 () () ()	495.
T post, monolithic V1 techwood (no base plate)	42"	R3R0TP142 () () ()	276.
	49"	R3R0TP149 () () ()	313.

Order Code	Specification Information	Application Notes
Example: R3R0TTL34E2AA118	<i>To order please specify pattern number including:</i>	5. Finish, Aluminum trim (top cap and reveals) <i>Anodized aluminum or painted finish options listed on page 10 excluding silver</i>
R3 AutoStrada w/generation 3 post	1. Surface <i>L = Painted to match laminate</i>	* Painted to match laminate.
R0 No base raceway exposed	<i>V1 = V1 Techwood</i>	
T T post	<i>V2 = V2 Natural</i>	
T Tiled	<i>V3 = V3 Exotic</i>	
L Laminate match	2. Height	6. Finish, Tiles <i>Laminate *, V1, V2 or V3 finish</i>
34 34" high	3. Extruded aluminum top cap <i>E = default</i>	See page 8 for finish options applicable.
E Extruded aluminum top cap	4. Top Cap Configuration <i>1 = Regular L, finished 2 adjacent sides</i>	
2 Regular T cap configuration	<i>2 = Regular T, finished one side</i>	
AA Finish, top cap and reveal	<i>3 = Regular X, no sides finished</i>	
118 Finish, tiles	<i>4 = Hi/Lo cap at direction change, finished 3 sides</i>	
	<i>5 = Hi/Lo cap in line, finished 2 opposite sides</i>	

Posts, panels

T post

description	h	pattern no.	list
T post, monolithic V2 natural (no base plate)	42"	R3R0TP242 () () ()	\$303.
	49"	R3R0TP249 () () ()	341.
T post, monolithic laminate (no base plate)	42"	R3R0TPL42 () () ()	263.
	49"	R3R0TPL49 () () ()	297.
T post, monolithic V3 exotic (no base plate)	42"	R3R0TP342 () () ()	396.
	49"	R3R0TP349 () () ()	448.

Order Code	Specification Information	Application Notes
Example: R3R0TTL34E2AA118	<i>To order please specify pattern number including:</i>	
R3 AutoStrada w/generation 3 post	1. Surface <i>L = Painted to match laminate</i>	5. Finish, Aluminum trim (top cap and reveals) <i>Anodized aluminum or painted finish options listed on page 10 excluding silver</i>
R0 No base raceway exposed	<i>V1 = V1 Techwood</i>	6. Finish, Tiles <i>Laminate *, V1, V2 or V3 finish</i>
T T post	<i>V2 = V2 Natural</i>	
T Tiled	<i>V3 = V3 Exotic</i>	See page 8 for finish options applicable.
L Laminate match	2. Height	
34 34" high	3. Extruded aluminum top cap <i>E = default</i>	
E Extruded aluminum top cap	4. Top Cap Configuration <i>1 = Regular L, finished 2 adjacent sides</i>	
2 Regular T cap configuration	<i>2 = Regular T, finished one side</i>	
AA Finish, top cap and reveal	<i>3 = Regular X, no sides finished</i>	
118 Finish, tiles	<i>4 = Hi/Lo cap at direction change, finished 3 sides</i>	
	<i>5 = Hi/Lo cap in line, finished 2 opposite sides</i>	

Posts, panels

L post, no base plates

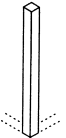
description	h	pattern no.	list
 L post, tiled (to match) laminate (no base plate)	34"	R3R0LTL34 () () () ()	\$199.
	42"	R3R0LTL42 () () () ()	297.
	49"	R3R0LTL49 () () () ()	329.
	64"	R3R0LTL64 () () () ()	367.
	Tiled laminate both sides		
L post, tiled V1 techwood (no base plate)	34"	R3R0LT134 () () () ()	210.
	42"	R3R0LT142 () () () ()	313.
	49"	R3R0LT149 () () () ()	346.
	64"	R3R0LT164 () () () ()	383.
	Tiled V1 both sides		
L post, tiled V2 natural (no base plate)	34"	R3R0LT234 () () () ()	230.
	42"	R3R0LT242 () () () ()	341.
	49"	R3R0LT249 () () () ()	379.
	64"	R3R0LT264 () () () ()	421.
	Tiled V2 both sides		
L post, tiled V3 exotic (no base plate)	34"	R3R0LT334 () () () ()	296.
	42"	R3R0LT342 () () () ()	448.
	49"	R3R0LT349 () () () ()	495.
	64"	R3R0LT364 () () () ()	547.
	Tiled V3 both sides		
L post, monolithic (to match) laminate (no base plate)	42"	R3R0LPL42 () () () ()	297.
	49"	R3R0LPL49 () () () ()	329.

Order Code	Specification Information	Application Notes
Example: R3R0LTL34E1AA118	<i>To order please specify pattern number including:</i>	5. Post cover configuration
R3 AutoStrada w/generation 3 post	1. Finish type tiles <i>L = Painted to match laminate</i>	1 = 1 piece (same finish both sides)
R0 No base raceway exposed	<i>V1 = V1 Techwood</i>	2 = 2 piece (same or different finish per side)
L L post	<i>V2 = V2 Natural</i>	6. Finish, Aluminum trim (top cap and reveals)
T Tiled (both faces)	<i>V3 = V3 Exotic</i>	<i>Anodized aluminum or painted finish options listed on page 10 excluding silver</i>
L Laminate match	2. Height	7. Finish, Side 1
34 34" high	3. Extruded aluminum top cap <i>E = default</i>	<i>Laminate *, V1, V2 or V3 finish</i>
E Extruded aluminum top cap	4. Top Cap Configuration <i>1 = Regular L, finished 2 adjacent sides</i>	8. Finish, Side 2 (side 2 finish applicable only when 2 piece post cover configuration selected)
1 Regular L cap configuration	<i>2 = Regular T, finished one side</i>	<i>Laminate *, V1, V2, or V3 finish</i>
AA Finish, top cap and reveal	<i>3 = Regular X, no sides finished</i>	
118 Finish, tiles	<i>4 = Hi/Lo cap at direction change, finished 3 sides</i>	
	<i>5 = Hi/Lo cap in line, finished 2 opposite sides</i>	
		See page 8 for finish options applicable.

Posts, panels

L post, no base plates

description	h	pattern no.	list
L post, monolithic V1 techwood (no base plate)	42"	R3R0LP142 () () () ()	\$313.
	49"	R3R0LP149 () () () ()	346.
L post, monolithic V2 natural (no base plate)	42"	R3R0LP242 () () () ()	341.
	49"	R3R0LP249 () () () ()	379.
L post, monolithic V3 exotic (no base plate)	42"	R3R0LP342 () () () ()	448.
	49"	R3R0LP349 () () () ()	495.

Order Code	Specification Information	Application Notes
Example: R3R0LTL34E1AA118	<i>To order please specify pattern number including:</i>	
R3 AutoStrada w/generation 3 post	1. Finish type tiles <i>L = Painted to match laminate</i>	5. Post cover configuration 1 = 1 piece (same finish both sides) 2 = 2 piece (same or different finish per side)
R0 No base raceway exposed	<i>V1 = V1 Techwood</i>	6. Finish, Aluminum trim (top cap and reveals) <i>Anodized aluminum or painted finish options listed on page 10 excluding silver</i>
L L post	<i>V2 = V2 Natural</i>	7. Finish, Side 1 <i>Laminate *, V1, V2 or V3 finish</i>
T Tiled (both faces)	<i>V3 = V3 Exotic</i>	8. Finish, Side 2 (side 2 finish applicable only when 2 piece post cover configuration selected) <i>Laminate *, V1, V2, or V3 finish</i>
L Laminate match	2. Height	
34 34" high	3. Extruded aluminum top cap <i>E = default</i>	
E Extruded aluminum top cap	4. Top Cap Configuration <i>1 = Regular L, finished 2 adjacent sides</i>	
1 Regular L cap configuration	<i>2 = Regular T, finished one side</i>	
AA Finish, top cap and reveal	<i>3 = Regular X, no sides finished</i>	
118 Finish, tiles	<i>4 = Hi/Lo cap at direction change, finished 3 sides</i>	
	<i>5 = Hi/Lo cap in line, finished 2 opposite sides</i>	
		See page 8 for finish options applicable.

Posts, panels

L post, one face only w/base plate

description	h	pattern no.	list
L post, tiled laminate left face w/o base, fabric/mono right face w/base	34"	R3R1LALL34 () () () () () ()	\$199.
	42"	R3R1LALL42 () () () () () ()	297.
	49"	R3R1LALL49 () () () () () ()	329.
	64"	R3R1LALL64 () () () () () ()	367.

Laminate side 1, fabric side 2

L post, tiled laminate right face w/o base, fabric/mono left face w/base	34"	R3R1LARL34 () () () () () ()	199.
	42"	R3R1LARL42 () () () () () ()	297.
	49"	R3R1LARL49 () () () () () ()	329.
	64"	R3R1LARL64 () () () () () ()	367.

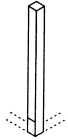

Fabric side 1, laminate side 2

L post, tiled V1 techwood left face w/o base, fabric/mono right face w/base	34"	R3R1LAL134 () () () () () ()	210.
	42"	R3R1LAL142 () () () () () ()	313.
	49"	R3R1LAL149 () () () () () ()	346.
	64"	R3R1LAL164 () () () () () ()	383.

V1 side 1, fabric side 2

L post, tiled V1 techwood right face w/o base, fabric/mono left face w/base	34"	R3R1LAR134 () () () () () ()	210.
	42"	R3R1LAR142 () () () () () ()	313.
	49"	R3R1LAR149 () () () () () ()	346.
	64"	R3R1LAR164 () () () () () ()	383.

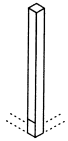

Fabric side 1, V1 side 2

Order Code	Specification Information	Application Notes
Example: R3R1LALL34E1AA4N613118W359-	To order please specify pattern number including:	6. Finish, Aluminum trim (top cap and reveals) Anodized aluminum or painted finish options listed on page 10 excluding silver
R3 AutoStrada w/generation 3 post	1. Tiled side L = Tiled left face, monolithic right face R = Tiled right face, monolithic left face	7. Base height 4 = 4" h, default
R1 Base raceway, mono side	2. Finish type tiled side L = Painted to match laminate V1 = V1 Techwood V2 = V2 Natural V3 = V3 Exotic	8. Base infeed - applicable for face with base plate only N = None F = Base infeed fabric face side
L L post	3. Height	9. Finish, base raceway
A Tiled one side/Mono other	4. Extruded aluminum top cap E = default	10. Finish, Side 1 If side 1 tiled specify laminate *, V1, V2 or V3 finish; If side 1 monolithic specify fabric
L Left face tiled	5. Top Cap Configuration 1 = Regular L, finished 2 adjacent sides 2 = Regular T, finished one side 3 = Regular X, no sides finished 4 = Hi/Lo cap at direction change, finished 3 sides 5 = Hi/Lo cap in line, finished 2 opposite sides	11. Finish, Side 2 If side 2 tiled specify laminate *, V1, V2 or V3 finish; If side 2 monolithic specify fabric
L Laminate match		
34 34" high		
E Extruded aluminum top cap		
1 Regular L cap configuration		
AA Finish, top cap and reveal		
4 4" high base		
N No base infeed		
613 Finish, base plate		
118 Finish, tiles		
W359- Finish, fabric (mono side)		

Posts, panels

L post, one face only w/base plate

description	h	pattern no.	list
L post, tiled V2 natural left face w/o base, fabric/mono right face w/base	34"	R3R1LAL234 () () () () () ()	\$230.
	42"	R3R1LAL242 () () () () () ()	341.
	49"	R3R1LAL249 () () () () () ()	379.
	64"	R3R1LAL264 () () () () () ()	421.

V2 side 1, fabric side 2

L post, tiled V2 natural right face w/o base, fabric/mono left face w/base	34"	R3R1LAR234 () () () () () ()	230.
	42"	R3R1LAR242 () () () () () ()	341.
	49"	R3R1LAR249 () () () () () ()	379.
	64"	R3R1LAR264 () () () () () ()	421.

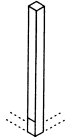

Fabric side 1, V2 side 2

L post, tiled V3 exotic left face w/o base, fabric/mono right face w/base	34"	R3R1LAL334 () () () () () ()	296.
	42"	R3R1LAL342 () () () () () ()	448.
	49"	R3R1LAL349 () () () () () ()	495.
	64"	R3R1LAL364 () () () () () ()	547.

V3 side 1, fabric side 2

L post, tiled V3 exotic right face w/o base, fabric/mono left face w/base	34"	R3R1LAR334 () () () () () ()	296.
	42"	R3R1LAR342 () () () () () ()	448.
	49"	R3R1LAR349 () () () () () ()	495.
	64"	R3R1LAR364 () () () () () ()	547.

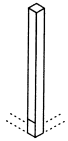

Fabric side 1, V3 side 2

Order Code	Specification Information	Application Notes
Example: R3R1LALL34E1AA4N 613118W359-	To order please specify pattern number including:	Aluminum vertical hookstrip cover ordered separately.
R3 AutoStrada w/generation 3 post	1. Tiled side <i>L = Tiled left face, monolithic right face</i> <i>R = Tiled right face, monolithic left face</i>	* Painted to match laminate.
R1 Base raceway, mono side	2. Finish type tiled side <i>L = Painted to match laminate</i> <i>V1 = V1 Techwood</i> <i>V2 = V2 Natural</i> <i>V3 = V3 Exotic</i>	See page 8 for finish options applicable.
L L post	3. Height	
A Tiled one side/Mono other	4. Extruded aluminum top cap <i>E = default</i>	
L Left face tiled	5. Top Cap Configuration <i>1 = Regular L, finished 2 adjacent sides</i> <i>2 = Regular T, finished one side</i> <i>3 = Regular X, no sides finished</i> <i>4 = Hi/Lo cap at direction change, finished 3 sides</i> <i>5 = Hi/Lo cap in line, finished 2 opposite sides</i>	
L Laminate match	6. Finish, Aluminum trim (top cap and reveals) <i>Anodized aluminum or painted finish options listed on page 10 excluding silver</i>	
34 34" high	7. Base height <i>4 = 4" h, default</i>	
E Extruded aluminum top cap	8. Base infeed - applicable for face with base plate only <i>N = None</i> <i>F = Base infeed fabric face side</i>	
1 Regular L cap configuration	9. Finish, base raceway	
AA Finish, top cap and reveal	10. Finish, Side 1 <i>If side 1 tiled specify laminate *, V1, V2 or V3 finish;</i> <i>If side 1 monolithic specify fabric</i>	
4 4" high base	11. Finish, Side 2 <i>If side 2 tiled specify laminate *, V1, V2 or V3 finish;</i> <i>If side 2 monolithic specify fabric</i>	
N No base infeed		
613 Finish, base plate		
118 Finish, tiles		
W359- Finish, fabric (mono side)		

Posts, panels x and straight posts

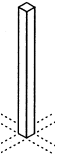
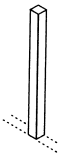
description	h	pattern no.	list
 X post, universal aluminum top cap	34"	R3X34E ()	\$226.
	42"	R3X42E ()	243.
	49"	R3X49E ()	261.
	64"	R3X64E ()	292.
 Straight post, tiled laminate face w/o base, fabric/mono face w/base	34"	R3R1SAL34 () () () () ()	199.
	42"	R3R1SAL42 () () () () ()	297.
	49"	R3R1SAL49 () () () () ()	329.
	64"	R3R1SAL64 () () () () ()	367.
Straight post, tiled V1 techwood face w/o base, fabric/mono face w/base	34"	R3R1SA134 () () () () ()	210.
	42"	R3R1SA142 () () () () ()	313.
	49"	R3R1SA149 () () () () ()	346.
	64"	R3R1SA164 () () () () ()	383.
Straight post, tiled V2 natural face w/o base, fabric/mono face w/base	34"	R3R1SA234 () () () () ()	230.
	42"	R3R1SA242 () () () () ()	341.
	49"	R3R1SA249 () () () () ()	379.
	64"	R3R1SA264 () () () () ()	421.

Order Code	Order Code	Specification Information
Example: R3X34E3AA	Example: R3R1SAL34E1AA4 N613118W359-	<i>To order please specify pattern number including:</i>
R3 AutoStrada w/generation 3 Post	R3 AutoStrada w/generation 3 Post	1. Post type <i>X = X post S = Straight post</i>
X X post	R1 Base raceway, fabric mono side	2. Tiled surface type (applicable straight posts only, embedded in pattern number) <i>L = Painted to match laminate 1 = V1 Techwood 2 = V2 Natural 3 = V3 Exotic</i>
34 34" high	S Straight post	3. Height
E Extruded aluminum top cap	A Tiled one face/mono other	4. Extruded aluminum top cap <i>E = default</i>
3 Regular X cap configuration	L Tiled face, Laminate match	5. Top Cap Configuration <i>1 = Regular L, finished 2 adjacent sides 2 = Regular T, finished one side 3 = Regular X, no sides finished 4 = Hi/Lo cap at direction change, finished 3 sides 5 = Hi/Lo cap in line, finished 2 opposite sides</i>
AA Finish, aluminum top cap	34 34" high	6. Finish, Aluminum top cap and reveals <i>Anodized aluminum or painted finish options listed on page 10 excluding silver</i>
	E Extruded aluminum top cap	7. Base height <i>4 = 4" h, default</i>
	1 Reg L cap config	8. Base infeed (applicable straight posts only) <i>N = None F = Base infeed fabric face side</i>
	AA Finish, aluminum top cap & reveal	9. Finish, base raceway (applicable straight posts only)
	4 4" high base	10. Finish, Tiled side <i>Laminate *, V1, V2 or V3 finish</i>
	N No base infeed	11. Finish, mono side <i>Fabric selection</i>
	613 Finish, base raceway	See page 8 for finish options applicable.
	118 Finish, tiled side	Aluminum vertical hookstrip cover ordered separately.
	W359- Finish, mono side	* Painted to match laminate.

Posts, panels *x and straight posts*

description	h	pattern no.	list
Straight post, tiled V3 exotic face w/o base, fabric/mono face w/base	34"	R3R1SA334 () () () () ()	\$296.
	42"	R3R1SA342 () () () () ()	448.
	49"	R3R1SA349 () () () () ()	495.
	64"	R3R1SA364 () () () () ()	547.
Straight post, monolithic (to match) laminate (no base plate)	42"	R3R0SPL42 () () ()	297.
	49"	R3R0SPL49 () () ()	329.
Straight post, monolithic V1 techwood (no base plate)	42"	R3R0SP142 () () ()	313.
	49"	R3R0SP149 () () ()	346.
Straight post, monolithic V2 natural (no base plate)	42"	R3R0SP242 () () ()	341.
	49"	R3R0SP249 () () ()	379.
Straight post, monolithic V3 exotic (no base plate)	42"	R3R0SP342 () () ()	448.
	49"	R3R0SP349 () () ()	495.

Panels

Order Code	Order Code	Specification Information
Example: R3X34E3AA	Example: R3R1SAL34E1AA4 N613118W359-	<i>To order please specify pattern number including:</i>
R3 AutoStrada w/generation 3 Post	R3 AutoStrada w/generation 3 Post	6. Finish, Aluminum top cap and reveals <i>Anodized aluminum or painted finish options listed on page 10 excluding silver</i>
X X post	R1 Base raceway, fabric mono side	7. Base height <i>4 = 4" h, default</i>
34 34" high	S Straight post	8. Base infeed (applicable straight posts only) <i>N = None</i>
E Extruded aluminum top cap	A Tiled one face/mono other	9. Finish, base raceway (applicable straight posts only)
3 Regular X cap configuration	L Tiled face, Laminate match	10. Finish, Tiled side <i>Laminate *, V1, V2 or V3 finish</i>
AA Finish, aluminum top cap	34 34" high	11. Finish, mono side <i>Fabric selection</i>
	E Extruded aluminum top cap	See page 8 for finish options applicable.
	1 Reg L cap config	Aluminum vertical hookstrip cover ordered separately.
	AA Finish, aluminum top cap & reveal	* Painted to match laminate.
	4 4" high base	
	N No base infeed	
	613 Finish, base raceway	
	118 Finish, tiled side	
	W359- Finish, mono side	
		1. Post type <i>X = X post</i> <i>S = Straight post</i>
		2. Tiled surface type (applicable straight posts only, embedded in pattern number) <i>L = Painted to match laminate</i> <i>1 = V1 Techwood</i> <i>2 = V2 Natural</i> <i>3 = V3 Exotic</i>
		3. Height
		4. Extruded aluminum top cap <i>E = default</i>
		5. Top Cap Configuration <i>1 = Regular L, finished 2 adjacent sides</i> <i>2 = Regular T, finished one side</i> <i>3 = Regular X, no sides finished</i> <i>4 = Hi/Lo cap at direction change, finished 3 sides</i> <i>5 = Hi/Lo cap in line, finished 2 opposite sides</i>

Posts, panels

120° post, tiled

description	h	pattern no.	list
120° post, tiled (to match) laminate (no base plate)	34"	R3R0120VTL34() () () () ()	\$669.
	42"	R3R0120VTL42() () () () ()	762.
	49"	R3R0120VTL49() () () () ()	785.
	64"	R3R0120VTL64() () () () ()	932.
Tiled laminate both sides			
120° post, tiled V1 techwood (no base plate)	34"	R3R0120VT134() () () () ()	682.
	42"	R3R0120VT142() () () () ()	773.
	49"	R3R0120VT149() () () () ()	797.
	64"	R3R0120VT164() () () () ()	942.
Tiled V1 both sides			
120° post, tiled V2 techwood (no base plate)	34"	R3R0120VT234() () () () ()	698.
	42"	R3R0120VT242() () () () ()	790.
	49"	R3R0120VT249() () () () ()	817.
	64"	R3R0120VT264() () () () ()	961.
Tiled V2 both sides			
120° post, tiled V3 techwood (no base plate)	34"	R3R0120VT334() () () () ()	732.
	42"	R3R0120VT342() () () () ()	825.
	49"	R3R0120VT349() () () () ()	851.
	64"	R3R0120VT364() () () () ()	995.
Tiled V3 both sides			

Order Code	Specification Information	Application Notes
Example: R3R0120VTL34E1AA118	<i>To order please specify pattern number including:</i>	5. Post cover configuration 1 = 1 piece
R3 AutoStrada w/generation 3 post	1. Height	6. Finish, Aluminum trim (top cap and reveals) Anodized aluminum or painted finish options listed on page 10 excluding silver
RO No base raceway exposed	2. Finish type tiles L = Painted to match laminate V1 = V1 Techwood V2 = V2 Natural V3 = V3 Exotic F = Fabric	7. Finish, Laminate *, V1, V2, V3 finish or Fabric
120V V post	3. Extruded aluminum top cap E = default	See page 8 for finish options applicable.
T Tiled (both faces)	4. Top Cap Configuration 1 = Regular L, finished 2 adjacent sides 2 = Regular T, finished one side 3 = Regular X, no sides finished 4 = Hi/Lo cap at direction change, finished 3 sides 5 = Hi/Lo cap in line, finished 2 opposite sides	Aluminum vertical hookstrip cover ordered separately. * Painted to match laminate.
L Laminate match		
34 34" high		
E Extruded aluminum top cap		
1 Regular L cap configuration		
AA Finish, top cap and reveal		
118 Finish, tiles		

Posts, panels

120° post, monolithic

description	h	pattern no.	list
120° post, monolithic (to match laminate (no base plate))	34"	R3R0120VPL34() () () () ()	\$606.
	42"	R3R0120VPL42() () () () ()	636.
	49"	R3R0120VPL49() () () () ()	660.
	64"	R3R0120VPL64() () () () ()	743.
Monolithic laminate both sides			
120° post, monolithic V1 techwood (no base plate)	34"	R3R0120VP134() () () () ()	617.
	42"	R3R0120VP142() () () () ()	646.
	49"	R3R0120VP149() () () () ()	671.
	64"	R3R0120VP164() () () () ()	753.
Monolithic V1 both sides			
120° post, monolithic V2 techwood (no base plate)	34"	R3R0120VP234() () () () ()	636.
	42"	R3R0120VP242() () () () ()	663.
	49"	R3R0120VP249() () () () ()	689.
	64"	R3R0120VP264() () () () ()	772.
Monolithic V2 both sides			
120° post, monolithic V3 techwood (no base plate)	34"	R3R0120VP334() () () () ()	669.
	42"	R3R0120VP342() () () () ()	698.
	49"	R3R0120VP349() () () () ()	723.
	64"	R3R0120VP364() () () () ()	806.
Monolithic V3 both sides			

Panels

Order Code	Specification Information	Application Notes
Example: R3R0135VT34E1AA118	<i>To order please specify pattern number including:</i>	5. Post cover configuration 1 = 1 piece
R3 AutoStrada w/generation 3 post	1. Height	Aluminum vertical hookstrip cover ordered separately.
RO No base raceway exposed	2. Finish type tiles <i>L = Painted to match laminate V1 = V1 Techwood V2 = V2 Natural V3 = V3 Exotic F = Fabric</i>	* Painted to match laminate.
135V V post	3. Extruded aluminum top cap <i>E = default</i>	6. Finish, Aluminum trim (top cap and reveals) <i>Anodized aluminum or painted finish options listed on page 10 excluding silver</i>
T Tiled (both faces)	4. Top Cap Configuration <i>1 = Regular L, finished 2 adjacent sides 2 = Regular T, finished one side 3 = Regular X, no sides finished 4 = Hi/Lo cap at direction change, finished 3 sides 5 = Hi/Lo cap in line, finished 2 opposite sides</i>	7. Finish, <i>Laminate *, V1, V2, V3 finish or Fabric</i>
L Laminate match		See page 8 for finish options applicable.
34 34" high		
E Extruded aluminum top cap		
1 Regular L cap configuration		
AA Finish, top cap and reveal		
118 Finish, tiles		

Posts, panels

135° post, tiled

description	h	pattern no.	list
135° post, tiled (to match) laminate (no base plate)	34"	R3R0135VTL34 () () () ()	\$625.
	42"	R3R0135VTL42 () () () ()	671.
	49"	R3R0135VTL49 () () () ()	713.
	64"	R3R0135VTL64 () () () ()	823.
Tiled laminate both sides			
<hr/>			
135° post, tiled V1 techwood (no base plate)	34"	R3R0135VT134 () () () ()	637.
	42"	R3R0135VT142 () () () ()	684.
	49"	R3R0135VT149 () () () ()	725.
	64"	R3R0135VT164 () () () ()	833.
Tiled V1 both sides			
<hr/>			
135° post, tiled V2 techwood (no base plate)	34"	R3R0135VT234 () () () ()	652.
	42"	R3R0135VT242 () () () ()	700.
	49"	R3R0135VT249 () () () ()	743.
	64"	R3R0135VT264 () () () ()	852.
Tiled V2 both sides			
<hr/>			
135° post, tiled V3 techwood (no base plate)	34"	R3R0135VT334 () () () ()	688.
	42"	R3R0135VT342 () () () ()	736.
	49"	R3R0135VT349 () () () ()	777.
	64"	R3R0135VT364 () () () ()	886.
Tiled V3 both sides			

Order Code	Specification Information	Application Notes
Example: R3R0135VTL34E1AA118	<i>To order please specify pattern number including:</i>	5. Post cover configuration 1 = 1 piece
R3 AutoStrada w/generation 3 post	1. Height	6. Finish, Aluminum trim (top cap and reveals) Anodized aluminum or painted finish options listed on page 10 excluding silver
RO No base raceway exposed	2. Finish type tiles <i>L = Painted to match laminate</i> <i>V1 = V1 Techwood</i> <i>V2 = V2 Natural</i> <i>V3 = V3 Exotic</i> <i>F = Fabric</i>	7. Finish, <i>Laminate *</i> , <i>V1</i> , <i>V2</i> , <i>V3</i> finish or <i>Fabric</i>
135V V post	3. Extruded aluminum top cap <i>E = default</i>	See page 8 for finish options applicable.
T Tiled (both faces)	4. Top Cap Configuration <i>1 = Regular L, finished 2 adjacent sides</i> <i>2 = Regular T, finished one side</i> <i>3 = Regular X, no sides finished</i> <i>4 = Hi/Lo cap at direction change, finished 3 sides</i> <i>5 = Hi/Lo cap in line, finished 2 opposite sides</i>	Aluminum vertical hookstrip cover ordered separately. * Painted to match laminate.
L Laminate match		
34 34" high		
E Extruded aluminum top cap		
1 Regular L cap configuration		
AA Finish, top cap and reveal		
118 Finish, tiles		

Posts, panels

135° post, monolithic

description	h	pattern no.	list
135° post, monolithic (to match laminate (no base plate))	34"	R3R0135VPL34() () () ()	\$708.
	42"	R3R0135VPL42() () () ()	871.
	49"	R3R0135VPL49() () () ()	882.
	64"	R3R0135VPL64() () () ()	1,074.
Monolithic laminate both sides			
135° post, monolithic V1 techwood (no base plate)	34"	R3R0135VP134() () () ()	720.
	42"	R3R0135VP142() () () ()	883.
	49"	R3R0135VP149() () () ()	892.
	64"	R3R0135VP164() () () ()	1,087.
Monolithic V1 both sides			
135° post, monolithic V2 techwood (no base plate)	34"	R3R0135VP234() () () ()	738.
	42"	R3R0135VP242() () () ()	901.
	49"	R3R0135VP249() () () ()	910.
	64"	R3R0135VP264() () () ()	1,103.
Monolithic V2 both sides			
135° post, monolithic V3 techwood (no base plate)	34"	R3R0135VP334() () () ()	772.
	42"	R3R0135VP342() () () ()	934.
	49"	R3R0135VP349() () () ()	943.
	64"	R3R0135VP364() () () ()	1,138.
Monolithic V3 both sides			

Panels

Order Code	Specification Information	Application Notes
Example: R3R0135VT34E1AA118	<i>To order please specify pattern number including:</i>	
R3 AutoStrada w/generation 3 post	1. Height	5. Post cover configuration 1 = 1 piece
RO No base raceway exposed	2. Finish type tiles <i>L = Painted to match laminate</i> <i>V1 = V1 Techwood</i> <i>V2 = V2 Natural</i> <i>V3 = V3 Exotic</i> <i>F = Fabric</i>	6. Finish, Aluminum trim (top cap and reveals) <i>Anodized aluminum or painted finish options listed on page 10 excluding silver</i>
135V V post	3. Extruded aluminum top cap <i>E = default</i>	7. Finish, <i>Laminate *, V1, V2, V3 finish or Fabric</i>
T Tiled (both faces)	4. Top Cap Configuration <i>1 = Regular L, finished 2 adjacent sides</i> <i>2 = Regular T, finished one side</i> <i>3 = Regular X, no sides finished</i> <i>4 = Hi/Lo cap at direction change, finished 3 sides</i> <i>5 = Hi/Lo cap in line, finished 2 opposite sides</i>	Aluminum vertical hookstrip cover ordered separately. * Painted to match laminate.
L Laminate match		
34 34" high		
E Extruded aluminum top cap		See page 8 for finish options applicable.
1 Regular L cap configuration		
AA Finish, top cap and reveal		
118 Finish, tiles		

Trim, panels
aluminum reveals

description	h	w	pattern no.	AA or paint
Aluminum hookstrip cover condition including stacking modules without exposed 4" raceway	33.5"		R2AHCN34 ()	\$71.
	41.5"		R2AHCN42 ()	86.
	48.5"		R2AHCN49 ()	100.
	63.5"		R2AHCN64 ()	133.
	78.5"		R2AHCN79 ()	169.
Aluminum hookstrip cover condition including stacking modules with 4"h base raceway.	30"		R2AHCR34 ()	72.
	38"		R2AHCR42 ()	87.
	45"		R2AHCR49 ()	103.
	60"		R2AHCR64 ()	136.
	75"		R2AHCR79 ()	171.
Alum horizontal reveal for between base panel and stacking window module		18"	R2AHWR18 ()	43.
		20"	R2AHWR20 ()	43.
		24"	R2AHWR24 ()	45.
		30"	R2AHWR30 ()	46.
		36"	R2AHWR36 ()	50.
		42"	R2AHWR42 ()	52.
Alum horizontal reveal for between two stacking window modules or between stacking and window modules or between two stacking modules		18"	R2AHBW18 ()	43.
		20"	R2AHBW20 ()	43.
		24"	R2AHBW24 ()	45.
		30"	R2AHBW30 ()	46.
		36"	R2AHBW36 ()	50.
		42"	R2AHBW42 ()	52.
Alum horizontal reveal for between base panel and stacking module (FL/F1/F2)		18"	R2AHSR18 ()	43.
		20"	R2AHSR20 ()	43.
		24"	R2AHSR24 ()	45.
		30"	R2AHSR30 ()	46.
		36"	R2AHSR36 ()	50.
		42"	R2AHSR42 ()	52.
	48"	R2AHSR48 ()	58.	

Order Code	Specification Information	Application Notes
Example: R2AHCN34 AA	<i>To order please specify pattern number including:</i> 1. Height or 2. Width 3. Finish <i>Anodized aluminum or painted finish options listed on page 8 excluding silver</i>	Aluminum hookstrip covers best suited for hard side (laminare, V1, V2 or V3) of panels only. Not recommended for fabric tiled side of panels. Recommend use on outside of stations/clusters only. When and where aluminum vertical hookstrip cover installed, forfeit panel hung capability.
R2 AutoStrada/Reff		
A Aluminum		
HC Hookstrip cover		
N No exposed raceway		
34 for 34"h		
AA Finish, anodized aluminum		

Trim, panels end trim and post trim

description	height	to height	width	pattern no.	list
 Aluminum end trim (full height), w/hookstrip	34"			A1FHETE34 ()	\$145.
	42"			A1FHETE42 ()	169.
	49"			A1FHETE49 ()	193.
	64"			A1FHETE64 ()	217.

 Aluminum end trim for Hi/Lo w/hookstrip (no post involved)	34"	42"		A1HLETE3442 ()	127.
	34"	49"		A1HLETE3449 ()	129.
	34"	64"		A1HLETE3464 ()	133.
	42"	49"		A1HLETE4249 ()	127.
	42"	64"		A1HLETE4264 ()	129.
	49"	64"		A1HLETE4964 ()	133.

 Post cover trim for Hi/Lo (post involved)	34"	42"		A1HLPTE3442 ()	34.
	34"	49"		A1HLPTE3449 ()	49.
	34"	64"		A1HLPTE3464 (F/T)() ()	99.
	42"	49"		A1HLPTE4249 ()	34.
	42"	64"		A1HLPTE4264 (F/T)() ()	83.
	49"	64"		A1HLPTE4964 ()	49.

Finish options fabric, V1, V2, V3 or painted to match laminate only, not available in AA anodized aluminum.

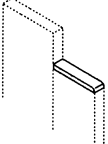
 Alum Top Trim for Hi/Lo condition, no post involved			18"	AHLTTE18 ()	25.
			20"	AHLTTE20 ()	28.
			24"	AHLTTE24 ()	31.
			30"	AHLTTE30 ()	36.
			36"	AHLTTE36 ()	47.
			42"	AHLTTE42 ()	48.
			48"	AHLTTE48 ()	65.

Order Code	Specification Information	Application Notes
Example: A1HLETE3442AA	<i>To order please specify pattern number including:</i>	
A AutoStrada		3. If (T) for tiled cover set, specify tile divider finish B - Black reveal E - painted silver to match AA extruded aluminum panel reveal or painted finish options list on page 8
1 Generation 1	1. Hi/Lo Condition <i>ETE = End trim, no post w/hookstrip, height changes does not involve a post</i> <i>PTE = Post end trim, height change involves post</i>	Aluminum end trim (full height), with hookstrip does not have base plate detail.
HL Hi/Lo	2. Hi/Lo Height 3442 = 34" h to 42" h 3449 = 34" h to 49" h 3464 = 34" h to 64" h * 4249 = 42" h to 49" h 4264 = 42" h to 64" h * 4964 = 49" h to 64" h	Post cover trim for hi/lo conditions are available in choice of fabric, V1, V2, V3 or painted to match laminate finishes only.
ET End Trim		See page 8 for finish options applicable.
E Extruded Aluminum Profile		
3442 34" h to 42" h		
AA Finish, anodized aluminum		
	*Applicable for post cover trim: Specify (F) for full monolithic cover or (T) for tiled cover set.	
		4. Finish <i>If end trim: Anodized aluminum or painted finish options listed on page 10 excluding silver</i> <i>If post cover trim: () fabric, V1, V2, V3 or painted to match laminate</i>

Trim, panels
full length top trim

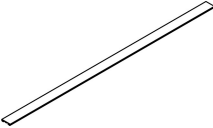
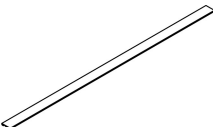
description	width	pattern no.	paint	AA
Continuous run top trim 	60"	A1CRTT60 ()	\$90.	\$90.
	66"	A1CRTT66 ()	90.	90.
	72"	A1CRTT72 ()	98.	98.
	78"	A1CRTT78 ()	98.	98.
	84"	A1CRTT84 ()	111.	111.
	90"	A1CRTT90 ()	149.	149.
	96"	A1CRTT96 ()	149.	149.
	102"	A1CRTT102 ()	n/a	160.
	108"	A1CRTT108 ()	n/a	160.
	114"	A1CRTT114 ()	n/a	160.
	120"	A1CRTT120 ()	n/a	160.
	126"	A1CRTT126 ()	n/a	169.
	132"	A1CRTT132 ()	n/a	169.
	138"	A1CRTT138 ()	n/a	176.
	144"	A1CRTT144 ()	n/a	176.
Continuous run top trim for Hi/Lo conditions 	60"	A1CHLTT60 ()	90.	90.
	66"	A1CHLTT66 ()	90.	90.
	72"	A1CHLTT72 ()	98.	98.
	78"	A1CHLTT78 ()	98.	98.
	84"	A1CHLTT84 ()	111.	111.
	90"	A1CHLTT90 ()	149.	149.
	96"	A1CHLTT96 ()	149.	149.
	102"	A1CHLTT102 ()	n/a	160.
	108"	A1CHLTT108 ()	n/a	160.
	114"	A1CHLTT114 ()	n/a	160.
	120"	A1CHLTT120 ()	n/a	160.
	126"	A1CHLTT126 ()	n/a	169.
	132"	A1CHLTT132 ()	n/a	169.
	138"	A1CHLTT138 ()	n/a	176.
	144"	A1CHLTT144 ()	n/a	176.

Order Code

Example:	A1CRTT60AA
A	AutoStrada
1	Generation 1
CR	Continuous Run
TT	Top Trim
60	60" wide
AA	Finish, anodized aluminum

Specification Information

To order please specify pattern number including:

1. Width
2. Finish, where applicable
Up to and including 96" w AA anodized aluminum or painted finish options listed on page 8 excluding silver

Only available in AA-anodized aluminum over 96" w

Application Notes

Continuous run top trim for spanning multiple panels with one piece of trim. Continuous run top trim ships with "W" clips which secures trim to panel frame.

Trim, panels

panel trim and install aids

description	type	h	pattern no.	list
Hookstrip cover strips, black flexible PVC	15 pcs/pack	79"	RHSCN15	\$0.
	70 pcs/pack	79"	RHSCN70	0.
	250 pcs/pack	79"	RHSCN250	0.
cut to size to fit during installation recommended use interior of station or where aluminum vertical reveals not installed				
Panel alignment kits	panel-to-panel		RSPABPP	7.
	window-to-panel		RSPABPW	7.
	window-to-window		RSPABWW	7.
	stacking module-to-panel		R3SPABPT	7.
	stacking module-to-stacking module		R3SPABTT	7.
	window-to-stacking module		R3SPABTW	7.
Panel leveling plates	10 pcs/pack		APLP10	43.
	25 pcs/pack		APLP25	96.
Carpet grippers	10 pcs/pack		R2CG	22.

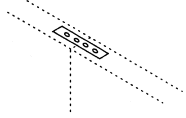

Panels

Order Code	Specification Information	Application Notes
Example: APLP10	<i>To order please specify pattern number including:</i> 1. Pack quantity required	Panel leveling plates are for installation aid only. The plate fits on top of the hookstrip connecting two panels and spans the joint between the panels. Simply drop the plate in the cavity between the two panels, tighten top wedges as you would normally during installation. The dimension and shape will force panel alignment. Remove the plate and proceed onto the next connection.
A AutoStrada		
P Panel		
L Leveling		
P Plates		
10 Pack of 10	Panel alignment kits are required for stacking modules and long panel runs. Panel alignment kits are required at the highest point of each panel and stacking module connection. They are recommended when panels are supporting overhead storage. One alignment bracket required for every two panels. Please refer to Reff planning guide, page 45 for additional information.	

description	type	h	w	d	pattern no.	list
Power rail for panel with one side only base raceway (8 wire)	24" panel	2"	6"	2"	RR3-E24S	\$162.
	30" panel	2"	12"	2"	RR3-E30S	187.
	36" panel	2"	18"	2"	RR3-E36S	204.
	42" panel	2"	24"	2"	RR3-E42S	220.
	48" panel	2"	30"	2"	RR3-E48S	226.

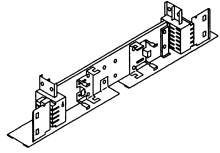

Power rail for panel with one side only base raceway (10 wire)	24" panel	2"	6"	2"	RR3-T24S	195.
	30" panel	2"	12"	2"	RR3-T30S	213.
	36" panel	2"	18"	2"	RR3-T36S	226.
	42" panel	2"	24"	2"	RR3-T42S	247.
	48" panel	2"	30"	2"	RR3-T48S	252.

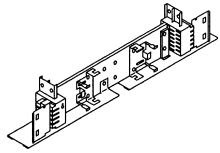

Order Code

Example: RR3-T24S
RR3 Reff panel frame raceway
T Ten wire, 3+3
24 for 24" w panel
S Single sided raceway

Specification Information

Power rails are the primary power distribution component. Each rail provides outlet mounting position on one side and receptacles for branching power connectors at each end.

Power rail for 24" wide panel accepts one duplex outlet or one power infeed. Power rails for 30" to 48" wide panels accept two outlets.

Application Notes

Power rails on this page are for use with panels with one side raceway only.

Power connections and duplexes as required to be specified from following pages for 8 or 10 wire as required for panels with either one sided base raceway or both sides with base raceway.

Power distribution components
 2+2 Base Raceway
 four circuit, eight-wire raceway for panels
 power rails and connector

description	type	w	d	h	pattern no.	list price
	24" panel	6"	2"	2"	RR3-E24	\$155.
	30" panel	12"	2"	2"	RR3-E30NS	170.
	36" panel	18"	2"	2"	RR3-E36NS	187.
	42" panel	24"	2"	2"	RR3-E42NS	195.
	48" panel	30"	2"	2"	RR3-E48NS	204.
	60" panel	42"	2"	2"	RR3-E60-4	310.
	66" panel	48"	2"	2"	RR3-E66-4	326.
72" panel	54"	2"	2"	RR3-E72-4	349.	

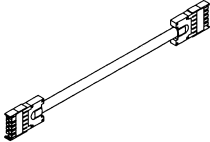
	Straight	16 1/2"	2"	2"	RR3-EPC24M	89.
		18 1/2"	2"	2"	RR3-EPCSM	89.
		20 1/4"	2"	2"	RR3-EPCM	89.
	Through post	19"	2"	2"	RR3-EPCP24M	89.
21"		2"	2"	RR3-EPCPSM	89.	
22 3/4"		2"	2"	RR3-EPCPM	89.	

Use **RR3-EPC24M** for straight 24" to 24" wide panel.

Use **RR3-EPCSM** for straight 24" to any other width panel and for 30" to 30" wide panels.

Use **RR3-EPCM** for all other straight power connection configurations.

Use **RR3-EPCP24M** for through post 24" to 24" wide panels.

Use **RR3-EPCPSM** for through post 24" to any other width panel and for 30" to 30" wide panels.

Use **RR3-EPCPM** for all other through post power connection configurations.

	Circuit A	RR3-DA	43.
	Circuit A, with controlled symbol	RR3-DAC	43.
	Circuit B	RR3-DB	43.
	Circuit B, with controlled symbol	RR3-DBC	43.
	Circuit X	RR3-DX	43.
	Circuit X, with controlled symbol	RR3-DXC	43.
	Circuit Y	RR3-DY	43.
	Circuit Y, with controlled symbol	RR3-DYC	43.

	Circuit X	RR3-DXO	48.
	Circuit Y	RR3-DYO	48.

Order Code	Specification Information	Application Notes
Example: RR3-E-24		
RR3 Reff raceway		
E Eight wire 2+2		
24 for 24" panel		
	<p>Reff 2+2 Raceway is a four-circuit, eight-wire modular power distribution system for use in Reff panels. 2+2 Raceway components distribute two 20-amp convenience circuits (A and B) with neutral and ground, and two protected 20-amp circuits (X and Y) with separate neutral and ground. In Canada circuits carry 15 amp load resting.</p> <p>Specify the suffix "RF" after the power rail pattern number for panels manufactured before June 1996.</p>	<p>Power rails are the primary power distribution component of the Reff 2+2 Raceway. Each rail provides outlet mounting positions on both sides and receptacles for two branching power connectors at each end. Center supports permit lay-in cabling from either side of the raceway.</p> <p>Rail for 24" wide panel accepts one duplex outlet or power infeed centered on each side. Rails for 30" to 48" panels accept two outlets (or one outlet and one infeed) on each side. 60", 66" and 72"W panels accept four duplex outlets per side. Duplex outlets are preconfigured to access one of the four circuits, A, B, X, Y, and snap into any standard outlet location. Duplexes on circuits X and Y may be specified in orange to signify protected circuits for electronic equipment.</p>

Power connectors transmit power between adjacent powered panels. Specify straight power connector for straight connections and through-post power connector when passing in a 90° or straight through a T, X or L post connection.

*Power connectors must be specified according to the panel widths in the specified orientation.

If separation of cabling and electrical wires is required, a data shield can be attached below the power rail. Data Shields are field installed.

Power distribution components
2+2 Base Raceway
four circuit, eight-wire raceway for panels
power rails and connector

description	type	w	d	h	pattern no.	list price
Data Shield	1 pair				RR3-DATSHD	\$30.
Attaches to power rail, sits under duplex						

Power distribution components

2+2 Base Raceway

four circuit, eight-wire raceway for panels

jumpers and infeed

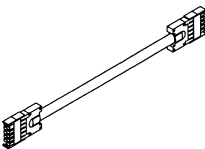
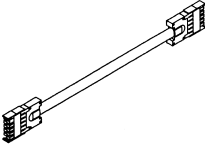
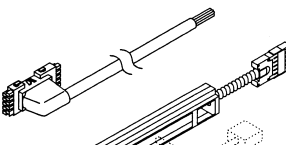
description	type	w	d	h	pattern no.	list price
	18" panel	38"	2"	2"	RR3-EJ18	\$112.
	20" panel	40"	2"	2"	RR3-EJ20	112.
	24" panel	44"	2"	2"	RR3-EJ24	121.
	30" panel	50"	2"	2"	RR3-EJ30	129.
	36" panel	56"	2"	2"	RR3-EJ36	140.
	42" panel	62"	2"	2"	RR3-EJ42	148.
	48" panel	68"	2"	2"	RR3-EJ48	155.
	54" panel run	76 1/2"	2"	2"	RR3-EJ54P	162.
	60" panel run	82 1/2"	2"	2"	RR3-EJ60P	170.
	66" panel run	88 1/2"	2"	2"	RR3-EJ66P	179.
	72" panel run	94 1/2"	2"	2"	RR3-EJ72P	187.
	78" panel run	100 1/2"	2"	2"	RR3-EJ78P	195.
	84" panel run	106 1/2"	2"	2"	RR3-EJ84P	204.
90" panel run	112 1/2"	2"	2"	RR3-EJ90P	213.	
96" panel run	118 1/2"	2"	2"	RR3-EJ96P	220.	
	18" + post	40 1/2"	2"	2"	RR3-EJ18P	112.
	20" + post	42 1/2"	2"	2"	RR3-EJ20P	112.
	24" + post	46 1/2"	2"	2"	RR3-EJ24P	121.
	30" + post	52 1/2"	2"	2"	RR3-EJ30P	129.
	36" + post	58 1/2"	2"	2"	RR3-EJ36P	140.
	42" + post	64 1/2"	2"	2"	RR3-EJ42P	148.
	48" + post	70 1/2"	2"	2"	RR3-EJ48P	155.
	Ceiling power cable infeed. Eight-wire				RR3-EPVR	310.
	Hardwire infeed (NYC) one direction				RR3-EPNY1	310.
	Hardwire infeed (NYC) two directions				RR3-EPNY2	310.
	Panel base end feed				RR3-REPI	269.
	Panel base side infeed				RR3-EPI	269.
	Surge suppressors				RR3-SP-(A,B,X,Y)	195.

Panels

Order Code	Specification Information	Application Notes								
<p>Example: RR3-EPVR</p> <table border="1"> <tr> <td>RR3</td> <td>Reff raceway</td> </tr> <tr> <td>E</td> <td>Eight wire 2+2</td> </tr> <tr> <td>P</td> <td>power infeed</td> </tr> <tr> <td>VR</td> <td>for vertical raceway</td> </tr> </table>	RR3	Reff raceway	E	Eight wire 2+2	P	power infeed	VR	for vertical raceway	<p>Reff 2+2 Raceway is a four-circuit, eight-wire modular power distribution system for use in Reff panels. 2+2 Raceway components distribute two 20-amp convenience circuits (A and B) with neutral and ground, and two 20-amp circuits (X and Y) with separate neutral and ground.</p> <p>For use in Canada, all circuits are CGA rated 15 amp capacity.</p> <p><i>Note:</i> For NYC hardwire infeeds specify bracket height: 4", 5", or 6"H.</p> <p>Beltway panels can use jumpers at the panel base in a straight run or around a corner.</p>	<p>Jumpers pass power through the raceway of panels that do not require power access to the next available power rail. Jumpers only connect to power rails. Jumpers 18" to 48" are available standard or extended. Extended jumpers should be specified when passing through a panel and a post. Jumpers 54" to 96" wide can be used with or without a post application. Extended jumpers and jumpers 54" to 96" wide can only pass through panels and one post.</p> <p>Power infeeds connect building power supply to a cluster of interconnected power rails. Panel base infeed snaps into any outlet position in rail, and includes 6 foot liquid-tight conduit and pigtail for connection to floor or wall electrical box. Ceiling infeeds include up to 13' pigtail for connection</p> <p>into panel base through power pole adjacent to panel with power rail. Power pole and post must be ordered separately.</p> <p>Hardwire infeed, used in all New York City installations, includes junction box that mounts within non-powered panel base (any width 30" or greater). Electrical contractor supplies watertight conduit from building power supply to panel and trims power connectors to length. RR3-EPNY2 includes two power connectors to power panels on both sides of infeed panel; RR3-EPNY1 includes only one power connector.</p> <p>Cable sizes are nominal. Use the "type" column to specify the required cable for your panel.</p>
RR3	Reff raceway									
E	Eight wire 2+2									
P	power infeed									
VR	for vertical raceway									

Power distribution components

3+3 Base Raceway

six circuit, ten-wire raceway for panels

power rails and connectors

description	type	w	d	h	pattern no.	list price
	24" panel	6"	2"	2"	RR3-T24	\$179.
	30" panel	12"	2"	2"	RR3-T30NS	195.
	36" panel	18"	2"	2"	RR3-T36NS	213.
	42" panel	24"	2"	2"	RR3-T42NS	226.
	48" panel	30"	2"	2"	RR3-T48NS	235.
	60" panel	42"	2"	2"	RR3-T60-4	367.
	66" panel	48"	2"	2"	RR3-T66-4	381.
72" panel	54"	2"	2"	RR3-T72-4	408.	

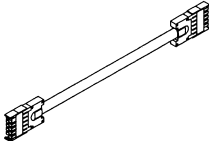
	Straight	16 1/2"	2"	2"	RR3-TPC24M	112.
		18 1/2"	2"	2"	RR3-TPCSM	112.
		20 1/4"	2"	2"	RR3-TPCM	112.

Use **RR3-TPC24** for through post 24" to 24" wide panels.

Use **RR3-TPCS** for through post 24" to any other width panel and for 30" to 30" wide panels.

Use **RR3-TPC** for all other through post power connection configurations.

Through post	19"	2"	2"	RR3-TPCP24M	112.
	21"	2"	2"	RR3-TPCPSM	112.
	22 3/4"	2"	2"	RR3-TPCPM	112.

Use **RR3-TPCP24** for through post 24" to 24" wide panels.

Use **RR3-TPCPS** for through post 24" to any other width panel and for 30" to 30" wide panels.

Use **RR3-TPCP** for all other through post power connection configurations.

	Circuit A	RR3-DA	43.
	Circuit A, with controlled symbol	RR3-DAC	43.
	Circuit B	RR3-DB	43.
	Circuit B, with controlled symbol	RR3-DBC	43.
	Circuit C	RR3-DC	43.
	Circuit C, with controlled symbol	RR3-DCC	43.
	Circuit X	RR3-DX	43.
	Circuit X, with controlled symbol	RR3-DXC	43.
	Circuit Y	RR3-DY	43.
	Circuit Y, with controlled symbol	RR3-DYC	43.
	Circuit Z	RR3-DZ	43.
	Circuit Z, with controlled symbol	RR3-DZC	43.

Order Code	Specification Information	Application Notes
Example: RR3-T-24		
RR3 Reff raceway	Reff 3+3 Raceway is a six-circuit, ten-wire modular power distribution system for use in Reff panels. 3+3 Raceway components distribute three 20-amp convenience circuits (A,B and C) with neutral and ground, and three 20-amp circuits (X, Y and Z) with separate neutral and ground.	Power rails are the primary power distribution component of the Reff 3+3 Raceway. Each rail provides outlet mounting positions on both sides and receptacles for branching power connectors at each end. Center supports permit lay-in cabling from either side of the raceway.
T Ten wire 3+3	A, B, X, Y outlets are identical to eight wire, 2+2 components.	Power connectors transmit power between adjacent powered panels. Specify straight power connector for straight connections and through-post power connector when passing in a 90° or straight through a T or X or L post connection.
24 for 24" panel	Duplex outlet circuits are designated by white letters on black background.	Duplex outlets are preconfigured to access one of the four circuits, A, B, X, Y, and snap into any standard outlet location. Duplexes on circuits X and Y may be specified in orange to signify protected circuits for electronic equipment; all duplexes are black.
	In Canada, circuits carry a 15 amp load rating.	Rail for 24"W panel accepts one duplex outlet or power infeed one either side. Rails for 30" to 48" panels accept two outlets each side, 60", 66" and 72" rails accept four duplex outlets per side.
	<i>Note:</i> Specify the suffix "RF" after the power rail pattern number for panels manufactured before June 1996.	*Power connectors must be specified according to the panel widths in the specified orientation.
		If separation of cabling and electrical wires is required, a data shield can be attached below the power rail. Data Shields are field installed.

Power distribution components
3+3 Base Raceway
six circuit, ten-wire raceway for panels
power rails and connectors

description	type	w	d	h	pattern no.	list price
Duplex outlets, orange 	Circuit X				RR3-DXO	\$48.
	Circuit Y				RR3-DYO	48.
	Circuit Z				RR3-DZO	48.
Data Shield	1 pair				RR3-DATSHD	30.

Power distribution components
3+3 Base Raceway
six circuit, ten-wire raceway for panels
jumpers and infeed

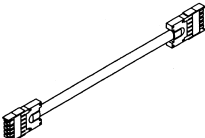
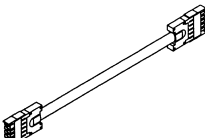
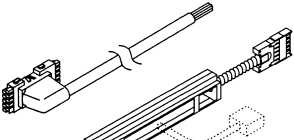
description	type	w	d	h	pattern no.	list price
	18" panel	38"	2"	2"	RR3-TJ18	\$129.
	20" panel	40"	2"	2"	RR3-TJ20	129.
	24" panel	44"	2"	2"	RR3-TJ24	140.
	30" panel	50"	2"	2"	RR3-TJ30	148.
	36" panel	56"	2"	2"	RR3-TJ36	155.
	42" panel	62"	2"	2"	RR3-TJ42	170.
	48" panel	68"	2"	2"	RR3-TJ48	187.
	54" panel run	76 1/2"	2"	2"	RR3-TJ54P	195.
	60" panel	82 1/2"	2"	2"	RR3-TJ60P	204.
	66" panel run	86 1/2"	2"	2"	RR3-TJ66P	213.
	72" panel run	94 1/2"	2"	2"	RR3-TJ72P	220.
	78" panel run	100 1/2"	2"	2"	RR3-TJ78P	226.
	84" panel run	106 1/2"	2"	2"	RR3-TJ84P	247.
90" panel run	112 1/2"	2"	2"	RR3-TJ90P	252.	
96" panel run	118 1/2"	2"	2"	RR3-TJ96P	259.	
	18" + post	40 1/2"	2"	2"	RR3-TJ18P	129.
	20" + post	46 1/2"	2"	2"	RR3-TJ20P	129.
	24" + post	46 1/2"	2"	2"	RR3-TJ24P	140.
	30" + post	52 1/2"	2"	2"	RR3-TJ30P	148.
	36" + post	58 1/2"	2"	2"	RR3-TJ36P	155.
	42" + post	64 1/2"	2"	2"	RR3-TJ42P	170.
	48" + post	70 1/2"	2"	2"	RR3-TJ48P	187.
	Ceiling power cable infeed. Ten-wire				RR3-TPVR	374.
	Hardwire infeed (NYC) one direction **				RR3-TPNY1	374.
	Hardwire infeed (NYC) two directions **				RR3-TPNY2	374.
	Panel base end feed				RR3-RTPI	310.
	Panel base side infeed				RR3-TPI	310.
	Surge suppressors *				RR3-SP-(A, B, C, X, Y, Z)	195.

* Select which circuit needs protecting and order the specified surge processor.

** For RR3-TPNY1 and RR3-TPNY2 specify base height of panel for NYC.

Order Code	Specification Information	Application Notes
Example: RR3-TPVR RR3 Reff raceway T Ten wire 3+3 P power infeed VR for vertical raceway	<p>Reff 3+3 Raceway is a six-circuit, ten-wire modular power distribution system for use in Reff panels. 3+3 Raceway components distribute three 20-amp convenience circuits (A, B and C) with neutral and ground, and three 20-amp circuits (X, Y and Z) with separate neutral and ground.</p> <p>In Canada, circuits carry a 15 amp load rating.</p> <p>Power infeeds connect building power supply to a cluster of interconnected power rails. Panel base infeed snaps into any outlet position in rail, and includes 6 foot liquid-tight conduit and pigtail for connection to floor or wall electrical box. Ceiling infeeds include up to 13' pigtail for connection into panel base through standard power pole. Power pole and post must be ordered separately.</p>	<p>Jumpers pass power through the raceway of panels that do not require power access to the next available power rail. Jumpers only connect to power rails. Jumpers 18" to 48" are available standard or extended. Extended jumpers should be specified when passing through a panel and a post. Jumpers 54" to 96" wide can be used with or without a post application. Extended jumpers and jumpers 54" to 96" wide can only pass through panels and one post.</p> <p>Cable sizes are nominal. Use the "type" column to specify the required cable for your panel.</p> <p>Beltway panels can use jumpers at the panel base in a straight run or around a corner.</p>

Power distribution components

Hardwire box

AutoStrada

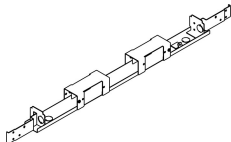
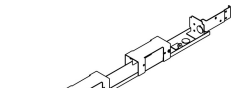
description	type	pattern no.	list
Chicago Hardwire Box 1 Sided 	24" panel	RR3CHI241	\$241.
	30" panel	RR3CHI301	281.
	36" panel	RR3CHI361	302.
	42" panel	RR3CHI421	305.
	48" panel	RR3CHI481	327.
Chicago Hardwire Box 2 Sided 	24" panel	RR3CHI242	250.
	30" panel	RR3CHI302	299.
	36" panel	RR3CHI362	308.
	42" panel	RR3CHI422	312.
	48" panel	RR3CHI482	347.

Panels

Order Code

Example:	RR3CHI241
RR3	Reff/AutoStrada raceway G3
CHI	Chicago Hardwire Box
24	For 24" wide panel
1	One sided raceway

Specification Information

Hardwire box is dedicated for panels with raceway either one or two sided, be sure to match to panel specification.

Application Notes

Certified electrician to install.
 Reff Hardwire Box
 Installation instruction sheet available on Knoll Exchange. Part number 6TR45715.

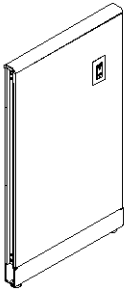

Ported Panel Components

Reff and AutoStrada ported panel components offer a cost effective alternative to using beltway panels which will provide users convenient access to data or power outlets at any user defined height on a Reff and AutoStrada panel. Ports are one sided and may be installed below a worksurface, at desk height or even within a panel hung overhead storage unit.

Select option "Milled for ported components" when specifying panels. Ports may be added as technology needs change. Ports are field installed on the left or right hand side of a panel's vertical frame in fabric inserts only. Installation instructions will be shipped with each kit, including a template for port placement along the vertical frame.

Panel jumpers are used to connect standard base electrical to the ported panel kit. Jumpers can be specified to connect a port within the same panel or to adjacent panels. Panel jumpers always pass through base raceway. If one port is installed, an additional port may be added within the same panel with an internal power jumper between the two ports. Ports can also be daisy-chained together in adjacent panels. Ported panel components are not available for stackable modules.

The kit includes a bracket set and cover plate and is ordered separately from the modular power components. Specify electrical components as you would for base raceway power then add the ported panel bracket kit, applicable duplexes and power jumpers.

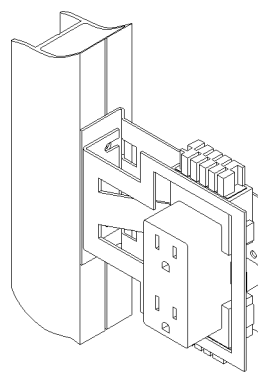
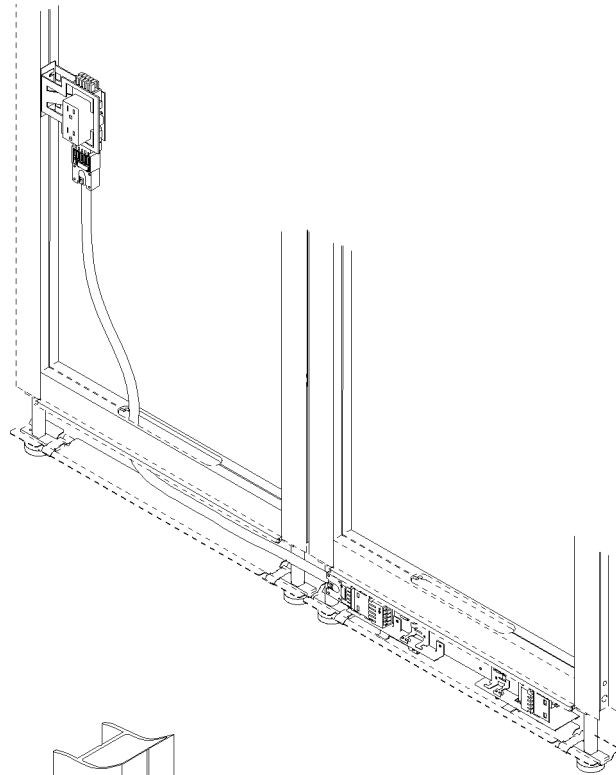

Vertical power port bracket kit and duplex.

AutoStrada Ported Panel Components

port, vertical duplex and panel jumpers

AutoStrada

description	type	pattern no.	list price
	Floating data port	RR3FDP	\$60.
	Vertical Power Port Bracket Kit (includes bracket, cover plate & installation instructions)	RR3VPBK	95.

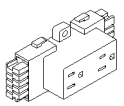
description	type	pattern no.	list price
	Vertical Duplex A (8/10 wire applications)	RR3VDA	32.
	Vertical Duplex A (8/10 wire applications) with controlled symbol	RR3VDAC	32.
	Vertical Duplex B (8/10 wire applications)	RR3VDB	32.
	Vertical Duplex B (8/10 wire applications) with controlled symbol	RR3VDBC	32.
	Vertical Duplex C (10 wire applications)	RR3VDC	32.
	Vertical Duplex C (8/10 wire applications) with controlled symbol	RR3VDCC	32.
	Vertical Duplex X (8/10 wire applications)	RR3VDX	32.
	Vertical Duplex X (8/10 wire applications) with controlled symbol	RR3VDXC	32.
	Vertical Duplex X Iso (8/10 wire applications)	RR3VDXO	32.
	Vertical Duplex Y (8/10 wire applications)	RR3VDY	32.
	Vertical Duplex Y (8/10 wire applications) with controlled symbol	RR3VDYC	32.
	Vertical Duplex Y Iso (8/10 wire applications)	RR3VDYO	32.
	Vertical Duplex Z (10 wire applications)	RR3VDZ	32.
	Vertical Duplex Z (8/10 wire applications) with controlled symbol	RR3VDZC	32.
Vertical Duplex Z Iso (10 wire applications)	RR3VDZO	32.	

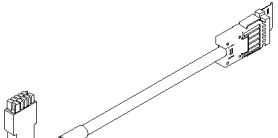
description	type	pattern no.	list price
	30" Same Panel Jumper 50" 8w	RR3EBVC50	162.
	30" Same Panel Jumper 64" 8w	RR3EBVC64	176.
	30" Same Panel Jumper 78" 8w	RR3EBVC78	192.
	36" + Same Panel Jumper 62" 8w	RR3EBVC62	175.
	36" + Same Panel Jumper 76" 8w	RR3EBVC76	191.
	36" + Same Panel Jumper 90" 8w	RR3EBVC90	208.

Order Code	Specification Information	Application Note	
Example: RR3FDP RR3 Reff F Floating DP Data Port	For data and communications specify product listed on page 0.	30" same panel jumper only used if there is a harness in base of 30" panel . Length of panel jumper required driven by intended location of port. 50" will support port location in extreme top corner of 49"h 64" will support port location in extreme top corner of 64"h 78" will support port location in extreme top corner of 79"h 36"+ same panel jumper only used if there is a harness in the base of 36", 42" or 48" panels. Length of panel jumper required driven by intended location of port. 62" will support port location in extreme top corner of 49"h 76" will support port location in extreme top corner of 64"h 90" will support port location in extreme top corner of 79"h	If harness is in base of 24" panel you can not jump vertically, must remove harness. A harness for Reff 30" wide panel with raceway on one side will only accept one same panel jumper. A duplex will not fit with the same panel jumper installed in the harness. Internal panel jumper to be used within a panel, between two ports approximate span 48". Both duplex units must be the same circuit for this application. Adjacent Panel Jumpers: 82" is max for 49" high panel 96" is max if panel is 64" high 110" is max if panel is 79" high All covers plates and snap in modules are black.

Panels

AutoStrada Ported Panel Components

port, vertical duplex and panel jumpers

AutoStrada

description	type	pattern no.	list price
Same Panel Jumper, 10w	30" Same Panel Jumper 50" 10w	RR3TBVC50	\$186.
	30" Same Panel Jumper 64" 10w	RR3TBVC64	204.
	30" Same Panel Jumper 78" 10w	RR3TBVC78	222.
	36" + Same Panel Jumper 62" 10w	RR3TBVC62	199.
	36" + Same Panel Jumper 76" 10w	RR3TBVC76	218.
	36" + Same Panel Jumper 90" 10w	RR3TBVC90	235.

AutoStrada Ported Panel Components

port, vertical duplex and panel jumpers

AutoStrada

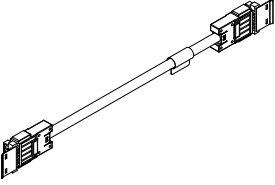
description	type	pattern no.	list price
 Adjacent Panel Jumper, 10w	Adjacent Panel Jumper 110" 10w	RR3TVJ110	\$255.
	Adjacent Panel Jumper 82" 10w	RR3TVJ82	219.
	Adjacent Panel Jumper 96" 10w	RR3TVJ96	238.
 Adjacent Panel Jumper, 8w	Adjacent Panel Jumper 110" 8w	RR3EVJ110	223.
	Adjacent Panel Jumper 82" 8w	RR3EVJ82	195.
	Adjacent Panel Jumper 96" 8w	RR3EVJ96	212.
 Internal Panel Jumper	Internal Panel Jumper 10 w	RR3TVJ	163.
	Internal Panel Jumper 8 w	RR3EVJ	152.

Panels

Order Code

Example:	RR3FDP
RR3	Reff
F	Floating
DP	Data Port

Specification Information

For data and communications specify product listed on page 0.

30" same panel jumper only used if there is a harness in base of 30" panel . Length of panel jumper required driven by intended location of port.
 50" will support port location in extreme top corner of 49"h
 64" will support port location in extreme top corner of 64"h
 78" will support port location in extreme top corner of 79"h

36"+ same panel jumper only used if there is a harness in the base of 36", 42" or 48" panels. Length of panel jumper required driven by intended location of port.
 62" will support port location in extreme top corner of 49"h
 76" will support port location in extreme top corner of 64"h
 90" will support port location in extreme top corner of 79"h

If harness is in base of 24" panel you can not jump vertically, must remove harness.

A harness for Reff 30" wide panel with raceway on one side will only accept one same panel jumper. A duplex will not fit with the same panel jumper installed in the harness.

Internal panel jumper to be used within a panel, between two ports approximate span 48". Both duplex units must be the same circuit for this application.

Adjacent Panel Jumpers:
 82" is max for 49" high panel
 96" is max if panel is 64" high
 110" is max if panel is 79" high

All covers plates and snap in modules are black.

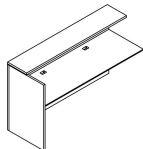
description	type	h*	w*	d	pattern no.	L	M/V1 or V1	M/V2 or V2	M/V3 or V3
 <p>left hand shown, worksurface height fixed 27" h to underside</p>	left hand	42"	42"	26 1/2"	AMB42L424 () () () () ()	\$1,579.	\$1,987.	\$2,285.	\$2,969.
		42"	48"	26 1/2"	AMB42L484 () () () () ()	1,642.	2,067.	2,377.	3,090.
		42"	54"	26 1/2"	AMB42L544 () () () () ()	1,707.	2,149.	2,472.	3,210.
		42"	60"	26 1/2"	AMB42L604 () () () () ()	1,771.	2,229.	2,565.	3,333.
		42"	66"	26 1/2"	AMB42L664 () () () () ()	1,837.	2,311.	2,659.	3,456.
		42"	72"	26 1/2"	AMB42L724 () () () () ()	1,901.	2,391.	2,750.	3,574.
		42"	78"	26 1/2"	AMB42L784 () () () () ()	1,965.	2,474.	2,843.	3,696.
		42"	84"	26 1/2"	AMB42L844 () () () () ()	2,028.	2,553.	2,938.	3,818.
		42"	90"	26 1/2"	AMB42L904 () () () () ()	2,095.	2,633.	3,031.	3,940.
		42"	96"	26 1/2"	AMB42L964 () () () () ()	2,157.	2,716.	3,124.	4,063.
	right hand	42"	42"	26 1/2"	AMB42R424 () () () () ()	1,579.	1,987.	2,285.	2,969.
		42"	48"	26 1/2"	AMB42R484 () () () () ()	1,642.	2,067.	2,377.	3,090.
		42"	54"	26 1/2"	AMB42R544 () () () () ()	1,707.	2,149.	2,472.	3,210.
		42"	60"	26 1/2"	AMB42R604 () () () () ()	1,771.	2,229.	2,565.	3,333.
		42"	66"	26 1/2"	AMB42R664 () () () () ()	1,837.	2,311.	2,659.	3,456.
		42"	72"	26 1/2"	AMB42R724 () () () () ()	1,901.	2,391.	2,750.	3,574.
		42"	78"	26 1/2"	AMB42R784 () () () () ()	1,965.	2,474.	2,843.	3,696.
		42"	84"	26 1/2"	AMB42R844 () () () () ()	2,028.	2,553.	2,938.	3,818.
		42"	90"	26 1/2"	AMB42R904 () () () () ()	2,095.	2,633.	3,031.	3,940.
		42"	96"	26 1/2"	AMB42R964 () () () () ()	2,157.	2,716.	3,124.	4,063.

Order Code	Specification Information	Application Notes
Example: AMB42L424GFEV316 V316613AA	To order please specify pattern number including:	Median end without gable to be attached to a storage anchored cabinet. Optional face drill option is to drill outside face of gable to attach to next median in line, if last unit in run specify no drill. Optional end drill gable option is for attachment to bridge units on page 159, specify no drill if configuration does not include bridge unit.
A AutoStrada	1. Hand <i>L = Left hand R = Right hand</i>	Mixed finish options applicable with V1, V2 or V3 finish surround, top shelf and worksurface front edge with laminate finish worksurface.
M Median	2. Width	Products on this page shipped knocked-down.
B Binder depth top shelf	3. Depth <i>4 = 26.5" d nominal 5 = 32.5" d nominal</i>	
42 42" high	4. Grommet option <i>G = Grommet(s) N = No grommet(s)</i>	
L Left hand	5. Face drill option <i>F = face drill for attachment to next unit N = no drill, last unit in run</i>	
42 42" wide	6. End drill option <i>E = end drill gable to attach to bridge N = no drill</i>	
4 26.5" d	7. Finish, surround, top shelf and worksurface front edge <i>Laminate, V1, V2 or V3 finish</i>	
G Grommet	8. Finish, worksurface <i>Laminate, V1, V2 or V3 finish</i>	
F Face drill gable	9. Finish, Grommet(s) <i>specify painted or plated finish</i>	
E End drill gable	10. Finish, Aluminum trim <i>AA - Anodized aluminum or painted finish option from page 8 excluding silver</i>	
V316 Finish, surround, top shelf & worksurface edge	Order worksurface stiffener for unsupported spans exceeding 48".	
V316 Finish, worksurface	*42"h to top of gable; with aluminum trim and top shelf 43.2"h.	
613 Finish, grommet	*Width noted is interior nominal dimension, overall footprint additional 1" nominal.	
AA Trim, anodized aluminum	See page 8 for finish options applicable.	

Product on this page will accept wood grain laminate where laminate is currently an option.

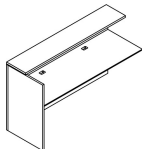
description	type	h*	w*	d	pattern no.	L	M/V1 or V1	M/V2 or V2	M/V3 or V3
 <p>left hand shown, worksurface height fixed 27" h to underside</p>	left hand	42"	42"	32 1/2"	AMB42L425 () () () () ()	\$1,671.	\$2,081.	\$2,394.	\$3,111.
		42"	48"	32 1/2"	AMB42L485 () () () () ()	1,733.	2,162.	2,487.	3,230.
		42"	54"	32 1/2"	AMB42L545 () () () () ()	1,798.	2,242.	2,577.	3,353.
		42"	60"	32 1/2"	AMB42L605 () () () () ()	1,860.	2,320.	2,670.	3,470.
		42"	66"	32 1/2"	AMB42L665 () () () () ()	1,924.	2,400.	2,761.	3,590.
		42"	72"	32 1/2"	AMB42L725 () () () () ()	1,991.	2,479.	2,855.	3,707.
		42"	78"	32 1/2"	AMB42L785 () () () () ()	2,054.	2,559.	2,948.	3,829.
		42"	84"	32 1/2"	AMB42L845 () () () () ()	2,117.	2,640.	3,036.	3,948.
		42"	90"	32 1/2"	AMB42L905 () () () () ()	2,181.	2,719.	3,129.	4,068.
		42"	96"	32 1/2"	AMB42L965 () () () () ()	2,245.	2,798.	3,222.	4,187.
	right hand	42"	42"	32 1/2"	AMB42R425 () () () () ()	1,671.	2,081.	2,394.	3,111.
		42"	48"	32 1/2"	AMB42R485 () () () () ()	1,733.	2,162.	2,487.	3,230.
		42"	54"	32 1/2"	AMB42R545 () () () () ()	1,798.	2,242.	2,577.	3,353.
		42"	60"	32 1/2"	AMB42R605 () () () () ()	1,860.	2,320.	2,670.	3,470.
		42"	66"	32 1/2"	AMB42R665 () () () () ()	1,924.	2,400.	2,761.	3,590.
		42"	72"	32 1/2"	AMB42R725 () () () () ()	1,991.	2,479.	2,855.	3,707.
		42"	78"	32 1/2"	AMB42R785 () () () () ()	2,054.	2,559.	2,948.	3,829.
		42"	84"	32 1/2"	AMB42R845 () () () () ()	2,117.	2,640.	3,036.	3,948.
		42"	90"	32 1/2"	AMB42R905 () () () () ()	2,181.	2,719.	3,129.	4,068.
		42"	96"	32 1/2"	AMB42R965 () () () () ()	2,245.	2,798.	3,222.	4,187.

Medians

Order Code	Specification Information	Application Notes
Example: AMB42L425GFEV316 V316613AA	To order please specify pattern number including:	Median end without gable to be attached to a storage anchored cabinet. Optional face drill option is to drill outside face of gable to attach to next median in line, if last unit in run specify no drill. Optional end drill gable option is for attachment to bridge units on page 159, specify no drill if configuration does not include bridge unit.
A AutoStrada	1. Hand <i>L = Left hand R = Right hand</i>	Mixed finish options applicable with V1, V2 or V3 finish surround, top shelf and worksurface front edge with laminate finish worksurface.
M Median	2. Width	Products on this page shipped knocked-down.
B Binder depth top shelf	3. Depth <i>4 = 26.5" d nominal 5 = 32.5" d nominal</i>	
42 42" high	4. Grommet option <i>G = Grommet(s) N = No grommet(s)</i>	
L Left hand	5. Face drill option <i>F = face drill for attachment to next unit N = no drill, last unit in run</i>	
42 42" wide	6. End drill option <i>E = end drill gable to attach to bridge N = no drill</i>	
5 32.5" d	7. Finish, surround, top shelf and worksurface front edge <i>Laminate, V1, V2 or V3 finish</i>	
G Grommet	8. Finish, worksurface <i>Laminate, V1, V2 or V3 finish</i>	
F Face drill gable	9. Finish, Grommet(s) <i>specify painted or plated finish</i>	
E End drill gable	10. Finish, Aluminum trim <i>AA - Anodized aluminum or painted finish option from page 8 excluding silver</i>	
V316 Finish, surround, top shelf & worksurface edge	Order worksurface stiffener for unsupported spans exceeding 48".	
V316 Finish, worksurface	*42" h to top of gable; with aluminum trim and top shelf 43.2" h.	
613 Finish, grommet	*Width noted is interior nominal dimension, overall footprint additional 1" nominal.	
AA Trim, anodized aluminum	See page 8 for finish options applicable.	

Product on this page will accept wood grain laminate where laminate is currently an option.

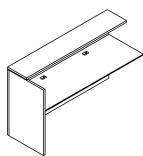
description	type	h*	w*	d	pattern no.	L	M/V1 or V1	M/V2 or V2	M/V3 or V3
 <p>left hand shown, worksurface height fixed 27" h to underside</p>	left hand	42"	42"	26 1/2"	AMG42L424 () () () () ()	\$1,611.	\$2,026.	\$2,330.	\$3,029.
		42"	48"	26 1/2"	AMG42L484 () () () () ()	1,677.	2,108.	2,426.	3,151.
		42"	54"	26 1/2"	AMG42L544 () () () () ()	1,743.	2,192.	2,520.	3,277.
		42"	60"	26 1/2"	AMG42L604 () () () () ()	1,808.	2,272.	2,616.	3,402.
		42"	66"	26 1/2"	AMG42L664 () () () () ()	1,873.	2,355.	2,712.	3,523.
		42"	72"	26 1/2"	AMG42L724 () () () () ()	1,938.	2,441.	2,806.	3,648.
		42"	78"	26 1/2"	AMG42L784 () () () () ()	2,005.	2,522.	2,902.	3,772.
		42"	84"	26 1/2"	AMG42L844 () () () () ()	2,071.	2,604.	2,995.	3,894.
		42"	90"	26 1/2"	AMG42L904 () () () () ()	2,136.	2,686.	3,091.	4,017.
		42"	96"	26 1/2"	AMG42L964 () () () () ()	2,202.	2,769.	3,187.	4,143.
	right hand	42"	42"	26 1/2"	AMG42R424 () () () () ()	1,611.	2,026.	2,330.	3,029.
		42"	48"	26 1/2"	AMG42R484 () () () () ()	1,677.	2,108.	2,426.	3,151.
		42"	54"	26 1/2"	AMG42R544 () () () () ()	1,743.	2,192.	2,520.	3,277.
		42"	60"	26 1/2"	AMG42R604 () () () () ()	1,808.	2,272.	2,616.	3,402.
		42"	66"	26 1/2"	AMG42R664 () () () () ()	1,873.	2,355.	2,712.	3,523.
		42"	72"	26 1/2"	AMG42R724 () () () () ()	1,938.	2,441.	2,806.	3,648.
		42"	78"	26 1/2"	AMG42R784 () () () () ()	2,005.	2,522.	2,902.	3,772.
		42"	84"	26 1/2"	AMG42R844 () () () () ()	2,071.	2,604.	2,995.	3,894.
		42"	90"	26 1/2"	AMG42R904 () () () () ()	2,136.	2,686.	3,091.	4,017.
		42"	96"	26 1/2"	AMG42R964 () () () () ()	2,202.	2,769.	3,187.	4,143.

Order Code	Specification Information	Application Notes
Example: AMG42L424GFEV316 V316613AA	To order please specify pattern number including:	Median end without gable to be attached to a storage anchored cabinet. Optional face drill option is to drill outside face of gable to attach to next median in line, if last unit in run specify no drill. Optional end drill gable option is for attachment to bridge units on page 159, specify no drill if configuration does not include bridge unit.
A AutoStrada	1. Left or Right hand <i>L = Left hand</i> <i>R = Right hand</i>	Mixed finish options applicable with V1, V2 or V3 finish surround, top shelf and worksurface front edge with laminate finish worksurface.
M Median	2. Width	Product on this page shipped knocked-down.
G Legal depth top shelf	3. Depth <i>4 = 26.5" d nominal</i> <i>5 = 32.5" d nominal</i>	
42 42" high	4. Grommet option <i>G = Grommet(s)</i> <i>N = No grommet(s)</i>	
L Left hand	5. Face drill option <i>F = face drill for attachment to next unit</i> <i>N = no drill, last unit in run</i>	
42 42" wide	6. End drill option <i>E = end drill gable to attach to bridge</i> <i>N = no drill</i>	
4 26.5" d	7. Finish, surround, top shelf & worksurface edge <i>Laminate, V1, V2 or V3 finish</i>	
G Grommet	8. Finish, worksurface <i>Laminate, V1, V2 or V3</i>	
F Face drill gable	9. Finish, Grommet(s) <i>specify painted or plated finish</i>	
E End drill gable	10. Finish, Aluminum trim <i>AA - Anodized aluminum or painted finish option from page 8 excluding silver</i>	
V316 Finish, surround, top shelf & worksurface edge	Order worksurface stiffener for unsupported spans exceeding 48".	
V316 Finish, worksurface	*42" h to top of gable; with aluminum trim and top shelf 43.2" h.	
613 Finish, grommet	*Width noted is interior nominal dimension, overall footprint additional 1" nominal.	
AA Trim, anodized aluminum	See page 8 for finish options applicable.	

Product on this page will accept wood grain laminate where laminate is currently an option.

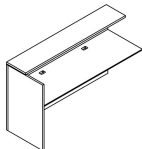
description	type	h*	w*	d	pattern no	L	M/V1 or V1	M/V2 or V2	M/V3 or V3
 <p>left hand shown, worksurface height fixed 27" h to underside</p>	left hand	42"	42"	32 1/2"	AMG42L425 () () () () ()	\$1,704.	\$2,124.	\$2,442.	\$3,173.
		42"	48"	32 1/2"	AMG42L485 () () () () ()	1,768.	2,205.	2,535.	3,294.
		42"	54"	32 1/2"	AMG42L545 () () () () ()	1,835.	2,287.	2,628.	3,417.
		42"	60"	32 1/2"	AMG42L605 () () () () ()	1,899.	2,366.	2,721.	3,541.
		42"	66"	32 1/2"	AMG42L665 () () () () ()	1,964.	2,450.	2,816.	3,660.
		42"	72"	32 1/2"	AMG42L725 () () () () ()	2,028.	2,529.	2,910.	3,781.
		42"	78"	32 1/2"	AMG42L785 () () () () ()	2,095.	2,611.	3,003.	3,906.
		42"	84"	32 1/2"	AMG42L845 () () () () ()	2,158.	2,690.	3,097.	4,027.
		42"	90"	32 1/2"	AMG42L905 () () () () ()	2,226.	2,772.	3,193.	4,148.
		42"	96"	32 1/2"	AMG42L965 () () () () ()	2,289.	2,857.	3,284.	4,273.
	right hand	42"	42"	32 1/2"	AMG42R425 () () () () ()	1,704.	2,124.	2,442.	3,173.
		42"	48"	32 1/2"	AMG42R485 () () () () ()	1,768.	2,205.	2,535.	3,294.
		42"	54"	32 1/2"	AMG42R545 () () () () ()	1,835.	2,287.	2,628.	3,417.
		42"	60"	32 1/2"	AMG42R605 () () () () ()	1,899.	2,366.	2,721.	3,541.
		42"	66"	32 1/2"	AMG42R665 () () () () ()	1,964.	2,450.	2,816.	3,660.
		42"	72"	32 1/2"	AMG42R725 () () () () ()	2,028.	2,529.	2,910.	3,781.
		42"	78"	32 1/2"	AMG42R785 () () () () ()	2,095.	2,611.	3,003.	3,906.
		42"	84"	32 1/2"	AMG42R845 () () () () ()	2,158.	2,690.	3,097.	4,027.
		42"	90"	32 1/2"	AMG42R905 () () () () ()	2,226.	2,772.	3,193.	4,148.
		42"	96"	32 1/2"	AMG42R965 () () () () ()	2,289.	2,857.	3,284.	4,273.

Order Code	Specification Information	Application Notes
Example: AMG42L425GFEV316 V316613AA	To order please specify pattern number including:	Median end without gable to be attached to a storage anchored cabinet. Optional face drill option is to drill outside face of gable to attach to next median in line, if last unit in run specify no drill. Optional end drill gable option is for attachment to bridge units on page 159, specify no drill if configuration does not include bridge unit.
A AutoStrada	1. Left or Right hand <i>L = Left hand</i> <i>R = Right hand</i>	Mixed finish options applicable with V1, V2 or V3 finish surround, top shelf and worksurface front edge with laminate finish worksurface.
M Median	2. Width	Product on this page shipped knocked-down.
G Legal depth top shelf	3. Depth <i>4 = 26.5" d nominal</i> <i>5 = 32.5" d nominal</i>	
42 42" high	4. Grommet option <i>G = Grommet(s)</i> <i>N = No grommet(s)</i>	
L Left hand	5. Face drill option <i>F = face drill for attachment to next unit</i> <i>N = no drill, last unit in run</i>	
42 42" wide	6. End drill option <i>E = end drill gable to attach to bridge</i> <i>N = no drill</i>	
5 32.5" d	7. Finish, surround, top shelf & worksurface edge <i>Laminate, V1, V2 or V3 finish</i>	
G Grommet	8. Finish, worksurface <i>Laminate, V1, V2 or V3</i>	
F Face drill gable	9. Finish, Grommet(s) <i>specify painted or plated finish</i>	
E End drill gable	10. Finish, Aluminum trim <i>AA - Anodized aluminum or painted finish option from page 8 excluding silver</i>	
V316 Finish, surround, top shelf & worksurface edge	Order worksurface stiffener for unsupported spans exceeding 48".	
V316 Finish, worksurface	*42" h to top of gable; with aluminum trim and top shelf 43.2" h.	
613 Finish, grommet	*Width noted is interior nominal dimension, overall footprint additional 1" nominal.	
AA Trim, anodized aluminum	See page 8 for finish options applicable.	

Product on this page will accept wood grain laminate where laminate is currently an option.

description	h*	w*	d	pattern no.	L	M/V1 or V1	M/V2 or V2	M/V3 or V3
Medians with double end gable 42"h x 26.5"d with binder depth top shelf	42"	60"	26.5"	AMB42E604() () () () ()	\$2,179.	\$2,780.	\$3,210.	\$4,178.
	42"	66"	26.5"	AMB42E664() () () () ()	2,243.	2,862.	3,306.	4,298.
	42"	72"	26.5"	AMB42E724() () () () ()	2,304.	2,947.	3,400.	4,418.
	42"	78"	26.5"	AMB42E784() () () () ()	2,371.	3,026.	3,493.	4,538.
	42"	84"	26.5"	AMB42E844() () () () ()	2,436.	3,106.	3,586.	4,662.
	42"	90"	26.5"	AMB42E904() () () () ()	2,500.	3,187.	3,681.	4,783.
	42"	96"	26.5"	AMB42E964() () () () ()	2,565.	3,268.	3,773.	4,904.

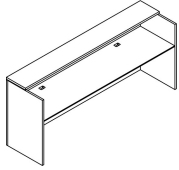

Medians with double end gable 42"h x 32.5"d with binder depth top shelf	42"	60"	32.5"	AMB42E605() () () () ()	2,293.	2,905.	3,367.	4,375.
	42"	66"	32.5"	AMB42E665() () () () ()	2,355.	2,983.	3,459.	4,495.
	42"	72"	32.5"	AMB42E725() () () () ()	2,420.	3,063.	3,550.	4,617.
	42"	78"	32.5"	AMB42E785() () () () ()	2,482.	3,143.	3,644.	4,737.
	42"	84"	32.5"	AMB42E845() () () () ()	2,549.	3,224.	3,734.	4,853.
	42"	90"	32.5"	AMB42E905() () () () ()	2,611.	3,305.	3,827.	4,975.
	42"	96"	32.5"	AMB42E965() () () () ()	2,676.	3,381.	3,919.	5,096.

Order Code	Specification Information	Application Notes
Example: AMB42E604GFNEBV316V316613AA A AutoStrada M Median B Binder depth top shelf 42 42" high E End gables, both sides 60 60" wide 4 26.5" d G Grommet FN Face drill gable, none EB End drill gable, both V316 Finish, surround, top shelf & worksurface edge V316 Finish, worksurface 613 Finish, grommet AA Trim, anodized aluminum	To order please specify pattern number including: 1. Width 2. Depth 4 = 26.5" d nominal 5 = 32.5" d nominal 3. Grommet option G = Grommet(s) N = No grommet(s) 4. Face drill option FL = face drill left gable for ganging FR = face drill right gable for ganging FN = face drill none 5. End drill option EL = end drill left gable to attach to bridge ER = end drill right gable to attach to bridge EB = end drill both gables to attach to bridges (applicable 84"w, 90"w and 96"w only) EN = no drill (for freestanding applications)	6. Finish, surround, top shelf and worksurface front edge Laminate, V1, V2 or V3 finish 7. Finish, worksurface Laminate, V1, V2 or V3 finish 8. Finish, Grommet(s) specify painted or plated finish 9. Finish, Aluminum trim AA - Anodized aluminum or painted finish option from page 8 excluding silver Order worksurface stiffener for unsupported spans exceeding 48". *42"h to top of gable; with aluminum trim and top shelf 43.2"h. *Width noted is interior nominal dimension, overall footprint additional 2" nominal. See page 8 for finish options applicable. Product on this page will accept wood grain laminate where laminate is currently an option.

Application Notes

Median with double end gables to be specified for single work station or end of run unit without storage anchored cabinet terminating work space. Optional end drill gable option is for attachment to bridge units on page 159, specify no drill if configuration does not include bridge unit.

Mixed finish options applicable with V1, V2 or V3 finish surround, top shelf and worksurface front edge with laminate finish worksurface.

Product on this page shipped knocked-down.

description	h*	w*	d	pattern no.	L	M/V1 or V1	M/V2 or V2	M/V3 or V3
Medians with double end gable 42"h x 26.5"d with legal depth top shelf	42"	60"	26.5"	AMG42E604 () () () () ()	\$2,215.	\$2,825.	\$3,263.	\$4,241.
	42"	66"	26.5"	AMG42E664 () () () () ()	2,280.	2,909.	3,359.	4,368.
	42"	72"	26.5"	AMG42E724 () () () () ()	2,344.	2,992.	3,455.	4,490.
	42"	78"	26.5"	AMG42E784 () () () () ()	2,411.	3,073.	3,547.	4,613.
	42"	84"	26.5"	AMG42E844 () () () () ()	2,476.	3,156.	3,644.	4,739.
	42"	90"	26.5"	AMG42E904 () () () () ()	2,543.	3,237.	3,738.	4,860.
	42"	96"	26.5"	AMG42E964 () () () () ()	2,608.	3,322.	3,835.	4,988.

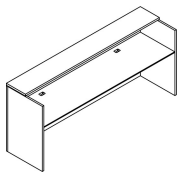

Medians with double end gable 42"h x 32.5"d with legal depth top shelf	42"	60"	32.5"	AMG42E605 () () () () ()	2,329.	2,951.	3,420.	4,446.
	42"	66"	32.5"	AMG42E665 () () () () ()	2,393.	3,032.	3,514.	4,567.
	42"	72"	32.5"	AMG42E725 () () () () ()	2,460.	3,112.	3,608.	4,691.
	42"	78"	32.5"	AMG42E785 () () () () ()	2,525.	3,197.	3,702.	4,813.
	42"	84"	32.5"	AMG42E845 () () () () ()	2,591.	3,277.	3,797.	4,934.
	42"	90"	32.5"	AMG42E905 () () () () ()	2,657.	3,357.	3,891.	5,057.
	42"	96"	32.5"	AMG42E965 () () () () ()	2,720.	3,438.	3,983.	5,177.

Medians

Order Code	Specification Information	Application Notes
Example: AMB42E604GFNEBV316 V316613AA A AutoStrada M Median B Binder depth top shelf 42 42" high E End gables, both sides 60 60" wide 4 26.5" d G Grommet FN Face drill gable, none EB End drill gable, both V316 Finish, surround, top shelf & worksurface edge V316 Finish, worksurface 613 Finish, grommet AA Trim, anodized aluminum	To order please specify pattern number including: 1. Width 2. Depth <i>4 = 26.5" d nominal</i> <i>5 = 32.5" d nominal</i> 3. Grommet option <i>G = Grommet(s)</i> <i>N = No grommet(s)</i> 4. Face drill option <i>FL = face drill left gable for ganging</i> <i>FR = face drill right gable for ganging</i> <i>FN = face drill none</i> 5. End drill option <i>EL = end drill left gable to attach to bridge</i> <i>ER = end drill right gable to attach to bridge</i> <i>EB = end drill both gables to attach to bridges (applicable 84"w, 90"w and 96"w only)</i> <i>EN = no drill (for freestanding applications)</i>	6. Finish, surround, top shelf and worksurface front edge <i>Laminate, V1, V2 or V3 finish</i> 7. Finish, worksurface <i>Laminate, V1, V2 or V3 finish</i> 8. Finish, Grommet(s) <i>specify painted or plated finish</i> 9. Finish, Aluminum trim <i>AA - Anodized aluminum or painted finish option from page 8 excluding silver</i> Order worksurface stiffener for unsupported spans exceeding 48". *42"h to top of gable; with aluminum trim and top shelf 43.2"h. *Width noted is interior nominal dimension, overall footprint additional 2" nominal. See page 8 for finish options applicable. Product on this page will accept wood grain laminate where laminate is currently an option.
		Median with double end gables to be specified for single work station or end of run unit without storage anchored cabinet terminating work space. Optional end drill gable option is for attachment to bridge units on page 159, specify no drill if configuration does not include bridge unit. Mixed finish options applicable with V1, V2 or V3 finish surround, top shelf and worksurface front edge with laminate finish worksurface. Product on this page shipped knocked-down.

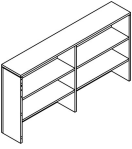
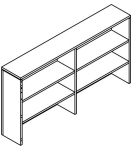
description	type	h*	w*	d	pattern no.	L	V1	V2	V3
 <p>Storage Median, 42" h w/ wood shelves</p> <p>center gable only in units 54" w and over</p>	binder depth	42"	42"	14"	ASM42WB42 () () ()	\$1,813.	\$2,286.	\$2,624.	\$3,414.
		42"	48"	14"	ASM42WB48 () () ()	1,888.	2,377.	2,733.	3,552.
		42"	54"	14"	ASM42WB54 () () ()	2,066.	2,815.	3,383.	4,398.
		42"	60"	14"	ASM42WB60 () () ()	2,144.	2,920.	3,513.	4,563.
		42"	66"	14"	ASM42WB66 () () ()	2,222.	3,027.	3,642.	4,734.
		42"	72"	14"	ASM42WB72 () () ()	2,299.	3,133.	3,767.	4,897.
		42"	78"	14"	ASM42WB78 () () ()	2,376.	3,237.	3,896.	5,066.
		42"	84"	14"	ASM42WB84 () () ()	2,456.	3,344.	4,025.	5,230.
		42"	90"	14"	ASM42WB90 () () ()	2,534.	3,449.	4,151.	5,398.
		42"	96"	14"	ASM42WB96 () () ()	2,611.	3,554.	4,280.	5,565.
 <p>Storage Median, 42" h w/ metal shelves</p> <p>center gable only in units 54" w and over</p>	binder depth	42"	42"	14"	ASM42MB42 () () ()	2,502.	3,060.	3,110.	3,733.
		42"	48"	14"	ASM42MB48 () () ()	2,604.	3,186.	3,237.	3,886.
		42"	54"	14"	ASM42MB54 () () ()	2,847.	3,484.	4,008.	4,812.
		42"	60"	14"	ASM42MB60 () () ()	2,955.	3,614.	4,160.	4,990.
		42"	66"	14"	ASM42MB66 () () ()	3,062.	3,745.	4,309.	5,174.
		42"	72"	14"	ASM42MB72 () () ()	3,168.	3,880.	4,463.	5,357.
		42"	78"	14"	ASM42MB78 () () ()	3,276.	4,008.	4,616.	5,538.
		42"	84"	14"	ASM42MB84 () () ()	3,386.	4,140.	4,767.	5,720.
		42"	90"	14"	ASM42MB90 () () ()	3,490.	4,272.	4,916.	5,902.
		42"	96"	14"	ASM42MB96 () () ()	3,599.	4,403.	5,069.	6,083.

Order Code	Specification Information	Application Notes
Example: ASM42WB42FNELV316AA	To order please specify pattern number including:	<p>Storage medians may be used in free-standing applications alone or multiple units side by side. When specifying side by side applications, be sure to select appropriate face drilling option (see specification option #4) and EN for no end drilling in gables. Storage medians may also be used with bridges on page 159 for creating L shaped work area configurations. When specifying for use with bridges, be sure to specify appropriate end drill option (see specification option #5).</p> <p>Center shelf fixed at 27" h to underside to align with bridge worksurface height and always same material as case (wood or laminate).</p> <p>Bridge units include hardware kit with washers to accommodate connection of 1" thick fixed storage median shelf to 1 1/4" thick bridge worksurface.</p> <p>Product on this page shipped knocked-down.</p>
A AutoStrada	1. Wood or Metal shelves Embedded in pattern number W = wood shelves M = metal shelves (Two piece extruded assembly) Note: shelf at worksurface height always wood	
SM Storage Median	2. Depth Embedded in pattern number B = Binder depth G = Legal depth	
42 42" high	3. Width	
W Wood shelves	4. Face drill option FL = face drill left gable for ganging FR = face drill right gable for ganging FB = face drill both gables for ganging FN = face drill none	
B Binder depth	5. End drill option EL = end drill left gable to attach to bridge ER = end drill right gable to attach to bridge EB = end drill both gables to attach to bridges (applicable 84" w, 90" w and 96" w only) EN = no drill (for freestanding applications)	
42 42" wide	6. Finish Laminate, V1, V2 or V3 finish	
FN Face drill gable, no	7. Finish, metal shelves AA - anodized aluminum or painted finish option from page 8 excluding silver	
EL End drill left gable	8. Finish, Aluminum trim AA - Anodized aluminum or painted finish option from page 8 excluding silver	
V316 Finish, Maple	*42" h to top of gables, with aluminum trim and top shelf 43.2" h. Inside width above, overall footprint additional 2" nominal.	
AA Trim, anodized aluminum	See page 8 for finish options applicable.	
	Product on this page will accept wood grain laminate where laminate is currently an option.	

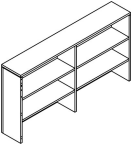
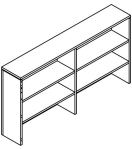
description	type	h*	w*	d	pattern no.	L	V1	V2	V3
 <p>Storage Median, 42" h w/wood shelves</p> <p>center gable only in units 54" w and over</p>	legal depth	42"	42"	17"	ASM42WG42 () () ()	\$1,908.	\$2,399.	\$2,757.	\$3,586.
		42"	48"	17"	ASM42WG48 () () ()	1,983.	2,497.	2,871.	3,733.
		42"	54"	17"	ASM42WG54 () () ()	2,171.	2,953.	3,553.	4,620.
		42"	60"	17"	ASM42WG60 () () ()	2,251.	3,065.	3,688.	4,794.
		42"	66"	17"	ASM42WG66 () () ()	2,333.	3,178.	3,822.	4,968.
		42"	72"	17"	ASM42WG72 () () ()	2,415.	3,287.	3,957.	5,143.
		42"	78"	17"	ASM42WG78 () () ()	2,497.	3,402.	4,092.	5,318.
		42"	84"	17"	ASM42WG84 () () ()	2,577.	3,512.	4,225.	5,491.
		42"	90"	17"	ASM42WG90 () () ()	2,660.	3,624.	4,359.	5,668.
		42"	96"	17"	ASM42WG96 () () ()	2,741.	3,734.	4,494.	5,845.
 <p>Storage Median, 42" h w/ metal shelves</p> <p>center gable only in units 54" w and over</p>	legal depth	42"	42"	17"	ASM42MG42 () () ()	2,628.	3,212.	3,266.	3,919.
		42"	48"	17"	ASM42MG48 () () ()	2,734.	3,348.	3,400.	4,081.
		42"	54"	17"	ASM42MG54 () () ()	2,990.	3,656.	4,209.	5,049.
		42"	60"	17"	ASM42MG60 () () ()	3,104.	3,796.	4,369.	5,241.
		42"	66"	17"	ASM42MG66 () () ()	3,215.	3,932.	4,528.	5,434.
		42"	72"	17"	ASM42MG72 () () ()	3,329.	4,070.	4,686.	5,624.
		42"	78"	17"	ASM42MG78 () () ()	3,440.	4,209.	4,846.	5,814.
		42"	84"	17"	ASM42MG84 () () ()	3,554.	4,348.	5,005.	6,005.
		42"	90"	17"	ASM42MG90 () () ()	3,665.	4,483.	5,163.	6,194.
		42"	96"	17"	ASM42MG96 () () ()	3,780.	4,622.	5,323.	6,389.

Order Code	Specification Information	Application Notes
<p>Example: ASM42WG42FNELV316AA</p> <p>A AutoStrada</p> <p>SM Storage Median</p> <p>42 42" high</p> <p>W Wood shelves</p> <p>G Legal depth</p> <p>42 42" wide</p> <p>FN Face drill gable, no</p> <p>EL End drill left gable</p> <p>V316 Finish, Maple</p> <p>AA Trim, anodized aluminum</p>	<p>To order please specify pattern number including:</p> <p>1. Wood or Metal shelves Embedded in pattern number W = wood shelves M = metal shelves (Two piece extruded assembly) Note: shelf at worksurface height always wood</p> <p>2. Depth Embedded in pattern number B = Binder depth G = Legal depth</p> <p>3. Width</p> <p>4. Face drill option FL = face drill left gable for ganging FR = face drill right gable for ganging FB = face drill both gables for ganging FN = face drill none</p> <p>5. End drill option EL = end drill left gable to attach to bridge ER = end drill right gable to attach to bridge EB = end drill both gables to attach to bridges (applicable 84" w, 90" w and 96" w only) EN = no drill (for freestanding applications)</p> <p>6. Finish Laminate, V1, V2 or V3 finish</p> <p>7. Finish, metal shelves AA - Anodized aluminum or painted finish option from page 8 excluding silver</p> <p>8. Finish, Aluminum trim AA - Anodized aluminum or painted finish option from page 8 excluding silver</p> <p>See page 8 for finish options applicable.</p> <p>*42" h to top of gables, with aluminum trim and top shelf 43.2" h. Inside width above, overall footprint additional 2" nominal.</p> <p>See page 8 for finish options applicable.</p> <p>Product on this page will accept wood grain laminate where laminate is currently an option.</p>	<p>Storage medians may be used in free-standing applications alone or multiple units side by side. When specifying side by side applications, be sure to select appropriate face drilling option (see specification option #4) and EN for no end drilling in gables. Storage medians may also be used with bridges on page 159 for creating L shaped work area configurations. When specifying for use with bridges, be sure to specify appropriate end drill option (see specification option #5).</p> <p>Center shelf fixed at 27" h to underside to align with bridge worksurface height and always same material as case (wood or laminate).</p> <p>Bridge units include hardware kit with washers to accommodate connection of 1" thick fixed storage median shelf to 1 1/4" thick bridge worksurface.</p> <p>Products on this page shipped knocked-down.</p>

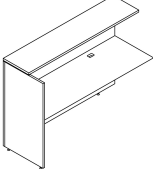
description	type	h*	w*	d	pattern no.	L	M/V1 or V1	M/V2 or V2	M/V3 or V3
 <p>left hand shown, worksurface height fixed 27" h to underside</p>	left hand	49"	42"	26 1/2"	AMBL424 () () () () () ()	\$1,659.	\$2,090.	\$2,403.	\$3,126.
		49"	48"	26 1/2"	AMBL484 () () () () () ()	1,730.	2,175.	2,501.	3,253.
		49"	54"	26 1/2"	AMBL544 () () () () () ()	1,797.	2,262.	2,601.	3,379.
		49"	60"	26 1/2"	AMBL604 () () () () () ()	1,864.	2,345.	2,700.	3,511.
		49"	66"	26 1/2"	AMBL664 () () () () () ()	1,931.	2,432.	2,797.	3,639.
		49"	72"	26 1/2"	AMBL724 () () () () () ()	2,002.	2,515.	2,896.	3,763.
		49"	78"	26 1/2"	AMBL784 () () () () () ()	2,068.	2,602.	2,993.	3,891.
		49"	84"	26 1/2"	AMBL844 () () () () () ()	2,136.	2,688.	3,091.	4,018.
		49"	90"	26 1/2"	AMBL904 () () () () () ()	2,206.	2,772.	3,190.	4,148.
		49"	96"	26 1/2"	AMBL964 () () () () () ()	2,270.	2,859.	3,286.	4,278.
			right hand	49"	42"	26 1/2"	AMBR424 () () () () () ()	1,659.	2,090.
		49"	48"	26 1/2"	AMBR484 () () () () () ()	1,730.	2,175.	2,501.	3,253.
		49"	54"	26 1/2"	AMBR544 () () () () () ()	1,797.	2,262.	2,601.	3,379.
		49"	60"	26 1/2"	AMBR604 () () () () () ()	1,864.	2,345.	2,700.	3,511.
		49"	66"	26 1/2"	AMBR664 () () () () () ()	1,931.	2,432.	2,797.	3,639.
		49"	72"	26 1/2"	AMBR724 () () () () () ()	2,002.	2,515.	2,896.	3,763.
		49"	78"	26 1/2"	AMBR784 () () () () () ()	2,068.	2,602.	2,993.	3,891.
		49"	84"	26 1/2"	AMBR844 () () () () () ()	2,136.	2,688.	3,091.	4,018.
		49"	90"	26 1/2"	AMBR904 () () () () () ()	2,206.	2,772.	3,190.	4,148.
		49"	96"	26 1/2"	AMBR964 () () () () () ()	2,270.	2,859.	3,286.	4,278.

Order Code	Specification Information	Application Notes
Example: AMBL424GFEV316 V316613AA	<i>To order please specify pattern number including:</i>	
A AutoStrada	1. Hand <i>L = Left hand R = Right hand</i>	Median end without gable to be attached to a storage anchored cabinet. Optional face drill option is to drill outside face of gable to attach to next median in line, if last unit in run specify no drill. Optional end drill gable option is for attachment to bridge units on page 159, specify no drill if configuration does not include bridge unit. Mixed finish options applicable with V1, V2 or V3 finish surround, top shelf and worksurface front edge with laminate finish worksurface. Products on this page shipped knocked-down. *49"h to top of gable; with aluminum trim and top shelf 50.2"h. *Width noted is interior nominal dimension, overall footprint additional 1" nominal. See page 8 for finish options applicable.
M Median	2. Width	
B Binder depth top shelf	3. Depth <i>4 = 26.5" d nominal 5 = 32.5" d nominal</i>	
L Left hand	4. Grommet option <i>G = Grommet(s) N = No grommet(s)</i>	
42 42" wide	5. Face drill option <i>F = face drill for attachment to next unit N = no drill, last unit in run</i>	
4 26.5" d	6. End drill option <i>E = end drill gable to attach to bridge N = no drill</i>	
G Grommet	7. Finish, surround, top shelf and worksurface front edge <i>Laminate, V1, V2 or V3 finish</i>	
F Face drill gable	8. Finish, worksurface <i>Laminate, V1, V2 or V3 finish</i>	
E End drill gable	9. Finish, Grommet(s) <i>specify painted or plated finish</i>	
V316 Finish, surround, top shelf & worksurface edge	10. Finish, Aluminum trim <i>AA - Anodized aluminum or painted finish option from page 8 excluding silver</i>	
V316 Finish, worksurface	Order worksurface stiffener for unsupported spans exceeding 48".	
613 Finish, grommet		
AA Trim, anodized aluminum		

Product on this page will accept wood grain laminate where laminate is currently an option.

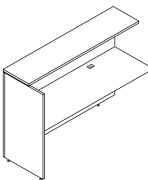
description	type	h*	w*	d	pattern no.	L	M/V1 or V1	M/V2 or V2	M/V3 or V3
 <p>left hand shown, worksurface height fixed 27" h to underside</p>	left hand	49"	42"	32 1/2"	AMBL425 () () () () () ()	\$1,758.	\$2,189.	\$2,520.	\$3,276.
		49"	48"	32 1/2"	AMBL485 () () () () () ()	1,825.	2,274.	2,616.	3,402.
		49"	54"	32 1/2"	AMBL545 () () () () () ()	1,892.	2,358.	2,714.	3,525.
		49"	60"	32 1/2"	AMBL605 () () () () () ()	1,960.	2,442.	2,811.	3,652.
		49"	66"	32 1/2"	AMBL665 () () () () () ()	2,026.	2,527.	2,907.	3,776.
		49"	72"	32 1/2"	AMBL725 () () () () () ()	2,094.	2,610.	3,003.	3,906.
		49"	78"	32 1/2"	AMBL785 () () () () () ()	2,159.	2,695.	3,101.	4,029.
		49"	84"	32 1/2"	AMBL845 () () () () () ()	2,230.	2,778.	3,197.	4,154.
		49"	90"	32 1/2"	AMBL905 () () () () () ()	2,295.	2,862.	3,293.	4,283.
		49"	96"	32 1/2"	AMBL965 () () () () () ()	2,364.	2,947.	3,392.	4,408.
			right hand	49"	42"	32 1/2"	AMBR425 () () () () () ()	1,758.	2,189.
		49"	48"	32 1/2"	AMBR485 () () () () () ()	1,825.	2,274.	2,616.	3,402.
		49"	54"	32 1/2"	AMBR545 () () () () () ()	1,892.	2,358.	2,714.	3,525.
		49"	60"	32 1/2"	AMBR605 () () () () () ()	1,960.	2,442.	2,811.	3,652.
		49"	66"	32 1/2"	AMBR665 () () () () () ()	2,026.	2,527.	2,907.	3,776.
		49"	72"	32 1/2"	AMBR725 () () () () () ()	2,094.	2,610.	3,003.	3,906.
		49"	78"	32 1/2"	AMBR785 () () () () () ()	2,159.	2,695.	3,101.	4,029.
		49"	84"	32 1/2"	AMBR845 () () () () () ()	2,230.	2,778.	3,197.	4,154.
		49"	90"	32 1/2"	AMBR905 () () () () () ()	2,295.	2,862.	3,293.	4,283.
		49"	96"	32 1/2"	AMBR965 () () () () () ()	2,364.	2,947.	3,392.	4,408.

Order Code

Example:	AMBR425GFEV316 V316613AA
A	AutoStrada
M	Median
B	Binder depth top shelf
R	Right hand
42	42" wide
5	32.5" d
G	Grommet
F	Face drill gable
E	End drill gable
V316	Finish, surround, top shelf & worksurface edge
V316	Finish, worksurface
613	Finish, grommet
AA	Trim, anodized aluminum

Specification Information

To order please specify pattern number including:

1. Hand
L = Left hand
R = Right hand
2. Width
3. Depth
4 = 26.5" d nominal
5 = 32.5" d nominal
4. Grommet option
G = Grommet(s)
N = No grommet(s)
5. Face drill option
F = face drill for attachment to next unit
N = no drill, last unit in run
6. End drill option
E = end drill gable to attach to bridge
N = no drill

7. Finish, surround, top shelf and worksurface front edge
Laminate, V1, V2 or V3 finish
8. Finish, worksurface
Laminate, V1, V2 or V3 finish
9. Finish, Grommet(s)
specify painted or plated finish
10. Finish, Aluminum trim
AA - Anodized aluminum or painted finish option from page 8 excluding silver

Order worksurface stiffener for unsupported spans exceeding 48".

*49" h to top of gable; with aluminum trim and top shelf 50.2" h.

*Width noted is interior nominal dimension, overall footprint additional 1" nominal.

See page 8 for finish options applicable.

Product on this page will accept wood grain laminate where laminate is currently an option.

Application Notes

Median end without gable to be attached to a storage anchored cabinet. Optional face drill option is to drill outside face of gable to attach to next median in line, if last unit in run specify no drill. Optional end drill gable option is for attachment to bridge units on page 159, specify no drill if configuration does not include bridge unit.

Mixed finish options applicable with V1, V2 or V3 finish surround, top shelf and worksurface front edge with laminate finish worksurface.

Product on this page shipped knocked-down.

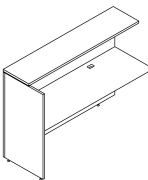
description	type	h*	w*	d	pattern no.	L	M/V1 or V1	M/V2 or V2	M/V3 or V3
 <p>left hand shown, worksurface height fixed 27" h to underside</p>	left hand	49"	42"	26 1/2"	AMGL424 () () () () () ()	\$1,695.	\$2,132.	\$2,453.	\$3,188.
		49"	48"	26 1/2"	AMGL484 () () () () () ()	1,765.	2,219.	2,552.	3,319.
		49"	54"	26 1/2"	AMGL544 () () () () () ()	1,835.	2,307.	2,651.	3,448.
		49"	60"	26 1/2"	AMGL604 () () () () () ()	1,902.	2,393.	2,754.	3,581.
		49"	66"	26 1/2"	AMGL664 () () () () () ()	1,972.	2,481.	2,853.	3,708.
		49"	72"	26 1/2"	AMGL724 () () () () () ()	2,041.	2,569.	2,954.	3,840.
		49"	78"	26 1/2"	AMGL784 () () () () () ()	2,109.	2,655.	3,053.	3,970.
		49"	84"	26 1/2"	AMGL844 () () () () () ()	2,180.	2,740.	3,152.	4,100.
		49"	90"	26 1/2"	AMGL904 () () () () () ()	2,248.	2,826.	3,254.	4,229.
		49"	96"	26 1/2"	AMGL964 () () () () () ()	2,319.	2,915.	3,355.	4,362.
	right hand	49"	42"	26 1/2"	AMGR424 () () () () () ()	1,695.	2,132.	2,453.	3,188.
		49"	48"	26 1/2"	AMGR484 () () () () () ()	1,765.	2,219.	2,552.	3,319.
		49"	54"	26 1/2"	AMGR544 () () () () () ()	1,835.	2,307.	2,651.	3,448.
		49"	60"	26 1/2"	AMGR604 () () () () () ()	1,902.	2,393.	2,754.	3,581.
		49"	66"	26 1/2"	AMGR664 () () () () () ()	1,972.	2,481.	2,853.	3,708.
		49"	72"	26 1/2"	AMGR724 () () () () () ()	2,041.	2,569.	2,954.	3,840.
		49"	78"	26 1/2"	AMGR784 () () () () () ()	2,109.	2,655.	3,053.	3,970.
		49"	84"	26 1/2"	AMGR844 () () () () () ()	2,180.	2,740.	3,152.	4,100.
		49"	90"	26 1/2"	AMGR904 () () () () () ()	2,248.	2,826.	3,254.	4,229.
		49"	96"	26 1/2"	AMGR964 () () () () () ()	2,319.	2,915.	3,355.	4,362.

Order Code	Specification Information	Application Notes
Example: AMGL424GFEV316 V316613AA	To order please specify pattern number including:	
A AutoStrada	1. Left or Right hand <i>L = Left hand</i> <i>R = Right hand</i>	Median end without gable to be attached to a storage anchored cabinet. Optional face drill option is to drill outside face of gable to attach to next median in line, if last unit in run specify no drill. Optional end drill gable option is for attachment to bridge units on page 159, specify no drill if configuration does not include bridge unit. Mixed finish options applicable with V1, V2 or V3 finish surround, top shelf and worksurface front edge with laminate finish worksurface. Product on this page shipped knocked-down. *49"h to top of gable; with aluminum trim and top shelf 50.2"h. *Width noted is interior nominal dimension, overall footprint additional 1" nominal. See page 8 for finish options applicable.
M Median	2. Width	
G Legal depth top shelf	3. Depth <i>4 = 26.5" d nominal</i> <i>5 = 32.5" d nominal</i>	
L Left hand	4. Grommet option <i>G = Grommet(s)</i> <i>N = No grommet(s)</i>	
42 42" wide	5. Face drill option <i>F = face drill for attachment to next unit</i> <i>N = no drill, last unit in run</i>	
4 26.5" d	6. End drill option <i>E = end drill gable to attach to bridge</i> <i>N = no drill</i>	
G Grommet	7. Finish, surround, top shelf & worksurface edge <i>Laminate, V1, V2 or V3 finish</i>	
F Face drill gable	8. Finish, worksurface <i>Laminate, V1, V2 or V3</i>	
E End drill gable	9. Finish, Grommet(s) <i>specify painted or plated finish</i>	
V316 Finish, surround, top shelf & worksurface edge	10. Finish, Aluminum trim <i>AA - Anodized aluminum or painted finish option from page 8 excluding silver</i>	
V316 Finish, worksurface	Order worksurface stiffener for unsupported spans exceeding 48".	
613 Finish, grommet		
AA Trim, anodized aluminum		

Product on this page will accept wood grain laminate where laminate is currently an option.

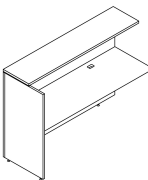
description	type	h*	w*	d	pattern no.	L	M/V1 or V1	M/V2 or V2	M/V3 or V3
 <p>left hand shown, worksurface height fixed 27" h to underside</p>	left hand	49"	42"	32 1/2"	AMGL425 () () () () () ()	\$1,794.	\$2,237.	\$2,570.	\$3,338.
		49"	48"	32 1/2"	AMGL485 () () () () () ()	1,860.	2,320.	2,668.	3,468.
		49"	54"	32 1/2"	AMGL545 () () () () () ()	1,928.	2,405.	2,766.	3,596.
		49"	60"	32 1/2"	AMGL605 () () () () () ()	2,000.	2,493.	2,864.	3,728.
		49"	66"	32 1/2"	AMGL665 () () () () () ()	2,067.	2,577.	2,964.	3,855.
		49"	72"	32 1/2"	AMGL725 () () () () () ()	2,136.	2,662.	3,062.	3,981.
		49"	78"	32 1/2"	AMGL785 () () () () () ()	2,206.	2,749.	3,164.	4,110.
		49"	84"	32 1/2"	AMGL845 () () () () () ()	2,271.	2,832.	3,261.	4,239.
		49"	90"	32 1/2"	AMGL905 () () () () () ()	2,341.	2,917.	3,361.	4,368.
		49"	96"	32 1/2"	AMGL965 () () () () () ()	2,409.	3,006.	3,459.	4,496.
	right hand	49"	42"	32 1/2"	AMGR425 () () () () () ()	1,794.	2,237.	2,570.	3,338.
		49"	48"	32 1/2"	AMGR485 () () () () () ()	1,860.	2,320.	2,668.	3,468.
		49"	54"	32 1/2"	AMGR545 () () () () () ()	1,928.	2,405.	2,766.	3,596.
		49"	60"	32 1/2"	AMGR605 () () () () () ()	2,000.	2,493.	2,864.	3,728.
		49"	66"	32 1/2"	AMGR665 () () () () () ()	2,067.	2,577.	2,964.	3,855.
		49"	72"	32 1/2"	AMGR725 () () () () () ()	2,136.	2,662.	3,062.	3,981.
		49"	78"	32 1/2"	AMGR785 () () () () () ()	2,206.	2,749.	3,164.	4,110.
		49"	84"	32 1/2"	AMGR845 () () () () () ()	2,271.	2,832.	3,261.	4,239.
		49"	90"	32 1/2"	AMGR905 () () () () () ()	2,341.	2,917.	3,361.	4,368.
		49"	96"	32 1/2"	AMGR965 () () () () () ()	2,409.	3,006.	3,459.	4,496.

Order Code	Specification Information	Application Notes
Example: AMGR425GFEV316 V316613AA	To order please specify pattern number including:	Median end without gable to be attached to a storage anchored cabinet. Optional face drill option is to drill outside face of gable to attach to next median in line, if last unit in run specify no drill. Optional end drill gable option is for attachment to bridge units on page 159, specify no drill if configuration does not include bridge unit.
A AutoStrada	1. Left or Right hand <i>L = Left hand</i> <i>R = Right hand</i>	7. Finish, surround, top shelf & worksurface edge <i>Laminate, V1, V2 or V3 finish</i>
M Median	2. Width	8. Finish, worksurface <i>Laminate, V1, V2 or V3</i>
G Legal depth top shelf	3. Depth <i>4 = 26.5" d nominal</i> <i>5 = 32.5" d nominal</i>	9. Finish, Grommet(s) <i>specify painted or plated finish</i>
R Right hand	4. Grommet option <i>G = Grommet(s)</i> <i>N = No grommet(s)</i>	10. Finish, Aluminum trim <i>AA - Anodized aluminum or painted finish option from page 8 excluding silver</i>
42 42" wide	5. Face drill option <i>F = face drill for attachment to next unit</i> <i>N = no drill, last unit in run</i>	Order worksurface stiffener for unsupported spans exceeding 48".
5 32.5" d	6. End drill option <i>E = end drill gable to attach to bridge</i> <i>N = no drill</i>	*49" h to top of gable; with aluminum trim and top shelf 50.2" h.
G Grommet		*Width noted is interior nominal dimension, overall footprint additional 1" nominal.
F Face drill gable		See page 8 for finish options applicable.
E End drill gable		Product on this page will accept wood grain laminate where laminate is currently an option.
V316 Finish, surround, top shelf & worksurface edge		
V316 Finish, worksurface		
613 Finish, grommet		
AA Trim, anodized aluminum		

Medians

description	h*	w*	d	pattern no.	L	M/V1 or V1	M/V2 or V2	M/V3 or V3
Medians with double end gable	49"	60"	26.5"	AMBE604 () () () () ()	\$2,293.	\$2,927.	\$3,379.	\$4,395.
49"h x 26.5"d with binder depth top shelf	49"	66"	26.5"	AMBE664 () () () () ()	2,362.	3,012.	3,479.	4,524.
	49"	72"	26.5"	AMBE724 () () () () ()	2,428.	3,100.	3,577.	4,651.
	49"	78"	26.5"	AMBE784 () () () () ()	2,497.	3,184.	3,677.	4,778.
	49"	84"	26.5"	AMBE844 () () () () ()	2,563.	3,270.	3,773.	4,906.
	49"	90"	26.5"	AMBE904 () () () () ()	2,631.	3,355.	3,873.	5,036.
	49"	96"	26.5"	AMBE964 () () () () ()	2,700.	3,439.	3,971.	5,162.

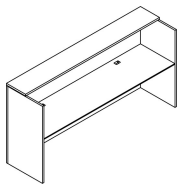

Medians with double end gable	49"	60"	32.5"	AMBE605 () () () () ()	2,414.	3,058.	3,543.	4,606.
49"h x 32.5"d with binder depth top shelf	49"	66"	32.5"	AMBE665 () () () () ()	2,479.	3,141.	3,643.	4,734.
	49"	72"	32.5"	AMBE725 () () () () ()	2,549.	3,224.	3,738.	4,857.
	49"	78"	32.5"	AMBE785 () () () () ()	2,613.	3,308.	3,836.	4,986.
	49"	84"	32.5"	AMBE845 () () () () ()	2,684.	3,394.	3,929.	5,110.
	49"	90"	32.5"	AMBE905 () () () () ()	2,748.	3,477.	4,028.	5,235.
	49"	96"	32.5"	AMBE965 () () () () ()	2,816.	3,560.	4,125.	5,365.

Order Code	Specification Information	Application Notes
Example: AMBE604GFNEBV316 V316613AA	<i>To order please specify pattern number including:</i>	
A AutoStrada	1. Width	
M Median	2. Depth	
B Binder depth top shelf	4 = 26.5" d nominal	
E End gables, both sides	5 = 32.5" d nominal	
60 60" wide	3. Grommet option	
4 26.5" d	G = Grommet(s)	
G Grommet	N = No grommet(s)	
FN Face drill gable, none	4. Face drill option	
EB End drill gable, both	FL = face drill left gable for ganging	
V316 Finish, surround, top shelf & worksurface edge	FR = face drill right gable for ganging	
	FN = face drill none	
V316 Finish, worksurface	5. End drill option	
613 Finish, grommet	EL = end drill left gable to attach to bridge	
AA Trim, anodized aluminum	ER = end drill right gable to attach to bridge	
	EB = end drill both gables to attach to bridges (applicable 84"w, 90"w and 96"w only)	
	EN = no drill (for freestanding applications)	
	6. Finish, surround, top shelf and worksurface front edge	
	Laminate, V1, V2 or V3 finish	
	7. Finish, worksurface	
	Laminate, V1, V2 or V3 finish	
	8. Finish, Grommet(s)	
	specify painted or plated finish	
	9. Finish, Aluminum trim	
	AA - Anodized aluminum or painted finish option from page 8 excluding silver	
	Order worksurface stiffener for unsupported spans exceeding 48".	
	*49"h to top of gable; with aluminum trim and top shelf 50.2"h.	
	*Width noted is interior nominal dimension, overall footprint additional 2" nominal.	
	See page 8 for finish options applicable.	
	Product on this page will accept wood grain laminate where laminate is currently an option.	
		Median with double end gables to be specified for single work station or end of run unit without storage anchored cabinet terminating work space. Optional end drill gable option is for attachment to bridge units on page 159, specify no drill if configuration does not include bridge unit.
		Mixed finish options applicable with V1, V2 or V3 finish surround, top shelf and worksurface front edge with laminate finish worksurface.
		Product on this page shipped knocked-down.

description	h*	w*	d	pattern no.	L	M/V1 or V1	M/V2 or V2	M/V3 or V3
Medians with double end gable 49"h x 26.5"d with legal depth top shelf	49"	60"	26.5"	AMGE604() () () () ()	\$2,330.	\$2,975.	\$3,435.	\$4,466.
	49"	66"	26.5"	AMGE664() () () () ()	2,400.	3,061.	3,535.	4,598.
	49"	72"	26.5"	AMGE724() () () () ()	2,469.	3,149.	3,637.	4,726.
	49"	78"	26.5"	AMGE784() () () () ()	2,539.	3,236.	3,735.	4,854.
	49"	84"	26.5"	AMGE844() () () () ()	2,607.	3,322.	3,836.	4,988.
	49"	90"	26.5"	AMGE904() () () () ()	2,676.	3,409.	3,934.	5,118.
	49"	96"	26.5"	AMGE964() () () () ()	2,744.	3,496.	4,033.	5,250.

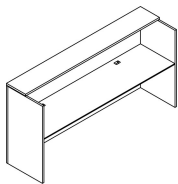

Medians with double end gable 49"h x 32.5"d with legal depth top shelf	49"	60"	32.5"	AMGE605() () () () ()	2,453.	3,106.	3,600.	4,680.
	49"	66"	32.5"	AMGE665() () () () ()	2,522.	3,191.	3,698.	4,808.
	49"	72"	32.5"	AMGE725() () () () ()	2,588.	3,277.	3,799.	4,936.
	49"	78"	32.5"	AMGE785() () () () ()	2,658.	3,364.	3,897.	5,066.
	49"	84"	32.5"	AMGE845() () () () ()	2,727.	3,448.	3,996.	5,197.
	49"	90"	32.5"	AMGE905() () () () ()	2,795.	3,533.	4,095.	5,322.
	49"	96"	32.5"	AMGE965() () () () ()	2,863.	3,619.	4,193.	5,452.

Medians

Order Code	Specification Information	Application Notes
Example: AMBE604GFNEBV316V316613AA A AutoStrada M Median B Binder depth top shelf E End gables, both sides 60 60" wide 4 26.5" d G Grommet FN Face drill gable, none EB End drill gable, both V316 Finish, surround, top shelf & worksurface edge V316 Finish, worksurface 613 Finish, grommet AA Trim, anodized aluminum	To order please specify pattern number including: 1. Width 2. Depth 4 = 26.5" d nominal 5 = 32.5" d nominal 3. Grommet option G = Grommet(s) N = No grommet(s) 4. Face drill option FL = face drill left gable for ganging FR = face drill right gable for ganging FN = face drill none 5. End drill option EL = end drill left gable to attach to bridge ER = end drill right gable to attach to bridge EB = end drill both gables to attach to bridges (applicable 84"w, 90"w and 96"w only) EN = no drill (for freestanding applications)	6. Finish, surround, top shelf and worksurface front edge Laminate, V1, V2 or V3 finish 7. Finish, worksurface Laminate, V1, V2 or V3 finish 8. Finish, Grommet(s) specify painted or plated finish 9. Finish, Aluminum trim AA - Anodized aluminum or painted finish option from page 8 excluding silver Order worksurface stiffener for unsupported spans exceeding 48". *49"h to top of gable; with aluminum trim and top shelf 50.2"h. *Width noted is interior nominal dimension, overall footprint additional 2" nominal. See page 8 for finish options applicable. Product on this page will accept wood grain laminate where laminate is currently an option.

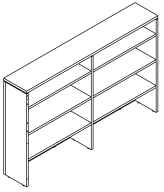
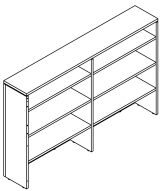
description	type	h*	w*	d	pattern no.	L	V1	V2	V3	
 <p>center gable only in units 54" w and over</p>	Storage Median, 49"h w/ wood shelves	binder depth	49"	42"	14"	ASMWB42 () () ()	\$1,911.	\$2,404.	\$2,763.	\$3,594.
			49"	48"	14"	ASMWB48 () () ()	1,990.	2,501.	2,876.	3,739.
			49"	54"	14"	ASMWB54 () () ()	2,176.	2,961.	3,562.	4,630.
			49"	60"	14"	ASMWB60 () () ()	2,257.	3,073.	3,697.	4,804.
			49"	66"	14"	ASMWB66 () () ()	2,338.	3,186.	3,834.	4,983.
			49"	72"	14"	ASMWB72 () () ()	2,420.	3,296.	3,967.	5,156.
			49"	78"	14"	ASMWB78 () () ()	2,502.	3,409.	4,102.	5,332.
			49"	84"	14"	ASMWB84 () () ()	2,584.	3,519.	4,236.	5,505.
			49"	90"	14"	ASMWB90 () () ()	2,667.	3,633.	4,371.	5,683.
			49"	96"	14"	ASMWB96 () () ()	2,748.	3,741.	4,506.	5,858.
 <p>center gable only in units 54" w and over</p>	Storage Median, 49"h w/ metal shelves	binder depth	49"	42"	14"	ASMMB42 () () ()	2,579.	3,153.	3,207.	3,848.
			49"	48"	14"	ASMMB48 () () ()	2,687.	3,282.	3,335.	4,005.
			49"	54"	14"	ASMMB54 () () ()	2,936.	3,591.	4,133.	4,961.
			49"	60"	14"	ASMMB60 () () ()	3,045.	3,728.	4,291.	5,143.
			49"	66"	14"	ASMMB66 () () ()	3,156.	3,861.	4,443.	5,334.
			49"	72"	14"	ASMMB72 () () ()	3,267.	3,999.	4,602.	5,524.
			49"	78"	14"	ASMMB78 () () ()	3,378.	4,133.	4,758.	5,709.
			49"	84"	14"	ASMMB84 () () ()	3,488.	4,269.	4,914.	5,897.
			49"	90"	14"	ASMMB90 () () ()	3,600.	4,402.	5,069.	6,082.
			49"	96"	14"	ASMMB96 () () ()	3,708.	4,541.	5,225.	6,271.

Order Code	Specification Information	Application Notes
Example: ASMWB42FNELV316AA A AutoStrada SM Storage Median W Wood shelves B Binder depth 42 42" wide FN Face drill gable, no EL End drill left gable V316 Finish, Maple AA Trim, anodized aluminum	To order please specify pattern number including: 1. Wood or Metal shelves Embedded in pattern number W = wood shelves M = metal shelves (Two piece extruded assembly) Note: shelf at worksurface height always wood 2. Depth Embedded in pattern number B = Binder depth G = Legal depth 3. Width 4. Face drill option FL = face drill left gable for ganging FR = face drill right gable for ganging FB = face drill both gables for ganging FN = face drill none	5. End drill option EL = end drill left gable to attach to bridge ER = end drill right gable to attach to bridge EB = end drill both gables to attach to bridges (applicable 84" w, 90" w and 96" w only) EN = no drill (for freestanding applications) 6. Finish Laminate, V1, V2 or V3 finish 7. Finish, metal shelves AA - anodized aluminum or painted finish option from page 8 excluding silver 8. Finish, Aluminum trim AA - Anodized aluminum or painted finish option from page 8 excluding silver See page 8 for finish options applicable. *49" h to top of gables, with aluminum trim and top shelf 50.2" h. Inside width above, overall footprint additional 2" nominal. See page 8 for finish options applicable. Product on this page will accept wood grain laminate where laminate is currently an option.

Storage medians may be used in free-standing applications alone or multiple units side by side. When specifying side by side applications, be sure to select appropriate face drilling option (see specification option #4) and EN for no end drilling in gables. Storage medians may also be used with bridges on page 159 for creating L shaped work area configurations. When specifying for use with bridges, be sure to specify appropriate end drill option (see specification option #5).

Center shelf fixed at 27" h to underside to align with bridge worksurface height and always same material as case (wood or laminate). Nominally top shelf 7 1/2" h, other two 13" h.

Bridge units include hardware kit with washers to accommodate connection of 1" thick fixed storage median shelf to 1 1/4" thick bridge worksurface.

Product on this page shipped knocked-down.

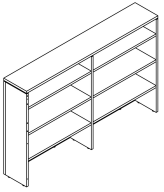
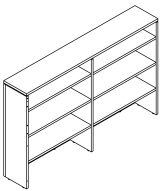
description	type	h*	w*	d	pattern no.	L	V1	V2	V3
 <p>Storage Median, 49"h w/wood shelves</p> <p>center gable only in units 54"w and over</p>	legal depth	49"	42"	17"	ASMWG42 () () ()	\$2,007.	\$2,526.	\$2,902.	\$3,773.
		49"	48"	17"	ASMWG48 () () ()	2,087.	2,627.	3,021.	3,927.
		49"	54"	17"	ASMWG54 () () ()	2,285.	3,108.	3,740.	4,862.
		49"	60"	17"	ASMWG60 () () ()	2,370.	3,226.	3,883.	5,046.
		49"	66"	17"	ASMWG66 () () ()	2,456.	3,344.	4,024.	5,230.
		49"	72"	17"	ASMWG72 () () ()	2,543.	3,463.	4,165.	5,413.
		49"	78"	17"	ASMWG78 () () ()	2,628.	3,581.	4,307.	5,598.
		49"	84"	17"	ASMWG84 () () ()	2,712.	3,696.	4,446.	5,780.
		49"	90"	17"	ASMWG90 () () ()	2,798.	3,815.	4,588.	5,966.
		49"	96"	17"	ASMWG96 () () ()	2,886.	3,929.	4,733.	6,152.
 <p>Storage Median, 49"h w/ metal shelves</p> <p>center gable only in units 54"w and over</p>	legal depth	49"	42"	17"	ASMMG42 () () ()	2,708.	3,312.	3,367.	4,042.
		49"	48"	17"	ASMMG48 () () ()	2,818.	3,448.	3,502.	4,207.
		49"	54"	17"	ASMMG54 () () ()	3,081.	3,768.	4,340.	5,206.
		49"	60"	17"	ASMMG60 () () ()	3,199.	3,913.	4,505.	5,403.
		49"	66"	17"	ASMMG66 () () ()	3,316.	4,056.	4,668.	5,600.
		49"	72"	17"	ASMMG72 () () ()	3,432.	4,195.	4,831.	5,798.
		49"	78"	17"	ASMMG78 () () ()	3,548.	4,340.	4,995.	5,994.
		49"	84"	17"	ASMMG84 () () ()	3,662.	4,481.	5,160.	6,192.
		49"	90"	17"	ASMMG90 () () ()	3,780.	4,623.	5,323.	6,387.
		49"	96"	17"	ASMMG96 () () ()	3,895.	4,766.	5,488.	6,585.

Order Code	Specification Information	Application Notes
<p>Example: ASMWG42FNELV316AA</p> <p>A AutoStrada</p> <p>SM Storage Median</p> <p>W Wood shelves</p> <p>G Legal depth</p> <p>42 42" wide</p> <p>FN Face drill gable, no</p> <p>EL End drill left gable</p> <p>V316 Finish, Maple</p> <p>AA Trim, anodized aluminum</p>	<p>To order please specify pattern number including:</p> <p>1. Wood or Metal shelves Embedded in pattern number W = wood shelves M = metal shelves (Two piece extruded assembly) Note: shelf at worksurface height always wood</p> <p>2. Depth Embedded in pattern number B = Binder depth G = Legal depth</p> <p>3. Width</p> <p>4. Face drill option FL = face drill left gable for ganging FR = face drill right gable for ganging FB = face drill both gables for ganging FN = face drill none</p> <p>5. End drill option EL = end drill left gable to attach to bridge ER = end drill right gable to attach to bridge EB = end drill both gables to attach to bridges (applicable 84"w, 90"w and 96"w only) EN = no drill (for freestanding applications)</p> <p>6. Finish Laminate, V1, V2 or V3 finish</p> <p>7. Finish, metal shelves AA - Anodized aluminum or painted finish option from page 8 excluding silver</p> <p>8. Finish, Aluminum trim AA - Anodized aluminum or painted finish option from page 8 excluding silver</p> <p>See page 8 for finish options applicable.</p> <p>*49"h to top of gables, with aluminum trim and top shelf 50.2"h. Inside width above, overall footprint additional 2" nominal.</p> <p>See page 8 for finish options applicable.</p> <p>Product on this page will accept wood grain laminate where laminate is currently an option.</p>	<p>Storage medians may be used in free-standing applications alone or multiple units side by side. When specifying side by side applications, be sure to select appropriate face drilling option (see specification option #4) and EN for no end drilling in gables. Storage medians may also be used with bridges on page 159 for creating L shaped work area configurations. When specifying for use with bridges, be sure to specify appropriate end drill option (see specification option #5).</p> <p>Center shelf fixed at 27"h to underside to align with bridge worksurface height and always same material as case (wood or laminate). Nominally top shelf 7 1/2"h, other two 13"h.</p> <p>Bridge units include hardware kit with washers to accommodate connection of 1" thick fixed storage median shelf to 1 1/4" thick bridge worksurface.</p> <p>Products on this page shipped knocked-down.</p>

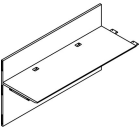
description	h	w	d	pattern no.	L	M/V1 or V1	M/V2 or V2	M/V3 or V3
 <p>worksurface height fixed 27" h to underside</p>	42"	42"	26 1/2"	AOB4242 () () () ()	\$1,047.	\$1,318.	\$1,516.	\$1,970.
	42"	48"	26 1/2"	AOB4248 () () () ()	1,089.	1,370.	1,575.	2,050.
	42"	54"	26 1/2"	AOB4254 () () () ()	1,135.	1,422.	1,640.	2,130.
	42"	60"	26 1/2"	AOB4260 () () () ()	1,175.	1,478.	1,700.	2,211.
	42"	66"	26 1/2"	AOB4266 () () () ()	1,217.	1,531.	1,763.	2,289.
	42"	72"	26 1/2"	AOB4272 () () () ()	1,261.	1,584.	1,825.	2,372.
	42"	78"	26 1/2"	AOB4278 () () () ()	1,303.	1,640.	1,884.	2,453.

Order Code	Specification Information	Application Notes
Example: AOB4242GDV316V316613	<i>To order please specify pattern number including:</i>	Overall depth is 26.5" nominal
A AutoStrada	1. Width	Product on this page shipped knocked-down.
OB Open Bridge	2. Grommet option <i>G = Grommet(s)</i> <i>N = No grommet(s)</i>	
42 42" high	3. Drill for top shelf option <i>Note: not applicable for window bridges</i> <i>D = drill for top shelf attachment</i> <i>N = no drill for top shelf attachment</i>	
42 42" wide	4. Finish, back and worksurface edge <i>Laminate, V1, V2 or V3 finish</i>	Bridge units attach one side to gable end of medians or storage medians, and other end to 26.5" deep storage anchored cabinets. Attachment method is universal, bridge units are not handed.
G Grommet	5. Finish, worksurface <i>Laminate, V1, V2 or V3 finish</i>	
D Drill for top shelf attachment	6. Finish, Grommet(s) <i>specify painted or plated finish</i>	Mixed finish options must only be combination of laminate surface with V1 or V2 or V3 back and edge.
V316 Finish, back panel & edge	Order worksurface stiffener for unsupported spans exceeding 48".	Optional top shelf for bridge assembly specified separately, refer to page 160. Be sure to specify drill for top shelf if required.
V316 Finish, worksurface	See page 8 for finish options applicable.	
613 Finish, grommet	Product on this page will accept wood grain laminate where laminate is currently an option.	

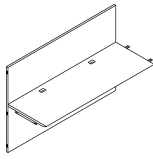
description	h	w	d	pattern no.	L	M/V1 or V1	M/V2 or V2	M/V3 or V3
 <p>Bridge assembly, 49"h includes work surface</p>	49"	42"	26 1/2"	AOBS42 () () () ()	\$1,100.	\$1,388.	\$1,595.	\$2,074.
	49"	48"	26 1/2"	AOBS48 () () () ()	1,147.	1,442.	1,659.	2,160.
	49"	54"	26 1/2"	AOBS54 () () () ()	1,191.	1,497.	1,725.	2,244.
	49"	60"	26 1/2"	AOBS60 () () () ()	1,235.	1,557.	1,790.	2,326.
	49"	66"	26 1/2"	AOBS66 () () () ()	1,282.	1,613.	1,856.	2,410.
	49"	72"	26 1/2"	AOBS72 () () () ()	1,326.	1,669.	1,920.	2,497.
	49"	78"	26 1/2"	AOBS78 () () () ()	1,371.	1,725.	1,982.	2,581.

work surface height fixed 27" h to underside

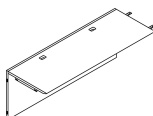
 <p>Bridge assembly, includes work surface</p>	28"	42"	26 1/2"	AWBS42 () () () ()	1,032.	1,298.	1,489.	1,937.
	28"	48"	26 1/2"	AWBS48 () () () ()	1,071.	1,348.	1,552.	2,017.
	28"	54"	26 1/2"	AWBS54 () () () ()	1,113.	1,402.	1,613.	2,095.
	28"	60"	26 1/2"	AWBS60 () () () ()	1,155.	1,456.	1,672.	2,174.
	28"	66"	26 1/2"	AWBS66 () () () ()	1,196.	1,509.	1,733.	2,251.
	28"	72"	26 1/2"	AWBS72 () () () ()	1,241.	1,560.	1,795.	2,335.
	28"	78"	26 1/2"	AWBS78 () () () ()	1,282.	1,613.	1,856.	2,410.
	28"	84"	26 1/2"	AWBS84 () () () ()	1,323.	1,667.	1,917.	2,491.
	28"	90"	26 1/2"	AWBS90 () () () ()	1,365.	1,718.	1,976.	2,570.
	28"	96"	26 1/2"	AWBS96 () () () ()	1,406.	1,771.	2,037.	2,647.

work surface height fixed 27" h to underside

Specify with window bridge kits to achieve 49" h

Order Code	Specification Information	Application Notes
Example: AOBS42GDV316V316613	To order please specify pattern number including:	Overall depth is 26.5" nominal
A AutoStrada	1. Width	Bridge units attach one side to gable end of medians or storage medians, and other end to 26.5" deep storage anchored cabinets. Attachment method is universal, bridge units are not handed.
OB Open Bridge	2. Grommet option <i>G = Grommet(s)</i> <i>N = No grommet(s)</i>	
S Single	3. Drill for top shelf option <i>Note: not applicable for window bridges</i>	Mixed finish options must only be combination of laminate surface with V1 or V2 or V3 back and edge.
42 42" wide	<i>D = drill for top shelf attachment</i> <i>N = no drill for top shelf attachment</i>	
G Grommet	4. Finish, back and work surface edge <i>Laminate, V1, V2 or V3 finish</i>	Window kit and window trim kit for window bridge assembly specified separately, refer to page 162.
D Drill for top shelf attachment	5. Finish, work surface <i>Laminate, V1, V2 or V3 finish</i>	
V316 Finish, back panel & edge	6. Finish, Grommet(s) <i>specify painted or plated finish</i>	Optional top shelf for bridge assembly specified separately, refer to page 160. Be sure to specify drill for top shelf if required.
V316 Finish, work surface	Order work surface stiffener for unsupported spans exceeding 48".	
613 Finish, grommet	See page 8 for finish options applicable.	
	Product on this page will accept wood grain laminate where laminate is currently an option.	

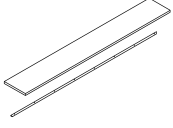

description	thickness	w	d	pattern no.	L	V1	V2	V3
Top shelf for bridge assy to median w/26.5" gable & binder depth top 	1 1/4"	54 7/16"	14"	ATSBA42 ()()	\$310.	\$394.	\$452.	\$590.
	1 1/4"	60 7/16"	14"	ATSBA48 ()()	321.	408.	469.	610.
	1 1/4"	66 7/16"	14"	ATSBA54 ()()	332.	423.	488.	636.
	1 1/4"	72 7/16"	14"	ATSBA60 ()()	349.	441.	506.	658.
	1 1/4"	78 7/16"	14"	ATSBA66 ()()	361.	456.	524.	684.
	1 1/4"	84 7/16"	14"	ATSBA72 ()()	371.	475.	542.	707.
	1 1/4"	90 7/16"	14"	ATSBA78 ()()	385.	488.	561.	730.
Top shelf for bridge assy to median w/26.5" gable & legal depth top	1 1/4"	51 7/16"	14"	ATSBB42 ()()	310.	394.	452.	590.
	1 1/4"	57 7/16"	14"	ATSBB48 ()()	321.	408.	469.	610.
	1 1/4"	63 7/16"	14"	ATSBB54 ()()	332.	423.	488.	636.
	1 1/4"	69 7/16"	14"	ATSBB60 ()()	349.	441.	506.	658.
	1 1/4"	75 7/16"	14"	ATSBB66 ()()	361.	456.	524.	684.
	1 1/4"	81 7/16"	14"	ATSBB72 ()()	371.	475.	542.	707.
	1 1/4"	87 7/16"	14"	ATSBB78 ()()	385.	488.	561.	730.
Top shelf for bridge assy to median w/32.5" gable & binder depth top	1 1/4"	60 7/16"	14"	ATSBC42 ()()	382.	487.	560.	726.
	1 1/4"	66 7/16"	14"	ATSBC48 ()()	398.	505.	583.	755.
	1 1/4"	72 7/16"	14"	ATSBC54 ()()	414.	525.	607.	784.
	1 1/4"	78 7/16"	14"	ATSBC60 ()()	432.	545.	629.	818.
	1 1/4"	84 7/16"	14"	ATSBC66 ()()	446.	565.	650.	848.
	1 1/4"	90 7/16"	14"	ATSBC72 ()()	461.	585.	673.	876.
	1 1/4"	96 7/16"	14"	ATSBC78 ()()	477.	607.	696.	906.
Top shelf for bridge assy to median w/32.5" gable & legal depth top	1 1/4"	57 7/16"	14"	ATSBD42 ()()	382.	487.	560.	726.
	1 1/4"	63 7/16"	14"	ATSBD48 ()()	398.	505.	583.	755.
	1 1/4"	69 7/16"	14"	ATSBD54 ()()	414.	525.	607.	784.
	1 1/4"	75 7/16"	14"	ATSBD60 ()()	432.	545.	629.	818.
	1 1/4"	81 7/16"	14"	ATSBD66 ()()	446.	565.	650.	848.
	1 1/4"	87 7/16"	14"	ATSBD72 ()()	461.	585.	673.	876.
	1 1/4"	93 7/16"	14"	ATSBD78 ()()	477.	607.	696.	906.
Top shelf for bridge assy to storage median	1 1/4"	42"	14"	ATSBE42 ()()	310.	394.	452.	590.
	1 1/4"	48"	14"	ATSBE48 ()()	321.	408.	469.	610.
	1 1/4"	54"	14"	ATSBE54 ()()	332.	423.	488.	636.

Order Code	Specification Information	Application Notes
Example: ATSBA42V316AA A AutoStrada TS Top Shelf B Bridge A for bridge to median condition A 42 42" wide plus condition A V316 Finish, Maple AA Trim, anodized aluminum	To order please specify pattern number including: 1. Bridge to Median condition <i>A = to 26.5" d median w/binder depth top shelf</i> <i>B = to 26.5" d median w/legal depth top shelf</i> <i>C = to 32.5" d median w/binder depth top shelf</i> <i>D = to 32.5" d median w/legal depth top shelf</i> <i>E = to storage median binder or legal depth</i> 2. Width <i>specify same as corresponding bridge assembly</i> 3. Finish, Shelf <i>Laminate, V1, V2 or V3 finish</i> 4. Finish, Aluminum trim <i>AA - Anodized aluminum or painted finish option from page 8 excluding silver</i>	See page 8 for finish options applicable. Product on this page will accept wood grain laminate where laminate is currently an option. Top shelf extends width of bridge assembly plus exposed portion of the median gable where the median gable extends beyond median's top shelf. Top shelf assembly includes aluminum trim to install between bridge assembly and underside of top shelf; and aligns with aluminum trim detail of median or storage median.

description	thickness	w	d	pattern no.	L	V1	V2	V3
Top shelf for bridge assy to storage median	1 1/4"	60"	14"	ATSBE60 () ()	\$349.	\$441.	\$506.	\$658.
	1 1/4"	66"	14"	ATSBE66 () ()	361.	456.	524.	684.
	1 1/4"	72"	14"	ATSBE72 () ()	371.	475.	542.	707.
	1 1/4"	78"	14"	ATSBE78 () ()	385.	488.	561.	730.

Order Code	Specification Information	Application Notes
Example: ATSBA42V316AA	<i>To order please specify pattern number including:</i>	See page 8 for finish options applicable.
A AutoStrada		Product on this page will accept wood grain laminate where laminate is currently an option.
TS Top Shelf		
B Bridge		Top shelf extends width of bridge assembly plus exposed portion of the median gable where the median gable extends beyond median's top shelf.
A for bridge to median condition A		
42 42" wide plus condition A		Top shelf assembly includes aluminum trim to install between bridge assembly and underside of top shelf; and aligns with aluminum trim detail of median or storage median.
V316 Finish, Maple		
AA Trim, anodized aluminum		

1. Bridge to Median condition
A = to 26.5" d median w/binder depth top shelf
B = to 26.5" d median w/legal depth top shelf
C = to 32.5" d median w/binder depth top shelf
D = to 32.5" d median w/legal depth top shelf
E = to storage median binder or legal depth
2. Width
specify same as corresponding bridge assembly
3. Finish, Shelf
Laminate, V1, V2 or V3 finish
4. Finish, Aluminum trim
AA - Anodized aluminum or painted finish option from page 8 excluding silver

description	h	w	pattern no.	clear	architectural	list
Window Bridge Kit 	21"	42"	AWBK42 () () ()	\$794.	\$957.	
	21"	48"	AWBK48 () () ()	859.	1,030.	
	21"	54"	AWBK54 () () ()	920.	1,105.	
	21"	60"	AWBK60 () () ()	982.	1,179.	
	21"	66"	AWBK66 () () ()	1,043.	1,252.	
	21"	72"	AWBK72 () () ()	1,107.	1,327.	
	21"	78"	AWBK78 () () ()	1,166.	1,402.	
	21"	84"	AWBK84 () () ()	1,230.	1,476.	
	21"	90"	AWBK90 () () ()	1,292.	1,552.	
	21"	96"	AWBK96 () () ()	1,353.	1,626.	
Median gable top trim for window to median w/26.5" gable & binder depth top		12"	AMGTTA ()			108.
	Median gable top trim for window to median w/26.5" gable & legal depth top	9"	AMGTTB ()			90.
	Median gable top trim for window to median w/32.5" gable & binder depth top	18"	AMGTTC ()			133.
Median gable top trim for window to median w/32.5" gable & legal depth top		15"	AMGTTD ()			119.

Order Code	Specification Information	Application Notes
Example: AWBK42EAAGL13AA A AutoStrada W Window BK Bridge kit 42 42" wide E Extruded Aluminum Top Trim AA Finish, window frame GL13 Finish, glass AA Finish, aluminum top trim	To order please specify pattern number including: Window bridge kit: 1. Width <i>Note: Be sure to specify window bridge kit to correspond with width of window bridge assembly</i> 2. Extruded Aluminum Top Trim profile <i>E = default</i> 3. Finish, window frame <i>Paint or Anodized Aluminum</i> 4. Finish, glass <i>TEMP - Clear, tempered</i> <i>GL6 - Block Matrix</i> <i>GL13 - Powder</i> 5. Finish, Aluminum top trim <i>AA - anodized aluminum or painted finish option from page 8 excluding silver</i>	Window bridge kits are for use with window bridge assemblies on page 159. Be sure to include median gable top trim when attaching window bridge assembly and window bridge kit to medians for the appropriate condition of median gable and top shelf. The median gable top trim is an aluminum extrusion which finishes the exposed portion of the median gable and continues a consistent aluminum trim detail from one unit to the next.

description	hand	h	w	d	pattern no.	L	V1	V2	V3
Storage anchored cabinet, BBF front, open interior side	left	42"	19"	24"	ACAL4224 () () () ()	\$3,333.	\$4,890.	\$5,308.	\$6,899.
		42"	19"	30"	ACAL4230 () () () ()	3,590.	5,169.	5,671.	7,375.
		42"	19"	26.5"	ACAL4226 () () () ()	3,462.	5,030.	5,491.	7,140.
		42"	19"	32.5"	ACAL4232 () () () ()	3,717.	5,311.	5,855.	7,611.
		49"	19"	24"	ACAL4924 () () () () ()	3,402.	4,990.	5,416.	7,042.
		49"	19"	30"	ACAL4930 () () () () ()	3,661.	5,276.	5,787.	7,526.
		49"	19"	26.5"	ACAL4926 () () () () ()	3,532.	5,133.	5,604.	7,285.
		49"	19"	32.5"	ACAL4932 () () () () ()	3,793.	5,417.	5,974.	7,766.
		left hand shown, shelf aligns with worksurface at 28 1/4" overall, or 27"h to underside	right	42"	19"	24"	ACAR4224 () () () ()	3,333.	4,890.
42"	19"			30"	ACAR4230 () () () ()	3,590.	5,169.	5,671.	7,375.
42"	19"			26.5"	ACAR4226 () () () ()	3,462.	5,030.	5,491.	7,140.
42"	19"			32.5"	ACAR4232 () () () ()	3,717.	5,311.	5,855.	7,611.
49"	19"			24"	ACAR4924 () () () () ()	3,402.	4,990.	5,416.	7,042.
49"	19"			30"	ACAR4930 () () () () ()	3,661.	5,276.	5,787.	7,526.
49"	19"			26.5"	ACAR4926 () () () () ()	3,532.	5,133.	5,604.	7,285.
49"	19"			32.5"	ACAR4932 () () () () ()	3,793.	5,417.	5,974.	7,766.

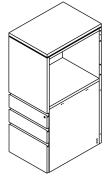

Order Code	Specification Information	Application Notes
Example: ACAL4924NEDWV316AA	To order please specify pattern number including:	*Upcharge applicable as follows for ACA(L/R)49 and ACB(L/R)49 cabinets: Option S upcharge for L/V1/V2 or V3 to correspond to shelf to match case; Option M upcharge under AA or paint for aluminum metal shelf
A AutoStrada	1. Hand L = User's Left R = User's Right	When planning with panels, single station or cluster groups where all workstations within the group are the same direction/hand, then specify 26.5" or 32.5" deep storage anchor cabinet units. When planning multi-station clusters mirroring left hand/right hand or with stations back to back with panel run perpendicular to two cabinets, you then need to specify one 24" d with one 26.5" d or 30" d with one 32.5" d cabinet to go side by side or back to back as the case may be. Brackets to secure cabinets to panel are required, specified separately - see page 178.
C Cabinet	2. Height	24" and 30" deep storage anchored cabinets may be specified for freestanding applications, specify drill option F for freestanding, otherwise connection detail will be exposed.
A BBF front, Open interior side	3. Depth 24 = 24" deep 26 = 26.5" deep 30 = 30" deep 32 = 32.5" deep	Cabinets include angle bracket to side support worksurfaces except when drill option "F" for freestanding selected.
L Left Hand	4. Shelf option for open interior side 42"h do not have shelf options 49"h have shelf option 64"h do not have "no" shelf option, shelf included N = No shelf S = Shelf to match case * M = Two piece extruded aluminum metal shelf assembly * (*upcharge applicable)	Cabinets drilled for locks, keying instructions must accompany order.
49 49" high	5. Pull E = extruded aluminum pull P = extruded aluminum protruding pull	See page 8 for finish options applicable.
24 24" deep	6. Drill option, applicable only for 24" and 30" deep units D = drilled to anchor to panel or median F = no drill, freestanding	Pencil trays not included in pedestals with metal interior.
N No Shelf	7. Interior W = wood drawer interior M = metal drawer interior, deduct \$100 list	One pencil tray is included in pedestals with wood interior.
E Extruded Aluminum Pull	8. Finish Laminate, V1, V2 or V3 finish	
D Drilled to anchor	9. Finish, Aluminum trim (trim, M shelf option & pull) AA - Anodized aluminum or painted finish option from page 8 excluding silver	
W Wood interior		
V316 Finish, Maple		
AA Finish, trim & pull, anodized aluminum		

3rd digit in pattern number indicates storage configuration, see individual pattern groups above for description.

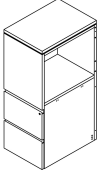
description	hand	h	w	d	pattern no.	L	V1	V2	V3
Storage anchored cabinet, FF front, open interior side 	left	42"	19"	24"	ACBL4224 () () () ()	\$2,858.	\$4,222.	\$4,685.	\$6,088.
		42"	19"	30"	ACBL4230 () () () ()	3,074.	4,461.	5,006.	6,506.
		42"	19"	26.5"	ACBL4226 () () () ()	2,965.	4,343.	4,844.	6,298.
		42"	19"	32.5"	ACBL4232 () () () ()	3,187.	4,586.	5,166.	6,717.
		49"	19"	24"	ACBL4924 () () () () ()	2,916.	4,309.	4,780.	6,215.
		49"	19"	30"	ACBL4930 () () () () ()	3,140.	4,554.	5,111.	6,640.
		49"	19"	26.5"	ACBL4926 () () () () ()	3,027.	4,430.	4,946.	6,425.
		49"	19"	32.5"	ACBL4932 () () () () ()	3,251.	4,676.	5,271.	6,853.
left hand shown, shelf aligns with worksurface at 28 1/2" h overall, or 27" h to underside	right	42"	19"	24"	ACBR4224 () () () ()	2,858.	4,222.	4,685.	6,089.
		42"	19"	30"	ACBR4230 () () () ()	3,074.	4,461.	5,006.	6,506.
		42"	19"	26.5"	ACBR4226 () () () ()	2,965.	4,343.	4,844.	6,298.
		42"	19"	32.5"	ACBR4232 () () () ()	3,187.	4,586.	5,166.	6,717.
		49"	19"	24"	ACBR4924 () () () () ()	2,916.	4,309.	4,780.	6,215.
		49"	19"	30"	ACBR4930 () () () () ()	3,140.	4,554.	5,111.	6,640.
		49"	19"	26.5"	ACBR4926 () () () () ()	3,027.	4,430.	4,946.	6,425.
		49"	19"	32.5"	ACBR4932 () () () () ()	3,251.	4,676.	5,271.	6,853.

Order Code	Specification Information	Application Notes
Example: ACAL4924NEDWV316AA	To order please specify pattern number including:	*Upcharge applicable as follows for ACA(L/R)49 and ACB(L/R)49 cabinets: Option S upcharge for L/V1/V2 or V3 to correspond to shelf to match case; Option M upcharge under AA or paint for aluminum metal shelf
A AutoStrada	1. Hand L = User's Left R = User's Right	When planning with panels, single station or cluster groups where all workstations within the group are the same direction/hand, then specify 26.5" or 32.5" deep storage anchor cabinet units. When planning multi-station clusters mirroring left hand/right hand or with stations back to back with panel run perpendicular to two cabinets, you then need to specify one 24" d with one 26.5" d or 30" d with one 32.5" d cabinet to go side by side or back to back as the case may be. Brackets to secure cabinets to panel are required, specified separately - see page 178.
C Cabinet	2. Height	24" and 30" deep storage anchored cabinets may be specified for freestanding applications, specify drill option F for freestanding, otherwise connection detail will be exposed.
A BBF front, Open interior side	3. Depth 24 = 24" deep 26 = 26.5" deep 30 = 30" deep 32 = 32.5" deep	Cabinets include angle bracket to side support worksurfaces except when drill option "F" for freestanding selected.
L Left Hand	4. Shelf option for open interior side 42" h do not have shelf options 49" h have shelf option 64" h do not have "no" shelf option, shelf included N = No shelf S = Shelf to match case * M = Two piece extruded aluminum metal shelf assembly * (*upcharge applicable)	Cabinets drilled for locks, keying instructions must accompany order.
49 49" high	5. Pull E = extruded aluminum pull P = extruded aluminum protruding pull	See page 8 for finish options applicable.
24 24" deep	6. Drill option, applicable only for 24" and 30" deep units D = drilled to anchor to panel or median F = no drill, freestanding	Pencil trays not included in pedestals with metal interior.
N No Shelf	7. Interior W = wood drawer interior M = metal drawer interior, deduct \$100 list	One pencil tray is included in pedestals with wood interior.
E Extruded Aluminum Pull	8. Finish Laminate, V1, V2 or V3 finish	
D Drilled to anchor	9. Finish, Aluminum trim (trim, M shelf option & pull) AA - Anodized aluminum or painted finish option from page 8 excluding silver	
W Wood interior		
V316 Finish, Maple		
AA Finish, trim & pull, anodized aluminum		

3rd digit in pattern number indicates storage configuration, see individual pattern groups above for description.

description	hand	h	w	d	pattern no.	L	V1	V2	V3
Storage anchored cabinet, Hinged Door front, open interior side	left	42"	19"	24"	ACCL4224 () () () ()	\$2,380.	\$3,519.	\$3,905.	\$5,072.
		42"	19"	30"	ACCL4230 () () () ()	2,563.	3,720.	4,173.	5,424.
		42"	19"	26.5"	ACCL4226 () () () ()	2,472.	3,617.	4,036.	5,251.
		42"	19"	32.5"	ACCL4232 () () () ()	2,656.	3,820.	4,306.	5,597.
		49"	19"	24"	ACCL4924 () () () ()	2,430.	3,591.	3,986.	5,175.
		49"	19"	30"	ACCL4930 () () () ()	2,615.	3,796.	4,258.	5,534.
		49"	19"	26.5"	ACCL4926 () () () ()	2,523.	3,691.	4,121.	5,357.
		49"	19"	32.5"	ACCL4932 () () () ()	2,708.	3,898.	4,392.	5,709.
left hand shown, shelf aligns with worksurface at 28 1/2" h overall, or 27" h to underside	right	42"	19"	24"	ACCR4224 () () () ()	2,380.	3,519.	3,905.	5,072.
		42"	19"	30"	ACCR4230 () () () ()	2,563.	3,720.	4,173.	5,424.
		42"	19"	26.5"	ACCR4226 () () () ()	2,472.	3,617.	4,036.	5,251.
		42"	19"	32.5"	ACCR4232 () () () ()	2,656.	3,820.	4,306.	5,597.
		49"	19"	24"	ACCR4924 () () () ()	2,430.	3,591.	3,986.	5,175.
		49"	19"	30"	ACCR4930 () () () ()	2,615.	3,796.	4,258.	5,534.
		49"	19"	26.5"	ACCR4926 () () () ()	2,523.	3,691.	4,121.	5,357.
		49"	19"	32.5"	ACCR4932 () () () ()	2,708.	3,898.	4,392.	5,709.

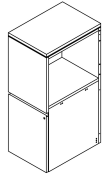

Order Code	Specification Information	Application Notes
Example: ACCL4924NEDV316AA	To order please specify pattern number including:	*Upcharge applicable as follows for ACC(L/R)49 units on this page: For option S upcharge for LV1/V2 or V3 to correspond to shelf to match case; option M upcharge under AA or paint for aluminum metal shelf
A AutoStrada	1. Hand L = User's Left R = User's Right	When planning with panels, single station or cluster groups where all workstations within the group are the same direction/hand, then specify 26.5" or 32.5" deep storage anchor cabinet units. When planning multi-station clusters mirroring left hand/right hand or with stations back to back with panel run perpendicular to two cabinets, you then need to specify one 24" d with one 26.5" d or 30" d with one 32.5" d cabinet to go side by side or back to back as the case may be. Brackets to secure cabinets to panel are required, specified separately - see page 178.
C Cabinet	2. Height	24" and 30" deep storage anchored cabinets may be specified for freestanding applications, specify drill option F for freestanding, otherwise connection detail will be exposed.
C HD front, Open interior side	3. Depth 24 = 24" deep 30 = 30" deep 26 = 26.5" deep 32 = 32.5" deep	24" and 30" deep storage anchored cabinets may be specified for freestanding applications, specify drill option F for freestanding, otherwise connection detail will be exposed.
L Left Hand	4. Shelf option for open interior side 42" h do not have shelf options 49" h have shelf option 64" h do not have "no" shelf option, shelf included N = No shelf S = Shelf to match case * M = Two piece extruded aluminum metal shelf assembly * (*upcharge applicable)	24" and 30" deep storage anchored cabinets may be specified for freestanding applications, specify drill option F for freestanding, otherwise connection detail will be exposed.
49 49" high	5. Pull E = extruded aluminum pull P = extruded aluminum protruding pull	24" and 30" deep storage anchored cabinets may be specified for freestanding applications, specify drill option F for freestanding, otherwise connection detail will be exposed.
24 24" deep	6. Drill option applicable only for 24" and 30" deep units D = drilled to anchor to panel or median F = no drill, freestanding	24" and 30" deep storage anchored cabinets may be specified for freestanding applications, specify drill option F for freestanding, otherwise connection detail will be exposed.
N No Shelf	7. Finish Laminate, V1, V2 or V3 finish	24" and 30" deep storage anchored cabinets may be specified for freestanding applications, specify drill option F for freestanding, otherwise connection detail will be exposed.
E Extruded Aluminum Pull	8. Finish, Aluminum trim (trim M shelf option & pull) AA - Anodized aluminum or painted finish option from page 8 excluding silver	24" and 30" deep storage anchored cabinets may be specified for freestanding applications, specify drill option F for freestanding, otherwise connection detail will be exposed.
D Drilled to anchor		Cabinets include angle bracket to side support worksurfaces except when drill option "F" for freestanding selected.
V316 Finish, Maple		Cabinets drilled for locks, keying instructions must accompany order.
AA Finish, trim & pull, anodized aluminum		See page 8 for finish options applicable.

3rd digit in pattern number indicates storage configuration, see individual pattern groups above for description.

description	hand	h	w	d	pattern no.	L	V1	V2	V3
Storage anchored cabinet, Hinged Door front, open side	left	49"	19"	24"	ACDL4924 () () () ()	\$2,744.	\$4,056.	\$4,501.	\$5,851.
		49"	19"	30"	ACDL4930 () () () ()	2,955.	4,289.	4,811.	6,253.
		49"	19"	26.5"	ACDL4926 () () () ()	2,848.	4,171.	4,657.	6,050.
		49"	19"	32.5"	ACDL4932 () () () ()	3,061.	4,404.	4,962.	6,453.
	right	49"	19"	24"	ACDR4924 () () () ()	2,744.	4,056.	4,501.	5,851.
		49"	19"	30"	ACDR4930 () () () ()	2,955.	4,289.	4,811.	6,253.
		49"	19"	26.5"	ACDR4926 () () () ()	2,848.	4,171.	4,657.	6,050.
		49"	19"	32.5"	ACDR4932 () () () ()	3,061.	4,404.	4,962.	6,453.

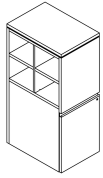

left hand shown, shelf aligns with worksurface at 28 1/4" h overall, or 27" h to underside

Order Code	Specification Information	Application Notes
Example: ACCL4924NEDV316AA	To order please specify pattern number including:	*Upcharge applicable as follows for ACC(L/R)49 units on this page: For option S upcharge for L/V1/V2 or V3 to correspond to shelf to match case; option M upcharge under AA or paint for aluminum metal shelf
A AutoStrada	1. Hand L = User's Left R = User's Right	
C Cabinet	2. Height	
C HD front, Open interior side	3. Depth	depth L V1
L Left Hand	24 = 24" deep	24" \$ 97 217
49 49" high	30 = 30" deep	26.5" \$102 223
24 24" deep	26 = 26.5" deep	30" \$107 234
N No Shelf	32 = 32.5" deep	32.5" \$113 239
E Extruded Aluminum Pull	4. Shelf option for open interior side	depth V2 V3
D Drilled to anchor	42" h do not have shelf options	24" \$240 310
V316 Finish, Maple	49" h have shelf option	26.5" \$248 321
AA Finish, trim & pull, anodized aluminum	64" h do not have "no" shelf option, shelf included	30" \$260 338
	N = No shelf	32.5" \$268 348
	S = Shelf to match case *	depth AA or paint
	M = Two piece extruded aluminum metal shelf assembly * (*upcharge applicable)	24" \$296
	5. Pull	26.5" \$317
	E = extruded aluminum pull	30" \$347
	P = extruded aluminum protruding pull	32.5" \$368
	6. Drill option	42" h - 42" h to below trim, 43.2" h overall
	applicable only for 24" and 30" deep units	49" h - 49" h to below trim, 50.2" h overall
	D = drilled to anchor to panel or median	Product on this page will accept wood grain laminate where laminate is currently an option.
	F = no drill, freestanding	When planning with medians and bridges (single station or clusters of stations) specify either 26.5" or 32.5" deep storage anchored cabinets for anchoring the median or bridge unit of the same depth. Connection method to medians, median storage or bridges incorporated into product design, no additional hardware required.
	7. Finish	
	Laminate, V1, V2 or V3 finish	
	8. Finish, Aluminum trim (trim M shelf option & pull)	
	AA - Anodized aluminum or painted finish option from page 8 excluding silver	

3rd digit in pattern number indicates storage configuration, see individual pattern groups above for description.

When planning with panels, single station or cluster groups where all workstations within the group are the same direction/hand, then specify 26.5" or 32.5" deep storage anchor cabinet units. When planning multi-station clusters mirroring left hand/right hand or with stations back to back with panel run perpendicular to two cabinets, you then need to specify one 24" d with one 26.5" d or 30" d with one 32.5" d cabinet to go side by side or back to back as the case may be. Brackets to secure cabinets to panel are required, specified separately - see page 178.

24" and 30" deep storage anchored cabinets may be specified for freestanding applications, specify drill option F for freestanding, otherwise connection detail will be exposed.

Cabinets include angle bracket to side support worksurfaces except when drill option "F" for freestanding selected.

Cabinets drilled for locks, keying instructions must accompany order.

See page 8 for finish options applicable.

description	h	w	d	pattern no.	L	V1	V2	V3
Storage anchored cabinet, wardrobe and BBF front, open interior side	42"	24"	24"	ACWJ(L/R)4224() () () ()	\$4,275.	\$6,337.	\$6,755.	\$8,784.
	42"	24"	30"	ACWJ(L/R)4230() () () ()	4,604.	6,699.	7,216.	9,393.
	42"	24"	26.5"	ACWJ(L/R)4226() () () ()	4,435.	6,520.	6,987.	9,090.
	42"	24"	32.5"	ACWJ(L/R)4232() () () ()	4,765.	6,882.	7,452.	9,690.
	49"	24"	24"	ACWJ(L/R)4924() () () () ()	4,350.	6,451.	6,881.	8,947.
	49"	24"	30"	ACWJ(L/R)4930() () () () ()	4,688.	6,823.	7,349.	9,564.
	49"	24"	26.5"	ACWJ(L/R)4926() () () () ()	4,518.	6,636.	7,118.	9,259.
	49"	24"	32.5"	ACWJ(L/R)4932() () () () ()	4,850.	7,009.	7,588.	9,870.
	64"	24"	24"	ACWJ(L/R)6424() () () () ()	4,432.	6,566.	7,078.	9,248.
	64"	24"	30"	ACWJ(L/R)6430() () () () ()	4,774.	6,942.	7,561.	9,888.
	64"	24"	26.5"	ACWJ(L/R)6426() () () () ()	4,604.	6,752.	7,322.	9,571.
	64"	24"	32.5"	ACWJ(L/R)6432() () () () ()	4,943.	7,129.	7,805.	10,202.

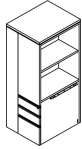

64" h left hand shown, shelf aligns with work surface at 28 1/4" overall, or 27" h to underside

Order Code	Specification Information	Application Notes
Example: ACWJL4924NEDWV316AA	To order please specify pattern number including:	*Upcharge applicable as follows
A AutoStrada	1. Hand L = User's Left R = User's Right	49" h and 64" h only: Option S upcharge for L/V1/V2 or V3 to correspond to shelf to match case
C Cabinet	2. Height	depth L V1
WJ Wardrobe/ BBF Front, Side Open	3. Depth 24 = 24" deep 26 = 26.5" deep 30 = 30" deep 32 = 32.5" deep	24" \$ 97 217 26.5" \$102 223 30" \$107 234 32.5" \$113 239
L Left Hand	4. Shelf option for open interior side 42" h do not have shelf options 49" h have shelf option 64" h do not have "no" shelf option, shelf included N = No shelf S = Shelf to match case * M = Two piece extruded aluminum metal shelf assembly * (*upcharge applicable)	depth V2 V3 24" \$240 310 26.5" \$248 321 30" \$260 338 32.5" \$268 348
49 49" high	5. Pull E = extruded aluminum pull P = extruded aluminum protruding pull	49" and 64" h: Option M upcharge under AA or paint for aluminum metal shelf
24 24" deep	6. Drill option, applicable only for 24" and 30" deep units D = drilled to anchor to panel or median F = no drill, freestanding	depth AA or paint 24" \$296 26.5" \$317 30" \$347 32.5" \$367
N No Shelf	7. Interior W = wood drawer interior M = metal drawer interior, deduct \$100 list	Product on this page will accept wood grain laminate where laminate is currently an option.
E Extruded Aluminum Pull	8. Finish Laminate, V1, V2 or V3 finish	Specify either 26.5" or 32.5" deep storage anchored cabinets for anchoring median or bridge units of the same depth. Connection method to medians, median storage or bridges incorporated into product design, no additional hardware required.
D Drilled to anchor	9. Finish, Aluminum trim (trim, M shelf option & pull) AA - Anodized aluminum or painted finish option from page 8 excluding silver	When planning with panels, single station or cluster groups where all workstations within the group are the same direction/hand, then specify 26.5" or 32.5" deep storage anchor cabinet units. When planning multi-station clusters mirroring left hand/right hand or with stations back to back with panel run perpendicular to two cabinets, you then need to specify one 24" d with one 26.5" d or 30" d with one 32.5" d cabinet to go side by side or back to back as the case may be. Brackets to secure cabinets to panel are required, specified separately - see page 178.
W Wood interior		24" and 30" deep storage anchored cabinets may be specified for freestanding applications, specify drill option F for freestanding, otherwise connection detail will be exposed.
V316 Finish, Maple		Cabinets include angle bracket to side support work surfaces except when drill option "F" for freestanding selected.
AA Finish, trim & pull, anodized aluminum		Cabinets drilled for locks, keying instructions must accompany order.
		See page 8 for finish options applicable.

3rd and 4th digit in pattern number indicates storage configuration, see individual pattern groups above for description.

description	h	w	d	pattern no.	L	V1	V2	V3
Storage anchored cabinet, wardrobe and FF front, open interior side	42"	24"	24"	ACWK(L/R)4224() () () ()	\$3,797.	\$5,666.	\$6,133.	\$7,975.
	42"	24"	30"	ACWK(L/R)4230() () () ()	4,090.	5,995.	6,554.	8,523.
	42"	24"	26.5"	ACWK(L/R)4226() () () ()	3,943.	5,829.	6,343.	8,252.
	42"	24"	32.5"	ACWK(L/R)4232() () () ()	4,235.	6,155.	6,761.	8,795.
	49"	24"	24"	ACWK(L/R)4924() () () ()	3,875.	5,785.	6,259.	8,135.
	49"	24"	30"	ACWK(L/R)4930() () () ()	4,173.	6,116.	6,686.	8,695.
	49"	24"	26.5"	ACWK(L/R)4926() () () ()	4,023.	5,951.	6,472.	8,417.
	49"	24"	32.5"	ACWK(L/R)4932() () () ()	4,321.	6,281.	6,899.	8,976.
	64"	24"	24"	ACWK(L/R)6424() () () ()	3,956.	5,897.	6,453.	8,439.
	64"	24"	30"	ACWK(L/R)6430() () () ()	4,260.	6,235.	6,895.	9,019.
	64"	24"	26.5"	ACWK(L/R)6426() () () ()	4,107.	6,066.	6,675.	8,731.
	64"	24"	32.5"	ACWK(L/R)6432() () () ()	4,413.	6,402.	7,117.	9,307.

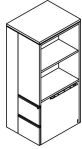

64" h left hand shown, shelf aligns with work surface at 28 1/8" overall, or 27" h to underside

Order Code	Specification Information	Application Notes
Example: ACWKL4924NEDWV316AA	To order please specify pattern number including:	*Upcharge applicable as follows
A AutoStrada	1. Hand L = User's Left R = User's Right	49" h and 64" h only: Option S upcharge for L/V1/V2 or V3 to correspond to shelf to match case
C Cabinet	2. Height	depth L V1
WK Wardrobe/FF front, side open	3. Depth 24 = 24" deep 26 = 26.5" deep 30 = 30" deep 32 = 32.5" deep	24" \$ 95 212 26.5" \$100 218 30" \$104 229 32.5" \$110 234
L Left Hand	4. Shelf option for open interior side 42" h do not have shelf options 49" h have shelf option 64" h do not have "no" shelf option, shelf included N = No shelf S = Shelf to match case * M = Two piece extruded aluminum metal shelf assembly * (*upcharge applicable)	depth V2 V3 24" \$235 303 26.5" \$243 314 30" \$254 331 32.5" \$262 341
49 49" high	5. Pull E = extruded aluminum pull P = extruded aluminum protruding pull	49" and 64" h: Option M upcharge under AA or paint for aluminum metal shelf
24 24" deep	6. Drill option, applicable only for 24" and 30" deep units D = drilled to anchor to panel or median F = no drill, freestanding	depth AA or paint 24" \$290 26.5" \$310 30" \$340 32.5" \$359
N No Shelf	7. Interior W = wood drawer interior M = metal drawer interior, deduct \$100 list	Specify either 26.5" or 32.5" deep storage anchored cabinets for anchoring median or bridge units of the same depth. Connection method to medians, median storage or bridges incorporated into product design, no additional hardware required.
E Extruded Aluminum Pull	8. Finish Laminate, V1, V2 or V3 finish	When planning with panels, single station or cluster groups where all workstations within the group are the same direction/hand, then specify 26.5" or 32.5" deep storage anchor cabinet units. When planning multi-station clusters mirroring left hand/right hand or with stations back to back with panel run perpendicular to two cabinets, you then need to specify one 24" d with one 26.5" d or 30" d with one 32.5" d cabinet to go side by side or back to back as the case may be. Brackets to secure cabinets to panel are required, specified separately - see page 178.
D Drilled to anchor	9. Finish, Aluminum trim (trim, M shelf option & pull) AA - Anodized aluminum or painted finish option from page 8 excluding silver	24" and 30" deep storage anchored cabinets may be specified for freestanding applications, specify drill option F for freestanding, otherwise connection detail will be exposed.
W Wood interior		Cabinets include angle bracket to side support work surfaces except when drill option "F" for freestanding selected.
V316 Finish, Maple		Cabinets drilled for locks, keying instructions must accompany order.
AA Finish, trim & pull, anodized aluminum		See page 8 for finish options applicable.

3rd and 4th digit in pattern number indicates storage configuration, see individual pattern groups above for description.

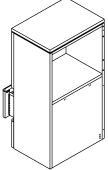
description	hand	h	w	d	pattern no.	L	V1	V2	V3
Storage anchored cabinet, FF lower front, open interior back 	49"h left	49"	24"	19"	ACEL4924 () () () ()	\$2,993.	\$4,421.	\$4,818.	\$6,265.
		49"	30"	19"	ACEL4930 () () () ()	3,224.	4,673.	5,150.	6,693.
		49"	26.5"	19"	ACEL4926 () () () ()	3,109.	4,547.	4,985.	6,481.
		49"	32.5"	19"	ACEL4932 () () () ()	3,335.	4,801.	5,314.	6,909.
	49"h right	49"	24"	19"	ACER4924 () () () ()	2,993.	4,421.	4,818.	6,265.
		49"	30"	19"	ACER4930 () () () ()	3,224.	4,673.	5,150.	6,693.
		49"	26.5"	19"	ACER4926 () () () ()	3,109.	4,547.	4,985.	6,481.
		49"	32.5"	19"	ACER4932 () () () ()	3,335.	4,801.	5,314.	6,909.
	64"h left	64"	24"	19"	ACEL6424 () () () ()	3,292.	4,862.	5,301.	6,891.
		64"	30"	19"	ACEL6430 () () () ()	3,545.	5,139.	5,662.	7,364.
		64"	26.5"	19"	ACEL6426 () () () ()	3,417.	5,003.	5,483.	7,126.
		64"	32.5"	19"	ACEL6432 () () () ()	3,668.	5,279.	5,847.	7,602.
	64"h right	64"	24"	19"	ACER6424 () () () ()	3,292.	4,862.	5,301.	6,891.
		64"	30"	19"	ACER6430 () () () ()	3,545.	5,139.	5,662.	7,364.

left hand shown, shelf aligns with worksurface at 28 1/4" h overall, or 27" h to underside

Order Code	Specification Information	Application Notes
Example: ACEL4924SEWV316AA	To order please specify pattern number including:	See page 8 for finish options applicable.
A AutoStrada	6. Drawer Interior applicable ACE(L/R) and ACI(L/R) only	Product on this page will accept wood grain laminate where laminate is currently an option.
C Cabinet	7. Finish Laminate, V1, V2 or V3 finish	When planning with medians and bridges (single station or clusters of stations) specify 49"h cabinets in either 26.5" or 32.5" deep storage anchored cabinets for anchoring the median or bridge unit of the same depth.
E File/File lower front, Interior back open shelf	8. Finish, Aluminum trim (trim, M shelf option & pull) AA - Anodized aluminum or painted finish option from page 8 excluding silver	When planning with panels, single station or cluster groups where all workstations within the group are the same direction/hand, then specify 26.5" or 32.5" deep storage anchor cabinet units. When planning multi-station clusters mirroring left hand/right hand or back to back stations with panel run perpendicular to two cabinets, you then need to specify one 24"d with one 26.5"d or 30"d with one 32.5" d cabinet to go side by side or back to back as the case may be.
L Left Hand	1. Hand L = User's Left R = User's Right	Cabinets with front and back access not to be used in freestanding applications.
49 49" high	2. Height 49 = 49"h (for use with medians, bridges or panels, 49"h to below trim, 50.2"h overall) 64 = 64"h (for use with panels 64"h to below trim, 65.2"h overall)	Cabinet to panel attachment brackets required, see page 178.
24 24" deep	3. Depth 24 = 24" deep (use with 26.5"d unit for side by side cabinet application with panels) 30 = 30" deep (use with 32.5"d unit for side by side cabinet application with panels) 26 = 26.5" deep (use with medians, bridges & panels) 32 = 32.5" deep (use with medians, bridges & panels)	Cabinets include angle bracket to side support worksurfaces. Cabinets drilled for locks, keying instructions must accompany order.
S w/shelf to match cabinet case	4. Shelf option for open interior side 42"h do not have shelf options 49"h have shelf option 64"h do not have "no" shelf option, shelf included N = No shelf S = Shelf to match case * M = Two piece extruded aluminum metal shelf assembly * (*upcharge applicable)	File drawers in cabinet styles prefixed ACIL and ACIR do not accommodate legal filing side to side.
E Extruded Aluminum Pull	5. Pull E = extruded aluminum pull P = extruded aluminum protruding pull	
W Wood interior		
V316 Finish, Maple		
AA Finish, trim & pull, anodized aluminum		

3rd digit in pattern number indicates storage configuration, see individual pattern groups above for description.

depth	L	V1
24"	\$ 97	217
26.5"	\$102	223
30"	\$107	235
32.5"	\$113	239
depth	V2	V3
24"	\$240	310
26.5"	\$248	321
30"	\$260	338
32.5"	\$268	348
depth	AA or paint	
24"	\$296	
26.5"	\$317	
30"	\$347	
32.5"	\$368	

description	hand	h	w	d	pattern no.	L	V1	V2	V3
Storage anchored cabinet, FF lower front, open interior back	64"h right	64"	26.5"	19"	ACER6426 (X)(X)(X)(X)	\$3,417.	\$5,003.	\$5,483.	\$7,126.
		64"	32.5"	19"	ACER6432 (X)(X)(X)(X)	3,668.	5,279.	5,847.	7,602.

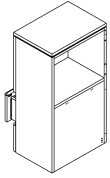

left hand shown, shelf aligns with work surface at 28 1/4" h overall, or 27" h to underside

Order Code	Specification Information	Application Notes																																													
Example: ACEL4924SEWV316AA	To order please specify pattern number including:	See page 8 for finish options applicable.																																													
A AutoStrada																																															
C Cabinet																																															
E File/File lower front, Interior back open shelf		Product on this page will accept wood grain laminate where laminate is currently an option.																																													
L Left Hand																																															
49 49" high																																															
24 24" deep																																															
S w/shelf to match cabinet case																																															
E Extruded Aluminum Pull																																															
W Wood interior																																															
V316 Finish, Maple																																															
AA Finish, trim & pull, anodized aluminum																																															
	<p>1. Hand L = User's Left R = User's Right</p> <p>2. Height 49 = 49" h (for use with medians, bridges or panels, 49" h to below trim, 50.2" h overall) 64 = 64" h (for use with panels 64" h to below trim, 65.2" h overall)</p> <p>3. Depth 24 = 24" deep (use with 26.5" d unit for side by side cabinet application with panels) 30 = 30" deep (use with 32.5" d unit for side by side cabinet application with panels) 26 = 26.5" deep (use with medians, bridges & panels) 32 = 32.5" deep (use with medians, bridges & panels)</p> <p>4. Shelf option for open interior side 42" h do not have shelf options 49" h have shelf option 64" h do not have "no" shelf option, shelf included N = No shelf S = Shelf to match case * M = Two piece extruded aluminum metal shelf assembly * (*upcharge applicable)</p> <p>5. Pull E = extruded aluminum pull P = extruded aluminum protruding pull</p> <p>6. Drawer Interior applicable ACE(L/R) and ACI(L/R) only W = wood interior M = metal drawer interior, deduct \$100 list</p> <p>7. Finish Laminate, V1, V2 or V3 finish</p> <p>8. Finish, Aluminum trim (trim, M shelf option & pull) AA - Anodized aluminum or painted finish option from page 8 excluding silver</p> <p>Connection method to medians, median storage or bridges incorporated into product design, no additional hardware required.</p> <p>64" h cabinets include shelf to match case in price list above. Upcharge below applicable as follows for 49" h shelf to match case for L/V1/V2/V3 or AA or paint for aluminum metal shelf for M option for both 49" h and 64" h cabinets.</p> <table border="1"> <tr> <td>depth</td> <td>L</td> <td>V1</td> </tr> <tr> <td>24"</td> <td>\$ 97</td> <td>217</td> </tr> <tr> <td>26.5"</td> <td>\$102</td> <td>223</td> </tr> <tr> <td>30"</td> <td>\$107</td> <td>235</td> </tr> <tr> <td>32.5"</td> <td>\$113</td> <td>239</td> </tr> <tr> <td>depth</td> <td>V2</td> <td>V3</td> </tr> <tr> <td>24"</td> <td>\$240</td> <td>310</td> </tr> <tr> <td>26.5"</td> <td>\$248</td> <td>321</td> </tr> <tr> <td>30"</td> <td>\$260</td> <td>338</td> </tr> <tr> <td>32.5"</td> <td>\$268</td> <td>348</td> </tr> <tr> <td>depth</td> <td>AA or paint</td> <td></td> </tr> <tr> <td>24"</td> <td>\$296</td> <td></td> </tr> <tr> <td>26.5"</td> <td>\$317</td> <td></td> </tr> <tr> <td>30"</td> <td>\$347</td> <td></td> </tr> <tr> <td>32.5"</td> <td>\$368</td> <td></td> </tr> </table>	depth	L	V1	24"	\$ 97	217	26.5"	\$102	223	30"	\$107	235	32.5"	\$113	239	depth	V2	V3	24"	\$240	310	26.5"	\$248	321	30"	\$260	338	32.5"	\$268	348	depth	AA or paint		24"	\$296		26.5"	\$317		30"	\$347		32.5"	\$368		<p>When planning with medians and bridges (single station or clusters of stations) specify 49" h cabinets in either 26.5" or 32.5" deep storage anchored cabinets for anchoring the median or bridge unit of the same depth.</p> <p>When planning with panels, single station or cluster groups where all workstations within the group are the same direction/hand, then specify 26.5" or 32.5" deep storage anchor cabinet units. When planning multi-station clusters mirroring left hand/right hand or back to back stations with panel run perpendicular to two cabinets, you then need to specify one 24" d with one 26.5" d or 30" d with one 32.5" d cabinet to go side by side or back to back as the case may be.</p> <p>Cabinets with front and back access not to be used in freestanding applications.</p> <p>Cabinet to panel attachment brackets required, see page 178.</p> <p>Cabinets include angle bracket to side support work surfaces. Cabinets drilled for locks, keying instructions must accompany order.</p> <p>File drawers in cabinet styles prefixed ACIL and ACIR do not accommodate legal filing side to side.</p>
depth	L	V1																																													
24"	\$ 97	217																																													
26.5"	\$102	223																																													
30"	\$107	235																																													
32.5"	\$113	239																																													
depth	V2	V3																																													
24"	\$240	310																																													
26.5"	\$248	321																																													
30"	\$260	338																																													
32.5"	\$268	348																																													
depth	AA or paint																																														
24"	\$296																																														
26.5"	\$317																																														
30"	\$347																																														
32.5"	\$368																																														

3rd digit in pattern number indicates storage configuration, see individual pattern groups above for description.

description	hand	h	w	d	pattern no.	L	V1	V2	V3
Storage anchored cabinet, HD lower front, open interior back	49"h left	49"	24"	19"	ACFL4924 () () ()	\$2,650.	\$3,837.	\$4,341.	\$5,645.
		49"	30"	19"	ACFL4930 () () ()	2,850.	4,053.	4,641.	6,030.
		49"	26.5"	19"	ACFL4926 () () ()	2,750.	3,945.	4,492.	5,838.
		49"	32.5"	19"	ACFL4932 () () ()	2,953.	4,166.	4,791.	6,225.
	49"h right	49"	24"	19"	ACFR4924 () () ()	2,650.	3,837.	4,341.	5,645.
		49"	30"	19"	ACFR4930 () () ()	2,850.	4,053.	4,641.	6,030.
		49"	26.5"	19"	ACFR4926 () () ()	2,750.	3,945.	4,492.	5,838.
		49"	32.5"	19"	ACFR4932 () () ()	2,953.	4,166.	4,791.	6,225.
	64"h left	64"	24"	19"	ACFL6424 () () ()	2,914.	4,221.	4,774.	6,205.
		64"	30"	19"	ACFL6430 () () ()	3,138.	4,461.	5,100.	6,636.
		64"	26.5"	19"	ACFL6426 () () ()	3,024.	4,339.	4,939.	6,421.
		64"	32.5"	19"	ACFL6432 () () ()	3,247.	4,581.	5,269.	6,847.
64"h right	64"	24"	19"	ACFR6424 () () ()	2,914.	4,221.	4,774.	6,205.	
	64"	30"	19"	ACFR6430 () () ()	3,138.	4,461.	5,100.	6,636.	

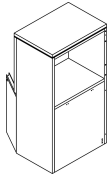

left hand shown, shelf aligns with worksurface at 28 1/4" h overall, or 27" h to underside

Order Code	Specification Information	Application Notes																																													
<p>Example: ACEL4924SEWV316AA</p> <p>A AutoStrada</p> <p>C Cabinet</p> <p>E File/File lower front, Interior back open shelf</p> <p>L Left Hand</p> <p>49 49" high</p> <p>24 24" deep</p> <p>S w/shelf to match cabinet case</p> <p>E Extruded Aluminum Pull</p> <p>W Wood interior</p> <p>V316 Finish, Maple</p> <p>AA Finish, trim & pull, anodized aluminum</p>	<p>To order please specify pattern number including:</p> <p>1. Hand L = User's Left R = User's Right</p> <p>2. Height 49 = 49"h (for use with medians, bridges or panels, 49"h to below trim, 50.2"h overall) 64 = 64"h (for use with panels 64"h to below trim, 65.2"h overall)</p> <p>3. Depth 24 = 24" deep (use with 26.5" d unit for side by side cabinet application with panels) 30 = 30" deep (use with 32.5" d unit for side by side cabinet application with panels) 26 = 26.5" deep (use with medians, bridges & panels) 32 = 32.5" deep (use with medians, bridges & panels)</p> <p>4. Shelf option for open interior side 42"h do not have shelf options 49"h have shelf option 64"h do not have "no" shelf option, shelf included N = No shelf S = Shelf to match case * M = Two piece extruded aluminum metal shelf assembly * (*upcharge applicable)</p> <p>5. Pull E = extruded aluminum pull P = extruded aluminum protruding pull</p> <p>6. Drawer Interior applicable ACE(L/R) and ACI(L/R) only W = wood interior M = metal drawer interior, deduct \$100 list</p> <p>7. Finish Laminate, V1, V2 or V3 finish</p> <p>8. Finish, Aluminum trim (trim, M shelf option & pull) AA - Anodized aluminum or painted finish option from page 8 excluding silver</p> <p>Connection method to medians, median storage or bridges incorporated into product design, no additional hardware required.</p> <p>64"h cabinets include shelf to match case in price list above. Upcharge below applicable as follows for 49"h shelf to match case for L/V1/V2/V3 or AA or paint for aluminum metal shelf for M option for both 49"h and 64"h cabinets.</p> <table border="1"> <tr> <td>depth</td> <td>L</td> <td>V1</td> </tr> <tr> <td>24"</td> <td>\$ 97</td> <td>217</td> </tr> <tr> <td>26.5"</td> <td>\$102</td> <td>223</td> </tr> <tr> <td>30"</td> <td>\$107</td> <td>235</td> </tr> <tr> <td>32.5"</td> <td>\$113</td> <td>239</td> </tr> <tr> <td>depth</td> <td>V2</td> <td>V3</td> </tr> <tr> <td>24"</td> <td>\$240</td> <td>310</td> </tr> <tr> <td>26.5"</td> <td>\$248</td> <td>321</td> </tr> <tr> <td>30"</td> <td>\$260</td> <td>338</td> </tr> <tr> <td>32.5"</td> <td>\$268</td> <td>348</td> </tr> <tr> <td>depth</td> <td>AA or paint</td> <td></td> </tr> <tr> <td>24"</td> <td>\$296</td> <td></td> </tr> <tr> <td>26.5"</td> <td>\$317</td> <td></td> </tr> <tr> <td>30"</td> <td>\$347</td> <td></td> </tr> <tr> <td>32.5"</td> <td>\$368</td> <td></td> </tr> </table>	depth	L	V1	24"	\$ 97	217	26.5"	\$102	223	30"	\$107	235	32.5"	\$113	239	depth	V2	V3	24"	\$240	310	26.5"	\$248	321	30"	\$260	338	32.5"	\$268	348	depth	AA or paint		24"	\$296		26.5"	\$317		30"	\$347		32.5"	\$368		<p>See page 8 for finish options applicable.</p> <p>Product on this page will accept wood grain laminate where laminate is currently an option.</p> <p>When planning with medians and bridges (single station or clusters of stations) specify 49"h cabinets in either 26.5" or 32.5" deep storage anchored cabinets for anchoring the median or bridge unit of the same depth.</p> <p>When planning with panels, single station or cluster groups where all workstations within the group are the same direction/hand, then specify 26.5" or 32.5" deep storage anchor cabinet units. When planning multi-station clusters mirroring left hand/right hand or back to back stations with panel run perpendicular to two cabinets, you then need to specify one 24" d with one 26.5" d or 30" d with one 32.5" d cabinet to go side by side or back to back as the case may be.</p> <p>Cabinets with front and back access not to be used in freestanding applications.</p> <p>Cabinet to panel attachment brackets required, see page 178.</p> <p>Cabinets include angle bracket to side support worksurfaces. Cabinets drilled for locks, keying instructions must accompany order.</p> <p>File drawers in cabinet styles prefixed ACIL and ACIR do not accommodate legal filing side to side.</p>
depth	L	V1																																													
24"	\$ 97	217																																													
26.5"	\$102	223																																													
30"	\$107	235																																													
32.5"	\$113	239																																													
depth	V2	V3																																													
24"	\$240	310																																													
26.5"	\$248	321																																													
30"	\$260	338																																													
32.5"	\$268	348																																													
depth	AA or paint																																														
24"	\$296																																														
26.5"	\$317																																														
30"	\$347																																														
32.5"	\$368																																														

3rd digit in pattern number indicates storage configuration, see individual pattern groups above for description.

description	hand	h	w	d	pattern no.	L	V1	V2	V3
Storage anchored cabinet, HD lower front, open interior back	64" h right	64"	26.5"	19"	ACFR6426 () () ()	\$3,024.	\$4,339.	\$4,939.	\$6,421.
		64"	32.5"	19"	ACFR6432 () () ()	3,247.	4,581.	5,269.	6,847.

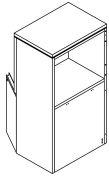

left hand shown, shelf aligns with worksurface at 28 1/4" h overall, or 27" h to underside

Order Code	Specification Information	Application Notes
Example: ACEL4924SEWV316AA	To order please specify pattern number including:	See page 8 for finish options applicable.
A AutoStrada		
C Cabinet		
E File/File lower front, Interior back open shelf		Product on this page will accept wood grain laminate where laminate is currently an option.
L Left Hand		
49 49" high		When planning with medians and bridges (single station or clusters of stations) specify 49" h cabinets in either 26.5" or 32.5" deep storage anchored cabinets for anchoring the median or bridge unit of the same depth.
24 24" deep		
S w/shelf to match cabinet case		
E Extruded Aluminum Pull		
W Wood interior		When planning with panels, single station or cluster groups where all workstations within the group are the same direction/hand, then specify 26.5" or 32.5" deep storage anchor cabinet units. When planning multi-station clusters mirroring left hand/right hand or back to back stations with panel run perpendicular to two cabinets, you then need to specify one 24" d with one 26.5" d or 30" d with one 32.5" d cabinet to go side by side or back to back as the case may be.
V316 Finish, Maple		
AA Finish, trim & pull, anodized aluminum		Cabinets with front and back access not to be used in freestanding applications.
	1. Hand L = User's Left R = User's Right	
	2. Height 49 = 49" h (for use with medians, bridges or panels, 49" h to below trim, 50.2" h overall) 64 = 64" h (for use with panels 64" h to below trim, 65.2" h overall)	
	3. Depth 24 = 24" deep (use with 26.5" d unit for side by side cabinet application with panels) 30 = 30" deep (use with 32.5" d unit for side by side cabinet application with panels) 26 = 26.5" deep (use with medians, bridges & panels) 32 = 32.5" deep (use with medians, bridges & panels)	
	4. Shelf option for open interior side 42" h do not have shelf options 49" h have shelf option 64" h do not have "no" shelf option, shelf included N = No shelf S = Shelf to match case * M = Two piece extruded aluminum metal shelf assembly * (*upcharge applicable)	
	5. Pull E = extruded aluminum pull P = extruded aluminum protruding pull	
	6. Drawer Interior applicable ACE(L/R) and ACI(L/R) only W = wood interior M = metal drawer interior, deduct \$100 list	
	7. Finish Laminate, V1, V2 or V3 finish	
	8. Finish, Aluminum trim (trim, M shelf option & pull) AA - Anodized aluminum or painted finish option from page 8 excluding silver	
	Connection method to medians, median storage or bridges incorporated into product design, no additional hardware required.	
	64" h cabinets include shelf to match case in price list above. Upcharge below applicable as follows for 49" h shelf to match case for L/V1/V2/V3 or AA or paint for aluminum metal shelf for M option for both 49" h and 64" h cabinets.	
	depth L V1	
	24" \$ 97 217	
	26.5" \$102 223	
	30" \$107 235	
	32.5" \$113 239	
	depth V2 V3	
	24" \$240 310	
	26.5" \$248 321	
	30" \$260 338	
	32.5" \$268 348	
	depth AA or paint	
	24" \$296	
	26.5" \$317	
	30" \$347	
	32.5" \$368	
		Cabinets to panel attachment brackets required, see page 178.
		Cabinets include angle bracket to side support worksurfaces. Cabinets drilled for locks, keying instructions must accompany order.
		File drawers in cabinet styles prefixed ACIL and ACIR do not accommodate legal filing side to side.

3rd digit in pattern number indicates storage configuration, see individual pattern groups above for description.

description	hand	h	w	d	pattern no.	L	V1	V2	V3
Storage anchored cabinet, 49"h Personal wardrobe and storage	left	49"	30"	19"	ACIL4930 ()() ()	\$4,257.	\$6,203.	\$6,748.	\$8,713.
		49"	32.5"	19"	ACIL4932 ()() ()	4,497.	6,478.	7,092.	9,169.
	right	49"	30"	19"	ACIR4930 ()() ()	4,257.	6,203.	6,748.	8,713.
		49"	32.5"	19"	ACIR4932 ()() ()	4,497.	6,478.	7,092.	9,169.

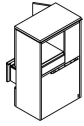

left hand shown, attach perpendicular to panel at back right side

Left hand = wardrobe on left front side
 Right hand = wardrobe on right front side
 wardrobe includes coat rod
 supports worksurface on back side at 28 1/4" overall or 27" h to underside of worksurface
 49" h I style cabinets do not have shelf above box drawer on back side access
 File drawers (front side) do not accommodate side to side legal filing

Order Code	Specification Information	Application Notes
Example: ACEL4924SEWV316AA	To order please specify pattern number including:	See page 8 for finish options applicable.
A AutoStrada	6. Drawer Interior applicable ACE(L/R) and ACI(L/R) only W = wood interior M = metal drawer interior, deduct \$100 list	Product on this page will accept wood grain laminate where laminate is currently an option.
C Cabinet	7. Finish Laminate, V1, V2 or V3 finish	When planning with medians and bridges (single station or clusters of stations) specify 49" h cabinets in either 26.5" or 32.5" deep storage anchored cabinets for anchoring the median or bridge unit of the same depth.
E File/File lower front, Interior back open shelf	8. Finish, Aluminum trim (trim, M shelf option & pull) AA - Anodized aluminum or painted finish option from page 8 excluding silver	When planning with panels, single station or cluster groups where all workstations within the group are the same direction/hand, then specify 26.5" or 32.5" deep storage anchor cabinet units. When planning multi-station clusters mirroring left hand/right hand or back to back stations with panel run perpendicular to two cabinets, you then need to specify one 24" d with one 26.5" d or 30" d with one 32.5" d cabinet to go side by side or back to back as the case may be.
L Left Hand	1. Hand L = User's Left R = User's Right	
49 49" high	2. Height 49 = 49" h (for use with medians, bridges or panels, 49" h to below trim, 50.2" h overall) 64 = 64" h (for use with panels 64" h to below trim, 65.2" h overall)	
24 24" deep	3. Depth 24 = 24" deep (use with 26.5" d unit for side by side cabinet application with panels) 30 = 30" deep (use with 32.5" d unit for side by side cabinet application with panels) 26 = 26.5" deep (use with medians, bridges & panels) 32 = 32.5" deep (use with medians, bridges & panels)	
S w/shelf to match cabinet case	4. Shelf option for open interior side 42" h do not have shelf options 49" h have shelf option 64" h do not have "no" shelf option, shelf included N = No shelf S = Shelf to match case * M = Two piece extruded aluminum metal shelf assembly * (*upcharge applicable)	
E Extruded Aluminum Pull	5. Pull E = extruded aluminum pull P = extruded aluminum protruding pull	
W Wood interior		
V316 Finish, Maple		
AA Finish, trim & pull, anodized aluminum		
3rd digit in pattern number indicates storage configuration, see individual pattern groups above for description.	depth L V1 24" \$ 97 217 26.5" \$102 223 30" \$107 235 32.5" \$113 239 depth V2 V3 24" \$240 310 26.5" \$248 321 30" \$260 338 32.5" \$268 348 depth AA or paint 24" \$296 26.5" \$317 30" \$347 32.5" \$368	Cabinets with front and back access not to be used in freestanding applications. Cabinet to panel attachment brackets required, see page 178. Cabinets include angle bracket to side support worksurfaces. Cabinets drilled for locks, keying instructions must accompany order. File drawers in cabinet styles prefixed ACIL and ACIR do not accommodate legal filing side to side.

Cabinets

description	hand	h	w	d	pattern no.	L	V1	V2	V3
Storage anchored cabinet, 64"h Personal wardrobe and storage	left	64"	30"	19"	ACIL6430 () () () ()	\$4,273.	\$6,251.	\$6,853.	\$8,910.
		64"	32.5"	19"	ACIL6432 () () () ()	4,587.	6,600.	7,309.	9,499.
	right	64"	30"	19"	ACIR6430 () () () ()	4,273.	6,251.	6,853.	8,910.
		64"	32.5"	19"	ACIR6432 () () () ()	4,587.	6,600.	7,309.	9,499.

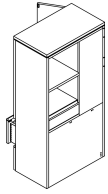

left hand shown, attach perpendicular to panel at back right side

Left hand = wardrobe on left front side
 Right hand = wardrobe on right front side
 supports worksurface on back side at 28 1/4" overall, 27"h to underside of worksurface
 wardrobe includes coat rod
 File drawers (front side) do not accommodate side to side legal filing

Order Code	Specification Information	Application Notes																																													
Example: ACEL4924SEWV316AA	To order please specify pattern number including:	See page 8 for finish options applicable.																																													
A AutoStrada																																															
C Cabinet																																															
E File/File lower front, Interior back open shelf		Product on this page will accept wood grain laminate where laminate is currently an option.																																													
L Left Hand																																															
49 49" high																																															
24 24" deep																																															
S w/shelf to match cabinet case																																															
E Extruded Aluminum Pull																																															
W Wood interior																																															
V316 Finish, Maple																																															
AA Finish, trim & pull, anodized aluminum																																															
3rd digit in pattern number indicates storage configuration, see individual pattern groups above for description.	<p>1. Hand L = User's Left R = User's Right</p> <p>2. Height 49 = 49"h (for use with medians, bridges or panels, 49"h to below trim, 50.2"h overall) 64 = 64"h (for use with panels 64"h to below trim, 65.2"h overall)</p> <p>3. Depth 24 = 24" deep (use with 26.5"d unit for side by side cabinet application with panels) 30 = 30" deep (use with 32.5"d unit for side by side cabinet application with panels) 26 = 26.5" deep (use with medians, bridges & panels) 32 = 32.5" deep (use with medians, bridges & panels)</p> <p>4. Shelf option for open interior side 42"h do not have shelf options 49"h have shelf option 64"h do not have "no" shelf option, shelf included N = No shelf S = Shelf to match case * M = Two piece extruded aluminum metal shelf assembly * (*upcharge applicable)</p> <p>5. Pull E = extruded aluminum pull P = extruded aluminum protruding pull</p> <p>6. Drawer Interior applicable ACE(L/R) and ACI(L/R) only W = wood interior M = metal drawer interior, deduct \$100 list</p> <p>7. Finish Laminate, V1, V2 or V3 finish</p> <p>8. Finish, Aluminum trim (trim, M shelf option & pull) AA - Anodized aluminum or painted finish option from page 8 excluding silver</p> <p>Connection method to medians, median storage or bridges incorporated into product design, no additional hardware required.</p> <p>64"h cabinets include shelf to match case in price list above. Upcharge below applicable as follows for 49"h shelf to match case for L/V1/V2/V3 or AA or paint for aluminum metal shelf for M option for both 49"h and 64"h cabinets.</p> <table border="1"> <tr> <td>depth</td> <td>L</td> <td>V1</td> </tr> <tr> <td>24"</td> <td>\$ 97</td> <td>217</td> </tr> <tr> <td>26.5"</td> <td>\$102</td> <td>223</td> </tr> <tr> <td>30"</td> <td>\$107</td> <td>235</td> </tr> <tr> <td>32.5"</td> <td>\$113</td> <td>239</td> </tr> <tr> <td>depth</td> <td>V2</td> <td>V3</td> </tr> <tr> <td>24"</td> <td>\$240</td> <td>310</td> </tr> <tr> <td>26.5"</td> <td>\$248</td> <td>321</td> </tr> <tr> <td>30"</td> <td>\$260</td> <td>338</td> </tr> <tr> <td>32.5"</td> <td>\$268</td> <td>348</td> </tr> <tr> <td>depth</td> <td>AA or paint</td> <td></td> </tr> <tr> <td>24"</td> <td>\$296</td> <td></td> </tr> <tr> <td>26.5"</td> <td>\$317</td> <td></td> </tr> <tr> <td>30"</td> <td>\$347</td> <td></td> </tr> <tr> <td>32.5"</td> <td>\$368</td> <td></td> </tr> </table>	depth	L	V1	24"	\$ 97	217	26.5"	\$102	223	30"	\$107	235	32.5"	\$113	239	depth	V2	V3	24"	\$240	310	26.5"	\$248	321	30"	\$260	338	32.5"	\$268	348	depth	AA or paint		24"	\$296		26.5"	\$317		30"	\$347		32.5"	\$368		<p>When planning with medians and bridges (single station or clusters of stations) specify 49"h cabinets in either 26.5" or 32.5" deep storage anchored cabinets for anchoring the median or bridge unit of the same depth.</p> <p>When planning with panels, single station or cluster groups where all workstations within the group are the same direction/hand, then specify 26.5" or 32.5" deep storage anchor cabinet units. When planning multi-station clusters mirroring left hand/right hand or back to back stations with panel run perpendicular to two cabinets, you then need to specify one 24"d with one 26.5"d or 30"d with one 32.5" d cabinet to go side by side or back to back as the case may be.</p> <p>Cabinets with front and back access not to be used in freestanding applications.</p> <p>Cabinet to panel attachment brackets required, see page 178.</p> <p>Cabinets include angle bracket to side support worksurfaces. Cabinets drilled for locks, keying instructions must accompany order.</p> <p>File drawers in cabinet styles prefixed ACIL and ACIR do not accommodate legal filing side to side.</p>
depth	L	V1																																													
24"	\$ 97	217																																													
26.5"	\$102	223																																													
30"	\$107	235																																													
32.5"	\$113	239																																													
depth	V2	V3																																													
24"	\$240	310																																													
26.5"	\$248	321																																													
30"	\$260	338																																													
32.5"	\$268	348																																													
depth	AA or paint																																														
24"	\$296																																														
26.5"	\$317																																														
30"	\$347																																														
32.5"	\$368																																														

description	hand	h	w	d	pattern no.	L	V1	V2	V3
Storage anchored cabinet, FFF and HD above (49"h)	left	49"	24"	19"	ACGL4924 () () () ()	\$3,395.	\$4,719.	\$5,315.	\$6,913.
		49"	30"	19"	ACGL4930 () () () ()	3,511.	4,859.	5,592.	7,267.
		49"	26.5"	19"	ACGL4926 () () () ()	3,453.	4,789.	5,455.	7,091.
		49"	32.5"	19"	ACGL4932 () () () ()	3,569.	4,927.	5,727.	7,446.
	right	49"	24"	19"	ACGR4924 () () () ()	3,395.	4,719.	5,315.	6,913.
		49"	30"	19"	ACGR4930 () () () ()	3,511.	4,859.	5,592.	7,267.
		49"	26.5"	19"	ACGR4926 () () () ()	3,453.	4,789.	5,455.	7,091.
		49"	32.5"	19"	ACGR4932 () () () ()	3,569.	4,927.	5,727.	7,446.

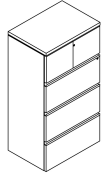

inside clearance behind hinged doors approx 9 1/4" h

Storage anchored cabinet, FFF and HD above (64"h)	left	64"	24"	19"	ACGL6424 () () () ()	3,563.	4,954.	5,584.	7,259.
		64"	30"	19"	ACGL6430 () () () ()	3,687.	5,100.	5,871.	7,630.
		64"	26.5"	19"	ACGL6426 () () () ()	3,625.	5,028.	5,727.	7,446.
		64"	32.5"	19"	ACGL6432 () () () ()	3,747.	5,172.	6,016.	7,816.
	right	64"	24"	19"	ACGR6424 () () () ()	3,563.	4,954.	5,584.	7,259.
		64"	30"	19"	ACGR6430 () () () ()	3,687.	5,100.	5,871.	7,630.
		64"	26.5"	19"	ACGR6426 () () () ()	3,625.	5,028.	5,727.	7,446.
		64"	32.5"	19"	ACGR6432 () () () ()	3,747.	5,172.	6,016.	7,816.

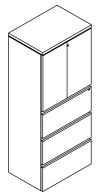

64" h includes adjustable shelf behind hinged doors, doors must be removed to adjust shelf

Order Code	Specification Information	Application Notes
Example: ACGL4924EDWV316AA	To order please specify pattern number including:	<p>Products listed on this page are for use with panel based stations or freestanding applications. Not to be used with median based storage anchored planning model.</p> <p>Product on this page will accept wood grain laminate where laminate is currently an option.</p> <p>When planning with panels, single station or cluster groups where all workstations within the group are the same direction/hand, then specify 26.5" or 32.5" deep storage anchor cabinet units. When planning multi-station clusters mirroring left hand/right hand with stations back to back with panel run perpendicular to two cabinets you then need to specify one 24" d with one 26.5" d or 30" d with one 32.5" d cabinet to go side by side or back to back as the case may be.</p> <p>Cabinet to panel attachment brackets required, see page 178</p>
A AutoStrada	1. Hand (applicable for personal wardrobe & storage units only) L = wardrobe on left R = wardrobe on right	
C Cabinet	2. Height 49 = 49" h (where applicable). 49" h to below trim, 50.2" h overall) 64 = 64" h (64" h to below trim, 65.2" h overall)	
G File drawers w/Hinged doors above	3. Depth 24 = 24" deep (use with one 26.5" d for side by side or freestanding) 30 = 30" deep (use with one 32.5" d for side by side or freestanding) 26 = 26.5" deep (use with panels) 32 = 32.5" deep (use with panels)	
L Left Hand	4. Pull (where applicable) E = Extruded aluminum pull P = Extruded aluminum protruding pull	
49 49" high	5. Drill option, applicable only for 24" and 30" deep units D = drilled to anchor to panel F = no drill, freestanding	
24 24" deep	6. Interior option W = wood drawer interior M = metal drawer interior, deduct \$200 list	
E Extruded Aluminum Pull	7. Finish Laminate, V1, V2 or V3 finish	
D Drilled to anchor	8. Finish, Metal Shelves (if applicable) (paint finish or anodized aluminum two piece assembly)	
W Wood interior	9. Finish, Aluminum trim (trim & pull) AA - Anodized aluminum or painted finish option from page 8 excluding silver	
V316 Finish, Maple	Hinged doors above feature touch latches and do not lock.	
AA Finish, trim & pull, anodized aluminum	File drawers are drilled for locks, keying instructions must accompany order.	

3rd digit in pattern number indicates storage configuration, see individual pattern groups above for description.

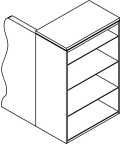
description	hand	h	w	d	pattern no.	L	V1	V2	V3
Storage anchored cabinet, 49" h bookcase w/metal shelves 	left	49"	24"	19"	ACHL4924M () () ()	\$2,117.	\$2,886.	\$3,319.	\$3,987.
		49"	30"	19"	ACHL4930M () () ()	2,292.	3,121.	3,591.	4,312.
		49"	26.5"	19"	ACHL4926M () () ()	2,206.	3,004.	3,457.	4,147.
		49"	32.5"	19"	ACHL4932M () () ()	2,377.	3,240.	3,726.	4,474.
	right	49"	24"	19"	ACHR4924M () () ()	2,117.	2,886.	3,319.	3,987.
		49"	30"	19"	ACHR4930M () () ()	2,292.	3,121.	3,591.	4,312.
		49"	26.5"	19"	ACHR4926M () () ()	2,206.	3,004.	3,457.	4,147.
		49"	32.5"	19"	ACHR4932M () () ()	2,377.	3,240.	3,726.	4,474.

left hand shown

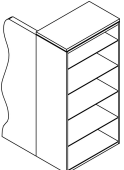
Storage anchored cabinet, 64" h bookcase w/metal shelves 	left	64"	24"	19"	ACHL6424M () () ()	2,226.	3,035.	3,487.	4,183.
		64"	30"	19"	ACHL6430M () () ()	2,407.	3,277.	3,770.	4,524.
		64"	26.5"	19"	ACHL6426M () () ()	2,317.	3,154.	3,627.	4,352.
		64"	32.5"	19"	ACHL6432M () () ()	2,498.	3,402.	3,913.	4,696.
	right	64"	24"	19"	ACHR6424M () () ()	2,226.	3,035.	3,487.	4,183.
		64"	30"	19"	ACHR6430M () () ()	2,407.	3,277.	3,770.	4,524.
		64"	26.5"	19"	ACHR6426M () () ()	2,317.	3,154.	3,627.	4,352.
		64"	32.5"	19"	ACHR6432M () () ()	2,498.	3,402.	3,913.	4,696.

left hand shown

Order Code	Specification Information	Application Notes
Example: ACGL4924EDWV316AA	To order please specify pattern number including:	<p>Products listed on this page are for use with panel based stations or freestanding applications. Not to be used with median based storage anchored planning model.</p> <p>Product on this page will accept wood grain laminate where laminate is currently an option.</p> <p>When planning with panels, single station or cluster groups where all workstations within the group are the same direction/hand, then specify 26.5" or 32.5" deep storage anchor cabinet units. When planning multi-station clusters mirroring left hand/right hand with stations back to back with panel run perpendicular to two cabinets you then need to specify one 24" d with one 26.5" d or 30" d with one 32.5" d cabinet to go side by side or back to back as the case may be.</p> <p>Cabinet to panel attachment brackets required, see page 178</p>
A AutoStrada		
C Cabinet		
G File drawers w/Hinged doors above		
L Left Hand		
49 49" high		
24 24" deep		
E Extruded Aluminum Pull		
D Drilled to anchor		
W Wood interior		
V316 Finish, Maple		
AA Finish, trim & pull, anodized aluminum		
3rd digit in pattern number indicates storage configuration, see individual pattern groups above for description.	<p>1. Hand (applicable for personal wardrobe & storage units only) L = wardrobe on left R = wardrobe on right</p> <p>2. Height 49 = 49" h (where applicable, 49" h to below trim, 50.2" h overall) 64 = 64" h (64" h to below trim, 65.2" h overall)</p> <p>3. Depth 24 = 24" deep (use with one 26.5" d for side by side or freestanding) 30 = 30" deep (use with one 32.5" d for side by side or freestanding) 26 = 26.5" deep (use with panels) 32 = 32.5" deep (use with panels)</p> <p>4. Pull (where applicable) E = Extruded aluminum pull P = Extruded aluminum protruding pull</p> <p>5. Drill option, applicable only for 24" and 30" deep units D = drilled to anchor to panel F = no drill, freestanding</p> <p>6. Interior option W = wood drawer interior M = metal drawer interior, deduct \$200 list</p> <p>7. Finish Laminate, V1, V2 or V3 finish</p> <p>8. Finish, Metal Shelves (if applicable) (paint finish or anodized aluminum two piece assembly)</p> <p>9. Finish, Aluminum trim (trim & pull) AA - Anodized aluminum or painted finish option from page 8 excluding silver</p> <p>Hinged doors above feature touch latches and do not lock.</p> <p>File drawers are drilled for locks, keying instructions must accompany order.</p> <p>Cabinets include angle brackets to side support worksurfaces perpendicular to cabinet except when drill option "F" for freestanding selected.</p>	

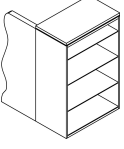
description	hand	h	w	d	pattern no.	L	V1	V2	V3
Storage anchored cabinet, 49" h bookcase w/shelves  left hand shown	left	49"	24"	19"	ACHL4924W () ()	\$2,525.	\$3,618.	\$4,119.	\$5,357.
		49"	30"	19"	ACHL4930W () ()	2,630.	3,769.	4,290.	5,575.
		49"	26.5"	19"	ACHL4926W () ()	2,570.	3,686.	4,192.	5,453.
		49"	32.5"	19"	ACHL4932W () ()	2,668.	3,827.	4,351.	5,659.
	right	49"	24"	19"	ACHR4924W () ()	2,525.	3,618.	4,119.	5,357.
		49"	30"	19"	ACHR4930W () ()	2,630.	3,769.	4,290.	5,575.
		49"	26.5"	19"	ACHR4926W () ()	2,570.	3,686.	4,192.	5,453.
		49"	32.5"	19"	ACHR4932W () ()	2,668.	3,827.	4,351.	5,659.

shelves same as case finish

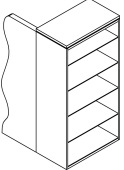
Storage anchored cabinet, 64" h bookcase w/shelves  left hand shown	left	64"	24"	19"	ACHL6424W () ()	2,786.	3,993.	4,546.	5,908.
		64"	30"	19"	ACHL6430W () ()	2,909.	4,173.	4,745.	6,174.
		64"	26.5"	19"	ACHL6426W () ()	2,837.	4,072.	4,634.	6,021.
		64"	32.5"	19"	ACHL6432W () ()	2,958.	4,244.	4,831.	6,277.
	right	64"	24"	19"	ACHR6424W () ()	2,786.	3,993.	4,546.	5,908.
		64"	30"	19"	ACHR6430W () ()	2,909.	4,173.	4,745.	6,174.
		64"	26.5"	19"	ACHR6426W () ()	2,837.	4,072.	4,634.	6,021.
		64"	32.5"	19"	ACHR6432W () ()	2,958.	4,244.	4,831.	6,277.

shelves same as case finish

Order Code	Specification Information	Application Notes
Example: ACGL4924EDWV316AA	<i>To order please specify pattern number including:</i>	<p>Products listed on this page are for use with panel based stations or freestanding applications. Not to be used with median based storage anchored planning model.</p> <p>Product on this page will accept wood grain laminate where laminate is currently an option.</p> <p>When planning with panels, single station or cluster groups where all workstations within the group are the same direction/hand, then specify 26.5" or 32.5" deep storage anchor cabinet units. When planning multi-station clusters mirroring left hand/right hand with stations back to back with panel run perpendicular to two cabinets you then need to specify one 24" d with one 26.5" d or 30" d with one 32.5" d cabinet to go side by side or back to back as the case may be.</p> <p>Cabinet to panel attachment brackets required, see page 178</p>
A AutoStrada	1. Hand <i>(applicable for personal wardrobe & storage units only)</i> L = wardrobe on left R = wardrobe on right	
C Cabinet	2. Height 49 = 49" h (where applicable, 49" h to below trim, 50.2" h overall) 64 = 64" h (64" h to below trim, 65.2" h overall)	
G File drawers w/Hinged doors above	3. Depth 24 = 24" deep (use with one 26.5" d for side by side or freestanding) 30 = 30" deep (use with one 32.5" d for side by side or freestanding) 26 = 26.5" deep (use with panels) 32 = 32.5" deep (use with panels)	
L Left Hand	4. Pull (where applicable) E = Extruded aluminum pull P = Extruded aluminum protruding pull	
49 49" high	5. Drill option, applicable only for 24" and 30" deep units D = drilled to anchor to panel F = no drill, freestanding	
24 24" deep	6. Interior option W = wood drawer interior M = metal drawer interior, deduct \$200 list	
E Extruded Aluminum Pull	7. Finish Laminate, V1, V2 or V3 finish	
D Drilled to anchor	8. Finish, Metal Shelves (if applicable) <i>(paint finish or anodized aluminum two piece assembly)</i>	
W Wood interior	9. Finish, Aluminum trim (trim & pull) AA - Anodized aluminum or painted finish option from page 8 excluding silver	
V316 Finish, Maple	Hinged doors above feature touch latches and do not lock.	
AA Finish, trim & pull, anodized aluminum	File drawers are drilled for locks, keying instructions must accompany order. Cabinets include angle brackets to side support worksurfaces perpendicular to cabinet except when drill option "F" for freestanding selected.	

3rd digit in pattern number indicates storage configuration, see individual pattern groups above for description.

description	type	pattern no.	49" h	64" h	list
-------------	------	-------------	-------	-------	------

Bracket kit, cabinet to panel attachment
top and bottom connection for single cabinet
attachment to panel run

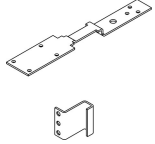

kit includes hookstrip connector (not shown)

Bracket kit, cabinet to panel attachment top and bottom connection for use with two cabinets side by side or back to back attached perpendicular to panel run	left	A3CPBDL () ()	236.	247.
	right	A3CPBDR () ()	236.	247.

Note - one of the two cabinets should be 2.5" wider or deeper (width or depth dimension depending on style of cabinet) than the other

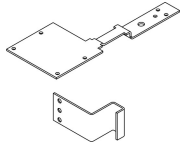

Left hand shown, (kit includes hookstrip
connector not shown)

Order Code

Example:	A3CPBS4
A3	AutoStrada, generation3
CPB	Cabinet to Panel bracket
S	Single
4	With 49" h hookstrip connector
()	Finish

Specification Information

To order please specify pattern
number including:

- Hand (if applicable)
L = left hand attachment
R = right hand attachment
- Hookstrip connector height
*2 = for 42" h cabinet to panel
connection*
*4 = for 49" h cabinet to panel
connection*
*6 = for 64" h cabinet to panel
connection*
- Finish
*Painted finish options only from
page 8*

Application Notes

Bracket kits for use when attaching
storage anchored cabinets to panels;
kit includes top and bottom bracket
as shown and ships with hookstrip
connector. Please be sure to specify
height to correspond with cabinet
and panel height. When one cabinet
perpendicular to panel run, use S
bracket; when two cabinets are side
by side and perpendicular to panel
run, use D bracket.

Brackets are NOT to be used with
Reff stacking modules. Only use for
cabinet to panel attachment (panel
and cabinet at same height) or with
cabinet to panel plus window
modules (overall at same height).

Painted finish 613 used when AA
trim finish specified.

description	type	d	pattern no.	list
Worksurface to cabinet trim		24"	AWTCT24 ()	\$106.
		30"	AWTCT30 ()	119.
Slatwall end trim, use w/SA "D" cabinets	2 pc trim kit		ATSCD19 ()	139.

Note: for use with ACD style storage anchored cabinets when slatwall adjacent to cabinet

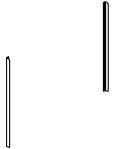

Order Code

Example:	AWTCT24AA
A	AutoStrada
W	Worksurface
TC	to Cabinet
T	Trim
24	24" d worksurface
AA	Finish, anodized aluminum

Specification Information

To order please specify pattern number including:

1. Depth of worksurface
 24 = 24" d worksurface
 30 = 30" d worksurface
2. Finish
 AA = anodized aluminum or painted finish option from page 8 excluding silver

Application Notes

Aluminum spacer optional to fill 1/8" gap at worksurface and storage anchored cabinet connection in AS-2 storage anchored panel based planning. Trim piece installed at worksurface level and rests on side support bracket to cabinet.

description	type	h	w	d	pattern no.	L	V1	V2	V3
File drawers (2) with open wood shelves above		70"	30"	24"	ACJ722WE () ()	\$3,568.	\$4,926.	\$5,725.	\$7,440.
		70"	36"	24"	ACJ723WE () ()	3,674.	5,073.	5,895.	7,663.

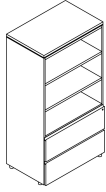

File drawers (3) with open wood shelves above		84"	30"	24"	ACJ822WE () ()	4,175.	5,761.	6,695.	8,706.
		84"	36"	24"	ACJ823WE () ()	4,300.	5,934.	6,896.	8,967.

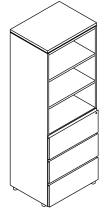

Order Code	Specification Information	Application Notes
Example: ACKL722WEV316AAAA	<i>To order please specify pattern number including:</i>	
A AutoStrada	1. Hand <i>(applicable for units with wardrobes only)</i> <i>L = wardrobe on left</i> <i>R = wardrobe on right</i>	
C Cabinet	2. Height <i>7 = 70" h</i> <i>8 = 84" h</i>	
K Wardrobe/Open bookcase	3. Width <i>2 = 30" wide</i> <i>3 = 36" wide</i>	
L Left Hand	4. Interior & shelf <i>W = wood drawer interior and wood shelves</i> <i>M = wood drawer interior and metal shelves</i>	
7 70" high	5. Extruded aluminum pull <i>E = extruded aluminum pull (default)</i>	
2 24" deep	6. Finish <i>Laminate, V1, V2 or V3 finish</i>	
2 30" wide	7. Finish, Metal Shelves <i>(if applicable)</i> <i>(paint finish or anodized aluminum three piece assembly)</i>	
W Wood interior	8. Finish, Aluminum trim (trim & if pull) <i>AA - Anodized aluminum or painted finish option from page 8 excluding silver</i>	
E Extruded Aluminum Pull	9. Finish, cabinet feet <i>AA - Anodized aluminum or painted finish option from page 8 excluding silver</i>	
V316 Finish, Maple		
AA Finish, trim & pull, anodized aluminum		
AA Finish, cabinet feet, anodized alum		

- 6. Finish
Laminate, V1, V2 or V3 finish
- 7. Finish, Metal Shelves *(if applicable)*
(paint finish or anodized aluminum three piece assembly)
- 8. Finish, Aluminum trim (trim & if pull)
AA - Anodized aluminum or painted finish option from page 8 excluding silver
- 9. Finish, cabinet feet
AA - Anodized aluminum or painted finish option from page 8 excluding silver

Cabinets on this page are styled for the private office and include aluminum feet detail which is optional addition to lower storage beginning on page 190. Specify 70" h cabinets for use with single high overhead storage and 84" h cabinets for use with double high overhead storage.

Hinged doors feature touch latches and do not lock. Sliding doors do not lock. File drawers dilled for locks, keying instructions must accompany order.

Coat rod included in wardrobes.

See page 8 for finish options applicable.

Product on this page will accept wood grain laminate where laminate is currently an option.

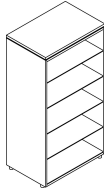
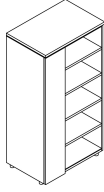
description	type	h	w	d	pattern no.	L	V1	V2	V3	
 <p>Open bookcase</p>	metal shelves	70"	30"	24"	ACL722M () () ()	\$3,064.	\$4,148.	\$4,356.	\$5,661.	
		70"	36"	24"	ACL723M () () ()	3,240.	4,367.	4,585.	5,963.	
		84"	30"	24"	ACL822M () () ()	3,412.	4,586.	4,815.	6,262.	
		84"	36"	24"	ACL823M () () ()	3,585.	4,806.	5,048.	6,562.	
	wood shelves	70"	30"	24"	ACL722W () () ()	2,453.	3,340.	3,844.	4,994.	
		70"	36"	24"	ACL723W () () ()	2,591.	3,514.	4,073.	5,293.	
		84"	30"	24"	ACL822W () () ()	2,730.	3,689.	4,302.	5,593.	
		84"	36"	24"	ACL823W () () ()	2,871.	3,864.	4,529.	5,890.	
 <p>Wardrobe with hinged door open bookcase w/wood shelves</p>	left hand	70"	30"	24"	ACKL722WE () () ()	3,317.	4,758.	5,318.	6,914.	
		70"	36"	24"	ACKL723WE () () ()	3,482.	4,995.	5,584.	7,259.	
		84"	30"	24"	ACKL822WE () () ()	3,482.	4,995.	5,584.	7,259.	
		84"	36"	24"	ACKL823WE () () ()	3,602.	5,167.	5,777.	7,508.	
	<i>left hand = wardrobe on left side facing cabinet (1/3rd of width)</i>									
	right hand	70"	30"	24"	ACKR722WE () () ()	3,317.	4,758.	5,318.	6,914.	
		70"	36"	24"	ACKR723WE () () ()	3,482.	4,995.	5,584.	7,259.	
		84"	30"	24"	ACKR822WE () () ()	3,482.	4,995.	5,584.	7,259.	
		84"	36"	24"	ACKR823WE () () ()	3,602.	5,167.	5,777.	7,508.	
	<i>right hand = wardrobe on right side facing cabinet (1/3rd of width)</i>									

left hand shown

Order Code	Specification Information	Application Notes
Example: ACKL722WEV316AAAA	<i>To order please specify pattern number including:</i>	
A AutoStrada		
C Cabinet		
K Wardrobe/Open bookcase	1. Hand <i>(applicable for units with wardrobes only)</i> <i>L = wardrobe on left</i> <i>R = wardrobe on right</i>	
L Left Hand		
7 70" high	2. Height <i>7 = 70" h</i> <i>8 = 84" h</i>	
2 24" deep		
2 30" wide	3. Width <i>2 = 30" wide</i> <i>3 = 36" wide</i>	
W Wood interior		
E Extruded Aluminum Pull	4. Interior & shelf <i>W = wood drawer interior and wood shelves</i> <i>M = wood drawer interior and metal shelves</i>	
V316 Finish, Maple		
AA Finish, trim & pull, anodized aluminum	5. Extruded aluminum pull <i>E = extruded aluminum pull (default)</i>	
AA Finish, cabinet feet, anodized alum	6. Finish <i>Laminate, V1, V2 or V3 finish</i>	Cabinets on this page are styled for the private office and include aluminum feet detail which is optional addition to lower storage beginning on page 190. Specify 70" h cabinets for use with single high overhead storage and 84" h cabinets for use with double high overhead storage.
	7. Finish, Metal Shelves <i>(if applicable)</i> <i>(paint finish or anodized aluminum three piece assembly)</i>	
	8. Finish, Aluminum trim (trim & if pull) <i>AA - Anodized aluminum or painted finish option from page 8 excluding silver</i>	Hinged doors feature touch latches and do not lock. Sliding doors do not lock. File drawers dilled for locks, keying instructions must accompany order.
	9. Finish, cabinet feet <i>AA - Anodized aluminum or painted finish option from page 8 excluding silver</i>	
	See page 8 for finish options applicable.	Coat rod included in wardrobes.
	Product on this page will accept wood grain laminate where laminate is currently an option.	

description	type	h	w	d	pattern no.	L	V1	V2	V3
Wardrobe w/sliding door open bookcase w/wood shelves	left hand	70"	30"	24"	ACMWL722 () () ()	\$3,523.	\$4,802.	\$5,525.	\$7,181.
		70"	36"	24"	ACMWL723 () () ()	3,699.	5,041.	5,800.	7,542.
		84"	30"	24"	ACMWL822 () () ()	3,810.	5,167.	5,991.	7,788.
		84"	36"	24"	ACMWL823 () () ()	3,991.	5,395.	6,289.	8,176.
	right hand	70"	30"	24"	ACMWR722 () () ()	3,523.	4,802.	5,525.	7,181.
		70"	36"	24"	ACMWR723 () () ()	3,699.	5,041.	5,800.	7,542.
		84"	30"	24"	ACMWR822 () () ()	3,810.	5,167.	5,991.	7,788.
		84"	36"	24"	ACMWR823 () () ()	3,991.	5,395.	6,289.	8,176.

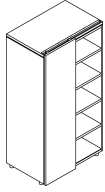

left hand shown

Wardrobe w/sliding door open bookcase w/metal shelves	left hand	70"	30"	24"	ACMML722 () () ()	3,758.	5,059.	5,781.	7,439.
		70"	36"	24"	ACMML723 () () ()	3,963.	5,330.	6,089.	7,831.
		84"	30"	24"	ACMML822 () () ()	4,103.	5,488.	6,313.	8,109.
		84"	36"	24"	ACMML823 () () ()	4,314.	5,749.	6,643.	8,530.
	right hand	70"	30"	24"	ACMMR722 () () ()	3,758.	5,059.	5,781.	7,439.
		70"	36"	24"	ACMMR723 () () ()	3,963.	5,330.	6,089.	7,831.
		84"	30"	24"	ACMMR822 () () ()	4,103.	5,488.	6,313.	8,109.
		84"	36"	24"	ACMMR823 () () ()	4,314.	5,749.	6,643.	8,530.

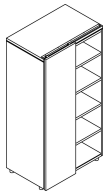

left hand shown

Order Code	Specification Information	Application Notes
Example: ACKL722WEV316AAAA	To order please specify pattern number including:	Cabinets on this page are styled for the private office and include aluminum feet detail which is optional addition to lower storage beginning on page 190. Specify 70" h cabinets for use with single high overhead storage and 84" h cabinets for use with double high overhead storage. Hinged doors feature touch latches and do not lock. Sliding doors do not lock. File drawers dilled for locks, keying instructions must accompany order. Coat rod included in wardrobes.
A AutoStrada	1. Hand (applicable for units with wardrobes only) L = wardrobe on left R = wardrobe on right	
C Cabinet	2. Height 7 = 70" h 2 = 24" deep 2 = 30" wide	
K Wardrobe/Open bookcase	3. Width 2 = 30" wide 3 = 36" wide	
L Left Hand	4. Interior & shelf W = wood drawer interior and wood shelves M = wood drawer interior and metal shelves	
7 70" high	5. Extruded aluminum pull E = extruded aluminum pull (default)	
2 24" deep	6. Finish Laminate, V1, V2 or V3 finish	
2 30" wide	7. Finish, Metal Shelves (if applicable) (paint finish or anodized aluminum three piece assembly)	
W Wood interior	8. Finish, Aluminum trim (trim & if pull) AA - Anodized aluminum or painted finish option from page 8 excluding silver	
E Extruded Aluminum Pull	9. Finish, cabinet feet AA - Anodized aluminum or painted finish option from page 8 excluding silver	
V316 Finish, Maple	See page 8 for finish options applicable.	
AA Finish, trim & pull, anodized aluminum	Product on this page will accept wood grain laminate where laminate is currently an option.	
AA Finish, cabinet feet, anodized alum		

description	type	h	w	d	pattern no.	L	V1	V2	V3
Full wardrobe		70"	30"	24"	ACW722 () ()	\$3,301.	\$4,646.	\$5,301.	\$6,893.
		70"	36"	24"	ACW723 () ()	3,468.	4,880.	5,566.	7,234.
		84"	30"	24"	ACW822 () ()	3,468.	4,880.	5,566.	7,234.
		84"	36"	24"	ACW823 () ()	3,585.	5,045.	5,758.	7,487.

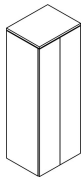

Touch latch only, no pulls/no lock; includes coat rod.

Order Code	Specification Information	Application Notes
Example: ACKL722WEV316AAAA	<i>To order please specify pattern number including:</i>	
A AutoStrada		
C Cabinet		
K Wardrobe/Open bookcase	1. Hand <i>(applicable for units with wardrobes only)</i> <i>L = wardrobe on left</i> <i>R = wardrobe on right</i>	
L Left Hand		
7 70" high	2. Height <i>7 = 70" h</i> <i>8 = 84" h</i>	
2 24" deep		
2 30" wide	3. Width <i>2 = 30" wide</i> <i>3 = 36" wide</i>	
W Wood interior		
E Extruded Aluminum Pull	4. Interior & shelf <i>W = wood drawer interior and wood shelves</i> <i>M = wood drawer interior and metal shelves</i>	
V316 Finish, Maple		
AA Finish, trim & pull, anodized aluminum	5. Extruded aluminum pull <i>E = extruded aluminum pull (default)</i>	
AA Finish, cabinet feet, anodized alum	6. Finish <i>Laminate, V1, V2 or V3 finish</i>	
	7. Finish, Metal Shelves <i>(if applicable)</i> <i>(paint finish or anodized aluminum three piece assembly)</i>	Cabinets on this page are styled for the private office and include aluminum feet detail which is optional addition to lower storage beginning on page 190. Specify 70" h cabinets for use with single high overhead storage and 84" h cabinets for use with double high overhead storage.
	8. Finish, Aluminum trim (trim & if pull) <i>AA - Anodized aluminum or painted finish option from page 8 excluding silver</i>	Hinged doors feature touch latches and do not lock. Sliding doors do not lock. File drawers dilled for locks, keying instructions must accompany order.
	9. Finish, cabinet feet <i>AA - Anodized aluminum or painted finish option from page 8 excluding silver</i>	Coat rod included in wardrobes.
	See page 8 for finish options applicable.	
	Product on this page will accept wood grain laminate where laminate is currently an option.	

Freestanding Cabinets for open plan use with metal case pedestals

AutoStrada

description	h	w	d	pattern no.	lam. case	lam. case	lam. case	lam. case	lam. case	ven. case	ven. case	ven. case
					P1/P2/P3 front	lam front	V1 front	V2 front	V3 front	V1 front	V2 front	V3 front
Freestanding cabinet, 48"h	48"	24"	24"	AAV1 4824 S2D1F () () () ()	\$3,072.	\$2,983.	\$3,327.	\$3,419.	\$4,026.	\$4,033.	\$4,702.	\$6,364.
	48"	30"	24"	AAV1 4830 S2D1F () () () ()	3,219.	3,119.	3,456.	3,576.	4,278.	4,144.	4,920.	6,902.

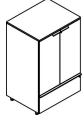

Freestanding cabinet, 64"h	64"	24"	24"	AAV1 6424 S2D2F () () () ()	3,327.	3,216.	3,600.	3,649.	4,440.	4,572.	5,280.	7,306.
	64"	30"	24"	AAV1 6430 S2D2F () () () ()	3,511.	3,379.	3,758.	3,841.	4,759.	4,668.	5,584.	7,977.

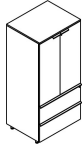

Order Code	Specification Information	Application Notes
Example: AAV1 4824 S2D1F L 118 P 613 AA	<i>To order please specify pattern number including:</i>	Freestanding cabinets for open plan are designed to match drawer fronts of AutoStrada metal pedestals in heights and thickness. Doors have 5 1/2" wide protruding pull and drawers have full width pulls. Cabinets are wood construction with 1 1/2" telescoping glides to match pedestals.
AAV1 Freestanding cabinet	L Lock	48"H cabinets have 2 doors over 1 file.
48 Height	N No lock	64"H cabinets have 2 doors over 2 files.
24 Width	Case finish (laminate or veneer only)	Files are full extension steel drawers that accept suspended legal file folders side to side. File bars are included to also support suspended letter or A4 side to side or front to back. File drawers are not bottom loadable.
S Depth	Front type	Cabinets are laminate case and top with painted, laminate or veneer fronts, or all veneer case and fronts.
2D Two door	L Laminate	
1F One file	P Paint	
L With lock	V Veneer	
118 Case finish	Front finish code	
P Front type	Pull finish (AA only)	
613 Front finish		
AA Pull finish		

Metal case
Pedestals
Floorstanding

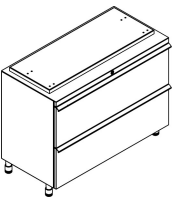
description	type	width	depth	height	pattern number	P1/P2 front	P3 front	L front	V1 front	V2 front	V3 front
	personal/data/file	15"	17"	27"	ASFS1PDF18 () () ()	\$1,253.	\$1,313.	\$1,211.	\$1,620.	\$1,669.	\$1,811.
		15"	23"	27"	ASFS1PDF24 () () ()	1,356.	1,423.	1,327.	1,690.	1,738.	1,888.
	file/file	15"	17"	27"	ASFS1FF18 () () ()	1,069.	1,124.	1,068.	1,408.	1,486.	1,631.
		15"	23"	27"	ASFS1FF24 () () ()	1,161.	1,218.	1,164.	1,471.	1,554.	1,703.
	personal/data/file	30"	17"	27"	ASFS1WPDF30 () () ()	1,784.	1,873.	1,784.	2,145.	2,411.	3,137.
		36"	17"	27"	ASFS1WPDF36 () () ()	2,180.	2,291.	2,180.	2,630.	2,963.	3,850.
	file/file	30"	17"	27"	ASFS1WFF30 () () ()	1,550.	1,628.	1,550.	1,867.	2,099.	2,724.
		36"	17"	27"	ASFS1WFF36 () () ()	1,896.	1,992.	1,896.	2,289.	2,577.	3,349.
	data/file	30"	17"	23"	ASFS1WDF30 () () ()	1,474.	1,547.	1,474.	1,772.	1,991.	2,590.
		36"	17"	23"	ASFS1WDF36 () () ()	1,803.	1,892.	1,803.	2,175.	2,449.	3,181.
	2 door	30"	17"	27"	ASFS1WDD30 () () ()	1,550.	1,628.	1,550.	1,867.	2,099.	2,724.
		36"	17"	27"	ASFS1WDD36 () () ()	1,896.	1,992.	1,896.	2,289.	2,577.	3,349.

Order Code

Example:	ASFS1 FF18 111 P 114 AA
ASFS1	Autostrada floorstanding pedestal
FF	Configuration
18	Depth
111	Finish for case
P	Finish type for fronts
114	Finish for fronts
AA	Finish for pulls

Specification Information

All pedestals include front lock with KnollKey lock system. Personal drawer is 4" h. Data drawer is 7" h. File drawers are 11" h. Deep file drawers include file support for letter (width) or legal (depth) suspended file folders. All drawers have full extension, ball bearing drawer slides.

Please specify painted finish for case or fronts from paint finish options; front finish also optional from laminate, V1, V2 or V3 finish options listed on page 8.

Pulls are available in anodized aluminum or painted finish options listed on page 8 excluding silver.

Application Notes

Floorstanding pedestals include levelling glides and closed top with 1" spacer to support one end of a worksurface at 27" h to underside of worksurface. 18" d pedestals fit under any worksurface with standard stiffener. Deep floorstanding pedestals fit under worksurfaces with worksurface stiffener 18" less than nominal width.

The metal case pedestals come with a 1" h board spacer that installs between the case and the worksurface it is supporting. The tops of the pedestals are drilled to accept the attachment screws.

Pedestals may not be used in freestanding applications.

Metal case
Pedestals
Mobile

AutoStrada

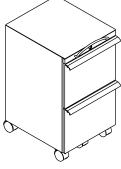
description	type	width	depth	height	pattern number	P1/P2 front	P3 front	L front	V1 front	V2 front	V3 front	
	Mobile pedestal	Standard - data/file	15"	17"	22"	ASMS1 DF18 () () ()	\$1,057.	\$1,107.	\$1,068.	\$1,425.	\$1,521.	\$1,584.
	Deep - data/file	15"	23"	22"	ASMS1 DF24 () () ()	1,194.	1,256.	1,205.	1,635.	1,737.	1,803.	
	Standard - personal/data/file	15"	17"	26 1/2"	ASMS1 PDF18 () () ()	1,231.	1,295.	1,205.	1,622.	1,669.	1,805.	
	Deep - personal/data/file	15"	23"	26 1/2"	ASMS1 PDF24 () () ()	1,369.	1,439.	1,342.	1,841.	1,890.	2,044.	
	Standard - file/file	15"	17"	26 1/2"	ASMS1 FF18 () () ()	1,114.	1,170.	1,115.	1,494.	1,573.	1,584.	
	Deep - file/file	15"	23"	26 1/2"	ASMS1 FF24 () () ()	1,255.	1,315.	1,259.	1,635.	1,718.	1,872.	
Mobile pedestal, open top	Standard - data/file	15"	17"	22"	ASMS1 DFO18 () () ()	997.	1,050.	1,006.	1,386.	1,484.	1,542.	
Deep - data/file	15"	23"	22"	ASMS1 DFO24 () () ()	1,126.	1,181.	1,130.	1,585.	1,685.	1,754.		

Order Code

Specification Information

Application Notes

Example: **ASMS1 FF18 111 P 114 AA**

ASMS1	Autostrada mobile pedestal
FF	Configuration
18	Depth
111	Finish for case
P	Finish type for fronts
114	Finish for fronts
AA	Finish for pulls

All pedestals include front lock with KnollKey lock system. Personal drawer is 4"H. Data drawer is 7"H. File drawers are 11"H. Deep file drawers include file support for letter (width) or legal (depth) suspended file folders. All drawers have full extension, ball bearing drawer slides.

Please specify painted finish for case or fronts from paint finish options: front finish also optional from laminate, V1, V2 or V3 finish options listed on page 8.

Pulls are available in anodized aluminum or painted finish options listed on page 8 excluding silver.

Mobile pedestals are independent storage components with locking casters and pull. Standard mobile pedestals roll under worksurfaces set at 28" or higher. Deep mobile pedestals with two files or personal/data/file will not fit under stiffener of universal worksurface or desk set at 29" or lower. Specify data/file mobile pedestal under worksurfaces adjusted lower than 28"H.

Metal case
Pedestals
Accessories
cushion - fabric

description	type	width	depth	pattern number	A	com		C	D	E	F	G	H	I
						B								
Cushion	Deep	15"	23"	AS1 DPAD ()	\$241.	\$270.	\$316.	\$330.	\$362.	\$393.	\$436.	\$481.	\$498.	
	Standard	15"	17"	AS1 SPAD ()	195.	224.	256.	270.	286.	316.	345.	393.	406.	

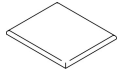

Order Code

Example: **AS1 SPAD**

AS1 Pedestal

S Depth

PAD Cushion

Specification Information

There is a \$80 upcharge on CAL133 backing on the cushion.

Consult the Currents price list for fabric information and grades

Application Notes

Pedestal cushions are for use on open top mobile pedestals.

For Customers Own Material (COM) applications, specify .75 yards of fabric for 17 inch deep mobile pedestal seat cushions, and .90 yards for 23 inch deep seat cushion.

Metal case
Pedestals
Accessories
cushion - leather

description	type	width	depth	pattern number	COL U	V	W	X	Y
Cushion	Deep	15"	23"	AS1 DPAD ()	\$481.	\$572.	\$705.	\$738.	\$780.
	Standard	15"	17"	AS1 SPAD ()	376.	450.	555.	572.	601.

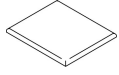

Order Code	Specification Information	Application Notes
Example: AS1 SPAD		
ASI Pedestal	There is a \$105 upcharge for perforated leather.	Pedestal cushions are for use on open top mobile pedestals.
S Depth	Consult the Currents price list for leather information and grades.	For Customers Own Leather (COL) applications, specify 11.5 sq. feet of leather for 17 inch deep mobile pedestal seat cushions, and 14.5 sq. feet for 23 inch deep seat cushion.
PAD Cushion		

Metal case
Pedestals
Accessories
various

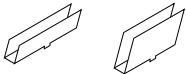
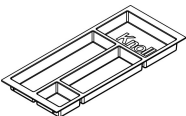
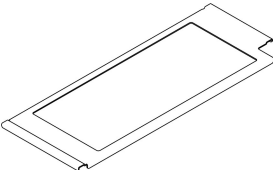
description	type	width	depth	height	pattern number	list
Drawer divider 	Personal or data drawer				MD6-BD	\$40.
File support rail	File drawer, set of 2				MD6-FS	14.
Bumper kits for mobile pedestal	21"H pedestal			21"	AS1 BKL	47.
	26"H pedestal			26"	AS1 BKH	56.
Pencil tray 	Personal or data drawer for 16" (letter width) Peds	13 1/4"	5 7/8"	1"	AS2 PT(C)	47.
	Personal or data drawer for 16" (letter width) Peds	13 1/4"	5 7/8"	1"	AS2 PT(N)	40.
Pencil tray adapter 	Use with 19" (Legal width) peds Includes metal adapter tray and plastic pencil tray				RPETAD	87.

Order Code	Specification Information	Application Notes
Example: AS2 PT <hr/> AS2 Pedestal <hr/> PT Pencil tray	Pencil tray is molded plastic and is available in black or clear. Black: N Clear: C Replacement worksurface stiffeners are black painted steel. Bumper kit is trim grey plastic.	Pencil tray sets in top of personal or data drawer. Moveable dividers organize pencils, pens, and paper clips in separate compartments. Drawer divider mounts in slots in bottom of personal or data drawer. U-shaped divider supports two rows of four CDs with titles visible in data drawer. File support spans width of file drawer to support side-to-side letter or legal width suspended files.

Wood or laminate case

Pedestals, wood drawer interiors

AutoStrada

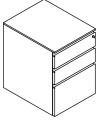
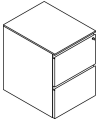
description	type	h	w	d	pattern no.	L	V1	V2	V3
	19" deep	26"	16"	19"	AFPB10(E/P)(W)() ()	\$1,494.	\$1,767.	\$1,990.	\$2,579.
		26"	19"	19"	AFPB11(E/P)(W)() ()	1,494.	1,767.	1,990.	2,579.
	23" deep	26"	16"	23"	AFPB20(E/P)(W)() ()	1,641.	1,940.	2,185.	2,832.
		26"	19"	23"	AFPB21(E/P)(W)() ()	1,641.	1,940.	2,185.	2,832.
	29" deep	26"	16"	29"	AFPB30(E/P)(W)() ()	1,887.	2,228.	2,508.	3,255.
		26"	19"	29"	AFPB31(E/P)(W)() ()	1,887.	2,228.	2,508.	3,255.
	19" deep	26"	16"	19"	AFPF10(E/P)(W)() ()	1,392.	1,641.	1,850.	2,404.
		26"	19"	19"	AFPF11(E/P)(W)() ()	1,392.	1,641.	1,850.	2,404.
		26"	30"	19"	AFPF12(E/P)(W)() ()	1,797.	2,118.	2,380.	3,096.
		26"	36"	19"	AFPF13(E/P)(W)() ()	2,197.	2,598.	2,925.	3,800.
		26"	42"	19"	AFPF14(E/P)(W)() () *	2,695.	3,186.	3,594.	4,673.
	23" deep	26"	16"	23"	AFPF20(E/P)(W)() ()	1,599.	1,888.	2,128.	2,764.
		26"	19"	23"	AFPF21(E/P)(W)() ()	1,599.	1,888.	2,128.	2,764.
		26"	30"	23"	AFPF22(E/P)(W)() ()	2,061.	2,434.	2,741.	3,559.
		26"	36"	23"	AFPF23(E/P)(W)() ()	2,528.	2,987.	3,366.	4,374.
		26"	42"	23"	AFPF24(E/P)(W)() () *	3,100.	3,663.	4,134.	5,374.
	29" deep	26"	16"	29"	AFPF30(E/P)(W)() ()	1,840.	2,172.	2,446.	3,178.
		26"	19"	29"	AFPF31(E/P)(W)() ()	1,840.	2,172.	2,446.	3,178.

Order Code	Specification Information	Application Notes
Example: AFPB21EWW316AA	<i>To order please specify pattern number including:</i>	
A AutoStrada	1. Pedestal type (<i>embedded in pattern number</i>)	5. Pull
F Floor standing	<i>F = Floor standing</i>	<i>E = extruded aluminum pull</i>
P Pedestal	<i>M = Mobile</i>	<i>P = extruded aluminum protruding pull</i>
B Box/Box/File configuration	2. Pedestal configuration	6. Interior
2 23" deep (<i>nominal</i>)	<i>B = BBF (floorstanding) or BF (mobile)</i>	<i>W = wood drawer interior</i>
1 19" wide (<i>nominal</i>)	<i>F = File/File</i>	7. Finish
E Extruded aluminum pull	3. Depth (<i>nominal</i>)	<i>Laminate, V1, V2 or V3 finish</i>
W Wood interior	<i>1 = 19" deep</i>	8. Finish, pull
V316 Finish, Maple	<i>2 = 23" deep</i>	<i>Anodized aluminum or painted finish options listed on page 10 excluding silver.</i>
AA Finish, pull (anodized aluminum)	<i>3 = 29" deep *</i>	See page 8 for finish options applicable.
	<i>(*available only in 16" or 19" widths)</i>	Product on this page will accept wood grain laminate where laminate is currently an option.
	4. Width	Note: Optional cabinet feet are recommended when pedestals used in free-standing applications to achieve overall desk height of 29 ⁵ / ₈ " (see page 266).
	<i>0 = 16" wide (nominal)</i>	Primary finished top required in freestanding applications, ordered separately when item stands alone.
	<i>1 = 19" wide (nominal)</i>	
	<i>2 = 30" wide (nominal)</i>	
	<i>3 = 36" wide (nominal)</i>	
	<i>4 = 42" wide (nominal)</i>	
		Wood pencil tray included with BBF pedestals.
		Actual depth nominal plus 3/8", finished back adds 1/2" (see page 195 for backs). Mobile pedestal includes finished back. All pedestals on this page include a finished sub-top and anti-tip spacer. Height to underside of worksurface including anti-tip spacer is 27"h. Optional work surface stand-offs (to use in place of anti-tip spacer) are specified separately from page 266.
		19" wide (nominal) units accommodate legal filing front to back. File bars included to accommodate letter filing front to back. 30", 36" and 42" wide units include file bars to accommodate legal and letter filing front to back and side to side.
		File drawers are bottom loadable for 30" and 36" only.
		* 42" are not bottom loadable.
		Note: 42" wide pedestals, require 4 counter weights.
		Pedestals drilled for locks, keying instructions must accompany order.

Wood or laminate case

Pedestals, wood drawer interiors

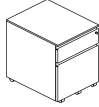
description	type	h	w	d	pattern no.	L	V1	V2	V3
Counterweight (for file/file configurations when used in single use freestanding applications)					RCOUNTWT	\$109.			
 Mobile ped, BF	19" deep	21 3/4"	16"	19"	AMPB10(E/P)(W)() ()	2,020.	2,383.	2,684.	3,489.
		21 3/4"	19"	19"	AMPB11(E/P)(W)() ()	2,020.	2,383.	2,684.	3,489.
	23" deep	21 3/4"	16"	23"	AMPB20(E/P)(W)() ()	2,323.	2,738.	3,090.	4,015.
		21 3/4"	19"	23"	AMPB21(E/P)(W)() ()	2,323.	2,738.	3,090.	4,015.

Order Code	Specification Information	Application Notes
Example: AFPB21EWW316AA A AutoStrada F Floor standing P Pedestal B Box/Box/File configuration 2 23" deep (nominal) 1 19" wide (nominal) E Extruded aluminum pull W Wood interior V316 Finish, Maple AA Finish, pull (anodized aluminum)	To order please specify pattern number including: 1. Pedestal type (embedded in pattern number) <i>F = Floor standing</i> <i>M = Mobile</i> 2. Pedestal configuration <i>B = BBF (floorstanding) or BF (mobile)</i> <i>F = File/File</i> 3. Depth (nominal) <i>1 = 19" deep</i> <i>2 = 23" deep</i> <i>3 = 29" deep *</i> (*available only in 16" or 19" widths) 4. Width <i>0 = 16" wide (nominal)</i> <i>1 = 19" wide (nominal)</i> <i>2 = 30" wide (nominal)</i> <i>3 = 36" wide (nominal)</i> <i>4 = 42" wide (nominal)</i>	5. Pull <i>E = extruded aluminum pull</i> <i>P = extruded aluminum protruding pull</i> 6. Interior <i>W = wood drawer interior</i> 7. Finish <i>Laminate, V1, V2 or V3 finish</i> 8. Finish, pull <i>Anodized aluminum or painted finish options listed on page 10 excluding silver.</i> See page 8 for finish options applicable. Product on this page will accept wood grain laminate where laminate is currently an option. Note: Optional cabinet feet are recommended when pedestals used in free-standing applications to achieve overall desk height of 29 5/8" (see page 266). Primary finished top required in freestanding applications, ordered separately when item stands alone. Wood pencil tray included with BBF pedestals.
		Actual depth nominal plus 3/8", finished back adds 1/2" (see page 195 for backs). Mobile pedestal includes finished back. All pedestals on this page include a finished sub-top and anti-tip spacer. Height to underside of worksurface including anti-tip spacer is 27"h. Optional work surface stand-offs (to use in place of anti-tip spacer) are specified separately from page 266. 19" wide (nominal) units accommodate legal filing front to back. File bars included to accommodate letter filing front to back. 30", 36" and 42" wide units include file bars to accommodate legal and letter filing front to back and side to side. File drawers are bottom loadable for 30" and 36" only. * 42" are not bottom loadable. Note: 42" wide pedestals, require 4 counter weights. Pedestals drilled for locks, keying instructions must accompany order.

Wood or laminate case

Pedestals, metal drawer interiors

AutoStrada

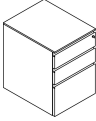
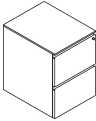
description	type	h	w	d	pattern no.	L	V1	V2	V3	
	19" deep	26"	16"	19"	AFPB10(E/P)(M)() ()	\$1,356.	\$1,611.	\$1,833.	\$2,418.	
		26"	19"	19"	AFPB11(E/P)(M)() ()	1,356.	1,611.	1,833.	2,418.	
	23" deep	26"	16"	23"	AFPB20(E/P)(M)() ()	1,500.	1,784.	2,027.	2,669.	
		26"	19"	23"	AFPB21(E/P)(M)() ()	1,500.	1,784.	2,027.	2,669.	
	29" deep	26"	16"	29"	AFPB30(E/P)(M)() ()	1,740.	2,067.	2,346.	3,083.	
		26"	19"	29"	AFPB31(E/P)(M)() ()	1,740.	2,067.	2,346.	3,083.	
		19" deep	26"	16"	19"	AFPF10(E/P)(M)() ()	1,252.	1,487.	1,694.	2,242.
			26"	19"	19"	AFPF11(E/P)(M)() ()	1,252.	1,487.	1,694.	2,242.
26"			30"	19"	AFPF12(E/P)(M)() ()	1,530.	1,820.	2,086.	2,791.	
26"			36"	19"	AFPF13(E/P)(M)() ()	1,924.	2,295.	2,624.	3,489.	
23" deep		26"	16"	23"	AFPF20(E/P)(M)() ()	1,458.	1,730.	1,970.	2,600.	
		26"	19"	23"	AFPF21(E/P)(M)() ()	1,458.	1,730.	1,970.	2,600.	
		26"	30"	23"	AFPF22(E/P)(M)() ()	1,791.	2,132.	2,442.	3,252.	
		26"	36"	23"	AFPF23(E/P)(M)() ()	2,253.	2,681.	3,061.	4,055.	
29" deep		26"	16"	29"	AFPF30(E/P)(M)() ()	1,695.	2,010.	2,283.	3,008.	
		26"	19"	29"	AFPF31(E/P)(M)() ()	1,695.	2,010.	2,283.	3,008.	
Counterweight (for file/file configurations when used in single use freestanding applications)					RCOUNTWT	109.				

Order Code	Specification Information	Application Notes
Example: AFPB21EMV316AA	To order please specify pattern number including:	
A AutoStrada	1. Pedestal type (embedded in pattern number) F = Floor standing M = Mobile	5. Pull E = extruded aluminum pull P = extruded aluminum protruding pull
F Floor standing	2. Pedestal configuration B = BBF (floorstanding) or BF (mobile) F = File/File	6. Interior M = metal drawer interior
P Pedestal	3. Depth (nominal) 1 = 19" deep 2 = 23" deep 3 = 29" deep * (*available only in 16" or 19" widths)	7. Finish Laminate, V1, V2 or V3 finish
B Box/Box/File configuration	4. Width 0 = 16" wide (nominal) 1 = 19" wide (nominal) 2 = 30" wide (nominal) 3 = 36" wide (nominal)	8. Finish, pull Anodized aluminum or painted finish options listed on page 10 excluding silver.
2 23" deep (nominal)		See page 8 for finish options applicable.
1 19" wide (nominal)		Product on this page will accept wood grain laminate where laminate is currently an option.
E Extruded aluminum pull		Note: Optional cabinet feet are recommended when pedestals used in free-standing applications to achieve overall desk height of 29 ⁵ / ₈ " (see page 266).
M Metal interior		Primary finished top required in freestanding applications, ordered separately when item stands alone.
V316 Finish, Maple		Pencil tray to be ordered separately see page 189.
AA Finish, pull (anodized aluminum)		

Wood or laminate case
Pedestals, metal drawer interiors

AutoStrada

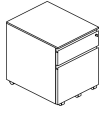
description	type	h	w	d	pattern no.	L	V1	V2	V3
 Mobile ped, BF	19" deep	21 ³ / ₄ "	16"	19"	AMPB10(E/P)(M)() ()	\$1,904.	\$2,253.	\$2,555.	\$3,350.
		21 ³ / ₄ "	19"	19"	AMPB11(E/P)(M)() ()	1,904.	2,253.	2,555.	3,350.
	23" deep	21 ³ / ₄ "	16"	23"	AMPB20(E/P)(M)() ()	2,204.	2,607.	2,954.	3,868.
		21 ³ / ₄ "	19"	23"	AMPB21(E/P)(M)() ()	2,204.	2,607.	2,954.	3,868.

Order Code

Example:	AFPB21EMV316AA
A	AutoStrada
F	Floor standing
P	Pedestal
B	Box/Box/File configuration
2	23" deep (nominal)
1	19" wide (nominal)
E	Extruded aluminum pull
M	Metal interior
V316	Finish, Maple
AA	Finish, pull (anodized aluminum)

Specification Information

To order please specify pattern number including:

- Pedestal type (embedded in pattern number)
F = Floor standing
M = Mobile
- Pedestal configuration
B = BBF (floorstanding) or BF (mobile)
F = File/File
- Depth (nominal)
1 = 19" deep
2 = 23" deep
3 = 29" deep *
(*available only in 16" or 19" widths)
- Width
0 = 16" wide (nominal)
1 = 19" wide (nominal)
2 = 30" wide (nominal)
3 = 36" wide (nominal)

Application Notes

- Pull
E = extruded aluminum pull
P = extruded aluminum protruding pull
- Interior
M = metal drawer interior
- Finish
Laminate, V1, V2 or V3 finish
- Finish, pull
Anodized aluminum or painted finish options listed on page 10 excluding silver.

See page 8 for finish options applicable.

Product on this page will accept wood grain laminate where laminate is currently an option.

Note: Optional cabinet feet are recommended when pedestals used in free-standing applications to achieve overall desk height of 29⁵/₈" (see page 266).

Primary finished top required in freestanding applications, ordered separately when item stands alone.

Pencil tray to be ordered separately see page 189.

Actual depth nominal plus 3/8", finished back adds 1/2" (see page 195 for backs). Mobile pedestal includes finished back. All pedestals on this page include a finished sub-top and anti-tip spacer. Height to underside of worksurface including anti-tip spacer is 27"h. Optional work surface stand-offs (to use in place of anti-tip spacer) are specified separately from page 266.

19" wide (nominal) units accommodate legal filing front to back. File bars included to accommodate letter filing front to back. 30", 36" and 42" wide units include file bars to accommodate legal and letter filing front to back and side to side.

File drawers are bottom loadable for 30" and 36" only. 42" are not bottom loadable.

Pedestals drilled for locks, keying instructions must accompany order.

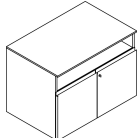

Wood or laminate case

Lower storage

description	type	h	w	d	pattern no.	L	V1	V2	V3
 <p>36" w shown</p>	19" deep	26"	16"	19"	AFPHL10(E/P)(L/N)(W)() ()	\$953.	\$1,101.	\$1,269.	\$1,649.
		26"	16"	19"	AFPHR10(E/P)(L/N)(W)() ()	953.	1,101.	1,269.	1,649.
		26"	19"	19"	AFPHL11(E/P)(L/N)(W)() ()	953.	1,101.	1,269.	1,649.
		26"	19"	19"	AFPHR11(E/P)(L/N)(W)() ()	953.	1,101.	1,269.	1,649.
		26"	30"	19"	AFPH12(E/P)(L/N)(W)() ()	1,134.	1,308.	1,502.	1,955.
		26"	36"	19"	AFPH13(E/P)(L/N)(W)() ()	1,412.	1,634.	1,882.	2,444.
		26"	42"	19"	AFPH14(E/P)(L/N)(W)() ()	1,768.	2,035.	2,349.	3,056.
	23" deep	26"	16"	23"	AFPHL20(E/P)(L/N)(W)() ()	1,096.	1,269.	1,460.	1,896.
		26"	16"	23"	AFPHR20(E/P)(L/N)(W)() ()	1,096.	1,269.	1,460.	1,896.
		26"	19"	23"	AFPHL21(E/P)(L/N)(W)() ()	1,096.	1,269.	1,460.	1,896.
		26"	19"	23"	AFPHR21(E/P)(L/N)(W)() ()	1,096.	1,269.	1,460.	1,896.
		26"	30"	23"	AFPH22(E/P)(L/N)(W)() ()	1,299.	1,505.	1,730.	2,249.
		26"	36"	23"	AFPH23(E/P)(L/N)(W)() ()	1,626.	1,880.	2,161.	2,810.
		26"	42"	23"	AFPH24(E/P)(L/N)(W)() ()	2,032.	2,344.	2,700.	3,510.

Order Code	Specification Information	Application Notes
Example: AFPHL21ELWV316AA	To order please specify pattern number including:	Units on this page include a finished sub-top and anti-tip spacer. Height to underside of worksurface including anti-tip spacer is 27" h. Optional work surface stand-offs (to use in place of anti-tip spacer) are specified separately from page 266.
A AutoStrada	1. Hand (applicable 16" and 19" wide units) <i>L = hinges on left</i> <i>R = hinges on right</i>	Primary finished top required in freestanding applications, ordered separately when item stands alone.
F Floor standing	2. Depth <i>1 = 20" deep</i> <i>2 = 24" deep</i>	Note: Optional cabinet feet are recommended when units used in free-standing applications to achieve overall desk height of 29 3/8" (see page 266).
P Pedestal	3. Width <i>0 = 16" wide</i> <i>1 = 19" wide</i> <i>2 = 30" wide</i> <i>3 = 36" wide</i> <i>4 = 42" wide</i>	
H Hinged door/open shelf above	4. Pull <i>E = Extruded aluminum pull</i> <i>P = Extruded aluminum protruding pull</i>	
L Left hand	5. Lock option <i>L = drilled for locks</i> <i>N = not drilled for locks</i>	
2 24" deep	6. Interior <i>W = wood interior (only)</i>	
1 19" wide	7. Finish <i>Laminate, V1, V2 or V3 finish</i>	
E Extruded aluminum pull	8. Finish, pull <i>Anodized aluminum or painted finish options listed on page 10 excluding silver.</i>	
L Drilled for lock	Optional lock drilled to be specified. If drilled for locks selected, keying instructions must accompany order.	
W Wood interior	See page 8 for finish options applicable.	
V316 Finish, Maple	Product on this page will accept wood grain laminate where laminate is currently an option.	
AA Finish, pull (anodized aluminum)		

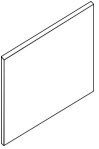
Wood or laminate case
Finished backs for lower storage

description	h	w	thickness	pattern no.	L	V1	V2	V3
Finished back 	25 1/2"	16"	1/2"	AFB16 ()	\$131.	\$146.	\$169.	\$222.
	25 1/2"	19"	1/2"	AFB19 ()	131.	146.	169.	222.
	25 1/2"	30"	1/2"	AFB30 ()	260.	291.	334.	434.
	25 1/2"	36"	1/2"	AFB36 ()	308.	347.	399.	516.
	25 1/2"	42"	1/2"	AFB42 ()	428.	516.	597.	776.
	25 1/2"	60"	1/2"	AFB60 ()	518.	633.	726.	943.
	25 1/2"	72"	1/2"	AFB72 ()	598.	726.	836.	1,085.
	25 1/2"	84"	1/2"	AFB84 ()	673.	822.	942.	1,226.
	25 1/2"	90"	1/2"	AFB90 ()	714.	869.	996.	1,296.
25 1/2"	96"	1/2"	AFB96 ()	734.	889.	1,022.	1,329.	
Pedestal filler strip	25 1/2"	5"	1/2"	AWCPFS ()	100.	145.	146.	154.
								
Pedestal filler for 3/4 planning	20 3/4"	6"	1/2"	AWCPFS19 ()	92.	133.	136.	144.
								

Order Code

Example: AFB19V316
A AutoStrada
FB Finished back
19 19" wide
V316 Finish, Maple

Specification Information

To order please specify pattern number including:

- Width
 - 16 = for 16" wide units
 - 19 = for 19" wide units
 - 30 = for 30" wide units
 - 36 = for 36" wide units
 - 42 = for 42" wide units
 - 60 = for two 30" w side by side
 - 72 = for two 36" w side by side
 - 84 = for two 42" w side by side
 - 90 = for three 30" w side by side
 - 96 = for two 30" w & one 36" w side by side
- Finish
 - Laminate, V1, V2 or V3 finish

Application Notes



Finished backs are used with lower storage in free-standing applications where the back is exposed. Backs are 1/2" thick. Finished backs also recommended for "ganging" units together when creating build-to-spec credenza units.

Pedestal filler strip used in lieu of finished back when full back not exposed to finish gap to wall.

See page 8 for finish options applicable.

Product on this page will accept wood grain laminate where laminate is currently an option.

Wood or laminate case
Pedestals, Open Access
Wood drawer interior

description	w	d	h	pattern no.	L	V1	V2	V3
Pedestal, Open Access 	30"	19"	20 3/4"	AFPA12()	\$1,025.	\$1,183.	\$1,359.	\$1,835.
	36"	19"	20 3/4"	AFPA13()	1,219.	1,409.	1,624.	2,188.
	30"	23"	20 3/4"	AFPA22()	1,276.	1,480.	1,705.	2,299.
	36"	23"	20 3/4"	AFPA23()	1,525.	1,761.	2,026.	2,736.
Pedestal, Hinge doors 	30"	19"	20 3/4"	AFPHD12(E/P)W()()	1,236.	1,410.	1,604.	2,057.
	36"	19"	20 3/4"	AFPHD13(E/P)W()()	1,515.	1,736.	1,984.	2,546.
	30"	23"	20 3/4"	AFPHD22(E/P)W()()	1,401.	1,607.	1,833.	2,351.
	36"	23"	20 3/4"	AFPHD23(E/P)W()()	1,728.	1,982.	2,263.	2,912.
Pedestal, (desk height planning) box/file configuration 	16"	19"	20 3/4"	AFPR10(E/P)W()()	1,597.	1,835.	2,092.	2,681.
	19"	19"	20 3/4"	AFPR11(E/P)W()()	1,597.	1,835.	2,092.	2,681.
	30"	19"	20 3/4"	AFPR12(E/P)W()()	1,990.	2,287.	2,611.	3,358.
	36"	19"	20 3/4"	AFPR13(E/P)W()()	2,299.	2,650.	3,028.	3,902.
	16"	23"	20 3/4"	AFPR20(E/P)W()()	1,744.	2,005.	2,288.	2,935.
	19"	23"	20 3/4"	AFPR21(E/P)W()()	1,744.	2,005.	2,288.	2,935.
	30"	23"	20 3/4"	AFPR22(E/P)W()()	1,990.	2,287.	2,611.	3,358.
	36"	23"	20 3/4"	AFPR23(E/P)W()()	2,630.	3,031.	3,469.	4,476.

Order Code

Example: AFPA12()
A AutoStrada
F Floor Standing
P Pedestal
A Open Access Configuration
1 19" deep
2 30" wide
316 Finish

Specification Information

To order please specify pattern number including:

- Pedestal type (embedded in pattern number)
 A = Open access
 HD = Hinge doors
 R = Box File
- Depth (nominal)
 1 = 19" deep
 2 = 23" deep
- Width (nominal)
 2 = 30" wide
 3 = 36" wide
- Finish:
Laminate, V1, V2 or V3

Application Notes

Product on this page will accept wood grain laminate where laminate is currently an option.

The open access pedestals are available with Wood interior only.

Wood or laminate case
Pedestals, Open Access
Metal drawer interior

description	w	d	h	pattern no.	L	V1	V2	V3
Pedestal, (desk height planning) box/file configuration 	16"	19"	20 ³ / ₄ "	AFPR10(E/P)M() ()	\$1,459.	\$1,682.	\$1,935.	\$2,520.
	19"	19"	20 ³ / ₄ "	AFPR11(E/P)M() ()	1,459.	1,682.	1,935.	2,520.
	30"	19"	20 ³ / ₄ "	AFPR12(E/P)M() ()	1,843.	2,129.	2,449.	3,186.
	36"	19"	20 ³ / ₄ "	AFPR13(E/P)M() ()	2,026.	2,352.	2,727.	3,592.
	16"	23"	20 ³ / ₄ "	AFPR20(E/P)M() ()	1,602.	1,851.	2,130.	2,772.
	19"	23"	20 ³ / ₄ "	AFPR21(E/P)M() ()	1,602.	1,851.	2,130.	2,772.
	30"	23"	20 ³ / ₄ "	AFPR22(E/P)M() ()	1,843.	2,129.	2,449.	3,186.
	36"	23"	20 ³ / ₄ "	AFPR23(E/P)M() ()	2,355.	2,732.	3,163.	4,157.

Order Code

Example:	AFPA10(E/P)()W()
A	AutoStrada
F	Floor Standing
P	Pedestal
R	Box / File Configuration
1	19" deep
0	16" wide
E	Extruded pull option
M	Metal interior
V316	Pedestal finish
AA	Pull Finish

Specification Information

To order please specify pattern number including:

- Pedestal type (embedded in pattern number)
 A = Open access
 HD = Hinge doors
 R = Box File
- Depth (nominal)
 1 = 19" deep
 2 = 23" deep
- Width (nominal)
 0 = 16" wide
 1 = 19" wide
 2 = 30" wide
 3 = 36" wide
- Pull
 E = Extruded
 P = Extruded aluminum

Application Notes

- Interior Option:
 W = Wood
 M = Metal
- Pedestal Finish:
 Laminate, V1, V2 or V3
- Pull finish:
 Anodized aluminum or painted finish options, listed on page 10 excluding silver.

See page 8 for finish options.

Product on this page will accept wood grain laminate where laminate is currently an option.

The open access pedestals are available with Wood interior only.

Wood or laminate case
 Pedestals, Equipment style, 22³/₄" high
 Wood drawer interiors

description	type	h	w	d	pattern no.	L	V1	V2	V3
 Pedestal, Equipment	19" deep	20 ³ / ₄ "	30"	19"	AFPE12(L/R)(E/P)()W()	\$2,249.	\$3,194.	\$3,530.	\$4,212.
		20 ³ / ₄ "	36"	19"	AFPE13(L/R)(E/P)()W()	2,304.	3,260.	3,605.	4,337.
	23" deep	20 ³ / ₄ "	30"	23"	AFPE22(L/R)(E/P)()W()	2,290.	3,252.	3,588.	4,344.
		20 ³ / ₄ "	36"	23"	AFPE23(L/R)(E/P)()W()	2,342.	3,310.	3,679.	4,468.

Order Code	Specification Information	Application Notes
Example: AFPE12(L/R)(E/P)()W()	<i>To order please specify pattern number including:</i>	
A AutoStrada		6. Pull finish Anodized aluminum or painted finish options listed on page 9 excluding silver
F Floor standing	1. Pedestal type (<i>embedded in pattern number</i>) E = Equipment pedestal	7. Interior W = Wood interior
P Pedestal	2. Depth (nominal) 1 = 19" deep 2 = 23" deep	8. Finish: Wood or Laminate
E Equipment	3. Width (nominal) 2 = 30" wide 3 = 36" wide	<i>See page 8 for finish options applicable</i>
1 19" deep	4. Hand L = Left hand R = Right hand	
2 30" wide	5. Pull Option E = Extruded P = Extruded Aluminum	Product on this page will accept wood grain laminate where laminate is currently an option. The equipment pedestals are available with Wood interior only.
L Left hand		
E Pull option		
AA Pull finish		
W Wood interior		
V316 Finish, Maple		

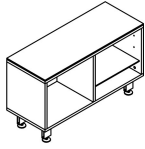
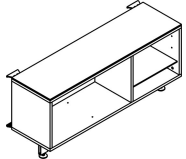
description	w	d	h	pattern no.	L	V1	V2	V3	list
Box shelf, freestanding 	36"	15"	21"	ASBF1 36() ()	\$1,038.	\$1,553.	\$1,792.	\$2,222.	
	42"	15"	21"	ASBF1 42() ()	1,073.	1,591.	1,832.	2,315.	
	48"	15"	21"	ASBF1 48() ()	1,109.	1,630.	1,872.	2,410.	
Box shelf, spine support 	36"	15"	21"	ASBS1 36() () ()	1,038.	1,553.	1,792.	2,222.	
	42"	15"	21"	ASBS1 42() () ()	1,073.	1,591.	1,832.	2,315.	
	48"	15"	21"	ASBS1 48() () ()	1,109.	1,630.	1,872.	2,410.	
Box top	36"	15"		ASBT1 36()					220.
	42"	15"		ASBT1 42()					235.
	48"	15"		ASBT1 48()					249.

Order Code	Specification Information	Application Notes
Example: ASBF1 48 114 AA AS AutoStrada storage B Box shelf F1 freestanding 48 width 114 case finish AA leg finish	To order please specify pattern number including: Box shelf freestanding 1. Finish, Case <i>Laminate, V1, V2 or V3</i> 2. Finish, Legs <i>Clear anodized aluminum or painted finish option</i> Box shelf spine support 1. Finish, Case <i>Laminate, V1, V2 or V3</i> 2. Finish, Legs <i>Clear anodized aluminum or painted finish options listed on page 10 excluding silver.</i> 3. Finish, Bracket <i>All standard paint finishes</i> Painted finish options listed on page 8 excluding silver.	Box top 1. Finish, surface <i>TEMP Clear tempered glass</i> Product on this page will accept wood grain laminate where laminate is currently an option. Box shelf is an open storage unit for binders or other material. Box shelf has full back, sides and partition which support one 16" wide, adjustable height glass shelf. Freestanding box shelf includes four clear anodized aluminum or painted legs with leveling glides. Spine support version includes two legs and two brackets that clamp on to the structural base cover of AutoStrada spine or Currents service wall. Box shelf also serves as spine support in place of outrigger. Fixed height end support bracket can be attached behind spine-attached Box shelf. Optional Box top is 1/4" clear tempered glass.

Overhead storage, wood cases

Stack-on Overheads (for use with Medians)

open

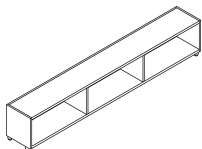
description	type	sections	h	w	d	pattern no.	L	V1	V2	V3	
 <p>96" w shown</p>	binder depth	2	15"	42"	14 1/4"	ASOBO42 () ()	\$1,882.	\$1,964.	\$2,259.	\$2,936.	
		2	15"	48"	14 1/4"	ASOBO48 () ()	1,949.	2,036.	2,339.	3,041.	
		2	15"	54"	14 1/4"	ASOBO54 () ()	1,973.	2,057.	2,368.	3,077.	
		2	15"	60"	14 1/4"	ASOBO60 () ()	1,993.	2,082.	2,395.	3,114.	
		2	15"	66"	14 1/4"	ASOBO66 () ()	2,218.	2,315.	2,663.	3,463.	
		2	15"	72"	14 1/4"	ASOBO72 () ()	2,445.	2,548.	2,932.	3,810.	
		3	15"	78"	14 1/4"	ASOBO78 () ()	2,524.	2,634.	3,028.	3,939.	
		3	15"	84"	14 1/4"	ASOBO84 () ()	2,608.	2,719.	3,128.	4,066.	
		3	15"	90"	14 1/4"	ASOBO90 () ()	2,688.	2,804.	3,225.	4,193.	
		3	15"	96"	14 1/4"	ASOBO96 () ()	2,784.	2,909.	3,342.	4,344.	
		legal depth	2	15"	42"	17 1/4"	ASOGO42 () ()	2,032.	2,116.	2,443.	3,172.
			2	15"	48"	17 1/4"	ASOGO48 () ()	2,106.	2,197.	2,526.	3,286.
			2	15"	54"	17 1/4"	ASOGO54 () ()	2,128.	2,223.	2,558.	3,326.
			2	15"	60"	17 1/4"	ASOGO60 () ()	2,153.	2,247.	2,585.	3,363.
			2	15"	66"	17 1/4"	ASOGO66 () ()	2,394.	2,500.	2,877.	3,738.
			2	15"	72"	17 1/4"	ASOGO72 () ()	2,636.	2,750.	3,166.	4,113.
			3	15"	78"	17 1/4"	ASOGO78 () ()	2,725.	2,843.	3,272.	4,255.
			3	15"	84"	17 1/4"	ASOGO84 () ()	2,814.	2,936.	3,377.	4,391.
3	15"		90"	17 1/4"	ASOGO90 () ()	2,901.	3,028.	3,482.	4,529.		
3	15"		96"	17 1/4"	ASOGO96 () ()	3,006.	3,140.	3,610.	4,695.		

Order Code	Specification Information	Application Notes
Example: ASOBO42V316AA A AutoStrada S Stack-on O Overhead B Binder depth O Open 42 42" wide V316 Finish, Maple AA Finish, Support feet	To order please specify pattern number including: 1. Depth <i>B = Binder depth</i> <i>G = Legal depth</i> 2. Width 3. Finish <i>Laminate, V1, V2 or V3</i> 4. Finish, support feet <i>Anodized aluminum or painted finish options listed on page 10 excluding silver.</i> See page 8 for finish options applicable. Product on this page will accept wood grain laminate where laminate is currently an option.	Stack-on overheads, as the description implies "stack-on" median top shelf, please make sure median top shelf depth and overhead depth correspond. Stack-on overheads correspond to interior width of medians and median storage. NOTE: Knoll does not assume any responsibility for the installation, attachment or the securing of wall hung units to the wall. A certified building contractor should be consulted. Please refer to wall mounting information on page 324 .

Overhead storage, wood cases

Stack-on Overheads (for use with Medians)

hinged door

description	type	# drs/locks	h	w	d	pattern no.	L	V1	V2	V3
Stack-on Overhead, Wood Hinged Doors	binder depth	3/2	15"	42"	15 1/4"	ASOBD42 () () ()	\$2,087.	\$2,179.	\$2,508.	\$3,258.
		3/2	15"	48"	15 1/4"	ASOBD48 () () ()	2,163.	2,259.	2,596.	3,377.
		3/2	15"	54"	15 1/4"	ASOBD54 () () ()	2,187.	2,285.	2,628.	3,417.
		4/2	15"	60"	15 1/4"	ASOBD60 () () ()	2,212.	2,312.	2,658.	3,454.
		4/2	15"	66"	15 1/4"	ASOBD66 () () ()	2,461.	2,567.	2,956.	3,842.
		4/2	15"	72"	15 1/4"	ASOBD72 () () ()	2,713.	2,834.	3,261.	4,240.
		5/3	15"	78"	15 1/4"	ASOBD78 () () ()	2,802.	2,923.	3,363.	4,373.
		5/3	15"	84"	15 1/4"	ASOBD84 () () ()	2,894.	3,018.	3,470.	4,513.
		6/3	15"	90"	15 1/4"	ASOBD90 () () ()	2,987.	3,115.	3,581.	4,657.
	6/3	15"	96"	15 1/4"	ASOBD96 () () ()	3,090.	3,229.	3,716.	4,829.	
	legal depth	3/2	15"	42"	18 1/4"	ASOGD42 () () ()	2,254.	2,353.	2,708.	3,521.
		3/2	15"	48"	18 1/4"	ASOGD48 () () ()	2,336.	2,443.	2,804.	3,648.
		3/2	15"	54"	18 1/4"	ASOGD54 () () ()	2,363.	2,469.	2,836.	3,690.
		4/2	15"	60"	18 1/4"	ASOGD60 () () ()	2,390.	2,496.	2,871.	3,731.
		4/2	15"	66"	18 1/4"	ASOGD66 () () ()	2,659.	2,775.	3,193.	4,152.
		4/2	15"	72"	18 1/4"	ASOGD72 () () ()	2,929.	3,062.	3,521.	4,580.
		5/3	15"	78"	18 1/4"	ASOGD78 () () ()	3,028.	3,155.	3,631.	4,722.
5/3		15"	84"	18 1/4"	ASOGD84 () () ()	3,122.	3,258.	3,747.	4,874.	
6/3		15"	90"	18 1/4"	ASOGD90 () () ()	3,226.	3,364.	3,868.	5,030.	
6/3	15"	96"	18 1/4"	ASOGD96 () () ()	3,340.	3,487.	4,012.	5,215.		

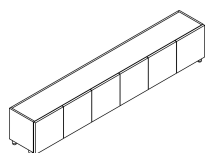

96" w shown

Order Code	Specification Information	Application Notes
Example: ASOBD42LV316AA	<i>To order please specify pattern number including:</i>	Stack-on overheads, as the description implies "stack-on" median top shelf, please make sure median top shelf depth and overhead depth correspond.
A AutoStrada	1. Depth <i>B = Binder depth</i> <i>G = Legal depth</i>	Optional lock drilling to be specified. If drilled for locks selected, keying instructions must accompany order.
S Stack-on	2. Width	Stack-on overheads correspond to interior width of medians and median storage.
O Overhead	3. Lock option <i>L = Lock hole drilled</i> <i>N = Not drilled for locks</i>	Hinged doors extend slightly beyond case construction to allow for easy finger pull access along the bottom. No pulls available.
B Binder depth	4. Finish <i>Laminate, V1, V2 or V3</i>	NOTE: Knoll does not assume any responsibility for the installation, attachment or the securing of wall hung units to the wall.
D Hinged Door	5. Finish, support feet <i>Anodized aluminum or painted finish options listed on page 10 excluding silver.</i>	A certified building contractor should be consulted.
42 42" wide	See page 8 for finish options applicable.	Please refer to wall mounting information on page 324.
L Locking	Product on this page will accept wood grain laminate where laminate is currently an option.	
V316 Finish, Maple		
AA Finish, support feet		

Overhead storage, wood cases

Stack-on Overheads (for use with Medians)

open / hinged door / open

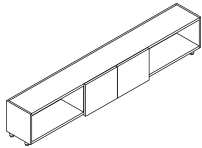
description	type	locks	h	w	d	pattern no.	L	V1	V2	V3
Stack-on Overhead, Open/Wood hinged doors/Open  96" w shown	binder depth	1	15"	60"	15 1/4"	ASOBT60 () ()	\$2,090.	\$2,185.	\$2,514.	\$3,268.
		1	15"	66"	15 1/4"	ASOBT66 () ()	2,328.	2,430.	2,797.	3,635.
		1	15"	72"	15 1/4"	ASOBT72 () ()	2,565.	2,675.	3,077.	4,002.
		1	15"	78"	15 1/4"	ASOBT78 () ()	2,650.	2,766.	3,181.	4,136.
		1	15"	84"	15 1/4"	ASOBT84 () ()	2,736.	2,854.	3,284.	4,268.
		1	15"	90"	15 1/4"	ASOBT90 () ()	2,821.	2,944.	3,387.	4,401.
		1	15"	96"	15 1/4"	ASOBT96 () ()	2,923.	3,056.	3,510.	4,560.
	legal depth	1	15"	60"	18 1/4"	ASOGT60 () ()	2,261.	2,361.	2,715.	3,533.
		1	15"	66"	18 1/4"	ASOGT66 () ()	2,515.	2,623.	3,019.	3,926.
		1	15"	72"	18 1/4"	ASOGT72 () ()	2,770.	2,888.	3,326.	4,322.
		1	15"	78"	18 1/4"	ASOGT78 () ()	2,861.	2,987.	3,435.	4,469.
		1	15"	84"	18 1/4"	ASOGT84 () ()	2,956.	3,085.	3,549.	4,610.
		1	15"	90"	18 1/4"	ASOGT90 () ()	3,046.	3,180.	3,655.	4,755.
		1	15"	96"	18 1/4"	ASOGT96 () ()	3,156.	3,297.	3,791.	4,926.

Order Code	Specification Information	Application Notes
Example: ASOBT60LV316AA	<i>To order please specify pattern number including:</i>	Stack-on overheads, as the description implies "stack-on" median top shelf, please make sure median top shelf depth and overhead depth correspond.
A AutoStrada	1. Depth <i>B = Binder depth</i> <i>G = Legal depth</i>	Optional lock drilling to be specified. If drilled for locks selected, keying instructions must accompany order.
S Stack-on	2. Width	Stack-on overheads correspond to interior width of medians and median storage.
O Overhead	3. Lock option <i>L = Lock hole drilled</i> <i>N = Not drilled for locks</i>	NOTE: Knoll does not assume any responsibility for the installation, attachment or the securing of wall hung units to the wall.
B Binder depth	4. Finish <i>Laminate, V1, V2 or V3</i>	A certified building contractor should be consulted.
T Open/Hinged Door/Open	5. Finish, support feet <i>Anodized aluminum or painted finish options listed on page 10 excluding silver.</i>	Please refer to wall mounting information on page 324.
60 60" wide	See page 8 for finish options applicable.	
L Locking	Product on this page will accept wood grain laminate where laminate is currently an option.	
V316 Finish, Maple		
AA Finish, support feet		

Overhead storage, wood cases

Stack-on Overheads (for use with Medians with sliding wood door(s))

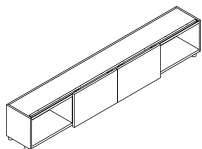
description	type	h	w	d	pattern no.	L	V1	V2	V3	
 <p>96" w shown</p>	binder depth	15"	42"	15 1/4"	ASOBS42 () () ()	\$2,820.	\$3,002.	\$3,796.	\$4,933.	
		15"	48"	15 1/4"	ASOBS48 () () ()	2,922.	3,114.	3,932.	5,110.	
		15"	54"	15 1/4"	ASOBS54 () () ()	2,956.	3,149.	3,976.	5,171.	
		15"	60"	15 1/4"	ASOBS60 () () ()	2,988.	3,183.	4,023.	5,233.	
		15"	66"	15 1/4"	ASOBS66 () () ()	3,327.	3,539.	4,474.	5,815.	
		15"	72"	15 1/4"	ASOBS72 () () ()	3,665.	3,896.	4,926.	6,402.	
		15"	78"	15 1/4"	ASOBS78 () () ()	3,784.	4,028.	5,088.	6,615.	
		15"	84"	15 1/4"	ASOBS84 () () ()	3,908.	4,159.	5,255.	6,829.	
		15"	90"	15 1/4"	ASOBS90 () () ()	4,029.	4,293.	5,418.	7,043.	
		15"	96"	15 1/4"	ASOBS96 () () ()	4,175.	4,449.	5,614.	7,299.	
		legal depth	15"	42"	18 1/4"	ASOGS42 () () ()	3,045.	3,244.	4,100.	5,330.
			15"	48"	18 1/4"	ASOGS48 () () ()	3,156.	3,363.	4,245.	5,519.
			15"	54"	18 1/4"	ASOGS54 () () ()	3,193.	3,402.	4,295.	5,582.
			15"	60"	18 1/4"	ASOGS60 () () ()	3,227.	3,438.	4,346.	5,649.
			15"	66"	18 1/4"	ASOGS66 () () ()	3,592.	3,822.	4,832.	6,283.
			15"	72"	18 1/4"	ASOGS72 () () ()	3,955.	4,210.	5,319.	6,914.
			15"	78"	18 1/4"	ASOGS78 () () ()	4,087.	4,350.	5,497.	7,144.
			15"	84"	18 1/4"	ASOGS84 () () ()	4,220.	4,496.	5,673.	7,376.
15"	90"		18 1/4"	ASOGS90 () () ()	4,352.	4,634.	5,852.	7,604.		
15"	96"		18 1/4"	ASOGS96 () () ()	4,511.	4,804.	6,062.	7,882.		

Order Code	Specification Information	Application Notes
Example: ASOBS42V316AA A AutoStrada S Stack-on O Overhead B Binder depth S Open/Sliding (wood) Door 42 42" wide AR Radius pull option V316 Finish, Maple AA Finish, support feet	To order please specify pattern number including: 1. Depth <i>B = Binder depth</i> <i>G = Legal depth</i> 2. Sliding door material <i>S = wood, same as case</i> <i>R = glass</i> 3. Width 4. Pull option: AR = AutoStrada Radius pull AB = AutoStrada Bar pull 5. Finish <i>Laminate, V1, V2 or V3</i> 6. Finish, support feet and pull <i>Anodized aluminum or painted finish options listed on page 10 excluding silver.</i> See page 8 for finish options applicable. Product on this page will accept wood grain laminate where laminate is currently an option.	Sliding doors are not available with locks. Stack-on overheads, as the description implies "stack-on" median top shelf, please make sure median top shelf depth and overhead depth correspond. Sliding door pulls included, not visible on image. When AA finish specified pull is complimentary painted match to AA, pull not anodized. Stack-on overheads correspond to interior width of medians and median storage. NOTE: Knoll does not assume any responsibility for the installation, attachment or the securing of wall hung units to the wall. A certified building contractor should be consulted. Please refer to wall mounting information on page 324 .

Overhead storage, wood cases

Stack-on Overheads (for use with Medians)

with sliding glass door(s)

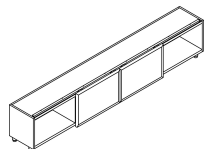
description	type	h	w	d	pattern no.	L	V1	V2	V3				
 <p>96" w shown</p>	Stack-on Overhead, Glass Sliding Door(s)	binder depth	15"	42"	15 1/4"	ASOBR42 () () () ()	\$3,366.	\$3,572.	\$4,450.	\$5,788.			
			15"	48"	15 1/4"	ASOBR48 () () () ()	3,486.	3,702.	4,610.	5,994.			
			15"	54"	15 1/4"	ASOBR54 () () () ()	3,528.	3,745.	4,664.	6,062.			
			15"	60"	15 1/4"	ASOBR60 () () () ()	3,569.	3,787.	4,718.	6,133.			
			15"	66"	15 1/4"	ASOBR66 () () () ()	3,970.	4,213.	5,247.	6,821.			
			15"	72"	15 1/4"	ASOBR72 () () () ()	4,373.	4,635.	5,776.	7,509.			
			15"	78"	15 1/4"	ASOBR78 () () () ()	4,518.	4,794.	5,967.	7,758.			
			15"	84"	15 1/4"	ASOBR84 () () () ()	4,665.	4,948.	6,162.	8,009.			
			15"	90"	15 1/4"	ASOBR90 () () () ()	4,808.	5,105.	6,353.	8,260.			
			15"	96"	15 1/4"	ASOBR96 () () () ()	4,984.	5,292.	6,584.	8,560.			
			legal depth			15"	42"	18 1/4"	ASOGR42 () () () ()	3,633.	3,857.	4,807.	6,248.
						15"	48"	18 1/4"	ASOGR48 () () () ()	3,767.	4,001.	4,977.	6,472.
						15"	54"	18 1/4"	ASOGR54 () () () ()	3,811.	4,045.	5,037.	6,550.
						15"	60"	18 1/4"	ASOGR60 () () () ()	3,850.	4,092.	5,096.	6,626.
						15"	66"	18 1/4"	ASOGR66 () () () ()	4,288.	4,548.	5,666.	7,366.
						15"	72"	18 1/4"	ASOGR72 () () () ()	4,721.	5,008.	6,238.	8,108.
						15"	78"	18 1/4"	ASOGR78 () () () ()	4,880.	5,175.	6,445.	8,378.
15"	84"	18 1/4"				ASOGR84 () () () ()	5,037.	5,345.	6,654.	8,650.			
15"	90"	18 1/4"				ASOGR90 () () () ()	5,195.	5,513.	6,863.	8,921.			
15"	96"	18 1/4"				ASOGR96 () () () ()	5,382.	5,715.	7,109.	9,242.			

Order Code	Specification Information	Application Notes
Example: ASOBR42V316GL6AA AA	To order please specify pattern number including:	Sliding doors are not available with locks.
A AutoStrada	1. Depth <i>B = Binder depth</i>	Stack-on overheads, as the description implies "stack-on" median top shelf, please make sure median top shelf depth and overhead depth correspond.
S Stack-on	<i>G = Legal depth</i>	
O Overhead	2. Sliding door material <i>S = wood, same as case</i>	Sliding door pulls included, not visible on image. When AA finish specified pull is complimentary painted match, pull not anodized.
B Binder depth	<i>R = glass</i>	
R Open/Sliding (glass) Door	3. Width	See page 8 for finish options applicable.
42 42" wide	4. Pull option: AR = AutoStrada Radius pull AB = AutoStrada Bar pull	
AR Radius pull option	5. Finish <i>Laminate, V1, V2 or V3</i>	Product on this page will accept wood grain laminate where laminate is currently an option.
V316 Finish, Maple	6. Finish, Glass sliding door <i>TEMP - Clear, tempered</i> <i>GL6 - Block Matrix</i> <i>GL13 - Powder</i> <i>GL11, GL14, GL15, GL17, GL18</i>	
GL6 Glass, Block Matrix	7. Finish, Glass sliding door frame and pull <i>Anodized aluminum or painted finish options listed on page 10 excluding silver.</i>	Stack-on overheads correspond to interior width of medians and median storage. NOTE: Knoll does not assume any responsibility for the installation, attachment or the securing of wall hung units to the wall. A certified building contractor should be consulted. Please refer to wall mounting information on page 324 .
AA Frame, anodized aluminum	8. Finish, support feet <i>Anodized aluminum or painted finish options listed on page 8 excluding silver.</i>	
AA Finish, support feet		

Overhead storage, wood cases

Panel hung overheads

open

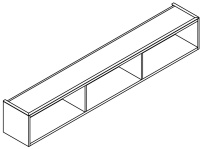
description	type	sections	h	w	d	pattern no.	L	V1	V2	V3		
 <p>96" w shown</p>	binder depth	2	15"	42"	14 1/4"	A2PHOBO42 ()	\$1,882.	\$1,964.	\$2,259.	\$2,936.		
		2	15"	48"	14 1/4"	A2PHOBO48 ()	1,949.	2,036.	2,339.	3,041.		
		2	15"	54"	14 1/4"	A2PHOBO54 ()	1,973.	2,057.	2,368.	3,077.		
		2	15"	60"	14 1/4"	A2PHOBO60 ()	1,993.	2,082.	2,395.	3,114.		
		2	15"	66"	14 1/4"	A2PHOBO66 ()	2,218.	2,315.	2,663.	3,463.		
		2	15"	72"	14 1/4"	A2PHOBO72 ()	2,445.	2,548.	2,932.	3,810.		
		3	15"	78"	14 1/4"	A2PHOBO78 ()	2,524.	2,634.	3,028.	3,939.		
		3	15"	84"	14 1/4"	A2PHOBO84 ()	2,608.	2,719.	3,128.	4,066.		
		3	15"	90"	14 1/4"	A2PHOBO90 ()	2,688.	2,804.	3,225.	4,193.		
		3	15"	96"	14 1/4"	A2PHOBO96 ()	2,784.	2,909.	3,342.	4,344.		
		legal depth		2	15"	42"	17 1/4"	A2PHOGO42 ()	2,032.	2,116.	2,443.	3,172.
				2	15"	48"	17 1/4"	A2PHOGO48 ()	2,106.	2,197.	2,526.	3,286.
				2	15"	54"	17 1/4"	A2PHOGO54 ()	2,128.	2,223.	2,558.	3,326.
2	15"			60"	17 1/4"	A2PHOGO60 ()	2,153.	2,247.	2,585.	3,363.		
2	15"			66"	17 1/4"	A2PHOGO66 ()	2,394.	2,500.	2,877.	3,738.		
2	15"			72"	17 1/4"	A2PHOGO72 ()	2,636.	2,750.	3,166.	4,113.		
3	15"			78"	17 1/4"	A2PHOGO78 ()	2,725.	2,843.	3,272.	4,255.		
3	15"			84"	17 1/4"	A2PHOGO84 ()	2,814.	2,936.	3,377.	4,391.		
3	15"			90"	17 1/4"	A2PHOGO90 ()	2,901.	3,028.	3,482.	4,529.		
3	15"			96"	17 1/4"	A2PHOGO96 ()	3,006.	3,140.	3,610.	4,695.		

Order Code

Example:	APHOBO42V316
A	AutoStrada
PH	Panel hung
O	Overhead
B	Binder depth
O	Open
42	42" wide
V316	Finish, Maple

Specification Information

To order please specify pattern number including:

- Depth
B = Binder depth
G = Legal depth
- Width
- Finish
Laminate, V1, V2 or V3

See page 8 for finish options applicable.

Product on this page will accept wood grain laminate where laminate is currently an option.

Application Notes

Panel hung overhead storage units include hardware to hang unit on panels.

NOTE: Knoll does not assume any responsibility for the installation, attachment or the securing of wall hung units to the wall.

A certified building contractor should be consulted.

Please refer to wall mounting information on page 324 .

Overhead storage, wood cases

Panel hung overheads

hinged door

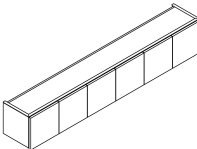
description	type	# drs/locks	h	w	d	pattern no.	L	V1	V2	V3		
 <p>96" w shown</p>	binder depth	3/2	15"	42"	15 1/4"	A2PHOBD42 () ()	\$2,087.	\$2,179.	\$2,508.	\$3,258.		
		3/2	15"	48"	15 1/4"	A2PHOBD48 () ()	2,163.	2,259.	2,596.	3,377.		
		3/2	15"	54"	15 1/4"	A2PHOBD54 () ()	2,187.	2,285.	2,628.	3,417.		
		4/2	15"	60"	15 1/4"	A2PHOBD60 () ()	2,212.	2,312.	2,658.	3,454.		
		4/2	15"	66"	15 1/4"	A2PHOBD66 () ()	2,461.	2,567.	2,956.	3,842.		
		4/2	15"	72"	15 1/4"	A2PHOBD72 () ()	2,713.	2,834.	3,261.	4,240.		
		5/3	15"	78"	15 1/4"	A2PHOBD78 () ()	2,802.	2,923.	3,363.	4,373.		
		5/3	15"	84"	15 1/4"	A2PHOBD84 () ()	2,894.	3,018.	3,470.	4,513.		
		6/3	15"	90"	15 1/4"	A2PHOBD90 () ()	2,987.	3,115.	3,581.	4,657.		
		6/3	15"	96"	15 1/4"	A2PHOBD96 () ()	3,090.	3,229.	3,716.	4,829.		
		legal depth		3/2	15"	42"	18 1/4"	A2PHOGD42 () ()	2,254.	2,353.	2,708.	3,521.
				3/2	15"	48"	18 1/4"	A2PHOGD48 () ()	2,336.	2,443.	2,804.	3,648.
				3/2	15"	54"	18 1/4"	A2PHOGD54 () ()	2,363.	2,469.	2,836.	3,690.
4/2	15"			60"	18 1/4"	A2PHOGD60 () ()	2,390.	2,496.	2,871.	3,731.		
4/2	15"			66"	18 1/4"	A2PHOGD66 () ()	2,659.	2,775.	3,193.	4,152.		
4/2	15"			72"	18 1/4"	A2PHOGD72 () ()	2,929.	3,062.	3,521.	4,580.		
5/3	15"			78"	18 1/4"	A2PHOGD78 () ()	3,028.	3,155.	3,631.	4,722.		
5/3	15"			84"	18 1/4"	A2PHOGD84 () ()	3,122.	3,258.	3,747.	4,874.		
6/3	15"			90"	18 1/4"	A2PHOGD90 () ()	3,226.	3,364.	3,868.	5,030.		
6/3	15"	96"	18 1/4"	A2PHOGD96 () ()	3,340.	3,487.	4,012.	5,215.				

Order Code

Example:	APHOBD42LV316
A	AutoStrada
PH	Panel hung
O	Overhead
B	Binder depth
D	Hinged Door
42	42" wide
L	Locking
V316	Finish, Maple

Specification Information

To order please specify pattern number including:

1. Depth
B = Binder depth
G = Legal depth
2. Width
3. Lock option
L = Lock hole drilled
N = Not drilled for locks
4. Finish
Laminate, V1, V2 or V3

See page 8 for finish options applicable.

Product on this page will accept wood grain laminate where laminate is currently an option.

Application Notes

Panel hung overhead storage units include hardware to hang unit on panels.

Hinged doors extend slightly beyond case construction to allow for easy finger pull access along the bottom. No pulls available.

Optional lock drilling to be specified. If drilled for locks selected, keying instructions must accompany order.

NOTE: Knoll does not assume any responsibility for the installation, attachment or the securing of wall hung units to the wall.

A certified building contractor should be consulted.

Please refer to wall mounting information on page 324.

Overhead storage, wood cases
Panel hung overheads
open / hinged door / open

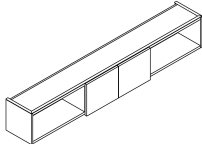
description	type	locks	h	w	d	pattern no.	L	V1	V2	V3
Panel hung Overhead, Open/Wood hinged doors/Open  <i>96" w shown</i>	binder depth	1	15"	60"	15 1/4"	A2PHOBT60 () ()	\$2,090.	\$2,185.	\$2,514.	\$3,268.
		1	15"	66"	15 1/4"	A2PHOBT66 () ()	2,328.	2,430.	2,797.	3,635.
		1	15"	72"	15 1/4"	A2PHOBT72 () ()	2,565.	2,675.	3,077.	4,002.
		1	15"	78"	15 1/4"	A2PHOBT78 () ()	2,650.	2,766.	3,181.	4,136.
		1	15"	84"	15 1/4"	A2PHOBT84 () ()	2,736.	2,854.	3,284.	4,268.
		1	15"	90"	15 1/4"	A2PHOBT90 () ()	2,821.	2,944.	3,387.	4,401.
		1	15"	96"	15 1/4"	A2PHOBT96 () ()	2,923.	3,056.	3,510.	4,560.
	legal depth	1	15"	60"	18 1/4"	A2PHOGT60 () ()	2,261.	2,361.	2,715.	3,533.
		1	15"	66"	18 1/4"	A2PHOGT66 () ()	2,515.	2,623.	3,019.	3,926.
		1	15"	72"	18 1/4"	A2PHOGT72 () ()	2,770.	2,888.	3,326.	4,322.
		1	15"	78"	18 1/4"	A2PHOGT78 () ()	2,861.	2,987.	3,435.	4,469.
		1	15"	84"	18 1/4"	A2PHOGT84 () ()	2,956.	3,085.	3,549.	4,610.
		1	15"	90"	18 1/4"	A2PHOGT90 () ()	3,046.	3,180.	3,655.	4,755.
		1	15"	96"	18 1/4"	A2PHOGT96 () ()	3,156.	3,297.	3,791.	4,926.

Order Code

Example:	APHOBT60LV316
A	AutoStrada
PH	Panel hung
O	Overhead
B	Binder depth
T	Open/Hinged Door/Open
60	60" wide
L	Locking
V316	Finish, Maple

Specification Information

To order please specify pattern number including:

1. Depth
B = Binder depth
G = Legal depth
2. Width
3. Lock option
L = Lock hole drilled
N = Not drilled for locks
4. Finish
Laminate, V1, V2 or V3

See page 8 for finish options applicable.

Product on this page will accept wood grain laminate where laminate is currently an option.

Application Notes

Panel hung overhead storage units include hardware to hang unit on panels.

Hinged doors extend slightly beyond case construction to allow for easy finger pull access along the bottom. No pulls available

Optional lock drilling to be specified. If drilled for locks selected, keying instructions must accompany order.

NOTE: Knoll does not assume any responsibility for the installation, attachment or the securing of wall hung units to the wall.

A certified building contractor should be consulted.

Please refer to wall mounting information on page 324.

Overhead storage, wood cases

Panel hung overheads

with sliding wood door(s)

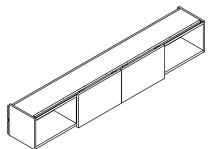
description	type	sections	h	w	d	pattern no.	L	V1	V2	V3		
 <p>96" w shown</p>	binder depth	1/1	15"	42"	15 1/4"	APHOBS42 () ()	\$2,820.	\$3,002.	\$3,796.	\$4,933.		
		1/1	15"	48"	15 1/4"	APHOBS48 () ()	2,922.	3,114.	3,932.	5,110.		
		1/1	15"	54"	15 1/4"	APHOBS54 () ()	2,956.	3,149.	3,976.	5,171.		
		2/2	15"	60"	15 1/4"	APHOBS60 () ()	2,988.	3,183.	4,023.	5,233.		
		2/2	15"	66"	15 1/4"	APHOBS66 () ()	3,327.	3,539.	4,474.	5,815.		
		2/2	15"	72"	15 1/4"	APHOBS72 () ()	3,665.	3,896.	4,926.	6,402.		
		2/2	15"	78"	15 1/4"	APHOBS78 () ()	3,784.	4,028.	5,088.	6,615.		
		2/2	15"	84"	15 1/4"	APHOBS84 () ()	3,908.	4,159.	5,255.	6,829.		
		2/2	15"	90"	15 1/4"	APHOBS90 () ()	4,029.	4,293.	5,418.	7,043.		
		2/2	15"	96"	15 1/4"	APHOBS96 () ()	4,175.	4,449.	5,614.	7,299.		
		legal depth		1/1	15"	42"	18 1/4"	APHOGS42 () ()	3,045.	3,244.	4,100.	5,330.
				1/1	15"	48"	18 1/4"	APHOGS48 () ()	3,156.	3,363.	4,245.	5,519.
				1/1	15"	54"	18 1/4"	APHOGS54 () ()	3,193.	3,402.	4,295.	5,582.
				2/2	15"	60"	18 1/4"	APHOGS60 () ()	3,227.	3,438.	4,346.	5,649.
2/2	15"			66"	18 1/4"	APHOGS66 () ()	3,592.	3,822.	4,832.	6,283.		
2/2	15"			72"	18 1/4"	APHOGS72 () ()	3,955.	4,210.	5,319.	6,914.		
2/2	15"			78"	18 1/4"	APHOGS78 () ()	4,087.	4,350.	5,497.	7,144.		
2/2	15"			84"	18 1/4"	APHOGS84 () ()	4,220.	4,496.	5,673.	7,376.		
2/2	15"			90"	18 1/4"	APHOGS90 () ()	4,352.	4,634.	5,852.	7,604.		
2/2	15"			96"	18 1/4"	APHOGS96 () ()	4,511.	4,804.	6,062.	7,882.		

Order Code	Specification Information	Application Notes
Example: APHOBS42V316	<i>To order please specify pattern number including:</i>	Sliding doors are not available with locks.
A AutoStrada	1. Depth <i>B = Binder depth</i>	Panel hung overhead storage units include hardware to hang unit on panels.
PH Panel hung	2. Sliding door material <i>G = Legal depth</i>	
O Overhead	3. Width <i>S = wood, same as case</i>	Sliding door pulls included, not visible on image.
B Binder depth	4. Pull option: AR = AutoStrada Radius pull AB = AutoStrada Bar pull	
S Open/Sliding (wood) Door	5. Finish <i>Laminate, V1, V2 or V3</i>	<p>NOTE: Knoll does not assume any responsibility for the installation, attachment or the securing of wall hung units to the wall.</p> <p>A certified building contractor should be consulted.</p> <p>Please refer to wall mounting information on page 324 .</p>
42 42" wide	6. <i>Finish, pull</i> <i>AA-complimentary painted match to anodized aluminum or painted finish options listed on page 8 excluding silver.</i>	
AR Radius pull option		
V316 Finish, Maple		
118 Pull Finish		

Specification Information

To order please specify pattern number including:

- Depth
B = Binder depth
- Sliding door material
G = Legal depth
- Width
S = wood, same as case
- Pull option:
AR = AutoStrada Radius pull
AB = AutoStrada Bar pull
- Finish
Laminate, V1, V2 or V3
- Finish, pull*
AA-complimentary painted match to anodized aluminum or painted finish options listed on page 8 excluding silver.

See page 8 for finish options applicable.

Product on this page will accept wood grain laminate where laminate is currently an option.

Application Notes

Sliding doors are not available with locks.

Panel hung overhead storage units include hardware to hang unit on panels.

Sliding door pulls included, not visible on image.

NOTE: Knoll does not assume any responsibility for the installation, attachment or the securing of wall hung units to the wall.

A certified building contractor should be consulted.

Please refer to wall mounting information on page 324 .

Overhead storage, wood cases

Panel hung overheads

with sliding glass door(s)

description	type	sections	h	w	d	pattern no.	L	V1	V2	V3	
	binder depth	1/1	15"	42"	15 1/4"	APHOBR42 () () ()	\$3,366.	\$3,572.	\$4,450.	\$5,788.	
		1/1	15"	48"	15 1/4"	APHOBR48 () () ()	3,486.	3,702.	4,610.	5,994.	
		1/1	15"	54"	15 1/4"	APHOBR54 () () ()	3,528.	3,745.	4,664.	6,062.	
		2/2	15"	60"	15 1/4"	APHOBR60 () () ()	3,569.	3,787.	4,718.	6,133.	
		2/2	15"	66"	15 1/4"	APHOBR66 () () ()	3,970.	4,213.	5,247.	6,821.	
		2/2	15"	72"	15 1/4"	APHOBR72 () () ()	4,373.	4,635.	5,776.	7,509.	
		2/2	15"	78"	15 1/4"	APHOBR78 () () ()	4,518.	4,794.	5,967.	7,758.	
		2/2	15"	84"	15 1/4"	APHOBR84 () () ()	4,665.	4,948.	6,162.	8,009.	
		2/2	15"	90"	15 1/4"	APHOBR90 () () ()	4,808.	5,105.	6,353.	8,260.	
		2/2	15"	96"	15 1/4"	APHOBR96 () () ()	4,984.	5,292.	6,584.	8,560.	
		legal depth	1/1	15"	42"	18 1/4"	APHOGR42 () () ()	3,633.	3,857.	4,807.	6,248.
			1/1	15"	48"	18 1/4"	APHOGR48 () () ()	3,767.	4,001.	4,977.	6,472.
			1/1	15"	54"	18 1/4"	APHOGR54 () () ()	3,811.	4,045.	5,037.	6,550.
			2/2	15"	60"	18 1/4"	APHOGR60 () () ()	3,850.	4,092.	5,096.	6,626.
			2/2	15"	66"	18 1/4"	APHOGR66 () () ()	4,288.	4,548.	5,666.	7,366.
			2/2	15"	72"	18 1/4"	APHOGR72 () () ()	4,721.	5,008.	6,238.	8,108.
2/2	15"		78"	18 1/4"	APHOGR78 () () ()	4,880.	5,175.	6,445.	8,378.		
2/2	15"		84"	18 1/4"	APHOGR84 () () ()	5,037.	5,345.	6,654.	8,650.		
2/2	15"		90"	18 1/4"	APHOGR90 () () ()	5,195.	5,513.	6,863.	8,921.		
2/2	15"		96"	18 1/4"	APHOGR96 () () ()	5,382.	5,715.	7,109.	9,242.		

Order Code	Specification Information	Application Notes
Example: APHOBR42V316GL6AA	<i>To order please specify pattern number including:</i>	Sliding doors are not available with locks.
A AutoStrada	1. Depth <i>B = Binder depth</i> <i>G = Legal depth</i>	Panel hung overhead storage units include hardware to hang unit on panels.
PH Panel hung	2. Sliding door material <i>S = wood, same as case</i>	Sliding door pulls included, not visible on image. When AA finish specified pull is complimentary painted match, pull is not anodized.
O Overhead	3. Width	See page 8 for finish options applicable.
B Binder depth	4. Pull option: AR = AutoStrada Radius pull AB = AutoStrada Bar pull	Product on this page will accept wood grain laminate where laminate is currently an option.
R Open/Sliding (glass) Door	5. Finish <i>Laminate, V1, V2 or V3</i>	
42 42" wide	6. Finish, Glass sliding door <i>TEMP - Clear, tempered</i> <i>GL6 - Block Matrix</i> <i>GL13 - Powder</i> <i>GL11, GL14, GL15, GL17, GL18</i>	
AR Radius pull option	7. Finish, Glass sliding door frame and pull <i>Anodized aluminum or painted finish options listed on page 8 excluding silver.</i>	
V316 Finish, Maple		
GL6 Glass, Block Matrix		
AA Frame, anodized aluminum		

NOTE: Knoll does not assume any responsibility for the installation, attachment or the securing of wall hung units to the wall.

A certified building contractor should be consulted.

Please refer to wall mounting information on page 324 .

Overhead storage, wood cases

Shared open overhead mounting options

AutoStrada

description	type	h	pattern no.	paint
Mounting brackets for 64" horizon on 48" Service Wall or for 55" horizon on 39" Service Wall and 39" Fence	For 24" w - 48" w overhead		AUOMBCC2 ()	\$108.
	For 54" w - 72" w overhead		AUOMBCC3 ()	141.
Mounting brackets for AutoStrada panels	For 24" w - 48" w overhead		AUOMBAP2 ()	69.
	For 54" w - 72" w overhead		AUOMBAP3 ()	103.
Stanchion upmount brackets for 49" horizon on 28" Fence or for 48" horizon on 27" Fence	For 24" w - 48" w overhead	6 1/2"	AUOMBSS62 ()	148.
	For 54" w - 72" w overhead	6 1/2"	AUOMBSS63 ()	197.
Stanchion upmount brackets for 49" horizon on 27" Fence	For 24" w - 48" w overhead	7 1/2"	AUOMBSS72 ()	153.
	For 54" w - 72" w overhead	7 1/2"	AUOMBSS73 ()	204.
Stanchion upmount brackets for 64" horizon on 39" Service Wall and 39" Fence	For 24" w - 48" w overhead	9 1/2"	AUOMBSS92 ()	158.
	For 54" w - 72" w overhead	9 1/2"	AUOMBSS93 ()	215.

Order Code	Specification Information	Application Notes
Example: AUO MB CC 2 118		
A AutoStrada	Specify painted finish.	Shared open overhead mounting brackets for the Service Wall are designed for use on the compact crown only.
U Upmounted	6 1/2" h stanchions are for use on 28" Fence for 49" horizon or on 27" Fence for 48" horizon.	
O Overhead		
MB Mounting brackets	7 1/2" h stanchions are for use on 27" Fence for 49" horizon.	
CC Compact Crown		
2 Quantity of brackets	9 1/2" h stanchions are for use on 39" Service Wall and 39" Fence for 64" horizon.	
118 Finish	Mounting brackets for 24" w - 48" w upmounted overheads come in a pair.	
	Mounting brackets for 54" w - 72" w upmounted overheads come in a quantity of 3.	
	9 1/2" h stanchions can only be used on 39" Fence when Fence is supported by attached perpendicular panels or screens.	

Overhead storage, wood cases

Wall-attached overheads for private office

open, single high

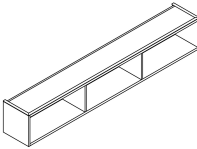
description	type	h	w	d	pattern no.	L	V1	V2	V3
 <p>96" w shown</p>	binder height & depth	15"	30"	14 1/4"	A2WHOB S030 () ()	\$1,804.	\$1,886.	\$2,171.	\$2,819.
		15"	36"	14 1/4"	A2WHOB S036 () ()	1,851.	1,935.	2,226.	2,891.
		15"	42"	14 1/4"	A2WHOB S042 () ()	1,900.	1,982.	2,284.	2,967.
		15"	48"	14 1/4"	A2WHOB S048 () ()	1,952.	2,037.	2,342.	3,045.
		15"	54"	14 1/4"	A2WHOB S054 () ()	2,052.	2,142.	2,469.	3,205.
		15"	60"	14 1/4"	A2WHOB S060 () ()	2,156.	2,247.	2,587.	3,364.
		15"	66"	14 1/4"	A2WHOB S066 () ()	2,217.	2,315.	2,660.	3,460.
		15"	72"	14 1/4"	A2WHOB S072 () ()	2,274.	2,380.	2,733.	3,554.
		15"	78"	14 1/4"	A2WHOB S078 () ()	2,389.	2,501.	2,871.	3,731.
		15"	84"	14 1/4"	A2WHOB S084 () ()	2,461.	2,575.	2,956.	3,843.
		15"	90"	14 1/4"	A2WHOB S090 () ()	2,535.	2,655.	3,043.	3,957.
		15"	96"	14 1/4"	A2WHOB S096 () ()	2,611.	2,731.	3,138.	4,402.

Units up to 36" w have one section, units 42" w up to 72" wide have two sections, over 72" w have three sections

binder height & legal depth	15"	30"	17 1/4"	A2WHOG S030 () ()	1,949.	2,038.	2,341.	3,044.
	15"	36"	17 1/4"	A2WHOG S036 () ()	2,001.	2,091.	2,403.	3,122.
	15"	42"	17 1/4"	A2WHOG S042 () ()	2,051.	2,142.	2,467.	3,205.
	15"	48"	17 1/4"	A2WHOG S048 () ()	2,108.	2,201.	2,532.	3,290.
	15"	54"	17 1/4"	A2WHOG S054 () ()	2,218.	2,313.	2,663.	3,463.
	15"	60"	17 1/4"	A2WHOG S060 () ()	2,328.	2,428.	2,793.	3,633.
	15"	66"	17 1/4"	A2WHOG S066 () ()	2,391.	2,501.	2,875.	3,736.
	15"	72"	17 1/4"	A2WHOG S072 () ()	2,458.	2,570.	2,952.	3,839.
	15"	78"	17 1/4"	A2WHOG S078 () ()	2,581.	2,700.	3,102.	4,029.
	15"	84"	17 1/4"	A2WHOG S084 () ()	2,659.	2,783.	3,193.	4,152.
	15"	90"	17 1/4"	A2WHOG S090 () ()	2,739.	2,864.	3,288.	4,276.
	15"	96"	17 1/4"	A2WHOG S096 () ()	2,820.	2,950.	3,388.	4,402.

Units up to 36" w have one section, units 42" w up to 72" w have two sections, over 72" wide have three sections

Order Code	Specification Information	Application Notes
Example: AWHOB S030 V 316 AA	<p>To order please specify pattern number including:</p> <ol style="list-style-type: none"> Depth B = Binder depth G = Legal depth Width Finish Laminate, V1, V2 or V3 Finish, aluminum trim Anodized aluminum or painted finish options listed on page 8 excluding silver. <p>See page 8 for finish options applicable.</p> <p>Product on this page will accept wood grain laminate where laminate is currently an option.</p>	<p>Wood cleat included for wall mounting. Two piece cleat, full width of overhead. Each piece nominally 3 5/8" h. Bottom piece attached to wall.</p> <p>Single high overhead storage to be mounted at 68 1/2" from floor to top of overhead unit. Dimension is to top of wood side gable of corresponding 70" h floor standing cabinet not including aluminum and wood top trim.</p> <p>NOTE: Knoll does not assume any responsibility for the installation, attachment or the securing of wall hung units to the wall.</p> <p>A certified building contractor should be consulted.</p> <p>Please refer to wall mounting information on page 324 .</p>
A AutoStrada		
WH Wall hung		
O Overhead		
B Binder depth		
S Single high		
O Open		
30 30" wide		
V316 Finish, Maple		
AA Finish, Aluminum trim		

Overhead storage, wood cases

Wall-attached overheads for private office

hinged door, single high

description	type	# drs/locks	h	w	d	pattern no.	L	V1	V2	V3	
Wall hung overhead Hinged doors (wood) single high	binder height and depth	2/1	15"	30"	15 1/4"	A2WHOBSD30 () ()	\$2,627.	\$2,740.	\$3,150.	\$4,096.	
		2/1	15"	36"	15 1/4"	A2WHOBSD36 () ()	2,773.	2,899.	3,332.	4,332.	
		3/2	15"	42"	15 1/4"	A2WHOBSD42 () ()	2,794.	2,921.	3,357.	4,364.	
		3/2	15"	48"	15 1/4"	A2WHOBSD48 () ()	2,851.	2,974.	3,422.	4,449.	
		3/2	15"	54"	15 1/4"	A2WHOBSD54 () ()	2,996.	3,128.	3,602.	4,680.	
		4/2	15"	60"	15 1/4"	A2WHOBSD60 () ()	3,140.	3,275.	3,767.	4,901.	
		4/2	15"	66"	15 1/4"	A2WHOBSD66 () ()	3,232.	3,378.	3,884.	5,051.	
		4/2	15"	72"	15 1/4"	A2WHOBSD72 () ()	3,322.	3,468.	3,989.	5,184.	
		5/3	15"	78"	15 1/4"	A2WHOBSD78 () ()	3,489.	3,650.	4,190.	5,447.	
		5/3	15"	84"	15 1/4"	A2WHOBSD84 () ()	3,594.	3,761.	4,315.	5,612.	
		6/3	15"	90"	15 1/4"	A2WHOBSD90 () ()	3,701.	3,872.	4,445.	5,781.	
		6/3	15"	96"	15 1/4"	A2WHOBSD96 () ()	3,813.	3,989.	4,580.	5,951.	
		binder height and legal depth	2/1	15"	30"	18 1/4"	A2WHOGSD30 () ()	2,835.	2,958.	3,403.	4,423.
			2/1	15"	36"	18 1/4"	A2WHOGSD36 () ()	2,995.	3,132.	3,601.	4,678.
			3/2	15"	42"	18 1/4"	A2WHOGSD42 () ()	3,016.	3,152.	3,625.	4,714.
3/2	15"		48"	18 1/4"	A2WHOGSD48 () ()	3,077.	3,209.	3,697.	4,807.		
3/2	15"		54"	18 1/4"	A2WHOGSD54 () ()	3,237.	3,377.	3,888.	5,055.		
4/2	15"		60"	18 1/4"	A2WHOGSD60 () ()	3,390.	3,538.	4,070.	5,292.		
4/2	15"		66"	18 1/4"	A2WHOGSD66 () ()	3,491.	3,649.	4,194.	5,454.		
4/2	15"		72"	18 1/4"	A2WHOGSD72 () ()	3,589.	3,745.	4,309.	5,601.		
5/3	15"		78"	18 1/4"	A2WHOGSD78 () ()	3,768.	3,943.	4,525.	5,884.		
5/3	15"		84"	18 1/4"	A2WHOGSD84 () ()	3,882.	4,062.	4,660.	6,060.		
6/3	15"		90"	18 1/4"	A2WHOGSD90 () ()	3,998.	4,182.	4,802.	6,242.		
6/3	15"		96"	18 1/4"	A2WHOGSD96 () ()	4,115.	4,309.	4,947.	6,429.		

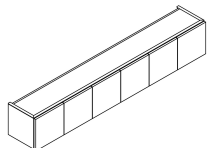

96" w shown

Order Code	Specification Information	Application Notes
Example: AWHOBSD30LV316AA	<i>To order please specify pattern number including:</i>	Single high overhead storage to be mounted at 68 1/2" from floor to top of overhead unit. Dimension is to top of wood side gable of corresponding 70" h floor standing cabinet not including aluminum and wood top trim.
A AutoStrada	1. Depth <i>B = Binder depth</i> <i>G = Legal depth</i>	Wood cleat included for wall mounting. Two piece cleat, full width of overhead. Each piece nominally 3 7/8" h. Bottom piece attached to wall.
WH Wall hung	2. Width	NOTE: Knoll does not assume any responsibility for the installation, attachment or the securing of wall hung units to the wall.
O Overhead	3. Lock <i>L = lock hole drilled</i> <i>N = not drilled for locks</i>	A certified building contractor should be consulted.
B Binder depth	4. Finish <i>Laminate, V1, V2 or V3</i>	Please refer to wall mounting information on page 324.
S Single high	5. Finish, aluminum trim <i>Anodized aluminum or painted finish options listed on page 8 excluding silver.</i>	
D Hinged doors, wood		Hinged doors extend slightly beyond case construction to allow for easy finger pull access along the bottom. No pulls available.
30 30" wide		Optional lock drilling to be specified. If drilled for locks selected, keying instructions must accompany order.
L Lock holes drilled		
V316 Finish, Maple		
AA Finish, Aluminum trim		

See page 8 for finish options applicable.

Product on this page will accept wood grain laminate where laminate is currently an option.

Overhead storage, wood cases

Wall-attached overheads for private office

open / hinged door / open, single high

description	type	h	w	d	pattern no.	L	V1	V2	V3
Wall hung overhead Open/Hinged doors (wood) single high	binder height & depth	15"	60"	15 1/4"	A2WHOBST60 () ()	\$2,263.	\$2,361.	\$2,715.	\$3,534.
		15"	66"	15 1/4"	A2WHOBST66 () ()	2,327.	2,430.	2,793.	3,631.
		15"	72"	15 1/4"	A2WHOBST72 () ()	2,389.	2,501.	2,871.	3,731.
		15"	78"	15 1/4"	A2WHOBST78 () ()	2,508.	2,624.	3,015.	3,919.
		15"	84"	15 1/4"	A2WHOBST84 () ()	2,584.	2,702.	3,104.	4,034.
		15"	90"	15 1/4"	A2WHOBST90 () ()	2,661.	2,786.	3,196.	4,156.
		15"	96"	15 1/4"	A2WHOBST96 () ()	2,743.	2,870.	3,293.	4,282.
	binder height & legal depth	15"	60"	18 1/4"	A2WHOGST60 () ()	2,446.	2,549.	2,933.	3,812.
		15"	66"	18 1/4"	A2WHOGST66 () ()	2,513.	2,623.	3,017.	3,923.
		15"	72"	18 1/4"	A2WHOGST72 () ()	2,581.	2,700.	3,102.	4,029.
		15"	78"	18 1/4"	A2WHOGST78 () ()	2,711.	2,834.	3,252.	4,231.
		15"	84"	18 1/4"	A2WHOGST84 () ()	2,790.	2,921.	3,354.	4,356.
		15"	90"	18 1/4"	A2WHOGST90 () ()	2,877.	3,008.	3,453.	4,487.
		15"	96"	18 1/4"	A2WHOGST96 () ()	2,960.	3,100.	3,557.	4,623.

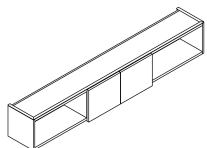

96" w shown

Order Code	Specification Information	Application Notes
Example: AWHOBST60LV316AA	<i>To order please specify pattern number including:</i>	Single high overhead storage to be mounted at 68 1/2" from floor to top of overhead unit. Dimension is to top of wood side gable of corresponding 70" h floor standing cabinet not including aluminum and wood top trim.
A AutoStrada	1. Depth <i>B = Binder depth</i> <i>G = Legal depth</i>	Wood cleat included for wall mounting. Two piece cleat, full width of overhead. Each piece nominally 3 3/8" h. Bottom piece attached to wall.
WH Wall hung	2. Width	NOTE: Knoll does not assume any responsibility for the installation, attachment or the securing of wall hung units to the wall.
O Overhead	3. Lock <i>L = lock hole drilled</i> <i>N = not drilled for locks</i>	A certified building contractor should be consulted.
B Binder depth	4. Finish <i>Laminate, V1, V2 or V3</i>	Please refer to wall mounting information on page 324.
S Single high	5. Finish, aluminum trim <i>Anodized aluminum or painted finish options listed on page 8 excluding silver.</i>	
T Open/Hinged doors/Open		Optional lock drilling to be specified. If drilled for locks selected, keying instructions must accompany order.
60 60" wide		
L Lock holes drilled		
V316 Finish, Maple		
AA Finish, Aluminum trim		

See page 8 for finish options applicable.

Product on this page will accept wood grain laminate where laminate is currently an option.

Overhead storage, wood cases

Wall-attached overheads for private office with sliding door(s), single high

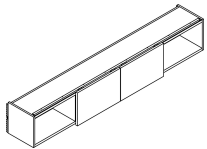
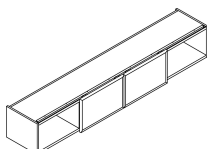
description	type	h	w	d	pattern no.	L	V1	V2	V3
Wall hung overhead Open/Sliding door(s) wood single high  96" w shown	binder height and depth	15"	60"	15 1/4"	AWHOBSS60 () () ()	\$3,231.	\$3,438.	\$4,348.	\$5,653.
		15"	66"	15 1/4"	AWHOBSS66 () () ()	3,324.	3,539.	4,471.	5,809.
		15"	72"	15 1/4"	AWHOBSS72 () () ()	3,415.	3,645.	4,592.	5,969.
		15"	78"	15 1/4"	AWHOBSS78 () () ()	3,585.	3,825.	4,825.	6,268.
		15"	84"	15 1/4"	AWHOBSS84 () () ()	3,690.	3,940.	4,966.	6,458.
		15"	90"	15 1/4"	AWHOBSS90 () () ()	3,803.	4,060.	5,115.	6,652.
		15"	96"	15 1/4"	AWHOBSS96 () () ()	3,916.	4,179.	5,269.	6,852.
	binder height and legal depth	15"	60"	18 1/4"	AWHOGSS60 () () ()	3,489.	3,716.	4,697.	6,104.
		15"	66"	18 1/4"	AWHOGSS66 () () ()	3,590.	3,825.	4,828.	6,275.
		15"	72"	18 1/4"	AWHOGSS72 () () ()	3,685.	3,934.	4,961.	6,446.
		15"	78"	18 1/4"	AWHOGSS78 () () ()	3,871.	4,132.	5,207.	6,769.
		15"	84"	18 1/4"	AWHOGSS84 () () ()	3,986.	4,257.	5,362.	6,974.
		15"	90"	18 1/4"	AWHOGSS90 () () ()	4,107.	4,383.	5,522.	7,183.
		15"	96"	18 1/4"	AWHOGSS96 () () ()	4,231.	4,514.	5,694.	7,398.
Wall hung overhead Open/Sliding door(s) glass single high  96" w shown	binder height and depth	15"	60"	15 1/4"	AWHOBSR60 () () ()	3,856.	4,092.	5,097.	6,119.
		15"	66"	15 1/4"	AWHOBSR66 () () ()	3,966.	4,213.	5,244.	6,289.
		15"	72"	15 1/4"	AWHOBSR72 () () ()	4,072.	4,334.	5,385.	6,462.
		15"	78"	15 1/4"	AWHOBSR78 () () ()	4,278.	4,553.	5,655.	6,788.
		15"	84"	15 1/4"	AWHOBSR84 () () ()	4,404.	4,690.	5,825.	6,988.
		15"	90"	15 1/4"	AWHOBSR90 () () ()	4,537.	4,828.	5,998.	7,200.
		15"	96"	15 1/4"	AWHOBSR96 () () ()	4,675.	4,973.	6,178.	7,415.
	binder height and legal depth	15"	60"	18 1/4"	AWHOGSR60 () () ()	4,163.	4,419.	5,506.	6,607.
		15"	66"	18 1/4"	AWHOGSR66 () () ()	4,283.	4,548.	5,660.	6,794.
		15"	72"	18 1/4"	AWHOGSR72 () () ()	4,397.	4,679.	5,815.	6,980.
		15"	78"	18 1/4"	AWHOGSR78 () () ()	4,619.	4,918.	6,107.	7,329.
		15"	84"	18 1/4"	AWHOGSR84 () () ()	4,756.	5,064.	6,289.	7,547.
		15"	90"	18 1/4"	AWHOGSR90 () () ()	4,901.	5,213.	6,479.	7,776.
		15"	96"	18 1/4"	AWHOGSR96 () () ()	5,048.	5,372.	6,671.	8,007.

Order Code	Specification Information	Application Notes
Example: AWHOBSS60V316AA	<i>To order please specify pattern number including:</i>	Wood cleat included for wall mounting. Two piece cleat, full width of overhead. Each piece nominally 3 3/8" h. Bottom piece attached to wall.
A AutoStrada	1. Depth <i>B = Binder depth C = Legal depth</i>	Sliding doors are not available with locks. When AA finish specified pull is complimentary painted match, pull is not anodized.
WH Wall hung	2. Sliding door material <i>S = wood, same as case R = glass</i>	
O Overhead	3. Width	
B Binder depth	4. Pull options for Glass doors (as applicable)	
S Single high	AR=AutoStrada Radius pull AB=AutoStrada Bar pull	See page 8 for finish options applicable.
S Open/Sliding door(s)/wood	5. Finish <i>Laminate, V1, V2 or V3</i>	
60 60" wide	6. Finish, Glass sliding door (as applicable) <i>TEMP - Clear, tempered GL6 - Block Matrix GL13 - Powder GL11, GL14, GL15, GL17, GL18</i>	Product on this page will accept wood grain laminate where laminate is currently an option.
AR Radius pull option	7. Finish, Glass sliding door frame and pull (as applicable) <i>Anodized aluminum or painted finish options listed on page 8 excluding silver.</i>	
V316 Finish, Maple		
AA Finish, Aluminum trim		Single high overhead storage to be mounted at 68 1/2" from floor to top of overhead unit. Dimension is to top of wood side gable of corresponding 70" h floor standing cabinet not including aluminum and wood top trim. Sliding door pulls included, not visible on image. NOTE: Knoll does not assume any responsibility for the installation, attachment or the securing of wall hung units to the wall. A certified building contractor should be consulted. Please refer to wall mounting information on page 324.

Overhead storage, wood cases

Wall-attached overheads for private office

open, double high

description	type	h	w	d	pattern no.	L	V1	V2	V3
Wall hung overhead open, double high	binder height & depth	29"	30"	14 1/4"	A2WHOBDO30 () ()	\$2,434.	\$2,548.	\$2,928.	\$3,807.
		29"	36"	14 1/4"	A2WHOBDO36 () ()	2,500.	2,614.	3,003.	3,907.
		29"	42"	14 1/4"	A2WHOBDO42 () ()	2,565.	2,679.	3,082.	4,007.
		29"	48"	14 1/4"	A2WHOBDO48 () ()	2,633.	2,749.	3,166.	4,112.
		29"	54"	14 1/4"	A2WHOBDO54 () ()	2,771.	2,889.	3,330.	4,329.
		29"	60"	14 1/4"	A2WHOBDO60 () ()	2,911.	3,033.	3,491.	4,541.
		29"	66"	14 1/4"	A2WHOBDO66 () ()	2,989.	3,122.	3,591.	4,668.
		29"	72"	14 1/4"	A2WHOBDO72 () ()	3,072.	3,215.	3,690.	4,798.
		29"	78"	14 1/4"	A2WHOBDO78 () ()	3,226.	3,376.	3,876.	5,037.
		29"	84"	14 1/4"	A2WHOBDO84 () ()	3,324.	3,476.	3,991.	5,190.
		29"	90"	14 1/4"	A2WHOBDO90 () ()	3,420.	3,580.	4,109.	5,345.
		29"	96"	14 1/4"	A2WHOBDO96 () ()	3,524.	3,689.	4,236.	5,945.

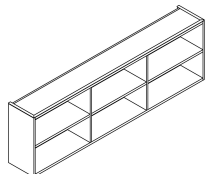

96" w shown

units up to 36" w have one section, 42" w up to 72" w have two sections, over 72" w have three sections

binder height & legal depth	h	w	d	pattern no.	L	V1	V2	V3
binder height & legal depth	29"	30"	17 1/4"	A2WHOGDO30 () ()	2,630.	2,750.	3,164.	4,110.
	29"	36"	17 1/4"	A2WHOGDO36 () ()	2,702.	2,822.	3,245.	4,216.
	29"	42"	17 1/4"	A2WHOGDO42 () ()	2,770.	2,891.	3,329.	4,328.
	29"	48"	17 1/4"	A2WHOGDO48 () ()	2,846.	2,968.	3,418.	4,442.
	29"	54"	17 1/4"	A2WHOGDO54 () ()	2,992.	3,121.	3,596.	4,672.
	29"	60"	17 1/4"	A2WHOGDO60 () ()	3,142.	3,275.	3,775.	4,904.
	29"	66"	17 1/4"	A2WHOGDO66 () ()	3,230.	3,375.	3,880.	5,041.
	29"	72"	17 1/4"	A2WHOGDO72 () ()	3,319.	3,473.	3,986.	5,181.
	29"	78"	17 1/4"	A2WHOGDO78 () ()	3,484.	3,647.	4,184.	5,441.
	29"	84"	17 1/4"	A2WHOGDO84 () ()	3,590.	3,755.	4,311.	5,606.
	29"	90"	17 1/4"	A2WHOGDO90 () ()	3,697.	3,868.	4,439.	5,773.
	29"	96"	17 1/4"	A2WHOGDO96 () ()	3,807.	3,985.	4,574.	5,945.

units up to 36" w have one section, 42" w up to 72" w have two sections, over 72" w have three sections

Order Code	Specification Information	Application Notes
Example: AWHOBDO30V316AA	<p>To order please specify pattern number including:</p> <ol style="list-style-type: none"> Depth B = Binder depth G = Legal depth Width Finish Laminate, V1, V2 or V3 Finish, aluminum trim Anodized aluminum or painted finish options listed on page 8 excluding silver. 	<p>Wood cleat included for wall mounting. Two piece cleat, full width of overhead. Each piece nominally 3 5/8" h. Bottom piece attached to wall.</p> <p>Double high overhead storage to be mounted at 82-5/16" from floor to top of overhead unit. Dimension is to top of wood side gable of corresponding 84" h floor standing cabinet not including aluminum and wood top trim.</p>
A AutoStrada		
WH Wall hung		
O Overhead		
B Binder depth		
D Double high		
O Open		
30 30" wide		
V316 Finish, Maple		
AA Finish, Aluminum trim		

NOTE: Knoll does not assume any responsibility for the installation, attachment or the securing of wall hung units to the wall.

A certified building contractor should be consulted.

Please refer to wall mounting information on page 324 .

See page 8 for finish options applicable.

Product on this page will accept wood grain laminate where laminate is currently an option.

Overhead storage, wood cases

Wall-attached overheads for private office

hinged door, double high

description	type	# drs/locks	h	w	d	pattern no.	L	V1	V2	V3	
Wall hung overhead Hinged doors (wood) double high	binder height and depth	2/1	29"	30"	15 1/4"	A2WHOBDD30 () ()	\$3,543.	\$3,699.	\$4,254.	\$5,529.	
		2/1	29"	36"	15 1/4"	A2WHOBDD36 () ()	3,745.	3,911.	4,499.	5,848.	
		3/2	29"	42"	15 1/4"	A2WHOBDD42 () ()	3,773.	3,941.	4,533.	5,891.	
		3/2	29"	48"	15 1/4"	A2WHOBDD48 () ()	3,845.	4,015.	4,621.	6,009.	
		3/2	29"	54"	15 1/4"	A2WHOBDD54 () ()	4,047.	4,221.	4,859.	6,319.	
		4/2	29"	60"	15 1/4"	A2WHOBDD60 () ()	4,239.	4,424.	5,088.	6,615.	
		4/2	29"	66"	15 1/4"	A2WHOBDD66 () ()	4,365.	4,560.	5,245.	6,816.	
		4/2	29"	72"	15 1/4"	A2WHOBDD72 () ()	4,484.	4,680.	5,385.	7,000.	
		5/3	29"	78"	15 1/4"	A2WHOBDD78 () ()	4,711.	4,928.	5,658.	7,353.	
		5/3	29"	84"	15 1/4"	A2WHOBDD84 () ()	4,850.	5,074.	5,830.	7,575.	
		6/3	29"	90"	15 1/4"	A2WHOBDD90 () ()	4,996.	5,228.	6,002.	7,802.	
		6/3	29"	96"	15 1/4"	A2WHOBDD96 () ()	5,148.	5,385.	6,180.	8,037.	
		binder height and legal depth	2/1	29"	30"	18 1/4"	A2WHOGDD30 () ()	3,827.	3,993.	4,592.	5,969.
			2/1	29"	36"	18 1/4"	A2WHOGDD36 () ()	4,043.	4,222.	4,857.	6,315.
			3/2	29"	42"	18 1/4"	A2WHOGDD42 () ()	4,073.	4,258.	4,893.	6,361.
3/2	29"		48"	18 1/4"	A2WHOGDD48 () ()	4,155.	4,335.	4,991.	6,490.		
3/2	29"		54"	18 1/4"	A2WHOGDD54 () ()	4,370.	4,559.	5,249.	6,823.		
4/2	29"		60"	18 1/4"	A2WHOGDD60 () ()	4,577.	4,780.	5,494.	7,142.		
4/2	29"		66"	18 1/4"	A2WHOGDD66 () ()	4,716.	4,926.	5,665.	7,361.		
4/2	29"		72"	18 1/4"	A2WHOGDD72 () ()	4,841.	5,056.	5,814.	7,558.		
5/3	29"		78"	18 1/4"	A2WHOGDD78 () ()	5,084.	5,321.	6,110.	7,945.		
5/3	29"		84"	18 1/4"	A2WHOGDD84 () ()	5,239.	5,484.	6,292.	8,183.		
6/3	29"		90"	18 1/4"	A2WHOGDD90 () ()	5,395.	5,646.	6,481.	8,426.		
6/3	29"		96"	18 1/4"	A2WHOGDD96 () ()	5,559.	5,814.	6,675.	8,680.		

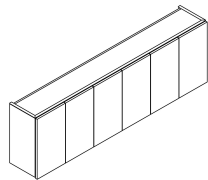

96" w shown

Order Code	Specification Information	Application Notes
Example: AWHOBDD30LV316AA	<i>To order please specify pattern number including:</i>	Double high overhead storage to be mounted at 82-5/16" from floor to top of overhead unit. Dimension is to top of wood side gable of corresponding 84" h floor standing cabinet not including aluminum and wood top trim.
A AutoStrada	1. Depth <i>B = Binder depth G = Legal depth</i>	Wood cleat included for wall mounting. Two piece cleat, full width of overhead. Each piece nominally 3 7/8" h. Bottom piece attached to wall.
WH Wall hung	2. Width	NOTE: Knoll does not assume any responsibility for the installation, attachment or the securing of wall hung units to the wall.
O Overhead	3. Lock <i>L = lock hole drilled N = not drilled for locks</i>	A certified building contractor should be consulted.
B Binder depth	4. Finish <i>Laminate, V1, V2 or V3</i>	Please refer to wall mounting information on page 324 .
D Double high	5. Finish, aluminum trim <i>Anodized aluminum or painted finish options listed on page 8 excluding silver.</i>	
D Hinged doors, wood		
30 30" wide	See page 8 for finish options applicable.	
L Lock holes drilled		
V316 Finish, Maple	Product on this page will accept wood grain laminate where laminate is currently an option.	
AA Finish, Aluminum trim		
		Optional lock drilling to be specified. If drilled for locks selected, keying instructions must accompany order.

Overhead storage, wood cases

Wall-attached overheads for private office

open / hinged door / open, double high

description	type	h	w	d	pattern no.	L	V1	V2	V3
Wall hung overhead Open/Hinged doors (wood) double high	binder height & depth	29"	60"	15 1/4"	A2WHOBTD60 () ()	\$3,056.	\$3,187.	\$3,667.	\$4,768.
		29"	66"	15 1/4"	A2WHOBTD66 () ()	3,142.	3,280.	3,770.	4,903.
		29"	72"	15 1/4"	A2WHOBTD72 () ()	3,226.	3,376.	3,876.	5,037.
		29"	78"	15 1/4"	A2WHOBTD78 () ()	3,388.	3,545.	4,068.	5,288.
		29"	84"	15 1/4"	A2WHOBTD84 () ()	3,487.	3,650.	4,190.	5,447.
		29"	90"	15 1/4"	A2WHOBTD90 () ()	3,594.	3,761.	4,315.	5,612.
		29"	96"	15 1/4"	A2WHOBTD96 () ()	3,700.	3,872.	4,445.	5,781.
	binder height & legal depth	29"	60"	18 1/4"	A2WHOGDT60 () ()	3,298.	3,440.	3,963.	5,150.
		29"	66"	18 1/4"	A2WHOGDT66 () ()	3,390.	3,545.	4,072.	5,295.
		29"	72"	18 1/4"	A2WHOGDT72 () ()	3,484.	3,647.	4,184.	5,441.
		29"	78"	18 1/4"	A2WHOGDT78 () ()	3,657.	3,830.	4,394.	5,713.
		29"	84"	18 1/4"	A2WHOGDT84 () ()	3,768.	3,943.	4,525.	5,884.
		29"	90"	18 1/4"	A2WHOGDT90 () ()	3,882.	4,062.	4,660.	6,060.
29"		96"	18 1/4"	A2WHOGDT96 () ()	3,998.	4,182.	4,802.	6,242.	

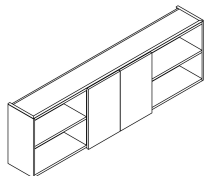

Order Code	Specification Information	Application Notes
Example: AWHOBTD60LV316AA	<i>To order please specify pattern number including:</i>	Double high overhead storage to be mounted at 82-5/16" from floor to top of overhead unit. Dimension is to top of wood side gable of corresponding 84" h floor standing cabinet not including aluminum and wood top trim.
A AutoStrada	1. Depth <i>B = Binder depth</i>	Wood cleat included for wall mounting. Two piece cleat, full width of overhead. Each piece nominally 3 3/8" h. Bottom piece attached to wall.
WH Wall hung	<i>G = Legal depth</i>	
O Overhead	2. Width	NOTE: Knoll does not assume any responsibility for the installation, attachment or the securing of wall hung units to the wall.
B Binder depth	3. Lock <i>L = lock hole drilled</i>	
D Double high	<i>N = not drilled for locks</i>	A certified building contractor should be consulted.
T Open/Hinged doors/Open	4. Finish <i>Laminate, V1, V2 or V3</i>	
60 60" wide	5. Finish, aluminum trim <i>Anodized aluminum or painted finish options listed on page 8 excluding silver.</i>	Please refer to wall mounting information on page 324.
L Lock holes drilled	See page 8 for finish options applicable.	
V316 Finish, Maple	Product on this page will accept wood grain laminate where laminate is currently an option.	Optional lock drilling to be specified. If drilled for locks selected, keying instructions must accompany order.
AA Finish, Aluminum trim		

Overhead storage, wood cases

Wall-attached overheads for private office with sliding door(s), double high

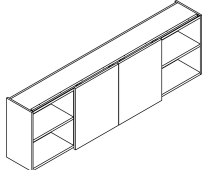
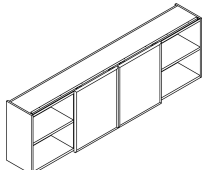
description	type	h	w	d	pattern no.	L	V1	V2	V3
Wall hung overhead Open/Sliding door(s) wood double high  96" w shown	binder height and depth	29"	60"	15 1/4"	AWHOBDS60 () () ()	\$4,362.	\$4,643.	\$5,869.	\$7,629.
		29"	66"	15 1/4"	AWHOBDS66 () () ()	4,485.	4,781.	6,033.	7,845.
		29"	72"	15 1/4"	AWHOBDS72 () () ()	4,607.	4,920.	6,199.	8,058.
		29"	78"	15 1/4"	AWHOBDS78 () () ()	4,838.	5,165.	6,509.	8,464.
		29"	84"	15 1/4"	AWHOBDS84 () () ()	4,984.	5,319.	6,705.	8,718.
		29"	90"	15 1/4"	AWHOBDS90 () () ()	5,133.	5,478.	6,906.	8,979.
	binder height and legal depth	29"	60"	18 1/4"	AWHOGDS60 () () ()	4,713.	5,014.	6,339.	8,239.
		29"	66"	18 1/4"	AWHOGDS66 () () ()	4,843.	5,164.	6,519.	8,473.
		29"	72"	18 1/4"	AWHOGDS72 () () ()	4,978.	5,312.	6,694.	8,707.
		29"	78"	18 1/4"	AWHOGDS78 () () ()	5,226.	5,577.	7,030.	9,140.
		29"	84"	18 1/4"	AWHOGDS84 () () ()	5,383.	5,742.	7,243.	9,415.
		29"	90"	18 1/4"	AWHOGDS90 () () ()	5,545.	5,919.	7,460.	9,697.
		29"	96"	18 1/4"	AWHOGDS96 () () ()	5,710.	6,096.	7,682.	9,989.
		Wall hung overhead Open/Sliding door(s) glass double high  96" w shown	binder height and depth	29"	60"	15 1/4"	AWHOBDR60 () () ()	5,207.	5,521.
29"	66"			15 1/4"	AWHOBDR66 () () ()	5,354.	5,687.	7,078.	8,492.
29"	72"			15 1/4"	AWHOBDR72 () () ()	5,499.	5,851.	7,271.	8,723.
29"	78"			15 1/4"	AWHOBDR78 () () ()	5,776.	6,142.	7,632.	9,162.
29"	84"			15 1/4"	AWHOBDR84 () () ()	5,949.	6,326.	7,863.	9,436.
29"	90"			15 1/4"	AWHOBDR90 () () ()	6,126.	6,519.	8,099.	9,719.
binder height and legal depth	29"		60"	18 1/4"	AWHOGDR60 () () ()	5,622.	5,964.	7,433.	8,920.
	29"		66"	18 1/4"	AWHOGDR66 () () ()	5,781.	6,140.	7,642.	9,171.
	29"		72"	18 1/4"	AWHOGDR72 () () ()	5,938.	6,319.	7,852.	9,423.
	29"		78"	18 1/4"	AWHOGDR78 () () ()	6,236.	6,634.	8,244.	9,893.
	29"		84"	18 1/4"	AWHOGDR84 () () ()	6,424.	6,834.	8,492.	10,191.
	29"		90"	18 1/4"	AWHOGDR90 () () ()	6,615.	7,038.	8,744.	10,498.
	29"		96"	18 1/4"	AWHOGDR96 () () ()	6,814.	7,249.	9,010.	10,810.

Order Code	Specification Information	Application Notes
Example: AWHOBDS60V316AA A AutoStrada WH Wall hung O Overhead B Binder depth D Double high S Open/Sliding door(s)/wood 60 60" wide AR Radius pull option V316 Finish, Maple AA Finish, Aluminum trim	To order please specify pattern number including: 1. Depth <i>B = Binder depth</i> <i>G = Legal depth</i> 2. Sliding door material <i>S = wood, same as case</i> <i>R = glass</i> 3. Width 4. Pull options for Glass doors (as applicable) AR=AutoStrada Radius pull AB=AutoStrada Bar pull 5. Finish <i>Laminate, V1, V2 or V3</i> 6. Finish, Glass sliding door (as applicable) <i>TEMP - Clear, tempered</i> <i>GL6 - Block Matrix</i> <i>GL13 - Powder</i> <i>GL11, GL14, GL15, GL17, GL18</i> 7. Finish, Glass sliding door frame and pull (as applicable) <i>Anodized aluminum or painted finish options listed on page 8 excluding silver.</i>	Wood cleat included for wall mounting. Two piece cleat, full width of overhead. Each piece nominally 3 3/8" h. Bottom piece attached to wall. Sliding doors are not available with locks. When AA finish specified pull is complimentary painted match, pull is not anodized. See page 8 for finish options applicable. Product on this page will accept wood grain laminate where laminate is currently an option.

Double high overhead storage to be mounted at 82-5/16" from floor to top of overhead unit. Dimension is to top of wood side gable of corresponding 84" h floor standing cabinet not including aluminum and wood top trim.

Sliding door pulls included, not visible on image.

NOTE: Knoll does not assume any responsibility for the installation, attachment or the securing of wall hung units to the wall.

A certified building contractor should be consulted.

Please refer to wall mounting information on page 324.

Reuter flat front overhead cabinet
flat front
Designed by Robert Reuter

description	w	d	h	pattern no.	P1/P2/P3	L	V1	V2	V3
Enclosed cabinet (no mounting hardware) - One door, no pull, no lock	30"	14 1/4"	14 3/4"	RO3-A30NN () () ()	n/a	\$1,255.	\$1,365.	\$1,426.	\$1,726.
	36"	14 1/4"	14 3/4"	RO3-A36NN () () ()	n/a	1,425.	1,583.	1,666.	2,127.
	42"	14 1/4"	14 3/4"	RO3-A42NN () () ()	n/a	1,618.	1,835.	1,960.	2,627.
	48"	14 1/4"	14 3/4"	RO3-A48NN () () ()	n/a	1,826.	1,987.	2,134.	3,047.
Enclosed cabinet (no mounting hardware) - Two doors, no pull, no lock	60"	14 1/4"	14 3/4"	RO3-A60NN () () ()	n/a	2,433.	2,540.	2,672.	3,309.
	72"	14 1/4"	14 3/4"	RO3-A72NN () () ()	n/a	2,749.	2,946.	3,128.	4,103.
Enclosed cabinet (no mounting hardware) - One door, no pull, with lock	30"	14 1/4"	14 3/4"	RO3-A30NL () () ()	1,254.	1,335.	1,447.	1,506.	1,805.
	36"	14 1/4"	14 3/4"	RO3-A36NL () () ()	1,403.	1,504.	1,663.	1,750.	2,206.
	42"	14 1/4"	14 3/4"	RO3-A42NL () () ()	1,557.	1,700.	1,921.	2,040.	2,710.
	48"	14 1/4"	14 3/4"	RO3-A48NL () () ()	1,814.	1,906.	2,069.	2,214.	3,128.
Enclosed cabinet (no mounting hardware) - Two doors, no pull, with lock	60"	14 1/4"	14 3/4"	RO3-A60NL () () ()	2,408.	2,593.	2,699.	2,833.	3,474.
	72"	14 1/4"	14 3/4"	RO3-A72NL () () ()	2,723.	2,908.	3,109.	3,286.	4,262.
Enclosed cabinet (no mounting hardware) - One door, with pull, no lock	30"	14 1/4"	14 3/4"	RO3-A30PN () () ()	n/a	1,488.	1,599.	1,659.	1,959.
	36"	14 1/4"	14 3/4"	RO3-A36PN () () ()	n/a	1,660.	1,821.	1,902.	2,363.
	42"	14 1/4"	14 3/4"	RO3-A42PN () () ()	n/a	1,859.	2,078.	2,198.	2,865.
	48"	14 1/4"	14 3/4"	RO3-A48PN () () ()	n/a	2,070.	2,233.	2,379.	3,292.
Enclosed cabinet (no mounting hardware) - Two doors, with pull, no lock	60"	14 1/4"	14 3/4"	RO3-A60PN () () ()	n/a	2,899.	3,006.	3,137.	3,776.
	72"	14 1/4"	14 3/4"	RO3-A72PN () () ()	n/a	3,216.	3,417.	3,595.	4,573.
Enclosed cabinet (no mounting hardware) - One door, with pull, with lock	30"	14 1/4"	14 3/4"	RO3-A30PL () () ()	1,484.	1,568.	1,679.	1,740.	2,038.
	36"	14 1/4"	14 3/4"	RO3-A36PL () () ()	1,638.	1,741.	1,900.	1,983.	2,444.
	42"	14 1/4"	14 3/4"	RO3-A42PL () () ()	1,794.	1,938.	2,157.	2,279.	2,944.
	48"	14 1/4"	14 3/4"	RO3-A48PL () () ()	2,054.	2,150.	2,314.	2,461.	3,372.
Enclosed cabinet (no mounting hardware) - Two doors, with pull, with lock	60"	14 1/4"	14 3/4"	RO3-A60PL () () ()	2,873.	3,060.	3,165.	3,297.	3,938.
	60"	14 1/4"	14 3/4"	RO3-A72PL () () ()	3,191.	3,378.	3,580.	3,757.	4,730.

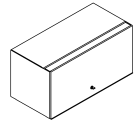



Order Code	Specification Information	Application Notes
Example: RO3-A30PL-117-V-H-Y316 AA	Specify mounting hardware separately.	Reuter storage is a universal product applicable Knoll systems.
RO3 Reuter overhead	Optional anodized aluminum or painted front pull trims the entire width of cabinet door.	Cabinet door rotates above cabinet on side pivots, counterbalanced by two pneumatic cylinders. Two-door cabinets have center divider and four pneumatic cylinders. Vertical interior partitions may be positioned on 1 1/2" increments of width anywhere across shelf, 1 1/2" in from each side. Vertical partitions contain cutouts for mounting up to five horizontal partitions at 2" increments on either or both sides.
A flat front	<i>Specify paint finishes for case. Finish types for front:</i>	Horizontals are suspended between two verticals, and may be positioned end-to-end in any combination up to 3" less than cabinet width. Available in sets of 10; 6", 9", 12", 15" widths.
30 width	L laminate	Order locks for overheads with a KnollKey order form. Please note that Reuter overhead cabinets 60"W or wider require two lock cores.
P with pull	P paint	
L with lock	V veneer or techwood	
117 case finish	Specify grain direction for veneer fronts.	
V front finish type		
H front grain direction		
Y316 front color		
AA pull finish		

Please refer to the AutoStrada price list for finishes available on Reuter Flat Front overhead cabinets fronts.

description	type	width	depth	height	pattern number	black	paint
Reuter overhead downmount brackets	For 64"H spine				AA1ARODN()		\$242.
Reuter overhead upmount brackets	For 48"H spine with standard crown				AA1ROUP()		242.
Reuter overhead extended upmount brackets	For 39"H spine with standard crown				AA1ROXUP()		483.
Upmount brackets	For AutoStrada panels				RO1-RCB()		119.
	For Morrison panels				RO1-CB()		119.
Panel mount brackets, pair	For AutoStrada panels				RO1-RPB	55.	
	For Morrison panels				RO1-MPB	55.	
Wall mount frames, overhead cabinet	30"W overheads	23"	1/2"	13"	RO1-WMF2	104.	
	36" or 42"W overheads	35"	1/2"	13"	RO1-WMF3	113.	
	48" or 60"W overheads	47"	1/2"	13"	RO1-WMF4	119.	
Wall mount wire manager, set of 10					MWM-J	189.	

Order Code	Specification Information	Application Notes
Example: AA1RODN 613	Please specify painted finish for overhead upmount or downmount kit. Paint options are listed on page 8.	Reuter upmount brackets attach overhead cabinet anywhere along standard spine crown, lifting 1" above nominal wall height. Extended upmount brackets lift overhead to 10" above nominal wall height. Downmount brackets attach overheads within the upper 16" of 64"H walls with either compact or standard crown. The AutoStrada version of the downmount brackets extends to the bottom of the access cover, making contact with the bottom trim extrusion.
AA1 Spine accessory		
RO Reuter overhead		
DN Configuration		
613 Finish		Specify an extra bracket (one-half pair) for center support of overhead cabinets wider than 60". Upmount or downmount brackets may be inset to permit overhead to extend 1" or 3" beyond the end of the spine at T-ends. Wall mount frames secure Reuter overhead cabinets to wall (frame/wall mounting hardware is not included). Frame is concealed behind storage. Use 2 RO1-WMF2 to wall mount 66" and 72" wide Reuter overheads. Wall mount wire manager is two-part wire concealment kit, 22"H (medium grey only).

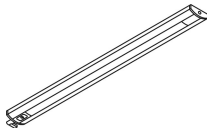
description	type	w	d	h	pattern no.	list
	Use with 24" and wider overhead	19"	4"	1 1/2"	RTAT5E19S	\$260.
	Use with 30" and wider overhead	25"	4"	1 1/2"	RTAT5E25S	280.
	Use with 42" and wider overhead	37"	4"	1 1/2"	RTAT5E37S	302.
	Use with 60" and wider overhead	49"	4"	1 1/2"	RTAT5E49S	327.
	Use with 66" and wider overhead	61"	4"	1 1/2"	RTAT5E61S	348.
	Use with 30" and wider overhead	25"	4"	1 1/2"	RTAT5E25A	483.
	Use with 42" and wider overhead	37"	4"	1 1/2"	RTAT5E37A	508.
	Use with 60" and wider overhead	49"	4"	1 1/2"	RTAT5E49A	528.
	Use with 66" and wider overhead	61"	4"	1 1/2"	RTAT5E61A	550.
	Use with 24" and wider overhead (24 LED's)	17"	2"	1/2"	ML4L17	507.
	Use with 36" and wider overhead (48 LED's)	31"	2"	1/2"	ML4L31	846.
	Use with 48" and wider overhead (72 LED's)	44"	2"	1/2"	ML4L44	1,102.
	Use with 66" and wider overhead (96 LED's)	58"	2"	1/2"	ML4L58	1,384.

Order Code	
T5 Standard Task Light	
Example:	RTAT5E25S
RTA	Task Light
T5	T5 lamp
E	Electronic ballast
25	Width
S	Standard
LED Task Light	
Example:	ML4L17
ML4	Task Light
L	LED
17	Width

Specification Information

T5 Task Lights:
120v and includes T5 cool white (4100K) fluorescent lamp, electronic ballast, 9' grounded cordset, prismatic lens, rocker switch, one cord exit management clip and mounting hardware. Housings are black.

LED Task Lights:
Includes LED's, power supply with 9-12' cord and mounting hardware. Housings are clear anodized aluminum with white color end-caps.

Application Notes

T5 Task Lights:
Specify suffix -CH and add \$45 list for City of Chicago installations.
Example: DL3T5E25S-CH

Cordset is center exit. On smaller units cord exit is off-center, but still not handed.



T5 advanced task lights are fitted with ballasts and lamps compliant with LEED requirements, meeting the LEED EB standard for mercury content.

Notes:
All task lights mount into the recess in the underside of overhead cabinets and shelves at least 6" wider than task light width.

All task lights are TCLP compliant and meet requirements of California Title 20 and Title 24.

Task Lights

for wood and laminate overhead storage

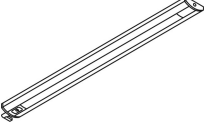
description	type	w	d	h	pattern no.	list
	Use with 24" and wider overhead	19"	4"	1 1/2"	AL1T5E19S	\$299.
	Use with 30" and wider overhead	25"	4"	1 1/2"	AL1T5E25S	305.
	Use with 42" and wider overhead	37"	4"	1 1/2"	AL1T5E37S	313.
	Use with 60" and wider overhead	49"	4"	1 1/2"	AL1T5E49S	318.
	Use with 72" and wider overhead	61"	4"	1 1/2"	AL1T5E61S	336.
	Use with 84" and wider overhead	73"	4"	1 1/2"	AL1T5E73S	367.
	Use with 96" and wider overhead	85"	4"	1 1/2"	AL1T5E85S	458.
	Use with 30" and wider overhead	25"	4"	1 1/2"	AL1T5E25A	442.
	Use with 42" and wider overhead	37"	4"	1 1/2"	AL1T5E37A	463.
	Use with 60" and wider overhead	49"	4"	1 1/2"	AL1T5E49A	482.
	Use with 72" and wider overhead	61"	4"	1 1/2"	AL1T5E61A	501.
	Use with 84" and wider overhead	73"	4"	1 1/2"	AL1T5E73A	521.
	Use with 96" and wider overhead	85"	4"	1 1/2"	AL1T5E85A	539.
	Use with 24" and wider overhead (24 LED's)	17"	2"	1/2"	AL4L17	495.
	Use with 36" and wider overhead (48 LED's)	31"	2"	1/2"	AL4L31	825.
	Use with 48" and wider overhead (72 LED's)	44"	2"	1/2"	AL4L44	1,075.
	Use with 66" and wider overhead (96 LED's)	58"	2"	1/2"	AL4L58	1,350.

Order Code	
T5 Standard Task Light	
Example: AL1T5E19S	
AL1	Task Light
T5	T5 lamp
E	Electronic ballast
19	Width
S	Standard
LED Task Light	
Example: AL4L17	
AL4	Task Light
L	LED
17	Width

Specification Information
<p>T5 Task Lights: 120v and includes T5 cool white (4100K) fluorescent lamp, electronic ballast, 9' grounded cordset, prismatic lens, rocker switch, one cord exit management clip and mounting hardware. Housings are black.</p> <p>LED Task Lights: Includes LED's, power supply with 9-12' cord and mounting hardware. Housings are clear anodized aluminum with white color end-caps.</p>

Application Notes
<p>T5 Task Lights: Specify suffix -CH and add \$45 list for City of Chicago installations. Example: DL3T5E25S-CH</p> <p>Cordset is center exit. On smaller units cord exit is off-center, but still not handed.</p> <p>T5 advanced task lights are fitted with ballasts and lamps compliant with LEED requirements, meeting the LEED EB standard for mercury content.</p> <p>Notes: All task lights mount into the recess in the underside of overhead cabinets and shelves at least 6" wider than task light width.</p> <p>All task lights are TCLP compliant and meet requirements of California Title 20 and Title 24.</p>

Reuter T5 mounting kit for binder depth wood overhead storage

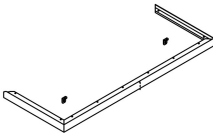
description	type	h	w	d	pattern no.	list		
	binder depth	1 1/2"	18"	13 1/8"	RT1 SMK 1813 ()	\$164.		
		1 1/2"	24"	13 1/8"	RT1 SMK 2413 ()	166.		
		1 1/2"	30"	13 1/8"	RT1 SMK 3013 ()	168.		
		1 1/2"	36"	13 1/8"	RT1 SMK 3613 ()	171.		
		1 1/2"	42"	13 1/8"	RT1 SMK 4213 ()	174.		
		1 1/2"	48"	13 1/8"	RT1 SMK 4813 ()	177.		
		1 1/2"	54"	13 1/8"	RT1 SMK 5413 ()	179.		
		1 1/2"	60"	13 1/8"	RT1 SMK 6013 ()	185.		
		1 1/2"	66"	13 1/8"	RT1 SMK 6613 ()	192.		
		1 1/2"	72"	13 1/8"	RT1 SMK 7213 ()	194.		
		1 1/2"	78"	13 1/8"	RT1 SMK 7813 ()	198.		
		1 1/2"	84"	13 1/8"	RT1 SMK 8413 ()	201.		
		1 1/2"	90"	13 1/8"	RT1 SMK 9013 ()	203.		
		1 1/2"	96"	13 1/8"	RT1 SMK 9613 ()	205.		
		binder depth with tackboard		1 1/2"	18"	12 3/8"	RT1 SMK 1812 ()	164.
				1 1/2"	24"	12 3/8"	RT1 SMK 2412 ()	166.
				1 1/2"	30"	12 3/8"	RT1 SMK 3012 ()	168.
				1 1/2"	36"	12 3/8"	RT1 SMK 3612 ()	171.
				1 1/2"	42"	12 3/8"	RT1 SMK 4212 ()	174.
				1 1/2"	48"	12 3/8"	RT1 SMK 4812 ()	177.
				1 1/2"	54"	12 3/8"	RT1 SMK 5412 ()	179.
		1 1/2"	60"	12 3/8"	RT1 SMK 6012 ()	184.		
		1 1/2"	66"	12 3/8"	RT1 SMK 6612 ()	192.		
		1 1/2"	72"	12 3/8"	RT1 SMK 7212 ()	194.		
		1 1/2"	78"	12 3/8"	RT1 SMK 7812 ()	198.		
		1 1/2"	84"	12 3/8"	RT1 SMK 8412 ()	201.		
		1 1/2"	90"	12 3/8"	RT1 SMK 9012 ()	203.		
		1 1/2"	96"	12 3/8"	RT1 SMK 9612 ()	204.		
Additional T5 mounting brackets					RT1 SMK B	27.		

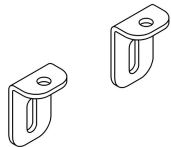

Order Code

Example:	RT1 SMK 2413 AA
RT1	Reuter task lamp
SMK	Mounting kit
24	Width
13	Depth
AA	Finish

Specification Information

Mounting kit finish choice:
Anodized Aluminum or painted finish options listed on page 10 excluding silver.

12" deep: binder depth wood overhead, wall mounted with tackboard below.

13" deep: binder depth wood overhead on Applied Wall System or wall mounted without tackboard.

Application

Reuter T5 task lamp mounting kit enables task lamp to be mounted under veneer or laminate overhead storage cabinets (with or without doors). Mounting kit includes anodized aluminum fascia to conceal lamp and manage power cord along front and side of cabinet. Specify mounting kit in width corresponding to overhead cabinet. Mounting kit also includes back supports for one task lamp.

To mount a second task lamp within one longer mounting kit specify one additional pair of back supports. Back supports are L brackets into which the pins at the back of the Reuter are inserted. Sliding brackets on sides of the lamp slide over the inside lip of the fascia at any point to support the front of the lamp.

Reuter T5 mounting kit for legal depth wood overhead storage

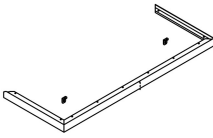
description	type	h	w	d	pattern no.	list		
	legal depth	1 1/2"	18"	16 1/8"	RT1 SMK 1816 ()	\$166.		
		1 1/2"	24"	16 1/8"	RT1 SMK 2416 ()	168.		
		1 1/2"	30"	16 1/8"	RT1 SMK 3016 ()	170.		
		1 1/2"	36"	16 1/8"	RT1 SMK 3616 ()	174.		
		1 1/2"	42"	16 1/8"	RT1 SMK 4216 ()	175.		
		1 1/2"	48"	16 1/8"	RT1 SMK 4816 ()	178.		
		1 1/2"	54"	16 1/8"	RT1 SMK 5416 ()	184.		
		1 1/2"	60"	16 1/8"	RT1 SMK 6016 ()	186.		
		1 1/2"	66"	16 1/8"	RT1 SMK 6616 ()	194.		
		1 1/2"	72"	16 1/8"	RT1 SMK 7216 ()	197.		
		1 1/2"	78"	16 1/8"	RT1 SMK 7816 ()	199.		
		1 1/2"	84"	16 1/8"	RT1 SMK 8416 ()	202.		
		1 1/2"	90"	16 1/8"	RT1 SMK 9016 ()	204.		
		1 1/2"	96"	16 1/8"	RT1 SMK 9616 ()	206.		
		legal depth with tackboard		1 1/2"	18"	15 3/8"	RT1 SMK 1815 ()	166.
				1 1/2"	24"	15 3/8"	RT1 SMK 2415 ()	167.
				1 1/2"	30"	15 3/8"	RT1 SMK 3015 ()	170.
				1 1/2"	36"	15 3/8"	RT1 SMK 3615 ()	172.
				1 1/2"	42"	15 3/8"	RT1 SMK 4215 ()	175.
				1 1/2"	48"	15 3/8"	RT1 SMK 4815 ()	178.
				1 1/2"	54"	15 3/8"	RT1 SMK 5415 ()	184.
				1 1/2"	60"	15 3/8"	RT1 SMK 6015 ()	186.
		1 1/2"	66"	15 3/8"	RT1 SMK 6615 ()	193.		
		1 1/2"	72"	15 3/8"	RT1 SMK 7215 ()	197.		
		1 1/2"	78"	15 3/8"	RT1 SMK 7815 ()	199.		
		1 1/2"	84"	15 3/8"	RT1 SMK 8415 ()	202.		
		1 1/2"	90"	15 3/8"	RT1 SMK 9015 ()	204.		
		1 1/2"	96"	15 3/8"	RT1 SMK 9615 ()	206.		
Additional T5 mounting brackets					RT1 SMK B	27.		

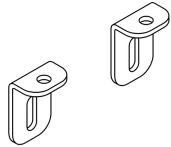

Order Code

Example:	RT1 SMK 2416 AA
RT1	Reuter task lamp
SMK	Mounting kit
24	Width
16	depth
AA	Finish

Specification Information

Mounting kit finish choice:
Anodized Aluminum or painted finish options listed on page 10 excluding silver.

15" deep: legal depth wood overhead, wall mounted with tackboard below.

16" deep: legal depth wood overhead on Applied Wall System or wall mounted without tackboard.

Application

Reuter T5 task lamp mounting kit enables task lamp to be mounted under veneer or laminate overhead storage cabinets (with or without doors). Mounting kit includes anodized aluminum fascia to conceal lamp and manage power cord along front and side of cabinet. Specify mounting kit in width corresponding to overhead cabinet. Mounting kit also includes back supports for one task lamp.

To mount a second task lamp within one longer mounting kit specify one additional pair of back supports. Back supports are L brackets into which the pins at the back of the Reuter are inserted. Sliding brackets on sides of the lamp slide over the inside lip of the fascia at any point to support the front of the lamp.

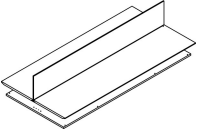
description	h	w	d	pattern no.	L	V1/M	V2	V3
	15"	60	40	A1GCTDK60141(L/V/M)() () ()	\$2,448.	\$2,834.	\$2,957.	\$3,549.
	15"	60"	48"	A1GCTDK60142(L/V/M)() () ()	2,506.	2,898.	3,041.	3,650.
	15"	72"	40"	A1GCTDK72141(L/V/M)() () ()	2,660.	3,053.	3,198.	3,837.
	15"	72"	48"	A1GCTDK72142(L/V/M)() () ()	2,729.	3,127.	3,296.	3,955.
	15"	90"	40"	A1GCTDK90141(L/V/M)() () ()	2,901.	3,305.	3,481.	4,178.
	15"	90"	48"	A1GCTDK90142(L/V/M)() () ()	2,992.	3,403.	3,603.	4,326.
	15"	96"	40"	A1GCTDK96141(L/V/M)() () ()	2,970.	3,375.	3,560.	4,272.
	15"	96"	48"	A1GCTDK96142(L/V/M)() () ()	3,063.	3,474.	3,692.	4,430.

1=use with nominal 19" deep storage.
 2=use with nominal 23" deep storage.

Order Code	Specifications	Application Notes
Example: A1GCTDK60141L	<i>To order please specify pattern number including:</i>	Credenza top glass divider kit to include glass divider, pair of worksurfaces under one product code per size.
A AutoStrada	1. Surface type <i>L = Laminate</i>	Worksurfaces are dedicated to kit and to be notched for securing divider capture.
1 Generation 1	<i>M = Mixed, Laminate surface/V1, V2 or V3 edge</i>	
G Glass	<i>V = V1, V2 or V3</i>	Grommets not optional in worksurface.
CT Credenza top	2. Finish, Surface <i>Laminate, V1, V2 or V3 finish</i>	
DK Divider kit	3. Finish, Edge <i>Must be same as surface finish</i>	Hardware included.
60 60" wide	4. Finish, Glass <i>TEMP = clear tempered glass</i>	
141 Nominal glass height	<i>GL13 = powder</i>	Assembly required.
L Laminate	<i>GL25 = bronze</i>	
V316 Finish, primary worksurface	<i>GL35 = grey</i>	
111 Subtop spacer	5. Finish, capture/ divider Anodized aluminum or painted finish options, listed on page 8 excluding 613 Silver.	Standoff / subtop only available in 111.
TEMP Finish, glass		
AA Finish, divider capture		

Applications to be restricted for use with common depth of storage either 19" deep or 23" deep on both sides. Will not offer 19" deep on one side and 23" deep on other side.

width	GL13	GL25/GL35
60"	\$122	\$390
72"	\$145	\$467
90"	\$181	\$584
96"	\$196	\$625

Flush, user edge tapered Rectilinear, 20" and 24" deep

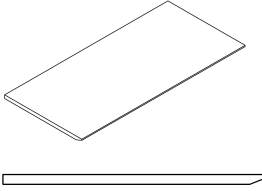
description	d	w	pattern no.	L	M	V1	V2	V3	
Straight rectangular, (full depth) front edge tapered 	20"	18"	AW1T1RF1820 () () () ()	\$367.	\$448.	\$470.	\$536.	\$699.	
		20"	AW1T1RF2020 () () () ()	381.	458.	482.	551.	718.	
		24"	AW1T1RF2420 () () () ()	392.	470.	494.	564.	734.	
		30"	AW1T1RF3020 () () () ()	422.	517.	542.	622.	808.	
		36"	AW1T1RF3620 () () () ()	426.	543.	571.	658.	855.	
		42"	AW1T1RF4220 () () () ()	437.	569.	598.	688.	894.	
		48"	AW1T1RF4820 () () () ()	448.	591.	621.	712.	927.	
		54"	AW1T1RF5420 () () () ()	461.	616.	647.	747.	971.	
		60"	AW1T1RF6020 () () () ()	488.	666.	699.	803.	1,042.	
		66"	AW1T1RF6620 () () () ()	524.	686.	720.	829.	1,078.	
		72"	AW1T1RF7220 () () () ()	528.	721.	756.	870.	1,128.	
		78"	AW1T1RF7820 () () () ()	544.	729.	766.	882.	1,145.	
		84"	AW1T1RF8420 () () () ()	576.	775.	814.	937.	1,221.	
		90"	AW1T1RF9020 () () () ()	589.	810.	851.	977.	1,270.	
		96"	AW1T1RF9620 () () () ()	629.	841.	882.	1,012.	1,317.	
		24"	18"	AW1T1RF1824 () () () ()	393.	472.	495.	567.	739.
			20"	AW1T1RF2024 () () () ()	408.	482.	506.	581.	756.
			24"	AW1T1RF2424 () () () ()	417.	492.	517.	598.	776.
			30"	AW1T1RF3024 () () () ()	436.	559.	586.	674.	876.
		36"	AW1T1RF3624 () () () ()	449.	582.	611.	701.	913.	
		42"	AW1T1RF4224 () () () ()	464.	599.	629.	722.	939.	
		48"	AW1T1RF4824 () () () ()	514.	643.	674.	774.	1,006.	
		54"	AW1T1RF5424 () () () ()	518.	686.	720.	829.	1,078.	
		60"	AW1T1RF6024 () () () ()	544.	735.	771.	886.	1,150.	
		66"	AW1T1RF6624 () () () ()	590.	762.	800.	915.	1,191.	
		72"	AW1T1RF7224 () () () ()	606.	794.	833.	960.	1,248.	
		78"	AW1T1RF7824 () () () ()	625.	830.	872.	1,006.	1,308.	
		84"	AW1T1RF8424 () () () ()	651.	867.	910.	1,042.	1,358.	
		90"	AW1T1RF9024 () () () ()	695.	902.	947.	1,093.	1,419.	
		96"	AW1T1RF9624 () () () ()	711.	937.	984.	1,137.	1,475.	

Order Code	Specification Information	Application Notes
Example: AW1T1RF1820MG118 V316613	<i>To order please specify pattern number including:</i>	
A AutoStrada	1. Width	
W Worksurface	2. Depth	
1 Generation 1	3. Surface type	
T1 Tapered one side, user	<i>L = Laminate</i>	
R Rectilinear	<i>M = Mixed, Laminate surface/V1, V2 or V3 edge</i>	
F Full depth, flush	<i>V = V1, V2 or V3</i>	
18 18" wide	4. Grommet option	
20 20" deep	<i>N = No grommets</i>	
M Surface type, Mixed	<i>G = Grommet(s), flush</i>	
G Grommet	<i>R = Grommet(s), recessed</i>	
118 Finish surface, Bright white	<i>EG = Edge Grommet (for worksurfaces 30" wide or greater)</i>	
V316 Finish edge, Maple	5. Finish, Surface	
613 Finish, grommet	<i>Laminate, V1, V2 or V3 finish</i>	
	6. Finish, Edge	
	<i>Must be same as surface finish unless M surface type specified, then must be V1, V2 or V3 finish</i>	
	7. Finish, Grommet(s)	
	<i>specify painted or plated finish</i>	Hardware to attach to vertical support to be specified separately.
	See page 8 for finish options applicable.	1 1/4" tops require additional support when distance spans over 48".
	Product on this page will accept wood grain laminate where laminate is currently an option.	Actual widths are 1/16" less than nominal dimension noted and depths are 1/8" less than nominal dimension noted.
		When grommets specified up to 48" w tops have one grommet, over 48" w tops have two grommets.
		Edge grommets are available on worksurfaces 30" wide or greater. The upcharge for Edge Grommet is \$175.

Flush, user edge tapered Rectilinear, 30" and 36" deep

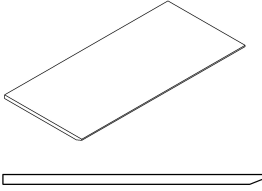
description	d	w	pattern no.	L	M	V1	V2	V3	
Straight rectangular, (full depth) front edge tapered 	30"	18"	AW1T1RF1830 () () () ()	\$401.	\$509.	\$535.	\$619.	\$803.	
		20"	AW1T1RF2030 () () () ()	407.	524.	550.	634.	821.	
		24"	AW1T1RF2430 () () () ()	416.	536.	563.	649.	846.	
		30"	AW1T1RF3030 () () () ()	437.	607.	637.	729.	949.	
		36"	AW1T1RF3630 () () () ()	452.	654.	687.	784.	1,023.	
		42"	AW1T1RF4230 () () () ()	474.	675.	710.	816.	1,061.	
		48"	AW1T1RF4830 () () () ()	527.	723.	759.	875.	1,140.	
		54"	AW1T1RF5430 () () () ()	540.	781.	821.	944.	1,228.	
		60"	AW1T1RF6030 () () () ()	574.	811.	852.	978.	1,271.	
		66"	AW1T1RF6630 () () () ()	617.	829.	871.	1,001.	1,302.	
		72"	AW1T1RF7230 () () () ()	637.	851.	894.	1,027.	1,335.	
		78"	AW1T1RF7830 () () () ()	660.	889.	934.	1,077.	1,397.	
		84"	AW1T1RF8430 () () () ()	686.	926.	971.	1,119.	1,457.	
		90"	AW1T1RF9030 () () () ()	746.	966.	1,014.	1,173.	1,522.	
		96"	AW1T1RF9630 () () () ()	748.	1,002.	1,052.	1,214.	1,574.	
		36"	18"	AW1T1RF1836 () () () ()	410.	552.	580.	670.	872.
			20"	AW1T1RF2036 () () () ()	415.	568.	597.	690.	896.
			24"	AW1T1RF2436 () () () ()	433.	582.	611.	703.	916.
			30"	AW1T1RF3036 () () () ()	450.	657.	690.	790.	1,028.
		36"	AW1T1RF3636 () () () ()	479.	730.	767.	877.	1,142.	
		42"	AW1T1RF4236 () () () ()	516.	765.	803.	927.	1,203.	
		48"	AW1T1RF4836 () () () ()	569.	817.	857.	990.	1,288.	
		54"	AW1T1RF5436 () () () ()	587.	898.	942.	1,074.	1,396.	
		60"	AW1T1RF6036 () () () ()	593.	901.	945.	1,081.	1,404.	
		66"	AW1T1RF6636 () () () ()	657.	905.	950.	1,097.	1,425.	
		72"	AW1T1RF7236 () () () ()	679.	930.	977.	1,124.	1,462.	
		78"	AW1T1RF7836 () () () ()	711.	951.	998.	1,153.	1,499.	
		84"	AW1T1RF8436 () () () ()	737.	989.	1,038.	1,201.	1,562.	
		90"	AW1T1RF9036 () () () ()	796.	1,037.	1,090.	1,255.	1,632.	
		96"	AW1T1RF9636 () () () ()	818.	1,071.	1,124.	1,294.	1,680.	

Worksurfaces

Order Code	Specification Information	Application Notes
Example: AW1T1RF1830MG118 V316613	<i>To order please specify pattern number including:</i>	
A AutoStrada	1. Width	
W Worksurface	2. Depth	
1 Generation 1	3. Surface type	
T1 Tapered 1 side, user	<i>L = Laminate</i>	
R Rectilinear	<i>M = Mixed, Laminate surface/V1, V2 or V3 edge</i>	
F Full depth, flush	<i>V = V1, V2 or V3</i>	
18 18" wide	4. Grommet option	
30 30" deep	<i>N = No grommets</i>	
M Surface type, Mixed	<i>G = Grommet(s), flush</i>	
G Grommet	<i>R = Grommet(s), recessed</i>	
118 Finish surface, Bright white	<i>GR = Edge Grommet (for worksurfaces 30" wide or greater)</i>	
V316 Finish edge, Maple	5. Finish, Surface	
613 Finish, grommet	<i>Laminate, V1, V2 or V3 finish</i>	
	6. Finish, Edge	
	<i>Must be same as surface finish unless M surface type specified, then must be V1, V2 or V3 finish</i>	
	7. Finish, Grommet(s)	
	<i>specify painted or plated finish</i>	
	See page 8 for finish options applicable.	Hardware to attach to vertical support to be specified separately.
	Product on this page will accept wood grain laminate where laminate is currently an option.	1 1/4" tops require additional support when distance spans over 48".
		Actual widths are 1/16" less than nominal dimension noted and depths are 1/8" less than nominal dimension noted.
		When grommets specified up to 48" w tops have one grommet, over 48" w have two grommets.
		Edge grommets are available on worksurfaces 30" wide or greater. The upcharge for Edge Grommet is \$175.

Flush, user edge tapered Wedge

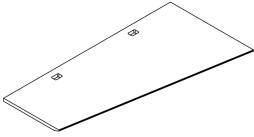
description	d, left	w	d, right	pattern no.	L	M	V1	V2	V3
Wedge, (full depth) front edge tapered 	24"	48"	30"	AW1T1WF4823 () () () ()	\$609.	\$723.	\$759.	\$875.	\$1,140.
	24"	60"	30"	AW1T1WF6023 () () () ()	646.	811.	852.	978.	1,271.
	24"	72"	36"	AW1T1WF7226 () () () ()	798.	911.	957.	1,096.	1,423.
	30"	48"	24"	AW1T1WF4832 () () () ()	609.	723.	759.	875.	1,140.
	30"	60"	24"	AW1T1WF6032 () () () ()	646.	811.	852.	978.	1,271.
	36"	72"	24"	AW1T1WF7262 () () () ()	798.	911.	957.	1,096.	1,423.
Presentation wood sample (with tapered edge detail)	16"	16"	16"	ASAMP1616 ()	121.	176.	185.	245.	290.

Order Code	Specification Information	Application Notes
Example: AW1T1WF4823MG118 V316613	<i>To order please specify pattern number including:</i>	
A AutoStrada	1. Width	6. Finish, Edge <i>Must be same as surface finish unless M surface type specified, then must be V1, V2 or V3 finish</i>
W Worksurface	2. Depth 23 = 24" deep left, 30" deep right 32 = 30" deep left, 24" deep right 26 = 24" deep left, 36" deep right 62 = 36" deep left, 24" deep right	7. Finish, Grommet(s) <i>specify painted or plated finish</i>
1 Generation 1	3. Surface type <i>L = Laminate</i> <i>M = Mixed, Laminate surface/V1, V2 or V3 edge</i> <i>V = V1, V2 or V3</i>	See page 8 for finish options applicable.
T1 Tapered 1 side, user	4. Grommet option <i>N = No grommets</i> <i>G = Grommet(s), flush</i> <i>R = Grommet(s), recessed</i>	Product on this page will accept wood grain laminate where laminate is currently an option.
W Wedge	5. Finish, Surface <i>Laminate, V1, V2 or V3 finish</i>	
F Full depth, flush		
48 48" wide		Hardware to attach to vertical support to be specified separately.
2 24" deep, left		1 1/4" tops require additional support when distance spans over 48".
3 30" deep, right		Actual widths are 1/16" less than nominal dimension noted and depths are 1/8" less than nominal dimension noted.
M Surface type, Mixed		When grommets specified up to 48" w tops have one grommet, over 48" w have two grommets.
G Grommet		
118 Finish surface, Bright white		
V316 Finish edge, Maple		
613 Finish, grommet		

Cord drop, user edge tapered

Rectilinear

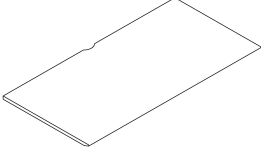
description	d	w	pattern no.	L	M	V1	V2	V3
Straight rectangular, (cord drop) front edge tapered 	20"	18"	AW1T1RU1820 () () ()	\$378.	\$448.	\$470.	\$536.	\$699.
	20"	20"	AW1T1RU2020 () () ()	381.	458.	482.	551.	718.
	24"	18"	AW1T1RU2420 () () ()	392.	470.	494.	564.	734.
	24"	20"	AW1T1RU3020 () () ()	438.	517.	542.	622.	808.
	24"	30"	AW1T1RU3620 () () ()	442.	543.	571.	658.	855.
	24"	42"	AW1T1RU4220 () () ()	447.	569.	598.	688.	894.
	24"	48"	AW1T1RU4820 () () ()	460.	591.	621.	712.	927.
	24"	54"	AW1T1RU5420 () () ()	474.	616.	647.	747.	971.
	24"	60"	AW1T1RU6020 () () ()	500.	666.	699.	803.	1,042.
	24"	66"	AW1T1RU6620 () () ()	534.	686.	720.	829.	1,078.
	24"	72"	AW1T1RU7220 () () ()	538.	721.	756.	870.	1,128.
	24"	78"	AW1T1RU7820 () () ()	558.	729.	766.	882.	1,145.
	24"	84"	AW1T1RU8420 () () ()	586.	775.	814.	937.	1,221.
	24"	90"	AW1T1RU9020 () () ()	599.	810.	851.	977.	1,270.
	24"	96"	AW1T1RU9620 () () ()	640.	841.	882.	1,012.	1,317.
	24"	18"	AW1T1RU1824 () () ()	404.	472.	495.	567.	739.
	24"	20"	AW1T1RU2024 () () ()	409.	482.	506.	581.	756.
	24"	24"	AW1T1RU2424 () () ()	412.	492.	517.	598.	776.
	24"	30"	AW1T1RU3024 () () ()	415.	559.	586.	674.	876.
	24"	36"	AW1T1RU3624 () () ()	422.	582.	611.	701.	913.
24"	42"	AW1T1RU4224 () () ()	439.	599.	629.	722.	939.	
24"	48"	AW1T1RU4824 () () ()	452.	643.	674.	774.	1,006.	
24"	54"	AW1T1RU5424 () () ()	532.	686.	720.	829.	1,078.	
24"	60"	AW1T1RU6024 () () ()	585.	735.	771.	886.	1,150.	
24"	66"	AW1T1RU6624 () () ()	602.	762.	800.	915.	1,191.	
24"	72"	AW1T1RU7224 () () ()	617.	794.	833.	960.	1,248.	
24"	78"	AW1T1RU7824 () () ()	638.	830.	872.	1,006.	1,308.	
24"	84"	AW1T1RU8424 () () ()	663.	867.	910.	1,042.	1,358.	
24"	90"	AW1T1RU9024 () () ()	705.	902.	947.	1,093.	1,419.	
24"	96"	AW1T1RU9624 () () ()	723.	937.	984.	1,137.	1,475.	

Worksurfaces

Order Code	Specification Information	Application Notes
Example: AW1T1RC1820M118 V316 812	To order please specify pattern number including:	Worksurfaces with cord drop are not recommended for freestanding applications.
A AutoStrada	1. Width	See page 8 for finish options applicable.
W Worksurface	2. Depth	Product on this page will accept wood grain laminate where laminate is currently an option.
1 Generation 1	3. Surface type <i>L = Laminate</i>	Hardware to attach to vertical support to be specified separately.
T1 Tapered 1 side, user	<i>M = Mixed, Laminate surface/V1, V2 or V3 edge</i>	1 1/4" tops require additional support when distance spans over 48".
R Rectilinear	<i>V = V1, V2 or V3</i>	Actual widths are 1/16" less than nominal dimension noted and depths are 3/8" less than nominal dimension noted.
U Cord drop	4. Finish, Surface <i>Laminate, V1, V2 or V3 finish</i>	
18 18" wide	5. Finish, Edge <i>Must be same as surface finish unless M surface type specified, then must be V1, V2 or V3 finish</i>	
20 20" deep	6. Finish, Grommet	
M Surface type, Mixed	111 Jet black	
118 Finish surface, Bright white	812 Easy grey	
V316 Finish edge, Maple		
812 Finish grommet, Easy grey		

Cord drop, user edge tapered

Rectilinear

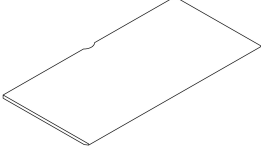
description	d	w	pattern no.	L	M	V1	V2	V3
Straight rectangular, (cord drop) front edge tapered 	30"	18"	AW1T1RU1830 () () ()	\$411.	\$509.	\$535.	\$619.	\$803.
		20"	AW1T1RU2030 () () ()	417.	524.	550.	634.	821.
		24"	AW1T1RU2430 () () ()	432.	536.	563.	649.	846.
		30"	AW1T1RU3030 () () ()	447.	607.	637.	729.	949.
		36"	AW1T1RU3630 () () ()	464.	654.	687.	784.	1,023.
		42"	AW1T1RU4230 () () ()	485.	675.	710.	816.	1,061.
		48"	AW1T1RU4830 () () ()	537.	723.	759.	875.	1,140.
		54"	AW1T1RU5430 () () ()	550.	781.	821.	944.	1,228.
		60"	AW1T1RU6030 () () ()	614.	811.	852.	978.	1,271.
		66"	AW1T1RU6630 () () ()	628.	829.	871.	1,001.	1,302.
		72"	AW1T1RU7230 () () ()	648.	851.	894.	1,027.	1,335.
		78"	AW1T1RU7830 () () ()	668.	889.	934.	1,077.	1,397.
		84"	AW1T1RU8430 () () ()	695.	926.	971.	1,119.	1,457.
		90"	AW1T1RU9030 () () ()	758.	966.	1,014.	1,173.	1,522.
		96"	AW1T1RU9630 () () ()	761.	1,002.	1,052.	1,214.	1,574.

Order Code	Specification Information	Application Notes
Example: AW1T1RC1820M118 V316 812	To order please specify pattern number including:	Worksurfaces with cord drop are not recommended for freestanding applications.
A AutoStrada	1. Width	See page 8 for finish options applicable.
W Worksurface	2. Depth	Product on this page will accept wood grain laminate where laminate is currently an option.
1 Generation 1	3. Surface type <i>L = Laminate</i>	Hardware to attach to vertical support to be specified separately.
T1 Tapered 1 side, user	<i>M = Mixed, Laminate surface/V1, V2 or V3 edge</i>	1 1/4" tops require additional support when distance spans over 48".
R Rectilinear	<i>V = V1, V2 or V3</i>	Actual widths are 1/16" less than nominal dimension noted and depths are 3/8" less than nominal dimension noted.
U Cord drop	4. Finish, Surface <i>Laminate, V1, V2 or V3 finish</i>	
18 18" wide	5. Finish, Edge <i>Must be same as surface finish unless M surface type specified, then must be V1, V2 or V3 finish</i>	
20 20" deep	6. Finish, Grommet	
M Surface type, Mixed	111 Jet black	
118 Finish surface, Bright white	812 Easy grey	
V316 Finish edge, Maple		
812 Finish grommet, Easy grey		

Cord drop, user edge tapered

Wedge

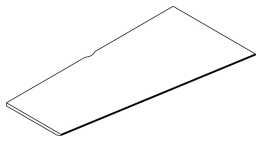
description	d, left	w	d, right	pattern no.	L	M	V1	V2	V3
Wedge, (cord drop) front edge tapered 	24"	48"	30"	AW1T1WU4823 () () ()	\$614.	\$723.	\$759.	\$875.	\$1,140.
	24"	60"	30"	AW1T1WU6023 () () ()	649.	811.	852.	978.	1,271.
	24"	72"	36"	AW1T1WU7226 () () ()	806.	911.	957.	1,096.	1,423.
	30"	48"	24"	AW1T1WU4832 () () ()	614.	723.	759.	875.	1,140.
	30"	60"	24"	AW1T1WU6032 () () ()	649.	811.	852.	978.	1,271.
	36"	72"	24"	AW1T1WU7262 () () ()	806.	911.	957.	1,096.	1,423.

Order Code	Specification Information	Application Notes
Example: AW1T1WU4823M118 V316 812	To order please specify pattern number including:	Worksurfaces with cord drop are not recommended for freestanding applications. Hardware to attach to vertical support to be specified separately. 1 1/4" tops require additional support when distance spans over 48". Actual widths are 1/16" less than nominal dimension noted and depths are 3/8" less than nominal dimension noted.
A AutoStrada	1. Width	
W Worksurface	2. Depth 23 = 24" deep left, 30" deep right 32 = 30" deep left, 24" deep right 26 = 24" deep left, 36" deep right 62 = 36" deep left, 24" deep right	
1 Generation 1	3. Surface type L = Laminate M = Mixed, Laminate surface/V1, V2 or V3 edge V = V1, V2 or V3	
T1 Tapered 1 side, user	4. Finish, Surface Laminate, V1, V2 or V3 finish	
W Wedge	5. Finish, Edge Must be same as surface finish unless M surface type specified, then must be V1, V2 or V3 finish	
U Cord drop	6. Finish, Grommet 111 Jet black 812 Easy grey	
48 48" wide	See page 8 for finish options applicable.	
2 24" deep, left	Product on this page will accept wood grain laminate where laminate is currently an option.	
3 30" deep, right		
M Surface type, Mixed		
118 Finish surface, Bright white		
V316 Finish edge, Maple		
812 Finish grommet, Easy grey		

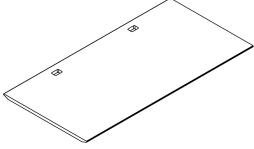
description	d	w	pattern no.	L	M	V1	V2	V3	
Straight rectangular, (full depth) front & back edge tapered 	30"	30"	AW1T2R3030 () () () ()	\$499.	\$739.	\$776.	\$870.	\$1,091.	
		36"	AW1T2R3630 () () () ()	514.	783.	823.	925.	1,160.	
		42"	AW1T2R4230 () () () ()	535.	810.	851.	958.	1,202.	
		48"	AW1T2R4830 () () () ()	559.	857.	900.	1,014.	1,278.	
		54"	AW1T2R5430 () () () ()	633.	916.	962.	1,087.	1,367.	
		60"	AW1T2R6030 () () () ()	654.	943.	990.	1,118.	1,411.	
		66"	AW1T2R6630 () () () ()	673.	961.	1,010.	1,143.	1,442.	
		72"	AW1T2R7230 () () () ()	694.	983.	1,032.	1,166.	1,472.	
		78"	AW1T2R7830 () () () ()	720.	1,022.	1,073.	1,218.	1,539.	
		84"	AW1T2R8430 () () () ()	740.	1,059.	1,112.	1,257.	1,596.	
		90"	AW1T2R9030 () () () ()	795.	1,099.	1,154.	1,312.	1,662.	
		96"	AW1T2R9630 () () () ()	817.	1,136.	1,192.	1,351.	1,714.	
		36"	30"	AW1T2R3036 () () () ()	515.	788.	827.	931.	1,167.
			36"	AW1T2R3636 () () () ()	537.	864.	908.	1,016.	1,280.
			42"	AW1T2R4236 () () () ()	561.	899.	943.	1,064.	1,344.
			48"	AW1T2R4836 () () () ()	589.	949.	996.	1,129.	1,429.
			54"	AW1T2R5436 () () () ()	667.	1,035.	1,088.	1,216.	1,538.
			60"	AW1T2R6036 () () () ()	691.	1,030.	1,081.	1,222.	1,542.
			66"	AW1T2R6636 () () () ()	729.	1,039.	1,092.	1,234.	1,565.
		72"	AW1T2R7236 () () () ()	738.	1,064.	1,117.	1,267.	1,603.	
		78"	AW1T2R7836 () () () ()	770.	1,087.	1,141.	1,294.	1,640.	
		84"	AW1T2R8436 () () () ()	789.	1,122.	1,179.	1,342.	1,702.	
		90"	AW1T2R9036 () () () ()	847.	1,170.	1,228.	1,394.	1,770.	
		96"	AW1T2R9636 () () () ()	872.	1,205.	1,267.	1,432.	1,819.	

Order Code	Specification Information	Application Notes
Example: AW1T2R3030MG118 V316613	To order please specify pattern number including:	7. Finish, Grommet(s) <i>specify painted or plated finish</i>
A AutoStrada	1. Width	Hardware to attach to vertical support to be specified separately.
W Worksurface	2. Depth	See page 8 for finish options applicable.
1 Generation 1	3. Surface type <i>L = Laminate</i> <i>M = Mixed, Laminate surface/V1, V2 or V3 edge</i> <i>V = V1, V2 or V3</i>	1 1/4" tops require additional support when distance spans over 48".
T2 Tapered 2 sides, user & approach	4. Grommet option <i>N = No grommets</i> <i>G = Grommet(s), flush</i> <i>R = Grommet(s), recessed</i>	When grommets specified up to 48" w tops have one grommet, over 48" w have two grommets.
R Rectilinear	5. Finish, Surface <i>Laminate, V1, V2 or V3 finish</i>	
30 30" wide	6. Finish, Edge <i>Must be same as surface finish unless M surface type specified, then must be V1, V2 or V3 finish</i>	
30 30" deep		
M Surface type, Mixed		
G Grommet		
118 Finish surface, Bright white		
V316 Finish edge, Maple		
613 Finish, grommet		

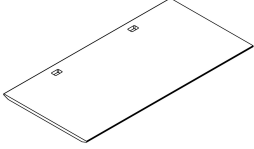
description	d	w	pattern no.	L	M	V1	V2	V3
Straight rectangular, (full depth) front & back edge tapered 	42"	30"	AW1T2R3042 () () () ()	\$536.	\$854.	\$897.	\$1,006.	\$1,308.
		36"	AW1T2R3642 () () () ()	561.	969.	1,017.	1,139.	1,476.
		42"	AW1T2R4242 () () () ()	586.	1,011.	1,061.	1,205.	1,570.
		48"	AW1T2R4842 () () () ()	616.	1,070.	1,123.	1,280.	1,665.
		54"	AW1T2R5442 () () () ()	697.	1,103.	1,158.	1,314.	1,707.
		60"	AW1T2R6042 () () () ()	724.	1,137.	1,193.	1,348.	1,753.
		66"	AW1T2R6642 () () () ()	749.	1,144.	1,201.	1,359.	1,765.
		72"	AW1T2R7242 () () () ()	775.	1,148.	1,205.	1,368.	1,777.
		78"	AW1T2R7842 () () () ()	826.	1,163.	1,222.	1,386.	1,800.
		84"	AW1T2R8442 () () () ()	834.	1,202.	1,262.	1,437.	1,871.
		90"	AW1T2R9042 () () () ()	896.	1,254.	1,316.	1,498.	1,948.
		96"	AW1T2R9642 () () () ()	925.	1,287.	1,352.	1,528.	1,989.

Worksurfaces

Order Code	Specification Information	Application Notes
Example: AW1T2R3030MG118 V316613	<i>To order please specify pattern number including:</i>	7. Finish, Grommet(s) <i>specify painted or plated finish</i>
A AutoStrada	1. Width	See page 8 for finish options applicable.
W Worksurface	2. Depth	
1 Generation 1	3. Surface type <i>L = Laminate</i>	Product on this page will accept wood grain laminate where laminate is currently an option.
T2 Tapered 2 sides, user & approach	<i>M = Mixed, Laminate surface/V1, V2 or V3 edge</i>	
R Rectilinear	<i>V = V1, V2 or V3</i>	When grommets specified up to 48" w tops have one grommet, over 48" w have two grommets.
30 30" wide	4. Grommet option <i>N = No grommets</i>	
30 30" deep	<i>G = Grommet(s), flush</i>	
M Surface type, Mixed	<i>R = Grommet(s), recessed</i>	
G Grommet	5. Finish, Surface <i>Laminate, V1, V2 or V3 finish</i>	
118 Finish surface, Bright white	6. Finish, Edge <i>Must be same as surface finish unless M surface type specified, then must be V1, V2 or V3 finish</i>	
V316 Finish edge, Maple		
613 Finish, grommet		

Rectilinear for C-Leg and T-Leg bases 24", 30" and 36" Deep

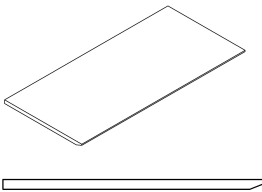
description	type	d*	d	w*	w	pattern no.	L	V1	V2	V3
	For use with 24"D C-Leg base	24"	23"	36"	34"	AW1T1R3423()N()	\$422.	\$611.	\$701.	\$913.
		24"	23"	42"	40"	AW1T1R4023()N()	439.	629.	722.	939.
		24"	23"	48"	46"	AW1T1R4623()N()	452.	674.	774.	1,006.
		24"	23"	54"	52"	AW1T1R5223()N()	532.	720.	829.	1,078.
		24"	23"	60"	58"	AW1T1R5823()N()	585.	771.	886.	1,150.
		24"	23"	66"	64"	AW1T1R6423()N()	602.	800.	915.	1,191.
		24"	23"	72"	70"	AW1T1R7023()N()	617.	833.	960.	1,248.
	For use with 30"D C-Leg base	30"	29"	36"	34"	AW1T1R3429()N()	464.	687.	784.	1,023.
		30"	29"	42"	40"	AW1T1R4029()N()	485.	710.	816.	1,061.
		30"	29"	48"	46"	AW1T1R4629()N()	537.	759.	875.	1,140.
		30"	29"	54"	52"	AW1T1R5229()N()	550.	821.	944.	1,228.
		30"	29"	60"	58"	AW1T1R5829()N()	614.	852.	978.	1,271.
		30"	29"	66"	64"	AW1T1R6429()N()	628.	871.	1,001.	1,302.
		30"	29"	72"	70"	AW1T1R7029()N()	648.	894.	1,027.	1,335.
	For use with 30"D T-Leg base	36"	35"	48"	46"	AW1T2R4635()N()	589.	996.	1,129.	1,429.
		36"	35"	54"	52"	AW1T2R5235()N()	667.	1,088.	1,216.	1,538.
		36"	35"	60"	58"	AW1T2R5835()N()	691.	1,081.	1,222.	1,542.
		36"	35"	66"	64"	AW1T2R6435()N()	729.	1,092.	1,234.	1,565.
		36"	35"	72"	70"	AW1T2R7035()N()	738.	1,117.	1,267.	1,603.

Order Code

Example:	AW1T1R5829LN, 118
AW	Worksurface
1	Generation 1
T1	Tapered 1 side, user
R	Rectilinear
58	Width
29	Depth
L	Laminate
N	No Grommets
118	Bright White Laminate

Specification Information

To order please specify pattern number including:

1. Width
2. Depth
3. Surface Type:
L = Laminate
V = V1, V2 or V3
4. N = No Grommet
5. Finish, Surface
Laminate, V1, V2 or V3

See page 7 for finish options applicable.

Product on this page will accept woodgrain laminate where laminate is currently an option.

Application Notes

Worksurfaces on this page are designed for use with fixed and height adjustable C-Leg and T-Leg bases to create freestanding tables.

23", 29" and 35" rectangular worksurfaces are for use with corresponding depth fixed and height adjustable C-Leg bases and T-Leg bases.

23" and 29" worksurfaces are user edge tapered. 35" worksurfaces are user and approach edges tapered.

Worksurfaces are pre-drilled with pilot holes for use with wood screws.

Actual worksurfaces are undersized by 1" on each side edge and by 1" on the back edge.

w* and d* = nominal dimensions

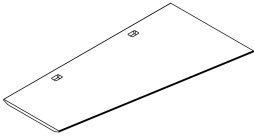
description	d, left	w	d, right	pattern no.	L	M	V1	V2	V3
Wedge, front and back edge tapered 	24"	48"	30"	AW1T2W4823 () () () ()	\$657.	\$857.	\$900.	\$1,014.	\$1,278.
	24"	60"	30"	AW1T2W6023 () () () ()	726.	943.	990.	1,118.	1,411.
	24"	72"	36"	AW1T2W7226 () () () ()	847.	1,044.	1,097.	1,233.	1,562.
	30"	48"	24"	AW1T2W4832 () () () ()	657.	857.	900.	1,014.	1,278.
	30"	60"	24"	AW1T2W6032 () () () ()	726.	943.	990.	1,118.	1,411.
	36"	72"	24"	AW1T2W7262 () () () ()	847.	1,044.	1,097.	1,233.	1,562.

Worksurfaces

Order Code	Specification Information	Application Notes
Example: AW1T2W4823MG118 V316613	To order please specify pattern number including:	Hardware to attach to vertical support to be specified separately.
A AutoStrada	1. Width 23 = 24" deep left, 30" deep right 32 = 30" deep left, 24" deep right 26 = 24" deep left, 36" deep right 62 = 36" deep left, 24" deep right	1 1/4" tops require additional support when distance spans over 48".
W Worksurface	2. Depth	Important: Please note placement of grommet(s) when specified assumes user edge is wedge side. If application requires user side to be straight edge and wedge edge as approach side, then specify no grommets.
1 Generation 1	3. Surface type L = Laminated M = Mixed, Laminated surface/V1, V2 or V3 edge V = V1, V2 or V3	When grommets specified up to 48" w tops have one grommet, over 48" w have two grommets.
T2 Tapered 2 sides, user & approach	4. Grommet option N = No grommets G = Grommet(s), flush R = Grommet(s), recessed	
W Wedge	5. Finish, Surface Laminated, V1, V2 or V3 finish	
48 48" wide	6. Finish, Edge Must be same as surface finish unless M surface type specified, then must be V1, V2 or V3 finish	
2 24" deep, left	7. Finish, Grommet(s) specify painted or plated finish	
3 30" deep, right	See page 8 for finish options applicable.	
M Surface type, Mixed	Product on this page will accept wood grain laminate where laminate is currently an option.	
G Grommet		
118 Finish surface, Bright white		
V316 Finish edge, Maple		
613 Finish, grommet		

description	d, left	w	d, right	pattern no.	L	M	V1	V2	V3
Double wedge, front and back edge tapered	24"	48"	36"	AW1T2DW4826 () () () ()	\$686.	\$949.	\$996.	\$1,129.	\$1,429.
	24"	60"	36"	AW1T2DW6026 () () () ()	764.	1,030.	1,081.	1,222.	1,542.
	24"	72"	36"	AW1T2DW7226 () () () ()	847.	1,087.	1,141.	1,294.	1,640.

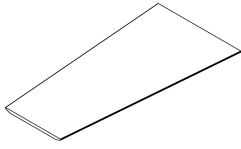

Order Code	Specification Information	Application Notes
Example: AW1T2DW4826MG118 V316613	To order please specify pattern number including:	5. Finish, Grommet <i>specify painted or plated finish</i>
A AutoStrada	1. Surface type <i>L = Laminate</i>	See page 8 for finish options applicable.
W Worksurface	<i>M = Mixed, Laminate surface/V1, V2 or V3 edge</i>	Product on this page will accept wood grain laminate where laminate is currently an option.
1 Generation 1	<i>V = V1, V2 or V3</i>	
T2 Tapered 2 sides, user & approach	2. Grommet option <i>N = No grommet</i>	Hardware to attach to vertical support to be specified separately.
DW Double Wedge	<i>G = Grommet</i>	1 1/4" tops require additional support when distance spans over 48".
48 48" wide	3. Finish, Surface <i>Laminate, V1, V2 or V3 finish</i>	Grommet when specified, centered 36" w end.
2 24" deep	4. Finish, Edge <i>Must be same as surface finish unless M surface type specified, then must be V1, V2 or V3 finish</i>	
6 36" deep		
M Surface type, Mixed		
G Grommet		
118 Finish surface, Bright white		
V316 Finish edge, Maple		
613 Finish, grommet		

Peninsulas

with straight legs and simple stand-off

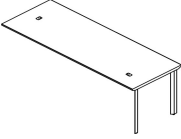
description	d	h	w	leg height	pattern no.	L	M	V1	V2	V3	
Rectangular peninsulas, tapered 2 sides with straight legs and simple stand-off		30"	28 ³ / ₈ "	60"	27"	APRT2S1ST(L/R)6030() () () () ()	\$1,178.	\$1,467.	\$1,514.	\$1,642.	\$1,935.
		28 ³ / ₈ "	66"	27"	APRT2S1ST(L/R)6630() () () () ()	1,216.	1,485.	1,533.	1,667.	1,966.	
		28 ³ / ₈ "	72"	27"	APRT2S1ST(L/R)7230() () () () ()	1,218.	1,507.	1,556.	1,690.	1,996.	
		28 ³ / ₈ "	78"	27"	APRT2S1ST(L/R)7830() () () () ()	1,243.	1,546.	1,597.	1,741.	2,062.	
		28 ³ / ₈ "	84"	27"	APRT2S1ST(L/R)8430() () () () ()	1,264.	1,583.	1,636.	1,780.	2,120.	
		28 ³ / ₈ "	90"	27"	APRT2S1ST(L/R)9030() () () () ()	1,319.	1,623.	1,678.	1,836.	2,185.	
		28 ³ / ₈ "	96"	27"	APRT2S1ST(L/R)9630() () () () ()	1,341.	1,659.	1,716.	1,875.	2,238.	
		29 ⁵ / ₈ "	60"	28 ³ / ₈ "	APRT2S2ST(L/R)6030() () () () ()	1,178.	1,467.	1,514.	1,642.	1,935.	
		29 ⁵ / ₈ "	66"	28 ³ / ₈ "	APRT2S2ST(L/R)6630() () () () ()	1,216.	1,485.	1,533.	1,667.	1,966.	
		29 ⁵ / ₈ "	72"	28 ³ / ₈ "	APRT2S2ST(L/R)7230() () () () ()	1,218.	1,507.	1,556.	1,690.	1,996.	
		29 ⁵ / ₈ "	78"	28 ³ / ₈ "	APRT2S2ST(L/R)7830() () () () ()	1,243.	1,546.	1,597.	1,741.	2,062.	
		29 ⁵ / ₈ "	84"	28 ³ / ₈ "	APRT2S2ST(L/R)8430() () () () ()	1,264.	1,583.	1,636.	1,780.	2,120.	
		29 ⁵ / ₈ "	90"	28 ³ / ₈ "	APRT2S2ST(L/R)9030() () () () ()	1,319.	1,623.	1,678.	1,836.	2,185.	
		29 ⁵ / ₈ "	96"	28 ³ / ₈ "	APRT2S2ST(L/R)9630() () () () ()	1,341.	1,659.	1,716.	1,875.	2,238.	
		36"	28 ³ / ₈ "	60"	27"	APRT2S1ST(L/R)6036() () () () ()	1,215.	1,554.	1,605.	1,746.	2,065.
			28 ³ / ₈ "	66"	27"	APRT2S1ST(L/R)6636() () () () ()	1,253.	1,563.	1,615.	1,758.	2,089.
			28 ³ / ₈ "	72"	27"	APRT2S1ST(L/R)7236() () () () ()	1,262.	1,588.	1,641.	1,791.	2,127.
			28 ³ / ₈ "	78"	27"	APRT2S1ST(L/R)7836() () () () ()	1,294.	1,610.	1,665.	1,817.	2,164.
			28 ³ / ₈ "	84"	27"	APRT2S1ST(L/R)8436() () () () ()	1,313.	1,646.	1,703.	1,866.	2,225.
			28 ³ / ₈ "	90"	27"	APRT2S1ST(L/R)9036() () () () ()	1,370.	1,693.	1,752.	1,918.	2,294.
28 ³ / ₈ "	96"		27"	APRT2S1ST(L/R)9636() () () () ()	1,396.	1,729.	1,791.	1,956.	2,343.		
29 ⁵ / ₈ "	60"		28 ³ / ₈ "	APRT2S2ST(L/R)6036() () () () ()	1,215.	1,554.	1,605.	1,746.	2,065.		
29 ⁵ / ₈ "	66"		28 ³ / ₈ "	APRT2S2ST(L/R)6636() () () () ()	1,253.	1,563.	1,615.	1,758.	2,089.		
29 ⁵ / ₈ "	72"		28 ³ / ₈ "	APRT2S2ST(L/R)7236() () () () ()	1,262.	1,588.	1,641.	1,791.	2,127.		
29 ⁵ / ₈ "	78"		28 ³ / ₈ "	APRT2S2ST(L/R)7836() () () () ()	1,294.	1,610.	1,665.	1,817.	2,164.		
29 ⁵ / ₈ "	84"		28 ³ / ₈ "	APRT2S2ST(L/R)8436() () () () ()	1,313.	1,646.	1,703.	1,866.	2,225.		
29 ⁵ / ₈ "	90"		28 ³ / ₈ "	APRT2S2ST(L/R)9036() () () () ()	1,370.	1,693.	1,752.	1,918.	2,294.		
29 ⁵ / ₈ "	96"		28 ³ / ₈ "	APRT2S2ST(L/R)9636() () () () ()	1,396.	1,729.	1,791.	1,956.	2,343.		

Worksurfaces

Order Code	Specification Information	Application Notes
Example: APRT2S1ST(L/R)6030	<i>To order please specify pattern number including:</i>	
A AutoStrada		
PR Peninsula Rectilinear		
T2 Tapered 2 sides; user and approach		
S1 27" h Straight leg		
ST Simple stand-off		
L Left hand		
60 Width		
30 Depth		
M Grommet option		
111 Grommet finish		
V316 Finish, Top		
111 Finish, Leg		
111 Finish, Stand-off		
	1. Leg height S1 = 27" high S2 = 28 3/8" high	
	2. Hand L = Left hand R = Right hand	
	3. Grommet option M = Mid grommet N = No grommet S = Stand-off SE = Stand-off, end location SD = Stand-off with drop in box SDR = Right hand stand-off with drop in box SDL = Left hand stand-off with drop in box Note: SD, SDR and SDL are only factory cut out, no grommet option is necessary.	
	4. Finish, Grommet Painted or plated	
	5. Finish, Top Laminate, V1, V2 or V3 finish	
	6. Finish, Edge Must be same as surface finish unless M surface type specified, then must be V1, V2 or V3 finish	
	7. Finish, Leg Anodized aluminum or painted finish option, excluding silver.	
	8. Finish, Stand-off Painted finish only	
	See page 8 for finish options applicable.	
	Product on this page will accept wood grain laminate where laminate is currently an option.	
	Worksurface stiffeners are recommended to provide additional support for open spans greater than 48" w.	
	Modesties sold separately and can be field installed.	
	Wire chase sold separately.	
		From users perspective, if the leg is on the right side, the peninsula is classified a "Right Hand" peninsula.
		Peninsula worksurfaces with power center do not come with Electrical Components.
		Peninsulas can be specified to overall surface height of: 28 ³ / ₈ " : specify 27" leg. 29 ⁵ / ₈ " : specify 28" leg.

Peninsulas

with straight legs and simple stand-off with power center

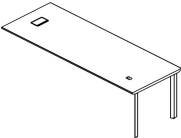
description	d	h	w	leg height	pattern no.	L	M	V1	V2	V3	
Rectangular peninsulas, tapered 2 sides with straight legs and simple stand-off with power cen		30"	28 ³ / ₈ "	60"	27"	APRT2S1PC(L/R)6030() () () () ()	\$1,210.	\$1,499.	\$1,546.	\$1,674.	\$1,967.
		28 ³ / ₈ "	66"	27"	APRT2S1PC(L/R)6630() () () () ()	1,247.	1,517.	1,565.	1,698.	1,998.	
		28 ³ / ₈ "	72"	27"	APRT2S1PC(L/R)7230() () () () ()	1,249.	1,539.	1,588.	1,722.	2,027.	
		28 ³ / ₈ "	78"	27"	APRT2S1PC(L/R)7830() () () () ()	1,275.	1,577.	1,629.	1,773.	2,094.	
		28 ³ / ₈ "	84"	27"	APRT2S1PC(L/R)8430() () () () ()	1,296.	1,614.	1,668.	1,812.	2,151.	
		28 ³ / ₈ "	90"	27"	APRT2S1PC(L/R)9030() () () () ()	1,351.	1,654.	1,710.	1,868.	2,217.	
		28 ³ / ₈ "	96"	27"	APRT2S1PC(L/R)9630() () () () ()	1,372.	1,691.	1,748.	1,907.	2,269.	
		29 ⁵ / ₈ "	60"	28 ³ / ₈ "	APRT2S2PC(L/R)6030() () () () ()	1,210.	1,499.	1,546.	1,674.	1,967.	
		29 ⁵ / ₈ "	66"	28 ³ / ₈ "	APRT2S2PC(L/R)6630() () () () ()	1,247.	1,517.	1,565.	1,698.	1,998.	
		29 ⁵ / ₈ "	72"	28 ³ / ₈ "	APRT2S2PC(L/R)7230() () () () ()	1,249.	1,539.	1,588.	1,722.	2,027.	
		29 ⁵ / ₈ "	78"	28 ³ / ₈ "	APRT2S2PC(L/R)7830() () () () ()	1,275.	1,577.	1,629.	1,773.	2,094.	
		29 ⁵ / ₈ "	84"	28 ³ / ₈ "	APRT2S2PC(L/R)8430() () () () ()	1,296.	1,614.	1,668.	1,812.	2,151.	
		29 ⁵ / ₈ "	90"	28 ³ / ₈ "	APRT2S2PC(L/R)9030() () () () ()	1,351.	1,654.	1,710.	1,868.	2,217.	
		29 ⁵ / ₈ "	96"	28 ³ / ₈ "	APRT2S2PC(L/R)9630() () () () ()	1,372.	1,691.	1,748.	1,907.	2,269.	
		36"	28 ³ / ₈ "	60"	27"	APRT2S1PC(L/R)6036() () () () ()	1,246.	1,586.	1,637.	1,777.	2,097.
		28 ³ / ₈ "	66"	27"	APRT2S1PC(L/R)6636() () () () ()	1,284.	1,595.	1,647.	1,790.	2,121.	
		28 ³ / ₈ "	72"	27"	APRT2S1PC(L/R)7236() () () () ()	1,294.	1,620.	1,673.	1,822.	2,159.	
		28 ³ / ₈ "	78"	27"	APRT2S1PC(L/R)7836() () () () ()	1,325.	1,642.	1,696.	1,849.	2,196.	
		28 ³ / ₈ "	84"	27"	APRT2S1PC(L/R)8436() () () () ()	1,345.	1,678.	1,734.	1,897.	2,257.	
		28 ³ / ₈ "	90"	27"	APRT2S1PC(L/R)9036() () () () ()	1,402.	1,725.	1,784.	1,950.	2,326.	
28 ³ / ₈ "	96"	27"	APRT2S1PC(L/R)9636() () () () ()	1,428.	1,761.	1,822.	1,987.	2,375.			
29 ⁵ / ₈ "	60"	28 ³ / ₈ "	APRT2S2PC(L/R)6036() () () () ()	1,246.	1,586.	1,637.	1,777.	2,097.			
29 ⁵ / ₈ "	66"	28 ³ / ₈ "	APRT2S2PC(L/R)6636() () () () ()	1,284.	1,595.	1,647.	1,790.	2,121.			
29 ⁵ / ₈ "	72"	28 ³ / ₈ "	APRT2S2PC(L/R)7236() () () () ()	1,294.	1,620.	1,673.	1,822.	2,159.			
29 ⁵ / ₈ "	78"	28 ³ / ₈ "	APRT2S2PC(L/R)7836() () () () ()	1,325.	1,642.	1,696.	1,849.	2,196.			
29 ⁵ / ₈ "	84"	28 ³ / ₈ "	APRT2S2PC(L/R)8436() () () () ()	1,345.	1,678.	1,734.	1,897.	2,257.			
29 ⁵ / ₈ "	90"	28 ³ / ₈ "	APRT2S2PC(L/R)9036() () () () ()	1,402.	1,725.	1,784.	1,950.	2,326.			
29 ⁵ / ₈ "	96"	28 ³ / ₈ "	APRT2S2PC(L/R)9636() () () () ()	1,428.	1,761.	1,822.	1,987.	2,375.			

Order Code	Specification Information	Application Notes
Example: APRT2S1PC(L/R)6030	<i>To order please specify pattern number including:</i>	
A AutoStrada		
PR Peninsula Rectilinear		
T2 Tapered 2 sides; user and approach		
S1 27" h Straight leg		
PC Power center		
L Left hand		
60 Width		
30 Depth		
M Grommet option		
111 Grommet finish		
V316 Finish, Top		
111 Finish, Leg		
111 Finish, Stand-off		
	1. Leg height S1 = 27" high S2 = 28 3/8" high	
	2. Hand L = Left hand R = Right hand	
	3. Grommet option P = Power Center PE = Power center grommet	
	4. Finish, Grommet Painted or plated	
	5. Finish, Top Laminate, V1, V2 or V3 finish	
	6. Finish, Edge Must be same as surface finish unless M surface type specified, then must be V1, V2 or V3 finish	
	7. Finish, Leg Anodized aluminum or painted finish option, excluding silver.	From users perspective, if the leg is on the right side, the peninsula is classified a "Right Hand" peninsula.
	8. Finish, Stand-off Painted finish only	Peninsula worksurfaces with power center do not come with Electrical Components.
	See page 8 for finish options applicable.	
	Product on this page will accept wood grain laminate where laminate is currently an option.	Peninsulas can be specified to overall surface height of: 28 ³ / ₈ " : specify 27" leg. 29 ⁵ / ₈ " : specify 28" leg.
	Worksurface stiffeners are recommended to provide additional support for open spans greater than 48" w.	
	Modesties sold separately and can be field installed.	
	Wire chase sold separately.	

Peninsulas

with L- legs and simple stand-off

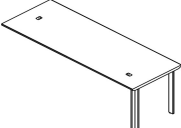
description	d	h	w	leg height	pattern no.	L	M	V1	V2	V3	
Rectangular peninsulas, tapered 2 sides with L-legs and simple stand-off 	30"	28 ³ / ₈ "	60"	27"	APRT2L1ST(L/R)6030() () () () ()	\$1,475.	\$1,764.	\$1,811.	\$1,939.	\$2,232.	
		28 ³ / ₈ "	66"	27"	APRT2L1ST(L/R)6630() () () () ()	1,513.	1,782.	1,831.	1,964.	2,263.	
		28 ³ / ₈ "	72"	27"	APRT2L1ST(L/R)7230() () () () ()	1,515.	1,804.	1,853.	1,987.	2,293.	
		28 ³ / ₈ "	78"	27"	APRT2L1ST(L/R)7830() () () () ()	1,541.	1,843.	1,894.	2,039.	2,360.	
		28 ³ / ₈ "	84"	27"	APRT2L1ST(L/R)8430() () () () ()	1,561.	1,880.	1,933.	2,078.	2,417.	
		28 ³ / ₈ "	90"	27"	APRT2L1ST(L/R)9030() () () () ()	1,616.	1,920.	1,975.	2,133.	2,483.	
		28 ³ / ₈ "	96"	27"	APRT2L1ST(L/R)9630() () () () ()	1,638.	1,957.	2,013.	2,172.	2,535.	
		29 ⁵ / ₈ "	60"	28 ³ / ₈ "	APRT2L2ST(L/R)6030() () () () ()	1,475.	1,764.	1,811.	1,939.	2,232.	
		29 ⁵ / ₈ "	66"	28 ³ / ₈ "	APRT2L2ST(L/R)6630() () () () ()	1,513.	1,782.	1,831.	1,964.	2,263.	
		29 ⁵ / ₈ "	72"	28 ³ / ₈ "	APRT2L2ST(L/R)7230() () () () ()	1,515.	1,804.	1,853.	1,987.	2,293.	
		29 ⁵ / ₈ "	78"	28 ³ / ₈ "	APRT2L2ST(L/R)7830() () () () ()	1,541.	1,843.	1,894.	2,039.	2,360.	
		29 ⁵ / ₈ "	84"	28 ³ / ₈ "	APRT2L2ST(L/R)8430() () () () ()	1,561.	1,880.	1,933.	2,078.	2,417.	
		29 ⁵ / ₈ "	90"	28 ³ / ₈ "	APRT2L2ST(L/R)9030() () () () ()	1,616.	1,920.	1,975.	2,133.	2,483.	
		29 ⁵ / ₈ "	96"	28 ³ / ₈ "	APRT2L2ST(L/R)9630() () () () ()	1,638.	1,957.	2,013.	2,172.	2,535.	
		36"	28 ³ / ₈ "	60"	27"	APRT1L2ST(L/R)6036() () () () ()	1,512.	1,851.	1,902.	2,043.	2,363.
			28 ³ / ₈ "	66"	27"	APRT2L1ST(L/R)6636() () () () ()	1,550.	1,860.	1,913.	2,055.	2,386.
			28 ³ / ₈ "	72"	27"	APRT2L1ST(L/R)7236() () () () ()	1,559.	1,885.	1,938.	2,088.	2,424.
			28 ³ / ₈ "	78"	27"	APRT2L1ST(L/R)7836() () () () ()	1,591.	1,908.	1,962.	2,115.	2,461.
			28 ³ / ₈ "	84"	27"	APRT2L1ST(L/R)8436() () () () ()	1,610.	1,943.	2,000.	2,163.	2,523.
			28 ³ / ₈ "	90"	27"	APRT2L1ST(L/R)9036() () () () ()	1,668.	1,991.	2,049.	2,215.	2,591.
28 ³ / ₈ "	96"		27"	APRT2L1ST(L/R)9636() () () () ()	1,693.	2,026.	2,088.	2,253.	2,640.		
29 ⁵ / ₈ "	60"		28 ³ / ₈ "	APRT2L1ST(L/R)6036() () () () ()	1,512.	1,851.	1,902.	2,043.	2,363.		
29 ⁵ / ₈ "	66"		28 ³ / ₈ "	APRT2L2ST(L/R)6636() () () () ()	1,550.	1,860.	1,913.	2,055.	2,386.		
29 ⁵ / ₈ "	72"		28 ³ / ₈ "	APRT2L2ST(L/R)7236() () () () ()	1,559.	1,885.	1,938.	2,088.	2,424.		
29 ⁵ / ₈ "	78"		28 ³ / ₈ "	APRT2L2ST(L/R)7836() () () () ()	1,591.	1,908.	1,962.	2,115.	2,461.		
29 ⁵ / ₈ "	84"		28 ³ / ₈ "	APRT2L2ST(L/R)8436() () () () ()	1,610.	1,943.	2,000.	2,163.	2,523.		
29 ⁵ / ₈ "	90"		28 ³ / ₈ "	APRT2L2ST(L/R)9036() () () () ()	1,668.	1,991.	2,049.	2,215.	2,591.		
29 ⁵ / ₈ "	96"		28 ³ / ₈ "	APRT2L2ST(L/R)9636() () () () ()	1,693.	2,026.	2,088.	2,253.	2,640.		

Worksurfaces

Order Code	Specification Information	Application Notes
Example: APRT2L1ST(L/R)6030	<i>To order please specify pattern number including:</i>	
A AutoStrada		
PR Peninsula Rectilinear		
T2 Tapered 2 sides; user and approach		
L1 27" h L-leg		
ST Simple stand-off		
L Left hand		
60 Width		
30 Depth		
M Grommet option		
111 Grommet finish		
V316 Finish, Top		
111 Finish, Leg		
111 Finish, Stand-off		
	<ol style="list-style-type: none"> Leg height L1 = 27" high L2 = 28 3/8" high Hand L = Left hand R = Right hand Grommet option M = Mid grommet N = No grommet S = Stand-off SE = Stand-off, end location SD = Stand-off with drop in box SDR = Right hand stand-off with drop in box SDL = Left hand stand-off with drop in box Note: SD, SDR and SDL are only factory cut out, no grommet option is necessary. Finish, Grommet Painted or plated Finish, Top Laminate, V1, V2 or V3 finish Finish, Edge Must be same as surface finish unless M surface type specified, then must be V1, V2 or V3 finish Finish, Leg Anodized aluminum or painted finish option, excluding silver. Finish, Stand-off Painted finish only 	<p>From users perspective, if the leg is on the right side, the peninsula is classified a "Right Hand" peninsula.</p> <p>Peninsula worksurfaces with power center do not come with Electrical Components.</p> <p>Peninsulas can be specified to overall surface height of: 28³/₈" : specify 27" leg. 29⁵/₈" : specify 28" leg.</p> <p>Worksurface stiffeners are recommended to provide additional support for open spans greater than 48" w.</p> <p>Modesties sold separately and can be field installed.</p> <p>Wire chase sold separately.</p>

Peninsulas

with L- legs and simple stand-off with power center

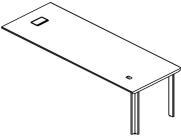
description	d	h	w	leg height	pattern no.	L	M	V1	V2	V3	
Rectangular peninsulas, tapered 2 sides with L-legs and simple stand-off with power center		30"	28 3/8"	60"	27"	APRT2L1PC(L/R)6030()	\$1,507.	\$1,796.	\$1,843.	\$1,971.	\$2,264.
		28 3/8"	66"	27"	APRT2L1PC(L/R)6630()	1,545.	1,814.	1,862.	1,996.	2,295.	
		28 3/8"	72"	27"	APRT2L1PC(L/R)7230()	1,547.	1,836.	1,885.	2,019.	2,325.	
		28 3/8"	78"	27"	APRT2L1PC(L/R)7830()	1,572.	1,875.	1,926.	2,071.	2,391.	
		28 3/8"	84"	27"	APRT2L1PC(L/R)8430()	1,593.	1,912.	1,965.	2,109.	2,449.	
		28 3/8"	90"	27"	APRT2L1PC(L/R)9030()	1,648.	1,952.	2,007.	2,165.	2,514.	
		28 3/8"	96"	27"	APRT2L1PC(L/R)9630()	1,670.	1,989.	2,045.	2,204.	2,567.	
		29 3/8"	60"	28 3/8"	APRT2L2PC(L/R)6030()	1,507.	1,796.	1,843.	1,971.	2,264.	
		29 3/8"	66"	28 3/8"	APRT2L2PC(L/R)6630()	1,545.	1,814.	1,862.	1,996.	2,295.	
		29 3/8"	72"	28 3/8"	APRT2L2PC(L/R)7230()	1,547.	1,836.	1,885.	2,019.	2,325.	
		29 3/8"	78"	28 3/8"	APRT2L2PC(L/R)7830()	1,572.	1,875.	1,926.	2,071.	2,391.	
		29 3/8"	84"	28 3/8"	APRT2L2PC(L/R)8430()	1,593.	1,912.	1,965.	2,109.	2,449.	
		29 3/8"	90"	28 3/8"	APRT2L2PC(L/R)9030()	1,648.	1,952.	2,007.	2,165.	2,514.	
		29 3/8"	96"	28 3/8"	APRT2L2PC(L/R)9630()	1,670.	1,989.	2,045.	2,204.	2,567.	
		36"	28 3/8"	60"	27"	APRT2L1PC(L/R)6036()	1,544.	1,883.	1,934.	2,075.	2,394.
			28 3/8"	66"	27"	APRT2L1PC(L/R)6636()	1,582.	1,892.	1,944.	2,087.	2,418.
			28 3/8"	72"	27"	APRT2L1PC(L/R)7236()	1,591.	1,917.	1,970.	2,120.	2,456.
			28 3/8"	78"	27"	APRT2L1PC(L/R)7836()	1,623.	1,939.	1,994.	2,146.	2,493.
			28 3/8"	84"	27"	APRT2L1PC(L/R)8436()	1,642.	1,975.	2,032.	2,195.	2,554.
			28 3/8"	90"	27"	APRT2L1PC(L/R)9036()	1,699.	2,022.	2,081.	2,247.	2,623.
28 3/8"	96"		27"	APRT2L1PC(L/R)9636()	1,725.	2,058.	2,120.	2,285.	2,672.		
29 3/8"	60"		28 3/8"	APRT2L2PC(L/R)6036()	1,544.	1,883.	1,934.	2,075.	2,394.		
29 3/8"	66"		28 3/8"	APRT2L2PC(L/R)6636()	1,582.	1,892.	1,944.	2,087.	2,418.		
29 3/8"	72"		28 3/8"	APRT2L2PC(L/R)7236()	1,591.	1,917.	1,970.	2,120.	2,456.		
29 3/8"	78"		28 3/8"	APRT2L2PC(L/R)7836()	1,623.	1,939.	1,994.	2,146.	2,493.		
29 3/8"	84"		28 3/8"	APRT2L2PC(L/R)8436()	1,642.	1,975.	2,032.	2,195.	2,554.		
29 3/8"	90"		28 3/8"	APRT2L2PC(L/R)9036()	1,699.	2,022.	2,081.	2,247.	2,623.		
29 3/8"	96"		28 3/8"	APRT2L2PC(L/R)9636()	1,725.	2,058.	2,120.	2,285.	2,672.		

Order Code	Specification Information	Application Notes
Example: APRT2L1PC(L/R)6030	To order please specify pattern number including:	
A AutoStrada		
PR Peninsula Rectilinear		
T2 Tapered 2 sides; user and approach		
L1 27" h L-leg		
PC Power center		
L Left hand		
60 Width		
30 Depth		
M Grommet option		
111 Grommet finish		
V316 Finish, Top		
111 Finish, Leg		
111 Finish, Stand-off		
	1. Leg height L1 = 27" high L2 = 28 3/8" high	
	2. Hand L = Left hand R = Right hand	
	3. Grommet option P = Power Center PE = Power center grommet	
	4. Finish, Grommet Painted or plated	
	5. Finish, Top Laminate, V1, V2 or V3 finish	
	6. Finish, Edge Must be same as surface finish unless M surface type specified, then must be V1, V2 or V3 finish	
	7. Finish, Leg Anodized aluminum or painted finish option, excluding silver.	From users perspective, if the leg is on the right side, the peninsula is classified a "Right Hand" peninsula.
	8. Finish, Stand-off Painted finish only	Peninsula worksurfaces with power center do not come with Electrical Components.
	See page 8 for finish options applicable.	Peninsulas can be specified to overall surface height of: 28 3/8" : specify 27" leg. 29 3/8" : specify 28" leg.
	Product on this page will accept wood grain laminate where laminate is currently an option.	
	Worksurface stiffeners are recommended to provide additional support for open spans greater than 48" w.	
	Modesties sold separately and can be field installed.	
	Wire chase sold separately.	

Peninsulas

with Open frame legs and simple stand-off

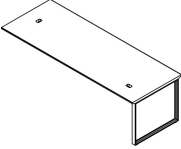
description	d	h	w	leg height	pattern no.	L	M	V1	V2	V3	
Rectangular peninsulas, tapered 2 sides with open frame legs and simple stand-off		28 3/8"	60"	27"	APRT201ST(L/R)6030	\$1,401.	\$1,690.	\$1,737.	\$1,866.	\$2,159.	
		28 3/8"	66"	27"	APRT201ST(L/R)6630	1,439.	1,709.	1,757.	1,890.	2,189.	
		28 3/8"	72"	27"	APRT201ST(L/R)7230	1,441.	1,730.	1,779.	1,914.	2,219.	
		28 3/8"	78"	27"	APRT201ST(L/R)7830	1,467.	1,769.	1,820.	1,965.	2,286.	
		28 3/8"	84"	27"	APRT201ST(L/R)8430	1,487.	1,806.	1,859.	2,004.	2,343.	
		28 3/8"	84"	27"	APRT201ST(L/R)9030	1,543.	1,846.	1,901.	2,059.	2,409.	
		28 3/8"	96"	27"	APRT201ST(L/R)9630	1,564.	1,883.	1,939.	2,098.	2,461.	
		29 5/8"	60"	28 3/8"	APRT202ST(L/R)6030	1,401.	1,690.	1,737.	1,866.	2,159.	
		29 5/8"	66"	28 3/8"	APRT202ST(L/R)6630	1,439.	1,709.	1,757.	1,890.	2,189.	
		29 5/8"	72"	28 3/8"	APRT202ST(L/R)7230	1,441.	1,730.	1,779.	1,914.	2,219.	
		29 5/8"	78"	28 3/8"	APRT202ST(L/R)7830	1,467.	1,769.	1,820.	1,965.	2,286.	
		29 5/8"	84"	28 3/8"	APRT202ST(L/R)8430	1,487.	1,806.	1,859.	2,004.	2,343.	
		29 5/8"	90"	28 3/8"	APRT202ST(L/R)9030	1,543.	1,846.	1,901.	2,059.	2,409.	
		29 5/8"	96"	28 3/8"	APRT202ST(L/R)9630	1,564.	1,883.	1,939.	2,098.	2,461.	
		36"	28 3/8"	60"	27"	APRT201ST(L/R)6036	1,438.	1,777.	1,829.	1,969.	2,289.
		36"	28 3/8"	66"	27"	APRT201ST(L/R)6636	1,476.	1,787.	1,839.	1,981.	2,312.
		36"	28 3/8"	72"	27"	APRT201ST(L/R)7236	1,485.	1,811.	1,864.	2,014.	2,350.
		36"	28 3/8"	78"	27"	APRT201ST(L/R)7836	1,517.	1,834.	1,888.	2,041.	2,387.
		36"	28 3/8"	78"	27"	APRT201ST(L/R)8436	1,536.	1,870.	1,926.	2,089.	2,449.
		36"	28 3/8"	90"	27"	APRT201ST(L/R)9036	1,594.	1,917.	1,975.	2,141.	2,517.
		36"	28 3/8"	96"	27"	APRT201ST(L/R)9636	1,620.	1,953.	2,014.	2,179.	2,567.
		36"	29 5/8"	60"	28 3/8"	APRT202ST(L/R)6036	1,438.	1,777.	1,829.	1,969.	2,289.
		36"	29 5/8"	66"	28 3/8"	APRT202ST(L/R)6636	1,476.	1,787.	1,839.	1,981.	2,312.
		36"	29 5/8"	72"	28 3/8"	APRT202ST(L/R)7236	1,485.	1,811.	1,864.	2,014.	2,350.
36"	29 5/8"	78"	28 3/8"	APRT202ST(L/R)7836	1,517.	1,834.	1,888.	2,041.	2,387.		
36"	29 5/8"	84"	28 3/8"	APRT202ST(L/R)8436	1,536.	1,870.	1,926.	2,089.	2,449.		
36"	29 5/8"	90"	28 3/8"	APRT202ST(L/R)9036	1,594.	1,917.	1,975.	2,141.	2,517.		
36"	29 5/8"	96"	28 3/8"	APRT202ST(L/R)9636	1,620.	1,953.	2,014.	2,179.	2,567.		

Worksurfaces

Order Code	Specification Information	Application Notes
Example: APRT201ST(L/R)6030	To order please specify pattern number including:	7. Finish, Leg
A AutoStrada		Anodized aluminum or painted finish option, excluding silver.
PR Peninsula Rectilinear	1. Leg height	8. Finish, Stand-off
T2 Tapered 2 sides; user and approach	O1 = 27" high	Painted finish only
O1 27" h Open frame leg	O2 = 28 3/8" high	See page 8 for finish options applicable.
ST Simple stand-off	2. Hand	Product on this page will accept wood grain laminate where laminate is currently an option.
L Left hand	L = Left hand	Worksurface stiffeners are recommended to provide additional support for open spans greater than 48" w.
60 Width	R = Right hand	Modesties sold separately and can be field installed.
30 Depth	3. Grommet option	Wire chase sold separately.
M Grommet option	M = Mid grommet	
111 Grommet finish	N = No grommet	
V316 Finish, Top	S = Stand-off	
111 Finish, Leg	SE = Stand-off, end location	
111 Finish, Stand-off	SD = Stand-off with drop in box	
	SDR = Right hand stand-off with drop in box	
	SDL = Left hand stand-off with drop in box	
	Note:SD, SDR and SDL are only factory cut out, no grommet option is necessary.	
	4. Finish, Grommet	
	Painted or plated	
	5. Finish, Top	
	Laminate, V1, V2 or V3 finish	
	6. Finish, Edge	
	Must be same as surface finish unless M surface type specified, then must be V1, V2 or V3 finish	

Peninsulas

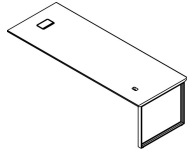

with Open frame legs and simple stand-off with power center

description	d	h	w	leg height	pattern no.	L	M	V1	V2	V3	
Rectangular peninsulas, tapered 2 sides with open frame legs and simple stand-off with power c	30"	28 3/8"	60"	27"	APRT2O1PC(L/R)6030()	\$1,433.	\$1,722.	\$1,769.	\$1,897.	\$2,190.	
		28 3/8"	66"	27"	APRT2O1PC(L/R)6630()	1,471.	1,740.	1,789.	1,922.	2,221.	
		28 3/8"	72"	27"	APRT2O1PC(L/R)7230()	1,473.	1,762.	1,811.	1,945.	2,251.	
		28 3/8"	78"	27"	APRT2O1PC(L/R)7830()	1,499.	1,801.	1,852.	1,997.	2,318.	
		28 3/8"	84"	27"	APRT2O1PC(L/R)8430()	1,519.	1,838.	1,891.	2,036.	2,375.	
		28 3/8"	90"	27"	APRT2O1PC(L/R)9030()	1,575.	1,878.	1,933.	2,091.	2,441.	
		28 3/8"	96"	27"	APRT2O1PC(L/R)9630()	1,596.	1,915.	1,971.	2,130.	2,493.	
		29 3/8"	60"	28 3/8"	APRT2O2PC(L/R)6030()	1,433.	1,722.	1,769.	1,897.	2,190.	
		29 3/8"	66"	28 3/8"	APRT2O2PC(L/R)6630()	1,471.	1,740.	1,789.	1,922.	2,221.	
		29 3/8"	72"	28 3/8"	APRT2O2PC(L/R)7230()	1,473.	1,762.	1,811.	1,945.	2,251.	
		29 3/8"	78"	28 3/8"	APRT2O2PC(L/R)7830()	1,499.	1,801.	1,852.	1,997.	2,318.	
		29 3/8"	84"	28 3/8"	APRT2O2PC(L/R)8430()	1,519.	1,838.	1,891.	2,036.	2,375.	
		29 3/8"	90"	28 3/8"	APRT2O2PC(L/R)9030()	1,575.	1,878.	1,933.	2,091.	2,441.	
		29 3/8"	96"	28 3/8"	APRT2O2PC(L/R)9630()	1,596.	1,915.	1,971.	2,130.	2,493.	
		36"	28 3/8"	60"	27"	APRT2O1PC(L/R)6036()	1,470.	1,809.	1,860.	2,001.	2,321.
			28 3/8"	66"	27"	APRT2O1PC(L/R)6636()	1,508.	1,818.	1,871.	2,013.	2,344.
			28 3/8"	72"	27"	APRT2O1PC(L/R)7236()	1,517.	1,843.	1,896.	2,046.	2,382.
			28 3/8"	78"	27"	APRT2O1PC(L/R)7836()	1,549.	1,866.	1,920.	2,073.	2,419.
			28 3/8"	84"	27"	APRT2O1PC(L/R)8436()	1,568.	1,901.	1,958.	2,121.	2,481.
			28 3/8"	90"	27"	APRT2O1PC(L/R)9036()	1,626.	1,949.	2,007.	2,173.	2,549.
		28 3/8"	96"	27"	APRT2O1PC(L/R)9636()	1,651.	1,984.	2,046.	2,211.	2,598.	
		29 3/8"	60"	28 3/8"	APRT2O2PC(L/R)6036()	1,470.	1,809.	1,860.	2,001.	2,321.	
		29 3/8"	66"	28 3/8"	APRT2O2PC(L/R)6636()	1,508.	1,818.	1,871.	2,013.	2,344.	
		29 3/8"	72"	28 3/8"	APRT2O2PC(L/R)7236()	1,517.	1,843.	1,896.	2,046.	2,382.	
		29 3/8"	78"	28 3/8"	APRT2O2PC(L/R)7836()	1,549.	1,866.	1,920.	2,073.	2,419.	
		29 3/8"	84"	28 3/8"	APRT2O2PC(L/R)8436()	1,568.	1,901.	1,958.	2,121.	2,481.	
		29 3/8"	90"	28 3/8"	APRT2O2PC(L/R)9036()	1,626.	1,949.	2,007.	2,173.	2,549.	
		29 3/8"	96"	28 3/8"	APRT2O2PC(L/R)9636()	1,651.	1,984.	2,046.	2,211.	2,598.	



Order Code	Specification Information	Application Notes
Example: APRT2O1PC(L/R)6030	<i>To order please specify pattern number including:</i>	
A AutoStrada		
PR Peninsula Rectilinear		
T2 Tapered 2 sides; user and approach		
O1 27" h Open frame leg		
PC Power center		
L Left hand		
60 Width		
30 Depth		
M Grommet option		
111 Grommet finish		
V316 Finish, Top		
111 Finish, Leg		
111 Finish, Stand-off		
	1. Leg height O1 = 27" high O2 = 28 3/8" high	
	2. Hand L = Left hand R = Right hand	
	3. Grommet option P = Power Center PE = Power center grommet	
	4. Finish, Grommet Painted or plated	
	5. Finish, Top Laminate, V1, V2 or V3 finish	
	6. Finish, Edge Must be same as surface finish unless M surface type specified, then must be V1, V2 or V3 finish	
	7. Finish, Leg Anodized aluminum or painted finish option, excluding silver.	From users perspective, if the leg is on the right side, the peninsula is classified a "Right Hand" peninsula.
	8. Finish, Stand-off Painted finish only	Peninsula worksurfaces with power center do not come with Electrical Components.
	See page 8 for finish options applicable.	
	Product on this page will accept wood grain laminate where laminate is currently an option.	Peninsulas can be specified to overall surface height of: 28 3/8" : specify 27" leg. 29 3/8" : specify 28" leg.
	Worksurface stiffeners are recommended to provide additional support for open spans greater than 48" w.	
	Modesties sold separately and can be field installed.	
	Wire chase sold separately.	

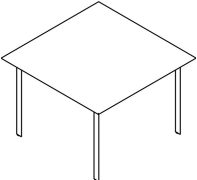
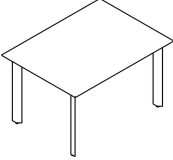

Tables with straight legs

description	h	w	d	dia.	pattern no.	L	M	V1	V2	V3
Square table, tapered 4 sides 	28 3/4"	42"	42"		ATA1T44242 () () () ()	\$1,673.	\$1,855.	\$1,948.	\$1,986.	\$2,300.
	28 3/4"	48"	48"		ATA1T44848 () () () ()	1,810.	1,899.	1,995.	2,050.	2,444.
Rectangular table, tapered 4 sides 	28 3/4"	48"	30"		ATA1T44830 () () () ()	1,708.	1,839.	1,930.	1,957.	2,230.
	28 3/4"	60"	30"		ATA1T46030 () () () ()	1,800.	1,940.	2,037.	2,079.	2,407.
	28 3/4"	72"	30"		ATA1T47230 () () () ()	1,890.	1,978.	2,078.	2,127.	2,511.
	28 3/4"	72"	36"		ATA1T47236 () () () ()	1,935.	2,011.	2,112.	2,177.	2,626.
Round table, tapered edge 	28 3/4"			36"	ATA1R36 () () () ()	1,734.	1,990.	1,889.	1,950.	2,213.
	28 3/4"			42"	ATA1R42 () () () ()	1,816.	2,026.	1,933.	2,008.	2,351.
	28 3/4"			48"	ATA1R48 () () () ()	1,964.	2,074.	1,987.	2,078.	2,508.

Worksurfaces

Order Code	Specification Information	Application Notes
Example: ATA1T44242V27C V316AA	<i>To order please specify pattern number including:</i>	7. Finish, Edge <i>Must be same as surface finish unless M surface type specified, then must be V1, V2 or V3 finish</i>
A AutoStrada	1. Width	AutoStrada tables include four straight legs with glides or casters.
TA Table	2. Depth	Tables can be specified to surface height of:
1 Generation 1	3. Surface type <i>L = Laminate</i>	28 3/8" : specify 27" leg.
T4 Tapered edge 4 sides	<i>M = Mixed, Laminate surface/V1, V2 or V3 edge</i>	29 5/8" : specify 28" leg.
42 42" wide	<i>V = V1, V2 or V3</i>	31 1/2" : specify 30" leg.
42 42" deep	4. Leg height (to underside of surface) <i>27 = 27"h</i>	
V Surface type, veneer	<i>28 = 28 3/8"h (add \$30 for this option)</i>	
27 27" leg height	<i>30 = 30 1/8"h (add \$66 for this option)</i>	
C Caster	5. Leg type <i>C = with Caster</i>	See page 8 for finish options applicable.
V316 Finish top, Maple	<i>G = with Glide</i>	Product on this page will accept wood grain laminate where laminate is currently an option.
AA Finish, leg	6. Finish, Surface <i>Laminate, Mixed, V1, V2 or V3 finish</i>	Grommets are not optional for tables.
		Stiffener included with rectangular tables 60"w and over.

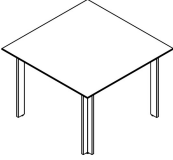
Tables with L-legs

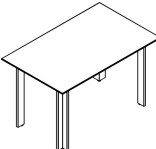
description	h	w	d	dia.	leg height	pattern no.	L	M	V1	V2	V3
Square table, tapered 4 sides with L-legs 	28 ³ / ₈ "	42"	42"		27"	ATAT4LL424227(L/M/V)() ()	\$2,426.	\$2,696.	\$2,830.	\$2,887.	\$3,321.
	28 ³ / ₈ "	48"	48"		27"	ATAT4LL484827(L/M/V)() ()	2,442.	2,712.	2,847.	2,906.	3,340.
	29 ⁵ / ₈ "	42"	42"		28 ³ / ₈ "	ATAT4LL424228(L/M/V)() ()	2,430.	2,701.	2,836.	2,894.	3,329.
	29 ⁵ / ₈ "	48"	48"		28 ³ / ₈ "	ATAT4LL484828(L/M/V)() ()	2,472.	2,745.	2,882.	2,941.	3,383.
Round table, tapered edge with L-legs 	28 ³ / ₈ "			36"	27"	ATARLL3627(L/M/V)() ()	2,362.	2,624.	2,755.	2,811.	3,232.
	28 ³ / ₈ "			42"	27"	ATARLL4227(L/M/V)() ()	2,368.	2,632.	2,763.	2,819.	3,242.
	28 ³ / ₈ "			48"	27"	ATARLL4827(L/M/V)() ()	2,381.	2,645.	2,777.	2,835.	3,261.
	29 ⁵ / ₈ "			36"	28 ³ / ₈ "	ATARLL3628(L/M/V)() ()	2,402.	2,668.	2,801.	2,858.	3,287.
	29 ⁵ / ₈ "			42"	28 ³ / ₈ "	ATARLL4228(L/M/V)() ()	2,408.	2,675.	2,810.	2,867.	3,296.
29 ⁵ / ₈ "			48"	28 ³ / ₈ "	ATARLL4828(L/M/V)() ()	2,422.	2,689.	2,823.	2,882.	3,314.	
Rectangular table desk, tapered 4 sides with L-legs 	28 ³ / ₈ "	48"	30"		27"	ATDT4LL483027(L/M/V)() ()	2,216.	2,461.	2,584.	2,638.	3,034.
	28 ³ / ₈ "	60"	30"		27"	ATDT4LL603027(L/M/V)() ()	2,256.	2,505.	2,631.	2,686.	3,087.
	28 ³ / ₈ "	72"	30"		27"	ATDT4LL723027(L/M/V)() ()	2,274.	2,528.	2,655.	2,708.	3,115.
	28 ³ / ₈ "	72"	36"		27"	ATDT4LL723627(L/M/V)() ()	2,295.	2,550.	2,677.	2,734.	3,142.
	29 ⁵ / ₈ "	48"	30"		28 ³ / ₈ "	ATDT4LL483028(L/M/V)() ()	2,304.	2,561.	2,690.	2,745.	3,155.
	29 ⁵ / ₈ "	60"	30"		28 ³ / ₈ "	ATDT4LL603028(L/M/V)() ()	2,365.	2,629.	2,760.	2,816.	3,239.
	29 ⁵ / ₈ "	72"	30"		28 ³ / ₈ "	ATDT4LL723028(L/M/V)() ()	2,415.	2,683.	2,818.	2,875.	3,307.
29 ⁵ / ₈ "	72"	36"		28 ³ / ₈ "	ATDT4LL723628(L/M/V)() ()	2,455.	2,728.	2,864.	2,923.	3,360.	

Order Code	Specification Information	Application Notes
Example: ATAT4LL424227 V316AA <hr/> A AutoStrada <hr/> TA Table <hr/> T4 Top tapered 4 sides <hr/> LL L-Leg <hr/> 42 42" wide <hr/> 42 42" deep <hr/> 27 Leg height <hr/> V Surface type, veneer <hr/> V316 Finish top, Maple <hr/> AA Finish, leg	To order please specify pattern number including: 1. Width 2. Depth 3. Leg height (to underside of surface) 27 = 27"h 28 = 28 ³ / ₈ "h 4. Surface type L = Laminate M = Mixed, Laminate surface/V1, V2 or V3 edge V = V1, V2 or V3 5. Finish, Surface Laminate, Mixed, V1, V2 or V3 finish	AutoStrada table desks include four L-legs with glides. Tables can be specified to overall surface height of: 28 ³ / ₈ " : specify 27" leg. 29 ⁵ / ₈ " : specify 28" leg.
	6. Finish, Edge (if applicable) Must be same as surface finish unless M surface type specified, then must be V1, V2 or V3 finish 7. Finish, Leg Anodized aluminum finish or painted finish option excluding silver.	
	See page 8 for finish options applicable.	
	Product on this page will accept wood grain laminate where laminate is currently an option.	
	Grommets are not optional for tables.	
	Worksurface stiffener included with rectangular table desks 60"w and over.	

Tables with Open Frame legs

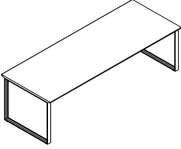
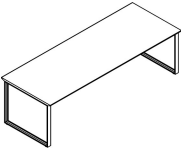
description	d	h	w	leg height	pattern no.	L	M	V1	V2	V3
Rectangular Table, tapered 2 sides with Open Frame legs, 27" high 	30"	28 ³ / ₈ "	60"	27"	ATRT2DOF60301()()	\$1,855.	\$2,144.	\$2,191.	\$2,320.	\$2,798.
		28 ³ / ₈ "	66"	27"	ATRT2DOF66301()()	1,897.	2,185.	2,233.	2,367.	2,857.
		28 ³ / ₈ "	72"	27"	ATRT2DOF72301()()	1,921.	2,210.	2,259.	2,393.	2,888.
		28 ³ / ₈ "	78"	27"	ATRT2DOF78301()()	1,959.	2,261.	2,312.	2,457.	2,969.
		28 ³ / ₈ "	84"	27"	ATRT2DOF84301()()	1,981.	2,300.	2,353.	2,498.	3,030.
		28 ³ / ₈ "	90"	27"	ATRT2DOF90301()()	2,039.	2,342.	2,397.	2,555.	3,098.
		28 ³ / ₈ "	96"	27"	ATRT2DOF96301()()	2,062.	2,381.	2,437.	2,596.	3,152.
	36"	28 ³ / ₈ "	60"	27"	ATRT2DOF60361()()	1,892.	2,231.	2,283.	2,423.	2,743.
		28 ³ / ₈ "	66"	27"	ATRT2DOF66361()()	1,953.	2,263.	2,315.	2,458.	2,789.
		28 ³ / ₈ "	72"	27"	ATRT2DOF72361()()	1,965.	2,291.	2,344.	2,494.	2,830.
		28 ³ / ₈ "	78"	27"	ATRT2DOF78361()()	2,009.	2,326.	2,380.	2,533.	2,879.
		28 ³ / ₈ "	84"	27"	ATRT2DOF84361()()	2,031.	2,364.	2,420.	2,583.	2,943.
		28 ³ / ₈ "	90"	27"	ATRT2DOF90361()()	2,090.	2,413.	2,471.	2,637.	3,014.
		28 ³ / ₈ "	96"	27"	ATRT2DOF96361()()	2,118.	2,451.	2,512.	2,677.	3,065.
Rectangular Table, tapered 2 sides with Open Frame legs, 28 ³ / ₈ " high 	30"	29 ⁵ / ₈ "	60"	28 ³ / ₈ "	ATRT2DOF60302()()	1,855.	2,144.	2,191.	2,320.	2,798.
		29 ⁵ / ₈ "	66"	28 ³ / ₈ "	ATRT2DOF66302()()	1,897.	2,185.	2,233.	2,367.	2,857.
		29 ⁵ / ₈ "	72"	28 ³ / ₈ "	ATRT2DOF72302()()	1,921.	2,210.	2,259.	2,393.	2,888.
		29 ⁵ / ₈ "	78"	28 ³ / ₈ "	ATRT2DOF78302()()	1,959.	2,261.	2,312.	2,457.	2,969.
		29 ⁵ / ₈ "	84"	28 ³ / ₈ "	ATRT2DOF84302()()	1,981.	2,300.	2,353.	2,498.	3,030.
		29 ⁵ / ₈ "	90"	28 ³ / ₈ "	ATRT2DOF90302()()	2,039.	2,342.	2,397.	2,555.	3,098.
		29 ⁵ / ₈ "	96"	28 ³ / ₈ "	ATRT2DOF96302()()	2,062.	2,381.	2,437.	2,596.	3,152.
	36"	29 ⁵ / ₈ "	60"	28 ³ / ₈ "	ATRT2DOF60362()()	1,892.	2,231.	2,283.	2,423.	2,743.
		29 ⁵ / ₈ "	66"	28 ³ / ₈ "	ATRT2DOF66362()()	1,953.	2,263.	2,315.	2,458.	2,789.
		29 ⁵ / ₈ "	72"	28 ³ / ₈ "	ATRT2DOF72362()()	1,965.	2,291.	2,344.	2,494.	2,830.
		29 ⁵ / ₈ "	78"	28 ³ / ₈ "	ATRT2DOF78362()()	2,009.	2,326.	2,380.	2,533.	2,879.
		29 ⁵ / ₈ "	84"	28 ³ / ₈ "	ATRT2DOF84362()()	2,031.	2,364.	2,420.	2,583.	2,943.
		29 ⁵ / ₈ "	90"	28 ³ / ₈ "	ATRT2DOF90362()()	2,090.	2,413.	2,471.	2,637.	3,014.
		29 ⁵ / ₈ "	96"	28 ³ / ₈ "	ATRT2DOF96362()()	2,118.	2,451.	2,512.	2,677.	3,065.

Worksurfaces

Order Code

Example:	ATRT2DOF60301()()
A	AutoStrada
TR	Table Rectangular
T2	Tapered 2 sides, User & approach
D	1 ¹ / ₄ " thick top
OF	Open Frame leg
60	Width
30	Depth
1	27" height leg 2 = 28 ³ / ₈ " height leg
V316	Finish, top
111	Finish, leg

Specification Information

To order please specify pattern number including:

1. Leg height
1 = 27" h
2 = 28³/₈" h
2. Finish: Top
Laminate, Mixed, V1, V2 or V3 finish

3. Finish: Leg
Anodized aluminum finish or painted finish option excluding silver.

See page 8 for finish options applicable.

Product on this page will accept wood grain laminate where laminate is currently an option.

Grommets are not optional for tables.

The tables on this page, will come with appropriate stiffener support. Modesty & wire chase sold separately.

For infill options please refer to page 246

Assembly required. Ships knock down.

Open Frame Legs Infill Options for Tables and Peninsulas

description	d	h	leg height	pattern no.	L	V1	V2	V3
Inside Infill Options for Open Frame leg for 27" h leg 	30"	24"	27"	AIPI301()	\$341.	\$442.	\$507.	\$661.
	30"	26"	28 ³ / ₈ "	AIPI302()	341.	442.	507.	661.
	36"	24"	27"	AIPI361()	362.	469.	538.	700.
	36"	26"	28 ³ / ₈ "	AIPI362()	362.	469.	538.	700.

description	d	h	leg height	pattern no.	L	V1	V2	V3
Outside Infill Options for Open Frame leg 	30"	25"	27"	AIPO301()	343.	445.	510.	664.
	30"	27"	28 ³ / ₈ "	AIPO302()	343.	445.	510.	664.
	36"	25"	27"	AIPO361()	363.	470.	540.	702.
	36"	27"	28 ³ / ₈ "	AIPO362()	363.	470.	540.	702.

Order Code	
Example: AIPI301()	
A	AutoStrada
IP	Infill Panel
I	Inside, O = Outside
20	Depth
1	27" height leg 2 = 28 ³ / ₈ " height leg
()	Finish

Specification Information

To order please specify pattern number including:

- Leg height
1 = 27" h
2 = 28³/₈" h
- Infill finish:
Laminate, V1, V2 or V3

Application Notes

Product on this page will accept wood grain laminate where laminate is currently an option.
Both inside and outside infill panels are required and must be ordered separately.

Infills fill entire opening of the open frame leg.
Infills connect to each other. Can be removed without any damage to the frame leg.
Please refer to installation instructions.

Table desks with L-legs

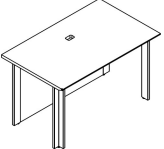
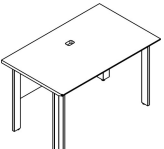
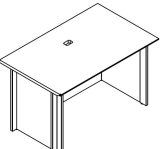
description	h	w	d	leg height	pattern no.	L	M	V1	V2	V3
Rectangular table desk with L-legs and full front modesty 	28 ³ / ₈ "	48"	30"	27"	ATDT1LFM483027(L/M/V)() () () ()	\$2,728.	\$3,031.	\$3,182.	\$3,248.	\$3,735.
	28 ³ / ₈ "	60"	30"	27"	ATDT1LFM603027(L/M/V)() () () ()	2,769.	3,076.	3,230.	3,295.	3,789.
	28 ³ / ₈ "	72"	30"	27"	ATDT1LFM723027(L/M/V)() () () ()	2,801.	3,113.	3,269.	3,334.	3,835.
	28 ³ / ₈ "	72"	36"	27"	ATDT1LFM723627(L/M/V)() () () ()	2,820.	3,134.	3,290.	3,358.	3,860.
	29 ⁵ / ₈ "	48"	30"	28 ³ / ₈ "	ATDT1LFM483028(L/M/V)() () () ()	2,877.	3,195.	3,355.	3,422.	3,937.
	29 ⁵ / ₈ "	60"	30"	28 ³ / ₈ "	ATDT1LFM603028(L/M/V)() () () ()	2,881.	3,200.	3,360.	3,429.	3,944.
	29 ⁵ / ₈ "	72"	30"	28 ³ / ₈ "	ATDT1LFM723028(L/M/V)() () () ()	2,891.	3,212.	3,373.	3,441.	3,959.
	29 ⁵ / ₈ "	72"	36"	28 ³ / ₈ "	ATDT1LFM723628(L/M/V)() () () ()	2,921.	3,245.	3,407.	3,476.	3,999.
Rectangular table desk with L-legs and partial front modesty 	28 ³ / ₈ "	48"	30"	27"	ATDT1LPM483027(L/M/V)() () () ()	2,616.	2,907.	3,052.	3,115.	3,580.
	28 ³ / ₈ "	60"	30"	27"	ATDT1LPM603027(L/M/V)() () () ()	2,622.	2,912.	3,059.	3,120.	3,589.
	28 ³ / ₈ "	72"	30"	27"	ATDT1LPM723027(L/M/V)() () () ()	2,632.	2,924.	3,070.	3,133.	3,603.
	28 ³ / ₈ "	72"	36"	27"	ATDT1LPM723627(L/M/V)() () () ()	2,662.	2,957.	3,106.	3,168.	3,644.
	29 ⁵ / ₈ "	48"	30"	28 ³ / ₈ "	ATDT1LPM483028(L/M/V)() () () ()	2,725.	3,029.	3,180.	3,245.	3,733.
	29 ⁵ / ₈ "	60"	30"	28 ³ / ₈ "	ATDT1LPM603028(L/M/V)() () () ()	2,731.	3,034.	3,186.	3,251.	3,739.
	29 ⁵ / ₈ "	72"	30"	28 ³ / ₈ "	ATDT1LPM723028(L/M/V)() () () ()	2,742.	3,044.	3,197.	3,264.	3,754.
	29 ⁵ / ₈ "	72"	36"	28 ³ / ₈ "	ATDT1LPM723628(L/M/V)() () () ()	2,771.	3,079.	3,232.	3,298.	3,795.
Rectangular table desk with L-legs and full front & side modesties 	28 ³ / ₈ "	48"	30"	27"	ATDT1LFS483027(L/M/V)() () () ()	3,378.	3,755.	3,942.	4,023.	4,625.
	28 ³ / ₈ "	60"	30"	27"	ATDT1LFS603027(L/M/V)() () () ()	3,424.	3,804.	3,993.	4,075.	4,687.
	28 ³ / ₈ "	72"	30"	27"	ATDT1LFS723027(L/M/V)() () () ()	3,463.	3,848.	4,042.	4,123.	4,742.
	28 ³ / ₈ "	72"	36"	27"	ATDT1LFS723627(L/M/V)() () () ()	3,492.	3,882.	4,075.	4,159.	4,782.
	29 ⁵ / ₈ "	48"	30"	28 ³ / ₈ "	ATDT1LFS483028(L/M/V)() () () ()	3,479.	3,864.	4,057.	4,140.	4,762.
	29 ⁵ / ₈ "	60"	30"	28 ³ / ₈ "	ATDT1LFS603028(L/M/V)() () () ()	3,523.	3,914.	4,110.	4,193.	4,825.
	29 ⁵ / ₈ "	72"	30"	28 ³ / ₈ "	ATDT1LFS723028(L/M/V)() () () ()	3,564.	3,961.	4,157.	4,240.	4,879.
	29 ⁵ / ₈ "	72"	36"	28 ³ / ₈ "	ATDT1LFS723628(L/M/V)() () () ()	3,593.	3,992.	4,191.	4,276.	4,920.

Worksurfaces

Order Code	Specification Information	Application Notes
Example: ATDT1LPS483027VG V316AA111 <hr/> A AutoStrada <hr/> TD Table desk <hr/> T1 Top tapered 1 side (user only) <hr/> L L-Leg <hr/> FM Full front modesty <hr/> 48 48" wide <hr/> 30 30" deep <hr/> 27 Leg height <hr/> V Surface type, veneer <hr/> G Grommet <hr/> V316 Finish top, Maple <hr/> AA Finish, leg <hr/> 111 Grommet finish	To order please specify pattern number including: 1. Full or partial modesty (and end panels when applicable) 2. Width 3. Depth 4. Leg height (to underside of surface) 27 = 27" h 28 = 28 ³ / ₈ " h 5. Surface type L = Laminate M = Mixed, Laminate surface/V1, V2 or V3 edge V = V1, V2 or V3 6. Grommet G=Grommet N=No Grommet 7. Finish, Surface Laminate, Mixed, V1, V2 or V3 finish	8. Finish, Edge Must be same as surface finish unless M surface type specified, then must be V1, V2 or V3 finish 9. Finish, Support Must be same as surface type. Laminate and Mix surfaces can only have Laminate support. 10. Finish, Grommet 11. Finish, Leg Anodized aluminum finish or painted finish option excluding silver. See page 8 for finish options applicable. Laminate finish options for modesty panels on this page are as follows: 111 = Jet Black 114 = Folkstone grey 115 = Medium Grey 117 = Soft grey 118 = Bright white 119 = Pumice 128 = Fog

AutoStrada tables include four L-legs with glides and full or partial height modesty (and optional end panels).
 Tables can be specified to overall surface height of:
 28³/₈" : specify 27" leg.
 29⁵/₈" : specify 28" leg.
 Partial height option for 27" leg is nominally 13" and 14" h nominally with 28³/₈" h legs; and may be mounted flush to underside of worksurface or with 1" gap below worksurface.

Product on this page will accept wood grain laminate where laminate is currently an option. Worksurface stiffener included with rectangular tables 60" w and over.

Table desks with L-legs

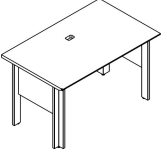
description	h	w	d	leg height	pattern no.	L	M	V1	V2	V3
Rectangular table desk with L-legs and partial front and side modesties 	28 ³ / ₈ "	48"	30"	27"	ATDT1LPS483027(L/M/V)() () () ()	\$3,207.	\$3,564.	\$3,741.	\$3,817.	\$4,389.
	28 ³ / ₈ "	60"	30"	27"	ATDT1LPS603027(L/M/V)() () () ()	3,251.	3,614.	3,795.	3,871.	4,453.
	28 ³ / ₈ "	72"	30"	27"	ATDT1LPS723027(L/M/V)() () () ()	3,293.	3,657.	3,841.	3,920.	4,506.
	28 ³ / ₈ "	72"	36"	27"	ATDT1LPS723627(L/M/V)() () () ()	3,322.	3,690.	3,875.	3,954.	4,548.
	29 ⁵ / ₈ "	48"	30"	28 ³ / ₈ "	ATDT1LPS483028(L/M/V)() () () ()	3,307.	3,674.	3,857.	3,937.	4,526.
	29 ⁵ / ₈ "	60"	30"	28 ³ / ₈ "	ATDT1LPS603028(L/M/V)() () () ()	3,353.	3,724.	3,910.	3,990.	4,588.
	29 ⁵ / ₈ "	72"	30"	28 ³ / ₈ "	ATDT1LPS723028(L/M/V)() () () ()	3,392.	3,768.	3,957.	4,036.	4,643.
	29 ⁵ / ₈ "	72"	36"	28 ³ / ₈ "	ATDT1LPS723628(L/M/V)() () () ()	3,420.	3,802.	3,991.	4,073.	4,685.

Order Code	Specification Information	Application Notes
Example: ATDT1LPS483027VG V316AA111	<i>To order please specify pattern number including:</i>	
A AutoStrada	1. Full or partial modesty (and end panels when applicable)	8. Finish, Edge <i>Must be same as surface finish unless M surface type specified, then must be V1, V2 or V3 finish</i>
TD Table desk	2. Width	9. Finish, Support <i>Must be same as surface type. Laminate and Mix surfaces can only have Laminate support.</i>
T1 Top tapered 1 side (user only)	3. Depth	10. Finish, Grommet
L L-Leg	4. Leg height (<i>to underside of surface</i>) 27 = 27" 28 = 28 ³ / ₈ "	11. Finish, Leg <i>Anodized aluminum finish or painted finish option excluding silver.</i>
FM Full front modesty	5. Surface type <i>L = Laminate</i> <i>M = Mixed, Laminate surface/V1, V2 or V3 edge</i> <i>V = V1, V2 or V3</i>	See page 8 for finish options applicable.
48 48" wide	6. Grommet G=Grommet N=No Grommet	Laminate finish options for modesty panels on this page are as follows: 111 = Jet Black 114 = Folkstone grey 115 = Medium Grey 117 = Soft grey 118 = Bright white 119 = Pumice 128 = Fog
30 30" deep	7. Finish, Surface Laminate, Mixed, V1, V2 or V3 finish	AutoStrada tables include four L-legs with glides and full or partial height modesty (and optional end panels). Tables can be specified to overall surface height of: 28 ³ / ₈ " : specify 27" leg. 29 ⁵ / ₈ " : specify 28" leg. Partial height option for 27" leg is nominally 13" and 14" h nominally with 28 ³ / ₈ " h legs; and may be mounted flush to underside of worksurface or with 1" gap below worksurface.
27 Leg height		
V Surface type, veneer		
G Grommet		
V316 Finish top, Maple		
AA Finish, leg		
111 Grommet finish		

description	w	d	t	pattern no.	L	M	V1	V2	V3
Transaction Top 1 1/4" Thick, Straight	24"	15"	1 1/4"	ATTA24S()	\$769.	\$779.	\$795.	\$819.	\$1,040.
	30"	15"	1 1/4"	ATTA30S()	784.	798.	815.	834.	1,057.
	36"	15"	1 1/4"	ATTA36S()	798.	809.	825.	848.	1,069.
	42"	15"	1 1/4"	ATTA42S()	809.	820.	835.	859.	1,080.
	48"	15"	1 1/4"	ATTA48S()	826.	837.	855.	875.	1,097.
	54"	15"	1 1/4"	ATTA54S()	844.	854.	871.	892.	1,115.
	60"	15"	1 1/4"	ATTA60S()	859.	871.	888.	910.	1,128.
	66"	15"	1 1/4"	ATTA66S()	876.	888.	906.	928.	1,143.
	72"	15"	1 1/4"	ATTA72S()	889.	901.	918.	976.	1,327.

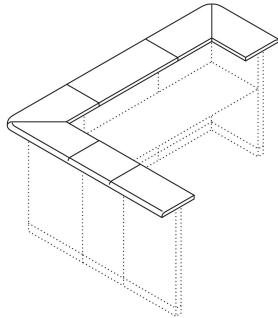

Straight



Transaction Top 1 1/4" Thick, mitered left Left Side	24"	15"	1 1/4"	ATTA24L()	1,016.	1,029.	1,049.	1,076.	1,329.
	30"	15"	1 1/4"	ATTA30L()	1,034.	1,046.	1,067.	1,094.	1,347.
	36"	15"	1 1/4"	ATTA36L()	1,046.	1,057.	1,077.	1,105.	1,357.
	42"	15"	1 1/4"	ATTA42L()	1,057.	1,068.	1,090.	1,117.	1,369.
	48"	15"	1 1/4"	ATTA48L()	1,073.	1,085.	1,107.	1,135.	1,387.
	54"	15"	1 1/4"	ATTA54L()	1,091.	1,101.	1,123.	1,151.	1,404.
	60"	15"	1 1/4"	ATTA60L()	1,107.	1,119.	1,142.	1,167.	1,418.
	66"	15"	1 1/4"	ATTA66L()	1,124.	1,136.	1,157.	1,187.	1,431.
	72"	15"	1 1/4"	ATTA72L()	1,138.	1,148.	1,172.	1,233.	1,616.



Transaction Top 1 1/4" Thick, mitered right Right Side	24"	15"	1 1/4"	ATTA24R()	1,016.	1,029.	1,049.	1,076.	1,329.
	30"	15"	1 1/4"	ATTA30R()	1,034.	1,046.	1,067.	1,094.	1,347.
	36"	15"	1 1/4"	ATTA36R()	1,046.	1,057.	1,077.	1,105.	1,357.
	42"	15"	1 1/4"	ATTA42R()	1,057.	1,068.	1,090.	1,117.	1,369.
	48"	15"	1 1/4"	ATTA48R()	1,073.	1,085.	1,107.	1,135.	1,387.
	54"	15"	1 1/4"	ATTA54R()	1,091.	1,101.	1,123.	1,151.	1,404.
	60"	15"	1 1/4"	ATTA60R()	1,107.	1,119.	1,142.	1,167.	1,418.
	66"	15"	1 1/4"	ATTA66R()	1,124.	1,136.	1,157.	1,187.	1,431.
	72"	15"	1 1/4"	ATTA72R()	1,138.	1,148.	1,172.	1,233.	1,616.



Order Code

Example:	ATTA24S1
A	AutoStrada
TT	Transaction top
A	1 1/4" thick
24	24" wide
S	Straight end treatment
1	V1 finish
V316	Maple

To order please specify pattern number including:

1. End treatment type
2. Finish type
3. Finish

1. End treatment options:

- S = Straight
- L = Left side mitre
- R = Right side mitre

2. Finish type:

- L = Laminate
- M = Wood/laminate mixed
- 1 = V1
- 2 = V2
- 3 = V3

Transaction tops are for mounting to 42" h panel or overall panel height achieved from 34" h base panel plus 8" h stacking module. Transaction tops ship with necessary bracketry included.

No grommets included.

Tops may be used to span more than one consecutive panel.

Transaction tops will not fit between panel Hi-Lo conditions without notching the underside of the top. This can be done in the field or through Custom Product Development.

Applicable finishes are listed on page 8.

Product on this page will accept woodgrain laminate where laminate is currently an option.

Transaction Top Brackets for Alternative Material

AutoStrada

description	w	h	pattern no.	list
Attachment Bracketry			AAMTB	\$62.
Foam Tape			AAMTT	25.
Transaction Top Bracket Cover			AAMTC24()	45.
			AAMTC30()	48.
			AAMTC36()	51.
			AAMTC42()	55.
			AAMTC48()	58.
			AAMTC54()	62.
			AAMTC60()	65.
			AAMTC66()	70.
			AAMTC72()	72.
Transaction Top Bracket Cover Hilo			AAMTCH24()	62.
			AAMTCH30()	65.
			AAMTCH36()	70.
			AAMTCH42()	73.
			AAMTCH48()	76.
			AAMTCH54()	79.
			AAMTCH60()	82.
			AAMTCH66()	85.
			AAMTCH72()	87.

Order Code



Example: AAMTC	
A	Reff
A	Alternative
M	Material
T	Transaction Top
C	Cover
24	Width
L/R/M	Left/Right/Mitered
()	Finish

Application Information

To order please specify pattern number including:

- End treatment options
L = Left side miter
R = Right side miter
M = Mitered both sides
- Finish:
Core paint finishes

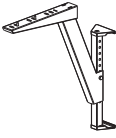
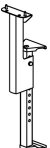
Transaction top Brackets are available in core paint finishes.

description	type	width	depth	height	pattern no.	painting	list
Adjustable cantilever bracket (up to 24"D)		3"	20"	23-33"	AB1 AC24 ()	\$218.	
 <p>Maximum of 24" deep worksurfaces may be cantilevered from Spine.</p>							
Adjustable end support bracket			6"	23-33"	AB2 AE ()		176.
							
Compact fixed height end support bracket	for 28"h worksurface		6"	27"	AB2 FE27 ()		149.
	for 29 ⁵ / ₈ "h worksurface		6"	28"	AB2 FE28 ()		149.
							
Adjustable cantilever bridging bracket		3"	20"	23-33"	AB1-ABC24 ()		283.
<p>Maximum of 24" deep worksurfaces may be cantilevered from Spine.</p>							
spacers (20 per pack) use with spine worksurface support brackets					AA1 BS		14.

Order Code

Example: AB1 AC24118
AB1 Bracket
AC Type
24 Depth
118 Finish

Specification Information

Please specify painted finish from paint options listed on page 8.

Specify worksurface cantilever and end support brackets to attach worksurfaces to spine walls.

Specify two cantilever brackets to support any 24"D worksurface up to 84" wide, or one back edge of corner worksurface. Specify three cantilever brackets to support any 24"D worksurface greater than 84" wide. Specify two end support brackets to support one end of straight, conference, or arc-shape surface.

Application Notes



Adjustable height cantilever and bridging cantilever brackets support underside of worksurface in 1" increments from 23" to 33"H (24" to 34" top height).

Spacers (AA1 BS) to be used with adjustable cantilever or end support brackets to accommodate wood case AutoStrada pedestals and lower storage with optional cabinet feet. Resulting overall worksurface height achieved 29⁵/₈"h.

Adjustable bridging cantilever supports adjacent 48"W straight or corner worksurfaces.

End support brackets adjust 23"-33"H (24" to 34" top height). Fixed height brackets support worksurface at 28"H and 29⁵/₈"H.

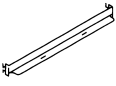
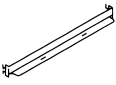
Cannot exceed maximum of 24" deep worksurfaces cantilevered from Spine.

description	type	w	d	h	pattern no.	paint	list
 End support brackets - E with wood screws	18"d straight worksurface		18"	1 1/4"	MB3-E18W-()	\$51.	
	24"d straight worksurface		24"	1 1/4"	MB3-E24W-()	54.	
	30"d straight worksurface		30"	1 1/4"	MB3-E30W-()	60.	
	36"d straight worksurface		36"	1 1/4"	MB3-E36W-()	69.	
 End support brackets - E with wood screws End support for 30"h linkable screen	18"d straight worksurface		18"	1 1/4"	MB3-EC18W-() *	48.	
	24"d straight worksurface		24"	1 1/4"	MB3-EC24W-() *	51.	
	30"d straight worksurface		30"	1 1/4"	MB3-EC30W-() *	57.	
 Cantilever brackets - C with wood screws	18"d worksurface	1/2"	15"	8 1/2"	MB2-C18W-(L/R)-()		67.
	24"d worksurface	1/2"	21"	11 1/2"	MB2-C24W-(L/R)-()		77.
	30"d worksurface	1/2"	24"	13 1/2"	MB2-C30W-(L/R)-()		91.
Cantilever tie-clips - AUX-C (10)					MB1-AUX-C		15.
 Worksurface/vertical panel spacer Y with wood screws		1/16"	15"	8 1/2"	MB2-YW-(L/R)-()		56.

Order Code	Specification Information	Application Notes
Example: MB3-E30W-613	Bracket type:	E-type end support brackets support 1 1/4" or 1 3/4" worksurface from connector tracks at both back and front.
MB3 Bracket	E End Support	C-type cantilever brackets support worksurfaces from connector track at the back. Specify left or right hand.
E Bracket type	C Cantilever	
30 Bracket depth	Y Worksurface/vertical panel spacer	
W with wood screws		AUX-C cantilever tie-clips tie together two adjacent cantilever brackets for added stability.
613 Finish, paint	<i>Please specify painted finish from paint options listed on page 8.</i>	Y-type spacer brackets secure the end of pedestal-supported worksurfaces to a connector track. Y brackets maintain the 3/8" wire drop and allow pedestal fronts to align with the end of the worksurface. * MB3-EC18W-(), MB3-EC24W-() and MB3-EC30W-() end support brackets should be specified when supporting worksurfaces from 30" high linkable screens.

description	d	pattern no.	P1	P2	P3
Cantilever bracket, panel hung	18"	ASBC18 (L/R) ()	\$101.	\$107.	\$111.
	24"	ASBC24 (L/R) ()	111.	119.	125.

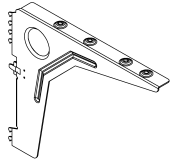

18" for 20" and 24" deep tops
 24" for 30" and 36" deep tops
 specify paint finish

Side hung support bracket, pair		RBCCP ()	43.	47.	49.
---------------------------------	--	------------------	-----	-----	-----

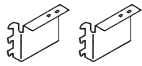

specify paint finish

top to top brackets (pair) for use when top to top condition is without tapered edges	6" x 1"	RBF	5.		
--	---------	------------	----	--	--



Top to top bracket for use with tapered edge worksurface conditions ('tapered to tapered' or 'tapered to straight')	4" x 7"	AT2TB (pair)	108.		
--	---------	---------------------	------	--	--

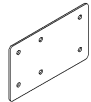

Order Code	Specification Information	Application Notes
Example: RBC18L111	<i>To order please specify pattern number including:</i>	<i>Flat edge to flat edge:</i>
R from Reff	1. Left or right hand where applicable	RBF top to top brackets are for end to end worksurface connection, no tapered edges.
B Bracket	2. Paint finish where applicable	
C Cantilever	<i>Specify painted finish from paint options listed on page 8.</i>	A cantilever bracket should be used to join two adjacent straight worksurfaces along with pair of RBF top to top brackets. RBF brackets install between screw ports on cantilever bracket to underside of worksurface.
18 18" deep		
L Left hand		
111 Finish, Jet black		

Tapered edges:
 AT2TB top to top brackets are for connection of worksurfaces at right angle, with one or both edges tapered.

A cantilever bracket should be used to join two worksurfaces along with pair of AT2TB top to top brackets. Install one AT2TB bracket behind cantilever and one in front of cantilever.



Midspan support required every 48" for all worksurfaces.

Side hung support brackets provide primary connection of a worksurface to a panel, not recommended for midspan support.

Worksurface support

Straight legs, wide legs and L-legs

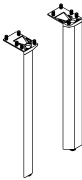
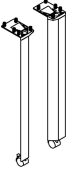
AutoStrada

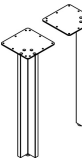
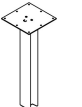
description	type	height	pattern number	list
 Straight leg (pair)	Fixed height	27"	AB1AS27 ()	\$387.
		28 ³ / ₈ "	AB1AS28 ()	408.
		30 ¹ / ₈ "	AB1AS30 ()	419.
 Straight leg with casters (pair)	Fixed height	27"	AB1ASC27 ()	387.
		28 ³ / ₈ "	AB1ASC28 ()	408.
		30 ¹ / ₈ "	AB1ASC30 ()	419.
 Wide leg	Fixed height	27"	AB1AW27 ()	358.
		28 ³ / ₈ "	AB1AW28 ()	379.
 L-legs (pair)	Fixed height	26 ¹ / ₂ "	APTLL26 ()	686.
		27"	APTLL27 ()	704.
		28 ³ / ₈ "	APTLL28 ()	716.
 Wide Flange Leg (Single)	Fixed height	27"	AWFL27 ()	610.
		28 ³ / ₈ "	AWFL28 ()	610.

Order Code

Example:	AB1AS28 AA
A	AutoStrada leg
S	Straight
28	Height
AA	Finish

Specification Information

AutoStrada straight legs, wide legs and L-Legs are available in anodized aluminum or painted finish option listed on page 8 excluding silver.

To order specify pattern number including height
1. Specify finish

Application Notes

A pair of straight legs or a pair of L-legs or one wide leg can support one end of the worksurface when the other end is spine-supported, panel-supported or joined to a perpendicular worksurface with AT2TB bracket. If distance between support spans over 48", additional support is required.

Two pairs of straight legs or L-legs may also be specified to create a freestanding table in combination with an AutoStrada worksurface not to exceed 72" x 36" with a corresponding worksurface stiffener.

Wide Flange legs are for use with Peninsula applications only.

AutoStrada straight legs are available in three heights with or without casters:

27" from floor to underside of worksurface (28³/₈" desk height)

28³/₈" from floor to underside of worksurface (29³/₄" desk height)

30¹/₈" from floor to underside of worksurface (31¹/₂" desk height)

AutoStrada wide legs are only available on glides, 27" or 28³/₈" to underside of worksurface.

AutoStrada L-legs are available in three heights, glide only (no caster option) 26¹/₂"h, 27"h and 28³/₈"h.

Worksurface support

Open frame leg sets

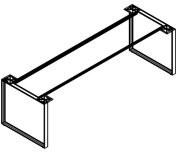
description	d	h	w	pattern no.	list
Open frame legs, Set of One, For Peninsulas 	30"	27"		AOFL1301()	\$633.
		28 ³ / ₈ "		AOFL1302()	633.
	36"	27"		AOFL1361()	633.
		28 ³ / ₈ "		AOFL1362()	633.
Open frame legs, Set of Two, For Tables 	30"	27"	60"	AOFL260301()	1,321.
		27"	66"	AOFL266301()	1,347.
		27"	72"	AOFL272301()	1,349.
		27"	78"	AOFL278301()	1,362.
		27"	84"	AOFL284301()	1,366.
		27"	90"	AOFL290301()	1,368.
		27"	96"	AOFL296301()	1,370.
		28 ³ / ₈ "	60"	AOFL260302()	1,321.
		28 ³ / ₈ "	66"	AOFL266302()	1,347.
		28 ³ / ₈ "	72"	AOFL272302()	1,349.
		28 ³ / ₈ "	78"	AOFL278302()	1,362.
		28 ³ / ₈ "	84"	AOFL284302()	1,366.
	28 ³ / ₈ "	90"	AOFL290302()	1,368.	
	28 ³ / ₈ "	96"	AOFL296302()	1,370.	
	36"	27"	60"	AOFL260361()	1,321.
		27"	66"	AOFL266361()	1,347.
		27"	72"	AOFL272361()	1,349.
		27"	78"	AOFL278361()	1,362.
		27"	84"	AOFL284361()	1,366.
		27"	90"	AOFL290361()	1,368.
		27"	96"	AOFL296361()	1,370.
		28 ³ / ₈ "	60"	AOFL260362()	1,321.
		28 ³ / ₈ "	66"	AOFL266362()	1,347.
		28 ³ / ₈ "	72"	AOFL272362()	1,349.
28 ³ / ₈ "		78"	AOFL278362()	1,362.	
28 ³ / ₈ "		84"	AOFL284362()	1,366.	
28 ³ / ₈ "	90"	AOFL290362()	1,368.		
28 ³ / ₈ "	96"	AOFL296362()	1,370.		

Order Code	Specification Information	Application Notes
Example: AOFL1301()	<i>To order please specify pattern number including:</i>	Peninsulas are supplied with one leg and attachment hardware. Stiffeners are required for a span greater than 54" wide. Table are supplied with two legs, two stiffeners and attachment hardware. Stiffeners must be installed in a specific location relative to the leg top plates. Stiffeners are finished in black. Please refer to installation instructions.
A AutoStrada	1. Leg height <i>1 = 27" h</i> <i>2 = 28³/₈" h</i>	
OFL Open Frame Leg	2. Finish: Leg <i>Anodized aluminum or painted finish option, excluding silver.</i>	
1 Set of one(for peninsulas) 2 = Set of two for tables	See page 8 for finish options applicable	
20 Depth		
1 26 ¹ / ₂ " h, 2 = 28 ³ / ₈ "h		Open Frame legs include glides with 1/4" height adjustability. Open Frame legs are not intended or able to be used adjacent to full height 28 ³ / ₈ "h desk height storage. Note: These legs are intended to be used with Knoll worksurfaces only.
() Leg Finish (all core paint, AA, AP, AU)		

Worksurface support

Fixed Height and Height Adjustable C-Leg and T-Leg Bases

AutoStrada

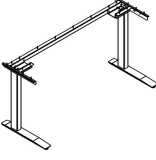
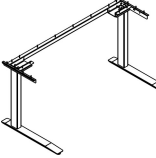
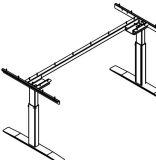
description	type	w*	w	d	pattern no.	Fixed	Pin-Set	Handcrank	Electric	Advanced
						(F)	(P)	(H)	(E)	Electric (A)
	For use with 36"W, 24"D AutoStrada C-Leg Top	36"	34"	23"	ABAC3423 () () ()	\$979.	\$1,305.	\$1,957.	\$3,399.	\$3,578.
	For use with 42"W, 24"D AutoStrada C-Leg Top	42"	40"	23"	ABAC4023 () () ()	979.	1,305.	1,957.	3,399.	3,578.
	For use with 48"W, 24"D AutoStrada C-Leg Top	48"	46"	23"	ABAC4623 () () ()	979.	1,305.	1,957.	3,399.	3,578.
	For use with 54"W, 24"D AutoStrada C-Leg Top	54"	52"	23"	ABAC5223 () () ()	979.	1,305.	1,957.	3,399.	3,578.
	For use with 60"W, 24"D AutoStrada C-Leg Top	60"	58"	23"	ABAC5823 () () ()	979.	1,305.	1,957.	3,399.	3,578.
	For use with 66"W, 24"D AutoStrada C-Leg Top	66"	64"	23"	ABAC6423 () () ()	1,001.	1,327.	1,980.	3,421.	3,602.
	For use with 72"W, 24"D AutoStrada C-Leg Top	72"	70"	23"	ABAC7023 () () ()	1,001.	1,327.	1,980.	3,421.	3,602.
<i>Fixed Shown</i>										
	For use with 36"W, 30"D AutoStrada C-Leg Top	36"	34"	29"	ABAC3429 () () ()	1,025.	1,351.	2,004.	3,444.	3,624.
	For use with 42"W, 30"D AutoStrada C-Leg Top	42"	40"	29"	ABAC4029 () () ()	1,025.	1,351.	2,004.	3,444.	3,624.
	For use with 48"W, 30"D AutoStrada C-Leg Top	48"	46"	29"	ABAC4629 () () ()	1,025.	1,351.	2,004.	3,444.	3,624.
	For use with 54"W, 30"D AutoStrada C-Leg Top	54"	52"	29"	ABAC5229 () () ()	1,025.	1,351.	2,004.	3,444.	3,624.
	For use with 60"W, 30"D AutoStrada C-Leg Top	60"	58"	29"	ABAC5829 () () ()	1,025.	1,351.	2,004.	3,444.	3,624.
	For use with 66"W, 30"D AutoStrada C-Leg Top	66"	64"	29"	ABAC6429 () () ()	1,049.	1,375.	2,026.	3,466.	3,648.
	For use with 72"W, 30"D AutoStrada C-Leg Top	72"	70"	29"	ABAC7029 () () ()	1,049.	1,375.	2,026.	3,466.	3,648.
<i>Fixed Shown</i>										
	For use with 48"W, 36"D AutoStrada T-Leg Top	48"	46"	29"	ABAT4629 () () ()	1,025.	1,351.	2,004.	3,444.	3,624.
	For use with 54"W, 36"D AutoStrada T-Leg Top	54"	52"	29"	ABAT5229 () () ()	1,025.	1,351.	2,004.	3,444.	3,624.
	For use with 60"W, 36"D AutoStrada T-Leg Top	60"	58"	29"	ABAT5829 () () ()	1,025.	1,351.	2,004.	3,444.	3,624.
	For use with 66"W, 36"D AutoStrada T-Leg Top	66"	64"	29"	ABAT6429 () () ()	1,049.	1,375.	2,026.	3,466.	3,648.
	For use with 72"W, 36"D AutoStrada T-Leg Top	72"	70"	29"	ABAT7029 () () ()	1,049.	1,375.	2,026.	3,466.	3,648.



Pin-Set Shown

Order Code	Specification Information	Application Notes
Example: ABAC5829HS, 9005, 613	To order please specify pattern number including:	Bases are designed for use with corresponding worksurfaces to create freestanding tables. Worksurfaces must be specified separately.
ABA Universal Base	1. <i>Base Type:</i>	Base comes with worksurface mounting hardware and leveling glides with 1/4" of height adjustability.
C C-Leg	(F) = Fixed (27" High)	23"D C-Leg bases support rectangular tops up to 24"D. 29"D C-Leg bases support rectangular tops up to 30"D. 29"D T-Leg bases support rectangular tops 36"D centered over feet.
58 Width	(P) = Pin-Set (22" - 35" High)	36"W C-Leg bases (except for Pin-set) support tops up to 60"w centered over feet (max 12" overhang on each side). 36"W Pin-Set C-Leg bases cannot support tops wider than the base. 42"W C-Leg bases support tops up to 66"W centered over feet (max 12" overhang on each side). 48", 54", 60" and 66"W C-Leg and T-Leg bases support tops up to 30" wider than the base centered over feet (max 15" overhang on each side). 72"W C-Leg and T-Leg bases support tops up to 96"W centered over feet (max 12" overhang on each side).
29 Depth	(H) = Handcrank (22" - 35" High)	
H Handcrank	(E) = Electric (27" - 46 1/2" High)	
S Shroud	(A) = Advanced Electric (21" - 47 1/2" High)	
9005 Black Base Finish	Base height ranges shown do not include worksurface thickness.	Bases available in Black paint finish (9005), Silver finish (613), or Bright White finish (118). Painted lower leg shroud and feet can be specified in Knoll Core paint finishes (for Black base only).
613 Shroud/Feet Paint Finish		Fixed and Pin-Set bases support up to 440lbs. Handcrank bases support up to 260lbs. Electric bases support up to 300lbs.
w * = nominal width	2. <i>Shroud Options:</i>	Pin-Set base adjusts on 1" increments.
	(N) = Leg without a metal shroud	Crank handle is located on the right side of the base. Five turns of the handle adjust worksurface height 1".
	(S) = Painted metal shroud to surround lower leg with matching foot. Add \$100 to the list price.	
	3. <i>Base Finish:</i>	
	(9005) Black paint	
	(613) Silver paint	
	(118) Bright White paint	
	4. <i>Shroud/Feet Paint Finish, when applicable</i>	

Worksurface support

Fixed Height and Height Adjustable C-Leg and T-Leg Bases

AutoStrada

description	type	w	d	h	pattern no.	list
Electric Table Memory Switch with Digital Display 	For use with Electric C-Leg and T-Leg bases	5"	.75"	1"	SISDDPS	\$384.
Locking Casters, Set of 4 	For use with C-Leg and T-Leg bases	2"	2"	1.5"	SISLC4	51.
Insert Kit, Antenna Privacy Screen	To attach Antenna Workspaces Privacy Screens to C-Leg and T-Leg worksurfaces				SISAWDSIK	26.

Support Components

Order Code

Example: SISDDPS	
SIS	Universal Base
DDPS	Electric Table Memory Switch with Digital Display

Application Notes

Locking casters replace standard glides to facilitate reconfiguration. Locking casters raise top height 1 1/2".

Insert kit is required when attaching Antenna Workspaces privacy screens to C-leg and T-leg worksurfaces.

Electric table memory switch with digital display offers three programmable memory settings with digital read out display. Mounting options include a 90° bracket and a 45° bracket. (Both are supplied) This memory switch will replace the standard up/down control.

Worksurface support

T and L bases

AutoStrada

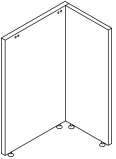
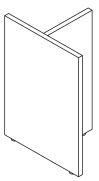
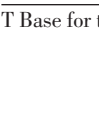
description	type	h	w	d	pattern no.	L	V1	V2	V3
	right hand	28 ³ / ₈ "	24"		ALBR24 ()	\$501.	\$523.	\$601.	\$779.
		28 ³ / ₈ "	30"		ALBR30 ()	579.	606.	700.	911.
		28 ³ / ₈ "	36"		ALBR36 ()	658.	695.	796.	1,035.
	left hand	28 ³ / ₈ "	24"		ALBL24 ()	501.	523.	601.	779.
		28 ³ / ₈ "	30"		ALBL30 ()	579.	606.	700.	911.
		28 ³ / ₈ "	36"		ALBL36 ()	658.	695.	796.	1,035.
	T Base for tapered 1 edge tops	28 ³ / ₈ "	18"	12"	ATBT120 ()	459.	486.	564.	736.
		28 ³ / ₈ "	22"	12"	ATBT124 ()	491.	523.	601.	779.
		28 ³ / ₈ "	28"	12"	ATBT130 ()	579.	606.	700.	911.
		28 ³ / ₈ "	34"	12"	ATBT136 ()	658.	695.	796.	1,035.
	T Base for tapered 2 edge tops	28 ³ / ₈ "	20"	12"	ATBT224 ()	491.	523.	601.	779.
		28 ³ / ₈ "	26"	12"	ATBT230 ()	579.	606.	700.	911.
		28 ³ / ₈ "	32"	12"	ATBT236 ()	658.	695.	796.	1,035.
		28 ³ / ₈ "	38"	12"	ATBT242 ()	812.	855.	985.	1,280.

Order Code

Example:	ATB24V316
A	Autostrada
TB	T-base
24	24" w x 12" d
V316	Finish, Maple

Specification Information

To order please specify pattern number including:

1. Hand (applicable for L bases only)
L = left hand
R = right hand
2. Width
3. Finish
Laminate, V1, V2 or V3 finish

See page 8 for finish options applicable.

Product on this page will accept wood grain laminate where laminate is currently an option.

Application Notes

T and L bases are 28³/₈" h to underside of worksurface. If used with wood case pedestals or lower storage as support, must specify cabinet feet (see page 266) for pedestals/lower storage to achieve required height.

Worksurface support

Modesty panels

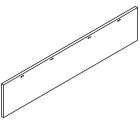
description	h	w	pattern no.	L	V1	V2	V3
Half height suspended modesty 	12"	33 1/2"	AHHSM36 ()	\$361.	\$435.	\$473.	\$613.
	12"	39 1/2"	AHHSM42 ()	371.	444.	485.	632.
	12"	45 1/2"	AHHSM48 ()	380.	453.	496.	646.
	12"	51 1/2"	AHHSM54 ()	394.	460.	510.	662.
	12"	57 1/2"	AHHSM60 ()	402.	472.	524.	681.
	12"	63 1/2"	AHHSM66 ()	412.	479.	536.	697.
	12"	69 1/2"	AHHSM72 ()	424.	488.	549.	712.
	12"	75 1/2"	AHHSM78 ()	435.	496.	561.	730.
	12"	81 1/2"	AHHSM84 ()	446.	505.	575.	748.
	12"	87 1/2"	AHHSM90 ()	455.	515.	589.	765.
	12"	93 1/2"	AHHSM96 ()	465.	525.	602.	780.

Order Code

Example:	AHHSM30V316
A	AutoStrada
HH	Half height
S	Suspended
M	Modesty
30	for 30" w work surface
V316	Finish, Maple

Specification Information

To order please specify pattern number including:

1. Finish
Laminate, V1, V2 or V3 finish

See page 8 for finish options applicable.

Product on this page will accept wood grain laminate where laminate is currently an option.

Application Notes

To be used for free-standing private office applications.

Half height suspended modesty intended for optional use with work surfaces when creating configurations including a peninsula top supported at one end by a pair of legs (legs on page 254) or "freestanding" table desk by set of legs and would install just behind the legs by angle bracket that ships with modesty. Attachment hardware included.

If installing below worksurface with grommets, be sure to specify recessed grommet location.

Worksurface support

Modesty

Hinged

28³/₈" planning

description	application	th	w	h	pattern no.	L	V1	V2	V3
 <p>Hinged Modesty for End panel and Storage Unit</p> <p><i>Back side shown</i></p>	72" wide assembly - 16" storage	1"	72"	25"	ADHMH7210()	\$867.	\$1,080.	\$1,136.	\$1,363.
	72" wide assembly - 19" storage	1"	72"	25"	ADHMH7220()	859.	1,075.	1,126.	1,352.
	72" wide assembly - 30" storage	1"	72"	25"	ADHMH7230()	691.	898.	945.	1,136.
	72" wide assembly - 36" storage	1"	72"	25"	ADHMH7240()	681.	886.	928.	1,113.
	78" wide assembly - 16" storage	1"	78"	25"	ADHMH7810()	883.	1,092.	1,152.	1,383.
	78" wide assembly - 19" storage	1"	78"	25"	ADHMH7820()	871.	1,087.	1,144.	1,371.
	78" wide assembly - 30" storage	1"	78"	25"	ADHMH7830()	703.	915.	962.	1,154.
	78" wide assembly - 36" storage	1"	78"	25"	ADHMH7840()	691.	898.	945.	1,136.
	84" wide assembly - 16" storage	1"	84"	25"	ADHMH8410()	899.	1,111.	1,175.	1,411.
	84" wide assembly - 19" storage	1"	84"	25"	ADHMH8420()	888.	1,096.	1,166.	1,401.
	84" wide assembly - 30" storage	1"	84"	25"	ADHMH8430()	861.	1,075.	1,128.	1,354.
	84" wide assembly - 36" storage	1"	84"	25"	ADHMH8440()	703.	915.	962.	1,154.
	90" wide assembly - 16" storage	1"	90"	25"	ADHMH9010()	909.	1,121.	1,193.	1,431.
	90" wide assembly - 19" storage	1"	90"	25"	ADHMH9020()	903.	1,116.	1,185.	1,421.
	90" wide assembly - 30" storage	1"	90"	25"	ADHMH9030()	873.	1,088.	1,145.	1,374.
	90" wide assembly - 36" storage	1"	90"	25"	ADHMH9040()	861.	1,075.	1,128.	1,354.
	96" wide assembly - 16" storage	1"	96"	25"	ADHMH9610()	921.	1,134.	1,208.	1,451.
	96" wide assembly - 19" storage	1"	96"	25"	ADHMH9620()	914.	1,126.	1,200.	1,441.
	96" wide assembly - 30" storage	1"	96"	25"	ADHMH9630()	889.	1,098.	1,170.	1,404.
96" wide assembly - 36" storage	1"	96"	25"	ADHMH9640()	873.	1,088.	1,145.	1,374.	

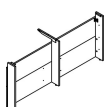
 <p>Hinged Modesty for Between Two Storage Elements</p> <p><i>Back side shown</i></p>	72" wide assembly - 16"/16" storage	1"	72"	25"	ADHMH7211()	691.	898.	943.	1,135.
	72" wide assembly - 19"/19" storage	1"	72"	25"	ADHMH7212()	685.	891.	935.	1,122.
	72" wide assembly - 16"/19" storage	1"	72"	25"	ADHMH7222()	681.	886.	928.	1,113.
	78" wide assembly - 16"/16" storage	1"	78"	25"	ADHMH7811()	703.	915.	962.	1,154.
	78" wide assembly - 16"/19" storage	1"	78"	25"	ADHMH7812()	696.	909.	955.	1,145.
	78" wide assembly - 16"/30" storage	1"	78"	25"	ADHMH7813()	673.	882.	915.	1,098.
	78" wide assembly - 19"/19" storage	1"	78"	25"	ADHMH7822()	691.	898.	943.	1,135.
	78" wide assembly - 19"/30" storage	1"	78"	25"	ADHMH7823()	668.	875.	902.	1,081.
	84" wide assembly - 16"/16" storage	1"	84"	25"	ADHMH8411()	861.	1,075.	1,128.	1,354.
	84" wide assembly - 16"/19" storage	1"	84"	25"	ADHMH8412()	854.	1,070.	1,119.	1,343.
	84" wide assembly - 16"/36" storage	1"	84"	25"	ADHMH8413()	687.	892.	937.	1,125.
	84" wide assembly - 16"/30" storage	1"	84"	25"	ADHMH8414()	673.	882.	915.	1,098.
	84" wide assembly - 19"/19" storage	1"	84"	25"	ADHMH8422()	703.	915.	962.	1,154.
	84" wide assembly - 19"/30" storage	1"	84"	25"	ADHMH8423()	681.	886.	930.	1,116.
	84" wide assembly - 19"/36" storage	1"	84"	25"	ADHMH8424()	668.	875.	902.	1,081.
	90" wide assembly - 16"/16" storage	1"	90"	25"	ADHMH9011()	873.	1,088.	1,145.	1,374.
	90" wide assembly - 16"/19" storage	1"	90"	25"	ADHMH9012()	867.	1,081.	1,137.	1,364.
	90" wide assembly - 16"/36" storage	1"	90"	25"	ADHMH9013()	697.	910.	956.	1,147.
	90" wide assembly - 16"/30" storage	1"	90"	25"	ADHMH9014()	687.	892.	937.	1,125.

Order Code	Specification Information	Application Notes
Example: ADHMH7222	<i>To order please specify pattern number including:</i>	Modesty may prohibit the adjacent drawer from opening.
A AutoStrada	1. <i>Finish Type</i> L, V1, V2, V3	Recommended that when using a modesty the adjacent ped is an open configuration.
DH Desk height	2. <i>Finish</i> V316	Hardware shipped with modesty to attach to worksurface.
M Modesty		J-Extrusion Wire Trough sold separately.
H Hinged		
72 Width		
22 19"/19" storage		
V2 Finish type		
V316 Light Maple		

- Modesty End panel and storage unit.
- 10= 16" storage
- 20= 19" storage
- 30= 30" storage
- 40= 36" storage
- Modesty between two storage units.
- 11= 16"/16" storage
- 12= 16"/19" storage
- 13= 16"/36" storage
- 14= 16"/30" storage
- 22= 19"/19" storage
- 23= 19"/30" storage
- 24= 19"/36" storage
- 33= 30"/30" storage
- 34= 36"/36" storage

Worksurface support

Modesty

Hinged

28³/₈" planning

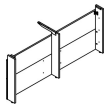
description	application	th	w	h	pattern no.	L	V1	V2	V3
Hinged Modesty for Between Two Storage Elements  Back side shown	90" wide assembly - 19"/19" storage	1"	90"	25"	ADHMH9022()	\$861.	\$1,075.	\$1,128.	\$1,354.
	90" wide assembly - 19"/30" storage	1"	90"	25"	ADHMH9023()	692.	899.	945.	1,136.
	90" wide assembly - 19"/36" storage	1"	90"	25"	ADHMH9024()	681.	886.	930.	1,116.
	90" wide assembly - 30"/30" storage	1"	90"	25"	ADHMH9033()	669.	876.	904.	1,085.
	96" wide assembly - 16"/16" storage	1"	96"	25"	ADHMH9611()	889.	1,097.	1,167.	1,403.
	96" wide assembly - 16"/19" storage	1"	96"	25"	ADHMH9612()	884.	1,093.	1,153.	1,384.
	96" wide assembly - 16"/36" storage	1"	96"	25"	ADHMH9613()	856.	1,071.	1,120.	1,344.
	96" wide assembly - 16"/30" storage	1"	96"	25"	ADHMH9614()	697.	910.	956.	1,147.
	96" wide assembly - 19"/19" storage	1"	96"	25"	ADHMH9622()	873.	1,088.	1,145.	1,374.
	96" wide assembly - 19"/30" storage	1"	96"	25"	ADHMH9623()	703.	916.	964.	1,155.
	96" wide assembly - 19"/36" storage	1"	96"	25"	ADHMH9624()	692.	899.	945.	1,136.
	96" wide assembly - 30"/30" storage	1"	96"	25"	ADHMH9633()	683.	888.	931.	1,117.
	96" wide assembly - 36"/36" storage	1"	96"	25"	ADHMH9634()	669.	876.	904.	1,085.

Support Components

Order Code	Specification Information	Application Notes
Example: ADHMH7222	<i>To order please specify pattern number including:</i>	Modesty may prohibit the adjacent drawer from opening.
A AutoStrada	1. <i>Finish Type</i> L, V1, V2, V3	Recommended that when using a modesty the adjacent ped is an open configuration.
DH Desk height	2. <i>Finish</i> V316	Hardware shipped with modesty to attach to worksurface.
M Modesty		J-Extrusion Wire Trough sold separately.
H Hinged		Modesty End panel and storage unit.
72 Width		10= 16" storage
22 19"/19" storage		20= 19" storage
V2 Finish type		30= 30" storage
V316 Light Maple		40= 36" storage
		Modesty between two storage units.
		11= 16"/16" storage
		12= 16"/19" storage
		13= 16"/36" storage
		14= 16"/30" storage
		22= 19"/19" storage
		23= 19"/30" storage
		24= 19"/36" storage
		33= 30"/30" storage
		34= 36"/36" storage

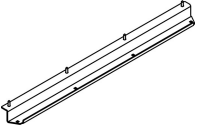
description	type	width	depth	height	pattern number	list
Stiffener for worksurface, full depths 	36"	20"	1 1/2"	1"	AWM1 S36	\$58.
	42"	26"	1 1/2"	1"	AWM1 S42	62.
	48"	32"	1 1/2"	1"	AWM1 S48	64.
	60"	44"	1 1/2"	1"	AWM1 S60	66.
	66"	50"	1 1/2"	1"	AWM1 S66	70.
	72"	56"	1 1/2"	1"	AWM1 S72	72.
	78"	62"	1 1/2"	1"	AWM1 S78	75.
	84"	68"	1 1/2"	1"	AWM1 S84	77.

Order CodeExample: **AWM1 S36****AWM1** Stiffener**S** Straight**36** Application**Specification Information**

Stiffeners are black painted finish.

Application Notes

AutoStrada worksurfaces require stiffeners when the span between structural supports exceeds 60". Stiffener also serves as horizontal cable manager.

Stiffener corresponds in width to straight or corner worksurface back edge. Specify 12" less wide stiffener to mount adjacent to floor standing pedestal.

For 90" application span, use AWM1-S84 stiffener.

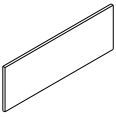
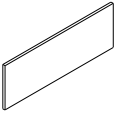
description	h	w	y	pattern no.	list
Tackboard for 49" h Median 	21"	26 1/2"	0.7	ATBM26 ()	\$161.
	21"	32 1/2"	1.0	ATBM32 ()	196.
	21"	42"	1.3	ATBM42 ()	258.
	21"	48"	1.5	ATBM48 ()	295.
	21"	54"	1.6	ATBM54 ()	331.
	21"	60"	1.8	ATBM60 ()	369.
	21"	66"	2.0	ATBM66 ()	406.
	21"	72"	2.2	ATBM72 ()	444.
	21"	78"	2.3	ATBM78 ()	480.
	21"	84"	2.5	ATBM84 ()	516.
	21"	90"	2.6	ATBM90 ()	552.
21"	96"	2.8	ATBM96 ()	590.	
Tackboard for 49" h Bridge 	21"	42"	1.3	ATBB42 ()	258.
	21"	48"	1.5	ATBB48 ()	295.
	21"	54"	1.6	ATBB54 ()	331.
	21"	60"	1.8	ATBB60 ()	369.
	21"	66"	2.0	ATBB66 ()	406.
	21"	72"	2.2	ATBB72 ()	444.
	21"	78"	2.3	ATBB78 ()	480.
14" h Tackboard for use with 42" h medians or bridges	14"	26 1/2"	0.7	ATB1426 ()	156.
	14"	32 1/2"	1.0	ATB1432 ()	190.
	14"	42"	1.3	ATB1442 ()	250.
	14"	48"	1.5	ATB1448 ()	286.
	14"	54"	1.6	ATB1454 ()	322.
	14"	60"	1.8	ATB1460 ()	359.
	14"	66"	2.0	ATB1466 ()	396.
	14"	72"	2.2	ATB1472 ()	431.
	14"	78"	2.3	ATB1478 ()	465.
	14"	84"	2.5	ATB1484 ()	502.
	14"	90"	2.6	ATB1490 ()	537.
	14"	96"	2.8	ATB1496 ()	574.

Order Code	Specification Information	Application Notes
Example: ATBM26W359- A AutoStrada TB Tackboard M for median 26 for 26.5" d gable W359- Fabric selection	To order please specify pattern number including: 1. For median or bridge <i>M = for medians</i> <i>B = for bridges</i> 2. Width <i>26 = for 26.5 d median gable</i> <i>32 = for 32.5 d median gable</i> <i>All others specify to match width of corresponding median or bridge</i> 3. Fabric selection	Velcro included to attach tackboard to median or bridge as required. Fabric orientation is applied "railroaded". Fabric choices listed on page 9.

Note: Y = Fabric requirements.

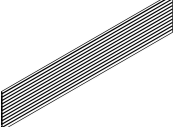
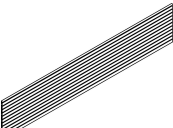

description	h	w	pattern no.	AA or paint
Slatwall for Median 	19"	26 1/2"	ASWM26 ()	\$255.
	19"	32 1/2"	ASWM32 ()	319.
	19"	42"	ASWM42 ()	380.
	19"	48"	ASWM48 ()	427.
	19"	54"	ASWM54 ()	476.
	19"	60"	ASWM60 ()	522.
	19"	66"	ASWM66 ()	568.
	19"	72"	ASWM72 ()	614.
	19"	78"	ASWM78 ()	659.
	19"	84"	ASWM84 ()	692.
	19"	90"	ASWM90 ()	725.
19"	96"	ASWM96 ()	757.	
Slatwall for Bridge 	19"	42"	ASWB42 ()	380.
	19"	48"	ASWB48 ()	427.
	19"	54"	ASWB54 ()	476.
	19"	60"	ASWB60 ()	522.
	19"	66"	ASWB66 ()	568.
	19"	72"	ASWB72 ()	614.
	19"	78"	ASWB78 ()	659.

Order Code	Specification Information	Application Notes
Example: ASWM26AA A AutoStrada SW Slatwall M for median 26 for 26.5" d gable AA Finish, anodized aluminum	To order please specify pattern number including: 1. For median or bridge <i>M = for medians</i> <i>B = for bridges</i> 2. Width <i>26 = for 26.5 d median gable</i> <i>32 = for 32.5 d median gable</i> <i>All others specify to match width of corresponding median or bridge</i> 3. Finish <i>AA - anodized aluminum or painted finish option from page 8 excluding silver</i>	Slatwall attaches to median or bridge assembly with brackets (supplied with slatwall) which are then screwed onto modesty of median or bridge assembly. Modesties are not predrilled for attachment, field drill required during installation.

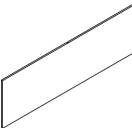
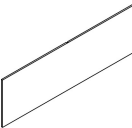
Wall hung tackboards 24" and 30" high

description	w	y	pattern no.	grade								
				10	15	20	30	35	40	45	50	55
Wall hung tackboards, 24" high 	30"	1	AWHTB3024 ()	\$285.	\$313.	\$341.	\$370.	\$375.	\$380.	\$385.	\$423.	\$459.
	36"	1.1	AWHTB3624 ()	303.	335.	366.	397.	403.	409.	416.	455.	496.
	42"	1.3	AWHTB4224 ()	334.	371.	406.	444.	451.	457.	465.	513.	560.
	48"	1.5	AWHTB4824 ()	364.	405.	447.	489.	498.	506.	515.	569.	623.
	54"	1.6	AWHTB5424 ()	382.	427.	474.	518.	527.	536.	545.	604.	660.
	60"	1.8	AWHTB6024 ()	412.	462.	514.	564.	575.	585.	595.	660.	724.
	66"	1.9	AWHTB6624 ()	433.	486.	538.	592.	604.	613.	625.	693.	761.
	72"	2.1	AWHTB7224 ()	462.	523.	581.	640.	651.	663.	674.	750.	825.
	78"	2.3	AWHTB7824 ()	491.	557.	620.	686.	699.	711.	724.	806.	888.
	84"	2.5	AWHTB8424 ()	523.	592.	662.	732.	747.	761.	775.	863.	953.
	90"	2.6	AWHTB9024 ()	540.	613.	687.	759.	774.	790.	805.	897.	988.
96"	2.8	AWHTB9624 ()	571.	649.	729.	808.	823.	837.	855.	954.	1,052.	
Wall hung tackboards, 30" high 	30"	1	AWHTB3030 ()	301.	328.	356.	381.	387.	394.	399.	427.	463.
	36"	1.1	AWHTB3630 ()	324.	354.	382.	414.	420.	425.	433.	463.	502.
	42"	1.3	AWHTB4230 ()	357.	393.	426.	462.	470.	478.	484.	522.	567.
	48"	1.5	AWHTB4830 ()	390.	431.	472.	510.	521.	528.	536.	579.	632.
	54"	1.6	AWHTB5430 ()	412.	455.	498.	542.	551.	560.	568.	614.	670.
	60"	1.8	AWHTB6030 ()	445.	494.	542.	591.	602.	611.	621.	672.	736.
	66"	1.9	AWHTB6630 ()	468.	519.	569.	621.	633.	643.	655.	708.	773.
	72"	2.1	AWHTB7230 ()	500.	558.	613.	670.	684.	695.	707.	767.	838.
	78"	2.3	AWHTB7830 ()	533.	596.	658.	720.	735.	746.	758.	824.	904.
	84"	2.5	AWHTB8430 ()	565.	634.	701.	770.	783.	797.	812.	883.	969.
	90"	2.6	AWHTB9030 ()	589.	660.	729.	800.	815.	829.	846.	917.	1,008.
96"	2.8	AWHTB9630 ()	621.	698.	773.	850.	864.	882.	898.	977.	1,072.	

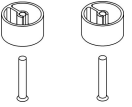
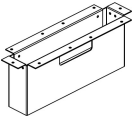
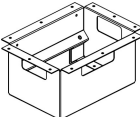
Order Code	Specification Information	Application Notes
Example: AWHTB3024 ()	<i>To order please specify pattern number including:</i>	Fabric orientation is applied railroaded.
A AutoStrada	1. Fabric selection	Vertical channel is routed in the center of the tackboard to accept T5 light cord.
WH Wall hung	24" high Nominal = 23.8"h Actual	Note: Y = Fabric requirements.
TB Tackboard	30" high Nominal = 29.9"h Actual	Note: The 24" tackboards work with 24" high pedestals. The 30" tackboards work with 21 3/4" high pedestals.
30 Wide		Velcro supplied for attaching to wall.
24 Height		Fabric choices listed on page 9.
W359- Fabric selection		

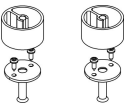
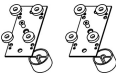
description	height	width	dia.	pattern no.	list
Worksurface stand-off (pair) 	1"		1 3/4"	AWSO ()	\$34.
AutoStrada Stand-Off 	5"	12"	5"	AST()	114.
AutoStrada Power Center Stand-Off 	5"	12"	5"	APCST()	146.
Cabinet feet (pair) 	1 7/8"		1 3/4"	ACF1 ()	172.
Worksurface stand-off (pair), for "ganging" 	1"		1 3/4"	AWSOG ()	34.
Cabinet feet (pair) for "ganging" 	1 7/8"		1 3/4"	ACFG1 ()	172.

Order Code	Specification Information	Application Notes
Example: AWSOAA	To order please specify pattern number including:	Worksurface stand-offs are for use primarily in the private office between work surfaces and wood case pedestals or lower storage. Worksurface stand-offs may also be installed in place of anti-tip wood spacer between worksurfaces and wood case pedestals or lower storage in storage anchored planning. Anti-tip wood spacer and stand-offs are both 1"h.
A AutoStrada	1. Finish	When "ganging" units together to create "build-to-spec" credenzas, one pair of worksurface stand-offs and one pair of cabinet feet are required to span side-by-side units. For instance, if creating a credenza with 3 lower storage units, specify 4 pairs of stand-offs and 4 pairs of cabinet feet.
WSO Work surface stand-off	AA - anodized aluminum or painted finish option from page 8 excluding silver	Cabinet feet should not be used in spine-based or storage anchored planning models. Use only with wood case pedestals and laterals to achieve overall worksurface height of 29 3/8" (or 28 3/8" to underside of worksurface). Spine based and Storage Anchored planning model components are engineered at 27" from floor to underside of worksurface.
AA Finish, anodized aluminum		To install cabinet feet, first remove leveller from pedestal or lower storage, then reinstall with feet.
		Note: Free-standing cabinets on page 180 include cabinet feet.
		If you are planning to create an open knee space credenza with one storage unit on either end of the credenza, you would require 2 pairs of work surface stand-offs and 2 pairs of cabinet feet for each lower storage unit.

description	height	width	dia.	pattern no.	list
Cabinet metal cap leveler (12/pk)				ACMCL	\$19.



Order Code	Specification Information	Application Notes
Example: AWSOAA A AutoStrada WSO Work surface stand-off AA Finish, anodized aluminum	To order please specify pattern number including: 1. Finish <i>AA - anodized aluminum or painted finish option from page 8 excluding silver</i>	<p>Worksurface stand-offs are for use primarily in the private office between work surfaces and wood case pedestals or lower storage. Worksurface stand-offs may also be installed in place of anti-tip wood spacer between worksurfaces and wood case pedestals or lower storage in storage anchored planning. Anti-tip wood spacer and stand-offs are both 1”h.</p> <p>Cabinet feet are for use with lower storage units in private office planning to achieve overall worksurface height of 29³/₈”.</p> <p>Note: Free-standing cabinets on page 180 include cabinet feet.</p> <p>If you are planning to create an open knee space credenza with one storage unit on either end of the credenza, you would require 2 pairs of work surface stand-offs and 2 pairs of cabinet feet for each lower storage unit.</p> <p>When “ganging” units together to create “build-to-spec” credenzas, one pair of worksurface stand-offs and one pair of cabinet feet are required to span side-by-side units. For instance, if creating a credenza with 3 lower storage units, specify 4 pairs of stand-offs and 4 pairs of cabinet feet.</p> <p>Cabinet feet should not be used in spine-based or storage anchored planning models. Use only with wood case pedestals and laterals to achieve overall worksurface height of 29³/₈” (or 28³/₈” to underside of worksurface). Spine based and Storage Anchored planning model components are engineered at 27” from floor to underside of worksurface.</p> <p>To install cabinet feet, first remove leveller from pedestal or lower storage, then reinstall with feet.</p>

without Cabinet Feet

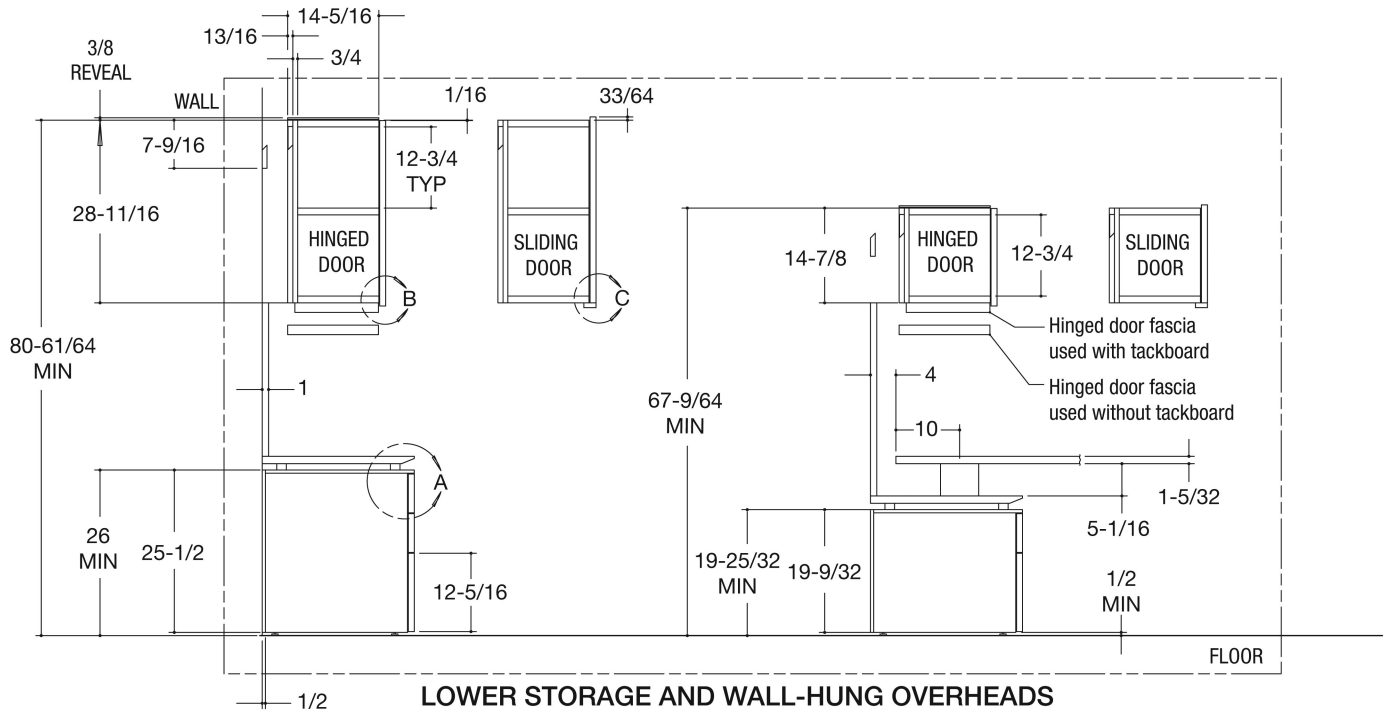

with Cabinet Feet

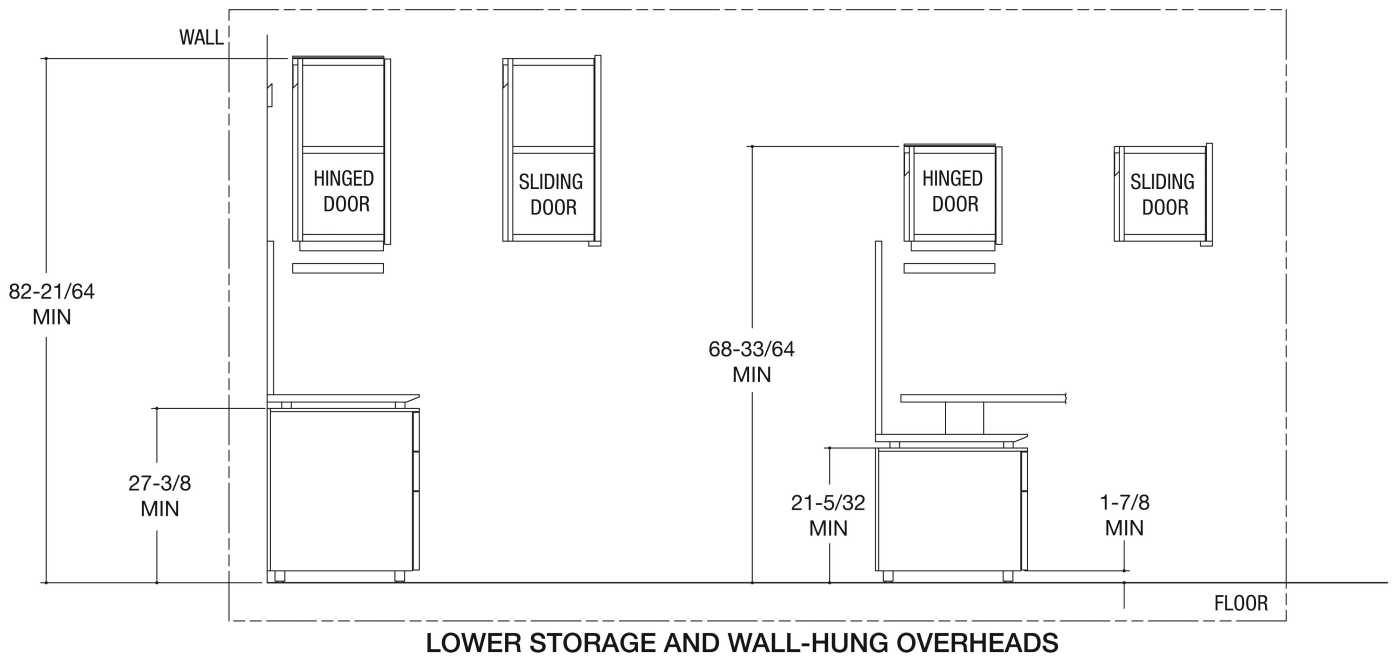

Note: Planning Side Elevations are nominal. Dimensions are actual.

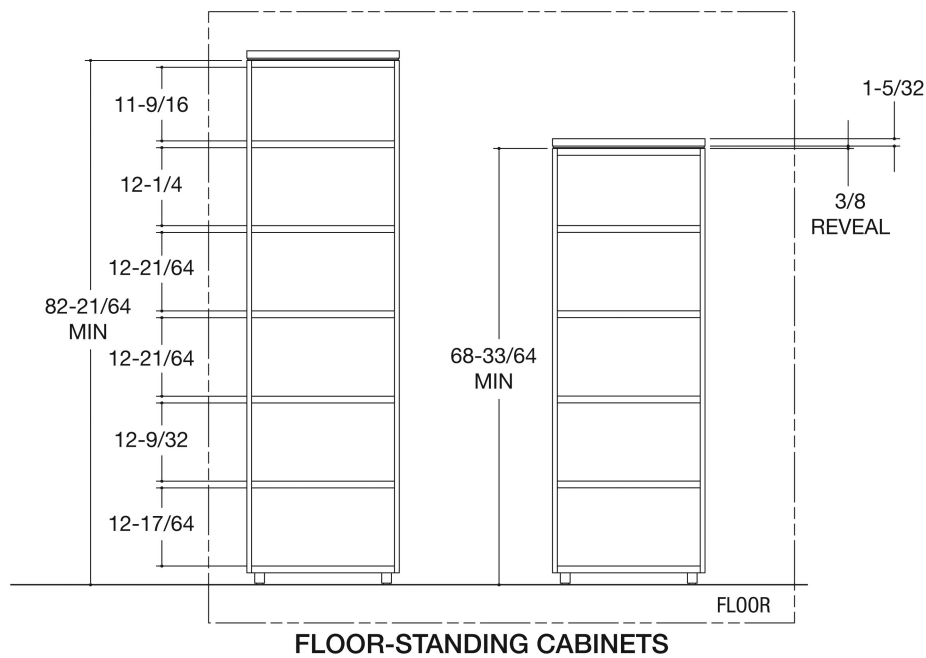
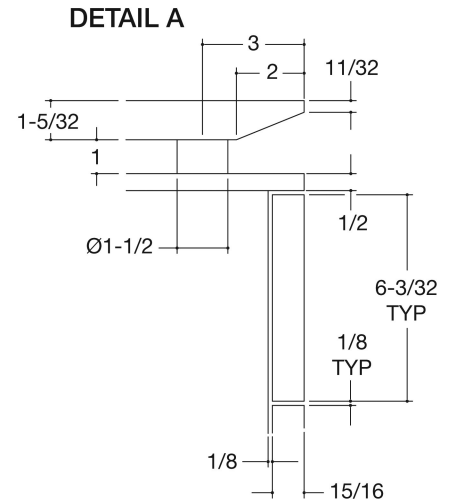
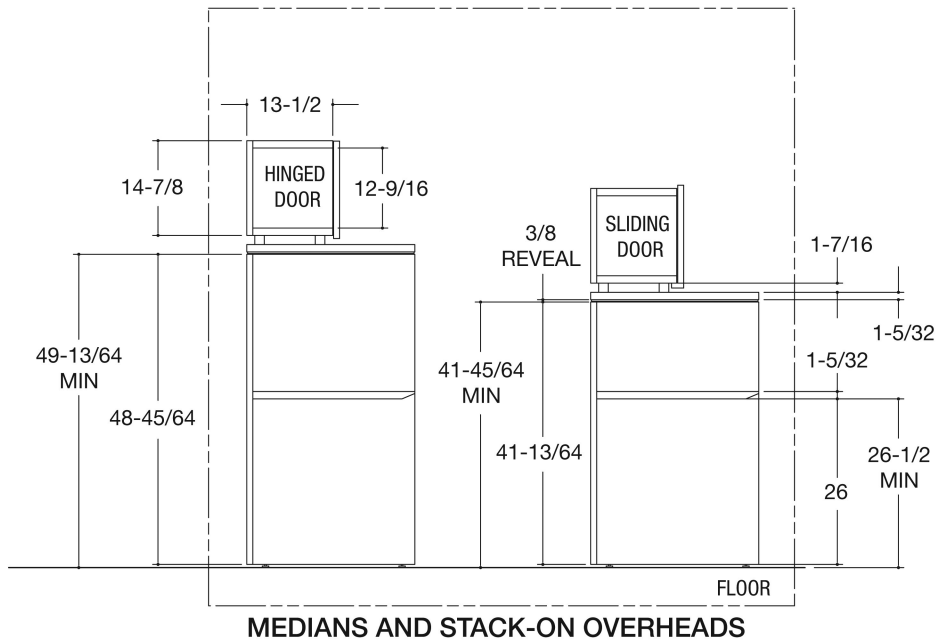

DETAIL B
 OVERHEAD w/ HINGED DOOR

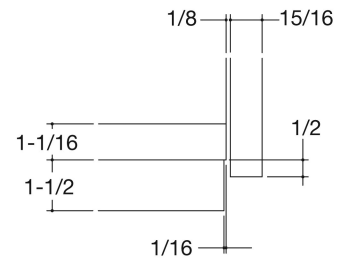

DETAIL C
 OVERHEAD w/ SLIDING DOOR

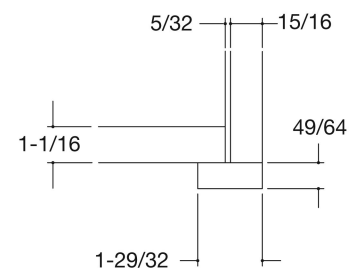

This Order Guide provides basic planning, specifications and pricing information for Crinion Open Tables.

Refer to KnollExtra price list for compatible accessories such as flat screen monitor supports, task lights, paper management accessories, keyboard and storage drawers.

Refer to Calibre, Reff or Currents price lists for shared and individual storage options. Additional information can be found at www.knoll.com.

Crinion Open Table is the straightforward alternative for open, collaborative work environments. The table accommodates a group of four to eight or more at a continuous work surface.

Crinion Open Table typically consists of deep worksurfaces end-to-end and back-to-back, cantilever supported by parallel beams between end legs. The beams form a technology corridor for flat screen monitor supports, outlets and power/data distribution. Also available is a single-sided configuration, with a single main beam and a smaller back beam, and a single beam configuration for tables with shallower (24" deep) worksurface.

The center of dual tables or back of single-sided tables features a top channel which supports privacy screens above the table and modular power distribution below the worksurface.

Crinion Open Table is appropriate for libraries and education environments, laboratories, finance and trading desks, teaming areas and design offices.

Crinion Open Table is unique in offering individual height-adjustability and extraordinarily deep worksurfaces. Overall dual table depth is 48", 60" or 72".

The table structure is strong enough to span 16 feet between end legs or intermediate supports to build tables of any length.

The continuous worksurfaces and clear kneespace enable varying numbers of workers to sit on each side. Storage is typically separated from the table in parallel, shared file-and-storage islands, perpendicular files and filetops as returns or mobile pedestals.

Crinion is distinguished by a minimalist, modern design, and details like square or tapered edge worksurfaces, plastic laminate, Techwood or natural veneers, and aluminum fittings.

Crinion Open Table simplifies the planning and specifications of an open office, and it can make a dramatic visual and functional statement of collaboration.

The quality and classic design of Crinion work well in virtually any interior.

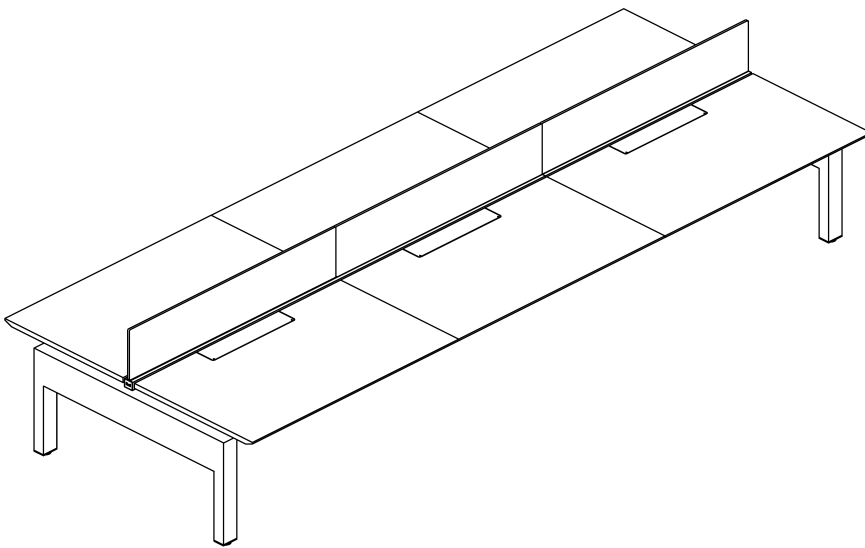

Crinion Open Tables are comprised of worksurfaces, table base assemblies, power components and screens.

Worksurfaces

Individual worksurfaces are available in four standard widths (48", 60", 72", 96") and three depths (nominal 24", 30", 36"), which may be combined to form single-sided or dual-sided groups of two to ten or more positions.

Worksurface edge options

Worksurfaces are 1 1/4" thick, with three front edge options: Tapered edge, laminate, veneer or mixed.

Square edge, veneer

Postformed edge, laminate only

Power and accessory options

Worksurfaces may be specified with hinged power access door and continuous 1/2" cord drop, or edge grommet and continuous cord drop, or just cord drop.

Hinged power access door is 24"W and 5"D, centered on worksurface width. Door hinges toward user for continuity between access opening and cord drop.

Any worksurface (except end counters) accepts clamp on KnollExtra accessories such as flat screen monitor arm or task light.

Other worksurface types

End counters have front edge detail on side edges as well and are designed to extend dual tables 24" or 30" beyond the endleg. End counters also include 3" wide center grommet. Extended end counters are 36"D surfaces with center grommet or hinged power access door. Base of the table must be extended 12" under the back of each extended end counter (although top channels should be specified only as wide as the worksurfaces on each side of the table).

All end counters must be supported by end counter cantilevers and endlegs for end counters.

Worksurface heights

Fixed height cantilevers support worksurfaces at 28 1/2"H, with 27" clear below the top (except directly below cantilevers).

Adjustable height cantilevers enable worksurfaces to be independently set at 27", 27 3/4", 28 1/2", 29 1/4", or 30"H.

Open Table base assemblies

Complete base assemblies simplify specifications for most common configurations of dual or single-sided open tables. Base assemblies include top channels and end caps, beams, end legs and intermediate legs (where required), trusses and top channel supports, cantilever brackets (specify fixed or adjustable height) and midspan supports. Specify worksurfaces, screens, power components, cable trays and accessories separately.

Complete base assemblies are available for the following typical tables, combinations of 60" or 72" worksurfaces.

Single-sided or dual, 24"D, 30"D, or 36"D, with continuous beam span between end legs

10' W two/four positions 60"W

12' W two/four positions 72"W

15' W three/six positions 60"W

Single sided or dual 24"D, 30"D, or 36"D, with intermediate leg

18' W three/six positions 72"W

20' W four/eight positions 60"W

24' W four/eight positions 72"W

25' W five/ten positions 60"W

Open Table base components

Base assemblies may also be specified by individual components to create configurations other than those listed above, or to create tables with end counters or frameless glass add ups.

In addition to worksurfaces Open tables require top channel, starter beams for spans up to 15', extension beams for additional spans of 4' to 15', intermediate legs every 16' or less, two end legs, trusses at every worksurface junction and at each end leg. Adjustable tables require two cantilevers per worksurface (or three for 96"W). Fixed height tables may be supported by a fixed height cantilever at each end, shared cantilevers at each worksurface joint, and a midspan support bracket at the center of each worksurface greater than 48" wide. For 96"W worksurfaces the midspan support should be a 24"D cantilever. Power components, cable trays and screens are optional.

Power distribution

Optional modular raceway distributes 2+2 four circuit or 3+3 six circuit configuration from a single point of supply. Bundles of cables can be managed from the floor in a cable infeed shroud located at any intermediate leg. Raceway provides power outlets and data/communications outlet openings on one or both sides, accessed through hinged access doors in worksurfaces or from under table. Specify 30" raceway for two duplex outlets each side or 42" raceway for four duplex outlets each side. Duplex outlets, power infeed and jumpers between raceways must be specified separately.

Specify compact power module for outlets under extended end counters.

Privacy screens

There are four screen options for Crinion Open Table.

The standard screens are 14"H (42" horizon) or 21"H (49" horizon) in acrylic, slat wall or combination surfaces. Center screens include mounting hardware to attach to the standard top channel. Center screens are available full width, 48", 60" or 72", or shorter by 1" to leave space at either end of the table for a dual end screen. Side screens attach to the front and back of a worksurface at any point other than at a hinged access door. Mounting brackets are specified separately to correspond to each worksurface edge detail. Dual end screens span across the end of a table (or above an end counter) from worksurface front edges.

Frameless glass add ups are available in 12" height only, 48", 60", and 72"W. Add ups can only mount to a top channel for frameless glass add ups, which may be at the center of a dual table or back of a single-sided table specified by components.

Original Crinion privacy screens are 12"H or 19"H (41" or 48" horizons) and mount to a standard top channel only.

Morrison Network fabric screens (15"H or 22"H) can also be mounted to the standard top channel with Crinion Open Table mast kit.

Accessories and storage

All Crinion worksurfaces accept clamp base KnollExtra flat screen monitor arms and task lights at any point except behind the hinged power access door. Worksurfaces also accept suspended accessories like adjustable keyboard supports, BackPack center file or keyboard drawers, or CPU holders. Beam location under most tables prevents pedestals deeper than 20" underneath. However 36"D tops can be planned on 30"D table bases to create additional kneespace depth and room for 24"D pedestals.

Crinion Open Table file tops are available for 27"H Calibre files positioned perpendicular to the table to act as returns. Tapered front and back edges assure consistent detail with tapered worksurface edges. File tops are also available for pairs of files and back to back files.

Finishes

L - Laminate

Matching edge band unless noted otherwise

- 117 Soft Grey
- 118 Bright White
- 114 Folkstone Grey
- 111 Jet Black
- 119 Pumice
- 121 Micro Grey with 114 Folkstone grey edge band
- 122 Brushed Sand with 119 Pumice edge band
- 123 Brushed Grey with 128 Fog edge band
- 128 Fog
- 129 Micro Sand with 119 Pumice edge band

Woodgrain Laminates

- 125 Natural Maple
 - 126 Natural Cherry
 - 124 Medium Cherry
 - 127 Walnut
 - 139 Light Ash
 - 140 Warm Ash
 - 141 Whitened Ash
 - 142 Grey Ash
 - 143 Classic Oak
 - 144 Graphite Pear
 - 145 Zebra
- Woodgrain laminates not available on all components.*

V1 - Techwood Veneer

- Y316 Maple
- Y319 Cherry
- Y323 Medium Walnut
- Y326 Dark Mahogany
- Y329 Medium Oak
- Y341 Wenge
- Y342 Medium Teak
- Y344 Espresso
- Y811 Natural
- Y821 Blond Maple
- Y831 Light Cherry
- Y851 Black Oak
- Y881 Light Walnut
- Y882 Dove Grey

V2 – Natural Veneer/Premium Techwood Veneer

- V312 Bronze Cherry
 - V316 Maple
 - V319 Medium Cherry
 - V411 Light Walnut
 - V412 Natural Cherry
 - V413 Sand Oak
 - V414 Natural Oak
 - V415 Peacock Green Walnut
 - V417 Old English Walnut
 - V433 Light Fawn Cherry
 - V436 Medium Brown Cherry
- (above V2's are flat cut)*

- V421 Chalk Oak
 - V423 Light Oak
- (above V2 Oaks are rift cut)*

- V439 Straight Anigre
 - V440 Natural Hemock
- (above V2's are quarter cut)*

- Y841 Ebony
 - Y861 Grigio
- (above Premium Techwoods are straight grain)*

V3 – Natural Exotic veneer

- V512 Figured Anigre
 - V514 Makore
 - V515 Figured Sycamore
 - V517 Sapele
 - V518 Natural Chestnut
- (all remaining V3s are quarter cut)*

Paint

- P1**
- 111 Jet Black
 - 112 Brown
 - 113 Dark Grey
 - 114 Folkstone Grey
 - 115 Medium Grey
 - 116 Sandstone
 - 117 Soft Grey
- P2**
- 611 Beige Mist Metallic
 - 612 Medium Metallic Grey

P3

- 613 Silver
- 118 Bright White

Anodized

- AA Anodized Aluminum

Glass

- TEMP Clear Tempered
- GL13 Powder

Acrylic

- O Opal
- T Translucent

Architectural

- GL13 Powder

Fabric Options

- Grade 10*
- Annex (W1360)
 - Beacon (W1597)
 - Broadcloth II (W1619)
 - Circuit W1754
 - Element (W1077)
 - Foundation (W351)
 - Growth Spurt (W692)
 - Skylark (W1718)
 - Symbolic Detail (W693)
 - Tailor Made II (W1610)
 - Versatility (W432)

Fabric Options

- Grade 20*
- Bauhaus Block (W296A)
 - Circle Line (W1146)
 - Criss Cross (W305)
 - Logic (W1318)
 - Mainframe (W1783)
 - Newmatic II (W1620)
 - Photon II (W1695)
 - Reflect (W884)
 - Resolution (W280)
 - Weave Three (W298)

Grade 30

- Basket Draft (W249)
- Flow (W565)
- Harmony (W232)
- Match Point (W1145)
- Micro (W465)
- Relay (W1020)

Grade 40

- Amplify (W1215)
- Bandwidth (W1219)
- Ornament (W1078)
- Spellbound (W1464)

Grade 45

- Macro (W544)
- Mezzo (W543)

Grade 50

- Presto (K1000)

Grade 55

- Ransom (K1298)
- Transition (W816)

Customers Own Material

Prices for panels that are to be manufactured with a customer supplied fabric will follow Grade 10 panel pricing. COM fabrics are subject to a testing charge prior to acceptance for use on panels. Panels bearing COM fabrics are subject to extended leadtimes. It is the responsibility of the customer's purchasing agent to ensure COM fabric is supplied for testing and manufacturing. Delays in receiving COM fabric for manufacturing will result in rescheduled delivery dates.

Mixed Finish work surfaces:

To order mixed finishes, enter four digit finish code as follows:

Use 2 digit prefix to indicate surface finish (laminate)

- 11 Jet Black
- 14 Folkstone Grey
- 17 Soft Grey
- 18 Bright White
- 19 Pumice
- 21 Micro Grey
- 22 Brushed Sand
- 23 Brushed Grey
- 28 Fog
- 29 Micro Sand

Use 2 digit suffix to indicate edge finish (wood)

- 16 for V316, Y316
- Y9 for Y319
- Y3 for Y323
- 26 for Y326
- 27 for Y327
- 29 for Y329
- 43 for V433
- 45 for V415
- 46 for V436
- 47 for V417
- 48 for V418
- 52 for V512
- 54 for V514
- 55 for V515
- 57 for V517
- 61 for V411
- 71 for V421
- 73 for V423
- 75 for V425
- 77 for V427

Example:

For a Micro Grey laminate surface with Bronzed Cherry edge, enter finish code 2112

For a Jet Black laminate surface with Light Maple edge, enter finish code 1116

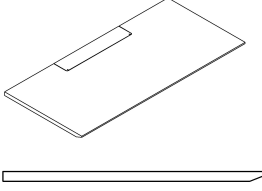
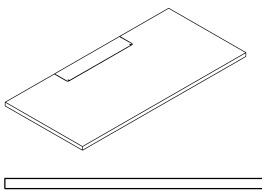
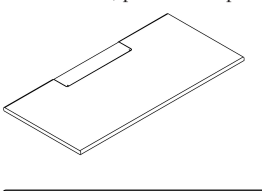
description	nominal depth	w	d	h	pattern number	L	M	V1	V2	V3
Worksurface, tapered edge 	24"	48"	22"	1 1/4"	XTTK4824A (L/M/1/2/3) () ()	\$847.	\$992.	\$992.	\$1,090.	\$1,322.
	24"	60"	22"	1 1/4"	XTTK6024A (L/M/1/2/3) () ()	878.	1,088.	1,088.	1,200.	1,465.
	24"	72"	22"	1 1/4"	XTTK7224A (L/M/1/2/3) () ()	939.	1,149.	1,149.	1,275.	1,564.
	24"	96"	22"	1 1/4"	XTTK9624A (L/M/1/2/3) () ()	1,049.	1,299.	1,299.	1,449.	1,790.
	30"	48"	28"	1 1/4"	XTTK4830A (L/M/1/2/3) () ()	860.	1,076.	1,076.	1,191.	1,451.
	30"	60"	28"	1 1/4"	XTTK6030A (L/M/1/2/3) () ()	907.	1,166.	1,166.	1,294.	1,584.
	30"	72"	28"	1 1/4"	XTTK7230A (L/M/1/2/3) () ()	972.	1,207.	1,207.	1,340.	1,646.
	30"	96"	28"	1 1/4"	XTTK9630A (L/M/1/2/3) () ()	1,088.	1,368.	1,368.	1,525.	1,887.
	36"	48"	34"	1 1/4"	XTTK4836A (L/M/1/2/3) () ()	902.	1,173.	1,173.	1,306.	1,602.
	36"	60"	34"	1 1/4"	XTTK6036A (L/M/1/2/3) () ()	929.	1,258.	1,258.	1,395.	1,716.
	36"	72"	34"	1 1/4"	XTTK7236A (L/M/1/2/3) () ()	1,015.	1,272.	1,272.	1,410.	1,736.
	36"	96"	34"	1 1/4"	XTTK9636A (L/M/1/2/3) () ()	1,157.	1,440.	1,440.	1,606.	1,993.
	Worksurface, veneer square edge 	24"	48"	22"	1 1/4"	XTTS4824A (1/2/3) () ()	n/a	n/a	808.	891.
24"		60"	22"	1 1/4"	XTTS6024A (1/2/3) () ()	n/a	n/a	848.	932.	1,058.
24"		72"	22"	1 1/4"	XTTS7224A (1/2/3) () ()	n/a	n/a	891.	974.	1,114.
24"		96"	22"	1 1/4"	XTTS9624A (1/2/3) () ()	n/a	n/a	959.	1,043.	1,210.
30"		48"	28"	1 1/4"	XTTS4830A (1/2/3) () ()	n/a	n/a	932.	1,016.	1,154.
30"		60"	28"	1 1/4"	XTTS6030A (1/2/3) () ()	n/a	n/a	959.	1,050.	1,211.
30"		72"	28"	1 1/4"	XTTS7230A (1/2/3) () ()	n/a	n/a	988.	1,087.	1,321.
30"		96"	28"	1 1/4"	XTTS9630A (1/2/3) () ()	n/a	n/a	1,043.	1,154.	1,503.
36"		48"	34"	1 1/4"	XTTS4836A (1/2/3) () ()	n/a	n/a	1,016.	1,119.	1,295.
36"		60"	34"	1 1/4"	XTTS6036A (1/2/3) () ()	n/a	n/a	1,058.	1,162.	1,327.
36"		72"	34"	1 1/4"	XTTS7236A (1/2/3) () ()	n/a	n/a	1,099.	1,227.	1,453.
36"		96"	34"	1 1/4"	XTTS9636A (1/2/3) () ()	n/a	n/a	1,183.	1,349.	1,682.
Worksurface, postformed plastic 		24"	48"	22"	1 1/4"	XTPP4824A (L) () ()	616.	n/a	n/a	n/a
	24"	60"	22"	1 1/4"	XTPP6024A (L) () ()	705.	n/a	n/a	n/a	n/a
	24"	72"	22"	1 1/4"	XTPP7224A (L) () ()	774.	n/a	n/a	n/a	n/a
	24"	96"	22"	1 1/4"	XTPP9624A (L) () ()	849.	n/a	n/a	n/a	n/a
	30"	48"	28"	1 1/4"	XTPP4830A (L) () ()	644.	n/a	n/a	n/a	n/a
	30"	60"	28"	1 1/4"	XTPP6030A (L) () ()	739.	n/a	n/a	n/a	n/a
	30"	72"	28"	1 1/4"	XTPP7230A (L) () ()	816.	n/a	n/a	n/a	n/a
	30"	96"	28"	1 1/4"	XTPP9630A (L) () ()	905.	n/a	n/a	n/a	n/a
	36"	48"	34"	1 1/4"	XTPP4836A (L) () ()	681.	n/a	n/a	n/a	n/a
	36"	60"	34"	1 1/4"	XTPP6036A (L) () ()	816.	n/a	n/a	n/a	n/a
	36"	72"	34"	1 1/4"	XTPP7236A (L) () ()	881.	n/a	n/a	n/a	n/a
	36"	96"	34"	1 1/4"	XTPP9636A (L) () ()	981.	n/a	n/a	n/a	n/a

Order Code	Specifications	Application Notes
Example: XTPP6030AL 118 118	Worksurfaces are 1 1/4" thick with square edge or tapered edge option tapering to 1/2" thick front edge.	Crinion 30"D worksurfaces correspond in width to table bases, which are specified separately.
XT Crinion Open Table		48"W worksurfaces plan on 12' wide or 20' wide bases. 60"W worksurfaces plan on 5', 10', 15' and 20' wide bases. 72" W worksurfaces plan on 6', 12' and 18' wide bases.
T Worksurface		Worksurfaces with hinged power access enable access to suspended modular raceway.
P Postformed plastic	1. Specify finish group: L - Laminate M - Laminate/veneer edge	Power access door is 24" wide, 5" deep, centered at back edge of worksurface.
60 Width	1 - Veneer group 1 2 - Veneer group 2 3 - Veneer group 3	Continous 1/2" wire drop accommodates clamp-on flat screen monitor arm or most power cords plugs.
30 Depth	2. Specify worksurface finish.	Actual worksurface depth is 22.35", 28.35" or 34.35".
A With center hinged power access	3. Specify hinged access cover finish.	
L Finish Type	AA anodized aluminum and all P1,P2 and P3 paint finishes are available except 613 Silver.	
118 Work Surface finish		
118 Access door finish		

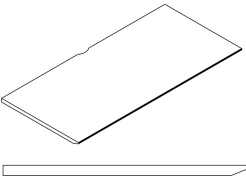
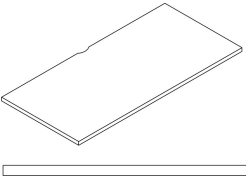
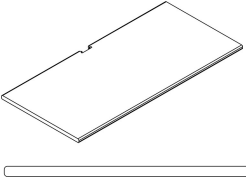
description	nominal depth	w	d	h	pattern number	L	M	V1	V2	V3
Worksurface, tapered edge 	24"	48"	22"	1 1/4"	XTTK4824U (L/M/1/2/3) () ()	\$569.	\$715.	\$715.	\$812.	\$1,044.
	24"	60"	22"	1 1/4"	XTTK6024U (L/M/1/2/3) () ()	602.	810.	810.	924.	1,188.
	24"	72"	22"	1 1/4"	XTTK7224U (L/M/1/2/3) () ()	662.	872.	872.	997.	1,286.
	24"	96"	22"	1 1/4"	XTTK9624U (L/M/1/2/3) () ()	772.	1,021.	1,021.	1,173.	1,513.
	30"	48"	28"	1 1/4"	XTTK4830U (L/M/1/2/3) () ()	583.	800.	800.	913.	1,175.
	30"	60"	28"	1 1/4"	XTTK6030U (L/M/1/2/3) () ()	630.	889.	889.	1,016.	1,307.
	30"	72"	28"	1 1/4"	XTTK7230U (L/M/1/2/3) () ()	695.	931.	931.	1,063.	1,368.
	30"	96"	28"	1 1/4"	XTTK9630U (L/M/1/2/3) () ()	810.	1,092.	1,092.	1,248.	1,609.
	36"	48"	34"	1 1/4"	XTTK4836U (L/M/1/2/3) () ()	624.	896.	896.	1,029.	1,325.
	36"	60"	34"	1 1/4"	XTTK6036U (L/M/1/2/3) () ()	651.	981.	981.	1,118.	1,439.
	36"	72"	34"	1 1/4"	XTTK7236U (L/M/1/2/3) () ()	738.	994.	994.	1,134.	1,460.
	36"	96"	34"	1 1/4"	XTTK9636U (L/M/1/2/3) () ()	880.	1,163.	1,163.	1,329.	1,715.
	Worksurface, veneer square edge 	24"	48"	22"	1 1/4"	XTTS4824U (1/2/3) () ()	n/a	n/a	531.	614.
24"		60"	22"	1 1/4"	XTTS6024U (1/2/3) () ()	n/a	n/a	570.	655.	780.
24"		72"	22"	1 1/4"	XTTS7224U (1/2/3) () ()	n/a	n/a	614.	696.	836.
24"		96"	22"	1 1/4"	XTTS9624U (1/2/3) () ()	n/a	n/a	683.	767.	933.
30"		48"	28"	1 1/4"	XTTS4830U (1/2/3) () ()	n/a	n/a	655.	739.	877.
30"		60"	28"	1 1/4"	XTTS6030U (1/2/3) () ()	n/a	n/a	683.	773.	934.
30"		72"	28"	1 1/4"	XTTS7230U (1/2/3) () ()	n/a	n/a	711.	809.	1,043.
30"		96"	28"	1 1/4"	XTTS9630U (1/2/3) () ()	n/a	n/a	767.	877.	1,226.
36"		48"	34"	1 1/4"	XTTS4836U (1/2/3) () ()	n/a	n/a	739.	843.	1,017.
36"		60"	34"	1 1/4"	XTTS6036U (1/2/3) () ()	n/a	n/a	780.	885.	1,050.
36"		72"	34"	1 1/4"	XTTS7236U (1/2/3) () ()	n/a	n/a	822.	950.	1,176.
36"		96"	34"	1 1/4"	XTTS9636U (1/2/3) () ()	n/a	n/a	906.	1,071.	1,405.
Worksurface, postformed plastic 		24"	48"	22"	1 1/4"	XTPP4824B (L) () ()	339.	n/a	n/a	n/a
	24"	60"	22"	1 1/4"	XTPP6024B (L) () ()	428.	n/a	n/a	n/a	n/a
	24"	72"	22"	1 1/4"	XTPP7224B (L) () ()	497.	n/a	n/a	n/a	n/a
	24"	96"	22"	1 1/4"	XTPP9624B (L) () ()	571.	n/a	n/a	n/a	n/a
	30"	48"	28"	1 1/4"	XTPP4830B (L) () ()	367.	n/a	n/a	n/a	n/a
	30"	60"	28"	1 1/4"	XTPP6030B (L) () ()	461.	n/a	n/a	n/a	n/a
	30"	72"	28"	1 1/4"	XTPP7230B (L) () ()	538.	n/a	n/a	n/a	n/a
	30"	96"	28"	1 1/4"	XTPP9630B (L) () ()	628.	n/a	n/a	n/a	n/a
	36"	48"	34"	1 1/4"	XTPP4836B (L) () ()	403.	n/a	n/a	n/a	n/a
	36"	60"	34"	1 1/4"	XTPP6036B (L) () ()	538.	n/a	n/a	n/a	n/a
	36"	72"	34"	1 1/4"	XTPP7236B (L) () ()	605.	n/a	n/a	n/a	n/a
	36"	96"	34"	1 1/4"	XTPP9636B (L) () ()	703.	n/a	n/a	n/a	n/a

Order Code	Specifications	Application Notes
Example: XTPP6030BL 118 812	Worksurfaces are 1 1/4" thick with square edge or tapered edge option tapering to 1/2" thick front edge.	Crinion 30"D worksurfaces correspond in width to table bases, which are specified separately.
XT Crinion Open Table		48"W worksurfaces plan on 12' wide or 20' wide bases. 60"W worksurfaces plan on 5', 10', 15' and 20' wide bases. 72" W worksurfaces plan on 6', 12' and 18' wide bases.
T Worksurface	1. Specify finish group: L - Laminate M - Laminate/veneer edge	Edge grommet accommodates most power cord plugs up to 1" deep.
P Postformed plastic	1 - Veneer group 1 2 - Veneer group 2 3 - Veneer group 3	
60 Width	2. Specify worksurface finish.	
30 Depth	3. Specify grommet color: 812 - Easy grey 111 - Black	
B With edge grommet		
L Finish type		
118 Surface finish		
812 Grommet finish		

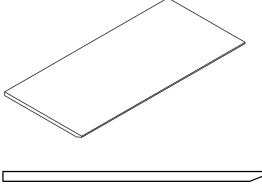
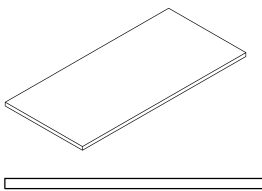
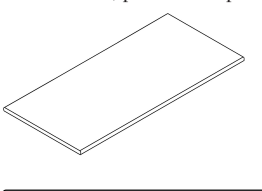
description	nominal depth	w	d	h	pattern number	L	M	V1	V2	V3
Worksurface, tapered edge 	24"	48"	22"	1 1/4"	XTTK4824C (L/M/1/2/3) ()	\$527.	\$672.	\$672.	\$770.	\$1,002.
	24"	60"	22"	1 1/4"	XTTK6024C (L/M/1/2/3) ()	559.	768.	768.	880.	1,145.
	24"	72"	22"	1 1/4"	XTTK7224C (L/M/1/2/3) ()	619.	829.	829.	955.	1,244.
	24"	96"	22"	1 1/4"	XTTK9624C (L/M/1/2/3) ()	729.	979.	979.	1,130.	1,470.
	30"	48"	28"	1 1/4"	XTTK4830C (L/M/1/2/3) ()	540.	756.	756.	871.	1,132.
	30"	60"	28"	1 1/4"	XTTK6030C (L/M/1/2/3) ()	587.	847.	847.	974.	1,264.
	30"	72"	28"	1 1/4"	XTTK7230C (L/M/1/2/3) ()	652.	888.	888.	1,020.	1,326.
	30"	96"	28"	1 1/4"	XTTK9630C (L/M/1/2/3) ()	768.	1,049.	1,049.	1,205.	1,567.
	36"	48"	34"	1 1/4"	XTTK4836C (L/M/1/2/3) ()	582.	853.	853.	986.	1,282.
	36"	60"	34"	1 1/4"	XTTK6036C (L/M/1/2/3) ()	609.	938.	938.	1,075.	1,396.
	36"	72"	34"	1 1/4"	XTTK7236C (L/M/1/2/3) ()	695.	952.	952.	1,091.	1,417.
	36"	96"	34"	1 1/4"	XTTK9636C (L/M/1/2/3) ()	837.	1,120.	1,120.	1,286.	1,673.
	Worksurface, veneer square edge 	24"	48"	22"	1 1/4"	XTTS4824C (1/2/3) ()	n/a	n/a	488.	571.
24"		60"	22"	1 1/4"	XTTS6024C (1/2/3) ()	n/a	n/a	528.	612.	738.
24"		72"	22"	1 1/4"	XTTS7224C (1/2/3) ()	n/a	n/a	571.	654.	794.
24"		96"	22"	1 1/4"	XTTS9624C (1/2/3) ()	n/a	n/a	640.	724.	890.
30"		48"	28"	1 1/4"	XTTS4830C (1/2/3) ()	n/a	n/a	612.	696.	834.
30"		60"	28"	1 1/4"	XTTS6030C (1/2/3) ()	n/a	n/a	640.	730.	891.
30"		72"	28"	1 1/4"	XTTS7230C (1/2/3) ()	n/a	n/a	668.	767.	1,001.
30"		96"	28"	1 1/4"	XTTS9630C (1/2/3) ()	n/a	n/a	724.	834.	1,183.
36"		48"	34"	1 1/4"	XTTS4836C (1/2/3) ()	n/a	n/a	696.	799.	975.
36"		60"	34"	1 1/4"	XTTS6036C (1/2/3) ()	n/a	n/a	738.	843.	1,008.
36"		72"	34"	1 1/4"	XTTS7236C (1/2/3) ()	n/a	n/a	779.	907.	1,134.
36"		96"	34"	1 1/4"	XTTS9636C (1/2/3) ()	n/a	n/a	863.	1,029.	1,362.
Worksurface, postformed plastic 		24"	48"	22"	1 1/4"	XTPP4824C (L) ()	296.	n/a	n/a	n/a
	24"	60"	22"	1 1/4"	XTPP6024C (L) ()	385.	n/a	n/a	n/a	n/a
	24"	72"	22"	1 1/4"	XTPP7224C (L) ()	454.	n/a	n/a	n/a	n/a
	24"	96"	22"	1 1/4"	XTPP9624C (L) ()	529.	n/a	n/a	n/a	n/a
	30"	48"	28"	1 1/4"	XTPP4830C (L) ()	324.	n/a	n/a	n/a	n/a
	30"	60"	28"	1 1/4"	XTPP6030C (L) ()	419.	n/a	n/a	n/a	n/a
	30"	72"	28"	1 1/4"	XTPP7230C (L) ()	496.	n/a	n/a	n/a	n/a
	30"	96"	28"	1 1/4"	XTPP9630C (L) ()	585.	n/a	n/a	n/a	n/a
	36"	48"	34"	1 1/4"	XTPP4836C (L) ()	361.	n/a	n/a	n/a	n/a
	36"	60"	34"	1 1/4"	XTPP6036C (L) ()	496.	n/a	n/a	n/a	n/a
	36"	72"	34"	1 1/4"	XTPP7236C (L) ()	562.	n/a	n/a	n/a	n/a
	36"	96"	34"	1 1/4"	XTPP9636C (L) ()	661.	n/a	n/a	n/a	n/a

Order Code	Specifications
Example: XTPP6030CL 118	
XT Crinion Open Table	
T Worksurface	
P Postformed plastic	
60 Width	
30 Depth	
C With cord drop	
L Finish type	
118 Surface	

Worksurfaces are 1 1/4" thick with square edge or tapered edge option tapering to 1/2" thick front edge.

Specify finishes:
 L - Laminate
 M - Laminate/veneer edge
 1 - Veneer group 1
 2 - Veneer group 2
 3 - Veneer group 3

Application Notes

Crinion 30"D worksurfaces correspond in width to table bases, which are specified separately. 48"W worksurfaces plan on 12' wide or 20' wide bases. 60"W worksurfaces plan on 5', 10', 15' and 20' wide bases. 72" W worksurfaces plan on 6', 12' and 18' wide bases.

Continuous 1/2" cord drop accommodates clamp-on flat screen monitor arm or most power cords.

Actual worksurface depth is 21.85", 27.85" or 33.85".

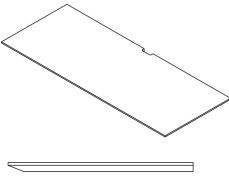
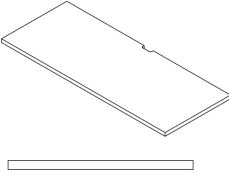
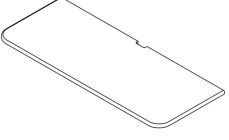
description	nominal depth	w	l	h	pattern number	L	M	V1	V2	V3
End counter, tapered edge 	24"	48"	24"	1 1/4"	XTTK4824E (L/M/1/2/3) ()	\$739.	\$951.	\$951.	\$1,049.	\$1,279.
	24"	60"	24"	1 1/4"	XTTK6024E (L/M/1/2/3) ()	874.	1,046.	1,046.	1,161.	1,424.
	24"	72"	24"	1 1/4"	XTTK7224E (L/M/1/2/3) ()	908.	1,105.	1,105.	1,234.	1,521.
	30"	48"	30"	1 1/4"	XTTK4830E (L/M/1/2/3) ()	827.	1,034.	1,034.	1,150.	1,410.
	30"	60"	30"	1 1/4"	XTTK6030E (L/M/1/2/3) ()	901.	1,124.	1,124.	1,251.	1,543.
	30"	72"	30"	1 1/4"	XTTK7230E (L/M/1/2/3) ()	940.	1,166.	1,166.	1,298.	1,605.
End counter, veneer square edge 	24"	48"	24"	1 1/4"	XTTS4824E (1/2/3) ()	n/a	n/a	488.	571.	684.
	24"	60"	24"	1 1/4"	XTTS6024E (1/2/3) ()	n/a	n/a	528.	612.	738.
	24"	72"	24"	1 1/4"	XTTS7224E (1/2/3) ()	n/a	n/a	571.	654.	794.
	30"	48"	30"	1 1/4"	XTTS4830E (1/2/3) ()	n/a	n/a	612.	696.	834.
	30"	60"	30"	1 1/4"	XTTS6030E (1/2/3) ()	n/a	n/a	640.	730.	891.
	30"	72"	30"	1 1/4"	XTTS7230E (1/2/3) ()	n/a	n/a	668.	767.	1,001.
End counter for postformed plastic 	24"	48"	24"	1 1/4"	XTTP4824E (L) ()	551.	n/a	n/a	n/a	n/a
	24"	60"	24"	1 1/4"	XTTP6024E (L) ()	654.	n/a	n/a	n/a	n/a
	24"	72"	24"	1 1/4"	XTTP7224E (L) ()	737.	n/a	n/a	n/a	n/a
	30"	48"	30"	1 1/4"	XTTP4830E (L) ()	618.	n/a	n/a	n/a	n/a
	30"	60"	30"	1 1/4"	XTTP6030E (L) ()	737.	n/a	n/a	n/a	n/a
	30"	72"	30"	1 1/4"	XTTP7230E (L) ()	880.	n/a	n/a	n/a	n/a

* Note

Order Code	Specifications	Application Notes
Example: XTTP6024EL 118		
XT Crinion Open Table	End counters are 1 1/4" thick with square edge or tapered edge option tapering to 1/2" thick front edge. End counters are tapered front and side edges only.	End counters mount at the ends of dual tables with two end counter cantilever brackets. Specify dual end legs for end counters instead of standard dual end legs (tables with end counters must be specified from components, not assemblies).
T Worksurface		Specify added length of 24" or 30" beyond end leg for end counters.
P Postformed plastic		* Note - End counters for postformed plastic are not available in these finishes:
60 Width	Specify finishes:	121 Micro grey
24 Length	L - Laminate	129 Micro sand
E End counter	M- Laminate/veneer edge	122 Brushed sand
L Finish Type	1 - Veneer group 1	123 Brushed grey
118 Surface	2 - Veneer group 2	
	3 - Veneer group 3	End counters may not be used with end panel kits.

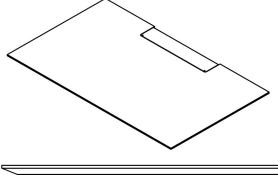
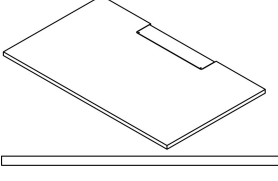
description	nominal depth	w	l	h	pattern no.	L	M	V1	V2	V3
Extended end counter, tapered edge with hinged power access 	36"	48"	36"	1 1/4"	XTTK4836D (L/M/1/2/3) () ()	\$1,227.	\$1,424.	\$1,424.	\$1,552.	\$1,839.
	36"	60"	36"	1 1/4"	XTTK6036D (L/M/1/2/3) () ()	1,259.	1,485.	1,485.	1,616.	1,924.
	36"	72"	36"	1 1/4"	XTTK7236D (L/M/1/2/3) () ()	1,351.	1,599.	1,599.	1,738.	2,079.
Extended end counter, tapered edge with grommet	36"	48"	36"	1 1/4"	XTTK4836E (L/M/1/2/3) ()	908.	1,105.	1,105.	1,234.	1,521.
	36"	60"	36"	1 1/4"	XTTK6036E (L/M/1/2/3) ()	940.	1,166.	1,166.	1,298.	1,605.
	36"	72"	36"	1 1/4"	XTTK7236E (L/M/1/2/3) ()	1,032.	1,280.	1,280.	1,420.	1,760.
Extended end counter, veneer square edge with hinged power access 	36"	48"	36"	1 1/4"	XTTS4836D (1/2/3) () ()	n/a	n/a	862.	941.	1,074.
	36"	60"	36"	1 1/4"	XTTS6036D (1/2/3) () ()	n/a	n/a	987.	1,085.	1,320.
	36"	72"	36"	1 1/4"	XTTS7236D (1/2/3) () ()	n/a	n/a	1,085.	1,188.	1,467.
Extended end counter, veneer square edge with grommet	36"	48"	36"	1 1/4"	XTTS4836E (1/2/3) ()	n/a	n/a	543.	622.	755.
	36"	60"	36"	1 1/4"	XTTS6036E (1/2/3) ()	n/a	n/a	668.	767.	1,001.
	36"	72"	36"	1 1/4"	XTTS7236E (1/2/3) ()	n/a	n/a	767.	869.	1,148.

Order Code	Specifications
Example: XTTP6036DL 118 AA	
XT Crinion Open Table	
T Worksurface	
P Postformed plastic	
60 Width	
36 Length	
D End counter, center hinged power access	
L Finish Type	
118 Surface finish	
AA Access door finish	

Specifications
End counters are 1 1/4" thick with square edge or tapered edge option tapering to 1/2" thick front edge. End counters are tapered front and side edges only.
1. Specify finish group: L - Laminate M - Laminate/veneer edge 1 - Veneer group 1 2 - Veneer group 2 3 - Veneer group 3
2. Specify worksurface finish.
3. Specify hinged access cover finish.

Application Notes
End counters mount at the ends of dual tables with two end counter cantilever brackets. Specify dual end legs for end counters instead of standard dual end legs (tables with end counters must be specified from components, not assemblies).
Specify 48" W for dual 24" tables, 60" W for dual 30" tables and 72" W for dual 36" tables.
End counters may not be used with end panel kits.

Each extended end counter requires base assembly 12" longer than worksurfaces on each side.
* Note - End counters for postformed plastic are not available in these finishes:
121 Micro grey
129 Micro sand
122 Brushed sand
123 Brushed grey

Hinged access covers are available in AA anodized aluminum and all standard paint finishes except 613 Silver.

description	nominal depth	w	l	h	pattern no.	L	M	V1	V2	V3
Extended end counter, postformed plastic with hinged power access	36"	48"	36"	1 1/4"	XTTP4836D (L) () ()	\$1,056.	n/a	n/a	n/a	n/a
	36"	60"	36"	1 1/4"	XTTP6036D (L) () ()	1,199.	n/a	n/a	n/a	n/a
	36"	72"	36"	1 1/4"	XTTP7236D (L) () ()	1,304.	n/a	n/a	n/a	n/a

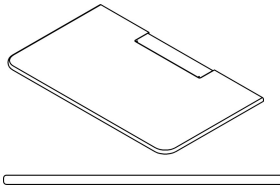

* Note

Extended end counter, postformed plastic with grommet	36"	48"	36"	1 1/4"	XTTP4836E (L) () ()	737.	n/a	n/a	n/a	n/a
	36"	60"	36"	1 1/4"	XTTP6036E (L) () ()	880.	n/a	n/a	n/a	n/a
	36"	72"	36"	1 1/4"	XTTP7236E (L) () ()	985.	n/a	n/a	n/a	n/a

* Note

Order Code	Specifications	Application Notes
Example: XTTP6036DL 118 AA		
XT Crinion Open Table	End counters are 1 1/4" thick with square edge or tapered edge option tapering to 1/2" thick front edge. End counters are tapered front and side edges only. 1. Specify finish group: L - Laminate M - Laminate/veneer edge 1 - Veneer group 1 2 - Veneer group 2 3 - Veneer group 3 2. Specify worksurface finish. 3. Specify hinged access cover finish.	End counters mount at the ends of dual tables with two end counter cantilever brackets. Specify dual end legs for end counters instead of standard dual end legs (tables with end counters must be specified from components, not assemblies). Specify 48" W for dual 24" tables, 60" W for dual 30" tables and 72" W for dual 36" tables. End counters may not be used with end panel kits.
T Worksurface		
P Postformed plastic		
60 Width		
36 Length		
D End counter, center hinged power access		
L Finish Type		
118 Surface finish		
AA Access door finish		

Hinged access covers are available in AA anodized aluminum and all standard paint finishes except 613 Silver.

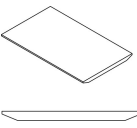
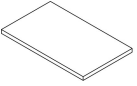
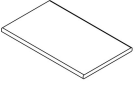
description	w	d	h	pattern number	L	M	V1	V2	V3
File top, tapered edge 	30"	18"	1 1/4"	XTTK3018F (L/M/1/2/3) ()	\$385.	\$654.	\$640.	\$684.	\$988.
	30"	36"	1 1/4"	XTTK3036F (L/M/1/2/3) ()	528.	826.	826.	926.	1,162.
	36"	18"	1 1/4"	XTTK3618F (L/M/1/2/3) ()	401.	668.	654.	690.	1,054.
	36"	36"	1 1/4"	XTTK3636F (L/M/1/2/3) ()	551.	905.	905.	1,013.	1,276.
	42"	18"	1 1/4"	XTTK4218F (L/M/1/2/3) ()	414.	684.	668.	702.	1,118.
	42"	36"	1 1/4"	XTTK4236F (L/M/1/2/3) ()	576.	939.	939.	1,061.	1,338.
	60"	18"	1 1/4"	XTTK6018F (L/M/1/2/3) ()	654.	1,010.	1,010.	1,113.	1,391.
	60"	36"	1 1/4"	XTTK6036F (L/M/1/2/3) ()	708.	1,075.	1,075.	1,215.	1,536.
	72"	18"	1 1/4"	XTTK7218F (L/M/1/2/3) ()	688.	1,044.	1,044.	1,169.	1,464.
	72"	36"	1 1/4"	XTTK7236F (L/M/1/2/3) ()	756.	1,092.	1,092.	1,230.	1,554.
	84"	18"	1 1/4"	XTTK8418F (L/M/1/2/3) ()	743.	1,113.	1,113.	1,252.	1,531.
84"	36"	1 1/4"	XTTK8436F (L/M/1/2/3) ()	808.	1,172.	1,172.	1,335.	1,694.	
File top, veneer square edge 	30"	18"	1 1/4"	XTTS3018F (1/2/3) ()	n/a	n/a	286.	314.	521.
	36"	18"	1 1/4"	XTTS3618F (1/2/3) ()	n/a	n/a	293.	320.	561.
	42"	18"	1 1/4"	XTTS4218F (1/2/3) ()	n/a	n/a	299.	328.	607.
File top, postformed plastic 	30"	18"	1 1/4"	XTTP3018F (L) ()	262.	n/a	n/a	n/a	n/a
	36"	18"	1 1/4"	XTTP3618F (L) ()	276.	n/a	n/a	n/a	n/a
	42"	18"	1 1/4"	XTTP4218F (L) ()	289.	n/a	n/a	n/a	n/a

Order Code	
Example: XTTP4218FL 118	
XT	Crinion Open Table
T	Worksurface
P	Postformed
42	Width
18	Depth
F	File top
L	Finish type
118	Surface

Specifications	
File tops are 1 1/4" thick with square edge or tapered edge option tapering to 1/2" thick front edge. Tapered edge file tops are tapered front and back edges only.	
Specify finishes:	
L - Laminate	
M - Laminate/veneer edge	
1 - Veneer group 1	
2 - Veneer group 2	
3 - Veneer group 3	

Application Notes	
File tops correspond to 30", 36" or 42"W lateral files. File tops on 2 high Calibre files positioned perpendicular to the Crinion Open Table serve as a worksurface return.	

Complete base assemblies fixed height 24" D dual

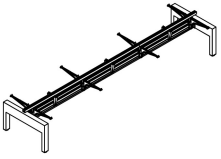
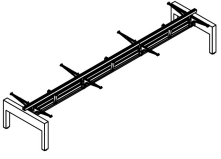
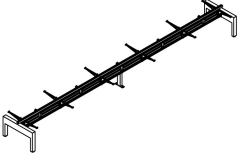
description	nominal	w	d	h	pattern number	P1/P2	P3
	10' dual	120"	44"	28 1/2"	XTB1 BAS 24D10CF () ()	\$9,888.	\$10,150.
	12' dual	144"	44"	28 1/2"	XTB1 BAS 24D12CF () ()	10,302.	10,566.
	15' dual	180"	44"	28 1/2"	XTB1 BAS 24D15CF () ()	11,922.	12,193.
	10' + 5' dual	180"	44"	28 1/2"	XTB1 BAS 24D15SF () ()	12,789.	13,064.
	12' + 6' dual	216"	44"	28 1/2"	XTB1 BAS 24D18SF () ()	14,112.	14,385.
	10' + 10' dual	240"	44"	28 1/2"	XTB1 BAS 24D20SF () ()	15,424.	15,706.
	12' + 12' dual	288"	44"	28 1/2"	XTB1 BAS 24D24SF () ()	16,252.	16,535.
	15' + 10' dual	300"	44"	28 1/2"	XTB1 BAS 24D25SF () ()	17,458.	17,750.

Order Code

Example:	XTB1BAS24D10CF 613 AA
XT	Crinion Open Table
B1	Base components
BAS	Assembly
24	Depth
D	Dual
10	Width
C	Continuous
F	Fixed height
613	Base finish
AA	Top channel finish

Specifications

Base assemblies include end legs, beams, trusses, cantilever brackets, channels and end caps.

Fixed height base assemblies have shared cantilever brackets for adjacent worksurfaces and midspan support brackets for every worksurface.

- Specify painted finish for base assembly.
For leg and cantilever brackets specify one paint finish for all.
- Specify finish for top channel.
AA anodized aluminum and all paint finishes are available except 613 Silver.
Beams are anodized aluminum only.

Application Notes



Complete base assemblies include all base components necessary to support worksurfaces. Specify screens, power components and cable trays separately. Base assemblies include end legs, intermediate leg (where required), beams, trusses, cantilever brackets, mid span support brackets, top channel and end caps.

No table on this page has beams longer than 15'.

Base assemblies correspond to:
10': four 60"x24"D worksurfaces
12': four 72"x24"D worksurfaces
15': six 60"x24"D worksurfaces
18': six 72"x24"D worksurfaces
20': eight 60"x24"D worksurfaces
24': eight 72"x24"D worksurfaces
25': ten 60"x24"D worksurfaces

Complete base assemblies fixed height 24" D single sided

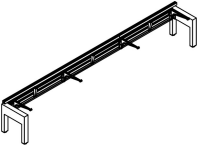
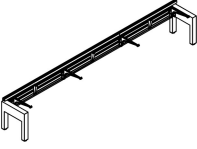
AutoStrada

description	nominal	w	d	h	pattern number	P1/P2	P3
 Base assembly, continuous	10' single sided	120"	24"	28 1/2"	XTB1 BAS 24S10CF () ()	\$8,897.	\$9,150.
	12' single sided	144"	24"	28 1/2"	XTB1 BAS 24S12CF () ()	9,312.	9,563.
	15' single sided	180"	24"	28 1/2"	XTB1 BAS 24S15CF () ()	10,563.	10,819.
 Base assembly, segmented	10' + 5' single sided	180"	24"	28 1/2"	XTB1 BAS 24S15SF () ()	11,431.	11,687.
 Base assembly, with intermediate leg	12' + 6' single sided	216"	24"	28 1/2"	XTB1 BAS 24S18SF () ()	12,751.	13,009.
	10' + 10' single sided	240"	24"	28 1/2"	XTB1 BAS 24S20SF () ()	13,695.	13,957.
	12' + 12' single sided	288"	24"	28 1/2"	XTB1 BAS 24S24SF () ()	14,523.	14,785.
	15' + 10' single sided	300"	24"	28 1/2"	XTB1 BAS 24S25SF () ()	15,359.	15,627.

Order Code

Example:	XTB1BAS24S10CF 613 118
XT	Crinion Open Table
B1	Base components
BAS	Assembly
24	Depth
S	Single
10	Width
C	Continuous
F	Fixed height
613	Base finish
118	Top channel finish

Specifications

Base assemblies include end legs, beams, trusses, cantilever brackets, channels and end caps.

Fixed height base assemblies have shared cantilever brackets for adjacent worksurfaces and midspan support brackets for every worksurface.

- Specify base finish for base assembly.
For legs and cantilever brackets specify one paint finish for all.
- Specify top channel finish.
AA anodized aluminum and all paint finishes are available except 613 Silver.
Beams are anodized aluminum only.

Application Notes

Complete base assemblies include all base components necessary to support worksurfaces. Specify screens, power components and cable trays separately. Base assemblies include end legs, intermediate leg (where required), beams, trusses, cantilever brackets, mid span support brackets, top channel and end caps.

No table on this page has beams longer than 15'.

Base assemblies correspond to:
 10': two 60"x24"D worksurfaces
 12': two 72"x24"D worksurfaces
 15': three 60"x24"D worksurfaces
 18': three 72"x24"D worksurfaces
 20': four 60"x24"D worksurfaces
 24': four 72"x24"D worksurfaces
 25': five 60"x24"D worksurfaces

Complete base assemblies fixed height 30" D dual

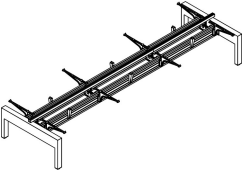
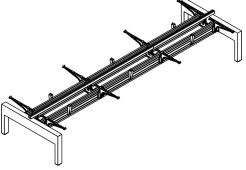
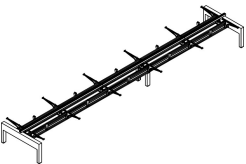
description	nominal	w	d	h	pattern number	P1/P2	P3
	10' dual	120"	54"	28 1/2"	XTB1 BAS 30D10CF () ()	\$11,768.	\$12,101.
	12' dual	144"	54"	28 1/2"	XTB1 BAS 30D12CF () ()	12,248.	12,580.
	15' dual	180"	54"	28 1/2"	XTB1 BAS 30D15CF () ()	14,257.	14,626.
	10' + 5' dual	180"	54"	28 1/2"	XTB1 BAS 30D15SF () ()	15,458.	15,827.
	12' + 6' dual	216"	54"	28 1/2"	XTB1 BAS 30D18SF () ()	17,128.	17,552.
	10' + 10' dual	240"	54"	28 1/2"	XTB1 BAS 30D20SF () ()	19,098.	19,554.
	12' + 12' dual	288"	54"	28 1/2"	XTB1 BAS 30D24CF () ()	20,059.	20,515.
	15' + 10' dual	300"	54"	28 1/2"	XTB1 BAS 30D25CF () ()	21,586.	22,077.

Order Code

Example:	XTB1BAS30D18SF 613 111
XT	Crinion Open Table
B1	Base components
BAS	Assembly
30	Depth
D	Dual
18	Width
S	Segmented
F	Fixed height
613	Base finish
111	Top channel finish

Specifications

Base assemblies include end legs, beams, trusses, cantilever brackets, channels and end caps.

Fixed height base assemblies have shared cantilever brackets for adjacent worksurfaces and midspan support brackets for every worksurface.

- Specify base finish for base assembly.
For legs and cantilever brackets specify one paint finish for all.
- Specify top channel finish.
AA anodized aluminum and all paint finishes are available except 613 Silver.
Beams are anodized aluminum only.

Application Notes



Complete base assemblies include all base components necessary to support worksurfaces. Specify screens, power components and cable trays separately. Base assemblies include end legs, intermediate leg (where required), beams, trusses, cantilever brackets, mid span support brackets, top channel and end caps.

No table on this page has beams longer than 15'.

Base assemblies correspond to:
 10': four 60"x30"D worksurfaces
 12': four 72"x30"D worksurfaces
 15': six 60"x30"D worksurfaces
 18': six 72"x30"D worksurfaces
 20': eight 60"x30"D worksurfaces
 24': eight 72"x30"D worksurfaces
 25': ten 60"x30"D worksurfaces

Complete base assemblies fixed height 30" D single sided

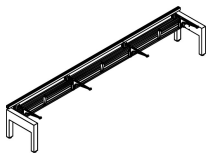
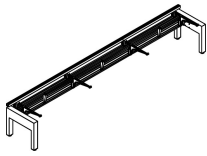
AutoStrada

description	nominal	w	d	h	pattern number	P1/P2	P3
 Base assembly, continuous	10' single sided	120"	28 ³ / ₄ "	28 ¹ / ₂ "	XTB1 BAS 30S10CF () ()	\$10,358.	\$10,646.
	12' single sided	144"	28 ³ / ₄ "	28 ¹ / ₂ "	XTB1 BAS 30S12CF () ()	10,837.	11,124.
	15' single sided	180"	28 ³ / ₄ "	28 ¹ / ₂ "	XTB1 BAS 30S15CF () ()	12,330.	12,635.
 Base assembly, segmented	10' + 5' single sided	180"	28 ³ / ₄ "	28 ¹ / ₂ "	XTB1 BAS 30S15SF () ()	11,529.	11,833.
 Base assembly, with intermediate leg	12' + 6' single sided	216"	28 ³ / ₄ "	28 ¹ / ₂ "	XTB1 BAS 30S18SF () ()	12,518.	12,821.
	10' + 10' single sided	240"	28 ³ / ₄ "	28 ¹ / ₂ "	XTB1 BAS 30S20SF () ()	14,235.	14,558.
	12' + 12' single sided	288"	28 ³ / ₄ "	28 ¹ / ₂ "	XTB1 BAS 30S24SF () ()	17,201.	17,523.
	15' + 10' single sided	300"	28 ³ / ₄ "	28 ¹ / ₂ "	XTB1 BAS 30S25SF () ()	18,213.	18,551.

Order Code

Example:	XTB1BAS30S15CF 613 115
XT	Crinion Open Table
B1	Base components
BAS	Assembly
30	Depth
S	Single
15	Width
C	Continuous
F	Fixed height
613	Base finish
115	Top channel finish

Specifications

Base assemblies include end legs, beams, trusses, cantilever brackets, channels and end caps.

Fixed height base assemblies have shared cantilever brackets for adjacent worksurfaces and midspan support brackets for every worksurface.

- Specify base finish for base assembly.
For legs and cantilever brackets specify one paint finish for all.
- Specify top channel finish.
AA anodized aluminum and all paint finishes are available except 613 Silver.
Beams are anodized aluminum only.

Application Notes

Complete base assemblies include all base components necessary to support worksurfaces. Specify screens, power components and cable trays separately. Base assemblies include end legs, intermediate leg (where required), beams, trusses, cantilever brackets, mid span support brackets, top channel and end caps.

No table on this page has beams longer than 15'.

Base assemblies correspond to:
 10': two 60"x30"D worksurfaces
 12': two 72"x30"D worksurfaces
 15': three 60"x30"D worksurfaces
 18': three 72"x30"D worksurfaces
 20': four 60"x30"D worksurfaces
 24': four 72"x30"D worksurfaces
 25': five 60"x30"D worksurfaces

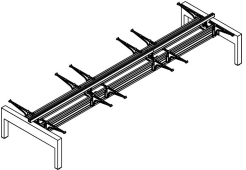
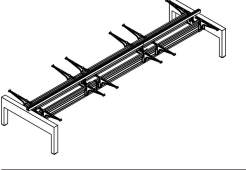
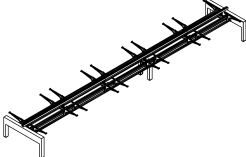

Complete base assemblies adjustable height 30" D dual

AutoStrada

description	nominal	w	d	h	pattern number	P1/P2	P3
 Base assembly, continuous	10' dual	120"	54"	28 1/2"	XTB1 BAS 30D10CA () ()	\$11,941.	\$12,288.
	12' dual	144"	54"	28 1/2"	XTB1 BAS 30D12CA () ()	12,422.	12,768.
	15' dual	180"	54"	28 1/2"	XTB1 BAS 30D15CA () ()	14,759.	15,159.
 Base assembly, segmented	10' + 5' dual	180"	54"	28 1/2"	XTB1 BAS 30D15SA () ()	15,960.	16,362.
 Base assembly, with intermediate leg	12' + 6' dual	216"	54"	28 1/2"	XTB1 BAS 30D18SA () ()	17,631.	18,086.
	10' + 10' dual	240"	54"	28 1/2"	XTB1 BAS 30D20SA () ()	19,927.	20,435.
	12' + 12' dual	288"	54"	28 1/2"	XTB1 BAS 30D24CA () ()	20,890.	21,397.
	15' + 10' dual	300"	54"	28 1/2"	XTB1 BAS 30D25CA () ()	22,745.	23,307.

Order Code	Specifications	Application Notes
Example: XTB1BAS30D18SA 613 118	Base assemblies include end legs, beams, trusses, cantilever brackets, channels and end caps.	Complete base assemblies include all base components necessary to support worksurfaces. Specify screens, power components and cable trays separately. Base assemblies include end legs, intermediate leg (where required), beams, trusses, cantilever brackets, top channel and end caps.
XT Crinion Open Table	1. Specify base finish for base assembly.	Base assemblies correspond to: 10': four 60"x30"D worksurfaces 12': four 72"x30"D worksurfaces 15': six 60"x30"D worksurfaces 18': six 72"x30"D worksurfaces 20': eight 60"x30"D worksurfaces 24': eight 72"x30"D worksurfaces 25': ten 60"x30"D worksurfaces
B1 Base components	For legs and cantilever brackets specify one paint finish for all.	No table on this page has beams longer than 15'.
BAS Assembly	2. Specify top channel finish.	
30 Depth	AA anodized aluminum and all paint finishes are available except 613 Silver.	
D Dual	Beams are anodized aluminum only.	
18 Width		
S Segmented		
A Adjustable height		
613 Base finish		
118 Top channel finish		

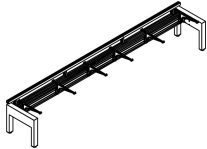
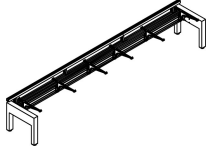
Complete base assemblies adjustable height 30" D single sided

description	nominal	w	d	h	pattern number	P1/P2	P3
 Base assembly, continuous	10' single sided	120"	28 ³ / ₄ "	28 ¹ / ₂ "	XTB1 BAS 30S10CA () ()	\$10,472.	\$10,765.
	12' single sided	144"	28 ³ / ₄ "	28 ¹ / ₂ "	XTB1 BAS 30S12CA () ()	10,952.	11,244.
	15' single sided	180"	28 ³ / ₄ "	28 ¹ / ₂ "	XTB1 BAS 30S15CA () ()	12,622.	12,942.
 Base assembly, segmented	10' +5' single sided	180"	28 ³ / ₄ "	28 ¹ / ₂ "	XTB1 BAS 30S15SA () ()	11,822.	12,142.
 Base assembly, with intermediate leg	12' + 6' single sided	216"	28 ³ / ₄ "	28 ¹ / ₂ "	XTB1 BAS 30S18SA () ()	13,076.	13,397.
	10' + 10' single sided	240"	28 ³ / ₄ "	28 ¹ / ₂ "	XTB1 BAS 30S20SA () ()	14,705.	15,053.
	12' + 12' single sided	288"	28 ³ / ₄ "	28 ¹ / ₂ "	XTB1 BAS 30S24SA () ()	17,670.	18,017.
	15' + 10' single sided	300"	28 ³ / ₄ "	28 ¹ / ₂ "	XTB1 BAS 30S25SA () ()	18,858.	19,232.

Order Code	Specifications	Application Notes
Example: XTB1BAS30S18SA 613 AA	Base assemblies include end legs, beams, trusses, cantilever brackets, channels and end caps.	Complete base assemblies include all base components necessary to support worksurfaces. Specify screens, power components and cable trays separately. Base assemblies include end legs, intermediate leg (where required), beams, trusses, cantilever brackets, top channel and end caps.
XT Crinion Open Table	1. Specify base finish for base assembly.	Base assemblies correspond to: 10': two 60"x30"D worksurfaces 12': two 72"x30"D worksurfaces 15': three 60"x30"D worksurfaces 18': three 72"x30"D worksurfaces 20': four 60"x30"D worksurfaces 24': four 72"x30"D worksurfaces 25': five 60"x30"D worksurfaces
B1 Base components	For legs and cantilever brackets specify one paint finish for all.	No table on this page has beams longer than 15'.
BAS Assembly	2. Specify top channel finish.	
30 Depth	AA anodized aluminum and all paint finishes are available except 613 Silver.	
S Single	Beams are anodized aluminum only.	
18 Width		
S Segmented		
A Adjustable height		
613 Base finish		
AA Top channel finish		

Complete base assemblies fixed height 36" D dual

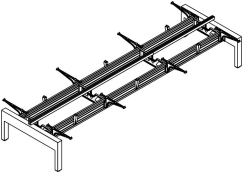
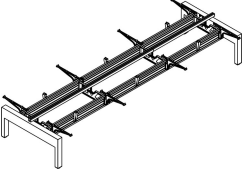
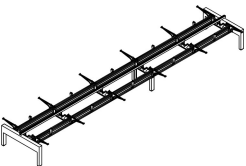
description	nominal	w	h	d	pattern number	P1/P2	P3
 Base assembly, continuous	10' dual	120"	28 1/2"	54"	XTB1 BAS 36D10CF () ()	\$11,927.	\$12,261.
	12' dual	144"	28 1/2"	54"	XTB1 BAS 36D12CF () ()	12,408.	12,741.
	15' dual	180"	28 1/2"	54"	XTB1 BAS 36D15CF () ()	14,469.	14,839.
 Base assembly, segmented	10' + 5' dual	180"	28 1/2"	54"	XTB1 BAS 36D15SF () ()	15,672.	16,042.
 Base assembly, with intermediate leg	12' + 6' dual	216"	28 1/2"	54"	XTB1 BAS 36D18SF () ()	17,342.	17,763.
	10' + 10' dual	240"	28 1/2"	54"	XTB1 BAS 36D20SF () ()	19,364.	19,821.
	12' + 12' dual	288"	28 1/2"	54"	XTB1 BAS 36D24CF () ()	20,324.	20,781.
	15' + 10' dual	300"	28 1/2"	54"	XTB1 BAS 36D25CF () ()	21,906.	22,397.

Order Code

Example:	XTB1BAS36D18SF 613 111
XT	Crinion Open Table
B1	Base components
BAS	Assembly
36	Depth
D	Dual
18	Width
S	Segmented
F	Fixed height
613	Base finish
111	Top channel finish

Specifications

Base assemblies include end legs, beams, trusses, cantilever brackets, channels and end caps.

Fixed height base assemblies have shared cantilever brackets for adjacent worksurfaces and midspan support brackets for every worksurface.

- Specify base finish for base assembly.
For legs and cantilever brackets specify one paint finish for all.
- Specify top channel finish.
AA anodized aluminum and all paint finishes are available except 613 Silver.
Beams are anodized aluminum only.

Application Notes



Complete base assemblies include all base components necessary to support worksurfaces. Specify screens, power components and cable trays separately. Base assemblies include end legs, intermediate leg (where required), beams, trusses, cantilever brackets, mid span support brackets, top channel and end caps.

No table on this page has beams longer than 15'.

Base assemblies correspond to:
 10': four 60"x36"D worksurfaces
 12': four 72"x36"D worksurfaces
 15': six 60"x36"D worksurfaces
 18': six 72"x36"D worksurfaces
 20': eight 60"x36"D worksurfaces
 24': eight 72"x36"D worksurfaces
 25': ten 60"x36"D worksurfaces

Complete base assemblies fixed height 36" D single sided

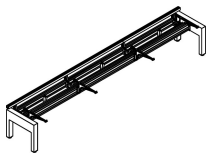
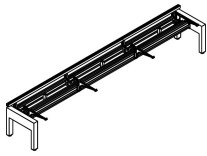
AutoStrada

description	nominal	w	d	h	pattern number	P1/P2	P3
 Base assembly, continuous	10' single sided	120"	28 ³ / ₄ "	28 ¹ / ₂ "	XTB1 BAS 36S10CF () ()	\$10,518.	\$10,805.
	12' single sided	144"	28 ³ / ₄ "	28 ¹ / ₂ "	XTB1 BAS 36S12CF () ()	10,997.	11,284.
	15' single sided	180"	28 ³ / ₄ "	28 ¹ / ₂ "	XTB1 BAS 36S15CF () ()	12,545.	12,848.
 Base assembly, segmented	10' + 5' single sided	180"	28 ³ / ₄ "	28 ¹ / ₂ "	XTB1 BAS 36S15SF () ()	11,742.	12,048.
 Base assembly, with intermediate leg	12' + 6' single sided	216"	28 ³ / ₄ "	28 ¹ / ₂ "	XTB1 BAS 36S18SF () ()	12,998.	13,302.
	10' + 10' single sided	240"	28 ³ / ₄ "	28 ¹ / ₂ "	XTB1 BAS 36S20SF () ()	14,504.	14,825.
	12' + 12' single sided	288"	28 ³ / ₄ "	28 ¹ / ₂ "	XTB1 BAS 36S24SF () ()	17,468.	17,791.
	15' + 10' single sided	300"	28 ³ / ₄ "	28 ¹ / ₂ "	XTB1 BAS 36S25SF () ()	18,532.	18,873.

Order Code

Example:	XTB1BAS36S18SF 613 AA
XT	Crinion Open Table
B1	Base components
BAS	Assembly
36	Depth
S	Single
18	Width
S	Segmented
F	Fixed height
613	Base finish
AA	Top channel finish

Specifications

Base assemblies include end legs, beams, trusses, cantilever brackets, channels and end caps.

Fixed height base assemblies have shared cantilever brackets for adjacent worksurfaces and midspan support brackets for every worksurface.

- Specify base finish for base assembly.
For legs and cantilever brackets specify one paint finish for all.
- Specify top channel finish.
AA anodized aluminum and all paint finishes are available except 613 Silver.
Beams are anodized aluminum only.

Application Notes

Complete base assemblies include all base components necessary to support worksurfaces. Specify screens, power components and cable trays separately. Base assemblies include end legs, intermediate leg (where required), beams, trusses, cantilever brackets, mid span support brackets, top channel and end caps.

No table on this page has beams longer than 15'.

Base assemblies correspond to:
 10': two 60"x36"D worksurfaces
 12': two 72"x36"D worksurfaces
 15': three 60"x36"D worksurfaces
 18': three 72"x36"D worksurfaces
 20': four 60"x36"D worksurfaces
 24': four 72"x36"D worksurfaces
 25': five 60"x36"D worksurfaces

Complete base assemblies adjustable height 36" D dual

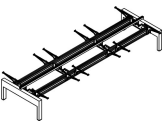
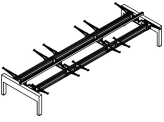
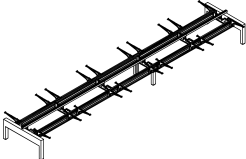

AutoStrada

description	nominal	w	d	h	pattern number	P1/P2	P3
 Base assembly, continuous	10' dual	120"	54"	28 1/2"	XTB1 BAS 36D10CA () ()	\$12,101.	\$12,447.
	12' dual	144"	54"	28 1/2"	XTB1 BAS 36D12CA () ()	12,580.	12,929.
	15' dual	180"	54"	28 1/2"	XTB1 BAS 36D15CA () ()	14,973.	15,374.
 Base assembly, segmented	10' + 5' dual	180"	54"	28 1/2"	XTB1 BAS 36D15SA () ()	16,175.	16,574.
 Base assembly, with intermediate leg	12' + 6' dual	216"	54"	28 1/2"	XTB1 BAS 36D18SA () ()	17,844.	18,298.
	10' + 10' dual	240"	54"	28 1/2"	XTB1 BAS 36D20SA () ()	20,195.	20,702.
	12' + 12' dual	288"	54"	28 1/2"	XTB1 BAS 36D24CA () ()	21,156.	21,663.
	15' + 10' dual	300"	54"	28 1/2"	XTB1 BAS 36D25CA () ()	23,065.	23,628.

Order Code	Specifications	Application Notes
Example: XTB1BAS36D18SA 613 115	Base assemblies include end legs, beams, trusses, cantilever brackets, channels and end caps.	Complete base assemblies include all base components necessary to support worksurfaces. Specify screens, power components and cable trays separately. Base assemblies include end legs, intermediate leg (where required), beams, trusses, cantilever brackets, top channel and end caps.
XT Crinion Open Table		Base assemblies correspond to: 10': four 60"x36"D worksurfaces 12': four 72"x36"D worksurfaces 15': six 60"x36"D worksurfaces 18': six 72"x36"D worksurfaces 20': eight 60"x36"D worksurfaces 24': eight 72"x36"D worksurfaces 25': ten 60"x36"D worksurfaces
B1 Base components	1. Specify base finish for base assembly.	No table on this page has beams longer than 15'.
BAS Assembly	For legs and cantilever brackets specify one paint finish for all.	
36 Depth	2. Specify top channel finish.	
D Dual	AA anodized aluminum and all paint finishes are available except 613 Silver.	
18 Width	Beams are anodized aluminum only.	
S Segmented		
A Adjustable height		
613 Base finish		
115 Top channel finish		

Complete base assemblies adjustable height 36" D single sided

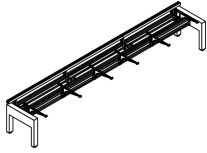
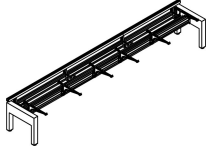
AutoStrada

description	nominal	w	d	h	pattern number	P1/P2	P3
 Base assembly, continuous	10' single sided	120"	28 ³ / ₄ "	28 ¹ / ₂ "	XTB1 BAS 36S10CA () ()	\$10,631.	\$10,927.
	12' single sided	144"	28 ³ / ₄ "	28 ¹ / ₂ "	XTB1 BAS 36S12CA () ()	11,113.	11,406.
	15' single sided	180"	28 ³ / ₄ "	28 ¹ / ₂ "	XTB1 BAS 36S15CA () ()	12,837.	13,157.
 Base assembly, segmented	10' + 5' single sided	180"	28 ³ / ₄ "	28 ¹ / ₂ "	XTB1 BAS 36S15SA () ()	12,035.	12,356.
 Base assembly, with intermediate leg	12' + 6' single sided	216"	28 ³ / ₄ "	28 ¹ / ₂ "	XTB1 BAS 36S18SA () ()	13,290.	13,611.
	10' + 10' single sided	240"	28 ³ / ₄ "	28 ¹ / ₂ "	XTB1 BAS 36S20SA () ()	14,973.	15,319.
	12' + 12' single sided	288"	28 ³ / ₄ "	28 ¹ / ₂ "	XTB1 BAS 36S24SA () ()	17,938.	18,284.
	15' + 10' single sided	300"	28 ³ / ₄ "	28 ¹ / ₂ "	XTB1 BAS 36S25SA () ()	19,181.	19,554.

Order Code	Specifications	Application Notes
Example: XTB1BAS36S18SA 613 AA	Base assemblies include end legs, beams, trusses, cantilever brackets, channels and end caps.	Complete base assemblies include all base components necessary to support worksurfaces. Specify screens, power components and cable trays separately. Base assemblies include end legs, intermediate leg (where required), beams, trusses, cantilever brackets, top channel and end caps.
XT Crinion Open Table	1. Specify base finish for base assembly.	Base assemblies correspond to: 10': two 60"x36"D worksurfaces 12': two 72"x36"D worksurfaces 15': three 60"x36"D worksurfaces 18': three 72"x36"D worksurfaces 20': four 60"x36"D worksurfaces 24': four 72"x36"D worksurfaces 25': five 60"x36"D worksurfaces
B1 Base components	For legs and cantilever brackets specify one paint finish for all.	No table on this page has beams longer than 15'.
BAS Assembly	2. Specify top channel finish.	
36 Depth	AA anodized aluminum and all paint finishes are available except 613 Silver.	
S Single	Beams are anodized aluminum only.	
18 Width		
S Segmented		
A Adjustable height		
613 Base finish		
AA Top channel finish		

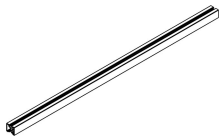
description	nominal	w	d	h	pattern number	list price
	4'	48"	2 1/2"	2"	XTC1 48 ()	\$179.
	5'	60"	2 1/2"	2"	XTC1 60 ()	228.
	6'	72"	2 1/2"	2"	XTC1 72 ()	267.
	8'	96"	2 1/2"	2"	XTC1 96 ()	363.
	10'	120"	2 1/2"	2"	XTC1 120 AA	454.
	12'	144"	2 1/2"	2"	XTC1 144 AA	535.

Top channel end cap			2 1/2"	2"	XTC1 END ()	41.
---------------------	--	--	--------	----	---------------------	-----

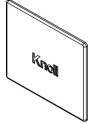

	4'	48"	2 1/2"	2"	XTCA1 48 ()	267.
	5'	60"	2 1/2"	2"	XTCA1 60 ()	322.
	6'	72"	2 1/2"	2"	XTCA1 72 ()	379.
	8'	96"	2 1/2"	2"	XTCA1 96 ()	495.
	10'	120"	2 1/2"	2"	XTCA1 120 AA	602.
	12'	144"	2 1/2"	2"	XTCA1 144 AA	748.

		48"			XTCF 48 ()	34.
		60"			XTCF 60 ()	46.
		72"			XTCF 72 ()	46.

Order Code

Example: XTC1120AA	
XT	Crinion open table
C1	Top channel
120	Width
AA	Finish

Specifications

Top channels are extruded aluminum with natural anodized finish AA or any standard painted finish except 613 Silver.

Top channel end caps are die cast aluminum AA or any standard painted finish except 613 Silver.

Top channel filler is 812 Easy Grey or 111 Black.

Application Notes

Crinion Open Table top channel supports privacy screens and suspended raceway components at any point. Top channel is required at the center of dual tables.

Top channels and end caps are included in complete base assemblies.

Top channels correspond in width to one or two worksurface widths.

Beams for single sided or dual tables 24" D

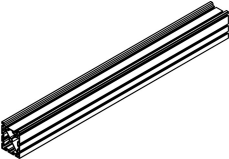
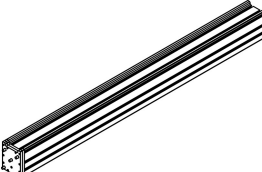
description	nominal	w	d	h	pattern number	list price
Starter beam set for 24" D 	5'	52"	3"	8"	XTB1TB5C	\$1,202.
	6'	64"	3"	8"	XTB1TB6C	1,335.
	8'	88"	3"	8"	XTB1TB8C	1,604.
	10'	112"	3"	8"	XTB1TB10C	1,938.
	12'	136"	3"	8"	XTB1TB12C	2,270.
	15'	172"	3"	8"	XTB1TB15C	2,803.
Extension beam set for 24" D tables 	4'	48"	3"	8"	XTB1TB4E	1,604.
	5'	60"	3"	8"	XTB1TB5E	1,735.
	6'	72"	3"	8"	XTB1TB6E	1,870.
	8'	96"	3"	8"	XTB1TB8E	2,136.
	10'	120"	3"	8"	XTB1TB10E	2,472.
	12'	144"	3"	8"	XTB1TB12E	2,803.
	15'	180"	3"	8"	XTB1TB15E	3,339.

Order Code

Example:	XTB1TB15C
XT	Crinion Open Table
B1	Base components
TB	Dual beam set
15	Width
C	Starter

Specifications

Beams are extruded aluminum with natural anodized finish.

Application Notes

Crinion Open Table bases are assembled from beams, end legs or end panels, intermediate legs and trusses.

Beam sets can be used with either dual or single sided tables. Table bases require one starter beam and extension beam adding up to the length as the sum of the worksurface widths on one side.

Extension beam sets are specified only to add on to starter sets or other extension beams.

Beam sets must be supported by intermediate legs at least every 16'. Intermediate leg must be positioned at beam truss location, where two worksurfaces meet.

Beams for dual tables

30" and 36" D

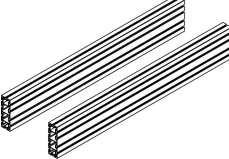
description	nominal	w		h	pattern number	list price
Starter beam set for dual table 30" or 36" (pair of beams) 	5'	52"	3"	8"	XTB1DB5C	\$1,604.
	6'	64"	3"	8"	XTB1DB6C	1,735.
	8'	88"	3"	8"	XTB1DB8C	2,270.
	10'	112"	3"	8"	XTB1DB10C	2,671.
	12'	136"	3"	8"	XTB1DB12C	3,071.
	15'	172"	3"	8"	XTB1DB15C	3,607.

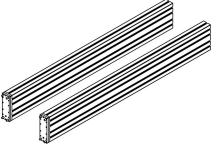
Extension beam set for dual table 30" or 36" (pair of beams) 	4'	48"	3"	8"	XTB1DB4E	2,136.
	5'	60"	3"	8"	XTB1DB5E	2,136.
	6'	72"	3"	8"	XTB1DB6E	2,270.
	8'	96"	3"	8"	XTB1DB8E	2,803.
	10'	120"	3"	8"	XTB1DB10E	3,205.
	12'	144"	3"	8"	XTB1DB12E	3,607.
	15'	180"	3"	8"	XTB1DB15E	4,141.

Order Code

Example: XTB1DB15C
XT Crinion Open Table
B1 Base components
DB Dual beam set
15 Width
C Starter

Specifications

Beams are extruded aluminum with natural anodized finish.

Beam sets are starter or extension.

Extension beam sets are specified only to add on to starter sets or other extension beams.

Application Notes

Crinion Open Table bases are assembled from beams, end legs or end panels, intermediate legs and trusses. Beam sets may be used with either worksurface depth. Dual tables require one pair of main beams of the same nominal width as the sum of the worksurfaces on each side.

Beam sets must be supported by intermediate legs at least every 16'. Intermediate leg must be positioned at beam truss location, where two worksurfaces meet.

Beams for single sided tables 30" and 36" D

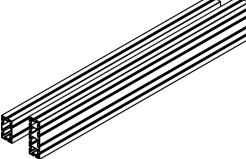
description	nominal	w	d	h	pattern number	list price
Starter beam set for single sided table 30" or 36" (main and back beam) 	5'	52"		8"	XTB1SB5C	\$1,403.
	6'	64"		8"	XTB1SB6C	1,469.
	8'	88"		8"	XTB1SB8C	1,938.
	10'	112"		8"	XTB1SB10C	2,270.
	12'	136"		8"	XTB1SB12C	2,671.
	15'	172"		8"	XTB1SB15C	3,071.

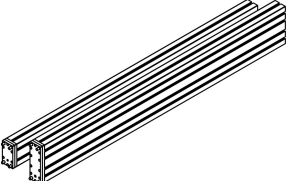
Extension beam set for single sided table 30" or 36" (main and back beam) 	4'	48"		8"	XTB1SB4E	1,870.
	5'	60"		8"	XTB1SB5E	1,938.
	6'	72"		8"	XTB1SB6E	2,004.
	8'	96"		8"	XTB1SB8E	2,472.
	10'	120"		8"	XTB1SB10E	2,803.
	12'	144"		8"	XTB1SB12E	3,205.
	15'	180"		8"	XTB1SB15E	3,607.

Order Code

Example: XTB1DB15C
XT Crinion Open Table
B1 Base components
DB Dual beam set
15 Width
C Starter

Specifications

Beams are extruded aluminum with natural anodized finish.

Beam sets are starter or extension.

Extension beam sets are specified only to add on to starter sets or other extension beams.

Application Notes

Crinion Open Table bases are assembled from beams, end legs or end panels, intermediate legs and trusses. Beam sets may be used with either worksurface depth. Single sided tables require one pair of main beams of the same nominal width as the sum of the worksurfaces on each side.

Beam sets must be supported by intermediate legs at least every 16'. Intermediate leg must be positioned at beam truss location, where two worksurfaces meet.

description	application	w	d	h	pattern number	P1/P2	P3
End leg for dual tables (pair of legs for 36" D worksurface)	24" D worksurface	4"	44"	24"	XTB1EDD24 ()	\$4,834.	\$5,076.
	30" D worksurface	4"	54"	24"	XTB1EDD30 ()	4,834.	5,076.
	36" D worksurface	4"	54"	24"	XTB1EDD36 ()	4,834.	5,076.

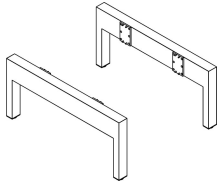

Intermediate leg for dual table (pair of legs for 30" and 36" D)	24" D worksurfaces	4"	2 ³ / ₄ "	16"	XTB2LDD24 ()	580.	580.
	30" & 36" D worksurfaces	4"	2 ³ / ₄ "	16"	XTB2LDD ()	638.	638.

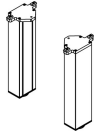

Shroud for intermediate leg infeed kit	24" D or single sided	3 ³ / ₄ "	2 ¹ / ₂ "	15"	XTB1 SLIK ()	182.	191.
	30" D	11"	4"	15"	XTB1 SLIK30 ()	230.	241.
	36" D	23"	4"	15"	XTB1 SLIK36 ()	269.	285.

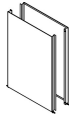

End leg for end counters both ends (pair of legs for 36" D worksurface)	48" W end counter	4"	44"	24"	XTB1XDD24 ()	5,168.	5,411.
	60" W end counter	4"	54"	24"	XTB1XDD30 ()	5,168.	5,411.
	72" W end counter	4"	54"	24"	XTB1XDD36 ()	5,168.	5,411.

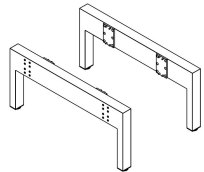

Order Code	Specifications	Application Notes
Example: XTB1EDD30 118	Specify paint finish code after pattern number.	Crinion Open Table bases are assembled from main beams, end legs or end panels, intermediate legs and trusses. After selecting starter or segmented beam sets, specify legs to support each end of beams. End legs support main beams at each end of a table.
XT Crinion Open Table		Dual end legs for end counters have threaded metal inserts on the outside of the leg to accept two fixed height or adjustable cantilevers for end counters.
B1 Base components		Intermediate legs must be specified to provide support under beam sets spanning longer than 16'.
E End leg		Intermediate legs may be positioned under beams at any beam truss location. End legs include beam end plates and hardware.
D Dual		Shroud for intermediate leg kit encloses the space between legs to protect power, data and communication cables between floor and table base. Side covers may be removed for access.
D Desk height		Shroud for 24" d intermediate leg is U-shaped cover that attaches to side of intermediate leg for 24" d or any single sided intermediate leg.
30 Depth of tops		End legs for 24" D worksurfaces and end legs for 48" W end counters have only one end plate for attaching a single centered beam for 24" D tables.
118 Finish		End legs for 30" D and 36" D worksurfaces and end legs for 60" W and 72" W end counters have two end plates for attaching two beams for 30" D and 36" D tables.

description	application	w	d	h	pattern number	P1/P2	P3
End leg for end counters one end only (pair of legs for 36"D worksurface)	48" W end counter	4"	44"	24"	XTB1YDD24 ()	\$5,003.	\$5,243.
	60" W end counter	4"	54"	24"	XTB1YDD30 ()	5,003.	5,243.
	72" W end counter	4"	54"	24"	XTB1YDD36 ()	5,003.	5,243.

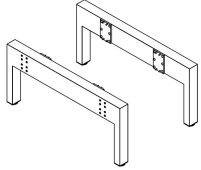

Order Code

Example:	XTB1EDD30 118
XT	Crinion Open Table
B1	Base components
E	End leg
D	Dual
D	Desk height
30	Depth of tops
118	Finish

Specifications

Specify paint finish code after pattern number.

Application Notes

Crinion Open Table bases are assembled from main beams, end legs or end panels, intermediate legs and trusses. After selecting starter or segmented beam sets, specify legs to support each end of beams. End legs support main beams at each end of a table.

Dual end legs for end counters have threaded metal inserts on the outside of the leg to accept two fixed height or adjustable cantilevers for end counters.

Intermediate legs must be specified to provide support under beam sets spanning longer than 16'.

Intermediate legs may be positioned under beams at any beam truss location. End legs include beam end plates and hardware.

Shroud for intermediate leg kit encloses the space between legs to protect power, data and communication cables between floor and table base. Side covers may be removed for access.

Shroud for 24"d intermediate leg is U-shaped cover that attaches to side of intermediate leg for 24"d or any single sided intermediate leg.

End legs for 24"D worksurfaces and end legs for 48"W end counters have only one end plate for attaching a single centered beam for 24"D tables.

End legs for 30"D and 36"D worksurfaces and end legs for 60"W and 72"W end counters have two end plates for attaching two beams for 30"D and 36"D tables.

description	application	width	depth	height	pattern number	P1/P2	P3
End leg for single sided tables (pair of legs)	24" D worksurface	4"	24"	24"	XTB1ESD24 ()	\$4,834.	\$5,076.
	30" D worksurface	4"	28 ³ / ₄ "	24"	XTB1ESD30 ()	4,834.	5,076.
	36" D worksurface	4"	28 ³ / ₄ "	24"	XTB1ESD36 ()	4,834.	5,076.

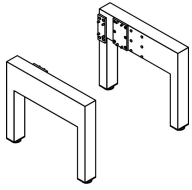

Intermediate leg for single sided table	24" D worksurfaces	4"	2 ³ / ₄ "	16"	XTB2LSD24 ()	522.	522.
	30" & 36" D worksurfaces	4"	2 ³ / ₄ "	16"	XTB2LSD ()	638.	638.



Order Code

Example:	XTB1ESD30 118
XT	Crinion Open Table
B1	Base components
E	End leg
S	Single
D	Desk height
30	Depth of tops
118	Finish

Specifications

Specify paint finish code after pattern number.

Application Notes

Crinion Open Table bases are assembled from main beams, end legs or end panels, intermediate legs and trusses. After selecting starter or segmented beam sets, specify legs to support each end of beams. End legs support main beams at each end of a table.

Dual end legs for end counters have threaded metal inserts on the outside of the leg to accept two fixed height or adjustable cantilvers for end counters.

Intermediate legs must be specified to provide support under beam sets spanning longer than 16'. Intermediate legs may be positioned under beams at any beam truss location. End legs include beam end plates and hardware.

Shroud for intermediate leg kit encloses the space between legs to protect power, data and communication cables between floor and table base. Side covers may be removed for access.

description	application	width	depth	height	pattern no.	P1/P2/P3
End panels for dual tables (pair of end panels)	24" D worksurface	1 1/4"	46"	25 1/2"	XTB1EP2DD24P () ()	\$2,551.
	30" D worksurface	1 1/4"	58"	25 1/2"	XTB1EP2DD30P () ()	3,594.
	36" D worksurface	1 1/4"	70"	25 1/2"	XTB1EP2DD36P () ()	3,826.

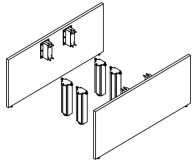

End panels for dual tables (single end panel)	24" D worksurface	1 1/4"	46"	25 1/2"	XTB1EP1DD24P () ()	1,276.
	30" D worksurface	1 1/4"	58"	25 1/2"	XTB1EP1DD30P () ()	1,797.
	36" D worksurface	1 1/4"	70"	25 1/2"	XTB1EP1DD36P () ()	1,913.

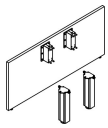

End panels for single sided tables (pair of end panels)	24" D worksurface	1 1/4"	25 3/16"	25 1/2"	XTB1EP2SD24P () ()	2,261.
	30" D worksurface	1 1/4"	30 3/16"	25 1/2"	XTB1EP2SD30P () ()	3,246.
	36" D worksurface	1 1/4"	36 3/16"	25 1/2"	XTB1EP2SD36P () ()	3,362.

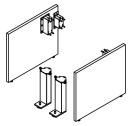

End panels for single sided tables (single end panel)	24" D worksurface, Left	1 1/4"	25 3/16"	25 1/2"	XTB1EP1LD24P () ()	1,130.
	24" D worksurface, Right	1 1/4"	25 3/16"	25 1/2"	XTB1EP1RD24P () ()	1,130.
	30" D worksurface, Left	1 1/4"	30 3/16"	25 1/2"	XTB1EP1LD30P () ()	1,623.
	30" D worksurface, Right	1 1/4"	30 3/16"	25 1/2"	XTB1EP1RD30P () ()	1,623.
	36" D worksurface, Left	1 1/4"	36 3/16"	25 1/2"	XTB1EP1LD36P () ()	1,681.
	36" D worksurface, Right	1 1/4"	36 3/16"	25 1/2"	XTB1EP1RD36P () ()	1,681.

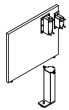

LH Shown
RH Opposite

Order Code	Specification	Application Notes
Example: XTB1EP2DD 24P118	Specify paint finish for brackets, then specify paint finish for end panel.	End panels may be specified as an alternative to End legs to support each end of beams.
XT	Crinion Open Table	
B1	Base components	End panel kits include end panel, connecting hardware and support legs.
EP2	End panel	End panel kits are not compatible with end counters.
D	Dual	
D	Desk Height	
24	Depth of tops	
P	Finish	
118	Finish	
118	Finish	

End panels for dual tables and single sided tables, laminate and veneer

description	application	w	d	h	pattern no.	L	V1	V2	V3
End panels for dual tables (pair of end panels)	24" D worksurface	1 1/4"	46"	25 1/2"	XTB1EP2DD24 () ()	\$2,667.	\$2,782.	\$3,362.	\$3,477.
	30" D worksurface	1 1/4"	58"	25 1/2"	XTB1EP2DD30 () ()	3,708.	3,942.	4,522.	4,753.
	36" D worksurface	1 1/4"	70"	25 1/2"	XTB1EP2DD36 () ()	3,942.	4,058.	4,753.	4,985.

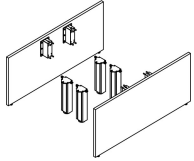

End panel for dual tables (single end panel)	24" D worksurface	1 1/4"	46"	25 1/2"	XTB1EP1DD24 () ()	1,333.	1,391.	1,681.	1,739.
	30" D worksurface	1 1/4"	58"	25 1/2"	XTB1EP1DD30 () ()	1,855.	1,971.	2,261.	2,376.
	36" D worksurface	1 1/4"	70"	25 1/2"	XTB1EP1DD36 () ()	1,971.	2,028.	2,376.	2,493.

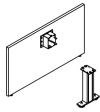

End panels for single sided tables (pair of end panels)	24" D worksurface	1 1/4"	25 3/16"	25 1/2"	XTB1EP2SD24 () ()	2,376.	2,551.	2,899.	3,014.
	30" D worksurface	1 1/4"	30 3/16"	25 1/2"	XTB1EP2SD30 () ()	3,362.	3,594.	3,942.	4,174.
	36" D worksurface	1 1/4"	36 3/16"	25 1/2"	XTB1EP2SD36 () ()	3,477.	3,708.	4,174.	4,404.

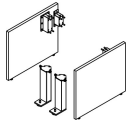

End panel for single sided tables (single end panel)	24" D worksurface, Left	1 1/4"	25 3/16"	25 1/2"	XTB1EP1LD24 () ()	1,189.	1,276.	1,448.	1,508.
	24" D worksurface, Right	1 1/4"	25 3/16"	25 1/2"	XTB1EP1RD24 () ()	1,189.	1,276.	1,448.	1,508.
	30" D worksurface, Left	1 1/4"	30 3/16"	25 1/2"	XTB1EP1LD30 () ()	1,681.	1,797.	1,971.	2,086.
	30" D worksurface, Right	1 1/4"	30 3/16"	25 1/2"	XTB1EP1RD30 () ()	1,681.	1,797.	1,971.	2,086.
	36" D worksurface, Left	1 1/4"	36 3/16"	25 1/2"	XTB1EP1LD36 () ()	1,739.	1,855.	2,086.	2,203.
	36" D worksurface, Right	1 1/4"	36 3/16"	25 1/2"	XTB1EP1RD36 () ()	1,739.	1,855.	2,086.	2,203.

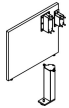

LH Shown
RH Opposite

Order Code	Specifications	Application Notes
Example: XTB1EP2DD 24118 118		
XT Crinion Open Table	Specify paint finish for brackets, then specify laminate or veneer finish for end panel.	End panels may be specified as an alternative to End legs to support each end of beams.
B1 Base components		
EP2 End panel	Brushed and woodgrain laminates are not available on 70" wide end panels for use on 36"D dual sided tables.	End panel kits include end panel, connecting hardware and support legs.
D Dual		
D Desk Height		
24 Depth of tops		End panel kits are not compatible with end counters.
118 Finish		
118 Finish		

description	application	w	d	h	pattern number	P1/P2/P3
Beam truss for dual tables	30" D worksurface	3"	11"	10"	XTB1XD30 ()	\$589.
	36" D worksurface	3"	23"	10"	XTB1XD36 ()	642.

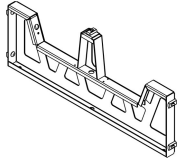

Top channel support	24" D worksurface				XTB1T24 ()	213.
---------------------	-------------------	--	--	--	--------------------	------



Beam truss for single sided tables	30" D worksurface	3"			XTB1XS30 ()	589.
	36" D worksurface	3"			XTB1XS36 ()	642.

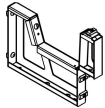

Beam truss for dual tables no top channel support	30" D worksurface	3"	11"	8"	XTB1XD30N ()	455.
	36" D worksurface	3"	23"	8"	XTB1XD36N ()	523.

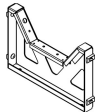

Beam truss for single sided tables no top channel support	30" D worksurface	3"			XTB1XS30N ()	455.
	36" D worksurface	3"			XTB1XS36N ()	523.

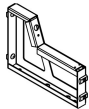

Order Code

Example: XTB1XD30 613	
XT	Crinion Open Table
B1	Base components
XD	Beam truss for dual table
30	Depth
613	Finish

Specifications

Beam trusses are available in all standard painted finishes.

Application Notes



Crinion Open Table bases are assembled from beams, end legs or end panels, intermediate legs and trusses. After selecting beams and leg kits, specify trusses between beams.

Specify beam trusses adjacent to each end leg and at each worksurface junction.

For 24"D tables specify top channel support instead of truss.

Beam trusses with no top channel support must be specified in combination with intermediate legs planned other than at worksurface junctions (as for cable infeed shrouds).

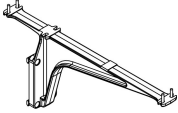
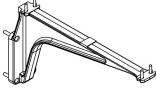
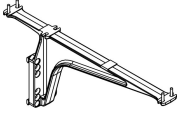
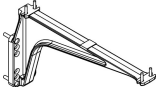
Worksurface support cantilever and mid span support

description	w	d	h	pattern number	P1/P2	P3
Cantilever, fixed height 30" or 36" D 	3"	24"	9"	XTB1FC ()	\$242.	\$252.
Cantilever, fixed height 24" D 	3"	19"	9"	XTB1FC24 ()	242.	252.
Cantilever, adjustable height 30" or 36" D 	3"	24"	9" - 12"	XTB1AC ()	267.	282.
Cantilever, adjustable height 24" D 	3"	24"	9" - 12"	XTB1AC24 ()	267.	282.
Mid span support 	2	2	8	XTB1MB ()	114.	121.

Order Code

Example: XTB1FC 118
XT Crinion Open Table
B1 Base components
FC Fixed height cantilever
118 Finish

Specifications

Specify paint finish code after pattern number.

48"worksurfaces: shared cantilevers each end or two adjustable per worksurface.

60" and 72" worksurfaces: shared cantilevers each end plus mid span support or two adjustable cantilevers inset 8".

96"worksurfaces: shared cantilevers at ends plus one in center or three adjustable cantilevers.

96"x 24" with hinged door: shared cantilever each end plus two mid span supports.

96"x 30" with hinged door: shared cantilever each end plus 24"d cantilever as center support.

96"x 36" with hinged door: shared cantilever each end plus 24", 30" or 36"d cantilever as center support.

Application Notes

Cantilever brackets are required to support each end of worksurfaces.

Brackets can be positioned at ends of worksurface, or inset at legs or floorstanding pedestal locations.

Fixed height cantilevers can be shared between adjacent worksurfaces. Mid span support bracket must be specified for worksurface spans exceeding 4'.

Fixed height cantilever supports worksurface at 28 1/2" H.

Adjustable cantilevers enable worksurfaces to be set at 27", 27 3/4", 28 1/2", 29 1/4" or 30" H.

Worksurface support

linking plate and cantilever for end counters

AutoStrada

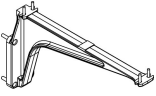
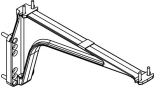
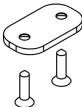
description	w	d	h	pattern no.	P1/P2	P3
Cantilever for end counters, fixed height	3"	19"	9"	XTB1FCEND ()	\$242.	\$252.
						
Cantilever for end counters, adjustable height	3"	19"	9" - 12"	XTB1ACEND ()	267.	282.
						
Worksurface linking plate				XTB1LP		33.
						

Order Code	Specification	Application Notes
Example: XTB1FCEND 613	Specify paint finish code after pattern number.	Cantilever brackets are required to support each end of worksurface.
XT Crinion Open Table		Brackets attach to inserts on the outside face of end legs for end counters.
B1 Base components		Fixed height cantilever supports for end counter at 28 1/2" H.
FC Fixed height cantilever		Adjustable cantilevers for end counter enables end counter to be set at 28 1/2", 29 1/4" or 30" H.
END for end counter		A linking plate is recommended to join adjacent worksurfaces that are independently supported at the same height. Specify two linking plates at the junction of two worksurfaces, or four total for each end counter to two worksurfaces. A linking plate is not required where adjacent tops are supported by a shared fixed height cantilever bracket, as with complete fixed height base assemblies. Linking plates are recommended for complete adjustable height base assemblies in which tops are set at the same height.
613 Finish		

Modular Raceway

2 + 2 eight-wire Raceway with covers

AutoStrada

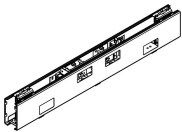
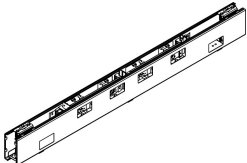
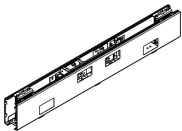
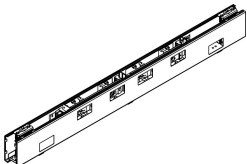
description	type	h	w	d	pattern number	list price
Dual raceway, two power + two data outlets each side 		4"	30"	2"	XTR1E30D ()	\$317.
Dual raceway, four power + two data outlets each side 		4"	42"	2"	XTR1E424D ()	454.
Flat end cover					XTR1FE ()	28.
Extended end cover					XTR1EE ()	28.
Single sided raceway two power + two data outlets one side 		4"	30"	2"	XTR1E30S ()	317.
Single sided raceway four power + two data outlets one side 		4"	42"	2"	XTR1E424S ()	454.

Order Code

Example: XTR1E424D 613
XT Crinion Open Table
R1 Raceway
E Eight wire system
42 Width
4 Extra outlets
D Dual Raceway
613 Finish

Specifications

Eight wire 2+2 has two sets of circuits, each set with a separate ground and neutral.

Specify paint finish code after pattern number.

Covers have two openings for data/com outlet modules (Decora-size, specified separately).

Applications notes

Raceway for Crinion Open Table is suspended from the top channel. For ideal access, worksurfaces should be specified with hinged power access.

Each raceway requires four or eight duplex outlets, on any of four circuits.

Jumpers connect power from one raceway to another.

To join power between 30" raceways: specify 30" jumper for 60" desks and specify 42" jumper for 72" desks.

To join power between 42" raceways: specify 18" jumper for 60" desks and 30" jumper for 72" desks.

Flat end covers enclose the end of a raceway at the end of a table.



Extended end covers enclose the end of a raceway at the end of a table where power infeed is located.

Specify outlet fillers separately for unused outlet openings.

Modular Raceway

2 + 2 eight-wire Raceway components

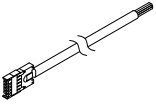
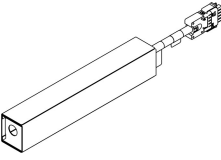
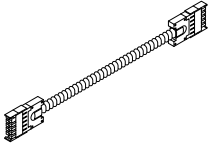
AutoStrada

description	type	h	w	d	pattern number	list price
Modular infeed					XTR1EPI	\$239.
						
NYC infeed kit					XTR1EPH	545.
						
Jumper			18"		XTR1EJ18	110.
			30"		XTR1EJ30	125.
			42"		XTR1EJ42	144.
Duplex outlet	Circuit A				XTR1DA	41.
	Circuit A, with controlled symbol				XTR1DAC	41.
	Circuit B				XTR1DB	41.
	Circuit B, with controlled symbol				XTR1DBC	41.
	Circuit X, orange				XTR1DXO	46.
	Circuit Y, orange				XTR1DYO	46.
Outlet filler	Set of 10				XTR1OF	34.
PDC module extension kit	Set of 10				XTR1PDCX	139.
Compact Power Module					XTR1ECPM ()	589.
						

Order Code	Specifications	Application Notes
Example: XTR1EJ18		
XT Crinion Open Table	Eight wire 2+2 has two sets of circuits, each set with a separate ground and neutral.	Raceway for Crinion Open Table is suspended from the top channel. For ideal access, worksurfaces should be specified with hinged power access.
R1 Raceway		Each raceway requires four or eight duplex outlets, on any of four circuits.
E Eight wire		Power infeed includes pigtail for connection to building power supply and connector to either end of any raceway.
J Jumper		NYC infeed kit includes junction box that mounts to inside face of beams in table base.
18 Width		Jumper length is difference between worksurface width and specified raceway width. Compact power module is designed to supply power outlets under extended end counter worksurfaces, or additional outlets under desks. Compact power module can be suspended from top channel or attached to inside face of beams. Each face of compact power module accepts two duplex outlets.

Modular Raceway

3 + 3 ten-wire Raceway with covers

AutoStrada

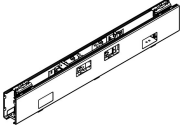
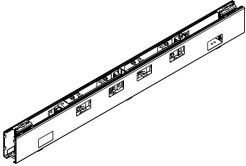
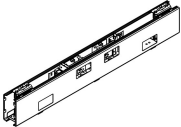
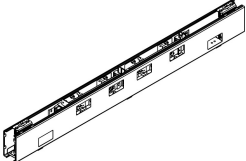
description	type	h	w	d	pattern number	list price
Dual raceway, two power + two data outlets each side		4"	30"	2"	XTR1T30D ()	\$331.
						
Dual raceway, four power + two data outlets each side		4"	42"	2"	XTR1T424D ()	469.
						
Flat end cover					XTR1FE ()	28.
Extended end cover					XTR1EE ()	28.
Single sided raceway two power + two data outlets one side		4"	30"	2"	XTR1T30S ()	331.
						
Single sided raceway four power + two data outlets one side		4"	42"	2"	XTR1T424S ()	469.
						

Order Code

Example: XTR1T424D 613	
XT Crinion Open Table	
R1 Raceway	
T Ten wire system	
42 Width	
4 Extra outlets	
D Dual Raceway	
613 Finish	

Specifications

Ten wire 3+3 has two sets of three circuits, each set with a separate ground and neutral.

Specify paint finish code after pattern number.

Covers have two openings for data/com outlet modules (Decora-size, specified separately).

Application Notes

Raceway for Crinion Open Table is suspended from the top channel. For ideal access, worksurfaces should be specified with hinged power access.

Each raceway requires four or eight duplex outlets, on any of six circuits.

Jumpers connect power from one raceway to another.

To join power between 30" raceways: specify 30" jumper for 60" desks and specify 42" jumper for 72" desks.

To join power between 42" raceways: specify 18" jumper for 60" desks and 30" jumper for 72" desks.



Flat end covers enclose the end of a raceway at the end of a table.

Extended end covers enclose the end of a raceway at the end of a table where power infeed is located.

Specify outlet fillers separately for unused outlet openings.

Modular Raceway

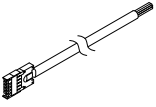
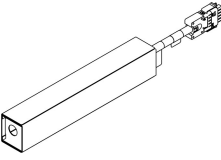
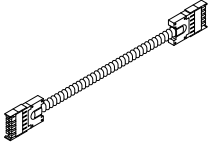
3 + 3 ten-wire Raceway components

description	type	h	w	d	pattern number	list pricing
Modular infeed					XTR1TPI	\$268.
						
NYC infeed kit					XTR1TPH	545.
						
Jumper			18"		XTR1TJ18	125.
			30"		XTR1TJ30	144.
			42"		XTR1TJ42	166.
Duplex outlet	Circuit A				XTR1DA	41.
	Circuit A, with controlled symbol				XTR1DAC	41.
	Circuit B				XTR1DB	41.
	Circuit B, with controlled symbol				XTR1DBC	41.
	Circuit C				XTR1DC	41.
	Circuit C, with controlled symbol				XTR1DCC	41.
	Circuit X, orange				XTR1DXO	46.
	Circuit Y, orange				XTR1DYO	46.
	Circuit Z, orange				XTR1DZO	46.
Outlet filler	Set of 10				XTR1OF	34.
PDC module extension kit	Set of 10				XTR1PDCX	139.
Compact Power Module					XTR1TCPM ()	607.
						

Order Code	Specifications	Application Notes
Example: XTR1TJ18		
XT Crinion Open Table	Ten wire 3+3 has two sets of three circuits, each set with a separate ground and neutral.	Raceway for Crinion Open Table is suspended from the top channel. For ideal access, worksurfaces should be specified with hinged power access.
R1 Raceway		
T Ten wire		
J Jumper		Each raceway requires four or eight duplex outlets, on any of six circuits.
18 Width		Power infeed includes pigtail for connection to building power supply and connector to either end of any raceway.
		NYC infeed kit includes junction box that mounts to inside face of beams in table base.
		Jumper length is difference between worksurface width and specified raceway width.
		Compact power module is designed to supply power outlets under extended end counter worksurfaces, or additional outlets under desks.
		Compact power module can be suspended from top channel or attached to inside face of beams.
		Each face of compact power module accepts two duplex outlets.

Modular Raceway

4-4-2 ten-wire Raceway with covers

AutoStrada

description	type	h	w	d	pattern number	list price
Dual raceway, two power + two data outlets each side		4"	30"	2"	XTR1X30D ()	\$350.

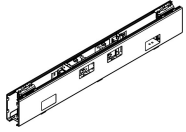

Dual raceway, four power + two data outlets each side		4"	42"	2"	XTR1X424D ()	492.
---	--	----	-----	----	----------------------	------

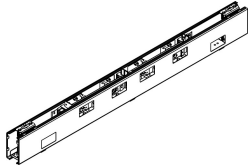

Single sided raceway two power + two data outlets one side		4"	30"	2"	XTR1X30S ()	350.
---	--	----	-----	----	---------------------	------

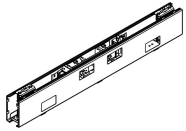

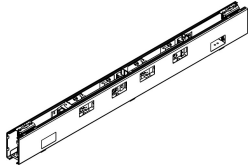

Single sided raceway four power + two data outlets one side		4"	42"	2"	XTR1X424S ()	492.
--	--	----	-----	----	----------------------	------



Order Code	Specifications	Application Notes
Example: XTR1X424D 613		
XT Crinion Open Table	Ten wire 4-4-2 has four circuits each with a separate neutral, plus a ground wire for circuit 1 and 2 and another ground for circuit 3 and 4.	Raceway for Crinion Open Table is suspended from the top channel. For ideal access, worksurfaces should be specified with hinged power access.
R1 Raceway		
X Ten wire 4-4-2	Specify paint finish code after pattern number.	Each raceway requires four or eight duplex outlets, on any of six circuits.
42 Width		
4 Extra outlets	Covers have two openings for data/com outlet modules (Decora-size, specified separately).	Jumpers connect power from one raceway to another.
D Dual Raceway		To join power between 30" raceways: specify 30" jumper for 60" desks and specify 42" jumper for 72" desks.
613 Finish		To join power between 42" raceways: specify 18" jumper for 60" desks and 30" jumper for 72" desks.
		Flat end covers enclose the end of a raceway at the end of a table.
		Extended end covers enclose the end of a raceway at the end of a table where power infeed is located.
		Specify outlet fillers separately for unused outlet openings.

Modular Raceway

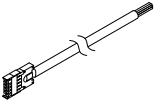
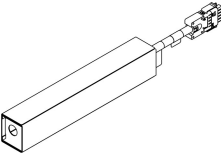
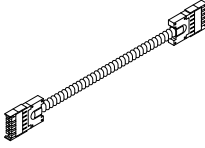
4-4-2 ten-wire Raceway components

description	type	h	w	d	pattern number	list price
Modular infeed					XTR1XPI	\$282.
						
NYC infeed kit					XTR1XPH	572.
						
Jumper			18"		XTR1XJ18	131.
			30"		XTR1XJ30	151.
			42"		XTR1XJ42	172.
Duplex outlet	Circuit 1				XTR1D1	43.
	Circuit 1, with controlled symbol				XTR1D1C	
	Circuit 2				XTR1D2	43.
	Circuit 2, with controlled symbol				XTR1D2C	
	Circuit 3				XTR1D3	43.
	Circuit 3, with controlled symbol				XTR1D3C	
	Circuit 4				XTR1D4	43.
	Circuit 4, with controlled symbol				XTR1D4C	
Compact Power Module					XTR1XCPM ()	607.
						

Order Code

Example:	XTR1XJ18
XT	Crinion Open Table
R1	Raceway
X	Ten wire 4-4-2
J	Jumper
18	Width

Specifications

Ten wire 4-4-2 has four circuits each with a separate neutral, plus a ground wire for circuit 1 and 2 and another ground for circuit 3 and 4.

All duplex outlets are black.

Application Notes

Raceway for Crinion Open Table is suspended from the top channel. For ideal access, worksurfaces should be specified with hinged power access.

Each raceway requires four or eight duplex outlets, on any of six circuits.

Power infeed includes pigtail for connection to building power supply and connector to either end of any raceway.

NYC infeed kit includes junction box that mounts to inside face of beams in table base.

Jumper length is difference between worksurface width and specified raceway width.

Compact power module is designed to supply power outlets under extended end counter worksurfaces, or additional outlets under desks.

Compact power module can be suspended from top channel or attached to inside face of beams.

Each face of compact power module accepts two duplex outlets.

description	type	h	w	d	pattern number	list price
Dual raceway, two power + two data outlets each side		4"	30"	2"	XTR1H30D ()	\$690.
Flat end cover					XTR1FE ()	28.
Extended end cover					XTR1EE ()	28.
Outlet filler	Set of 10				XTR1OF	34.

Order Code

Example: XTR1H30D 613
XT Crinion Open Table
R1 Raceway
H Hard wire system
30 Width
D Dual Raceway
613 Finish

Specifications

Specify paint finish code after pattern number.

Hardwired raceway components are designed for use in City of Chicago installations.

Covers have two openings for data/com outlet modules (Decora-size, by others).



Application Notes

Raceway for Crinion Open Table is suspended from the top channel. For ideal access, worksurfaces should be specified with hinged power access.

Dual raceways are code-approved boxed with openings for two or four duplex outlets on each face, plus two additional openings for data/communications faceplates on each face. A continuous horizontal metal septum divides power wires and connections from data and communications cables. Each raceway requires Decora-type architectural power outlets, internal wiring and connecting cables, supplied by electrical contractor.

Flat end covers enclose the raceway at the end of a table. Extended end covers provide an opening on the underside to permit cables to enter the raceway.

Specify outlet filler plates for unused outlet openings. Specify PDC extenders to create space behind data/com for cable distribution inside dual raceway.

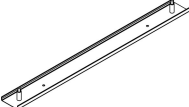
description	table size	w	d	pattern number	list price
 Cable trays, leg position, pair	5', 30"D	53"	1"	XTCT6030LD ()	\$287.
	5', 36"D	53"	4"	XTCT6036LD ()	391.
	6', 30"D	65"	1"	XTCT7230LD ()	311.
	6', 36"D	65"	4"	XTCT7236LD ()	453.
 Cable trays, full width, pair	5', 30"D	60"	1"	XTCT6030D ()	287.
	5', 36"D	60"	4"	XTCT6036D ()	391.
	6', 30"D	72"	1"	XTCT7230D ()	311.
	6', 36"D	72"	4"	XTCT7236D ()	453.
Data tray kit		42"		XTDT42 ()	201.
 Data + excess cable tray kit		42"		XTDTX42 ()	334.
Truss cable clips, set of 25				XTR1TCC25	16.
Beam cable clips, set of 50				XTR1BCC50	267.
Random attachment kit, set of 10				XTB1RAK	92.

Order Code	Specifications	Applications notes
Example: XTCT7230D 613	Cable trays and Data tray kits are available in all standard paint finishes.	Cable trays are optional kits to manage cables on each side of dual table bases. Specify cable trays for leg position at each end of the table. Specify cable trays, full width for other positions. Data tray kit provides 3" wide horizontal open cable tray directly below either 30" or 42" W raceway module (at center of 60" or 72" desks). Data + excess tray kit provides two open trays below either raceway module, one 3" W and one 5" W.
XT Crinion Open Table		
CT Cable tray		
72 Width		
30 Depth		
D Dual table		
613 Finish	Truss cable clips manage cables between raceway. Specify 2 clips per truss (one set of 10 for each five trusses). Beam cable clips manage cables along the inside faces of each beam set. Random attachment kit is a set of ten M8 slot nuts for attaching various products to the Crinion Open Table beams or top channel. Specify appropriate M8 screws separately.	

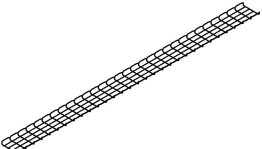
description	application	w	d	h	pattern no.	list
	24"D tables	18"	2"	3/4"	XTBT18 ()	\$90.
	24"D tables	24"	2"	3/4"	XTBT24 ()	103.
	24"D tables	36"	2"	3/4"	XTBT36 ()	111.
	24"D tables	48"	2"	3/4"	XTBT48 ()	122.
	24"D tables	60"	2"	3/4"	XTBT60 ()	131.
Cable basket, 10'		120"	8"	1"	XTWB120	497.
	From truss 30/36D only				XTWTX ()	79.
	From truss at infeed shroud				XTWTBSLIK ()	242.
	From main beam, 24D only				XTWTB ()	79.
	From top channel, 30/36D only				XTWTC ()	104.

Order Code	Specifications	Application Notes
Example: XTBT36 118		
XT Crinion Open Table	Beam mounted cable trays are available in any standard painted finish.	Beam mounted cable trays may be inserted in slots on either face of Crinion Open Table main beams. On 24"D dual or single sided tables beam mounted cable trays are the only option for cable management other than the shallow channel on top of the beam or a cable basket. On 30"D and 36"D tables beam mounted trays may complement other cable tray options.
BT Beam mounted cable tray	Cable basket is zinc metal finish only.	For 48"W worksurfaces with shared cantilevers specify 36"W trays. For 60"W worksurfaces with shared cantilevers and midspan supports specify 24"W trays adjacent to end legs specify 18"W trays.
36 Width	Basket hangers can be specified in any standard painted finish.	For 72"W worksurfaces with shared cantilevers and midspan supports specify 24"W trays.
118 Paint finish		For 96"W worksurfaces specify 36"W trays between supports. Specify 48"W trays for additional cable management between trusses on the inside face of beams on dual 30"D and 36"D tables with 60" worksurfaces. Specify 60"W trays on the inside face of beams on dual 30"D and 36"D tables with 72"W worksurfaces.
		Beam mounted cable trays must be segmented to fit between cantilever and midspan support brackets.
		Cable basket is suspended below the center of dual tables instead of or in addition to cable trays. Cable basket offers the most flexibility for managing large bundles of cables and for entering or exiting the tray at any point. Cable basket ships in 10' lengths and is cut to size in field. Specify cable basket hangers separately. Each hanger can suspend one end of a tray or two adjacent trays. Hanger from trusses is for 30" or 36"D dual or single sided tables. Hanger from main beam is for 24"D dual tables only. Hangers from top channel are for 30" or 36"D dual tables only.

Center screens

Acrylic, slatwall, combination, marker or veneer surface

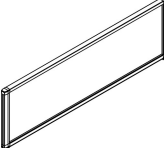
description	appl.	w	d	h	pattern no.	Opal acrylic	Trans. acrylic / Marker	slatwall	Comb. acrylic / slatwall	V1	V2	V3
Center screen to 43" H 	48"	48"	1 1/4"	14"	XTCS1 4814 () () ()	\$968.	\$1,001.	\$1,538.	n/a	\$1,335.	\$1,464.	\$1,713.
	60"	60"	1 1/4"	14"	XTCS1 6014 () () ()	1,270.	1,331.	1,670.	n/a	1,443.	1,594.	1,911.
	72"	72"	1 1/4"	14"	XTCS1 7214 () () ()	1,335.	1,398.	1,804.	n/a	1,517.	1,690.	2,069.

acrylic shown

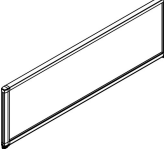
Center screen to 43" H adjacent to end screen 	48"	47"	1 1/4"	14"	XTCS1 4714 () () ()	968.	1,001.	1,538.	n/a	1,335.	1,464.	1,713.
	60"	59"	1 1/4"	14"	XTCS1 5914 () () ()	1,270.	1,331.	1,670.	n/a	1,443.	1,594.	1,911.
	72"	71"	1 1/4"	14"	XTCS1 7114 () () ()	1,335.	1,398.	1,804.	n/a	1,517.	1,690.	2,069.

acrylic shown

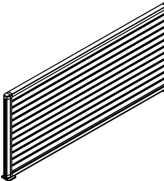
Center screen to 50" H 	48"	48"	1 1/4"	21"	XTCS1 4821 () () ()	1,135.	1,185.	1,804.	1,670.	1,465.	1,631.	1,992.
	60"	60"	1 1/4"	21"	XTCS1 6021 () () ()	1,469.	1,564.	2,004.	1,938.	1,575.	1,777.	2,228.
	72"	72"	1 1/4"	21"	XTCS1 7221 () () ()	1,537.	1,630.	2,206.	2,072.	1,632.	1,867.	2,413.

slatwall shown

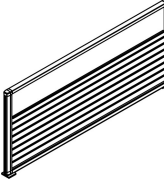
Center screen to 50" H adjacent to end screen 	48"	47"	1 1/4"	21"	XTCS1 4721 () () ()	1,135.	1,185.	1,804.	1,670.	1,465.	1,631.	1,992.
	60"	59"	1 1/4"	21"	XTCS1 5921 () () ()	1,469.	1,564.	2,004.	1,938.	1,575.	1,777.	2,228.
	72"	71"	1 1/4"	21"	XTCS1 7121 () () ()	1,537.	1,630.	2,206.	2,072.	1,632.	1,867.	2,413.

combination shown

Order Code	Specifications	Application Notes
Example: XTCS16014A O 111		
XT Crinion Open Table	Acrylic surface is AO opal or AT translucent.	Center screens mount to continuous channel at center of tables. Specify 14" H screens for a 42" horizon. Specify 21" H screens for a 49" horizon. Horizons are maintained regardless of worksurface height.
CS1 Center screen	For Marker surface both sides specify suffix M.	Center screens adjacent to end screens allow space for dual or single sided end screens.
60 Width	For Slatwall screens specify slatwall and frame finish.	Slatwall screens require buttresses to support Knoll Extra flat screen monitor arm. Specify one buttress per monitor arm, up to four buttresses per screen.
14 Height	For combination acrylic/slatwall screens specify suffixes CO (opal) or CT (translucent), slatwall and frame finish.	Combination screens include 14" high slatwall with acrylic above.
A Surface	Slatwall surface is available in (AA) or any standard painted finish except 613 Silver.	Center screens include mounting hardware for standard top channel only.
O Opal	For veneer surface specify suffix V and finish code from list on Crinion Open Table.	Slatwall screens will support flat panel monitor arms with varying weight limitations based on mounting and application. Please refer to the KnollExtra price list for comprehensive mounting and weight limitation information by application.
111 Frame finish	Frame is clear anodized aluminum or any standard paint finish except 613 Silver.	Veneer grain direction is horizontal. Marker surface has wood core.

Center screens

Tackable fabric surface

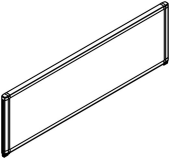

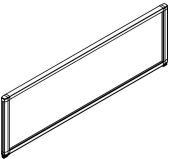

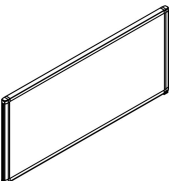
description	application	w	d	h	pattern no.	10	15	20	30	35	40	45
	Center screen to 43" H	48"	48"	1 1/4"	14"	XTCS1 4814F () () ()	\$1,022.	\$1,041.	\$1,047.	\$1,068.	\$1,085.	\$1,122.
		60"	60"	1 1/4"	14"	XTCS1 6014F () () ()	1,117.	1,141.	1,145.	1,172.	1,194.	1,240.
		72"	72"	1 1/4"	14"	XTCS1 7214F () () ()	1,143.	1,173.	1,177.	1,211.	1,237.	1,290.

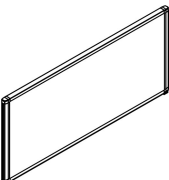
	Center screen to 43" H adjacent to end screen	48"	47"	1 1/4"	14"	XTCS1 4714F () () ()	1,013.	1,032.	1,035.	1,057.	1,074.	1,111.
		60"	59"	1 1/4"	14"	XTCS1 5914F () () ()	1,117.	1,141.	1,145.	1,172.	1,194.	1,240.
		72"	71"	1 1/4"	14"	XTCS1 7114F () () ()	1,143.	1,173.	1,177.	1,211.	1,237.	1,290.

	Center screen to 50" H	48"	48"	1 1/4"	21"	XTCS1 4821F () () ()	1,084.	1,103.	1,107.	1,128.	1,145.	1,180.
		60"	60"	1 1/4"	21"	XTCS1 6021F () () ()	1,208.	1,236.	1,240.	1,265.	1,286.	1,332.
		72"	72"	1 1/4"	21"	XTCS1 7221F () () ()	1,221.	1,252.	1,257.	1,289.	1,316.	1,369.

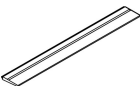
	Center screen to 50" H adjacent to end screen	48"	47"	1 1/4"	21"	XTCS1 4721F () () ()	1,084.	1,103.	1,107.	1,128.	1,145.	1,180.
		60"	59"	1 1/4"	21"	XTCS1 5921F () () ()	1,208.	1,236.	1,240.	1,265.	1,286.	1,333.
		72"	71"	1 1/4"	21"	XTCS1 7121F () () ()	1,221.	1,252.	1,257.	1,289.	1,316.	1,369.

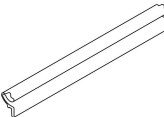
Order Code	Specifications	Application Notes
Example: XTCS16014F20 (W2801) AA	1. Tackable fabric surface is suffix F.	Fabric center screens mount to continuous channel at center of tables. Specify 14" H screens for a 43" horizon. Specify 21" H screens for a 50" horizon. Horizons are maintained regardless of worksurface height.
XT Crinion Open Table	2. Select fabric surface finish code from list on page Crinion Open Table.	
CS1 Center screen	Frame is clear anodized aluminum or any standard paint finish except 613 Silver.	Center screens adjacent to end screens allow space for dual or single sided end screens.
60 Width		
14 Height	Fabric is railroaded.	Center screens include mounting hardware for standard top channel only.
F Surface		
20 Fabric grade		
W2801 Fabric		
AA Frame finish		

description	application	w	d	h	pattern no.	list	AA/paint	L	V1	V2	V3
Display shelf 5"D aluminum only 	48" slatwall	45"	5"	1"	XT1DS4505 ()		\$296.				
	60" slatwall	57"	5"	1"	XT1DS5705 ()		332.				
	72" slatwall	69"	5"	1"	XT1DS6905 ()		361.				
Open shelf 9"D laminate or veneer only 	48" slatwall	45"	9"	1"	XT1LS4509 ()()			332.	435.	499.	673.
	60" slatwall	57"	9"	1"	XT1LS5709 ()()			381.	498.	571.	774.
	72" slatwall	69"	9"	1"	XT1LS6909 ()()			433.	562.	646.	872.
Slatwall adapters for applied wall accessories 		24"			XT1SA24 ()						
			30"			XT1SA30 ()					
			36"			XT1SA36 ()					
			42"			XT1SA42 ()					
			48"			XT1SA48 ()					
			54"			XT1SA54 ()					
			60"			XT1SA60 ()					
			66"			XT1SA66 ()					
		72"			XT1SA72 ()						
Buttress for slatwall screen 					XTCS1 SBA ()			267.			

Order Code	Specifications	Application Notes
Example: XT1LS5709 118 AA		
XT1 Crinion Open Table	Display shelves are anodized aluminum (AA) or any standard painted finish except silver.	Open shelves and display shelves for slatwall are designed for use on Crinion Open Table center screens with slatwall inserts.
LS Open shelf		
57 Width	For open shelves specify any standard laminate or veneer finish, then platform finish.	Shelves include adapter that snaps into horizontal channels in slatwall, approximately every 2" vertically.
09 Depth	Shelf platform may be AA or any standard paint finish except silver.	Shelf width fits either full width center screens or screens adjacent to end screens.
118 Shelf finish		
AA Platform finish	Slatwall adapters are integral color 812 Easy grey or 111 Black only.	Slatwall adapters enable other Applied Wall System shelves and accessories to be mounted to Crinion Open Table slatwall. Adapter will also fit other Knoll system slatwalls, such as AutoStrada spine or panels, but use of shelves in these applications may not comply with ANSI/BIFMA safety standards for anti-dislodgment.

Side screens

Acrylic, Marker or veneer surface

AutoStrada

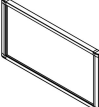
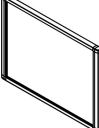
description	application	w	d	h	pattern no.	list	Opal acrylic	Trans. acrylic / Marker	V1	V2	V3
 Side screen to 43" H	24" D worksurface	22"	1 1/4"	14"	XTSS1 2414 () () ()		\$701.	\$721.	\$1,057.	\$1,134.	\$1,248.
	30" D worksurface	28"	1 1/4"	14"	XTSS1 3014 () () ()		736.	761.	1,091.	1,177.	1,325.
	36" D worksurface	34"	1 1/4"	14"	XTSS1 3614 () () ()		801.	833.	1,119.	1,218.	1,397.
	acrylic shown										
 Side screen to 50" H	24" D worksurface	22"	1 1/4"	21"	XTSS1 2421 () () ()		801.	833.	1,131.	1,227.	1,391.
	30" D worksurface	28"	1 1/4"	21"	XTSS1 3021 () () ()		835.	873.	1,167.	1,279.	1,488.
	36" D worksurface	34"	1 1/4"	21"	XTSS1 3621 () () ()		901.	944.	1,200.	1,329.	1,585.
	acrylic shown										
Side screen brackets (pair)	postformed edge				XTSM1P ()		282.				
	squared edge				XTSM1S ()		199.				
	tapered edge				XTSM1K ()		199.				

Order Code	Specifications	Application Notes
Example: XTSS13014A O AA		
XT Crinion Open Table		
SS1 Side screen		
30 Width		
14 Height		
A Surface		
O Opal		
AA Frame finish		
	1. Specify surface <i>A = Acrylic</i> <i>V = Veneer</i> <i>M = Marker</i> 2. For Acrylic surface specify <i>O = Opal</i> <i>T = Translucent</i> Veneer surfaces may be any standard AutoStrada V1, V2 or V3 veneer. Specify veneer finish code from list on table finishes page in beginning of price list.	Side screens clamp to front and back edge of worksurface at any point (except at hinged access door). Specify side screen brackets separately. Specify 14" H screens for a 42" horizon. Specify 21" H screens for a 49" horizon. Side screens align in height with center screens when worksurfaces are set at 28 3/8" H.
	Frame is clear anodized aluminum or any standard paint finish except 613 Silver.	Veneer grain direction is horizontal.
	Brackets are available in all paint finishes	

Side screens

Tackable fabric surface

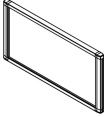
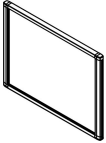
description	application	w	d	h	pattern no.	list	10	15	20	30	35	40	45
	24" D worksurface	22"	1 1/4"	14"	XTSS1 2414F () ()		\$796.	\$805.	\$807.	\$820.	\$828.	\$828.	\$846.
	30" D worksurface	28"	1 1/4"	14"	XTSS1 3014F () ()		820.	833.	835.	849.	859.	859.	880.
	36" D worksurface	34"	1 1/4"	14"	XTSS1 3614F () ()		844.	859.	877.	889.	889.	889.	917.
	24" D worksurface	22"	1 1/4"	21"	XTSS1 2421F () ()		832.	842.	843.	854.	863.	863.	880.
	30" D worksurface	28"	1 1/4"	21"	XTSS1 3021F () ()		868.	878.	880.	895.	906.	906.	929.
	36" D worksurface	34"	1 1/4"	21"	XTSS1 3621F () ()		883.	899.	901.	917.	930.	930.	957.
Side screen brackets (pair)	postformed edge				XTSM1P ()		282.						
	squared edge				XTSM1S ()		199.						
	tapered edge				XTSM1K ()		199.						

Order Code	Specifications	Application Notes
Example: XTSS13014F20 (W2801) 115		
XT Crinion Open Table	1. Tackable fabric surface is suffix F.	Side screens clamp to front and back edge of worksurface at any point (except at hinged access door). Specify side screen brackets separately. Specify 14" H screens for a 43" horizon. Specify 21" H screens for a 50" horizon. Side screens align in height with center screens when worksurfaces are set at 28 3/8" H.
SS1 Side screen	2. Select fabric surface finish code from list on page Crinion Open Table.	
30 Width	3. Specify frame finish.	
14 Height	Frame is clear anodized aluminum or any standard paint finish except 613 Silver.	
F Surface	Fabric is railroaded.	
20 Fabric grade	Brackets are available in all paint finishes.	
W2801 Fabric		
115 Frame finish		

Return screens

Acrylic, Marker or veneer surface

AutoStrada

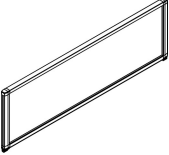
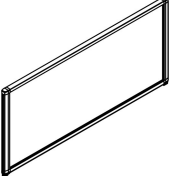
description	application	w	d	h	pattern no.	list	Opal acrylic	Trans. acrylic / Marker	V1	V2	V3
	Return screen to 43" H	54"	52"	1 1/4"	14"	XTRS1 5414 () () ()	\$1,169.	\$1,232.	\$1,274.	\$1,407.	\$1,680.
		60"	58"	1 1/4"	14"	XTRS1 6014 () () ()	1,169.	1,232.	1,289.	1,437.	1,741.
		66"	64"	1 1/4"	14"	XTRS1 6614 () () ()	1,169.	1,232.	1,317.	1,473.	1,813.
		72"	70"	1 1/4"	14"	XTRS1 7214 () () ()	1,169.	1,232.	1,334.	1,502.	1,873.
		78"	76"	1 1/4"	14"	XTRS1 7814 () () ()	1,303.	1,363.	1,580.	1,723.	2,125.
	Return screen to 50" H	54"	52"	1 1/4"	21"	XTRS1 5421 () () ()	1,368.	1,464.	1,396.	1,574.	1,968.
		60"	58"	1 1/4"	21"	XTRS1 6021 () () ()	1,368.	1,464.	1,421.	1,617.	2,057.
		66"	64"	1 1/4"	21"	XTRS1 6621 () () ()	1,368.	1,464.	1,443.	1,656.	2,143.
		72"	70"	1 1/4"	21"	XTRS1 7221 () () ()	1,368.	1,464.	1,468.	1,697.	2,229.
		78"	76"	1 1/4"	21"	XTRS1 7821 () () ()	1,538.	1,630.	1,721.	1,929.	2,504.
Side screen brackets (pair)	postformed edge				XTSM1P ()	282.					
	squared edge				XTSM1S ()	199.					

Order Code

Example:	XTRS16014A O 118
XT	Crinion Open Table
RS1	Return screen
60	Width
14	Height
A	Acrylic
O	Opal
118	Frame finish

Specifications

- Specify surface
A = Acrylic
V = Veneer
M = Marker
- For Acrylic surface specify
O = Opal
T = Translucent
 Veneer surfaces may be any standard AutoStrada V1, V2 or V3 veneer.
 Specify veneer finish code from list on table finishes page in beginning of price list.
- Specify frame finish.

 Frame is clear anodized aluminum (AA) or any standard paint finish except 613 Silver.

 Brackets are available in all paint finishes.

Application Notes

Return screens span the depth of Crinion Open Table worksurfaces and the width of a 30", 36" or 42" worksurface planned as perpendicular return. Specify 14" H screens for 42" horizon. Specify 21" H screens for a 49" horizon. Returns (file tops or AutoStrada worksurfaces) must be at the same height as worksurface.

Specify side brackets separately.

Veneer grain direction is horizontal.

Return screens

Tackable fabric surface

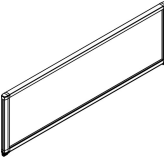
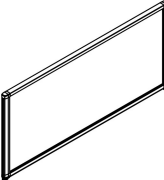
description	application	w	d	h	pattern no.	list	10	15	20	30	35	40	45
 Return screen to 43" H	54"	52"	1 1/4"	14"	XTRS1 5414F () () ()	\$972.	\$994.	\$1,001.	\$1,023.	\$1,041.	\$1,041.	\$1,085.	
	60"	58"	1 1/4"	14"	XTRS1 6014F () () ()	980.	1,004.	1,010.	1,035.	1,057.	1,057.	1,103.	
	66"	64"	1 1/4"	14"	XTRS1 6614F () () ()	1,000.	1,025.	1,031.	1,062.	1,084.	1,084.	1,134.	
	72"	70"	1 1/4"	14"	XTRS1 7214F () () ()	1,006.	1,034.	1,040.	1,075.	1,097.	1,097.	1,155.	
	78"	76"	1 1/4"	14"	XTRS1 7814F () () ()	1,157.	1,189.	1,196.	1,231.	1,255.	1,255.	1,316.	
 Return screen to 50" H	54"	52"	1 1/4"	21"	XTRS1 5421F () () ()	951.	972.	977.	1,003.	1,021.	1,021.	1,063.	
	60"	58"	1 1/4"	21"	XTRS1 6021F () () ()	986.	1,012.	1,015.	1,044.	1,064.	1,064.	1,109.	
	66"	64"	1 1/4"	21"	XTRS1 6621F () () ()	992.	1,020.	1,024.	1,055.	1,077.	1,077.	1,128.	
	72"	70"	1 1/4"	21"	XTRS1 7221F () () ()	1,000.	1,028.	1,034.	1,067.	1,093.	1,093.	1,147.	
	78"	76"	1 1/4"	21"	XTRS1 7821F () () ()	1,178.	1,211.	1,218.	1,253.	1,280.	1,280.	1,340.	
Side screen brackets (pair)	postformed edge				XTSM1P ()	282.							
	squared edge				XTSM1S ()	199.							

Order Code	
Example:	XTRS16014F20 (W2801) 611
XT	Crinion Open Table
RS1	Return screen
60	Width
14	Height
F	Surface
20	Fabric grade
W2801	Fabric
611	Frame finish

- Specifications**
- Tackable fabric surface is suffix F.
 - Select fabric surface finish code from list on page Crinion Open Table.
 - Specify frame finish.
- Frame is clear anodized aluminum or any standard paint finish except 613 Silver.
- Fabric is railroaded.
- Brackets are available in all paint finishes.

Application Notes

Fabric return screens span the depth of Crinion Open Table worksurfaces and the width of a 30", 36" or 42" worksurface planned as perpendicular return. Specify 14" H screens for a 43" horizon. Specify 21" H screens for a 50" horizon. Returns must be at the same height as worksurface.

Specify mounting brackets separately.

Crinion Open Table

Dual end screens

Acrylic, Marker or veneer surface

description	application	w	d	h	pattern no.	list	Opal acrylic	Trans. acrylic / Marker	V1	V2	V3
	24" D dual	48"	1 1/4"	14"	XTES1 4814 () () ()		\$870.	\$900.	\$1,221.	\$1,349.	\$1,600.
	30" D dual	60"	1 1/4"	14"	XTES1 6014 () () ()		1,135.	1,199.	1,330.	1,483.	1,797.
	36" D dual	72"	1 1/4"	14"	XTES1 7214 () () ()		1,169.	1,232.	1,404.	1,576.	1,954.
	acrylic shown										

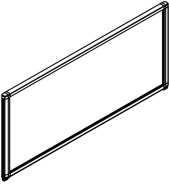
	24" D dual	48"	1 1/4"	21"	XTES1 4821 () () ()		1,034.	1,085.	1,350.	1,517.	1,880.
	30" D dual	60"	1 1/4"	21"	XTES1 6021 () () ()		1,335.	1,429.	1,463.	1,662.	2,115.
	36" D dual	72"	1 1/4"	21"	XTES1 7221 () () ()		1,368.	1,587.	1,520.	1,752.	2,298.
	acrylic shown										

Replacement mast Kit	acrylic center screen				XTSM1C ()	113.					
	slatwall center screen				XTSM1SLAT ()	299.					

End screen brackets (pair)	tapered edge worksurface				XTSM1KK ()	199.					
------------------------------	-----------------------------	--	--	--	--------------------	------	--	--	--	--	--

Side screen brackets (pair)	postformed edge				XTSM1P ()	282.					
	squared edge				XTSM1S ()	199.					

Order Code	Specifications	Application Notes
Example: XTES16014A O AA		
XT Crinion Open Table	1. Specify surface <i>A = Acrylic</i> <i>V = Veneer</i> <i>M = Marker</i>	Dual end screens clamp to front edge of worksurface on either side of table. Specify 14" H screens for a 42" horizon. Specify 21" H screens for a 49" horizon. Side screens align with center screens when worksurfaces are set at 28 3/8" H.
ES1 End screen	2. For Acrylic surface specify <i>O = Opal</i> <i>T = Translucent</i> Veneer surfaces may be any standard AutoStrada V1,V2 or V3 veneer. Specify veneer finish code from list on table finishes page in beginning of price list.	
60 Width	3. Specify frame finish.	
14 Height	Frame is clear anodized aluminum or any standard paint finish except 613 Silver.	Specify end screen brackets separately for each screen.
A Surface	Brackets are available in all paint finishes.	Veneer grain direction is horizontal.
O Opal	Replacement mast kit for acrylic center screen is 812 Easy Grey or 111 Black.	
AA Frame finish		

Dual end screens

Tackable fabric surface

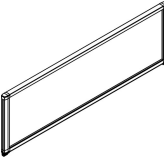
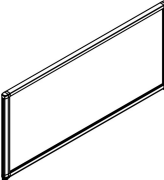
description	application	w	d	h	pattern no.	list	10	15	20	30	35	40	45
 Dual end screens to 43" H	24" D dual	48"	1 1/4"	14"	XTES1 4814F () ()	\$895.	\$916.	\$920.	\$942.	\$958.	\$958.	\$996.	
	30" D dual	60"	1 1/4"	14"	XTES1 6014F () ()	980.	1,005.	1,010.	1,035.	1,057.	1,057.	1,103.	
	36" D dual	72"	1 1/4"	14"	XTES1 7214F () ()	1,006.	1,034.	1,040.	1,074.	1,097.	1,097.	1,155.	
 Dual end screens to 50" H	24" D dual	48"	1 1/4"	21"	XTES1 4821F () ()	967.	987.	992.	1,014.	1,031.	1,031.	1,068.	
	30" D dual	60"	1 1/4"	21"	XTES1 6021F () ()	1,051.	1,076.	1,082.	1,108.	1,129.	1,129.	1,175.	
	36" D dual	72"	1 1/4"	21"	XTES1 7221F () ()	1,065.	1,095.	1,099.	1,132.	1,158.	1,158.	1,211.	
Replacement mast Kit	acrylic center screen				XTSM1C ()	113.							
	slatwall center screen				XTSM1SLAT ()	299.							
End screen brackets (pair)	tapered edge				XTSM1KK ()	199.							
	worksurface												
Side screen brackets (pair)	postformed edge				XTSM1P ()	282.							
	squared edge				XTSM1S ()	199.							

Order Code

Example:	XTES16014F20
	(W2801) 112
XT	Crinion Open Table
ES1	End screen
60	Width
14	Height
F	Surface
20	Fabric grade
W2801	Fabric
112	Frame finish

Specifications

- Tackable fabric surface is suffix F.
 - Select fabric surface finish code from list on page Crinion Open Table.
 - Specify frame finish.
- Frame is clear anodized aluminum or any standard paint finish except 613 Silver.
- Fabric is railroaded.
- Brackets are available in all paint finishes.
- Replacement mast kit is 812 Easy Grey or 111 Black.

Application Notes

Dual end screens clamp to front edge of worksurface on either side of table. Specify 14" H screens for a 43" horizon. Specify 21" H screens for a 50" horizon. Side screens align with center screens when worksurfaces are set at 28 3/8" H.

Specify end screen brackets separately for each screen.

Single sided end screen

Acrylic, Marker or veneer surface

AutoStrada

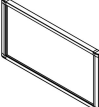
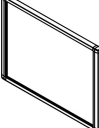
description	application	w	d	h	pattern no.	list	Opal acrylic	Trans. acrylic / Marker	V1	V2	V3	
	Single sided end screens to 43" H	24" D Single sided	24 1/2"	1 1/4"	14"	XTES1 2414 () ()	\$701.	\$721.	\$1,057.	\$1,134.	\$1,248.	
		30" D Single sided	30 1/2"	1 1/4"	14"	XTES1 3014 () ()	736.	761.	1,091.	1,177.	1,325.	
		36" D Single sided	36 1/2"	1 1/4"	14"	XTES1 3614 () ()	801.	833.	1,119.	1,218.	1,397.	
	acrylic shown											
	Single sided end screen to 50" H	24" D single sided	24 1/2"	1 1/4"	21"	XTES1 2421 () ()	801.	833.	1,131.	1,227.	1,391.	
		30" D single sided	30 1/2"	1 1/4"	21"	XTES1 3021 () ()	835.	873.	1,167.	1,279.	1,488.	
		36" D single sided	36 1/2"	1 1/4"	21"	XTES1 3621 () ()	901.	944.	1,200.	1,329.	1,585.	
	acrylic shown											
Single sided end screen brackets (set)	postformed edge					XTSM1PC ()	201.					
	square edge					XTSM1SC ()	149.					
	tapered edge					XTSM1KC ()	149.					

Order Code	Specifications	Application Notes
Example: XTES13614A O 114		
XT Crinion Open Table	1. Specify surface <i>A = Acrylic</i> <i>V = Veneer</i> <i>M = Marker</i>	Single sided end screens clamp to front edge of worksurface and attach to top of channel. Specify 14" H screens for a 42" horizon. Specify 21" H screens for a 49" horizon. Side screens align with center screens when worksurfaces are set at 28 3/8" H.
ES1 End screen	2. For Acrylic surface specify <i>O = Opal</i> <i>T = Translucent</i> Veneer surfaces may be any standard AutoStrada V1,V2 or V3 veneer. Specify veneer finish code from list on table finishes page in beginning of price list.	
36 Width	3. Specify frame finish.	
14 Height	Frame is clear anodized aluminum or any standard paint finish except 613 Silver.	Specify end screen brackets separately for each screen.
A Surface	Brackets are available in all paint finishes.	Veneer grain direction is horizontal.
O Opal		
114 Frame finish		

Single sided end screen

Tackable fabric surface

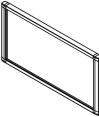
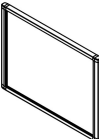
description	application	w	d	h	pattern no.	list	10	15	20	30	35	40	45
	Single sided end screens to 43" H	24" D Single sided	24 1/2"	1 1/4"	14"	XTES1 2414F () () ()	\$796.	\$805.	\$807.	\$820.	\$828.	\$828.	\$846.
		30" D Single sided	30 1/2"	1 1/4"	14"	XTES1 3014F () () ()	820.	833.	835.	849.	859.	859.	880.
		36" D Single sided	36 1/2"	1 1/4"	14"	XTES1 3614F () () ()	844.	859.	877.	889.	889.	889.	917.
	Single sided end screen to 50" H	24" D single sided	24 1/2"	1 1/4"	21"	XTES1 2421F () () ()	832.	842.	843.	854.	863.	863.	880.
		30" D single sided	30 1/2"	1 1/4"	21"	XTES1 3021F () () ()	868.	878.	880.	895.	906.	906.	929.
		36" D single sided	36 1/2"	1 1/4"	21"	XTES1 3621F () () ()	883.	899.	901.	917.	930.	930.	957.
Single sided end screen brackets (set)	postformed edge				XTSM1PC ()	201.							
	square edge				XTSM1SC ()	149.							
	tapered edge				XTSM1KC ()	149.							

Order Code	
Example:	XTES13614F20
	(W2801) 111
XT	Crinion Open Table
ES1	End screen
36	Width
14	Height
F	Surface
20	Fabric grade
W2801	Fabric
111	Frame finish

Specifications
1. Tackable fabric surface is suffix F.
2. Select fabric surface finish code from list on table finishes page in beginning of price list.
3. Specify frame finish.
Frame is clear anodized aluminum or any paint finish except 613 Silver.
Fabric is railroaded.
Brackets are available in all paint finishes.

Application Notes
Single sided end screens clamp to front edge of worksurface and attach to top of channel. Specify 14" H screens for a 43" horizon. Specify 21" H screens for a 50" horizon. Side screens align with center screens when worksurfaces are set at 28 3/8" H.
Specify end screen brackets separately for each screen.

Frameless glass Add up for *Crinion Open Table*

description	w	d	h	pattern number	clear tempered	powder
Frameless glass Add ups	48"	1/2"	12"	XAUA 1248G () ()	\$596.	\$618.
	60"	1/2"	12"	XAUA 1260G () ()	728.	757.
	72"	1/2"	12"	XAUA 1272G () ()	861.	894.

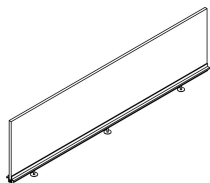

Order Code	Specifications	Application Notes
Example: XAUA 1248G TEMP AA	<i>Add up type:</i>	Frameless glass addups for Crinion Open Table match those available for the AutoStrada spine.
X Crinion Open Table	G Glass	
AUA Frameless addup screen	Glass add-ups are available with the following glass options: TEMP Clear tempered GL13 Powder	Tempered glass in clear or powered finish is 1/2" thick. Base frame is secured with bolts to top channel for frameless glass addups.
48 Width		
12 Height		
G Glass	Specify base finish: AA anodized aluminum and all standard painted finishes except 613 Silver.	Frameless addups cannot be mounted to standard top channel included with base assemblies.
TEMP Finish		
AA Base finish		Base extrusion is clear anodized aluminum or any standard painted finish except Silver.

Morrison Network privacy screens mounting kit for Crinion Open Table

AutoStrada

description	w	d	h	pattern number	list price
Fabric screen mounting kit				XTPS1MZKIT	\$136.



Order Code	Specifications	Applications notes
Example: XTPS1MZKIT		
XT	Crinion Open Table	<p>Crinion Open Tables are designed to accept Morrison Network privacy screens with fabric screen mounting kit. Screens are tackable fabric, $\frac{3}{4}$" thick, in widths corresponding to Crinion worksurfaces 48", 60" or 72" wide. Specify screens MZ1-B4815F, MZ1B6015F or MZ1B7215F.</p> <p>Specify one mounting kit for each screen. Fabric screen mounting kits include two uprights that fasten to the top channel at any point. Uprights slide into internal channels in screens. Fabric screens do not align in height with acrylic privacy screens.</p>
PS1	Privacy Screen	
MZ	Fabric	
KIT	Kit	

Wall Mounting Suggestions

The following information is provided only as a guide, and represents minimum recommendations only. Knoll does not accept responsibility for the attachment of any Knoll product to a Customer's site wall. Wall specification/construction is the responsibility of the Customer and its structural engineer/architect. Failure to properly attach Knoll products to adequate wall structures can lead to property damage and/or personal injury.

You should consult your own structural engineers and/or architects and must not rely on the information provided herein.

It is the responsibility of the Customer and its structural engineers/architects to verify that the permanent structural walls (studs, blocks, solid masonry, etc.) on which the Knoll products are intended to be mounted are designed appropriately to support the product weight, PLUS 3 lbs. per linear inch for each useable shelf length

NOTE: A cabinet's top is considered a "useable shelf" and MUST be included in the calculation of the total load for an overhead cabinet.

It is the responsibility of the Customer and its structural engineer/architects to specify the fasteners and method for attaching the Knoll supplied wall mounting cleat, bracket, frame, etc. to the supporting wall and to confirm that the installers have adhered to these specifications. For all local building standards and codes, and additional requirements (including, but not limited to, seismic conditions) the Customer should always consult local code agencies.

	EXISTING CONSTRUCTION					
	NEW CONSTRUCTION	Cinder Block or Poured Concrete Masonry Wall	Wood Stud Wall, the studs being FULL HEIGHT to the roof/floor above	Wood Stud Wall, the studs being only Ceiling Height	Steel Stud Wall, the studs being FULL HEIGHT to the roof/floor above	Steel Stud Wall, the studs being only Ceiling Height
Stud Specification	Wood studs, grade #2 or better, 3 1/2" minimum width, OR Metal studs, minimum 25 gage thickness, 3 5/8" minimum width	The wall must be a minimum of 6" thick, and must be full height to the roof/ floor structure above	Wood studs must be Grade #2, or better, 3 1/2" minimum width	Wood studs must be Grade #2, or better, 3 1/2" minimum width	Metal studs must be minimum 25 gage thickness, 3 5/8" minimum width	Metal studs must be minimum 25 gage thickness, 3 5/8" minimum width
Stud Centers	Metal and wood studs must be spaced at 16" c/c maximum	N/A	Wood studs must be spaced at 16" c/c maximum	Wood studs must be spaced at 16" c/c maximum"	Metal studs must be spaced at 16" c/c maximum	Metal studs must be spaced at 16" c/c maximum
Stud Height	Metal and wood studs must extend upwards, and be securely attached to the roof/ floor structure above			Wood studs must be braced above the ceiling, and be securely attached to the roof/floor structure above Affix #2 grade 'cap' across the top of the studs, then place diagonal studs from the top cap up to underside of the roof/ floor structure above		Metal studs must be braced above the ceiling, and be securely attached to the roof/floor structure above Affix metal bracing 'cap' across the top of the studs, then place diagonal studs from the top cap up to underside of the roof / floor structure above
Mounting the Knoll Supplied Cleat, Bracket, Frame, etc*	Insert a 2" X 6" wood block, #2 grade or better, [or a Danback™ flexible wood backing system] horizontally between each of the studs to accommodate the full width of the cabinet, and beyond to the next stud. Fasten the wood block to each stud using three screws at the ends of each block. (Fasten the Danback™ as directed by the manufacturer) Fasten the Knoll supplied wall mounting cleat, bracket, frame, etc directly to each wood block every 6" For wall mounting structures that have a rectangular frame-like configuration: fasten the top horizontal element of the frame to the wood blocking every 6", and fasten the lower horizontal element to each wall stud, using one fastener per stud.	Fasten the Knoll supplied cabinet wall mounting cleat, bracket, frame, etc. directly to the masonry wall every 6" For wall mounting structures that have a rectangular frame-like configuration: fasten the top horizontal element of the frame to the wall every 6", and fasten the lower horizontal element to the wall every 16"	In the desired location of the cabinet mounting rail, remove an 8" high section of drywall the width of the cabinet, and beyond to the next stud. Insert a 2" X 6" wood block, #2 grade or better, horizontally between each of the exposed studs. Fasten the wood block to each stud using three screws at the ends of each block. Replace the drywall and repair as desired. Fasten the Knoll supplied wall mounting cleat, rail, frame, etc directly to the wood block every 6" For wall mounting structures that have a rectangular frame-like configuration: fasten the top horizontal element of the frame to the wood blocking every 6", and fasten the lower horizontal element to each wall stud, using one fastener per stud.	In the desired location of the cabinet mounting rail, remove an 8" high section of drywall the width of the cabinet, and beyond to the next stud. Insert a 2" X 6" wood block, #2 grade or better, horizontally between each of the exposed studs. Fasten the wood block to each stud using three screws at the ends of each block. Replace the drywall and repair as desired. Fasten the Knoll supplied wall mounting cleat, rail, frame, etc directly to the wood block every 6" For wall mounting structures that have a rectangular frame-like configuration: fasten the top horizontal element of the frame to the wood blocking every 6", and fasten the lower horizontal element to each wall stud, using one fastener per stud.	In the desired location of the cabinet mounting rail, remove an 8" high section of drywall the width of the cabinet, and beyond to the next stud. Insert a 2" X 6" wood block, #2 grade or better, [or a Danback™ flexible wood backing system] horizontally between each of the exposed studs. Fasten the wood block to each stud using three screws at the ends of each block. Replace the drywall and repair as desired. Fasten the Knoll supplied wall mounting cleat, rail, frame, etc directly to the wood block every 6" For wall mounting structures that have a rectangular frame-like configuration: fasten the top horizontal element of the frame to the wood blocking every 6", and fasten the lower horizontal element to each wall stud, using one fastener per stud.	In the desired location of the cabinet mounting rail, remove an 8" high section of drywall the width of the cabinet, and beyond to the next stud. Insert a 2" X 6" wood block, #2 grade or better, [or a Danback™ flexible wood backing system] horizontally between each of the exposed studs. Fasten the wood block to each stud using three screws at the ends of each block. Replace the drywall and repair as desired. Fasten the Knoll supplied wall mounting cleat, rail, frame, etc directly to the wood block every 6" For wall mounting structures that have a rectangular frame-like configuration: fasten the top horizontal element of the frame to the wood blocking every 6", and fasten the lower horizontal element to each wall stud, using one fastener per stud.
*Graham Wall Hung Shelf	The Graham Wall Hung Shelf Bracket (and others like it) requires full support behind the full height of the bracket This should be accomplished by insertion of additional 2"X 6" wood blocking between the studs as defined above	Fasten the Knoll supplied wall mounting brackets directly to the masonry wall, using the holes provided in each bracket	The Graham Wall Hung Shelf Bracket (and others like it) requires full support behind the full height of the bracket This should be accomplished by insertion of additional 2"X 6" wood blocking between the studs as defined above	The Graham Wall Hung Shelf Bracket (and others like it) requires full support behind the full height of the bracket This should be accomplished by insertion of additional 2"X 6" wood blocking between the studs as defined above	The Graham Wall Hung Shelf Bracket (and others like it) requires full support behind the full height of the bracket This should be accomplished by insertion of additional 2"X 6" wood blocking between the studs as defined above	The Graham Wall Hung Shelf Bracket (and others like it) requires full support behind the full height of the bracket This should be accomplished by insertion of additional 2"X 6" wood blocking between the studs as defined above
Fasten the Knoll supplied wall cleat with...	#10 x 2 1/2" Grabber Woodys Screws or equiv. @ 6" c/c, screwed directly into the wood blocking	3/16" x 3 1/2" Tapcon Masonry Screws or equiv. @ 6" c/c with 1-1/4" embedment, screwed directly into the masonry wall	#10 x 2 1/2" Grabber Woodys Screws or equiv. @ 6" c/c, screwed directly into the wood blocking	#10 x 2 1/2" Grabber Woodys Screws or equiv. @ 6" c/c, screwed directly into the wood blocking	#10 x 2 1/2" Grabber Woodys Screws or equiv. @ 6" c/c, screwed directly into the wood blocking	#10 x 2 1/2" Grabber Woodys Screws or equiv. @ 6" c/c, screwed directly into the wood blocking

Alpha-Numeric Index

<i>pattern no.</i>	<i>page</i>	<i>pattern no.</i>	<i>page</i>	<i>pattern no.</i>	<i>page</i>	<i>pattern no.</i>	<i>page</i>
A1CHLTT102	128	A1PCG4972	89, 113	A2WHOBDD54	216	A2WHOGDD48	216
A1CHLTT108	128	A1SGG4860	89, 113	A2WHOBDD60	216	A2WHOGDD54	216
A1CHLTT114	128	A1SGG4872	89, 113	A2WHOBDD66	216	A2WHOGDD60	216
A1CHLTT120	128	A2PHOBD42	206	A2WHOBDD72	216	A2WHOGDD66	216
A1CHLTT126	128	A2PHOBD48	206	A2WHOBDD78	216	A2WHOGDD72	216
A1CHLTT132	128	A2PHOBD54	206	A2WHOBDD84	216	A2WHOGDD78	216
A1CHLTT138	128	A2PHOBD60	206	A2WHOBDD90	216	A2WHOGDD84	216
A1CHLTT144	128	A2PHOBD66	206	A2WHOBDD96	216	A2WHOGDD90	216
A1CHLTT60	128	A2PHOBD72	206	A2WHOBDO30	215	A2WHOGDD96	216
A1CHLTT66	128	A2PHOBD78	206	A2WHOBDO36	215	A2WHOGDO30	215
A1CHLTT72	128	A2PHOBD84	206	A2WHOBDO42	215	A2WHOGDO36	215
A1CHLTT78	128	A2PHOBD90	206	A2WHOBDO48	215	A2WHOGDO42	215
A1CHLTT84	128	A2PHOBD96	206	A2WHOBDO54	215	A2WHOGDO48	215
A1CHLTT90	128	A2PHOBO42	205	A2WHOBDO60	215	A2WHOGDO54	215
A1CHLTT96	128	A2PHOBO48	205	A2WHOBDO66	215	A2WHOGDO60	215
A1CRTT102	128	A2PHOBO54	205	A2WHOBDO72	215	A2WHOGDO66	215
A1CRTT108	128	A2PHOBO60	205	A2WHOBDO78	215	A2WHOGDO72	215
A1CRTT114	128	A2PHOBO66	205	A2WHOBDO84	215	A2WHOGDO78	215
A1CRTT120	128	A2PHOBO72	205	A2WHOBDO90	215	A2WHOGDO84	215
A1CRTT126	128	A2PHOBO78	205	A2WHOBDO96	215	A2WHOGDO90	215
A1CRTT132	128	A2PHOBO84	205	A2WHOBDO096	215	A2WHOGDO96	215
A1CRTT138	128	A2PHOBO90	205	A2WHOBDO160	217	A2WHOGDO096	215
A1CRTT144	128	A2PHOBO96	205	A2WHOBDO166	217	A2WHOGDO160	217
A1CRTT60	128	A2PHOBT60	207	A2WHOBDO172	217	A2WHOGDO166	217
A1CRTT66	128	A2PHOBT66	207	A2WHOBDO178	217	A2WHOGDO172	217
A1CRTT72	128	A2PHOBT72	207	A2WHOBDO184	217	A2WHOGDO178	217
A1CRTT78	128	A2PHOBT78	207	A2WHOBDO190	217	A2WHOGDO184	217
A1CRTT84	128	A2PHOBT84	207	A2WHOBDO196	217	A2WHOGDO190	217
A1CRTT90	128	A2PHOBT90	207	A2WHOBDS030	212	A2WHOGDO196	217
A1CRTT96	128	A2PHOBT96	207	A2WHOBDS36	212	A2WHOGSD30	212
A1FHETE34	127	A2PHOBT96	207	A2WHOBDS42	212	A2WHOGSD36	212
A1FHETE42	127	A2PHOCD42	206	A2WHOBDS48	212	A2WHOGSD42	212
A1FHETE49	127	A2PHOCD48	206	A2WHOBDS54	212	A2WHOGSD48	212
A1FHETE64	127	A2PHOCD54	206	A2WHOBSD60	212	A2WHOGSD54	212
A1GCTDK60141(L/V/M)	225	A2PHOCD60	206	A2WHOBSD66	212	A2WHOGSD60	212
A1GCTDK60142(L/V/M)	225	A2PHOCD66	206	A2WHOBSD72	212	A2WHOGSD66	212
A1GCTDK72141(L/V/M)	225	A2PHOCD72	206	A2WHOBSD78	212	A2WHOGSD72	212
A1GCTDK72142(L/V/M)	225	A2PHOCD78	206	A2WHOBSD84	212	A2WHOGSD78	212
A1GCTDK90141(L/V/M)	225	A2PHOCD84	206	A2WHOBSD90	212	A2WHOGSD84	212
A1GCTDK90142(L/V/M)	225	A2PHOCD90	206	A2WHOBSD96	212	A2WHOGSD90	212
A1GCTDK96141(L/V/M)	225	A2PHOCD96	206	A2WHOBSD030	211	A2WHOGSD96	212
A1GCTDK96142(L/V/M)	225	A2PHOGO42	205	A2WHOBSD036	211	A2WHOGSD030	211
A1GGPC4234(L/R)	89, 113	A2PHOGO48	205	A2WHOBSD042	211	A2WHOGSD036	211
A1GGPC4934(L/R)	89, 113	A2PHOGO54	205	A2WHOBSD048	211	A2WHOGSD042	211
A1GGSE30(L/R)	89, 113	A2PHOGO60	205	A2WHOBSD054	211	A2WHOGSD048	211
A1GGSPSC30(L/R)	89, 113	A2PHOGO66	205	A2WHOBSD060	211	A2WHOGSD054	211
A1HLETE3442	127	A2PHOGO72	205	A2WHOBSD066	211	A2WHOGSD060	211
A1HLETE3449	127	A2PHOGO78	205	A2WHOBSD072	211	A2WHOGSD066	211
A1HLETE3464	127	A2PHOGO84	205	A2WHOBSD078	211	A2WHOGSD072	211
A1HLETE4249	127	A2PHOGO90	205	A2WHOBSD084	211	A2WHOGSD078	211
A1HLETE4264	127	A2PHOGO96	205	A2WHOBSD090	211	A2WHOGSD084	211
A1HLETE4964	127	A2PHOCT60	207	A2WHOBSD096	211	A2WHOGSD090	211
A1HLPTE3442	127	A2PHOCT66	207	A2WHOBSD96	211	A2WHOGSD96	212
A1HLPTE3449	127	A2PHOCT72	207	A2WHOBST60	213	A2WHOGSD96	212
A1HLPTE3464 (F/T)	127	A2PHOCT78	207	A2WHOBST66	213	A2WHOGSD030	211
A1HLPTE4249	127	A2PHOCT84	207	A2WHOBST72	213	A2WHOGSD036	211
A1HLPTE4264 (F/T)	127	A2PHOCT90	207	A2WHOBST78	213	A2WHOGSD042	211
A1HLPTE4964	127	A2PHOCT96	207	A2WHOBST84	213	A2WHOGSD048	211
A1PGC4260	89, 113	A2WHOBDD30	216	A2WHOBST90	213	A2WHOGSD054	211
A1PGC4272	89, 113	A2WHOBDD36	216	A2WHOBST96	213	A2WHOGSD060	211
A1PGC4960	89, 113	A2WHOBDD42	216	A2WHOGDD30	216	A2WHOGSD066	211
		A2WHOBDD48	216	A2WHOGDD36	216	A2WHOGSD072	212
				A2WHOGDD42	216	A2WHOGSD078	212
				A2WHOGDD48	216	A2WHOGSD084	212
						A2WHOGSD090	212
						A2WHOGSD096	212
						A2WHOGSD102	212
						A2WHOGSD108	212
						A2WHOGSD114	212
						A2WHOGSD120	212
						A2WHOGSD126	212
						A2WHOGSD132	212
						A2WHOGSD138	212
						A2WHOGSD144	212
						A2WHOGSD150	212
						A2WHOGSD156	212
						A2WHOGSD162	212
						A2WHOGSD168	212
						A2WHOGSD174	212
						A2WHOGSD180	212
						A2WHOGSD186	212
						A2WHOGSD192	212
						A2WHOGSD198	212
						A2WHOGSD204	212
						A2WHOGSD210	212
						A2WHOGSD216	212
						A2WHOGSD222	212
						A2WHOGSD228	212
						A2WHOGSD234	212
						A2WHOGSD240	212
						A2WHOGSD246	212
						A2WHOGSD252	212
						A2WHOGSD258	212
						A2WHOGSD264	212
						A2WHOGSD270	212
						A2WHOGSD276	212
						A2WHOGSD282	212
						A2WHOGSD288	212
						A2WHOGSD294	212
						A2WHOGSD300	212
						A2WHOGSD306	212
						A2WHOGSD312	212
						A2WHOGSD318	212
						A2WHOGSD324	212
						A2WHOGSD330	212
						A2WHOGSD336	212
						A2WHOGSD342	212
						A2WHOGSD348	212
						A2WHOGSD354	212
						A2WHOGSD360	212
						A2WHOGSD366	212
						A2WHOGSD372	212
						A2WHOGSD378	212
						A2WHOGSD384	212
						A2WHOGSD390	212
						A2WHOGSD396	212
						A2WHOGSD402	212
						A2WHOGSD408	212
						A2WHOGSD414	212
						A2WHOGSD420	212
						A2WHOGSD426	212
						A2WHOGSD432	212
						A2WHOGSD438	212
						A2WHOGSD444	212
						A2WHOGSD450	212
						A2WHOGSD456	212
						A2WHOGSD462	212
						A2WHOGSD468	212
						A2WHOGSD474	212
						A2WHOGSD480	212
						A2WHOGSD486	212
						A2WHOGSD492	212
						A2WHOGSD498	212
						A2WHOGSD504	212
						A2WHOGSD510	212
						A2WHOGSD516	212
						A2WHOGSD522	212
						A2WHOGSD528	212
						A2WHOGSD534	212
						A2WHOGSD540	212
						A2WHOGSD546	212
						A2WHOGSD552	212
						A2WHOGSD558	212
						A2WHOGSD564	212
						A2WHOGSD570	212
						A2WHOGSD576	212
						A2WHOGSD582	212
						A2WHOGSD588	212
						A2WHOGSD594	212
						A2WHOGSD600	212
						A2WHOGSD606	212
						A2WHOGSD612	212
						A2WHOGSD618	212
						A2WHOGSD624	212
						A2WHOGSD630	212
						A2WHOGSD636	212
						A2WHOGSD642	212
						A2WHOGSD648	212
						A2WHOGSD654	212
						A2WHOGSD660	212
						A2WHOGSD666	212
						A2WHOGSD672	212
						A2WHOGSD678	212
						A2WHOGSD684	212
						A2WHOGSD690	212
						A2WHOGSD696	212
						A2WHOGSD702	212
						A2WHOGSD708	212
						A2WHOGSD714	212
						A2WHOGSD720	212
						A2WHOGSD726	212
						A2WHOGSD732	212
						A2WHOGSD738	212
						A2WHOGSD744	212
						A2WHOGSD750	212
						A2WHOGSD756	212
						A2WHOGSD762	212
						A2WHOGSD768	212
						A2WHOGSD774	212
						A2WHOGSD780	212
						A2WHOGSD786	212
						A2WHOGSD792	212
						A2WHOGSD798	212
						A2WHOGSD804	212
						A2WHOGSD810	212
						A2WHOGSD816	212
						A2WHOGSD822	212
						A2WHOGSD828	212
						A2WHOGSD834	212
						A2WHOGSD840	212
						A2WHOGSD846	212
						A2WHOGSD852	212
						A2WHOGSD858	212
						A2WHOGSD864	212
						A2WHOGSD870	212
						A2WHOGSD876	212
						A2WHOGSD882	212
						A2WHOGSD888	212
						A2WHOGSD894	212
						A2WHOGSD900	212
						A2WHOGSD906	212
						A2WHOGSD912	212
						A2WHOGSD918	212
						A2WHOGSD924	212
						A2WHOGSD930	212

<i>pattern no.</i>	<i>page</i>	<i>pattern no.</i>	<i>page</i>	<i>pattern no.</i>	<i>page</i>	<i>pattern no.</i>	<i>page</i>
A3CPBS	178	AAMTC72	250	AAWS C0748	31	AAWS C1530 G	35
AA1 30E	86	AAMTCH24	250	AAWS C0748 A	27	AAWS C1530 L	26
AA1 39E	86	AAMTCH30	250	AAWS C0748 F	29	AAWS C1530 M	24
AA1 48E	86	AAMTCH36	250	AAWS C0748 M	24	AAWS C1530 P	33
AA1 64E	86	AAMTCH42	250	AAWS C0748 P	33	AAWS C1536	31
AA1 ARE	71	AAMTCH48	250	AAWS C0748 R	22	AAWS C1536 A	27
AA1 BS	251	AAMTCH54	250	AAWS C0748 S	23	AAWS C1536 F	29
AA1 T06	86	AAMTCH60	250	AAWS C0754	31	AAWS C1536 G	35
AA1 T18	86	AAMTCH66	250	AAWS C0754 A	27	AAWS C1536 L	26
AA1 T24	86	AAMTCH72	250	AAWS C0754 F	29	AAWS C1536 M	24
AA1 T30	86	AAMTT	250	AAWS C0754 M	24	AAWS C1536 P	33
AA1 T36	86	AAV1 4824 S2D1F	184	AAWS C0754 P	33	AAWS C1542	31
AA1 T42	86	AAV1 4830 S2D1F	184	AAWS C0754 R	22	AAWS C1542 A	27
AA1 T48	86	AAV1 6424 S2D2F	184	AAWS C0754 S	23	AAWS C1542 F	29
AA1 T60	86	AAV1 6430 S2D2F	184	AAWS C0760	31	AAWS C1542 G	35
AA1 T72	87	AAWS BC 036	19	AAWS C0760 A	27	AAWS C1542 L	26
AA1ARODN	220	AAWS BC 042	19	AAWS C0760 F	29	AAWS C1542 M	24
AA1CET39	70	AAWS BC 048	19	AAWS C0760 M	24	AAWS C1542 P	33
AA1CET48	70	AAWS BC 054	19	AAWS C0760 P	33	AAWS C1548	31
AA1CET64	70	AAWS BC 060	19	AAWS C0760 R	22	AAWS C1548 A	27
AA1DHPS36(5)	76	AAWS BC 066	19	AAWS C0760 S	23	AAWS C1548 F	29
AA1DHPS42(5)	76	AAWS BC 072	19	AAWS C0766	31	AAWS C1548 G	35
AA1DHPS50(5)	76	AAWS BC 078	19	AAWS C0766 A	27	AAWS C1548 L	26
AA1DHPS57(5)	76	AAWS BC 084	19	AAWS C0766 F	29	AAWS C1548 M	24
AA1DHPS64(5)	76	AAWS BC 090	19	AAWS C0766 M	24	AAWS C1548 P	33
AA1DHTC	76	AAWS BC 096	19	AAWS C0766 P	33	AAWS C1554	31
AA1GPS	75	AAWS BC 102	19	AAWS C0766 R	22	AAWS C1554 A	27
AA1MPS30	70	AAWS BC 108	19	AAWS C0766 S	23	AAWS C1554 F	29
AA1MPS39	70	AAWS BC 114	19	AAWS C0772	31	AAWS C1554 G	35
AA1MPS42	70	AAWS BC 120	19	AAWS C0772 A	27	AAWS C1554 L	26
AA1MPS48	70	AAWS BC 126	19	AAWS C0772 F	29	AAWS C1554 M	24
AA1MPS56	70	AAWS BC 132	19	AAWS C0772 M	24	AAWS C1554 P	33
AA1MPS64	70	AAWS BC 138	19	AAWS C0772 P	33	AAWS C1560	31
AA1MPS74	70	AAWS BC 144	19	AAWS C0772 R	22	AAWS C1560 A	27
AA1MPS80	70	AAWS BE	37, 38	AAWS C0772 S	23	AAWS C1560 F	29
AA1MRS	70	AAWS BE27	44	AAWS C0778	31	AAWS C1560 G	35
AA1NSK	87	AAWS BE28	44	AAWS C0778 F	29	AAWS C1560 L	26
AA1OR	60	AAWS C0724	31	AAWS C0778 P	33	AAWS C1560 M	24
AA1ORD	60	AAWS C0724 A	27	AAWS C0778 R	22	AAWS C1560 P	33
AA1RE	87	AAWS C0724 F	29	AAWS C0778 S	23	AAWS C1566	31
AA1ROUP	220	AAWS C0724 M	24	AAWS C0784	31	AAWS C1566 A	27
AA1ROXUP	220	AAWS C0724 P	33	AAWS C0784 F	29	AAWS C1566 F	29
AA1RPS34	72	AAWS C0724 R	22	AAWS C0784 P	33	AAWS C1566 G	35
AA1RPS42	72	AAWS C0724 S	23	AAWS C0784 R	22	AAWS C1566 L	26
AA1RPS49	72	AAWS C0730	31	AAWS C0784 S	23	AAWS C1566 M	24
AA1RPS64	72	AAWS C0730 A	27	AAWS C0790	31	AAWS C1566 P	33
AA1RPS79	72	AAWS C0730 F	29	AAWS C0790 F	29	AAWS C1572	31
AA1RTC	73	AAWS C0730 M	24	AAWS C0790 P	33	AAWS C1572 A	27
AA1UA39	77	AAWS C0730 P	33	AAWS C0790 R	22	AAWS C1572 F	29
AA1UA48	77	AAWS C0730 R	22	AAWS C0790 S	23	AAWS C1572 G	35
AA1UA64	77	AAWS C0730 S	23	AAWS C0796	31	AAWS C1572 L	26
AA1UPS39	77	AAWS C0736	31	AAWS C0796 F	29	AAWS C1572 M	24
AA1UPS48	77	AAWS C0736 A	27	AAWS C0796 P	33	AAWS C1572 P	33
AA1UPS64	77	AAWS C0736 F	29	AAWS C0796 R	22	AAWS C1578	31
AA2 MTC	70	AAWS C0736 M	24	AAWS C0796 S	23	AAWS C1578 F	29
AA2 UTC	77	AAWS C0736 P	33	AAWS C1524	31	AAWS C1578 L	26
AAMTB	250	AAWS C0736 R	22	AAWS C1524 A	27	AAWS C1578 P	33
AAMTC24	250	AAWS C0736 S	23	AAWS C1524 F	29	AAWS C1584	31
AAMTC30	250	AAWS C0742	31	AAWS C1524 G	35	AAWS C1584 F	29
AAMTC36	250	AAWS C0742 A	27	AAWS C1524 L	26	AAWS C1584 L	26
AAMTC42	250	AAWS C0742 F	29	AAWS C1524 M	24	AAWS C1584 P	33
AAMTC48	250	AAWS C0742 M	24	AAWS C1524 P	33	AAWS C1590	31
AAMTC54	250	AAWS C0742 P	33	AAWS C1530	31	AAWS C1590 F	29
AAMTC60	250	AAWS C0742 R	22	AAWS C1530 A	27	AAWS C1590 L	26
AAMTC66	250	AAWS C0742 S	23	AAWS C1530 F	29	AAWS C1590 P	33

<i>pattern no.</i>	<i>page</i>	<i>pattern no.</i>	<i>page</i>	<i>pattern no.</i>	<i>page</i>	<i>pattern no.</i>	<i>page</i>
AAWS C1596	31	AAWS C2272 M	24	AAWS C3078 P	34	AAWS ET 91	20
AAWS C1596 F	29	AAWS C2272 P	34	AAWS C3084	32	AAWS ET 99	20
AAWS C1596 L	26	AAWS C2278	32	AAWS C3084 F	30	AAWS ETO 69	20
AAWS C1596 P	33	AAWS C2278 F	30	AAWS C3084 P	34	AAWS ETO 84	20
AAWS C2224	32	AAWS C2278 L	26	AAWS C3090	32	AAWS F2236	14
AAWS C2224 A	28	AAWS C2278 P	34	AAWS C3090 F	30	AAWS F2248	14
AAWS C2224 F	30	AAWS C2284	32	AAWS C3090 P	34	AAWS F3036	14
AAWS C2224 G	35	AAWS C2284 F	30	AAWS C3096	32	AAWS F3048	14
AAWS C2224 L	26	AAWS C2284 L	26	AAWS C3096 F	30	AAWS F6936	14
AAWS C2224 M	24	AAWS C2284 P	34	AAWS C3096 P	34	AAWS F6948	14
AAWS C2224 P	34	AAWS C2290	32	AAWS C4524 M	25	AAWS F8436	14
AAWS C2230	32	AAWS C2290 F	30	AAWS C4530 M	25	AAWS F8448	14
AAWS C2230 A	28	AAWS C2290 L	26	AAWS C4536 M	25	AAWS IBT	20
AAWS C2230 F	30	AAWS C2290 P	34	AAWS C4542 M	25	AAWS IC 024	18
AAWS C2230 G	35	AAWS C2296	32	AAWS C4548 M	25	AAWS IC 030	18
AAWS C2230 L	26	AAWS C2296 F	30	AAWS C4554 M	25	AAWS IC 036	18
AAWS C2230 M	24	AAWS C2296 L	26	AAWS C4560 M	25	AAWS IC 042	18
AAWS C2230 P	34	AAWS C2296 P	34	AAWS C4566 M	25	AAWS IC 048	18
AAWS C2236	32	AAWS C3024	32	AAWS C4572 M	25	AAWS IC 054	18
AAWS C2236 A	28	AAWS C3024 A	28	AAWS CC 036	17	AAWS IC 060	18
AAWS C2236 F	30	AAWS C3024 F	30	AAWS CC 042	17	AAWS IC 066	18
AAWS C2236 G	35	AAWS C3024 M	24	AAWS CC 048	17	AAWS IC 072	18
AAWS C2236 L	26	AAWS C3024 P	34	AAWS CC 054	17	AAWS IC 078	18
AAWS C2236 M	24	AAWS C3030	32	AAWS CC 060	17	AAWS IC 084	18
AAWS C2236 P	34	AAWS C3030 A	28	AAWS CC 066	17	AAWS IC 090	18
AAWS C2242	32	AAWS C3030 F	30	AAWS CC 072	17	AAWS IC 096	18
AAWS C2242 A	28	AAWS C3030 M	24	AAWS CC 078	17	AAWS IC 102	18
AAWS C2242 F	30	AAWS C3030 P	34	AAWS CC 084	17	AAWS IC 108	18
AAWS C2242 G	35	AAWS C3036	32	AAWS CC 090	17	AAWS IC 114	18
AAWS C2242 L	26	AAWS C3036 A	28	AAWS CC 096	17	AAWS IC 120	18
AAWS C2242 M	24	AAWS C3036 F	30	AAWS CC 102	17	AAWS IC 126	18
AAWS C2242 P	34	AAWS C3036 M	24	AAWS CC 108	17	AAWS IC 132	18
AAWS C2248	32	AAWS C3036 P	34	AAWS CC 114	17	AAWS IC 138	18
AAWS C2248 A	28	AAWS C3042	32	AAWS CC 120	17	AAWS IC 144	18
AAWS C2248 F	30	AAWS C3042 A	28	AAWS CC 126	17	AAWS LS2409 G	37
AAWS C2248 G	35	AAWS C3042 F	30	AAWS CC 132	17	AAWS LS2412	38
AAWS C2248 L	26	AAWS C3042 M	24	AAWS CC 138	17	AAWS LS3009 G	37
AAWS C2248 M	24	AAWS C3042 P	34	AAWS CC 144	17	AAWS LS3012	38
AAWS C2248 P	34	AAWS C3048	32	AAWS CG	46	AAWS LS3609 G	37
AAWS C2254	32	AAWS C3048 A	28	AAWS CH	46	AAWS LS3612	38
AAWS C2254 A	28	AAWS C3048 F	30	AAWS CT24	44	AAWS LS4209 G	37
AAWS C2254 F	30	AAWS C3048 M	24	AAWS CT30	44	AAWS LS4212	38
AAWS C2254 G	35	AAWS C3048 P	34	AAWS CT36	44	AAWS LS4809 G	37
AAWS C2254 L	26	AAWS C3054	32	AAWS CT42	44	AAWS LS4812	38
AAWS C2254 M	24	AAWS C3054 A	28	AAWS CT48	44	AAWS LS5409 G	37
AAWS C2254 P	34	AAWS C3054 F	30	AAWS CT54	44	AAWS LS5412	38
AAWS C2260	32	AAWS C3054 M	24	AAWS CT60	44	AAWS LS6009 G	37
AAWS C2260 A	28	AAWS C3054 P	34	AAWS CT66	44	AAWS LS6012	38
AAWS C2260 F	30	AAWS C3060	32	AAWS CT72	44	AAWS LS6609 G	37
AAWS C2260 G	35	AAWS C3060 A	28	AAWS DS0605	36	AAWS LS6612	38
AAWS C2260 L	26	AAWS C3060 F	30	AAWS DS2405	36	AAWS LS7209 G	37
AAWS C2260 M	24	AAWS C3060 M	24	AAWS DS3005	36	AAWS LS7212	38
AAWS C2260 P	34	AAWS C3060 P	34	AAWS DS3605	36	AAWS MT24	46
AAWS C2266	32	AAWS C3066	32	AAWS DS4205	36	AAWS MT30	46
AAWS C2266 A	28	AAWS C3066 A	28	AAWS DS4805	36	AAWS MT36	46
AAWS C2266 F	30	AAWS C3066 F	30	AAWS DS5405	36	AAWS MT42	46
AAWS C2266 G	35	AAWS C3066 M	24	AAWS DS6005	36	AAWS MT48	46
AAWS C2266 L	26	AAWS C3066 P	34	AAWS DS6605	36	AAWS MT54	46
AAWS C2266 M	24	AAWS C3072	32	AAWS DS7205	36	AAWS MT60	46
AAWS C2266 P	34	AAWS C3072 A	28	AAWS EASEL	46	AAWS MT66	46
AAWS C2272	32	AAWS C3072 F	30	AAWS ET 106	20	AAWS MT72	46
AAWS C2272 A	28	AAWS C3072 M	24	AAWS ET 114	20	AAWS OBD 18L	42
AAWS C2272 F	30	AAWS C3072 P	34	AAWS ET 144	20	AAWS OBD 18R	42
AAWS C2272 G	35	AAWS C3078	32	AAWS ET 69	20	AAWS OBD 24	42
AAWS C2272 L	26	AAWS C3078 F	30	AAWS ET 84	20	AAWS OBD 30	42

<i>pattern no.</i>	<i>page</i>	<i>pattern no.</i>	<i>page</i>	<i>pattern no.</i>	<i>page</i>	<i>pattern no.</i>	<i>page</i>
AAWS OBD 36	42	AAWS OGO 48	39	AAWS TU 096	16	AB1AS30	254
AAWS OBD 42	42	AAWS OGO 54	39	AAWS TU 102	16	AB1ASC27	254
AAWS OBD 48	42	AAWS OGO 60	39	AAWS TU 108	16	AB1ASC28	254
AAWS OBD 54	42	AAWS OGO 66	39	AAWS TU 114	16	AB1ASC30	254
AAWS OBD 60	42	AAWS OGO 72	39	AAWS TU 120	16	AB1AW27	254
AAWS OBD 66	42	AAWS OGO 78	39	AAWS TU 126	16	AB1AW28	254
AAWS OBD 72	42	AAWS OGO 84	39	AAWS TU 132	16	AB2 AE	251
AAWS OBD 78	42	AAWS OGO 90	39	AAWS TU 138	16	AB2 FE27	251
AAWS OBD 84	42	AAWS OGO 96	39	AAWS TU 144	16	AB2 FE28	251
AAWS OBD 90	42	AAWS OGR 42	40	AAWS US2409 G	37	ABAC3423	256
AAWS OBD 96	42	AAWS OGR 48	40	AAWS US2412	38	ABAC3429	256
AAWS OBO 18	39	AAWS OGR 54	40	AAWS US3009 G	37	ABAC4023	256
AAWS OBO 24	39	AAWS OGR 60	40	AAWS US3012	38	ABAC4029	256
AAWS OBO 30	39	AAWS OGR 66	40	AAWS US3609 G	37	ABAC4623	256
AAWS OBO 36	39	AAWS OGR 72	40	AAWS US3612	38	ABAC4629	256
AAWS OBO 42	39	AAWS OGR 78	40	AAWS US4209 G	37	ABAC5223	256
AAWS OBO 48	39	AAWS OGR 84	40	AAWS US4212	38	ABAC5229	256
AAWS OBO 54	39	AAWS OGR 90	40	AAWS US4809 G	37	ABAC5823	256
AAWS OBO 60	39	AAWS OGR 96	40	AAWS US4812	38	ABAC5829	256
AAWS OBO 66	39	AAWS OGS 42	41	AAWS US5409 G	37	ABAC6423	256
AAWS OBO 72	39	AAWS OGS 48	41	AAWS US5412	38	ABAC6429	256
AAWS OBO 78	39	AAWS OGS 54	41	AAWS US6009 G	37	ABAC7023	256
AAWS OBO 84	39	AAWS OGS 60	41	AAWS US6012	38	ABAC7029	256
AAWS OBO 90	39	AAWS OGS 66	41	AAWS US6609 G	37	ABAT4629	256
AAWS OBO 96	39	AAWS OGS 72	41	AAWS US6612	38	ABAT5229	256
AAWS OBR 42	40	AAWS OGS 78	41	AAWS US7209 G	37	ABAT5829	256
AAWS OBR 48	40	AAWS OGS 84	41	AAWS US7212	38	ABAT6429	256
AAWS OBR 54	40	AAWS OGS 90	41	AAWS VFC	20	ABAT7029	256
AAWS OBR 60	40	AAWS OGS 96	41	AAWS WMC	46	AC1 39L2	85
AAWS OBR 66	40	AAWS PH	46	AAWS WOMK 18	43	AC1 39T3	85
AAWS OBR 72	40	AAWS RET	22	AAWS WOMK 24	43	AC1 39V2	85
AAWS OBR 78	40	AAWS RO MK	43	AAWS WOMK 30	43	AC1 39X4	85
AAWS OBR 84	40	AAWS RPM1 05	45	AAWS WOMK 36	43	AC1 39Y3	85
AAWS OBR 90	40	AAWS RPM2 02	45	AAWS WOMK 42	43	AC1 48L2	85
AAWS OBR 96	40	AAWS RPM2 05	45	AAWS WOMK 48	43	AC1 48T3	85
AAWS OBS 42	41	AAWS RPM2I 05	45	AAWS WOMK 54	43	AC1 48V2	85
AAWS OBS 48	41	AAWS TC 036	15	AAWS WOMK 60	43	AC1 48X4	85
AAWS OBS 54	41	AAWS TC 042	15	AAWS WOMK 66	43	AC1 48Y3	86
AAWS OBS 60	41	AAWS TC 048	15	AAWS WOMK 72	43	AC1 64L2	85
AAWS OBS 66	41	AAWS TC 054	15	AAWS WOMK 78	43	AC1 64T3	85
AAWS OBS 72	41	AAWS TC 060	15	AAWS WOMK 84	43	AC1 64V2	85
AAWS OBS 78	41	AAWS TC 066	15	AAWS WOMK 90	43	AC1 64X4	85
AAWS OBS 84	41	AAWS TC 072	15	AAWS WOMK 96	43	AC1 64Y3	86
AAWS OBS 90	41	AAWS TC 078	15	AAWSIL106	21	ACA1 30E1	86
AAWS OBS 96	41	AAWS TC 084	15	AAWSIL114	21	ACA1 39E1	86
AAWS OGD 18L	42	AAWS TC 090	15	AAWSIL144	21	ACA1 48E1	86
AAWS OGD 18R	42	AAWS TC 096	15	AAWSIL69	21	ACA1 64E1	86
AAWS OGD 24	42	AAWS TC 102	15	AAWSIL84	21	ACAL4224	163
AAWS OGD 30	42	AAWS TC 108	15	AAWSIL91	21	ACAL4226	163
AAWS OGD 36	42	AAWS TC 114	15	AAWSIL99	21	ACAL4230	163
AAWS OGD 42	42	AAWS TC 120	15	AAWSILO69	21	ACAL4232	163
AAWS OGD 48	42	AAWS TC 126	15	AAWSILO84	21	ACAL4924	163
AAWS OGD 54	42	AAWS TC 132	15	AAWSOL106	21	ACAL4926	163
AAWS OGD 60	42	AAWS TC 138	15	AAWSOL114	21	ACAL4930	163
AAWS OGD 66	42	AAWS TC 144	15	AAWSOL144	21	ACAL4932	163
AAWS OGD 72	42	AAWS TU 036	16	AAWSOL69	21	ACAR4224	163
AAWS OGD 78	42	AAWS TU 042	16	AAWSOL84	21	ACAR4226	163
AAWS OGD 84	42	AAWS TU 048	16	AAWSOL91	21	ACAR4230	163
AAWS OGD 90	42	AAWS TU 054	16	AAWSOL99	21	ACAR4232	163
AAWS OGD 96	42	AAWS TU 060	16	AAWSOLO69	21	ACAR4924	163
AAWS OGO 18	39	AAWS TU 066	16	AAWSOLO84	21	ACAR4926	163
AAWS OGO 24	39	AAWS TU 072	16	ABI AC24	251	ACAR4930	163
AAWS OGO 30	39	AAWS TU 078	16	ABI-ABC24	251	ACAR4932	163
AAWS OGO 36	39	AAWS TU 084	16	AB1AS27	254	ACBL4224	164
AAWS OGO 42	39	AAWS TU 090	16	AB1AS28	254	ACBL4226	164

<i>pattern no.</i>	<i>page</i>	<i>pattern no.</i>	<i>page</i>	<i>pattern no.</i>	<i>page</i>	<i>pattern no.</i>	<i>page</i>
ACBL4230	164	ACFR4926	171	ACJ822WE	180	ADHMH7212	260
ACBL4232	164	ACFR4930	171	ACJ823WE	180	ADHMH7220	260
ACBL4924	164	ACFR4932	171	ACKL722WE	181	ADHMH7222	260
ACBL4926	164	ACFR6424	171	ACKL723WE	181	ADHMH7230	260
ACBL4930	164	ACFR6426	172	ACKL822WE	181	ADHMH7240	260
ACBL4932	164	ACFR6430	171	ACKL823WE	181	ADHMH7310	260
ACBR4224	164	ACFR6432	172	ACKR722WE	181	ADHMH7311	260
ACBR4226	164	ACGL4924	175	ACKR723WE	181	ADHMH7312	260
ACBR4230	164	ACGL4926	175	ACKR822WE	181	ADHMH7313	260
ACBR4232	164	ACGL4930	175	ACKR823WE	181	ADHMH7320	260
ACBR4924	164	ACGL4932	175	ACL722M	181	ADHMH7322	260
ACBR4926	164	ACGL6424	175	ACL722W	181	ADHMH7323	260
ACBR4930	164	ACGL6426	175	ACL723M	181	ADHMH7330	260
ACBR4932	164	ACGL6430	175	ACL723W	181	ADHMH7340	260
ACCL4224	165	ACGL6432	175	ACL822M	181	ADHMH8410	260
ACCL4226	165	ACGR4924	175	ACL822W	181	ADHMH8411	260
ACCL4230	165	ACGR4926	175	ACL823M	181	ADHMH8412	260
ACCL4232	165	ACGR4930	175	ACL823W	181	ADHMH8413	260
ACCL4924	165	ACGR4932	175	ACMCL	267	ADHMH8414	260
ACCL4926	165	ACGR6424	175	ACMML722	182	ADHMH8420	260
ACCL4930	165	ACGR6426	175	ACMML723	182	ADHMH8422	260
ACCL4932	165	ACGR6430	175	ACMML822	182	ADHMH8423	260
ACCR4224	165	ACGR6432	175	ACMML823	182	ADHMH8424	260
ACCR4226	165	ACHL4924M	176	ACMMR722	182	ADHMH8430	260
ACCR4230	165	ACHL4924W	177	ACMMR723	182	ADHMH8440	260
ACCR4232	165	ACHL4926M	176	ACMMR822	182	ADHMH9010	260
ACCR4924	165	ACHL4926W	177	ACMMR823	182	ADHMH9011	260
ACCR4926	165	ACHL4930M	176	ACMWL722	182	ADHMH9012	260
ACCR4930	165	ACHL4930W	177	ACMWL723	182	ADHMH9013	260
ACCR4932	165	ACHL4932M	176	ACMWL822	182	ADHMH9014	260
ACDL4924	166	ACHL4932W	177	ACMWL823	182	ADHMH9020	260
ACDL4926	166	ACHL6424M	176	ACMWR722	182	ADHMH9022	261
ACDL4930	166	ACHL6424W	177	ACMWR723	182	ADHMH9023	261
ACDL4932	166	ACHL6426M	176	ACMWR822	182	ADHMH9024	261
ACDR4924	166	ACHL6426W	177	ACMWR823	182	ADHMH9030	260
ACDR4926	166	ACHL6430M	176	ACW722	183	ADHMH9033	261
ACDR4930	166	ACHL6430W	177	ACW723	183	ADHMH9040	260
ACDR4932	166	ACHL6432M	176	ACW822	183	ADHMH9610	260
ACEL4924	169	ACHL6432W	177	ACW823	183	ADHMH9611	261
ACEL4926	169	ACHR4924M	176	ACWJ(L/R)4224	167	ADHMH9612	261
ACEL4930	169	ACHR4924W	177	ACWJ(L/R)4226	167	ADHMH9613	261
ACEL4932	169	ACHR4926M	176	ACWJ(L/R)4230	167	ADHMH9614	261
ACEL6424	169	ACHR4926W	177	ACWJ(L/R)4232	167	ADHMH9620	260
ACEL6426	169	ACHR4930M	176	ACWJ(L/R)4924	167	ADHMH9622	261
ACEL6430	169	ACHR4930W	177	ACWJ(L/R)4926	167	ADHMH9623	261
ACEL6432	169	ACHR4932M	176	ACWJ(L/R)4930	167	ADHMH9624	261
ACER4924	169	ACHR4932W	177	ACWJ(L/R)4932	167	ADHMH9630	260
ACER4926	169	ACHR6424M	176	ACWJ(L/R)6424	167	ADHMH9633	261
ACER4930	169	ACHR6424W	177	ACWJ(L/R)6426	167	ADHMH9634	261
ACER4932	169	ACHR6426M	176	ACWJ(L/R)6430	167	ADHMH9640	260
ACER6424	169	ACHR6426W	177	ACWJ(L/R)6432	167	ADS 0821	55
ACER6426	170	ACHR6430M	176	ACWK(L/R)4224	168	ADS 0824	55
ACER6430	169	ACHR6430W	177	ACWK(L/R)4226	168	ADS 0833	55
ACER6432	170	ACHR6432M	176	ACWK(L/R)4230	168	ADS 0836	55
ACF1	266	ACHR6432W	177	ACWK(L/R)4232	168	ADS 0845	55
ACFG1	266	ACHL4930	173	ACWK(L/R)4924	168	ADS 0848	55
ACFL4924	171	ACHL4932	173	ACWK(L/R)4926	168	ADS 0857	55
ACFL4926	171	ACHL6430	174	ACWK(L/R)4930	168	ADS 0860	55
ACFL4930	171	ACHL6432	174	ACWK(L/R)4932	168	ADS 0869	55
ACFL4932	171	ACIR4930	173	ACWK(L/R)6424	168	ADS 0872	55
ACFL6424	171	ACIR4932	173	ACWK(L/R)6426	168	AFB16	195
ACFL6426	171	ACIR6430	174	ACWK(L/R)6430	168	AFB19	195
ACFL6430	171	ACIR6432	174	ACWK(L/R)6432	168	AFB30	195
ACFL6432	171	ACJ722WE	180	ADHMH7210	260	AFB36	195
ACFR4924	171	ACJ723WE	180	ADHMH7211	260	AFB42	195

<i>pattern no.</i>	<i>page</i>	<i>pattern no.</i>	<i>page</i>	<i>pattern no.</i>	<i>page</i>	<i>pattern no.</i>	<i>page</i>
AFB60	195	AFPR10(E/P)M	197	AIP1361	246	AMB42R484	142
AFB72	195	AFPR10(E/P)W	196	AIP1362	246	AMB42R485	143
AFB84	195	AFPR11(E/P)M	197	AIPO301	246	AMB42R544	142
AFB90	195	AFPR11(E/P)W	196	AIPO302	246	AMB42R545	143
AFB96	195	AFPR12(E/P)M	197	AIPO361	246	AMB42R604	142
AFPA12	196	AFPR12(E/P)W	196	AIPO362	246	AMB42R605	143
AFPA13	196	AFPR13(E/P)M	197	ALIT5E19S	222	AMB42R664	142
AFPA22	196	AFPR13(E/P)W	196	ALIT5E25A	222	AMB42R665	143
AFPA23	196	AFPR20(E/P)M	197	ALIT5E25S	222	AMB42R724	142
AFPB10(E/P)(M)	192	AFPR20(E/P)W	196	ALIT5E37A	222	AMB42R725	143
AFPB10(E/P)(W)	190	AFPR21(E/P)M	197	ALIT5E37S	222	AMB42R784	142
AFPB11(E/P)(M)	192	AFPR21(E/P)W	196	ALIT5E49A	222	AMB42R785	143
AFPB11(E/P)(W)	190	AFPR22(E/P)M	197	ALIT5E49S	222	AMB42R844	142
AFPB20(E/P)(M)	192	AFPR22(E/P)W	196	ALIT5E61A	222	AMB42R845	143
AFPB20(E/P)(W)	190	AFPR23(E/P)M	197	ALIT5E61S	222	AMB42R904	142
AFPB21(E/P)(M)	192	AFPR23(E/P)W	196	ALIT5E73A	222	AMB42R905	143
AFPB21(E/P)(W)	190	AG1B	75	ALIT5E73S	222	AMB42R964	142
AFPB30(E/P)(M)	192	AG1B3920	88	ALIT5E85A	222	AMB42R965	143
AFPB30(E/P)(W)	190	AG1B3924	88	ALIT5E85S	222	AMBE604	154
AFPB31(E/P)(M)	192	AG1B3930	88	AL4L17	222	AMBE605	154
AFPB31(E/P)(W)	190	AG1B3936	88	AL4L31	222	AMBE664	154
AFPE12(L/R)(E/P)	198	AG1B3942	88	AL4L44	222	AMBE665	154
AFPE13(L/R)(E/P)	198	AG1B3948	88	AL4L58	222	AMBE724	154
AFPE22(L/R)(E/P)	198	AG1B3954	88	ALBL24	258	AMBE725	154
AFPE23(L/R)(E/P)	198	AG1B3960	88	ALBL30	258	AMBE784	154
AFPF10(E/P)(M)	192	AG1B3966	88	ALBL36	258	AMBE785	154
AFPF10(E/P)(W)	190	AG1B3972	88	ALBR24	258	AMBE844	154
AFPF11(E/P)(M)	192	AG1B3978	88	ALBR30	258	AMBE845	154
AFPF11(E/P)(W)	190	AG1B3984	88	ALBR36	258	AMBE904	154
AFPF12(E/P)(M)	192	AG1B3990	88	AMB42E604	146	AMBE905	154
AFPF12(E/P)(W)	190	AG1B3996	88	AMB42E605	146	AMBE964	154
AFPF13(E/P)(M)	192	AG1B4920	88	AMB42E664	146	AMBE965	154
AFPF13(E/P)(W)	190	AG1B4924	88	AMB42E665	146	AMBL424	150
AFPF14(E/P)(W)	190	AG1B4930	88	AMB42E724	146	AMBL425	151
AFPF20(E/P)(M)	192	AG1B4936	88	AMB42E725	146	AMBL484	150
AFPF20(E/P)(W)	190	AG1B4942	88	AMB42E784	146	AMBL485	151
AFPF21(E/P)(M)	192	AG1B4948	88	AMB42E785	146	AMBL544	150
AFPF21(E/P)(W)	190	AG1B4954	88	AMB42E844	146	AMBL545	151
AFPF22(E/P)(M)	192	AG1B4960	88	AMB42E845	146	AMBL604	150
AFPF22(E/P)(W)	190	AG1B4966	88	AMB42E904	146	AMBL605	151
AFPF23(E/P)(M)	192	AG1B4972	88	AMB42E905	146	AMBL664	150
AFPF23(E/P)(W)	190	AG1B4978	88	AMB42E964	146	AMBL665	151
AFPF24(E/P)(W)	190	AG1B4984	88	AMB42E965	146	AMBL724	150
AFPF30(E/P)(M)	192	AG1B4990	88	AMB42L424	142	AMBL725	151
AFPF30(E/P)(W)	190	AG1B4996	88	AMB42L425	143	AMBL784	150
AFPF31(E/P)(M)	192	AHHSM36	259	AMB42L484	142	AMBL785	151
AFPF31(E/P)(W)	190	AHHSM42	259	AMB42L485	143	AMBL844	150
AFPH12(E/P)(L/N)(W)	194	AHHSM48	259	AMB42L544	142	AMBL845	151
AFPH13(E/P)(L/N)(W)	194	AHHSM54	259	AMB42L545	143	AMBL904	150
AFPH14(E/P)(L/N)(W)	194	AHHSM60	259	AMB42L604	142	AMBL905	151
AFPH22(E/P)(L/N)(W)	194	AHHSM66	259	AMB42L605	143	AMBL964	150
AFPH23(E/P)(L/N)(W)	194	AHHSM72	259	AMB42L664	142	AMBL965	151
AFPH24(E/P)(L/N)(W)	194	AHHSM78	259	AMB42L665	143	AMBR424	150
AFPHD12(E/P)W	196	AHHSM84	259	AMB42L724	142	AMBR425	151
AFPHD13(E/P)W	196	AHHSM90	259	AMB42L725	143	AMBR484	150
AFPHD22(E/P)W	196	AHHSM96	259	AMB42L784	142	AMBR485	151
AFPHD23(E/P)W	196	AHLTTE18	127	AMB42L785	143	AMBR544	150
AFPHL10(E/P)(L/N)(W)	194	AHLTTE20	127	AMB42L844	142	AMBR545	151
AFPHL11(E/P)(L/N)(W)	194	AHLTTE24	127	AMB42L845	143	AMBR604	150
AFPHL20(E/P)(L/N)(W)	194	AHLTTE30	127	AMB42L904	142	AMBR605	151
AFPHL21(E/P)(L/N)(W)	194	AHLTTE36	127	AMB42L905	143	AMBR664	150
AFPHR10(E/P)(L/N)(W)	194	AHLTTE42	127	AMB42L964	142	AMBR665	151
AFPHR11(E/P)(L/N)(W)	194	AHLTTE48	127	AMB42L965	143	AMBR724	150
AFPHR20(E/P)(L/N)(W)	194	AIP1301	246	AMB42R424	142	AMBR725	151
AFPHR21(E/P)(L/N)(W)	194	AIP1302	246	AMB42R425	143	AMBR784	150

<i>pattern no.</i>	<i>page</i>	<i>pattern no.</i>	<i>page</i>	<i>pattern no.</i>	<i>page</i>	<i>pattern no.</i>	<i>page</i>
AMBR785	151	AMCE724	155	AOB4260	158	APIL 4818 N	82
AMBR844	150	AMCE725	155	AOB4266	158	APIL 4818G	83
AMBR845	151	AMCE784	155	AOB4272	158	APIL 4824 N	82
AMBR904	150	AMCE785	155	AOB4278	158	APIL 4824G	83
AMBR905	151	AMCE844	155	AOBS42	159	APIL 4830 N	82
AMBR964	150	AMCE845	155	AOBS48	159	APIL 4830G	83
AMBR965	151	AMGE904	155	AOBS54	159	APIL 4836 N	82
AMG42E604	147	AMGE905	155	AOBS60	159	APIL 4836G	83
AMG42E605	147	AMGE964	155	AOBS66	159	APIL 4842 N	82
AMG42E664	147	AMGE965	155	AOBS72	159	APIL 4842G	83
AMG42E665	147	AMGL424	152	AOBS78	159	APIL 4848 N	82
AMG42E724	147	AMGL425	153	AOFL1301	255	APIL 4848G	83
AMG42E725	147	AMGL484	152	AOFL1302	255	APIL 4860 N	82
AMG42E784	147	AMGL485	153	AOFL1361	255	APIL 4872 N	82
AMG42E785	147	AMGL544	152	AOFL1362	255	APIL 6418 A	82
AMG42E844	147	AMGL545	153	AOFL260301	255	APIL 6418G	83
AMG42E845	147	AMGL604	152	AOFL260302	255	APIL 6424 A	82
AMG42E904	147	AMGL605	153	AOFL260361	255	APIL 6424G	83
AMG42E905	147	AMGL664	152	AOFL260362	255	APIL 6430 A	82
AMG42E964	147	AMGL665	153	AOFL266301	255	APIL 6430G	83
AMG42E965	147	AMGL724	152	AOFL266302	255	APIL 6436 A	82
AMG42L424	144	AMGL725	153	AOFL266361	255	APIL 6436G	83
AMG42L425	145	AMGL784	152	AOFL266362	255	APIL 6442 A	82
AMG42L484	144	AMGL785	153	AOFL272301	255	APIL 6442G	83
AMG42L485	145	AMGL844	152	AOFL272302	255	APIL 6448 A	82
AMG42L544	144	AMGL845	153	AOFL272361	255	APIL 6448G	83
AMG42L545	145	AMGL904	152	AOFL272362	255	APIL 6460 A	82
AMG42L604	144	AMGL905	153	AOFL278301	255	AP1W 1624G	84
AMG42L605	145	AMGL964	152	AOFL278302	255	AP1W 1630G	84
AMG42L664	144	AMGL965	153	AOFL278361	255	AP1W 1636G	84
AMG42L665	145	AMGR424	152	AOFL278362	255	AP1W 1642G	84
AMG42L724	144	AMGR425	153	AOFL284301	255	AP1W 1648G	84
AMG42L725	145	AMGR484	152	AOFL284302	255	AP1W 1660G	84
AMG42L784	144	AMGR485	153	AOFL284361	255	AP1W 1672G	84
AMG42L785	145	AMGR544	152	AOFL284362	255	AP1W 1824G	84
AMG42L844	144	AMGR545	153	AOFL290301	255	AP1W 1830G	84
AMG42L845	145	AMGR604	152	AOFL290302	255	AP1W 1836G	84
AMG42L904	144	AMGR605	153	AOFL290361	255	AP1W 1842G	84
AMG42L905	145	AMGR664	152	AOFL290362	255	AP1W 1848G	84
AMG42L964	144	AMGR665	153	AOFL296301	255	AP1W 1860G	84
AMG42L965	145	AMGR724	152	AOFL296302	255	AP1W 1872G	84
AMG42R424	144	AMGR725	153	AOFL296361	255	AP1W 2224G	84
AMG42R425	145	AMGR784	152	AOFL296362	255	AP1W 2230G	84
AMG42R484	144	AMGR785	153	APIL 3018 N	82	AP1W 2236G	84
AMG42R485	145	AMGR844	152	APIL 3024 N	82	AP1W 2242G	84
AMG42R544	144	AMGR845	153	APIL 3030 N	82	AP1W 2248G	84
AMG42R545	145	AMGR904	152	APIL 3036 N	82	AP1W 2260G	84
AMG42R604	144	AMGR905	153	APIL 3042 N	82	AP1W 2272G	84
AMG42R605	145	AMGR964	152	APIL 3048 N	82	AP1W 2524G	84
AMG42R664	144	AMGR965	153	APIL 3060 N	82	AP1W 2530G	84
AMG42R665	145	AMGTTA	162	APIL 3072 N	82	AP1W 2536G	84
AMG42R724	144	AMGTTB	162	APIL 3918 N	82	AP1W 2542G	84
AMG42R725	145	AMGTTT	162	APIL 3918G	83	AP1W 2548G	84
AMG42R784	144	AMGTTD	162	APIL 3924 N	82	AP1W 2560G	84
AMG42R785	145	AMPB10(E/P)(M)	193	APIL 3924G	83	AP1W 2572G	84
AMG42R844	144	AMPB10(E/P)(W)	191	APIL 3930 N	82	APA 39	47
AMG42R845	145	AMPB11(E/P)(M)	193	APIL 3930G	83	APA 48	47
AMG42R904	144	AMPB11(E/P)(W)	191	APIL 3936 N	82	APA 64	47
AMG42R905	145	AMPB20(E/P)(M)	193	APIL 3936G	83	APA1 LF	87
AMG42R964	144	AMPB20(E/P)(W)	191	APIL 3942 N	82	APCA 0912	56
AMG42R965	145	AMPB21(E/P)(M)	193	APIL 3942G	83	APCA 0912 A	57
AMGE604	155	AMPB21(E/P)(W)	191	APIL 3948 N	82	APCA 0912 C	53
AMGE605	155	AOB4242	158	APIL 3948G	83	APCA 0912 S	53
AMGE664	155	AOB4248	158	APIL 3960 N	82	APCA 0924	56
AMGE665	155	AOB4254	158	APIL 3972 N	82	APCA 0924 A	57

<i>pattern no.</i>	<i>page</i>	<i>pattern no.</i>	<i>page</i>	<i>pattern no.</i>	<i>page</i>	<i>pattern no.</i>	<i>page</i>
APCA 0924 C	53	APF1 3972	47	APRT2L1PC(L/R)6636	240	APRT2O1PC(L/R)9636	242
APCA 0924 S	53	APF1 4848	47	APRT2L1PC(L/R)7230	240	APRT2O1ST(L/R)6030	241
APCA 0936	56	APF1 4860	47	APRT2L1PC(L/R)7236	240	APRT2O1ST(L/R)6036	241
APCA 0936 A	57	APF1 4872	47	APRT2L1PC(L/R)7830	240	APRT2O1ST(L/R)6630	241
APCA 0936 C	53	APF1 6448	47	APRT2L1PC(L/R)7836	240	APRT2O1ST(L/R)6636	241
APCA 0936 S	53	APF1 6460	47	APRT2L1PC(L/R)8430	240	APRT2O1ST(L/R)7230	241
APCA 0948	56	APF1 6472	47	APRT2L1PC(L/R)8436	240	APRT2O1ST(L/R)7236	241
APCA 0948 A	57	APFA1 3948	47	APRT2L1PC(L/R)9030	240	APRT2O1ST(L/R)7830	241
APCA 0948 C	53	APFA1 3960	47	APRT2L1PC(L/R)9036	240	APRT2O1ST(L/R)7836	241
APCA 0948 S	53	APFA1 3972	47	APRT2L1PC(L/R)9630	240	APRT2O1ST(L/R)8430	241
APCA 0960	56	APFA1 4848	47	APRT2L1PC(L/R)9636	240	APRT2O1ST(L/R)8436	241
APCA 0960 A	57	APFA1 4860	47	APRT2L1ST(L/R)6030	239	APRT2O1ST(L/R)9030	241
APCA 0960 C	53	APFA1 4872	47	APRT2L1ST(L/R)6036	239	APRT2O1ST(L/R)9036	241
APCA 0960 S	53	APFA1 6448	47	APRT2L1ST(L/R)6630	239	APRT2O1ST(L/R)9630	241
APCA 0972	56	APFA1 6460	47	APRT2L1ST(L/R)6636	239	APRT2O1ST(L/R)9636	241
APCA 0972 A	57	APFA1 6472	47	APRT2L1ST(L/R)7230	239	APRT2O2PC(L/R)6030	242
APCA 0972 C	53	APHOBR42	209	APRT2L1ST(L/R)7236	239	APRT2O2PC(L/R)6036	242
APCA 0972 S	53	APHOBR48	209	APRT2L1ST(L/R)7830	239	APRT2O2PC(L/R)6630	242
APCA 1612	56	APHOBR54	209	APRT2L1ST(L/R)7836	239	APRT2O2PC(L/R)6636	242
APCA 1612 A	57	APHOBR60	209	APRT2L1ST(L/R)8430	239	APRT2O2PC(L/R)7230	242
APCA 1624	56	APHOBR66	209	APRT2L1ST(L/R)8436	239	APRT2O2PC(L/R)7236	242
APCA 1624 A	57	APHOBR72	209	APRT2L1ST(L/R)9030	239	APRT2O2PC(L/R)7830	242
APCA 1636	56	APHOBR78	209	APRT2L1ST(L/R)9036	239	APRT2O2PC(L/R)7836	242
APCA 1636 A	57	APHOBR84	209	APRT2L1ST(L/R)9630	239	APRT2O2PC(L/R)8430	242
APCA 1648	56	APHOBR90	209	APRT2L1ST(L/R)9636	239	APRT2O2PC(L/R)8436	242
APCA 1648 A	57	APHOBR96	209	APRT2L2PC(L/R)6030	240	APRT2O2PC(L/R)9030	242
APCA 1660	56	APHOBS42	208	APRT2L2PC(L/R)6036	240	APRT2O2PC(L/R)9036	242
APCA 1660 A	57	APHOBS48	208	APRT2L2PC(L/R)6630	240	APRT2O2PC(L/R)9630	242
APCA 1672	56	APHOBS54	208	APRT2L2PC(L/R)6636	240	APRT2O2PC(L/R)9636	242
APCA 1672 A	57	APHOBS60	208	APRT2L2PC(L/R)7230	240	APRT2O2ST(L/R)6030	241
APCA 1812	56	APHOBS66	208	APRT2L2PC(L/R)7236	240	APRT2O2ST(L/R)6036	241
APCA 1812 A	57	APHOBS72	208	APRT2L2PC(L/R)7830	240	APRT2O2ST(L/R)6630	241
APCA 1824	56	APHOBS78	208	APRT2L2PC(L/R)7836	240	APRT2O2ST(L/R)6636	241
APCA 1824 A	57	APHOBS84	208	APRT2L2PC(L/R)8430	240	APRT2O2ST(L/R)7230	241
APCA 1836	56	APHOBS90	208	APRT2L2PC(L/R)8436	240	APRT2O2ST(L/R)7236	241
APCA 1836 A	57	APHOBS96	208	APRT2L2PC(L/R)9030	240	APRT2O2ST(L/R)7830	241
APCA 1848	56	APHOGR42	209	APRT2L2PC(L/R)9036	240	APRT2O2ST(L/R)7836	241
APCA 1848 A	57	APHOGR48	209	APRT2L2PC(L/R)9630	240	APRT2O2ST(L/R)8430	241
APCA 1860	56	APHOGR54	209	APRT2L2PC(L/R)9636	240	APRT2O2ST(L/R)8436	241
APCA 1860 A	57	APHOGR60	209	APRT2L2ST(L/R)6030	239	APRT2O2ST(L/R)9030	241
APCA 1872	56	APHOGR66	209	APRT2L2ST(L/R)6630	239	APRT2O2ST(L/R)9036	241
APCA 1872 A	57	APHOGR72	209	APRT2L2ST(L/R)6636	239	APRT2O2ST(L/R)9630	241
APCA 2712	56	APHOGR78	209	APRT2L2ST(L/R)7230	239	APRT2O2ST(L/R)9636	241
APCA 2712 A	57	APHOGR84	209	APRT2L2ST(L/R)7236	239	APRT2S1PC(L/R)6030	238
APCA 2724	56	APHOGR90	209	APRT2L2ST(L/R)7830	239	APRT2S1PC(L/R)6036	238
APCA 2724 A	57	APHOGR96	209	APRT2L2ST(L/R)7836	239	APRT2S1PC(L/R)6630	238
APCA 2736	56	APHOCS42	208	APRT2L2ST(L/R)8430	239	APRT2S1PC(L/R)6636	238
APCA 2736 A	57	APHOCS48	208	APRT2L2ST(L/R)8436	239	APRT2S1PC(L/R)7230	238
APCA 2748	56	APHOCS54	208	APRT2L2ST(L/R)9030	239	APRT2S1PC(L/R)7236	238
APCA 2748 A	57	APHOCS60	208	APRT2L2ST(L/R)9036	239	APRT2S1PC(L/R)7830	238
APCA 2760	56	APHOCS66	208	APRT2L2ST(L/R)9630	239	APRT2S1PC(L/R)7836	238
APCA 2760 A	57	APHOCS72	208	APRT2L2ST(L/R)9636	239	APRT2S1PC(L/R)8430	238
APCA 2772	56	APHOCS78	208	APRT2O1PC(L/R)6030	242	APRT2S1PC(L/R)8436	238
APCA 2772 A	57	APHOCS84	208	APRT2O1PC(L/R)6036	242	APRT2S1PC(L/R)9030	238
APCA AZ48	52	APHOCS90	208	APRT2O1PC(L/R)6630	242	APRT2S1PC(L/R)9036	238
APCA AZ48S	51	APHOCS96	208	APRT2O1PC(L/R)6636	242	APRT2S1PC(L/R)9630	238
APCA AZ60	52	APLP10	129	APRT2O1PC(L/R)7230	242	APRT2S1PC(L/R)9636	238
APCA AZ60S	51	APLP25	129	APRT2O1PC(L/R)7236	242	APRT2S1ST(L/R)6030	237
APCA AZ72	52	APRA 480	49	APRT2O1PC(L/R)7830	242	APRT2S1ST(L/R)6036	237
APCA AZ72S	51	APRA 600	49	APRT2O1PC(L/R)7836	242	APRT2S1ST(L/R)6630	237
APCA HOC	54	APRA 720	49	APRT2O1PC(L/R)8430	242	APRT2S1ST(L/R)6636	237
APCA OC	53	APRT1L2ST(L/R)6036	239	APRT2O1PC(L/R)8436	242	APRT2S1ST(L/R)7230	237
APCST	266	APRT2L1PC(L/R)6030	240	APRT2O1PC(L/R)9030	242	APRT2S1ST(L/R)7236	237
APF1 3948	47	APRT2L1PC(L/R)6036	240	APRT2O1PC(L/R)9036	242	APRT2S1ST(L/R)7830	237
APF1 3960	47	APRT2L1PC(L/R)6630	240	APRT2O1PC(L/R)9630	242	APRT2S1ST(L/R)7836	237

<i>pattern no.</i>	<i>page</i>	<i>pattern no.</i>	<i>page</i>	<i>pattern no.</i>	<i>page</i>	<i>pattern no.</i>	<i>page</i>
APRT2S1ST(L/R)8430	237	APTA 72	48	AR1 TPH2	79	ASM42WB84	148
APRT2S1ST(L/R)8436	237	APTA C24	49	AR1 TPI5	79	ASM42WB90	148
APRT2S1ST(L/R)9030	237	APTA C36	49	AR1 TPIC	79	ASM42WB96	148
APRT2S1ST(L/R)9036	237	APTA C48	49	AR1 TT1	79	ASM42WG42	149
APRT2S1ST(L/R)9630	237	APTA C60	49	AR1 TT3	79	ASM42WG48	149
APRT2S1ST(L/R)9636	237	APTA C72	49	AR1 TT5	79	ASM42WG54	149
APRT2S2PC(L/R)6030	238	APTA CC	49	AR1 TT8	79	ASM42WG60	149
APRT2S2PC(L/R)6036	238	APTA CC1	49	AR1-ELS-B	78, 79	ASM42WG66	149
APRT2S2PC(L/R)6630	238	APTH	50	AS1 BKH	189	ASM42WG72	149
APRT2S2PC(L/R)6636	238	APTH 120	48	AS1 BKL	189	ASM42WG78	149
APRT2S2PC(L/R)7230	238	APTH 48	48	AS1 DPAD	187, 188	ASM42WG84	149
APRT2S2PC(L/R)7236	238	APTH 60	48	AS1 SPAD	187, 188	ASM42WG90	149
APRT2S2PC(L/R)7830	238	APTH 72	48	AS2 PT(C)	189	ASM42WG96	149
APRT2S2PC(L/R)7836	238	APTH 96	48	AS2 PT(N)	189	ASMMB42	156
APRT2S2PC(L/R)8430	238	APTL	50	ASAMP1616	228	ASMMB48	156
APRT2S2PC(L/R)8436	238	APTL 120	48	ASBC18 (L/R)	253	ASMMB54	156
APRT2S2PC(L/R)9030	238	APTL 48	48	ASBC24 (L/R)	253	ASMMB60	156
APRT2S2PC(L/R)9036	238	APTL 60	48	ASBF1 36	199	ASMMB66	156
APRT2S2PC(L/R)9630	238	APTL 72	48	ASBF1 42	199	ASMMB72	156
APRT2S2PC(L/R)9636	238	APTL 96	48	ASBF1 48	199	ASMMB78	156
APRT2S2ST(L/R)6030	237	APTL126	254	ASBS1 36	199	ASMMB84	156
APRT2S2ST(L/R)6036	237	APTL127	254	ASBS1 42	199	ASMMB90	156
APRT2S2ST(L/R)6630	237	APTL128	254	ASBS1 48	199	ASMMB96	156
APRT2S2ST(L/R)6636	237	APX CIP4	80	ASBT1 36	199	ASMMG42	157
APRT2S2ST(L/R)7230	237	APX CIP6	80	ASBT1 42	199	ASMMG48	157
APRT2S2ST(L/R)7236	237	APX CIP8	80	ASBT1 48	199	ASMMG54	157
APRT2S2ST(L/R)7830	237	AR1 DA	78, 79	ASFS1FF18	185	ASMMG60	157
APRT2S2ST(L/R)7836	237	AR1 DB	78, 79	ASFS1FF24	185	ASMMG66	157
APRT2S2ST(L/R)8430	237	AR1 DC	79	ASFS1PDF18	185	ASMMG72	157
APRT2S2ST(L/R)8436	237	AR1 DX	78, 79	ASFS1PDF24	185	ASMMG78	157
APRT2S2ST(L/R)9030	237	AR1 DY	78, 79	ASFS1WDD30	185	ASMMG84	157
APRT2S2ST(L/R)9036	237	AR1 DZ	79	ASFS1WDD36	185	ASMMG90	157
APRT2S2ST(L/R)9630	237	AR1 EJ1	78	ASFS1WDF30	185	ASMMG96	157
APRT2S2ST(L/R)9636	237	AR1 EJ10	78	ASFS1WDF36	185	ASMS1 DF18	186
APSA 0921	55	AR1 EJ12	78	ASFS1WFF30	185	ASMS1 DF24	186
APSA 0924	55	AR1 EJ2	78	ASFS1WFF36	185	ASMS1 DFO18	186
APSA 0933	55	AR1 EJ3	78	ASFS1WPDF30	185	ASMS1 DFO24	186
APSA 0936	55	AR1 EJ4	78	ASFS1WPDF36	185	ASMS1 FF18	186
APSA 0945	55	AR1 EJ5	78	ASM42MB42	148	ASMS1 FF24	186
APSA 0948	55	AR1 EJ6	78	ASM42MB48	148	ASMS1 PDF18	186
APSA 0957	55	AR1 EJ8	78	ASM42MB54	148	ASMS1 PDF24	186
APSA 0960	55	AR1 EOM	78	ASM42MB60	148	ASMWB42	156
APSA 0969	55	AR1 EPH1	78	ASM42MB66	148	ASMWB48	156
APSA 0972	55	AR1 EPH2	78	ASM42MB72	148	ASMWB54	156
APSA 1621	55	AR1 EPI5	78	ASM42MB78	148	ASMWB60	156
APSA 1624	55	AR1 EPIC	78	ASM42MB84	148	ASMWB66	156
APSA 1633	55	AR1 ET1	78	ASM42MB90	148	ASMWB72	156
APSA 1636	55	AR1 ET3	78	ASM42MB96	148	ASMWB78	156
APSA 1645	55	AR1 ET5	78	ASM42MC42	149	ASMWB84	156
APSA 1648	55	AR1 ET8	78	ASM42MC48	149	ASMWB90	156
APSA 1657	55	AR1 HCC H10	80	ASM42MC54	149	ASMWB96	156
APSA 1660	55	AR1 HOB	54	ASM42MC60	149	ASMWC42	157
APSA 1669	55	AR1 HOB2	54	ASM42MC66	149	ASMWC48	157
APSA 1672	55	AR1 PCC 100	80	ASM42MC72	149	ASMWC54	157
APT	49	AR1 TJ1	79	ASM42MC78	149	ASMWC60	157
APT 48	48	AR1 TJ10	79	ASM42MC84	149	ASMWC66	157
APT 60	48	AR1 TJ12	79	ASM42MC90	149	ASMWC72	157
APT 72	48	AR1 TJ2	79	ASM42MC96	149	ASMWC78	157
APT1 C24	49	AR1 TJ3	79	ASM42WB42	148	ASMWC84	157
APT1 C36	49	AR1 TJ4	79	ASM42WB48	148	ASMWC90	157
APT1 C48	49	AR1 TJ5	79	ASM42WB54	148	ASMWC96	157
APT1 C60	49	AR1 TJ6	79	ASM42WB60	148	ASOBD42	201
APT1 C72	49	AR1 TJ8	79	ASM42WB66	148	ASOBD48	201
APTA 48	48	AR1 TOM	79	ASM42WB72	148	ASOBD54	201
APTA 60	48	AR1 TPH1	79	ASM42WB78	148	ASOBD60	201

<i>pattern no.</i>	<i>page</i>	<i>pattern no.</i>	<i>page</i>	<i>pattern no.</i>	<i>page</i>	<i>pattern no.</i>	<i>page</i>
ASOBD66	201	ASOGR54	204	ATAT4LL424227(L/M/V)	244	ATDT1LPM723627(L/M/V)	247
ASOBD72	201	ASOGR60	204	ATAT4LL424228(L/M/V)	244	ATDT1LPM723628(L/M/V)	247
ASOBD78	201	ASOGR66	204	ATAT4LL484827(L/M/V)	244	ATDT1LPS483027(L/M/V)	248
ASOBD84	201	ASOGR72	204	ATAT4LL484828(L/M/V)	244	ATDT1LPS483028(L/M/V)	248
ASOBD90	201	ASOGR78	204	ATB1426	263	ATDT1LPS603027(L/M/V)	248
ASOBD96	201	ASOGR84	204	ATB1432	263	ATDT1LPS603028(L/M/V)	248
ASOBO42	200	ASOGR90	204	ATB1442	263	ATDT1LPS723027(L/M/V)	248
ASOBO48	200	ASOGR96	204	ATB1448	263	ATDT1LPS723028(L/M/V)	248
ASOBO54	200	ASOGS42	203	ATB1454	263	ATDT1LPS723627(L/M/V)	248
ASOBO60	200	ASOGS48	203	ATB1460	263	ATDT1LPS723628(L/M/V)	248
ASOBO66	200	ASOGS54	203	ATB1466	263	ATDT4LL483027(L/M/V)	244
ASOBO72	200	ASOGS60	203	ATB1472	263	ATDT4LL483028(L/M/V)	244
ASOBO78	200	ASOGS66	203	ATB1478	263	ATDT4LL603027(L/M/V)	244
ASOBO84	200	ASOGS72	203	ATB1484	263	ATDT4LL603028(L/M/V)	244
ASOBO90	200	ASOGS78	203	ATB1490	263	ATDT4LL723027(L/M/V)	244
ASOBO96	200	ASOGS84	203	ATB1496	263	ATDT4LL723028(L/M/V)	244
ASOBR42	204	ASOGS90	203	ATBB42	263	ATDT4LL723627(L/M/V)	244
ASOBR48	204	ASOGS96	203	ATBB48	263	ATDT4LL723628(L/M/V)	244
ASOBR54	204	ASOCT60	202	ATBB54	263	ATRT2DOF60301	245
ASOBR60	204	ASOCT66	202	ATBB60	263	ATRT2DOF60302	245
ASOBR66	204	ASOCT72	202	ATBB66	263	ATRT2DOF60361	245
ASOBR72	204	ASOCT78	202	ATBB72	263	ATRT2DOF60362	245
ASOBR78	204	ASOCT84	202	ATBB78	263	ATRT2DOF66301	245
ASOBR84	204	ASOCT90	202	ATBM26	263	ATRT2DOF66302	245
ASOBR90	204	ASOCT96	202	ATBM32	263	ATRT2DOF66361	245
ASOBR96	204	AST	266	ATBM42	263	ATRT2DOF66362	245
ASOBS42	203	ASWB42	264	ATBM48	263	ATRT2DOF72301	245
ASOBS48	203	ASWB48	264	ATBM54	263	ATRT2DOF72302	245
ASOBS54	203	ASWB54	264	ATBM60	263	ATRT2DOF72361	245
ASOBS60	203	ASWB60	264	ATBM66	263	ATRT2DOF72362	245
ASOBS66	203	ASWB66	264	ATBM72	263	ATRT2DOF78301	245
ASOBS72	203	ASWB72	264	ATBM78	263	ATRT2DOF78302	245
ASOBS78	203	ASWB78	264	ATBM84	263	ATRT2DOF78361	245
ASOBS84	203	ASWM26	264	ATBM90	263	ATRT2DOF78362	245
ASOBS90	203	ASWM32	264	ATBM96	263	ATRT2DOF84301	245
ASOBS96	203	ASWM42	264	ATBT120	258	ATRT2DOF84302	245
ASOBT60	202	ASWM48	264	ATBT124	258	ATRT2DOF84361	245
ASOBT66	202	ASWM54	264	ATBT130	258	ATRT2DOF84362	245
ASOBT72	202	ASWM60	264	ATBT136	258	ATRT2DOF90301	245
ASOBT78	202	ASWM66	264	ATBT224	258	ATRT2DOF90302	245
ASOBT84	202	ASWM72	264	ATBT230	258	ATRT2DOF90361	245
ASOBT90	202	ASWM78	264	ATBT236	258	ATRT2DOF90362	245
ASOBT96	202	ASWM84	264	ATBT242	258	ATRT2DOF96301	245
ASOGD42	201	ASWM90	264	ATDT1LFM483027(L/M/V)	247	ATRT2DOF96302	245
ASOGD48	201	ASWM96	264	ATDT1LFM483028(L/M/V)	247	ATRT2DOF96361	245
ASOGD54	201	ASWRB42	110	ATDT1LFM603027(L/M/V)	247	ATRT2DOF96362	245
ASOGD60	201	ASWRB49	110	ATDT1LFM603028(L/M/V)	247	ATLSBA42	160
ASOGD66	201	ASWRB64	110	ATDT1LFM723027(L/M/V)	247	ATLSBA48	160
ASOGD72	201	ASWRB79	110	ATDT1LFM723028(L/M/V)	247	ATLSBA54	160
ASOGD78	201	AT2TB (pair)	253	ATDT1LFM723627(L/M/V)	247	ATLSBA60	160
ASOGD84	201	ATA1R36	243	ATDT1LFM723628(L/M/V)	247	ATLSBA66	160
ASOGD90	201	ATA1R42	243	ATDT1LFS483027(L/M/V)	247	ATLSBA72	160
ASOGD96	201	ATA1R48	243	ATDT1LFS483028(L/M/V)	247	ATLSBA78	160
ASOGO42	200	ATA1T44242	243	ATDT1LFS603027(L/M/V)	247	ATLSBB42	160
ASOGO48	200	ATA1T44830	243	ATDT1LFS603028(L/M/V)	247	ATLSBB48	160
ASOGO54	200	ATA1T44848	243	ATDT1LFS723027(L/M/V)	247	ATLSBB54	160
ASOGO60	200	ATA1T46030	243	ATDT1LFS723028(L/M/V)	247	ATLSBB60	160
ASOGO66	200	ATA1T47230	243	ATDT1LFS723627(L/M/V)	247	ATLSBB66	160
ASOGO72	200	ATA1T47236	243	ATDT1LFS723628(L/M/V)	247	ATLSBB72	160
ASOGO78	200	ATARLL3627(L/M/V)	244	ATDT1LPM483027(L/M/V)	247	ATLSBB78	160
ASOGO84	200	ATARLL3628(L/M/V)	244	ATDT1LPM483028(L/M/V)	247	ATLSBC42	160
ASOGO90	200	ATARLL4227(L/M/V)	244	ATDT1LPM603027(L/M/V)	247	ATLSBC48	160
ASOGO96	200	ATARLL4228(L/M/V)	244	ATDT1LPM603028(L/M/V)	247	ATLSBC54	160
ASOGR42	204	ATARLL4827(L/M/V)	244	ATDT1LPM723027(L/M/V)	247	ATLSBC60	160
ASOGR48	204	ATARLL4828(L/M/V)	244	ATDT1LPM723028(L/M/V)	247	ATLSBC66	160

<i>pattern no.</i>	<i>page</i>	<i>pattern no.</i>	<i>page</i>	<i>pattern no.</i>	<i>page</i>	<i>pattern no.</i>	<i>page</i>
ATSBC72	160	AUOMBSS72	210	AW1T1RF7836	227	AW1T1WU4832	231
ATSBC78	160	AUOMBSS73	210	AW1T1RF8420	226	AW1T1WU6023	231
ATSBD42	160	AUOMBSS92	210	AW1T1RF8424	226	AW1T1WU6032	231
ATSBD48	160	AUOMBSS93	210	AW1T1RF8430	227	AW1T1WU7226	231
ATSBD54	160	AW1T1R3423	234	AW1T1RF8436	227	AW1T1WU7262	231
ATSBD60	160	AW1T1R3429	234	AW1T1RF9020	226	AW1T2DW4826	236
ATSBD66	160	AW1T1R4023	234	AW1T1RF9024	226	AW1T2DW6026	236
ATSBD72	160	AW1T1R4029	234	AW1T1RF9030	227	AW1T2DW7226	236
ATSBD78	160	AW1T1R4623	234	AW1T1RF9036	227	AW1T2R3030	232
ATSBE42	160	AW1T1R4629	234	AW1T1RF9620	226	AW1T2R3036	232
ATSBE48	160	AW1T1R5223	234	AW1T1RF9624	226	AW1T2R3042	233
ATSBE54	160	AW1T1R5229	234	AW1T1RF9630	227	AW1T2R3630	232
ATSBE60	161	AW1T1R5823	234	AW1T1RF9636	227	AW1T2R3636	232
ATSBE66	161	AW1T1R5829	234	AW1T1RU1820	229	AW1T2R3642	233
ATSBE72	161	AW1T1R6423	234	AW1T1RU1824	229	AW1T2R4230	232
ATSBE78	161	AW1T1R6429	234	AW1T1RU1830	230	AW1T2R4236	232
ATSCD19	179	AW1T1R7023	234	AW1T1RU2020	229	AW1T2R4242	233
ATTA24L	249	AW1T1R7029	234	AW1T1RU2024	229	AW1T2R4635	234
ATTA24R	249	AW1T1RF1820	226	AW1T1RU2030	230	AW1T2R4830	232
ATTA24S	249	AW1T1RF1824	226	AW1T1RU2420	229	AW1T2R4836	232
ATTA30L	249	AW1T1RF1830	227	AW1T1RU2424	229	AW1T2R4842	233
ATTA30R	249	AW1T1RF1836	227	AW1T1RU2430	230	AW1T2R5235	234
ATTA30S	249	AW1T1RF2020	226	AW1T1RU3020	229	AW1T2R5430	232
ATTA36L	249	AW1T1RF2024	226	AW1T1RU3024	229	AW1T2R5436	232
ATTA36R	249	AW1T1RF2030	227	AW1T1RU3030	230	AW1T2R5442	233
ATTA36S	249	AW1T1RF2036	227	AW1T1RU3620	229	AW1T2R5835	234
ATTA42L	249	AW1T1RF2420	226	AW1T1RU3624	229	AW1T2R6030	232
ATTA42R	249	AW1T1RF2424	226	AW1T1RU3630	230	AW1T2R6036	232
ATTA42S	249	AW1T1RF2430	227	AW1T1RU4220	229	AW1T2R6042	233
ATTA48L	249	AW1T1RF2436	227	AW1T1RU4224	229	AW1T2R6435	234
ATTA48R	249	AW1T1RF3020	226	AW1T1RU4230	230	AW1T2R6630	232
ATTA48S	249	AW1T1RF3024	226	AW1T1RU4820	229	AW1T2R6636	232
ATTA54L	249	AW1T1RF3030	227	AW1T1RU4824	229	AW1T2R6642	233
ATTA54R	249	AW1T1RF3036	227	AW1T1RU4830	230	AW1T2R7035	234
ATTA54S	249	AW1T1RF3620	226	AW1T1RU5420	229	AW1T2R7230	232
ATTA60L	249	AW1T1RF3624	226	AW1T1RU5424	229	AW1T2R7236	232
ATTA60R	249	AW1T1RF3630	227	AW1T1RU5430	230	AW1T2R7242	233
ATTA60S	249	AW1T1RF3636	227	AW1T1RU6020	229	AW1T2R7830	232
ATTA66L	249	AW1T1RF4220	226	AW1T1RU6024	229	AW1T2R7836	232
ATTA66R	249	AW1T1RF4224	226	AW1T1RU6030	230	AW1T2R7842	233
ATTA66S	249	AW1T1RF4230	227	AW1T1RU6620	229	AW1T2R8430	232
ATTA72L	249	AW1T1RF4236	227	AW1T1RU6624	229	AW1T2R8436	232
ATTA72R	249	AW1T1RF4820	226	AW1T1RU6630	230	AW1T2R8442	233
ATTA72S	249	AW1T1RF4824	226	AW1T1RU7220	229	AW1T2R9030	232
AUA1 0824 G	81	AW1T1RF4830	227	AW1T1RU7224	229	AW1T2R9036	232
AUA1 0836 G	81	AW1T1RF4836	227	AW1T1RU7230	230	AW1T2R9042	233
AUA1 0848 G	81	AW1T1RF5420	226	AW1T1RU7820	229	AW1T2R9630	232
AUA1 0860 G	81	AW1T1RF5424	226	AW1T1RU7824	229	AW1T2R9636	232
AUA1 0872 G	81	AW1T1RF5430	227	AW1T1RU7830	230	AW1T2R9642	233
AUA1 1224 G	81	AW1T1RF5436	227	AW1T1RU8420	229	AW1T2W4823	235
AUA1 1236 G	81	AW1T1RF6020	226	AW1T1RU8424	229	AW1T2W4832	235
AUA1 1248 G	81	AW1T1RF6024	226	AW1T1RU8430	230	AW1T2W6023	235
AUA1 1260 G	81	AW1T1RF6030	227	AW1T1RU9020	229	AW1T2W6032	235
AUA1 1272 G	81	AW1T1RF6036	227	AW1T1RU9024	229	AW1T2W7226	235
AUA1 1524 G	81	AW1T1RF6620	226	AW1T1RU9030	230	AW1T2W7262	235
AUA1 1536 G	81	AW1T1RF6624	226	AW1T1RU9620	229	AWBK42	162
AUA1 1548 G	81	AW1T1RF6630	227	AW1T1RU9624	229	AWBK48	162
AUA1 1560 G	81	AW1T1RF6636	227	AW1T1RU9630	230	AWBK54	162
AUA1 1572 G	81	AW1T1RF7220	226	AW1T1WF4823	228	AWBK60	162
AUOMBAP2	210	AW1T1RF7224	226	AW1T1WF4832	228	AWBK66	162
AUOMBAP3	210	AW1T1RF7230	227	AW1T1WF6023	228	AWBK72	162
AUOMBCC2	210	AW1T1RF7236	227	AW1T1WF6032	228	AWBK78	162
AUOMBCC3	210	AW1T1RF7820	226	AW1T1WF7226	228	AWBK84	162
AUOMBSS62	210	AW1T1RF7824	226	AW1T1WF7262	228	AWBK90	162
AUOMBSS63	210	AW1T1RF7830	227	AW1T1WU4823	231	AWBK96	162

<i>pattern no.</i>	<i>page</i>	<i>pattern no.</i>	<i>page</i>	<i>pattern no.</i>	<i>page</i>	<i>pattern no.</i>	<i>page</i>
AWBS42	159	AWHOGSS72	214	AX1 R36439	72	AX1GES48	68
AWBS48	159	AWHOGSS78	214	AX1 R36448	72	AX1LES E	66
AWBS54	159	AWHOGSS84	214	AX1 R36464	72	AX1LES30	66
AWBS60	159	AWHOGSS90	214	AX1 R37939	72	AX1LES39	66
AWBS66	159	AWHOGSS96	214	AX1 R37948	72	AX1LES48	66
AWBS72	159	AWHTB3024	265	AX1 R37964	72	AX1LES64	66
AWBS78	159	AWHTB3030	265	AX1 RF1	71	AX1MES30	66
AWBS84	159	AWHTB3624	265	AX1 RF3	71	AX1MES39	66
AWBS90	159	AWHTB3630	265	AX1 S	60	AX1MES42	66
AWBS96	159	AWHTB4224	265	AX1 SWS39	60	AX1MES48	66
AWCPFS	195	AWHTB4230	265	AX1 SWS48	60	AX1MES56	66
AWCPFS19	195	AWHTB4824	265	AX1 SWS64	60	AX1MES64	66
AWFL27	254	AWHTB4830	265	AX1A C39	58	AX1MES80	66
AWFL28	254	AWHTB5424	265	AX1A C48	58	AX1SEA3939	63
AWHOBDR60	218	AWHTB5430	265	AX1A C64	58	AX1SEA4239	63
AWHOBDR66	218	AWHTB6024	265	AX1A EH39	58	AX1SEA4339 C	63
AWHOBDR72	218	AWHTB6030	265	AX1A EH48	58	AX1SEA4848	63
AWHOBDR78	218	AWHTB6624	265	AX1A EH64	58	AX1SEA4939	63
AWHOBDR84	218	AWHTB6630	265	AX1A EL39	58	AX1SEA4948	63
AWHOBDR90	218	AWHTB7224	265	AX1A EL48	58	AX1SEA4964	63
AWHOBDR96	218	AWHTB7230	265	AX1A EL64	58	AX1SEA5248 C	63
AWHOBDS60	218	AWHTB7824	265	AX1A F39	58	AX1SEA6439	63
AWHOBDS66	218	AWHTB7830	265	AX1A F48	58	AX1SEA6448	63
AWHOBDS72	218	AWHTB8424	265	AX1A F64	58	AX1SEA6464	63
AWHOBDS78	218	AWHTB8430	265	AX1A L39	59	AX1SEA6864 C	63
AWHOBDS84	218	AWHTB9024	265	AX1A L48	59	AX1SEA7948	63
AWHOBDS90	218	AWHTB9030	265	AX1A L64	59	AX1SEA7964	63
AWHOBDS96	218	AWHTB9624	265	AX1A T39	59	AX1SEC3939	61
AWHOBDR60	214	AWHTB9630	265	AX1A T48	59	AX1SEC4039 L	61
AWHOBDR66	214	AWM1 S36	262	AX1A T64	59	AX1SEC4239	62
AWHOBDR72	214	AWM1 S42	262	AX1A V39	59	AX1SEC4339 C	61
AWHOBDR78	214	AWM1 S48	262	AX1A V48	59	AX1SEC4839	62
AWHOBDR84	214	AWM1 S60	262	AX1A V64	59	AX1SEC4848	61
AWHOBDR90	214	AWM1 S66	262	AX1A X39	59	AX1SEC4948 L	61
AWHOBDR96	214	AWM1 S72	262	AX1A X48	59	AX1SEC5248 C	61
AWHOBSS60	214	AWM1 S78	262	AX1A X64	59	AX1SEC5639	62
AWHOBSS66	214	AWM1 S84	262	AX1A Y39	59	AX1SEC5648	62
AWHOBSS72	214	AWSO	266	AX1A Y48	59	AX1SEC6439	62
AWHOBSS78	214	AWSOC	266	AX1A Y64	59	AX1SEC6448	62
AWHOBSS84	214	AWTCT24	179	AX1AES34	67	AX1SEC6464	61
AWHOBSS90	214	AWTCT30	179	AX1AES42	67	AX1SEC6564 L	61
AWHOBSS96	214	AX1 A34239	72	AX1AES49	67	AX1SEC6864 C	61
AWHOGDR60	218	AX1 A34939	72	AX1AES64	67	AX1SEC8048	62
AWHOGDR66	218	AX1 A34948	72	AX1AES79	67	AX1SEC8064	62
AWHOGDR72	218	AX1 A36439	72	AX1DHES3600L(5)	69	AX1SECBT	61, 62, 63, 64
AWHOGDR78	218	AX1 A36448	73	AX1DHES3600R(5)	69	AX1SED3939	64
AWHOGDR84	218	AX1 A36464	73	AX1DHES3603L(5)	69	AX1SED4239	64
AWHOGDR90	218	AX1 HLS4839	60	AX1DHES3603R(5)	69	AX1SED4339C	64
AWHOGDR96	218	AX1 HLS6439	60	AX1DHES4200L(5)	69	AX1SED4848	64
AWHOGDS60	218	AX1 HLS6448	60	AX1DHES4200R(5)	69	AX1SED5039	64
AWHOGDS66	218	AX1 M3939	71	AX1DHES4203L(5)	69	AX1SED5048	64
AWHOGDS72	218	AX1 M4239	71	AX1DHES4203R(5)	69	AX1SED5248C	64
AWHOGDS78	218	AX1 M4839	71	AX1DHES5000L(5)	69	AX1SED5739	64
AWHOGDS84	218	AX1 M4848	71	AX1DHES5000R(5)	69	AX1SED5748	64
AWHOGDS90	218	AX1 M5639	71	AX1DHES5003L(5)	69	AX1SED6439	64
AWHOGDS96	218	AX1 M5648	71	AX1DHES5003R(5)	69	AX1SED6448	64
AWHOGSR60	214	AX1 M6439	71	AX1DHES5700L(5)	69	AX1SED6464	64
AWHOGSR66	214	AX1 M6448	71	AX1DHES5700R(5)	69	AX1SED7848	64
AWHOGSR72	214	AX1 M6464	71	AX1DHES5703L(5)	69	AX1SED7864	64
AWHOGSR78	214	AX1 M8039	71	AX1DHES5703R(5)	69	AX1SX39 A (L/C/P)	65
AWHOGSR84	214	AX1 M8048	71	AX1DHES6400L(5)	69	AX1SX39 C (L/C/P)	65
AWHOGSR90	214	AX1 M8064	71	AX1DHES6400R(5)	69	AX1SX48 A (L/C/P)	65
AWHOGSR96	214	AX1 R34239	72	AX1DHES6403L(5)	69	AX1SX48 C (L/C/P)	65
AWHOGSS60	214	AX1 R34939	72	AX1DHES6403R(5)	69	AX1SX64 A (L/C/P)	65
AWHOGSS66	214	AX1 R34948	72	AX1GES39	68	AX1SX64 C (L/C/P)	65

<i>pattern no.</i>	<i>page</i>	<i>pattern no.</i>	<i>page</i>	<i>pattern no.</i>	<i>page</i>	<i>pattern no.</i>	<i>page</i>
AX2 C3939	71	R3B0P0F7907	74	R3R0120VP349	123	R3R0LT164	116
AX2 C4839	71	R3B0P0H4207	74	R3R0120VP364	123	R3R0LT234	116
AX2 C4848	71	R3B0P0H4907	74	R3R0120VPL34	123	R3R0LT242	116
AX2 C6439	71	R3B0P0H6407	74	R3R0120VPL42	123	R3R0LT249	116
AX2 C6448	71	R3B0P0H7907	74	R3R0120VPL49	123	R3R0LT264	116
AX2 C6464	71	R3B0T0F4207	74	R3R0120VPL64	123	R3R0LT334	116
MB1-AUX-C	252	R3B0T0F4907	74	R3R0120VT134	122	R3R0LT342	116
MB2-C18W-(L/R)	252	R3B0T0F6407	74	R3R0120VT142	122	R3R0LT349	116
MB2-C24W-(L/R)	252	R3B0T0F7907	74	R3R0120VT149	122	R3R0LT364	116
MB2-C30W-(L/R)	252	R3B0T0H4207	74	R3R0120VT164	122	R3R0LTL34	116
MB2-YW-(L/R)	252	R3B0T0H4907	74	R3R0120VT234	122	R3R0LTL42	116
MB3-E18W	252	R3B0T0H6407	74	R3R0120VT242	122	R3R0LTL49	116
MB3-E24W	252	R3B0T0H7907	74	R3R0120VT249	122	R3R0LTL64	116
MB3-E30W	252	R3GAU0818	111	R3R0120VT264	122	R3R0SP142	121
MB3-E36W	252	R3GAU0820	111	R3R0120VT334	122	R3R0SP149	121
MB3-EC18W	252	R3GAU0824	111	R3R0120VT342	122	R3R0SP242	121
MB3-EC24W	252	R3GAU0830	111	R3R0120VT349	122	R3R0SP249	121
MB3-EC30W	252	R3GAU0836	111	R3R0120VT364	122	R3R0SP342	121
MC1-39S1	86	R3GAU0842	111	R3R0120VTL34	122	R3R0SP349	121
MC1-48S1	86	R3GAU0848	111	R3R0120VTL42	122	R3R0SPL42	121
MC1-64S1	86	R3GAU1218	111	R3R0120VTL49	122	R3R0SPL49	121
MD6-BD	189	R3GAU1220	111	R3R0120VTL64	122	R3R0TOH4207	74
MD6-FS	189	R3GAU1224	111	R3R0135VP134	125	R3R0TOH4907	74
ML4L17	221	R3GAU1230	111	R3R0135VP142	125	R3R0TOH6407	74
ML4L31	221	R3GAU1236	111	R3R0135VP149	125	R3R0TP142	114
ML4L44	221	R3GAU1242	111	R3R0135VP164	125	R3R0TP149	114
ML4L58	221	R3GAU1248	111	R3R0135VP234	125	R3R0TP242	115
MM2-CG	87	R3GAU1518	111	R3R0135VP242	125	R3R0TP249	115
MWM-J	220	R3GAU1520	111	R3R0135VP249	125	R3R0TP342	115
R2AHBW18	126	R3GAU1524	111	R3R0135VP264	125	R3R0TP349	115
R2AHBW20	126	R3GAU1530	111	R3R0135VP334	125	R3R0TPL42	115
R2AHBW24	126	R3GAU1536	111	R3R0135VP342	125	R3R0TPL49	115
R2AHBW30	126	R3GAU1542	111	R3R0135VP349	125	R3R0TT134	114
R2AHBW36	126	R3GAU1548	111	R3R0135VP364	125	R3R0TT142	114
R2AHBW42	126	R3GAUHL0818	111	R3R0135VPL34	125	R3R0TT149	114
R2AHBW48	126	R3GAUHL0820	111	R3R0135VPL42	125	R3R0TT164	114
R2AHCN34	126	R3GAUHL0824	111	R3R0135VPL49	125	R3R0TT234	114
R2AHCN42	126	R3GAUHL0830	111	R3R0135VPL64	125	R3R0TT242	114
R2AHCN49	126	R3GAUHL0836	111	R3R0135VT134	124	R3R0TT249	114
R2AHCN64	126	R3GAUHL0842	111	R3R0135VT142	124	R3R0TT264	114
R2AHCN79	126	R3GAUHL0848	111	R3R0135VT149	124	R3R0TT334	114
R2AHCR34	126	R3GAUHL1218	112	R3R0135VT164	124	R3R0TT342	114
R2AHCR42	126	R3GAUHL1220	112	R3R0135VT234	124	R3R0TT349	114
R2AHCR49	126	R3GAUHL1224	112	R3R0135VT242	124	R3R0TT364	114
R2AHCR64	126	R3GAUHL1230	112	R3R0135VT249	124	R3R0TTL34	114
R2AHCR79	126	R3GAUHL1236	112	R3R0135VT264	124	R3R0TTL42	114
R2AHSR18	126	R3GAUHL1242	112	R3R0135VT334	124	R3R0TTL49	114
R2AHSR20	126	R3GAUHL1248	112	R3R0135VT342	124	R3R0TTL64	114
R2AHSR24	126	R3GAUHL1518	112	R3R0135VT349	124	R3R1AF13418	91
R2AHSR30	126	R3GAUHL1520	112	R3R0135VT364	124	R3R1AF13424	91
R2AHSR36	126	R3GAUHL1524	112	R3R0135VTL34	124	R3R1AF13430	91
R2AHSR42	126	R3GAUHL1530	112	R3R0135VTL42	124	R3R1AF13436	91
R2AHSR48	126	R3GAUHL1536	112	R3R0135VTL49	124	R3R1AF13442	91
R2AHWR18	126	R3GAUHL1542	112	R3R0135VTL64	124	R3R1AF13448	91
R2AHWR20	126	R3GAUHL1548	112	R3R0LP142	117	R3R1AF14218	91
R2AHWR24	126	R3R0120VP134	123	R3R0LP149	117	R3R1AF14224	91
R2AHWR30	126	R3R0120VP142	123	R3R0LP242	117	R3R1AF14230	91
R2AHWR36	126	R3R0120VP149	123	R3R0LP249	117	R3R1AF14236	91
R2AHWR42	126	R3R0120VP164	123	R3R0LP342	117	R3R1AF14242	91
R2AHWR48	126	R3R0120VP234	123	R3R0LP349	117	R3R1AF14248	91
R2CCG	129	R3R0120VP242	123	R3R0LPL42	116	R3R1AF14918	91
R3AUAC10	112	R3R0120VP249	123	R3R0LPL49	116	R3R1AF14924	91
R3B0P0F4207	74	R3R0120VP264	123	R3R0LT134	116	R3R1AF14930	91
R3B0P0F4907	74	R3R0120VP334	123	R3R0LT142	116	R3R1AF14936	91
R3B0P0F6407	74	R3R0120VP342	123	R3R0LT149	116	R3R1AF14942	91

<i>pattern no.</i>	<i>page</i>	<i>pattern no.</i>	<i>page</i>	<i>pattern no.</i>	<i>page</i>	<i>pattern no.</i>	<i>page</i>
R3R1AF14948	91	R3R1AFL4242	90	R3R1CX24936	108	R3R1LAR234	119
R3R1AF16418	91	R3R1AFL4248	90	R3R1CX24942	108	R3R1LAR242	119
R3R1AF16424	91	R3R1AFL4918	90	R3R1CX24948	108	R3R1LAR249	119
R3R1AF16430	91	R3R1AFL4924	90	R3R1CX26418	108	R3R1LAR264	119
R3R1AF16436	91	R3R1AFL4930	90	R3R1CX26424	108	R3R1LAR334	119
R3R1AF16442	91	R3R1AFL4936	90	R3R1CX26430	108	R3R1LAR342	119
R3R1AF16448	91	R3R1AFL4942	90	R3R1CX26436	108	R3R1LAR349	119
R3R1AF23418	92	R3R1AFL4948	90	R3R1CX26442	108	R3R1LAR364	119
R3R1AF23424	92	R3R1AFL6418	90	R3R1CX26448	108	R3R1LARL34	118
R3R1AF23430	92	R3R1AFL6424	90	R3R1CX34218	109	R3R1LARL42	118
R3R1AF23436	92	R3R1AFL6430	90	R3R1CX34224	109	R3R1LARL49	118
R3R1AF23442	92	R3R1AFL6436	90	R3R1CX34230	109	R3R1LARL64	118
R3R1AF23448	92	R3R1AFL6442	90	R3R1CX34236	109	R3R1PF14218	97
R3R1AF24218	92	R3R1AFL6448	90	R3R1CX34242	109	R3R1PF14224	97
R3R1AF24224	92	R3R1ALL3418	94	R3R1CX34248	109	R3R1PF14230	97
R3R1AF24230	92	R3R1ALL3424	94	R3R1CX34918	109	R3R1PF14236	97
R3R1AF24236	92	R3R1ALL3430	94	R3R1CX34924	109	R3R1PF14242	97
R3R1AF24242	92	R3R1ALL3436	94	R3R1CX34930	109	R3R1PF14248	97
R3R1AF24248	92	R3R1ALL3442	94	R3R1CX34936	109	R3R1PF14918	97
R3R1AF24918	92	R3R1ALL3448	94	R3R1CX34942	109	R3R1PF14924	97
R3R1AF24924	92	R3R1ALL4218	94	R3R1CX34948	109	R3R1PF14930	97
R3R1AF24930	92	R3R1ALL4224	94	R3R1CX36418	109	R3R1PF14936	97
R3R1AF24936	92	R3R1ALL4230	94	R3R1CX36424	109	R3R1PF14942	97
R3R1AF24942	92	R3R1ALL4236	94	R3R1CX36430	109	R3R1PF14948	97
R3R1AF24948	92	R3R1ALL4242	94	R3R1CX36436	109	R3R1PF24218	98
R3R1AF26418	92	R3R1ALL4248	94	R3R1CX36442	109	R3R1PF24224	98
R3R1AF26424	92	R3R1ALL4918	95	R3R1CX36448	109	R3R1PF24230	98
R3R1AF26430	92	R3R1ALL4924	95	R3R1CXL4218	106	R3R1PF24236	98
R3R1AF26436	92	R3R1ALL4930	95	R3R1CXL4224	106	R3R1PF24242	98
R3R1AF26442	92	R3R1ALL4936	95	R3R1CXL4230	106	R3R1PF24248	98
R3R1AF26448	92	R3R1ALL4942	95	R3R1CXL4236	106	R3R1PF24918	98
R3R1AF33418	93	R3R1ALL4948	95	R3R1CXL4242	106	R3R1PF24924	98
R3R1AF33424	93	R3R1ALL6418	95	R3R1CXL4248	106	R3R1PF24930	98
R3R1AF33430	93	R3R1ALL6424	95	R3R1CXL4918	106	R3R1PF24936	98
R3R1AF33436	93	R3R1ALL6430	95	R3R1CXL4924	106	R3R1PF24942	98
R3R1AF33442	93	R3R1ALL6436	95	R3R1CXL4930	106	R3R1PF24948	98
R3R1AF33448	93	R3R1ALL6442	95	R3R1CXL4936	106	R3R1PF34218	99
R3R1AF34218	93	R3R1ALL6448	95	R3R1CXL4942	106	R3R1PF34224	99
R3R1AF34224	93	R3R1CX14218	107	R3R1CXL4948	106	R3R1PF34230	99
R3R1AF34230	93	R3R1CX14224	107	R3R1CXL6418	106	R3R1PF34236	99
R3R1AF34236	93	R3R1CX14230	107	R3R1CXL6424	106	R3R1PF34242	99
R3R1AF34242	93	R3R1CX14236	107	R3R1CXL6430	106	R3R1PF34248	99
R3R1AF34248	93	R3R1CX14242	107	R3R1CXL6436	106	R3R1PF34918	99
R3R1AF34918	93	R3R1CX14248	107	R3R1CXL6442	106	R3R1PF34924	99
R3R1AF34924	93	R3R1CX14918	107	R3R1CXL6448	106	R3R1PF34930	99
R3R1AF34930	93	R3R1CX14924	107	R3R1LAL134	118	R3R1PF34936	99
R3R1AF34936	93	R3R1CX14930	107	R3R1LAL142	118	R3R1PF34942	99
R3R1AF34942	93	R3R1CX14936	107	R3R1LAL149	118	R3R1PF34948	99
R3R1AF34948	93	R3R1CX14942	107	R3R1LAL164	118	R3R1PFL4218	96
R3R1AF36418	93	R3R1CX14948	107	R3R1LAL234	119	R3R1PFL4224	96
R3R1AF36424	93	R3R1CX16418	107	R3R1LAL242	119	R3R1PFL4230	96
R3R1AF36430	93	R3R1CX16424	107	R3R1LAL249	119	R3R1PFL4236	96
R3R1AF36436	93	R3R1CX16430	107	R3R1LAL264	119	R3R1PFL4242	96
R3R1AF36442	93	R3R1CX16436	107	R3R1LAL334	119	R3R1PFL4248	96
R3R1AF36448	93	R3R1CX16442	107	R3R1LAL342	119	R3R1PFL4918	96
R3R1AFL3418	90	R3R1CX16448	107	R3R1LAL349	119	R3R1PFL4924	96
R3R1AFL3424	90	R3R1CX24218	108	R3R1LAL364	119	R3R1PFL4930	96
R3R1AFL3430	90	R3R1CX24224	108	R3R1LALL34	118	R3R1PFL4936	96
R3R1AFL3436	90	R3R1CX24230	108	R3R1LALL42	118	R3R1PFL4942	96
R3R1AFL3442	90	R3R1CX24236	108	R3R1LALL49	118	R3R1PFL4948	96
R3R1AFL3448	90	R3R1CX24242	108	R3R1LALL64	118	R3R1SA134	120
R3R1AFL4218	90	R3R1CX24248	108	R3R1LAR134	118	R3R1SA142	120
R3R1AFL4224	90	R3R1CX24918	108	R3R1LAR142	118	R3R1SA149	120
R3R1AFL4230	90	R3R1CX24924	108	R3R1LAR149	118	R3R1SA164	120
R3R1AFL4236	90	R3R1CX24930	108	R3R1LAR164	118	R3R1SA234	120

<i>pattern no.</i>	<i>page</i>	<i>pattern no.</i>	<i>page</i>	<i>pattern no.</i>	<i>page</i>	<i>pattern no.</i>	<i>page</i>
R3R1SA242	120	R3R2AFL3418	100	R3X34E	120	RR3-DZ	134
R3R1SA249	120	R3R2AFL3424	100	R3X42E	120	RR3-DZC	134
R3R1SA264	120	R3R2AFL3430	100	R3X49E	120	RR3-DZO	135
R3R1SA334	121	R3R2AFL3436	100	R3X64E	120	RR3-E24	131
R3R1SA342	121	R3R2AFL3442	100	RBCCP	253	RR3-E24S	130
R3R1SA349	121	R3R2AFL3448	100	RBF	253	RR3-E30NS	131
R3R1SA364	121	R3R2AFL4918	100	RCOUNTWT	191, 192	RR3-E30S	130
R3R1SAL34	120	R3R2AFL4924	100	RHSCN15	129	RR3-E36NS	131
R3R1SAL42	120	R3R2AFL4930	100	RHSCN250	129	RR3-E36S	130
R3R1SAL49	120	R3R2AFL4936	100	RHSCN70	129	RR3-E42NS	131
R3R1SAL64	120	R3R2AFL4942	100	RO1-CB	220	RR3-E42S	130
R3R2AF13418	101	R3R2AFL4948	100	RO1-MPB	220	RR3-E48NS	131
R3R2AF13424	101	R3R2AFL6418	100	RO1-RCB	220	RR3-E48S	130
R3R2AF13430	101	R3R2AFL6424	100	RO1-RPB	220	RR3-E60-4	131
R3R2AF13436	101	R3R2AFL6430	100	RO1-WMF2	220	RR3-E66-4	131
R3R2AF13442	101	R3R2AFL6436	100	RO1-WMF3	220	RR3-E72-4	131
R3R2AF13448	101	R3R2AFL6442	100	RO1-WMF4	220	RR3EBVC50	139
R3R2AF14918	101	R3R2AFL6448	100	RO3-A30NL	219	RR3EBVC62	139
R3R2AF14924	101	R3R2ALL3418	104	RO3-A30NN	219	RR3EBVC64	139
R3R2AF14930	101	R3R2ALL3424	104	RO3-A30PL	219	RR3EBVC76	139
R3R2AF14936	101	R3R2ALL3430	104	RO3-A30PN	219	RR3EBVC78	139
R3R2AF14942	101	R3R2ALL3436	104	RO3-A36NL	219	RR3EBVC90	139
R3R2AF14948	101	R3R2ALL3442	104	RO3-A36NN	219	RR3-EJ18	133
R3R2AF16418	101	R3R2ALL3448	104	RO3-A36PL	219	RR3-EJ18P	133
R3R2AF16424	101	R3R2ALL4218	104	RO3-A36PN	219	RR3-EJ20	133
R3R2AF16430	101	R3R2ALL4220	104	RO3-A42NL	219	RR3-EJ20P	133
R3R2AF16436	101	R3R2ALL4224	104	RO3-A42NN	219	RR3-EJ24	133
R3R2AF16442	101	R3R2ALL4230	104	RO3-A42PL	219	RR3-EJ24P	133
R3R2AF16448	101	R3R2ALL4236	104	RO3-A42PN	219	RR3-EJ30	133
R3R2AF23418	102	R3R2ALL4242	104	RO3-A48NL	219	RR3-EJ30P	133
R3R2AF23424	102	R3R2ALL4248	104	RO3-A48NN	219	RR3-EJ36	133
R3R2AF23430	102	R3R2ALL4918	105	RO3-A48PL	219	RR3-EJ36P	133
R3R2AF23436	102	R3R2ALL4924	105	RO3-A48PN	219	RR3-EJ42	133
R3R2AF23442	102	R3R2ALL4930	105	RO3-A60NL	219	RR3-EJ42P	133
R3R2AF23448	102	R3R2ALL4936	105	RO3-A60NN	219	RR3-EJ48	133
R3R2AF24918	102	R3R2ALL4942	105	RO3-A60PL	219	RR3-EJ48P	133
R3R2AF24924	102	R3R2ALL4948	105	RO3-A60PN	219	RR3-EJ54P	133
R3R2AF24930	102	R3R2ALL6418	105	RO3-A72NL	219	RR3-EJ60P	133
R3R2AF24936	102	R3R2ALL6424	105	RO3-A72NN	219	RR3-EJ66P	133
R3R2AF24942	102	R3R2ALL6430	105	RO3-A72PL	219	RR3-EJ72P	133
R3R2AF24948	102	R3R2ALL6436	105	RO3-A72PN	219	RR3-EJ78P	133
R3R2AF26418	102	R3R2ALL6442	105	RPETAD	189	RR3-EJ84P	133
R3R2AF26424	102	R3R2ALL6448	105	RR3CHI241	137	RR3-EJ90P	133
R3R2AF26430	102	R3R2SXX4218	110	RR3CHI242	137	RR3-EJ96P	133
R3R2AF26436	102	R3R2SXX4224	110	RR3CHI301	137	RR3-EPC24M	131
R3R2AF26442	102	R3R2SXX4230	110	RR3CHI302	137	RR3-EPCM	131
R3R2AF26448	102	R3R2SXX4236	110	RR3CHI361	137	RR3-EPCP24M	131
R3R2AF33418	103	R3R2SXX4242	110	RR3CHI362	137	RR3-EPCPM	131
R3R2AF33424	103	R3R2SXX4248	110	RR3CHI421	137	RR3-EPCPSM	131
R3R2AF33430	103	R3R2SXX4918	110	RR3CHI422	137	RR3-EPCSM	131
R3R2AF33436	103	R3R2SXX4924	110	RR3CHI481	137	RR3-EPI	133
R3R2AF33442	103	R3R2SXX4930	110	RR3CHI482	137	RR3-EPNY1	133
R3R2AF33448	103	R3R2SXX4936	110	RR3-DA	131, 134	RR3-EPNY2	133
R3R2AF34918	103	R3R2SXX4942	110	RR3-DAC	131, 134	RR3-EPVR	133
R3R2AF34924	103	R3R2SXX4948	110	RR3-DATSHD	132, 135	RR3EVJ	141
R3R2AF34930	103	R3R2SXX6418	110	RR3-DB	131, 134	RR3EVJ110	141
R3R2AF34936	103	R3R2SXX6424	110	RR3-DBC	131, 134	RR3EVJ82	141
R3R2AF34942	103	R3R2SXX6430	110	RR3-DC	134	RR3EVJ96	141
R3R2AF34948	103	R3R2SXX6436	110	RR3-DCC	134	RR3FDP	139
R3R2AF36418	103	R3R2SXX6442	110	RR3-DX	131, 134	RR3-REPI	133
R3R2AF36424	103	R3R2SXX6448	110	RR3-DXC	131, 134	RR3-RTPI	136
R3R2AF36430	103	R3SKIT	112	RR3-DXO	131, 135	RR3-SP-(A, B, C, X, Y, Z)	136
R3R2AF36436	103	R3SPABPT	129	RR3-DY	131, 134	RR3-SP-(A,B,X,Y)	133
R3R2AF36442	103	R3SPABTT	129	RR3-DYC	131, 134	RR3-T24	134
R3R2AF36448	103	R3SPABTW	129	RR3-DYO	131, 135	RR3-T24S	130

<i>pattern no.</i>	<i>page</i>	<i>pattern no.</i>	<i>page</i>	<i>pattern no.</i>	<i>page</i>	<i>pattern no.</i>	<i>page</i>
RR3-T30NS	134	RR3VDZ	139	RTAT5E25A	221	XTB1 BAS 30S15CA	285
RR3-T30S	130	RR3VDZC	139	RTAT5E25S	221	XTB1 BAS 30S15CF	283
RR3-T36NS	134	RR3VDZO	139	RTAT5E37A	221	XTB1 BAS 30S15SA	285
RR3-T36S	130	RR3VPBK	139	RTAT5E37S	221	XTB1 BAS 30S15SF	283
RR3-T42NS	134	RSPABPP	129	RTAT5E49A	221	XTB1 BAS 30S18SA	285
RR3-T42S	130	RSPABPW	129	RTAT5E49S	221	XTB1 BAS 30S18SF	283
RR3-T48NS	134	RSPABWW	129	RTAT5E61A	221	XTB1 BAS 30S20SA	285
RR3-T48S	130	RT1 SMK 1812	223	RTAT5E61S	221	XTB1 BAS 30S20SF	283
RR3-T60-4	134	RT1 SMK 1813	223	SISAWDSIK	257	XTB1 BAS 30S24SA	285
RR3-T66-4	134	RT1 SMK 1815	224	SISDDPS	257	XTB1 BAS 30S24SF	283
RR3-T72-4	134	RT1 SMK 1816	224	SISLC4	257	XTB1 BAS 30S25SA	285
RR3TBVC50	140	RT1 SMK 2412	223	XAUA 1248G	322	XTB1 BAS 30S25SF	283
RR3TBVC62	140	RT1 SMK 2413	223	XAUA 1260G	322	XTB1 BAS 36D10CA	288
RR3TBVC64	140	RT1 SMK 2415	224	XAUA 1272G	322	XTB1 BAS 36D10CF	286
RR3TBVC76	140	RT1 SMK 2416	224	XTIDS4505	313	XTB1 BAS 36D12CA	288
RR3TBVC78	140	RT1 SMK 3012	223	XTIDS5705	313	XTB1 BAS 36D12CF	286
RR3TBVC90	140	RT1 SMK 3013	223	XTIDS6905	313	XTB1 BAS 36D15CA	288
RR3-TJ18	136	RT1 SMK 3015	224	XTILS4509	313	XTB1 BAS 36D15CF	286
RR3-TJ18P	136	RT1 SMK 3016	224	XTILS5709	313	XTB1 BAS 36D15SA	288
RR3-TJ20	136	RT1 SMK 3612	223	XTILS6909	313	XTB1 BAS 36D15SF	286
RR3-TJ20P	136	RT1 SMK 3613	223	XTISA24	313	XTB1 BAS 36D18SA	288
RR3-TJ24	136	RT1 SMK 3615	224	XTISA30	313	XTB1 BAS 36D18SF	286
RR3-TJ24P	136	RT1 SMK 3616	224	XTISA36	313	XTB1 BAS 36D20SA	288
RR3-TJ30	136	RT1 SMK 4212	223	XTISA42	313	XTB1 BAS 36D20SF	286
RR3-TJ30P	136	RT1 SMK 4213	223	XTISA48	313	XTB1 BAS 36D24CA	288
RR3-TJ36	136	RT1 SMK 4215	224	XTISA54	313	XTB1 BAS 36D24CF	286
RR3-TJ36P	136	RT1 SMK 4216	224	XTISA60	313	XTB1 BAS 36D25CA	288
RR3-TJ42	136	RT1 SMK 4812	223	XTISA66	313	XTB1 BAS 36D25CF	286
RR3-TJ42P	136	RT1 SMK 4813	223	XTISA72	313	XTB1 BAS 36S10CA	289
RR3-TJ48	136	RT1 SMK 4815	224	XTB1 BAS 24D10CF	280	XTB1 BAS 36S10CF	287
RR3-TJ48P	136	RT1 SMK 4816	224	XTB1 BAS 24D12CF	280	XTB1 BAS 36S12CA	289
RR3-TJ54P	136	RT1 SMK 5412	223	XTB1 BAS 24D15CF	280	XTB1 BAS 36S12CF	287
RR3-TJ60P	136	RT1 SMK 5413	223	XTB1 BAS 24D15SF	280	XTB1 BAS 36S15CA	289
RR3-TJ66P	136	RT1 SMK 5415	224	XTB1 BAS 24D18SF	280	XTB1 BAS 36S15CF	287
RR3-TJ72P	136	RT1 SMK 5416	224	XTB1 BAS 24D20SF	280	XTB1 BAS 36S15SA	289
RR3-TJ78P	136	RT1 SMK 6012	223	XTB1 BAS 24D24SF	280	XTB1 BAS 36S15SF	287
RR3-TJ84P	136	RT1 SMK 6013	223	XTB1 BAS 24D25SF	280	XTB1 BAS 36S18SA	289
RR3-TJ90P	136	RT1 SMK 6015	224	XTB1 BAS 24S10CF	281	XTB1 BAS 36S18SF	287
RR3-TJ96P	136	RT1 SMK 6016	224	XTB1 BAS 24S12CF	281	XTB1 BAS 36S20SA	289
RR3-TPC24M	134	RT1 SMK 6612	223	XTB1 BAS 24S15CF	281	XTB1 BAS 36S20SF	287
RR3-TPCM	134	RT1 SMK 6613	223	XTB1 BAS 24S15SF	281	XTB1 BAS 36S24SA	289
RR3-TPCP24M	134	RT1 SMK 6615	224	XTB1 BAS 24S18SF	281	XTB1 BAS 36S24SF	287
RR3-TPCPM	134	RT1 SMK 6616	224	XTB1 BAS 24S20SF	281	XTB1 BAS 36S25SA	289
RR3-TPCPSM	134	RT1 SMK 7212	223	XTB1 BAS 24S24SF	281	XTB1 BAS 36S25SF	287
RR3-TPCSM	134	RT1 SMK 7213	223	XTB1 BAS 24S25SF	281	XTB1 SLIK	294
RR3-TPI	136	RT1 SMK 7215	224	XTB1 BAS 30D10CA	284	XTB1 SLIK30	294
RR3-TPNY1	136	RT1 SMK 7216	224	XTB1 BAS 30D10CF	282	XTB1 SLIK36	294
RR3-TPNY2	136	RT1 SMK 7812	223	XTB1 BAS 30D12CA	284	XTB1AC	300
RR3-TPVR	136	RT1 SMK 7813	223	XTB1 BAS 30D12CF	282	XTB1AC24	300
RR3TVJ	141	RT1 SMK 7815	224	XTB1 BAS 30D15CA	284	XTB1ACEND	301
RR3TVJ110	141	RT1 SMK 7816	224	XTB1 BAS 30D15CF	282	XTB1DB10C	292
RR3TVJ82	141	RT1 SMK 8412	223	XTB1 BAS 30D15SA	284	XTB1DB10E	292
RR3TVJ96	141	RT1 SMK 8413	223	XTB1 BAS 30D15SF	282	XTB1DB12C	292
RR3VDA	139	RT1 SMK 8415	224	XTB1 BAS 30D18SA	284	XTB1DB12E	292
RR3VDAC	139	RT1 SMK 8416	224	XTB1 BAS 30D18SF	282	XTB1DB15C	292
RR3VDB	139	RT1 SMK 9012	223	XTB1 BAS 30D20SA	284	XTB1DB15E	292
RR3VDBC	139	RT1 SMK 9013	223	XTB1 BAS 30D20SF	282	XTB1DB4E	292
RR3VDC	139	RT1 SMK 9015	224	XTB1 BAS 30D24CA	284	XTB1DB5C	292
RR3VDCC	139	RT1 SMK 9016	224	XTB1 BAS 30D24CF	282	XTB1DB5E	292
RR3VDX	139	RT1 SMK 9612	223	XTB1 BAS 30D25CA	284	XTB1DB6C	292
RR3VDXC	139	RT1 SMK 9613	223	XTB1 BAS 30D25CF	282	XTB1DB6E	292
RR3VDXO	139	RT1 SMK 9615	224	XTB1 BAS 30S10CA	285	XTB1DB8C	292
RR3VDY	139	RT1 SMK 9616	224	XTB1 BAS 30S10CF	283	XTB1DB8E	292
RR3VDYC	139	RT1 SMK B	223, 224	XTB1 BAS 30S12CA	285	XTB1EDD24	294
RR3VDYO	139	RTAT5E19S	221	XTB1 BAS 30S12CF	283	XTB1EDD30	294

<i>pattern no.</i>	<i>page</i>	<i>pattern no.</i>	<i>page</i>	<i>pattern no.</i>	<i>page</i>	<i>pattern no.</i>	<i>page</i>
XTB1EDD36	294	XTB1TB8C	291	XTCS1 SBA	313	XTR1FE	302, 304, 308
XTB1EP1DD24	298	XTB1TB8E	291	XTCT6030D	309	XTR1H30D	308
XTB1EP1DD24P	297	XTB1XD30	299	XTCT6030LD	309	XTR1IOF	303, 305, 308
XTB1EP1DD30	298	XTB1XD30N	299	XTCT6036D	309	XTR1PCX	303, 305
XTB1EP1DD30P	297	XTB1XD36	299	XTCT6036LD	309	XTR1T30D	304
XTB1EP1DD36	298	XTB1XD36N	299	XTCT7230D	309	XTR1T30S	304
XTB1EP1DD36P	297	XTB1XDD24	294	XTCT7230LD	309	XTR1T424D	304
XTB1EP1LD24	298	XTB1XDD30	294	XTCT7236D	309	XTR1T424S	304
XTB1EP1LD24P	297	XTB1XDD36	294	XTCT7236LD	309	XTR1TCC25	309
XTB1EP1LD30	298	XTB1XS30	299	XTDT42	309	XTR1TCPM	305
XTB1EP1LD30P	297	XTB1XS30N	299	XTDTX42	309	XTR1TJ18	305
XTB1EP1LD36	298	XTB1XS36	299	XTES1 2414	320	XTR1TJ30	305
XTB1EP1LD36P	297	XTB1XS36N	299	XTES1 2414F	321	XTR1TJ42	305
XTB1EP1RD24	298	XTB1YDD24	295	XTES1 2421	320	XTR1TPH	305
XTB1EP1RD24P	297	XTB1YDD30	295	XTES1 2421F	321	XTR1TPI	305
XTB1EP1RD30	298	XTB1YDD36	295	XTES1 3014	320	XTR1X30D	306
XTB1EP1RD30P	297	XTB2LDD	294	XTES1 3014F	321	XTR1X30S	306
XTB1EP1RD36	298	XTB2LDD24	294	XTES1 3021	320	XTR1X424D	306
XTB1EP1RD36P	297	XTB2LSD	296	XTES1 3021F	321	XTR1X424S	306
XTB1EP2DD24	298	XTB2LSD24	296	XTES1 3614	320	XTR1XCPM	307
XTB1EP2DD24P	297	XTBT18	310	XTES1 3614F	321	XTR1XJ18	307
XTB1EP2DD30	298	XTBT24	310	XTES1 3621	320	XTR1XJ30	307
XTB1EP2DD30P	297	XTBT36	310	XTES1 3621F	321	XTR1XJ42	307
XTB1EP2DD36	298	XTBT48	310	XTES1 4814	318	XTR1XPH	307
XTB1EP2DD36P	297	XTBT60	310	XTES1 4814F	319	XTR1XPI	307
XTB1EP2SD24	298	XTC1 120 AA	290	XTES1 4821	318	XTRS1 5414	316
XTB1EP2SD24P	297	XTC1 144 AA	290	XTES1 4821F	319	XTRS1 5414F	317
XTB1EP2SD30	298	XTC1 48	290	XTES1 6014	318	XTRS1 5421	316
XTB1EP2SD30P	297	XTC1 60	290	XTES1 6014F	319	XTRS1 5421F	317
XTB1EP2SD36	298	XTC1 72	290	XTES1 6021	318	XTRS1 6014	316
XTB1EP2SD36P	297	XTC1 96	290	XTES1 6021F	319	XTRS1 6014F	317
XTB1ESD24	296	XTC1 END	290	XTES1 7214	318	XTRS1 6021	316
XTB1ESD30	296	XTCA1 120 AA	290	XTES1 7214F	319	XTRS1 6021F	317
XTB1ESD36	296	XTCA1 144 AA	290	XTES1 7221	318	XTRS1 6614	316
XTB1FC	300	XTCA1 48	290	XTES1 7221F	319	XTRS1 6614F	317
XTB1FC24	300	XTCA1 60	290	XTPS1MZKIT	323	XTRS1 6621	316
XTB1FCEND	301	XTCA1 72	290	XTR1BCC50	309	XTRS1 6621F	317
XTB1LP	301	XTCA1 96	290	XTR1D1	307	XTRS1 7214	316
XTB1MB	300	XTCF 48	290	XTR1D1C	307	XTRS1 7214F	317
XTB1RAK	309	XTCF 60	290	XTR1D2	307	XTRS1 7221	316
XTB1SB10C	293	XTCF 72	290	XTR1D2C	307	XTRS1 7221F	317
XTB1SB10E	293	XTCS1 4714	311	XTR1D3	307	XTRS1 7814	316
XTB1SB12C	293	XTCS1 4714F	312	XTR1D3C	307	XTRS1 7814F	317
XTB1SB12E	293	XTCS1 4721	311	XTR1D4	307	XTRS1 7821	316
XTB1SB15C	293	XTCS1 4721F	312	XTR1D4C	307	XTRS1 7821F	317
XTB1SB15E	293	XTCS1 4814	311	XTR1DA	303, 305	XTSM1C	318, 319
XTB1SB4E	293	XTCS1 4814F	312	XTR1DAC	303, 305	XTSM1K	314, 315
XTB1SB5C	293	XTCS1 4821	311	XTR1DB	303, 305	XTSM1KC	320, 321
XTB1SB5E	293	XTCS1 4821F	312	XTR1DBC	303, 305	XTSM1KK	318, 319
XTB1SB6C	293	XTCS1 5914	311	XTR1DC	305	XTSM1P	314, 315, 316, 317, 318, 319
XTB1SB6E	293	XTCS1 5914F	312	XTR1DCC	305	XTSM1PC	320, 321
XTB1SB8C	293	XTCS1 5921	311	XTR1DXO	303, 305	XTSM1S	314, 315, 316, 317, 318, 319
XTB1SB8E	293	XTCS1 5921F	312	XTR1DYO	303, 305	XTSM1SC	320, 321
XTB1T24	299	XTCS1 6014	311	XTR1DZO	305	XTSM1SLAT	318, 319
XTB1TB10C	291	XTCS1 6014F	312	XTR1E30D	302	XTSS1 2414	314
XTB1TB10E	291	XTCS1 6021	311	XTR1E30S	302	XTSS1 2414F	315
XTB1TB12C	291	XTCS1 6021F	312	XTR1E424D	302	XTSS1 2421	314
XTB1TB12E	291	XTCS1 7114	311	XTR1E424S	302	XTSS1 2421F	315
XTB1TB15C	291	XTCS1 7114F	312	XTR1ECPM	303	XTSS1 3014	314
XTB1TB15E	291	XTCS1 7121	311	XTR1EE	302, 304, 308	XTSS1 3014F	315
XTB1TB4E	291	XTCS1 7121F	312	XTR1EJ18	303	XTSS1 3021	314
XTB1TB5C	291	XTCS1 7214	311	XTR1EJ30	303	XTSS1 3021F	315
XTB1TB5E	291	XTCS1 7214F	312	XTR1EJ42	303	XTSS1 3614	314
XTB1TB6C	291	XTCS1 7221	311	XTR1EPH	303	XTSS1 3614F	315
XTB1TB6E	291	XTCS1 7221F	312	XTR1EPI	303	XTSS1 3621	314

<i>pattern no.</i>	<i>page</i>	<i>pattern no.</i>	<i>page</i>	<i>pattern no.</i>	<i>page</i>
XTSS1 3621F	315	XTPP4824B (L)	274	XTTS6024E (1/2/3)	276
XTTK3018F (L/M/1/2/3)	279	XTPP4824C (L)	275	XTTS6024U (1/2/3)	274
XTTK3036F (L/M/1/2/3)	279	XTPP4824E (L)	276	XTTS6030A (1/2/3)	273
XTTK3618F (L/M/1/2/3)	279	XTPP4830A (L)	273	XTTS6030C (1/2/3)	275
XTTK3636F (L/M/1/2/3)	279	XTPP4830B (L)	274	XTTS6030E (1/2/3)	276
XTTK4218F (L/M/1/2/3)	279	XTPP4830C (L)	275	XTTS6030U (1/2/3)	274
XTTK4236F (L/M/1/2/3)	279	XTPP4830E (L)	276	XTTS6036A (1/2/3)	273
XTTK4824A (L/M/1/2/3)	273	XTPP4836A (L)	273	XTTS6036C (1/2/3)	275
XTTK4824C (L/M/1/2/3)	275	XTPP4836B (L)	274	XTTS6036D (1/2/3)	277
XTTK4824E (L/M/1/2/3)	276	XTPP4836C (L)	275	XTTS6036E (1/2/3)	277
XTTK4824U (L/M/1/2/3)	274	XTPP4836D (L)	278	XTTS6036U (1/2/3)	274
XTTK4830A (L/M/1/2/3)	273	XTPP4836E (L)	278	XTTS7224A (1/2/3)	273
XTTK4830C (L/M/1/2/3)	275	XTPP6024A (L)	273	XTTS7224C (1/2/3)	275
XTTK4830E (L/M/1/2/3)	276	XTPP6024B (L)	274	XTTS7224E (1/2/3)	276
XTTK4830U (L/M/1/2/3)	274	XTPP6024C (L)	275	XTTS7224U (1/2/3)	274
XTTK4836A (L/M/1/2/3)	273	XTPP6024E (L)	276	XTTS7230A (1/2/3)	273
XTTK4836C (L/M/1/2/3)	275	XTPP6030A (L)	273	XTTS7230C (1/2/3)	275
XTTK4836D (L/M/1/2/3)	277	XTPP6030B (L)	274	XTTS7230E (1/2/3)	276
XTTK4836E (L/M/1/2/3)	277	XTPP6030C (L)	275	XTTS7230U (1/2/3)	274
XTTK4836U (L/M/1/2/3)	274	XTPP6030E (L)	276	XTTS7236A (1/2/3)	273
XTTK6018F (L/M/1/2/3)	279	XTPP6036A (L)	273	XTTS7236C (1/2/3)	275
XTTK6024A (L/M/1/2/3)	273	XTPP6036B (L)	274	XTTS7236D (1/2/3)	277
XTTK6024C (L/M/1/2/3)	275	XTPP6036C (L)	275	XTTS7236E (1/2/3)	277
XTTK6024E (L/M/1/2/3)	276	XTPP6036D (L)	278	XTTS7236U (1/2/3)	274
XTTK6024U (L/M/1/2/3)	274	XTPP6036E (L)	278	XTTS9624A (1/2/3)	273
XTTK6030A (L/M/1/2/3)	273	XTPP7224A (L)	273	XTTS9624C (1/2/3)	275
XTTK6030C (L/M/1/2/3)	275	XTPP7224B (L)	274	XTTS9624U (1/2/3)	274
XTTK6030E (L/M/1/2/3)	276	XTPP7224C (L)	275	XTTS9630A (1/2/3)	273
XTTK6030U (L/M/1/2/3)	274	XTPP7224E (L)	276	XTTS9630C (1/2/3)	275
XTTK6036A (L/M/1/2/3)	273	XTPP7230A (L)	273	XTTS9630U (1/2/3)	274
XTTK6036C (L/M/1/2/3)	275	XTPP7230B (L)	274	XTTS9636A (1/2/3)	273
XTTK6036D (L/M/1/2/3)	277	XTPP7230C (L)	275	XTTS9636C (1/2/3)	275
XTTK6036E (L/M/1/2/3)	277	XTPP7230E (L)	276	XTTS9636U (1/2/3)	274
XTTK6036F (L/M/1/2/3)	279	XTPP7236A (L)	273	XTWB120	310
XTTK6036U (L/M/1/2/3)	274	XTPP7236B (L)	274	XTWTB	310
XTTK7218F (L/M/1/2/3)	279	XTPP7236C (L)	275	XTWTBSLIK	310
XTTK7224A (L/M/1/2/3)	273	XTPP7236D (L)	278	XTWTC	310
XTTK7224C (L/M/1/2/3)	275	XTPP7236E (L)	278	XTWTX	310
XTTK7224E (L/M/1/2/3)	276	XTPP9624A (L)	273		
XTTK7224U (L/M/1/2/3)	274	XTPP9624B (L)	274		
XTTK7230A (L/M/1/2/3)	273	XTPP9624C (L)	275		
XTTK7230C (L/M/1/2/3)	275	XTPP9630A (L)	273		
XTTK7230E (L/M/1/2/3)	276	XTPP9630B (L)	274		
XTTK7230U (L/M/1/2/3)	274	XTPP9630C (L)	275		
XTTK7236A (L/M/1/2/3)	273	XTPP9636A (L)	273		
XTTK7236C (L/M/1/2/3)	275	XTPP9636B (L)	274		
XTTK7236D (L/M/1/2/3)	277	XTPP9636C (L)	275		
XTTK7236E (L/M/1/2/3)	277	XTTS3018F (1/2/3)	279		
XTTK7236F (L/M/1/2/3)	279	XTTS3618F (1/2/3)	279		
XTTK7236U (L/M/1/2/3)	274	XTTS4218F (1/2/3)	279		
XTTK8418F (L/M/1/2/3)	279	XTTS4824A (1/2/3)	273		
XTTK8436F (L/M/1/2/3)	279	XTTS4824C (1/2/3)	275		
XTTK9624A (L/M/1/2/3)	273	XTTS4824E (1/2/3)	276		
XTTK9624C (L/M/1/2/3)	275	XTTS4824U (1/2/3)	274		
XTTK9624U (L/M/1/2/3)	274	XTTS4830A (1/2/3)	273		
XTTK9630A (L/M/1/2/3)	273	XTTS4830C (1/2/3)	275		
XTTK9630C (L/M/1/2/3)	275	XTTS4830E (1/2/3)	276		
XTTK9630U (L/M/1/2/3)	274	XTTS4830U (1/2/3)	274		
XTTK9636A (L/M/1/2/3)	273	XTTS4836A (1/2/3)	273		
XTTK9636C (L/M/1/2/3)	275	XTTS4836C (1/2/3)	275		
XTTK9636U (L/M/1/2/3)	274	XTTS4836D (1/2/3)	277		
XTPP3018F (L)	279	XTTS4836E (1/2/3)	277		
XTPP3618F (L)	279	XTTS4836U (1/2/3)	274		
XTPP4218F (L)	279	XTTS6024A (1/2/3)	273		
XTPP4824A (L)	273	XTTS6024C (1/2/3)	275		

Selling Policy

	<p>This Selling Policy supercedes all previous selling policies. Prices, discounts and product offerings are subject to change without notice.</p>
Terms & Conditions of Sales	<p>Sales by Knoll, Inc. or Knoll North America Corp. ("Seller") of Knoll Product Lines (hereinafter "Products") within the United States and Canada are made only on the terms which are contained in this Selling Policy. Seller hereby gives notice of its objection to any different or additional terms and conditions. This sale is expressly conditional upon Purchaser's assent to the terms and conditions set forth below. Additional terms and conditions may apply to KnollStudio and KnollTextiles orders. These terms and conditions may be modified or supplemented only by a written document signed by an authorized representative of Seller. These terms and conditions supercede any prior and/or contemporaneous agreements or correspondence between Purchaser and Seller. Written quotations expire thirty (30) days from the date of issuance and can be withdrawn by written notice anytime during that period. Where Purchaser and Seller have entered into the Knoll Electronic Terms and Conditions, all orders, acknowledgements, invoices and other business communications placed or transmitted in accordance with the Knoll Electronic Terms and Conditions shall be deemed to be in writing and signed and shall be valid for all purposes as if they were originated and maintained in documentary form.</p>
Ordering Information	<p>All orders must be in writing. The product pattern number(s) contained on Seller's order acknowledgement shall be the final expression of the order.</p>
Order Confirmation	<p>A purchase order is not binding on Seller until Purchaser has received Seller's order confirmation or acknowledgment.</p>
Pricing Policies	<p>List prices are subject to change without notice.</p> <p>List prices shall be those prices in effect on the date of receipt of a complete purchase order unless shipment is requested more than ninety (90) days after order entry in which case prices in effect on the date of shipment apply. List prices include specified freight costs. Unless specified in writing by Seller, no other charges are included in Seller's list prices.</p>
Taxes	<p>All sales, use, excise and other taxes applicable to the sale of the Products shall be paid by Purchaser. If Purchaser claims an exemption from any tax, Purchaser shall submit to Seller the appropriate exemption certificates.</p>
Terms of Payment	<p>Payment for one hundred percent (100%) of the net order amount is due within thirty (30) days of the date of invoice, which is generally issued upon shipment. In case of any discrepancies, such as shortages, and Seller is notified in writing within ten (10) days of receipt of Product, only that portion may be deducted and the balance paid. For orders greater than \$100,000 net, a fifty percent (50%) deposit is due at the time of order placement, with the remainder due within thirty (30) days of the date of invoice.</p> <p>KnollStudio orders less than \$2,000 require payment for one hundred percent (100%) of the net order amount (including any applicable sales tax and charges for inside delivery, special packaging, etc.), due at time of order placement. For KnollStudio orders greater than \$2,000, a one-half (50%) deposit is due at time of order placement with the remainder (including any applicable sales tax and charges for inside delivery, special packaging, etc.) due prior to shipment.</p> <p>If, in the judgment of Seller, Purchaser's financial condition does not justify the terms of the payment, Seller may require full or partial payment in advance.</p> <p>Past due accounts shall be charged one and one-half percent (1.5%) per month, or the highest rate permitted by law, whichever is less, and will be added to the outstanding balance. In the event Purchaser defaults on payment, Purchaser shall be liable for all collection costs, including reasonable attorney's fees and costs.</p>
Changes and Cancellation	<p>Purchase orders may not be changed or cancelled, in whole or in part, without prior written consent of Seller. Changes may effect delivery dates. Expenses incurred because of changes shall be charged to Purchaser. In the event of cancellations, Purchaser will be liable for reasonable cancellation charges established by Seller. Orders for special Product, orders including "COM" (hereinafter defined) material and orders pursuant to expedited delivery programs, may not be canceled.</p>
Freight Prepaid	<p>Freight is prepaid and included in the price of all Products, except KnollTextiles, within the 48 contiguous United States for orders placed with Knoll, Inc. and within Canada, excluding the Yukon, Northwest Territories, Nunavut and Newfoundland for orders placed with Knoll North America Corp. Packing is tested for rigorous motion and transportation but is not guaranteed to protect furniture from all conditions. If special packaging is required for any reason, please consult with your sales representative or dealer. Seller shall select the method of shipment and routing. Freight for all KnollTextiles orders is prepaid and added to the invoice.</p>
Delivery/Freight Charges	<p>Shipments outside the contiguous 48 United States and Canada shall be shipped F.O.B. Origin.</p> <p>For shipments outside the contiguous United States and Canada, Purchaser is responsible for the cost of freight from point of embarkation, including any handling and transportation charges incidental to loading at the point of departure and unloading at the final destination.</p> <p>Conditions beyond the control of Seller, including weather, available facilities and traffic conditions, may affect exact time of delivery. Seller shall not be responsible for specific carrier delivery date or time unless it has made a specific delivery commitment, in writing.</p> <p>Nonstandard methods of shipment and/or additional services are available upon request. Purchaser will be billed for the differential cost of any special services in excess of standard surface carrier freight costs. Premium charges, at Purchaser's request, will be added for airfreight, exclusive use of vehicle and extra, export or special packaging. Accessorial charges will be added for inside delivery, extra labor, reassignment and redelivery.</p> <p>Partial shipments may be made and invoiced by Seller.</p>
Claims	<p>All shipments for Knoll Products within the contiguous United States and Canada are F.O.B. Origin. All risk of loss passes to Purchaser at time of delivery to carrier. Purchaser shall inspect all Products upon receipt and notify Seller within ten (10) working days after receipt of any damage or defects which are, or should be, apparent from an inspection of the Product and its packaging. Failure of Purchaser to notify Seller during the ten (10) working day period shall constitute acceptance of the Products and waiver of any apparent defects, errors or shortages. For all claims relating to Product damaged in transit or for any other claims relating to or arising out of the transportation of the Product, Purchaser must seek recovery from the carrier and Seller has no liability to Purchaser for such claims. Seller may, upon request, assist Purchaser with filing of such claims with the carrier, but Seller will not be liable for any of these transportation related claims.</p>
Seller's Security Interest	<p>Until Seller receives the full payment for the Product, Seller shall have a security interest in the Product. Purchaser agrees to perform all acts, including but not limited to the execution and filing of documentation, which may be necessary to perfect and assure the security interest of Seller.</p>
Returns	<p>The return of Products without a written authorization by Seller shall not be accepted. To receive authorization for Product return, please call Customer Service. All Products that are returned pursuant to a valid authorization shall be subject to a twenty-five percent (25%) of list restocking charge. Products not currently offered for sale by Seller (including COM) shall not be authorized for return. All returned Products must be unused, in original condition and in the original Seller packing cartons. No refund or credit shall be given for damaged Products.</p>
Held Orders/Storage	<p>If Purchaser requests that an order be held or delayed, prices and terms and conditions in effect at the time of shipment shall apply. If Purchaser requests a delay after the time when Seller can defer production, Purchaser will be invoiced for the Product, payable in accordance with standard terms, when the order is ready for shipment. Seller may transfer the Product to storage, in which case all expenses incurred in connection with storage, including demurrage, preparation for storage, storage charges and handling shall be payable by Purchaser upon submission of invoices by Seller. Risk of loss to the Product shall pass to the Purchaser upon delivery of the Product into storage.</p>

Selling Policy

Customer's Own Material	A Purchaser who requests a fabric or other surface material not standard to Seller's line of Products ("COM") must submit samples of the requested material to Seller prior to entry of a purchaser order. Seller shall determine if the material is suitable to its manufacturing processes and meets any requirements of Underwriters Laboratories. If the COM is acceptable, Seller will then establish a price for using the COM or the Product in question. For a description of the procedures for submitting samples and testing, contact customer resources or your sales representative. Seller shall have no responsibility for the appearance, condition, performance, durability, colorfastness or any other physical attribute of the COM. Purchaser shall indemnify and hold Seller harmless for any damages, injuries or losses arising out of or related to use of the COM on the Product.
Warranty	<p>Seller warrants to the original Purchaser only that the Products Seller manufactures and sells to Purchaser are free of defects in workmanship and materials, during the applicable warranty period set forth below.</p> <p>Warranty period set forth below is for 24-hour, 7 days a week, multi shift use (includes parts and labor to repair).</p> <p>Should any failure to conform with this limited warranty appear to a Product listed below during the applicable warranty period from the date of shipment, Seller shall, upon prompt written notice, repair or replace, at its option and costs, the affected part or parts.</p> <p><i>Product and Period of Warranty</i></p> <p><i>Lifetime: Antenna Workspaces, AutoStrada, Calibre, Crinion Open Table, Currents, Dividends Horizon, Morrison, Reff Profiles laminate, Series 2 Storage, Template and other non-wood components (except cascade edge worksurfaces, operational parts, controls, electrical, Lighting, Series 2 Veneer Front Storage, special or custom products, see below)</i></p> <p><i>12 Years: Chadwick, Essentials Work Chairs, Generation by Knoll, Life, Moment, MultiGeneration by Knoll, ReGeneration by Knoll, Remix, RPM, Sapper and Toboggan seating (except seating upholstery, textiles, leathers and finishes, see below).</i></p> <p><i>10 Years: Anchor Storage except digital keypad lock, Antenna Workspaces, AutoStrada, Crinion Open Table, Dividends Horizon, Dividends Horizon Satellite Surfaces, Reff Profiles, Template wood components, Series 2 Veneer Front Storage, cascade edge worksurfaces, Wood Casegoods (The Graham Collection) (except wood casegoods upholstered surfaces, see below), Reuter overheads, Reuter vertical storage, KnollExtra Sapper Monitor Arm Collection, Sapper XYZ Monitor Arm, Adjustable keyboard mechanisms and platforms, Communication Boards (except fabric board textiles, see below), Smokador collection (except leathers, see below), and Orchestra Universal Systems Accessories, k. lounge structural components.</i></p> <p><i>5 Years: Operational parts, controls, electrical, Lighting (except light ballasts, bulbs and power supply, see below), special or custom product, wood veneer products, Currents handcrank, Interaction Counterforce, KnollStudio, Spark Series seating structural elements, structural elements of all KnollStudio outdoor products including all Richard Schultz designed products, KnollExtra CPU storage and all universal storage drawers and Power Collection, Tone Tables.</i></p> <p><i>3 Years: Seating upholstery, textiles, leathers and finishes. Fabric boards textiles and Smokador Collection leathers.</i></p> <p><i>2 Years: Anchor Storage digital keypad lock, all other KnollExtra product</i></p> <p><i>1 Year: Light ballasts, bulbs and power supply, seating upholstered amp pads and soft amp pads, wood casegoods upholstered surfaces. KnollStudio, outdoor product finishes, k. lounge upholstery and k. lounge fabric.</i></p> <p>This warranty does not apply to:</p> <ul style="list-style-type: none">• Damage caused by a carrier other than the Seller.• Normal wear and tear or acts or omissions of parties other than Seller (including user modification, improper use or installation of Products).• COM or other third party materials applied to Products.• Products not installed by or under the auspices of a Knoll Dealer.• Dramatic temperature variations or exposure to unusual conditions.• Changes in surface finishes, including colorfastness due to aging or exposure to light.• Clear paint finish applied to Antenna Workspaces steel or aluminum part.• Except as specifically noted above, textiles and upholstery supplied by <i>KnollTextiles</i> (consult current <i>KnollTextiles</i> price list for applicable warranty). <p>Natural variations occurring in wood, marble, and leather shall not be considered defects, and the Seller does not guarantee the colorfastness or matching of the colors, grains or textures, or surface hardness of such materials. The Seller also does not guarantee the colorfastness of fiberglass panel surfaces. THE EXPRESS WARRANTIES CONTAINED HEREIN ARE IN LIEU OF ALL OTHER WARRANTIES, EXPRESS OR IMPLIED, INCLUDING ANY WARRANTIES OF MERCHANTABILITY AND FITNESS FOR PARTICULAR PURPOSE AND ALL OTHER WARRANTIES ARISING FROM COURSE OF DEALING OR USAGE OF TRADE.</p> <p>The remedies provided above are the Purchaser's sole remedies for any failure of Seller to comply with its obligations regarding the workmanship of its Products. Correction of any nonconformity in the manner and for the period of time provided shall constitute complete fulfillment of all liabilities of Seller, with respect to or arising out of the Product furnished hereunder.</p>
Delay/Force Majeure	Seller shall not be liable for failure to perform or for delay in performance due to fire, flood, strike or other labor difficulty, act of God, act of any governmental authority or of the Purchaser, riot, embargo, fuel or energy shortage, wrecks or delay in transportation, inability to obtain necessary labor, materials or manufacturing facilities from usual sources or failure of suppliers to meet their contractual obligations, or due to any cause beyond its reasonable control. If any such event occurs, Seller may extend delivery dates by a period of time necessary to overcome the effect of such delay, allocate available Product or cancel any purchase order.
Compliance with Law	PURCHASER IS SOLELY RESPONSIBLE FOR COMPLIANCE WITH ALL APPLICABLE FEDERAL, STATE AND LOCAL LAWS, ORDINANCES, REGULATIONS, RULES AND STANDARDS RELATING TO THE INSTALLATION, MAINTENANCE, USE AND OPERATION OF THE PRODUCTS.
Patents	<p>Subject to the following provisions, Seller shall, at its own expense, defend or, at its option, settle any claim, suit or proceeding brought against the Purchaser, and/or its vendees, mediate and immediate, so far as based on an allegation that any Product or any part thereof furnished hereunder constitutes a direct or a contributory infringement of any claim of any patent of the United States or Canada. This obligation shall be effective only if Purchaser shall have made all payments then due hereunder and if Seller is notified promptly in writing and given authority, information and assistance for the defense of said claim, suit or proceeding. Seller shall pay all damages and costs awarded in such suit or proceedings so defended.</p> <p>The foregoing indemnity does not apply to the following:</p> <ul style="list-style-type: none">• Products supplied according to a design other than that of Seller, and which is required by the Purchaser.• Combination of the Product with another product not furnished hereunder unless Seller is a contributory infringer.• Any settlements of a suit or proceeding made without Seller's written consent.
Limitations of Liability	<p>SELLER, ITS CONTRACTORS, AUTHORIZED DEALERS AND SUBCONTRACTORS OR SUPPLIERS OF ANY TIER SHALL NOT BE LIABLE TO PURCHASER FOR ANY SPECIAL, INDIRECT, INCIDENTAL OR CONSEQUENTIAL DAMAGES ARISING FROM A BREACH OF THIS AGREEMENT.</p> <p>Purchaser's remedies set forth herein are exclusive and the liability of Seller with respect to the breach of this agreement or any contract entered into between the parties pursuant hereto shall not exceed the price of the Product or part on which such liability is based.</p>

KnollKey Lock Program

KnollKey Lock Program General Information

Following is the KnollKey lock policy, applicable to all products.

Knoll furniture can be ordered keyed-alike or random keyed. Key-alike and random keying instructions cannot be mixed on any single order. Only one of the two instructions can be used on an individual order. When an order is submitted with mixed (key-alike and random) instructions, Knoll will release the order as key-alike only and lock cores will have to be specified separately.

Key-alike

For the convenience of the user, furniture may be keyed alike at no charge. Write "Key-alike" in the description of your purchase order for any pedestal, overhead, file or other item you wish to have keyed alike.

Using the key-alike instructions, order cores and keys as line items on your purchase order. Do NOT submit a key-alike form. The Knoll East Greenville Lock Center will select key numbers from the standard range of K 001 - K 250. Key numbers will not be repeated unless over 250 sets are ordered. Lock cores keyed-alike will ship separately from the product, ready for field installation.

There is no charge for key-alike orders if placed with the furniture order.

IF THE KEY-ALIKE ORDER IS NOT PLACED AT LEAST TWO WEEKS PRIOR TO THE FURNITURE SHIP DATE, A \$50 HANDLING CHARGE AND AIR FREIGHT CHARGES WILL APPLY.

If product is ordered and shipped random-keyed, additional lock cores for key-alike are billable.

Random-Keying

To specify product keyed-random, write "key-random" in the product description. Random-keyed product is shipped with the lock core factory installed. A shrouded key is included. Random means no effort has been made to match key numbers, or to make them different.

Keys

A Knoll shrouded key is shipped with every lock core. 250 Key numbers are available. For numbers above 250, contact Custom Product Development. Additional keys and key blanks are available. See service parts for more information.

Master Keying

Knoll locks can be controlled by means of a master key. There is no additional per-lock charge for master keying. A letter of approval from the client must accompany orders for master keys.

Installing Lock Cores

Lock cores can be installed or removed in the field by using a change key. Cores must be in the unlocked position to be removed. See service parts for change key pattern number and pricing.

Lock Distribution

All orders for key-alike lock cores/keys are packaged and shipped from the East Greenville Lock Center, regardless of where the pedestals, overhead, or other units are produced. Random keyed product will have cores factory-installed.

How to Specify Key-Alike

Following is an example of how to specify key-alike for a cluster of 10 workstations.

Step 1 - Using the project floorplan, count the number of locks in each workstation.

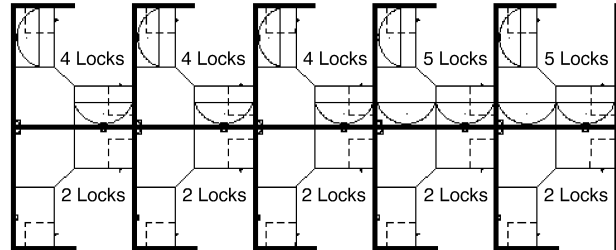

Step 2 - Count the number of workstations with the same quantity of locks. Group together the workstations with a like number of locks.

5 workstations with 2 locks per station
3 workstations with 4 locks per station
2 workstations with 5 locks per station

Step 3 - For the first group (5 sets of 2 locks), enter the number of workstations in the quantity column.

Qty	Pattern #	Description	Unit List	Ext. List
5				

Step 4 - Then enter the pattern number "KSPEC_ _" and add a suffix for the number of locks for that group (i.e., for 2 locks per station, add the suffix "2"). Up to 30 lock cores are available in a set (i.e., KSPEC 30).

Qty	Pattern #	Description	Unit List	Ext. List
5	KSPEC 2	Set of 2 cores/keys	N / C	N / C

Step 5 - Repeat for other groups.

Qty	Pattern #	Description	Unit List	Ext. List
5	KSPEC 2	Set of 2 cores/keys	N / C	N / C
3	KSPEC 4	Set of 4 cores/keys	N / C	N / C
2	KSPEC 5	Set of 5 cores/keys	N / C	N / C

Your Key instructions are complete.

Knoll will select key numbers for each set from 250 available numbers. Additional key numbers are available through Custom Product Development. **For additions to existing installations, specify desired key numbers in the description.**

Service Parts

Pattern #	Description	List Price
KKEY_ _ _	Shrouded Key Specify key number desired	\$10
KBLANK	Shrouded Key Blank	\$10
KSPECB_ _ _	Retrofit Universal Core/Key Specify key number desired	\$22
KCHANGE	Change Key	\$10
HLKRKMASTER*	Master Key	\$10

*Note: A letter of approval on company letterhead from the client must accompany all orders for master keys.

General Ordering Information

The Products

This guide encompasses all standard products for this product group.

Sizes

Dimensions listed in this guide are indicated as:

H = height

W = width

D = depth

Dia. = diameter

Rad. = radius

Pricing

All prices shown are list.

How to Order

Select pattern numbers and quantities required for your complete installation. Product questions can be addressed in the specific sections of this guide or by contacting your sales representative or customer resource representative at 1-800-343-5665.

Next, select options (if required), along with colors and finishes appropriate to each product. Reference the Finishes and Fabrics pages for color designations.

On large installations, an item's "designated area" can be specified to assist in product organization and handling.

To expedite complete / correct entry of your order, be certain all pattern numbers, quantities, colors and area identifications are completely specified. Also, include complete purchase order numbers, bill-to and ship-to addresses, a contact name and specific factory shipping dates required.

Mail all orders to:

Knoll, Inc.

1235 Water Street

P.O. Box 157

East Greenville, PA 18041

Attention: Order Entry

Once your order is entered at Knoll, an acknowledgment will be mailed to you. You will be advised of your scheduled shipping date within five days of the original acknowledgment. If it is necessary to revise your order, please contact your customer resource representative.

Sustainability Statement

Sustainable design is a key component of Knoll's environmental focus. Our commitment to social responsibility and a healthy environment has prompted us to further articulate our longstanding environmental programs and, with encouragement and support from our colleagues in the industry, we have re-energized our focus on such "green" initiatives as life cycle analysis and LEED™ certification. Knoll is proud to have contributed to projects that have received LEED certification from the U.S. Green Building Council.

For the latest information on Knoll products that help our customers achieve LEED certification, log on to knoll.com, click on "About Knoll" and then "Environmental Focus."