

# Office Seating

Price List  
May 2016

**Knoll**

Introduction	Knoll and Sustainable Design	2
	GREENGUARD Certified®	3
	Placing Your Knoll Office Seating Order	4
	Office Seating Visual Index	5
	Office Seating Control Index	8
	KnollTextiles Fabric Application	9
	Customer's Own Material Seating Process Overview	10
Life®	Spinneybeck Leather Application	20
	Life® : plastic base, seat topper, no back topper	24
	Life® : plastic base, seat topper and back topper	26
	Life® : aluminum base, seat topper, no back topper	28
	Life® : aluminum base, seat topper and back topper	30
	Life® : replacement parts	32
	How to Specify a Life® Chair	34
	Life® Upholstery Options and Construction Information	36
Generation by Knoll®	Life® Dimensions, Features and Operating Instructions	38
	Generation by Knoll® : work chair	40
	Generation by Knoll® Dimensions, Features and Operating Instructions	42
ReGeneration by Knoll®	Generation by Knoll® Technical Information	44
	ReGeneration by Knoll® : Flex Back Net work chair	46
	ReGeneration by Knoll® : fully upholstered work chair	48
	ReGeneration by Knoll® : Flex Back Net high task chair	50
	ReGeneration by Knoll® : fully upholstered high task chair	52
	ReGeneration by Knoll® Dimensions, Features and Operating Instructions	54
MultiGeneration by Knoll®	ReGeneration by Knoll® Technical Information	56
	MultiGeneration by Knoll® : multipurpose chair	58
	MultiGeneration by Knoll® : stools	60
	MultiGeneration by Knoll® Dimensions and Instructions	62
Remix®	MultiGeneration by Knoll® Technical Information	64
	Remix® : work chair	66
	Remix® : high back chair	68
	Remix® Work and High Back Chair Dimensions	70
	Remix® Features and Operating Instructions	72
	Remix® : side chair	74
Chadwick®	Remix® Side Chair Dimensions	76
	Chadwick® : tilt stop control	78
	Chadwick® : basic control	80
	Chadwick® : high task chair	82
	Chadwick® Construction Information	86
Essentials Work Chairs™	Chadwick® Dimensions and Operating Instructions	88
	EWC Pro™ : upholstered mid-back task chair	90
	EWC Pro™ : upholstered side chair	92
	EWC Pro™ : seat and back replacements for task and side chairs	94
Moment™	EWC Pro™ Dimensions, Features and Operating Instructions	96
	Moment™ : side chair	98
Toboggan®	Moment™ Technical and Environmental Information	100
	Toboggan®	102
Alpha-Numeric Index	Toboggan® Technical and Environmental Information	104
Selling Policy		107
General Ordering Information		109

# Knoll and Sustainable Design

---

Each year Knoll sets key initiatives in our journey to sustainability. We are members of a global consortium on energy, have adopted a scientific, metrics-based approach to sustainable product design, and maintain a leadership position in establishing universal, verifiable, sustainability standards for our industry.

Knoll promotes independent third-party certification because it provides the most impartial and trustworthy foundation for industry-wide environmental compliance. Certification by established and respected third parties ensures that all manufacturers are held to the same high standards and that customers can trust a company's declaration about the environmental benefits of its products. Knoll third-party partners include: the International Standards Organization (ISO); Forest Stewardship Council (FSC®); Rainforest Alliance; GREENGUARD® Environmental Institute; and The Business and Institutional Furniture Manufacturer's Association (BIFMA) level® certification from Scientific Certification Systems (SCS).

In addition, Knoll is aligned with the U.S. Green Building Council and can help companies, healthcare organizations and educational institutions achieve Leadership in Energy and Environmental Design (LEED®) workplace certification.

## Global Climate Change

- Knoll is a sponsor of the Clinton Global Initiative, which brings together a community of global leaders to devise and implement solutions to some of the world's most pressing challenges, including environmental change.
- Knoll has a comprehensive Energy Management Program to increase energy efficiency in products and processes.

## Life Cycle Assessment (LCA) Tool

- Life Cycle Assessment is a science-based measurement of a product's environmental impacts throughout its life cycle, from raw materials sourcing through manufacture, shipping, use and re-use or end-of-life. LCA enables cradle-to-cradle implementation of sustainable practices.
- Knoll has partnered with The Green Standard.org to develop an affordable, universal ISO-compliant computer-based LCA tool that can be used by the entire contract furniture industry and is partnering on the development of an Environmental Product Declaration System (EPDs) for Knoll products. EPDs are verified documents containing LCA results and additional environmental performance information about a product.

## Setting Industry Standards

- Knoll partners with MTS (The Institute for Market Transformation to Sustainability) to develop the SMaRT® Consensus Sustainable Products Standards, a set of consensus-based sustainable product standards based on the LEED® model, for all building products, fabric, apparel, flooring and carpet. MTS, the developer of SMaRT®, is an accredited American National Standards Institute (ANSI) standard developer.
- Knoll also partners with BIFMA (Business and Institutional Furniture Manufacturers Association) to promote level® sustainability standards for the contract furniture industry.
- Knoll has established FSC® (Forest Stewardship Council) certified wood as the standard for general office open plan office systems, casegoods and tables.
- Knoll has launched Full Circle, a resource recovery program developed with ANEW, to help customers extend the life cycle of surplus furniture, fixtures and equipment (FF&E) in an economically, socially and environmentally responsible manner.
- Our goal is to encourage all manufacturers in the contract furniture industry and related industries to adopt standards that will lead to sustainable products and practices.

*For more information about Knoll and sustainable design, visit [knoll.com/environment](http://knoll.com/environment).*



All Knoll Office Seating is GREENGUARD and GREENGUARD Gold certified.

All KnollExtra® products are GREENGUARD certified.

Visit GREENGUARD.org for more information and to find printable certificates for Knoll Office Seating that can be used for verification and LEED® submission.

GREENGUARD provides the only guide to certified low-emitting interior products and building materials. Its goal is to help building owners and managers, architects, interior designers and product specifiers build and furnish healthier offices, hospitals, schools and homes by providing a register of tested and certified low-emitting products and materials.

GREENGUARD certification is recognized by the U.S. Green Building Council's LEED® Program. Air Quality Science, an independent indoor air quality laboratory, tests products submitted for certification using stringent environmental chamber testing protocols and current indoor air quality standard. Certification is administered by the GREENGUARD Environmental Institute (GEI), an industry-independent, non-profit organization.

GREENGUARD Gold certification complies with the State of California's Department of Health Services Standard Practice (CA Section 01350) for testing chemical emissions from building products used in schools, offices and other sensitive environments. Certified products can contribute to achieving credits in the CHPS Best Practices Manual for K-12 schools, the LEED® Green Building Rating System, Green Guide for Healthcare™, NAHB Green Building Guidelines, Green Globes, Regreen and numerous other local authorities' green building codes.

Knoll Office Seating and KnollExtra® products can contribute to achieving LEED® credits. GREENGUARD-tested and certified office furniture is required for Credit 4.5 in the LEED-CI Indoor Environmental Quality section.

#### GREENGUARD Certification Program

- Internationally recognized for evaluating product emissions and certifying building materials, furnishings, finishes and cleaning products and processes that meet stringent indoor air quality criteria defined by GEL.
- Products undergo rigorous, third-party testing to determine their impact on indoor air pollution with requirements for ongoing testing and verification.
- Certification confirms a manufacturer's environmental responsibility, and signifies their environmental achievements through independent, third-party testing and verification.
- GREENGUARD Certified products are recommended by leading sustainable building programs, including:
  - U.S Green Building Council's (USGBC) LEED Rating System,
  - National Association of Home Builders (NAHB) Green Building Guidelines,
  - Green Guide for Health Care (GGHC),
  - Collaborative for High Performance Schools (CHPS) Best Practices Manual,
  - New York City Department of Design and Construction Sustainable Design Specifications, among others.



---

**Use the Following Addresses**

If you would like to send a standard lead time order to our order entry department, please use the following address:

*For North American orders:*  
Knoll, Inc.  
1235 Water Street  
East Greenville, PA 18041  
Attn: Order Entry

Fax: 215 679-1788  
Tel: 800 343-KNOLL (5665)

All accepted orders will be confirmed in writing on the Knoll standard order confirmation form.

**For More Information**

For complete Knoll Selling Policy and warranty information, please refer to page 107 of this price list.

For additional information on Knoll Office Seating, contact your Knoll representative, a Knoll dealer, or telephone Customer Services at 800 343-KNOLL (5665).

**Shipping Method**

All Generation by Knoll chairs, ReGeneration by Knoll chairs, Remix chairs, EWC Pro task, and Chadwick task chairs in this price list will ship boxed in two pieces.

If you would like a fully assembled, blanket wrapped Generation by Knoll chair, ReGeneration by Knoll chair, Remix chair, EWC Pro task chair, or Chadwick task chair, please consult the Office Seating Standard Specials price list for pattern numbers and associated upcharges.

---

**Life®**

Plastic base, p. 24

Aluminum base, p. 28

Aluminum base, seat topper and back topper, p. 30



---

**Generation by Knoll®**

Dark finish, plastic base p. 40

Dark finish, aluminum base, p. 40



---

Light finish, plastic base, p. 40

Light finish, aluminum base, p. 40



---

**ReGeneration by Knoll®**

Flex Back Net, p. 46

Fully upholstered, p.48

Flex Back Net High task, p. 50

Fully upholstered High task, p. 52



---

**MultiGeneration by Knoll®**

Stacking, p. 58



Hybrid, p. 58



Stools, p. 60



---

**Remix®**

Work, p. 66



High Back, p. 68



Side chair, p. 0



---

**Chadwick®**

Task, p. 78



High task, p. 82





---

**Essentials Work Chairs™**

EWC Pro™ mid-back  
task, p. 90



EWC Pro™ side, p. 92



---

**Moment™**

Side, p. 98



---

**Toboggan®**

Sled base chair desk, p. 102



Pull up table, p.102





Seat, p. 102



Bench, p. 102



Control	Illustration	Description	Application
Weight-Compensated Control with Synchronized Recline		360° swivel; uses body weight in seat as counterbalance for recline resistance, the chair is perfectly adjusted by sitting in it — no adjustment necessary; promotes movement and balance; preference control accommodates a wider range of users.	Life task chairs Generation by Knoll work chairs ReGeneration by Knoll work chairs
Synchronized Spring Tilt Control		360° swivel; back and seat recline in one synchronized movement to support the user's back throughout the recline. As back reclines, the seat drops down slightly, relieving pressure points.	Chadwick task chairs (tilt stop and basic controls) EWC Pro task chairs Remix chairs (Work and High Back models)

**Fabric Application**

The application of KnollTextiles fabrics on Knoll Office Seating provides the broadest and most exciting selection of standard fabrics in the contract furniture industry.

Developed in collaboration with leading designers, KnollTextiles upholstery harmonizes pattern, color and texture in the Modernist tradition. Choose from a wide selection of fabrics that are appropriate for corporate, hospitality, and healthcare use, ranging from natural fibers such as wool and cotton, to high performance options like Crypton® fabrics. Visit KnollTextiles.com to search the online database.

Fabrics are grouped into categories referred to as “grades.” The selection of approved fabrics varies by chair.

**Always check with KnollTextiles for textile changes or new applications on seating.**

Visit KnollTextiles.com and click on “Textile Matrices” to find the link to the most up-to-date Seating Approval Matrix.

**Performance Upholstery Fabrics**

KnollTextiles offers a wide selection of high durability and high performance fabric options. For excellent stain resistance, choose from upholstery products with a Nano-Tex® finish. For a complete moisture barrier, so that nothing penetrates the fabric into the cushion, you can select from among Crypton® stain, moisture, odor and bacteria resistant fabrics. In addition, there are bleach-cleanable upholstery products, such as vinyl and solution-dyed nylon. Visit KnollTextiles.com and click on “Upholstery” or “Technical Documents” for details.

**Nano-Tex® and Teflon®:** Both Nano-Tex and Teflon provide additional performance—spill and stain protection—and come stocked on a number of fabrics. These finishes can also be applied to dozens of KnollTextiles fabrics for an upcharge and additional lead time. For a moisture barrier, we also offer Crypton and Nano-Tex with DuraBlock™.

**Crypton®:** KnollTextiles stocks over a dozen patterns with Crypton. It has a moisture barrier plus stain, odor and bacteria resistance, to protect the fabric and the cushion.

**Nano-Tex® with DuraBlock™:**

Nano-Tex with DuraBlock provides a durable moisture barrier with a soil and stain resistant topical treatment. Even under high pressure, no liquid can travel through the treatment into the cushion. This finish option is stocked on some products and can be added to many existing KnollTextiles upholstery fabrics for an additional upcharge and lead time.

**Environmental Options**

KnollTextiles offers dozens of upholstery patterns with recycled content or natural fiber. Included in the line is a selection of 100% recycled upholstery fabrics that have no added backing or finish. Visit KnollTextiles.com and click on “Environmental Fabrics” for details.

**California Technical Bulletin 133 (Cal 133)**

Cal 133 is a flammability test procedure for seating furniture for use in public occupancies. Testing must be performed on the designated chair and textile together. Component data alone cannot be used to certify compliance with the regulation. Under Cal 133, one cannot assume that seating or textiles that have passed individually will pass together.

**Cal 133 (cont.)**

Many Knoll Office Seating products can be specified to comply with Cal 133. Applicable upcharge and specification rules are listed on the respective price list page. Chadwick, MultiGeneration by Knoll (non-upholstered) and Toboggan are Cal 133 approved standard. Please refer to the textile matrix for pre-approved Cal 133 upholstery options for the following chairs:

- Sapper
- Life
- Generation by Knoll (dark finish only)
- ReGeneration by Knoll
- Remix
- RPM
- Essentials Work Chairs
- Moment
- MultiGeneration by Knoll (upholstered)

If any other KnollTextiles fabric or COM is desired, Knoll will test the compliance of the specified fabric on the specified chair. The cost of the test will be the price of the chair in the specified fabric plus \$520. The additional fee is to cover the cost of the test. Please see the respective price list page for yardage requirements. The process time for test results is 4-8 weeks. Contact your Knoll customer service representative at 800 343-KNOLL (5665) for further test processing instructions.

	Soil & Stain Resistance		Moisture Barrier Plus Soil & Stain Resistance	
	Teflon® (Topical)	Nano-Tex® (Immersion)	Crypton®	Nano-Tex® with DuraBlock™
Soil and Stain Resistant Topical Treatment	Yes	Yes	Yes	Yes
Water Repellant Finish	No	Yes	Yes	Yes
Moisture Resistant Backing/Barrier	No	No	Yes *	Yes
Breathable	Yes	Yes	Yes	Yes
Microbial Resistant	No	Yes	Yes	Yes
Fabrics Stocked with Finish	Some	Some	Yes	No
Minimum Yardage on Non-Stocked Fabrics	5	5	n/a	5

\*Please Note: The moisture resistant backing/barrier on Crypton fabrics is compromised in the Cal 133 lamination process and is therefore not covered under warranty when specified as Cal 133.



Knoll is pleased to cooperate with Customer's Own Material (COM) or Customer's Own Leather (COL) selections after they have been approved by Knoll.

Please refer to the table below for COM process overview. See price list pages for specific chair information. For additional information see Customer's Own Material section in the Selling Policy.

Seating	Pre-Approval				Application Testing		
	Color Specific Testing?	Send to CSR/PM:	Process Time	Application Test Required?	Requires:	Yardage Required for Test	Process Time
Life	No	COM Seating Form & Memo Sample	2-3 days	No*			
Generation by Knoll	No	COM Seating Form & Memo Sample	2-3 days	No*			
ReGeneration by Knoll	No	COM Seating Form & Memo Sample	2-3 days	No*			
MultiGeneration by Knoll	No	COM Seating Form & Memo Sample	2-3 days	No*			
Remix	No	COM Seating Form & Memo Sample	2-3 days	No*			
EWC Pro	No	COM Seating Form & Memo Sample	2-3 days	No*		1	2-3 weeks
Moment	No	COM Seating Form & Memo Sample	2-3 days	No*			

\*Guideline only – subject to the discretion of the production floor.

**Cal 133 COM Process Overview**

If COM is desired, the fire barrier must be attached when fabric arrives at Knoll. Intek F187 fire barrier is recommended. Knoll will test the compliance of the specified fabric on the specified chair. The cost of the test will include the price of the chair and COM fabric plus \$520. The fee is to cover the cost of the test. Please see respective price list page for yardage requirement. The process time for test results is 4-8 weeks. Contact your Knoll Customer Service Representative at 800-343-KNOLL (5665) for further test processing instructions.

Textile Name	Grade	Direction	Part #	EWC Pro Side	EWC Pro Task	Generation by Knoll	Life Back Topper	Life Seat Topper
Abacus	B	NR	K715	■ ♣	■ ♣	■ ♣	■ ♣	■ ♣
Alignment	A	NR	K349	■ ♣	■ ♣	■ ♣	■ ♣	■ ♣
Argyle	B	NR	K1938	■	■	■	■	■
Arno	H	NR*	K128	■	■	○	○	○
Aswan	I	NR	K2046	■	■	■	■	■
Atelier	F	NR	K1607	■	■	■	■	■
Atlas	C	NR*	K1236	■	■	■	■	■
Axiom	C	NR	K1650	■	■	○	○	○
Bank Shot	B	NR*	K134	○	○	○	○	○
Baxter	C	NR	K1557	■	■	■	■	■
Beacon	A	NR	W1597	○	○	■	○	○
Belize	B	NR	K1165	■	■	■	■	■
Biota	C	NR	K1297	■ ♣	■	■ ♣	■	■
Biscayne	F	NR	K1771	■	■	■	■	■
Bistro	B	NR	K1775	■ ♣	■ ♣	■ ♣	■ ♣	○
Bocce	A	NR	K1255	■	■	■ ♣	■	■
Boundary	B	NR	K1828	■ ♣	■ ♣	■ ♣	■ ♣	■ ♣
Cairo	C	NR	K2034	■ ♣	■ ♣	■	■	■
Calais Cotton Velvet	F	NR	K787	○	○	○	○	○
Cameo	B	NR	K1443	■	■	■	■	■
Cat's Cradle	A	NR	K1290	■	■	■ ♣	■	■
Cato	I	RR	KH800	○	○	○	○	○
Century	F	NR	K1051	■	■	■	■ ♣	■ ♣
Chance	A	NR	K1552	■	■	■	■	■
Charm	C	NR	K1049	■ ♣	■	■	■ ♣	■ ♣
Chroma	B	NR	K345	■ ♣	■ ♣	■	■ ♣	■ ♣
Chronicle	B	NR	K1525	■ ♣	■ ♣	■ ♣	■	■
Circa	C	NR	K1054	■	■	■	■ ♣	■ ♣
Classic Boucle	C	NR*	K162	■	■	■	■ ♣	■ ♣
Close Knit	B	NR	K201	■	■	■	■	■
Coco	F	NR	K1024	■	■	■	■	■
Common Ground	A	NR*	K448	■ ♣	■ ♣	■ ♣	■ ♣	■ ♣
Commuter Cloth	A	NR	K1778	■ ♣	■ ♣	■ ♣	■ ♣	■ ♣
Compass CR	D	NR	HC1183	■	■	■	■	■
Cornaro	F	NR	K1320	■	■	■	■	■
Coterie	D	NR	K1564	○	○	○	○	○
Dahlia CR	C	NR	HC1660	■	■	■	■ ♣	■ ♣
Delite	A	NR	K2026	■	■	■	■ ♣	■ ♣
Diva	B	NR	K2051	■	■	■	■	■
Djenne	G	RR	K2029	■	■	■	■	■
Dovetail	B	NR	K1150	■ ♣	■ ♣	■ ♣	■ ♣	■ ♣
Dristi	A	NR*	K872	■	■	■	○	○
Dune	C	NR	K2047	■	■	■	■	■
Durand	C	NR	K1885	■	■	■	■	■
Dynamic	I	NR	K1617	■	■	■	■	■
Earthwork	C	NR	K1238	■ ♣	■	■ ♣	■	■
Eclat Weave	D	NR	K1104	■	■	■	■	■
Empire Stripe	C	NR	K1025	■	■	○	■ ♣	■ ♣

■ = Available

○ = Not Available

♣ = Cal 133 Pre-approved

\* = Can be Railroad Cut

Textile Name	Grade	Moment	Multi-Generation by Knoll	ReGeneration by Knoll Seat	ReGeneration by Knoll Inner Back	Remix Back	Remix Seat	Remix Side
Abacus	B	■ 𐀀	■ 𐀀	■ 𐀀	■ 𐀀	○	○	○
Alignment	A	■ *** 𐀀	■ 𐀀	■ 𐀀	■ 𐀀	○	○	○
Argyle	B	■	■	■	■	■	■	■
Arno	H	■ *** 𐀀	■	○	○	○	○	○
Aswan	I	■	■	■	■	■	■	■
Atelier	F	■	■	■	■	■	■	■
Atlas	C	■	■	■	■	■	■	○
Axiom	C	○	○	○	○	○	○	○
Bank Shot	B	■ 𐀀	■	○	○	○	○	○
Baxter	C	■	■	■	■	■	■	○
Beacon	A	■	■	○	○	○	○	○
Belize	B	■	■	■	■	■	■	■
Biota	C	■	■ 𐀀	■ 𐀀	■ 𐀀	■ 𐀀	■ 𐀀	■ 𐀀
Biscayne	F	■	■	■	■	■	■	■
Bistro	B	■ 𐀀	■ 𐀀	■ 𐀀	■ 𐀀	■ 𐀀	■ 𐀀	○
Bocce	A	■	■ 𐀀	■ 𐀀	■ 𐀀	■ 𐀀	■ 𐀀	■ 𐀀
Boundary	B	■ 𐀀	■ 𐀀	■ 𐀀	■ 𐀀	■ 𐀀	■ 𐀀	■ 𐀀
Cairo	C	■ 𐀀	■	■	■	■	■	■
Calais Cotton Velvet	F	○	○	○	○	○	○	○
Cameo	B	■	■	■	■	■	■	■
Cat's Cradle	A	■	■ 𐀀	■ 𐀀	■ 𐀀	■ 𐀀	■ 𐀀	■ 𐀀
Cato	I	○	○	○	○	○	○	○
Century	F	■	○	■	■	■	■	■
Chance	A	■	■	■	■	■	■	■
Charm	C	■ 𐀀	■	■	■	■	■	■
Chroma	B	■ 𐀀	■ 𐀀	■	■	■	■	■
Chronicle	B	■ 𐀀	■ 𐀀	■	■ 𐀀	■	■	■
Circa	C	■	■	■	■	■	■	■
Classic Boucle	C	■	○	■	■	■	■	■
Close Knit	B	■	■	■	■	■	■	■
Coco	F	○	■	■	■	■	■	■
Common Ground	A	■ 𐀀	■ 𐀀	■ 𐀀	■ 𐀀	■ 𐀀	■ 𐀀	■
Commuter Cloth	A	■ 𐀀	■ 𐀀	■ 𐀀	■ 𐀀	■ 𐀀	■ 𐀀	■ 𐀀
Compass CR	D	■	■ 𐀀	■	○	○	○	○
Cornaro	F	■	■	■	■	■	■	■
Coterie	D	○	■	○	○	○	○	○
Dahlia CR	C	■ 𐀀	■	■	■	■	■	■
Delite	A	■ 𐀀	■	■	■	■ 𐀀	■ 𐀀	■ 𐀀
Diva	B	■	■	■	■	■	■	■
Djenne	G	■	■	■	■	■	■	■
Dovetail	B	■ 𐀀	■ 𐀀	■ 𐀀	■ 𐀀	■ 𐀀	■ 𐀀	■ 𐀀
Dristi	A	○	■	■	■	■	■	■
Dune	C	■	■	■	■	■	■	■
Durand	C	■	■	■	■	■	■	■
Dynamic	I	■ 𐀀	■	■	■	■	■	■
Earthwork	C	■ 𐀀	■ 𐀀	■ 𐀀	■ 𐀀	■ 𐀀	■ 𐀀	■ 𐀀
Eclat Weave	D	■	■	■	■	■	■	■
Empire Stripe	C	■	○	○	○	○	○	○

\*\*\*=Only available with Cal 133 approved fire barrier

Updated as of April 2016



Textile Name	Grade	Direction	Part #	EWC Pro Side	EWC Pro Task	Generation by Knoll	Life Back Topper	Life Seat Topper
Entourage	C	NR	K1389	■ ♣	■ ♣	■	■ ♣	■ ♣
Essence	C	NR	K2059	■	■	■	■	■
EWC Sport	A	ND	K1196	■	■	○	○	○
Fable CR	C	RR	HC1122	■	■	■	■	■
Ferry	B	NR*	K1697	■	■	■	■	■
Fibra	C	NR	K1105	■ ♣	■	■	■	■
Firefly	H	NR	K2021	■	■	■	■	■
Foil Rap	A	NR	W535	○	○	○	○	○
Forza	B	NR*	K584	○	○	○	○	○
Gala II	B	NR	K1520	■ ♣	■ ♣	■ ♣	■ ♣	■ ♣
Gibson	G	NR	K1086	■	■	■	■	■
Glider	F	NR	K1717	■	■	■	■	■
Grande	B	NR*	K180	■	■	■	■	■
Grandview	B	NR	K1463	■	■	■	■	■
Greenwich	C	NR	K1753	■	■	■	■	■
Haze	G	NR	K109	■	■	■	■	■
Heavy Metal	A	NR	W539	○	○	○	○	○
Highland	E	NR*	K2010	■	■	■	■	■
Hive	B	NR	K1694	○	○	○	○	○
Holbrook	B	NR	K1928	■	■	■	■	■
Hologram	D	NR	K500	■	■ ♣	■	■	■
Hourglass	A	NR	K1523	■	■	■	■	■
Hudson	C	NR	K1765	■	■	■	■	■
Hula Hoop	C	NR	K753	■ ♣	■	■	■ ♣	■ ♣
Icon	F	NR	K1028	■ ♣	■	■	■ ♣	■ ♣
Ilkat Square	E	NR	K1703	■	■	■	■ ♣	■ ♣
Ilkat Stripe	D	NR	K1701	■	■	■	■	■
Intrigue	F	NR	K1551	■	■	■	■	■
Island	D	NR	K2053	■	■	■	■	■
Journey	B	NR	K1806	■ ♣	■ ♣	■	■	■
Katazome	E	NR	K1459	■	■	■	■	■
Kampala	E	NR	K2032	■	■	■	■	■
Keaton	B	NR	K1596	■	■	■	■	■
Kimono	E	NR	K1174	■	■	■	■	■
Kinabalu	G	NR	K1800	■	■	■	○	■
Kingston	G	NR	K1826	○	○	■	○	■
Knoll Felt	B	NR	K1207	■	■	■	■ ♣	■ ♣
Knoll Hopsack	B	NR	K1206	■	■	■	■ ♣	■ ♣
Knoll Velvet	I	RR	K784	○	○	○	○	○
Kora CR	C	NR	HC1010	■	■	■	■	■
Lagos	C	NR	K2028	■	■	■	■	■
Legend CR	C	NR	HC1124	○	○	○	○	○
Liberty	F	NR	K1888	■	■	■	■	■
Lore CR	C	NR	HC1123	■	■	■	■	■
Ludlow	B	NR	K1998	■	■	■	■	■
Lyric	B	NR	K698	■	■	■	■	■
Magnolia	C	NR	K1999	■	■	■	■	■
Mamba	E	NR	K549	■	■	■	■	■

■ = Available

○ = Not Available

♣ = Cal 133 Pre-approved

\* = Can be Railroad Cut

Textile Name	Grade	Moment	Multi-Generation by Knoll	ReGeneration by Knoll Seat	ReGeneration by Knoll Inner Back	Remix Back	Remix Seat	Remix Side
Entourage	C	■ 🔥	■ 🔥	■	■	■	■	■
Essence	C	■	■	■	■	○	■	○
EWC Sport	A	○	○	○	○	○	○	○
Fable CR	C	■	■ 🔥	■	■	■	■	■
Ferry	B	■	■	■	■	■	■	■
Fibra	C	■ 🔥	■	■	■	■	■	■
Firefly	H	■	■	■	■	■	■	■
Foil Rap	A	○	○	○	○	○	○	○
Forza	B	○	○	○	○	○	○	○
Gala II	B	■ 🔥	■ 🔥	■ 🔥	■ 🔥	■ 🔥	■ 🔥	■
Gibson	G	■ 🔥	■	■	■	■	■	○
Glider	F	■	■	■	■	■	■	■
Grande	B	■	■	■	■	■	■	■
Grandview	B	■	■	■	■	■	■	■
Greenwich	C	■	■	■	■	■	■	■
Haze	G	■	■	■	■	■	■	■
Heavy Metal	A	○	○	○	○	○	○	○
Highland	E	■	■	■	■	■	■	■
Hive	B	○	○	○	○	○	○	○
Holbrook	B	■	■	■	■	■	■	■
Hologram	D	■	■	■	■	■	■	■
Hourglass	A	■	■	■	■	■	■	■
Hudson	C	■	■	■	■	■	■	■
Hula Hoop	C	■	■	■	■	■	■	■
Icon	F	■ 🔥	■	■	■	■	■	■
Ilkat Square	E	■	■	■	■	■	■	■
Ilkat Stripe	D	■	■	■	■	■	■	■
Intrigue	F	■	■	■	■	■	■	■
Island	D	■	■	■	■	■	■	■
Journey	B	■ 🔥	■	■	■	■	■	■
Katazome	E	■	■	■	■	■	■	■
Kampala	E	■	■	■	■	■	■	○
Keaton	B	■	■	■	■	■	■	■
Kimono	E	■ 🔥	■	■	■	■	■	■
Kinabalu	G	○	■	○	○	○	○	○
Kingston	G	■	■	○	○	○	○	○
Knoll Felt	B	■ 🔥	■ 🔥	■	■	■	■	■
Knoll Hopsack	B	■ 🔥	■ 🔥	■	■	■	■	■
Knoll Velvet	I	○	○	○	○	○	○	○
Kora CR	C	■	■	■	■	■	■	■
Lagos	C	■	■	■	■	■	■	■
Legend CR	C	○	■ 🔥	○	○	○	○	○
Liberty	F	■	■	■	■	■	■	■
Lore CR	C	■	■ 🔥	■	■	■	■	■
Ludlow	B	■	■	■	■	■	■	■
Lyric	B	■	■	■	■	■	■	■
Magnolia	C	■	■	■	■	■	■	■
Mamba	E	■	■	■	■	■	■	■

\*\*\*=Only available with Cal 133 approved fire barrier

Updated as of April 2016

Textile Name	Grade	Direction	Part #	EWC Pro Side	EWC Pro Task	Generation by Knoll	Life Back Topper	Life Seat Topper
Mariner	A	NR*	K642	■	■	■	■	■
Marquee	E	NR	K1608	■	■	■	■♣	■♣
Masquerade	D	NR	K806	■	■	■	■	■
Melange	G	NR	K1882	■	■	■	■♣	■♣
Melody	B	NR	K2067	○	○	■	○	■
Menagerie	D	NR	K1322	■	■	■	■	■
Meroe	E	NR	K2043	■	■	■	■	■
Metro	C	NR	K1018	■	■	○	○	○
Milestone	C	NR	K1886	■	■	■	■	○
Mini Stitch	B	RR	K1130	■♣	■♣	■♣	■♣	■♣
Mod Plaid	F	NR	K1630	■	■	■	■♣	■♣
Monarch	A	NR	K1149	■♣	■♣	■♣	■♣	■♣
Moto CR	C	NR	HC1002	■♣	■♣	■	■	■
Night Life	B	NR	K181	■	■	■	○	○
Noble	C	NR	K1556	■	■	■	■	■
Nonchalant CR	B	NR	HC198	○	○	■	○	■
Origins	D	NR	K1700	■	■	■	■	■
Palisade	C	NR	K2030	○	○	■	○	■
Panache CR	C	NR	HC1047	■	■	■	■	■
Paradigm	B	NR	K1101	■	■	■	■♣	■♣
Petal Pusher	B	NR	K1968	○	○	○	○	○
Pogo	B	NR	K1100	■♣	■♣	○	■	○
Prairie	B	NR	K1925	■	■	○	○	○
Prep	A	NR	K1076	■♣	■	■♣	○	○
Presto	A	NR	K1000	■♣	■♣	■♣	■♣	■♣
Prim	B	NR	K1884	■♣	■♣	■♣	■♣	■♣
Quark	C	NR	K781	■	■	■	■	■
Radiance	B	NR	K1921	■	■	■	■	■
Ransom	B	NR	K1298	■	■	■♣	■	■
Regard CR	C	NR	HC1063	○	○	■	■♣	■♣
Ricochet	B	NR*	K498	■♣	■♣	■♣	■♣	■♣
Rivington	F	NR	K1080	■	■	■	■	■
Roam	B	NR	K1657	■	■	■	■	■
Roundtrip	C	NR	K1430	■♣	■♣	■	■♣	■♣
Rush Hour	B	NR	K1824	■	■	■	■	■
Sahara	C	NR	HC1269	■	■	○	■	○
Sandpiper	C	NR	HC1258	○	○	■	■	■
Sequin CR	C	NR	HC1009	■	■	■	■♣	■♣
Serendipity	G	NR	K1528	■	■	■	■	■
Sherman	E	RR	K1789	■	■	■	■	■
Shima	E	NR	K1468	○	○	○	○	○
Sinclair	C	NR	K1555	■	■	■	■	■
Smart	C	NR	K1268	■	■	■	■	■
Soiree	B	NR	K1616	■♣	■♣	■♣	■♣	■♣
Soliloquy	A	NR	K1458	■	■	■	■	■
Sonnet	A	NR	K1460	■♣	■♣	■♣	■	■
Soon	F	NR	K1787	■	■	○	○	○

■=Available

○ =Not Available

♣=Cal 133 Pre-approved

\*=Can be Railroad Cut



Textile Name	Grade	Moment	Multi-Generation by Knoll	ReGeneration by Knoll Seat	ReGeneration by Knoll Inner Back	Remix Back	Remix Seat	Remix Side
Mariner	A	■ ♯	■	■	■	■	■	■
Marquee	E	■ ♯	■	■	■	■	■	■
Masquerade	D	■	■	■	■	■	■	■
Melange	G	■ ♯	■	■	■	■	■	■
Melody	B	■	■	○	○	■	■	■
Menagerie	D	■	■	■	■	■	■	■
Meroe	E	■	■	■	■	■	■	■
Metro	C	■ *** ♯	■	○	○	○	○	○
Milestone	C	■	■	○	○	○	○	○
Mini Stitch	B	■ ♯	■ ♯	■ ♯	■ ♯	■ ♯	■ ♯	■ ♯
Mod Plaid	F	■	■	■	■	■	■	■
Monarch	A	■ ♯	■ ♯	■ ♯	■ ♯	■ ♯	■ ♯	■ ♯
Moto CR	C	■	■	■	■	■	■	■
Night Life	B	■	■	■	■	■	■	○
Noble	C	■	■	■	■	■	■	■
Nonchalant CR	B	○	■ ♯	○	○	■	■	○
Origins	D	■	■	■	■	■	■	■
Palisade	C	■	■	○	○	○	○	○
Panache CR	C	■	■ ♯	■	■	■	■	■
Paradigm	B	■ ♯	■	■	■	■	■	■
Petal Pusher	B	○	○	○	○	○	○	○
Pogo	B	■ ♯	○	○	○	○	○	○
Prairie	B	○	○	○	○	○	○	○
Prep	A	■ ♯	■ ♯	■ ♯	■ ♯	○	○	○
Presto	A	■ ♯	■ ♯	■ ♯	■ ♯	■ ♯	■ ♯	■ ♯
Prim	B	■ ♯	■ ♯	■ ♯	■ ♯	■ ♯	■ ♯	■
Quark	C	■	■	■	■	■	■	■
Radiance	B	■	■	■	■	■	■	■
Ransom	B	■	■ ♯	■ ♯	■ ♯	■ ♯	■ ♯	■ ♯
Regard CR	C	■	○	■	○	■	■	○
Ricochet	B	○	■ ♯	○	○	○	○	○
Rivington	F	■	■	■	■	■	■	■
Roam	B	■	■	■	■	■	■	■
Roundtrip	C	■ ♯	■ ♯	■ ♯	■ ♯	■ ♯	■ ♯	■
Rush Hour	B	■	■	■	■	■	■	■
Sahara	C	■	■	○	○	○	○	○
Sandpiper	C	■	■ ♯	■	■	■	■	■
Sequin CR	C	■	■	■	■	■	■	■
Serendipity	G	■	■	■	■	■	■	■
Sherman	E	■	■	■	■	■	■	■
Shima	E	○	○	○	○	○	○	○
Sinclair	C	■	■	■	■	■	■	■
Smart	C	■	■	■	■	■	■	○
Soiree	B	■ ♯	■ ♯	■ ♯	■ ♯	■ ♯	■ ♯	■ ♯
Soliloquy	A	■	■	■	■	■	■	■
Sonnet	A	■ ♯	■	■ ♯	■ ♯	■	■	■
Soon	F	■	■	○	○	○	○	○

\*\*\*=Only available with Cal 133 approved fire barrier

Updated as of April 2016

Textile Name	Grade	Direction	Part #	EWC Pro Side	EWC Pro Task	Generation by Knoll	Life Back Topper	Life Seat Topper
Spark	B	NR	K1075	■ ♣	■	■ ♣	■ ♣	■ ♣
Spectator	C	NR	K1391	■ ♣	■ ♣	■	■ ♣	■ ♣
Spencer	G	NR	K1106	■	■	■	○	○
Spot On	C	NR	K1324	■	■	■	■	■
Spree	B	NR	K1600	■ ♣	■ ♣	■ ♣	■ ♣	■ ♣
Stacks	A	NR	K528	■	■	■ ♣	■	■
Star Struck	C	NR	K1048	■ ♣	■	■	■	■
Stepping Stones	C	RR	K346	■	■	■	■	■
Striae Stripe	G	NR	K1827	■	■	■	■	■
Summit	B	NR	K2020	■	■	■	■	■
Sutton	B	NR	K1750	■ ♣	■ ♣	■	■	■
Swing	C	NR	K479	■	■	■	■	■
Synth	B	NR	K1693	■ ♣	■ ♣	■ ♣	■ ♣	■ ♣
Tabloid	B	NR	K2023	■ ♣	■ ♣	■ ♣	■	■
Theory	D	NR	K1656	○	○	○	○	○
Tight Rope	C	NR	K1798	■	■	■	○	■
Tilden	C	NR	K1779	○	○	■	○	■
Tinge	B	NR	K2068	○	○	■	○	■
Topography	F	NR	K1052	■	■	■	■ ♣	■ ♣
Totem	F	NR	K1561	■	■	○	○	○
Tower Grid	C	NR	K1887	■	■	■	■	■
Treble CR	C	NR	HC1062	■	■	■	■ ♣	■ ♣
Trophy	A	NR	K1709	■ ♣	■ ♣	■ ♣	■ ♣	■ ♣
Tryst	E	NR	K1522	■	■	■	■	■
Tweed Frieze	F	NR	K754	○	○	○	○	○
Ultrasuede	G	NR	K1021	■ ♣	■ ♣	■ ♣	■	■
Una	F	NR	K451	○	○	○	○	○
Utmost	B	NR	K1325	■	■	○	■	■
Utrillo	G	NR	K1807	■	■	■	■	■
Venue	B	NR	K1558	■	■	■	■	■
Versa	B	NR*	K1698	■ ♣	■ ♣	■ ♣	■ ♣	■ ♣
Vibe	C	NR*	K1029	○	○	■	■	■
Vinyl	B	ND	K242	■	■	○	○	○
Westwood	B	RR	K1949	○	○	■	○	■
Whip	E	NR	K1386	■	■	■	■	■
Wide Angle	B	NR	K244	■ ♣	■ ♣	■ ♣	■ ♣	■ ♣
Wit	C	NR	K2050	■	■	■	■	■
Woodland	D	NR	K2049	■	■	■	■	■
Zari CR	C	NR	HC1008	■	■	■	■ ♣	■ ♣
Zipline	B	NR	K1448	■ ♣	■ ♣	■	■ ♣	■ ♣
Zoom	D	NR	K113	■	■ ♣	■	○	○

■ =Available

○ =Not Available

♣=Cal 133 Pre-approved

\*=Can be Railroad Cut

Textile Name	Grade	Moment	Multi-Generation by Knoll	ReGeneration by Knoll Seat	ReGeneration by Knoll Inner Back	Remix Back	Remix Seat	Remix Side
Spark	B	■ 🔥	■ 🔥	■ 🔥	■ 🔥	■ 🔥	■ 🔥	■ 🔥
Spectator	C	■ 🔥	■ 🔥	■ 🔥	■ 🔥	■ 🔥	■ 🔥	■
Spencer	G	○	■	■	■	■	■	○
Spot On	C	■	■	■	■	■	■	■
Spree	B	■ 🔥	■ 🔥	■ 🔥	■ 🔥	■ 🔥	■ 🔥	■ 🔥
Stacks	A	■	■ 🔥	■ 🔥	■ 🔥	○	○	○
Star Struck	C	■ 🔥	■	■	■	■	■	■
Stepping Stones	C	■	■	■	■	■	■	■
Striae Stripe	G	○	■	○	○	○	○	○
Summit	B	■	■	■	■	■	■	■
Sutton	B	○	■	○	○	○	○	○
Swing	C	■	■	■	■	■	■	■
Synth	B	■ 🔥	■ 🔥	■ 🔥	■ 🔥	■ 🔥	■ 🔥	■ 🔥
Tabloid	B	■ 🔥	■ 🔥	■ 🔥	■ 🔥	■	■	■
Theory	D	○	○	○	○	○	○	○
Tight Rope	C	■	■	■	■	■	■	○
Tilden	C	■	■	○	○	○	○	○
Tinge	B	■	■	○	■	■	■	■
Topography	F	■	■	■	■	■	■	■
Totem	F	■	○	○	○	○	○	○
Tower Grid	C	■	■	■	■	■	■	■
Treble CR	C	■	■	■	■	■	■	■
Trophy	A	■ 🔥	■ 🔥	■ 🔥	■ 🔥	■ 🔥	■ 🔥	■ 🔥
Tryst	E	○	■	○	○	○	○	○
Tweed Frieze	F	○	○	○	○	○	○	○
Ultrasuede	G	■ 🔥	■ 🔥	■ 🔥	■ 🔥	■ 🔥	■ 🔥	○
Una	F	○	○	○	○	○	○	○
Utmost	B	■	■ 🔥	○	○	○	○	○
Utrillo	G	■ 🔥	■	■	■	■	■	■
Venue	B	■	■	■	■	■ 🔥	■ 🔥	■ 🔥
Versa	B	■ 🔥	■ 🔥	■ 🔥	■ 🔥	■ 🔥	■ 🔥	■ 🔥
Vibe	C	■	■	■	■	○	○	○
Vinyl	B	○	○	○	○	○	○	○
Westwood	B	■	■	○	○	○	○	○
Whip	E	■ 🔥	■	■	■	■	■	■
Wide Angle	B	○	○	■ 🔥	■ 🔥	■ 🔥	■ 🔥	■ 🔥
Wit	C	■	■	■	■	■	■	■
Woodland	D	■	■	■	■	■	■	■
Zari CR	C	■	■	■	○	○	○	○
Zipline	B	■ 🔥	■ 🔥	■ 🔥	■ 🔥	■ 🔥	■ 🔥	■
Zoom	D	■ *** 🔥	■	■	■	■	■	○

**This page intentionally left blank**

For the ultimate in comfort, durability, and prestige, many Knoll Office Seating products can be upholstered in Spinneybeck leathers.

Spinneybeck leathers are made from the top 2% of the world's finest hides, inspected numerous times during production.

After tanning, all Spinneybeck leathers are drum-dyed, a time-consuming procedure which ensures color penetration throughout the hide. Then each hide is finished in the manner which will best bring out its individual character.

Spinneybeck leathers are all full-grain aniline drum-dyed products imported from Italy.

The following Spinneybeck leathers are approved for application on Knoll Office Seating products. Leathers are grouped into five price categories referred to as "grades." The selection of approved leathers varies by product. Please refer to the pricing page for each product line for more information.

Square footage requirements for Customer's Own Leather (COL) are listed on each chair's pricing page. Please refer to COM Seating Process Overview for further information regarding COL.

For further information, call Spinneybeck at 1 800 482-7777.

Grades	Characteristics
<b>T</b> Vicenza	Finished cowhide, corrected grain that is slightly raised.
<b>U</b> Volo	Finished cowhide, corrected grain, slightly raised grain texture.
<b>V</b> Acqua Andes Embossed Tipped España Hand Tipped Maremma Velluto Pelle	Water-repellent finished cowhide, corrected grain, slightly raised grain texture. Slightly pronounced grain, finished cowhide and enhanced grain. Corrected grain, aniline dyed, two-tone, heavily finished leathers breathable protective finish. Smooth, tight grain cowhide; breathable, protective finish, enhanced grain. Two-toned leather, lightly finished cowhide, pronounced pebble grain texture. Full grain textured suede with impregnated soil-resistant treatment. Slightly pronounced grain, finished cowhide and enhanced grain.
<b>W</b> Alaska Amazon Antique Arizona Derby Forte Lucente Sabrina	Pearlized-iridescent protective finish cowhide, full grain with smooth texture. Mid-weight, full grain cowhide; colors of the Amazonian jungle, raised grain texture. Smooth tight grain cowhide, lightly antiqued to produce an elegant patina, enhanced grain . Full grain, lightly finished kip; ironed for tight, smooth texture, glove-like hand. Combination-tanned cowhide; full grain, lightly finished and raised grain texture. High performance, full grain leather with slightly pronounced grain texture. Smooth, very tight grain cowhide; subtle sheen; light casein finish. Smooth, tight and full grain cowhide with a breathable protective finish.
<b>X</b> Ducale Ducale Velour	Embossed shrunken grain cowhide with protective finish, full grain. Full grain-sueded cowhide, embossed shrunken grain, scotch-guarded.
<b>Y</b> Capri Cervo Copenhagen Cordovan Distressed Lucca Marissa Portofino Prima Riva Saddle Salon	Chrome-free, light protective finish, full grain cowhide. Full aniline, cowhide, pronounced grain texture, extremely soft and supple hand. Full aniline, 100% vegetable tanned leather, full grain. Aniline-dyed cowhide, light waxy finish, supple hand, full grain. Aniline-dyed, paraffin wax final ironing process with a smooth finish, and full grain. Grain sueded, aniline dyed, velvety suede surface. Grain-sueded cowhide, smooth suede grain with soil resistant treatment. Full grain, lightly finished cowhide with a pronounced raised texture. Full aniline, special oils provide a very elegant and supple hand. Slightly pronounced grain texture, water-repellent, full grain. Full aniline, smooth very tight grain surface takes on a rich patina over time. Full aniline cowhide, ironing process provides a lustrous sheen of traditional leathers.

Leather Name	Grade	Part #	EWC Pro Side	EWC Pro Task	Generation by Knoll
Acqua	V	AU	■ ♣	■ ♣	■ ♣
Alaska	W	AL	■ ♣	■ ♣	■ ♣
Amazon	W	AM	○	○	■
Andes	V	AD	■ ♣	■ ♣	■ ♣
Antique	W	AQ	■ ♣	■ ♣	■ ♣
Arizona	W	AR	■	■	■ ♣
Capri	Y	CP	○	○	■
Cervo	Y	CV	■	■	■
Copenhagen	Y	CO	■**	■**	■
Cordovan	Y	CD	○	○	■ ♣
Derby	W	DE	○	○	■
Distressed	Y	DT	■**	■**	■
Ducale	X	DL	○	○	■
Ducale Velour	X	DV	○	○	■
Embossed Tipped	V	ET	○	○	■ ♣
España	V	ES	■ ♣	■ ♣	■ ♣
Forte	W	FE	■ ♣	■ ♣	○
Hand Tipped	V	HT	○	○	■
Lucca	Y	LC	○	○	■
Lucente	W	LU	○	○	○
Maremma	V	MM	○	○	■
Marissa	Y	MA	■ ♣	■ ♣	■ ♣
Portofino	Y	PT	○	○	○
Prima	Y	PR	■ ♣	■ ♣	■ ♣
Riva	Y	RA	■	■	■ ♣
Sabrina	W	SA	■ ♣	■ ♣	■ ♣
Saddle	Y	SL	○	○	○
Salon	Y	SN	○	○	■
Velluto Pelle	V	VP	■ ♣	■ ♣	■ ♣
Vicenza	T	VZ	■	■	■ ♣
Volo	U	VO	■ ♣	■ ♣	■ ♣

■=Available    ○=Not Available  
 \* =Not available with VP4 numbers

♣=Cal 133 Approved  
 \*\*=Not available with upholstered outer back

Updated as of March 2016

Leather Name	Life Back Topper	Life Seat Topper	Moment	ReGeneration by Knoll Seat	ReGeneration by Knoll Inner Back	Remix	Remix Side
Acqua	■ ♣	■ ♣	■ ♣	■ ♣	■ ♣	■ ♣	■
Alaska	■ ♣	■ ♣	■ ♣	■ ♣	■ ♣	■ ♣	■
Amazon	■	■	■ ♣	■	■	■	○
Andes	■ ♣	■ ♣	■ ♣	■ ♣	■ ♣	■ ♣	■
Antique	■ ♣	■ ♣	■ ♣	■ ♣	■ ♣	■ ♣	■
Arizona	■ ♣	■ ♣	■ ♣	■ ♣	■ ♣	■ ♣	■
Capri	■	■	■ ♣	■	■	■	○
Cervo	■	■	■	■	■	■	■
Copenhagen	■	■	■ ♣	■	■	■	■
Cordovan	■ ♣	■ ♣	■ ♣	■ ♣	■ ♣	■ ♣	○
Derby	■	■	■ ♣	■	■	■	○
Distressed	■	■	■ ♣	■	■	■	■
Ducale	○	○	○	■	■	○	○
Ducale Velour	○	○	○	■	■	○	○
Embossed Tipped	○	■ ♣	■ ♣	■	■	○	○
España	■ ♣	■ ♣	■ ♣	■ ♣	■ ♣	■ ♣	■
Forte	■ ♣	■ ♣	■ ♣	○	○	○	○
Hand Tipped	○	■	■ ♣	■	■	○	○
Lucca	○	■	■	■	○	○	○
Lucente	○	○	○	○	○	○	○
Maremma	■	■	■ ♣	■	■	■	○
Marissa	■ ♣	■ ♣	■ ♣	■ ♣	■ ♣	■ ♣	■
Portofino	○	○	■ ♣	○	○	○	○
Prima	■ ♣	■ ♣	■ ♣	■ ♣	■ ♣	■ ♣	■
Riva	■ ♣	■ ♣	■ ♣	■ ♣	■ ♣	■ ♣	■
Sabrina	■ ♣	■ ♣	■ ♣	■ ♣	■ ♣	■ ♣	■
Saddle	○	○	○	○	○	○	○
Salon	○	■	■ ♣	■	■	○	○
Velluto Pelle	■ ♣	■ ♣	■ ♣	■ ♣	■ ♣	■ ♣	■*
Vicenza	■ ♣	■ ♣	■ ♣	■ ♣	■ ♣	○	○
Volo	■ ♣	■ ♣	■ ♣	■ ♣	■ ♣	■ ♣	■

■=Available    ○ =Not Available  
 \* =Not available with VP4 numbers

♣=Cal 133 Approved  
 \*\*=Not available with upholstered outer back

Updated as of March 2016



Any of our leather grades may be perforated with any of the patterns shown below to create a crisp, contemporary look.

Perforated Leather is a specialty product, available only on a custom order basis. Please use pattern numbers below. Perforated Leather is available in half hides only. Not recommended on outside back applications (e.g. EWC Pro)

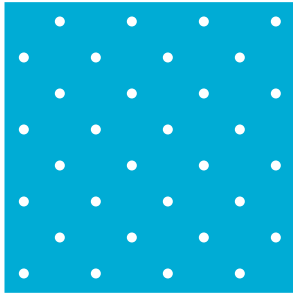

Pattern #330  
.052 in. diameter  
diagonal pattern  
12 holes per square inch

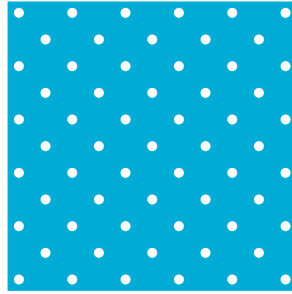

Pattern #457  
.052 in. diameter  
diagonal pattern  
21 holes per square inch

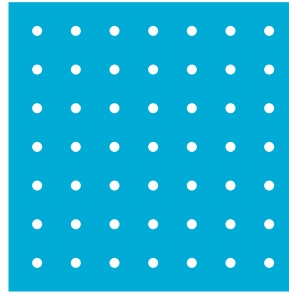

Pattern #1875  
.052 in. diameter  
straight pattern  
25 holes per square inch

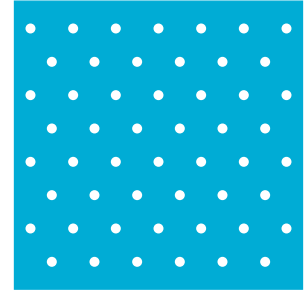

Pattern #560  
.052 in. diameter  
staggered pattern  
22 holes per square inch

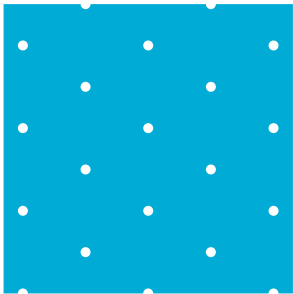

Pattern #280  
.052 in. diameter  
staggered pattern  
7 holes per square inch

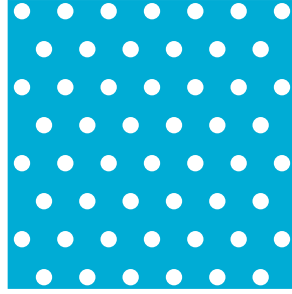

Pattern #560-85  
.085 in. diameter  
staggered pattern  
20 holes per square inch





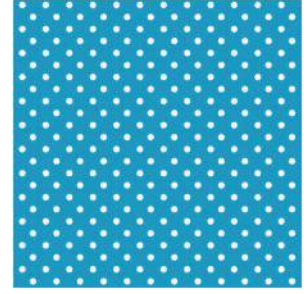

Pattern Multiple Diamond  
.052 in. diameter  
tri-star pattern  
18 holes per square inch

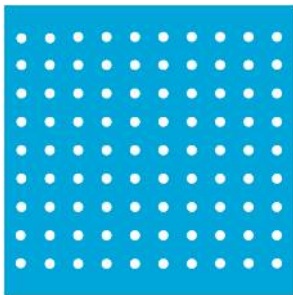

Pattern #825  
.050 in. diameter  
diagonal pattern  
75 holes per square inch



Pattern #419 Mini Perf  
.052 in. diameter  
straight pattern  
70 holes per square inch

arm	description	pattern no. *
Armless <i>Designer(s):</i> Formway Design Studio, 2002	Plastic base, fabric or leather seat topper, no back topper	<b>55C-3-(2 or 6)-A-5-K-GH BSF( )-ST( )-NB</b>
		
<i>Award(s):</i> GOOD DESIGN Award, Chicago Athenaeum, 2003, USA NeoCon Gold, Best of NeoCon, Task Chair - Seating Design, June 2002, USA IIDEX/NeoCon, Sustainable Design Gold Award, 2002, Canada	Fixed Aluminum Plastic base, fabric or leather seat topper, no back topper	<b>55M-3-(2 or 6)-A-5-K-GH BSF( )-ST( )-NB</b>
		
Height Adjustable	Plastic base, fabric or leather seat topper, no back topper	<b>55H-3-(2 or 6)-A-5-K-GH BSF( )-ST( )-NB</b>
		
High Performance	Plastic base, fabric or leather seat topper, no back topper	<b>55P-3-(2 or 6)-A-5-K-GH BSF( )-ST( )-NB</b>
		





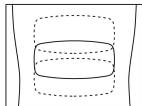
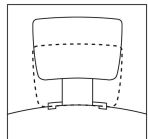

List price base grade or COM	A	B	C	D	E	F	G	H	I	T	COL U	V	W	X	Y
\$1,380.	\$1,437.	\$1,443.	\$1,469.	\$1,497.	\$1,516.	\$1,544.	\$1,557.	\$1,577.	\$1,606.	\$1,819.	\$1,852.	\$1,922.	\$2,087.	\$2,104.	\$2,200.
1,613.	1,670.	1,677.	1,704.	1,730.	1,750.	1,777.	1,791.	1,811.	1,839.	2,052.	2,086.	2,156.	2,320.	2,337.	2,433.
1,617.	1,674.	1,681.	1,708.	1,735.	1,754.	1,781.	1,795.	1,816.	1,843.	2,056.	2,090.	2,160.	2,325.	2,342.	2,438.
1,724.	1,781.	1,787.	1,814.	1,841.	1,861.	1,887.	1,902.	1,922.	1,950.	2,163.	2,197.	2,267.	2,431.	2,448.	2,544.

Order Code	Ordering Information	Options
<i>Example:</i> <b>55H-3-6-A5K-GH-BSF33-ST-K1206/9-NB</b>	<i>Specify:</i>	<i>Cylinder Height Options:</i>
<b>55</b> Life chair	1. Pattern number with back suspension fabric BSF().	For height ranges see Life Dimensions and Operating Instructions. Replace 5 in pattern with one of the following options:
<b>H</b> Height adjustable arms	2. Seat topper textile, either KST() for knitted seat topper or ST() for fabric or leather. NS for no seat topper.	<i>Code: Upchg: Description:</i>
<b>3</b> High back	3. Back topper textile, BT() for fabric or leather. NB for no back topper.	L n/c low cylinder
<b>6</b> Grey base		H n/c high cylinder
<b>A</b> Advanced control with sliding seat		<i>Lumbar Options:</i>
<b>5</b> Standard height cylinder		For lumbar, replace K with L() in the pattern number. Specify color code in the parentheses after L.
<b>K</b> No lumbar		<i>Code: Upchg: Description:</i>
<b>GH</b> Grey hard caster		L(K1029/13) \$102 Vibe, Glam
<b>BSF33</b> Plum Back Suspension Fabric	<i>Armpad Options:</i>	L(K1029/14) \$102 Vibe, Poise
<b>ST-K1206/9</b> Knoll Hopsack, Magenta seat topper	For leather armpads, add J after the arm pattern code (Example: 55PJ) and specify leather. Available in Spinneybeck Volo (Grade U) and Sabrina (Grade W) leathers.	L(K1029/BLK) \$102 Vibe, Black
<b>NB</b> No back topper	<i>Code: Upchg: Description:</i>	<i>Lumbar detail</i>
	J \$268 Spinneybeck Volo	
	J \$360 Spinneybeck Sabrina	
	<i>Base Options:</i>	<i>Headrest Option:</i>
	<i>Code: Upchg: Description:</i>	To order a headrest, use pattern number 55HEADREST.
	2 n/c black plastic base	The list price is \$102. Headrest cannot be used on Life chair with back topper.
	6 n/c grey plastic base	

Back Suspension Fabric - Standard	Knitted Seat Topper - Base Grade	Textile Options
<i>Code: Description:</i>	<i>Code: Description:</i>	Please refer to the matrices at the beginning of the price list for approved KnollTextiles fabrics and Spinneybeck leathers for seat and back toppers.
BSF 15 Eclipse	KST 15 Eclipse/Blackout	<i>Ultra Seat Topper Options:</i>
BSF 17 Blackout	KST 18 Camel	For ultra seat topper, which is 1/2" thicker foam than standard seat topper, add U before the seat topper pattern code.
BSF 19 Beige	KST 19 Beige	<i>Code: Upchg: Description:</i>
BSF 22 Grain	KST 31 Dark Blue	UST \$61 Ultra Seat Topper in fabric or leather
BSF 31 Navy	KST 32 Scarlet	UKST \$61 Ultra Knitted Seat Topper
BSF 32 Rouge	KST 33 Grape	
BSF 33 Plum	KST 36 Olive	<i>Perforated Leather Option:</i>
BSF 34 Sunset	KST 38 Dark Brown	For perforated patterns in leather seat and/or back toppers, insert PERF() after ST() and/or BT() in pattern number. Seat topper upcharge is \$107. Back topper upcharge is \$224. See Spinneybeck Leather Application section for pattern codes.
BSF 35 Avocado	KST 40 Dark Grey	
BSF 37 Bronze		<b>COM/COL Textile Requirements</b>
BSF 38 Chestnut		<i>Seat Topper:</i>
BSF 39 Platinum		0.7 yards fabric
BSF 40 Charcoal		9.0 sq ft leather
BSF 41 Frost		<i>Back Topper:</i>
		1.3 yards fabric
		16.0 sq ft leather

plastic base, seat topper and back topper

arm	description	pattern no. *
Armless <i>Designer(s):</i> Formway Design Studio, 2002	Plastic base, fabric or leather seat and back toppers	<b>55C-3-(2 or 6)-A-5-K-GH BSF( )-ST( )-BT( )</b>
		
<i>Award(s):</i> GOOD DESIGN Award, Chicago Athenaeum, 2003, USA NeoCon Gold, Best of NeoCon, Task Chair - Seating Design, June 2002, USA IIDEX/NeoCon, Sustainable Design Gold Award, 2002, Canada	Plastic base, fabric or leather seat and back toppers	<b>55M-3-(2 or 6)-A-5-K-GH BSF( )-ST( )-BT( )</b>
Fixed Aluminum 		
Height Adjustable 	Plastic base, fabric or leather seat and back toppers	<b>55H-3-(2 or 6)-A-5-K-GH BSF( )-ST( )-BT( )</b>
High Performance 	Plastic base, fabric or leather seat and back toppers	<b>55P-3-(2 or 6)-A-5-K-GH BSF( )-ST( )-BT( )</b>





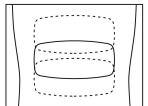

List price base or COM	grades A	B	C	D	E	F	G	H	I	T	COL U	V	W	X	Y
\$1,612.	\$1,710.	\$1,745.	\$1,805.	\$1,871.	\$1,921.	\$1,955.	\$2,085.	\$2,111.	\$2,155.	\$2,486.	\$2,617.	\$2,749.	\$3,264.	\$3,292.	\$3,437.
1,845.	1,943.	1,979.	2,040.	2,104.	2,155.	2,188.	2,319.	2,345.	2,388.	2,719.	2,851.	2,983.	3,497.	3,525.	3,670.
1,849.	1,947.	1,983.	2,044.	2,109.	2,159.	2,192.	2,323.	2,350.	2,392.	2,723.	2,855.	2,987.	3,502.	3,530.	3,675.
1,956.	2,054.	2,089.	2,150.	2,215.	2,266.	2,299.	2,430.	2,456.	2,499.	2,830.	2,962.	3,094.	3,608.	3,636.	3,781.

Order Code	Ordering Information	Options
<i>Example:</i> <b>55H-3-6-A5K-GH-BSF33-ST-K1206/9-NB</b>	<i>Specify:</i>	<i>Cylinder Height Options:</i>
<b>55</b> Life chair	1. Pattern number with back suspension fabric BSF( ).	For height ranges see Life Dimensions and Operating Instructions. Replace 5 in pattern with one of the following options:
<b>H</b> Height adjustable arms	2. Seat topper textile, either KST( ) for knitted seat topper or ST( ) for fabric or leather. NS for no seat topper.	<i>Code: Upchg: Description:</i>
<b>3</b> High back	3. Back topper textile, BT( ) for fabric or leather. NB for no back topper.	L n/c low cylinder
<b>6</b> Grey base		H n/c high cylinder
<b>A</b> Advanced control with sliding seat		<i>Lumbar Options:</i>
<b>5</b> Standard height cylinder		For lumbar, replace K with L( ) in the pattern number. Specify color code in the parentheses after L.
<b>K</b> No lumbar		<i>Code: Upchg: Description:</i>
<b>GH</b> Grey hard caster		L(K1029/13) \$102 Vibe, Glam
<b>BSF33</b> Plum Back Suspension Fabric	<i>Armpad Options:</i>	L(K1029/14) \$102 Vibe, Poise
<b>ST-K1206/9</b> Knoll Hopsack, Magenta seat topper	For leather armpads, add J after the arm pattern code (Example: 55PJ) and specify leather. Available in Spinneybeck Volo (Grade U) and Sabrina (Grade W) leathers.	L(K1029/BLK) \$102 Vibe, Black
<b>NB</b> No back topper	<i>Code: Upchg: Description:</i>	<i>Lumbar detail</i>
	J \$268 Spinneybeck Volo	
	J \$360 Spinneybeck Sabrina	
	<i>Base Options:</i>	
	<i>Code: Upchg: Description:</i>	
	2 n/c black plastic base	
	6 n/c grey plastic base	





Back Suspension Fabric - Standard	Knitted Seat Topper - Base Grade	Textile Options
<i>Code: Description:</i> BSF 15 Eclipse BSF 17 Blackout BSF 19 Beige BSF 22 Grain BSF 31 Navy BSF 32 Rouge BSF 33 Plum BSF 34 Sunset BSF 35 Avocado BSF 37 Bronze BSF 38 Chestnut BSF 39 Platinum BSF 40 Charcoal BSF 41 Frost	<i>Code: Description:</i> KST 15 Eclipse/Blackout KST 18 Camel KST 19 Beige KST 31 Dark Blue KST 32 Scarlet KST 33 Grape KST 36 Olive KST 38 Dark Brown KST 40 Dark Grey	Please refer to the matrices at the beginning of the price list for approved KnollTextiles fabrics and Spinneybeck leathers for seat and back toppers.  <i>Ultra Seat Topper Options:</i> For ultra seat topper, which is 1/2" thicker foam than standard seat topper, add U before the seat topper pattern code.  <i>Code: Upchg: Description:</i> UST \$61 Ultra Seat Topper in fabric or leather UKST \$61 Ultra Knitted Seat Topper
	For no seat topper (NS), subtract \$57 from KST base grade list price.	<i>CAL 133 Options:</i> To meet Cal 133 requirements, Life must have seat topper or seat and back toppers with approved FR upholstery. Not compliant with KST. See textile matrix at the beginning of the price list for pre-approved Cal 133 textiles. ▲ = Cal 133 pre-approved.  Insert C after ST( ) option. See below for upcharges. <i>Code: Upchg: Description:</i> C \$84 CAL 133 fabric seat topper C \$288 CAL 133 fabric seat and back toppers C \$165 CAL 133 leather seat topper C \$405 CAL 133 leather seat and back toppers No minimum order required
	There is no base grade upholstery for the back topper.	<i>Perforated Leather Option:</i> For perforated patterns in leather seat and/or back toppers, insert PERF( ) after ST( ) and/or BT( ) in pattern number. Seat topper upcharge is \$107. Back topper upcharge is \$224. See Spinneybeck Leather Application section for pattern codes.
	Ordering Samples/Viewing online: To view BSF and KST colors see Surface Finish Library on knoll.com. Physical samples are the best representation of color. To order samples, contact a Knoll sales representative or Knoll dealer.	<b>COM/COL Textile Requirements</b> <i>Seat Topper:</i> 0.7 yards fabric 9.0 sq ft leather  <i>Back Topper:</i> 1.3 yards fabric 16.0 sq ft leather

aluminum base, seat topper, no back topper

arm	description	pattern no. *
<p><i>Designer(s):</i> Formway Design Studio, 2002</p> <p><i>Award(s):</i> GOOD DESIGN Award, Chicago Athenaeum, 2003, USA NeoCon Gold, Best of NeoCon, Task Chair - Seating Design, June 2002, USA IIDEX/NeoCon, Sustainable Design Gold Award, 2002, Canada</p> 	Aluminum base, fabric or leather seat topper, no back topper	<b>55C-3-(3 or 4)-A-5-K-GH BSF( )-ST( )-NB</b>
<p>Fixed Aluminum</p> 	Aluminum base, fabric or leather seat topper, no back topper	<b>55M-3-(3 or 4)-A-5-K-GH BSF( )-ST( )-NB</b>
<p>Height Adjustable</p> 	Aluminum base, fabric or leather seat topper, no back topper	<b>55H-3-(3 or 4)-A-5-K-GH BSF( )-ST( )-NB</b>
<p>High Performance</p> 	Aluminum base, fabric or leather seat topper, no back topper	<b>55P-3-(3 or 4)-A-5-K-GH BSF( )-ST( )-NB</b>



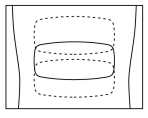

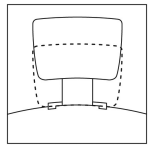

List price base grade or COM	A	B	C	D	E	F	G	H	I	T	COL U	V	W	X	Y
\$1,467.	\$1,524.	\$1,530.	\$1,558.	\$1,584.	\$1,605.	\$1,631.	\$1,645.	\$1,666.	\$1,693.	\$1,907.	\$1,940.	\$2,010.	\$2,174.	\$2,193.	\$2,288.
1,707.	1,764.	1,770.	1,797.	1,824.	1,843.	1,870.	1,884.	1,905.	1,933.	2,146.	2,178.	2,250.	2,415.	2,431.	2,527.
1,711.	1,768.	1,775.	1,801.	1,828.	1,848.	1,875.	1,888.	1,909.	1,937.	2,150.	2,185.	2,254.	2,419.	2,436.	2,532.
1,821.	1,878.	1,884.	1,912.	1,938.	1,958.	1,985.	1,998.	2,020.	2,047.	2,260.	2,293.	2,364.	2,528.	2,545.	2,641.

Order Code	Ordering Information	Options
<p><i>Example:</i> <b>55H-3-6-A5K-GH-BSF33-ST-K1206/9-NB</b></p> <p><b>55</b> Life chair</p> <p><b>H</b> Height adjustable arms</p> <p><b>3</b> High back</p> <p><b>6</b> Grey base</p> <p><b>A</b> Advanced control with sliding seat</p> <p><b>5</b> Standard height cylinder</p> <p><b>K</b> No lumbar</p> <p><b>GH</b> Grey hard caster</p> <p><b>BSF33</b> Plum Back Suspension Fabric</p> <p><b>ST-K1206/9</b> Knoll Hopsack, Magenta seat topper</p> <p><b>NB</b> No back topper</p>	<p><i>Specify:</i></p> <ol style="list-style-type: none"> <li>Pattern number with back suspension fabric BSF( ).</li> <li>Seat topper textile, either KST( ) for knitted seat topper or ST( ) for fabric or leather. NS for no seat topper.</li> <li>Back topper textile, BT( ) for fabric or leather. NB for no back topper.</li> </ol> <p><b>Options</b></p> <p><i>Armpad Options:</i> For leather armpads, add J after the arm pattern code (Example: 55PJ) and specify leather. Available in Spinneybeck Volo (Grade U) and Sabrina (Grade W) leathers.</p> <p><i>Code: Upchg: Description:</i> J \$268 Spinneybeck Volo J \$360 Spinneybeck Sabrina</p> <p><i>Base Options:</i></p> <p><i>Code: Upchg: Description:</i> 3 n/c painted matte aluminum base 4 n/c polished aluminum base</p>	<p><i>Cylinder Height Options:</i> For height ranges see Life Dimensions and Operating Instructions. Replace 5 in pattern with one of the following options:</p> <p><i>Code: Upchg: Description:</i> L n/c low cylinder H n/c high cylinder</p> <p><i>Lumbar Options:</i> For lumbar, replace K with L( ) in the pattern number. Specify color code in the parentheses after L.</p> <p><i>Code: Upchg: Description:</i> L(K1029/13) \$102 Vibe, Glam L(K1029/14) \$102 Vibe, Poise L(K1029/BLK) \$102 Vibe, Black</p> <p>Lumbar detail</p>  <p><i>Caster Options:</i> Replace GH in pattern with one of the following options:</p> <p><i>Code: Upchg: Description:</i> BH n/c hard black caster BR \$44 soft black caster GR \$44 soft grey caster CH \$26 hard clear caster CR \$69 soft clear caster</p> <p><i>Glides:</i> Replace GH in pattern with GG. No upcharge for this option.</p> <p>Glide detail</p>  <p><i>Headrest Option:</i> To order a headrest, use pattern number 55HEADREST. The list price is \$102. Headrest cannot be used on Life chair with back topper.</p> 

Back Suspension Fabric - Standard	Knitted Seat Topper - Base Grade	Textile Options
<p><i>Code: Description:</i> BSF 15 Eclipse BSF 17 Blackout BSF 19 Beige BSF 22 Grain BSF 31 Navy BSF 32 Rouge BSF 33 Plum BSF 34 Sunset BSF 35 Avocado BSF 37 Bronze BSF 38 Chestnut BSF 39 Platinum BSF 40 Charcoal BSF 41 Frost</p>	<p><i>Code: Description:</i> KST 15 Eclipse/Blackout KST 18 Camel KST 19 Beige KST 31 Dark Blue KST 32 Scarlet KST 33 Grape KST 36 Olive KST 38 Dark Brown KST 40 Dark Grey</p> <p>For no seat topper (NS), subtract \$57 from KST base grade list price.</p> <p>Ordering Samples/Viewing online: To view BSF and KST colors see Surface Finish Library on knoll.com. Physical samples are the best representation of color. To order samples, contact a Knoll sales representative or Knoll dealer.</p>	<p>Please refer to the matrices at the beginning of the price list for approved KnollTextiles fabrics and Spinneybeck leathers for seat and back toppers.</p> <p><i>Ultra Seat Topper Options:</i> For ultra seat topper, which is 1/2" thicker foam than standard seat topper, add U before the seat topper pattern code.</p> <p><i>Code: Upchg: Description:</i> UST \$61 Ultra Seat Topper in fabric or leather UKST \$61 Ultra Knitted Seat Topper</p> <p><i>Perforated Leather Option:</i> For perforated patterns in leather seat and/or back toppers, insert PERF( ) after ST( ) and/or BT( ) in pattern number. Seat topper upcharge is \$107. Back topper upcharge is \$224. See Spinneybeck Leather Application section for pattern codes.</p> <p><b>COM/COL Textile Requirements</b></p> <p><i>Seat Topper:</i> 0.7 yards fabric 9.0 sq ft leather</p> <p><i>Back Topper:</i> 1.3 yards fabric 16.0 sq ft leather</p> <p><i>CAL 133 Options:</i> To meet Cal 133 requirements, Life must have seat topper or seat and back toppers with approved FR upholstery. Not compliant with KST. See textile matrix at the beginning of the price list for pre-approved Cal 133 textiles. # = Cal 133 pre-approved.</p> <p>Insert C after ST( ) option. See below for upcharges.</p> <p><i>Code: Upchg: Description:</i> C \$84 CAL 133 fabric seat topper C \$288 CAL 133 fabric seat and back toppers C \$165 CAL 133 leather seat topper C \$405 CAL 133 leather seat and back toppers No minimum order required</p>

aluminum base, seat topper and back topper

	arm	description	pattern no. *
<i>Designer(s):</i> Formway Design Studio, 2002	Armless 	Aluminum base, fabric or leather seat and back topper	<b>55C-3-(3 or 4)-A-5-K-GH BSF( )-ST( )-BT( )</b>
<i>Award(s):</i> GOOD DESIGN Award, Chicago Athenaeum, 2003, USA NeoCon Gold, Best of NeoCon, Task Chair - Seating Design, June 2002, USA IINDEX/NeoCon, Sustainable Design Gold Award, 2002, Canada	Fixed Aluminum 	Aluminum base, fabric and leather seat and back topper	<b>55M-3-(3 or 4)-A-5-K-GH BSF( )-ST( )-BT( )</b>
	Height Adjustable 	Aluminum base, fabric and leather seat and back topper	<b>55H-3-(3 or 4)-A-5-K-GH BSF( )-ST( )-BT( )</b>
	High Performance 	Aluminum base, fabric and leather seat and back topper	<b>55P-3-(3 or 4)-A-5-K-GH BSF( )-ST( )-BT( )</b>

List price base grade or COM	A	B	C	D	E	F	G	H	I	T	COL U	V	W	X	Y
\$1,699.	\$1,797.	\$1,832.	\$1,894.	\$1,958.	\$2,010.	\$2,042.	\$2,173.	\$2,200.	\$2,242.	\$2,574.	\$2,705.	\$2,837.	\$3,351.	\$3,381.	\$3,525.
1,939.	2,037.	2,072.	2,133.	2,198.	2,248.	2,281.	2,412.	2,439.	2,482.	2,813.	2,943.	3,077.	3,592.	3,619.	3,764.
1,943.	2,041.	2,077.	2,137.	2,202.	2,253.	2,286.	2,416.	2,443.	2,486.	2,817.	2,950.	3,081.	3,596.	3,624.	3,769.
2,053.	2,151.	2,186.	2,248.	2,312.	2,363.	2,396.	2,526.	2,554.	2,596.	2,927.	3,058.	3,191.	3,705.	3,733.	3,878.

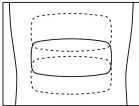
Order Code	Ordering Information	Options
<i>Example:</i> <b>55H-3-6-A5K-GH-BSF33-ST-K1206/9-NB</b>	<i>Specify:</i>	<i>Cylinder Height Options:</i>
<b>55</b> Life chair	1. Pattern number with back suspension fabric BSF( ).	For height ranges see Life Dimensions and Operating Instructions. Replace 5 in pattern with one of the following options:
<b>H</b> Height adjustable arms	2. Seat topper textile, either KST( ) for knitted seat topper or ST( ) for fabric or leather. NS for no seat topper.	<i>Code: Upchg: Description:</i>
<b>3</b> High back	3. Back topper textile, BT( ) for fabric or leather. NB for no back topper.	L n/c low cylinder
<b>6</b> Grey base		H n/c high cylinder
<b>A</b> Advanced control with sliding seat		<i>Lumbar Options:</i>
<b>5</b> Standard height cylinder		For lumbar, replace K with L( ) in the pattern number. Specify color code in the parentheses after L.
<b>K</b> No lumbar		<i>Code: Upchg: Description:</i>
<b>GH</b> Grey hard caster		L(K1029/13) \$102 Vibe, Glam
<b>BSF33</b> Plum Back Suspension Fabric	<i>Armpad Options:</i>	L(K1029/14) \$102 Vibe, Poise
<b>ST-K1206/9</b> Knoll Hopsack, Magenta seat topper	For leather armpads, add J after the arm pattern code (Example: 55PJ) and specify leather. Available in Spinneybeck Volo (Grade U) and Sabrina (Grade W) leathers.	L(K1029/BLK) \$102 Vibe, Black
<b>NB</b> No back topper	<i>Code: Upchg: Description:</i>	<i>Lumbar detail</i>
	J \$268 Spinneybeck Volo	
	J \$360 Spinneybeck Sabrina	
	<i>Base Options:</i>	
	<i>Code: Upchg: Description:</i>	
	3 n/c painted matte aluminum base	
	4 n/c polished aluminum base	

Back Suspension Fabric - Standard	Knitted Seat Topper - Base Grade	Textile Options
<i>Code: Description:</i> BSF 15 Eclipse BSF 17 Blackout BSF 19 Beige BSF 22 Grain BSF 31 Navy BSF 32 Rouge BSF 33 Plum BSF 34 Sunset BSF 35 Avocado BSF 37 Bronze BSF 38 Chestnut BSF 39 Platinum BSF 40 Charcoal BSF 41 Frost	<i>Code: Description:</i> KST 15 Eclipse/Blackout KST 18 Camel KST 19 Beige KST 31 Dark Blue KST 32 Scarlet KST 33 Grape KST 36 Olive KST 38 Dark Brown KST 40 Dark Grey	Please refer to the matrices at the beginning of the price list for approved KnollTextiles fabrics and Spinneybeck leathers for seat and back toppers.  <i>Ultra Seat Topper Options:</i> For ultra seat topper, which is 1/2" thicker foam than standard seat topper, add U before the seat topper pattern code.  <i>Code: Upchg: Description:</i> UST \$61 Ultra Seat Topper in fabric or leather UKST \$61 Ultra Knitted Seat Topper
	For no seat topper (NS), subtract \$57 from KST base grade list price.	<i>CAL 133 Options:</i> To meet Cal 133 requirements, Life must have seat topper or seat and back toppers with approved FR upholstery. Not compliant with KST. See textile matrix at the beginning of the price list for pre-approved Cal 133 textiles. ▲ = Cal 133 pre-approved.  Insert C after ST( ) option. See below for upcharges. <i>Code: Upchg: Description:</i> C \$84 CAL 133 fabric seat topper C \$288 CAL 133 fabric seat and back toppers C \$165 CAL 133 leather seat topper C \$405 CAL 133 leather seat and back toppers No minimum order required
	There is no base grade upholstery for the back topper.	<i>Perforated Leather Option:</i> For perforated patterns in leather seat and/or back toppers, insert PERF( ) after ST( ) and/or BT( ) in pattern number. Seat topper upcharge is \$107. Back topper upcharge is \$224. See Spinneybeck Leather Application section for pattern codes.
	Ordering Samples/Viewing online: To view BSF and KST colors see Surface Finish Library on knoll.com. Physical samples are the best representation of color. To order samples, contact a Knoll sales representative or Knoll dealer.	<b>COM/COL Textile Requirements</b> <i>Seat Topper:</i> 0.7 yards fabric 9.0 sq ft leather  <i>Back Topper:</i> 1.3 yards fabric 16.0 sq ft leather



	description	pattern no.
<i>Designer(s):</i> Formway Design Studio, 2002	Replacement KST or leather seat topper upholstery	<b>55SEATTOPPER</b>
<i>Award(s):</i> GOOD DESIGN Award, Chicago Athenaeum, 2003, USA NeoCon Gold, Best of NeoCon, Task Chair - Seating Design, June 2002, USA IIDEX/NeoCon, Sustainable Design Gold Award, 2002, Canada	Replacement fabric seat topper	<b>55FABRICTOPPER</b>
	Replacement fabric or leather back topper	<b>55BACKTOPPER</b>
	Replacement lumbar	<b>55LUMBAR</b>
	Replacement headrest	<b>55HEADREST</b>



List price base grade or COM	grades										COL					
	A	B	C	D	E	F	G	H	I	T	U	V	W	X	Y	
\$57.											\$497.	\$530.	\$599.	\$764.	\$782.	\$877.
57.	114.	120.	148.	174.	194.	221.	234.	255.	283.							
232.	273.	302.	336.	374.	405.	411.	528.	534.	549.	667.	765.	827.	1,177.	1,188.	1,237.	
102.																
102.																

Order Code	Ordering Information	Options
<i>Example:</i> <b>55FABRICTOPPER-ST-K1206/9</b>	<i>Specify:</i> 1. Pattern number 2. Textile	<i>Lumbar Options:</i> For lumbar, specify color code in the parentheses after L.  <i>Code:</i> <i>Upchg:</i> <i>Description:</i> K1029/13      \$102      Vibe, Glam K1029/14      \$102      Vibe, Poise K1029/BLK      \$102      Vibe, Black
<b>55</b> Life chair		<i>Headrest Option:</i> To order a headrest, use pattern number 55HEADREST. The list price is \$102. Headrest cannot be used on Life chair with back topper.
<b>FABRIC TOPPER</b> Replacement fabric seat topper		
<b>ST</b> Seat topper		
<b>K1206/9</b> Knoll Hopsack, Magenta		

Lumbar detail

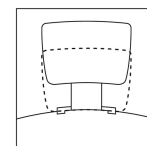
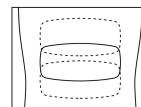

#### Knitted Seat Topper - Base Grade

*Code:*      *Description:*  
KST 15 Eclipse/Blackout  
KST 18 Camel  
KST 19 Beige  
KST 31 Dark Blue  
KST 32 Scarlet  
KST 33 Grape  
KST 36 Olive  
KST 38 Dark Brown  
KST 40 Dark Grey

There is no base grade upholstery for the back topper.

Ordering Samples/Viewing online:  
To view BSF and KST colors see Surface Finish Library on knoll.com. Physical samples are the best representation of color. To order samples, contact a Knoll sales representative or Knoll dealer.

#### Textile Options

Please refer to the matrices at the beginning of the price list for approved KnollTextiles fabrics and Spinneybeck leathers for seat and back toppers.

*Ultra Seat Topper Options:*  
For ultra seat topper, which is 1/2" thicker foam than standard seat topper, add U before the seat topper pattern code.

*Code:*      *Upchg:*      *Description:*  
UST      \$61      Ultra Seat Topper in fabric or leather  
UKST      \$61      Ultra Knitted Seat Topper

*Perforated Leather Option:*  
For perforated patterns in leather seat and/or back toppers, insert PERF( ) after ST( ) and/or BT( ) in pattern number. Seat topper upcharge is \$107. Back topper upcharge is \$224. See Spinneybeck Leather Application section for pattern codes.

#### COM/COL Textile Requirements

*Seat Topper:*  
0.7 yards fabric  
9.0 sq ft leather

*Back Topper:*  
1.3 yards fabric  
16.0 sq ft leather

#### CAL 133 Options:

To meet Cal 133 requirements, Life must have seat topper or seat and back toppers with approved FR upholstery. Not compliant with KST. See textile matrix at the beginning of the price list for pre-approved Cal 133 textiles. ▲ = Cal 133 pre-approved.

Insert C after ST( ) option. See below for upcharges.

*Code:*      *Upchg:*      *Description:*  
C      \$84      CAL 133 fabric seat topper  
C      \$288      CAL 133 fabric seat and back toppers  
C      \$165      CAL 133 leather seat topper  
C      \$405      CAL 133 leather seat and back toppers  
No minimum order required

## How to Specify a Life Chair

Step 1 Basic Pattern Number																						
Select a Chair Type (including arm, base, cylinder, lumbar and caster type)																						
	Arm				Base			Cylinder	Lumbar	Caster												
Life Chair	Height Adjustable Arms	High Performance Arms	Fixed Aluminum Arms	Armless	Leather Armpads	High Back	Grey Plastic Base	Polished Aluminum Base	Painted Matte Aluminum Base	Black Plastic Base	Advanced Control with Sliding Seat	Medium Height Cylinder	Low Height Cylinder	High Height Cylinder	Height Adjustable Lumbar, Color #	No Lumbar	Grey Hard Caster	Grey Soft Caster	Clear Hard Caster	Clear Soft Caster	Black Hard Caster	Black Soft Caster
<b>55</b>	<b>H</b>	<b>P</b>	<b>M</b>	<b>C</b>	<b>J</b>	<b>3</b>	<b>6</b>	<b>4</b>	<b>3</b>	<b>2</b>	<b>A</b>	<b>5</b>	<b>L</b>	<b>H</b>	<b>L</b>	<b>K</b>	<b>GH</b>	<b>GR</b>	<b>CH</b>	<b>CR</b>	<b>BH</b>	<b>BR</b>

The basic pattern numbers are configured for you in the price list.

### EXAMPLES:

**55PJ-3-6-A5L-K1029-13-GH-BSF17-ST-K451/4-BT-K451/4**

(Life with plastic base and upholstered seat and back toppers)  
 Life / High Performance Arm / Leather Armpads / Grey Base /  
 Height Adjustable Lumbar, Vibe K1029-13 Glam / Grey Hard Caster /  
 Life Back Suspension Fabric-Blackout / Seat Topper Fabric-Una, Ebony /  
 Back Topper Fabric-Una, Ebony

**55H-3-4-A5K-CH-BSF22-KST19-NB**

(Life with aluminum base and knitted seat topper, no back topper)  
 Life / Height Adjustable Arms / Polished Aluminum Base / No Lumbar /  
 Clear Hard Caster / Life Back Suspension Fabric-Grain /  
 Life Knitted Seat Topper / No Back Topper

Step 2	Step 3	Step 4
Select Back Suspension Fabric color	Select No Seat Topper <input type="checkbox"/> or Select Seat Topper and Upholstery Choice	Select No Back Topper <input type="checkbox"/> or Select Back Topper and Upholstery Choice
Life Back Suspension Fabric	No Seat Topper (-\$54 from base grade list price)	No Back Topper
	Seat Topper and Upholstery Number Life Knitted Seat Toppers are base grade. Additional options include all approved KnollTextiles fabrics, Spinneybeck leathers, COM or COL	Back Topper and Upholstery Code Options include all approved KnollTextiles fabrics, Spinneybeck leathers, COM or COL
<b>BSF(15-41)</b>	<b>NS</b>	<b>NB</b>
	Life Knitted Seat Topper <b>KST(15-40)</b> (base grade) or <b>UKST(15-40)</b> (optional Ultra Knitted Seat Topper) or <b>ST-(KnollTextiles or Spinneybeck Upholstery Code*)</b> (optional fabric or leather seat topper) or <b>UST-(Upholstery Code*)</b> (optional fabric or leather Ultra Seat Topper) or <b>COM or COL</b>	No base grade available or <b>BT-(KnollTextiles or Spinneybeck Upholstery Code*)</b> (optional fabric or leather back topper) or <b>COM or COL</b>

\* Please refer to the matrices at the beginning of the price list for approved fabrics and leathers.





**Back Suspension Fabric with No Seat Topper**

Life Back Suspension Fabric (BSF) is required for every chair and comes in 14 updated colors including warm and cool neutrals and vibrant, saturated colors.



**Back Suspension Fabric with Upholstered Seat Topper**

You may choose to add a seat topper. In addition to a wide range of approved KnollTextiles fabrics and Spinneybeck leathers, an exclusive Life Knitted Seat Topper (KST) is available in a palette to match the Life BSF. Life KST is base grade and included in the basic model pricing.



**Back Suspension Fabric with Upholstered Seat and Back Toppers**

Change the look of Life by adding an upholstered back topper. A wide range of approved KnollTextiles fabrics and Spinneybeck leathers are available as back toppers. Life KST is not available as a back topper. There is no base grade back topper.

**Construction**

**COM/COL Approval Procedure**

Prior to order placement a sample\* of the actual COM/COL must be submitted to Knoll East Greenville, with completed Knoll COM/COL Approval Request Form. Even after such preliminary approval, Knoll reserves the right to reject COM, including, if necessary, the item intended for use with COM, if Knoll considers the customer-supplied material inadequate for any reason. When specifying suede and shrunken cowhide, add 10% to the square footage requirement. When specifying calfskin, add 15% to the square footage requirement. COM is graded at Life KST base grade and COL is grade U.

\*Sample Requirement: 8" x 8" minimum memo sample if solid; if COM has a repeat, the sample must be large enough to show the repeat.

Call Customer Service at 800-343-5665 to obtain a copy of the COM/COL Approval Request Form.

**Cleaning Note:**

Life BSF is cleaning code W, meaning water-based cleaning agents or foam may be used.

Life KST is cleaning code W-S, meaning water-based cleaning agents and foam or mild water-free solvents may be used.

Both BSF and KST can be cleaned with low environmental impact cleaning fluids, including GS-37 certified products.

See KnollTextiles.com for further details on cleaning codes.

**Back:**

Glass filled nylon frame. Polyester multi-filament yarn with co-polymer polyester elastomeric knit back suspension fabric.

**Upholstery toppers:**

High density urethane foam material  
3/4" foam - back thickness  
1 3/4" foam - seat thickness  
2 1/4" foam - ultra seat thickness

**Flexing Seat Pan:**

Glass filled nylon seat structure.

**Fixed Aluminum Arms:**

Aluminum armpost with soft integrally colored self-skinning urethane pad and integrally molded thermoplastic glass-filled nylon support.

**Height Adjustable and High Performance Arms:**

Aluminum armpost with soft integrally colored self-skinning urethane pad and integrally molded thermoplastic glass-filled nylon support.

**Black and Grey Plastic Base:**

Glass filled nylon.

**Polished and painted matte aluminum base:**

Aluminum

**Optional Lumbar:**

Slow recovery urethane foam with KnollTextiles Vibe fabric cover. Attaches with neodymium magnets in TPU back frame.

**Casters:**

Nylon 6 hard caster.  
Nylon 6 soft caster with urethane overmolding.

**Optional Headrest:**

Soft integrally colored self-skinning urethane pad and integrally molded thermoplastic glass-filled nylon support.

**Visual impression and scale:**

Doesn't dominate the look of the work environment, it complements it. Translucent back, sculpted mechanism and thin profile integrate Life into the landscape. Generous scale and features accommodate all size users.

**Synchronized recline with auto-balanced tension:**

Utilizes user's body weight for resistance and recline. Allows for constant sightline — no need to refocus. Promotes movement and balance. Preference control accommodates a wider range of users.

**Dynamic seat pan with forward flex:**

Unique cut-out pattern with ribbed understructure provides dynamic movement and structural stability. Cradles and accommodates ischials (sit bones) without pressure points. Automatic flex responds to user's every move. Flex front automatically supports perching and enables a balanced posture. Flex front includes waterfall edge (gradual radius at the front edge that does not cause pressure under the knee). Ribs prevent "hammocking" or sagging and allow for easier movement.

**Back flex:**

The back frame is also a flexible plane like the seat that moves with you as you recline in the chair.

**Life Back Suspension Fabric (BSF):**

Exclusive elastomeric knit has built in lumbar support and is available in 14 color options. Has a soft feel that is not harsh to skin or clothing.

**Arms:**

Soft armpads alleviate pressure points. Types available: fixed, height adjustable, high performance (includes height adjustment and armpad positioning). Retrofittable or changeable.

**High performance arms:**

One-hand operation. Armposts are set toward the rear of the seat for a better fit. Soft armpads float in an orbital motion with locked stops. A great deal of adjustment in a surprisingly slim package.

**Optional lumbar attachment:**

Made of slow recovery foam, it magnetically attaches anywhere on the Life Back Suspension Fabric (BSF), and is covered in Vibe by KnollTextiles.

**Low profile base and casters:**

Feet can rest on the base comfortably. Low profile enables easier foot movement. Caster ribs absorb energy, flex and spread the static load for easier rolling.

**Controls:**

Adjustable from the seated position. Easy, obvious and labeled. Automated where possible.

**Environmental: SMaRT® Sustainable Gold certified.**

Life was the first product in the industry to be SMaRT® certified. SMaRT® Consensus Sustainable Product Standard is a comprehensive, transparent, sustainable product standard that measures a product's environmental, economic and social benefits over its life and throughout its global supply chain, from raw materials through reclamation or re-use. Life can contribute to achieving a LEED® Innovation in Design Credit.

**BIFMA level® 3 certified**

BIFMA has established level® as a common framework against which to evaluate the environmental and social responsibility of a variety of products. level® is part of BIFMA's ongoing development of voluntary product and industry standards that support safe, healthy and sustainable workplaces. To achieve level® certification, Knoll partners with Scientific Certification Systems (SCS), known for its integrity and scientific rigor.

**GREENGUARD® certified.**

Life is GREENGUARD and GREENGUARD Gold certified and can contribute to achieving LEED® credits.

**Warranty:**

Life is warranted for 24-hour, 7 days a week, multi shift use: 12 years parts and labor to repair; 3 years seating upholstery, textiles and leathers, and finishes. See Knoll Selling Policy for further details, conditions and exclusions.

**Life Awards:**

Good Design Award, Chicago Athenaeum, 2003, USA  
NeoCon Gold, Best of NeoCon, Task Chair - Seating Design, June 2002, USA  
IINDEX/NeoCon, Sustainable Design Gold Award, 2002, Canada  
IINDEX/NeoCon, Seating Desk, Workstation Chair Gold Award, 2002, Canada  
FX Awards, Seating Product of the Year, 2002, UK  
FX Awards, Overall Interior Product of the Year, 2002, UK

**Life Ergonomic Dimensions**

Seat*	Seat Topper	No Seat Topper	Ultra Seat Topper
Seat Height	14.75" - 18.5" (low cylinder)	14.25" - 18" (low cylinder)	15" - 18.75" (low cylinder)
	15.75" - 21" (standard cylinder)	15.25" - 20.5" (standard cylinder)	16" - 21.25" (standard cylinder)
	17.5" - 22.5" (high cylinder)	17" - 22" (high cylinder)	17.75" - 22.75" (high cylinder)
Seat Depth (Adjustable)	15" - 19"		
Seat Width	18.75"		
Seat Pan Angle (Fixed)	4° rearward		
<b>Back*</b>			
Backrest Height	25"		
Backrest Width	18.25"		
Lumbar Support (Fixed)	7.5"		
Lumbar Support (Adjustable)	Exceeds 5.5" - 9.8" (optional lumbar)		
Angle Between Seat and Back	95° - 119°		
Tilt Range of Back	24°		
<b>Arms*</b>			
Armrest Height (Fixed)	9.5" (fixed arm)	10.5" (fixed arm)	8.5" (fixed arm)
	6.8" - 10.8" (height adjustable)	7.8" - 11.8" (height adjustable)	5.8" - 9.8" (height adjustable)
	6.8" - 10.8" (high performance)	7.8" - 11.8" (high performance)	5.8" - 9.8" (high performance)
Inside Distance Between Armrests (Fixed)	18.5" (fixed); 18.25" (height adjustable)		
Inside Distance Between Armrests (Adjustable)	17.25" - 19.75" (high performance)		

\* All measurements taken with BIFMA Chair Measuring Device using the Universal Measurement Procedure which has a measurement uncertainty of ± 5%

**Life Chair Measurements\*\***

A. Overall Height	38.5" - 43.75" (back topper adds 0.5")
B. Overall Width	26.5"
C. Overall Depth	24.5"
D. Arm Height from Floor	25" - 30" (fixed arm)
	22" - 31.5" (height adjustable)
	22" - 31.5" (high performance)
E. Base Diameter	26"
Weight	36.5 lbs. (plastic base, high performance arms, seat topper)
	38 lbs. (aluminum base, high performance arms, seat topper)

\*\*Standard cylinder

**Life - Additional Information**

Synchronized recline ratio seat : back is 1° : 4.8°
High performance arms adjust 2.5" in armpad width (1.25" per side) and 3" armpad fore/aft movement
Optional lumbar measures 11.5" x 5.5"
Optional headrest measures 9"W x 6" - 9"H

Compliance: ANSI/BIFMA X5.1 : 2002 (U.S. structural standard)  
 ANSI/HFES 100-2007 (U.S. ergonomic standard)  
 BIFMA G1 : 2002 (U.S. ergonomic guidelines)  
 California T.B. 117 (U.S. flammability standard for foam)  
 California T.B. 133 with approved FR textile (U.S. flammability standard for full chair)  
 CAN/CGSB 44.232-2008, BS 5459.2 : 2000 (European structural standard)  
 EN 1335-1 : 2000 (European ergonomic standard)  
 AS/NZS 4438 : 1997 Level 6 (Australia, New Zealand structural and dimensional standard)  
 The Life chair has been tested and is approved for use by individuals weighing up to 300 pounds.

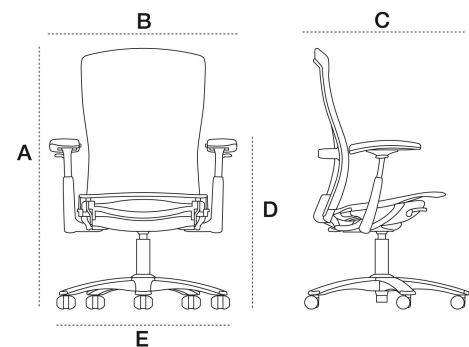

**Life® Operating Instructions**

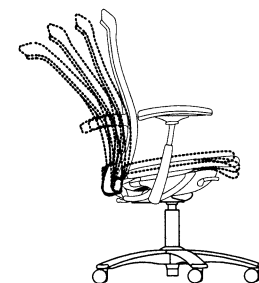

**Standard Features:**

**Synchronized recline with auto-balanced tension**  
 No need to adjust tension. Automatic recline tension counter-balances your body weight, resulting in perfect balance as you recline.

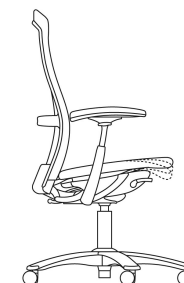

**Forward seat flex**  
 No knobs or levers needed. Lean forward or perch toward the edge of the seat and Life's seat pan automatically adjusts to support your position.

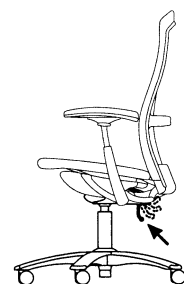

**Tension preference selector**  
 To perfect the tension adjust the preference lever located at the back left of the chair while in the upright position.

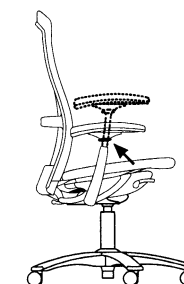

**Arm Options:**

**Fixed arms:**  
 Non-adjustable.

**Height Adjustable Arms:**  
 Lift the lever on the outside of the armpad to adjust arm height.

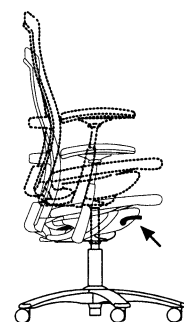

**Seat height adjustment**  
 To raise or lower the height, lift the lever on the right side of the chair and adjust to the proper height.

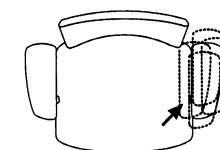

**High Performance Arms:**  
 Lift the lever on the outside of the armpad to adjust arm height.

The armpads adjust in an orbital motion and lock into a fixed position by pressing the button on the inside of the pad. The armpads can be positioned to the front or back and in width.

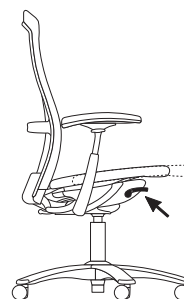

**Sliding seat depth adjustment**  
 Using the same lever as the seat height, push down to slide the seat within the 4" seat depth range. Release the lever to lock the seat into position.

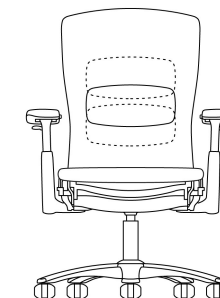

**Lumbar Options:**

**Height Adjustable Lumbar**  
 The lumbar support is held on to the chair with magnets for easy installation and a maximum range of adjustability.

To install the lumbar, separate the halves of the magnetic lumbar and place it in the desired position on your chair. Secure it by putting both halves back together around the back suspension fabric on the chair.

Adjust the lumbar by sliding the lumbar pad up and down the back of the chair.

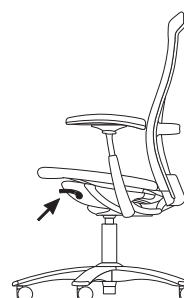

**Upright tilt lock**  
 To lock the seat in an upright position, push down the lever located on the left side of seat. Lift lever to unlock.

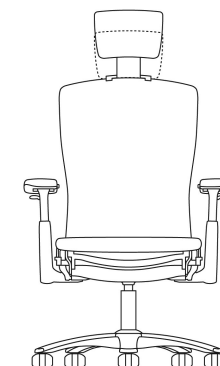





**Note:** Product contains magnets. Consult the lumbar hangtag for more information.

**Optional Headrest:**  
 Lift or lower the headrest itself to adjust the height. There are 12 levels of adjustment from the lowest to the highest point.

# Generation by Knoll®

## work chair

model	description	pattern no.
<p><i>Designer(s):</i> Formway Design, 2009</p> <p><i>Award(s):</i> NeoCon Gold, Best of NeoCon, Task Chair - Seating, June 2009, USA Best of Year Award, <i>Interior Design</i>, Seating: Contract/Task, December 2009, USA GOOD DESIGN Award, Chicago Athenaeum, 2009, USA Product of the Year: Workplace Seating, FX International Interior Design Awards, November 2010, UK Middle East Office, Exhibition Gold Award, 2010</p> 	<p>armless</p> <p>plastic base, standard cylinder, no optional lumbar, hard casters</p> 	<b>11-1-NA-2-S-X-HC</b>
<p>fixed arms</p> <p>plastic base, standard cylinder, no optional lumbar, hard casters</p> 	<b>11-1-FA-2-S-X-HC</b>	
<p>height adjustable arms</p> <p>plastic base, standard cylinder, no optional lumbar, hard casters</p> 	<b>11-1-HA-2-S-X-HC</b>	
<p>high performance arms</p> <p>plastic base, standard cylinder, no optional lumbar, hard casters</p> 	<b>11-1-HP-2-S-X-HC</b>	
<b>GENSEAT</b>	Replacement seat	<b>GENSEAT</b>

list price base grade	grades COM	A	B	C	D	E	F	G	H	I	T	COL	U	V	W	X	Y
\$1,094.	\$1,148.	\$1,170.	\$1,185.	\$1,204.	\$1,224.	\$1,236.	\$1,258.	\$1,295.	\$1,329.	\$1,351.	\$1,395.	\$1,489.	\$1,609.	\$1,664.	\$1,713.		
1,314.	1,368.	1,390.	1,405.	1,422.	1,444.	1,455.	1,477.	1,515.	1,549.	1,570.	1,614.	1,708.	1,828.	1,883.	1,933.		
1,314.	1,368.	1,390.	1,405.	1,422.	1,444.	1,455.	1,477.	1,515.	1,549.	1,570.	1,614.	1,708.	1,828.	1,883.	1,933.		
1,422.	1,477.	1,499.	1,515.	1,532.	1,554.	1,565.	1,587.	1,625.	1,659.	1,681.	1,724.	1,818.	1,938.	1,992.	2,043.		
165.	220.	242.	258.	275.	297.	307.	330.	368.	402.	423.	467.	561.	682.	736.	786.		

Order Code	Ordering Information	Options
<p><i>Example:</i> <b>11-1-HP-2-S-X-HC-DK-01-USF-GENU01</b></p> <p><b>11</b> Generation by Knoll</p> <p><b>1</b> Work chair</p> <p><b>HP</b> High performance arms</p> <p><b>2</b> Plastic base</p> <p><b>S</b> Standard cylinder</p> <p><b>X</b> No optional lumbar</p> <p><b>HC</b> Hard casters for soft floors</p> <p><b>DK</b> Dark finish</p> <p><b>01</b> Storm Flex Back Net color</p> <p><b>USF</b> Ultra seat foam</p> <p><b>GENU01</b> Generation Fabric, Storm</p>	<p><i>Specify:</i></p> <ol style="list-style-type: none"> <li>1. Pattern number</li> <li>2. Finish color</li> <li>3. Flex Back Net color</li> <li>4. Seat foam</li> <li>5. Seat textile</li> </ol> <p><b>Options</b></p> <p><i>Polished Aluminum Base:</i> Replace 2 in pattern with 4</p> <p><i>Code: Upchg: Description:</i> 4 \$89 polished aluminum base</p> <p><i>Cylinder Height Options:</i> For height ranges see Generation Dimensions page. Replace S in pattern with one of the following:</p> <p><i>Code: Description:</i> L low cylinder H high cylinder</p>	<p><i>Lumbar Option:</i> For height adjustable lumbar, replace X in pattern with L</p> <p><i>Code: Upchg: Description:</i> L \$83 height adjustable lumbar support</p> <p><i>Note:</i> To order a lumbar separately, use pattern number 11LUMBAR. The list price is \$83.</p> <p><i>Casters and Glides:</i> Replace HC in pattern with one of the following:</p> <p><i>Code: Upchg: Description:</i> SC \$42 soft casters for hard floors GL n/c glides (reduce chair height by 0.25")</p> <p><i>Glide detail</i></p> 
<p><i>Example for Cal 133:</i> <b>11-1-HP-2-S-X-HC-DK-01-USF-C-GENU01-133</b></p>		<p><i>Finish Colors:</i> Select one of the following:</p> <p><i>Code: Description:</i> DK Dark finish LT Light finish</p> <p><i>Flex Back Net Colors:</i> Select one of the following:</p> <p><i>Code: Description:</i> 01 Storm (dark grey) 02 Meteor (light grey) 03 Pebble (medium grey) 04 Desert (beige) 05 Lemongrass (green) 06 Espresso (brown) 07 Firecracker (red) 08 Bluemarine (blue) 09 Onyx (black) 10 Olive (dark green)</p> <p><i>Seat Foam Options:</i> Select one of the following:</p> <p><i>Code: Description:</i> TSF thin seat foam USF ultra seat foam (default)</p>

Generation Fabric - Base Grade	Textile Options
<p>Generation Fabric prefix GENT for thin seat foam or GENU for ultra seat foam, followed by two digit color code. Select one of the following:</p> <p><i>Code: Description:</i></p> <p>01 Storm 03 Pebble 04 Desert 05 Lemongrass 06 Espresso 07 Firecracker 08 Bluemarine 09 Onyx 10 Olive</p>	<p><i>KnollTextiles fabrics and Spinneybeck leathers:</i> Please refer to the textile matrices at the beginning of the price list for approved fabrics and leathers.</p> <p><i>Customer's Own Material/Leather:</i> See Customer's Own Material Seating Process Overview at the beginning of the price list</p> <p>COM/COL Textile Requirements (for both thin and ultra seat foam):</p> <p>COM fabric .75 yards COL leather 11 sq. ft.</p> <p><i>Cal 133:</i> See textile matrices at the beginning of the price list for additional Cal 133 pre-approved textiles. Dark finish with fire-retardant additive only approved for Cal 133. Generation Fabric is Cal 133 approved but it must be specified as described below and the upcharge does apply. ‡ = Cal 133 pre-approved</p> <p>To specify, insert C before seat textile selection and 133 after it.</p> <p><i>Code: Upchg: Description:</i> C( )133 \$ 104 Cal 133 compliant</p>



## Generation by Knoll Ergonomic Dimensions

Seat*	Thin Seat Foam	Ultra Seat Foam
Seat Height	15" - 19.5" (low cylinder) 16.5" - 21.75" (standard cylinder) 17.75" - 23.25" (high cylinder)	15.75" - 20.25" (low cylinder) 17.25" - 22.5" (standard cylinder) 18.5" - 24" (high cylinder)
Seat Depth (Adjustable)	15" - 18" (with arms) 15" - 17.5" (with arms)	15.75" - 18.75" (with arms) 15.75" - 18.25" (with arms)
Seat Width	21"	
Seat Pan Angle (Fixed)	2.85° rearward at rest	

Back*	
Backrest Height	24.125"
Backrest Width	19.375" at top of lumbar area
Lumbar Support (Fixed)	9.25"
Lumbar Support (Adjustable)	8.125" - 11.375" (optional lumbar)
Angle between Seat and Back	96° - 111°
Tilt Range of Back	15°

Arms*	Thin Seat Foam	Ultra Seat Foam
Armrest Height from Seat (Fixed)	10" (fixed)	9.5" (fixed)
Armrest Height from Seat (Adjustable)	6.625" - 11.125" (height adjustable arms) 6.625" - 11.125" (high performance arms)	6.125" - 10.625" (height adjustable arms) 6.125" - 10.625" (high performance arms)
Inside Distance between Armrests (Fixed)	21.5" (fixed and height adjustable arms)	
Inside Distance between Armrests (Adjustable)	17.5" - 19.5" (high performance arms)	

\*All measurements taken with the BIFMA Chair Measuring Device using the Universal Measurement Procedure which has a measurement uncertainty of ± 5%

## Generation by Knoll Chair Measurements\*\*

A. Overall Height	39.25" - 44.5" (glides reduce height by 0.25")
B. Overall Width	21" (armless) 28.5" (with arms)
C. Overall Depth	26" excluding base
D. Arm Height from Floor	26.625" - 32" (fixed arms) 22.75" - 32.5" (height adjustable and high performance arms)
E. Base Diameter	26.75"
Weight	37 lbs. (plastic base, high performance arms) 39 lbs. (aluminum base, high performance arms)

\*\*Standard cylinder

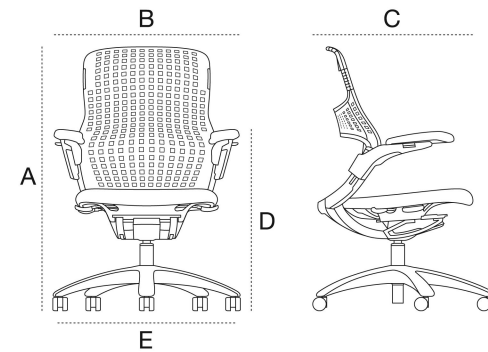

## Generation by Knoll Performance Information

Synchronized recline ratio seat:back is 1° : 4.4°
Arm pads measure 9.6" long x 4.3" wide
High performance arm pads adjust 2" in width (1" per arm), 1.5" in depth and pivot 45°
Flex Top folds up to 90° rearward

Compliance: ANSI/BIFMA X5.1 : 2011 (U.S. structural standard)  
 BIFMA G1 : 2013 (U.S. ergonomic guidelines)  
 ANSI/HFES 100-2007 (U.S. ergonomic standard)  
 California T.B. 117 (U.S. flammability standard for foam)  
 California T.B. 133 with approved FR textile and Dark finish with fire-retardant additive (U.S. flammability standard for full chair)  
 EN 1335-1 : 2000 (European ergonomic standard)  
 AS/NZS 4438 : 1997 Level 6 (Australia, New Zealand structural and dimensional standard)  
 The Generation by Knoll work chair has been tested and is approved for use by individuals weighing up to 300 pounds

## Generation by Knoll® Features and Operating Instructions

### No Adjustment Necessary

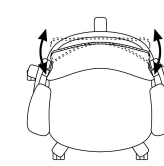

#### Flex Back

Sit back and the Flex Back supports you and responds to your multidimensional movements.



#### Flex Top

Simply rest your arms comfortably over the top of the Flex Back.

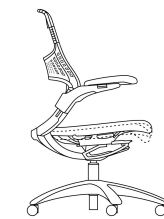

#### Flex Seat

Sit in any position—forward or sideways—and the Flex Seat supports you with 270° of seat edge flex.

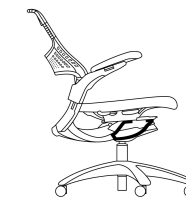

#### Dynamic Suspension control

The synchronized recline counterbalances your body weight for a smooth and effortless ride. Four independent flexors act as suspension devices that respond to your multidirectional movements—forward, backward and side-to-side.

### Intuitive Adjustments (Standard)

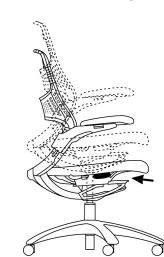

#### Seat height

Lift the right front lever. Sit down to lower the seat or remove your weight to raise it. Release the lever to lock.

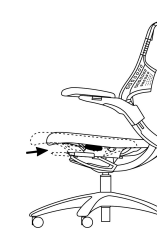

#### Seat depth

While seated, lift the left lever and slide the seat to the desired position. Release the lever to lock.

#### Tilt preference selector

Select the degree of recline movement for your preference and your task. Sit fully upright. Rotate the back right lever until it clicks into one of three positions—all the way back for the most movement, in the middle for less, or all the way forward for greater upright support.

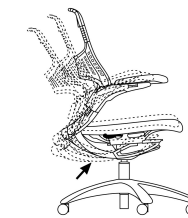

### Performance Options

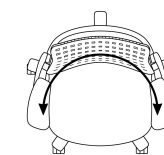

#### Arm options

Cantilevered arm supports provide seated clearance for your legs and feature Continuous Lumbar, so your back is supported when side sitting.

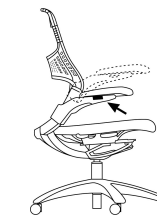

#### Height adjustable arm

To adjust the height, lift the lever on the arm and lift the arm to disengage. Slide the arm to the desired position and release the lever to lock.

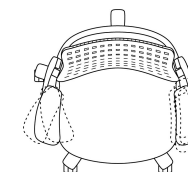

#### High performance arm

To adjust the height, lift the lever on the arm and lift the arm to disengage. Slide the arm to the desired position and release the lever to lock. Free float arm pads move easily in width and depth, and pivot.

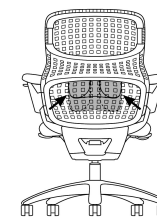

#### Height adjustable lumbar

Grasp both sides of the lumbar support and slide it to the desired position.

**CONSTRUCTION INFORMATION**

**Flex Back**

Integrally colored, high performance elastomer and glass reinforced polyester structure

**Fixed, height adjustable and high performance arms**

Burnished cast aluminum and integrally colored, glass reinforced nylon supports with integrally colored, self skinning polyurethane arm pads

**Flex Seat**

High-resiliency molded urethane foam with textile cover and integrally colored, glass reinforced, impact modified nylon structure

**Controls**

A. Dynamic Suspension control

A solid state construction of integrally colored, high performance elastomer, glass reinforced polyester and cast zinc

B. Tilt preference selector

Integrally colored nylon and acetal; integrally colored, glass reinforced acetal

C. Seat depth adjustment mechanism

Steel plate with integrally colored polypropylene parts

**Pneumatic cylinder**

Steel

**Base**

Burnished cast aluminum or integrally colored, glass reinforced nylon; five star design

**Hard casters and glides**

Integrally colored nylon

**Soft casters**

Integrally colored nylon over molded with thermoplastic polyurethane

**Height adjustable lumbar**

Integrally colored, glass reinforced polycarbonate

**CLEANING INSTRUCTIONS**

**Hard surfaces and Flex Back Net**

**General cleaning**

Frequent vacuuming or light brushing to remove dust and grime is recommended. Spot clean with a mild upholstery shampoo or the foam from a mild detergent. When using a cleaning product, follow instructions carefully and clean only in a well-ventilated room. Avoid any product that contains carbon tetrachloride or other toxic materials. With any method, pretest a small area before proceeding. When an overall soiled conditioned has been reached, use a professional furniture cleaning service or call Knoll Field Service at 800-445-5045 with questions.

**Healthcare cleaning**

Generation's hard surfaces and Flex Back Net successfully passed third-party testing for the following five cleaning agents commonly used in healthcare facilities:

- Clorox Germicidal Liquid Bleach diluted 1:5 ratio to tap water (pH 3.7)
- Clorox Cleanup undiluted 100% solution (pH 9.7)
- Wex-Cide 128 Concentrate Phenolic Germicide by Wexford Labs diluted 1 ounce to 1 gallon tap water (pH 3.7)
- Formula 880 Quaternary Germicide by Grand Technologies diluted 1/2 ounce to 1 gallon tap water (pH 8.1)
- Hydroxi Pro Concentrate 128 by Core Products diluted 1:8 ratio to tap water (pH 7.2)

In addition to the testing detailed above, Knoll has conducted internal testing of Virox 5 RTU cleaning solution on Generation structural parts with no adverse effects.

**Generation Fabric**

Cleaning code W-S: water or solvent based cleaning agent; can be cleaned with low environmental impact cleaning fluids, including CS-37 certified products. See KnollTextiles Price List for further details on cleaning codes.

**ENVIRONMENTAL**

**SMaRT® Sustainable Platinum certified**

SMaRT® Consensus Sustainable Product Standard is a comprehensive, transparent sustainable product standard that measures a product's environmental, economic and social benefits over its life cycle and throughout its global supply chain, from raw materials extraction through use, reclamation or re-use. Generation can contribute to achieving a LEED® Innovation in Design credit for its SMaRT® certification.

**BIFMA level® 3 certified**

BIFMA has established level® as a common framework against which to evaluate the environmental and social responsibility of a variety of products. level® is part of BIFMA's ongoing development of voluntary product and industry standards that support safe, healthy and sustainable workplaces. To achieve level® certification, Knoll partners with Scientific Certification Systems (SCS), known for its integrity and scientific rigor.

**GREENGUARD certified**

Generation is GREENGUARD and GREENGUARD Gold certified and can contribute to achieving LEED® credits.

**Warranty:**

Generation by Knoll is warranted for 12 years, 24-hour, 7 days a week, multi shift use including the Flex Back Net, structural and operational parts, controls, casters, and pneumatic cylinders; 12 years parts and labor to repair; 3 years upholstery, finishes and labor to repair. See Knoll Selling Policy for further details, conditions and exclusions.

This page intentionally left blank.

# ReGeneration by Knoll®

## Flex Back Net work chair

	model	description	pattern no.
<p><i>Designer(s):</i> Formway Design, 2012</p> <p><i>Award(s):</i> GOOD DESIGN, Chicago Athenaeum, 2012, USA</p> 	armless	high performance elastomer suspension back, recline resistance feature, sliding seat, plastic base, standard cylinder, no optional lumbar, hard casters	<b>44-1-NA-2-S-X-HC</b>
	height adjustable	high performance elastomer suspension back, recline resistance feature, sliding seat, plastic base, standard cylinder, no optional lumbar, hard casters	<b>44-1-HA-2-S-X-HC</b>
	high performance	high performance elastomer suspension back, recline resistance feature, sliding seat, plastic base, standard cylinder, no optional lumbar, hard casters	<b>44-1-HP-2-S-X-HC</b>
	<b>REGENSEAT</b>	Replacement seat	<b>REGENSEAT</b>

list price	base grade	grades	COM	C	D	E	F	G	H	I	T	COL	V	W	X	Y
\$809.		A	B									U				
\$824.				C	D	E	F	G	H	I	T		V	W	X	Y
\$829.																
\$845.																
\$865.																
\$870.																
\$895.																
\$911.																
\$941.																
\$987.																
\$1,007.																
\$1,028.																
\$1,114.																
\$1,201.																
\$1,231.																
\$1,267.																
1,012.																
1,028.																
1,033.																
1,048.																
1,068.																
1,073.																
1,099.																
1,114.																
1,145.																
1,190.																
1,211.																
1,231.																
1,318.																
1,404.																
1,435.																
1,470.																
1,114.																
1,129.																
1,135.																
1,150.																
1,170.																
1,175.																
1,201.																
1,216.																
1,246.																
1,292.																
1,313.																
1,333.																
1,419.																
1,506.																
1,536.																
1,572.																
198.																
214.																
219.																
234.																
254.																
259.																
285.																
300.																
331.																
376.																
397.																
417.																
504.																
590.																
621.																
656.																

Order Code	Ordering Information	Options
<p><i>Example:</i> <b>44-1-HP-2-S-X-HC-DK-09-USF-RU01</b></p> <p><b>44</b> ReGeneration by Knoll</p> <p><b>1</b> Flex Back Net model</p> <p><b>HP</b> High performance arms</p> <p><b>2</b> Plastic base</p> <p><b>S</b> Standard cylinder</p> <p><b>X</b> No optional lumbar</p> <p><b>HC</b> Hard casters for soft floors</p> <p><b>DK</b> Dark finish</p> <p><b>09</b> Onyx Flex Back Net color</p> <p><b>USF</b> Ultra seat foam</p> <p><b>RU01</b> Generation Fabric, Storm</p>	<p><i>Specify:</i></p> <ol style="list-style-type: none"> <li>1. Pattern number</li> <li>2. Finish color</li> <li>3. Flex Back Net color</li> <li>4. Seat foam</li> <li>5. Seat textile</li> </ol> <p><b>Options</b></p> <p><i>Polished Aluminum Base:</i> Replace 2 in pattern with 4</p> <p><i>Code: Upchg: Description:</i> 4 \$71 polished aluminum base</p> <p><i>Cylinder Height Options:</i> For height ranges see ReGeneration Dimensions page. Replace S in pattern with one of the following:</p> <p><i>Code: Description:</i> L low cylinder H high cylinder</p>	<p><i>Lumbar Option:</i> For optional lumbar, replace X in pattern with L</p> <p><i>Code: Upchg: Description:</i> L \$51 lumbar support</p> <p><i>Note:</i> To order a lumbar separately, use pattern number 44LUMBAR. The list price is \$51.</p> <p><i>Casters and Glides:</i> Replace HC in pattern with one of the following:</p> <p><i>Code: Upchg: Description:</i> SC \$41 soft casters for hard floors GL n/c glides</p> <p><i>Finish Color:</i> <i>Code: Description:</i> DK Dark finish</p>

Generation Fabric - Base Grade	Textile Options
<p>Generation Fabric prefix RT for thin seat foam or RU for ultra seat foam, followed by two digit color code. Select one of the following:</p> <p><i>Code: Description:</i></p> <p>01 Storm</p> <p>03 Pebble</p> <p>04 Desert</p> <p>05 Lemongrass</p> <p>06 Espresso</p> <p>07 Firecracker</p> <p>08 Bluemarine</p> <p>09 Onyx</p> <p>10 Olive</p>	<p><i>Knoll Textiles fabrics and Spinneybeck leathers:</i> Please refer to the textile matrices at the beginning of the price list for approved fabrics and leathers.</p> <p><i>Customer's Own Material/Leather:</i> See Customer's Own Material Seating Process Overview at the beginning of the price list</p> <p>COM/COL Textile Requirements For both thin and ultra seat foam:</p> <p>COM seat = .7 yards COL seat = 11 square feet</p>

ReGeneration by Knoll®  
fully upholstered work chair

	model	description	pattern no.
<p><i>Designer(s):</i> Formway Design, 2012</p> <p><i>Award(s):</i> GOOD DESIGN, Chicago Athenaeum, 2012, USA</p> 	armless	full upholstery over a high performance elastomer suspension back, recline resistance feature, sliding seat, plastic base, standard cylinder, hard casters	<b>44-2-NA-2-S-X-HC</b>
	height adjustable	full upholstery over a high performance elastomer suspension back, recline resistance feature, sliding seat, plastic base, standard cylinder, hard casters	<b>44-2-HA-2-S-X-HC</b>
	high performance	full upholstery over a high performance elastomer suspension back, recline resistance feature, sliding seat, plastic base, standard cylinder, hard casters	<b>44-2-HP-2-S-X-HC</b>
	<b>REGENSEAT</b>	Replacement seat	<b>REGENSEAT</b>





list price	base grade	grades	COM	C	D	E	F	G	H	I	T	COL	U	V	W	X	Y
\$962.		A	B														
1,165.	1,196.	1,226.	1,257.	1,277.	1,287.	1,338.	1,369.	1,430.	1,521.	1,531.	1,562.	1,582.	1,653.	1,694.	1,750.	1,852.	1,950.
1,267.	1,297.	1,328.	1,358.	1,379.	1,389.	1,440.	1,470.	1,531.	1,623.	1,633.	1,664.	1,684.	1,755.	1,796.	1,852.	1,950.	2,050.
198.	214.	219.	234.	254.	259.	285.	300.	331.	376.	397.	417.	504.	590.	621.	656.	700.	750.

Order Code	Ordering Information	Options	Generation Fabric - Base Grade
<i>Example:</i> <b>44-2-HP-2-S-X-HC-DK-USF-RU09-RB09-ROB09</b>	<i>Specify:</i>	<i>Casters and Glides:</i>	Generation Fabric prefix RT for thin seat foam or RU for ultra seat foam, RB for inner back textile, and ROB for outer back textile, followed by two digit color code. Select one of the following:
<b>44</b> ReGeneration by Knoll	1. Pattern number	<i>Code: Upchg: Description:</i>	<i>Code: Description:</i>
<b>2</b> Fully upholstered back	2. Finish color	SC \$41 soft casters for hard floors	01 Storm
<b>HP</b> High performance arms	3. Seat foam	GL n/c glides	03 Pebble
<b>2</b> Plastic base	4. Seat textile		04 Desert
<b>S</b> Standard cylinder	5. Inner back textile		05 Lemongrass
<b>X</b> No optional lumbar	6. Outer back Generation Fabric color		06 Espresso
<b>HC</b> Hard casters for soft floors			07 Firecracker
<b>DK</b> Dark finish	<b>Options</b>	<i>Finish Color:</i>	08 Bluemarine
<b>USF</b> Ultra seat foam	<i>Polished Aluminum Base:</i>	<i>Code: Description:</i>	09 Onyx
<b>RU09</b> Seat textile in Generation Fabric, Storm	Replace 2 in pattern with 4	DK Dark finish	10 Olive
<b>RB09</b> Inner back textile in Generation Fabric, Storm	<i>Code: Upchg: Description:</i>		
<b>ROB09</b> Outer back in Generation Fabric, Storm	4 \$71 polished aluminum base	<i>Seat Foam Options:</i>	
		Select one of the following:	
	<i>Cylinder Height Options:</i>	<i>Code: Description:</i>	
	For height ranges see ReGeneration Dimensions page. Replace S in pattern with one of the following:	TSF thin seat foam	
		USF ultra seat foam (default)	
<i>Example for Cal 133:</i>			
<b>44-2-HP-2-S-X-HC-DK-USF-C-RU09/133-RB09/133-ROB09</b>	<i>Code: Description:</i>		
	L low cylinder		
	H high cylinder		

Textile Options
<i>Knoll Textiles fabrics and Spinneybeck leathers:</i> Please refer to the textile matrices at the beginning of the price list for approved fabrics and leathers for the seat and inner back.
<i>Split upholstery:</i> ReGeneration seats and inner backs can be upholstered in any two approved fabrics or leathers. The list price of the chair equals the list price of the higher of the two upholstery grades.
<i>Customer's Own Material/Leather:</i> See Customer's Own Material Seating Process Overview at the beginning of the price list  COM/COL Textile Requirements  COM seat (TSF and USF) = .7 yards COM inner back = 1.2 yards COL seat (TSF and USF) = 11 square feet COL inner back = 14 square feet
<i>Cal 133:</i> See textile matrices at the beginning of the price list for pre-approved Cal 133 textiles. ♣ = Cal 133 pre-approved  To specify, insert C before textile selections and 133 after the seat and inner back textile codes. <i>Code: Upchg: Description:</i> C()133 \$102 Cal 133 compliant

# ReGeneration by Knoll®

## Flex Back Net high task chair

model	description	pattern no.
<p><i>Designer(s):</i> Formway Design, 2012</p> <p><i>Award(s):</i> GOOD DESIGN, Chicago Athenaeum, 2012, USA</p> 	<p>armless</p> <p>high performance elastomer suspension back, sliding seat, plastic base, high task cylinder, no optional lumbar, hard casters</p> 	<p><b>44-1-NA-2-T-X-HC</b></p> <p><b>Essentials 4wk delivery available:</b> limited finishes and quantities may apply, refer to Essentials CAP.</p>
<p>height adjustable</p> 	<p>high performance elastomer suspension back, sliding seat, plastic base, high task cylinder, no optional lumbar, hard casters</p>	<p><b>44-1-HA-2-T-X-HC</b></p> <p><b>Essentials 4wk delivery available:</b> limited finishes and quantities may apply, refer to Essentials CAP.</p>
<p>high performance</p> 	<p>high performance elastomer suspension back, sliding seat, plastic base, high task cylinder, no optional lumbar, hard casters</p>	<p><b>44-1-HP-2-T-X-HC</b></p> <p><b>Essentials 4wk delivery available:</b> limited finishes and quantities may apply, refer to Essentials CAP.</p>
<b>REGENSEAT</b>	Replacement seat	<b>REGENSEAT</b>
		<b>Essentials 4wk delivery available:</b> limited finishes and quantities may apply, refer to Essentials CAP.

list price	base grade	grades	COM	C	D	E	F	G	H	I	T	COL	V	W	X	Y
\$972.		A	B									U				
\$987.	\$987.															
\$992.	\$1,007.	\$1,028.	\$1,033.	\$1,058.	\$1,073.	\$1,104.	\$1,150.	\$1,170.	\$1,190.	\$1,277.	\$1,363.	\$1,394.	\$1,430.			
1,175.	1,190.	1,196.	1,211.	1,231.	1,236.	1,262.	1,277.	1,307.	1,353.	1,374.	1,394.	1,480.	1,567.	1,597.	1,633.	
1,277.	1,292.	1,297.	1,313.	1,333.	1,338.	1,363.	1,379.	1,409.	1,455.	1,475.	1,496.	1,582.	1,669.	1,699.	1,735.	
198.	214.	219.	234.	254.	259.	285.	300.	331.	376.	397.	417.	504.	590.	621.	656.	





Order Code	Ordering Information	Options
<i>Example:</i> <b>44-1-HP-2-T-X-HC-DK-09-USF-RU01</b>	<i>Specify:</i>	<i>Lumbar Option:</i>
<b>44</b> ReGeneration by Knoll	1. Pattern number	For optional lumbar, replace X in pattern with L
<b>1</b> Flex Back Net model	2. Finish color	
<b>HP</b> High performance arms	3. Flex Back Net color	<i>Code: Upchg: Description:</i>
<b>2</b> Plastic base	4. Seat foam	L \$51 lumbar support
<b>T</b> High task cylinder	5. Seat textile	
<b>X</b> No optional lumbar		<i>Note:</i>
<b>HC</b> Hard casters for soft floors		To order a lumbar separately, use pattern number 44LUMBAR. The list price is \$51.
<b>DK</b> Dark finish	<b>Options</b>	
<b>09</b> Onyx Flex Back Net color	<i>Polished Aluminum Base:</i>	<i>Casters and Glides:</i>
<b>USF</b> Ultra seat foam	Replace 2 in pattern with 4	Replace HC in pattern with one of the following:
<b>RU01</b> Generation Fabric, Storm	<i>Code: Upchg: Description:</i>	<i>Code: Upchg: Description:</i>
	4 \$71 polished aluminum base	SC \$41 soft casters for hard floors
		GL n/c glides
<i>Example for Cal 133:</i>	<b>Essentials 4wk</b>	<i>Finish Color:</i>
<b>44-1-HP-4-S-X-HC-DK-01-USF-C-K448/12-133</b>	Indicates select products available for 4-week delivery on Knoll Essentials program. Limited finishes, options and quantities may apply - refer to CAP.	<i>Code: Description:</i>
		DK Dark finish

Textile Options
<p>Generation Fabric prefix RT for thin seat foam or RU for ultra seat foam, followed by two digit color code. Select one of the following:</p> <p><i>Code: Description:</i></p> <p>01 Storm</p> <p>03 Pebble</p> <p>04 Desert</p> <p>05 Lemongrass</p> <p>06 Espresso</p> <p>07 Firecracker</p> <p>08 Bluemarine</p> <p>09 Onyx</p> <p>10 Olive</p>
<p><i>Knoll Textiles fabrics and Spinneybeck leathers:</i></p> <p>Please refer to the textile matrices at the beginning of the price list for approved fabrics and leathers.</p> <p><i>Customer's Own Material/Leather:</i></p> <p>See Customer's Own Material Seating Process Overview at the beginning of the price list</p> <p>COM/COL Textile Requirements</p> <p>For both thin and ultra seat foam:</p> <p>COM seat = .7 yards</p> <p>COL seat = 11 square feet</p>
<p><i>Cal 133:</i></p> <p>See textile matrices at the beginning of the price list for pre-approved Cal 133 textiles.</p> <p>♣ = Cal 133 pre-approved</p> <p>To specify, insert C before seat textile selection and 133 after it</p> <p><i>Code: Upchg: Description:</i></p> <p>C()133 \$51 Cal 133 compliant</p>



# ReGeneration by Knoll®

fully upholstered high task chair

model	description	pattern no.
<p><i>Designer(s):</i> Formway Design, 2012</p> <p><i>Award(s):</i> GOOD DESIGN, Chicago Athenaeum, 2012, USA</p> 	<p>armless</p>  <p>full upholstery over a high performance elastomer suspension back, sliding seat, plastic base, high task cylinder, hard casters</p>	<b>44-2-NA-2-T-X-HC</b>
<p>height adjustable</p> 	<p>full upholstery over a high performance elastomer suspension back, sliding seat, plastic base, high task cylinder, hard casters</p>	<b>44-2-HA-2-T-X-HC</b>
<p>high performance</p> 	<p>full upholstery over a high performance elastomer suspension back, sliding seat, plastic base, high task cylinder, hard casters</p>	<b>44-2-HP-2-T-X-HC</b>
<b>REGENSEAT</b>	Replacement seat	<b>REGENSEAT</b>

list price base grade	grades A	COM B	C	D	E	F	G	H	I	T	COL U	V	W	X	Y
\$1,124.	\$1,155.	\$1,185.	\$1,216.	\$1,236.	\$1,246.	\$1,297.	\$1,328.	\$1,389.	\$1,480.	\$1,491.	\$1,521.	\$1,542.	\$1,613.	\$1,653.	\$1,709.
1,328.	1,358.	1,389.	1,419.	1,440.	1,450.	1,501.	1,531.	1,592.	1,684.	1,694.	1,725.	1,745.	1,816.	1,857.	1,913.
1,430.	1,460.	1,491.	1,521.	1,542.	1,552.	1,603.	1,633.	1,694.	1,786.	1,796.	1,826.	1,847.	1,918.	1,959.	2,015.
198.	214.	219.	234.	254.	259.	285.	300.	331.	376.	397.	417.	504.	590.	621.	656.

Order Code	Ordering Information	Options	Generation Fabric - Base Grade
<i>Example:</i> <b>44-2-HP-2-T-X-HC-DK-USF-RU09-RB09-ROB09</b>	<i>Specify:</i>	<i>Casters and Glides:</i>	Generation Fabric prefix RT for thin seat foam or RU for ultra seat foam, RB for inner back textile, and ROB for outer back textile, followed by two digit color code. Select one of the following:
<b>44</b> ReGeneration by Knoll	1. Pattern number	<i>Code: Description:</i>	<i>Code: Description:</i>
<b>2</b> Fully upholstered back	2. Finish color	SC \$41 soft casters for hard floors	01 Storm
<b>HP</b> High performance arms	3. Seat foam	GL n/c glides	03 Pebble
<b>2</b> Plastic base	4. Seat textile		04 Desert
<b>T</b> High task cylinder	5. Inner back textile		05 Lemongrass
<b>X</b> No optional lumbar	6. Outer back Generation Fabric color		06 Espresso
<b>HC</b> Hard casters for soft floors			07 Firecracker
<b>DK</b> Dark finish	<b>Options</b>	<i>Finish Color:</i>	08 Bluemarine
<b>USF</b> Ultra seat foam	<i>Polished Aluminum Base:</i>	<i>Code: Description:</i>	09 Onyx
<b>RU09</b> Seat textile in Generation Fabric, Storm	Replace 2 in pattern with 4	DK Dark finish	10 Olive
<b>RB09</b> Inner back textile in Generation Fabric, Storm	<i>Code: Upchg: Description:</i>	<i>Seat Foam Options:</i>	
<b>ROB09</b> Outer back in Generation Fabric, Storm	4 \$71 polished aluminum base	Select one of the following:	
		<i>Code: Description:</i>	
		TSF thin seat foam	
		USF ultra seat foam (default)	

Textile Options			
<p><i>KnollTextiles fabrics and Spinneybeck leathers:</i> Please refer to the textile matrices at the beginning of the price list for approved fabrics and leathers for the seat and inner back.</p> <p>Note: ReGeneration outer back can only be upholstered with Generation Fabric.</p>	<p><i>Split upholstery:</i> ReGeneration seats and inner backs can be upholstered in any two approved fabrics or leathers. The list price of the chair equals the list price of the higher of the two upholstery grades.</p>	<p><i>Customer's Own Material/Leather:</i> See Customer's Own Material Seating Process Overview at the beginning of the price list</p> <p>COM/COL Textile Requirements</p> <p>COM seat (TSF and USF) = .7 yards COM inner back = 1.2 yards COL seat (TSF and USF) = 11 square feet COL inner back = 14 square feet</p>	<p><i>Cal 133:</i> See textile matrices at the beginning of the price list for pre-approved Cal 133 textiles. ▲ = Cal 133 pre-approved</p> <p>To specify, insert C before textile selections and 133 after the seat and inner back textile codes.</p> <p><i>Code: Upchg: Description:</i> C()133 \$102 Cal 133 compliant</p>

*Example for Cal 133:*  
**44-2-HP-2-S-X-HC-DK-USF-C-RU09/133-RB09/133-ROB09**

## ReGeneration by Knoll Ergonomic Dimensions

Seat*	Thin Seat Foam	Ultra Seat Foam
Seat Height	15" - 19.7" (low cylinder) 16.4" - 21.6" (standard cylinder) 18" - 23.2" (high cylinder) 22" - 30.8" (high task)	15.3" - 20" (low cylinder) 16.7" - 21.9" (standard cylinder) 18.3" - 23.5" (high cylinder) 22.2" - 31" (high task)
Seat Depth (Adjustable)	16" - 18"	16" - 18"
Seat Width	19.7"	19.7"
Seat Pan Angle (Fixed)	2° rearward at rest	3° rearward at rest
Seat Pan Angle (Adjustable)	2° - 6° rearward during recline	3° - 7° rearward during recline
Back*	Flex Back Net	Fully upholstered
Backrest Height	23.1"	23.1"
Backrest Width	19.9"	19.9"
Lumbar Support (Fixed)	8.5"	8.5"
Lumbar Support (Adjustable)	8.9"	n/a
Angle between Seat and Back	95° (work and high task chairs)	96° (work and high task chairs)
Tilt Range of Back	15° (work chair); 4° (high task chair)	15° (work chair); 4° (high task chairs)
Arms*	Thin Seat Foam	Ultra Seat Foam
Armrest Height from Seat (Adjustable)	6.8" - 10.8" height adjustable arms 6.6" - 10.8" high performance arms	6.5" - 10.5" height adjustable arms 6.3" - 10.5" high performance arms
Inside Distance between Armrests (Fixed)	19.7" height adjustable arms	19.7" height adjustable arms
Inside Distance between Armrests (Adjustable)	16" - 20" high performance arms	16" - 20" high performance arms

\* All measurements taken with the BIFMA Chair Measuring Device using the Universal Measurement Procedure which has a measurement uncertainty of ± 5%

## ReGeneration by Knoll Chair Measurements\*\*

A. Overall Height	38.1" - 43.3" with standard cylinder 43.5" - 52.3" with high task cylinder (add 0.4" for aluminum base)
B. Overall Width	26" armless 28.5" with height adjustable arms 29" with high performance arms
C. Overall Depth	24.6" excluding base
D. Arm Height from Floor	22.9" - 32.1" (work chair, height adjustable arms) 22.5" - 31.9" (work chair, high performance arms) 28.3" - 40.9" (high task chair, height adjustable arms) 27.9" - 40.7" (high task chair, high performance arms) (add 0.4" for aluminum base)
E. Base Diameter	26"
Weight	27 lbs. (height adjustable arms), 28 lbs. (high performance arms) (aluminum base adds 2 lbs., upholstered back option adds 3 lbs., high task chair adds 4.8 lbs.)

\*\* Flex Back Net, standard cylinder, plastic base

## ReGeneration by Knoll Performance Information

Synchronized recline ratio seat: back is 1° : 6°	High task footing measures 18" in diameter
High performance arm pads measure 8.2" long x 3.8" wide	Height adjustable arm pads measure 6.25" long x 3.4" wide
High performance arm pads adjust 4" in width (2" per arm), 1.75" in depth and pivot 30.5° (20° inward, 10.5° outward)	

Compliance: ANSI/BIFMA X5.1 : 2011 (U.S. structural standard)  
ANSI/HFES 100-2007 (U.S. ergonomic standard)  
BIFMA G1 : 2013 (U.S. ergonomic guidelines)  
EN 1335-1 : 2000 (Europe ergonomic standard) for Flex Back armless work chair  
AS/NXS 4438 : 1997 Level 6 (Australia, New Zealand structural and dimensional standard) for Flex Back armless work chair  
California T.B. 117 (U.S. flammability standard for foam)  
California T.B. 133 with approved FR textile (U.S. flammability standard for full chair)

The ReGeneration by Knoll work chair has been tested and is approved for use by individuals weighing up to 300 pounds.

## ReGeneration by Knoll® Features and Operating Instructions

### No Adjustment Necessary



#### Flex Back Net

Sit back and the Flex Back Net cradles your back, providing integral lumbar support. Optional fully upholstered back provides the additional comfort of foam and fabric over the Flex Back Net.

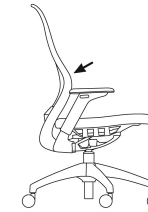

#### Slim profile back

The contoured frame provides continuous support, following the curves of your shoulders, back and lumbar.

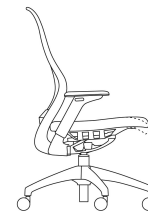

#### Flex Seat

Sit in any position—forward, sideways or perched—and the Flex Seat supports you with 270° of seat edge flex.

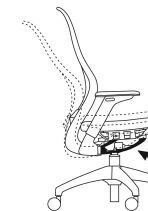

#### Dynamic Suspension control

The synchronized recline counterbalances your body weight for a smooth and effortless ride. Four independent flexors act as suspension devices that respond to your multidirectional movements—forward, backward and side-to-side.

### Intuitive Adjustments (Standard)

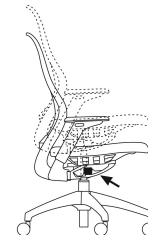

#### Seat height

Lift the right lever. Sit down to lower the seat or remove your weight to raise it. Release the lever to lock.

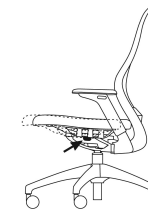

#### Seat depth

To adjust the seat depth while sitting on the chair, lift the left lever and slide the seat to the desired location. Release the lever to lock.

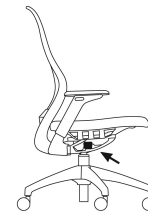

#### Recline resistance

Sit fully upright. Push the right lever backward for the full range of recline, or pull it forward for upright support.

### Performance Options

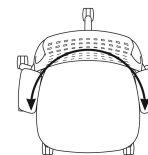

#### Arm options

Set-back arm supports provide clearance for your legs and feature Continuous Lumbar, so your back is supported when side sitting.

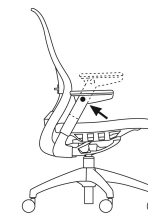

#### Height adjustable arm

To adjust the height, push the button on the arm. Slide the arm to the desired position and release the button to lock.

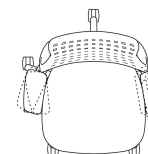

#### High performance arm

To adjust the height, lift the lever on the arm. Slide the arm to the desired position and release the lever to lock. Free float arm pads easily move in width and depth and pivot.

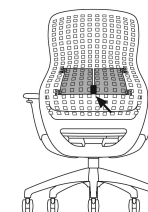

#### Adjustable lumbar

(Flex Back Net model only)  
Grasp the lever at the center of the outer back and slide it to the desired position.

**CONSTRUCTION INFORMATION**

**Slim profile back support**

Integrally colored, rapidly-renewable, high performance elastomer with postconsumer recycled content polyester structure; optional biobased urethane foam upholstery with glass reinforced nylon and ABS substrates and sewn textile cover

**Adjustable arm supports**

Integrally colored, glass reinforced, post consumer recycled content polyester structure

**Arm pads**

Integrally colored, self skinning polyurethane

**Flex Seat**

High-resiliency molded biobased foam with sewn textile cover and integrally colored, glass reinforced, impact modified nylon seat structure

**Controls**

A. Dynamic Suspension control  
A solid state construction of integrally colored, high performance elastomer, glass reinforced and cast aluminum

B. Adjustment levers. Integrally colored, glass reinforced nylon

C. Seat depth adjustment plate  
Integrally colored, glass reinforced, nylon

**Pneumatic cylinder**

Steel

**Base**

Integrally colored, glass reinforced nylon with cast zinc insert or polished, cast aluminum; five star design

**Hard casters**

Integrally colored nylon and steel

**Soft casters**

Integrally colored nylon over molded with polyurethane, and steel

**Glides**

Integrally colored nylon

**Optional adjustable lumbar**

Frosted clear polyester blend

**Footring**

Steel footring, aluminum die cast spokes and rubber fit ring

**Generation Fabric**

100% polyester; 100,000+ double rubs, Wyzenbeek method; Oeko-Tex certified for human safety; Greenguard Indoor Air Quality Certified®

**CLEANING INSTRUCTIONS**

**Hard surfaces and Flex Back Net**

**General cleaning**

Frequent vacuuming or light brushing to remove dust and grime is recommended. Spot clean with a mild upholstery shampoo or the foam from a mild detergent. When using a cleaning product, follow instructions carefully and clean only in a well-ventilated room. Avoid any product that contains carbon tetrachloride or other toxic materials. With any method, pretest a small area before proceeding. When an overall soiled conditioned has been reached, use a professional furniture cleaning service or call Knoll Field Service at 800-445-5045 with questions.

**Healthcare cleaning**

ReGeneration’s hard surfaces and Flex Back Net successfully passed third-party testing for the following five cleaning agents commonly used in healthcare facilities:

- Clorox Germicidal Liquid Bleach diluted 1:5 ratio to tap water (pH 3.7)
- Clorox Cleanup undiluted 100% solution (pH 9.7)
- Wexcide 128 Concentrate Phenolic Germicide by Wexford Labs diluted 1 ounce to 1 gallon tap water (pH 3.7)
- Formula 880 Quaternary Germicide by Grand Technologies diluted ½ ounce to 1 gallon tap water (pH 8.1)
- Hydroxi Pro Concentrate 128 by Core Products diluted 1:8 ratio to tap water (pH 7.2)

In addition to the testing detailed above, Knoll has conducted internal testing of Virox 5 RTU cleaning solution on ReGeneration structural parts with no adverse effects.

**Generation Fabric**

Fabric with cleaning codes W or W-S are designed to be cleaned with low environmental impact cleaning fluids, including GS-37 certified products. See KnollTextiles Price List for further details on cleaning codes.

**ENVIRONMENTAL**

**SMaRT® Sustainable Platinum certified**

SMaRT® Consensus Sustainable Product Standard is a comprehensive, transparent sustainable product standard that measures a product’s environmental, economic and social benefits over its life cycle and throughout its global supply chain, from raw materials extraction through use, reclamation or re-use. ReGeneration can contribute to achieving a LEED® Innovation in Design credit for its SMaRT® certificaton.

**BIFMA level® 3 certified** BIFMA has established level® as a common framework against which to evaluate the environmental and social responsibility of a variety of products. level® is part of BIFMA’s ongoing development of voluntary product and industry standards that support safe, healthy and sustainable workplaces. To achieve level® certification, Knoll partners with Scientific Certification Systems (SCS), known for its integrity and scientific rigor.

**GREENGUARD certified**

ReGeneration is GREENGUARD and GREENGUARD Gold certified and can contribute to achieving LEED® credits.

**Oeko-Tex certified**

Generation Fabric is certified by the international third party Oeko-Tex for human safety







**WARRANTY**

ReGeneration by Knoll is warranted for 24-hour, 7 days a week, multi shift use: 12 years parts and labor to repair; 3 years seating upholstery, textiles and leathers, and finishes. See Knoll Selling Policy for further details, conditions and exclusions.

This page intentionally left blank.

# MultiGeneration by Knoll®

## multipurpose chair

	model	description	pattern no.
<i>Designer(s):</i> Formway Design, 2010  <i>Award(s):</i> Chicago Athenaeum, GOOD DESIGN Award, 2010	stacking armless	armless stacking chair with glides	<b>2-S-C-N-X-GL</b>
			
	stacking arm	stacking chair with fixed arms and glides	<b>2-S-A-N-X-GL</b>
			
	hybrid armless	armless hybrid chair with glides	<b>2-H-C-N-X-GL</b>
			
	hybrid arm	hybrid chair with fixed arms and glides	<b>2-H-A-N-X-GL</b>
			
	upholstered seat	upholstered seat option (replace N in pattern with S)	<b>S</b>
	2SDOLLY	dolly to transport up to 10 stacking chairs	<b>2SDOLLY</b>
	2SGA	ganging clip to connect armless stacking chairs	<b>2SGA</b>
	2SEAT	seat reupholstery assembly	<b>2SEAT</b>

Stacking chair shown top,  
Hybrid chair shown bottom

list price non-upholstered	base grade	A	COM B	C	D	E	F	G	H	I
\$276.										
333.										
444.										
499.										
	111.	137.	152.	164.	180.	195.	216.	223.	264.	286.
390.										
7.										
	150.	175.	189.	202.	218.	233.	254.	261.	301.	324.

Order Code	Ordering Information	Options
<i>Example:</i> <b>2-H-A-S-X-HC 2 ON GENF09</b>	<i>Specify:</i> 1. Pattern number 2. Frame finish 3. Shell color 4. Seat upholstery fabric (if applicable)	<i>Tablet arm (2SC - models only, assembly required):</i>  For flip up tablet arm, replace C in pattern with L for left-handed tablet or R for right-handed tablet. Tablet arm surface is grey with black edgeband. Tablet arm support rod will match frame finish selected.  <b>Note:</b> Chairs with tablet arms do not stack. Assembly required. Visit Knoll.com for installation instructions. Seller not responsible for assembly costs.
<b>2</b>	MultiGeneration by Knoll	
<b>H</b>	hybrid chair	
<b>A</b>	fixed arms	
<b>S</b>	upholstered seat pad	
<b>X</b>	no book basket	
<b>HC</b>	hard casters	
<b>2</b>	Black frame finish	
<b>ON</b>	Onyx shell color	
<b>GENF09</b>	Generation Fabric, Onyx	
<i>Example for Cal 133:</i> <b>2-H-A-S-X-HC 2 ON C (GENF09)133</b>		
	<i>Code: Upchg: Description:</i> L \$208 Left-handed tablet arm chair R \$208 Right-handed tablet arm chair	<i>Book basket (2S- models only):</i> Replace X in pattern with B.  <b>Note:</b> Chairs with book basket do not stack.  <i>Code: Upchg: Description:</i> B \$83 Book basket, Silver finish  <i>Caster Options:</i> Replace GL in pattern with one of the following:  <i>Code: Upchg: Description:</i> HC \$32 hard casters for soft floors SC \$32 soft casters for hard floors

Finish Options	Generation Fabric - Base Grade	Fabric Options
<i>Frame finishes:</i> Select one of the following  <i>Code: Upchg: Description:</i> 2 n/c Black 3 n/c Metallic Grey 4 n/c Silver C \$208 Chrome (2H- models only)	<i>Seat pad fabric colors:</i> Use prefix GENF following by the two digit color code. Select one of the following:  <i>Code: Description:</i> 01 Storm (dark grey) 03 Pebble (medium grey) 04 Desert (beige) 05 Lemongrass (green) 06 Espresso (brown) 07 Firecracker (red) 08 Bluemarine (blue) 09 Onyx (black) 10 Olive (dark green)	<i>KnollTextiles fabrics:</i> Please refer to the textile matrices at the beginning of the price list for approved fabrics.  <i>Customer's Own Material:</i> See Customer's Own Material Seating Process Overview at the beginning of the price list  ♣ = Cal 133 pre-approved  COM Requirements: fabric .65 yards  <i>Cal 133:</i> MultiGeneration is Cal 133 compliant standard when non-upholstered. For upholstered seat chairs, an upcharge is required. See textile matrix at the beginning of the price list for pre-approved Cal 133 fabrics.  ♣ = Cal 133 pre-approved  To specify, insert C before seat fabric selection and 133 after it.  <i>Code: Upchg: Description:</i> C()133 \$ 52 Cal 133 compliant fabric
<i>Shell colors:</i> Select one of the following  <i>Code: Upchg: Description:</i> RD n/c Dark Red YW n/c Yellow WH n/c Off White GY n/c Grey DG n/c Dark Grey ON n/c Onyx (black)		

# MultiGeneration by Knoll® stools

Designer(s):  
Formway Design, 2015



Bar-height stool

model	description	pattern no.
counter-height stool	armless counter-height stool	<b>2-C-C-N-X</b>
bar-height stool	armless bar-height stool	<b>2-B-C-N-X</b>
upholstered seat	upholstered seat option (replace N in pattern with S)	<b>S</b>
2SEAT	seat reupholstery assembly	<b>2SEAT</b>

list price non-upholstered	base grade	A	COM B	C	D	E	F	G	H	I
\$600.										
600.										
	111.	137.	152.	164.	180.	195.	216.	223.	264.	286.
	150.	175.	189.	202.	218.	233.	254.	261.	301.	324.

Order Code	Ordering Information	Finish Options	Generation Fabric - Base Grade
<i>Example:</i> <b>2-B-C-S-X 2 ON GENF09</b>	<i>Specify:</i>	<i>Frame finishes:</i>	<i>Seat pad fabric colors:</i>
<b>2</b> MultiGeneration by Knoll	1. Pattern number	Select one of the following	Use prefix GENF following by the two digit color code. Select one of the following:
<b>B</b> bar-height stool	2. Frame finish	<i>Code: Upchg: Description:</i>	<i>Code: Description:</i>
<b>C</b> armless	3. Shell color	2 n/c Black	01 Storm (dark grey)
<b>S</b> upholstered seat pad	4. Seat upholstery fabric (if applicable)	3 n/c Metallic Grey	03 Pebble (medium grey)
<b>X</b> no book basket		4 n/c Silver	04 Desert (beige)
<b>2</b> Black frame finish			05 Lemongrass (green)
<b>ON</b> Onyx shell color		<i>Shell colors:</i>	06 Espresso (brown)
<b>GENF09</b> Generation Fabric, Onyx		Select one of the following	07 Firecracker (red)
		<i>Code: Upchg: Description:</i>	08 Bluemarine (blue)
		RD n/c Dark Red	09 Onyx (black)
		YW n/c Yellow	10 Olive (dark green)
		WH n/c Off White	
		GY n/c Grey	
		DG n/c Dark Grey	
		ON n/c Onyx	
<i>Example for Cal 133:</i>			
<b>2-B-C-S-X 2 ON C (GENF09)133</b>			

Fabric Options
<i>KnollTextiles fabrics:</i> Please refer to the textile matrices at the beginning of the price list for approved fabrics.
<i>Customer's Own Material:</i> See Customer's Own Material Seating Process Overview at the beginning of the price list
COM Requirements: fabric .65 yards
<i>Cal 133:</i> MultiGeneration is Cal 133 compliant standard when non-upholstered. For upholstered seat chairs, an upcharge is required. See textile matrix at the beginning of the price list for pre-approved Cal 133 fabrics.  ‡ = Cal 133 pre-approved  To specify, insert C before seat fabric selection and 133 after it.  <i>Code: Upchg: Description:</i> C()133 § 52 Cal 133 compliant fabric



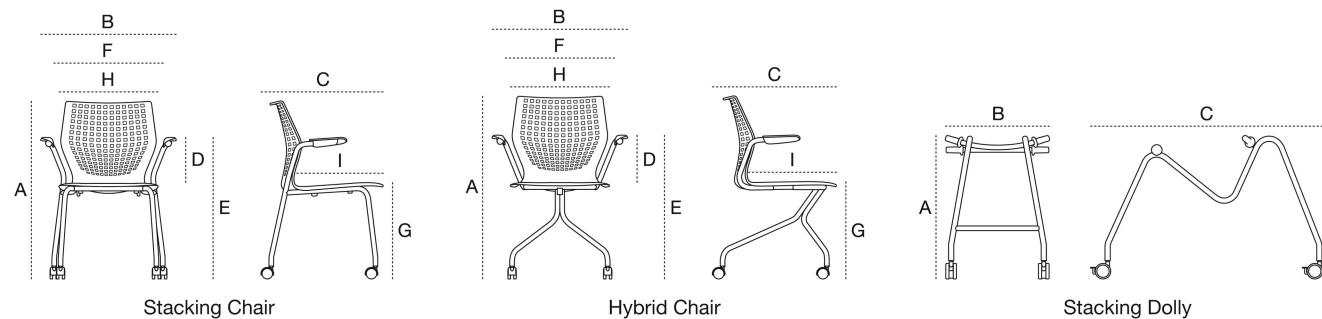

**MultiGeneration Chair Measurements \***

	Stacking Chair	Hybrid Chair	Stacking Dolly
A. Overall Height	33.6"	33.9"	27.1"
B. Overall Width	21.6" armless / 25.6" fixed arm	20.5" armless / 25.6" fixed arm	19.7"
C. Overall Depth	21.4"	21.9"	43.8"
D. Arm Height from Seat	9.1" non-upholstered / 8.8" upholstered seat	9.1" non-upholstered / 8.8" upholstered seat	n/a
E. Arm Height from Floor	26.8"	26.9"	n/a
F. Inside Distance between Arm Rests	20.8"	20.8"	n/a
G. Seat Height	17.3" non-upholstered / 17.6" upholstered seat	17.3" non-upholstered / 17.6" upholstered seat	n/a
H. Seat Width	18.1"	18.1"	n/a
I. Seat Depth	16.3"	16.3"	n/a
Book basket	6.7" height, 11.5" width, 11.8" depth, 9.2" from floor		
Tablet arm	21" length, 14.5" width, 0.5" thick		
Weight	12 lbs. armless; 15 lbs. fixed arm Seat upholstery adds 2 lbs. Book basket adds 1 lb.; can hold 20 lbs. Tablet arm assembly adds 9 lbs. to armless chair; can hold 150 lbs.	17.5 lbs. armless; 23.5 lbs. fixed arm Seat upholstery adds 1.5 lbs.	16.1 lbs.

\* All measurements taken with BIFMA Chair Measuring Device using the Universal Measurement Procedure which has a measurement uncertainty of ± 5%

**Stacking Instructions**

Stacking chairs—with or without fixed arms and with or without casters—stack up to 6 units high on the floor. Stacked 6 high on the floor measures 41.8" high non-upholstered or 42.6" high upholstered.

To stack chairs, place the rear legs of the top chair in front of the rear legs of the bottom chair and set the top chair down on the bottom chair.

To transport a stack of chairs, use the MultiGeneration by Knoll dolly. Stacking chairs stack up to 10 units high on the dolly.

The dolly stacked with 10 non-upholstered stacking chairs measures 53.5" high and with 10 upholstered seat stacking chairs, measures 55" high.

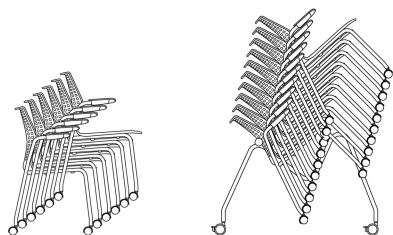

**Non-upholstered stacking chairs**

Non-upholstered stacking chairs feature bumpers to protect the seat finish of the chair below and prevent chairs from slipping. Do not stack non-upholstered chairs on upholstered chairs, as the bumpers could damage the upholstery of the chair below.

**Upholstered stacking chairs**

Upholstered stacking chairs feature a stacking shield on the underside of the seat to protect the upholstery of the chair below. Do not stack upholstered chairs on non-upholstered chairs, as the stacking shield could damage the seat finish of the chair below.

**Hybrid chairs and stacking chairs with book basket and/or tablet arm**

Hybrid chairs and stacking chairs with book basket and/or tablet arm do not stack.

**MultiGeneration Stacking Chair Ganging Instructions**

The MultiGeneration ganging clip adjoins the back legs of the armless stacking chairs. Position the chairs side-by-side and snap the ganging device onto the chair legs just above the top of the glides. Arm and armless chairs can be ganged if alternated, but armed chairs cannot be ganged side-by-side.

Compliance: ANSI / BIFMA X5.1 : 2011 (U.S. structural standard)  
 EN 15373 : 2007 (European structural standard)  
 GPD-6 (Canadian structural standard)  
 AS/NZS 4688 : 2000 (Australian/New Zealand structural and dimensional standard)  
 California T.B. 117 (U.S. flammability standard for foam)  
 California T.B. 133 standard for non-upholstered models, with approved FR textile for upholstered models (U.S. flammability standard for full chair)  
 MultiGeneration by Knoll has been tested and is approved for use by individuals weighing up to 300 lbs.

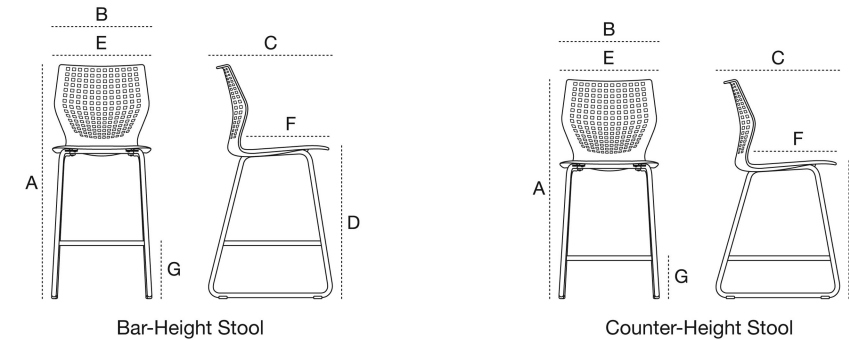

**MultiGeneration Chair Measurements \***

	Bar-Height Stool	Counter-Height Stool
A. Overall Height	44.5"	41.7"
B. Overall Width	18.6"	18.6"
C. Overall Depth	23.4"	23.4"
D. Seat Height	29.5" non-upholstered / 29.8" upholstered seat	26.7" non-upholstered / 27" upholstered seat
E. Seat Width	18.1"	18.1"
F. Seat Depth	16.3"	16.3"
G. Foot Rest Height	10.9" from floor, 18.6" from seat	8" from floor, 17.5" from seat
Weight	17.2 lbs. Seat upholstery adds 1.5 lbs.	16.6 lbs. Seat upholstery adds 1.5 lbs.

\* All measurements taken with BIFMA Chair Measuring Device using the Universal Measurement Procedure which has a measurement uncertainty of ± 5%

Compliance: ANSI / BIFMA X5.1 : 2011 (U.S. structural standard)  
 California T.B. 117 (U.S. flammability standard for foam)  
 California T.B. 133 standard for non-upholstered models, with approved FR textile for upholstered models (U.S. flammability standard for full chair)  
 MultiGeneration by Knoll has been tested and is approved for use by individuals weighing up to 300 lbs.

**CONSTRUCTION INFORMATION**

**Shell:**  
Integrally colored, textured, glass reinforced nylon.

**Stacking frame:**  
Powder coat over steel

**Hybrid frame:**  
Powder coat or chrome over steel

**Arm pads:**  
Integrally colored, textured thermoplastic polyurethane (TPU)

**Bumpers (non-upholstered stacking):**  
Integrally colored, textured TPU

**Stacking shield (upholstered stacking):**  
Clarified polypropylene copolymer

**Dynamic Seat Structure (hybrid):**  
Fiber-reinforced polymer spring and nylon

**Seat upholstery:**  
High resiliency molded biobased foam (7% biobased on average) with textile cover, plastic and steel

**Generation Fabric (upholstered chairs):**  
100% polyester, Cal 117 compliant, exceeds 100,000+ double rubs, Wyzenbeck method.

**Fasteners and hardware:**  
Steel

**Book basket:**  
Steel wire

**Tablet arm:**  
Phenolic board covered with black core laminate and tubular steel support.

**Glides:**  
Integrally colored, textured nylon

**Hard Casters:**  
Integrally colored, textured nylon and steel

**Soft Casters:**  
Integrally colored, textured nylon with polyurethane overmold and steel

**CLEANING INSTRUCTIONS**

**General cleaning:**  
Clean using a soft rag, either dry or wet. When needed, use mild pH-balanced soap diluted in water. Do not use abrasive sponges, acidic products or solvents containing ammonia.

**Healthcare cleaning:**  
The following products can be used safely on the MultiGeneration by Knoll shell only (not on the frame):

- Clorox Germicidal Liquid Bleach diluted 1:5 ratio to tap water (pH 3.7)
- Clorox Cleanup undiluted 100% solution (pH 9.7)
- Wex-Cide 128 Concentrate Phenolic Germicide by Wexford Labs diluted 1 ounce to 1 gallon tap water (pH 3.7)
- Formula 880 Quaternary Germicide by Grand Technologies diluted 1/2 ounce to 1 gallon tap water (pH 8.1)
- Hydroxi Pro Concentrate 128 by Core Products diluted 1:8 ration to tap water (pH 7.2)
- Virox 5 RTU cleaning solution

**Upholstery cleaning:**  
Base grade Generation Fabric is cleaning code W-S–Water or solvent based cleaning agent—and can be cleaned with low environmental impact cleaning fluids, including GS-37 certified products.

For further instruction, please see KnollTextiles Cleaning Information found in the Resources section of [knolltextiles.com](http://knolltextiles.com).

**ENVIRONMENTAL**

**SMaRT® Sustainable Gold certified**  
SMaRT® Consensus Sustainable Product Standard is a comprehensive, transparent sustainable product standard that measures a product’s environmental, economic and social benefits over its life cycle and throughout its global supply chain, from raw materials extraction through use, reclamation or re-use. MultiGeneration can contribute to achieving a LEED® Innovation in Design credit for its SMaRT® certification.

**BIFMA level® 3 certified**  
BIFMA has established level® as a common framework against which to evaluate the environmental and social responsibility of a variety of products. level® is part of BIFMA’s ongoing development of voluntary product and industry standards that support safe, healthy and sustainable workplaces. To achieve level® certification, Knoll partners with Scientific Certification Systems (SCS), known for its integrity and scientific rigor.

**GREENGUARD certified**  
MultiGeneration is GREENGUARD and GREENGUARD Gold certified and can contribute to achieving LEED® credits.

**WARRANTY**

MultiGeneration is warranted for 24-hour, 7 days a week, multi shift use: 12 years parts and labor to repair; 3 years seating upholstery, textiles and leathers, and finishes. See Knoll Selling Policy for further details, conditions and exclusions.

Designer(s):  
Formway Design, 2015



model	description	pattern no.
armless	Tandem Back with Flex Net Matrix, plastic base, standard cylinder, no optional lumbar, hard casters	<b>66-W-NA-2-S-X-HC</b>
plastic loop arms	Tandem Back with Flex Net Matrix, plastic base, standard cylinder, no optional lumbar, hard casters	<b>66-W-PL-2-S-X-HC</b>
aluminum loop arms	Tandem Back with Flex Net Matrix, plastic base, standard cylinder, no optional lumbar, hard casters	<b>66-W-AL-2-S-X-HC</b>
height adjustable arms	Tandem Back with Flex Net Matrix, plastic base, standard cylinder, no optional lumbar, hard casters	<b>66-W-HA-2-S-X-HC</b>
high performance arms	Tandem Back with Flex Net Matrix, plastic base, standard cylinder, no optional lumbar, hard casters	<b>66-W-HP-2-S-X-HC</b>
REMIKSEAT	Replacement seat	<b>REMIKSEAT</b>

list price	base grade	grades	COM	C	D	E	F	G	H	I	T	COL	U	V	W	X	Y
\$865.	\$906.	\$956.	\$997.	\$1,033.	\$1,084.	\$1,124.	\$1,180.	\$1,216.	\$1,389.	\$1,496.	\$1,618.	\$1,893.	\$2,152.	\$2,157.	\$2,427.		
992.	1,033.	1,084.	1,124.	1,160.	1,211.	1,252.	1,307.	1,343.	1,516.	1,623.	1,745.	2,020.	2,279.	2,284.	2,554.		
1,012.	1,053.	1,104.	1,145.	1,180.	1,231.	1,272.	1,328.	1,363.	1,536.	1,643.	1,765.	2,040.	2,300.	2,305.	2,574.		
1,012.	1,053.	1,104.	1,145.	1,180.	1,231.	1,272.	1,328.	1,363.	1,536.	1,643.	1,765.	2,040.	2,300.	2,305.	2,574.		
1,114.	1,155.	1,206.	1,246.	1,282.	1,333.	1,374.	1,430.	1,465.	1,638.	1,745.	1,867.	2,142.	2,401.	2,406.	2,676.		
214.	238.	251.	271.	286.	307.	327.	349.	365.	441.	489.	544.	667.	782.	844.	905.		

Order Code	Ordering Information	Options
<i>Example:</i> <b>66-W-HP-2-S-X-HC-DK-03-XOB03-USF-XU12-XB12</b>	<i>Specify:</i> 1. Pattern number 2. Finish color 3. Flex Net Matrix color 4. B-side textile color 5. Seat foam 6. Seat textile 7. Back textile	<i>Casters and Glides:</i> Replace HC in pattern with one of the following:  <i>Code: Upchg: Description:</i> SC \$41 soft casters for hard floors GL n/c glides  <i>Finish Color:</i> <i>Code: Description:</i> DK Dark finish
<b>66</b>	Remix	
<b>W</b>	Work chair	
<b>HP</b>	High performance arms	
<b>2</b>	Plastic base	
<b>S</b>	Standard cylinder	
<b>X</b>	No optional lumbar	
<b>HC</b>	Hard casters for soft floors	
<b>DK</b>	Dark finish	
<b>03</b>	Pebble Flex Net Matrix color	
<b>XOB03</b>	Pebble B-side textile color	
<b>USF</b>	Ultra seat foam	
<b>XU12</b>	Seat textile in Delite, Charcoal	
<b>XB12</b>	Back textile in Delite, Charcoal	
<i>Example for Cal 133:</i> <b>66-W-HP-2-S-X-HC-DK-03-XOB03-USF C-XU12/133-XB12/133</b>	<i>Polished Aluminum Base:</i> Replace 2 in pattern with 4  <i>Code: Upchg: Description:</i> 4 \$86 polished aluminum base  <i>Cylinder Height Options:</i> For height ranges see Remix Dimensions page. Replace S in pattern with one of the following:  <i>Code: Description:</i> L low cylinder H high cylinder	<i>Flex Net Matrix Colors:</i> Select one of the following back colors:  <i>Code: Description:</i> 01 Storm (dark grey) 03 Pebble (medium grey)  <i>B-Side Textile Colors:</i> <i>Code: Description:</i> 01 Storm (dark grey) 03 Pebble (medium grey)  Note: Remix outer back can only be upholstered with the B-side textile.  <i>Seat Foam Options:</i> Select one of the following:  <i>Code: Description:</i> TSF thin seat foam USF ultra seat foam (default)

Delite K2026 - Base Grade	Textile Options
KnollTextiles Delite K2026 is the base grade textile for the Remix chair. Choose XT for thin seat foam or XU for ultra seat foam, followed by a two digit color code. Select one of the following:  <i>Code: Description:</i> 01 Orange 02 Red 03 Catalina 04 Turquoise 05 Parrot 06 Green 07 Cinder 08 Stone 09 Gray 10 Slate 11 Tobacco 12 Charcoal 13 Onyx 14 Purple	<i>KnollTextiles fabrics and Spinneybeck leathers:</i> Please refer to the textile matrices at the beginning of the price list for approved fabrics and leathers.  <i>Split upholstery:</i> Remix seats and inner backs can be upholstered in any two approved fabrics or leathers. The list price of the chair equals the list price of the higher of the two upholstery grades.  <i>Customer's Own Material/Leather:</i> See Customer's Own Material Seating Process Overview at the beginning of the price list  COM/COL Textile Requirements For both thin and ultra seat foam:  COM fabric seat = .8 yards COL leather seat = 13 square feet COM fabric inner back = 1 yard COL leather inner back = 16 square feet  <i>Cal 133:</i> See textile matrices at the beginning of the price list for pre-approved Cal 133 textiles. ▲ = Cal 133 pre-approved  To specify, insert C before textile selections and 133 after the seat and inner back textile codes.  <i>Code: Upchg: Description:</i> C()133 \$102 Cal 133 compliant  Note: Cal133 upcharge for a replacement seat is \$51.



# Remix® high back chair

Designer(s):  
Formway Design, 2015



model	description	pattern no.
armless	Tandem Back with Flex Net Matrix, plastic base, standard cylinder, no optional lumbar, hard casters	<b>67-H-NA-2-S-X-HC</b>
plastic loop arms	Tandem Back with Flex Net Matrix, plastic base, standard cylinder, no optional lumbar, hard casters	<b>67-H-PL-2-S-X-HC</b>
aluminum loop arms	Tandem Back with Flex Net Matrix, plastic base, standard cylinder, no optional lumbar, hard casters	<b>67-H-AL-2-S-X-HC</b>
height adjustable arms	Tandem Back with Flex Net Matrix, plastic base, standard cylinder, no optional lumbar, hard casters	<b>67-H-HA-2-S-X-HC</b>
high performance arms	Tandem Back with Flex Net Matrix, plastic base, standard cylinder, no optional lumbar, hard casters	<b>67-H-HP-2-S-X-HC</b>
REMXSEAT	Replacement seat	<b>REMXSEAT</b>

list price	base grade	grades	COM	C	D	E	F	G	H	I	T	COL	V	W	X	Y
		A	B									U				
\$1,068.		\$1,114.	\$1,165.	\$1,206.	\$1,241.	\$1,292.	\$1,333.	\$1,389.	\$1,425.	\$1,597.	\$1,704.	\$1,826.	\$2,101.	\$2,361.	\$2,366.	\$2,635.
1,196.	1,241.	1,292.	1,333.	1,369.	1,419.	1,460.	1,516.	1,552.	1,725.	1,832.	1,954.	2,228.	2,488.	2,493.	2,763.	
1,216.	1,262.	1,313.	1,353.	1,389.	1,440.	1,480.	1,536.	1,572.	1,745.	1,852.	1,974.	2,249.	2,508.	2,513.	2,783.	
1,216.	1,262.	1,313.	1,353.	1,389.	1,440.	1,480.	1,536.	1,572.	1,745.	1,852.	1,974.	2,249.	2,508.	2,513.	2,783.	
1,318.	1,363.	1,414.	1,455.	1,491.	1,542.	1,582.	1,638.	1,674.	1,847.	1,954.	2,076.	2,350.	2,610.	2,615.	2,885.	
214.	238.	251.	271.	286.	307.	327.	349.	365.	441.	489.	544.	667.	782.	844.	905.	

Order Code	Ordering Information	Options
<i>Example:</i> <b>67-H-HP-2-S-X-HC-DK-03-XOB03-USF-XU12-XHB12</b>	<i>Specify:</i>	<i>Casters and Glides:</i>
<b>67</b> Remix	1. Pattern number	Replace HC in pattern with one of the following:
<b>H</b> High Back chair	2. Finish color	<i>Code: Upchg: Description:</i>
<b>HP</b> High performance arms	3. Flex Net Matrix color	SC \$41 soft casters for hard floors
<b>2</b> Plastic base	4. B-side textile color	GL n/c glides
<b>S</b> Standard cylinder	5. Seat foam	<i>Finish Color:</i>
<b>X</b> No optional lumbar	6. Seat textile	<i>Code: Description:</i>
<b>HC</b> Hard casters for soft floors	7. Back textile	DK Dark finish
<b>DK</b> Dark finish	<b>Options</b>	
<b>03</b> Pebble Flex Net Matrix color	<i>Polished Aluminum Base:</i>	
<b>XOB03</b> Pebble B-side textile color	Replace 2 in pattern with 4	
<b>USF</b> Ultra seat foam	<i>Code: Upchg: Description:</i>	
<b>XU12</b> Seat textile in Delite, Charcoal	4 \$86 polished aluminum base	
<b>XHB12</b> Back textile in Delite, Charcoal	<i>Cylinder Height Options:</i>	
	For height ranges see Remix Dimensions page. Replace S in pattern with one of the following:	
	<i>Code: Description:</i>	
	L low cylinder	
	H high cylinder	
<i>Example for Cal 133:</i>		
<b>67-H-HP-2-S-X-HC-DK-03-XOB03-USF C-XU12/133-XHB12/133</b>		

Delite K2026 - Base Grade	Textile Options
KnollTextiles Delite K2026 is the base grade textile for the Remix chair. Choose XT for thin seat foam or XU for ultra seat foam, followed by a two digit color code. Select one of the following:	<i>KnollTextiles fabrics and Spinneybeck leathers:</i> Please refer to the textile matrices at the beginning of the price list for approved fabrics and leathers.
<i>Code: Description:</i>	<i>Customer's Own Material/Leather:</i> See Customer's Own Material Seating Process Overview at the beginning of the price list
01 Orange	COM/COL Textile Requirements For both thin and ultra seat foam:
02 Red	COM fabric seat = .8 yards
03 Catalina	COL leather seat = 13 square feet
04 Turquoise	COM fabric inner back = 1.25 yard
05 Parrot	COL leather inner back = 19 square feet
06 Green	
07 Cinder	
08 Stone	
09 Gray	
10 Slate	
11 Tobacco	
12 Charcoal	
13 Onyx	
14 Purple	
	<i>Split upholstery:</i> Remix seats and inner backs can be upholstered in any two approved fabrics or leathers. The list price of the chair equals the list price of the higher of the two upholstery grades.
	<i>Cal 133:</i> See textile matrices at the beginning of the price list for pre-approved Cal 133 textiles. ▲ = Cal 133 pre-approved To specify, insert C before textile selections and 133 after the seat and inner back textile codes. <i>Code: Upchg: Description:</i> C()133 \$102 Cal 133 compliant
	Note: Cal133 upcharge for a replacement seat is \$51.

**Remix Work Chair Ergonomic Dimensions**

Seat*	Thin Seat Foam	Ultra Seat Foam
Seat Height	14.2" - 17.3" (low cylinder) 16.6" - 21.5" (standard cylinder) 17.5" - 22.8" (high cylinder)	14.8" - 17.9" (low cylinder) 17.2" - 22.1" (standard cylinder) 18.1" - 23.4" (high cylinder)
Seat Depth (Adjustable)	14.75" - 17.75"	14.75" - 17.75"
Seat Width	20.6"	20.6"
Seat Pan Angle (Fixed)	4.1° rearward at rest	4.1° rearward at rest

Back*		
Backrest Height	23.25"	
Backrest Width	20.25"	
Lumbar Support (Fixed)	7.6"	
Angle between Seat and Back	96°	
Tilt Range of Back	28°	

Arms*	Thin Seat Foam	Ultra Seat Foam
Armrest Height from Seat (Adjustable)	6.1" - 11.3" (height adjustable arms) 6.1" - 11.3" (high performance arms)	6.7" - 11.9" (height adjustable arms) 6.7" - 11.9" (high performance arms)
Inside Distance between Armrests (Fixed)	20.75" (loop arms)	20.75" (loop arms)
Inside Distance between Armrests (Adjustable)	15.5" - 23.3" (high performance arms)	15.5" - 23.3" (high performance arms)

\*All measurements taken with the BIFMA Chair Measuring Device using the Universal Measurement Procedure which has a measurement uncertainty of ± 5%

**Remix Work Chair Measurements\*\***

A. Overall Height	36.9" - 44.9" (add 0.25" for aluminum base)
B. Overall Width	21" armless 24.5" with loop arms 27" with HA arms 30" with HP arms
C. Overall Depth	23.5" excluding base
D. Arm Height from Floor	26.8" - 31.1" (height adjustable arms) 26.3" - 31.3" (high performance arms) 25" - 29.5" (loop arms) (add 0.25" for aluminum base)
E. Base Diameter	27.7"
Weight	42.5 lbs. (height adjustable/high performance arms) (add 1.5 lbs. for aluminum base)

\*\*standard cylinder, plastic base

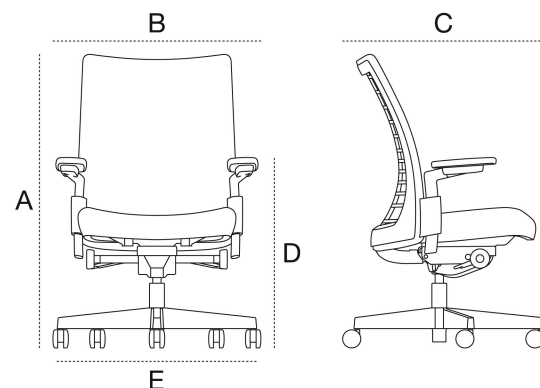

**Remix Performance Information**

Synchronized recline ratio seat:back is 1° : 2°
High performance arm pads measure 8.5" long x 4" wide
Height adjustable arm pads measure 8" long x 3.5" wide
High performance arm pads adjust 2" in width, 3" in depth and pivot 40° (20° inward, 20° outward)

Compliance: ANSI/BIFMA X5.1 : 2011 (U.S. structural standard)  
ANSI/HFES 100-2007 (U.S. ergonomic standard)  
BIFMA G1 : 2013 (U.S. ergonomic guidelines)  
California T.B. 117 (U.S. flammability standard for foam)  
California T.B. 133 with approved FR textile (U.S. flammability standard for full chair)

The Remix work chair has been tested and is approved for use by individuals weighing up to 300 pounds.

**Remix High Back Chair Ergonomic Dimensions**

Seat*	Thin Seat Foam	Ultra Seat Foam
Seat Height	14.2" - 17.3" (low cylinder) 16.6" - 21.5" (standard cylinder) 17.5" - 22.8" (high cylinder)	14.8" - 17.9" (low cylinder) 17.2" - 22.1" (standard cylinder) 18.1" - 23.4" (high cylinder)
Seat Depth (Adjustable)	14.75" - 17.75"	14.75" - 17.75"
Seat Width	20.6"	20.6"
Seat Pan Angle (Fixed)	4.1° rearward at rest	4.1° rearward at rest

Back*		
Backrest Height	28.4"	
Backrest Width	20.25"	
Lumbar Support (Fixed)	7.75"	
Angle between Seat and Back	96°	
Tilt Range of Back	28°	

Arms*	Thin Seat Foam	Ultra Seat Foam
Armrest Height from Seat (Adjustable)	6.1" - 11.3" (height adjustable arms) 6.1" - 11.3" (high performance arms)	6.7" - 11.9" (height adjustable arms) 6.7" - 11.9" (high performance arms)
Inside Distance between Armrests (Fixed)	20.75" (loop arms)	20.75" (loop arms)
Inside Distance between Armrests (Adjustable)	15.5" - 23.3" (high performance arms)	15.5" - 23.3" (high performance arms)

\*All measurements taken with the BIFMA Chair Measuring Device using the Universal Measurement Procedure which has a measurement uncertainty of ± 5%

**Remix High Back Chair Measurements\*\***

A. Overall Height	43.4" - 51.3" (add 0.25" for aluminum base)
B. Overall Width	21" armless 24.5" with loop arms 27" with HA arms 30" with HP arms
C. Overall Depth	23.5" excluding base
D. Arm Height from Floor	26.8" - 31.1" (height adjustable arms) 26.3" - 31.3" (high performance arms) 25" - 29.5" (loop arms) (add 0.25" for aluminum base)
E. Base Diameter	27.7"
Weight	44.8 lbs. (height adjustable/high performance arms) (add 1.5 lbs. for aluminum base)

\*\*standard cylinder, plastic base

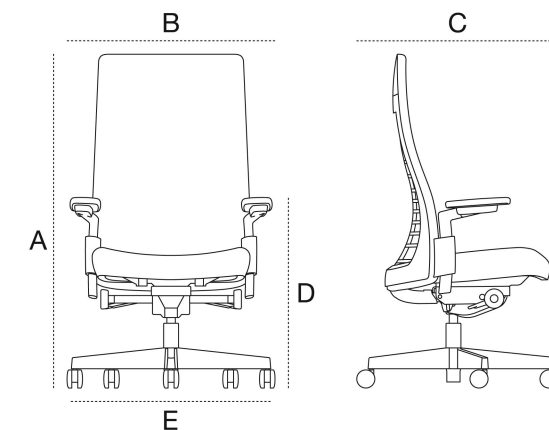

**Remix Performance Information**

Synchronized recline ratio seat:back is 1° : 2°
High performance arm pads measure 8.5" long x 4" wide
Height adjustable arm pads measure 8" long x 3.5" wide
High performance arm pads adjust 2" in width, 3" in depth and pivot 40° (20° inward, 20° outward)

Compliance: ANSI/BIFMA X5.1 : 2011 (U.S. structural standard)  
ANSI/HFES 100-2007 (U.S. ergonomic standard)  
BIFMA G1 : 2013 (U.S. ergonomic guidelines)  
California T.B. 117 (U.S. flammability standard for foam)  
California T.B. 133 with approved FR textile (U.S. flammability standard for full chair)

The Remix high back chair has been tested and is approved for use by individuals weighing up to 300 pounds.

## Remix® Features and Operating Instructions

### No Adjustment Necessary

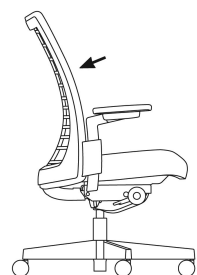

**Tandem Back**  
Comprised of intelligent layers of contrasting materials to provide movement and active support.

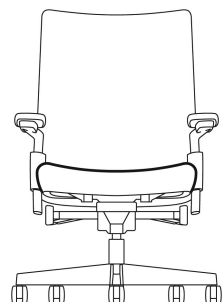

**Contoured Seat**  
Varying levels of thickness provide targeted cushioning for long-term comfort and waterfall edges for shifting postures.

### Intuitive Adjustments (Standard)

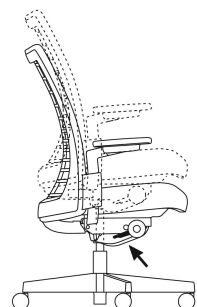

**Seat height**  
To lower seat, lift the right lever while seated in the chair. To raise seat, remove your weight from seat while lifting right lever. Release to lock.

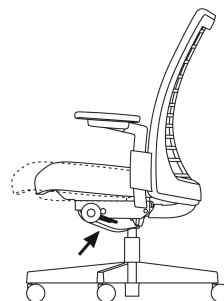

**Seat depth**  
Lift the left lever and slide to the desired position. Release to lock.

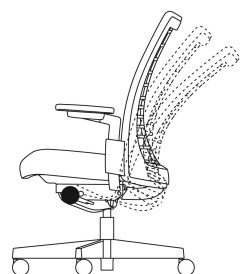

**Three-point tilt lock**  
Turn left knob backward to lock upright or forward to allow for recline. To set recline lock position, lean back and turn knob backward at mid-way point or at full recline. This will lock chair in place at that position. To release, turn knob forward, recline slightly and sit back upright.

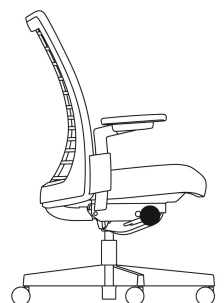

**Tilt tension**  
Turn right knob forward to increase the tilt tension or backward to reduce tension.

### Performance Options

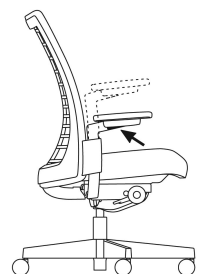

**Arm options**  
**Height adjustable arm**  
To adjust the height, push the button underneath the armpad. Slide the arm to the desired position and release the lever to lock.

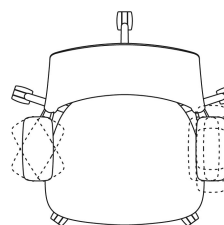

**High performance arm**  
In addition to arm height adjustment, free float arm pads easily move in width, depth and pivot.

### CONSTRUCTION INFORMATION

**Flex Net Matrix**  
Integrally colored, high performance bio-based elastomer (59% biobased by weight on average)

**Back frame**  
Engineered 33% glass filled nylon compound (at least 50% by weight post-industrial and post-consumer recycled content), polypropylene trim

**Foam**  
High-resiliency molded foam

**Adjustable arm supports**  
Integrally colored, 30% glass reinforced nylon with steel reinforcement

**Arm pads**  
Integrally colored, self skinning polyurethane

**Aluminum loop arms**  
Polished cast aluminum

**Plastic loop arms**  
Integrally colored, 30% glass reinforced nylon

**Seat**  
High-resiliency molded foam with textile cover and integrally colored, 30% glass reinforced polypropylene structure

**Control**  
Powder coated steel and cast aluminum, with integrally colored, glass reinforced nylon adjustment knobs and levers

**Pneumatic cylinder**  
Steel

**Base**  
Polished cast aluminum or integrally colored, 33% glass reinforced nylon with steel insert; five star design

**Fasteners and hardware**  
Steel

**Hard casters**  
Integrally colored nylon and steel

**Soft casters**  
Integrally colored nylon over molded with polyurethane, and steel

**Glides**  
Integrally colored nylon

**Delite textile**  
100% polyester

**B-side textile**  
100% polyester

### CLEANING INSTRUCTIONS

**Remix Fabric**  
Fabric with cleaning codes W or W-S are designed to be cleaned with low environmental impact cleaning fluids, including GS-37 certified products. See KnollTextiles Price List for further details on cleaning codes.

### ENVIRONMENTAL

**GREENGUARD certified**  
Remix is GREENGUARD® and GREENGUARD Gold<sup>SM</sup> certified and can contribute to achieving LEED® credits.

### WARRANTY

Remix is warranted for 24-hour, 7 days a week, multi shift use: 12 years parts and labor to repair; 3 years seating upholstery, textiles and leathers, and finishes. See Knoll Selling Policy for further details, conditions and exclusions.

model	description	pattern no.
side chair	Fully upholstered side chair with glides	<b>64-S-X-GL</b>

Designer(s):  
Formway Design, 2016



list price	base grade	grades	COM	C	D	E	F	G	H	I	T	COL	V	W	X	Y
\$620.		A	B									U				
\$620.	\$660.	\$725.	\$755.	\$795.	\$815.	\$895.	\$925.	\$1,045.	\$1,135.	\$1,150.	\$1,195.	\$1,245.	\$1,395.	\$1,420.	\$1,590.	

Order Code	Ordering Information	Options	Delite K2026 - Base Grade
<i>Example:</i> <b>64-S-X-HC-2-RXS02-RXB02</b>	<i>Specify:</i> 1. Pattern number 2. Finish color 3. Seat textile 4. Back textile	<i>Casters and Glides:</i> Replace GL in pattern with one of the following:  <i>Code: Upchg: Description:</i> HC \$32 hard casters for soft floors SC \$32 soft casters for hard floors  <i>Finish Color:</i> <i>Code: Description:</i> 2 Black frame finish	KnollTextiles Delite K2026 is the base grade textile for the Remix side chair. Select one of the following:  <i>Code: Description:</i> 01 Orange 02 Red 03 Catalina 04 Turquoise 05 Parrot 06 Green 07 Cinder 08 Stone 09 Gray 10 Slate 11 Tobacco 12 Charcoal 13 Onyx 14 Purple
<b>64</b>	Remix		
<b>S</b>	Side chair		
<b>X</b>	No option		
<b>HC</b>	Hard casters for soft floors		
<b>2</b>	Black finish		
<b>RXS02</b>	Seat textile in Delite, Red		
<b>RXB02</b>	Back textile in Delite, Red		
<i>Example for Cal 133:</i> <b>64-S-X-HC-2-RXS02/133-C-RXB02/133</b>			

Textile Options
<i>KnollTextiles fabrics and Spinneybeck leathers:</i> Please refer to the textile matrices at the beginning of the price list for approved fabrics and leathers.  <i>Split upholstery:</i> Remix side seats backs can be upholstered in any two approved fabrics or leathers. The list price of the chair equals the list price of the higher of the two upholstery grades.
<i>Customer's Own Material/Leather:</i> See Customer's Own Material Seating Process Overview at the beginning of the price list  COM/COL Textile Requirements  COM fabric seat = 1.4 yards COL leather seat = 9 square feet COM fabric back = 1.25 yard COL leather back = 14 square feet
<i>Cal 133:</i> See textile matrices at the beginning of the price list for pre-approved Cal 133 textiles. ‡ = Cal 133 pre-approved  To specify, insert C before seat textile selections and 133 after the seat and inner back textile codes. <i>Code: Upchg: Description:</i> C()133 \$100 Cal 133 compliant

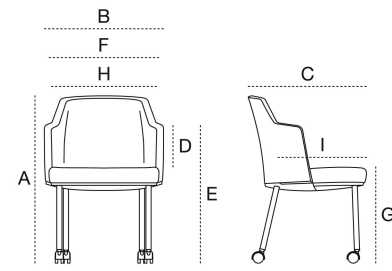

Side Chair with Casters

**Remix Side Chair Measurements \***

	Side Chair
A. Overall Height	31.5"
B. Overall Width	23"
C. Overall Depth	22.4"
D. Arm Height from Seat	9.4"
E. Arm Height from Floor	26"
F. Inside Distance between Arm Rests	20.1"
G. Seat Height	17.7"
H. Seat Width	18.9"
I. Seat Depth	17.3"
Weight	21.8 lbs.

\* All measurements taken with BIFMA Chair Measuring Device using the Universal Measurement Procedure which has a measurement uncertainty of ± 5%

Compliance: ANSI / BIFMA X5.1 : 2011 (U.S. structural standard)  
 California T.B. 117 (U.S. flammability standard for foam)  
 California T.B. 133 with approved FR textile (U.S. flammability standard for full chair)  
 Remix side chair has been tested and is approved for use by individuals weighing up to 300 lbs.

**CONSTRUCTION INFORMATION**

**Back**  
 High-resiliency foam with textile cover and integrally colored, 13% glass reinforced nylon structure

**Seat**  
 High-resiliency molded foam with textile cover and integrally colored, 13% glass reinforced nylon structure

**Seat cosmetic cover**  
 Integrally colored, 30% glass filled polypropylene

**Frame**  
 Powder coated steel

**Fasteners**  
 Steel

**Hard casters**  
 Integrally colored nylon and steel

**Soft casters**  
 Integrally colored nylon over molded with polyurethane, and steel

**Glides**  
 Integrally colored impact modified nylon

**Delite textile**  
 100% polyester

**CLEANING INSTRUCTIONS**

**Remix Fabric**  
 Fabric with cleaning codes W or W-S are designed to be cleaned with low environmental impact cleaning fluids, including GS-37 certified products. See KnollTextiles Price List for further details on cleaning codes.

**ENVIRONMENTAL**

**GREENGUARD certified**  
 Remix side is GREENGUARD® and GREENGUARD Gold<sup>SM</sup> certified and can contribute to achieving LEED® credits.

**WARRANTY**

Remix side is warranted for 24-hour, 7 days a week, multi shift use: 12 years parts and labor to repair; 3 years seating upholstery, textiles and leathers, and finishes. See Knoll Selling Policy for further details, conditions and exclusions.

	arm	description	pattern no.	list price
<p>Designer(s): Don Chadwick, 2005</p> 	Armless	Tilt stop control Note: Arms cannot be added later.	<b>33-NA-1-BK-T-S-X-HC#</b>	\$1,029.
	Fixed arms	Tilt stop control	<b>33-FA-1-BK-T-S-X-HC#</b>	1,109.
	Height and width adjustable arms	Tilt stop control Note: A tall adjustable arm option is available. See below for details.	<b>33-AA-1-BK-T-S-X-HC#</b>	1,219.

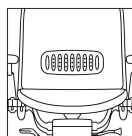
Order Code	Ordering Information	Options
<i>Example:</i> <b>33-AA-1-BK-T-S-X-HC-05</b>	<i>Specify:</i>	<i>Arm Option:</i>
<b>33</b> Chadwick Chair	1. Pattern number	For Tall Adjustable Arm, replace AA with TA in the pattern number. The tall arm is 3/4" higher than the standard adjustable arm. No upcharge for this option.
<b>AA</b> Adjustable Arms	2. Fabric color	<i>Cylinder Height Options:</i>
<b>1</b> Task Chair	<i>Finish color:</i>	For height ranges see Chadwick Dimensions and Operating Instructions. Replace S in pattern with one of the following options:
<b>BK</b> Black Frame	Black	<i>Code: Upchg: Description:</i>
<b>T</b> Tilt Stop Control		L n/c low cylinder
<b>S</b> Standard Cylinder		H n/c high cylinder
<b>X</b> No Lumbar		<i>Lumbar Option:</i>
<b>HC</b> Hard Black Caster		For lumbar, replace X with L in the pattern number. Add \$102 to list price
<b>05</b> Black Chadwick Fabric		Note: To order a lumbar separately, use pattern number 33LUMBAR. The list price is \$102.
		Lumbar detail
		

Chadwick Fabric
<i>Caster Option:</i>
For soft casters, replace HC with SC in the pattern number, and add \$43 to the list price
<i>Glides:</i>
For glides, replace HC with GL in the pattern number. No upcharge for this option.
<i>Glide detail</i>

Black Monofilament:
Code: Desc: Upcharge:
01 Beige n/c
03 Silver n/c
05 Black n/c
<i>Cal 133:</i>
Chadwick is Cal 133 approved standard. No options or upcharge required.

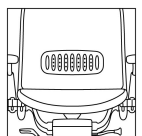

	arm	description	pattern no.	list price
<p>Designer(s): Don Chadwick, 2005</p> 	Armless	Basic control Note: Arms cannot be added later.	<b>33-NA-1-BK-B-S-X-HC #</b>	\$966.
	Fixed arms	Basic control	<b>33-FA-1-BK-B-S-X-HC #</b>	1,048.
	Height and width adjustable arms	Basic control Note: A tall adjustable arm option is available. See below for details.	<b>33-AA-1-BK-B-S-X-HC #</b>	1,156.

Order Code	Ordering Information	Options
<i>Example:</i> <b>33-AA-1-BK-B-S-X-HC-05</b>	<i>Specify:</i>	<i>Arm Option:</i>
<b>33</b> Chadwick Chair	1. Pattern number	For Tall Adjustable Arm, replace AA with TA in the pattern number. The tall arm is 3/4" higher than the standard adjustable arm. No upcharge for this option.
<b>AA</b> Adjustable Arms	2. Fabric color	<i>Cylinder Height Options:</i>
<b>1</b> Task Chair	<i>Finish color:</i>	For height ranges see Chadwick Dimensions and Operating Instructions. Replace S in pattern with one of the following options:
<b>BK</b> Black Frame	Black	<i>Code: Upchg: Description:</i>
<b>B</b> Basic Control		L n/c low cylinder
<b>S</b> Standard Cylinder		H n/c high cylinder
<b>X</b> No Lumbar		<i>Lumbar Option:</i>
<b>HC</b> Hard Black Caster		For lumbar, replace X with L in the pattern number. Add \$102 to list price
<b>05</b> Black Chadwick Fabric		Note: To order a lumbar separately, use pattern number 33LUMBAR. The list price is \$102.
		Lumbar detail
		
		

Chadwick Fabric
<i>Caster Option:</i>
For soft casters, replace HC with SC in the pattern number, and add \$43 to the list price
<i>Glides:</i>
For glides, replace HC with GL in the pattern number. No upcharge for this option.
Glide detail

Black Monofilament:
Code: Desc: Upcharge:
01 Beige n/c
03 Silver n/c
05 Black n/c
<i>Cal 133:</i>
Chadwick is Cal 133 approved standard. No options or upcharge required.

Chadwick®  
high task chair  
tilt stop control

Designer(s):  
Don Chadwick, 2005



arm	description	pattern no.	list price
Armless	Tilt stop control Note: Arms cannot be added later	<b>33-NA-2-BK-T-S-X-HC#</b>	\$1,278.
Fixed arms	Tilt stop control	<b>33-FA-2-BK-T-S-X-HC#</b>	1,358.
Height and width adjustable arms	Tilt stop control Note: A tall adjustable arm option is available. See below for details.	<b>33-AA-2-BK-T-S-X-HC#</b>	1,469.



Order Code	Ordering Information	Options
<i>Example:</i> <b>33-AA-2-BK-T-S-X-HC-05</b>	<i>Specify:</i>	<i>Arm Option:</i>
<b>33</b> Chadwick Chair	1. Pattern number	For Tall Adjustable Arm, replace AA with TA in the pattern number. The tall arm is 3/4" higher than the standard adjustable arm. No upcharge for this option.
<b>AA</b> Adjustable Arms	2. Fabric color	<i>Lumbar Option:</i>
<b>2</b> High Task Chair	<i>Finish color:</i>	For lumbar, replace X with L in the pattern number. Add \$102 to list price
<b>BK</b> Black Frame	Black	<i>Note:</i>
<b>T</b> Tilt Stop Control		To order a lumbar separately, use pattern number 33LUMBAR. The list price is \$102.
<b>S</b> Standard Cylinder		
<b>X</b> No Lumbar		
<b>HC</b> Hard Black Caster		
<b>05</b> Black Chadwick Fabric		

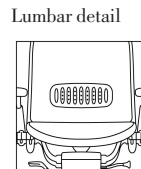
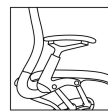



Chadwick Fabric		
<i>Caster Option:</i>		
For soft casters, replace HC with SC in the pattern number, and add \$43 to the list price		
<i>Glides:</i>		
For glides, replace HC with GL in the pattern number. No upcharge for this option.		
<i>Black Monofilament:</i>		
Code:	Desc:	Upcharge:
01	Beige	n/c
03	Silver	n/c
05	Black	n/c
<i>Cal 133:</i>		
Chadwick is Cal 133 approved standard. No options or upcharge required.		





Chadwick®  
high task chair  
basic control

	arm	description	pattern no.	list price
<p><i>Designer(s):</i> Don Chadwick, 2005</p> 	Armless	Basic control Note: Arms cannot be added later	<b>33-NA-2-BK-B-S-X-HC #</b>	\$1,216.
	Fixed arms	Basic control	<b>33-FA-2-BK-B-S-X-HC #</b>	1,297.
	Height and width adjustable arms	Basic control Note: A tall adjustable arm option is available. See below for details.	<b>33-AA-2-BK-B-S-X-HC #</b>	1,406.

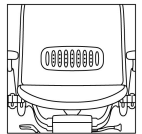
Order Code	Ordering Information	Options
<i>Example:</i> <b>33-AA-2-BK-T-S-X-HC-05</b>	<i>Specify:</i>	<i>Arm Option:</i>
<b>33</b> Chadwick Chair	1. Pattern number	For Tall Adjustable Arm, replace AA with TA in the pattern number. The tall arm is 3/4" higher than the standard adjustable arm. No upcharge for this option.
<b>AA</b> Adjustable Arms	2. Fabric color	<i>Lumbar Option:</i>
<b>2</b> High Task Chair	<i>Finish color:</i>	For lumbar, replace X with L in the pattern number. Add \$102 to list price.
<b>BK</b> Black Frame	Black	Note:
<b>T</b> Tilt Stop Control		To order a lumbar separately, use pattern number 33LUMBAR. The list price is \$102.
<b>S</b> Standard Cylinder		Tall Adjustable Arm detail
<b>X</b> No Lumbar		
<b>HC</b> Hard Black Caster		Lumbar detail
<b>05</b> Black Chadwick Fabric		

Chadwick Fabric		
<i>Caster Option:</i>		
For soft casters, replace HC with SC in the pattern number, and add \$43 to the list price		
<i>Glides:</i>		
For glides, replace HC with GL in the pattern number. No upcharge for this option.		
Glide detail		
		
Black Monofilament:		
Code:	Desc:	Upcharge:
01	Beige	n/c
03	Silver	n/c
05	Black	n/c
<i>Cal 133:</i>		
Chadwick is Cal 133 approved standard. No options or upcharge required.		



Standard Features	Benefits
Active Suspension™ Technology includes: 1. Responsive synchronized control and tilt tension	The synchronized control and tilt tension allow the user's torso to open up, promoting healthy circulation and creating a ride that is characterized by a cradled feeling that keeps the user's back in contact with the chair.
2. Resilient, breathable seat and back suspension fabric	Chadwick Fabric provides inherent, energizing support all day long, conforming to the user's shape and minimizing pressure points. The open weave provides aeration.
Forward Tilt: Mechanism automatically includes forward tilt movement	Chadwick offers automatic support for forward seated positions without requiring any additional adjustments.
Variable Seat Depth: Seat depth automatically expands while reclining in the chair	Fits a multitude of users comfortably, no additional adjustments required.
Generous Lumbar Curvature	Chadwick's ample lumbar curvature and conforming back suspension fabric eliminate the need for an additional lumbar mechanism or attachment.
Flexing Arm Pads on Fixed and Adjustable Arms	Suspended design and shape allows the arm pads to flex for additional softness to alleviate pressure points on the wrists.
2 Simple Adjustments: Tension and Seat Height	With so much responsive movement built in, Chadwick only needs two adjustments. They are obvious and simple to operate.

Optional Features	Benefits
Tilt Stop Control	Limits the recline in the upright position to 5 degrees.
Adjustable Arms or Tall Adjustable Arms: both include width adjustment	One finger, ratchet adjustment quickly and easily adjusts. Width adjustment can be accomplished with 3/32" Allen wrench.
Optional Lumbar	Magnetic for easy installation, the lumbar provides a maximum range of adjustability.

**Care:**  
Frequent vacuuming or light brushing to remove dust and grime is recommended. Spot clean, with a mild upholstery shampoo or the foam from a mild detergent. When using a cleaning product, follow instructions carefully and clean only in a well-ventilated room. Avoid any product that contains carbon tetrachloride or other toxic materials. With any method, pretest a small area before proceeding. Use a professional furniture cleaning service when an overall soiled conditioned has been reached.

Chadwick Fabric cleaning code is **W** or **W-S**, meaning water-based cleaning agents and foam or mild, water-free solvents may be used and it can be cleaned with low environmental impact cleaning fluids, including GS-37 certified products. See KnollTextiles.com for further details on cleaning codes.

**Healthcare Cleaning Agents:**  
Chadwick successfully passed third-party testing for the following five cleaning agents commonly used in healthcare facilities:

- Clorox Germicidal Liquid Bleach diluted 1:5 ratio to tap water (pH 3.7)
- Clorox Cleanup undiluted 100% solution (pH 9.7)
- Wex-Cide 128 Concentrate Phenolic Germicide by Wexford Labs diluted 1 ounce to 1 gallon tap water (pH 3.7)
- Formula 880 Quarternary Germicide by Grand Technologies diluted 1/2 ounce to 1 gallon tap water (pH 8.1)
- Hydroxi Pro concentrate 128 by Core Products diluted 1:8 ratio to tap water (pH 7.2)

In addition, Knoll has conducted internal testing of Virox 5 RTU cleaning solution on Chadwick with no adverse effects.

**Environmental:**  
**SMaRT® Sustainable Gold certified.**  
SMaRT® Consensus Sustainable Product Standard is a comprehensive, transparent, sustainable product standard that measures a product's environmental, economic and social benefits over its life and throughout its global supply chain, from raw materials through reclamation or re-use. Chadwick can contribute to achieving a LEED® Innovation in Design Credit.

**BIFMA level® 3 certified** BIFMA has established level® as a common framework against which to evaluate the environmental and social responsibility of a variety of products. level® is part of BIFMA's ongoing development of voluntary product and industry standards that support safe, healthy and sustainable workplaces. To achieve level® certification, Knoll partners with Scientific Certification Systems (SCS), known for its integrity and scientific rigor.

**GREENGUARD® certified.**  
Chadwick is GREENGUARD and GREENGUARD Gold certified and can contribute to achieving LEED® credits.

**Construction:**  
**Back Frame**  
Integrally-colored glass filled nylon

*Chadwick Fabric*  
Polyester monofilament warp with multifilament fill fibers

Chadwick Fabric exceeds 100,000 double rubs Wyzenbeck Method.

**Seat Frame**  
Integrally-colored glass filled nylon

*Chadwick Fabric*  
Polyester monofilament warp with multifilament fill fibers

*Soft Edge*  
Polyurethane foam

**Arms**  
*Fixed/Adjustable Arm Pads*  
Self skinning urethane armpad with flexible spring steel insert

*Fixed/Adjustable Arm Supports*  
Integrally-colored glass filled nylon

**Base & Casters**  
*Base*  
Integrally-colored glass filled nylon

*Casters and Glides*  
Integrally-colored nylon

*Soft Casters*  
Integrally-colored urethane covered nylon

**Cylinder**  
Gas-activated steel seat height mechanism with steel tube (contains nitrogen)

**Control**  
Control housing-aluminum casting and ABS top cover  
Component parts-steel, rubber and engineered plastics

**Optional Lumbar**  
Neodymium magnets, polypropylene carrier, TPE pad and back frame

**Warranty:**  
Chadwick is warranted for 24-hour, 7 days a week, multi shift use: 12 years parts and labor to repair; 3 years seating upholstery, textiles and leathers, and finishes. See Knoll Selling Policy for further details, conditions and exclusions.

**Chadwick Ergonomic Dimensions**

Seat*	Chadwick	Chadwick High Task
Seat Height	15" - 19.1" (low cylinder) 15.9" - 20" (standard cylinder) 16.9" - 21.6" (high cylinder)	23.25" - 30.75"
Seat Depth (Adjustable)	16.9" - 19.4" (range includes reclined position)	16.9" - 19.4" (range includes reclined position)
Seat Width	19.6"	19.6"
Seat Pan Angle (Adjustable)	-5° - +7° (range includes forward and reclined positions)	-5° - +7° (range includes forward and reclined positions)
Back*		
Backrest Height	22.8"	22.8"
Backrest Width	18.5"	18.5"
Lumbar Support (Fixed)	7"	7"
Lumbar Support (Adjustable)	Exceeds 5.9" - 9.9" (optional lumbar)	Exceeds 5.9" - 9.9" (optional lumbar)
Angle Between Seat and Back	94° - 120°	94° - 120°
Tilt Range of Back	26°	26°
Arms*		
Armrest Height (Fixed)	8.5" (fixed arm)	8.5" (fixed arm)
Armrest Height (Adjustable)	6.9" - 9.4" (adjustable) 8.3" - 10.8" (tall adjustable)	6.9" - 9.4" (adjustable) 8.3" - 10.8" (tall adjustable)
Inside Distance Between Armrests (Fixed)	19.5" (fixed)	19.5" (fixed)
Inside Distance Between Armrests (Adjustable)	18.5" - 20.5" (adjustable and tall adjustable)	18.5" - 20.5" (adjustable and tall adjustable)

\* All measurements taken with BIFMA Chair Measuring Device using the Universal Measurement Procedure which has a measurement uncertainty of ± 5%

**Chadwick Chair Measurements**

	Chadwick**	Chadwick High Task
A. Overall Height	37.5" - 42"	44.5" - 52"
B. Overall Width	26.5"	26.5"
C. Overall Depth	25.5"	25.5"
D. Arm Height from Floor	25.5" - 30" (fixed arm) 24" - 31" (adjustable) 24.75" - 31.75" (tall adjustable)	32.5" - 40" (fixed arm) 31" - 41" (adjustable) 31.75" - 41.75" (tall adjustable)
E. Base Diameter	26.5"	26.5"
Weight	37 lbs. (with arms)	41 lbs. (with arms)

\*\*Standard cylinder

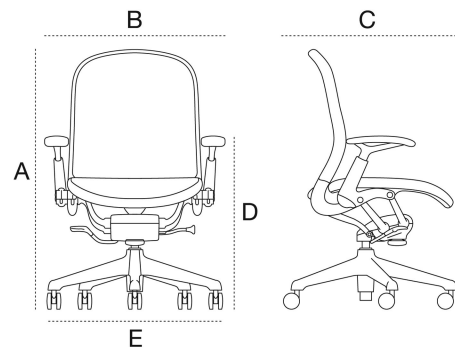

**Chadwick - Additional Information**

- Synchronized recline ratio seat : back is 1° : 1.2°
- Adjustable and tall adjustable arms adjust 2" in armpad width (1" per side) with 5/32" Allen wrench
- Optional lumbar measures 11.25" x 4.4"
- Chadwick High Task footring measures 19.875" in diameter
- Chadwick High Task footring adjusts 5" in height by a single lever mechanism with 11 locking positions in 1/2" increments

- Compliance: ANSI/BIFMA X5.1 : 2011 (U.S. structural standard)
- ANSI/HFES 100-2007 (U.S. ergonomic standard)
- BIFMA G1 : 2002 (U.S. ergonomic guidelines)
- California T.B. 117 (U.S. flammability standard for foam)
- California T.B. 133 (U.S. flammability standard for full chair)

The Chadwick chair line has been tested and is approved for use by individuals weighing up to 300 pounds.

**Chadwick® Operating Instructions**

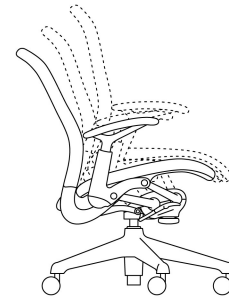

**Synchronized Recline with Tilt Tension**  
Chadwick has a synchronized recline that allows the torso to open up while reclining. To customize the tension of the recline, adjust the tension knob. To decrease the tension, turn the tension knob clockwise (while seated in the chair), and turn it counterclockwise to increase the tension. The underside of the knob also indicates the instructions with arrows.

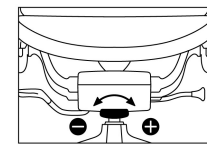

Front View

**Seat Height Adjustment**

To raise the seat height, remove your weight from the chair while lifting the lever on the right side of the chair. To lower the seat height, lift the lever while sitting in the chair.

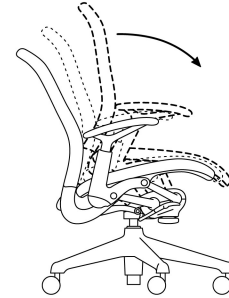
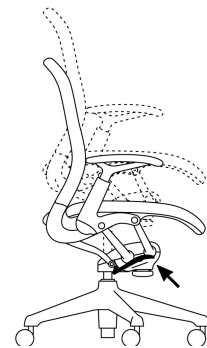

**Forward Tilt**

Chadwick has a built-in forward tilt that automatically follows and supports the user in the forward posture for typing. No adjustment is required.

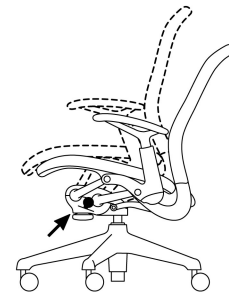

**Tilt Stop (Option)**

The tilt stop is an upright tilt limiter. When specified, it is the lever on the left side of the chair. If your chair does not have a lever on the left side of the chair, it does not have this feature. The in-and-out lever design operates with an audible click, whereby "out" is engaged, "in" is not engaged.

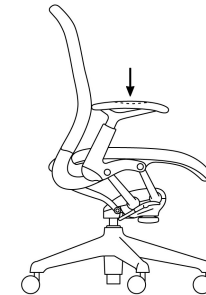

**Spring Loaded Arms**

Both fixed and adjustable armpads have a spring suspension, which provides the user with armpad softness and flexibility.

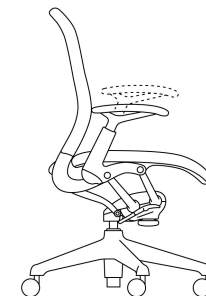

**Adjustable Arm Height (Option)**

The arm height is adjusted by lifting the armpads upward. No lever is required. Simply move the arms up in five, 1/2" increments for a total of 2 1/2". To lower the arms, lift them to the highest point and at the highest point pull up firmly; and they will return to the lowest point. The arm height adjustment is easy to maneuver with one hand.

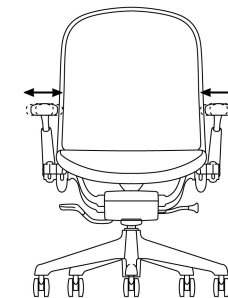

**Adjustable Arm Width (Option)**

The armpads have a width adjustment of 1/2" inward or 1/2" outward for 1" in total adjustability on each side. A 5/32" Allen wrench is required to adjust the armpad width.

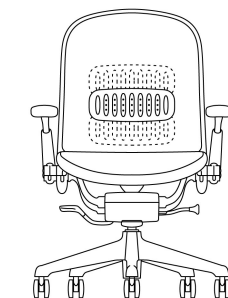

**Adjustable Lumbar (Option)**

Chadwick has an adjustable lumbar support, if needed. It is secured to the chair with magnets for easy installation and a maximum range of adjustability.

Separate both halves of the lumbar support and place them in the desired position on your chair. Secure the support by putting both halves together around the back suspension fabric of the chair.



Adjust the lumbar by sliding the lumbar pad up and down the back of the chair.

Note: Contains magnets. Consult the Knoll lumbar support hangtag for more information.

**EWC Pro™**  
*upholstered mid-back task chair*  
*synchronized tilt control*

*Designer(s):*  
 Jeffrey Bernett and  
 Nicholas Dodziuk, 2005



arm	description	pattern no.
Armless 	Upholstered mid-back task chair with plastic outer back, 2.5" back height adjustment, plastic base, synchronized control	<b>77W-MB-2-SY-NA-5-HC</b>
Height/width adjustable arms 	Upholstered mid-back task chair with plastic outer back, 2.5" back height adjustment, plastic base, synchronized control,	<b>77W-MB-2-SY-HA-5-HC</b>
High performance arms 	Upholstered mid-back task chair with plastic outer back, 2.5" back height adjustment, plastic base, synchronized control	<b>77W-MB-2-SY-HP-5-HC</b>

list price	base grade	grades	COM	C	D	E	F	G	H	I	T	COL	V	W	X	Y
		A	B									U				
\$732.		\$740.	\$760.	\$788.	\$821.	\$851.	\$887.	\$908.	\$915.	\$936.	\$1,249.	\$1,414.	\$1,569.	\$1,840.	n/a	\$2,091.
833.		840.	861.	888.	921.	952.	988.	1,005.	1,014.	1,038.	1,350.	1,514.	1,671.	1,942.	n/a	2,194.
851.		858.	879.	908.	939.	970.	1,005.	1,027.	1,033.	1,055.	1,370.	1,533.	1,688.	1,959.	n/a	2,210.

Order Code	Ordering Information	Options
<i>Example:</i> <b>77W-MB-2-SY-HA-5-SL-HC K1000/8</b>	<i>Specify:</i> 1. Pattern number 2. Seat and back upholstery	<i>Cylinder Height Option:</i> For low height cylinder (plastic base only), replace 5 in pattern number with L. See Dimensions page for seat height range.  <i>Code: Upchg: Description:</i> L \$73 low cylinder
<b>77W</b> EWC Pro task chair	<i>Finish color:</i> Black	<i>Caster and Glide Options:</i> Substitute HC in pattern with one of the following options:  <i>Code: Upchg: Description:</i> SC n/c soft black casters for hard surfaces GL n/c glides
<b>MB</b> Mid-back	<b>Options</b>	<i>Sliding Seat Option:</i> For sliding seat with 2.75" of depth adjustment insert SL after cylinder choice in pattern number. Adds 0.5" to seat height.  <i>Code: Upchg: Description:</i> SL \$41 sliding seat
<b>2</b> Black finish	<i>Polished Aluminum Base:</i> Replace 2 in pattern with 4. Only available with standard height cylinder.  <i>Code: Upchg: Description:</i> 4 \$156 polished aluminum base	
<b>SY</b> Synchronized tilt control		
<b>HA</b> Height and width adjustable arms		
<b>5</b> Standard height cylinder		
<b>SL</b> Sliding seat		
<b>HC</b> Hard wheel black casters		
<b>K1000/8</b> Presto, Red Carpet		

Presto - Base Grade Fabric	Split Upholstery:	CAL 133 Options:	COM/COL Upholstery Requirements
<i>Color options:</i> Presto Winter White K1000/1 Presto Sand K1000/2 Presto Stone K1000/3 Presto Saffron K1000/4 Presto Spring Green K1000/5 Presto Blue Chip K1000/6 Presto Scarlet K1000/7 Presto Red Carpet K1000/8 Presto Beige Taupe K1000/9 Presto Olive K1000/10 Presto Navy Blue K1000/11 Presto Clear Gray K1000/12 Presto Charcoal Gray K1000/13 Presto Black Tie K1000/14	EWC Pro seats and backs can be upholstered in any two approved KnollTextiles or Spinneybeck upholsteries. To specify, first indicate the seat upholstery (labeled "seat upholstery") and then indicate the back upholstery (labeled "back upholstery"). The list price of the chair equals the list price of the higher of the two upholstery grades.	<i>Code: Upchg: Description:</i> C133 \$81 CAL 133 textile on seat and back (add C133 to the end of the pattern number)	Textile yardage required: 2 yards Leather sq. ft. required: 28 sq. ft.

EWC Pro™  
upholstered side chair

Designer(s):  
Jeffrey Bernett and  
Nicholas Dodziuk, 2005



arm	description	pattern no.
Fixed arms	Upholstered side chair with plastic outer back	<b>77S-2-FA-HC</b>
Armless	Upholstered side chair with plastic outer back	<b>77S-2-NA-HC</b>



list price	base grade	grades	COM	C	D	E	F	G	H	I	T	COL	V	W	X	Y
		A	B									U				
\$457.		\$462.	\$480.	\$506.	\$533.	\$563.	\$594.	\$609.	\$619.	\$637.	\$955.	\$1,110.	\$1,264.	\$1,523.	n/a	\$1,767.
424.		429.	449.	473.	504.	531.	566.	581.	590.	611.	937.	1,100.	1,256.	1,527.	n/a	1,776.

Order Code	Ordering Information	Options
<i>Example:</i> <b>77S-2-FA-HC K1000/10</b>	<i>Specify:</i>	<i>Caster and Glide Options:</i>
<b>77S</b> EWC Pro side chair	1. Pattern number	Substitute HC in pattern with one of the following options:
<b>2</b> Black finish	2. Seat and back upholstery	
<b>FA</b> Fixed arms	<i>Finish color:</i>	<i>Code: Upchg: Description:</i>
<b>HC</b> Hard wheel black casters	Black	SC n/c soft black casters for hard surfaces
<b>K1000/10</b> Presto Olive		GL n/c glides

Presto - Base Grade Fabric			CAL 133 Options:		COM/COL Upholstery Requirements
<i>Color options:</i>	<i>Split Upholstery:</i>		<i>Code: Upchg: Description:</i>		Textile yardage required: 1.8 yards Leather sq. ft. required: 25 sq. ft.
Presto Winter White K1000/1	EWC Pro seats and backs can be upholstered in any two approved KnollTextiles or Spinneybeck upholsteries. To specify, first indicate the seat upholstery (labeled "seat upholstery") and then indicate the back upholstery (labeled "back upholstery"). The list price of the chair equals the list price of the higher of the two upholstery grades.		C133 \$58 CAL 133 textile on seat and back (add C133 to the end of the pattern number)		
Presto Sand K1000/2					
Presto Stone K1000/3					
Presto Saffron K1000/4					
Presto Spring Green K1000/5					
Presto Blue Chip K1000/6					
Presto Scarlet K1000/7					
Presto Red Carpet K1000/8					
Presto Beige Taupe K1000/9					
Presto Olive K1000/10					
Presto Navy Blue K1000/11					
Presto Clear Gray K1000/12					
Presto Charcoal Gray K1000/13					
Presto Black Tie K1000/14					

seat and back replacements for task and side chairs

Designer(s):  
Jeffrey Bennett and  
Nicholas Dodziuk, 2007



description	pattern no.
Replacement upholstered seat for EWC Pro task chairs	<b>ESSENWORKSEAT</b>
Replacement upholstered EWC Pro Task Midback with plastic outer back and 2.5" back height adjustment	<b>77WMIDBACK</b>
Replacement upholstered seat for EWC Pro side chairs	<b>ESSENSIDSEAT</b>
Replacement upholstered EWC Pro Side back with plastic outer back	<b>77SBACK</b>

list price	base grade	grades	COM	C	D	E	F	G	H	I	T	COL	V	W	X	Y
		A	B									U				
\$126.		\$153.	\$168.	\$189.	\$215.	\$237.	\$265.	\$279.	\$284.	\$304.	\$341.	\$401.	\$466.	\$577.	n/a	\$679.
306.		345.	368.	397.	434.	469.	510.	528.	541.	566.	685.	801.	913.	1,108.	n/a	1,287.
129.		161.	176.	197.	222.	243.	271.	283.	291.	308.	344.	406.	468.	577.	n/a	676.
188.		226.	246.	272.	302.	331.	361.	382.	388.	408.	508.	603.	697.	857.	n/a	1,005.

Order Code	Ordering Information	Presto - Base Grade Fabric	Options
Example: <b>ESSENWORKSEAT - K1000/8</b>	Specify: 1. Pattern number 2. Textile	Color options: Presto Winter White K1000/1 Presto Sand K1000/2 Presto Stone K1000/3 Presto Saffron K1000/4 Presto Spring Green K1000/5 Presto Blue Chip K1000/6 Presto Scarlet K1000/7 Presto Red Carpet K1000/8 Presto Beige Taupe K1000/9 Presto Olive K1000/10 Presto Navy Blue K1000/11 Presto Clear Gray K1000/12 Presto Charcoal Gray K1000/13 Presto Black Tie K1000/14	CAL 133 Options: Code: Upchg: Description: C133 \$52 CAL 133 textile on seat. (add C133 to the end of the pattern number)  Code: Upchg: Description: C133 \$52 CAL 133 textile on back. No additional upcharge for upholstered outer back (add C133 to the end of the pattern number)
<b>ESSENWORKSEAT</b> Upholstered seat replacement	<b>COM/COL Upholstery Requirements</b> See yardage requirements on respective price list pages.		
<b>K1000/8</b> Presto, Red Carpet			



## EWC Pro Ergonomic Dimensions

Seat*	Mid-back Task	Side
Seat Height**	16.25" - 20.75" (standard cylinder) 15.5" - 19.6" (standard cylinder, aluminum base) 15" - 19" (low cylinder) **sliding seat option adds 0.5" to all seat height dimensions	17"
Seat Depth	16.9" (fixed); 16.25" - 19" (adjustable)	16.9"
Seat Width	19"	19"
Seat Pan Angle (at rest)	2°	2°
Back*		
Backrest Height	22" - 24.5"	17.5"
Backrest Width	18"	18.5"
Lumbar Support	5.75" - 8.75"	6.75"
Angle between Seat and Back	96°	103°
Tilt Range of Back	24° (synchro); 14° (swivel)	N/A
Arms*		
Armrest Height (fixed)	8.2" (fixed)	9.4"
Armrest Height (adjustable)	7" - 10.5" (height adjustable) 7.875" - 11" (high performance)	N/A N/A
Inside Distance between Armrests (fixed)	19.5" - 21.5" (fixed)	19.5"
Inside Distance between Armrests (adjustable)	19.5" - 21.5" (height adjustable) 18.5" - 20.625" (high performance)	N/A

\*All measurements taken with the BIFMA Chair Measuring Device using the Universal Measurement Procedure which has a measurement uncertainty of ± 5%

## Chair Measurements\*\*\*

A. Overall Height	36.75" - 43.75" (plastic base); 36" - 42.6" (aluminum base)	32"
B. Overall Width	27"	21.75" (armless); 24.3" (with arms)
C. Overall Depth	27" (plastic base); 26.75" (aluminum base)	24"
D. Fixed Arm Height from Floor	24.2" - 28.7"	25.8"
Height Adj. Arm Height from Floor	23" - 31.5"	N/A
High Perf. Arm Height from Floor	22.875" - 30.5"	N/A
E. Recline Range	96° - 120° (synchro); 96° - 110° (swivel)	N/A
Back Recline Ratio	1:3 (synchro); 1:1 (swivel)	N/A
F. Base Diameter	27" (plastic base); 26.75" (aluminum base)	N/A
Weight	41.3 lbs. (plastic base); 43.3 lbs. (aluminum base)	20.2 lbs. (armless); 23.5 lbs. (with arms)

\*\*\*standard cylinder; sliding seat option adds 0.5" to overall height and arm height from floor

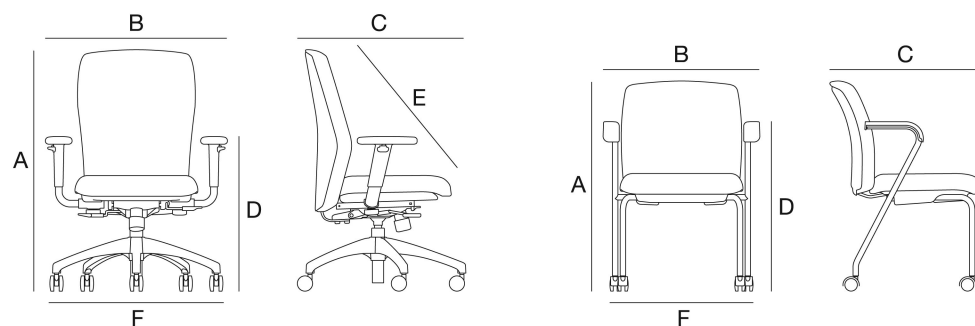

Compliance: ANSI/BIFMA X5.1 : 2011 (U.S. structural standard)  
ANSI/HFES 100-2007 (synchro control) (U.S. ergonomic standard)  
BIFMA G1 : 2002 (U.S. ergonomic guidelines)  
California T.B. 117 (U.S. flammability standard for foam)  
California T.B. 133 with approved FR textile (U.S. flammability standard for full chair)  
CAN/CGSB 44.232-2002; BS EN 13761 : 2002 (British visitor chair standard, EWC Pro side)

The EWC Pro chair line has been tested and is approved for use by individuals weighing up to 300 pounds.

## EWC Pro Mid-back Task Chair Operating Instructions

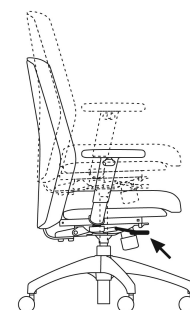

### Seat Height

To raise the seat height, remove your weight from the chair while lifting the lever under the right side of the seat. To lower the seat height, lift the lever while sitting in the chair.

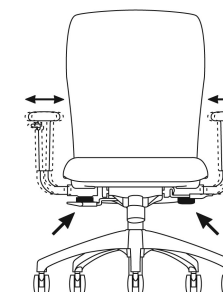

### Adjustable Arm Width (All arm options)

To adjust the arm width, loosen the knob under the arm support by turning clockwise. Slide the arm support toward or away from the seat to adjust the arm width. Tighten the knob under the arm to secure.

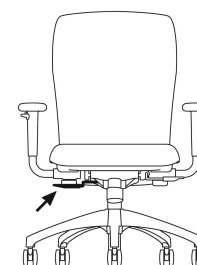

### Tilt Lock

To recline, pull out the lever under the right side of the seat. To lock the chair upright, push the lever in.

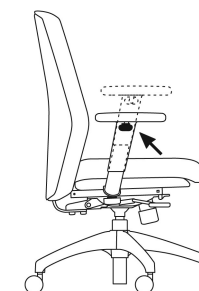

### Height Adjustable Arm (Optional)

To adjust the arm pad height, lift the lever on the outside of the arm support and move the arm up or down. Release the lever to lock.



### Tilt Tension

To adjust the tilt tension, turn the knob under the front of the seat. Turn counterclockwise to tighten, and clockwise to loosen. The tension adjustment provides a variable limiting function allowing the user to customize ranges of recline between upright and full recline.

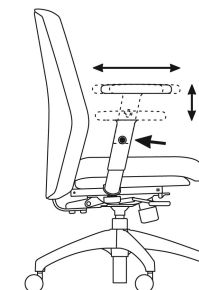

### High Performance Arm (Optional)

To adjust the arm pad height, push the button on the outside of the arm support and move the arm up or down. Release the button to lock. To adjust arm pad depth, grasp arm pad and push forward or pull backward. The arm pad adjusts 2.5" in depth.

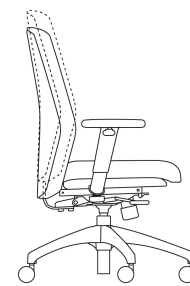

### Back Height

To raise the back height, firmly hold both sides of the back and lift. The back height adjusts 9 notches upward. To lower the back height, first raise the back to the highest position; the top notch releases the back to the lowest position.

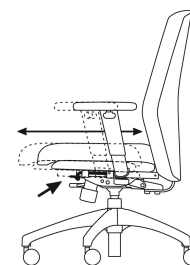

### Sliding Seat Depth Adjustment (Optional)

To adjust the seat depth, lift the lever under the left side of the seat and slide the seat to the desired location. Release the lever to lock in one of the 6 positions

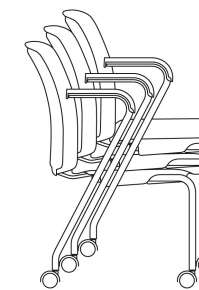

## EWC Pro Side Chair

### This is a stacking side chair.

Chairs should not be stacked more than 3 units high. To stack chairs, place the rear legs of the top chair in front of the rear legs of the bottom chair. The bottom of the top chair's seat should rest on the lower chair's seat.

# Moment™ side chair

Designer(s):  
Jeffrey Bennett and  
Nicholas Dodziuk, 2007



arm	description	pattern no.
fixed	Cantilevered side chair with painted frame, stacks 4 high on the floor	<b>9-A-SL-S</b>
<b>9RSEAT</b>	Replacement upholstered seat assembly	<b>9RSEAT</b>

list price	base grade	grades	COM	C	D	E	F	G	H	I	T	COL	V	W	X	Y
		A	B									U				
\$555.		\$573.	\$597.	\$605.	\$630.	\$650.	\$666.	\$697.	\$738.	\$753.	\$812.	\$861.	\$967.	\$1,103.	\$1,162.	\$1,222.
226.	250.	271.	289.	305.	326.	340.	359.	399.	431.	503.	557.	670.	818.	882.	947.	

Order Code	Ordering Information	Finish Options
<i>Example:</i> <b>9-A-SL-S-2-AB-K1000/14</b>	<i>Specify:</i>	<i>Frame:</i>
<b>9</b> Moment side chair	1. Pattern number	Select one of the following frame finishes
<b>A</b> Arms	2. Frame finish color	<i>Code: Upchg: Description:</i>
<b>SL</b> Sled base	3. Back color	2 n/c Black
<b>S</b> Upholstered seat	4. Upholstery selection	3 n/c Metallic Grey
<b>2</b> Black frame finish		4 n/c Metallic Silver
<b>AB</b> Almost Black back		C \$156 Trivalent Chrome
<b>K1000/14</b> Presto, Black Tie		<i>Back:</i>
		Select one of the following back colors
<i>Example for Cal 133:</i>		<i>Code: Upchg: Description:</i>
<b>9-A-SL-S-2-AB-C-K1000/14-133</b>		AB n/c Almost Black
		CH n/c Charcoal
		RD n/c Red
		OR n/c Orange
		WH n/c White

Presto - Base Grade Fabric	Textile Options
<i>Color options:</i>	<i>Knoll Textiles fabrics and Spinneybeck leathers:</i>
Presto, Winter White K1000/1	Please refer to the textile matrices at the beginning of the price list for approved fabrics and leathers.
Presto, Sand K1000/2	
Presto, Stone K1000/3	
Presto, Saffron K1000/4	
Presto, Spring Green K1000/5	
Presto, Blue Chip K1000/6	
Presto, Scarlet K1000/7	
Presto, Red Carpet K1000/8	
Presto, Beige Taupe K1000/9	
Presto, Olive K1000/10	
Presto, Navy Blue K1000/11	
Presto, Clear Gray K1000/12	
Presto, Charcoal Gray K1000/13	
Presto, Black Tie K1000/14	
	<i>CAL 133:</i>
	See textile matrices at the beginning of the price list for pre-approved Cal 133 textiles. # = Cal 133 pre-approved
	Insert C after back color and 133 after upholstery selection
	<i>Code: Upchg: Description:</i>
	C()133 \$52 Cal 133 compliant textile
	<i>Customer's Own Material/Leather:</i>
	See Customer's Own Material Seating Process Overview at the beginning of the price list
	COM/COL Textile Requirements
	Fabric yards 0.8 yards
	Leather square feet 14 sq. ft.

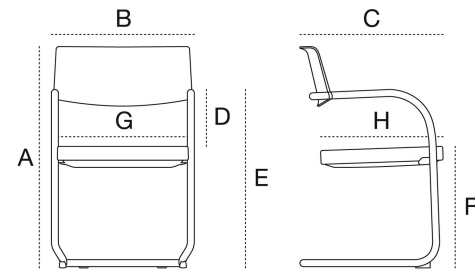

**Moment Chair Measurements**

A. Overall Height	32.5"
B. Overall Width	21"
C. Overall Depth	21"
D. Arm Height from Seat	8.5"
E. Arm Height from Floor	26.25"
F. Seat Height	17.75"
G. Seat Width	19"
H. Seat Depth	17.5"
Weight	24 lbs.

**Stacking Instructions**

Moment stacks up to 4 units high on the floor and features a non-marking cosmetic cover under the seat that reduces fabric wear from stacking.

To stack chairs, place the top chair seat on top of the seat of the chair below. The base of the top chair fits between the legs of the lower chair and rests on top of the lower chair base.

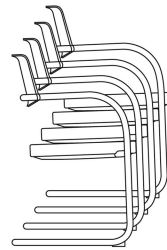

**Construction Information**

Frame	Powder coat or trivalent chrome over steel
Back structure	Integrally colored, textured, glass reinforced nylon
Back bar	Powder coat or trivalent chrome over aluminum die cast
Seat upholstery plate	Integrally colored polypropylene
Seat cosmetic cover	Integrally colored, textured, impact modified polypropylene
Upholstery	High resiliency molded urethane foam with textile cover
Tip stops and glides	Black, integrally colored, molded nylon
Fasteners and hardware	Steel

**Environmental Information**

SMaRT®	Moment is SmaRT® Sustainable Gold Certified
GREENGUARD	Moment is GREENGUARD and GREENGUARD Gold
Powder Coat	Knoll metal powder coating processes are 99% VOC-free
Trivalent Chrome	Trivalent chrome uses a safer, more environmentally friendly process to achieve a chrome finish

Compliancy: ANSI/BIFMA X5.1 : 2011 (U.S. structural standard)  
 California T.B. 117 (U.S. flammability standard for foam)  
 California T.B. 133 with approved FR textile (U.S. flammability standard for full chair)  
 The Moment chair has been tested and is approved for use by individuals weighing up to 300 lbs.

This page intentionally left blank.

	model	description	pattern number
<p><i>Designer(s):</i> Antenna Design, 2013</p> 	sled base chair desk	sled base chair with curved back that serves as backrest, armrest or tablet work surface	<b>ACT-TB-1-GL</b>
	pull up table	pull up table that also serves as a place to perch	<b>ACT-TB-2-GL</b>
	seat	generous seat that can also serve as a table in lounge settings	<b>ACT-TB-3-GL</b>
	bench	2 + person bench that can also serve as a table in lounge settings	<b>ACT-TB-4-GL</b>

	list price laminate	veneer	accent laminate
	\$682.	\$734.	\$804.
	636.	687.	748.
	1,119.	1,221.	1,323.
	1,628.	1,750.	1,882.

Order Code	Ordering Information	Finish Options
<i>Example:</i> <b>ACT-TB-1-GL-118-130-130</b>	<i>Specify:</i>	<i>Frame:</i>
<b>ACT</b> Activity Spaces	1. Pattern number	Select one of the following frame finishes
<b>TB</b> Toboggan	2. Frame finish	<i>Code: Description:</i>
<b>1</b> Sled base chair	3. Tablet finish	111T Jet Black
<b>GL</b> Glides	4. Seat finish	115T Medium Grey
<b>118T</b> Bright White frame finish		118T Bright White
<b>130</b> Dark Red laminate tablet finish		130T Dark Red
<b>130</b> Dark Red laminate seat finish		131T Slate Blue
		<i>Tablet:</i>
		Select one of the following tablet finishes
		<i>Code: Description:</i>
		111 Jet Black laminate
		115 Medium Grey laminate
		118 Bright White laminate
		130 Dark Red accent laminate
		131 Slate Blue accent laminate
		VWO White Oak veneer
		GSO Grey Stained Oak veneer
		<i>Seat:</i>
		Select one of the following seat finishes
		<i>Code: Description:</i>
		111 Jet Black laminate
		115 Medium Grey laminate
		118 Bright White laminate
		130 Dark Red accent laminate
		131 Slate Blue accent laminate
		VWO White Oak veneer
		GSO Grey Stained Oak veneer
		<b>Note:</b> Dark Red and Slate Blue accent laminates are priced differently than standard laminate colors.
		<b>Note:</b> Grey Stained Oak veneer is not available on the sled base chair desk.

<i>Split finishes:</i>	<i>CAL 133:</i>
For split finishes on tablet and seat, list price defaults to higher list price.	Toboggan is CAL 133 approved standard. No options or upcharge required.

Dimensions	Sled Base Chair Desk	Pull-up Table	Seat	Bench
A. Overall Height	27.1"	24.5"	15.8"	15.8"
B. Overall Width	16.2"	18.4"	29.0"	56.0"
C. Width of Seat	16.2"	-	27.0"	54.0"
D. Width of Tablet	15.0"	17.9"	-	-
E. Overall Depth	27.2"	16.4"	15.8"	15.8"
F. Depth of Seat	14.2"	-	15.5"	15.5"
G. Depth of Tablet	10.4"	13.0"	-	-
H. Seat Height	16.1"	-	-	-
Weight	19 lbs.	22 lbs.	21 lbs.	32 lbs.

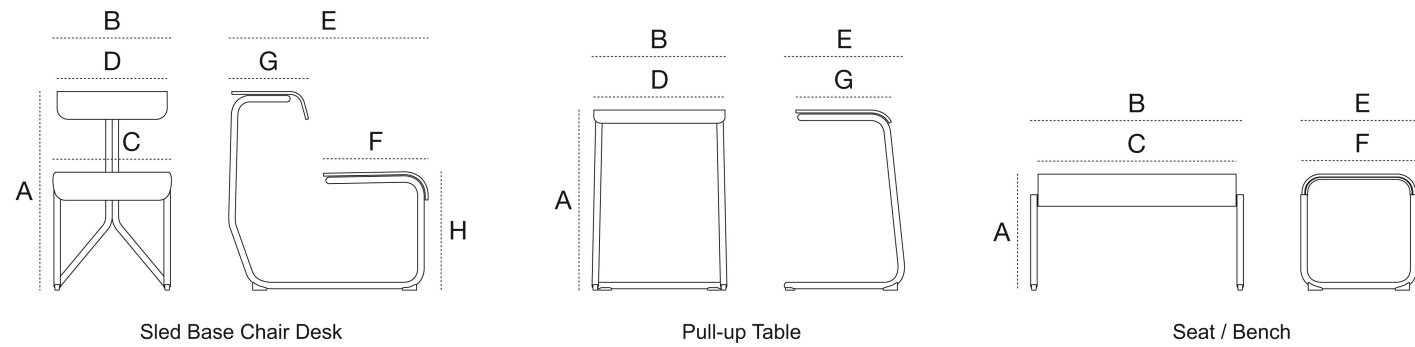

**Construction Information**

Frame	Powder-coated steel
Seat and tablet	Molded plywood with laminate or veneer surfaces
Tip stops and glides	Molded nylon
Fasteners and hardware	Steel

**Environmental:** GREENGUARD and GREENGUARD Gold certified, and can contribute to achieving LEED® credits.

**Compliance:** ANSI/BIFMA X5.1 : 2011 (U.S. structural standard)  
 The Toboggan chair has been tested and is approved for use by individuals weighing up to 300 pounds.  
 California T.B. 133 (U.S. flammability standard for full chair)

**Warranty:** Toboggan is warranted for 24-hour, 7 days a week, multi shift use:  
 12 years parts and labor to repair. See Knoll Selling Policy for further details, conditions and exclusions.

# Alpha-Numeric Index

<i>pattern no.</i>	<i>page</i>	<i>pattern no.</i>	<i>page</i>
11-1-FA-2-S-X-HC	40	77W-MB-2-SY-HP-5-HC	90
11-1-HA-2-S-X-HC	40	77W-MB-2-SY-NA-5-HC	90
11-1-HP-2-S-X-HC	40	77WMIDBACK	94
11-1-NA-2-S-X-HC	40	9-A-SL-S	98
2-B-C-N-X	60	9RSEAT	98
2-C-C-N-X	60	ACT-TB-1-GL	102
2-H-A-N-X-GL	58	ACT-TB-2-GL	102
2-H-C-N-X-GL	58	ACT-TB-3-GL	102
2-S-A-N-X-GL	58	ACT-TB-4-GL	102
2-S-C-N-X-GL	58	ESSENSIDESEAT	94
2SDOLLY	58	ESSENWORKSEAT	94
2SEAT	58, 60	GENSEAT	40
2SGA	58	REGENSEAT	46, 48, 50, 52
33-AA-1-BK-B-S-X-HC	80	REMIXSEAT	66, 68
33-AA-1-BK-T-S-X-HC	78	S	58, 60
33-AA-2-BK-B-S-X-HC	84		
33-AA-2-BK-T-S-X-HC	82		
33-FA-1-BK-B-S-X-HC	80		
33-FA-1-BK-T-S-X-HC	78		
33-FA-2-BK-B-S-X-HC	84		
33-FA-2-BK-T-S-X-HC	82		
33-NA-1-BK-B-S-X-HC	80		
33-NA-1-BK-T-S-X-HC	78		
33-NA-2-BK-B-S-X-HC	84		
33-NA-2-BK-T-S-X-HC	82		
44-1-HA-2-S-X-HC	46		
44-1-HA-2-T-X-HC	50		
44-1-HP-2-S-X-HC	46		
44-1-HP-2-T-X-HC	50		
44-1-NA-2-S-X-HC	46		
44-1-NA-2-T-X-HC	50		
44-2-HA-2-S-X-HC	48		
44-2-HA-2-T-X-HC	52		
44-2-HP-2-S-X-HC	48		
44-2-HP-2-T-X-HC	52		
44-2-NA-2-S-X-HC	48		
44-2-NA-2-T-X-HC	52		
55BACKTOPPER	32		
55C-3	24, 26, 28, 30		
55FABRICTOPPER	32		
55H-3	24, 26, 28, 30		
55HEADREST	32		
55LUMBAR	32		
55M-3	24, 26, 28, 30		
55P-3	24, 26, 28, 30		
55SEATTOPPER	32		
64-S-X-GL	74		
66-W-AL-2-S-X-HC	66		
66-W-HA-2-S-X-HC	66		
66-W-HP-2-S-X-HC	66		
66-W-NA-2-S-X-HC	66		
66-W-PL-2-S-X-HC	66		
67-H-AL-2-S-X-HC	68		
67-H-HA-2-S-X-HC	68		
67-H-HP-2-S-X-HC	68		
67-H-NA-2-S-X-HC	68		
67-H-PL-2-S-X-HC	68		
77S-2-FA-HC	92		
77S-2-NA-HC	92		
77SBACK	94		
77W-MB-2-SY-HA-5-HC	90		



# Selling Policy

	<p>This Selling Policy supercedes all previous selling policies. Prices, discounts and product offerings are subject to change without notice.</p>
<b>Terms &amp; Conditions of Sales</b>	<p>Sales by Knoll, Inc. or Knoll North America Corp. ("Seller") of Knoll Product Lines (hereinafter "Products") within the United States and Canada are made only on the terms which are contained in this Selling Policy. Seller hereby gives notice of its objection to any different or additional terms and conditions. This sale is expressly conditional upon Purchaser's assent to the terms and conditions set forth below. Additional terms and conditions may apply to KnollStudio and KnollTextiles orders. These terms and conditions may be modified or supplemented only by a written document signed by an authorized representative of Seller. These terms and conditions supercede any prior and/or contemporaneous agreements or correspondence between Purchaser and Seller. Written quotations expire thirty (30) days from the date of issuance and can be withdrawn by written notice anytime during that period. Where Purchaser and Seller have entered into the Knoll Electronic Terms and Conditions, all orders, acknowledgements, invoices and other business communications placed or transmitted in accordance with the Knoll Electronic Terms and Conditions shall be deemed to be in writing and signed and shall be valid for all purposes as if they were originated and maintained in documentary form.</p>
<b>Ordering Information</b>	<p>All orders must be in writing. The product pattern number(s) contained on Seller's order acknowledgement shall be the final expression of the order.</p>
<b>Order Confirmation</b>	<p>A purchase order is not binding on Seller until Purchaser has received Seller's order confirmation or acknowledgment.</p>
<b>Pricing Policies</b>	<p>List prices are subject to change without notice.</p> <p>List prices shall be those prices in effect on the date of receipt of a complete purchase order unless shipment is requested more than ninety (90) days after order entry in which case prices in effect on the date of shipment apply. List prices include specified freight costs. Unless specified in writing by Seller, no other charges are included in Seller's list prices.</p>
<b>Taxes</b>	<p>All sales, use, excise and other taxes applicable to the sale of the Products shall be paid by Purchaser. If Purchaser claims an exemption from any tax, Purchaser shall submit to Seller the appropriate exemption certificates.</p>
<b>Terms of Payment</b>	<p>Payment for one hundred percent (100%) of the net order amount is due within thirty (30) days of the date of invoice, which is generally issued upon shipment. In case of any discrepancies, such as shortages, and Seller is notified in writing within ten (10) days of receipt of Product, only that portion may be deducted and the balance paid. For orders greater than \$100,000 net, a fifty percent (50%) deposit is due at the time of order placement, with the remainder due within thirty (30) days of the date of invoice.</p> <p>KnollStudio orders less than \$2,000 require payment for one hundred percent (100%) of the net order amount (including any applicable sales tax and charges for inside delivery, special packaging, etc.), due at time of order placement. For KnollStudio orders greater than \$2,000, a one-half (50%) deposit is due at time of order placement with the remainder (including any applicable sales tax and charges for inside delivery, special packaging, etc.) due prior to shipment.</p> <p>If, in the judgment of Seller, Purchaser's financial condition does not justify the terms of the payment, Seller may require full or partial payment in advance.</p> <p>Past due accounts shall be charged one and one-half percent (1.5%) per month, or the highest rate permitted by law, whichever is less, and will be added to the outstanding balance. In the event Purchaser defaults on payment, Purchaser shall be liable for all collection costs, including reasonable attorney's fees and costs.</p>
<b>Changes and Cancellation</b>	<p>Purchase orders may not be changed or cancelled, in whole or in part, without prior written consent of Seller. Changes may effect delivery dates. Expenses incurred because of changes shall be charged to Purchaser. In the event of cancellations, Purchaser will be liable for reasonable cancellation charges established by Seller. Orders for special Product, orders including "COM" (hereinafter defined) material and orders pursuant to expedited delivery programs, may not be canceled.</p>
<b>Freight Prepaid</b>	<p>Freight is prepaid and included in the price of all Products, except KnollTextiles, within the 48 contiguous United States for orders placed with Knoll, Inc. and within Canada, excluding the Yukon, Northwest Territories, Nunavut and Newfoundland for orders placed with Knoll North America Corp. Packing is tested for rigorous motion and transportation but is not guaranteed to protect furniture from all conditions. If special packaging is required for any reason, please consult with your sales representative or dealer. Seller shall select the method of shipment and routing. Freight for all KnollTextiles orders is prepaid and added to the invoice.</p>
<b>Delivery/Freight Charges</b>	<p>Shipments outside the contiguous 48 United States and Canada shall be shipped F.O.B. Origin.</p> <p>For shipments outside the contiguous United States and Canada, Purchaser is responsible for the cost of freight from point of embarkation, including any handling and transportation charges incidental to loading at the point of departure and unloading at the final destination.</p> <p>Conditions beyond the control of Seller, including weather, available facilities and traffic conditions, may affect exact time of delivery. Seller shall not be responsible for specific carrier delivery date or time unless it has made a specific delivery commitment, in writing.</p> <p>Nonstandard methods of shipment and/or additional services are available upon request. Purchaser will be billed for the differential cost of any special services in excess of standard surface carrier freight costs. Premium charges, at Purchaser's request, will be added for airfreight, exclusive use of vehicle and extra, export or special packaging. Accessorial charges will be added for inside delivery, extra labor, reassignment and redelivery.</p> <p>Partial shipments may be made and invoiced by Seller.</p>
<b>Claims</b>	<p>All shipments for Knoll Products within the contiguous United States and Canada are F.O.B. Origin. All risk of loss passes to Purchaser at time of delivery to carrier. Purchaser shall inspect all Products upon receipt and notify Seller within ten (10) working days after receipt of any damage or defects which are, or should be, apparent from an inspection of the Product and its packaging. Failure of Purchaser to notify Seller during the ten (10) working day period shall constitute acceptance of the Products and waiver of any apparent defects, errors or shortages. For all claims relating to Product damaged in transit or for any other claims relating to or arising out of the transportation of the Product, Purchaser must seek recovery from the carrier and Seller has no liability to Purchaser for such claims. Seller may, upon request, assist Purchaser with filing of such claims with the carrier, but Seller will not be liable for any of these transportation related claims.</p>
<b>Seller's Security Interest</b>	<p>Until Seller receives the full payment for the Product, Seller shall have a security interest in the Product. Purchaser agrees to perform all acts, including but not limited to the execution and filing of documentation, which may be necessary to perfect and assure the security interest of Seller.</p>
<b>Returns</b>	<p>The return of Products without a written authorization by Seller shall not be accepted. To receive authorization for Product return, please call Customer Service. All Products that are returned pursuant to a valid authorization shall be subject to a twenty-five percent (25%) of list restocking charge. Products not currently offered for sale by Seller (including COM) shall not be authorized for return. All returned Products must be unused, in original condition and in the original Seller packing cartons. No refund or credit shall be given for damaged Products.</p>
<b>Held Orders/Storage</b>	<p>If Purchaser requests that an order be held or delayed, prices and terms and conditions in effect at the time of shipment shall apply. If Purchaser requests a delay after the time when Seller can defer production, Purchaser will be invoiced for the Product, payable in accordance with standard terms, when the order is ready for shipment. Seller may transfer the Product to storage, in which case all expenses incurred in connection with storage, including demurrage, preparation for storage, storage charges and handling shall be payable by Purchaser upon submission of invoices by Seller. Risk of loss to the Product shall pass to the Purchaser upon delivery of the Product into storage.</p>

# Selling Policy

<b>Customer's Own Material</b>	<p>A Purchaser who requests a fabric or other surface material not standard to Seller's line of Products ("COM") must submit samples of the requested material to Seller prior to entry of a purchaser order. Seller shall determine if the material is suitable to its manufacturing processes and meets any requirements of Underwriters Laboratories. If the COM is acceptable, Seller will then establish a price for using the COM or the Product in question. For a description of the procedures for submitting samples and testing, contact customer resources or your sales representative. Seller shall have no responsibility for the appearance, condition, performance, durability, colorfastness or any other physical attribute of the COM. Purchaser shall indemnify and hold Seller harmless for any damages, injuries or losses arising out of or related to use of the COM on the Product.</p>
<b>Warranty</b>	<p>Seller warrants to the original Purchaser only that the Products Seller manufactures and sells to Purchaser are free of defects in workmanship and materials, during the applicable warranty period set forth below.</p> <p>Warranty period set forth below is for 24-hour, 7 days a week, multi shift use (includes parts and labor to repair).</p> <p>Should any failure to conform with this limited warranty appear to a Product listed below during the applicable warranty period from the date of shipment, Seller shall, upon prompt written notice, repair or replace, at its option and costs, the affected part or parts.</p> <p><i>Product and Period of Warranty</i></p> <p><i>Lifetime: Antenna Workspaces, AutoStrada, Calibre, Crinion Open Table, Currents, Dividends Horizon, Morrison, Reff Profiles laminate, Series 2 Storage, Template and other non-wood components (except cascade edge worksurfaces, operational parts, controls, electrical, Lighting, Series 2 Veneer Front Storage, special or custom products, see below)</i></p> <p><i>12 Years: Chadwick, Essentials Work Chairs, Generation by Knoll, Life, Moment, MultiGeneration by Knoll, ReGeneration by Knoll, Remix, and Toboggan seating (except seating upholstery, textiles, leathers and finishes, see below).</i></p> <p><i>10 Years: Anchor Storage except digital keypad lock, Antenna Workspaces, AutoStrada, Crinion Open Table, Dividends Horizon, Dividends Horizon Satellite Surfaces, Reff Profiles, Template wood components, Series 2 Veneer Front Storage, cascade edge worksurfaces, Wood Casegoods (The Graham Collection) (except wood casegoods upholstered surfaces, see below), Reuter overheads, Reuter vertical storage, KnollExtra Sapper Monitor Arm Collection, Sapper XYZ Monitor Arm, Adjustable keyboard mechanisms and platforms, Communication Boards (except fabric board textiles, see below), Smokador collection (except leathers, see below), and Orchestra Universal Systems Accessories, k. lounge structural components.</i></p> <p><i>5 Years: Operational parts, controls, electrical, Lighting (except light ballasts, bulbs and power supply, see below), special or custom product, wood veneer products, Currents handcrank, Interaction Counterforce, KnollStudio, Spark Series seating structural elements, structural elements of all KnollStudio outdoor products including all Richard Schultz designed products, KnollExtra CPU storage and all universal storage drawers and Power Collection, Tone Tables.</i></p> <p><i>3 Years: Seating upholstery, textiles, leathers and finishes. Fabric boards textiles and Smokador Collection leathers.</i></p> <p><i>2 Years: Anchor Storage digital keypad lock, all other KnollExtra product</i></p> <p><i>1 Year: Light ballasts, bulbs and power supply, seating upholstered amp pads and soft amp pads, wood casegoods upholstered surfaces. KnollStudio, outdoor product finishes, k. lounge upholstery and k. lounge fabric.</i></p> <p>This warranty does not apply to:</p> <ul style="list-style-type: none"><li>• Damage caused by a carrier other than the Seller.</li><li>• Normal wear and tear or acts or omissions of parties other than Seller (including user modification, improper use or installation of Products).</li><li>• COM or other third party materials applied to Products.</li><li>• Products not installed by or under the auspices of a Knoll Dealer.</li><li>• Dramatic temperature variations or exposure to unusual conditions.</li><li>• Changes in surface finishes, including colorfastness due to aging or exposure to light.</li><li>• Except as specifically noted above, textiles and upholstery supplied by <i>KnollTextiles</i> (consult current <i>KnollTextiles</i> price list for applicable warranty).</li></ul> <p>Natural variations occurring in wood, marble, and leather shall not be considered defects, and the Seller does not guarantee the colorfastness or matching of the colors, grains or textures, or surface hardness of such materials. The Seller also does not guarantee the colorfastness of fiberglass panel surfaces. THE EXPRESS WARRANTIES CONTAINED HEREIN ARE IN LIEU OF ALL OTHER WARRANTIES, EXPRESS OR IMPLIED, INCLUDING ANY WARRANTIES OF MERCHANTABILITY AND FITNESS FOR PARTICULAR PURPOSE AND ALL OTHER WARRANTIES ARISING FROM COURSE OF DEALING OR USAGE OF TRADE.</p> <p>The remedies provided above are the Purchaser's sole remedies for any failure of Seller to comply with its obligations regarding the workmanship of its Products. Correction of any nonconformity in the manner and for the period of time provided shall constitute complete fulfillment of all liabilities of Seller, with respect to or arising out of the Product furnished hereunder.</p>
<b>Delay/Force Majeure</b>	<p>Seller shall not be liable for failure to perform or for delay in performance due to fire, flood, strike or other labor difficulty, act of God, act of any governmental authority or of the Purchaser, riot, embargo, fuel or energy shortage, wrecks or delay in transportation, inability to obtain necessary labor, materials or manufacturing facilities from usual sources or failure of suppliers to meet their contractual obligations, or due to any cause beyond its reasonable control. If any such event occurs, Seller may extend delivery dates by a period of time necessary to overcome the effect of such delay, allocate available Product or cancel any purchase order.</p>
<b>Compliance with Law</b>	<p>PURCHASER IS SOLELY RESPONSIBLE FOR COMPLIANCE WITH ALL APPLICABLE FEDERAL, STATE AND LOCAL LAWS, ORDINANCES, REGULATIONS, RULES AND STANDARDS RELATING TO THE INSTALLATION, MAINTENANCE, USE AND OPERATION OF THE PRODUCTS.</p>
<b>Patents</b>	<p>Subject to the following provisions, Seller shall, at its own expense, defend or, at its option, settle any claim, suit or proceeding brought against the Purchaser, and/or its vendees, mediate and immediate, so far as based on an allegation that any Product or any part thereof furnished hereunder constitutes a direct or a contributory infringement of any claim of any patent of the United States or Canada. This obligation shall be effective only if Purchaser shall have made all payments then due hereunder and if Seller is notified promptly in writing and given authority, information and assistance for the defense of said claim, suit or proceeding. Seller shall pay all damages and costs awarded in such suit or proceedings so defended.</p> <p>The foregoing indemnity does not apply to the following:</p> <ul style="list-style-type: none"><li>• Products supplied according to a design other than that of Seller, and which is required by the Purchaser.</li><li>• Combination of the Product with another product not furnished hereunder unless Seller is a contributory infringer.</li><li>• Any settlements of a suit or proceeding made without Seller's written consent.</li></ul>
<b>Limitations of Liability</b>	<p><b>SELLER, ITS CONTRACTORS, AUTHORIZED DEALERS AND SUBCONTRACTORS OR SUPPLIERS OF ANY TIER SHALL NOT BE LIABLE TO PURCHASER FOR ANY SPECIAL, INDIRECT, INCIDENTAL OR CONSEQUENTIAL DAMAGES ARISING FROM A BREACH OF THIS AGREEMENT.</b></p> <p>Purchaser's remedies set forth herein are exclusive and the liability of Seller with respect to the breach of this agreement or any contract entered into between the parties pursuant hereto shall not exceed the price of the Product or part on which such liability is based.</p>

# General Ordering Information

---

## **The Products**

This guide encompasses all standard products for this product group.

## **Sizes**

Dimensions listed in this guide are indicated as:

H = height

W = width

D = depth

Dia. = diameter

Rad. = radius

## **Pricing**

All prices shown are list.

## **How to Order**

Select pattern numbers and quantities required for your complete installation. Product questions can be addressed in the specific sections of this guide or by contacting your sales representative or customer resource representative at 1-800-343-5665.

Next, select options (if required), along with colors and finishes appropriate to each product. Reference the Finishes and Fabrics pages for color designations.

On large installations, an item's "designated area" can be specified to assist in product organization and handling.

To expedite complete / correct entry of your order, be certain all pattern numbers, quantities, colors and area identifications are completely specified. Also, include complete purchase order numbers, bill-to and ship-to addresses, a contact name and specific factory shipping dates required.

## **Mail all orders to:**

Knoll, Inc.

1235 Water Street

P.O. Box 157

East Greenville, PA 18041

Attention: Order Entry

Once your order is entered at Knoll, an acknowledgment will be mailed to you. You will be advised of your scheduled shipping date within five days of the original acknowledgment. If it is necessary to revise your order, please contact your customer resource representative.

## Sustainability Statement

---

Sustainable design is a key component of Knoll's environmental focus. Our commitment to social responsibility and a healthy environment has prompted us to further articulate our longstanding environmental programs and, with encouragement and support from our colleagues in the industry, we have re-energized our focus on such "green" initiatives as life cycle analysis and LEED™ certification. Knoll is proud to have contributed to projects that have received LEED certification from the U.S. Green Building Council.

For the latest information on Knoll products that help our customers achieve LEED certification, log on to [knoll.com](http://knoll.com), click on "About Knoll" and then "Environmental Focus."