

Table of Contents

Introduction	Knoll and Sustainable Design	3
	GREENGUARD Indoor Air Quality Certified®	4
	Using the KnollExtra Price List	5
	Placing Your Order	6
	KnollExtra Visual Index	7
	KnollExtra Bracket Chart	14
	Maintaining Your Purchase	15
Desktop Accessories	The Smokador™ Collection : Exec Rectilinear	16
	The Smokador™ Collection : Contemporary Leather	24
	The Smokador™ Collection : Traditional Leather	32
	The Smokador™ Collection : Replacement Parts	38
Boardroom Accessories	International Collection : Glassware	40
	International Collection : Stainless Boardroom Accessories	42
	International Collection : Plastic Boardroom Accessories	48
	International Collection : Umbrella Stand and Clocks	50
	International Collection : Replacement Parts	52
Organizational Tools	Orchestra® Universal System Accessories : by Bruce Hannah & Ayse Birsel	54
	Orchestra® Universal System Accessories : by Brooks Rorke	78
Technology Management	Sapper™ Monitor Arm Collection : Easy Order Single Arm Kits (16" Masts)	80
	Sapper™ Monitor Arm Collection : Easy Order Single Arm Kits (8" and 12" Masts)	82
	Sapper™ Monitor Arm Collection : Easy Order Double Arm Kits (16" Masts)	84
	Sapper™ Monitor Arm Collection : Easy Order Double Arm Kits (8" and 12" Masts)	86
	Sapper™ Monitor Arm Collection : Easy Order Triple Monitor Support Kits (16" Mast)	88
	Sapper™ Monitor Arm Collection : Easy Order Triple Monitor Support Kits (8" and 12" Masts)	90
	Sapper™ Monitor Arm Collection : Monitor Arms and Brackets	92
	Sapper™ Monitor Arm Collection : Monitor Arms and Movement Joints	94
	Sapper™ Monitor Arm Collection : Masts	96
	Sapper™ Monitor Arm Collection : Adjustment Knobs and Mast Cable Management Clips	98
	Sapper™ Monitor Arm Collection : Mounting Options	100
	Sapper™ Monitor Arm Collection : Mounting, Construction and Application Information	102
	Adjustable Keyboard Supports : Romeo and Juliet Platform/Mechanism Configurations	106
	Adjustable Keyboard Supports : Prospero Platform/Mechanism Configurations	108
	Adjustable Keyboard Supports : Caesar Platform/Mechanism Configurations	110
	Adjustable Keyboard Supports : Act I	112
	Adjustable Keyboard Supports : Act II	114
	Adjustable Keyboard Supports : Mousing Solutions	116
	Freestanding Surf® Ergonomic Accessories : by Ross Lovegrove & Stephen Peart	118
	Freestanding Ergonomic Accessories	120
	Wishbone Flat Panel Monitor Support System : by Colebrook Bosson Saunders	122
	Wishbone Rotation Flat Panel Monitor Support : by Colebrook Bosson Saunders	136
Zorro Flat Panel Monitor Support : by Colebrook Bosson Saunders	138	
Worksurface Support : CPU Holders	140	
Worksurface Support : Adjustable CPU Holders	142	
Worksurface Support : Equipment Storage	144	
Storage	BackPack® Universal Storage Drawers : by Robert Reuter	146
	Universal Pencil Drawer : by Brooks Rorke	156
Communication Boards	Universal Marker Boards : by Bruce Hannah&Ayse Birsel	158
	Universal Fabric Boards : Standard Sizes	160
	Universal Fabric Boards : Options and Mounting Information	164
	Universal Fabric Boards : Top Cap Hung Marker Board	166
Lighting	Copeland™ Light : by Stephan Copeland	168
	Tolomeo Light Fixtures by Artemide®	172
	Little Dipper and Big Dipper : Lighting System	176
	Desktop Lamp : By John Rizzi and Brooks Rorke	178
Electrical	Wire Management Spine : by Colebrook Bosson Saunders	180

Alpha-Numeric Index	182
Selling Policy	185
General Ordering Information	187

Knoll and Sustainable Design

Each year Knoll sets key initiatives in our journey to sustainability. We are members of a global consortium on energy, have adopted a scientific, metrics-based approach to sustainable product design, and maintain a leadership position in establishing universal, verifiable, sustainability standards for our industry.

Knoll promotes independent third-party certification because it provides the most impartial and trustworthy foundation for industry-wide environmental compliance. Certification by established and respected third parties ensures that all manufacturers are held to the same high standards and that customers can trust a company's declaration about the environmental benefits of its products. Knoll third-party partners include: the International Standards Organization (ISO); Forest Stewardship Council (FSC); GREENGUARD® Environmental Institute; and Chicago Climate Exchange (CCX®).

In addition, Knoll is aligned with the U.S. Green Building Council and can help companies, healthcare organizations and educational institutions achieve Leadership in Energy and Environmental Design (LEED®) workplace certification.

1. Global Climate Change

- Knoll is a sponsor of the Clinton Global Initiative, which brings together a community of global leaders to devise and implement solutions to some of the world's most pressing challenges, including environmental change.
- Knoll is a member of the Chicago Climate Exchange, which promotes greenhouse gas reduction through the trading of credits earned for reducing emissions.
- Knoll has a comprehensive Energy Management Program to increase energy efficiency in products and processes.

2. Life Cycle Assessment (LCA) Tool

Life Cycle Assessment is a science-based measurement of a product's environmental impacts throughout its life cycle, from raw materials sourcing through manufacture, shipping, use, and re-use or end-of-life. LCA enables cradle-to-cradle implementation of sustainable practices.

- Knoll partners with The Green Standard.org (formerly the International Design Center for the Environment, or IDCE) to develop an affordable, universal, ISO-compliant computer-based LCA tool that can be used by the entire contract furniture industry.

An affordable universal LCA tool has enormous potential value to:

- Help stop dangerous and irreversible climate change
- Conserve natural resources and reduce waste
- Improve quality of life
- Eliminate market confusion about green products using real metrics and sound science
- Facilitate design innovation
- Advance the sustainability triple bottom line: environment, economics and social equity

3. Setting Industry Standards

- Knoll partners with MTS (The Institute for Market Transformation to Sustainability) to develop the SMaRT® Consensus Sustainable Products Standards, a set of consensus-based sustainable product standards based on the LEED® model, for all building products, fabric, apparel, flooring and carpet. MTS, the developer of SMaRT®, is an accredited American National Standards Institute (ANSI) standard developer.
- Knoll also participates in an ongoing BIFMA (Business and Institutional Furniture Manufacturers Association) initiative to establish sustainability standards for the contract furniture industry.
- Our goal is to encourage all manufacturers in the contract furniture and related industries to adopt standards that will lead to sustainable products and practices.

For more information about Knoll environmental, health and safety programs, visit knoll.com/environment.

All Knoll Office Seating is GREENGUARD Indoor Air Quality® certified and GREENGUARD for Children & SchoolsSM certified.

All KnollExtra® products are GREENGUARD Indoor Air Quality® certified.

Visit GREENGUARD.org for more information and to find printable certificates for Knoll Office Seating that can be used for verification and LEED® submission.

GREENGUARD provides the only guide to certified low-emitting interior products and building materials. Its goal is to help building owners and managers, architects, interior designers and product specifiers build and furnish healthier offices, hospitals, schools and homes by providing a register of tested and certified low-emitting products and materials.

GREENGUARD certification is recognized by the U.S. Green Building Council's LEED® Program. Air Quality Science, an independent indoor air quality laboratory, tests products submitted for certification using stringent environmental chamber testing protocols and current indoor air quality standard. Certification is administered by the GREENGUARD Environmental Institute (GEI), an industry-independent, non-profit organization.

GREENGUARD for Children & SchoolsSM certification complies with the State of California's Department of Health Services Standard Practice (CA Section 01350) for testing chemical emissions from building products used in schools, offices and other sensitive environments. Certified products can contribute to achieving credits in the CHPS Best Practices Manual for K-12 schools, the LEED® Green Building Rating System, Green Guide for Healthcare™, NAHB Green Building Guidelines, Green Globes, Regreen and numerous other local authorities' green building codes.

Knoll Office Seating and KnollExtra® products can contribute to achieving LEED® credits. GREENGUARD-tested and certified office furniture is required for Credit 4.5 in the LEED-CI Indoor Environmental Quality section.

GREENGUARD Certification Program

- Internationally recognized for evaluating product emissions and certifying building materials, furnishings, finishes and cleaning products and processes that meet stringent indoor air quality criteria defined by GEL.
- Products undergo rigorous, third-party testing to determine their impact on indoor air pollution with requirements for ongoing testing and verification.
- Certification confirms a manufacturer's environmental responsibility, and signifies their environmental achievements through independent, third-party testing and verification.
- GREENGUARD Certified products are recommended by leading sustainable building programs, including:
 - U.S Green Building Council's (USGBC) LEED Rating System,
 - National Association of Home Builders (NAHB) Green Building Guidelines,
 - Green Guide for Health Care (GGHC),
 - Collaborative for High Performance Schools (CHPS) Best Practices Manual,
 - New York City Department of Design and Construction Sustainable Design Specifications, among others.

An Overview

In the first part of the Price List you'll find a full range of desktop accessories, including the Smokador and the International Collection of boardroom accessories.

The second part features Orchestra Universal System Accessories, a complete scope of paper management accessories perfect for panel-mounted or freestanding application.

Part three offers a broad range of systems support products, including computer accessories, storage drawers, communications boards, and lighting.

Can't find it? Consult the Table of Contents on page 1 or the Alpha-numeric Index on page 182.

Product Information on Each Page

The KnollExtra Price List was designed to provide you with everything you need to know in order to understand, specify, and care for KnollExtra products. On each page, the following features will assist you:

Description/Construction explains salient features, capabilities, materials, and country of origin.

Dimensions provide the overall space the product will require. Statistics are based on the maximum width, depth and height of the product.

Weight is based on the product itself. It does not include packaging or complementary items such as pens, memo paper or calendars.

Order Code/Ordering Information outlines exactly how to specify KnollExtra product and the full scope of finish options. The Order Code provides an example of how one pattern number is specified.

Custom Options reviews availability of special sizes, finishes etc.

For More Information

For more information, contact your Knoll sales representative, telephone Customer Service at 1-800-343-5665, or visit one of the Knoll showrooms listed on the last page of this book.

A Word About Finishes

KnollExtra finishes are designed to complement a broad range of interiors and office products.

Key KnollExtra finishes coordinate with specific Knoll systems finishes:

<i>Product</i>	<i>Core Finish</i>	<i>Office System Finishes</i>
Orchestra Load bar / Slat board	Medium grey (115)	Medium grey (115)
	Soft grey (117)	Soft grey (117)
	Black (111)	Black (111)
	Beige Mist (611)	Beige Mist (611)

Use the Following Addresses

If you would like to send a standard lead time order to our order entry department, please use the following address:

For North American orders:
Knoll, Inc.
1235 Water Street
East Greenville, PA 18041
Attn: Order Entry

Fax: 215 679-1788
Tel: 800 343-KNOLL

All accepted orders will be confirmed in writing on the Knoll standard order confirmation form.

Ship-Complete Orders

Orders that must ship complete are to be so stated on the purchase order. Products with different lead times, combined on one order, can be acknowledged for shipment based on the longest of those lead times. Orders not marked “ship complete” will be released according to the confirmation, and invoiced in increments.





For More Information

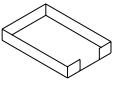
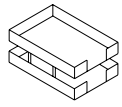
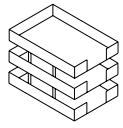

For complete Knoll Selling Policy and warranty information, please refer to page 185 of this price list.



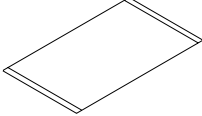
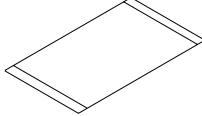
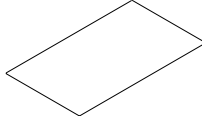
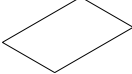
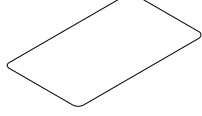

For additional information on KnollExtra, contact your Knoll representative, a Knoll dealer, or telephone Customer Services at 800 343-KNOLL.

Page **THE SMOKADOR COLLECTION ● Exec Rectilinear**

16-17	Single Letter Tray	Double Letter Tray	Triple Letter Tray
			

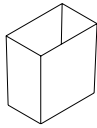
18-19	Memo Box	Business Card Holder	Round Pencil Cup	Round Clip cup
				

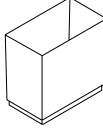
20-21	Desk Pad: 3/4" Side Panels	Desk Pad: 1 1/2" Side Panels	Rectilinear Desk Pad	Conference Pad	Radiused Desk Pad	Oval Conference Pad
						

22-23	Round Wastebasket	Rectilinear Wastebasket	Round Plastic Wastebasket	Rectilinear Plastic Wastebasket	Oval Plastic Wastebasket
					

Page **THE SMOKADOR COLLECTION ● Contemporary Leather**

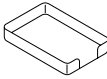
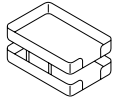

24-25	Letter Tray Cover	Single Letter Tray	Double Letter Tray
			

26-29	Memo Box	Pencil Cup	Coasters
			



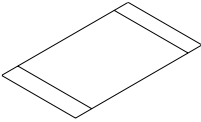
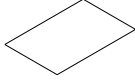

Appointment Book	Note Pad Holder	Picture Frame
		

Book Ends



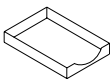

Page THE SMOKADOR COLLECTION ● Contemporary Leather

30-31	Desk Pad: 4'' Side Panels	Rectilinear Conference Pad	Oval Conference Pad	Round Wastebasket
				

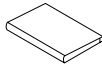
Page THE SMOKADOR COLLECTION ● Traditional Leather

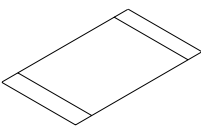
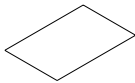

32-33	Letter Tray Cover	Single Letter Tray	Book Ends	Memo Box	Pencil Cup
					





34-35	Appointment Book	Note Pad Holder
		

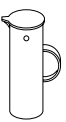
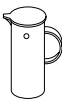

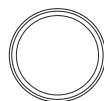
36-37	Desk Pad: 3 1/2'' Side Panels	Rectilinear Conference Pad	Oval Conference Pad	Round Wastebasket
				

Page THE INTERNATIONAL COLLECTION

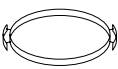



40-41	Aalto Vase	Savoy Vase	Aarne Glassware
			

42-43	Large Stainless Carafe	Small Stainless Carafe	Stainless Creamer	Stainless Sugar Bowl	Serving Tray
					

44-45	Stainless Coffee Pot	Stainless Tea Pot	Stainless Creamer and Sugar Bowl	Stainless Serving Tray with Handles	Stainless Ice Bucket
					

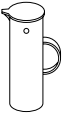
46-47	Stainless Ice Tongs	Stainless Coaster Set	Napkin Holder
			

Page THE INTERNATIONAL COLLECTION



48-49	Large Plastic Carafe 	Small Plastic Carafe 	Plastic Water Pitcher 	Plastic Creamer 	Plastic Sugar Bowl 
-------	---	---	--	--	---

50-51	Ivy Umbrella Stand 	Mathiesen Wall Clock 			
-------	---	---	--	--	--

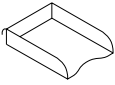
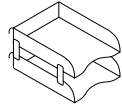
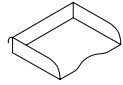
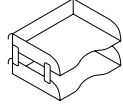
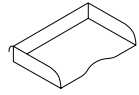
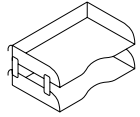

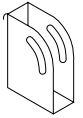
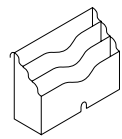
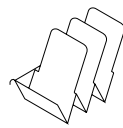
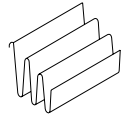
Page ORCHESTRA UNIVERSAL SYSTEM ACCESSORIES

54-57	Front Single Letter Tray 	Front Double Letter Tray 	Side Single Letter Tray 	Side Double Letter Tray 	Side Single Legal Tray 	Side Double Legal Tray 
-------	---	---	--	--	---	---

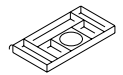

58-59	2-Way Binder Bin 	Vertical Paper Pack 	Slanted Sorter 	File Sorter 
-------	---	---	---	--

60-61	Hanging File Holders 	Pencil Cup 	Utility Tray 
-------	---	---	---

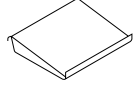

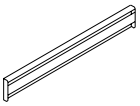
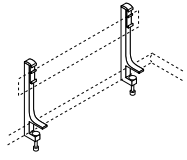
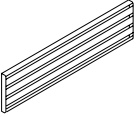
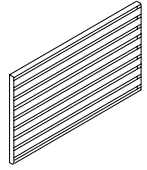

62-63	Tape Dispenser 	Memo Tray 
-------	---	--

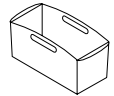
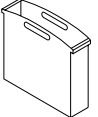
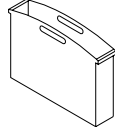
64-65	Clip/Cup Holder 	Bud Vase 	Telephone Shelf 
-------	--	---	--

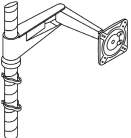
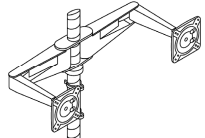
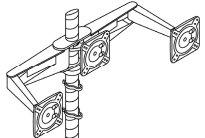
66-67	Racetack Desk Pad 	Wastebasket & Recycling Wastebasket 
-------	--	--

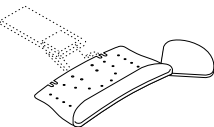
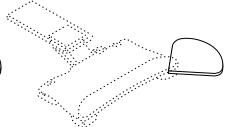
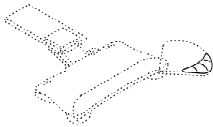
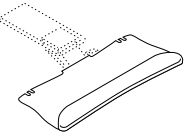
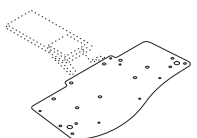
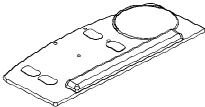
Page	ORCHESTRA UNIVERSAL SYSTEM ACCESSORIES			
68-74	Load Bar/Info Rail	Worksurface: Mounted Bracket	Slat board: 6½''H	Slat board: 14¾''H
				
78-79	Portable Small Diskette Tote	Portable Large Diskette Tote	Portable Letter Size File Tote	Portable Legal Size File Tote
				

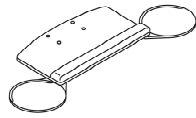
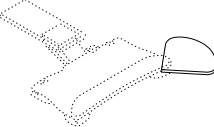
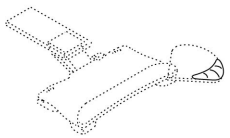
Page	TECHNOLOGY MANAGEMENT : SAPPER™ MONITOR ARM COLLECTION		
80-91	Single Arm Kits	Double Arm Kits	Triple Arm Kits
			

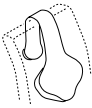
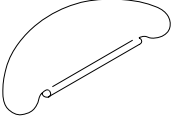

Page	TECHNOLOGY MANAGEMENT				
106-117	Adjustable Keyboard Support - Romeo and Juliet	Juliet	Juliet with Palm Rest		
					
	Adjustable Keyboard Support - Prospero	Adjustable Keyboard Support - Caesar	Act I	Act II	Act II Two Mouse Pads
					
	Juliet Mouse Pad	Juliet Palm Rest	Over-ten Mouse Pad		
					

Page **TECHNOLOGY MANAGEMENT : SURF® ERGONOMIC ACCESSORIES**

118	Wrist Rest	Lumbar support	Surf Board or VDT Corner
			

Page **TECHNOLOGY MANAGEMENT**

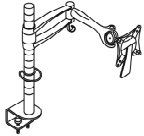
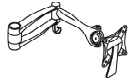
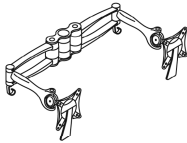
120	VDT Sleeve	Adjustable Foot Rest
		

122-139	Wishbone Kit	Wishbone Standard Arm	Wishbone Back to Back Arm	Wishbone Forearm	Wishbone C-Arm
					

Wishbone Rotation	Zorro
	

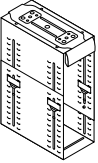
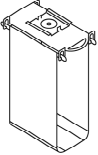
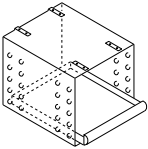

140	Adjustable Metal CPU Holder	Adjustable Mobile CPU Trolley
		

142-145	Adjustable Vertical Metal CPU Holder	Adjustable Vertical Sling CPU Holder	Printer/Fax Drawer
			

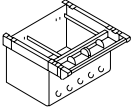
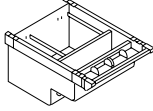
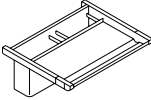
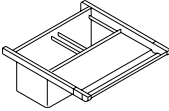
Page **STORAGE**

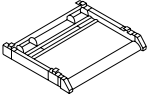
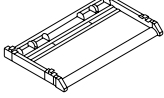
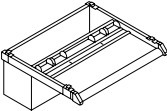
146-149	BackPack® Universal Standard Suspended File	BackPack® Universal Deep Suspended File	Standard Center File	Deep Center File
				

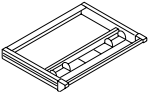
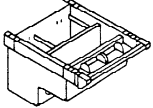

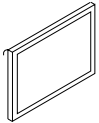
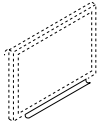
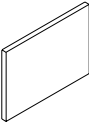
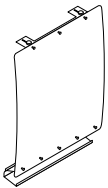

150-153	Narrow Keyboard Drawer	Wide Keyboard Drawer with Mouse Pad	Keyboard/Filing Drawer
			

154-157	Pencil Drawer	Top Drawer	Universal Pencil Drawer
			

Page **COMMUNICATIONS BOARDS**

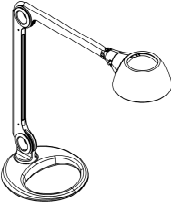
158-167	Marker Board	Marker Tray	Fabric Boards	Top Cap Hung Marker Board
				

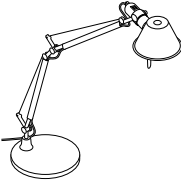
Page **LIGHTING**

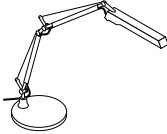
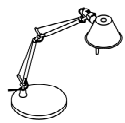
168-179	Copeland Standard	Copeland Compact	Tolomeo Standard	Tolomeo Mini	Tolomeo VDT	Tolomeo Micro
						

Big Dipper Little Dipper Desktop Lamp

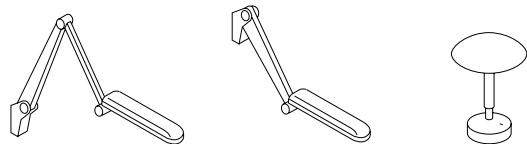

Page **ELECTRICAL**

180-181 Cable Manager



Manufacturer	System	Bracket Suffix
Knoll	Equity	E(Y)*
	<i>(stanchion-mounted)</i> Equity	ES
	Morrison	M
	<i>(stanchion-mounted)</i> Morrison Network	N
	Reff	R
	Dividends	DV
	<i>(stanchion-mounted)</i> Dividends	DS
	Calibre	CE
	Currents	C
	<i>(stanchion-mounted)</i> Currents	CS

*EY for orchestra brackets. If your system is not listed, please consult your Knoll sales representative or Customer Service at 1-800-343-5665.

For system and bracket information on the manufacturer's listed below or any other manufacturer, please consult your sales representative or Customer Service at 1-800-343-5665.

All-Steel	Herman Miller
American Seating	Kimball
Gunlocke	Smed
Hon	Steelcase
Haworth	Teknion

Maintenance

While KnollExtra relies on highly durable materials in each product line, regular basic maintenance will ensure the longevity of your product. Most stains, marks, and discolorations can be removed by following the simple instructions outlined on this page.

Plastic

Windex and a dry cloth.

SofStone

Early removal of a stain makes SofStone care much easier. This is especially true of coated areas which are frequently handled. If oil smudges are allowed to build up, they can soften the suede coating, and become very difficult to remove. Most dirt and smudges can be removed by the following methods:

1. *Greasy stains* (crayon, oil, lipstick, etc.): remove grease and wax stains with a naphtha-dampened lint-free cloth. Change the cloth frequently to remove as much grease as possible without spreading the stain.
2. *Non-greasy stains* (dirt, coffee, mustard, catsup, etc.): dirt and smudge areas can generally be removed by using a sponge or soft bristle brush with Liquid Ajax, Mr. Clean, Lestoil, or 3M brand carpet spot remover and upholstery cleaner. Follow the instructions on the label, and rinse thoroughly with clear water and a lint-free cloth.
3. *Combination stains* (chocolate, ice cream, gravy, soup, etc.): combination stains are caused by materials that contain both greasy and non-greasy substances. First use the procedures for non-greasy stains as stated above. Then, rinse thoroughly with clear water and thoroughly dry with a lint-free cloth. If greasy stain persists, follow the procedure for greasy stains as stated above. Repeat as necessary.

Stainless Steel:

Windex and a dry cloth.

Antique Brass, Brushed Zinc and Black Oxide:

A damp cloth with no cleaning agents.

Satin Brass:

Pledge.

Linoleum:

Windex and a dry cloth.

Contemporary and Traditional Standard Leathers:

Mild soap and water on a soft cloth.

Spinneybeck Leathers:

As a result of the high quality aniline dye process, most scratches or minor stains can be removed simply by gently rubbing them with your fingers. The body's natural oils revitalize the leather. For stubborn stains, use mild soap and water. Take care to wash the surface evenly since soaps may slightly alter the leather's tonality.

Surf Collection:

Wipe nylon skin using warm water and mild detergent. Do not use abrasives.

Office Automation

Accessories/Storage Drawers:

Clean with a soft cloth and Windex, Fantastik, Endust or other non-abrasive household cleaners. Remove stubborn stains with SofScrub.

For Surf Board and VDT Sleeve soft touch paints, never use abrasives. Clean with lukewarm water and a soft cloth.

Marker Boards:

For day-to-day use, surface requires only a dry cleaning with a standard felt eraser or dry cloth. For best results, keep marker board and marker pens at room temperature. KnollExtra suggests Alliance Rite-On Wipe-Off marker pens which are designed for use on marker boards. All marker pens should be tightly capped and stored horizontally when not in use. If Expo brand markers are used, use the manufacturer's recommended cleaning solution, Expo Dry Erase Cleaner.

Follow the instructions below as a periodic maintenance program, or to remove stubborn stains:

1. Clean with EV-1 or any liquid ammonia-added cleaner and rinse with clean water, then dry. For best results, wash board like a window with sponge and squeegee.
2. Interim cleaning may be done by sprinkling a dry powdered cleanser on an eraser and applying to the board in a circular motion. Rinse with clean water, then dry.

3. To remove crayon, scotch tape, or other stubborn materials, apply a mild solvent or paste made with scouring powder and water.

Fabric Boards:

Despite the durability of most panel textiles, fabric boards are subject to long-term soiling and wear. A regular maintenance program will significantly lessen soil and dirt build up or staining on your fabric boards. Cleaning is particularly important in areas adjacent to air conditioning or ventilation systems.

Remember to consult the care instructions provided by the fabric manufacturer. The general recommendations below should apply to most fabric boards.

1. Avoid excessive heat or moisture which can affect finishes and adhesives. Never allow fabric panels to become wet inside the core. Room temperature should be maintained between 50 and 85 degrees; humidity should be maintained between 20 and 50%.
2. Avoid contact with sharp edges which could puncture the surface.
3. Do not handle fabric boards more than necessary. Avoid bending or flexing the panels; this could break the bond between the surface and core materials.
4. Grease or oil should be wiped off immediately upon contact. Remove excess grease or oil by blotting. Use hot water and mild soap to remove any remaining residue.
5. Whenever possible, clean only with warm water and mild soap. Use caution when applying cleaning agents, particularly those that contain alcohol, strong alkalis, or solvents. These ingredients may react to the vinyl backing or adhesives used in the fabric boards. Always test cleaning agents on fabric from the rear of the panel before using on the front.
6. Care should be taken in using strong room cleaners or pesticides. Their fumes may contain agents which lead to the loosening of the fabric board glue bond.

The Smokador™ Collection
Exec Rectilinear
 letter trays

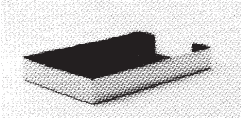
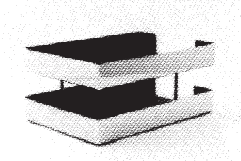
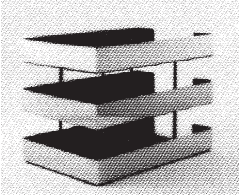
product	description	w	d	h	wgt.
Single Letter Tray 	Legal size. Matte black interior with black linoleum floor pad. Recessed rubber feet and black felt bottom prevent scuffing.	10"	15"	2 1/4"	4 lbs. 5 ozs.
Double Letter Tray 	Legal size. Matte black interiors with black linoleum floor pads and matte black posts. 2 1/2" between trays. Recessed rubber feet and black felt bottom prevent scuffing. Shipped fully assembled.	10"	15"	6 1/2"	9 lbs. 2 ozs.
Triple Letter Tray 	Legal size. Matte black interiors with black linoleum floor pads and matte black posts. 2 1/2" between trays. Recessed rubber feet and black felt bottom prevent scuffing. Shipped fully assembled.	10"	15"	11 1/2"	13 lbs. 2 ozs.

Order Code

Example: 1901-BO
1901 Single letter tray
BO Black oxide

Ordering Information

- Specify:*
1. Pattern number
 2. Finish
 3. Pattern suffix (Pen Set only)

Metal finishes:
 Black Oxide (BO)
 Brushed Zinc (BZ)
 Brushed Steel (BS)

Custom Options

Special sized letter and memo trays available. 100 piece minimum per line item.

Custom finishes available upon sample chip approval. 25 piece minimum per line item. Production set up fee varies by product. Contact your Knoll sales representative or Customer Service for complete pricing information.

pattern no.	black oxide	brushed steel and brushed zinc
1901	\$179.	\$225.
1901-2	402.	496.
1901-3	612.	753.

Construction



Black Oxide (BO) finish is a matte black hand-applied coating over steel.

Brushed Zinc (BZ) is zinc-plated brushed steel with a semi-gloss lacquer finish.

Brushed Steel (BS) is brushed steel with a lacquer finish.

Manufactured in the United States.

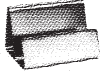
The Smokador™ Collection
Exec Rectilinear
desk accessories

product	description	w	d	h	wgt.
Memo Box 	Matte black interior. Includes 4" x 6" memo paper. Non-skid rubber pad on bottom.	4 1/4"	6 1/4"	3/8"	1 lb. 4 ozs.
Business Card Holder 	Felt base. Available in black oxide only.	3 1/2"	2"	2"	6 ozs.
Round Pencil Cup 	Matte black interior. Non-skid rubber pad on bottom.	3 1/8"		3 1/2"	9 ozs.
Round Clip Cup 	Matte black interior. Non-skid rubber pad on bottom.	3"		2"	8 ozs.

Order Code

Example: 1905-BZ	
1905	Memo box
BZ	Brushed zinc

Ordering Information

Specify:
 1. Pattern number
 2. Finish

Metal finishes:
 Black Oxide (BO)
 Brushed Zinc (BZ)
 Brushed Steel (BS)

Custom Options

Special sized letter and memo trays available. 100 piece minimum per line item.

 Custom finishes available upon sample chip approval. 25 piece minimum per line item. Production set up fee varies by product. Contact your Knoll sales representative or Customer Service for complete pricing information.

pattern no.	black oxide	brushed steel and brushed zinc
1905	\$109.	\$116.
1906	79.	
1915	85.	92.
1916	101.	109.



Construction

Brushed zinc is zinc-plated brushed steel with a semi-gloss lacquer finish.

Brushed steel is brushed steel with a lacquer finish.

Black oxide finish is a matte black hand-applied coating over steel.

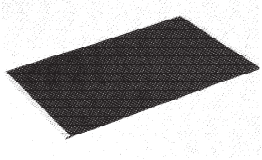
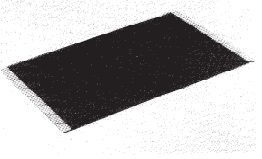
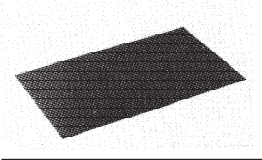
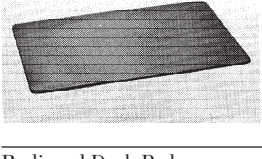
The Smokador™ Collection
Exec Rectilinear
desk pads

product	description	w	d	wt.
Desk Pad: 3/4" Side Panels 	Black linoleum with felt back. 3/4" wide flush rectilinear side panels in specified finish.	34"	20"	5 lbs.
		38"	24"	7 lbs. 12 ozs.
Desk Pad: 1 1/2" Side Panels 	Black linoleum with felt back. 1 1/2" wide raised rectilinear side panels in specified finish.	34"	20"	5 lbs.
		38"	24"	7 lbs. 12 ozs.
Rectilinear Desk Pad 	Black linoleum with felt back. Rectilinear edge detail. No side panels.	34"	20"	4 lbs.
		38"	24"	5 lbs.
Conference Pad 	Black linoleum with felt back. Rectilinear edge detail.	18"	12"	1 lb. 6 ozs.
Radiused Desk Pad 	Black linoleum with felt back. Radiused edge detail. No side panels.	23"	17"	3 lbs. 8 ozs.
		30"	18"	3 lbs. 12 ozs.
		34"	20"	4 lbs.
		38"	24"	5 lbs.
Oval Conference Pad 	Black linoleum with felt back.	18"	12"	1 lbs. 4 ozs.

Order Code

Example: 1912-31-BO	
1912-31	Desk pad with 3/4" side panels
BO	Black Oxide

Ordering Information

- Specify:*
1. Pattern number
 2. Finish(when applicable)
- Metal finishes:*
 Black Oxide (BO)
 Brushed Zinc (BZ)
 Brushed Steel (BS)

Custom Options

Additional linoleum colors available. Special sizes available up to 34"W x 28"D. 50 piece minimum on all custom desk pads. Contact your Knoll sales representative or Customer Service for complete pricing information.

pattern no.	black linoleum	black oxide	brushed steel and brushed zinc
1912-31		\$233.	
1912-41		246.	
1912-32		246.	271.
1912-42		256.	
1912-30	101.		
1912-40	116.		
1912-20	55.		
012-1	72.		
012-2	90.		
012-3	101.		
012-4	116.		
512-20	55.		

Construction

Desk accessories:



Brushed zinc is zinc-plated brushed steel with a semi-gloss lacquer finish.

Brushed steel is brushed steel with a lacquer finish.

Black oxide finish is a matte black hand-applied coating over steel.

All items are manufactured in the United States.

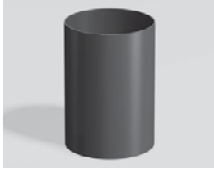
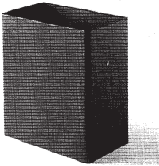
The Smokador™ Collection
Exec Rectilinear
waste baskets

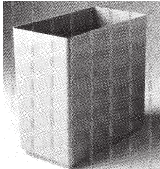
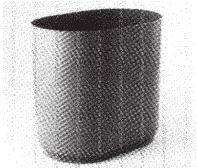
product	description	w	d	h	wgt.
	Round Wastebasket Black oxide exterior with matte black interior. Non-toxic. 15 qt. capacity.	10"		14 3/4"	5 lbs.
	Rectilinear Wastebasket Black oxide exterior with matte black interior. Non-toxic. 24 qt. capacity.	8"	13"	13 1/2"	7 lbs.
	Round Plastic Wastebasket 15 qt. capacity.	10"		13 3/4"	4 lbs.
	Rectilinear Plastic Wastebasket 24 qt. capacity.	8 3/8"	15"	13 3/4"	5 lbs.
	Oval Plastic Wastebasket 26 qt. capacity.	10"	15 1/2"	13 3/4"	6 lbs.

Order Code

Example: 050-BO	
050	Round wastebasket
BO	Black Oxide

Ordering Information

Specify:

1. Pattern number
2. Finish(when applicable)

Round wastebasket Metal finishes:
 Black Oxide (BO)

Standard plastic finishes:
 Black (BK)

Custom Options

Custom finishes available upon sample chip approval. 750 piece minimum on plated finishes; 100 piece minimum on painted finishes. Production set up fee varies by finish. Contact your Knoll sales representative or Customer Service for complete pricing information.

pattern no.	standard plastic	black oxide
050	n/a	\$116.
055-BO	n/a	202.
250	59.	n/a
255	72.	n/a
256	81.	n/a

Construction

Plastic Wastebaskets:
 Custom colors available upon sample chip approval. \$250 color match fee and 500 piece minimum per line item. Contact your KnollExtra representative or Customer Service for complete pricing information.

Metal Wastebaskets:
 The black oxide finish is a matte black hand-applied coating over steel.

Plastic Wastebaskets:
Round- High impact polystyrene.
Rectilinear and oval- High impact crystal styrene.

All items are manufactured in the United States.

The Smokador™ Collection
Contemporary Leather
letter trays

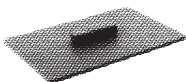
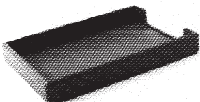
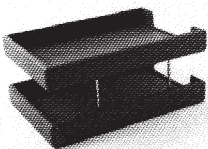
product	description	type	w	d	h	wt.
Letter Tray Cover	Legal size. Suede bottom.		10 1/2"	14 1/2"		2 lbs.
						
Single Letter Tray	Legal size. Suede bottom.		11 1/4"	15 1/4"	2"	3 lbs.
						
Double Letter Tray	Legal size. Suede bottom. Non-scuffing recessed rubber feet. Chrome posts on standard black leather. Specify chrome or brass posts on all other leather selections. Shipped fully assembled.		11 1/4"	15 1/4"	6 1/2"	6 lbs.
						

Order Code

Example:	3301-2-VP-MB-VP556
3301-2	Double letter tray
VP	Velluto Pelle
MB	Mirror brass posts
VP556	Sage

Ordering Information

Specify:

1. Pattern number
2. Leather selection
3. Hardware selection (Double Letter Tray only)

Spinneybeck leathers:
 Vicenza (VZ)
 Velluto Pelle (VP)
 Sabrina (SA)

Custom Options

There are 20 rich colors available in Vicenza and more than 100 vibrant colors available in Sabrina and Velluto Pelle. To view the complete color selection, please contact your Knoll sales representative or Spinneybeck.

Customer's own leather (COL) available upon approval of sample. 10 unit minimum on all specials. Upcharges based on number of cowhides required for production. Contact your Knoll sales representative or Customer Service for complete pricing information.

Please note that 10 or more units are required on all Spinneybeck orders.

Double letter tray hardware:
 Mirror Chrome (MC)
 Mirror Brass (MB)

pattern no.	Vicenza	Velluto Pelle	Sabrina
3333	\$233.	\$301.	\$331.
3301	326.	418.	472.
3301-2	709.	876.	951.

Construction

Spinneybeck Vicenza (VZ):
A corrected grain, aniline dyed leather. The correction process refines the surface of the leather preparing it for the reception of an embossed grain pattern prior to finishing.

Spinneybeck Sabrina (SA):
An aniline dyed, full grain, kip leather. The fine quality and lightweight material produce a supple hand and smooth, tight grain appearance. Sabrina receives a breathable, protective finish and is appropriate for high-traffic use.

Spinneybeck Velluto Pelle (VP):
An aniline dyed, enhanced full grain leather. The combination of the subtle surface enhancement and special ironing process creates the suppleness and smoothness of this leather. Velluto Pelle has a breathable, medium, protective finish.

Manufactured in the United States, using domestic and Spinneybeck Italian leathers.

The Smokador™ Collection
Contemporary Leather
desk accessories

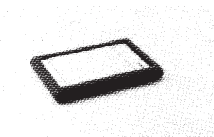
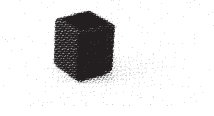
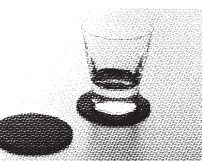
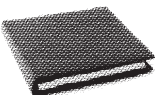
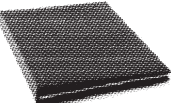
product	description	type	w	d	h	wt.
Memo Box	Includes 4" x 6" memo paper. Suede bottom.		5 1/4"	7 1/4"	3/4"	1 lb.
						
Pencil Cup	Suede bottom.		3 7/16"	3 7/16"	4 1/8"	1 lb.
						
Coasters	Set of four. Circular leather or black linoleum. Felt bottom.	Leather		3 1/4"		4 ozs. (set)
		Linoleum		3 1/4"		4 ozs. (set)
						
Appointment Book	Includes 7" x 8 1/2" Keith Clark "Weekly-Minder."		8 1/4"	9 1/4"		3 lbs.
						
Note Pad Holder	Includes a 8 1/2" x 11" ruled white pad.		8 7/8"	13 1/4"		3 lbs.
						

Order Code

Example: 3343-VZ BLK
3343 Appointment Book
VZ BLK Vicenza Black

Ordering Information

Specify:
 1. Pattern number
 2. Leather selection
Spinneybeck leathers:
 Vicenza (VZ)
 Velluto Pelle (VP)
 Sabrina (SA)

There are 20 rich colors available in vicenza and more than 100 vibrant colors available in Sabrina and Velluto Pelle. To view the complete color selection, please contact your Knoll sales representative or Spinneybeck.

Please note that 10 or more units are required on all Spinneybeck orders.

pattern no.	linoleum	Vicenza	Velluto Pelle	Sabrina
3305		\$225.	\$271.	\$301.
3315		194.	256.	287.
3319-4		71.	101.	133.
3319-4-LN	30.			
3343		271.	342.	380.
3345		271.	342.	380.

Custom Options

Customer's own leather (COL) available upon approval of sample. 10 unit minimum on all specials. Upcharges based on number of cowhides required for production. Contact your Knoll sales representative or Customer Service for complete pricing information.

Construction

Spinneybeck Vicenza (VZ):
A corrected grain, aniline dyed leather. The correction process refines the surface of the leather preparing it for the reception of an embossed grain pattern prior to finishing.

Spinneybeck Sabrina (SA):
An aniline dyed, full grain, kip leather. The fine quality and lightweight material produce a supple hand and smooth, tight grain appearance. Sabrina receives a breathable, protective finish and is appropriate for high-traffic use.

Spinneybeck Velluto Pelle (VP):
An aniline dyed, enhanced full grain leather. The combination of the subtle surface enhancement and special ironing process creates the suppleness and smoothness of this leather. Velluto Pelle has a breathable, medium, protective finish.

Manufactured in the United States, using domestic and Spinneybeck Italian leathers.

The Smokador™ Collection
Contemporary Leather
desk accessories

product	description	type	w	d	h	wt.
Picture Frame 	Sized for 4" x 6" photographs or 5" x 7" photographs. Easel-style stand. Frame is available in Spinneybeck leathers as a special only.		5 3/4"	3/4"	7 3/4"	1 lb.
	Sized for 4" x 6" photographs or 5" x 7" photographs. Easel-style stand. Frame is available in Spinneybeck leathers as a special only.		6 3/4"	3/4"	8 3/4"	1 lb.

Book Ends 	Suede interior facing. Suede under black steel bottom plate.		5"	6"	5"	3 lbs. 8 ozs.
--	--	--	----	----	----	---------------

Order Code

Example: 3343-VZ BLK
3343 Appointment Book
VZ BLK Vicenza Black

Ordering Information

Specify:

1. Pattern number
2. Leather selection

Spinneybeck leathers:
 Vicenza (VZ)
 Velluto Pelle (VP)
 Sabrina (SA)

There are 20 rich colors available in vicenza and more than 100 vibrant colors available in Sabrina and Velluto Pelle. To view the complete color selection, please contact your Knoll sales representative or Spinneybeck.

Please note that 10 or more units are required on all Spinneybeck orders.

pattern no.	linoleum	Vicenza	Velluto Pelle	Sabrina
3370 (4" x 6")		\$208.		
3371 (5" x 7")		219.		
3304		372.	433.	479.

Custom Options

Customer's own leather (COL) available upon approval of sample. 10 unit minimum on all specials. Upcharges based on number of cowhides required for production. Contact your Knoll sales representative or Customer Service for complete pricing information.

Construction

Spinneybeck Vicenza (VZ):
A corrected grain, aniline dyed leather. The correction process refines the surface of the leather preparing it for the reception of an embossed grain pattern prior to finishing.

Spinneybeck Sabrina (SA):
An aniline dyed, full grain, kip leather. The fine quality and lightweight material produce a supple hand and smooth, tight grain appearance. Sabrina receives a breathable, protective finish and is appropriate for high-traffic use.

Spinneybeck Velluto Pelle (VP):
An aniline dyed, enhanced full grain leather. The combination of the subtle surface enhancement and special ironing process creates the suppleness and smoothness of this leather. Velluto Pelle has a breathable, medium, protective finish.

Manufactured in the United States, using domestic and Spinneybeck Italian leathers.

The Smokador™ Collection
*Contemporary Leather
 deskpad and wastebaskets*

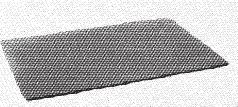
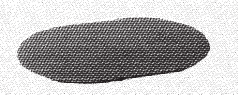
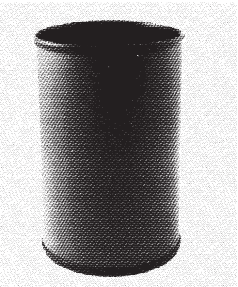
product	description	type	w	d	wgt.
Desk Pad: 4" Side Panels 	Black linoleum with black felt back. 4" wide raised side panels in specified leather.	Desk Pad: 4" Side Panels	34"	20"	6 lbs.
		Desk Pad: 4" Side Panels	38"	24"	7 lbs.12 ozs.
Rectilinear Conference Pad 	Leather or black linoleum. Black felt back.	Leather	18"	12"	3 lbs. 6 ozs.
		Linoleum	18"	12"	1 lb. 6 ozs.
Oval Conference Pad 	Leather or black linoleum. Black felt back.	Leather	18"	12"	2 lbs. 9 ozs.
		Linoleum	18"	12"	1 lb. 4 ozs.
Round Wastebasket 	Black interior. Steel covered with leather.	Round Wastebasket	10"	14 3/4"	6 lbs.

Order Code

Example:	3312-4-VZ BLK
3312-4	38" x 24" desk pad
VZ BLK	Vicenza Black

Ordering Information

Specify:

1. Pattern number
2. Leather selection

Spinneybeck leathers:
 Vicenza (VZ)
 Velluto Pelle (VP)
 Sabrina (SA)

There are 20 rich colors available in vicenza and more than 100 vibrant colors available in Sabrina and Velluto Pelle. To view the complete color selection, please contact your Knoll sales representative or Spinneybeck.

Please note that 10 or more units are required on all Spinneybeck orders.

Custom Options

Custom sized leather conference pads available in sizes up to 38"W x 24"D (rectangular) and 18"W x 12"D (oval). Customer's own leather (COL) available upon approval of sample. 10 unit minimum on all specials. Upcharges based on number of cowhides required for production. Contact your Knoll sales representative or Customer Service for complete pricing information.

pattern no.	black linoleum	Vicenza	Velluto Pelle	Sabrina
3312-3		\$241.	\$331.	\$372.
3312-4		271.	362.	402.
3313		233.	277.	310.
1912-20	55.			
3314		233.	277.	310.
512-20	55.			
3350		271.	356.	410.

Construction

Spinneybeck Vicenza (VZ):
A corrected grain, aniline dyed leather. The correction process refines the surface of the leather preparing it for the reception of an embossed grain pattern prior to finishing.

Spinneybeck Sabrina (SA):
An aniline dyed, full grain, kip leather. The fine quality and lightweight material produce a supple hand and smooth, tight grain appearance. Sabrina receives a breathable, protective finish and is appropriate for high-traffic use.

Spinneybeck Velluto Pelle (VP):
An aniline dyed, enhanced full grain leather. The combination of the subtle surface enhancement and special ironing process creates the suppleness and smoothness of this leather. Velluto Pelle has a breathable, medium, protective finish.

Manufactured in the United States, using domestic and Spinneybeck Italian leathers.

The Smokador™ Collection
Traditional Leather
desk accessories

product	description	type	w	d	h	wt.
Letter Tray Cover 	Legal size. Suede bottom. Leather wrapped handle and cover.		9 ⁵ / ₈ "	14"		2 lbs.
Single Letter Tray 	Legal size. Suede bottom.		10 ¹ / ₂ "	15"	2 ¹ / ₂ "	2 lbs.
Book Ends 	2 per set. Suede bottoms.		4"	4 ⁵ / ₈ "	6 ¹ / ₂ "	6 lbs.
Memo Box 	Includes 5" x 8" memo paper. Suede bottom.		6"	9"	1 ¹ / ₄ "	1 lb. 8 oz.
Pencil Cup 	Leather wrapped. Suede bottom.		3"	3 ¹ / ₂ "	4"	1 lb.

Order Code

Example: 3601-VZ BLK	
3601	Single letter tray
VZ BLK	Vicenza Black

Ordering Information

- Specify:*
1. Pattern number
 2. Leather selection
 3. Hardware selection (Calendar set)

Spinneybeck leathers:
 Vicenza (VZ)
 Velluto Pelle (VP)
 Sabrina (SA)

There are 20 rich colors available in vicenza and more than 100 vibrant colors available in Sabrina and Velluto Pelle. To view the complete color selection, please contact your Knoll sales representative or Spinneybeck.

Please note that 10 or more units are required on all Spinneybeck orders.

Custom Options

Customer's own leather (COL) available upon approval of sample. 10 unit minimum on all specials. Upcharges based on number of cowhides required for production. Contact your Knoll sales representative or Customer Service for complete pricing information.

pattern no.	Vicenza	Velluto Pelle	Sabrina
3633	\$256.	\$331.	\$348.
3601	362.	487.	534.
3604	442.	503.	534.
3605	256.	326.	356.
3615	209.	246.	277.

Construction

Spinneybeck Vicenza (VZ):
A corrected grain, aniline dyed leather. The correction process refines the surface of the leather preparing it for the reception of an embossed grain pattern prior to finishing.

Spinneybeck Sabrina (SA):
An aniline dyed, full grain, kip leather. The fine quality and lightweight material produce a supple hand and smooth, tight grain appearance. Sabrina receives a breathable, protective finish and is appropriate for high-traffic use.

Spinneybeck Velluto Pelle (VP):
An aniline dyed, enhanced full grain leather. The combination of the subtle surface enhancement and special ironing process creates the suppleness and smoothness of this leather. Velluto Pelle has a breathable, medium, protective finish.

Spinneybeck Sabrina (SA):
A durable, immersion aniline-dyed, full grain kip leather which has received a protective surface finish. The superbly soft hand is achieved by its fine quality and light weight.
Manufactured in the United States, using domestic and Spinneybeck Italian leathers.

The Smokador™ Collection
Traditional Leather
desk accessories

product	description	type	w	d	h	wt.
---------	-------------	------	---	---	---	-----

Appointment Book	Includes a 7" x 8 3/4" Keith Clark "Weekly- Minder."		8 3/4"	9 1/4"		2 lbs.
------------------	--	--	--------	--------	--	--------



Note Pad Holder	Includes a 8 1/2" x 11" ruled white pad.		8 3/4"	13 1/8"		2 lbs. 8 ozs.
-----------------	--	--	--------	---------	--	---------------

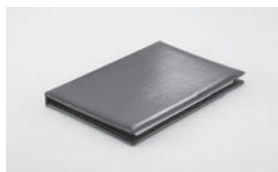

Order Code

Example: 3601-VZ BLK
3601 Single letter tray
VZ BLK Vicenza Black

Ordering Information

- Specify:*
1. Pattern number
 2. Leather selection
 3. Hardware selection (Calendar set)

Spinneybeck leathers:
 Vicenza (VZ)
 Velluto Pelle (VP)
 Sabrina (SA)

There are 20 rich colors available in vicenza and more than 100 vibrant colors available in Sabrina and Velluto Pelle. To view the complete color selection, please contact your Knoll sales representative or Spinneybeck.

Please note that 10 or more units are required on all Spinneybeck orders.

Custom Options

Customer's own leather (COL) available upon approval of sample. 10 unit minimum on all specials. Upcharges based on number of cowhides required for production. Contact your Knoll sales representative or Customer Service for complete pricing information.

pattern no.	Vicenza	Velluto Pelle	Sabrina
3643	\$326.	\$394.	\$424.
3645	326.	394.	424.

Construction

Spinneybeck Vicenza (VZ):
A corrected grain, aniline dyed leather. The correction process refines the surface of the leather preparing it for the reception of an embossed grain pattern prior to finishing.



Spinneybeck Sabrina (SA):
An aniline dyed, full grain, kip leather. The fine quality and lightweight material produce a supple hand and smooth, tight grain appearance. Sabrina receives a breathable, protective finish and is appropriate for high-traffic use.

Spinneybeck Velluto Pelle (VP):
An aniline dyed, enhanced full grain leather. The combination of the subtle surface enhancement and special ironing process creates the suppleness and smoothness of this leather. Velluto Pelle has a breathable, medium, protective finish.

Spinneybeck Sabrina (SA):
A durable, immersion aniline-dyed, full grain kip leather which has received a protective surface finish. The superbly soft hand is achieved by its fine quality and light weight.

Manufactured in the United States, using domestic and Spinneybeck Italian leathers.

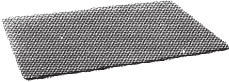
The Smokador™ Collection
Traditional Leather
desk pads and wastebaskets

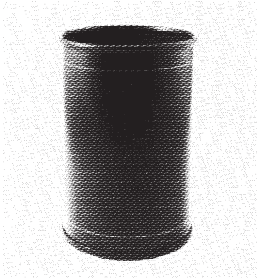
product	description	type	w	d	h	wt.
Desk Pad: 3 1/2" Side Panels 	Black linoleum with black felt back. 3 1/2" wide raised side panels.		34"	20"		6 lbs.
			38"	24"		7 lbs. 6 ozs.
Rectilinear Conference Pad 	Leather or black linoleum. Black felt back.	Leather	18"	12"		3 lbs. 6 ozs.
		Linoleum	18"	12"		1 lb. 6 ozs.
Oval Conference Pad 	Leather or black linoleum. Black felt back.	Leather	18"	12"		2 lbs. 9 ozs.
		Linoleum	18"	12"		1 lb. 4 ozs.
Round Wastebasket 	Black interior. Steel covered with leather.		10"		15"	6 lbs.

Order Code

Example:	3612-4-SA-764
3612-4	38 "x 24 "Desk pad
SA	Sabrina
764	Clay

Ordering Information

Specify:

1. Pattern number
2. Leather selection

Spinneybeck leathers:
 Vicenza (VZ)
 Velluto Pelle (VP)
 Sabrina (SA)

There are 20 rich colors available in Vicenza and more than 100 vibrant colors available in Sabrina and Velluto Pelle. To view the complete color selection, please contact your Knoll sales representative or Spinneybeck.

Please note that 10 or more units are required on all Spinneybeck orders.

Custom Options

Custom sized leather conference pads available in sizes up to 38"W x 24"D (rectangular) and 18"W x 12"D (oval). Customer's own leather (COL) available upon approval of sample. 10 unit minimum on all specials. Upcharges based on number of cowhides required for production. Contact your Knoll sales representative or Customer Service for complete pricing information.

pattern no.	black linoleum	Vicenza	Velluto Pelle	Sabrina
3612-3		\$263.	\$331.	\$372.
3612-4		295.	362.	402.
3613		241.	310.	326.
1912-20	55.			
3614		241.	310.	326.
512-20	55.			
3650		348.	424.	457.

Construction

Spinneybeck Vicenza (VZ):
A corrected grain, aniline dyed leather. The correction process refines the surface of the leather preparing it for the reception of an embossed grain pattern prior to finishing.



Spinneybeck Sabrina (SA):
An aniline dyed, full grain, kip leather. The fine quality and lightweight material produce a supple hand and smooth, tight grain appearance. Sabrina receives a breathable, protective finish and is appropriate for high-traffic use.

Spinneybeck Velluto Pelle (VP):
An aniline dyed, enhanced full grain leather. The combination of the subtle surface enhancement and special ironing process creates the suppleness and smoothness of this leather. Velluto Pelle has a breathable, medium, protective finish.

Manufactured in the United States, using domestic and Spinneybeck Italian leathers.

The Smokador™ Collection

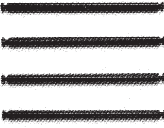
Replacement Parts

product	description	d	h
Metal Letter Tray Stacking Posts 	4 per set, with screws. For use with the Contemporary Leather and Exec Rectilinear Collections. Available in mirror chrome, mirror brass, and matte black only.	1/4"	4 1/4"
Letter Tray Stacking Post Threaded Rods 	4 per set. For use with stacking posts for the Contemporary Leather and Exec Rectilinear Collections.		

Order Code

Example: 001-214-MC
001-214 Metal letter tray stacking posts
MC Mirror chrome

Ordering Information

- Specify:*
1. Pattern number
 2. Finish (except Threaded Rods)

Metal letter tray post finishes:
 Mirror Brass (MB)
 Matte Black (BK)
 Mirror Chrome (MC)

pattern no.	list price
001-214	\$30.

001-315	8.
----------------	----

International Collection

Glassware

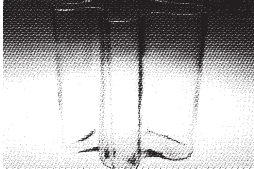
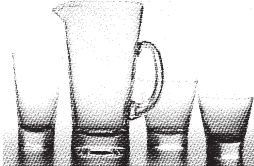
product	description	type	h	wt.
Aalto Vase 	Designed by Alvar Aalto, 1933-36. Permanent collection of the New York Museum of Modern Art. Available in clear and opal.		3 3/4" 4 3/4" 6 1/4"	
Savoy Vase 	Designed by Alvar Aalto, 1936. Larger, less convoluted versions of the Aalto Vases. Exhibited at the 1937 World Exhibition in Paris. Clear crystal.		24" 8"	
Aarne Glassware 	Designed by Goran Hongell, 1948.	11 1/2 oz. Double Old Fashioned 12 1/2 oz. Highball 3 pt. Pitcher 7 oz. Old Fashioned Pilsner		14 ozs. 14 ozs. 2 lbs. 8 ozs. 11 ozs.

Order Code

Example: **3030-120-OP**
3030-120 4 3/4" Aalto vase
OP Opal

Ordering Information

Specify:
 1. Pattern number
 2. Color (Aalto only)

Aalto Colors:
 Opal (OP)
 Clear (CL)

Ordering note:
 All crystal pieces are priced and shipped individually.

Custom Options

Additional barware sizes available. Contact your Knoll sales representative or Customer Service for selection and pricing information.

pattern no.	opal	clear
3030-095	\$170.	\$170.
3030-120	301.	301.
3030-160	410.	410.
3031-600		6,173.
3031-200		550.
2020-032		71.
2020-035		71.
2020-150		241.
2020-020		60.
2020-038		71.

Construction

Lead-free crystal.
Manufactured in Finland.

Design Award

Aalto Vase:
The International Tabletop Award,
1988.

Aarne Glassware:
The International Tabletop Award,
1989.

International Collection

Stainless Boardroom Accessories

product	description	type	w	d	h	wt.
Large Stainless Carafe 	Designed by Erik Magnussen, 1977. Delivered with automatic tilt close top and screw close top options. Glass vacuum liner for serving hot or cold liquids. Matte black plastic top and handle. Available in satin stainless or black oxide finish. 1 liter capacity.		4"		12"	2 lbs. 11 ozs.
Small Stainless Carafe 	Designed by Erik Magnussen, 1977. Delivered with automatic tilt close top and screw close top options. Glass vacuum liner for serving hot or cold liquids. Matte black plastic top and handle. Available in satin stainless or black oxide finish. 1/2 liter capacity.		4"		8 1/4"	1 lb. 11 ozs.
Stainless Creamer 	Designed by Erik Magnussen, 1977. Satin stainless. Matte black plastic top. 8 oz. capacity.		3 1/4"		3 3/4"	4 ozs.
Stainless Sugar Bowl 	Designed by Erik Magnussen, 1977. Satin stainless. Matte black plastic top. 10 oz. capacity.		4 1/4"		2 1/4"	5 ozs.
Serving Tray 	Designed by Erik Magnussen. Satin stainless with black rubber liner.				15" dia. x 3/4"	

Order Code

Example:	STL-900-ST
STL-900	Large stainless carafe
ST	Satin stainless

Ordering Information

Specify:

1. Pattern number
2. Finish (Carafe only)

Metal finishes:
 Satin Stainless (ST)
 Black Oxide (BO)

Custom Options

Additional stainless steel accessories available. Contact your Knoll sales representative or Customer Service for selection and pricing information.

pattern no.	black oxide	satin stainless	stainless
STL-900	\$457.	\$362.	
<hr/>			
STL-915	394.	301.	
<hr/>			
STL-1000		133.	
<hr/>			
STL-1100		133.	
<hr/>			
STL-2004		281.	
<hr/>			

Boardroom Accessories

Construction

Solid, satinized stainless steel that has been lacquered for long-term finish protection. Textured, ABS plastic top and handle. Black oxide finish is painted over stainless steel.

Manufactured in Denmark.

International Collection

Stainless Boardroom Accessories

product	description	type	w	d	h	wt.
	Stainless Coffee Pot Cylinda-line, designed by Arne Jacobsen, 1967. 1 1/2 liter capacity.		4"		8"	1 lb. 9 ozs.
	Stainless Tea Pot Cylinda-line, designed by Arne Jacobsen, 1967. 1 1/4 liter capacity.		5"		4 1/4"	1 lb. 9 ozs.
	Stainless Creamer & Sugar Bowl Cylinda-line, designed by Arne Jacobsen, 1967. Includes sugar bowl, creamer, and sugar bowl lid. Spoon not included. Creamer is 2" x 3 3/4". Sugar Bowl is 3" x 2 1/4".	Creamer Sugar Bowl				
	Stainless Serving Tray with Handles Cylinda-line, designed by Arne Jacobsen, 1967. Round tray with straight wall lip and curved handles. Brushed stainless.		13 1/8"		1"	2 lbs.
	Stainless Ice Bucket Cylinda-line, designed by Arne Jacobsen, 1967.	Small: 35 oz. capacity	5 1/8"		4 1/8"	2 lbs.
	Stainless Ice Tongs		6 3/4"		1/2"	3 ozs.
	Stainless Coaster Set Cylinda-line, designed by Arne Jacobsen, 1967. Set of 6.		3 1/4"		1/4"	10 ozs. (each)

Order Code

Example: **STL-900-ST**
STL-900 Large stainless carafe
ST Satin stainless

Ordering Information

Specify:
 1. Pattern number
 2. Finish (Carafe only)

Metal finishes:
 Satin Stainless (ST)
 Black Oxide (BO)

Custom Options

Additional stainless steel accessories available. Contact your Knoll sales representative or Customer Service for selection and pricing information.

pattern no.	black oxide	satin stainless	stainless
STL-01-2			\$764.
STL-04-2			764.
STL-06-2			165.
STL-06-3			214.
STL-014-2			342.
STL-05-1			587.
STL-015-1			79.
STL-019-1			185.

Construction

Solid, satinized stainless steel that has been lacquered for long-term finish protection. Textured, ABS plastic top and handle. Black oxide finish is painted over stainless steel.

Manufactured in Denmark.

International Collection

Stainless Boardroom Accessories

product	description	type	w	d	h	wgt.
Napkin Holder	Designed by Peter Holmblad Stainless Steel		7 ¹⁵ / ₁₆ "	7 ¹⁵ / ₁₆ "	3 ³ / ₄ "	



Order Code

Example:	STL-900-ST
STL-900	Large stainless carafe
ST	Satin stainless

Ordering Information

Specify:

1. Pattern number
2. Finish (Carafe only)

Metal finishes:
Satin Stainless (ST)
Black Oxide (BO)

Custom Options

Additional stainless steel accessories available. Contact your Knoll sales representative or Customer Service for selection and pricing information.

pattern no.	black oxide	satin stainless	stainless
STL-486			\$166.

Construction

Solid, satinized stainless steel that has been lacquered for long-term finish protection. Textured, ABS plastic top and handle. Black oxide finish is painted over stainless steel.

Manufactured in Denmark.

International Collection

Plastic Boardroom Accessories

product	description	w	d	h	wt.
Large Plastic Carafe 	Designed by Erik Magnussen, 1977. Automatic tilt-close top. Glass vacuum liner for serving hot or cold liquids. 1 liter capacity. Textured black top. Available in red, black, white and blue.	4"		11 3/4"	2 lbs. 6 ozs.
Small Plastic Carafe 	Designed by Erik Magnussen, 1977. Automatic tilt-close top. Glass vacuum liner for serving hot or cold liquids. 1/2 liter capacity. Textured black top. Available in black.	4"		8 3/4"	1 lb. 6 ozs.
Plastic Water Pitcher 	Designed by Erik Magnussen, 1977. Textured black top. Available in clear. 1 1/2 liter capacity.	4"		9 1/4"	1 lb. 4 ozs.
Plastic Creamer 	Designed by Erik Magnussen, 1977. Textured black top. Available in black. 8 oz. capacity.	3 1/4"		3 3/4"	4 ozs.
Plastic Sugar Bowl 	Designed by Erik Magnussen, 1977. Textured black top. Available in black. 10 oz. capacity.	4 1/4"		2 1/4"	4 ozs.

Order Code

Example: STL-9-30
STL-9 Plastic carafe
30 Black

Ordering Information

Specify:

1. Pattern number
2. Finish

Large carafe plastic finishes:
 Red (20)
 Black (30)
 White (60)
 Blue (70)

Custom Options

Small carafe plastic finish:
 Black (30)

Water pitcher plastic finish:
 Clear (10)

Creamer and sugar bowl plastic finish:
 Black (30)

Additional plastic accessories available. Contact your Knoll sales representative or Customer Service for selection and pricing information.

pattern no.	list price
STL-9	\$185.
STL-15	148.
STL-13	92.
STL-10	52.
STL-11	52.

Construction

Durable ABS plastic.

Manufactured in Denmark.

International Collection

Umbrella Stand and Clocks

product	description	w	d	h	wt.
Ivy Umbrella Stand	Designed by Emanuela Frattini, 1990. Lightweight aluminum. Comfortably holds 9 umbrellas. Saucer-shaped base collects water.	15"	15"	20"	7 lbs.

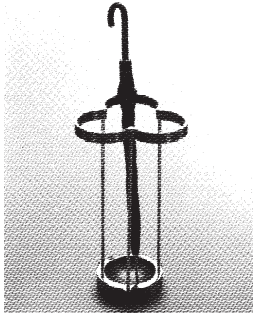

Mathiesen Wall Clock	Designed by Ole Mathiesen, 1972. Battery-operated Swiss quartz movement. Batteries included. Black finish.	8 ³ / ₄ "	1 lb.
		12 ¹ / ₄ "	2 lbs.
		17 ¹ / ₂ "	3 lbs.

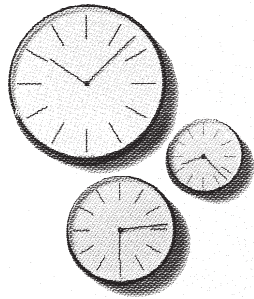

Order Code

Example: **EFM-IVYU**

EFM-IVYU Ivy umbrella stand

Ordering Information

Specify:

1. Pattern number

pattern no.	list price
EFM-IVYU	\$580.

1-2600	764.
1-2601	968.
1-2602	1,659.

Construction

Umbrella stand:

Cast aluminum base and top ring.
Solid aluminum rods. Polished on
top surfaces and bead blasted on
sides and center of base and top
ring.

Manufactured in the United States.

Mathiesen Wall Clock:

Hand-formed aluminum frame and
hands. Glass face cover.

Manufactured in Denmark.

International Collection

Replacement Parts

product	description
Carafe Stopper	For use with STL-900, STL-915, STL-9 and STL-15 stainless and plastic carafes.
Carafe Top	Black textured plastic. For use with STL-900, STL-915, STL-9 and STL-15 stainless and plastic carafes.
Large Carafe Thermal Liner & Gasket	For use with STL-900 and STL-915 stainless and plastic carafes.



Order Code

Example: **STL-900-1**

STL-900-1 Carafe stopper

Ordering Information

Specify:

1. Pattern number

Note:

Please consult Customer Service for additional replacement parts.

pattern no.	list price
STL-900-1	\$36.
STL-900-2	36.
STL-900-3	85.

Orchestra® Universal System Accessories
 by Bruce Hannah & Ayse Birsel
 letter trays

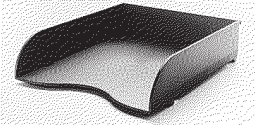
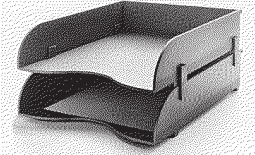
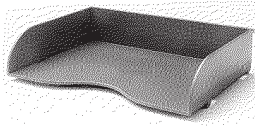
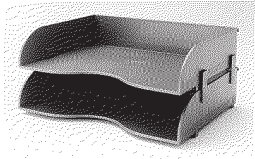
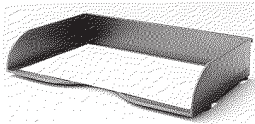
product	description	w	d	h	wgt.
Front Letter Single Tray 	Single tray. Non-scutting rubber feet.	10 1/4"	13"	2 3/4"	1 lb. 2 ozs.
Front Letter Double Tray 	Double tray. Non-scutting rubber feet. Removable stacking brackets included.	10 1/4"	13"	7 1/4"	2 lbs. 5 ozs.
Side Letter Single Tray 	Single tray. Non-scutting rubber feet. *Available in Translucent Orange and Blue	13 1/4"	9 1/2"	2 3/4"	1 lb. 7 ozs.
Side Letter Double Tray 	Double tray. Non-scutting rubber feet. Removable stacking brackets included. *Available Translucent in Orange and Blue	13 1/4"	9 1/2"	7 1/4"	2 lbs. 15 ozs.
Side Legal Single Tray 	Single tray. Non-scutting rubber feet.	15 1/2"	9 1/2"	2 3/4"	2 lbs.

Order Code

Example: **ORCH-F-LT-BK**
ORCH-F- Front letter tray
LT
BK Black

Ordering Information

Specify:
 1. Pattern number
 2. Finish
Opaque plastic finishes:
 Black (BK)
 Medium Grey (DG)
 Soft Grey (E)
 Warm Putty (WP)

Custom Options

Translucent polycarbonate finishes:
 Clear (CL)
 *Orange (OR)
 *Blue (BL)
 *Select Products Only

Custom colors available upon sample chip approval. \$350 color match fee and 500 piece minimum per line item.

Letter trays mounted on slat wall or load bars accommodate up to max. 15lbs of weight.

pattern no.	translucent colors list price	opaque colors list price
ORCH-F-LT	\$46.	\$36.
2ORCH-F-LT	90.	78.
ORCH-S-LT	46.	36.
2ORCH-S-LT	90.	78.
ORCH-S-LGT	55.	48.

System top cap-mounted signage plate available, designed to customer specifications and system. Customer responsible for graphics. 100 unit minimum. Contact your Knoll sales representative or Customer Service for complete pricing information.

Construction

Opaque plastic finishes:
Sturdy polystyrene plastic in matte, textured finish. Fingerprint resistant.

Translucent finishes:
Sturdy polycarbonate resin.

Manufactured in the United States.

Design Awards

Permanent Collection of the Cooper-Hewitt, National Design Museum, Smithsonian Institution, 1994; ROSCOE Award, Interior Design Magazine, 1991; Outstanding Performance, Product Design Achievement Award, IBD Southern California Chapter, 1991; Bronze Award, IBD Product Design Competition, 1990.

Orchestra® Universal System Accessories
 by Bruce Hannah & Ayse Birsel
letter trays

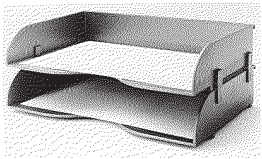
product	description	w	d	h	wgt.
Side Legal Double Tray 	Double tray. Non-scuffing rubber feet. Removable stacking brackets included.	15 1/2"	9 1/2"	7 1/4"	4 lbs. 1 oz.
Replacement Stacking Brackets	Set of four stacking brackets for all Orchestra letter trays. *Available in Translucent Orange and Blue	3/4"	1/2"	2"	1 oz. (set)

Order Code

Example: **ORCH-F-LT-BK**

ORCH-F- Front letter tray

LT

BK Black

Ordering Information

Specify:

1. Pattern number
2. Finish

Opaque plastic finishes:

- Black (BK)
- Medium Grey (DG)
- Soft Grey (E)
- Warm Putty (WP)

Translucent polycarbonate finishes:

- Clear (CL)
- *Orange (OR)
- *Blue (BL)
- *Select Products Only

Letter trays mounted on slat wall or load bars accommodate up to max. 15lbs of weight.

Custom Options

Custom colors available upon sample chip approval. \$350 color match fee and 500 piece minimum per line item.

pattern no.	translucent colors list price	opaque colors list price
2ORCH-S-LGT	\$109.	\$94.
ORCH-SB	6.	5.

System top cap-mounted signage plate available, designed to customer specifications and system. Customer responsible for graphics. 100 unit minimum. Contact your Knoll sales representative or Customer Service for complete pricing information.

Construction

Opaque plastic finishes:
Sturdy polystyrene plastic in matte, textured finish. Fingerprint resistant.



Translucent finishes:
Sturdy polycarbonate resin.

Manufactured in the United States.

Design Awards

Permanent Collection of the Cooper-Hewitt, National Design Museum, Smithsonian Institution, 1994; ROSCOE Award, Interior Design Magazine, 1991; Outstanding Performance, Product Design Achievement Award, IBD Southern California Chapter, 1991; Bronze Award, IBD Product Design Competition, 1990.

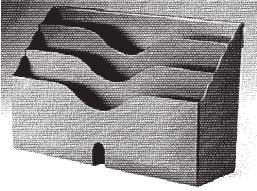
Orchestra® Universal System Accessories
 by Bruce Hannah & Ayse Birsel
paper management

product	description	w	d	h	wgt.
2-Way Binder Bin 	Horizontal or vertical positioning. Excellent for rail-mount, desktop, and overhead storage.	4 7/8"	12 1/4"	8 1/4"	1 lb. 6 ozs.
Vertical Paper Pack 	Holds memo, letter, legal and unbound EDP size material. *Available in Translucent Orange and Blue	15 1/4"	5"	9"	2 lbs. 1 oz.
Slanted Sorter 	Removable dividers tilt left and right. *Available in Translucent Orange and Blue	9"	11"	8 1/2"	2 lbs. 4 ozs.
File Sorter 	Versatile sorter holds small files, stationery, envelopes, messages and other desktop papers.	10 1/4"	5 1/2"	5 1/2"	1 lb. 8 ozs.

Order Code	Ordering Information	Custom Options
Example: ORCH-BDN-DG ORCH- Binder bin BDN DG Medium grey	Specify: 1. Pattern number 2. Finish <i>Opaque plastic finishes:</i> Black (BK) Medium Grey (DG) Soft Grey (E) Warm Putty (WP) <i>Translucent polycarbonate finishes:</i> Clear (CL) *Orange (OR) *Blue (BL) *Select Products Only	Custom colors available upon sample chip approval. \$350 color match fee and 500 piece minimum per line item. System top cap-mounted signage plate available, designed to customer specifications and system. Customer responsible for graphics. 100 unit minimum. Contact your KnollExtra representative or Customer Service for complete pricing information.

pattern no.	translucent colors list price	opaque colors list price
ORCH-BDN	\$58.	\$51.
ORCH-VPP	63.	58.
ORCH-SSD	63.	58.
ORCH-FS	44.	40.

Construction

Opaque plastic finishes:
Sturdy polystyrene plastic in matte, textured finish. Fingerprint resistant.



Translucent finishes:
Sturdy polycarbonate resin.

Manufactured in the United States.

Design Awards

Permanent Collection of the Cooper-Hewitt, National Design Museum, Smithsonian Institution, 1994; ROSCOE Award, Interior Design Magazine, 1991; Outstanding Performance, Product Design Achievement Award, IBD Southern California Chapter, 1991; Bronze Award, IBD Product Design Competition, 1990.

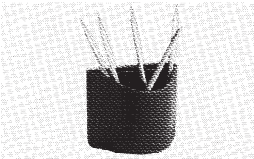
Orchestra® Universal System Accessories
 by Bruce Hannah & Ayse Birsal
 hanging file holders, pencil cup and utility trays

product	description	w	d	h	wt.
Hanging File Holders 	2 per set. Attach to rail and hold legal or letter size hanging folders for easy access. Black is anodized aluminum. Medium grey is painted aluminum. Not for use on Currents slat wall.	1"	8"	1"	8 ozs. (pair)
Pencil Cup 	Three compartments for pencils, 4" x 6" memo paper, and large Post-It™ Notes. *Available in Translucent Orange and Blue	5"	3"	4"	7 ozs.
Utility Tray 	6 versatile compartments hold pencils, paper clips, and other paper management items. Largest compartment is 3" x 8 1/4".	12"	7"	1"	12 ozs.

Order Code

Example: **ORCH-PC**
ORCH-PC Pencil cup
CL Clear

Ordering Information

Specify:
 1. Pattern number
 2. Finish
 3. Divider finish(mini-shelf only)

Opaque plastic finishes:
 Black (BK)
 Medium Grey (DG)
 Soft Grey (E)
 Warm Putty (WP)

Translucent polycarbonate finishes:
 Clear (CL)
 *Orange (OR)
 *Blue (BL)
 *Select Products Only

Hanging file holder metal finishes:
 Black (BK)
 Medium Grey (DG)

Custom Options

For plastic accessories, custom colors available upon sample chip approval. \$350 color match fee and 500 piece minimum per line item.

System top cap-mounted signage plate available, designed to customer specifications and system. Customer responsible for graphics. 100 unit minimum. Contact your Knoll sales representative or Customer Service for complete pricing information.

pattern no.	translucent colors list price	opaque colors list price
ORCH-HFH		\$43.
ORCH-PC	25.	23.
ORCH-UT	31.	29.

Construction

Hanging file holder and mini-shelf:
 Medium grey painted aluminum or black anodized aluminum.
 Mini-shelf dividers are poly-styrene plastic.

Pencil cup and utility tray:
 Sturdy polystyrene plastic in a matte, textured finish. Fingerprint resistant.

Translucent finishes:
 Sturdy polycarbonate resin.

All items are manufactured in the United States.

Design Awards

Permanent Collection of the Cooper-Hewitt, National Design Museum, Smithsonian Institution, 1994; ROSCOE Award, Interior Design Magazine, 1991; Outstanding Performance, Product Design Achievement Award, IBD Southern California Chapter, 1991; Bronze Award, IBD Product Design Competition, 1990.

Orchestra® Universal System Accessories
 by Bruce Hannah & Ayse Birsal
 tape dispenser and memo tray

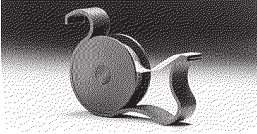
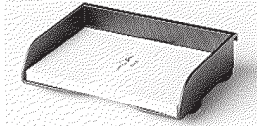
product	description	type	w	d	h	wgt.
Tape Dispenser 	Holds standard, clear tape (not included).		1"	4 1/2"	3 1/2"	3 ozs.
Memo Tray 	Includes 4" x 6" memo paper. Non-scuffing rubber feet. *Available in Translucent Orange and Blue		6"	4"	1"	9 ozs.

Order Code

Example: **ORCH-TD-E**
ORCH-TD Tape dispenser
E Soft grey

Ordering Information

Specify:
 1. Pattern number
 2. Finish

Opaque plastic finishes:
 Black (BK)
 Medium Grey (DG)
 Soft Grey (E)
 Warm Putty (WP)

Translucent polycarbonate finishes:
 Clear (CL)
 *Orange (OR)
 *Blue (BL)
 *Select Products Only

Custom Options

Custom colors available upon sample chip approval. \$350 color match fee and 500 piece minimum per line item.

System top cap-mounted signage plate available, designed to customer specifications and system. Customer responsible for graphics. 100 unit minimum. Contact your Knoll sales representative or Customer Service for complete pricing information.

pattern no.	translucent colors list price	opaque colors list price
ORCH-TD	\$22.	\$21.
ORCH-MT	25.	23.

Construction

Opaque plastic finishes:
Sturdy polystyrene plastic in matte, textured finish. Fingerprint resistant.



Translucent finishes:
Sturdy polycarbonate resin.

Manufactured in the United States.

Design Awards

Permanent Collection of the Cooper-Hewitt, National Design Museum, Smithsonian Institution, 1994; ROSCOE Award, Interior Design Magazine, 1991; Outstanding Performance, Product Design Achievement Award, IBD Southern California Chapter, 1991; Bronze Award, IBD Product Design Competition, 1990.

Orchestra® Universal System Accessories
 by Bruce Hannah & Ayse Birsal
clip/cup holder, bud vase and telephone shelf

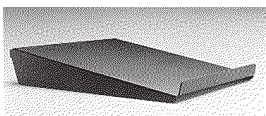
product	description	w	d	h	wgt.
Clip/Cup Holder 	Removes coffee cups, cans, paper clips, thumb tacks, etc. from the worksurface. Available in black and medium grey painted aluminum.	3 3/4"	4"	1"	4 ozs.
Bud Vase 	Available in black and clear. Rail-mounted only.	2"	2"	7"	3 ozs.
Telephone Shelf 	Holds virtually any standard office telephone. Available in black only.	12"	11 1/2"	2"	3 lbs. 12 ozs.

Order Code

Example: **ORCH-CCH-BK**
ORCH- Clip/ Cup Holder
CCH
BK Black

Ordering Information

Specify:
 1. Pattern number
 2. Finish (When applicable)

Acrylic vase finishes:
 Black (BK)
 Clear (CL)

Clip/cup holder finishes:
 Black (BK)
 Medium Grey (DG)

Custom Options

For plastic accessories, custom colors available upon sample chip approval. \$350 color match fee and 500 piece minimum per line item.

System top cap-mounted signage plate available, designed to customer specifications and system. Customer responsible for graphics. 100 unit minimum. Contact your Knoll sales representative or Customer Service for complete pricing information.

pattern no.	opaque colors list price
ORCH-CCH	\$50.
ORCH-VAS	23.
ORCH-TS-UNI	88.

Construction

Translucent finishes:
Sturdy polycarbonate resin.

Clip/cup holder:
Painted, sand cast aluminum.

Bud vase:
Acrylic with black polystyrene holder.

Telephone shelf:
16-gauge painted steel.

Bud Vase is manufactured in Taiwan, Republic of China. All other items are manufactured in the United States.

Design Awards

Permanent Collection of the Cooper-Hewitt, National Design Museum, Smithsonian Institution, 1994; ROSCOE Award, Interior Design Magazine, 1991; Outstanding Performance, Product Design Achievement Award, IBD Southern California Chapter, 1991; Bronze Award, IBD Product Design Competition, 1990.

Orchestra® Universal System Accessories
 by Bruce Hannah & Ayse Birsal
 desk pads and wastebaskets

product	description	w	d	h	wgt.
Racetrack Desk Pad	Black linoleum with felt back.	30"	18"		5 lbs.



Wastebasket	Freestanding, 24 qt. capacity.	8 1/2"	14"	14 7/8"	4 lbs. 6 ozs.
-------------	--------------------------------	--------	-----	---------	---------------

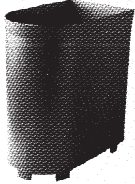

Recycling Wastebasket	Blue recycling color for desk-side separation of waste materials. Includes recycling stickers. Freestanding. 24 qt. capacity.	8 1/2"	14"	14 7/8"	4 lbs. 6 ozs.
-----------------------	---	--------	-----	---------	---------------



Order Code	
Example:	ORCH-WBK-E
ORCH-	Wastebasket
WBK	
E	Soft grey

Ordering Information

Specify:

1. Pattern number
2. Finish (When applicable)

Wastebasket finishes:
 Black (BK)
 Soft Grey (E)
 Warm putty (WP)
 Electric blue (EB)

Custom Options

Additional desk pad colors available. Special sizes available up to 34"W x 28"D. 50 piece minimum on all custom desk pads. Custom wastebasket colors available upon sample chip approval. \$350 color match fee and 750 minimum per line item. Contact your Knoll sales representative or Customer Service for complete pricing information.

pattern no.	list price
ORCH-DP	\$85.

ORCH-WBK	97.
-----------------	-----

ORCH-WBK-R-EB	97.
----------------------	-----

Construction

Desk pad:
Black linoleum with felt black

Wastebasket:
Polypropylene with matte textured finish.

All items are manufactured in the United States.

Design Awards

Permanent Collection of the Cooper-Hewitt, National Design Museum, Smithsonian Institution, 1994; ROSCOE Award, Interior Design Magazine, 1991; Outstanding Performance, Product Design Achievement Award, IBD Southern California Chapter, 1991; Bronze Award, IBD Product Design Competition, 1990.

Orchestra® Universal System Accessories

by Bruce Hannah & Ayse Birsel

load bar/info rail

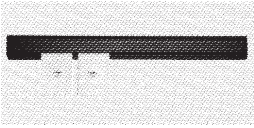
product	description	w	d	h	wgt.
Load Bar/Info Rail 	• Fits virtually every office system.	24"	1/2"	3"	1 lb. 9 ozs.
	• Mounts on panel, stanchion, wall or freestanding desk.	30"	1/2"	3"	2 lbs.
	• Info Rail underside holds memos and notes for easy access.	35"	1/2"	3"	2 lbs. 6 ozs.
	• Black plastic end caps.	36"	1/2"	3"	2 lbs. 9 ozs.
	• Wall, stanchion or panel-mounted brackets included in list price (see mounting options page).	42"	1/2"	3"	3 lbs.
		45"	1/2"	3"	3 lbs. 2 ozs.
		48"	1/2"	3"	3 lbs. 4 ozs.
		54"	1/2"	3"	4 lbs.
		60"	1/2"	3"	4 lbs. 5 ozs.
		66"	1/2"	3"	4 lbs. 8 ozs.
	72"	1/2"	3"	4 lbs. 12 ozs.	
Load Bar/Info Rail Morrison Network 2		11 5/8"	1/2"	3"	
		17 5/8"	1/2"	3"	
		23 5/8"	1/2"	3"	
		29 5/8"	1/2"	3"	
		35 5/8"	1/2"	3"	
		41 5/8"	1/2"	3"	
		47 5/8"	1/2"	3"	
Currents Work Shelf Load Bar		13 1/2"	1/2"	3"	
		17 7/8"	1/2"	3"	
		29 7/8"	1/2"	3"	
Currents Stanchion Mounted Load Bar		26 3/4"	1/2"	3"	
		38 3/4"	1/2"	3"	
Dividends and Caliber Stanchion Mounted Load Bar		31 5/8"	1/2"	3"	
		37 5/8"	1/2"	3"	
		43 5/8"	1/2"	3"	
		55 5/8"	1/2"	3"	
		67 5/8"	1/2"	3"	

Order Code	Ordering Information
Example: OR-LBI-36-111 OR-BKT-PM-R <hr/> OR-LBI-36 36" load bar <hr/> 111 Black <hr/> OR-BKT-PM-R Panel-mounted bracket for Reff	<i>Specify:</i> 1. Pattern number 2. System Suffix 3. Finish 4. Mounting Option Special sizes and small quantity orders may be painted <i>Anodized aluminum finish:</i> Silver Anodized (SV)
	<i>Painted Core aluminum finishes:</i> Medium Grey (115) Soft Grey (117) Black (111) Beige Mist Metallic (611) Brown (112) Dark Grey (113) Folkstone Grey (114) Sandstone (116) Bright White (118) Medium Grey Metallic (612)
	<i>Painted Legacy aluminum finishes are still available for existing customers only:</i> Medium Metallic Grey (DG) Soft Grey (E) Warm Putty (WP) Flint (F) Black (BK)

pattern no.	list
OR-LBI-24-()()	\$86.
OR-LBI-30-()()	86.
OR-LBI-35-()()	93.
OR-LBI-36-()()	93.
OR-LBI-42-()()	104.
OR-LBI-45-()()	116.
OR-LBI-48-()()	116.
OR-LBI-54-()()	126.
OR-LBI-60-()()	133.
OR-LBI-66-()()	148.
OR-LBI-72-()()	173.
OR-LBI-24-N2-()()	76.
OR-LBI-30-N2-()()	82.
OR-LBI-36-N2-()()	86.
OR-LBI-42-N2-()()	86.
OR-LBI-48-N2-()()	93.
OR-LBI-54-N2-()()	104.
OR-LBI-60-N2-()()	116.
OR-LBI-66-N2-()()	126.
OR-LBI-72-N2-()()	133.
OR-LBI-30-C-()()	35.
OR-LBI-36-C-()()	44.
OR-LBI-48-C-()()	61.
OR-LBI-36-CS-()()	56.
OR-LBI-48-CS-()()	83.
OR-LBI-36-DV-()()	60.
OR-LBI-42-DV-()()	72.
OR-LBI-48-DV-()()	84.
OR-LBI-60-DV-()()	101.
OR-LBI-72-DV-()()	126.

Mounting Options

Please note flat panel monitor arms cannot be mounted on Orchestra® load bars. Flat panel monitors can be mounted on Orchestra® slat wall only when mounted on an architectural wall. The Wishbone Test Matrix on Knoll Exchange outlines all monitor limitations. Please review before mounting. Please see p.130 for flat panel monitor tool bar options (Note: tool bars cannot hold Orchestra® organizational tools.)

See page 76 for mounting options

Custom Options

Note:
Load Bar/Info Rails are available in custom lengths. Please note that for all lengths greater than 66", load bar will be painted, not anodized. Contact your local Knoll Customer Service representative for details.

Construction

Load bar/info rail:
Corrosion-resistant T-6063 painted or anodized aluminum. End caps are textured polystyrene plastic. Load Bar is filled with 1/2" Delrin plastic pellets to support papers on info rail.

All items manufactured in the United States.

Design Awards

Permanent Collection of the Cooper-Hewitt, National Design Museum, Smithsonian Institution, 1994; ROSCOE Award, Interior Design Magazine, 1991; Outstanding Performance, Product Design Achievement Award, IBD Southern California Chapter, 1991; Bronze Award, IBD Product Design Competition, 1990.

Orchestra® Universal System Accessories
 by Bruce Hannah & Ayse Birsal
 load bar/info rail

product	description	w	d	h	wgt.
Equity Stanchion Load Bar		24"	1"	3"	
		30"	1"	3"	
		36"	1"	3"	
		42"	1"	3"	
		54"	1"	3"	
		66"	1"	3"	
Equity Application Load Bar		22 1/4"	1/2"	3"	
		28 1/4"	1/2"	3"	
		34 1/4"	1/2"	3"	
		40 1/4"	1/2"	3"	
		46 1/4"	1/2"	3"	
		52 1/4"	1/2"	3"	
		58 1/4"	1/2"	3"	
		64 1/4"	1/2"	3"	
		70 1/4"	1/2"	3"	

Order Code	Ordering Information
Example: OR-LBI-36-111 OR-BKT-PM-R	<i>Specify:</i>
OR-LBI-36 36" load bar	1. Pattern number
111 Black	2. System Suffix
OR-BKT- Panel-mounted bracket	3. Finish
PM-R for Reff	4. Mounting Option
	Special sizes and small quantity orders may be painted
	<i>Anodized aluminum finish:</i> Silver Anodized (SV)
	<i>Painted Core aluminum finishes:</i> Medium Grey (115) Soft Grey (117) Black (111) Beige Mist Metallic (611) Brown (112) Dark Grey (113) Folkstone Grey (114) Sandstone (116) Bright White (118) Medium Grey Metallic (612)
	<i>Painted Legacy aluminum finishes are still available for existing customers only:</i> Medium Metallic Grey (DG) Soft Grey (E) Warm Putty (WP) Flint (F) Black (BK)

pattern no.	list
OR-LBI-30-ES-()()	\$86.
OR-LBI-36-ES-()()	86.
OR-LBI-42-ES-()()	93.
OR-LBI-48-ES-()()	104.
OR-LBI-60-ES-()()	126.
OR-LBI-72-ES-()()	148.
OR-LBI-24-EY-()()	86.
OR-LBI-30-EY-()()	86.
OR-LBI-36-EY-()()	93.
OR-LBI-42-EY-()()	104.
OR-LBI-48-EY-()()	116.
OR-LBI-54-EY-()()	126.
OR-LBI-60-EY-()()	133.
OR-LBI-66-EY-()()	148.
OR-LBI-72-EY-()()	173.

Mounting Options

Please note flat panel monitor arms cannot be mounted on Orchestra® load bars. Flat panel monitors can be mounted on Orchestra® slat wall only when mounted on an architectural wall. The Wishbone Test Matrix on Knoll Exchange outlines all monitor limitations. Please review before mounting. Please see p.130 for flat panel monitor tool bar options (Note: tool bars cannot hold Orchestra® organizational tools.)

See page 76 for mounting options

Custom Options

Note:
Load Bar/Info Rails are available in custom lengths. Please note that for all lengths greater than 66", load bar will be painted, not anodized. Contact your local Knoll Customer Service representative for details.

Construction

Load bar/info rail:
Corrosion-resistant T-6063 painted or anodized aluminum. End caps are textured polystyrene plastic. Load Bar is filled with 1/2" Delrin plastic pellets to support papers on info rail.

All items manufactured in the United States.

Design Awards

Permanent Collection of the Cooper-Hewitt, National Design Museum, Smithsonian Institution, 1994; ROSCOE Award, Interior Design Magazine, 1991; Outstanding Performance, Product Design Achievement Award, IBD Southern California Chapter, 1991; Bronze Award, IBD Product Design Competition, 1990.

Orchestra® Universal System Accessories
 by Bruce Hannah & Ayse Birsal
 slat board 6 1/2"

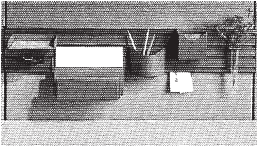
product	description	w	d	h	wgt.
Slat board-6 1/2" 	<ul style="list-style-type: none"> Fits virtually every office system. Mounts on panel, stanchion, wall or freestanding desk. 3 horizontal accessory channels. Info rail underside holds memos and notes for easy access. Wall, stanchion, or panel-mounted brackets included in list price (see mounting options page). 	24"	1"	6 1/2"	2 lbs. 9 ozs.
		30"	1"	6 1/2"	3 lbs. 3 ozs.
		35"	1"	6 1/2"	3 lbs. 13 ozs.
		36"	1"	6 1/2"	3 lbs. 13 ozs.
		42"	1"	6 1/2"	4 lbs. 8 ozs.
		45"	1"	6 1/2"	4 lbs. 8 ozs.
		48"	1"	6 1/2"	5 lbs. 2 ozs.
		54"	1"	6 1/2"	5 lbs. 12 ozs.
		60"	1"	6 1/2"	6 lbs. 6 ozs.
		66"	1"	6 1/2"	7 lbs.
		72"	1"	6 1/2"	7 lbs. 11 ozs.
Slat board Morrison Network 2		11 5/8"	1"	6 1/2"	
		17 5/8"	1"	6 1/2"	
		23 5/8"	1"	6 1/2"	
		29 5/8"	1"	6 1/2"	
		35 5/8"	1"	6 1/2"	
		41 5/8"	1"	6 1/2"	
		47 5/8"	1"	6 1/2"	
		53 5/8"	1"	6 1/2"	
	59 5/8"	1"	6 1/2"		
Slat board-Equity Stanchion		24"	1"	6 1/2"	
		30"	1"	6 1/2"	
		36"	1"	6 1/2"	
		42"	1"	6 1/2"	
		54"	1"	6 1/2"	
		66"	1"	6 3/4"	
Equity application		24"	1"	6 1/2"	2 lbs. 9 ozs.
		30"	1"	6 1/2"	3 lbs. 3 ozs.
		36"	1"	6 1/2"	3 lbs. 13 ozs.
		42"	1"	6 1/2"	4 lbs. 8 ozs.
		48"	1"	6 1/2"	5 lbs. 2 ozs.
		54"	1"	6 1/2"	5 lbs. 12 ozs.
		60"	1"	6 1/2"	6 lbs. 6 ozs.
		66"	1"	6 1/2"	7 lbs.
	72"	1"	6 1/2"	7 lbs. 11 ozs.	

Order Code

Example: OR-SL-06-42-EY-117-OR-BKT-PM-E
OR-SL-06- 42"W x 6 1/2"H slat board
42
EY Equity suffix
117 Soft grey
OR-BKT- Panel-mounted bracket
PM-E for Equity

Ordering Information

Specify:

1. Pattern number
2. System
3. Finish
4. Mounting Option

Satin anodized aluminum finish:
 Satin Anodized Aluminum (SA)
 includes painted matte black endcap. Special sizes and small quantity orders may be painted

Painted aluminum finishes:

- Medium Grey (115)
- Soft Grey (117)
- Black (111)
- Beige Mist Metallic (611)
- Brown (112)
- Dark Grey (113)
- Folkstone Grey (114)
- Sandstone (116)
- Bright White (118)
- Medium Grey Metallic (612)

Painted Legacy aluminum finishes are still available for existing customers only:

- Medium Metallic Grey (DG)
- Soft Grey (E)
- Warm Putty (WP)
- Flint (F)
- Black (BK)

Worksurface-mounted bracket:
 Metal posts attach to underside of worksurface with C-clamp, raising Load Bar 10" above worksurface. Usable on worksurfaces 1 1/8"-1 13/16" thick. Set of 2 brackets. For Slat boards wider than 66", order additional brackets.

For use with load bars and 6 1/2" slat boards only.

pattern no.	list price
OR-SL-06-24-()()	\$133.
OR-SL-06-30-()()	156.
OR-SL-06-35-()()	178.
OR-SL-06-36-()()	178.
OR-SL-06-42-()()	198.
OR-SL-06-45-()()	222.
OR-SL-06-48-()()	222.
OR-SL-06-54-()()	244.
OR-SL-06-60-()()	265.
OR-SL-06-66-()()	287.
OR-SL-06-72-()()	310.
OR-SL-06-24-N2-()()	88.
OR-SL-06-30-N2-()()	110.
OR-SL-06-36-N2-()()	133.
OR-SL-06-42-N2-()()	156.
OR-SL-06-48-N2-()()	178.
OR-SL-06-54-N2-()()	198.
OR-SL-06-60-N2-()()	222.
OR-SL-06-66-N2-()()	244.
OR-SL-06-72-N2-()()	265.
OR-SL-06-30-ES-()()	133.
OR-SL-06-36-ES-()()	156.
OR-SL-06-42-ES-()()	178.
OR-SL-06-48-ES-()()	198.
OR-SL-06-60-ES-()()	244.
OR-SL-06-72-ES-()()	287.
OR-SL-06-24-EY-()()	133.
OR-SL-06-30-EY-()()	156.
OR-SL-06-36-EY-()()	178.
OR-SL-06-42-EY-()()	198.
OR-SL-06-48-EY-()()	222.
OR-SL-06-54-EY-()()	244.
OR-SL-06-60-EY-()()	265.
OR-SL-06-66-EY-()()	287.
OR-SL-06-72-EY-()()	310.

Mounting Options

Please note flat panel monitor arms cannot be mounted on Orchestra® load bars. Flat panel monitors can be mounted on Orchestra® slat wall only when mounted on an architectural wall. The Wishbone Test Matrix on Knoll Exchange outlines all monitor limitations. Please review before mounting. Please see p.130 for flat panel monitor tool bar options (Note: tool bars cannot hold Orchestra® organizational tools.)

Panel, stanchion and wall-mounted brackets:

Wall, stanchion, or panel-mounted brackets are included in the list price.

Note: Other brackets for other manufacturers stations are available. Contact your Customer Representative for more information.

Custom Options

Note:

Slat board is available in custom lengths of up to 96". Please note that for all lengths greater than 66", load bar will be painted, not anodized.

Brackets are currently available for virtually every major office system. Panel-mounted brackets for other systems can be developed. Minimum of 100 sets per bracket. Tooling and set-up charges may be required.

Construction

Corrosion-resistant T-6063-T5 painted or anodized aluminum. End caps are 11 gauge steel painted matte black. Bottom rail is filled with 1/2" Delrin plastic pellets to support papers on Info Rail.

Worksurface-mounted bracket: Die-cast aluminum painted black.

All items manufactured in the United States.

Orchestra® Universal System Accessories
 by Bruce Hannah & Ayse Birsal
 slat board 14³/₄"

product	description	w	d	h	wgt.
Slat board-14 ³ / ₄ " 	<ul style="list-style-type: none"> Fits virtually every office system. Mounts on panel, stanchion, wall or freestanding desk. 8 horizontal accessory channels. Info rail underside holds memos and notes for easy access. Wall, stanchion, or panel-mounted brackets included in list price (see mounting options page). 	24"	1"	14 ³ / ₄ "	5 lbs. 2 ozs.
		30"	1"	14 ³ / ₄ "	6 lbs. 6 ozs.
		35"	1"	14 ³ / ₄ "	7 lbs. 1 oz.
		36"	1"	14 ³ / ₄ "	7 lbs. 1 oz.
		42"	1"	14 ³ / ₄ "	9 lbs.
		45"	1"	14 ³ / ₄ "	9 lbs.
		48"	1"	14 ³ / ₄ "	10 lbs. 4 ozs.
		54"	1"	14 ³ / ₄ "	11 lbs. 8 ozs.
		60"	1"	14 ³ / ₄ "	12 lbs. 12 ozs.
		66"	1"	14 ³ / ₄ "	14 lbs.
		72"	1"	14 ³ / ₄ "	15 lbs. 6 ozs.
Slat board-Equity Stanchion		24"	1"	14 ³ / ₄ "	5 lbs. 2 ozs.
		30"	1"	14 ³ / ₄ "	6 lbs. 6 ozs.
		36"	1"	14 ³ / ₄ "	7 lbs. 1 oz.
		42"	1"	14 ³ / ₄ "	9 lbs.
		54"	1"	14 ³ / ₄ "	11 lbs. 8 ozs.
		66"	1"	14 ³ / ₄ "	14 lbs.
Equity application		24"	1"	14 ³ / ₄ "	2 lbs. 9 ozs.
		30"	1"	14 ³ / ₄ "	3 lbs. 3 ozs.
		36"	1"	14 ³ / ₄ "	3 lbs. 13 ozs.
		42"	1"	14 ³ / ₄ "	4 lbs. 8 ozs.
		48"	1"	14 ³ / ₄ "	5 lbs. 2 ozs.
		54"	1"	14 ³ / ₄ "	5 lbs. 12 ozs.
		60"	1"	14 ³ / ₄ "	6 lbs. 6 ozs.
		66"	1"	14 ³ / ₄ "	7 lbs.
	72"	1"	14 ³ / ₄ "	7 lbs. 11 ozs.	

Order Code

Example: OR-SL-14-42-EY-117-OR-BKT-PM-E
OR-SL-14- 42"W x 14"H slat board
42
EY Equity suffix
117 Soft grey
OR-BKT- Panel-mounted bracket
PM-E for Equity

Ordering Information

Specify:
 1. Pattern number
 2. System
 3. Finish
 4. Mounting Option
anodized aluminum finish:
 Satin Anodized Aluminum (SA)
 Special sizes and small quantity orders may be painted

Painted aluminum finishes:
 Medium Grey (115)
 Soft Grey (117)
 Black (111)
 Beige Mist Metallic (611)
 Brown (112)
 Dark Grey (113)
 Folkstone Grey (114)
 Sandstone (116)
 Bright White (118)
 Medium Grey Metallic (612)

Painted Legacy aluminum finishes are still available for existing customers only:
 Medium Metallic Grey (DG)
 Soft Grey (E)
 Warm Putty (WP)
 Flint (F)
 Black (BK)

pattern no.	list price
OR-SL-14-24-()()	\$354.
OR-SL-14-30-()()	391.
OR-SL-14-35-()()	427.
OR-SL-14-36-()()	427.
OR-SL-14-42-()()	471.
OR-SL-14-45-()()	516.
OR-SL-14-48-()()	516.
OR-SL-14-54-()()	560.
OR-SL-14-60-()()	605.
OR-SL-14-66-()()	647.
OR-SL-14-72-()()	695.
<hr/>	
OR-SL-14-30-ES-()()	354.
OR-SL-14-36-ES-()()	391.
OR-SL-14-42-ES-()()	427.
OR-SL-14-48-ES-()()	471.
OR-SL-14-60-ES-()()	560.
OR-SL-14-72-ES-()()	647.
<hr/>	
OR-SL-14-24-EY-()()	354.
OR-SL-14-30-EY-()()	391.
OR-SL-14-36-EY-()()	427.
OR-SL-14-42-EY-()()	471.
OR-SL-14-48-EY-()()	516.
OR-SL-14-54-EY-()()	560.
OR-SL-14-60-EY-()()	605.
OR-SL-14-66-EY-()()	647.
OR-SL-14-72-EY-()()	695.

Mounting Options

Please note flat panel monitor arms cannot be mounted on Orchestra® load bars. Flat panel monitors can be mounted on Orchestra® slat wall only when mounted on an architectural wall. The Wishbone Test Matrix on Knoll Exchange outlines all monitor limitations. Please review before mounting. Please see p.130 for flat panel monitor tool bar options (Note: tool bars cannot hold Orchestra® organizational tools.)

Panel, stanchion and wall-mounted brackets:

Wall, stanchion, or panel-mounted brackets are included in the list price.

Note: Other brackets for other manufacturers stations are available. Contact your Customer Representative for more information.

Custom Options

Note:

Slat board is available in custom lengths of up to 96". Please note that for all lengths greater than 66", load bar will be painted, not anodized.

Brackets are currently available for virtually every major office system. Panel-mounted brackets for other systems can be developed. Minimum of 100 sets per bracket. Tooling and set-up charges may be required.

Panel, stanchion and wall-mounted brackets:

Wall, stanchion, or panel-mounted brackets are included in the list price and are specified when ordering pattern number. To specify appropriate panel-mounted bracket, consult the KnollExtra Bracket Chart on page 14 for appropriate suffix. For Equity panel-mounted applications, include an "EY" at end of base pattern number.

Worksurface mounted bracket is for use with load bars and 6 1/2" slat boards only.

Construction

Corrosion-resistant T-6063-T5 painted or anodized aluminum. End caps are 11 gauge steel painted matte black. Bottom rail is filled with 1/2" Delrin plastic pellets to support papers on Info Rail.

Worksurface-mounted bracket:
Die-cast aluminum painted black.

All items manufactured in the United States.

Orchestra® Universal System Accessories

by Bruce Hannah & Ayse Birsal

mounting options

product	description
Mounting Options 	Panel Mounted Bracket (Deep Universal only). Based on 1" centers. Set of 2.*
	Panel Mounted Bracket (Dividends Panel only). Set of 2.*
	Panel Mounted Bracket (Equity only). Set of 2.*
	Panel Mounted Bracket (Morrison only). Set of 2.*
	Panel Mounted Bracket (Reff only). Set of 2.*
	Panel Mounted Bracket (Shallow Universal only). Based on 1" centers. Set of 2.*
	Stanchion-Mounted Bracket (Calibre only). Set of 2.*
	Stanchion-Mounted Bracket (Currents workshelf and stanchion). Set of 2.*
	Stanchion-Mounted Bracket (Dividends only). Set of 2.*
	Stanchion-Mounted Bracket (Equity only). Set of 2.*
	Stanchion-Mounted Bracket (Morrison Network only). Set of 2.*
	Wall-Mounted Bracket. Set of 2.*
	Worksurface-Mounted Bracket. For load bars and 6 1/2" slat boards only. Set of 2. Black finish.

Worksurface - Mounted Brackets

* No charge when ordered with Load Bar or Slat board, configured in load bar and slat board pattern numbers when ordered with load bars and slat boards.

Order Code	Ordering Information	Mounting Options
Example: OR-BKT-SM-A OR-BKT-SM-A Worksurface-mounted bracket	Specify: 1. Pattern number	Panel, stanchion and wall-mounted brackets: Wall, stanchion, or panel-mounted brackets are included in the list price and are specified when ordering pattern number. Worksurface-mounted bracket: Metal posts attach to underside of worksurface with C-clamp, raising Load Bar 10" above worksurface. Usable on worksurfaces 3/8"-1 1/2" thick. There should be at least 3/4"-1" of space between the back of the desk and the surface behind (ie. it cannot be flush). Set of 2 brackets. For Load Bars wider than 66", order additional brackets. For use with load bars and 6 1/2" slat boards only.

pattern no.	list price
OR-BKT-PM-B *	\$11.
OR-BKT-PM-DV *	11.
OR-BKT-PM-E *	15.
OR-BKT-PM-M *	11.
OR-BKT-PM-R *	11.
OR-BKT-PM-D *	11.
OR-BKT-PM-CE *	15.
OR-BKT-PM-CS *	26.
OR-BKT-PM-DS *	15.
OR-BKT-PM-ES *	15.
OR-BKT-PM-N *	15.
OR-BKT-WM *	23.
OR-BKT-SM-A	142.

Mounting Options

Note: Flat panel monitor arms cannot be mounted to Orchestra® load bars. Arms can only be mounted on Orchestra® slat wall if mounted per the Wishbone Test Matrix mounting instructions on Knoll Exchange. Please review before mounting. Flat panel monitor arm mounting options start at p. 122-124

Note: Load bars and 6 1/2" slat boards only can be mounted to worksurface using the worksurface mounted bracket. 14 3/4" slat board is too large for this application.

Custom Options

Brackets are currently available for virtually every major office system. Panel-mounted brackets for other systems can be developed. Minimum of 100 sets per bracket. Tooling and set-up charges may be required. Contact your Knoll sales representative or Customer Service for complete pricing information.

Note: Other brackets for other manufacturers stations are available. Contact your KnollExtra Representative for more information.

Construction

Worksurface-mounted bracket:
Die-cast aluminum painted black.

All items manufactured in the United States.

Design Awards

Permanent Collection of the Cooper-Hewitt, National Design Museum, Smithsonian Institution, 1994; ROSCOE Award, Interior Design Magazine, 1991; Outstanding Performance, Product Design Achievement Award, IBD Southern California Chapter, 1991; Bronze Award, IBD Product Design Competition, 1990.

Orchestra® Universal System Accessories
 by Brooks Rorke
 file totes

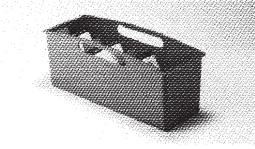
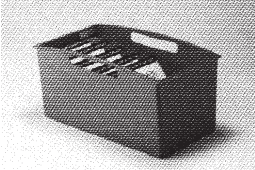
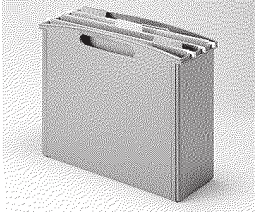
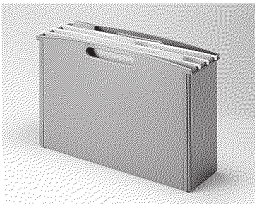
product	description	w	d	h	wgt.
Portable Small Diskette Tote 	<ul style="list-style-type: none"> • Holds up to 75 3 1/2" disks. • Suspends in standard hanging file drawer - up to 3 disk holders per drawer. • Integrated handles permit easy transport. • 4 adjustable divider inserts included for organizing and labeling disk files. • Ribbed floor holds disks in place. 	12"	4 1/2"	5"	1 lb. 1 oz.
Portable Large Diskette Tote 	<ul style="list-style-type: none"> • Holds up to 125 5 1/4" disks. • Holds CD Roms. • Suspends in standard hanging file drawer - up to 3 disk holders per drawer. • Integrated handles permit easy transport. • 4 adjustable divider inserts included for organizing and labeling disk files. • Ribbed floor holds disks in place. 	12"	6 1/2"	6"	1 lb. 3 ozs.
Portable Letter Size File Tote 	<ul style="list-style-type: none"> • Holds up to 15 letter size hanging files. • Suspends in standard hanging file drawer - up to 3 file holders per drawer. • Integrated handles permit easy transport. 	12"	4"	9 1/4"	1 lb. 2 ozs.
Portable Legal Size File Tote 	<ul style="list-style-type: none"> • Holds up to 15 legal size hanging files. • Suspends in standard hanging file drawer - up to 3 file holders per drawer. • Integrated handles permit easy transport. 	15"	4 1/4"	9 1/4"	1 lb. 6 ozs.

Order Code

Example: **ORCH-PF-SD-DG**

ORCH-PF- Small diskette tote

SD

DG Medium grey

Ordering Information

Specify:

1. Pattern number
2. Finish

opaque:
 Black (BK)
 Medium Grey (DG)

translucent:
 Clear (CL)

Note:

Portable Totes are for freestanding or file drawer-suspended use. They may not be rail-mounted.

Custom Options

Custom colors available upon sample chip approval. \$350 color match fee and 500 piece minimum per line item.

pattern no.	opaque	translucent
ORCH-PF-SD	\$46.	\$57.
ORCH-PF-LD	52.	59.
ORCH-PF-LT	56.	72.
ORCH-PF-LG	61.	83.

System top cap-mounted signage plate available, designed to customer specifications and system. Customer responsible for graphics. 100 unit minimum. Contact your KnollExtra representative or Customer Service for complete pricing information.

Construction

Opaque plastic finishes:
 Sturdy polystyrene plastic in matte, textured finish. Fingerprint resistant.
 Manufactured in the United States.

Design Awards

Permanent Collection of the Cooper-Hewitt, National Design Museum, Smithsonian Institution, 1994; ROSCOE Award, Interior Design Magazine, 1991; Outstanding Performance, Product Design Achievement Award, IBD Southern California Chapter, 1991; Bronze Award, IBD Product Design Competition, 1990.

Sapper™ Monitor Arm Collection

Easy Order Single Arm Kits (16" Masts)

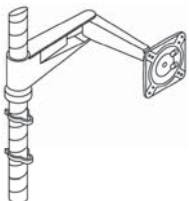
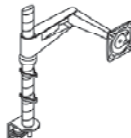
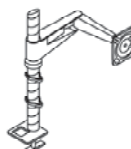
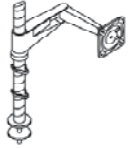
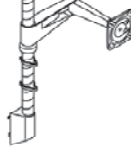
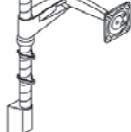
	type	description
 <p>Kit includes everything needed to mount one monitor to a worksurface, slat wall or wall: single standard arm, 16" mast, movement joint (includes fast release monitor plate), adjustment knob, cable management clips and mounting option (see right for options)</p>	 <p>Two-piece Table Clamp Mount</p>	Single monitor arm table clamp kit
	 <p>Grommet Mount</p>	Single monitor arm grommet mount kit
	 <p>Fixed Table Mount</p>	Single monitor arm fixed table mount kit
	 <p>Slat wall Mast Mount</p>	Single monitor arm slat wall 16" mast mount kit
	 <p>Wall Mast Mount</p>	Single monitor arm wall 16" mast mount kit

Order Code	Ordering Information	Mounting and Application Information
Example: SAP-MA-S-CLMP-K-118 SAP-MA-S-CLMP-K Sapper single monitor arm table clamp kit 118 Bright White	<p><i>Specify:</i></p> <ol style="list-style-type: none"> 1. Pattern number 2. Finish where required <p>Kits do not require any additional mounting specifications.</p> <p><i>Standard Monitor Arm Finish</i></p> <p><i>Options:</i></p> <ul style="list-style-type: none"> Jet Black (111) Medium Grey (115) Bright White (118) <p><i>Silver Monitor Arm Finish Option:</i></p> <ul style="list-style-type: none"> Silver (613) 	See pp. 102 for comprehensive mounting, application and construction information.

pattern no.	silver finish list price	standard finish list price
SAP MA S CLMP K ()	\$370.	\$270.
SAP MA S GRMT K ()	375.	275.
SAP MA S FTM K ()	360.	260.
SAP MA S SW MST 16 K ()	390.	290.
SAP MA S WL MST 16 K ()	385.	285.

Sapper™ Monitor Arm Collection

Easy Order Single Arm Kits (8" and 12" Masts)

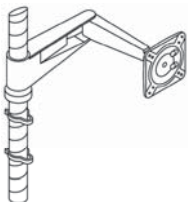
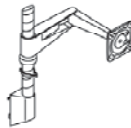
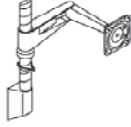
	type	description
 <p>Kit includes everything needed to mount one monitor to a slat wall or wall: single standard arm, 8" or 12" mast, movement joint (includes fast release monitor plate), adjustment knob, cable management clip(s) and mounting option (see right for options)</p>	 <p>Slat wall Mast Mount</p>	<p>Single monitor arm slat wall 8" mast mount kit</p> <hr/> <p>Single monitor arm slat wall 12" mast mount kit</p>
	 <p>Wall Mast Mount</p>	<p>Single monitor arm wall 8" mast mount kit</p> <hr/> <p>Single monitor arm wall 12" mast mount kit</p>

Order Code	Ordering Information	Mounting and Application Information
<p>Example: SAP-MA-S-SW-MST-8-K-111</p> <hr/> <p>SAP-MA-S-SW-MST-8-K-111 Sapper single monitor arm slat wall 8" mast mount kit</p> <hr/> <p>111 Jet Black</p>	<p><i>Specify:</i></p> <ol style="list-style-type: none"> 1. Pattern number 2. Finish where required <p>Kits do not require any additional mounting specifications.</p> <p><i>Standard Monitor Arm Finish</i></p> <p><i>Options:</i></p> <p>Jet Black (111) Medium Grey (115) Bright White (118)</p> <p><i>Silver Monitor Arm Finish Option:</i></p> <p>Silver (613)</p>	<p>See pp. 102 for comprehensive mounting, application and construction information.</p>

pattern no.	silver finish list price	standard finish list price
SAP MA S SW MST 8 K ()	\$380.	\$280.
SAP MA S SW MST 12 K ()	385.	285.
SAP MA S WL MST 8 K ()	375.	275.
SAP MA S WL MST 12 K ()	380.	280.

Sapper™ Monitor Arm Collection

Easy Order Double Arm Kits (16" Masts)

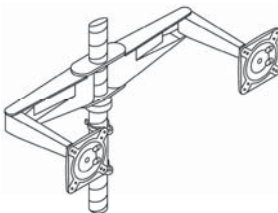
	type	description
 <p>Kit includes everything needed to mount two monitors to a worksurface, slat wall or wall: two standard arms, 16" mast, movement joints (includes fast release monitor plate), adjustment knob, cable management clips, double arm bracket and mounting option (see right for options)</p>	Two-piece Table Clamp Mount	Double monitor arm table clamp kit
	Grommet Mount	Double monitor arm grommet mount kit
	Fixed Table Mount	Double monitor arm fixed table mount kit
	Slat wall Mast Mount	Double monitor arm slat wall 16" mast mount kit
	Wall Mast Mount	Double monitor arm wall 16" mast mount kit

Order Code	Ordering Information	Mounting and Application Information
Example: SAP-MA-D-CLMP-K-115 SAP-MA-D-CLMP-K Sapper double monitor arm table clamp kit 115 Medium Grey	<p><i>Specify:</i></p> <ol style="list-style-type: none"> 1. Pattern number 2. Finish where required <p>Kits do not require any additional mounting specifications.</p> <p><i>Standard Monitor Arm Finish</i></p> <p><i>Options:</i></p> <ul style="list-style-type: none"> Jet Black (111) Medium Grey (115) Bright White (118) <p><i>Silver Monitor Arm Finish Option:</i></p> <ul style="list-style-type: none"> Silver (613) 	<p>See pp. 102 for comprehensive mounting, application and construction information.</p> <p>Silver finish arm is made in the USA. The kits (which come with foreign components) and individual arms in this finish are made in compliance with the Trade America Act (TAA).</p>

pattern no.	silver finish list price	standard finish list price
SAP MA D CLMP K ()	\$575.	\$475.
SAP MA D GRMT K ()	585.	485.
SAP MA D FTM K ()	565.	465.
SAP MA D SW MST 16 K ()	595.	495.
SAP MA D WL MST 16 K ()	590.	490.

Sapper™ Monitor Arm Collection

Easy Order Double Arm Kits (8" and 12" Masts)

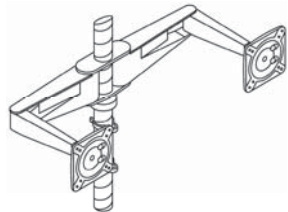
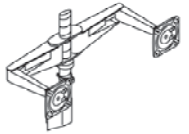
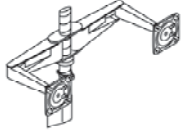
	type	description
	Slat wall Mast Mount	Double monitor arm slat wall 8" mast mount kit
		Double monitor arm slat wall 12" mast mount kit
<p>Kit includes everything needed to mount two monitors to a slat wall or wall: two standard arms, 8" or 12" mast, movement joints (includes fast release monitor plate), adjustment knob, cable management clip(s), double arm bracket and mounting option (see right for options)</p>	Wall Mast Mount	Double monitor arm wall 8" mast mount kit
		Double monitor arm wall 12" mast mount kit

Order Code	Ordering Information	Mounting and Application Information
<p>Example: SAP-MA-D-WL-MST-12-K-118</p> <hr/> <p>SAP-MA-D-WL-MST-12-K Sapper double monitor arm wall 12" mast mount kit</p> <hr/> <p>118 Bright White</p>	<p><i>Specify:</i></p> <ol style="list-style-type: none"> 1. Pattern number 2. Finish where required <p>Kits do not require any additional mounting specifications.</p> <p><i>Standard Monitor Arm Finish</i></p> <p><i>Options:</i></p> <p>Jet Black (111) Medium Grey (115) Bright White (118)</p> <p><i>Silver Monitor Arm Finish Option:</i></p> <p>Silver (613)</p>	<p>See pp. 102 for comprehensive mounting, application and construction information.</p>

pattern no.	silver finish list price	standard finish list price
SAP MA D SW MST 8 K ()	\$585.	\$485.
SAP MA D SW MST 12 K ()	590.	490.
SAP MA D WL MST 8 K ()	580.	480.
SAP MA D WL MST 12 K ()	585.	485.

Sapper™ Monitor Arm Collection

Easy Order Triple Monitor Support Kits (16" Mast)

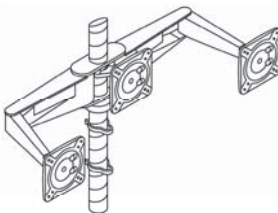
	type	description
 <p>Kit includes everything needed to mount three monitors to a worksurface, slat wall or wall: two standard arms, 16" mast, movement joints (includes fast release monitor plate), adjustment knob, cable management clips, triple monitor support bracket and mounting option (see right for options)</p>	Two piece clamp mount	Triple monitor support table clamp kit
	Grommet Mount	Triple monitor support grommet mount kit
	Fixed Table Mount	Triple monitor support fixed table mount kit
	Slat wall Mast Mount	Triple monitor support slat wall 16" mast mount kit
	Wall Mast Mount	Triple monitor support wall 16" mast mount kit

Order Code	Ordering Information	Ordering Note	Mounting and Application Information
Example: SAP-MA-T-CLMP-K-111	<i>Specify:</i>	Silver finish arm is made in the USA. The kits (which come with foreign components) and individual arms in this finish are made in compliance with the Trade America Act (TAA).	See pp. 102 for comprehensive mounting, application and construction information.
SAP-MA-T-CLMP-K Sapper triple monitor support table clamp kit	1. Pattern number 2. Finish where required	Please note a triple monitor support includes two standard arms plus one triple monitor support bracket with a movement joint. The monitor in the middle can rotate, tilt and swivel but has no depth adjustment. See page 102 for further details.	
111 Jet Black	Kits do not require any additional mounting specifications.		
	<i>Standard Monitor Arm Finish Options:</i> Jet Black (111) Medium Grey (115) Bright White (118)		
	<i>Silver Monitor Arm Finish Option:</i> Silver (613)		

pattern no.	silver finish list price	standard finish list price
SAP MA T CLMP K ()	\$670.	\$570.
SAP MA T GRMT K ()	680.	580.
SAP MA T FTM K ()	660.	560.
SAP MA T SW MST 16 K ()	690.	590.
SAP MA T WL MST 16 K ()	685.	585.

Sapper™ Monitor Arm Collection

Easy Order Triple Monitor Support Kits (8" and 12" Masts)

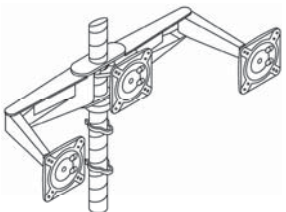
	type	description
 <p>Kit includes everything needed to mount three monitors to a slat wall or wall: two standard arms, 8" or 12" mast, movement joints (includes fast release monitor plate), adjustment knob, cable management clip(s), triple monitor support bracket and mounting option (see right for options)</p>	Slat wall Mast Mount	Triple monitor support slat wall 8" mast mount kit
		Triple monitor support slat wall 12" mast mount kit
	Wall Mast Mount	Triple monitor support wall 8" mast mount kit
		Triple monitor support wall 12" mast mount kit

Order Code	Ordering Information	Ordering Note	Mounting and Application Information
Example: SAP-MA-T-WL MST-12-K-118	<i>Specify:</i> 1. Pattern number 2. Finish where required	Silver finish arm is made in the USA. The kits (which come with foreign components) and individual arms in this finish are made in compliance with the Trade America Act (TAA).	See pp. 102 for comprehensive mounting, application and construction information.
SAP-MA-T-MST-12-K-118	Kits do not require any additional mounting specifications.	Please note a triple monitor support includes two standard arms plus one triple monitor support bracket with a movement joint. The monitor in the middle can rotate, tilt and swivel but has no depth adjustment. See page 102 for further details.	
Sapper triple monitor support wall 12" mast mount kit	<i>Standard Monitor Arm Finish Options:</i> Jet Black (111) Medium Grey (115) Bright White (118)		
Bright White	<i>Silver Monitor Arm Finish Option:</i> Silver (613)		

pattern no.	silver finish list price	standard finish list price
SAP MA T SW MST 8 K ()	\$680.	\$580.
SAP MA T SW MST 12 K ()	685.	585.
SAP MA T WL MST 8 K ()	675.	575.
SAP MA T WL MST 12 K ()	680.	580.

Sapper™ Monitor Arm Collection

Monitor Arms and Brackets

description

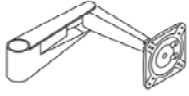

Single standard arm (with movement joint)



Arms and brackets can be ordered individually to easily reconfigure

Double arm bracket (does not include arms, must order separately)



Triple arm bracket (does not include arms, must order separately)



Double monitor to triple monitor support conversion kit
(Third monitor support bracket with movement joint)



Order Code

Example: **SAP-MA-S-115**

SAP-MA-S Sapper single standard monitor arm

115 Medium Grey

Ordering Information

Specify:

1. Pattern number
2. Finish where required

Kits do not require any additional mounting specifications.

Standard Monitor Arm Finish

Options:

- Jet Black (111)
- Medium Grey (115)
- Bright White (118)

Silver Monitor Arm Finish Option:

Silver (613)

Mounting and Application Information

See pp. 102 for comprehensive mounting, application and construction information.

pattern no.	silver finish list price	standard finish list price
SAP MA S ()	\$250.	\$150.
SAP DBKT		75.
SAP T BKT		125.
SAP MA TD		85.

Sapper™ Monitor Arm Collection

Monitor Arms and Movement Joints

description



Movement joint (includes fast release pin)

Arms and movement joints can be ordered individually to easily reconfigure parts

Sleeve mount arm (arm with movement joint)



Order Code

Example: **SAP-MJ**

SAM-MJ Sapper movement joint

Ordering Information

Specify:

1. Pattern number
2. Finish where required

Kits do not require any additional mounting specifications.

Monitor Arm Finish Options:

- Jet Black (111)
- Medium Grey (115)
- Bright White (118)

Mounting and Application Information

See pp. 102 for comprehensive mounting, application and construction information.

pattern no.	list price
SAP MJ	\$46.
SAP MA SL ()	50.

Sapper™ Monitor Arm Collection

Masts

description



Masts come in various sizes to accommodate different monitor mounting solutions

8" Mast (includes adjustment knob and 1 cable management clip)



12" Mast (includes adjustment knob and 2 cable management clips)



16" Mast (includes adjustment knob and 2 cable management clips)



24" Mast (includes adjustment knob and 2 cable management clips)



32" Mast (includes adjustment knob and 2 cable management clips)



Order Code

Example: **SAP-MST-12**
SAP-MST- Sapper 12" mast
12



Mounting and Application Information

See pp. 102 for comprehensive mounting, application and construction information.

pattern no.	list price
SAP MST 8	\$70.
SAP MST 12	75.
SAP MST 16	80.
SAP MST 24	120.
SAP MST 32	180.

Sapper™ Monitor Arm Collection

Adjustment Knobs and Mast Cable Management Clips

	description
	Adjustment knob 
<i>Adjustment knobs and mast cable management clips can be ordered individually</i>	Mast cable management clips (set of 10) 

Order Code

Example: **SAP-MST-KNB**
SAP-MST- Sapper adjustment knob
KNB









Mounting and Application Information

See pp. 102 for comprehensive mounting and application information.

pattern no.	list price
SAP MST KNB	\$15.
SAP MST CM	20.

Sapper™ Monitor Arm Collection

Mounting Options

	description
	Two-piece Table clamp mount 
<i>Seven interchangeable mounting options provide ultimate flexibility</i>	Grommet Mount 
	Fixed Table Mount 
	Slat wall Mast Mount 
	Direct Slat wall Mount 
	Wall Mast Mount 
	Direct wall mount 

Order Code

Example: **SAP-CLMP**
SAP- Sapper table clamp
CLMP

Mounting and Application Information

See pp. 102 for comprehensive mounting, application and construction information.

pattern no.	list price
SAP CLMP	\$55.
SAP GRMT	58.
SAP FTM	40.
SAP SW MST	70.
SAP SW DIR	75.
SAP WL MST	66.
SAP WL DIR	70.

Sapper™ Monitor Arm Collection

Mounting, Construction and Application Information

Mounting and Application Information:

All Sapper standard monitor arms:

- Maximum weight of 20 lbs * per arm, weight limits vary by mounting option
- Ship standard with fast release movement joint
- Offer 165 degrees of monitor tilt up and down, 180 degrees of swivel left and right and 360 degrees of rotation for portrait and landscape viewing
- Fold into themselves to be highly compact at (only 2 7/8" when fully compressed)
- Are durable and lightweight (standard arm weighs only 2.6 pounds)

*Please note this limit accommodates up to 95% of monitors on the market. There is not a specific monitor size maximum limitation for a single Sapper monitor arm. A larger size (e.g., 24" widescreen) does not necessarily equate to a higher weight monitor. It is key to understand the application to know if a certain size monitor will fit within a space and/or if there are multiple monitors. Also, it is important to note weight limitations vary by application. See details below.

Weight Limits:

Weight limitations for individual mounting options are outlined below. Taken together (both the mounting option weight limit and the individual arm limit of 20 lbs) you can best determine what mounting approach is best for your client given the number of monitors they desire to mount and the weight of those monitors. Weight limits are outlined by mounting option on the next few pages.

For example, if you want to mount two monitors on a worksurface with a grommet mount and each of those monitors weighs 18 lbs (2 monitors x 18 lbs each equals 36 lbs total), we can accommodate that with the 45 lbs weight limit for the grommet mount and the 20 lbs limitation for each arm. However, if they want to do three monitors weighing each 18 lbs (3 monitors x 18 lbs each equals 54 lbs total) with a grommet mount, we cannot do that on a single mast with this mount since the maximum weight limitation is 45 lbs.

Size Limits:

There is no specific size maximum for a single arm solution (outside the limitations of the space in which you are trying to put it). When mounting two monitors, the maximum outer horizontal width per monitor is 31.8" for a cockpit solution or 33.9" for a flat positioning flush next to each other. For three monitors, the maximum outer horizontal width per monitor is 15.2" for a cockpit solution or 16.35" for a flat positioning flush next to each other in a row. Clients can accommodate larger screen monitors in triples by turning monitor screens to a portrait position.



Double Cockpit

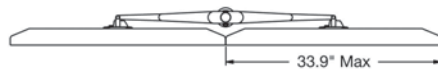

Double Flat

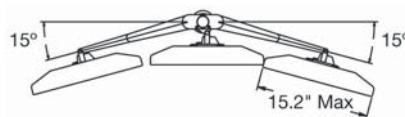

Triple Cockpit

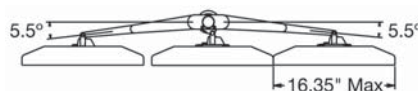

Triple Flat

KEY NOTE: Flat panel monitor manufacturers refer to their products by diagonal screen measurements. So a 19" widescreen monitor has a 19" screen measured diagonally, but is not necessarily 19" in horizontal width (refer to manufacturers specifications for specific overall height and width).

Monitor Mounting:

All Sapper monitor arms are compatible with the international Video Electronics Standard Association (VESA) industry interface standard (75 mm x 75 mm and 100 mm x 100 mm hole patterns or 2.95" x 2.95" and 3.94" x 3.94") adopted by most panel manufacturers. VESA compliance is a requirement to mount any monitor to a monitor arm. Please note our monitor plates come standard with both 75 mm x 75 mm and 100 mm x 100 mm holes. If your customer has a recessed monitor back with only 75 mm x 75 mm holes, additional spacers will be needed to ensure proper fit. Contact Customer Service for more details including part and pricing information.

Some larger (over 22" wide) widescreen monitors now come with the home VESA standard (200 mm x 100 mm or 200 mm x 200 mm) which can be accommodated as a special through Custom Product Development.

Knoll and its dealers will not take the responsibility for mounting the monitor to the arm. The end user's IT department must confirm VESA mounting compliance and mount the monitor to the arm using customer's own screws. The most common screws are M5 x 8mm and M5 x 10mm.

Please follow installation instructions closely (available in each kit box shipped as well as on Knoll Exchange).

Apple Computer Note:

Apple iMacs are not VESA compliant. To mount a 24-inch iMac or 24-inch LED Cinema Display to a Sapper arm requires a customer to purchase a Cinema Display VESA Mount Adapter Kit from Apple. The adapter kit comes standard with a 100 mm x 100 mm hole pattern and can be purchased online for .00 at: <http://store.apple.com/us/product/MB902ZM/A>

Unbalanced Monitor Note:

Please note there are some monitors on the market that have all of their media connections on one side which makes the monitor unbalanced. In order to level the monitor, a special set screw in the VESA plate is needed. Please contact Custom Product Development for pricing and details.

Table Clamp Mounting:

The standard two-piece table clamp is easy to install or retrofit and works on most worksurfaces or desks that are a minimum of 1 -1/8" thick solid core. The maximum worksurface thickness is 2-3/4". There are three settings to accommodate a range of worksurface thicknesses. It is important to mock up the table clamp, particularly on competitive product to ensure a proper fit. Maximum weight limit is 75 lbs.

Grommet Mounting:

With all systems furniture, it is important to pass monitor and peripheral plugs through grommet mount cover while it is still loose. Please note the grommet mount is compatible with Morrison, Autostrada, Ref, Propeller, Scope and Wa, but is not currently compatible with the Graham Collection grommet holes. The grommet cutout is 3" x 1.77" and the overall grommet mount is 4.5" x 4.5".

Maximum weight limit is 45 lbs.

Fixed Table Mounting:

Installers will need to drill a permanent hole into the worksurface so the mast will be fixed to a dedicated location on the worksurface. Please note with this mounting, the mast will not be able to be moved without leaving a permanent hole.

Maximum weight limit is 85 lbs. Please note that the worksurface must be of adequate structure. We recommend a minimum of 1 1/8" thick solid core for adequate structural integrity. Knoll cannot be held responsible for the structural integrity of non-Knoll worksurfaces.

Slat Wall Mounting:

For single monitor mounting, you can use either the slat wall mast mount or direct slat wall mount. For double or triple monitor mounting, you must use the slat wall mast mount. The direct slat wall mount cannot be used for multiple monitors.

Works with most Knoll slat board and slat wall profiles, however, load ratings vary across products and mounting approaches. Please review product breakdown on the following pages to ensure compatibility with your specific application needs.

Orchestra/KnollExtra slat board must be mounted to an architectural wall if a flat panel monitor arm is to be mounted to it. You can only use this slat board when it is wall-mounted as outlined below. Knoll cannot be held responsible for the structural integrity of a wall so please work with clients to ensure their wall is structurally sound to hold the slat board, the arm configuration and the monitor weight.

Maximum weight limit varies by slat wall type:
See table on following page.

Wall Mounting:

For single monitor mounting, you can use either the wall mast mount or direct wall mount. For double or triple monitor mounting, you must use the wall mast mount. The direct wall mount cannot be used for multiple monitors.

For use on architectural walls only as outlined further on this page. Knoll cannot be held responsible for the structural integrity of a wall so please work with clients to ensure their wall is structurally sound to hold the arm configuration and the monitor weight. See above for weight limits if mounting slat wall to an architectural wall.

Cable Management:

External cable management allows for easy installation and removal of monitors. There are gates under the the arm that will contain wires from the monitor to plastic cable management clips that go on the mast to keep wires tidy to the electrical socket.

Gates

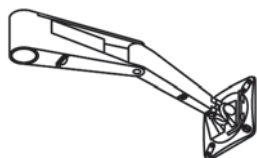

Clips



Adjustment:

The Sapper monitor arm collection offers intuitive adjustment. To adjust the height, you simply manually lift the arm and twist the adjustment knob like a screw up or down the mast to a comfortable setting. The easiest way to lift the monitor is to fold it in before making the adjustment. To adjust the depth, you can move the arm in or out. You can also rotate the monitor 360 degrees for landscape or portrait viewing and adjust the swivel back and forth 180 degrees and tilt up and down 165 degrees. The arm folds in and out from 2 7/8" fully compressed to approximately 17" when fully extended.

Height Adjustment

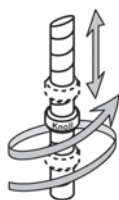

Rotation, Swivel, Tilt and Depth Adjustment

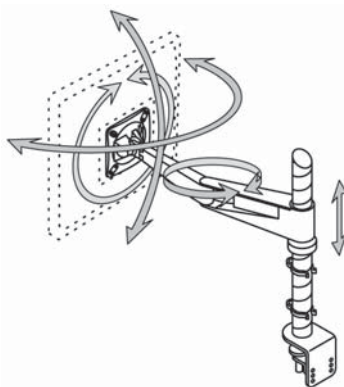

Fast Release:

Allows for swift installation and removal of flat panel monitors by merely popping the quick release pin up to remove monitor with movement joint/back plate attached.

Fast Release

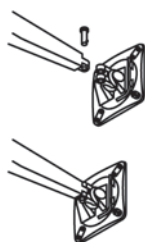

Theft Deterrence:

All movement joints come with a set screw within the fast release pin, to prevent fast release if so desired. Also there is a set screw at the top of the mast to deter removal of the entire arm and monitor from the mast.

Deactivate Fast Release with Set Screw



Set Screw to Prevent Arm Removal

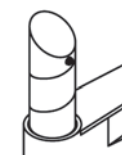

Compatibility:

The Sapper Monitor Arm Collection is not compatible with the Wishbone Flat Panel Monitor Support System (i.e., Wishbone, Zorro or Rotation arms, posts, tool bars, brackets, mounting, etc.). They have been designed independently and as such parts from one system cannot be used with the other.

Monitors cannot be mounted on KnollExtra®/Orchestra® load bars.

Installation Instructions:

Comprehensive installation instructions will be shipped with product and are also available on Knoll Exchange for easy reference.

Construction:

Arm: die cast aluminum with a cold rolled steel top plate

Mast: anodized aluminum extrusion

Adjustment knob: nylon undermold with a TPU overmold

Movement joint (includes fast release monitor plate): acetal bushings, zinc and acetal molded plastic tilt friction components and glass filled nylon VESA plate

Double arm bracket: die cast aluminum, steel top plate, extruded aluminum posts, acetal upper and lower bushings

Triple arm bracket: die cast aluminum, steel top plate, extruded aluminum posts, acetal upper and lower bushings

Cable management: transparent polycarbonate clips on the mast; acetal gates under standard arms

Sapper™ Monitor Arm Collection

Mounting, Construction and Application Information

Slat Wall Mounting Weight Limits and Mounting Notes

	Currents Spine / Autostrada AS1 Spine	Reff / Autostrada AS2 P Vertical Panel	Autostrada Applied Wall / AS3	Dividends Horizon panel	KnollExtra / Orchestra® Slat	COT Center Screen
Direct	20 lbs	Not an option	20 lbs	20 lbs	20 lbs	15 lbs
Mast Mount:						
8"	60 lbs	Not an option	60 lbs	10 lbs	45 lbs	15 lbs
12"	60 lbs	Not an option	60 lbs	7.5 lbs	45 lbs	10 lbs
16"	50 lbs	Not an option	50 lbs	5 lbs	30 lbs	5 lbs
24"	30 lbs	Not an option	30 lbs	0 lbs	15 lbs	0 lbs
32"	20 lbs	Not an option	20 lbs	0 lbs	15 lbs	0 lbs
	Note: no maximum total load limit.		Note: requires special mount plate through CPD as slat wall pitch is different from other AS product; no maximum total load limit.	Note: 30 lbs maximum weight limit per slat wall.	Note: 1) can only be used when mounted on a structural architectural wall, 2) must use one Orchestra® wall mount bracket (OR-BKT-WM) per arm installed on 24" on center maximum and 3) no maximum total load limit.	Note: 1) can only be used in combination with the AutoStrada buttress (see AS price list) and 2) must be used with COT mid-span support positioned under each buttress and 3) 45 lbs maximum weight limit per screen face. All weight limits above are per face or side of screen.

Wall Mounting Weight Limits and Mounting Notes (Architectural Walls Only)

Direct	20 lbs
Mast Mount:	
8"	75 lbs
12"	75 lbs
16"	75 lbs
24"	75 lbs
32"	70 lbs

Note: No maximum total load limit

This page intentionally left blank.

Adjustable Keyboard Supports

Romeo and Juliet Platform/Mechanism Configurations

product	description	type	w	d	h	wgt.
Romeo and Juliet Platform and Mouse Pad 	Romeo 20" min., 28" max. x 11" x 1". 2"H with palm rest for keyboard platform <ul style="list-style-type: none"> • Rigid plastic platform with steel stiffener plate for stable keying surface. • Flexible soft textured plastic overcoat. • Thin profile for extra knee room. Juliet A teardrop shaped mouse pad that swivels under the keyboard platform for easy storage. Soft plastic overcoat and lip keep mouse from sliding off during adjustments. See Mechanism Attributes below.	Romeo and Juliet with easy lift arm	20.25"-28"	12.5"-17.25"	2.25"	13.8 lbs.
		Romeo and Juliet with easy lift arm with pivot	20.25"-28"	12.5"-17.25"	2.25"	15.3 lbs.
		Romeo and Juliet with short easy lift arm	20.25"-28"	12.5"-17.25"	2.25"	13.2 lbs.
		Romeo and Juliet with short easy lift arm with pivot	20.25"-28"	12.5"-17.25"	2.25"	14.6 lbs.
		Romeo and Juliet with sit/stand arm	20.25"-28"	12.50"-17.25"	2.25"	15.4 lbs.
		Romeo and Juliet with sit/stand arm with pivot	20.25"-28"	12.5"-17.25"	2.25"	17 lbs.
		Juliet	Juliet with palm rest. Mounted for right-handed use.		9 1/2"	11"

Order Code	Ordering Information	Application Notes	Construction
Example: OA-K-RJ-EL2-BK (16,18,22,23,25) OA-K-RJ-EL2-BK Romeo and Juliet platform mounted on an (16,18, 22, easy lift mechanism 23,25)	<i>Specify:</i> 1. Pattern number 2. Track size (if applicable) <i>Track length:</i> Options are 16, 17.750, 21.625, 22.63 and 25 inches. Minimum clearance required is the length of the track plus 1/2". Romeo and Juliet and Act II have two width and depth measurements based on whether the mouse is open or closed. The larger measurement reflects an open mouse.	Keyboard support provides users with a more comfortable working environment by allowing them to adjust the height and pitch of the platform holding their computer keyboard. When not in use, the Adjustable Keyboard Support stores the keyboard under the worksurface to free vital worksurface space. Worksurface should be mounted in the desk height position. Dimensions above are for the platform only. For full configuration depths, all component measurements and application suggestions, refer to the Keyboard Measurements tool on Knoll Exchange.	<i>Romeo and Juliet Platform and Mouse pad:</i> Molded rigid PVC base with flexible soft textured PVC surface. Steel stiffener plate at the base of the platform. <i>Palm rests:</i> Nylon upholstered palm rest of dual density polyurethane. <i>Mechanisms:</i> All arms are steel with a powdercoat finish. Tracks are steel with nylon glides.

pattern no.	list price
OAK-RJ-EL2-BK-(16,18,22,23,25)	\$512.
OAK-RJ-EL2-BK-PT-(16,18,22,23,25)	576.
OAK-RJ-SL2-BK-(16,18,22,23,25)	458.
OAK-RJ-SL2-BK-PT-(16,18,22,23,25)	522.
OAK-RJ-SS2-BK-(16,18,22,23,25)	611.
OAK-RJ-SS2-BK-PT-(16,18,22,23,25)	674.
<hr/>	
4B2-MP-WR	61.

Mechanism Attributes

Short easy lift arm:

- Spring assist adjustment
- Knobless height adjustment
- Soft touch knob adjusts tilt from 0° to (-)15°
- Variable height adjustment of 4.26" (up 1.06", down 3.20")
- Pivots side to side 360°
- Black textured metal finish

Short easy lift arm with pivot:

Same features as the Short easy lift arm plus the keyboard platform moves independently from arm, allowing it to parallel the worksurface as the arm is moved laterally.

Easy lift arm:

- Spring assist adjustment
- Knobless height adjustment
- Soft touch knob adjusts tilt from 0° to (-) 15°
- Variable height adjustment of 7.04"(up 2.83",down 4.21")
- Pivots side to side 360°
- Black textured finish with black soft touch knob
- Mounts on virtually any worksurface

Easy lift arm with pivot:

Same features as the Easy lift arm plus the keyboard platform moves independently from arm, allowing it to parallel the worksurface as the arm is moved laterally.

Sit/Stand arm:

- Spring assist adjustment
- Knobless height adjustment
- Soft touch knob adjusts tilt from 0° to (-) 15°
- Variable height adjustment of 11.57"(up 6.40", down 5.17")
- Pivots side to side 360°
- Black textured finish.
- Mounts on virtually any worksurface

Sit/Stand arm with pivot:

Same features as the Sit/Stand arm plus the keyboard platform moves independently from arm, allowing it to parallel the worksurface as the arm is moved laterally.

Adjustable Keyboard Supports

Prospero Platform/Mechanism Configurations

product	description	type	w	d	h	wgt.
Prospero Platform 	Prospero <ul style="list-style-type: none"> • 26" x 11" x 1" • 2" with palm rest • Rigid plastic platform with steel stiffener plate for stable keying surface. • Flexible soft textured plastic overcoat. • Thin profile for extra knee room. • Included palm rest provides soothing support by displacement. • Sized to accommodate keyboard and mouse on the same plane. • No additional mousing surface required See Mechanism Attributes below	Prospero with easy lift arm	26.25"	11.50"	2"	14.5 lbs.
		Prospero with easy lift arm with pivot	26.25"	11.50"	2"	16 lbs.
		Prospero with short easy lift arm	26.25	11.50"	2"	13 lbs.
		Prospero with short easy lift arm with pivot	26.25"	11.50"	2"	14.4 lbs.
		Prospero with sit/stand arm	26.25"	11.50"	2"	16.3 lbs.
		Prospero with sit/stand arm with pivot	26.25"	11.50"	2"	17.9 lbs.

Order Code	Ordering Information	Application Notes	Construction
Example: OA-K-PR-EL2-BK (16,18,22,23,25) <hr/> OA-K-PR- Prospero platform EL2-BK mounted on an easy (16,18,22, lift mechanism 23,25)	<i>Specify:</i> 1. Pattern number 2. Track size (if applicable) <i>Track length:</i> Options are 16, 17.750, 21.625, 22.63 and 25 inches. Minimum clearance required is the length of the track plus 1/2".	Keyboard support provides users with a more comfortable working environment by allowing them to adjust the height and pitch of the platform holding their computer keyboard. When not in use, the Adjustable Keyboard Support stores the keyboard under the worksurface to free vital worksurface space. Worksurface should be mounted in the desk height position. Dimensions above are for the platform only. For full configuration depths, all component measurements and application suggestions refer to the Keyboard Measurements tool on Knoll Exchange.	<i>Prospero:</i> Molded rigid PVC base with flexible soft textured PVC surface. Steel stiffener plate at the base of the platform. <i>Mechanisms:</i> All arms are steel with a powdercoat finish. Tracks are steel with nylon glides.

pattern no.	list price
OA-K-PR-EL2-BK-(16,18,22,23,25)	\$477.
OA-K-PR-EL2-BK-PT-(16,18,22,23,25)	540.
OA-K-PR-SL2-BK-(16,18,22,23,25)	416.
OA-K-PR-SL2-BK-PT-(16,18,22,23,25)	479.
OA-K-PR-SS2-BK-(16,18,22,23,25)	550.
OA-K-PR-SS2-BK-PT-(16,18,22,23,25)	613.

Mechanism Attributes

Short Easy Lift Arm:

- Spring assist adjustment
- Knobless height adjustment
- Soft touch knob adjusts tilt from 0° to (-) 15°
- Variable height adjustment of 4.26" (up 1.06", down 3.20")
- Pivots side to side 360°
- Black textured metal finish

Short easy lift arm with pivot:
Same features as the short easy lift arm plus the keyboard platform moves independently from arm, allowing it to parallel the worksurface as the arm is moved laterally.

Easy lift arm:

- Spring assist adjustment
- Knobless height adjustment
- Soft touch knob adjusts tilt from 0° to (-) 15°
- Variable height adjustment of 7.04" (up 2.83", down 4.21")
- Pivots side to side 360°
- Black textured finish with black soft touch knob
- Mounts on virtually any worksurface

Easy lift arm with pivot:
Same features as the Easy lift arm plus the keyboard platform moves independently from arm, allowing it to parallel the worksurface as the arm is moved laterally.

Sit/Stand Arm:

- Spring assist adjustment
- Knobless height adjustment
- Soft touch knob adjusts tilt from 0° to (-) 15°
- Variable height adjustment of 11.57" (up 6.40", down 5.17")
- Pivots side to side 360°
- Black textured finish.
- Mounts on virtually any worksurface

Sit/Stand arm with pivot:
Same features as the sit/stand arm plus the keyboard platform moves independently from arm, allowing it to parallel the worksurface as the arm is moved laterally.

Adjustable Keyboard Supports

Caesar Platform/Mechanism Configurations

product	description	type	w	d	h	wgt.
Caesar Platform 	Caesar <ul style="list-style-type: none"> • 18" x 9 1/2" x 1/4" • Sturdy metal platform attaches Microsoft® keyboard to mechanism. • Suitable for both Natural and Elite styles of Microsoft keyboards. See Mechanism Attributes below.	Caesar with easy lift arm	18"	25"	2 1/2"	
		Caesar with sit/stand arm	18"	25"	4 1/4"	
Caesar Plate to retrofit to existing mechanisms						

Order Code	Ordering Information	Application Notes	Construction
Example: OA-K-EL2-MS (16,18,22,23,25)	<i>Specify:</i> <ol style="list-style-type: none"> 1. Pattern number 2. Mouse size Track length options are 16, 17.750, 21.625, 22.63 and 25 inches.	Keyboard support provides users with a more comfortable working environment by allowing them to adjust the height and pitch of the platform holding their computer keyboard. When not in use, the Adjustable Keyboard Support stores the keyboard under the worksurface to free vital worksurface space. Worksurface should be mounted in the desk height position.	<i>Caesar:</i> Black textured powdercoated steel plate <i>Mechanisms:</i> All arms are steel with a powdercoat finish. Tracks are steel with nylon glides. Microsoft® is a registered trademark of the Microsoft Corporation.
OA-K-EL2-MS (16,18,22,23,25)	Caesar platform mounted on an easy lift mechanism		

pattern no.	list price
OA-K-EL2-MS-(16,18,22,23,25)	\$378.
OA-K-SS2-MS-(16,18,22,23,25)	488.

OA-K-MS	85.
----------------	-----

Mechanism Attributes

Easy lift arm:

- Spring assist adjustment
- Knobless height adjustment
- Soft touch knob adjusts tilt from 0° to (-) 15°
- Variable height adjustment of 7.04" (up 2.83", down 4.21")
- Pivots side to side 360°
- Black textured finish with black soft touch knob
- Mounts on virtually any worksurface

Sit/Stand arm:

- Spring assist adjustment
- Knobless height adjustment
- Soft touch knob adjusts tilt from 0° to (-) 15°
- Variable height adjustment of 11.57" (up 6.40", down 5.17")
- Pivots side to side 360°
- Black textured finish.
- Mounts on virtually any worksurface

Adjustable Keyboard Supports

Act I

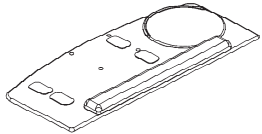
product	description	type	w	d	h	mdf	h phn	mdf wgt.	phn wgt.
	Act I keyboard platform	Act I with Easy Lift arm	26.75"	11.5"	1.44"	1.31"		10.2 lbs.	11 lbs.
	Act I keyboard platform	Act I with Easy Lift arm with Pivot	26.75"	11.5"	1.44"	1.31"		11.7 lbs.	12.5 lbs.
	Act I keyboard platform	Act I with Short Easy Lift	26.75"	11.5"	1.44"	1.31"		9.6 lbs.	10.4 lbs.
	Act I keyboard platform	Act I with Short Easy Lift and Pivot	26.75"	11.5"	1.44"	1.31"		11 lbs.	11.8 lbs.
	Act I keyboard platform	Act I with Sit/Stand arm	26.75"	11.5"	1.44"	1.31"		11.8 lbs.	12.6 lbs.
	Act I keyboard platform	Act I with Sit/Stand arm with Pivot	26.75"	11.5"	1.44"	1.31"		13.4 lbs.	14.2 lbs.

Order Code

Example:	OA-K-A1-W-EL2-BK-18
OAK	Office automation keyboard
A1	Act I
W	Wood
EL2	Easy-lift mechanism
BK	Black
18	Track length of 18 inches

Ordering Information

When you specify, you will be prompted to indicate either MDF (W) or phenolic (P).

Track length options are 16, 17.750, 21.625, 22.63 and 25 inches.

Standard color is black.

Minimum clearance required is the length of the track plus 1/2".

Application Notes

Keyboard support provides users with a more comfortable working environment by allowing them to adjust the height and pitch of the platform holding their computer keyboard. When not in use, the Adjustable Keyboard Support stores the keyboard under the worksurface to free vital worksurface space.

Worksurface should be mounted in the desk height position.

Dimensions above are for the platform only. For full configuration depths, all component measurements and application suggestions refer to the Keyboard Measurements tool on Knoll Exchange.

Construction

Board is either MDF or phenolic.

Wristrest is foam-filled vinyl on MDF board.

Mousepad is lycra covered polyurethane.

Mechanism: All arms are steel with a powder-coated finish. Tracks are steel with nylon glides.

pattern no.	list
OAK-A1-W/P-EL2-BK-(16,18,22,23,25)	\$384.
OAK-A1-W/P-EL2-BK-PT-(16,18,22,23,25)	449.
OAK-A1-W/P-SL2-BK-(16,18,22,23,25)	359.
OAK-A1-W/P-SL2-BK-PT-(16,18,22,23,25)	424.
OAK-A1-W/P-SS2-BK-(16,18,22,23,25)	482.
OAK-A1-W/P-SS2-BK-PT-(16,18,22,23,25)	547.

Mechanism Attributes

Short Easy Lift Arm:

- Spring assist adjustment
- Knobless height adjustment
- Soft touch knob adjusts tilt from 0° to (-)15°
- Variable height adjustment of 4.26"(up 1.06", down 3.20")
- Pivots side to side 360°
- Black textured metal finish

Short easy lift arm with pivot:

Same features as the short easy lift arm plus the keyboard platform moves independently from arm, allowing it to parallel the worksurface as the arm is moved laterally.

Easy Lift Arm:

- Spring assist adjustment
- Knobless height adjustment
- Soft touch knob adjusts tilt from 0° to (-) 15°
- Variable height adjustment of 7.04"(up 2.83",down 4.21")
- Pivots side to side 360°
- Black textured finish with Black Soft touch knob.
- Mounts on virtually any worksurface

Easy lift arm with pivot:

Same features as the easy lift arm plus the keyboard platform moves independently from arm, allowing it to parallel the worksurface as the arm is moved laterally.

Sit/Stand Arm:



- Spring assist adjustment
- Knobless height adjustment
- Sort touch knob adjusts tilt from 0° to (-) 15°
- Variable height adjustment of 11.57"(up 6.40", down 5.17")
- Pivots side to side 360°
- Black textured finish.
- Mounts on virtually any worksurface

Sit/Stand arm with pivot:

Same features as the sit/stand arm plus the keyboard platform moves independently from arm, allowing it to parallel the worksurface as the arm is moved laterally.

Adjustable Keyboard Supports

Act II

product	description	type	w	d	h	wgt.
 	Act II keyboard platform	Act II with Easy Lift arm	19"- 27.25"	11.50"- 14.75"	1.69"	10.2 lbs.
	Act II keyboard platform	Act II with Easy Lift arm with Pivot	19"- 27.25"	11.50"- 14.75"	1.69"	11.7 lbs.
	Act II keyboard platform	Act II with Easy Lift arm with two mouse pads with Pivot	19"- 35.5"	11.50"- 14.75"	1.69"	12.3 lbs.
	Act II keyboard platform	Act II with Easy Lift arm with two mouse pads	19"- 35.5"	11.50"- 14.75"	1.69"	10.8 lbs.
	Act II keyboard platform	Act II with Short Easy Lift arm	19"- 27.25"	11.50"- 14.75"	1.69"	9.6 lbs.
	Act II keyboard platform	Act II with Short Easy Lift arm with Pivot	19"- 27.25"	11.50"- 14.75"	1.69"	11 lbs.
	Act II keyboard platform	Act II with Short Easy Lift arm with two mouse pads	19"- 35.5"	11.50"- 14.75"	1.69"	10.2 lbs.
	Act II keyboard platform	Act II with Short Easy Lift arm with two mouse pads with Pivot	19"- 35.5"	11.50"- 14.75"	1.69"	11.6 lbs.
	Act II keyboard platform	Act II with Sit/Stand arm	19"- 27.25"	11.50"- 14.75"	1.69"	11.8 lbs.
	Act II keyboard platform	Act II with Sit/Stand arm with Pivot	19"- 27.25"	11.50"- 14.75"	1.69"	13.4 lbs.
	Act II keyboard platform	Act II with Sit/Stand arm with two mouse pads	19"- 35.5"	11.50"- 14.75"	1.69"	12.4 lbs.
	Act II keyboard platform	Act II with Sit/Stand arm with two mouse pads with Pivot	19"- 35.5"	11.50"- 14.75"	1.69"	14 lbs.

Order Code	Ordering Information	Application Notes	Construction
Example: OAK-A2-P-1-EL2-BK-(16,18,22,23,25)	Track length options are 16, 17.750, 21.625, 22.63 and 25 inches.	Keyboard support provides users with a more comfortable working environment by allowing them to adjust the height and pitch of the platform holding their computer keyboard. When not in use, the Adjustable Keyboard Support stores the keyboard under the worksurface to free vital worksurface space.	Board is phenolic. Wristrest is foam-filled vinyl on MDF board. Mousepad is lycra covered polyurethane. Mechanism: All arms are steel with a powder-coated finish. Tracks are steel with nylon glides.
OAK Office automation keyboard	Standard color is black.		
A2 Act II	Minimum clearance required is the length of the track plus 1/2".	Worksurface should be mounted in the desk height position.	
P phenolic (standard)			
1 Mouse pad comes standard on right side			
EL2 Easy-lift mechanism			
BK Black			
18 Track length of 18 inches		Dimensions above are for the platform only. For full configuration depths, all component measurements and application suggestions refer to the Keyboard Measurements tool on Knoll Exchange.	

pattern no.	list
OAK-A2-P-1-EL2-BK-(16,18,22,23,25)	\$416.
OAK-A2-P-1-EL2-BK-PT-(16,18,22,23,25)	479.
OAK-A2-P-2-EL2-BK-PT-(16,18,22,23,25)	513.
OAK-A2-P-2-EL2-BK-(16,18,22,23,25)	459.
OAK-A2-P-1-SL2-BK-(16,18,22,23,25)	391.
OAK-A2-P-1-SL2-BK-PT-(16,18,22,23,25)	454.
OAK-A2-P-2-SL2-BK-(16,18,22,23,25)	453.
OAK-A2-P-2-SL2-BK-PT-(16,18,22,23,25)	507.
OAK-A2-P-1-SS2-BK-(16,18,22,23,25)	512.
OAK-A2-P-1-SS2-BK-PT-(16,18,22,23,25)	576.
OAK-A2-P-2-SS2-BK-(16,18,22,23,25)	560.
OAK-A2-P-2-SS2-BK-PT-(16,18,22,23,25)	615.

Mechanism Attributes

Short Easy Lift Arm:

- Spring assist adjustment
- Knobless height adjustment
- Soft touch knob adjusts tilt from 0° to (-) 15°
- Variable height adjustment of 4.26"(up 1.06", down 3.20")
- Pivots side to side 360°
- Black textured metal finish

Short easy lift arm with pivot:

Same features as the Short easy lift arm plus the keyboard platform moves independently from arm, allowing it to parallel the worksurface as the arm is moved laterally.

Easy Lift Arm:

- Spring assist adjustment
- Knobless height adjustment
- Soft touch knob adjusts tilt from 0° to (-) 15°
- Variable height adjustment of 7.04"(up 2.83", down 4.21")
- Pivots side to side 360°
- Black textured finish with Black soft touch knob
- Mounts on virtually any worksurface

Easy lift arm with pivot:

Same features as the easy lift arm plus the keyboard platform moves independently from arm, allowing it to parallel the worksurface as the arm is moved laterally.

Sit/Stand Arm:



- Spring assist adjustment
- Knobless height adjustment
- Soft touch knob adjusts tilt from 0° to (-) 15°
- Variable height adjustment of 11.57"(up 6.40", down 5.17")
- Pivots side to side 360°
- Black textured finish.
- Mounts on virtually any worksurface

Sit/Stand arm with pivot:

Same features as the Sit/Stand arm plus the keyboard platform moves independently from arm, allowing it to parallel the worksurface as the arm is moved laterally.

Adjustable Keyboard Supports

Mousing Solutions

product	description	type	w	d	h	wgt.
Juliet Mouse Pad 	<ul style="list-style-type: none"> • Teardrop shaped mousing surface swivels under the keyboard platform. • Attaches to the underside of the platform. • Soft plastic overcoat keeps the mouse from sliding during adjustments. 		11"	10"	1 1/2"	1 lb. 3 oz.
		for use with Caesar platform	11"	10"	1 1/2"	1 lb. 3 oz.
Juliet Palm Rest 	<ul style="list-style-type: none"> • Palm rest to retrofit to existing mouse pad. • Palm rest provides soothing support. 		6"	2 1/4"	1/2"	1 oz.
Over ten-key mouse pad 	<ul style="list-style-type: none"> • Mouse flips over ten-keypad. • Tension fit allows users to adjust tilt • Generous size pad for easy mousing • For use with Romeo platform only (platforms manufactured from 2002 on) 	for use with Romeo only				

Order Code

Example: **4B2-MP**
4B2-MP Juliet mouse pad

Ordering Information

Specify:
 1. Pattern number
 Not all mousing solutions are appropriate with all platforms.

Construction

Worksurface mounted surf mousepad:
 Black painted steel mechanism mounted with hard surface backed surf mouse pad.
Juliet mouse pad:
 30% Glass filled molded black rigid PVC base with black flexible soft textured PVC surface for improved mouse tracking.

Juliet palm rest:
 Nylon upholstered palm rest is dual density polyurethane. The gel beneath the fabric, nominally .65", is formulated to provide soothing support.

pattern no. list price

4B2-MP \$39.



4B2-MP-MS 50.

4B2-WR 23.

OAK-OTK-MP 43.

Freestanding Surf® Ergonomic Accessories

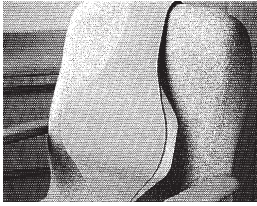
by Ross Lovegrove & Stephen Peart

product	description	type	w	d	h	wgt.									
	<ul style="list-style-type: none"> • Soft, biomorphic form reduces strain on wrist. • Long, radial shape with single straight edge ensures a tightfit with standard size keyboards. • Gel pad for greater use comfort. 		19"	4 1/8"	1"	7 ozs.									
	<ul style="list-style-type: none"> • Self-adjusts over any seat back. • Heat and pressure reactive foam responds to individual user. • Support returns to original form within 10 seconds after use. • Neoprene nylon outer skin allows body to breathe comfortably. 		12 1/2"	30 3/4"	2 3/8"	1 lbs. 10 ozs.									
	<ul style="list-style-type: none"> • Fits any worksurface thickness or edge profile. • Creates generous 24" wide VDT corner, 14" from worksurface corner. • Can be adjusted to any angle, or removed when not needed. • Integral non-handed mouse pad. • Felt back and rubber bumpers protect worksurface. 	<table border="1"> <tr> <td>Metallic finish</td> <td>41 1/2"</td> <td>16 1/2"</td> <td>1"</td> <td>14 lbs.</td> </tr> <tr> <td>Soft touch finish</td> <td>41 1/2"</td> <td>16 1/2"</td> <td>1"</td> <td>14 lbs.</td> </tr> </table>	Metallic finish	41 1/2"	16 1/2"	1"	14 lbs.	Soft touch finish	41 1/2"	16 1/2"	1"	14 lbs.			
Metallic finish	41 1/2"	16 1/2"	1"	14 lbs.											
Soft touch finish	41 1/2"	16 1/2"	1"	14 lbs.											

Order Code	Ordering Information	Ergonomic Value
Example: SF-SB-E SF-SB Metallic finish Surf Board VDT corner E Soft grey	<i>Specify:</i> 1. Pattern number 2. Finish <i>Neoprene nylon finishes:</i> Black (BK) <i>Surf Board painted finishes:</i> Soft Grey (E) Medium Metallic Grey (J) Soft Touch Light Grey (GS) Soft Touch Black (BS)	<p>The Surf Collection wrist rest, mouse pad, and lumbar support play a critical role in workplace ergonomics. Proper use of these pieces helps users maintain the body neutral position, reducing harmful strain on muscles and joints.</p> <p>The collection's design advantage is in its simplicity. These accessories are extraordinarily versatile and flexible, responding to the individual needs of the specific user, unlike over-engineered mechanical pieces.</p> <p>Each piece in the Surf Collection is a "footprint form," derived from natural ergonomic movements. No sharp edges or angles are used. As a result, the accessories can be approached by the user from any direction. The Surf soft, biomorphic shapes echo the curves and contours of the human body.</p> <p><i>Lumbar support note:</i> Back problems are the second leading cause of lost work time after the common cold. Most back rests utilize rigid, unyielding materials, ignoring the diversity of human form and movement.</p>

pattern no.	list price
SF-WR-FS-(BK)-G	\$89.
SF-LS	245.
SF-SB-(E, J)	267.
SF-SB-(GS, BS)	336.

General Notes

The Surf Lumbar Support rests loosely over the chair like a saddle bag, held in place by a counter balance weight. The piece is easily adjusted up or down, to the preference of the user.

The supports high performance patented foam molds itself to both the user and the chair back. As the user moves throughout the workday, the foam responds in kind, continuously resculpting itself around the user's body. When body pressure is removed, the lumbar support returns to its original form within 10 seconds, ready for the next user.

Construction

Surf Board:
Rigid steel plate with 1" thick rolled front detail. Black rubber bumpers and non-scuffing felt back.

Wrist rest and mouse pad:
Nylon upholstered dual-density polyurethane. Gel beneath fabric, nominally .65", is formulated to provide soothing support by displacement.

Lumbar support:
High memory, heat-reactive patented polyurethane foam developed for high performance use in military fighter pilot seats. Covered with wear-resistant, closed cell Neoprene and a bright colored, breathable nylon outer skin. Die-cast zinc counter-balance weight.

All items manufactured in the United States.

Design Awards

First place, Interior Design Product Award, ASID, 1994. High Design Quality Red Dot Award, Design Zentrum, Germany, 1994.

Lumbar support:
Honorable Mention, Furniture, *ID Magazine* Annual Design Review, 1994.

Surf Board:
Best of Category Award, Consumer Products, *ID Magazine* Annual Design Review, 1994.

Freestanding Ergonomic Accessories

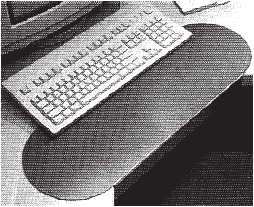
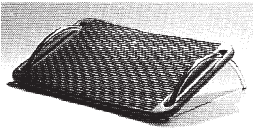
product	description	type	w	d	h	wt.
VDT Sleeve 	<ul style="list-style-type: none"> • Racetrack-shaped sleeve slides over worksurface to create VDT corner. • Creates 17³/₈" wide VDT corner, 9" from worksurface corner. • Can be adjusted to any angle, or removed when not needed. • Heavy-gauge steel with felt backing to prevent scuffing. • 1¹/₄", 1³/₄" and 2¹/₂" worksurface thicknesses. • 1/4" screw holes on underside for optional attachment to worksurface. • Available in two metallic and two soft-touch finishes. 	Metallic finish	26 ³ / ₄ "	9 ¹ / ₈ "	1 ¹ / ₄ "-2 ¹ / ₂ "	3 lbs.
		Soft touch finish	26 ³ / ₄ "	9 ¹ / ₈ "	1 ¹ / ₄ "-2 ¹ / ₂ "	3 lbs.
Adjustable Foot Rest 	<ul style="list-style-type: none"> • Self-adjusts +30°/-30°. • Durable, ribbed rubber platform. 		17 ¹ / ₈ "	12"	3 ³ / ₈ "	7 lbs. 14 ozs.

Order Code

Example: OA-SLV-A-E
OA-SLV VDT sleeve
A 1 ¹ / ₄ " sleeve
E Soft grey finish

Ordering Information

Specify:

1. Pattern number
2. Thickness (VDT sleeve only)
3. Finish

VDT sleeve worksurface thicknesses:
 1¹/₄" (A): Equity, Morrison, Reff
 1³/₄" (B): Morrison, Reff
 2¹/₂" (C): Reff

VDT sleeve finishes:
 Soft Grey (E)
 Medium Metallic Grey (J)
 Soft Touch Light Grey (GS)
 Soft Touch Black (BS)

Custom Options

Custom colors available upon sample chip approval. Contact your Knoll sales representative or Customer Service for complete pricing information.

pattern no.	list price
OA-SLV(A,B,C)-(E, J)	\$189.
OA-SLV(A,B,C)-(GS, BS)	245.

OA-FR-BK	205.
-----------------	------

Construction

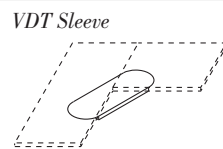

VDT sleeve:
 Heavy-gauge steel in painted finish.
 Felt backing protects worksurface.
 Manufactured in the United States.

Adjustable foot rest:
 Black rubber platform. Polished
 chrome frame.
 Manufactured in Sweden.

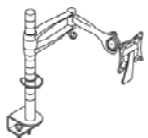

Wishbone Flat Panel Monitor Support System

by Colebrook Bosson Saunders
standard arm

product	description	type	w	d	h	wgt.
 <p>Wishbone Kit</p>	<ul style="list-style-type: none"> • Easy order kit. Wishbone kit includes everything needed to mount one flat panel monitor arm to a worksurface: Standard arm, 400 mm (15.75 inches) post, O-ring, Cable management clip, Table clamp (Top mount). 	Wishbone kit with fast release				
 <p>Standard Arm Post Mount</p>	<ul style="list-style-type: none"> • Adjusts at four joints. • Allows user to rotate arm 360° at pole connection. • Allows user to tilt monitor face up and down 180° and pivot monitor left and right. • Center hinge provides depth/location flexibility. • Generous arm reach - approximately 17 inches depending on mounting option. 	Standard wishbone arm, post mount with fast release				
 <p>Standard Arm Slat wall Mount *</p>	<ul style="list-style-type: none"> • Adjusts at four joints. • Allows user to rotate arm 180° at slat wall. • Allows user to tilt monitor face up and down 180° and pivot monitor left and right. • Center hinge provides depth/location flexibility. • Generous arm reach - approximately 17 inches depending on mounting option. 	Standard wishbone arm, Knoll Slat board / Slat wall Mount with fast release				

- The Wishbone system allows for a great flexibility in the mounting and adjustment of flat panel monitors. The system is particularly proficient at mounting multiple monitors easily to tables and system furniture.
- All arm options on this page:
 - Will mount to VESA compliant flat panel monitors
 - Will hold monitors of weights up to 22 lbs.
 - Are lightweight and durable.
 - Ship standard with fast release option (see notes below for fast release attributes).
 - Allow monitor to lie relatively flat against tool bar, Currents slat wall, or panel.

Order Code	Ordering Information	Mounting Information	*Slat wall Mount Note
Example: WSH-SA-TB-SV <hr/> WSH-SA- Standard Arm Tool Bar TB Mount <hr/> SV Silver	<i>Specify:</i> <ol style="list-style-type: none"> 1. Pattern number 2. Finish where required 3. Mounting pattern number(s) where required. <p>Kits and Currents slat wall mount arms do not require any additional mounting specification.</p> <p>Additional mounting pieces must be specified for post-mount arms and toolbar-mount arms.</p> <p><i>Finish option (when applicable):</i> Silver (SV)</p>	<i>Screen Mounting:</i> All wishbone arms are compatible with the international VESA standard adopted by most panel manufacturers. Knoll and its dealers will not take the responsibility for mounting the monitor to the arm. The end user's IT department must confirm VESA mounting compliance and mount the monitor to the arm using customer's own screws. Please review the Wishbone Test Matrix on Knoll Exchange for comprehensive mounting guidance.	<ul style="list-style-type: none"> • Works with all Knoll Slat board and Slat wall profiles. • Load ratings vary across products and mounting approaches. Check Knoll Exchange for Wishbone Test Matrix. • Note: Orchestra Slat board must be mounted to an architectural wall if Wishbone is to be mounted onto it. (See the Wishbone Text Matrix for complete mounting limitations for this application)

pattern no.	list price
WSH-SA-K-SV	\$574.

WSH-SA-SV	389.
------------------	------

WSH-SA-MP-SV	523.
---------------------	------

Cable Management:
Simple cable management for easy installation.

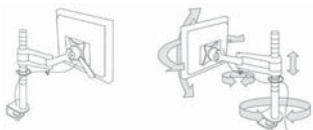

Cable Management

Adjustment

Adjustment:
The Wishbone system offers a wide range of adjustment. Height adjustment is easily accomplished by lifting the arm and sliding the o-ring up and down post to the required height.

Construction

Wishbone:
Products are manufactured in diecast and extruded aluminum and glass reinforced acetal plastic.

O-ring is made of an elasticated polymer.

Wishbone product line is patented in the United States.



Design Awards

Fast Release:
Allows for swift installation and removal of flat panel monitors.
Allows user to rotate monitor face from a landscape to portrait orientation.

Workplace 1999- Best New Workplace Product
Spectrum 2000-Award for Design Excellence
Neocon 2000-Gold award in Recognition of Product Excellence.
Innovations Award-Citation of Excellence Sponsors By Building
Malaysian Furniture Fair-Design of the Year.

Wishbone Flat Panel Monitor Support System

by Colebrook Bosson Saunders
standard arm

product	description	type	w	d	h	wgt.
Standard Arm Tool Bar Mount 	<ul style="list-style-type: none"> • Adjusts at four joints. • Allows user to rotate arm 180° at tool bar connection. • Allows user to tilt monitor face up and down 180° and pivot monitor left and right. • Center hinge provides depth/location flexibility. • Generous arm reach - approximately 17 inches depending on mounting option. 	Standard wishbone arm, tool bar mount with fast release				
Back to Back Arm 	<ul style="list-style-type: none"> • Mounts two flat panel monitors to one pole. • Made up of two arms that each adjust at four joints. • Allows user to rotate both arms 270° at pole connection. • Allows user to tilt monitor faces up and down 180° and pivot monitor left and right. • Enables user to position monitors side by side or back to back. • Available in post mount version only (see notes below for ordering information) 	Back to back arm, post mount with fast release (includes 2 fast release arms and a back to back bracket)				

- The Wishbone system allows for a great flexibility in the mounting and adjustment of flat panel monitors. The system is particularly proficient at mounting multiple monitors easily to tables and system furniture.
- All arm options on this page:
 Will mount to VESA compliant flat panel monitors
 Will hold monitors of weights up to 22 lbs.
 Are lightweight and durable.
 Ship standard with fast release option (see notes below for fast release attributes).
 Allow monitor to lie relatively flat against tool bar, Currents slat wall, or panel.

Order Code	Ordering Information	Mounting Information	*Slat wall Mount Note
Example: WSH-SA-TB-SV <hr/> WSH-SA- Standard Arm Tool Bar TB Mount <hr/> SV Silver	<i>Specify:</i> 1. Pattern number 2. Finish where required 3. Mounting pattern number(s) where required. Kits and Currents slat wall mount arms do not require any additional mounting specification. Additional mounting pieces must be specified for post-mount arms and toolbar-mount arms. <i>Finish option (when applicable):</i> Silver (SV)	<i>Screen Mounting:</i> All wishbone arms are compatible with the international VESA standard adopted by most panel manufacturers. Knoll and its dealers will not take the responsibility for mounting the monitor to the arm. The end user's IT department must confirm VESA mounting compliance and mount the monitor to the arm using customer's own screws. Please review the Wishbone Test Matrix on Knoll Exchange for comprehensive mounting guidance.	<ul style="list-style-type: none"> • Works with all Knoll Slat board and Slat wall profiles. • Load ratings vary across products and mounting approaches. Check Knoll Exchange for Wishbone Test Matrix. • Note: Orchestra Slat board must be mounted to an architectural wall if Wishbone is to be mounted onto it. (See the Wishbone Text Matrix for complete mounting limitations for this application)

pattern no.

list price

WSH-SA-TB

549.

WSH-SA-B2B-PT-SV

928.

Construction

Cable Management:
Simple cable management for easy installation.



Cable Management

Adjustment

Adjustment:
The Wishbone system offers a wide range of adjustment. Height adjustment is easily accomplished by lifting the arm and sliding the o-ring up and down post to the required height.

Wishbone:
Products are manufactured in diecast and extruded aluminum and glass reinforced acetal plastic.

O-ring is made of an elasticated polymer.

Wishbone product line is patented in the United States.



Fast Release:
Allows for swift installation and removal of flat panel monitors.
Allows user to rotate monitor face from a landscape to portrait orientation.

Design Awards

Workplace 1999- Best New Workplace Product
Spectrum 2000- Award for Design Excellence
Neocon 2000- Gold award in Recognition of Product Excellence.
Innovations Award- Citation of Excellence Sponsors By Building
Malaysian Furniture Fair- Design of the Year.

Wishbone Flat Panel Monitor Support System

by Colebrook Bosson Saunders
forearm

product	description	type	w	d	h	wgt.
 <p>Forearm Post Mount</p>	<ul style="list-style-type: none"> Moderate reach arm – Aproximately 10½” depending on mounting option. Adjusts at three joints. Allows user to tilt monitor face up and down 180° and pivot monitor left and right. Allows user to rotate arm 360° at pole connection. 	Forearm, post mount with fast release feature				
 <p>Forearm Slat wall Mount *</p>	<ul style="list-style-type: none"> Moderate reach arm – Aproximately 10½” depending on mounting option. Adjusts at three joints. Allows user to tilt monitor face up and down 180° and pivot monitor left and right. Allows user to rotate arm 180° at slatwall. 	Forearm, Knoll Slat board / Slat wall Mount with fast release feature				
 <p>Forearm Tool Bar Mount</p>	<ul style="list-style-type: none"> Moderate reach arm – Aproximately 10½” depending on mounting option. Adjusts at three joints. Allows user to tilt monitor face up and down 180° and pivot monitor left and right. Allows user to rotate arm 180° at tool bar connection. 	Forearm, tool bar mount with fast release feature				

Order Code	
Example:	WSH-02-PT-FR-SV
WSH-02-PT-FR	Wishbone forearm fast release
SV	Silver

Ordering Information
<p><i>Specify:</i></p> <ol style="list-style-type: none"> Pattern number Finish where required Mounting pattern number(s) where required. <p>Kits and Currents slat wall mount arms do not require any additional mounting specification.</p> <p>Additional mounting pieces must be specified for post-mount arms and toolbar-mount arms.</p>

Mounting Information
<p><i>Screen Mounting:</i></p> <p>All wishbone arms are compatible with the international VESA standard adopted by most panel manufacturers.</p> <p>Knoll and its dealers will not take the responsibility for mounting the monitor to the arm. The end user's IT department must confirm VESA mounting compliance and mount the monitor to the arm using customer's own screws.</p> <p>Please review the Wishbone Test Matrix on Knoll Exchange for comprehensive mounting guidance.</p>

* Slat wall Mount Note
<ul style="list-style-type: none"> Works with all Knoll Slat board and Slat wall profiles. Load ratings vary across products and mounting approaches. Check Knoll Exchange for Wishbone Test Matrix. Note: Orchestra Slat board must be mounted to an architectural wall if Wishbone is to be mounted onto it. (see the Wishbone Test Matrix for complete mounting limitations for this application)

pattern no.	list price
WSH-02-PT	\$396.
WSH-02-MP	530.
WSH-02-TB	556.

Cable Management:
Simple cable management for easy installation.



Cable Management

Adjustment

Adjustment:
The Wishbone system offers a wide range of adjustment. Height adjustment is easily accomplished by lifting the arm and sliding the o-ring up and down post to the required height.

Construction

Wishbone:
Products are manufactured in diecast and extruded aluminum and glass reinforced acetal plastic.

O-ring is made of an elasticated polymer.

Wishbone product line is patented in the United States.

Desing Awards

Fast Release:
Allows for swift installation and removal of flat panel monitors.



Allows user to rotate monitor face from a landscape to portrait orientation.

Workplace 1999- Best New Workplace Product
Spectrum 2000-Award for Design Excellence
Neocon 2000-Gold award in Recognition of Product Excellence.
Innovations Award-Citation of Excellence Sponsors By Building
Malaysian Furniture Fair-Design of the Year.

Wishbone Flat Panel Monitor Support System

by Colebrook Bosson Saunders

c-arm

product	description	type	w	d	h	wgt.
 C-Arm Post Mount	<ul style="list-style-type: none"> • Cost-effective arm alternative for use when less adjustment is required. • Adjusts at two joints. • Allows user to tilt monitor face up and down, up to 180° depending on mounting, and pivot monitor left and right. 	C-arm, post mount with fast release feature				
 C-Arm Slat wall Mount *	<ul style="list-style-type: none"> • Cost-effective arm alternative for use when less adjustment is required. • Adjusts at two joints. • Allows user to tilt monitor face up and down, up to 180° depending on mounting, and pivot monitor left and right. 	C-arm, Knoll Slat board / Slat wall Mount with fast release				
 C-Arm Tool Bar Mount	<ul style="list-style-type: none"> • Cost-effective arm alternative for use when less adjustment is required. • Adjusts at two joints. • Allows user to tilt monitor face up and down, up to 180° depending on mounting, and pivot monitor left and right. 	C-arm, tool bar mount with fast release feature				

Order Code	Ordering Information	Mounting Information	* Slat wall Mount Note
Example: WSH-03-PT-FR-SV WSH-03- C-Arm Post Mount with PT-FR fast release SV Silver	<i>Specify:</i> <ol style="list-style-type: none"> 1. Pattern number 2. Finish where required 3. Mounting pattern number(s) where required. <p>Kits and Currents slat wall mount arms do not require any additional mounting specification.</p>	<i>Screen Mounting:</i> All wishbone arms are compatible with the international VESA standard adopted by most panel manufacturers. Knoll and its dealers will not take the responsibility for mounting the monitor to the arm. The end user's IT department must confirm VESA mounting compliance and mount the monitor to the arm using customer's own screws.	<ul style="list-style-type: none"> • Works with all Knoll Slat board and Slat wall profiles. • Load ratings vary across products and mounting approaches. Check Knoll Exchange for Wishbone Test Matrix. • Note: Orchestra Slat board must be mounted to an architectural wall if Wishbone is to be mounted onto it. (see the Wishbone Test Matrix for complete mounting limitations for this application)

pattern no.	list price
WSH-03-PT	\$364.
WSH-03-SW	499.
WSH-03-TB	364.

Cable Management:
Simple cable management for easy installation.

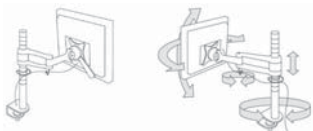

Cable Management

Adjustment

Adjustment:
The Wishbone system offers a wide range of adjustment. Height adjustment is easily accomplished by lifting the arm and sliding the o-ring up and down post to the required height.

Construction

Wishbone:
Products are manufactured in diecast and extruded aluminum and glass reinforced acetal plastic.

O-ring is made of an elasticated polymer.

Wishbone product line is patented in the United States.



Fast Release:
Allows for swift installation and removal of flat panel monitors.

Allows user to rotate monitor face from a landscape to portrait orientation.

Wishbone Flat Panel Monitor Support System

by Colebrook Bosson Saunders

posts and tool bar

product	description	type	dia.	l	h
Post with O-Ring and Cable Management Clip  <i>300 mm shown</i>	<ul style="list-style-type: none"> • Post with grooves in conjunction with o-ring allows for height adjustment of arms and tool bars. • O-ring is moved up and down pole to lock in height adjustment • Cable management clip provides simple cable management for easy installation. 	200 mm post (7.87")	1/2"	7 7/8"	
		300 mm post (11.8")	1/2"	11 7/8"	
		400 mm post (15.75")	1/2"	15 7/8"	
Extension Posts  <i>200 mm shown</i>	<ul style="list-style-type: none"> • Screws into post. • Allows for additional height adjustment. 	200 mm (7.87")	1/2"	7 15/16"	
		300 mm (11.8")	1/2"	11 7/8"	
		400 mm (15.75")	1/2"	15 7/8"	
Tool Bars 	<ul style="list-style-type: none"> • Sturdy construction tool bars can support the weight of multiple arms and monitors. • Note that posts connect to tool bars only at the end of the bars. Review of table/desk support locations is necessary to assure that the post clamps will mount at the required location. 	Tool bar – 37 1/4"			
		Tool bar – 45 1/8"			
		Tool bar – 61"			

Order Code

Example:	WSH-XP-300-SV
WSH-XP-300	Wishbone extension 300 mm. (11.8")
SV	Silver

Ordering Information

Specify:

1. Pattern number
2. Finish where required
3. Mounting pattern number(s) where required.

Kits and Currents slat wall mount arms do not require any additional mounting specification.

Finish option (when applicable):
Silver (SV)

Mounting Information

Screen Mounting:
All wishbone arms are compatible with the international VESA standard adopted by most panel manufacturers.

Knoll and its dealers will not take the responsibility for mounting the monitor to the arm. The end user's IT department must confirm VESA mounting compliance and mount the monitor to the arm using customer's own screws.

Please review the Wishbone Test Matrix on Knoll Exchange for comprehensive mounting guidance.

pattern no.	list price
WSH-200-PT-CLP-O-SV	\$113.
WSH-300-PT-CLP-O-SV	120.
WSH-PT-CLP-O-SV	126.
WSH-XP-200-SV	114.
WSH-XP-300-SV	121.
WSH-XP-CLP-O-SV	128.
WSH-PTB-37	332.
WSH-PTB-45	359.
WSH-PTB-61	386.

Cable Management:
Simple cable management for easy installation.



Cable Management

Adjustment

Adjustment:
The Wishbone system offers a wide range of adjustment. Height adjustment is easily accomplished by lifting the arm and sliding the o-ring up and down post to the required height.

Construction

Wishbone:
Products are manufactured in diecast and extruded aluminum and glass reinforced acetal plastic.

O-ring is made of an elasticated polymer.

Wishbone product line is patented in the United States.







Fast Release:
Allows for swift installation and removal of flat panel monitors.

Allows user to rotate monitor face from a landscape to portrait orientation.

Wishbone Flat Panel Monitor Support System

by Colebrook Bosson Saunders

mounting brackets

product	description	w	d	h	diam
 Table Clamp	<ul style="list-style-type: none"> Mounts post to virtually any worksurface. between $\frac{3}{4}$" and $1\frac{1}{2}$" thick. Requires 2" clear space from edge of underside of worksurface for proper mounting. 	3 $\frac{1}{8}$ "	4 $\frac{1}{8}$ "	2 $\frac{1}{4}$ "	
 Table Clamp, Top Mount	<ul style="list-style-type: none"> Two piece clamp. Allows the installation of the table clamp on worksurfaces in panel systems that do not have access room between the worksurface and the panel. Ideal for retrofitting. Mounts post to virtually any worksurface. between $\frac{3}{4}$" and $1\frac{1}{2}$" thick. Requires 2" clear space from edge of underside of worksurface for proper mounting. 	3 $\frac{1}{8}$ "	4 $\frac{1}{8}$ "	3"	
 Currents Crown Flower Pot Bracket	<ul style="list-style-type: none"> Mounts a post to the Currents crown mount (must specify post separately). Allows for easy height adjustment. 	2 $\frac{3}{4}$ "	5"	4 $\frac{1}{4}$ "	
 Knoll Slat wall Flower Pot Bracket *	<ul style="list-style-type: none"> Mounts a post to a slat wall (must specify post separately). Allows for easy height adjustment. Mount only 1 monitor per 3' of slat wall. 	4 $\frac{1}{4}$ "	2 $\frac{1}{2}$ "	5"	
 Fixed Table Mount	<ul style="list-style-type: none"> Mounts Wishbone post to worksurface. Mounts using field drilled hole. 			$\frac{3}{16}$ "	3"
 Spare Fast Release Monitor Plate	<ul style="list-style-type: none"> Male portion of fast release bracket. Allows for speedy replacement of malfunctioning monitors. For use with fast release arms only. 	6"	9 $\frac{3}{8}$ "	$\frac{1}{2}$ "	
 Toolbar Bracket	<ul style="list-style-type: none"> Bracket to mount Wishbone arms (Forearm, Wishbone standard arm, C-arm, Rotation) onto CBS toolbar 	2 $\frac{3}{16}$ "	2 $\frac{3}{4}$ "	3 $\frac{7}{16}$ "	

Order Code

Example:	WSH-CLMP-TM-SV
WSH-	Table clamp, top mount
CLMP-TM	
SV	Silver

Ordering Information

Specify:

- Pattern number
- Finish where required
- Mounting pattern number(s) where required.

Kits and Currents slat wall mount arms do not require any additional mounting specification.

Finish option (when required):
Silver (SV)

Mounting Information

Screen Mounting:
All wishbone arms are compatible with the international VESA standard adopted by most panel manufacturers.

Knoll and its dealers will not take the responsibility for mounting the monitor to the arm. The end user's IT department must confirm VESA mounting compliance and mount the monitor to the arm using customer's own screws.

Please review the Wishbone Test Matrix on Knoll Exchange for comprehensive mounting guidance.

Grommet Mounting:
Please follow installation instructions closely. With Reff, it is important to pass monitor plugs through grommet mount cover while it is still loose. The Reff worksurface will limit space in the grommet cover opening once the post is fully installed and grounded plugs will not fit through. The clear passthrough with Reff after installation is $\frac{1}{16}$ " x $2\frac{3}{8}$ ".

pattern no.	list price
WSH-CLMP-SV	\$75.
WSH-CLMP-TM-SV	92.
WSH-FPB-CCM	204.
WSH-FPB-CSL	131.
WSH-PTM-75-SV	36.
WSH-PMFR-BK	97.
WSH-TBP-BRKT	147.

*** Slat wall Mounting Note**

- Works with all Knoll Slat board and Slat wall profiles.
- Load ratings vary across products and mounting approaches. Check Knoll Exchange for Wishbone Test Matrix.
- Note: Orchestra Slat board must be mounted to an architectural wall if Wishbone is to be mounted onto it. (see the Wishbone Test Matrix for complete mounting limitations for this application)

Cable Management:
Simple cable management for easy installation.



Cable Management Adjustment

Adjustment:
The Wishbone system offers a wide range of adjustment. Height adjustment is easily accomplished by lifting the arm and sliding the o-ring up and down post to the required height.

Construction

Wishbone:
Products are manufactured in diecast and extruded aluminum and glass reinforced acetal plastic.





Fast Release:
Allows for swift installation and removal of flat panel monitors.

Allows user to rotate monitor face from a landscape to portrait orientation.

Wishbone Flat Panel Monitor Support System

by Colebrook Bosson Saunders

mounting brackets

product	description	w	d	h	diam
Back to Back Bracket 	<ul style="list-style-type: none"> Use with post and two arms to create back to back set up. 	6 ⁵ / ₈ "	2 ³ / ₄ "	3 ⁵ / ₈ "	
Grommet Mount 	<ul style="list-style-type: none"> Use with existing grommets on Morrison, Reff, Propeller desks. Please refer to grommet mounting information at the bottom of this page Can be retrofitted into existing worksurfaces that do not have a grommet hole. In that case, drill a 3¹/₄" diameter hole into surface. 			1/2"	4 ¹ / ₄ "
Wall Mount flower pot bracket 	<ul style="list-style-type: none"> Mounts post and arm to wall (must specify post separately) 	2 ³ / ₄ "	2 ¹ / ₄ "	5 ³ / ₄ "	
Knoll slat wall arm mount bracket 	<ul style="list-style-type: none"> Mounts an arm to a slat wall Allows for easy height adjustment 	4 ¹ / ₄ "	2 ⁵ / ₈ "	5 ³ / ₄ "	

Order Code

Example:	WSH-CLMP-TM-SV
WSH-	Table clamp, top mount
CLMP-TM	
SV	Silver

Ordering Information

Specify:

1. Pattern number
2. Finish where required
3. Mounting pattern number(s) where required.

Kits and Currents slat wall mount arms do not require any additional mounting specification.

Finish option (when required):
Silver (SV)

Mounting Information

Screen Mounting:
All wishbone arms are compatible with the international VESA standard adopted by most panel manufacturers.

Knoll and its dealers will not take the responsibility for mounting the monitor to the arm. The end user's IT department must confirm VESA mounting compliance and mount the monitor to the arm using customer's own screws.

Please review the Wishbone Test Matrix on Knoll Exchange for comprehensive mounting guidance.

Grommet Mounting:
Please follow installation instructions closely. With Reff, it is important to pass monitor plugs through grommet mount cover while it is still loose. The Reff worksurface will limit space in the grommet cover opening once the post is fully installed and grounded plugs will not fit through. The clear passthrough with Reff after installation is 1¹/₆" x 2³/₈".

pattern no.	list price
WSH-B2B-SV	\$230.
WSH-GRMT-SV	121.
WSH-FPB-WM	131.
WSH-MP-SV	131.

*** Slat wall Mounting Note**

- Works with all Knoll Slat board and Slat wall profiles.
- Load ratings vary across products and mounting approaches. Check Knoll Exchange for Wishbone Test Matrix.
- Note: Orchestra Slat board must be mounted to an architectural wall if Wishbone is to be mounted onto it. (see the Wishbone Test Matrix for complete mounting limitations for this application)

Cable Management:
Simple cable management for easy installation.

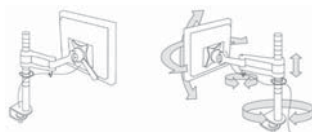

Cable Management Adjustment

Adjustment:
The Wishbone system offers a wide range of adjustment. Height adjustment is easily accomplished by lifting the arm and sliding the o-ring up and down post to the required height.

Construction

Wishbone:
Products are manufactured in diecast and extruded aluminum and glass reinforced acetal plastic.

Fast Release:
Allows for swift installation and removal of flat panel monitors.
Allows user to rotate monitor face from a landscape to portrait orientation.

Wishbone Rotation Flat Panel Monitor Support

by Colebrook Bosson Saunders

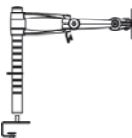
product	description	type	app	w	d	h	wgt.
Rotation 	<ul style="list-style-type: none"> Two movement joints allow for maximum adjustability. A warp spring clutch at the elbow joint allows the user fingertip height adjustment in addition to the movement inherent in the standard Wishbone range. The movement joint at the screen allows for 210 degrees of vertical and 90 degrees of horizontal adjustment. The center (elbow) joint provides 300 degrees of horizontal and 210 degrees of vertical adjustment. Available in standard release only. Supports monitors up to 17 lbs. in weight. 	Rotation, standard release arm	Arm only	2"	18"	3 1/2"	3 lbs.
Rotation kit 	<ul style="list-style-type: none"> Easy to order kit. Includes everything needed to attach one flat panel monitor to a worksurface: Rotation arm, post, o-ring, cable management clip and table clamp. Available in standard release only. 	Rotation kit with standard release. 300 mm (11.8") post Rotation kit with standard release. 400 mm (15.75") post		3"	4"	14"	2 lbs. 4 oz.
				3"	4"	18"	2 lbs. 8 oz.

Order Code

Example:	WSH-ROT-400-PT-SR-K-SV
WSH-ROT	Wishbone rotation
400-PT	400mm post
SR	Standard release
K	kit - includes clamp mount
SV	Silver

Ordering Information

Specify:

1. Pattern number
2. Finish when required
3. Mounting option pattern number(s) when required

Kits do not require mounting option.

Additional mounting pieces required for toolbar, back-to-back, slat wall, fixed table and grommet mounts.

Finish option (when required):
Silver (SV)

Mounting Information

Screen Mounting:
All Wishbone arms are compatible with the International VESA Standards adopted by most flat panel manufacturers.

Knoll and its dealers will not accept responsibility for mounting the flat panel to the arm. The end user's IT department must confirm VESA mounting compliance and mount the flat panel using the customer's own screws.

Please review the Wishbone Test Matrix on Knoll Exchange for comprehensive mounting guidance.

Grommet Mounting:
Please follow installation instructions closely. With Reff, it is important to pass monitor plugs through grommet mount cover while it is still loose. The Reff worksurface will limit space in the grommet cover opening once the post is fully installed and grounded plugs will not fit through. The clear passthrough with Reff after installation is 1 1/16" x 2 3/8".

pattern no.	list
WSH-ROT-PT-SR-SV	\$691.

WSH-ROT-300-PT-SR-K-SV	844.
-------------------------------	------

WSH-ROT-400-PT-SR-K-SV	874.
-------------------------------	------



Construction

Products are constructed of die cast and extruded aluminum and glass reinforced acetal plastic. O ring is made of elastic polymer.

Wishbone line is patented in the United States.

Zorro Flat Panel Monitor Support

by Colebrook Bosson Saunders

product	description	type	app	w	d	h	wgt.
 Zorro	<ul style="list-style-type: none"> • Ideal for single users in highly visible areas or private office, Zorro's simple yet innovative design allows for full movement of the screen. • Carries up to 22 lbs in weight. • The movement joint at the screen allows for 210 degrees of vertical and 90 degrees of horizontal adjustment. • The elbow allows for 360 degrees of horizontal movement. • The arm reach is 18" from the center of the post. 	Plastic Fast Release Arm	Arm only	2"	18"	10"	3 lbs.
 Zorro post kit	<ul style="list-style-type: none"> • Easy to order kit. Includes everything needed to attach one flat panel monitor to a worksurface: Zorro arm, post and table clamp. • Post height is 200mm (7.87"). 	Includes 200mm post, clamp and cable management		3"	4"	10"	2 lbs.
	<ul style="list-style-type: none"> • Easy to order kit. Includes everything needed to attach one flat panel monitor to a worksurface: Zorro arm, post and table clamp. • Post height is 300mm (11.8"). 	Includes 300mm post, clamp and cable management		3"	4"	14"	2 lbs. 4 oz.
	<ul style="list-style-type: none"> • Easy to order kit. Includes everything needed to attach one flat panel monitor to a worksurface: Zorro arm, post and table clamp. • Post height is 400mm (15.75"). 	Includes 400mm post, clamp and cable management		3"	4"	18"	2 lbs. 8 oz.

Order Code

Example:	WSH-ZOR-SA-200-PT-K-SV
WSH-ZOR-SA	Zorro arm with fast release arm
200-PT	200mm post (7.87")
K	Kit - includes clamp mount
SV	Silver

Ordering Information

Specify:

1. Pattern number
2. Finish option when required
3. Mounting option pattern number when required

Zorro is designed to work primarily for with a single monitor on a post. Mounting options other than table clamp include; grommet mount and through-the-desk mount. In the case of optional mounting, the arm, post and mounting option need to be specified separately.

Mounting Information

Screen Mounting:
All Wishbone arms are compatible with the International VESA Standards adopted by most flat panel manufacturers.

Knoll and its dealers will not accept responsibility for mounting the flat panel to the arm. The end user's IT department must confirm VESA mounting compliance and mount the flat panel using the customer's own screws.

Please review the Wishbone Test Matrix on Knoll Exchange for comprehensive mounting guidance.

Grommet Mounting:
Please follow installation instructions closely. With Reff, it is important to pass monitor plugs through grommet mount cover while it is still loose. The Reff worksurface will limit space in the grommet cover opening once the post is fully installed and grounded plugs will not fit through. The clear passthrough with Reff after installation is 1 1/16" x 2 3/8".

pattern no.	list
WSH-ZOR-SA-PT-SV	\$384.

WSH-ZOR-SA-200-PT-K-SV	544.
-------------------------------	------

WSH-ZOR-SA-300-PT-K-SV	549.
-------------------------------	------

WSH-ZOR-SA-400-PT-K-SV	574.
-------------------------------	------



Construction

Products are constructed of die cast and extruded aluminum and glass reinforced acetal plastic. O ring is made of elastic polymer.

Wishbone line is patented in the United States.

Worksurface Support

CPU Holders

product	description	type	w	d	h
Adjustable Metal CPU Clamp 	<ul style="list-style-type: none"> Adjusts horizontally and vertically to fit virtually every CPU. Mounts vertically or horizontally. Rigid metal construction. Rubber bumpers holds CPU securely in place. Easy to install and remove. Mounts directly to underside of worksurface. Holds CPU fixed to one spot (for a sliding and rotating option specify track separately). Color - silver Maximum weight capacity = 55 lbs. 	Large size - Holds CPUs as big as 22" x 9 1/4" and as small as 12" x 5 1/2"	varies	5 1/2"	varies
		Small size - Holds CPUs as big as 18" x 5 1/2" and as small as 10" x 3 1/4"	varies	5 1/2"	varies
Optional Track	<ul style="list-style-type: none"> Mounts to underside of worksurface. Allows unit to slide forward from under the desk. Allows unit to rotate 360° for cable access. Track has stop. Cannot use lock when order track. 	Optional track for CPU clamps	4 1/3"	21 1/4"	
Optional Lock	<ul style="list-style-type: none"> Offers theft deterrence for fixed mounted adjustable metal CPU clamp. Not for use with optional track mount. 	For use with large size metal CPU clamp			
		For use with small size metal CPU clamp			
Adjustable Mobile CPU Trolley 	<ul style="list-style-type: none"> Adjusts to hold CPUs as wide as 9 3/8" and as narrow as 4". Holds CPUs at least 10 1/2" deep. Made of sturdy steel tubing. Includes four robust casters. Maximum weight capacity = 55 lbs. 		varies	10.23"	11.8"

Order Code

Example: **CLAM-CPU-02**

CLAM-T

CLAM-CPU-02 Large Clamp

CLAM-T

Slide and rotate track

Ordering Information

Specify:

1. Pattern number
2. Special track or lock if required

pattern no.	list price
CLAM-CPU-02	\$334.
CLAM-CPU-01	334.
CLAM-T	132.
CLAM-L-02	132.
CLAM-L-01	132.
CBS-MBL-CPU	254.

Construction

Clamp:

- Painted extruded aluminum.

Adjustable Mobile Trolley:

- Epoxy polyester-coated tubular steel.

Worksurface Support

Adjustable CPU Holders

product	description	w, min	w, max	d, min	d, max	h, min	h, max	wgt.
Adjustable vertical metal CPU holder 	<ul style="list-style-type: none"> • Adjusts to hold equipment 6" to 10" wide by 14" to 24" high • Hangs vertically from worksurface to maximize knee space. • Slides on track under worksurface for easy CPU access. • Ventilation holes on sides. • Has a weight capacity of 60 pounds. • Mounts on virtually any worksurface. • Swivel is 360°. • Track length is 17 3/4". 	7"	11"	18"	18"	15"	25"	24 lbs.

Adjustable vertical sling CPU holder 	<ul style="list-style-type: none"> • Adjusts to hold equipment 6" to 10" wide by 14" to 24" high. • Sling made of woven vinyl coated polyester for flexibility and ventilation. • Hangs vertically from worksurface to maximize knee space under surface. • Slides on track under worksurface for easy CPU access. • Has a weight capacity of 60 pounds. • Swivel is 360°. • Track length is 17 3/4". 	7"	11"	18"	18"	15"	25"	13 lbs.
--	--	----	-----	-----	-----	-----	-----	---------

Order Code	Ordering Information	Installation Notes	Construction
Example: OA-CPU-SLNG-V	<i>Specify:</i>	CPU holders come standard with a 17 3/4" long track. They mount on work surfaces 18 1/2" or deeper.	<i>Metal CPU holder:</i> Rigid 16-gauge painted steel construction. Black paint finish. Black plastic pull.
OA-CPU CPU holder	1. Pattern number		
SLNG Sling style			
V Vertical mounting option			
			<i>Sling CPU holder:</i> Black painted steel mounting mechanism. Woven vinyl coated polyester sling. Black plastic pull.

pattern no.

list price

OA-CPU-MTL-V

\$492.

OA-CPU-SLNG-V

300.

Custom Options

Longer and shorter track lengths are available. Contact Customer Service for pricing information.

Worksurface Support

Equipment Storage

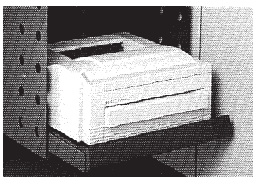
product	description	type	w	d	h	wgt.
Printer/Fax Drawer 	<ul style="list-style-type: none"> Stores equipment under worksurface, freeing space. Accommodates most printers and fax machines. Full extension drawer for easy equipment access. Ventilation holes on sides. Black painted steel. Mounts on virtually any wood worksurface. Weight capacity 135 lbs. Includes four type AB pan head 1/4-14 x 1 screws. 	Narrow (wt. limit 135 lbs.)	16 ³ / ₈ "	20 ³ / ₈ "	16 ⁵ / ₈ "	32 lbs.
		Wide (wt. limit 135 lbs.)	20 ³ / ₈ "	20 ³ / ₈ "	16 ⁵ / ₈ "	35 lbs.

Order Code	Ordering Information	Application Notes	Custom Options												
Example: OA-PFD-N OA-PFD-N Narrow printer/fax drawer	<i>Specify:</i> 1. Pattern number <i>Equipment note:</i> Each office equipment drawer is designed to accommodate the vast majority of products currently on the market. Specific interior dimensions: <table> <tr> <td></td> <td>w</td> <td>d</td> <td>h</td> </tr> <tr> <td>OA-PFD-N</td> <td>16¹/₈"</td> <td>20"</td> <td>12⁷/₈"</td> </tr> <tr> <td>OA-PFD-W</td> <td>20¹/₈"</td> <td>20"</td> <td>12⁷/₈"</td> </tr> </table>		w	d	h	OA-PFD-N	16 ¹ / ₈ "	20"	12 ⁷ / ₈ "	OA-PFD-W	20 ¹ / ₈ "	20"	12 ⁷ / ₈ "	<i>Printer/fax drawer:</i> Mounts on virtually any wood worksurface. Wide head key lock fasteners ensure stability. Mounts on 24" or deeper worksurface, with more than 3" wide clearance space in rear. For panel-flush applications, there is a 2 ¹ / ₈ " wide, 1/4" high bracket clearance on either side. For wider brackets, note that drawer worksurface connections are located 3 ¹ / ₂ " and 12" from front of drawer. For thicker brackets, use spacers when installing drawer.	Other widths and depths available. Minimum order of 25 units per line item. Contact your Knoll sales representative or Customer Service for pricing information.
	w	d	h												
OA-PFD-N	16 ¹ / ₈ "	20"	12 ⁷ / ₈ "												
OA-PFD-W	20 ¹ / ₈ "	20"	12 ⁷ / ₈ "												

pattern no.	list price
OA-PFD-N	\$549.
OA-PFD-W	565.

Construction

Rigid 16-gauge painted steel constructed. 2 1/4" high full width pull in black finish.

Accuride progressive metal slides on drawer. Rubber mat and 3/4" high rear metal lip prevent sliding. Perforated holes on side for ventilation.

All parts painted black.

Manufactured in the United States.

BackPack® Universal Storage Drawers

by Robert Reuter

suspended files

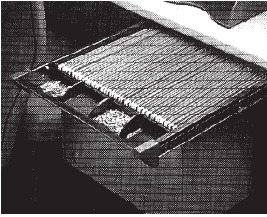
product	description	w	d	back/front h	wgt.
Standard Suspended File 	<ul style="list-style-type: none"> • Full width, 4³/₄" d 1³/₄"H pencil trough. • Two removable plastic organizing trays. • Generous 16"w 12"D filing space. • Accepts 16" side-to-side hanging letter files. • Accepts 12" front-to-back hanging legal or European A-4 and foolscap files. • Drawer contains 107% capacity of standard file drawer. • Optional lock. • Black painted steel construction with full extension ball-bearing slides. 	17"	18"	10 ¹ / ₂ "	16 lbs. 4 ozs.

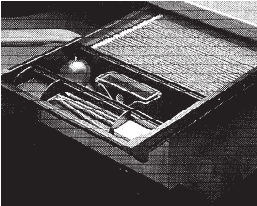
Deep Suspended File 	<ul style="list-style-type: none"> • Full width, 4³/₄" d 1³/₄"H pencil trough. • Two removable plastic organizing trays. • Full width, 5¹/₂" d 6"H intermediate compartment holds computer disks, desk supplies and personal items. • Generous 16"w 12"D filing space. • Accepts 16" side-to-side hanging letter files. • Accepts 12" front-to-back hanging legal or European A-4 and foolscap files. • Drawer contains 107% capacity of standard file drawer. • Optional lock and mouse pad. • Black painted steel construction with full extension ball-bearing slides. 	17"	24"	10 ¹ / ₂ "	18 lbs.
---	--	-----	-----	----------------------------------	---------

Order Code

Example: BP-SSF

BP-SSF Standard suspended file

Ordering Information

Specify:

1. Pattern number
2. Lock option

Lock option:

Lock attaches to slides in field.
Removable for use elsewhere.

Application Notes

BackPack drawers can be used with virtually any Knoll or other wood worksurface.

BackPack storage drawers attach to the underside of wood worksurfaces at any location. In most cases, the drawers may be mounted flush to side panels. When supporting brackets extend further than 2¹/₂" from the side panel, a slight reveal will occur. Mounting hardware and template included.

pattern no.

list price

BP-SSF

\$452.

BP-DSF

499.

Storage

For wire management needs, the minimum depth worksurface for standard depth drawers is 24"; minimum depth for deep drawers is 30". When no wire management is necessary, the Standard Suspended File may be used on an 18" worksurface and the Deep Suspended File may be used on a 24" worksurface.

Knee clearance:
In order to maximize filing capacity, the Standard and Deep Suspended Files do not provide adequate knee clearance. For center worksurface applications, specify the Keyboard or Center File Drawers.

Construction

Sturdy, 20-gauge painted steel with full-extension ball-bearing metal slides. Foam surface on mouse pad.
Die-cast zinc lock painted black.
Manufactured in the United States.

Design Awards

ROSCOE Award, *Interior Design Magazine*, 1994. Honorable Mention, Furniture, *ID Magazine Annual Design Review*, 1994.

BackPack® Universal Storage Drawers

by Robert Reuter

suspended files

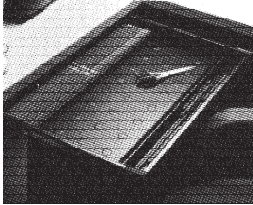
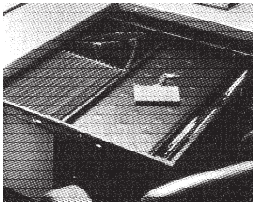
product	description	w	d	back/front h	wgt.
Standard Center File 	<ul style="list-style-type: none"> Includes 26"w 14"d 2"H storage for desk and personal items. Full width pencil trough and rear filing area. 3 1/2" deep filing area accepts 2 rows of front-to-back letter filing, or one row of front-to-back legal or European A-4/foolscap filing plus space for handbag. Drawer contains 57% capacity of standard file drawer. Optional lock. Black painted steel construction with full extension ball-bearing slides. 	27"	18"	11 1/8"/2"	16 lbs. 6 ozs.
Deep Center File 	<ul style="list-style-type: none"> Includes 26"w 14"d 2"H storage for desk and personal items Full width pencil trough and rear filing area. 9 1/2" deep filing area accepts 2 rows of front-to-back letter filing, or one row of front-to-back legal or European/foolscap filing plus space for handbag. Drawer contains 94% capacity of standard file drawer. Optional lock. Black painted steel construction with full extension ball-bearing slides. 	17" 27"	24" 24"	11 1/8"/2" 11 1/8"/2"	20 lbs. 13 ozs.
Optional Lock	<ul style="list-style-type: none"> Non-handed. 	1 1/4"	2 1/4"	1 1/4"	5 ozs.

Order Code

Example: BP-SSF
BP-SSF Standard suspended file

Ordering Information

Specify:
 1. Pattern number
 2. Lock option

Lock option:
 Lock attaches to slides in field.
 Removable for use elsewhere.

Application Notes

BackPack drawers can be used with virtually any Knoll or other wood worksurface.

BackPack storage drawers attach to the underside of wood worksurfaces at any location. In most cases, the drawers may be mounted flush to side panels. When supporting brackets extend further than 2 1/2" from the side panel, a slight reveal will occur. Mounting hardware and template included.

pattern no.	list price
BP-SCF	\$505.

BP-DCF-17	458.
BP-DCF	552.

BP-L	58.
-------------	-----

For wire management needs, the minimum depth worksurface for standard depth drawers is 24"; minimum depth for deep drawers is 30". When no wire management is necessary, the Standard Suspended File may be used on an 18" worksurface and the Deep Suspended File may be used on a 24" worksurface.

Knee clearance:
In order to maximize filing capacity, the Standard and Deep Suspended Files do not provide adequate knee clearance. For center worksurface applications, specify the Keyboard or Center File Drawers.

Construction

Sturdy, 20-gauge painted steel with full-extension ball-bearing metal slides. Foam surface on mouse pad.
Die-cast zinc lock painted black.
Manufactured in the United States.

Design Awards

ROSCOE Award, *Interior Design Magazine*, 1994. Honorable Mention, Furniture, *ID Magazine Annual Design Review*, 1994.

BackPack® Universal Storage Drawers

by Robert Reuter

keyboard drawers

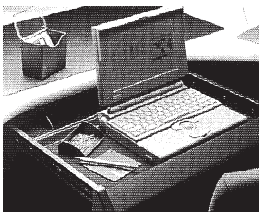
product	description	w	d	back/front h	wgt.
 <p>Narrow Keyboard Drawer</p>	<ul style="list-style-type: none"> • Accommodates virtually any standard keyboard or laptop computer. • Full width, 2³/₄"d³/₄"H integral palm rest. • 21¹/₄"w 9³/₈"D black padded keying space. • Full width rear pencil trough and 2 removable plastic organizing trays. • Thin profile maximizes knee clearance under drawer. • Optional lock. • Black painted steel construction. • Full extension ball-bearing slides, with click-stop in half open position for steady use. 	22 ¹ / ₂ "	18"	2"	8 lbs. 12 ozs.

 <p>Wide Keyboard Drawer with Mouse Pad</p>	<ul style="list-style-type: none"> • Accommodates virtually any standard keyboard or laptop computer. • Full width, 2³/₄"d³/₄"H integral palm rest. • Non-handed mouse pad, black foam with square corners 8" x 9". • 27¹/₄"w 9³/₈"D keying/mousing space. • Full width rear pencil trough and 4 removable plastic organizing trays. • Thin profile maximizes knee clearance under drawer. • Optional lock. • Black painted steel construction. • Full extension ball-bearing slides, with click-stop in half open position for steady use. 	25" 28 ¹ / ₂ "	18" 18"	2" 2"	10 lbs. 12 ozs.
---	--	---	------------	----------	-----------------

Order Code	Ordering Information	Application Notes
Example: BP-NKD-BK BP-NKD Narrow keyboard drawer BK Black palm rest	<i>Specify:</i> 1. Pattern number 2. Wrist rest finish 3. Lock option <i>Palm rest nylon finishes:</i> Black (BK)	Call Customer Service for availability and minimum requirement. <i>Lock option:</i> Lock attaches to slides in field. Removable for use elsewhere.

BackPack drawers can be used with virtually any Knoll or other wood worksurface.

pattern no.	list price
BP-NKD	\$401.

BP-WKD-25	417.
BP-WKD	431.

	Construction	Design Awards
<p>BackPack storage drawers attach 2$\frac{3}{8}$" below the underside of wood worksurfaces at any location. Mounting hardware and template included.</p> <p>For wire management needs, the minimum depth worksurface for the Narrow and Wide keyboard drawers is 24", and 30" for the Keyboard/Filing Drawer. When no wire management is necessary, both the Narrow and Wide Keyboard Drawers may be used on an 18" deep worksurface and the Keyboard/Filing Drawer may be used on a 24" deep worksurface.</p>	<p>Durable 20-gauge steel painted black. Full-extension ball-bearing metal slides with click-stop in half-open position. Nylon-sheathed foam palm rest.</p> <p>Die-cast zinc lock painted black.</p> <p>Manufactured in the United States.</p>	<p>ROSCOE Award, <i>Interior Design Magazine</i>, 1994. Honorable Mention, Furniture, <i>ID Magazine</i> Annual Design Review, 1994.</p>

BackPack® Universal Storage Drawers

by Robert Reuter

keyboard drawers

product	description	w	d	back/front h	wgt.
Keyboard/Filing Drawer 	<ul style="list-style-type: none"> Accommodates virtually any standard keyboard or laptop computer. Full width, 2 3/4" d 3/4" H integral palm rest. Non-handed mouse pad, black foam with square corners 8" x 9". 27 1/4" w 9 3/8" D keying/mousing space. 4 removable plastic organizing trays. 26 1/16" w 8" D filing space accepts 2 rows of front-to-back letter filing, or one row of front-to-back legal or European A4/foolscap filing. Optional lock. Black painted steel construction. Full extension ball-bearing slides, with click-stop in half open position for steady use. 	27 1/4"	24"	11 1/2"/2"	20 lbs. 7 ozs.
Optional Lock	<ul style="list-style-type: none"> Non-handed. 	1 1/4"	2 1/4"	1 1/4"	5 ozs.

Order Code

Example: **BP-NKD-BK**
BP-NKD Narrow keyboard drawer
BK Black palm rest

Ordering Information

Specify:

1. Pattern number
2. Wrist rest finish
3. Lock option

Palm rest nylon finishes:
 Black (BK)

Application Notes

Call Customer Service for availability and minimum requirement.

Lock option:
 Lock attaches to slides in field.
 Removable for use elsewhere.

BackPack drawers can be used with virtually any Knoll or other wood worksurface.

pattern no.

list price

BP-KFD

\$577.

BP-L

58.

Construction

BackPack storage drawers attach 2 $\frac{3}{8}$ " below the underside of wood worksurfaces at any location. Mounting hardware and template included.

For wire management needs, the minimum depth worksurface for the Narrow and Wide keyboard drawers is 24", and 30" for the Keyboard/Filing Drawer. When no wire management is necessary, both the Narrow and Wide Keyboard Drawers may be used on an 18" deep worksurface and the Keyboard/Filing Drawer may be used on a 24" deep worksurface.

Durable 20-gauge steel painted black. Full-extension ball-bearing metal slides with click-stop in half-open position. Nylon-sheathed foam palm rest.

Die-cast zinc lock painted black.
Manufactured in the United States.



Design Awards

ROSCOE Award, *Interior Design Magazine*, 1994. Honorable Mention, Furniture, *ID Magazine Annual Design Review*, 1994.

BackPack® Universal Storage Drawers

by Robert Reuter

pencil and top drawers

product	description	w	d	back/front h	wgt.
Pencil Drawer 	<ul style="list-style-type: none"> • 23" w 11 1/2" D paper storage. • Full width pencil trough. • Two removable plastic organizing trays. • Black painted steel construction with full extension ball-bearing slides. • Optional lock. 	24"	17 5/8"	2"	
Top Drawer 	<ul style="list-style-type: none"> • Full width, 4 3/4" d 1 3/4" H pencil trough. • Two removable plastic organizing trays. • 13" w 10" D filing space. • Black painted steel construction with full extension ball-bearing slides. • Optional lock. 	14 1/4"	18"	10 1/2"	
Optional Lock	<ul style="list-style-type: none"> • Non-handed. 	1 1/4"	2 1/4"	1 1/4"	5 ozs.

Order Code

Example: BP-PD

BP-PD Pencil drawer

BP-L Optional lock

Ordering Information

Specify:

1. Pattern number
2. Lock option

Lock option:

Lock attaches to slides in field.
Removable for use elsewhere.

Application Notes

BackPack drawers can be used with virtually any Knoll or other wood worksurface.

BackPack storage drawers attach to the underside of wood worksurfaces at any location. Mounting hardware and template included.

pattern no.	list price
BP-PD	\$194.
BP-TOP-C	411.
BP-L	58.

	Construction	Design Awards
For wire management needs, the minimum depth worksurface for standard depth drawers is 24"; minimum depth for deep drawers is 30". When no wire management is necessary, the Standard Center File may be used on an 18" worksurface and the Deep Center File may be used on a 24" worksurface.	<p>Sturdy 20-gauge painted steel with full extension ball-bearing metal slides.</p> <p>Die-cast zinc lock painted black.</p> <p>BackPack® Top Drawer Manufactured in the United States.</p> <p>BackPack® Pencil Drawer manufactured in Canada.</p>	<p>ROSCOE Award, <i>Interior Design Magazine</i>, 1994. Honorable Mention, Furniture, <i>ID Magazine</i> Annual Design Review, 1994.</p>

Universal Pencil Drawer

by Brooks Rorke

product	description	w	d	back/front h	wgt.
Universal Pencil Drawer 	<ul style="list-style-type: none"> • 7 roomy compartments. • Large rear compartment holds flat, legal files, ruler, etc. • Slanted card compartment holds index cards, Post-It™ Notes or business cards. • Middle compartment holds White-Out™ bottle or change. • Front middle compartment holds stapler, pens, scissors, etc. • Other compartments holds calculator, clips, pins, etc. • Available in textured matte black plastic. • Three-quarters extension, ball bearing metal slides with smooth, silent movement. 	16 1/2"	22 3/4"	1 3/4"	5 lbs. 12 ozs.

Order Code

Example: **ORCH-PD-A**
ORCH- Pencil drawer
PD-A

Ordering Information

Specify:
 1. Pattern number

Application Notes

Universal Pencil Drawer can be used with virtually any Knoll or competitor wood worksurface.
 Minimum depth worksurface for drawer is 24". On freestanding Morrison Network systems, a 30" deep worksurface is required.

pattern no.

list price

ORCH-PD-A\$193.



Construction

Universal pencil drawer:
Durable vacuum-formed ABS plastic drawer in a matte black, textured finish. Three-quarter extension, ball bearing metal slides with smooth, silent movement.

Manufactured in the United States.

Universal Marker Boards

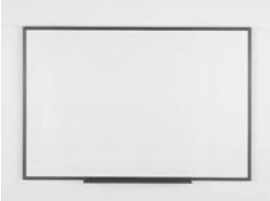
by Bruce Hannah & Ayse Birsel

product	description	w	d	h	wt.
Marker Board 	<ul style="list-style-type: none"> • 1/2" wide anodized aluminum frame with white surface. • Marker Tray option specified separately. • Mountable on load bar, panel, wall or top cap. • Load bar-mounted brackets included in list price, but specified separately (see Mounting Options below). 	24"	5/8"	18"	5 lbs. 2 ozs.
		30"	5/8"	18"	8 lbs. 10 ozs.
		30"	5/8"	24"	11 lbs. 7 ozs.
		36"	5/8"	18"	10 lbs. 5 ozs.
		36"	5/8"	24"	13 lbs. 12 ozs.
		42"	5/8"	24"	16 lbs. 1 oz.
		48"	5/8"	30"	22 lbs. 15 ozs.
Marker Board Equity panel-mount application 	<ul style="list-style-type: none"> • 1/2" wide anodized aluminum frame with white surface. • Marker Tray option specified separately. • Mountable on load bar, panel, wall or top cap. • Load bar-mounted brackets included in list price, but specified separately (see Mounting Options below). 	22 1/4"	5/8"	18"	5 lbs. 2 ozs.
		28 1/4"	5/8"	18"	8 lbs. 10 ozs.
		28 1/4"	5/8"	24"	11 lbs. 7 ozs.
		34 1/4"	5/8"	18"	10 lbs. 5 ozs.
		34 1/4"	5/8"	24"	13 lbs. 12 ozs.
		40 1/4"	5/8"	24"	16 lbs. 1 oz.
		40 1/4"	5/8"	30"	20 lbs. 1 oz.
46 1/4"	5/8"	30"	22 lbs. 15 ozs.		
Marker Tray 	<ul style="list-style-type: none"> • Anodized aluminum snap-fit tray for Marker Board markers and erasers. 	17"	1 1/4"		5 ozs.

Mounting Options	
	Load Bar-Mounted Brackets. Set of 2.
	Panel-Mounted Brackets (Generic deep)
	Panel-Mounted Brackets (Generic shallow)
	Panel-Mounted Brackets for Dividends
	Panel-Mounted Brackets for Equity
	Panel-Mounted Brackets for Morrison
	Panel-Mounted Brackets for Reff
	Top Cap-Mounted Brackets (Dividends only)
	Top Cap-Mounted Brackets (Equity only)
	Top Cap-Mounted Brackets (Reff only)
	Top Cap-Mounted Brackets. Set of 2. (Morrison only)
	Wall-Mounted Brackets. Set of 2.

* No charge when ordered with Marker or Tack Board

Order Code	Ordering Information		
Example: OR-WB-24-18-BK OR-WB-PM-M OR-WB-TR-BK	<i>Specify:</i> 1. Pattern number 2. Frame finish 3. Mounting option 4. System suffix (panel and top cap-mounted only) 5. Marker Tray (optional) 6. Marker Tray finish	<i>Mounting options:</i> Rail-Mounted: Standard option. Includes load bar clip and adhesive-backed rubber bumper to protect panel fabric and prevent deflection. Panel-Mounted: To ensure rigidity, specify two sets and brackets	Wall-Mounted: Specify pattern number. Top cap-mounted: Equity and Morrison Network Systems brackets available. Use bracket pattern numbers listed below: Equity E Morrison Network M
OR-WB-24-18	24" x 18" Marker board		
BK	Black frame		
OR-WB-PM	Panel-mounted		
M	Morrison Network		
OR-WB-TR	Marker tray		
BK	Black		
	Anodized finish: Black (BK) Silver (SV) * * *Please consult Customer Service for lead times.		

pattern no.	list price
OR-WB-24-18	\$192.
OR-WB-30-18	287.
OR-WB-30-24	324.
OR-WB-36-18	405.
OR-WB-36-24	450.
OR-WB-42-24	523.
OR-WB-42-30	582.
OR-WB-48-30	671.
OR-WB-22-18-E	192.
OR-WB-28-18-E	287.
OR-WB-28-24-E	324.
OR-WB-34-18-E	405.
OR-WB-34-24-E	450.
OR-WB-40-24-E	523.
OR-WB-40-30-E	582.
OR-WB-46-30-E	671.
OR-WB-TR	51.
OR-WB-LBZ *	7.
OR-WB-PM-B	21.
OR-WB-PM-D	21.
OR-WB-PM-DV	44.
OR-WB-PM-E	31.
OR-WB-PM-M	31.
OR-WB-PM-R	52.
OR-WB-TCM-DV *	7.
OR-WB-TCM-E *	7.
OR-WB-TCM-R *	7.
OR-WB-TCM-M *	7.
OR-WB-WM	34.

Equity application note:

For all Equity panel-mounted applications, add "E" to end of base pattern number.

Note:

If your system is not listed, contact your KnollExtra representative or Customer Service for appropriate panel-mounted bracket to specify.

Custom Options

Other writing surface and custom frame colors available. Custom frame sizes available up to 72"W x 48"D in size. High performance porcelain-covered steel market board also available. 25 unit minimum per line item on all customs. Contact your Knoll sales representative or Customer Service for pricing information.

Construction

Satin anodized aluminum frame (can be powder coated black). Porcelain coating on cold rolled steel laminated to corrugated and hardboard with a Mylar backing. All Universal Marker Boards are magnetized.

Manufactured in the United States.

Universal Fabric Boards

Standard Sizes

product	description	w	d	h	textile fabric yards
Fabric Boards 	<ul style="list-style-type: none"> Standard fabric board has 1/2" thick mineral board construction with squared corner. Rounded corner or radiused edge, available at upcharge. Panel or wall mounting options. 	24"	1/2"	14"	.66
		24"	1/2"	16"	.66
		24"	1/2"	18"	.66
		24"	1/2"	20"	.75
		24"	1/2"	24"	1
		30"	1/2"	14"	.66
		30"	1/2"	16"	.66
		30"	1/2"	18"	.66
		30"	1/2"	20"	.75
		30"	1/2"	24"	1
		36"	1/2"	14"	.66
		36"	1/2"	16"	.66
		36"	1/2"	18"	.66
		36"	1/2"	20"	.75
		36"	1/2"	24"	1
		42"	1/2"	14"	.66
42"	1/2"	16"	.66		

Order Code	Ordering Information	Mounting Options
Example: F-24-16-R2-A-30-W388/1 F-WM-F <hr/> F-24-16 24" x 16" Fabric board <hr/> R2 Rounded corner/radius edge detail <hr/> A Thickness <hr/> 30 Fabric grade 30 <hr/> W388/1 Freehand, Glacier <hr/> F-WM-F Wall-mounted, flush	<p><i>Specify:</i></p> <ol style="list-style-type: none"> Pattern number Corner/edge detail Thickness Fabric grade Fabric selection Mounting option pattern number System suffix (panel-mounted option only) <p><i>Equity application note:</i> For all Equity panel-mounted applications, add "E" to end of base pattern number.</p> <p><i>Corner/edge detail:</i> Squared corner/rectilinear edge (S1) Squared corner/radiused edge (S2) Rounded corner/radiused edge (R2)</p> <p>Standard fabric board has squared corner and rectilinear edge details. See page 160 for edge upcharge.</p> <p>Standard fabric board has 1/2" thick mineral board.</p>	<p><i>Panel-mounted brackets:</i> Panel-mounted brackets are included in the list price but must be specified separately. To specify appropriate panel-mounted bracket, consult the KnollExtra Bracket Chart on page 14.</p> <p>Panel mounted bracket size must match height of fabric board.</p> <p><i>Wall-mounted options:</i> Wall-mounted applications must be specified as flush (F-WM-F) or reveal (F-WM-R). Both options are appropriate for any smooth, clean surface. Flush wall-mount option utilizes velcro squares.</p> <p>Reveal wall-mount option provides 1/2" clearance for wire management behind fabric board. Fabric boards mount with 4 brackets onto 2 black painted wall rails that screw into wall to ensure rigidity. For other mounting options and pricing, contact Customer Service.</p> <p><i>Under overhead specification note:</i> For application under a system overhead, provide clearance distance between the worksurface and the bottom of the overhead or task light.</p> <p><i>Side by side fabric board specification note:</i> Please note if a panel-mounted fabric board will be used contiguous to another fabric board, drawings are required and there will be an up-charge.</p> <p><i>60" wide boards in fabric grades 50, 55 and 60:</i> Due to grades 50, 55 and 60 fabric widths being less than the width of a 60" board, contact your KnollExtra representative or Customer Service for pricing and fabric railroading information.</p>

pattern no.	10	COM 15	20	30	35	40	45/46	50	55	60
F-24-14-()-A-()()	\$259.	\$265.	\$296.	\$307.	\$310.	\$316.	\$326.	\$327.	\$345.	\$357.
F-24-16-()-A-()()	259.	265.	296.	307.	310.	316.	326.	327.	345.	357.
F-24-18-()-A-()()	277.	283.	305.	317.	319.	323.	334.	336.	354.	367.
F-24-20-()-A-()()	345.	349.	355.	369.	372.	376.	388.	391.	410.	424.
F-24-24-()-A-()()	387.	395.	436.	452.	457.	464.	480.	483.	510.	529.
F-30-14-()-A-()()	295.	300.	342.	350.	354.	358.	371.	372.	388.	401.
F-30-16-()-A-()()	303.	309.	348.	358.	361.	369.	378.	379.	399.	409.
F-30-18-()-A-()()	313.	318.	357.	370.	372.	376.	387.	388.	406.	420.
F-30-20-()-A-()()	390.	396.	425.	437.	441.	448.	459.	460.	480.	496.
F-30-24-()-A-()()	435.	444.	472.	488.	492.	501.	517.	518.	546.	564.
F-36-14-()-A-()()	303.	309.	357.	370.	372.	376.	387.	388.	406.	420.
F-36-16-()-A-()()	320.	326.	369.	376.	379.	384.	395.	396.	416.	427.
F-36-18-()-A-()()	329.	335.	375.	385.	388.	394.	405.	406.	423.	436.
F-36-20-()-A-()()	390.	396.	434.	447.	450.	454.	468.	469.	489.	503.
F-36-24-()-A-()()	459.	468.	525.	541.	545.	552.	569.	571.	598.	617.
F-42-14-()-A-()()	322.	327.	384.	395.	399.	404.	415.	416.	433.	445.
F-42-16-()-A-()()	347.	353.	391.	402.	405.	408.	420.	422.	438.	451.

Custom Options

For special sizes:
For specials contact Customer Service. Maximum fabric board size is 120"W x 24"H. Fabric must be railroaded on any panel wider than 60".

Customer's own material:
For approval, submit at least one yard of fabric for application testing. For panel-mounted applications, all COMs and textiles that are not pre-approved must be UL-tested. Please consult Knoll sales Customer Services for details.

Construction

1/2" thick mineral board for durable, highly tackable surface.
Manufactured in the United States.

Fabric Selection

<p><i>Grade 10</i> Bailey II Broadcloth Element Foundation Growth Spurt Newbury Solid Crepe Symbolic Details Tailor Made Taurus Versatility</p> <p><i>Grade 15</i> Fairfield Regency</p> <p><i>Grade 20</i> Banyan Bauhaus Block Circle Line Clarity Criss Cross Devon Melbourne Nematic</p>	<p><i>Grade 20 (cont.)</i> Outback Reflect Resolution Walkabout Weave Three</p> <p><i>Grade 30</i> Basket Draft Flow Harmony Interknit Match Point Micro Progression Progression Striae Promenade Raku Cloth Relay</p> <p><i>Grade 35</i> Saxony Plus</p>	<p><i>Grade 40</i> Analogy * Clarkson Foil Rap Hard Rock Heavy Metal Metaphor * Ornament Palladium Sierra</p> <p><i>Grade 45</i> Amplify Bandwidth Backdrop† Casual Elegance Dristi * Fast Forward† Macro Mezzo</p>	<p><i>Grade 50</i> Abacus * Bankshot * Chroma *‡ Extreme Velvet * Knoll Hopsack * Mariner *‡ Presto * Ricochet * Starry Night * Transit *‡</p>	<p><i>Grade 55</i> Field Day * Knoll Felt *</p> <p><i>Grade 60</i> Classic Boucle *‡</p> <p>† Not available with radiused edge. * Consult your Knoll sales representative or Customer Service for pricing on 60" wide boards. ‡ Available for wall mount only.</p> <p><i>Note:</i> As a general rule, all fabrics approved for a Morrison panel application are approved for KnollExtra fabric wrapped tack boards.</p>
--	---	---	--	---

Universal Fabric Boards

Standard Sizes

product	description	w	d	h	textile fabric yards
Fabric Boards 	<ul style="list-style-type: none"> Standard fabric board has 1/2" thick mineral board construction with squared corner. Rounded corner or radiused edge, available at upcharge. Panel or wall mounting options. 	42"	1/2"	18"	.66
		42"	1/2"	20"	.75
		42"	1/2"	24"	1
		48"	1/2"	14"	.66
		48"	1/2"	16"	.66
		48"	1/2"	18"	.66
		48"	1/2"	20"	.75
		48"	1/2"	24"	1
		60"	1/2"	14"	.66
		60"	1/2"	16"	.66
		60"	1/2"	18"	.66
		60"	1/2"	20"	.75
		60"	1/2"	24"	1

Order Code

Example:	F-24-16-R2-A-30-
	W388/1
	F-WM-F
F-24-16	24" x 16" Fabric board
R2	Rounded corner/radius edge detail
A	Thickness
30	Fabric grade 30
W388/1	Freehand, Glacier
F-WM-F	Wall-mounted, flush

Ordering Information

Specify:

1. Pattern number
2. Corner/edge detail
3. Thickness
4. Fabric grade
5. Fabric selection
6. Mounting option pattern number
7. System suffix (panel-mounted option only)

Equity application note:
For all Equity panel-mounted applications, add "E" to end of base pattern number.

Corner/edge detail:
Squared corner/rectilinear edge (S1)
Squared corner/radiused edge (S2)
Rounded corner/radiused edge (R2)

Standard fabric board has squared corner and rectilinear edge details. See page 160 for edge upcharge.

Standard fabric board has 1/2" thick mineral board.

Mounting Options

Panel-mounted brackets:
Panel-mounted brackets are included in the list price but must be specified separately. To specify appropriate panel-mounted bracket, consult the KnollExtra Bracket Chart on page 14.

Panel mounted bracket size must match height of fabric board.

Wall-mounted options:
Wall-mounted applications must be specified as flush (F-WM-F) or reveal (F-WM-R). Both options are appropriate for any smooth, clean surface. Flush wall-mount option utilizes velcro squares.

Reveal wall-mount option provides 1/2" clearance for wire management behind fabric board. Fabric boards mount with 4 brackets onto 2 black painted wall rails that screw into wall to ensure rigidity. For other mounting options and pricing, contact Customer Service.

Under overhead specification note:
For application under a system overhead, provide clearance distance between the worksurface and the bottom of the overhead or task light.

Side by side fabric board specification note:
Please note if a panel-mounted fabric board will be used contiguous to another fabric board, drawings are required and there will be an up-charge.

60" wide boards in fabric grades 50, 55 and 60:
Due to grades 50, 55 and 60 fabric widths being less than the width of a 60" board, contact your KnollExtra representative or Customer Service for pricing and fabric railroading information.

pattern no.	10	COM 15	20	30	35	40	45/46	50	55	60
F-42-18-(-)-A-(-)(-)(-)	\$347.	\$353.	\$410.	\$421.	\$423.	\$428.	\$438.	\$442.	\$459.	\$471.
F-42-20-(-)-A-(-)(-)(-)	444.	449.	487.	499.	502.	509.	521.	522.	542.	557.
F-42-24-(-)-A-(-)(-)(-)	539.	548.	597.	613.	617.	624.	642.	643.	671.	688.
F-48-14-(-)-A-(-)(-)(-)	329.	335.	393.	404.	406.	410.	422.	423.	442.	453.
F-48-16-(-)-A-(-)(-)(-)	347.	353.	410.	421.	423.	428.	438.	442.	459.	471.
F-48-18-(-)-A-(-)(-)(-)	356.	361.	410.	421.	423.	428.	438.	442.	459.	471.
F-48-20-(-)-A-(-)(-)(-)	444.	449.	487.	499.	502.	509.	521.	522.	542.	557.
F-48-24-(-)-A-(-)(-)(-)	549.	557.	683.	700.	703.	710.	728.	730.	757.	775.
F-60-14-(-)-A-(-)(-)(-)	418.	423.	498.	509.	511.	517.	528.	n/a	n/a	n/a
F-60-16-(-)-A-(-)(-)(-)	427.	432.	508.	518.	521.	526.	537.	n/a	n/a	n/a
F-60-18-(-)-A-(-)(-)(-)	452.	458.	519.	530.	532.	538.	549.	n/a	n/a	n/a
F-60-20-(-)-A-(-)(-)(-)	484.	491.	541.	552.	555.	561.	572.	n/a	n/a	n/a
F-60-24-(-)-A-(-)(-)(-)	549.	557.	683.	700.	703.	710.	728.	n/a	n/a	n/a

Custom Options*For special sizes:*

For specials contact Customer Service. Maximum fabric board size is 120"W x 24"H. Fabric must be railroaded on any panel wider than 60".

Customer's own material:

For approval, submit at least one yard of fabric for application testing. For panel-mounted applications, all COMs and textiles that are not pre-approved must be UL-tested. Please consult Knoll sales Customer Services for details.

Construction

1/2" thick mineral board for durable, highly tackable surface.

Manufactured in the United States.

Fabric Selection*Grade 10*

Bailey II
Broadcloth
Element
Foundation
Growth Spurt
Newbury
Solid Crepe
Symbolic
Details
Tailor Made
Taurus
Versatility

Grade 15

Fairfield
Regency

Grade 20

Banyan
Bauhaus
Block
Circle Line
Clarity
Criss Cross
Devon
Melbourne
Nematic

Grade 20 (cont.)

Outback
Reflect
Resolution
Walkabout
Weave Three

Grade 30

Basket Draft
Flow
Harmony
Interknit
Match Point
Micro
Progression
Progression
Striae
Promenade
Raku Cloth
Relay

Grade 35

Saxony Plus

Grade 40

Analogy *
Clarkson
Foil Rap
Hard Rock
Heavy Metal
Metaphor *
Ornament
Palladium
Sierra

Grade 45

Amplify
Bandwidth
Backdrop†
Casual
Elegance
Dristi *
Fast
Forward†
Macro
Mezzo

Grade 50

Abacus *
Bankshot *
Chroma *‡
Extreme
Velvet *
Knoll
Hopsack *
Mariner *‡
Presto *
Ricochet *
Starry Night *
Transit *‡

Grade 55

Field Day *
Knoll Felt *

Grade 60

Classic
Boucle *‡

† Not available with radiused edge.
* Consult your Knoll sales representative or Customer Service for pricing on 60" wide boards.
‡ Available for wall mount only.

Note:

As a general rule, all fabrics approved for a Morrison panel application are approved for KnollExtra fabric wrapped tack boards.

Universal Fabric Boards

Options and Mounting Information

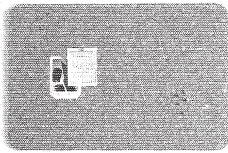
product	description	application	w	d	h
Fabric Boards	Mounting Options	1/2" Reveal Wall-Mounted			
		Flush Wall-Mounted (No charge when ordered with fabric board)			
		Panel-Mounted Dividends (No charge when ordered with fabric board)			
		Panel-Mounted Equity (No charge when ordered with fabric board)			
		Panel-Mounted Morrison (No charge when ordered with fabric board)			
		Panel-Mounted Reff (No charge when ordered with fabric board)			
		Edge Detail	Rounded corner/radiused edge (add -R2 to end of fabric board pattern number)		
		Squared corner/radiused edge (add -S2 to end of fabric board pattern number)			
		Squared corner/rectilinear edge (add -S1 to end of fabric board pattern number)			
		<ul style="list-style-type: none"> • Standard fabric board has 1/2" thick mineral board construction with squ • Rounded corner or radiused edge option available at upcharge. • Panel or wall mounting options. 			

Order Code	Ordering Information	Mounting Options
Example: F-60-14-S1-A-40-W337/4 F-PM-R-14	<i>Specify:</i>	<i>Panel-mounted brackets:</i>
F-60-14 60" x 14" fabric board	1. Pattern number	Panel-mounted brackets are included in the list price but must be specified separately. To specify appropriate panel-mounted bracket, consult the Knoll sales bracket chart on page 12.
S1 Squared corner/rectilinear edge	2. Corner/edge detail	
A Thickness	3. Fabric grade	Panel mounted bracket size must match height of fabric board.
40 Fabric grade	4. Fabric selection	<i>Wall-mounted options:</i>
W337/4 Sennit, Olivine	5. Mounting option pattern number	Wall-mounted applications must be specified as flush (F-WM-F) or reveal (F-WM-R). Both options are appropriate for any smooth, clean surface.
F-PM Panel-mounted	6. System suffix (panel-mounted option only)	Flush wall-mount option utilizes velcro squares.
R Reff	<i>Equity application note:</i>	
14 14" Fabric board bracket	For all Equity panel-mounted applications, add "E" to end of base pattern number.	
	<i>Corner/edge detail:</i>	
	Squared corner/rectilinear edge (S1)	
	Squared corner/radiused edge (S2)	
	Rounded corner/radiused edge (R2)	

pattern no.	list price
F-WM-R-(14, 16, 18, 20 or 24)	\$104.
F-WM-F-(24, 30, 36, 42, 48, 60)- (14, 16, 18, 20 or 24)	31.
F-PM-D-(14, 16, 18, 20 or 24)	40.
F-PM-E-(14, 16, 18, 20 or 24)	40.
F-PM-M-(14, 16, 18, 20 or 24)	40.
F-PM-R-(14, 16, 18, 20 or 24)	40.
R2	31.
S2	31.
S1	n/c

Under overhead specification note:
For application under a system overhead, provide clearance distance between the worksurface and the bottom of the overhead or task light.

Side by side fabric board specification note:
Please note if a panel-mounted fabric board will be used contiguous to another fabric board drawings are required and there will be an up-charge.

Construction

1/2" thick mineral board for durable, highly tackable surface.

Custom Options

For special sizes:
Refer to the standard size scope. Locate the standard fabric board size which is equal to or greater in width and depth than the requested special. Add 10% to the standard list price. Note "special" when ordering. For specials above 60"W x 24"H, contact Customer Service. Maximum fabric board size is 120"W x 24"H. Fabric must be railroaded on any panel wider than 60".

Customer's own material:
For approval, submit at least one yard of fabric for application testing. For panel-mounted applications, all COMs and textiles that are not pre-approved must be UL-tested. Please consult Knoll sales Customer Service for details.

Corner/Edge Detail

S1. Squared corner/Rectilinear edge

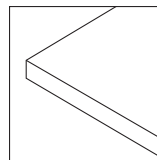

R2. Rounded corner/Radiused edge

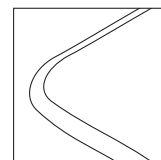

S2. Squared corner/Radiused edge

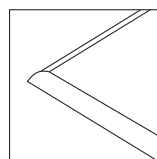

Universal Fabric Boards

Top Cap Hung Marker Board

product	description	application	w	d	h
Top Cap Hung Marker Board	<ul style="list-style-type: none"> • Incorporates erasable surface. • Includes tray for markers and erasers. 		30"	3"	36"
	Mounting Option	Wall Rail			









Order Code	Ordering Information	Mounting Options	Construction
Example: PR MB 3036 PR MB Top Cap Hung Marker 3036 Board	<i>Specify:</i> 1. Pattern number	<p><i>Top cap hung marker board:</i> Marker boards hang from top of systems panels between .375" and 2.5" inches wide.</p> <p>Reveal wall-mount option provides 1/2" clearance for wire management behind fabric board. Fabric boards mount with 4 brackets onto 2 black painted wall rails that screw into wall to ensure rigidity. For other mounting options and pricing, consult Customer Service.</p>	<p><i>Top cap hung marker board:</i> White laminate surface on Sintra core. Extruded aluminum trough.</p> <p>Manufactured in the United States.</p> <p><i>Wall Rail:</i> Machined aluminum powder coated light grey to match top cap hung marker board trough.</p>

pattern no.	list price
PR-MB-3036	\$700.
PR-MB-WM-Rail	31.

Copeland™ Light

by Stephan Copeland

product	description	
Standard Arm  <p>Shown with base</p>	<ul style="list-style-type: none"> • Standard Arm. • 15 watt compact fluorescent bulb (equivalent of 75 watt incandescent bulb). • Mounting option must be ordered separately. • 20.75" h x 21.75" w (at 90° angle) • Reaches height fo 29.75" when extended up and depth of 35.75" when extended out. 	
Compact Arm  <p>Shown with base</p>	<ul style="list-style-type: none"> • Compact Arm. • 13 watt compact fluorescent bulb (equivalent of 60 watt incandescent bulb). • Mounting option must be ordered separately. • 16.25" h x 17.75" w (at 90° angle) • Reaches height of 23.5" when extended up and depth of 28.75" when extended out. 	
Replacement bulb	<ul style="list-style-type: none"> • Compact light replacement 13 watt bulb • Compact light replacement 15 watt bulb 	
Mounting Options	Standard base <ul style="list-style-type: none"> • Standard base. • To be used with standard arm only 	
	Compact base <ul style="list-style-type: none"> • Compact base • To be used with compact arm only 	
	Table clamp <ul style="list-style-type: none"> • To be used with either size arm. • Works on desks of up to 1 3/4" thick. 	
	Panel Mount, Morrison <ul style="list-style-type: none"> • Panel mount bracket for Morrison. • To be used with either size arm 	







Order Code	Ordering Information	Light Bulb Information
Example: COPE-01-SV, COPE-01-BASE-SV COPE-01-SV Copeland light standard arm in silver COPE-01-BASE-SV Copeland standard base in silver	Specify: 1. Pattern number for arm 2. Finish for arm 3. Mounting option pattern number 4. Mounting option finish	Standard Light: <ul style="list-style-type: none"> • Ships with a 15 watt compact fluorescent light bulb. This is equivalent light output of a 75 watt incandescent light bulb. • An incandescent light bulb can also be used. 75 watt is the maximum. • See above for bulb replacement.

pattern no.	list price
COPE-01-()	\$181.
COPE-02-()	169.
COPE02BULB	13.
COPE01BULB	13.
COPE-01-BASE-()	99.
COPE-02-BASE-()	92.
COPE-CLMP-()	55.
COPE-PM-M-()	82.

	Construction	Design Awards
<p>Compact Light:</p> <ul style="list-style-type: none"> • Ships with a 13 watt compact fluorescent light bulb. This is equivalent light output of a 60 watt incandescent light bulb. • A “ceiling fan” incandescent bulb can also be used. 60 watt is the maximum. 	<p>The Copeland Light has a steel arm, aluminum axles, zinc coated cast iron base and metallic-painted ABS shade.</p>	<p>Best of NeoCon 2005, Silver Award</p>

Copeland™ Light

by Stephan Copeland



product	description
Mounting Options	Panel Mount, Equity <ul style="list-style-type: none"> • Panel mount bracket for Equity. • To be used with either size arm 
	Panel Mount, Reff <ul style="list-style-type: none"> • Panel mount bracket for Reff. • To be used with either size arm 
	Panel Mount, Dividends <ul style="list-style-type: none"> • Panel mount bracket for Dividends. • To be used with either size arm 
	Crinion Open Table, Mount <ul style="list-style-type: none"> • Crinion Open Table center spine mount . • To be used with either size arm 
	Grommet Mount <ul style="list-style-type: none"> • To be used with either size arm 
	<ul style="list-style-type: none"> • Slat wall mount. • To be used with either size arm • Can be used on all Knoll systems slat wall as well as Orchestra® slat boards and load bars. 

Order Code	Ordering Information	Light Bulb Information
Example: COPE-01-SV,COPE-01-BASE-SV COPE-01-SV Copeland light standard arm in silver COPE-01-BASE-SV Copeland standard base in silver	<i>Specify:</i> <ol style="list-style-type: none"> 1. Pattern number for arm 2. Finish for arm 3. Mounting option pattern number 4. Mounting option finish 	<i>Finish Options:</i> Silver (SV) Black (111)
		Standard Light: <ul style="list-style-type: none"> • Ships with a 15 watt compact fluorescent light bulb. This is equivalent light output of a 75 watt incandescent light bulb. • An incandescent light bulb can also be used. 75 watt is the maximum. • See above for bulb replacement.

pattern no.	list price
COPE-PM-E-()	\$82.
COPE-PM-R-()	82.
COPE-PM-D-()	82.
COPE-COTCS	65.
COPE-GRMT-()	99.
COPE-SLT-()	82.

	Construction	Design Awards
<p>Compact Light:</p> <ul style="list-style-type: none"> • Ships with a 13 watt compact fluorescent light bulb. This is equivalent light output of a 60 watt incandescent light bulb. • A “ceiling fan” incandescent bulb can also be used. 60 watt is the maximum. 	<p>The Copeland Light has a steel arm, aluminum axles, zinc coated cast iron base and metallic-painted ABS shade.</p>	<p>Best of NeoCon 2005, Silver Award</p>

Tolomeo Light Fixtures by Artemide®

product	description	type	dia	w	d	h	wgt.
 Tolomeo Standard <i>Shown with 9" base</i>	<ul style="list-style-type: none"> Fully adjustable arm. Incandescent or compact fluorescent bulbs can be used (bulb not included). UL listed. 		Diffuser - 5 3/4" dia.	1/4"	1"	25" min. - 54 1/2" max	3 lbs. 8 oz.
 Tolomeo Mini <i>Shown with 8" base</i>	<ul style="list-style-type: none"> 20% smaller fixture than standard Tolomeo. Fully adjustable arm. Incandescent or compact fluorescent bulbs can be used (bulb not included). UL listed. 		Diffuser - 5 3/4" dia.	1/4"	1"	21" min. - 40 1/2" max	3 lbs. 8 oz.
 Tolomeo VDT <i>Shown with 8" base</i>	<ul style="list-style-type: none"> Special diffuser for lighting video display terminal work areas. Fully adjustable arm. Mounted on the Tolomeo Mini arm. Fluorescent lamping (bulb not included). UL listed. 		Diffuser - 10 1/2" x 2 1/2" x 1 1/4"	1/4"	1"	32" min. - 44 1/4" max	3 lbs. 8 oz.
Standard, Mini, and VDT Mounting Options	Slat wall/load bar bracket			4 1/4"	3"	2"	11 oz.
	Fixed table mount - Mounts to virtually any worksurface up to 2 1/2" thick. Requires hole drilled in field.		1 3/8" dia.			5"	
	Table clamp - Can be clamped to the edge of or in the grommet hole of virtually any worksurface up to 2" thick.		2 1/4" dia.			4 1/2"	
	8" table base for use with Mini and VDT Tolomeo fixtures. See finish note below.		8" dia.			5/8"	7 lbs.
	9" table base for use with the Tolomeo std. fixture. See finish note below.		9" dia.			5/8"	8 lbs.
	Panel mount bracket (mid run). Universal.		4"	3 1/2"	3"		10 oz.
	Panel mount bracket (mid run). For Dividends.		4"	3 1/2"	3"		10 oz.

Order Code

Example:	ART-TOL-MIN-BK ART-BASE8-AL
ART-TOL-MIN	Tolomeo Mini Fixture
BK	Black finish
ART-BASE8	8" Table base
AL	Aluminum base finish

Ordering Information

- Specify:*
1. Pattern number
 2. Finish
 3. Mounting option
 4. Mounting finish (Table bases ART-BASE9 and ART-BASE8 only)

- Lamp information:*
- Incandescent
Requires one 100W (max.) bulb
 - INC
 - Fluorescent
Requires one 13W bulb
 - FLU PL-S 13W
 - Micro
Requires one 60W bulb. G-16 1/2 (2") 120V.

- Table base finishes:*
- Polished aluminum (AL)
 - Black (BK)

- Fixture body finishes:*
- Polished aluminum (AL)
 - Black (BK)

pattern no.	list price
ART-TOL-STD-(AL,BK)	\$441.
ART-TOL-MIN-(AL,BK)	419.
ART-TOL-VDT-(AL,BK)	545.
ART-TABC-MP-BK	79.
ART-TABF-MTAL	79.
ART-TABC-MTAL	92.
ART-BASE8-(AL,BK)	231.
ART-BASE9-(AL,BK)	252.
ART-BKT-PMM-BK	102.
ART-BKT-PMM-BK-D	102.

Construction

Arm:
Articulated arm body structure in extruded aluminum. Finished in high polished anodized finish.

Joints and tension control knobs:
Polished die-cast aluminum.

Tension cables:
Stainless steel.

Mini and standard diffusers:
Stamped anodized matte aluminum, rotating 360° on lampholder with incorporated on/off switch. Black, red and grey blue diffusers will have white painted interiors.

VDT diffusers:
Plastic, color to match arm. Rotates 360° on lampholder with incorporated on/off switch.

Brackets:
Table clamp: High polished die-cast aluminum

Slat wall/load bar bracket: Black die-cast aluminum

Panel mount (mid-run and corner):
Black die-cast aluminum

Fixed table mount: High polished die-cast aluminum

Crown mount: Black plastic

Tolomeo Light Fixtures by Artemide®

product	description	type	dia	w	d	h	wt.	
Standard, Mini, and VDT Mounting Options	Panel mount bracket (mid run). For Ref.			4"	3 1/2"	3"	10 oz.	
 Tolomeo Micro	<ul style="list-style-type: none"> • Small scale version of the classic. • Fully adjustable arm. • Incandescent lamping (1 bulb included). • UL listed. • On/Off switch on cord. • Available in aluminum finish. 	Arm only	Diffuser -					
			4 3/8" dia.					
		Arm With table base		1/4"	3/4"	15" min. - 28" max	1 lb.	
		Load bar mount bracket for Micro fixture						
Panel mount bracket for Micro fixture		Base -					3 lbs.	
		6 1/2" dia. 1/4" h						

Order Code

Example:	ART-TOL-MIN-BK ART-BASE8-AL
ART-TOL-MIN	Tolomeo Mini Fixture
BK	Black finish
ART-BASE8	8" Table base
AL	Aluminum base finish

Ordering Information

- Specify:*
1. Pattern number
 2. Finish
 3. Mounting option
 4. Mounting finish (Table bases ART-BASE9 and ART-BASE8 only)

Lamp information:
 Incandescent
 Requires one 100W (max.) bulb
 INC
 Fluorescent
 Requires one 13W bulb
 FLU PL-S 13W
 Micro
 Requires one 60W bulb. G-16 1/2 (2") 120V.

Table base finishes:
 Polished aluminum (AL)
 Black (BK)

Fixture body finishes:
 Polished aluminum (AL)
 Black (BK)

pattern no.	list price
ART-BKT-PMM-BK-R	\$102.
ART-TOL-MCR-AL-NB	391.
ART-TOL-MCR-AL	511.
ART-TOL-MCR-LBZ-BK	79.
ART-TOL-MCR-PMM-BK	102.

Construction

Arm:
Articulated arm body structure in extruded aluminum. Finished in high polished anodized finish.

Joints and tension control knobs:
Polished die-cast aluminum.

Tension cables:
Stainless steel.

Mini and standard diffusers:
Stamped anodized matte aluminum, rotating 360° on lampholder with incorporated on/off switch. Black, red and grey blue diffusers will have white painted interiors.

VDT diffusers:
Plastic, color to match arm. Rotates 360° on lampholder with incorporated on/off switch.

Brackets:
Table clamp: High polished die-cast aluminum

Slat wall/load bar bracket: Black die-cast aluminum

Panel mount (mid-run and corner):
Black die-cast aluminum

Fixed table mount: High polished die-cast aluminum

Crown mount: Black plastic

Little Dipper and Big Dipper Lighting System

product	description	w	d	h	wgt.	bulb type	watts
Big Dipper 	<ul style="list-style-type: none"> • 34" arm reach. • 18 watt fluorescent tube that provides output equivalent to an ordinary 100 watt lamp. • Applicable on virtually all systems. • Four joints easily adjust lamp to needs of user. • Shade adjusts to minimize glare and eyestrain. • Matte black plastic. • UL-listed. 	34"	3"	2"	3 lbs. 4 ozs.	Fluorescent	PL18

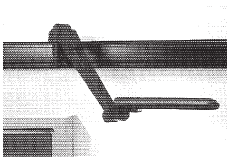
Little Dipper 	<ul style="list-style-type: none"> • 19" arm reach. • 18 watt fluorescent tube that provides output equivalent to an ordinary 100 watt lamp. • Applicable on virtually all systems. • Three joints easily adjust lamp to needs of user. • Shade adjusts to minimize glare and eyestrain. • Matte black plastic. • UL-listed. 	19"	3"	2"	2 lbs. 8 ozs.	Fluorescent	PL18
--	---	-----	----	----	---------------	-------------	------

Mounting Options	Desk-Mounted Bracket	3"	1 1/4"	3 3/4"	6 ozs.		
	Freestanding Weighted Base	8"	6 1/4"	2"	14 lbs.		
	Load bar mount						
	Load Bar-Mounted Bracket	4 1/4"	2"	3"	11 ozs.		
	Panel-Mounted Bracket - Mid-run	4"	3"	3 1/2"	10 ozs.		
	Panel-Mounted Bracket for Dividends	4"	3"	3 1/2"	10 ozs.		
	Panel-Mounted Bracket for Reff - Mid Run	4"	3"	3 1/2"	10 ozs.		
Wall-Mounted Bracket	3 1/4"	2 1/2"	2 1/2"	12 ozs.			

Order Code

Example: **ORCH-BD**
ORCH-D-PMC

ORCH-BD Big Dipper

ORCH-D- Panel-mounted bracket,
PMC corner

Ordering Information

Specify:

1. Pattern number
2. Mounting option pattern number

Mounting bracket:

To specify appropriate panel-mounting brackets consult the KnollExtra Bracket Chart on page 14.

pattern no.	list price
ORCH-BD	\$465.
<hr/>	
ORCH-LD	433.
<hr/>	
ORCH-D-DM	30.
ORCH-D-BASE	126.
ART-TOL-BELLA-LBZ-BK	70.
ORCH-D-LBZ	80.
ORCH-D-PMM	103.
ORCH-D-PMMD	103.
ORCH-D-PMR	129.
ORCH-D-WM	30.

Construction

Constructed of fingerprint-resistant matte black plastic. 3"W x 12"D x 2"H arched shade includes full-length reflector to distribute light evenly over work area. Compact 18-watt fluorescent tube offers light output equivalent to an ordinary 100-watt lamp, and provides approximately 10,000 hours of light. 7 foot black cord.

Manufactured in Taiwan, Republic of China.

Desktop Lamp

By John Rizzi and Brooks Rorke

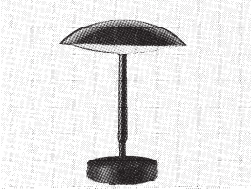
product	description	watts	w	d	h	wgt.	bulb type
Desktop Lamp 	<ul style="list-style-type: none"> • Freestanding. • Available in halogen or fluorescent. • Adjustable height extends to 19 1/2". • Dual intensity switch on halogen model. • Base, shaft and shade in black only. • UL-listed. 	22 watt, T5 circular 120V, 60 HZ, 3200K	11 1/2"	11 1/2"	15 1/4"	5 lbs. 11 ozs.	F
		50 watt, G8 120V, 60HZ Dimmable to 30 watt.	11 1/2"	11 1/2"	15 1/4"	5 lbs. 11 ozs.	H
Replacement bulb	<ul style="list-style-type: none"> • Fluorescent • Halogen 						

Order Code

Example: **ORCH-DES-H-BK**

ORCH-DES Desktop lamp

H Halogen bulb

BK Black shade

Ordering Information

Lamp, specify:

1. Pattern number
2. Bulb type

Bulb type:

Halogen (H)
Fluorescent (F)

Shade:

Black (BK)

pattern no.	list price
ORCH-DES-F	\$203.
ORCH-DES-H	192.
ORCH-DESF-BULB	10.
ORCH-DESH-BULB	10.

Construction

The weighted base is constructed of molded ABS plastic. Vertical posts are durable black aluminum. Covers are heat resistant polycarbonate. Halogen models feature dual intensity switch for 30/50 watt output. UL-listed.

Design Award

Furniture/Lighting Gold Award, IDSA/IDEA, 1992; Silver Award, IBD Product Design Competition, 1990.

Wire Management Spine

by Colebrook Bosson Saunders

product	description	w	d	h	wgt.
Cable Manager	<ul style="list-style-type: none"> • Cable Management Spine • Guides cable from underside of worksurface to floor. • Has four compartments to separate power, data, and voice cable. • Easy access to cables - no tools required. • Color - Black 			29.13"	

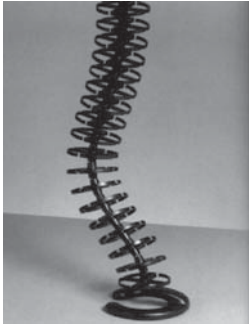

Order Code	Ordering Information	Construction
Example: CBS-WM-4CL CBS-WM-4CL Cable Manager	<i>Specify:</i> 1. Pattern number	Plastic spine with cast iron base.

pattern no.

list price

CBS-WM-4CL

\$266.

Alpha-Numeric Index

<i>pattern no.</i>	<i>page</i>	<i>pattern no.</i>	<i>page</i>	<i>pattern no.</i>	<i>page</i>	<i>pattern no.</i>	<i>page</i>
001-214	38	3612-3	36	COPE-PM-R	170	OAK-A2-P-2-SS2-BK-PT-(16,18,22,23,25)	114
001-315	38	3612-4	36	COPE-SLT	170	OA-K-EL2-MS-(16,18,22,23,25)	110
012-1	20	3613	36	EFM-IVYU	50	OA-K-MS	110
012-2	20	3614	36	F-24-14	160	OAK-OTK-MP	116
012-3	20	3615	32	F-24-16	160	OA-K-PR-EL2-BK-(16,18,22,23,25)	108
012-4	20	3633	32	F-24-18	160	OA-K-PR-EL2-BK-PT-(16,18,22,23,25)	108
050	22	3643	34	F-24-20	160	OA-K-PR-SL2-BK-(16,18,22,23,25)	108
055-BO	22	3645	34	F-24-24	160	OA-K-PR-SL2-BK-PT-(16,18,22,23,25)	108
1-2600	50	3650	36	F-30-14	160	OA-K-PR-SS2-BK-(16,18,22,23,25)	108
1-2601	50	4B2-MP	116	F-30-16	160	OA-K-PR-SS2-BK-PT-(16,18,22,23,25)	108
1-2602	50	4B2-MP-MS	116	F-30-18	160	OAK-RJ-EL2-BK-(16,18,22,23,25)	106
1901	16	4B2-MP-WR	106	F-30-20	160	OAK-RJ-EL2-BK-PT-(16,18,22,23,25)	106
1901-2	16	4B2-WR	116	F-30-24	160	OAK-RJ-SL2-BK-(16,18,22,23,25)	106
1901-3	16	512-20	20, 30, 36	F-36-14	160	OAK-RJ-SL2-BK-PT-(16,18,22,23,25)	106
1905	18	ART-BASE8-(AL,BK)	172	F-36-16	160	OAK-RJ-SS2-BK-(16,18,22,23,25)	106
1906	18	ART-BASE9-(AL,BK)	172	F-36-18	160	OAK-RJ-SS2-BK-PT-(16,18,22,23,25)	106
1912-20	20, 30, 36	ART-BKT-PMM-BK	172	F-36-20	160	OA-K-SS2-MS-(16,18,22,23,25)	110
1912-30	20	ART-BKT-PMM-BK-D	172	F-36-24	160	OA-PFD-N	144
1912-31	20	ART-BKT-PMM-BK-R	174	F-42-14	160	OA-PFD-W	144
1912-32	20	ART-TABC-MP-BK	172	F-42-16	160	OA-SLV(A,B,C)-(E, J)	120
1912-40	20	ART-TABC-MTAL	172	F-42-18	162	OA-SLV(A,B,C)-(GS, BS)	120
1912-41	20	ART-TABF-MTAL	172	F-42-20	162	OR-BKT-PM-B	76
1912-42	20	ART-TOL-BELLA-LBZ-BK	176	F-42-24	162	OR-BKT-PM-CE	76
1915	18	ART-TOL-MCR-AL	174	F-48-14	162	OR-BKT-PM-CS	76
1916	18	ART-TOL-MCR-AL-NB	174	F-48-16	162	OR-BKT-PM-D	76
2020-020	40	ART-TOL-MCR-LBZ-BK	174	F-48-18	162	OR-BKT-PM-DS	76
2020-032	40	ART-TOL-MCR-PMM-BK	174	F-48-20	162	OR-BKT-PM-DV	76
2020-035	40	ART-TOL-MIN-(AL,BK)	172	F-48-24	162	OR-BKT-PM-E	76
2020-038	40	ART-TOL-STD-(AL,BK)	172	F-60-14	162	OR-BKT-PM-ES	76
2020-150	40	ART-TOL-VDT-(AL,BK)	172	F-60-16	162	OR-BKT-PM-M	76
250	22	BP-DCF	148	F-60-18	162	OR-BKT-PM-N	76
255	22	BP-DCF-17	148	F-60-20	162	OR-BKT-PM-R	76
256	22	BP-DSF	146	F-60-24	162	OR-BKT-PM-A	76
2ORCH-F-LT	54	BP-KFD	152	F-PM-D-(14, 16, 18, 20 or 24)	164	OR-BKT-WM	76
2ORCH-S-LGT	56	BP-L	148, 152, 154	F-PM-E-(14, 16, 18, 20 or 24)	164	ORCH-BD	176
2ORCH-S-LT	54	BP-NKD	150	F-PM-M-(14, 16, 18, 20 or 24)	164	ORCH-BDN	58
3030-095	40	BP-PD	154	F-PM-R-(14, 16, 18, 20 or 24)	164	ORCH-CCH	64
3030-120	40	BP-SCF	148	F-WM-F-(24, 30, 36, 42, 48, 60)- (14, 16, 18, 20 or 24)	164	ORCH-D-BASE	176
3030-160	40	BP-SSF	146	F-WM-R-(14, 16, 18, 20 or 24)	164	ORCH-D-DM	176
3031-200	40	BP-TOP-C	154	OA-CPU-MTL-V	142	ORCH-DES-F	178
3031-600	40	BP-WKD	150	OA-CPU-SLNG-V	142	ORCH-DES-F-BULB	178
3301	24	BP-WKD-25	150	OA-FR-BK	120	ORCH-DES-H	178
3301-2	24	CBS-MBL-CPU	140	OAK-A1-W/P-EL2-BK-(16,18,22,23,25)	112	ORCH-DES-H-BULB	178
3304	28	CBS-WM-4CL	180	OAK-A1-W/P-EL2-BK-PT-(16,18,22,23,25)	112	ORCH-D-LBZ	176
3305	26	CLAM-CPU-01	140	OAK-A1-W/P-SL2-BK-(16,18,22,23,25)	112	ORCH-DP	66
3312-3	30	CLAM-CPU-02	140	OAK-A1-W/P-SL2-BK-PT-(16,18,22,23,25)	112	ORCH-D-PMM	176
3312-4	30	CLAM-L-01	140	OAK-A1-W/P-SS2-BK-(16,18,22,23,25)	112	ORCH-D-PMMD	176
3313	30	CLAM-L-02	140	OAK-A1-W/P-SS2-BK-PT-(16,18,22,23,25)	112	ORCH-D-PMR	176
3314	30	CLAM-T	140	OAK-A1-W/P-SS2-BK-PT-(16,18,22,23,25)	112	ORCH-D-WM	176
3315	26	COPE-01	168	OAK-A2-P-1-EL2-BK-(16,18,22,23,25)	114	ORCH-F-LT	54
3319-4	26	COPE-01-BASE	168	OAK-A2-P-1-EL2-BK-PT-(16,18,22,23,25)	114	ORCH-FS	58
3319-4-LN	26	COPE01BULB	168	OAK-A2-P-1-SL2-BK-(16,18,22,23,25)	114	ORCH-HFH	60
3333	24	COPE-02	168	OAK-A2-P-1-SL2-BK-PT-(16,18,22,23,25)	114	ORCH-LD	176
3343	26	COPE-02-BASE	168	OAK-A2-P-1-SS2-BK-(16,18,22,23,25)	114	ORCH-MT	62
3345	26	COPE02BULB	168	OAK-A2-P-1-SS2-BK-PT-(16,18,22,23,25)	114	ORCH-PC	60
3350	30	COPE-CLMP	168	OAK-A2-P-2-EL2-BK-(16,18,22,23,25)	114	ORCH-PD-A	156
3370 (4" x 6")	28	COPE-COTCS	170	OAK-A2-P-2-EL2-BK-PT-(16,18,22,23,25)	114	ORCH-PF-LD	78
3371 (5" x 7")	28	COPE-GRMT	170	OAK-A2-P-2-SL2-BK-(16,18,22,23,25)	114	ORCH-PF-LG	78
3601	32	COPE-PM-D	170	OAK-A2-P-2-SL2-BK-PT-(16,18,22,23,25)	114	ORCH-PF-LT	78
3604	32	COPE-PM-E	170	OAK-A2-P-2-SS2-BK-(16,18,22,23,25)	114	ORCH-PF-SD	78
3605	32	COPE-PM-M	168			ORCH-SB	56

<i>pattern no.</i>	<i>page</i>	<i>pattern no.</i>	<i>page</i>	<i>pattern no.</i>	<i>page</i>	<i>pattern no.</i>	<i>page</i>
ORCH-S-LGT	54	OR-SL-06-36-N2-())	72	OR-WB-46-30-E	158	SAP WL DIR	100
ORCH-S-LT	54	OR-SL-06-36-())	72	OR-WB-48-30	158	SAP WL MST	100
ORCH-SSD	58	OR-SL-06-42-ES-())	72	OR-WB-LBZ	158	SF-LS	118
ORCH-TD	62	OR-SL-06-42-EY-())	72	OR-WB-PM-B	158	SF-SB-(E, J)	118
ORCH-TS-UNI	64	OR-SL-06-42-N2-())	72	OR-WB-PM-D	158	SF-SB-(CS, BS)	118
ORCH-UT	60	OR-SL-06-42-())	72	OR-WB-PM-DV	158	SF-WR-FS-(BK)-G	118
ORCH-VAS	64	OR-SL-06-45-())	72	OR-WB-PM-E	158	STL-01-2	44
ORCH-VPP	58	OR-SL-06-48-ES-())	72	OR-WB-PM-M	158	STL-014-2	44
ORCH-WBK	66	OR-SL-06-48-EY-())	72	OR-WB-PM-R	158	STL-015-1	44
ORCH-WBK-R-EB	66	OR-SL-06-48-N2-())	72	OR-WB-TCM-DV	158	STL-019-1	44
OR-LBI-24-EY-())	70	OR-SL-06-48-())	72	OR-WB-TCM-E	158	STL-04-2	44
OR-LBI-24-N2-())	68	OR-SL-06-54-EY-())	72	OR-WB-TCM-M	158	STL-05-1	44
OR-LBI-24-())	68	OR-SL-06-54-N2-())	72	OR-WB-TCM-R	158	STL-06-2	44
OR-LBI-30-C-())	68	OR-SL-06-54-())	72	OR-WB-TR	158	STL-06-3	44
OR-LBI-30-ES-())	70	OR-SL-06-60-ES-())	72	OR-WB-WM	158	STL-10	48
OR-LBI-30-EY-())	70	OR-SL-06-60-EY-())	72	PR-MB-3036	166	STL-1000	42
OR-LBI-30-N2-())	68	OR-SL-06-60-N2-())	72	PR-MB-WM-Rail	166	STL-11	48
OR-LBI-30-())	68	OR-SL-06-60-())	72	R2	164	STL-1100	42
OR-LBI-35-())	68	OR-SL-06-66-EY-())	72	S1	164	STL-13	48
OR-LBI-36-CS-())	68	OR-SL-06-66-N2-())	72	S2	164	STL-15	48
OR-LBI-36-C-())	68	OR-SL-06-66-())	72	SAP CLMP	100	STL-2004	42
OR-LBI-36-DV-())	68	OR-SL-06-72-ES-())	72	SAP D BKT	92	STL-486	46
OR-LBI-36-ES-())	70	OR-SL-06-72-EY-())	72	SAP FTM	100	STL-9	48
OR-LBI-36-EY-())	70	OR-SL-06-72-N2-())	72	SAP GRMT	100	STL-900	42
OR-LBI-36-N2-())	68	OR-SL-06-72-())	72	SAP MA D CLMP K	84	STL-900-1	52
OR-LBI-36-())	68	OR-SL-14-24-EY-())	74	SAP MA D FTM K	84	STL-900-2	52
OR-LBI-42-DV-())	68	OR-SL-14-24-())	74	SAP MA D GRMT K	84	STL-900-3	52
OR-LBI-42-ES-())	70	OR-SL-14-30-ES-())	74	SAP MA D SW MST 12 K	86	STL-915	42
OR-LBI-42-EY-())	70	OR-SL-14-30-EY-())	74	SAP MA D SW MST 16 K	84	WSH-02-MP	126
OR-LBI-42-N2-())	68	OR-SL-14-30-())	74	SAP MA D SW MST 8 K	86	WSH-02-PT	126
OR-LBI-42-())	68	OR-SL-14-35-())	74	SAP MA D WL MST 12 K	86	WSH-02-TB	126
OR-LBI-45-())	68	OR-SL-14-36-ES-())	74	SAP MA D WL MST 16 K	84	WSH-03-PT	128
OR-LBI-48-CS-())	68	OR-SL-14-36-EY-())	74	SAP MA D WL MST 8 K	86	WSH-03-SW	128
OR-LBI-48-C-())	68	OR-SL-14-36-())	74	SAP MA S	92	WSH-03-TB	128
OR-LBI-48-DV-())	68	OR-SL-14-42-ES-())	74	SAP MA S CLMP K	80	WSH-200-PT-CLP-O-SV	130
OR-LBI-48-ES-())	70	OR-SL-14-42-EY-())	74	SAP MA S FTM K	80	WSH-300-PT-CLP-O-SV	130
OR-LBI-48-EY-())	70	OR-SL-14-42-())	74	SAP MA S GRMT K	80	WSH-B2B-SV	134
OR-LBI-48-N2-())	68	OR-SL-14-45-())	74	SAP MA S SW MST 12 K	82	WSH-CLMP-SV	132
OR-LBI-48-())	68	OR-SL-14-48-ES-())	74	SAP MA S SW MST 16 K	80	WSH-CLMP-TM-SV	132
OR-LBI-54-EY-())	70	OR-SL-14-48-EY-())	74	SAP MA S SW MST 8 K	82	WSH-FPB-CCM	132
OR-LBI-54-N2-())	68	OR-SL-14-48-())	74	SAP MA S WL MST 12 K	82	WSH-FPB-CSL	132
OR-LBI-54-())	68	OR-SL-14-54-EY-())	74	SAP MA S WL MST 16 K	80	WSH-FPB-WM	134
OR-LBI-60-DV-())	68	OR-SL-14-54-())	74	SAP MA S WL MST 8 K	82	WSH-GRMT-SV	134
OR-LBI-60-ES-())	70	OR-SL-14-60-ES-())	74	SAP MA SL	94	WSH-MP-SV	134
OR-LBI-60-EY-())	70	OR-SL-14-60-EY-())	74	SAP MA T CLMP K	88	WSH-PMFR-BK	132
OR-LBI-60-N2-())	68	OR-SL-14-60-())	74	SAP MA T FTM K	88	WSH-PTB-37	130
OR-LBI-60-())	68	OR-SL-14-66-EY-())	74	SAP MA T GRMT K	88	WSH-PTB-45	130
OR-LBI-66-EY-())	70	OR-SL-14-66-())	74	SAP MA T SW MST 12 K	90	WSH-PTB-61	130
OR-LBI-66-N2-())	68	OR-SL-14-72-ES-())	74	SAP MA T SW MST 16 K	88	WSH-PT-CLP-O-SV	130
OR-LBI-66-())	68	OR-SL-14-72-EY-())	74	SAP MA T SW MST 8 K	90	WSH-PTM-75-SV	132
OR-LBI-72-DV-())	68	OR-SL-14-72-())	74	SAP MA T WL MST 12 K	90	WSH-ROT-300-PT-SR-K-SV	136
OR-LBI-72-ES-())	70	OR-WB-22-18-E	158	SAP MA T WL MST 16 K	88	WSH-ROT-400-PT-SR-K-SV	136
OR-LBI-72-EY-())	70	OR-WB-24-18	158	SAP MA T WL MST 8 K	90	WSH-ROT-PT-SR-SV	136
OR-LBI-72-N2-())	68	OR-WB-28-18-E	158	SAP MA TD	92	WSH-SA-B2B-PT-SV	124
OR-LBI-72-())	68	OR-WB-28-24-E	158	SAP MJ	94	WSH-SA-K-SV	122
OR-SL-06-24-EY-())	72	OR-WB-30-18	158	SAP MST 12	96	WSH-SA-MP-SV	122
OR-SL-06-24-N2-())	72	OR-WB-30-24	158	SAP MST 16	96	WSH-SA-SV	122
OR-SL-06-24-())	72	OR-WB-34-18-E	158	SAP MST 24	96	WSH-SA-TB	124
OR-SL-06-30-ES-())	72	OR-WB-34-24-E	158	SAP MST 32	96	WSH-TBP-BRKT	132
OR-SL-06-30-EY-())	72	OR-WB-36-18	158	SAP MST 8	96	WSH-XP-200-SV	130
OR-SL-06-30-N2-())	72	OR-WB-36-24	158	SAP MST CM	98	WSH-XP-300-SV	130
OR-SL-06-30-())	72	OR-WB-40-24-E	158	SAP MST KNB	98	WSH-XP-CLP-O-SV	130
OR-SL-06-35-())	72	OR-WB-40-30-E	158	SAP SW DIR	100	WSH-ZOR-SA-200-PT-K-SV	138
OR-SL-06-36-ES-())	72	OR-WB-42-24	158	SAP SW MST	100	WSH-ZOR-SA-300-PT-K-SV	138
OR-SL-06-36-EY-())	72	OR-WB-42-30	158	SAP T BKT	92	WSH-ZOR-SA-400-PT-K-SV	138

<i>pattern no.</i>	<i>page</i>
WSH-ZOR-SA-PT-SV	138

Selling Policy

	<p>This Selling Policy supercedes all previous selling policies. Prices, discounts and product offerings are subject to change without notice.</p>
Terms & Conditions of Sales	<p>Sales by Knoll, Inc. or Knoll North America Corp. ("Seller") of Knoll Product Lines (hereinafter "Products") within the United States and Canada are made only on the terms which are contained in this Selling Policy. Seller hereby gives notice of its objection to any different or additional terms and conditions. This sale is expressly conditional upon Purchaser's assent to the terms and conditions set forth below. Additional terms and conditions may apply to KnollStudio and KnollTextiles orders. These terms and conditions may be modified or supplemented only by a written document signed by an authorized representative of Seller. These terms and conditions supercede any prior and/or contemporaneous agreements or correspondence between Purchaser and Seller. Written quotations expire thirty (30) days from the date of issuance and can be withdrawn by written notice anytime during that period. Where Purchaser and Seller have entered into the Knoll Electronic Terms and Conditions, all orders, acknowledgements, invoices and other business communications placed or transmitted in accordance with the Knoll Electronic Terms and Conditions shall be deemed to be in writing and signed and shall be valid for all purposes as if they were originated and maintained in documentary form.</p>
Ordering Information	<p>All orders must be in writing. The product pattern number(s) contained on Seller's order acknowledgement shall be the final expression of the order.</p>
Order Confirmation	<p>A purchase order is not binding on Seller until Purchaser has received Seller's order confirmation or acknowledgment.</p>
Pricing Policies	<p>List prices are subject to change without notice.</p> <p>List prices shall be those prices in effect on the date of receipt of a complete purchase order unless shipment is requested more than ninety (90) days after order entry in which case prices in effect on the date of shipment apply. List prices include specified freight costs. Unless specified in writing by Seller, no other charges are included in Seller's list prices.</p>
Taxes	<p>All sales, use, excise and other taxes applicable to the sale of the Products shall be paid by Purchaser. If Purchaser claims an exemption from any tax, Purchaser shall submit to Seller the appropriate exemption certificates.</p>
Terms of Payment	<p>Payment for one hundred percent (100%) of the net order amount is due within thirty (30) days of the date of invoice, which is issued upon shipment. In case of any discrepancies, such as shortages, and Seller is notified in writing within ten (10) days of receipt of Product, only that portion may be deducted and the balance paid. For orders greater than \$100,000 net, a fifty percent (50%) deposit is due at the time of order placement, with the remainder due within thirty (30) days of the date of invoice.</p> <p>KnollStudio orders less than \$2,000 require payment for one hundred percent (100%) of the net order amount (including any applicable sales tax and charges for inside delivery, special packaging, etc.), due at time of order placement. For KnollStudio orders greater than \$2,000, a one-half (50%) deposit is due at time of order placement with the remainder (including any applicable sales tax and charges for inside delivery, special packaging, etc.) due prior to shipment.</p> <p>If, in the judgment of Seller, Purchaser's financial condition does not justify the terms of the payment, Seller may require full or partial payment in advance.</p> <p>Past due accounts shall be charged one and one-half percent (1.5%) per month, or the highest rate permitted by law, whichever is less, and will be added to the outstanding balance. In the event Purchaser defaults on payment, Purchaser shall be liable for all collection costs, including reasonable attorney's fees and costs.</p>
Changes and Cancellation	<p>Purchase orders may not be changed or cancelled, in whole or in part, without prior written consent of Seller. Changes may effect delivery dates. Expenses incurred because of changes shall be charged to Purchaser. In the event of cancellations, Purchaser will be liable for reasonable cancellation charges established by Seller. Orders for special Product, orders including "COM" (hereinafter defined) material and orders pursuant to expedited delivery programs, may not be canceled.</p>
Freight Prepaid	<p>Freight is prepaid and included in the price of all Products, except KnollTextiles, within the 48 contiguous United States for orders placed with Knoll, Inc. and within Canada, excluding the Yukon, Northwest Territories, Nunavut and Newfoundland for orders placed with Knoll North America Corp. Packing is tested for rigorous motion and transportation but is not guaranteed to protect furniture from conditions over which the Seller has no control. If special packaging is required for any reason, please consult with your sales representative or dealer. Seller shall select the method of shipment and routing. All shipments shall be tailgate deliveries. Freight for all KnollTextiles orders is prepaid and added to the invoice.</p>
Delivery/Freight Charges	<p>Shipments outside the contiguous 48 United States and Canada shall be shipped F.O.B. Origin.</p> <p>For shipments outside the contiguous United States and Canada, Purchaser is responsible for the cost of freight from point of embarkation, including any handling and transportation charges incidental to loading at the point of departure and unloading at the final destination.</p> <p>Conditions beyond the control of Seller, including weather, available facilities and traffic conditions, may affect exact time of delivery. Seller shall not be responsible for specific carrier delivery date or time unless it has made a specific delivery commitment, in writing.</p> <p>Nonstandard methods of shipment and/or additional services are available upon request. Purchaser will be billed for the differential cost of any special services in excess of standard surface carrier freight costs. Premium charges, at Purchaser's request, will be added for airfreight, exclusive use of vehicle and extra, export or special packaging. Accessorial charges will be added for inside delivery, extra labor, reassignment and redelivery.</p> <p>Partial shipments may be made and invoiced by Seller.</p>
Claims	<p>All shipments for all Knoll Products within the contiguous United States and Canada are F.O.B. Origin. Risk of loss passes to Purchaser at time of delivery to carrier. Purchaser shall inspect all Products upon receipt and notify Seller within ten (10) working days after receipt of any damage or defects which are, or should be, apparent from an inspection of the Product and its packaging. Failure of Purchaser to make a claim against carrier or notify Seller during the ten (10) working day period shall constitute acceptance of the Products and waiver of any apparent defects, errors or shortages. Seller will agree to repair or replace Product damaged in shipment if Purchaser has notified Seller of freight damage within ten (10) working days after receipt and assigns its rights against the carrier.</p>
Seller's Security Interest	<p>Until Seller receives the full payment for the Product, Seller shall have a security interest in the Product. Purchaser agrees to perform all acts, including but not limited to the execution and filing of documentation, which may be necessary to perfect and assure the security interest of Seller.</p>
Returns	<p>The return of Products without a written authorization by Seller shall not be accepted. To receive authorization for Product return, please call Customer Service. All Products that are returned pursuant to a valid authorization shall be subject to a twenty-five percent (25%) of list restocking charge. Products not currently offered for sale by Seller (including COM) shall not be authorized for return. All returned Products must be unused, in original condition and in the original Seller packing cartons. No refund or credit shall be given for damaged Products.</p>
Held Orders/Storage	<p>If Purchaser requests that an order be held or delayed, prices and terms and conditions in effect at the time of shipment shall apply. If Purchaser requests a delay after the time when Seller can defer production, Purchaser will be invoiced for the Product, payable in accordance with standard terms, when the order is ready for shipment. Seller may transfer the Product to storage, in which case all expenses incurred in connection with storage, including demurrage, preparation for storage, storage charges and handling shall be payable by Purchaser upon submission of invoices by Seller. Risk of loss to the Product shall pass to the Purchaser upon delivery of the Product into storage.</p>

Selling Policy

Customer's Own Material	A Purchaser who requests a fabric or other surface material not standard to Seller's line of Products ("COM") must submit samples of the requested material to Seller prior to entry of a purchaser order. Seller shall determine if the material is suitable to its manufacturing processes and meets any requirements of Underwriters Laboratories. If the COM is acceptable, Seller will then establish a price for using the COM or the Product in question. For a description of the procedures for submitting samples and testing, contact customer resources or your sales representative. Seller shall have no responsibility for the appearance, condition, performance, durability, colorfastness or any other physical attribute of the COM. Purchaser shall indemnify and hold Seller harmless for any damages, injuries or losses arising out of or related to use of the COM on the Product.
Warranty	<p>Seller warrants to the original Purchaser only that the Products Seller manufactures and sells to Purchaser are free of defects in workmanship and materials, during the applicable warranty period set forth below.</p> <p>Warranty period set forth below is for 24-hour, 7 days a week, multi shift use.</p> <p>Should any failure to conform with this limited warranty appear to a Product listed below during the applicable warranty period from the date of shipment, Seller shall, upon prompt written notice, repair or replace, at its option and costs, the affected part or parts.</p> <p><i>Product and Period of Warranty</i></p> <p><i>Lifetime: AutoStrada, Calibre, Crinion Open Table, Currents, Dividends Horizon, Equity, Morrison, Reff laminate, Series 2 Storage, Template and other non-wood components (except cascade edge worksurfaces, operational parts, controls, electrical, Series 2 Veneer Front Storage, special or custom products, see below)</i></p> <p><i>10 Years: AutoStrada, Crinion Open Table, Reff wood components, Series 2 Veneer Front Storage, Wood Casegoods (Magnusson, The Graham Collection), Interaction tables (except height adjustment mechanisms for Counterforce, crank-adjustable, and split-top tables and worksurfaces, see below), Reuter overheads, Reuter vertical storage, Bulldog, Chadwick, Essentials Work Chairs, Generation by Knoll, Life, Moment, RPM and Sapper seating structural and operational parts, controls, casters, pneumatic cylinders, seat and back suspension material (except seating upholstery, finishes and labor, wood casegoods upholstered surfaces, see below)</i></p> <p><i>5 Years: Operational parts, controls, electrical (except light ballasts and bulbs, see below), cascade edge worksurfaces, special or custom product, wood veneer products, Currents handcrank, Interaction Counterforce, Interaction crank-adjustable, and split-top mechanisms, KnollStudio, KnollExtra adjustable keyboard supports, VDT carousel, monitor support, equipment storage drawers and all universal storage drawers.</i></p> <p><i>3 Years: Upholstery, finishes and labor to repair the following chairs: Bulldog, Chadwick, Essentials Work Chairs, Generation by Knoll, Life, Moment, RPM, and Sapper.</i></p> <p><i>2 Years: All other KnollExtra product</i></p> <p><i>1 Year: Light ballasts and bulbs, seating upholstered armpads and soft armpads, wood casegoods upholstered surfaces.</i></p> <p>This warranty does not apply to:</p> <ul style="list-style-type: none">• Damage caused by a carrier other than the Seller.• Normal wear and tear or acts or omissions of parties other than Seller (including user modification).• COM or other third party materials applied to Products.• Products not installed by or under the auspices of a certified dealer of Seller.• Dramatic temperature variations or exposure to unusual conditions.• Except as specifically noted above, textiles and upholstery supplied by <i>KnollTextiles</i> (consult current <i>KnollTextiles</i> price list for applicable warranty). <p>Natural variations occurring in wood, marble, and leather shall not be considered defects, and the Seller does not guarantee the colorfastness or matching of the colors, grains or textures, or surface hardness of such materials. The Seller also does not guarantee the colorfastness of fiberglass panel surfaces. THE EXPRESS WARRANTIES CONTAINED HEREIN ARE IN LIEU OF ALL OTHER WARRANTIES, EXPRESS OR IMPLIED, INCLUDING ANY WARRANTIES OF MERCHANTABILITY AND FITNESS FOR PARTICULAR PURPOSE AND ALL OTHER WARRANTIES ARISING FROM COURSE OF DEALING OR USAGE OF TRADE.</p> <p>The remedies provided above are the Purchaser's sole remedies for any failure of Seller to comply with its obligations regarding the workmanship of its Products. Correction of any nonconformity in the manner and for the period of time provided shall constitute complete fulfillment of all liabilities of Seller, with respect to or arising out of the Product furnished hereunder.</p>
Delay/Force Majeure	Seller shall not be liable for failure to perform or for delay in performance due to fire, flood, strike or other labor difficulty, act of God, act of any governmental authority or of the Purchaser, riot, embargo, fuel or energy shortage, wrecks or delay in transportation, inability to obtain necessary labor, materials or manufacturing facilities from usual sources or failure of suppliers to meet their contractual obligations, or due to any cause beyond its reasonable control. If any such event occurs, Seller may extend delivery dates by a period of time necessary to overcome the effect of such delay, allocate available Product or cancel any purchase order.
Compliance with Law	PURCHASER IS SOLELY RESPONSIBLE FOR COMPLIANCE WITH ALL APPLICABLE FEDERAL, STATE AND LOCAL LAWS, ORDINANCES, REGULATIONS, RULES AND STANDARDS RELATING TO THE INSTALLATION, MAINTENANCE, USE AND OPERATION OF THE PRODUCTS.
Patents	<p>Subject to the following provisions, Seller shall, at its own expense, defend or, at its option, settle any claim, suit or proceeding brought against the Purchaser, and/or its vendees, mediate and immediate, so far as based on an allegation that any Product or any part thereof furnished hereunder constitutes a direct or a contributory infringement of any claim of any patent of the United States or Canada. This obligation shall be effective only if Purchaser shall have made all payments then due hereunder and if Seller is notified promptly in writing and given authority, information and assistance for the defense of said claim, suit or proceeding. Seller shall pay all damages and costs awarded in such suit or proceedings so defended.</p> <p>The foregoing indemnity does not apply to the following:</p> <ul style="list-style-type: none">• Products supplied according to a design other than that of Seller, and which is required by the Purchaser.• Combination of the Product with another product not furnished hereunder unless Seller is a contributory infringer.• Any settlements of a suit or proceeding made without Seller's written consent.
Limitations of Liability	SELLER, ITS CONTRACTORS, AUTHORIZED DEALERS AND SUBCONTRACTORS OR SUPPLIERS OF ANY TIER SHALL NOT BE LIABLE TO PURCHASER FOR ANY SPECIAL, INDIRECT, INCIDENTAL OR CONSEQUENTIAL DAMAGES ARISING FROM A BREACH OF THIS AGREEMENT.
	Purchaser's remedies set forth herein are exclusive and the liability of Seller with respect to the breach of this agreement or any contract entered into between the parties pursuant hereto shall not exceed the price of the Product or part on which such liability is based.

General Ordering Information

The Products

This guide encompasses all standard products for this product group.

Sizes

Dimensions listed in this guide are indicated as:

H = height

W = width

D = depth

Dia. = diameter

Rad. = radius

Pricing

All prices shown are list.

How to Order

Select pattern numbers and quantities required for your complete installation. Product questions can be addressed in the specific sections of this guide or by contacting your sales representative or customer resource representative at 1-800-343-5665.

Next, select options (if required), along with colors and finishes appropriate to each product. Reference the Finishes and Fabrics pages for color designations.

On large installations, an item's "designated area" can be specified to assist in product organization and handling.

To expedite complete / correct entry of your order, be certain all pattern numbers, quantities, colors and area identifications are completely specified. Also, include complete purchase order numbers, bill-to and ship-to addresses, a contact name and specific factory shipping dates required.

Mail all orders to:

Knoll, Inc.

1235 Water Street

East Greenville, PA 18041

Attention: Order Entry

Once your order is entered at Knoll, an acknowledgment will be mailed to you. You will be advised of your scheduled shipping date within five days of the original acknowledgment. If it is necessary to revise your order, please contact your customer resource representative.

Sustainability Statement

Sustainable design is a key component of Knoll's environmental focus. Our commitment to social responsibility and a healthy environment has prompted us to further articulate our longstanding environmental programs and, with encouragement and support from our colleagues in the industry, we have re-energized our focus on such "green" initiatives as life cycle analysis and LEED™ certification. Knoll is proud to have contributed to projects that have received LEED certification from the U.S. Green Building Council.

For the latest information on Knoll products that help our customers achieve LEED certification, log on to knoll.com, click on "About Knoll" and then "Environmental Focus."