

Introduction	Knoll and Sustainable Design	3
	Knoll Color Program Finishes	4
	Dividends Legacy Finishes	6
	Dividends Horizon Fabrics	7
Planning Guidelines	Panel Specifications	8
Panels, Pre-Configured	Monolithic Panels	14
	Tiled Panels	22
	Beltway Panels	40
Panels, Build-To-Spec	Topway and Full View Panel Frame Assemblies	46
	Stack Frames	52
	Monolithic Panel Fabric Inserts	56
	Monolithic Laminate Inserts	60
	Tiled Fabric Inserts	66
	Tiled Laminate Inserts	70
	Beltway Inserts	74
	High Acoustic Core Inserts	78
	Window Insert Kits	80
	Markerboard Tiles	82
	Steel Insert Kits	86
	Slatwall Tiles	94
	Technology Tiles	96
	Rolling Door	100
	Open Weave and Glass Screens	102
Open Weave and Glass Stacking Screens	110	
Frameless Add Up	116	
Post Connectors/End Trim	Dividends Horizon DP7 Post Assemblies	120
	Dividends Horizon DP7 Post Components	122
	Legacy Post Assemblies	128
	Legacy Post Components	130
	Panel End Trim and Panel Top Caps	134
	Panel Wall Starter, Panel-to-Panel Top Cap Transition	140
	Wall Mount Tracks and Components	142
	Panel Rigidizer Brackets, Coat Hooks and Reveal Fillers	146
Alternative Planning	Concealed Post	150
	120° Planning	170
Electrical/Data Components	Electrical Specifications	178
	Base Raceway Electrical	181
	Receptacles	186
	Vertical Electrical	188
	Desktop Power and Data Modules	192
	Beltway Electrical	194
	Electrical Infeeds and Power Poles	198
	New York City, San Francisco and Chicago Electrical	202
Cable Management	206	
Storage Components	Flip-Up Door Overheads	210
	Sliding Door Overheads	214
	Up Mounted Overheads	226
	Overhead Bookshelf and Corner Shelf	228
	Mounting Brackets and Accessories	230
	Task Lights	234
	Pedestals	236
	Credenzas	244
	Flip-up Door Overdesk and Tackboards	266
	Sliding Door Overdesks	270
Sliding Door Overdesks with Tackboard	279	

Worksurfaces	Worksurface Specifications	290
	Rectangular Worksurfaces	294
	Curvilinear Wave End Worksurfaces	300
	Smooth Wave Worksurfaces	302
	Trapezoidal Worksurfaces	303
	Corner Worksurfaces	304
	Peninsula Worksurfaces	310
	Curvilinear Half- and Corner-Round Worksurfaces	312
	Transaction Counter Worksurfaces	314
Cascade Edge Worksurfaces	Rectangular with Cascade Edge	316
	Blended “D” and Curvilinear Corner with Cascade Edge	317
	Blended “L” with Cascade Edge	318
	Half Round and Corner Round with Cascade Edge	319
	Wave End with Cascade Edge	320
Worksurface Supports	Panel Mounted Worksurface Brackets	322
	Screen-to-Worksurface Brackets	326
	Panel Mounted Worksurface Supports	328
	Peninsula Worksurface Supports	330
Tables	Y Leg Tables	332
	X Base Tables	340
	Table Supports	345
	Conference Tables	348
Freestanding Desks	Preconfigured Desks	352
	Desk Components	364
	Desk Accessories	370
Alpha-Numeric Index		373
Selling Policy		385
KnollKey Lock Program		387
General Ordering Information		388

# Knoll and Sustainable Design

---

Each year Knoll sets key initiatives in our journey to sustainability. We are members of a global consortium on energy, have adopted a scientific, metrics-based approach to sustainable product design, and maintain a leadership position in establishing universal, verifiable, sustainability standards for our industry.

Knoll promotes independent third-party certification because it provides the most impartial and trustworthy foundation for industry-wide environmental compliance. Certification by established and respected third parties ensures that all manufacturers are held to the same high standards and that customers can trust a company's declaration about the environmental benefits of its products. Knoll third-party partners include: the International Standards Organization (ISO); Forest Stewardship Council (FSC®); Rainforest Alliance; GREENGUARD® Environmental Institute; and The Business and Institutional Furniture Manufacturer's Association (BIFMA) level™ certification from Scientific Certification Systems (SCS).

In addition, Knoll is aligned with the U.S. Green Building Council and can help companies, healthcare organizations and educational institutions achieve Leadership in Energy and Environmental Design (LEED®) workplace certification.

## Global Climate Change

- Knoll is a sponsor of the Clinton Global Initiative, which brings together a community of global leaders to devise and implement solutions to some of the world's most pressing challenges, including environmental change.
- Knoll has a comprehensive Energy Management Program to increase energy efficiency in products and processes.

## Life Cycle Assessment (LCA) Tool

- Life Cycle Assessment is a science-based measurement of a product's environmental impacts throughout its life cycle, from raw materials sourcing through manufacture, shipping, use and re-use or end-of-life. LCA enables cradle-to-cradle implementation of sustainable practices.
- Knoll has partnered with The Green Standard.org to develop an affordable, universal ISO-compliant computer-based LCA tool that can be used by the entire contract furniture industry and is partnering on the development of an Environmental Product Declaration System (EPDs) for Knoll products. EPDs are verified documents containing LCA results and additional environmental performance information about a product.

## Setting Industry Standards

- Knoll partners with MTS (The Institute for Market Transformation to Sustainability) to develop the SMaRT® Consensus Sustainable Products Standards, a set of consensus-based sustainable product standards based on the LEED® model, for all building products, fabric, apparel, flooring and carpet. MTS, the developer of SMaRT®, is an accredited American National Standards Institute (ANSI) standard developer.
- Knoll also partners with BIFMA (Business and Institutional Furniture Manufacturers Association) to promote level™ sustainability standards for the contract furniture industry.
- Knoll has established FSC® (Forest Stewardship Council) certified wood as the standard for general office open plan office systems, casegoods and tables.
- Knoll has launched Full Circle, a resource recovery program developed with ANEW, to help customers extend the life cycle of surplus furniture, fixtures and equipment (FF&E) in an economically, socially and environmentally responsible manner.
- Our goal is to encourage all manufacturers in the contract furniture industry and related industries to adopt standards that will lead to sustainable products and practices.

*For more information about Knoll and sustainable design, visit [knoll.com/environment](http://knoll.com/environment).*

**Specify Core finishes for all new customers****Paint Finishes:**

Beige Mist Metallic (611T)  
 Bright White (118T)  
 Brown (112T)  
 Dark Grey (113T)  
 Folkstone Grey (114T)  
 Jet Black (111T)  
 Medium Grey (115T)  
 Medium Metallic Grey (612T)  
 Sandstone (116T)  
 Silver (613)  
 Soft Grey (117T)

**Paint Finish Applications:**

Panel base raceway covers  
 Screen frames  
 Steel and slatwall tile inserts  
 D1 style tile supports  
 DP7 metal panel trim  
 DP7 power poles  
 Worksurface supports  
 Overhead and overdesk cases and doors  
 Credenza case, top and door  
 Pedestal case and fronts  
 Table bases

**Laminate Finishes:**

Bright White (118)  
 Brushed Grey (123)  
 Brushed Sand (122)  
 Fog (128)  
 Folkstone Grey (114)  
 Jet Black (111)  
 Medium Cherry (124)  
 Micro Grey (121)  
 Micro Sand (129)  
 Natural Cherry (126)  
 Natural Maple (125)  
 Pumice (119)  
 Soft Grey (117)  
 Walnut (127)

**Laminate Finish Applications:**

Worksurfaces  
 Overhead and overdesk doors  
 Credenza top and door  
 Laminate tile inserts  
 Freestanding desk worksurfaces  
 Table tops

**2mm Edgeband Finishes:**

Bright White (118)  
 Fog (128)  
 Folkstone Grey (114)  
 Jet Black (111)  
 Medium Cherry (124)  
 Natural Cherry (126)  
 Natural Maple (125)  
 Pumice (119)  
 Soft Grey (117)  
 Walnut (127)

**2mm Edgeband Finish Applications:**

Worksurfaces  
 Freestanding desk worksurfaces  
 Table tops

**Cascade Worksurface Finishes:**

Bright White (118)  
 Folkstone Grey (114)  
 Medium Cherry (124)  
 Natural Cherry (126)  
 Natural Maple (125)  
 Pumice (119)  
 Soft Grey (117)  
 Walnut (127)

**Cascade Worksurface Finish Applications:**

Cascade edge worksurface

**Techwood Finishes:**

Black Oak (Y851)  
 Blond Maple (Y821) (formerly known as maple techgrain)  
 Cherry (Y319)  
 Dark Grey Oak (Y343)  
 Dark Mahogany (Y326)  
 Espresso (Y344)  
 Light Cherry (Y831) (formerly known as cherry techgrain)  
 Light Oak (Y327)  
 Maple (Y316)  
 Medium Oak (Y329)  
 Medium Teak (Y342)  
 Medium Walnut (Y323)  
 Natural (Y811)  
 Wenge (Y341)

**Techwood Finish Applications:**

Worksurfaces  
 Overhead and overdesk doors  
 Credenza top and door  
 Panel trim  
 Veneer tile inserts  
 Table tops

**Plastic Trim Finishes:**

Dark Grey (113)  
 Medium Grey (115)  
 Soft Grey (117)

**Plastic Trim Finish Applications:**

Plastic panel trim  
 Beltway covers  
 Legacy power pole covers

**DS1 Storage Plastic Finishes:**

Bright White (118)  
 Brown (112)  
 Dark Grey (113)  
 Folkstone Grey (114)  
 Jet Black (111)  
 Medium Grey (115)  
 Sandstone (116)  
 Soft Grey (117)

**DS1 Storage Plastic Finish Applications:**

DS1 pedestal drawer plugs and handles  
 DS1 overhead door end plugs

**Note:** All Dividends Horizon products except DS1 and DS2 pedestals and doublewide pedestals are painted with a textured finish excluding 613 Silver, which is available as a smooth finish only. X and Y base tables and the freestanding screen kits are always painted with a textured finish, including 613 Silver.

**Note:** Laminates and other finishes may vary in color due to different dye lots. Slight variations are to be expected.

**Note:** Worksurfaces, overhead and overdesk doors, credenza tops and doors, and veneer tile inserts will have the same Techwood finish on the surface and the edge.

Order Code	Color Name	Old Order Code	Paint Grade	Paint Finishes	Laminate Finishes	2mm Edgeband Finishes	Cascade Worksurface Finishes	Techwood Finishes	Plastic Trim Finishes	DS1 Storage Plastic Finishes
<b>Paints and Laminates</b>										
611T*	Beige Mist Metallic		P2	•						
118T*	Bright White	LH	P3	•	•	•	•			•
112T*	Brown		P1	•						•
123	Brushed Grey				•					
122	Brushed Sand				•					
113T*	Dark Grey	Y3	P1	•		•			•	•
128	Fog	G			•	•				
114T*	Folkstone Grey		P1	•	•	•	•			•
111T*	Jet Black	27	P1	•	•	•				•
124	Medium Cherry				•	•	•			
115T*	Medium Grey	Y2	P1	•		•			•	•
612T*	Medium Metallic Grey	J	P2	•						
121	Micro Grey				•					
129	Micro Sand				•					
126	Natural Cherry				•	•	•			
125	Natural Maple				•	•	•			
119	Pumice	LB, F			•	•	•			
116T*	Sandstone		P1	•						•
613	Silver	3	P3	•						
117T*	Soft Grey	E, M42	P1	•	•	•	•		•	•
127	Walnut				•	•	•			
<b>Techwoods</b>										
Y851	Black Oak							•		
Y821	Blond Maple (formerly known as maple techgrain)							•		
Y319	Cherry							•		
Y343	Dark Grey Oak							•		
Y326	Dark Mahogany							•		
Y344	Espresso							•		
Y831	Light Cherry (formerly known as cherry techgrain)							•		
Y327	Light Oak							•		
Y316	Maple							•		
Y329	Medium Oak							•		
Y342	Medium Teak							•		
Y323	Medium Walnut							•		
Y811	Natural							•		
Y341	Wenge							•		

\*\*T' suffix is for paint finish only

**Most products introduced after 2004 are not available in Legacy finishes. See individual pricing pages for availability.**

**Specify Legacy finishes to match existing product only. Legacy finishes are not available for new customers.**

**Trim Finishes**

- Panel top caps
- Panel post trim
- Pedestal drawer top caps
- Overhead drawer top caps
- Pedestal drawer pulls
  - Y1 Pewter

**Paint Finishes**

- Panel base raceway covers
- Panel tiled insert supports
- Solid Steel panel inserts
- Perforated steel panel inserts
- Embossed steel panel inserts
- Overhead storage components
- Pedestals
- Desk components
- Metal panel topcaps and trim

**P1 Finishes**

- Y1 Pewter

**P2 Finishes**

- H Beige Metallic
- W Light Tan Metallic

All other Knoll paint finishes and custom finishes (Series 2 components only)

**Laminates**

Worksurfaces

**An upcharge applies where specifying Legacy laminates. Add an amount equal to 10% of the solid PVC edgeband list price to the price of any product specified with a Legacy laminate.**

- MC Caramel Maple
- CM Clear Maple
- M1 Light Grey
- PA Pearwood
- SD Sand
- B Snow
- WM Warm Cherry
- MR6 Winter Grey Matrix

**Note:** Laminates and other finishes may vary in color due to different dye lots. Slight variations are to be expected.

**Worksurface Edges**

2mm edgeband

- MC Caramel Maple
- CM Clear Maple
- Y3 Dark Grey
- Y2 Medium Grey
- MT Metal
- Y1 Pewter
- SD Sand
- B Snow
- WM Warm Cherry

---

**Fabric Options****Grade 10**

Bailey II (W359)  
Element (W1077)  
Foundation (W351)  
Growth Spurt (W692)  
Newbury (W812)  
Solid Crepe (W257)  
Symbolic Details (W693)  
Versatility (W432)

**Grade 20**

Bauhaus Block (W296)  
Circle Line (W1146)  
Clarity (W281)  
Criss Cross (W305)  
Devon (W809)  
Photon (W1293)  
Reflect (W884)  
Resolution (W280)  
Weave Three (W298)

**Grade 30**

Basket Draft (W249)  
Flow (W565)  
Harmony (W232)  
Interknit (W1090)  
Micro (W465)  
Progression (W403)

**Grade 40**

Amplify (W1215)  
Bandwidth (W1219)  
Clarkson (W1218)  
Ornament (W1078)  
Palladium (W1030)

**Grade 45**

Dristi (K872)

**Grade 50**

Knoll Hopsack (K1206)  
Presto (K1000)  
Ricochet (K498)

**Grade 55**

Transition (W816)

**Open Weave Fabrics****Warpnet**

White (W1113/1)  
Medium Grey (W1113/2)  
Dark Value Grey (W1113/3)  
Warm Cool Neutral (W1113/4)  
Brushed Gold (W1113/5)

**COM (Customer's Own Material)**

COM can be applied to Dividends Horizon product on a select basis. Please consult your Knoll Customer Service Representative for details on the COM approval process and testing requirements.

Pricing for COM fabrics is at Grade 10.

**Note:** Always contact your Customer Service Representative prior to sending any COM (including pre-approved KnollTextiles) to the manufacturing facility.

**Dividends Horizon Panels**

Dividends Horizon is a furniture system comprised of a wide variety of panels, hanging components, storage, screens and freestanding desks.

At the heart of the system is a universal panel frame. The universal frame is an open design that accepts many styles of panel inserts. These include:

- Monolithic Fabric Insert
- Monolithic Laminate Insert
- Tiled Fabric Insert
- Tiled Laminate Insert
- Beltway Electrical
- Technology Tile
- Painted Steel
- Perforated Steel
- Embossed Steel
- Window Kits
- Markerboard

**Panel Dimensions**

- Widths: 15", 18",24",30",36", 42",48" and 60"
- Heights: worksurface height, 36",42",50", 57", 64" and 78"
- Thickness: 3"

**Panel Frame Options**

Dividends Horizon offers two panel frame options, which are selected depending on customer's aesthetic and functional needs. Both frames are available in preconfigured and build-to-spec panels.

Topway panel frames feature an integral top cable trough, and are used with D1 style stack frames.

Full View frames have no top trough, leaving a larger window opening in the top position. Full View frames are used with D2 style stack frames.

**Dividends Horizon Panels and Components (Base Raceway shown)**

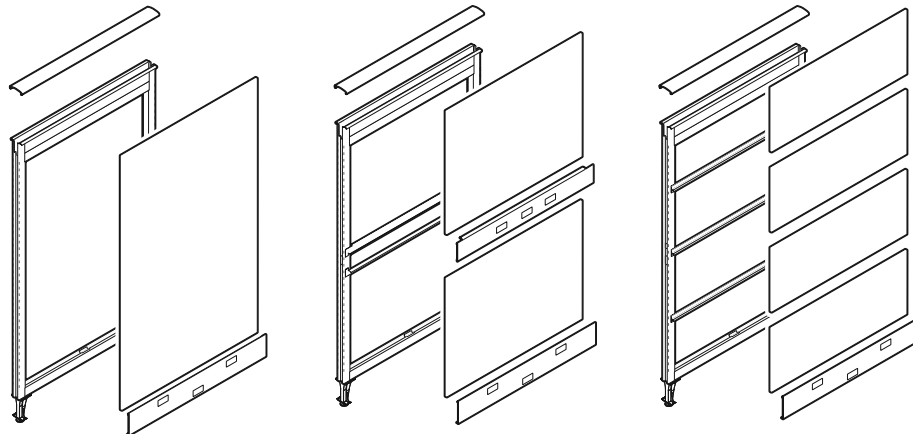

Monolithic Panel

Beltway Panel

Tiled Panel

**Panel Frame Construction**

Panel frames are robotically welded and consist of vertical channels, horizontal rails and panel feet with leveling glides.

- Topway trough: 22-gauge roll-formed steel (topway frames only)
- Vertical channels: 16-gauge roll-formed steel with 5/8" integral slotted standard with adjustments in 1 1/2" increments
- Horizontal rails: 15-gauge roll-formed steel
- Panel feet: extruded aluminum
- Leveling glides: Steel threads with 1-1/2" height adjustment and 1-1/2" diameter nylon foot

**Preconfigured Panels**

Dividends Horizon panels can be specified "Preconfigured" in various styles including:

- Monolithic Panel
- Tiled Panel
- Beltway Panel

**Monolithic Panel Components**

Monolithic panels provide a single fabric or laminate insert per panel side.

Preconfigured Dividends Horizon panels are shipped complete with panel frame, base components, top cap, panel to panel connection hardware and one full height panel insert per side.

**Tiled Panel Components**

Individual tiled panels allow for a "segmented" aesthetic. Individual tile supports create separation within the panel frame.

"Preconfigured" Dividends Horizon panels ship complete with panel frame, base components, top cap, panel to panel connection hardware, tile supports and tiles.

**Beltway Panel Components**

Beltway panels allow for electrical and/or data to be accessed above worksurface height. Beltway electrical/data can be specified on one or both sides of a panel.

"Preconfigured" Dividends Horizon beltway panels ship complete with panel frame, base components, top cap, panel to panel connection hardware, beltway panel inserts, beltway covers and beltway insert supports.

**Base Options**

- Base Raceway
- Open Base
- Tile to the Floor

**Note:** Standard base, Open base and Tile to the floor components can be retrofitted in either a topway or full view frame.

**Stack Frames**

Dividends Horizon stack frames increase the overall height of a standard panel.

The stack frame is available in three panel heights, 14", 21" and 28". Dividends Horizon stack panels may be attached to standard 36", 42", 50",57", 64" and 78" high panel. Maximum stacking height above a base panel height is 28".

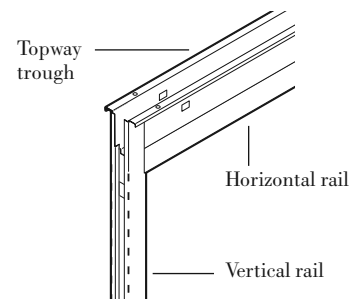

Topway Frame Construction

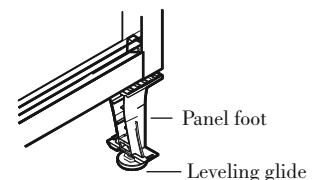

Panel Foot Construction



**Open Position Planner**

Dividends Horizon now offers an industry leading technology called Open Position Planner, allowing customers and dealers to design, specify and order factory-assembled Dividends Horizon panels in virtually any configuration.

This powerful specification tool eliminates the need for most built-to-spec panels. Since panels arrive at the job site assembled, installation labor is also reduced.

The functionality of Open Position Planner is available only to electronic specification users, and is not available in this price list.

**“Build-to-Spec” Panels**

“Build-to-Spec” panels are specified by component for special applications. These include: when a different fabric is required on each panel side and when retrofitting existing panels to another style. Panels and components are not shipped assembled.

**Universal Panel Connectors**

Universal panel connectors are included with Dividends panels. Panel connection hardware is universal to allow:

- Same-height straight panel-to-panel connections
- High-low straight panel-to-panel connections
- Straight high-low panel-to-post connections

Included with universal panel connection hardware:

- Upper wedge block connector
- Lower cactus connectors

Universal panel connection hardware construction:

- Lower connectors: Welded 14-gauge steel cactus style connectors
- Upper connector: Die cast wedge block with 13-gauge steel alignment bracket and 4 1/2" tension screw

**Panel Attachment**

The lower cactus style connectors engage the lower frames of adjacent panels. The upper wedge block engages the upper frames. The connection is secured by tightening the upper connector's tension screw.

**Panel-to-Panel Top Cap Transition**

Top cap transitions fill the gap between panel top cap sections in straight panel-to-panel configurations.

- **Construction:** Trim-color black when used with veneer top caps
- **Size:** 1" wide by 3" deep
- **Attachment:** Snaps between top cap sections in straight, same-height panel configurations

**Note:** Panel-to-panel top cap transitions are ordered separately from panels.

**Top Cap**

Top cap is included with preconfigured panels.

- **Construction:** Plastic top caps are trim colored, softly radiused plastic extrusion. Veneer top caps are techgrain veneer over plastic extrusion. Metal top caps, available in both radius and flat profiles, are powder coated steel.

- **Attachment:** Snaps onto the trough of a topway panel frame. Retainer clips are used to attach the top cap to the top rail of a full view frame.

**Panel End Trim**

Panel end trim matches the aesthetics of the panel top cap. It is used to end a panel run and for high-low, panel-to-panel applications.

**Four panel trim options are available:**

- Enhanced smooth plastic
- Radius Metal
- Flat Metal
- Thin Profile Flat

**Note:** Panel end trim is ordered separately from panels. Included with the panel end trim are panel end trim brackets.

- **Construction:** Standard panel end trims are trim colored, softly radiused plastic extrusions with a plastic injection molded end cap.

Metal trim is extruded aluminum with powder coat finish.

- **Attachment:** Panel-mount brackets are fastened to the panel with thread-forming screws into pre-punched holes. End trim snaps onto panel mount brackets.

The panel end top cap snaps over the panel end trim and panel top trim.

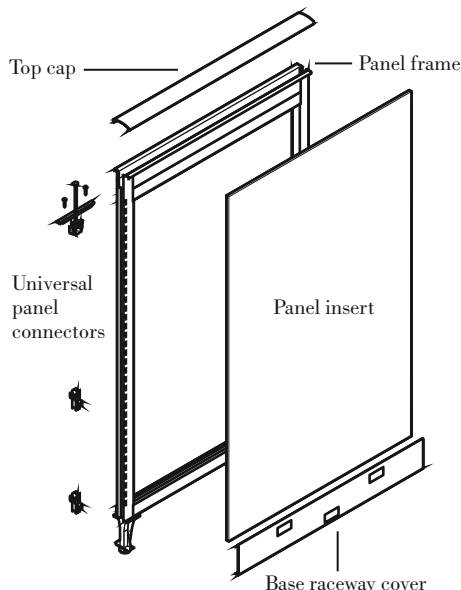

**Monolithic Panel**

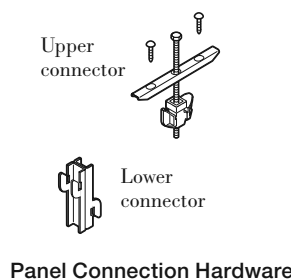

**Panel Connection Hardware**

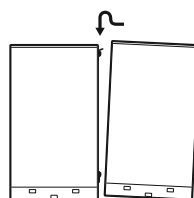

**Panel Attachment**

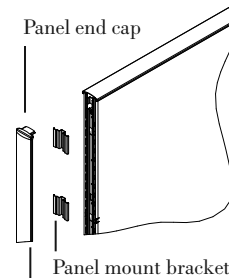

**Panel End Trim Attachment**

**Post Connectors**

Post connectors are required for all "L", "T", and "X" configurations. For same-height applications, post connectors are available as an assembly and include the post, vertical trim and top cap.

For high-low panel-to-post applications, post connectors are specified by component.

**Post and Post Component Construction**

- Post: 3" square extruded aluminum
- Plastic Post Cover: Trim-color plastic extrusion
- Metal Post Cover: 18 gauge steel with powder coat finish
- Post Top Cap: Trim-colored injection-molded plastic

**Attachment:** Post connectors use the universal panel connection hardware from adjacent panels

**Electrical and data access:** Posts have cut-outs that match the wire and cable access channels provided by panel frames. This allows wire conduits and data cables to be routed through the post at the topway, beltway and base raceway.

**Electrical and Communications**  
Dividends Horizon provides a logical approach for planning and installing electrical systems and communication cables.

Power is installed along the base raceway with access available in both the base raceway and optional beltway.

**Topway Panel Frame Electrical**

Allows data cables to be routed horizontally and vertically within the panel.

- Interior dimension: 2 1/2"H x 3/4"W

Cables can be routed along the tops of panels, routed through the interior of panels and along both the beltway and base raceway. The primary channel for distributing cable is provided in the horizontal topway along the top of panels. The topway allows cables to be easily laid-in during initial installation and additional cables to be added as required. It also separates data from power to reduce the chance of interference. A vertical wire pathway is provided in the center of the topway. This allows cables to be run vertically through the interior of the panel to the beltway or base raceway without the use of exterior cable managers.

**Data Cabling Bend Radius**

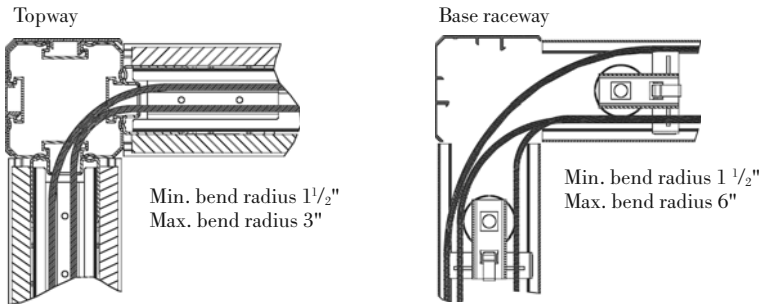

**Topway Panel Frame Trough**

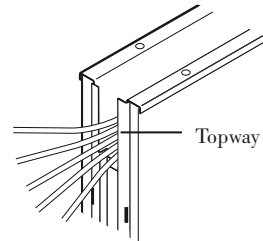

**Topway Panel Frame Cable Routing**

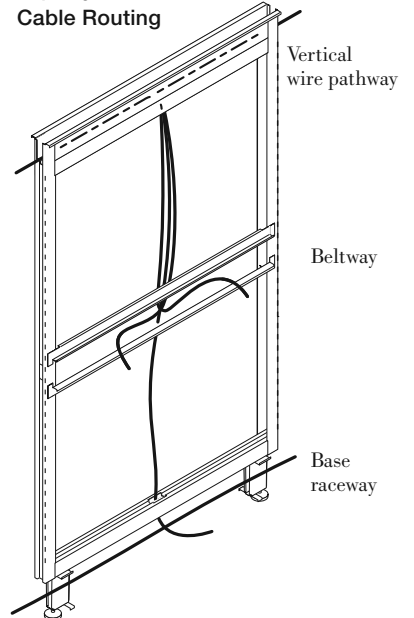

**"L" Post Connection**

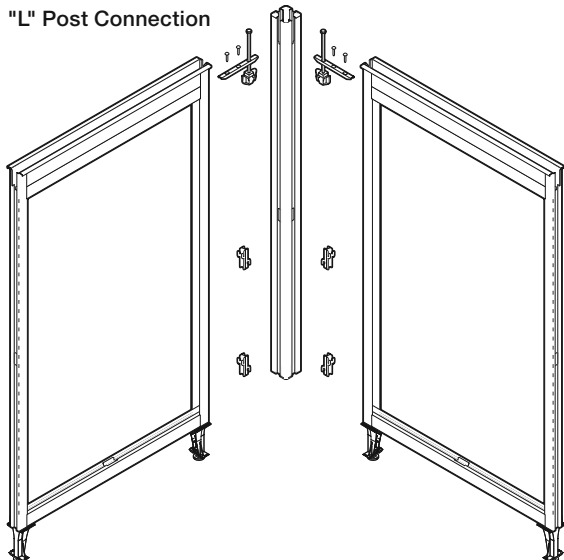

**"L" Post Cover Attachment**

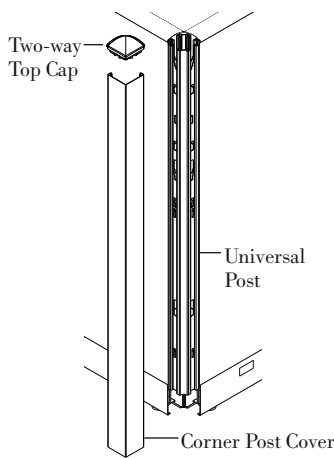

**Beltway Electrical**

Provides duplex receptacle and data port access at desk-height level.

- Exterior dimension: 4 1/4"H x 3"D
- Interior dimension: 3 1/2"H x 2 3/4"D
- Height from floor: 32 3/4" to center of beltway cover
- Beltway cover construction: Trim-color plastic extrusion
- Beltway cover attachment: Snaps onto beltway panel insert supports
- Duplex access: 30" and wider beltway covers have two duplex knockouts per panel side (18" and 24" wide beltways do not have duplex knockouts)
- Duplex location: Knockouts located 12" on center from each end of cover
- Data access: All beltway covers (except 30" wide) have one center-located data port knockout per panel side
- Additional data access: In panels 30" and wider, the two duplex knockouts can be used as additional data ports when the beltway is not used for duplex receptacles.
- Power capacity: One power module per panel (single or double-sided).

**Panel Base Options**

Dividends Horizon panels are available with three base options:

- Base Raceway
- Open Base
- Tile-to-Floor.

Overall panel heights, tile configurations and application rules are the same for all three base options.

**Base Raceway**

Provides duplex receptacle and data port access at base height. Base Raceway panels feature two roll formed steel raceway covers, which are available with or without electrical/data knockouts.

- Exterior dimension: 5"H x 2 15/16"D
- Interior dimension: 5"H x 2 7/8"D
- Dataport Knockout dimension: 1 3/8"H x 2 5/8"D
- Construction: Paint-colored 22-gauge roll-form steel cover
- Duplex access: 24" and wider base raceway covers have two duplex knockouts per panel side (18"W panels do not have duplex knockouts)

- Duplex location: 9" on center from each end
- Data access: All base raceway covers have one center-located data port knockout
- Additional data access: In panels 24" and wider, the outer knockouts can be used as additional data ports when the raceway is not used for duplex receptacles
- Power capacity: One power module or jumper

**Note:** Knockouts are standard unless specified without.

**Open Base** panels feature two extruded aluminum feet positioned at the end of each panel. A horizontal trim is located below the bottom tile.

**Tile-To-Floor** panels eliminate the raceway cover and access on one side, replaced by a fabric or steel tile extended to the floor. A heavy gauge steel internal raceway cover protects the raceway contents and the tile from deflecting when hit by shoes or vacuum cleaners. The other side of the panel features a raceway cover, available with or without electrical/data knockouts. If needed, use one-sided electrical and one-sided base cable trays with this base option.

**Beltway Electrical**

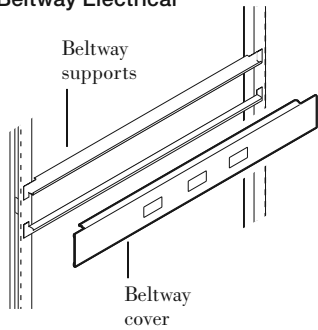

**Base Raceway Electrical**

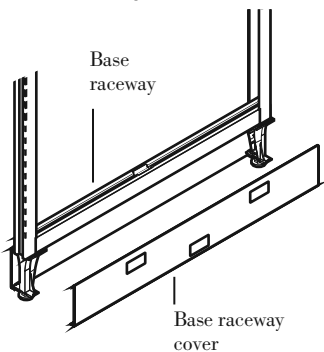

**Cable Management Capacities**

This chart shows the number of category 5, 4-pair cables that can be routed through various Dividends Horizon pathways. Cable capacities are based on 0.160, 0.200, and 0.250 diameter cables at a full fill capacity.

Pathway Description	Cable Pathway Area (Square Inches)	Cable Dia. 0.16"	Cable Dia. 0.20"	Cable Dia. 0.25"
Panel Top Way	3.00	109	75	41
Panel Base Raceway (w/o electrical)	8.52	270	178	108
Panel Base Raceway (with electrical)	3.65	162	102	56
Beltway (w/o electrical)	1.50	72	50	32
Beltway (with electrical)	1.10	26	18	11
Vertical Drop (within panel)	1.90	28	24	15

### Panel Planning Guidelines

The following panel planning guidelines are provided to ensure stability of Dividends Horizon panels.

Three different scenarios are shown:

- Panel run supported by panels on one end
- Panel run supported by panels on both ends
- High density storage

### Panel Run Supported by Panels at One End

- Minimum of an "L" panel connection on one end
- Maximum number of panels in run: 4
- End of panel run must be supported by a pedestal, panel-mounted Open Leg Support, C-leg Support or any height panel

### Formula for Depth of Return

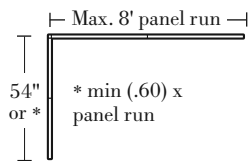

### Panel Run Supported by Panels at One End

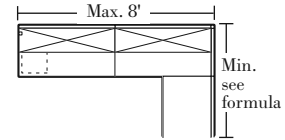
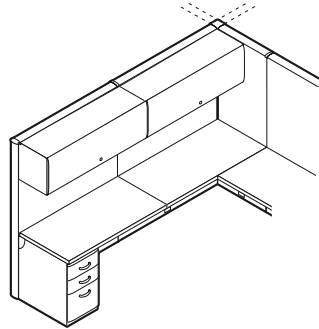

**End of Run Supported by Pedestal**

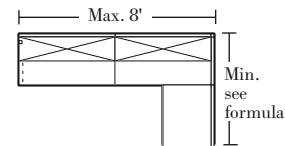
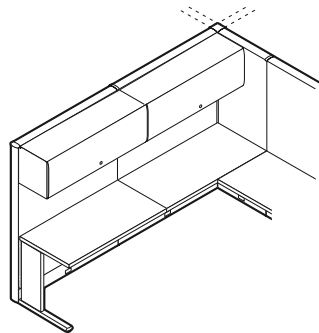

**End of Run Supported by Panel Mount C-Leg Support**

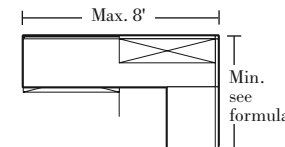
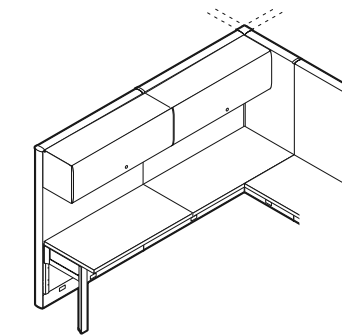

**End of Run Supported by Open Leg Support**

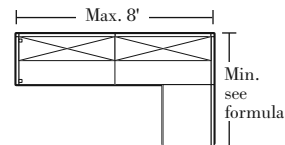
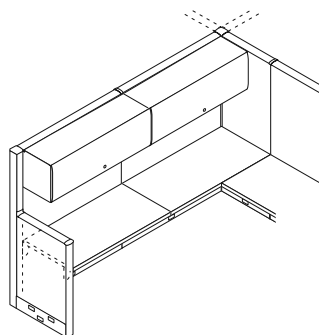

**End of Run Supported by Panel of Any Height**

### Panel Run Supported by Panels at Both Ends

- Minimum of an "L" panel connection on both ends (see Formulas 2 and 3 below)
- Maximum length panel run: 12'
- Maximum number of panels in run: 4

- Both ends of panel run must be supported by matching height panels (see Formulas 2 and 3 below)
- Panel run must be floor supported every 8' with a pedestal, panel mounted Open Support Leg or C-Leg support

### High Density Storage

If hanging more than one overhead component vertically per panel side the following is required:

- Panel must be supported by matching height return panels on both ends of the panel

### Panel Run Supported by Panels at Both Ends

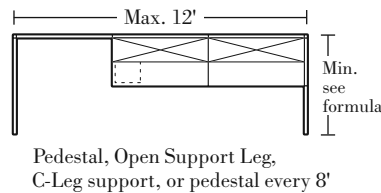
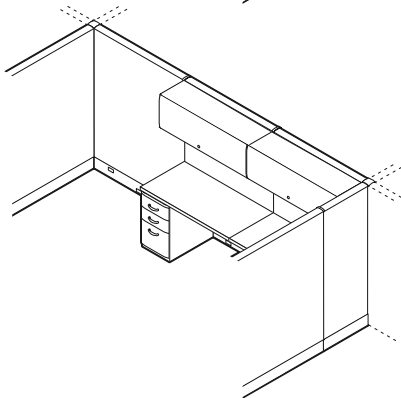
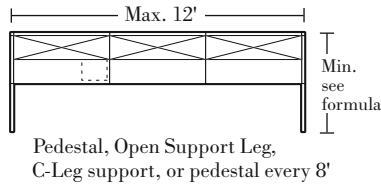
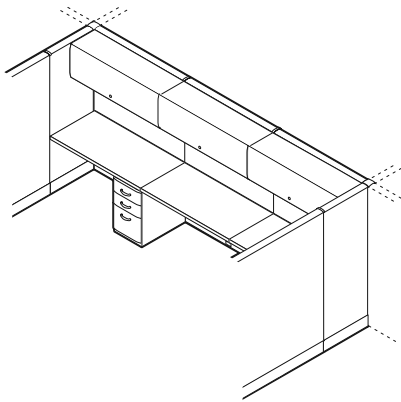

### Formulas for Depth Return

#### Formula 1

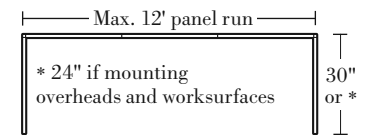

#### Formula 2

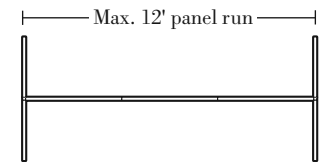

#### Formula 3

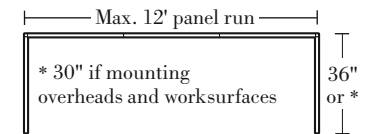

Return panel must be a minimum of 36" wide when laminate tiles are used along the spine panel run.

### High Density Storage

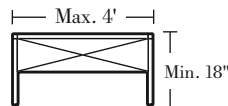
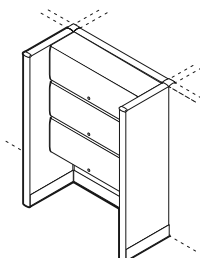

## Monolithic Panel

Monolithic panels provide a single fabric insert per panel side.

Preconfigured Dividends Horizon panels are shipped complete with topway or full view panel frame, base components, top cap, panel to panel connection hardware and one full height fabric panel insert per side.

Panels may also be ordered by components for "Build-to-Spec" applications. This includes when different fabric insert is required on each side of the panel.

## Monolithic Panel Insert Construction

Fabric laminated with web adhesive heat-cured to 7/16" thick tackable acoustical board.

## Monolithic Panel Ratings

- Noise Reduction Coefficient (NRC) rating: .70
- Sound Transmission Class (STC) rating: 11

Dividends Horizon panels meet the flame spread and smoke generation criteria established in UL1286 safety standard for office furnishings.

## Monolithic Panel Insert Attachment

Fabric panel inserts flex to attach to the troughs in the upper and lower horizontal frame supports. Mounting spring clips are attached to inserts for connection to the

vertical frame for additional support. No tools are required for the insert attachment.

## Top Cap Options

Three top cap options are available:

- Smooth Radius Plastic
- Radius Metal
- Flat Metal

## Top Cap Construction

Smooth radiused plastic top caps are made from extruded plastic. Radius metal and flat metal top caps are made from extruded aluminum.

## Top Cap Attachment

Snaps onto the trough of a topway panel frame. Retainer clips are included to attach top caps to a full view frame.

If additional support for monolithic panel inserts is required, a beltway cable tray can be installed.

## Three Base Options Available:

- Base Raceway
- Tile to the Floor
- Open Base

Base Raceway covers are available with or without knockouts.

See the preconfigured tiled panel pages for more information on base options.

## Carpet Grippers

Carpet grippers should be specified to increase rigidity of unsupported panel runs. The carpet grippers snap onto leveling glides to prevent panel runs from shifting on carpet. The glides rotate in carpet grippers to permit leveling. Carpet grippers have a black finish.

## Universal Panel Connectors

Dividends Horizon panels include universal panel connectors to allow same-height straight panel-to-panel connections, high-low straight panel-to-panel connections and straight and high-low panel-to-post connections.

## Electrical

Panels 24" and wider will accept two duplex receptacles per panel base side. 18" wide panels will provide pass-through electrical only. All electrical components are ordered separately and must be field-installed.

## Preconfigured Monolithic Panel

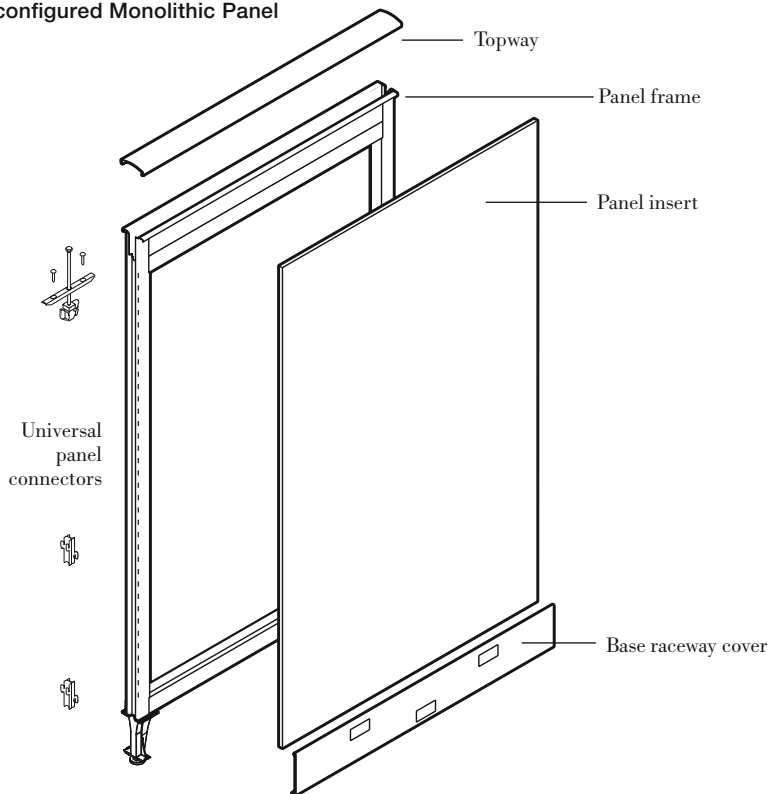



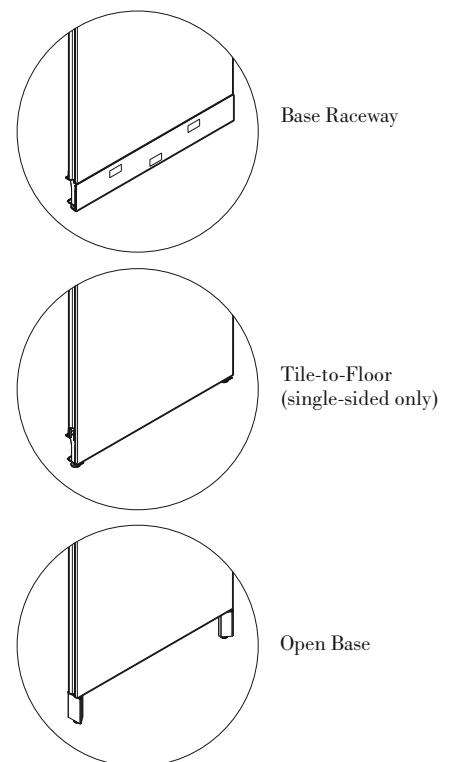

## Panel Base Options



# Monolithic Panels

## Standard Base Raceway

### Worksurface Height, 36", 42" and 50" High

description	h	w	d	pattern no.	grade							
					10	15	20	25	30	35	40	45
 Worksurface Height Monolithic Standard Base Raceway	28 1/2"	15"	3"	<b>DP7CMMRRWH15</b>	\$356.	\$370.	\$386.	\$391.	\$406.	\$412.	\$418.	\$428.
	28 1/2"	18"	3"	<b>DP7CMMRRWH18</b>	356.	370.	386.	391.	406.	412.	418.	428.
	28 1/2"	24"	3"	<b>DP7CMMRRWH24</b>	400.	412.	432.	439.	450.	458.	467.	477.
	28 1/2"	30"	3"	<b>DP7CMMRRWH30</b>	420.	434.	454.	462.	474.	483.	491.	504.
	28 1/2"	36"	3"	<b>DP7CMMRRWH36</b>	474.	490.	515.	522.	539.	548.	557.	572.
	28 1/2"	42"	3"	<b>DP7CMMRRWH42</b>	528.	545.	572.	582.	597.	608.	618.	636.
	28 1/2"	48"	3"	<b>DP7CMMRRWH48</b>	560.	577.	604.	614.	632.	643.	655.	671.
	28 1/2"	60"	3"	<b>DP7CMMRRWH60</b>	673.	692.	725.	739.	761.	775.	788.	806.
 36" High, Monolithic Standard Base Raceway	35 1/8"	15"	3"	<b>DP7CMMRR3615</b>	356.	370.	386.	391.	406.	412.	418.	428.
	35 1/8"	18"	3"	<b>DP7CMMRR3618</b>	356.	370.	386.	391.	406.	412.	418.	428.
	35 1/8"	24"	3"	<b>DP7CMMRR3624</b>	400.	412.	432.	439.	450.	458.	467.	477.
	35 1/8"	30"	3"	<b>DP7CMMRR3630</b>	420.	434.	454.	462.	474.	483.	491.	504.
	35 1/8"	36"	3"	<b>DP7CMMRR3636</b>	474.	490.	515.	522.	539.	548.	557.	572.
	35 1/8"	42"	3"	<b>DP7CMMRR3642</b>	528.	545.	572.	582.	597.	608.	618.	636.
	35 1/8"	48"	3"	<b>DP7CMMRR3648</b>	560.	577.	604.	614.	632.	643.	655.	671.
	35 1/8"	60"	3"	<b>DP7CMMRR3660</b>	673.	692.	725.	739.	761.	775.	788.	806.
 42" High, Monolithic Standard Base Raceway	42 3/16"	15"	3"	<b>DP7CMMRR4215</b>	374.	386.	406.	413.	423.	432.	439.	449.
	42 3/16"	18"	3"	<b>DP7CMMRR4218</b>	374.	386.	406.	413.	423.	432.	439.	449.
	42 3/16"	24"	3"	<b>DP7CMMRR4224</b>	406.	417.	438.	444.	457.	466.	472.	485.
	42 3/16"	30"	3"	<b>DP7CMMRR4230</b>	444.	458.	481.	490.	504.	514.	521.	537.
	42 3/16"	36"	3"	<b>DP7CMMRR4236</b>	486.	501.	525.	537.	551.	560.	570.	583.
	42 3/16"	42"	3"	<b>DP7CMMRR4242</b>	539.	554.	581.	591.	607.	618.	630.	645.
	42 3/16"	48"	3"	<b>DP7CMMRR4248</b>	571.	587.	616.	628.	645.	656.	667.	686.
	42 3/16"	60"	3"	<b>DP7CMMRR4260</b>	686.	706.	740.	755.	776.	789.	802.	822.
 50" High, Monolithic Standard Base Raceway	49 1/2"	15"	3"	<b>DP7CMMRR5015</b>	400.	412.	432.	439.	450.	458.	467.	477.
	49 1/2"	18"	3"	<b>DP7CMMRR5018</b>	400.	412.	432.	439.	450.	458.	467.	477.
	49 1/2"	24"	3"	<b>DP7CMMRR5024</b>	434.	447.	468.	476.	489.	496.	506.	519.
	49 1/2"	30"	3"	<b>DP7CMMRR5030</b>	480.	494.	518.	527.	544.	553.	562.	577.
	49 1/2"	36"	3"	<b>DP7CMMRR5036</b>	528.	545.	572.	582.	597.	608.	618.	636.
	49 1/2"	42"	3"	<b>DP7CMMRR5042</b>	583.	600.	630.	642.	660.	671.	681.	698.
	49 1/2"	48"	3"	<b>DP7CMMRR5048</b>	631.	649.	680.	693.	712.	724.	736.	757.
	49 1/2"	60"	3"	<b>DP7CMMRR5060</b>	757.	780.	817.	832.	854.	871.	885.	906.



Dimensions listed under h w d are actual to the nearest 1/16"

Ordering Information	Order Code	Included with:	Options
<b>Monolithic Panel with Standard Base Raceway:</b> 1. Pattern number 2. Top cap type 3. Top cap finish 4. Raceway knockout option 5. Raceway trim finish 6. Panel fabric	<b>Monolithic Panel Standard Base Raceway</b> <i>Example:</i> <b>DP7CMMRR3618</b> <b>4/117/K/117/B191</b> <hr/> <b>DP7</b> Dividends Horizon Panel <hr/> <b>C</b> Topway frame <hr/> <b>MM</b> Monolithic both sides <hr/> <b>RR</b> Base Raceway <hr/> <b>4</b> Radius Metal top cap <hr/> <b>117</b> Soft Grey top cap finish <hr/> <b>K</b> Base raceway with knockouts both sides <hr/> <b>117</b> Soft Grey base raceway finish <hr/> <b>B191</b> Fairfield fabric	<b>Monolithic Panel with Standard Base Raceway:</b> <ul style="list-style-type: none"> <li>Panel frame</li> <li>Acoustic panel inserts (2)</li> <li>Base raceway covers</li> <li>Top cap</li> <li>Connection hardware</li> </ul> <b>Note:</b> Preconfigured Worksurface Height panels are not available with plastic top caps.	<b>Monolithic Panel with Standard Base Raceway Options:</b> <b>Full View Frame Option:</b> To specify full view frame for window or stacking applications, replace the "C" in pattern number with "V", No upcharge. <b>Top Cap Options:</b> <b>(2)</b> = Extruded Plastic (Smooth Radius) <b>(3)</b> = No Top Cap <b>(4)</b> = Radius Metal, add \$38 P1, \$40 P2, \$42 P3 <b>(5)</b> = Flat Metal add \$38 P1, \$40 P2, \$42 P3 paint grades <b>Raceway Options:</b> <b>(K)</b> = Knockouts both side <b>(N)</b> = No Knockouts

# Monolithic Panels

## Standard Base Raceway

### 57", 64" and 78" High

description	h	w	d	pattern no.	grade							
					10	15	20	25	30	35	40	45
57" High, Monolithic Standard Base Raceway 	56 <sup>13</sup> / <sub>16</sub> "	15"	3"	<b>DP7CMMRR5715</b>	\$432.	\$444.	\$466.	\$473.	\$488.	\$495.	\$504.	\$518.
	56 <sup>13</sup> / <sub>16</sub> "	18"	3"	<b>DP7CMMRR5718</b>	432.	444.	466.	473.	488.	495.	504.	518.
	56 <sup>13</sup> / <sub>16</sub> "	24"	3"	<b>DP7CMMRR5724</b>	467.	480.	504.	514.	527.	538.	547.	560.
	56 <sup>13</sup> / <sub>16</sub> "	30"	3"	<b>DP7CMMRR5730</b>	519.	537.	561.	572.	587.	597.	607.	624.
	56 <sup>13</sup> / <sub>16</sub> "	36"	3"	<b>DP7CMMRR5736</b>	570.	587.	614.	628.	644.	655.	666.	682.
	56 <sup>13</sup> / <sub>16</sub> "	42"	3"	<b>DP7CMMRR5742</b>	619.	639.	670.	681.	700.	712.	724.	745.
	56 <sup>13</sup> / <sub>16</sub> "	48"	3"	<b>DP7CMMRR5748</b>	668.	688.	722.	735.	756.	768.	782.	802.
	56 <sup>13</sup> / <sub>16</sub> "	60"	3"	<b>DP7CMMRR5760</b>	758.	781.	819.	834.	856.	872.	886.	908.
64" High, Monolithic Standard Base Raceway 	64 <sup>1</sup> / <sub>16</sub> "	15"	3"	<b>DP7CMMRR6415</b>	462.	474.	499.	508.	521.	531.	542.	554.
	64 <sup>1</sup> / <sub>16</sub> "	18"	3"	<b>DP7CMMRR6418</b>	462.	474.	499.	508.	521.	531.	542.	554.
	64 <sup>1</sup> / <sub>16</sub> "	24"	3"	<b>DP7CMMRR6424</b>	499.	515.	541.	549.	563.	574.	584.	599.
	64 <sup>1</sup> / <sub>16</sub> "	30"	3"	<b>DP7CMMRR6430</b>	558.	576.	603.	613.	630.	641.	653.	668.
	64 <sup>1</sup> / <sub>16</sub> "	36"	3"	<b>DP7CMMRR6436</b>	608.	628.	658.	668.	689.	698.	712.	729.
	64 <sup>1</sup> / <sub>16</sub> "	42"	3"	<b>DP7CMMRR6442</b>	656.	676.	708.	722.	740.	756.	767.	789.
	64 <sup>1</sup> / <sub>16</sub> "	48"	3"	<b>DP7CMMRR6448</b>	706.	726.	763.	778.	798.	814.	825.	850.
	64 <sup>1</sup> / <sub>16</sub> "	60"	3"	<b>DP7CMMRR6460</b>	849.	874.	918.	931.	960.	976.	993.	1,019.
78" High, Monolithic Standard Base Raceway 	78 <sup>9</sup> / <sub>16</sub> "	15"	3"	<b>DP7CMMRR7815</b>	661.	680.	714.	726.	750.	761.	773.	793.
	78 <sup>9</sup> / <sub>16</sub> "	18"	3"	<b>DP7CMMRR7818</b>	661.	680.	714.	726.	750.	761.	773.	793.
	78 <sup>9</sup> / <sub>16</sub> "	24"	3"	<b>DP7CMMRR7824</b>	728.	754.	790.	803.	825.	838.	855.	879.
	78 <sup>9</sup> / <sub>16</sub> "	30"	3"	<b>DP7CMMRR7830</b>	792.	816.	855.	871.	895.	913.	926.	950.
	78 <sup>9</sup> / <sub>16</sub> "	36"	3"	<b>DP7CMMRR7836</b>	865.	893.	934.	952.	980.	996.	1,014.	1,040.
	78 <sup>9</sup> / <sub>16</sub> "	42"	3"	<b>DP7CMMRR7842</b>	938.	969.	1,018.	1,035.	1,061.	1,080.	1,101.	1,129.
	78 <sup>9</sup> / <sub>16</sub> "	48"	3"	<b>DP7CMMRR7848</b>	1,003.	1,034.	1,085.	1,103.	1,134.	1,154.	1,174.	1,203.

Dimensions listed under h w d are actual to the nearest 1/16"

Ordering Information	Order Code	Included with:	Options
<b>Monolithic Panel with Standard Base Raceway:</b> 1. Pattern number 2. Top cap type 3. Top cap finish 4. Raceway knockout option 5. Raceway trim finish 6. Panel fabric	<b>Monolithic Panel Standard Base Raceway</b> <i>Example:</i> <b>DP7CMMRR3618</b> <b>4/117/K/117/B191</b> <hr/> <b>DP7</b> Dividends Horizon Panel <hr/> <b>C</b> Topway frame <hr/> <b>MM</b> Monolithic both sides <hr/> <b>RR</b> Base Raceway <hr/> <b>4</b> Radius Metal top cap <hr/> <b>117</b> Soft Grey top cap finish <hr/> <b>K</b> Base raceway with knockouts both sides <hr/> <b>117</b> Soft Grey base raceway finish <hr/> <b>B191</b> Fairfield fabric	<b>Monolithic Panel with Standard Base Raceway:</b> <ul style="list-style-type: none"> <li>Panel frame</li> <li>Acoustic panel inserts (2)</li> <li>Base raceway covers</li> <li>Top cap</li> <li>Connection hardware</li> </ul>	<b>Monolithic Panel with Standard Base Raceway Options:</b> <b>Full View Frame Option:</b> To specify full view frame for window or stacking applications, replace the "C" in pattern number with "V", No upcharge.  <b>Top Cap Options:</b> <b>(2)</b> = Extruded Plastic (Smooth Radius) <b>(3)</b> = No Top Cap <b>(4)</b> = Radius Metal, add \$38 P1, \$40 P2, \$42 P3 <b>(5)</b> = Flat Metal add \$38 P1, \$40 P2, \$42 P3 paint grades  <b>Raceway Options:</b> <b>(K)</b> = Knockouts both side <b>(N)</b> = No Knockouts



# Monolithic Panels

## Open Base

### Worksurface Height, 36", 42" and 50" High

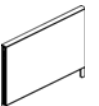
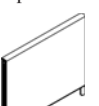
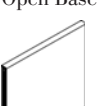
description	h	w	d	pattern no.	grade							
					10	15	20	25	30	35	40	45
Worksurface Height, Monolithic Open Base 	28 1/2"	18"	3"	<b>DP7CMMLLWH18</b>	\$356.	\$370.	\$386.	\$391.	\$406.	\$412.	\$418.	\$428.
	28 1/2"	24"	3"	<b>DP7CMMLLWH24</b>	400.	412.	432.	439.	450.	458.	467.	477.
	28 1/2"	30"	3"	<b>DP7CMMLLWH30</b>	420.	434.	454.	462.	474.	483.	491.	504.
	28 1/2"	36"	3"	<b>DP7CMMLLWH36</b>	474.	490.	515.	522.	539.	548.	557.	572.
	28 1/2"	42"	3"	<b>DP7CMMLLWH42</b>	528.	545.	572.	582.	597.	608.	618.	636.
	28 1/2"	48"	3"	<b>DP7CMMLLWH48</b>	560.	577.	604.	614.	632.	643.	655.	671.
	28 1/2"	60"	3"	<b>DP7CMMLLWH60</b>	673.	692.	725.	739.	761.	775.	788.	806.
36" High, Monolithic Open Base 	35 1/8"	18"	3"	<b>DP7CMMLL3618</b>	356.	370.	386.	391.	406.	412.	418.	428.
	35 1/8"	24"	3"	<b>DP7CMMLL3624</b>	400.	412.	432.	439.	450.	458.	467.	477.
	35 1/8"	30"	3"	<b>DP7CMMLL3630</b>	420.	434.	454.	462.	474.	483.	491.	504.
	35 1/8"	36"	3"	<b>DP7CMMLL3636</b>	474.	490.	515.	522.	539.	548.	557.	572.
	35 1/8"	42"	3"	<b>DP7CMMLL3642</b>	528.	545.	572.	582.	597.	608.	618.	636.
	35 1/8"	48"	3"	<b>DP7CMMLL3648</b>	560.	577.	604.	614.	632.	643.	655.	671.
	35 1/8"	60"	3"	<b>DP7CMMLL3660</b>	673.	692.	725.	739.	761.	775.	788.	806.
42" High, Monolithic Open Base 	42 3/16"	18"	3"	<b>DP7CMMLL4218</b>	374.	386.	406.	413.	423.	432.	439.	449.
	42 3/16"	24"	3"	<b>DP7CMMLL4224</b>	406.	417.	438.	444.	457.	466.	472.	485.
	42 3/16"	30"	3"	<b>DP7CMMLL4230</b>	444.	458.	481.	490.	504.	514.	521.	537.
	42 3/16"	36"	3"	<b>DP7CMMLL4236</b>	486.	501.	525.	537.	551.	560.	570.	583.
	42 3/16"	42"	3"	<b>DP7CMMLL4242</b>	539.	554.	581.	591.	607.	618.	630.	645.
	42 3/16"	48"	3"	<b>DP7CMMLL4248</b>	571.	587.	616.	628.	645.	656.	667.	686.
	42 3/16"	60"	3"	<b>DP7CMMLL4260</b>	686.	706.	740.	755.	776.	789.	802.	822.
50" High, Monolithic Open Base 	49 1/2"	18"	3"	<b>DP7CMMLL5018</b>	400.	412.	432.	439.	450.	458.	467.	477.
	49 1/2"	24"	3"	<b>DP7CMMLL5024</b>	434.	447.	468.	476.	489.	496.	506.	519.
	49 1/2"	30"	3"	<b>DP7CMMLL5030</b>	480.	494.	518.	527.	544.	553.	562.	577.
	49 1/2"	36"	3"	<b>DP7CMMLL5036</b>	528.	545.	572.	582.	597.	608.	618.	636.
	49 1/2"	42"	3"	<b>DP7CMMLL5042</b>	583.	600.	630.	642.	660.	671.	681.	698.
	49 1/2"	48"	3"	<b>DP7CMMLL5048</b>	631.	649.	680.	693.	712.	724.	736.	757.
	49 1/2"	60"	3"	<b>DP7CMMLL5060</b>	757.	780.	817.	832.	854.	871.	885.	906.

Dimensions listed under h w d are actual to the nearest 1/16"



Ordering Information	Order Code	Included with:	Options
<b>Monolithic Panel with Open Base:</b> 1. Pattern Number 2. Top cap type 3. Top cap finish 4. Base finish 5. Panel fabric	<b>Monolithic Panel with Open Base</b> <i>Example:</i> <b>DP7CMMLL 3618</b> <b>4/117/117/B191</b> <hr/> <b>DP7</b> Dividends Horizon Panel <hr/> <b>C</b> Topway frame <hr/> <b>MM</b> Monolithic both sides <hr/> <b>LL</b> Open base <hr/> <b>4</b> Radius Metal top cap <hr/> <b>117</b> Soft Grey top cap finish <hr/> <b>117</b> Soft Grey raceway finish <hr/> <b>B191</b> Fairfield light fabric	<b>Monolithic Panel with Open Base:</b> <ul style="list-style-type: none"> <li>Panel frame</li> <li>Acoustic panel inserts (2)</li> <li>Open base</li> <li>Top cap</li> <li>Connection hardware</li> </ul> <b>Note:</b> Preconfigured Worksurface Height panels are not available with plastic top caps.	<b>Monolithic Panel with Open Base:</b> <b>Full View Frame Option:</b> To specify full view frame for window or stacking applications, replace the "C" in pattern number with "V". No upcharge.  <b>Top Cap Options:</b> <b>(2)</b> = Extruded Plastic (Smooth Radius) <b>(3)</b> = No Top Cap <b>(4)</b> = Radius Metal, add \$38 P1, \$40 P2, \$42 P3 paint grades <b>(5)</b> = Flat Metal, add \$38 P1, \$40 P2, \$42 P3 paint grades

# Monolithic Panels

## Open Base

### 57", 64" and 78" High

Dividends Horizon

description	h	w	d	pattern no.	grade							
					10	15	20	25	30	35	40	45
57" High, Monolithic Open Base 	56 <sup>13</sup> / <sub>16</sub> "	18"	3"	<b>DP7CMMLL5718</b>	\$432.	\$444.	\$466.	\$473.	\$488.	\$495.	\$504.	\$518.
	56 <sup>13</sup> / <sub>16</sub> "	24"	3"	<b>DP7CMMLL5724</b>	467.	480.	504.	514.	527.	538.	547.	560.
	56 <sup>13</sup> / <sub>16</sub> "	30"	3"	<b>DP7CMMLL5730</b>	519.	537.	561.	572.	587.	597.	607.	624.
	56 <sup>13</sup> / <sub>16</sub> "	36"	3"	<b>DP7CMMLL5736</b>	570.	587.	614.	628.	644.	655.	666.	682.
	56 <sup>13</sup> / <sub>16</sub> "	42"	3"	<b>DP7CMMLL5742</b>	619.	639.	670.	681.	700.	712.	724.	745.
	56 <sup>13</sup> / <sub>16</sub> "	48"	3"	<b>DP7CMMLL5748</b>	668.	688.	722.	735.	756.	768.	782.	802.
	56 <sup>13</sup> / <sub>16</sub> "	60"	3"	<b>DP7CMMLL5760</b>	758.	781.	819.	834.	856.	872.	886.	908.
64" High, Monolithic Open Base 	64 <sup>1</sup> / <sub>16</sub> "	18"	3"	<b>DP7CMMLL6418</b>	462.	474.	499.	508.	521.	531.	542.	554.
	64 <sup>1</sup> / <sub>16</sub> "	24"	3"	<b>DP7CMMLL6424</b>	499.	515.	541.	549.	563.	574.	584.	599.
	64 <sup>1</sup> / <sub>16</sub> "	30"	3"	<b>DP7CMMLL6430</b>	558.	576.	603.	613.	630.	641.	653.	668.
	64 <sup>1</sup> / <sub>16</sub> "	36"	3"	<b>DP7CMMLL6436</b>	608.	628.	658.	668.	689.	698.	712.	729.
	64 <sup>1</sup> / <sub>16</sub> "	42"	3"	<b>DP7CMMLL6442</b>	656.	676.	708.	722.	740.	756.	767.	789.
	64 <sup>1</sup> / <sub>16</sub> "	48"	3"	<b>DP7CMMLL6448</b>	706.	726.	763.	778.	798.	814.	825.	850.
	64 <sup>1</sup> / <sub>16</sub> "	60"	3"	<b>DP7CMMLL6460</b>	849.	874.	918.	931.	960.	976.	993.	1,019.
78" High, Monolithic Open Base 	78 <sup>3</sup> / <sub>16</sub> "	18"	3"	<b>DP7CMMLL7818</b>	661.	680.	714.	726.	750.	761.	773.	793.
	78 <sup>3</sup> / <sub>16</sub> "	24"	3"	<b>DP7CMMLL7824</b>	728.	754.	790.	803.	825.	838.	855.	879.
	78 <sup>3</sup> / <sub>16</sub> "	30"	3"	<b>DP7CMMLL7830</b>	792.	816.	855.	871.	895.	913.	926.	950.
	78 <sup>3</sup> / <sub>16</sub> "	36"	3"	<b>DP7CMMLL7836</b>	865.	893.	934.	952.	980.	996.	1,014.	1,040.
	78 <sup>3</sup> / <sub>16</sub> "	42"	3"	<b>DP7CMMLL7842</b>	938.	969.	1,018.	1,035.	1,061.	1,080.	1,101.	1,129.
	78 <sup>3</sup> / <sub>16</sub> "	48"	3"	<b>DP7CMMLL7848</b>	1,003.	1,034.	1,085.	1,103.	1,134.	1,154.	1,174.	1,203.

Dimensions listed under h w d are actual to the nearest 1/16"

Ordering Information	Order Code	Included with:	Options
<b>Monolithic Panel with Open Base:</b> 1. Pattern Number 2. Top cap type 3. Top cap finish 4. Base finish 5. Panel fabric	<b>Monolithic Panel with Open Base</b> <i>Example:</i> <b>DP7CMMLL3618</b> <b>4/117/117/B191</b> <hr/> <b>DP7</b> Dividends Horizon Panel <hr/> <b>C</b> Topway frame <hr/> <b>MM</b> Monolithic both sides <hr/> <b>LL</b> Open Base <hr/> <b>4</b> Radius Metal top cap <hr/> <b>117</b> Soft Grey top cap finish <hr/> <b>117</b> Soft Grey base raceway finish <hr/> <b>B191</b> Fairfield light fabric	<b>Monolithic Panel with Open Base:</b> <ul style="list-style-type: none"> <li>Panel frame</li> <li>Acoustic panel inserts (2)</li> <li>Open base</li> <li>Top cap</li> <li>Connection hardware</li> </ul>	<b>Monolithic Panel with Open Base:</b> <b>Full View Frame Option:</b> To specify full view frame for window or stacking applications, replace the "C" in pattern number with "V". No upcharge.  <b>Top Cap Options:</b> <b>(2)</b> = Extruded Plastic (Smooth Radius) <b>(3)</b> = No Top Cap <b>(4)</b> = Radius Metal, add \$38 P1, \$40 P2, \$42 P3 paint grades <b>(5)</b> = Flat Metal, add \$38 P1, \$40 P2, \$42 P3 paint grades

# Monolithic Panels

## Tile to Floor One Side

### Worksurface Height, 36" and 42" High

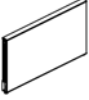
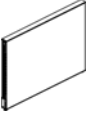
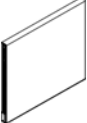
description	h	w	d	pattern no.	grade							
					10	15	20	25	30	35	40	45
Worksurface Height, Monolithic Tile to Floor 	28 1/2"	15"	3"	<b>DP7CMMFRWH15</b>	\$388.	\$402.	\$418.	\$423.	\$438.	\$444.	\$451.	\$460.
	28 1/2"	18"	3"	<b>DP7CMMFRWH18</b>	388.	402.	418.	423.	438.	444.	450.	460.
	28 1/2"	24"	3"	<b>DP7CMMFRWH24</b>	432.	444.	464.	471.	482.	490.	499.	509.
	28 1/2"	30"	3"	<b>DP7CMMFRWH30</b>	452.	466.	486.	494.	506.	515.	523.	536.
	28 1/2"	36"	3"	<b>DP7CMMFRWH36</b>	506.	522.	547.	554.	571.	580.	589.	604.
	28 1/2"	42"	3"	<b>DP7CMMFRWH42</b>	560.	577.	604.	614.	629.	640.	650.	668.
	28 1/2"	48"	3"	<b>DP7CMMFRWH48</b>	592.	609.	636.	646.	664.	675.	687.	703.
	28 1/2"	60"	3"	<b>DP7CMMFRWH60</b>	705.	724.	757.	771.	793.	807.	820.	838.
36" High, Monolithic Tile to Floor 	35 1/8"	15"	3"	<b>DP7CMMFR3615</b>	388.	402.	418.	423.	438.	444.	450.	460.
	35 1/8"	18"	3"	<b>DP7CMMFR3618</b>	388.	402.	418.	423.	438.	444.	450.	460.
	35 1/8"	24"	3"	<b>DP7CMMFR3624</b>	432.	444.	464.	471.	482.	490.	499.	509.
	35 1/8"	30"	3"	<b>DP7CMMFR3630</b>	452.	466.	486.	494.	506.	515.	523.	536.
	35 1/8"	36"	3"	<b>DP7CMMFR3636</b>	506.	522.	547.	554.	571.	580.	589.	604.
	35 1/8"	42"	3"	<b>DP7CMMFR3642</b>	560.	577.	604.	614.	629.	640.	650.	668.
	35 1/8"	48"	3"	<b>DP7CMMFR3648</b>	592.	609.	636.	646.	664.	675.	687.	703.
	35 1/8"	60"	3"	<b>DP7CMMFR3660</b>	705.	724.	757.	771.	793.	807.	820.	838.
42" High, Monolithic Tile to Floor 	42 3/16"	15"	3"	<b>DP7CMMFR4215</b>	406.	418.	438.	445.	455.	464.	471.	481.
	42 3/16"	18"	3"	<b>DP7CMMFR4218</b>	406.	418.	438.	445.	455.	464.	471.	481.
	42 3/16"	24"	3"	<b>DP7CMMFR4224</b>	438.	449.	470.	476.	489.	498.	504.	517.
	42 3/16"	30"	3"	<b>DP7CMMFR4230</b>	476.	490.	513.	522.	536.	546.	553.	569.
	42 3/16"	36"	3"	<b>DP7CMMFR4236</b>	518.	533.	557.	569.	583.	592.	602.	615.
	42 3/16"	42"	3"	<b>DP7CMMFR4242</b>	571.	586.	613.	623.	639.	650.	662.	677.
	42 3/16"	48"	3"	<b>DP7CMMFR4248</b>	603.	619.	648.	660.	677.	688.	699.	718.
	42 3/16"	60"	3"	<b>DP7CMMFR4260</b>	718.	738.	772.	787.	808.	821.	834.	854.



Dimensions listed under h w d are actual to the nearest 1/16"

Ordering Information	Order Code	Included with:	Options
<b>Monolithic Panel with Tile to Floor:</b> 1. Pattern Number 2. Top cap type 3. Top cap finish 4. Raceway knockout option 5. Base raceway finish 6. Panel fabric	<b>Monolithic Panel with Tile to Floor</b> <i>Example:</i> <b>DP7CMMFR 3618</b> <b>4/117/K/117/B191</b> <hr/> <b>DP7</b> Dividends Horizon Panel <hr/> <b>C</b> Topway frame <hr/> <b>MM</b> Monolithic both sides <hr/> <b>FR</b> Tile to Floor <hr/> <b>4</b> Radius Metal top cap <hr/> <b>117</b> Soft Grey top cap finish <hr/> <b>K</b> Base raceway with knockouts one side <hr/> <b>117</b> Soft Grey base raceway finish <hr/> <b>B191</b> Fairfield light fabric	<b>Monolithic Panel with Tile to Floor:</b> <ul style="list-style-type: none"> <li>Panel frame</li> <li>Acoustic panel inserts (2)</li> <li>Top cap</li> <li>Connection hardware</li> <li>Base raceway on one side</li> </ul> <b>Note:</b> Preconfigured Worksurface Height panels are not available with plastic top caps.	<b>Monolithic Panel with Tile to Floor:</b> <b>Full View Frame Option:</b> To specify full view frame for window or stacking applications, replace the "C" in pattern number with "V". No upcharge. <b>Tile to Floor Side Option:</b> Tile to Floor standard on side 2. To specify tile to floor on side 1, change "FR" in pattern number to "RF". <b>Top Cap Options:</b> (2) = Extruded Plastic (Smooth Radius) (3) = No Top Cap (4) = Radius Metal, add \$38 P1, \$40 P2, \$42 P3 (5) = Flat Metal, add \$38 P1, \$40 P2, \$42 P3 paint grades <b>Raceway Knockout Options:</b> (K) = Knockouts on raceway side (N) = No Knockouts

# Monolithic Panels

## Tile to Floor One Side

### 50", 57" and 64" High

description	h	w	d	pattern no.	grade							
					10	15	20	25	30	35	40	45
50" High, Monolithic Tile to Floor 	49 1/2"	15"	3"	<b>DP7CMMFR5015</b>	\$432.	\$444.	\$464.	\$471.	\$482.	\$490.	\$499.	\$509.
	49 1/2"	18"	3"	<b>DP7CMMFR5018</b>	432.	444.	464.	471.	482.	490.	499.	509.
	49 1/2"	24"	3"	<b>DP7CMMFR5024</b>	466.	479.	500.	508.	521.	528.	538.	551.
	49 1/2"	30"	3"	<b>DP7CMMFR5030</b>	512.	526.	550.	559.	576.	585.	594.	609.
	49 1/2"	36"	3"	<b>DP7CMMFR5036</b>	560.	577.	604.	614.	629.	640.	650.	668.
	49 1/2"	42"	3"	<b>DP7CMMFR5042</b>	615.	632.	662.	674.	692.	703.	713.	730.
	49 1/2"	48"	3"	<b>DP7CMMFR5048</b>	663.	681.	712.	725.	744.	756.	768.	789.
	49 1/2"	60"	3"	<b>DP7CMMFR5060</b>	789.	812.	849.	864.	886.	903.	917.	938.
57" High, Monolithic Tile to Floor 	56 13/16"	15"	3"	<b>DP7CMMFR5715</b>	464.	476.	498.	505.	520.	527.	536.	550.
	56 13/16"	18"	3"	<b>DP7CMMFR5718</b>	464.	476.	498.	505.	520.	527.	536.	550.
	56 13/16"	24"	3"	<b>DP7CMMFR5724</b>	499.	512.	536.	546.	559.	570.	579.	592.
	56 13/16"	30"	3"	<b>DP7CMMFR5730</b>	551.	569.	593.	604.	619.	629.	639.	656.
	56 13/16"	36"	3"	<b>DP7CMMFR5736</b>	602.	619.	646.	660.	676.	687.	698.	714.
	56 13/16"	42"	3"	<b>DP7CMMFR5742</b>	651.	671.	702.	713.	732.	744.	745.	777.
	56 13/16"	48"	3"	<b>DP7CMMFR5748</b>	700.	720.	754.	767.	788.	800.	814.	834.
	56 13/16"	60"	3"	<b>DP7CMMFR5760</b>	790.	813.	851.	866.	888.	904.	918.	940.
64" High, Monolithic Tile to Floor 	64 1/16"	15"	3"	<b>DP7CMMFR6415</b>	494.	506.	531.	540.	553.	563.	574.	586.
	64 1/16"	18"	3"	<b>DP7CMMFR6418</b>	494.	506.	531.	540.	553.	563.	574.	586.
	64 1/16"	24"	3"	<b>DP7CMMFR6424</b>	531.	547.	573.	581.	595.	606.	616.	631.
	64 1/16"	30"	3"	<b>DP7CMMFR6430</b>	590.	608.	635.	645.	662.	673.	685.	700.
	64 1/16"	36"	3"	<b>DP7CMMFR6436</b>	640.	660.	690.	700.	721.	730.	744.	761.
	64 1/16"	42"	3"	<b>DP7CMMFR6442</b>	688.	708.	740.	754.	772.	788.	799.	821.
	64 1/16"	48"	3"	<b>DP7CMMFR6448</b>	739.	759.	796.	811.	831.	847.	858.	883.
	64 1/16"	60"	3"	<b>DP7CMMFR6460</b>	881.	906.	950.	963.	992.	1,008.	1,025.	1,051.

Dimensions listed under h w d are actual to the nearest 1/16"

Ordering Information	Order Code	Included with:	Options
<b>Monolithic Panel with Tile to Floor:</b> 1. Pattern Number 2. Top cap type 3. Top cap finish 4. Raceway knockout option 5. Base raceway finish 6. Panel fabric	<b>Monolithic Panel with Tile to Floor</b> <i>Example:</i> <b>DP7CMMFR 3618</b> <b>4/117/K/117/B191</b> <hr/> <b>DP7</b> Dividends Horizon Panel <hr/> <b>C</b> Topway frame <hr/> <b>MM</b> Monolithic both sides <hr/> <b>FR</b> Tile to Floor <hr/> <b>4</b> Radius Metal top cap <hr/> <b>117</b> Soft Grey top cap finish <hr/> <b>K</b> Base raceway with knockouts one side <hr/> <b>117</b> Soft Grey raceway finish <hr/> <b>B191</b> Fairfield light fabric	<b>Monolithic Panel with Tile to Floor:</b> <ul style="list-style-type: none"> <li>Panel frame</li> <li>Acoustic panel inserts (2)</li> <li>Top cap</li> <li>Connection hardware</li> <li>Base raceway on one side</li> </ul>	<b>Monolithic Panel with Tile to Floor:</b> <b>Full View Frame Option:</b> To specify full view frame for window or stacking applications, replace the "C" in pattern number with "V". No upcharge.  <b>Tile to Floor Side Option:</b> Tile to Floor standard on side 2. To specify tile to floor on side 1, change "FR" in pattern number to "RF".  <b>Top Cap Options:</b> <b>(2)</b> = Extruded Plastic (Smooth Radius) <b>(3)</b> = No Top Cap <b>(4)</b> = Radius Metal, add \$38 P1, \$40 P2, \$42 P3 <b>(5)</b> = Flat Metal, add \$38 P1, \$40 P2, \$42 P3 paint grades  <b>Raceway Knockout Options:</b> <b>(K)</b> = Knockouts on raceway side <b>(N)</b> = No Knockouts

# Monolithic Panels

## Tile to Floor One Side

### 78" High

description	h	w	d	pattern no.	grade							
					10	15	20	25	30	35	40	45
78" High, Monolithic Tile to Floor	78 <sup>1</sup> / <sub>16</sub> "	15"	3"	<b>DP7CMMFR7815</b>	\$693.	\$712.	\$746.	\$758.	\$782.	\$793.	\$805.	\$825.
	78 <sup>1</sup> / <sub>16</sub> "	18"	3"	<b>DP7CMMFR7818</b>	693.	712.	746.	758.	782.	793.	805.	825.
	78 <sup>1</sup> / <sub>16</sub> "	24"	3"	<b>DP7CMMFR7824</b>	760.	786.	822.	835.	857.	870.	887.	911.
	78 <sup>1</sup> / <sub>16</sub> "	30"	3"	<b>DP7CMMFR7830</b>	824.	848.	887.	903.	927.	945.	958.	982.
	78 <sup>1</sup> / <sub>16</sub> "	36"	3"	<b>DP7CMMFR7836</b>	897.	925.	966.	984.	1,012.	1,028.	1,046.	1,072.
	78 <sup>1</sup> / <sub>16</sub> "	42"	3"	<b>DP7CMMFR7842</b>	970.	1,001.	1,050.	1,067.	1,093.	1,112.	1,133.	1,161.
	78 <sup>1</sup> / <sub>16</sub> "	48"	3"	<b>DP7CMMFR7848</b>	1,035.	1,066.	1,117.	1,135.	1,166.	1,186.	1,206.	1,235.



Dimensions listed under h w d are actual to the nearest 1/16"

Ordering Information	Order Code	Included with:	Options
<b>Monolithic Panel with Tile to Floor:</b> 1. Pattern Number 2. Top cap type 3. Top cap finish 4. Raceway knockout option 5. Base raceway finish 6. Panel fabric	<b>Monolithic Panel with Tile to Floor</b> <i>Example:</i> <b>DP7CMMFR 3618</b> <b>4/117/K/117/B191</b> <hr/> <b>DP7</b> Dividends Horizon Panel <hr/> <b>C</b> Topway frame <hr/> <b>MM</b> Monolithic both sides <hr/> <b>FR</b> Tile to Floor <hr/> <b>4</b> Radius Metal top cap <hr/> <b>117</b> Soft Grey top cap finish <hr/> <b>K</b> Base raceway with knockouts one side <hr/> <b>117</b> Soft Grey raceway finish <hr/> <b>B191</b> Fairfield light fabric	<b>Monolithic Panel with Tile to Floor:</b> <ul style="list-style-type: none"> <li>Panel frame</li> <li>Acoustic panel inserts (2)</li> <li>Top cap</li> <li>Connection hardware</li> <li>Base raceway on one side</li> </ul>	<b>Monolithic Panel with Tile to Floor:</b> <b>Full View Frame Option:</b> To specify full view frame for window or stacking applications, replace the "C" in pattern number with "V". No upcharge.  <b>Tile to Floor Side Option:</b> Tile to Floor standard on side 2. To specify tile to floor on side 1, change "FR" in pattern number to "RF".  <b>Top Cap Options:</b> <b>(2)</b> = Extruded Plastic (Smooth Radius) <b>(3)</b> = No Top Cap <b>(4)</b> = Radius Metal, add \$38 P1, \$40 P2, \$42 P3 <b>(5)</b> = Flat Metal, add \$38 P1, \$40 P2, \$42 P3 paint grades  <b>Raceway Knockout Options:</b> <b>(K)</b> = Knockouts on raceway side <b>(N)</b> = No Knockouts

### Tiled Panel Components

"Preconfigured" Dividends Horizon tiled panels ship completely assembled with a topway or full view panel frame, choice of standard base options including a standard raceway, open base, and tile to the floor. Also, included with every tiled panel are the panel-to-panel connection hardware, top cap, tile inserts and supports.

### Tiled Panel Insert Construction

Fabric laminated with roll coat adhesive, heat-cured to 7/16" thick tackable acoustical board.

### One-Sided Tiled Panel

Tiled panels are available with fabric tiled inserts attached to one or both panel sides. Non-tiled panel side will have a monolithic insert.

### Tiled Panel Insert Supports

All Dividends Horizon panel frames are prepunched to accept tiled panel insert supports which span horizontally across the panel frame. Tiled panel insert supports are mounted above a tiled insert with the exception of the uppermost tile. D2 style recessed insert supports are available in black only.

### Tiled Panel Insert Attachment

Tiled panel inserts attach to the troughs in the horizontal panel frame and tiled insert supports. Mounting clips are attached to inserts for connection to frame for additional support. No tools are required for attachment.

### Top Cap Options

Three Top Cap Options Available:

- Smooth Radius Plastic
- Radius Metal
- Flat Metal

### Top Cap Construction

Smooth radiused plastic top caps are made from extruded plastic. Radius metal and flat metal top caps are made from extruded aluminum.

### Top Cap Attachment

Snaps onto the trough of a topway panel frame. Retainer clips are included to attach top caps to full view frames.

### Preconfigured Tiled Panel

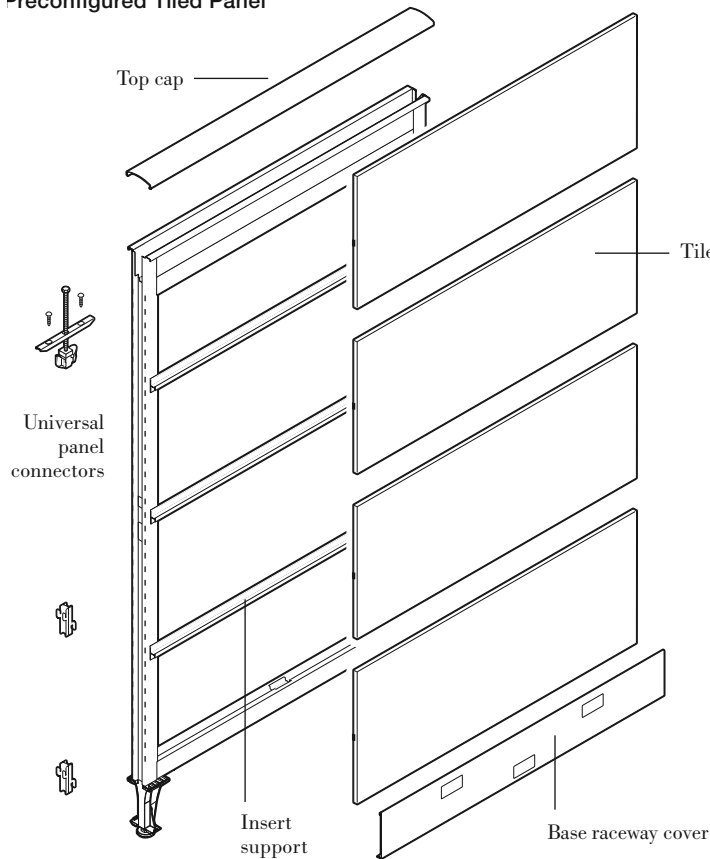

### Tiled Panel Standard Configurations

Tiled panels include the following inserts and insert supports per panel side:

- 36" High**
- Two 14"H tiles
  - One tile supports

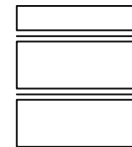
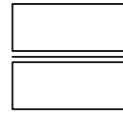

- 42" High**
- One 7"H tile and two 14"H tiles
  - Two tile supports

- 50" High**
- Three 14"H tiles
  - Two tile supports

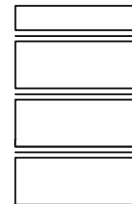
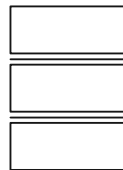

- 57" High**
- One 7"H tile and three 14"H tiles
  - Three tile supports

- 64" High**
- Four 14"H tiles
  - Three tile supports

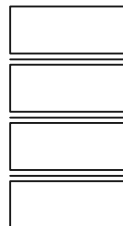

- 78" High**
- Five 14"H tiles
  - Four tile supports

## Panel Base Options

Dividends Horizon panels are available with three base options:

- Base Raceway
- Open Base
- Tile-to-Floor

Overall panel heights, tile configurations and application rules are the same for all three base options.

**Base Raceway** panels feature two roll formed steel raceway covers, which are available with or without electrical/data knockouts.

**Open Base** panels feature two extruded aluminum feet with triangular profile, positioned at the end of each panel. Open base panels offer a lighter aesthetic and improved ventilation over raceway panels.

**Tile-To-Floor** panels eliminate the raceway cover and access on one side, replaced by a fabric tile extended to the floor. A heavy gauge steel internal raceway cover protects the raceway contents and the tile from deflecting when hit by shoes or vacuum cleaners. The other side of the panel features a raceway cover, available with or without electrical/data knockouts. If electrical access is required, one-sided electrical and one-sided base cable trays must be used.

## Open Position Planner

Dividends Horizon now offers an industry leading technology called Open Position Planner, allowing customers and dealers to design, specify and order factory-assembled Dividends Horizon panel frames in virtually any configuration.

This powerful specification tool eliminates the need for built-to-spec panels. Since panels arrive at the job site assembled, installation labor is also reduced.

The functionality of Open Position Planner is available only to Electronic Specification users, and is not available in this price list.

Panels may be ordered by component throughout the “Built-to-Spec” option, allowing personalized combinations of the tile types and colors.

**Note:** Standard configurations of “Preconfigured” tiled panels are also available with 28” base tiles with a standard base raceway, open base or tile to the floor options.

**Note:** Overheads can only be attached to the upper most position of tiled panels. On 78” high panels the overhead may be positioned on the 4th or 5th tile location from the bottom, but not both locations of a single panel.

**Note:** Insert dimensions are nominal

## Panel Base Options

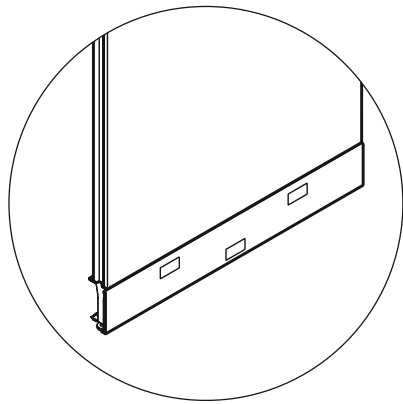

Base Raceway

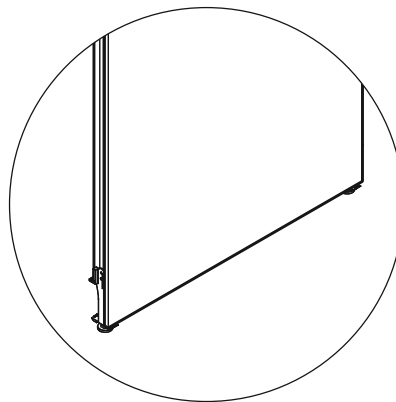

Tile-to-Floor  
(single-sided only)

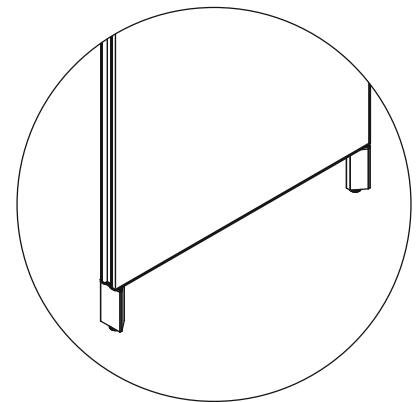



Open Base

# Tiled Panels

## Base Raceway

### 36", 42" and 50" High

Dividends Horizon

description	h	w	d	pattern no.	grade								Deduct for Monolithic One Side
					10	15	20	25	30	35	40	45	
 36" High Tiled Standard Base Raceway	35 1/8"	15"	3"	<b>DP7CTTRR3615</b>	\$578.	\$594.	\$625.	\$636.	\$653.	\$664.	\$675.	\$692.	\$85.
	35 1/8"	18"	3"	<b>DP7CTTRR3618</b>	578.	594.	625.	636.	653.	664.	675.	692.	85.
	35 1/8"	24"	3"	<b>DP7CTTRR3624</b>	614.	633.	664.	676.	693.	706.	719.	736.	86.
	35 1/8"	30"	3"	<b>DP7CTTRR3630</b>	652.	671.	701.	717.	734.	752.	762.	782.	87.
	35 1/8"	36"	3"	<b>DP7CTTRR3636</b>	714.	731.	768.	787.	804.	821.	834.	855.	89.
	35 1/8"	42"	3"	<b>DP7CTTRR3642</b>	765.	789.	825.	839.	864.	881.	895.	920.	88.
	35 1/8"	48"	3"	<b>DP7CTTRR3648</b>	802.	825.	866.	884.	905.	923.	937.	964.	90.
	35 1/8"	60"	3"	<b>DP7CTTRR3660</b>	963.	992.	1,040.	1,058.	1,087.	1,105.	1,126.	1,153.	92.
 42" High Tiled Standard Base Raceway	42 3/16"	15"	3"	<b>DP7CTTRR4215</b>	593.	610.	641.	653.	671.	681.	693.	712.	85.
	42 3/16"	18"	3"	<b>DP7CTTRR4218</b>	593.	610.	641.	653.	671.	681.	693.	712.	85.
	42 3/16"	24"	3"	<b>DP7CTTRR4224</b>	630.	649.	679.	692.	711.	723.	735.	756.	86.
	42 3/16"	30"	3"	<b>DP7CTTRR4230</b>	675.	694.	728.	746.	763.	778.	791.	813.	87.
	42 3/16"	36"	3"	<b>DP7CTTRR4236</b>	723.	748.	782.	796.	817.	831.	848.	866.	89.
	42 3/16"	42"	3"	<b>DP7CTTRR4242</b>	775.	797.	835.	852.	873.	890.	902.	927.	88.
	42 3/16"	48"	3"	<b>DP7CTTRR4248</b>	816.	838.	882.	897.	922.	935.	953.	980.	90.
	42 3/16"	60"	3"	<b>DP7CTTRR4260</b>	981.	1,010.	1,058.	1,077.	1,107.	1,127.	1,145.	1,175.	92.
 50" High Tiled Standard Base Raceway	49 1/2"	15"	3"	<b>DP7CTTRR5015</b>	614.	633.	664.	676.	693.	706.	719.	736.	84.
	49 1/2"	18"	3"	<b>DP7CTTRR5018</b>	614.	633.	664.	676.	693.	706.	719.	736.	84.
	49 1/2"	24"	3"	<b>DP7CTTRR5024</b>	663.	681.	717.	727.	752.	762.	776.	795.	87.
	49 1/2"	30"	3"	<b>DP7CTTRR5030</b>	700.	723.	758.	770.	793.	805.	821.	839.	84.
	49 1/2"	36"	3"	<b>DP7CTTRR5036</b>	746.	765.	802.	819.	838.	855.	870.	893.	79.
	49 1/2"	42"	3"	<b>DP7CTTRR5042</b>	792.	817.	856.	871.	895.	913.	926.	951.	74.
	49 1/2"	48"	3"	<b>DP7CTTRR5048</b>	835.	861.	901.	921.	943.	962.	979.	1,003.	72.
	49 1/2"	60"	3"	<b>DP7CTTRR5060</b>	1,001.	1,030.	1,080.	1,101.	1,130.	1,151.	1,171.	1,201.	92.

Dimensions listed under h w d are actual to the nearest 1/8"



Ordering Information	Order Code	Included with:	Options
<b>Tiled Panel with Standard Base Raceway:</b> 1. Pattern Number 2. Top cap type 3. Top cap finish 4. Raceway knockout option 5. Raceway finish 6. Tile Support profile 7. Panel fabric	<b>Tiled Panel with Standard Base Raceway</b> <i>Example:</i> <b>DP7CTTRR3618</b> <b>4/117/K/117/2/B191</b> <hr/> <b>DP7</b> Dividends Horizon Panel <hr/> <b>C</b> Topway frame <hr/> <b>TT</b> Tiled both sides <hr/> <b>RR</b> Base raceway <hr/> <b>36</b> Height <hr/> <b>18</b> Width <hr/> <b>4</b> Radius Metal top cap <hr/> <b>117</b> Soft Grey top cap finish <hr/> <b>K</b> Base raceway with knockouts both sides <hr/> <b>117</b> Soft Grey base raceway finish <hr/> <b>2</b> D2 style tile supports <hr/> <b>B191</b> Fairfield light fabric	<b>Tiled Panel with Standard Base Raceway:</b> <ul style="list-style-type: none"> <li>• Panel frame</li> <li>• Acoustic panel inserts</li> <li>• Base raceway covers</li> <li>• Top cap</li> <li>• Connection hardware</li> </ul>	<b>Tiled Panels with Standard Base Raceway:</b> <b>Full View Frame Option:</b> To specify full view frame for window or stacking applications, replace the "C" in pattern number with "V". No upcharge.  <b>Monolithic Side Option:</b> For one side tiled, one side monolithic, change "TT" in pattern number to "MT" and deduct amount in far right column.  <b>Top Cap Options:</b> <b>(2)</b> = Extruded Plastic (Smooth Radius) <b>(3)</b> = No Top Cap <b>(4)</b> = Radius Metal, add \$38 P1, \$40 P2, \$42 P3 paint grades <b>(5)</b> = Flat Metal, add \$38 P1, \$40 P2, \$42 P3 paint grades  <b>Raceway Knockout Options:</b> <b>(K)</b> = Knockouts <b>(N)</b> = No knockouts  <b>Tile Support Options:</b> <b>(1)</b> = D1 External Reveal <b>(2)</b> = D2 Recessed Reveal



# Tiled Panels

## Base Raceway

### 57", 64" and 78" High

description	h	w	d	pattern no.	grade									deduct for Monolithic One Side
					10	15	20	25	30	35	40	45		
 57" High Tiled Standard Base Raceway	56 <sup>13</sup> / <sub>16</sub> "	15"	3"	<b>DP7CTTRR5715</b>	\$748.	\$767.	\$805.	\$820.	\$842.	\$857.	\$873.	\$895.	\$106.	
	56 <sup>13</sup> / <sub>16</sub> "	18"	3"	<b>DP7CTTRR5718</b>	748.	767.	805.	820.	842.	857.	873.	895.	106.	
	56 <sup>13</sup> / <sub>16</sub> "	24"	3"	<b>DP7CTTRR5724</b>	802.	825.	865.	882.	904.	922.	937.	963.	110.	
	56 <sup>13</sup> / <sub>16</sub> "	30"	3"	<b>DP7CTTRR5730</b>	849.	874.	918.	931.	960.	976.	993.	1,019.	113.	
	56 <sup>13</sup> / <sub>16</sub> "	36"	3"	<b>DP7CTTRR5736</b>	901.	928.	974.	993.	1,020.	1,037.	1,054.	1,084.	115.	
	56 <sup>13</sup> / <sub>16</sub> "	42"	3"	<b>DP7CTTRR5742</b>	956.	985.	1,031.	1,051.	1,079.	1,099.	1,118.	1,145.	117.	
	56 <sup>13</sup> / <sub>16</sub> "	48"	3"	<b>DP7CTTRR5748</b>	1,009.	1,040.	1,090.	1,109.	1,139.	1,159.	1,179.	1,212.	119.	
	56 <sup>13</sup> / <sub>16</sub> "	60"	3"	<b>DP7CTTRR5760</b>	1,212.	1,246.	1,307.	1,331.	1,367.	1,393.	1,416.	1,451.	121.	
 64" High Tiled Standard Base Raceway	64 <sup>1</sup> / <sub>16</sub> "	15"	3"	<b>DP7CTTRR6415</b>	790.	815.	853.	868.	893.	906.	924.	948.	127.	
	64 <sup>1</sup> / <sub>16</sub> "	18"	3"	<b>DP7CTTRR6418</b>	790.	815.	853.	868.	893.	906.	924.	948.	127.	
	64 <sup>1</sup> / <sub>16</sub> "	24"	3"	<b>DP7CTTRR6424</b>	849.	872.	918.	930.	957.	974.	992.	1,019.	134.	
	64 <sup>1</sup> / <sub>16</sub> "	30"	3"	<b>DP7CTTRR6430</b>	897.	925.	969.	988.	1,017.	1,030.	1,051.	1,077.	130.	
	64 <sup>1</sup> / <sub>16</sub> "	36"	3"	<b>DP7CTTRR6436</b>	953.	985.	1,029.	1,050.	1,077.	1,098.	1,115.	1,144.	131.	
	64 <sup>1</sup> / <sub>16</sub> "	42"	3"	<b>DP7CTTRR6442</b>	1,011.	1,041.	1,093.	1,112.	1,142.	1,162.	1,182.	1,214.	133.	
	64 <sup>1</sup> / <sub>16</sub> "	48"	3"	<b>DP7CTTRR6448</b>	1,066.	1,098.	1,149.	1,171.	1,203.	1,226.	1,246.	1,277.	134.	
	64 <sup>1</sup> / <sub>16</sub> "	60"	3"	<b>DP7CTTRR6460</b>	1,277.	1,316.	1,382.	1,407.	1,445.	1,471.	1,495.	1,535.	134.	
 78" High Tiled Standard Base Raceway	78 <sup>7</sup> / <sub>16</sub> "	15"	3"	<b>DP7CTTRR7815</b>	1,242.	1,277.	1,341.	1,365.	1,401.	1,428.	1,452.	1,489.	228.	
	78 <sup>7</sup> / <sub>16</sub> "	18"	3"	<b>DP7CTTRR7818</b>	1,242.	1,277.	1,341.	1,365.	1,401.	1,428.	1,452.	1,489.	228.	
	78 <sup>7</sup> / <sub>16</sub> "	24"	3"	<b>DP7CTTRR7824</b>	1,335.	1,373.	1,443.	1,468.	1,511.	1,536.	1,561.	1,604.	236.	
	78 <sup>7</sup> / <sub>16</sub> "	30"	3"	<b>DP7CTTRR7830</b>	1,416.	1,457.	1,525.	1,556.	1,599.	1,625.	1,656.	1,695.	230.	
	78 <sup>7</sup> / <sub>16</sub> "	36"	3"	<b>DP7CTTRR7836</b>	1,513.	1,558.	1,633.	1,662.	1,710.	1,740.	1,770.	1,815.	250.	
	78 <sup>7</sup> / <sub>16</sub> "	42"	3"	<b>DP7CTTRR7842</b>	1,604.	1,651.	1,729.	1,762.	1,812.	1,842.	1,876.	1,923.	255.	
	78 <sup>7</sup> / <sub>16</sub> "	48"	3"	<b>DP7CTTRR7848</b>	1,698.	1,751.	1,836.	1,872.	1,921.	1,955.	1,989.	2,039.	306.	

Dimensions listed under h w d are actual to the nearest 1/8"



Ordering Information	Order Code	Included with:	Options
<b>Tiled Panel with Standard Base Raceway:</b> 1. Pattern Number 2. Top cap type 3. Top cap finish 4. Raceway knockout option 5. Raceway finish 6. Tile support profile 7. Tile support finish 8. Panel fabric	<b>Tiled Panel with Standard Base Raceway</b> <i>Example:</i> <b>DP7CTTRR3618</b> <b>4/117/K/117/2/B191</b> <hr/> <b>DP7</b> Dividends Horizon Panel <hr/> <b>C</b> Topway frame <hr/> <b>TT</b> Tiled both sides <hr/> <b>RR</b> Base raceway <hr/> <b>36</b> Height <hr/> <b>18</b> Width <hr/> <b>4</b> Radius Metal top cap <hr/> <b>117</b> Soft Grey top cap finish <hr/> <b>K</b> Base raceway with knockouts both sides <hr/> <b>117</b> Soft Grey base raceway finish <hr/> <b>2</b> D2 style tile supports <hr/> <b>B191</b> Fairfield light fabric	<b>Tiled Panel with Standard Base Raceway:</b> <ul style="list-style-type: none"> <li>• Panel frame</li> <li>• Acoustic panel inserts</li> <li>• Base raceway covers</li> <li>• Top cap</li> <li>• Connection hardware</li> </ul>	<b>Tiled Panels with Standard Base Raceway:</b> <b>Full View Frame Option:</b> To specify full view frame for window or stacking applications, replace the "C" in pattern number with "V". No upcharge.  <b>Monolithic Side Option:</b> For one side tiled, one side monolithic, change "TT" in pattern number to "MT" and deduct amount in far right column.  <b>Top Cap Options:</b> <b>(2)</b> = Extruded Plastic (Smooth Radius) <b>(3)</b> = No Top Cap <b>(4)</b> = Radius Metal, add \$38 P1, \$40 P2, \$42 P3 paint grades <b>(5)</b> = Flat Metal, add \$38 P1, \$40 P2, \$42 P3 paint grades  <b>Raceway Knockout Options:</b> <b>(K)</b> = Knockouts <b>(N)</b> = No knockouts  <b>Tile Support Options:</b> <b>(1)</b> = D1 External Reveal <b>(2)</b> = D2 Recessed Reveal

# Tiled Panels

## Open Base

### 36", 42" and 50" High

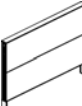
Dividends Horizon

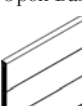
description	h	w	d	pattern no.									Deduct for Monolithic One Side
					10	15	20	25	30	35	40	45	
36" High Tiled Open Base 	35 1/8"	18"	3"	<b>DP7CTTLL3618</b>	\$578.	\$594.	\$625.	\$636.	\$653.	\$664.	\$675.	\$692.	\$85.
	35 1/8"	24"	3"	<b>DP7CTTLL3624</b>	614.	633.	664.	676.	693.	706.	719.	736.	86.
	35 1/8"	30"	3"	<b>DP7CTTLL3630</b>	652.	671.	701.	717.	734.	752.	762.	782.	87.
	35 1/8"	36"	3"	<b>DP7CTTLL3636</b>	714.	731.	768.	787.	804.	821.	834.	855.	89.
	35 1/8"	42"	3"	<b>DP7CTTLL3642</b>	765.	789.	825.	839.	864.	881.	895.	920.	88.
	35 1/8"	48"	3"	<b>DP7CTTLL3648</b>	802.	825.	866.	884.	905.	923.	937.	964.	90.
	35 1/8"	60"	3"	<b>DP7CTTLL3660</b>	963.	992.	1,040.	1,058.	1,087.	1,105.	1,126.	1,153.	92.
42" High Tiled Open Base 	42 3/16"	18"	3"	<b>DP7CTTLL4218</b>	593.	610.	641.	653.	671.	681.	693.	712.	85.
	42 3/16"	24"	3"	<b>DP7CTTLL4224</b>	630.	649.	679.	692.	711.	723.	735.	756.	86.
	42 3/16"	30"	3"	<b>DP7CTTLL4230</b>	675.	694.	728.	746.	763.	778.	791.	813.	87.
	42 3/16"	36"	3"	<b>DP7CTTLL4236</b>	723.	748.	782.	796.	817.	831.	848.	866.	89.
	42 3/16"	42"	3"	<b>DP7CTTLL4242</b>	775.	797.	835.	852.	873.	890.	902.	927.	88.
	42 3/16"	48"	3"	<b>DP7CTTLL4248</b>	816.	838.	882.	897.	922.	935.	953.	980.	90.
	42 3/16"	60"	3"	<b>DP7CTTLL4260</b>	981.	1,010.	1,058.	1,077.	1,107.	1,127.	1,145.	1,175.	92.
50" High Tiled Open Base 	49 1/2"	18"	3"	<b>DP7CTTLL5018</b>	614.	633.	664.	676.	693.	706.	719.	736.	85.
	49 1/2"	24"	3"	<b>DP7CTTLL5024</b>	663.	681.	717.	727.	752.	762.	776.	795.	87.
	49 1/2"	30"	3"	<b>DP7CTTLL5030</b>	700.	723.	758.	770.	793.	805.	821.	839.	85.
	49 1/2"	36"	3"	<b>DP7CTTLL5036</b>	746.	765.	802.	819.	838.	855.	870.	893.	79.
	49 1/2"	42"	3"	<b>DP7CTTLL5042</b>	792.	817.	856.	871.	895.	913.	926.	951.	74.
	49 1/2"	48"	3"	<b>DP7CTTLL5048</b>	835.	861.	901.	921.	943.	962.	979.	1,003.	72.
	49 1/2"	60"	3"	<b>DP7CTTLL5060</b>	1,001.	1,030.	1,080.	1,101.	1,130.	1,151.	1,171.	1,201.	92.



Dimensions listed under h w d are actual to the nearest 1/8"

Ordering Information	Order Code	Included with:	Options
<b>Tiled Panel with Open Base:</b> 1. Pattern Number 2. Top cap type 3. Top Cap finish 4. Base finish 5. Tile support profile 6. Panel fabric	<b>Tiled Panel with Open Base</b> <i>Example:</i> <b>DP7CTTLL3618</b> <b>4/117/117/2/B191</b> <hr/> <b>DP7</b> Dividends Horizon Panel <hr/> <b>C</b> Topway frame <hr/> <b>TT</b> Tiled both sides <hr/> <b>LL</b> Open base <hr/> <b>36</b> Height <hr/> <b>18</b> Width <hr/> <b>4</b> Radius Metal top cap <hr/> <b>117</b> Soft Grey top cap finish <hr/> <b>117</b> Soft Grey base finish <hr/> <b>2</b> D2 style tile supports <hr/> <b>B191</b> Fairfield light fabric	<b>Tiled Panel with Open Base:</b> <ul style="list-style-type: none"> <li>Panel frame</li> <li>Acoustic panel inserts</li> <li>Open base</li> <li>Top cap</li> <li>Connection hardware</li> </ul>	<b>Tiled Panel with Open Base:</b> <b>Full View Frame Option:</b> To specify full view frame for window or stacking applications, replace the "C" in pattern number with "V". No upcharge.  <b>Monolithic Side Option:</b> For one side tiled, one side monolithic, change "TT" in pattern number to "MT" and deduct amount in far right column.  <b>Top Cap Options:</b> <b>(2)</b> = Extruded Plastic (Smooth Radius) <b>(3)</b> = No Top Cap <b>(4)</b> = Radius Metal, add \$38 P1, \$40 P2, \$42 P3 paint grades <b>(5)</b> = Flat Metal, add \$38 P1, \$40 P2, \$42 P3 paint grades  <b>Tile Support Options:</b> <b>(1)</b> = D1 External Reveal <b>(2)</b> = D2 Recessed Reveal

# Tiled Panels

## Open Base

### 57", 64" and 78" High

description	h	w	d	pattern no.	10	15	20	25	30	35	40	45	deduct for Monolithic One Side
57" High Tiled Open Base 	56 <sup>13</sup> / <sub>16</sub> "	18"	3"	<b>DP7CTTLL5718</b>	\$748.	\$767.	\$805.	\$820.	\$842.	\$857.	\$873.	\$895.	\$106.
	56 <sup>13</sup> / <sub>16</sub> "	24"	3"	<b>DP7CTTLL5724</b>	802.	825.	865.	882.	904.	922.	937.	963.	110.
	56 <sup>13</sup> / <sub>16</sub> "	30"	3"	<b>DP7CTTLL5730</b>	849.	874.	918.	931.	960.	976.	993.	1,019.	113.
	56 <sup>13</sup> / <sub>16</sub> "	36"	3"	<b>DP7CTTLL5736</b>	901.	928.	974.	993.	1,020.	1,037.	1,054.	1,084.	115.
	56 <sup>13</sup> / <sub>16</sub> "	42"	3"	<b>DP7CTTLL5742</b>	956.	985.	1,031.	1,051.	1,079.	1,099.	1,118.	1,145.	117.
	56 <sup>13</sup> / <sub>16</sub> "	48"	3"	<b>DP7CTTLL5748</b>	1,009.	1,040.	1,090.	1,109.	1,139.	1,159.	1,179.	1,212.	119.
	56 <sup>13</sup> / <sub>16</sub> "	60"	3"	<b>DP7CTTLL5760</b>	1,212.	1,246.	1,307.	1,331.	1,367.	1,393.	1,416.	1,451.	121.
64" High Tiled Open Base 	64 <sup>1</sup> / <sub>16</sub> "	18"	3"	<b>DP7CTTLL6418</b>	790.	815.	853.	868.	893.	906.	924.	948.	127.
	64 <sup>1</sup> / <sub>16</sub> "	24"	3"	<b>DP7CTTLL6424</b>	849.	872.	918.	930.	957.	974.	992.	1,019.	134.
	64 <sup>1</sup> / <sub>16</sub> "	30"	3"	<b>DP7CTTLL6430</b>	897.	925.	969.	988.	1,017.	1,030.	1,051.	1,077.	130.
	64 <sup>1</sup> / <sub>16</sub> "	36"	3"	<b>DP7CTTLL6436</b>	953.	985.	1,029.	1,050.	1,077.	1,098.	1,115.	1,144.	131.
	64 <sup>1</sup> / <sub>16</sub> "	42"	3"	<b>DP7CTTLL6442</b>	1,011.	1,041.	1,093.	1,112.	1,142.	1,162.	1,182.	1,214.	133.
	64 <sup>1</sup> / <sub>16</sub> "	48"	3"	<b>DP7CTTLL6448</b>	1,066.	1,098.	1,149.	1,171.	1,203.	1,226.	1,246.	1,277.	134.
	64 <sup>1</sup> / <sub>16</sub> "	60"	3"	<b>DP7CTTLL6460</b>	1,277.	1,316.	1,382.	1,407.	1,445.	1,471.	1,495.	1,535.	134.
78" High Tiled Open Base 	78 <sup>7</sup> / <sub>16</sub> "	18"	3"	<b>DP7CTTLL7818</b>	1,242.	1,277.	1,341.	1,365.	1,401.	1,428.	1,452.	1,489.	228.
	78 <sup>7</sup> / <sub>16</sub> "	24"	3"	<b>DP7CTTLL7824</b>	1,335.	1,373.	1,443.	1,468.	1,511.	1,536.	1,561.	1,604.	236.
	78 <sup>7</sup> / <sub>16</sub> "	30"	3"	<b>DP7CTTLL7830</b>	1,416.	1,457.	1,525.	1,556.	1,599.	1,625.	1,656.	1,695.	230.
	78 <sup>7</sup> / <sub>16</sub> "	36"	3"	<b>DP7CTTLL7836</b>	1,513.	1,558.	1,633.	1,662.	1,710.	1,740.	1,770.	1,815.	250.
	78 <sup>7</sup> / <sub>16</sub> "	42"	3"	<b>DP7CTTLL7842</b>	1,604.	1,651.	1,729.	1,762.	1,812.	1,842.	1,876.	1,923.	255.
	78 <sup>7</sup> / <sub>16</sub> "	48"	3"	<b>DP7CTTLL7848</b>	1,698.	1,751.	1,836.	1,872.	1,921.	1,955.	1,989.	2,039.	306.

Dimensions listed under h w d are actual to the nearest 1/8"

#### Ordering Information

##### Tiled Panel with Open Base:

1. Pattern Number
2. Top cap type
3. Top Cap finish
4. Base finish
5. Tile support profile
6. Panel fabric

#### Order Code

##### Tiled Panel with Open Base

*Example:* **DP7CTTLL3618**  
**4/117/117/2/B191**

<b>DP7</b>	Dividends Horizon Panel
<b>C</b>	Topway frame
<b>TT</b>	Tiled both sides
<b>LL</b>	Open base
<b>36</b>	Height
<b>18</b>	Width
<b>4</b>	Radius Metal top cap
<b>117</b>	Soft Grey top cap finish
<b>117</b>	Soft Grey base finish
<b>2</b>	D2 style tile supports
<b>B191</b>	Fairfield light fabric

#### Included with:

##### Tiled Panel with Open Base:

- Panel frame
- Acoustic panel inserts
- Open base
- Top cap
- Connection hardware

#### Options

##### Tiled Panel with Open Base:

###### Full View Frame Option:

To specify full view frame for window or stacking applications, replace the "C" in pattern number with "V". No upcharge.

###### Monolithic Side Option:

For one side tiled, one side monolithic, change "TT" in pattern number to "MT" and deduct amount in far right column.

###### Top Cap Options:

- (2) = Extruded Plastic (Smooth Radius)
- (3) = No Top Cap
- (4) = Radius Metal, add \$38 P1, \$40 P2, \$42 P3 paint grades
- (5) = Flat Metal, add \$38 P1, \$40 P2, \$42 P3 paint grades

###### Tile Support Options:

- (1) = D1 External Reveal
- (2) = D2 Recessed Reveal

# Tiled Panels

## Tile To Floor One Side

### 36" and 42" High

Dividends Horizon

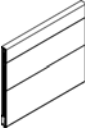
description	h	w	d	pattern no.									Deduct for
					10	15	20	25	30	35	40	45	Monolithic One Sideide 1
36" High Tiled Panel Tile to Floor One Side 	35 1/8"	15"	3"	<b>DP7CTTFR3615</b>	\$610.	\$626.	\$657.	\$668.	\$685.	\$696.	\$707.	\$724.	\$85.
	35 1/8"	18"	3"	<b>DP7CTTFR3618</b>	610.	626.	657.	668.	685.	696.	707.	724.	85.
	35 1/8"	24"	3"	<b>DP7CTTFR3624</b>	646.	665.	696.	708.	725.	738.	751.	768.	86.
	35 1/8"	30"	3"	<b>DP7CTTFR3630</b>	684.	703.	733.	749.	766.	784.	794.	814.	87.
	35 1/8"	36"	3"	<b>DP7CTTFR3636</b>	746.	763.	800.	819.	836.	853.	866.	887.	89.
	35 1/8"	42"	3"	<b>DP7CTTFR3642</b>	797.	821.	857.	871.	896.	913.	927.	952.	88.
	35 1/8"	48"	3"	<b>DP7CTTFR3648</b>	834.	857.	898.	916.	937.	955.	969.	996.	90.
	35 1/8"	60"	3"	<b>DP7CTTFR3660</b>	995.	1,024.	1,072.	1,090.	1,119.	1,137.	1,158.	1,185.	92.
42" High Tiled Panel Tile to Floor One Side 	42 3/16"	15"	3"	<b>DP7CTTFR4215</b>	625.	642.	673.	685.	703.	713.	725.	744.	85.
	42 3/16"	18"	3"	<b>DP7CTTFR4218</b>	625.	642.	673.	685.	703.	713.	725.	744.	85.
	42 3/16"	24"	3"	<b>DP7CTTFR4224</b>	662.	681.	711.	724.	743.	755.	767.	788.	86.
	42 3/16"	30"	3"	<b>DP7CTTFR4230</b>	707.	726.	760.	778.	795.	810.	823.	845.	87.
	42 3/16"	36"	3"	<b>DP7CTTFR4236</b>	755.	780.	814.	828.	849.	863.	880.	898.	89.
	42 3/16"	42"	3"	<b>DP7CTTFR4242</b>	807.	829.	867.	884.	905.	922.	934.	959.	88.
	42 3/16"	48"	3"	<b>DP7CTTFR4248</b>	848.	870.	914.	929.	954.	967.	985.	1,012.	90.
	42 3/16"	60"	3"	<b>DP7CTTFR4260</b>	1,013.	1,042.	1,090.	1,109.	1,139.	1,159.	1,177.	1,207.	92.

Dimensions listed under h w d are actual to the nearest 1/8"

#### Ordering Information

##### Tiled Panel with Tile to Floor:

1. Pattern Number
2. Top cap type
3. Top cap finish
4. Base raceway finish
5. Tile support profile
6. Panel fabric

#### Order Code

##### Tiled Panel with Tile to Floor

*Example:* **DP7CTTFR3618**  
**4/117/K/117/2/B191**

<b>DP7</b>	Dividends Horizon Panel
<b>C</b>	Topway frame
<b>TT</b>	Tiled both sides
<b>FR</b>	Tile to floor side one, raceway side two
<b>36</b>	Height
<b>18</b>	Width
<b>4</b>	Radius Metal top cap
<b>117</b>	Soft Grey top cap finish
<b>K</b>	Knockouts for one-sided base raceway
<b>117</b>	Soft Grey base raceway finish
<b>2</b>	D2 style tile supports
<b>B191</b>	Fairfield light fabric

#### Included with:

##### Tiled Panel with Tile to Floor:

- Panel frame
- Acoustic panel inserts
- Top cap
- Connection hardware
- Base raceway with knockout one side
- Tile to the floor one side

#### Options

##### Tiled Panels With Tile To Floor One Side:

###### Full View Frame Option:

To specify full view frame for window or stacking applications, replace the "C" in pattern number with "V". No upcharge.

###### Monolithic Side Option:

For side 1 monolithic, side 2 tiled, change "TT" in pattern number to "MT" and deduct amount in far right column.

###### Tile to Floor Side Option:

Tile to floor standard on side 2. To specify tile to floor on side 1, change "FR" in pattern number to "RF".

###### Top Cap Options:

**(2)** = Extruded Plastic (Smooth Radius)  
**(3)** = No Top Cap  
**(4)** = Radius Metal, add \$38 P1, \$40 P2, \$42 P3 paint grades  
**(5)** = Flat Metal, add \$38 P1, \$40 P2, \$42 P3 paint grades

###### Raceway Knockout Options:

**(K)** = Knockouts on raceway side  
**(N)** = No knockouts on raceway side

###### Tile Support Options:

**(1)** = D1 External Reveal  
**(2)** = D2 Recessed Reveal

# Tiled Panels

## Tile To Floor One Side

### 50" and 57" High

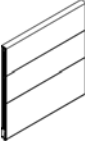
description	h	w	d	pattern no.	grade								deduct for Monolithic One Side
					10	15	20	25	30	35	40	45	
50" High Tiled Panel Tile to Floor One Side 	49 1/2"	15"	3"	<b>DP7CTTFR5015</b>	\$646.	\$665.	\$696.	\$708.	\$725.	\$738.	\$751.	\$768.	\$85.
	49 1/2"	18"	3"	<b>DP7CTTFR5018</b>	646.	665.	696.	708.	725.	738.	751.	768.	84.
	49 1/2"	24"	3"	<b>DP7CTTFR5024</b>	695.	713.	749.	759.	784.	794.	808.	827.	87.
	49 1/2"	30"	3"	<b>DP7CTTFR5030</b>	732.	755.	790.	802.	825.	837.	853.	871.	84.
	49 1/2"	36"	3"	<b>DP7CTTFR5036</b>	778.	797.	834.	851.	870.	887.	902.	925.	79.
	49 1/2"	42"	3"	<b>DP7CTTFR5042</b>	824.	849.	888.	903.	927.	945.	958.	983.	85.
	49 1/2"	48"	3"	<b>DP7CTTFR5048</b>	867.	893.	933.	953.	975.	994.	1,011.	1,035.	82.
	49 1/2"	60"	3"	<b>DP7CTTFR5060</b>	1,033.	1,062.	1,112.	1,133.	1,162.	1,183.	1,203.	1,233.	92.

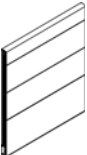
57" High Tiled Panel Tile to Floor One Side 	56 13/16"	15"	3"	<b>DP7CTTFR5715</b>	780.	799.	837.	852.	874.	889.	905.	927.	106.
	56 13/16"	18"	3"	<b>DP7CTTFR5718</b>	780.	799.	837.	852.	874.	889.	905.	927.	106.
	56 13/16"	24"	3"	<b>DP7CTTFR5724</b>	834.	857.	897.	914.	936.	954.	969.	995.	110.
	56 13/16"	30"	3"	<b>DP7CTTFR5730</b>	881.	906.	950.	963.	992.	1,008.	1,025.	1,051.	113.
	56 13/16"	36"	3"	<b>DP7CTTFR5736</b>	933.	960.	1,006.	1,025.	1,052.	1,069.	1,086.	1,116.	115.
	56 13/16"	42"	3"	<b>DP7CTTFR5742</b>	988.	1,017.	1,063.	1,083.	1,111.	1,131.	1,150.	1,177.	117.
	56 13/16"	48"	3"	<b>DP7CTTFR5748</b>	1,041.	1,072.	1,122.	1,141.	1,171.	1,191.	1,211.	1,244.	119.
	56 13/16"	60"	3"	<b>DP7CTTFR5760</b>	1,244.	1,278.	1,339.	1,363.	1,399.	1,425.	1,448.	1,483.	121.

Dimensions listed under h w d are actual to the nearest 1/8"

Ordering Information	Order Code	Included with:	Options
<b>Tiled Panel with Tile to Floor:</b> 1. Pattern Number 2. Top cap type 3. Top cap finish 4. Base raceway finish 5. Tile support profile 6. Panel fabric	<b>Tiled Panel with Tile to Floor</b> <i>Example:</i> <b>DP7CTTFR5018</b> <b>4/117/K/117/2/B191</b> <hr/> <b>DP7</b> Dividends Horizon Panel <hr/> <b>C</b> Topway frame <hr/> <b>TT</b> Tiled both sides <hr/> <b>FR</b> Tile to floor side one, raceway side two <hr/> <b>50</b> Height <hr/> <b>18</b> Width <hr/> <b>4</b> Radius Metal top cap <hr/> <b>117</b> Soft Grey top cap finish <hr/> <b>K</b> Knockouts for one-sided base raceway <hr/> <b>117</b> Soft Grey base raceway finish <hr/> <b>2</b> D2 style tile supports <hr/> <b>B191</b> Fairfield light fabric	<b>Tiled Panel with Tile to Floor:</b> <ul style="list-style-type: none"> <li>Panel frame</li> <li>Acoustic panel inserts</li> <li>Top cap</li> <li>Connection hardware</li> <li>Base raceway with knockout one side</li> <li>Tile to the floor one side</li> </ul>	<b>Tiled Panels With Tile To Floor One Side:</b> <b>Full View Frame Option:</b> To specify full view frame for window or stacking applications, replace the "C" in pattern number with "V". No upcharge. <b>Monolithic Side Options:</b> For side 1 monolithic, side 2 tiled, change "TT" in pattern number to "MT" and deduct amount in far right column. <b>Tile to Floor Side Option:</b> Tile to floor standard on side 2. To specify tile to floor on side 1, change "FR" in pattern number to "RF". <b>Top Cap Options:</b> <b>(2)</b> = Extruded Plastic (Smooth Radius) <b>(3)</b> = No Top Cap <b>(4)</b> = Radius Metal, add \$38 P1, \$40 P2, \$42 P3 paint grades <b>(5)</b> = Flat Metal, add \$38 P1, \$40 P2, \$42 P3 paint grades <b>Raceway Knockout Options:</b> <b>(K)</b> = Knockouts on raceway side <b>(N)</b> = No knockouts on raceway side <b>Tile Support Options:</b> <b>(1)</b> = D1 External Reveal <b>(2)</b> = D2 Recessed Reveal

# Tiled Panels

## Tile To Floor One Side

### 64" and 78" High

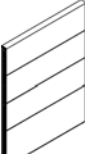
description	h	w	d	pattern no.	grade								deduct for Monolithic One Side
					10	15	20	25	30	35	40	45	
64" High Tiled Panel Tile to Floor One Side 	64 1/16"	15"	3"	<b>DP7CTTFR6415</b>	\$822.	\$847.	\$885.	\$900.	\$925.	\$938.	\$956.	\$980.	\$127.
	64 1/16"	18"	3"	<b>DP7CTTFR6418</b>	822.	847.	885.	900.	925.	938.	956.	980.	127.
	64 1/16"	24"	3"	<b>DP7CTTFR6424</b>	881.	904.	950.	962.	989.	1,006.	1,024.	1,051.	134.
	64 1/16"	30"	3"	<b>DP7CTTFR6430</b>	929.	957.	1,001.	1,020.	1,049.	1,062.	1,083.	1,109.	130.
	64 1/16"	36"	3"	<b>DP7CTTFR6436</b>	985.	1,017.	1,061.	1,082.	1,109.	1,130.	1,147.	1,176.	131.
	64 1/16"	42"	3"	<b>DP7CTTFR6442</b>	1,043.	1,073.	1,125.	1,144.	1,174.	1,194.	1,214.	1,246.	133.
	64 1/16"	48"	3"	<b>DP7CTTFR6448</b>	1,098.	1,130.	1,181.	1,203.	1,235.	1,258.	1,278.	1,309.	134.
	64 1/16"	60"	3"	<b>DP7CTTFR6460</b>	1,309.	1,348.	1,414.	1,439.	1,477.	1,503.	1,527.	1,567.	134.

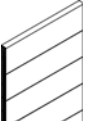
78" High Tiled Panel Tile to Floor One Side 	78 1/16"	15"	3"	<b>DP7CTTFR7815</b>	1,274.	1,309.	1,373.	1,397.	1,433.	1,460.	1,484.	1,521.	228.
	78 1/16"	18"	3"	<b>DP7CTTFR7818</b>	1,274.	1,309.	1,373.	1,397.	1,433.	1,460.	1,484.	1,521.	228.
	78 1/16"	24"	3"	<b>DP7CTTFR7824</b>	1,367.	1,405.	1,475.	1,500.	1,543.	1,568.	1,593.	1,636.	236.
	78 1/16"	30"	3"	<b>DP7CTTFR7830</b>	1,448.	1,489.	1,557.	1,588.	1,631.	1,657.	1,688.	1,727.	230.
	78 1/16"	36"	3"	<b>DP7CTTFR7836</b>	1,545.	1,590.	1,665.	1,694.	1,742.	1,772.	1,802.	1,847.	250.
	78 1/16"	42"	3"	<b>DP7CTTFR7842</b>	1,636.	1,683.	1,761.	1,794.	1,844.	1,874.	1,908.	1,955.	255.
	78 1/16"	48"	3"	<b>DP7CTTFR7848</b>	1,730.	1,783.	1,868.	1,904.	1,953.	1,987.	2,021.	2,071.	306.

Dimensions listed under h w d are actual to the nearest 1/8"

#### Ordering Information

##### Tiled Panel with Tile to Floor:

1. Pattern Number
2. Top cap type
3. Top cap finish
4. Base raceway finish
5. Tile support profile
6. Panel fabric

#### Order Code

##### Tiled Panel with Tile to Floor

*Example:* **DP7CTTFR6418**  
**4/117/K/117/2/B191**

<b>DP7</b>	Dividends Horizon Panel
<b>C</b>	Topway frame
<b>TT</b>	Tiled both sides
<b>FR</b>	Tile to floor side one, raceway side two
<b>64</b>	Height
<b>18</b>	Width
<b>4</b>	Radius Metal top cap
<b>117</b>	Soft Grey top cap finish
<b>K</b>	Knockouts for one-sided base raceway
<b>117</b>	Soft Grey base raceway finish
<b>2</b>	D2 style tile supports
<b>B191</b>	Fairfield light fabric

#### Included with:

##### Tiled Panel with Tile to Floor:

- Panel frame
- Acoustic panel inserts
- Top cap
- Connection hardware
- Base raceway with knockout one side
- Tile to the floor one side

#### Options

##### Tiled Panels With Tile To Floor One Side:

###### Full View Frame Option:

To specify full view frame for window or stacking applications, replace the "C" in pattern number with "V". No upcharge.

###### Monolithic Side Options:

For side 1 monolithic, side 2 tiled, change "TT" in pattern number to "MT" and deduct amount in far right column.

###### Tile to Floor Side Option:

Tile to floor standard on side 2. To specify tile to floor on side 1, change "FR" in pattern number to "RF".

###### Top Cap Options:

**(2)** = Extruded Plastic (Smooth Radius)  
**(3)** = No Top Cap  
**(4)** = Radius Metal, add \$38 P1, \$40 P2, \$42 P3 paint grades  
**(5)** = Flat Metal, add \$38 P1, \$40 P2, \$42 P3 paint grades

###### Raceway Knockout Options:

**(K)** = Knockouts on raceway side  
**(N)** = No knockouts on raceway side



###### Tile Support Options:

**(1)** = D1 External Reveal  
**(2)** = D2 Recessed Reveal

# Tiled Panels

## 28" Lower Tile and Base Raceway

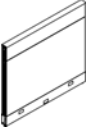
### 42" and 50" High

description	h	w	d	pattern no.	grade								Deduct for Monolithic One Side
					10	15	20	25	30	35	40	45	
42" High Tiled Panel with 28" Lower Tile and Base Raceway 	42 3/16"	15"	3"	<b>DP7CPPRR4215</b>	\$537.	\$552.	\$582.	\$595.	\$612.	\$624.	\$637.	\$653.	\$57.
	42 3/16"	18"	3"	<b>DP7CPPRR4218</b>	537.	552.	582.	595.	612.	624.	637.	653.	57.
	42 3/16"	24"	3"	<b>DP7CPPRR4224</b>	572.	591.	622.	636.	652.	666.	677.	696.	57.
	42 3/16"	30"	3"	<b>DP7CPPRR4230</b>	617.	638.	672.	686.	703.	719.	730.	755.	60.
	42 3/16"	36"	3"	<b>DP7CPPRR4236</b>	666.	688.	723.	737.	760.	774.	790.	808.	60.
	42 3/16"	42"	3"	<b>DP7CPPRR4242</b>	716.	739.	777.	794.	815.	831.	845.	870.	60.
	42 3/16"	48"	3"	<b>DP7CPPRR4248</b>	758.	780.	823.	839.	864.	878.	896.	921.	61.
	42 3/16"	60"	3"	<b>DP7CPPRR4260</b>	922.	950.	1,000.	1,020.	1,049.	1,068.	1,089.	1,117.	62.
50" High Tiled Panel with 28" Lower Tile and Base Raceway 	49 1/2"	15"	3"	<b>DP7CPPRR5015</b>	556.	576.	605.	618.	637.	648.	662.	678.	56.
	49 1/2"	18"	3"	<b>DP7CPPRR5018</b>	556.	576.	605.	618.	637.	648.	662.	678.	56.
	49 1/2"	24"	3"	<b>DP7CPPRR5024</b>	604.	624.	660.	671.	692.	702.	717.	736.	58.
	49 1/2"	30"	3"	<b>DP7CPPRR5030</b>	643.	666.	698.	712.	734.	749.	764.	781.	56.
	49 1/2"	36"	3"	<b>DP7CPPRR5036</b>	686.	706.	746.	762.	780.	797.	812.	835.	52.
	49 1/2"	42"	3"	<b>DP7CPPRR5042</b>	731.	760.	798.	813.	837.	854.	868.	894.	49.
	49 1/2"	48"	3"	<b>DP7CPPRR5048</b>	777.	802.	844.	863.	887.	901.	920.	943.	48.
	49 1/2"	60"	3"	<b>DP7CPPRR5060</b>	941.	973.	1,023.	1,043.	1,072.	1,094.	1,112.	1,142.	62.

Dimensions listed under h w d are actual to the nearest 1/8"

Ordering Information	Order Code	Included with:	Options
<b>Tiled Panel with 28" Lower Tile and Base Raceway:</b> 1. Pattern Number 2. Top cap type 3. Top cap finish 4. Raceway knockout option 5. Raceway trim finish 6. Tile support profile 7. Panel fabric	<b>Tiled Panels with 28" Lower Tile and Base Raceway</b> <i>Example:</i> <b>DP7CPPRR4218</b> <b>4/117/K/117/2/B191</b> <hr/> <b>DP7</b> Dividends Horizon Panel <hr/> <b>C</b> Topway frame <hr/> <b>PP</b> Tiled both sides, 28" Lower Tile <hr/> <b>RR</b> Raceway both sides <hr/> <b>42</b> Height <hr/> <b>18</b> Width <hr/> <b>4</b> Radius Metal top cap <hr/> <b>117</b> Soft Grey top cap finish <hr/> <b>K</b> Base raceway with knockouts both sides <hr/> <b>117</b> Soft Grey base raceway finish <hr/> <b>2</b> D2 style tile supports <hr/> <b>B191</b> Fairfield light fabric	<b>Tiled Panel with Standard Base Raceway and 28" Base Tile:</b> <ul style="list-style-type: none"> <li>• Panel frame</li> <li>• Acoustic panel inserts</li> <li>• Base raceway covers</li> <li>• Top cap</li> <li>• Connection hardware</li> </ul>	<b>Tiled Panel with 28" Lower Tile and Base Raceway:</b> <b>Full View Frame Option:</b> To specify full view frame for window or stacking applications, replace the "C" in pattern number with "V". No upcharge.  <b>Monolithic Side Option:</b> For side 1 monolithic, side 2 tiled, change "PP" in pattern number to "MP" and deduct amount in far right column.  <b>Top Cap Options:</b> <b>(2)</b> = Extruded Plastic (Smooth Radius) <b>(3)</b> = No Top Cap <b>(4)</b> = Radius Metal, add \$38 P1, \$40 P2, \$42 P3 paint grades <b>(5)</b> = Flat Metal, add \$38 P1, \$40 P2, \$42 P3 paint grades  <b>Raceway Knockout Options:</b> <b>(K)</b> = Knockouts on raceway side <b>(N)</b> = No knockouts  <b>Tile Support Options:</b> <b>(1)</b> = D1 External Reveal <b>(2)</b> = D2 Recessed Reveal

# Tiled Panels

## 28" Lower Tile and Base Raceway

### 57" and 64" High

description	h	w	d	pattern no.	grade								Deduct for Monolithic One Side
					10	15	20	25	30	35	40	45	
57" High Tiled Panel with 28" Lower Tile and Base Raceway	56 <sup>13/16"</sup>	15"	3"	<b>DP7CPPRR5715</b>	\$688.	\$708.	\$749.	\$763.	\$784.	\$799.	\$815.	\$837.	\$71.
	56 <sup>13/16"</sup>	18"	3"	<b>DP7CPPRR5718</b>	688.	708.	749.	763.	784.	799.	815.	837.	71.
	56 <sup>13/16"</sup>	24"	3"	<b>DP7CPPRR5724</b>	746.	768.	806.	823.	848.	864.	880.	902.	74.
	56 <sup>13/16"</sup>	30"	3"	<b>DP7CPPRR5730</b>	791.	816.	860.	874.	899.	918.	934.	962.	76.
	56 <sup>13/16"</sup>	36"	3"	<b>DP7CPPRR5736</b>	844.	871.	916.	934.	963.	980.	996.	1,024.	77.
	56 <sup>13/16"</sup>	42"	3"	<b>DP7CPPRR5742</b>	897.	925.	974.	993.	1,022.	1,041.	1,060.	1,089.	79.
	56 <sup>13/16"</sup>	48"	3"	<b>DP7CPPRR5748</b>	949.	982.	1,030.	1,051.	1,080.	1,101.	1,121.	1,152.	80.
	56 <sup>13/16"</sup>	60"	3"	<b>DP7CPPRR5760</b>	1,152.	1,190.	1,247.	1,272.	1,310.	1,334.	1,358.	1,394.	83.



64" High Tiled Panel with 28" Lower Tile and Base Raceway	64 <sup>1/16"</sup>	15"	3"	<b>DP7CPPRR6415</b>	729.	757.	795.	811.	835.	850.	866.	891.	86.
	64 <sup>1/16"</sup>	18"	3"	<b>DP7CPPRR6418</b>	729.	757.	795.	811.	835.	850.	866.	891.	86.
	64 <sup>1/16"</sup>	24"	3"	<b>DP7CPPRR6424</b>	791.	814.	860.	873.	898.	916.	933.	962.	90.
	64 <sup>1/16"</sup>	30"	3"	<b>DP7CPPRR6430</b>	839.	867.	909.	928.	960.	973.	993.	1,020.	87.
	64 <sup>1/16"</sup>	36"	3"	<b>DP7CPPRR6436</b>	896.	925.	972.	992.	1,020.	1,040.	1,058.	1,088.	88.
	64 <sup>1/16"</sup>	42"	3"	<b>DP7CPPRR6442</b>	951.	984.	1,034.	1,054.	1,086.	1,104.	1,123.	1,154.	89.
	64 <sup>1/16"</sup>	48"	3"	<b>DP7CPPRR6448</b>	1,009.	1,040.	1,093.	1,112.	1,144.	1,168.	1,190.	1,221.	90.
	64 <sup>1/16"</sup>	60"	3"	<b>DP7CPPRR6460</b>	1,221.	1,259.	1,323.	1,348.	1,387.	1,413.	1,438.	1,476.	90.



Dimensions listed under h w d are actual to the nearest 1/8"

Ordering Information	Order Code	Included with:	Options
<b>Tiled Panel with 28" Lower Tile and Base Raceway:</b> 1. Pattern Number 2. Top cap type 3. Top cap finish 4. Raceway knockout option 5. Raceway trim finish 6. Tile support style 7. Panel fabric	<b>Tiled Panels with 28" Lower Tile and Base Raceway</b> <i>Example:</i> <b>DP7CPPRR5718 4/117/K/117/2/B191</b> <hr/> <b>DP7</b> Dividends Horizon Panel <hr/> <b>C</b> Topway frame <hr/> <b>PP</b> Tiled both sides, 28" Lower Tile <hr/> <b>RR</b> Raceway both sides <hr/> <b>57</b> Height <hr/> <b>18</b> Width <hr/> <b>4</b> Radius Metal top cap <hr/> <b>117</b> Soft Grey top cap finish <hr/> <b>K</b> Base raceway with knockouts both sides <hr/> <b>117</b> Soft Grey base raceway finish <hr/> <b>2</b> D2 style tile support <hr/> <b>B191</b> Fairfield light fabric	<b>Tiled Panel with Standard Base Raceway and 28" Base Tile:</b> <ul style="list-style-type: none"> <li>• Panel frame</li> <li>• Acoustic panel inserts</li> <li>• Base raceway covers</li> <li>• Top cap</li> <li>• Connection hardware</li> </ul>	<b>Tiled Panels with 28" Lower Tile and Base Raceway:</b> <b>Full View Frame Option:</b> To specify full view frame for window or stacking applications, replace the "C" in pattern number with "V". No upcharge.  <b>Monolithic Side Option:</b> For side 1 monolithic, side 2 tiled, change "PP" in pattern number to "MP" and deduct amount in far right column.  <b>Top Cap Options:</b> <b>(2)</b> = Extruded Plastic (Smooth Radius) <b>(3)</b> = No Top Cap <b>(4)</b> = Radius Metal, add \$38 P1, \$40 P2, \$42 P3 paint grades <b>(5)</b> = Flat Metal, add \$38 P1, \$40 P2, \$42 P3 paint grades  <b>Raceway Knockout Options:</b> <b>(K)</b> = Knockouts on raceway side <b>(N)</b> = No knockouts  <b>Tile Support Options:</b> <b>(1)</b> = D1 External Reveal <b>(2)</b> = D2 Recessed Reveal



# Tiled Panels

## 28" Lower Tile and Base Raceway

### 78" High

description	h	w	d	pattern no.	grade								deduct for Monolithic One Side
					10	15	20	25	30	35	40	45	
78" High Tiled Panel with 28" Lower Tile and Base Raceway	78 <sup>1</sup> / <sub>16</sub> "	15"	3"	<b>DP7CPPRR7815</b>	\$1,186.	\$1,221.	\$1,282.	\$1,308.	\$1,343.	\$1,368.	\$1,395.	\$1,433.	\$153.
	78 <sup>1</sup> / <sub>16</sub> "	18"	3"	<b>DP7CPPRR7818</b>	1,186.	1,221.	1,282.	1,308.	1,343.	1,368.	1,395.	1,433.	153.
	78 <sup>1</sup> / <sub>16</sub> "	24"	3"	<b>DP7CPPRR7824</b>	1,276.	1,316.	1,385.	1,410.	1,452.	1,477.	1,502.	1,545.	158.
	78 <sup>1</sup> / <sub>16</sub> "	30"	3"	<b>DP7CPPRR7830</b>	1,358.	1,399.	1,468.	1,497.	1,540.	1,568.	1,598.	1,639.	155.
	78 <sup>1</sup> / <sub>16</sub> "	36"	3"	<b>DP7CPPRR7836</b>	1,455.	1,499.	1,574.	1,604.	1,652.	1,683.	1,711.	1,756.	168.
	78 <sup>1</sup> / <sub>16</sub> "	42"	3"	<b>DP7CPPRR7842</b>	1,545.	1,593.	1,671.	1,703.	1,752.	1,784.	1,818.	1,866.	171.
	78 <sup>1</sup> / <sub>16</sub> "	48"	3"	<b>DP7CPPRR7848</b>	1,642.	1,693.	1,779.	1,814.	1,864.	1,897.	1,931.	1,982.	205.

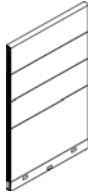

Dimensions listed under h w d are actual to the nearest 1/8"

Ordering Information	Order Code	Included with:	Options
<b>Tiled Panel with 28" Lower Tile and Base Raceway:</b> 1. Pattern Number 2. Top cap type 3. Top cap finish 4. Raceway knockout option 5. Raceway trim finish 6. Tile support style 7. Panel fabric	<b>Tiled Panels with 28" Lower Tile and Base Raceway</b> <i>Example:</i> <b>DP7CPPRR7818 4/117/K/117/2/B191</b> <hr/> <b>DP7</b> Dividends Horizon Panel <hr/> <b>C</b> Topway frame <hr/> <b>PP</b> Tiled both sides, 28" Lower Tile <hr/> <b>RR</b> Raceway both sides <hr/> <b>78</b> Height <hr/> <b>18</b> Width <hr/> <b>4</b> Radius Metal top cap <hr/> <b>117</b> Soft Grey top cap finish <hr/> <b>K</b> Base raceway with knockouts both sides <hr/> <b>117</b> Soft Grey base raceway finish <hr/> <b>2</b> D2 style tile support <hr/> <b>B191</b> Fairfield light fabric	<b>Tiled Panel with Standard Base Raceway and 28" Base Tile:</b> <ul style="list-style-type: none"> <li>• Panel frame</li> <li>• Acoustic panel inserts</li> <li>• Base raceway covers</li> <li>• Top cap</li> <li>• Connection hardware</li> </ul>	<b>Tiled Panels with 28" Lower Tile and Base Raceway:</b> <b>Full View Frame Option:</b> To specify full view frame for window or stacking applications, replace the "C" in pattern number with "V". No upcharge.  <b>Monolithic Side Option:</b> For side 1 monolithic, side 2 tiled, change "PP" in pattern number to "MP" and deduct amount in far right column.  <b>Top Cap Options:</b> <b>(2)</b> = Extruded Plastic (Smooth Radius) <b>(3)</b> = No Top Cap <b>(4)</b> = Radius Metal, add \$38 P1, \$40 P2, \$42 P3 paint grades <b>(5)</b> = Flat Metal, add \$38 P1, \$40 P2, \$42 P3 paint grades  <b>Raceway Knockout Options:</b> <b>(K)</b> = Knockouts on raceway side <b>(N)</b> = No knockouts  <b>Tile Support Options:</b> <b>(1)</b> = D1 External Reveal <b>(2)</b> = D2 Recessed Reveal

# Tiled Panels

## 28" Lower Tile and Open Base

### 42" and 50" High

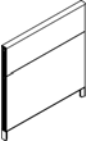
description	h	w	d	pattern no.	grade								Deduct for Monolithic One Side
					10	15	20	25	30	35	40	45	
42" High Tiled Panel with 28" Lower Tile and Open Base  	42 3/16"	18"	3"	<b>DP7CPPLL4218</b>	\$537.	\$552.	\$582.	\$595.	\$612.	\$624.	\$637.	\$653.	\$57.
	42 3/16"	24"	3"	<b>DP7CPPLL4224</b>	572.	591.	622.	636.	652.	666.	677.	696.	57.
	42 3/16"	30"	3"	<b>DP7CPPLL4230</b>	617.	638.	672.	686.	703.	719.	730.	755.	58.
	42 3/16"	36"	3"	<b>DP7CPPLL4236</b>	666.	688.	723.	737.	760.	774.	790.	808.	60.
	42 3/16"	42"	3"	<b>DP7CPPLL4242</b>	716.	739.	777.	794.	815.	831.	845.	870.	60.
	42 3/16"	48"	3"	<b>DP7CPPLL4248</b>	758.	780.	823.	839.	864.	878.	896.	921.	61.
	42 3/16"	60"	3"	<b>DP7CPPLL4260</b>	922.	950.	1,000.	1,020.	1,049.	1,068.	1,089.	1,117.	62.
50" High Tiled Panel with 28" Lower Tile and Open Base  	49 1/2"	18"	3"	<b>DP7CPPLL5018</b>	556.	576.	605.	618.	637.	648.	662.	678.	56.
	49 1/2"	24"	3"	<b>DP7CPPLL5024</b>	604.	624.	660.	671.	692.	702.	717.	736.	58.
	49 1/2"	30"	3"	<b>DP7CPPLL5030</b>	643.	666.	698.	712.	734.	749.	764.	781.	56.
	49 1/2"	36"	3"	<b>DP7CPPLL5036</b>	686.	706.	746.	762.	780.	797.	812.	835.	52.
	49 1/2"	42"	3"	<b>DP7CPPLL5042</b>	731.	760.	798.	813.	837.	854.	868.	894.	49.
	49 1/2"	48"	3"	<b>DP7CPPLL5048</b>	777.	802.	844.	863.	887.	901.	920.	943.	48.
	49 1/2"	60"	3"	<b>DP7CPPLL5060</b>	941.	973.	1,023.	1,043.	1,072.	1,094.	1,112.	1,142.	62.

Dimensions listed under h w d are actual to the nearest 1/8"

Ordering Information	Order Code	Included with:	Options
<b>Tiled Panels with 28" Lower Tile and Open Base:</b> 1. Pattern Number 2. Top cap type 3. Top cap trim finish 4. Base support trim finish 5. Tile support style 6. Panel fabric	<b>Tiled Panels with 28" Lower Tile and Open Base</b> <i>Example:</i> <b>DP7CPPLL4218</b> <b>4/117/KK/117/2/B191</b> <hr/> <b>DP7</b> Dividends Horizon Panel <hr/> <b>C</b> Topway frame <hr/> <b>PP</b> Tiled both sides, 28" Lower Tile <hr/> <b>LL</b> Open Base <hr/> <b>42</b> Height <hr/> <b>18</b> Width <hr/> <b>4</b> Radius Metal top cap <hr/> <b>117</b> Soft Grey top cap finish <hr/> <b>117</b> Soft Grey base support finish <hr/> <b>2</b> D2 style tile supports <hr/> <b>B191</b> Fairfield light fabric	<b>Tiled Panels with 28" Lower Tile and Open Base:</b> <ul style="list-style-type: none"> <li>Panel frame</li> <li>Acoustic panel inserts</li> <li>Open base</li> <li>Top cap</li> <li>Connection hardware</li> </ul>	<b>Tiled Panels with 28" Lower Tile and Open Base:</b> <b>Full View Frame Option:</b> To specify full view frames for window or stacking applications, replace the "C" in pattern number with "V". No upcharge.  <b>Monolithic Side Option:</b> To specify monolithic on side one of panel, change "PP" in pattern number to "MP" and deduct amount in far right column.  <b>Top Cap Options:</b> <b>(2)</b> = Extruded Plastic (Smooth Radius) <b>(3)</b> = No Top Cap <b>(4)</b> = Radius Metal, add \$38 P1, \$40 P2, \$42 P3 paint grades <b>(5)</b> = Flat Metal, add \$38 P1, \$40 P2, \$42 P3 paint grades  <b>Base Raceway Knockout Options:</b>  <b>(K)</b> = Knockouts on raceway side <b>(N)</b> = No knockouts  <b>Tile Support Options:</b> <b>(1)</b> = D1 External Reveal <b>(2)</b> = D2 Recessed Reveal

# Tiled Panels

## 28" Lower Tile and Open Base

### 57" and 64" High

description	h	w	d	pattern no.	grade								deduct for Monolithic One Side
					10	15	20	25	30	35	40	45	
57" High Tiled Panel with 28" Lower Tile and Open Base	56 <sup>13/16"</sup>	18"	3"	<b>DP7CPPLL5718</b>	\$688.	\$708.	\$749.	\$763.	\$784.	\$799.	\$815.	\$837.	\$71.
	56 <sup>13/16"</sup>	24"	3"	<b>DP7CPPLL5724</b>	746.	768.	806.	823.	848.	864.	880.	902.	74.
	56 <sup>13/16"</sup>	30"	3"	<b>DP7CPPLL5730</b>	791.	816.	860.	874.	899.	918.	934.	962.	76.
	56 <sup>13/16"</sup>	36"	3"	<b>DP7CPPLL5736</b>	844.	871.	916.	934.	963.	980.	996.	1,024.	77.
	56 <sup>13/16"</sup>	42"	3"	<b>DP7CPPLL5742</b>	897.	925.	974.	993.	1,022.	1,041.	1,060.	1,089.	79.
	56 <sup>13/16"</sup>	48"	3"	<b>DP7CPPLL5748</b>	949.	982.	1,030.	1,051.	1,080.	1,101.	1,121.	1,152.	80.
	56 <sup>13/16"</sup>	60"	3"	<b>DP7CPPLL5760</b>	1,152.	1,190.	1,247.	1,272.	1,310.	1,334.	1,358.	1,394.	83.



64" High Tiled Panel with 28" Lower Tile and Open Base	64 <sup>1/16"</sup>	18"	3"	<b>DP7CPPLL6418</b>	729.	757.	795.	811.	835.	850.	866.	891.	86.
	64 <sup>1/16"</sup>	24"	3"	<b>DP7CPPLL6424</b>	791.	814.	860.	873.	898.	916.	933.	962.	90.
	64 <sup>1/16"</sup>	30"	3"	<b>DP7CPPLL6430</b>	839.	867.	909.	928.	960.	973.	993.	1,020.	87.
	64 <sup>1/16"</sup>	36"	3"	<b>DP7CPPLL6436</b>	896.	925.	972.	992.	1,020.	1,040.	1,058.	1,088.	88.
	64 <sup>1/16"</sup>	42"	3"	<b>DP7CPPLL6442</b>	951.	984.	1,034.	1,054.	1,086.	1,104.	1,123.	1,154.	89.
	64 <sup>1/16"</sup>	48"	3"	<b>DP7CPPLL6448</b>	1,009.	1,040.	1,093.	1,112.	1,144.	1,168.	1,190.	1,221.	90.
	64 <sup>1/16"</sup>	60"	3"	<b>DP7CPPLL6460</b>	1,221.	1,259.	1,323.	1,348.	1,387.	1,413.	1,438.	1,476.	90.



Dimensions listed under h w d are actual to the nearest 1/8"

Ordering Information	Order Code	Included with:	Options
<b>Tiled Panels with 28" Lower Tile and Open Base:</b> 1. Pattern Number 2. Top cap type 3. Top cap trim finish 4. Base support trim finish 5. Tile support style 6. Panel fabric	<b>Tiled Panels with 28" Lower Tile and Open Base</b> <i>Example:</i> <b>DP7CPPLL5718</b> <b>4/117/KK/117/2/B191</b> <hr/> <b>DP7</b> Dividends Horizon Panel <hr/> <b>C</b> Topway frame <hr/> <b>PP</b> Tiled both sides, 28" Lower Tile <hr/> <b>LL</b> Open Base <hr/> <b>57</b> Height <hr/> <b>18</b> Width <hr/> <b>4</b> Radius Metal top cap <hr/> <b>117</b> Soft Grey top cap finish <hr/> <b>117</b> Soft Grey base support finish <hr/> <b>2</b> D2 style tile support <hr/> <b>B191</b> Fairfield light fabric	<b>Tiled Panels with 28" Lower Tile and Open Base:</b> <ul style="list-style-type: none"> <li>Panel frame</li> <li>Acoustic panel inserts</li> <li>Open base</li> <li>Top cap</li> <li>Connection hardware</li> </ul>	<b>Tiled Panels with 28" Lower Tile and Open Base:</b> <b>Full View Frame Option:</b> To specify full view frames for window or stacking applications, replace the "C" in pattern number with "V". No upcharge.  <b>Monolithic Side Option:</b> To specify monolithic on side one of panel, change "PP" in pattern number to "MP" and deduct amount in far right column.  <b>Top Cap Options:</b> <b>(2)</b> = Extruded Plastic (Smooth Radius) <b>(3)</b> = No Top Cap <b>(4)</b> = Radius Metal, add \$38 P1, \$40 P2, \$42 P3 paint grades <b>(5)</b> = Flat Metal, add \$38 P1, \$40 P2, \$42 P3 paint grades  <b>Base Raceway Knockout Options:</b>  <b>(K)</b> = Knockouts on raceway side <b>(N)</b> = No knockouts  <b>Tile Support Options:</b> <b>(1)</b> = D1 External Reveal <b>(2)</b> = D2 Recessed Reveal

# Tiled Panels

## 28" Lower Tile and Open Base

### 78" High

description	h	w	d	pattern no.	grade							deduct for Monolithic One Side	
					10	15	20	25	30	35	40		45
78" High Tiled Panel with 28" Lower Tile and Open Base	78 <sup>1</sup> / <sub>16</sub> "	18"	3"	<b>DP7CPPLL7818</b>	\$1,186.	\$1,221.	\$1,282.	\$1,308.	\$1,343.	\$1,368.	\$1,395.	\$1,433.	\$153.
	78 <sup>1</sup> / <sub>16</sub> "	24"	3"	<b>DP7CPPLL7824</b>	1,276.	1,316.	1,385.	1,410.	1,452.	1,477.	1,502.	1,545.	158.
	78 <sup>1</sup> / <sub>16</sub> "	30"	3"	<b>DP7CPPLL7830</b>	1,358.	1,399.	1,468.	1,497.	1,540.	1,568.	1,598.	1,639.	155.
	78 <sup>1</sup> / <sub>16</sub> "	36"	3"	<b>DP7CPPLL7836</b>	1,455.	1,499.	1,574.	1,604.	1,652.	1,683.	1,711.	1,756.	168.
	78 <sup>1</sup> / <sub>16</sub> "	42"	3"	<b>DP7CPPLL7842</b>	1,545.	1,593.	1,671.	1,703.	1,752.	1,784.	1,818.	1,866.	171.
	78 <sup>1</sup> / <sub>16</sub> "	48"	3"	<b>DP7CPPLL7848</b>	1,642.	1,693.	1,779.	1,814.	1,864.	1,897.	1,931.	1,982.	205.

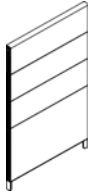

Dimensions listed under h w d are actual to the nearest 1/8"

Ordering Information	Order Code	Included with:	Options
<b>Tiled Panels with 28" Lower Tile and Open Base:</b> 1. Pattern Number 2. Top cap type 3. Top cap trim finish 4. Base support trim finish 5. Tile support style 6. Panel fabric	<b>Tiled Panels with 28" Lower Tile and Open Base</b> <i>Example:</i> <b>DP7CPPLL7818</b> <b>4/117/KK/117/2/B191</b> <hr/> <b>DP7</b> Dividends Horizon Panel <hr/> <b>C</b> Topway frame <hr/> <b>PP</b> Tiled both sides, 28" Lower Tile <hr/> <b>LL</b> Open Base <hr/> <b>78</b> Height <hr/> <b>18</b> Width <hr/> <b>4</b> Radius Metal top cap <hr/> <b>117</b> Soft Grey top cap finish <hr/> <b>117</b> Soft Grey base support finish <hr/> <b>2</b> D2 style tile support <hr/> <b>B191</b> Fairfield light fabric	<b>Tiled Panels with 28" Lower Tile and Open Base:</b> <ul style="list-style-type: none"> <li>Panel frame</li> <li>Acoustic panel inserts</li> <li>Open base</li> <li>Top cap</li> <li>Connection hardware</li> </ul>	<b>Tiled Panels with 28" Lower Tile and Open Base:</b> <b>Full View Frame Option:</b> To specify full view frames for window or stacking applications, replace the "C" in pattern number with "V". No upcharge.  <b>Monolithic Side Option:</b> To specify monolithic on side one of panel, change "PP" in pattern number to "MP" and deduct amount in far right column.  <b>Top Cap Options:</b> <b>(2)</b> = Extruded Plastic (Smooth Radius) <b>(3)</b> = No Top Cap <b>(4)</b> = Radius Metal, add \$38 P1, \$40 P2, \$42 P3 paint grades <b>(5)</b> = Flat Metal, add \$38 P1, \$40 P2, \$42 P3 paint grades  <b>Base Raceway Knockout Options:</b>  <b>(K)</b> = Knockouts on raceway side <b>(N)</b> = No knockouts  <b>Tile Support Options:</b> <b>(1)</b> = D1 External Reveal <b>(2)</b> = D2 Recessed Reveal

# Tiled Panels

## 28" Lower Tile and Tile To Floor

### 42" and 50" High

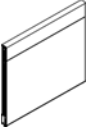
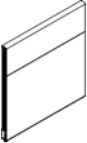
description	h	w	d	pattern no.	grade								Deduct for 1 side Monolithic
					10	15	20	25	30	35	40	45	
42" High Tiled Panel with 28" Lower Tile and Tile to Floor  	42 3/16"	15"	3"	<b>DP7CPPFR4215</b>	\$569.	\$584.	\$614.	\$627.	\$644.	\$656.	\$669.	\$685.	\$57.
	42 3/16"	18"	3"	<b>DP7CPPFR4218</b>	569.	584.	614.	627.	644.	656.	669.	685.	57.
	42 3/16"	24"	3"	<b>DP7CPPFR4224</b>	604.	623.	654.	668.	684.	698.	709.	728.	57.
	42 3/16"	30"	3"	<b>DP7CPPFR4230</b>	649.	670.	704.	718.	735.	751.	762.	787.	58.
	42 3/16"	36"	3"	<b>DP7CPPFR4236</b>	698.	720.	755.	769.	792.	806.	822.	840.	60.
	42 3/16"	42"	3"	<b>DP7CPPFR4242</b>	748.	771.	809.	826.	847.	863.	877.	902.	60.
	42 3/16"	48"	3"	<b>DP7CPPFR4248</b>	790.	812.	855.	871.	896.	910.	928.	953.	61.
	42 3/16"	60"	3"	<b>DP7CPPFR4260</b>	954.	982.	1,032.	1,052.	1,081.	1,100.	1,121.	1,148.	62.
50" High Tiled Panel with 28" Lower Tile and Tile to Floor  	49 1/2"	15"	3"	<b>DP7CPPFR5015</b>	588.	608.	637.	650.	669.	680.	694.	710.	56.
	49 1/2"	18"	3"	<b>DP7CPPFR5018</b>	588.	608.	637.	650.	669.	680.	694.	710.	56.
	49 1/2"	24"	3"	<b>DP7CPPFR5024</b>	636.	656.	692.	703.	724.	734.	749.	768.	58.
	49 1/2"	30"	3"	<b>DP7CPPFR5030</b>	675.	698.	730.	744.	766.	781.	796.	813.	56.
	49 1/2"	36"	3"	<b>DP7CPPFR5036</b>	719.	739.	779.	795.	813.	830.	845.	868.	52.
	49 1/2"	42"	3"	<b>DP7CPPFR5042</b>	763.	792.	830.	845.	869.	886.	900.	926.	59.
	49 1/2"	48"	3"	<b>DP7CPPFR5048</b>	809.	834.	876.	895.	919.	933.	952.	975.	48.
	49 1/2"	60"	3"	<b>DP7CPPFR5060</b>	973.	1,005.	1,055.	1,075.	1,104.	1,126.	1,144.	1,174.	62.

Dimensions listed under h w d are actual to the nearest 1/8"

#### Ordering Information

##### Tiled Panels with 28" Lower Tile and Tile To Floor:

1. Pattern Number
2. Top cap type
3. Top cap finish
4. Knockout option
5. Base raceway finish
6. Tile support style
7. Panel fabric

#### Order Code

##### Tiled Panels with 28" Lower Tile and Tile To Floor:

*Example:* **DP7CPPFF4218**  
**4/117/K/117/2B191**

<b>DP7CPP</b>	Pattern number
<b>FF4218</b>	
<b>4</b>	Radius Metal top cap
<b>117</b>	Soft Grey top cap finish
<b>K</b>	Base raceway with knockouts
<b>117</b>	Soft grey base raceway finish
<b>2</b>	D2 style tile supports
<b>B191</b>	Fairfield light fabric

#### Included with:

##### Tiled Panels with 28" Lower Tile and Tile To Floor:

- Panel frame
- Acoustic panel inserts
- Top cap
- Connection hardware
- Tile to floor side 1
- Base raceway with knockout when required side 2

#### Options

##### Tiled Panels with 28" Lower Tile and Tile To Floor:

##### Full View Frame Option:

To specify full view frames for window or stacking applications, replace the "C" in pattern number with "V". No upcharge.

##### Tile to Floor Side Option:

Tile to Floor standard on side 2. To specify tile to floor on side 1, change "FR" in pattern number to "RF".

##### Monolithic Side Option:

To specify monolithic on side one of panel, change "PP" in pattern number to "MP" and deduct amount in far right column. **Top Cap**

##### Options:

- (2) = Extruded Plastic (Smooth Radius)
- (3) = No Top Cap
- (4) = Radius Metal, add \$38 P1, \$40 P2, \$42 P3 paint grades
- (5) = Flat Metal, add \$38 P1, \$40 P2, \$42 P3 paint grades

##### Raceway Knockout Options:

- (K) = Knockouts on raceway side
- (N) = No knockouts

##### Tile Support Options:

- (1) = D1 External Reveal
- (2) = D2 Recessed Reveal

# Tiled Panels

## 28" Lower Tile and Tile To Floor

### 57" and 64" High

description	h	w	d	pattern no.	grade								deduct for
					10	15	20	25	30	35	40	45	1 side Monolithic
57" High Tiled Panel with 28" Lower Tile and Tile to Floor	56 <sup>13</sup> / <sub>16</sub> "	15"	3"	<b>DP7CPPFR5715</b>	\$720.	\$740.	\$781.	\$795.	\$816.	\$831.	\$847.	\$869.	\$71.
	56 <sup>13</sup> / <sub>16</sub> "	18"	3"	<b>DP7CPPFR5718</b>	720.	740.	781.	795.	816.	831.	847.	869.	71.
	56 <sup>13</sup> / <sub>16</sub> "	24"	3"	<b>DP7CPPFR5724</b>	778.	800.	838.	855.	880.	896.	912.	934.	74.
	56 <sup>13</sup> / <sub>16</sub> "	30"	3"	<b>DP7CPPFR5730</b>	823.	848.	892.	906.	931.	950.	966.	994.	76.
	56 <sup>13</sup> / <sub>16</sub> "	36"	3"	<b>DP7CPPFR5736</b>	876.	903.	948.	966.	995.	1,012.	1,028.	1,056.	77.
	56 <sup>13</sup> / <sub>16</sub> "	42"	3"	<b>DP7CPPFR5742</b>	929.	957.	1,006.	1,025.	1,054.	1,073.	1,092.	1,121.	79.
	56 <sup>13</sup> / <sub>16</sub> "	48"	3"	<b>DP7CPPFR5748</b>	981.	1,014.	1,062.	1,083.	1,112.	1,133.	1,153.	1,184.	80.
	56 <sup>13</sup> / <sub>16</sub> "	60"	3"	<b>DP7CPPFR5760</b>	1,184.	1,222.	1,279.	1,304.	1,342.	1,366.	1,390.	1,426.	83.

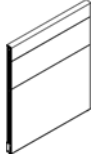

64" High Tiled Panel with 28" Lower Tile and Tile to Floor	64 <sup>1</sup> / <sub>16</sub> "	15"	3"	<b>DP7CPPFR6415</b>	761.	789.	827.	843.	867.	882.	898.	923.	86.
	64 <sup>1</sup> / <sub>16</sub> "	18"	3"	<b>DP7CPPFR6418</b>	761.	789.	827.	843.	867.	882.	898.	923.	86.
	64 <sup>1</sup> / <sub>16</sub> "	24"	3"	<b>DP7CPPFR6424</b>	823.	846.	892.	905.	930.	948.	965.	994.	90.
	64 <sup>1</sup> / <sub>16</sub> "	30"	3"	<b>DP7CPPFR6430</b>	871.	899.	941.	960.	992.	1,005.	1,025.	1,052.	87.
	64 <sup>1</sup> / <sub>16</sub> "	36"	3"	<b>DP7CPPFR6436</b>	928.	957.	1,004.	1,024.	1,052.	1,072.	1,090.	1,120.	88.
	64 <sup>1</sup> / <sub>16</sub> "	42"	3"	<b>DP7CPPFR6442</b>	983.	1,016.	1,066.	1,086.	1,118.	1,136.	1,155.	1,186.	89.
	64 <sup>1</sup> / <sub>16</sub> "	48"	3"	<b>DP7CPPFR6448</b>	1,041.	1,072.	1,125.	1,144.	1,176.	1,200.	1,222.	1,253.	90.
	64 <sup>1</sup> / <sub>16</sub> "	60"	3"	<b>DP7CPPFR6460</b>	1,253.	1,291.	1,355.	1,380.	1,419.	1,445.	1,470.	1,508.	90.

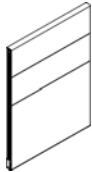

Dimensions listed under h w d are actual to the nearest 1/8"

Ordering Information	Order Code	Included with:	Options
<b>Tiled Panels with 28" Lower Tile and Tile To Floor:</b> 1. Pattern Number 2. Top cap type 3. Top cap finish 4. Knockout option 5. Base raceway finish 6. Tile support style 7. Panel fabric	<b>Tiled Panels with 28" Lower Tile and Tile To Floor:</b> <i>Example:</i> <b>DP7CPPFF4218</b> <b>4/117/K/117/2/B191</b> <hr/> <b>DP7CPP</b> Pattern number <hr/> <b>FF4218</b> <hr/> <b>4</b> Radius Metal top cap <hr/> <b>117</b> Soft Grey top cap finish <hr/> <b>K</b> Base raceway with knockouts <hr/> <b>117</b> Soft Grey base raceway finish <hr/> <b>2</b> D2 style tile supports <hr/> <b>B191</b> Fairfield light fabric	<b>Tiled Panels with 28" Lower Tile and Tile To Floor:</b> <ul style="list-style-type: none"> <li>Panel frame</li> <li>Acoustic panel inserts</li> <li>Top cap</li> <li>Connection hardware</li> <li>Tile to floor side 1</li> <li>Base raceway with knockout when required side 2</li> </ul>	<b>Tiled Panels with 28" Lower Tile and Tile To Floor:</b> <b>Full View Frame Option:</b> To specify full view frames for window or stacking applications, replace the "C" in pattern number with "V". No upcharge.  <b>Tile to Floor Side Option:</b> Tile to Floor standard on side 2. To specify tile to floor on side 1, change "FR" in pattern number to "RF".  <b>Monolithic Side Option:</b> To specify monolithic on side one of panel, change "PP" in pattern number to "MP" and deduct amount in far right column.  <b>Top Cap Options:</b> <b>(2)</b> = Extruded Plastic (Smooth Radius) <b>(3)</b> = No Top Cap <b>(4)</b> = Radius Metal, add \$38 P1, \$40 P2, \$42 P3 paint grades <b>(5)</b> = Flat Metal, add \$38 P1, \$40 P2, \$42 P3 paint grades  <b>Raceway Knockout Options:</b> <b>(K)</b> = Knockouts on raceway side <b>(N)</b> = No knockouts  <b>Tile Support Options:</b> <b>(1)</b> = D1 External Reveal <b>(2)</b> = D2 Recessed Reveal

# Tiled Panels

## 28" Lower Tile and Tile To Floor

### 78" High

description	h	w	d	pattern no.	grade								deduct for
					10	15	20	25	30	35	40	45	1 side Monolithic
78" High Tiled Panel with 28" Lower Tile and Tile to Floor	78 <sup>1</sup> / <sub>16</sub> "	15"	3"	<b>DP7CPPFR7815</b>	\$1,218.	\$1,253.	\$1,314.	\$1,340.	\$1,375.	\$1,400.	\$1,427.	\$1,465.	\$153.
	78 <sup>1</sup> / <sub>16</sub> "	18"	3"	<b>DP7CPPFR7818</b>	1,218.	1,253.	1,314.	1,340.	1,375.	1,400.	1,427.	1,465.	153.
	78 <sup>1</sup> / <sub>16</sub> "	24"	3"	<b>DP7CPPFR7824</b>	1,308.	1,348.	1,417.	1,442.	1,484.	1,509.	1,534.	1,577.	158.
	78 <sup>1</sup> / <sub>16</sub> "	30"	3"	<b>DP7CPPFR7830</b>	1,390.	1,431.	1,500.	1,529.	1,572.	1,600.	1,630.	1,671.	155.
	78 <sup>1</sup> / <sub>16</sub> "	36"	3"	<b>DP7CPPFR7836</b>	1,487.	1,531.	1,606.	1,636.	1,684.	1,715.	1,743.	1,788.	168.
	78 <sup>1</sup> / <sub>16</sub> "	42"	3"	<b>DP7CPPFR7842</b>	1,577.	1,625.	1,703.	1,735.	1,784.	1,816.	1,850.	1,898.	171.
	78 <sup>1</sup> / <sub>16</sub> "	48"	3"	<b>DP7CPPFR7848</b>	1,674.	1,725.	1,811.	1,846.	1,896.	1,929.	1,963.	2,014.	205.

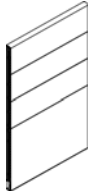

#### Ordering Information

##### Tiled Panels with 28" Lower Tile and Tile To Floor:

1. Pattern Number
2. Top cap type
3. Top cap finish
4. Knockout option
5. Base raceway finish
6. Tile support style
7. Panel fabric

#### Order Code

##### Tiled Panels with 28" Lower Tile and Tile To Floor:

*Example:* **DP7CPPFF4218**  
**4/117/K/117/2/B191**

<b>DP7CPP</b>	Pattern number
<b>FF4218</b>	
<b>4</b>	Radius Metal top cap
<b>117</b>	Soft Grey top cap finish
<b>K</b>	Base raceway with knockouts
<b>117</b>	Soft Grey base raceway finish
<b>2</b>	D2 style tile supports
<b>B191</b>	Fairfield light fabric

#### Included with:

##### Tiled Panels with 28" Lower Tile and Tile To Floor:

- Panel frame
- Acoustic panel inserts
- Top cap
- Connection hardware
- Base raceway with knockout when required

#### Options

##### Tiled Panels with 28" Lower Tile and Tile To Floor:

###### Full View Frame Option:

To specify full view frames for window or stacking applications, replace the "C" in pattern number with "V". No upcharge.

###### Tile to Floor Side Option:

Tile to Floor standard on side 2. To specify tile to floor on side 1, change "FR" in pattern number to "RF".

###### Monolithic Side Option:

To specify monolithic on side one of panel, change "PP" in pattern number to "MP" and deduct amount in far right column.

###### Top Cap Options:

- (2) = Extruded Plastic (Smooth Radius)
- (3) = No Top Cap
- (4) = Radius Metal, add \$38 P1, \$40 P2, \$42 P3 paint grades
- (5) = Flat Metal, add \$38 P1, \$40 P2, \$42 P3 paint grades

###### Raceway Knockout Options:

- (K) = Knockouts on raceway side
- (N) = No knockouts

###### Tile Support Options:

- (1) = D1 External Reveal
- (2) = D2 Recessed Reveal

### Beltway Panel Components

“Preconfigured” Dividends Horizon beltway panels ship completely assembled with a universal panel frame, choice of standard base raceway, open base or tiled to the floor base options, top cap, panel-to-panel connection hardware and beltway inserts.

Beltway panels may be ordered by component for “Build-to-Spec” applications. This includes when panel inserts are required on one side only or when a different fabric color or material is required on opposite panel sides.

### Beltway Panel Insert Supports

All Dividends Horizon panel frames are pre-punched to accept beltway supports which span horizontally across the panel frame. Beltway panel inserts are mounted above and below the beltway and attach to the upper and lower panel frame and the beltway supports. Beltway supports are painted black.

**Note:** Slatwall tiles may not be specified or installed with beltway.

### Beltway Panel Insert Construction

Fabric inserts are constructed of fabric laminated with a web adhesive and heat cured to 1/2" thick tackable acoustic board. Laminate inserts are constructed of a particle board core with laminate on the front and back. Steel tiles are constructed of formed steel that is painted in any Knoll core paint finish.

### Beltway Cover Construction

Trim-colored plastic extrusion available in smooth finish.

### Electrical

Panel base raceways 24" and wider will accept two duplex receptacles per panel side. 18" wide panels provide pass-through electrical only. Beltway raceways 30" and wider will accept two duplex receptacles per panel side. 18" and 24" wide beltways provide pass-through electrical only. All electrical components are ordered separately and must be field-installed.

### One-Sided Beltway Panel

Beltway panels are available with one beltway per panel or per panel sides. Non-beltway side will have a monolithic insert.

### Three Top Cap Options Available

- Smooth Radius Plastic
- Radius Metal
- Flat Metal

### Top Cap Construction

Smooth radiused top caps are made from extruded plastic. Radius and flat metal top caps are made from extruded aluminum.

### Top Cap Attachment

Snaps onto the trough of a topway panel frame. Retainer clips are included to attach top caps to full view frames.

### Preconfigured Beltway Panel

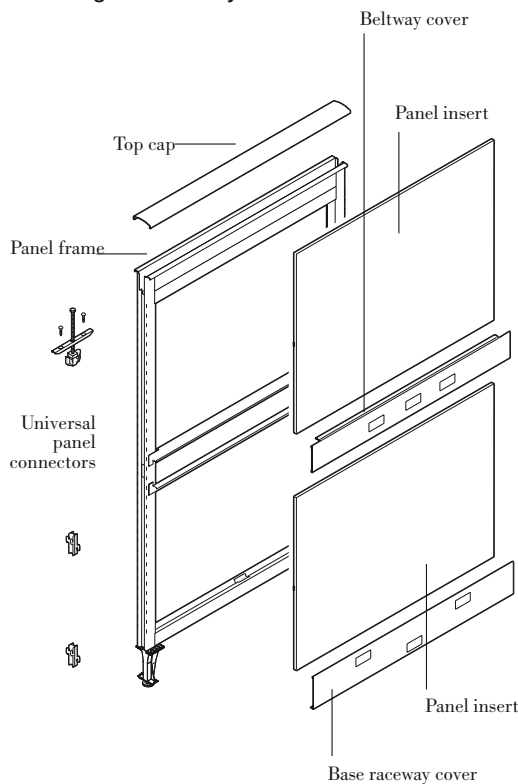

### Panel Base Options

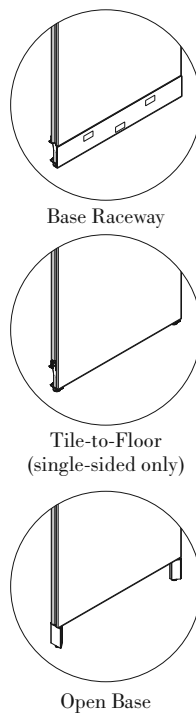

### Beltway Panel Standard Configurations

#### 42"H Panels

- One 7"H upper insert
- One 4"H beltway cover and insert support
- One 24"H lower insert

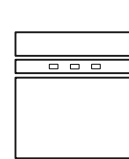

#### 57"H Panels

- One 21"H upper insert
- One 4"H beltway cover and insert support
- One 24"H lower insert



#### 64"H Panels

- One 28"H upper insert
- One 4"H beltway cover and insert support
- One 24"H lower insert

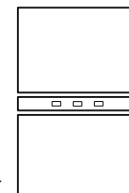

#### 50"H Panels

- One 14"H upper panel insert
- One 4"H beltway cover and insert support
- One 24"H lower insert

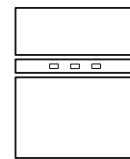

#### 78"H Panels

- One 50"H upper insert
- One 4"H beltway cover and insert support
- One 24"H lower panel insert

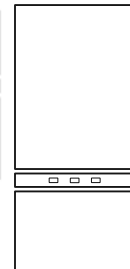





# Beltway Panels

## Standard Base Raceway

### 42" and 50" High

description	h	w	d	pattern no.	grade								Deduct for Monolithic on side 2
					10	15	20	25	30	35	40	45	
 42" Beltway Panels with Standard Base Raceway	42 <sup>3</sup> / <sub>16</sub> "	18"	3"	<b>DP7CBBRR4218</b>	\$577.	\$593.	\$624.	\$633.	\$652.	\$663.	\$674.	\$691.	\$89.
	42 <sup>3</sup> / <sub>16</sub> "	24"	3"	<b>DP7CBBRR4224</b>	655.	675.	706.	721.	739.	755.	765.	788.	111.
	42 <sup>3</sup> / <sub>16</sub> "	30"	3"	<b>DP7CBBRR4230</b>	719.	740.	778.	791.	814.	826.	839.	863.	119.
	42 <sup>3</sup> / <sub>16</sub> "	36"	3"	<b>DP7CBBRR4236</b>	789.	813.	852.	865.	891.	903.	922.	947.	132.
	42 <sup>3</sup> / <sub>16</sub> "	42"	3"	<b>DP7CBBRR4242</b>	855.	882.	924.	938.	967.	985.	1,000.	1,025.	138.
	42 <sup>3</sup> / <sub>16</sub> "	48"	3"	<b>DP7CBBRR4248</b>	914.	937.	987.	1,003.	1,029.	1,050.	1,067.	1,095.	149.
	42 <sup>3</sup> / <sub>16</sub> "	60"	3"	<b>DP7CBBRR4260</b>	1,036.	1,067.	1,119.	1,140.	1,171.	1,193.	1,213.	1,243.	149.
 50" Beltway Panels with Standard Base Raceway	49 <sup>1</sup> / <sub>2</sub> "	18"	3"	<b>DP7CBBRR5018</b>	599.	617.	648.	660.	676.	689.	700.	719.	88.
	49 <sup>1</sup> / <sub>2</sub> "	24"	3"	<b>DP7CBBRR5024</b>	687.	706.	740.	756.	776.	790.	802.	823.	112.
	49 <sup>1</sup> / <sub>2</sub> "	30"	3"	<b>DP7CBBRR5030</b>	748.	766.	803.	820.	839.	856.	871.	894.	116.
	49 <sup>1</sup> / <sub>2</sub> "	36"	3"	<b>DP7CBBRR5036</b>	808.	831.	872.	889.	914.	928.	943.	969.	121.
	49 <sup>1</sup> / <sub>2</sub> "	42"	3"	<b>DP7CBBRR5042</b>	873.	900.	943.	963.	989.	1,006.	1,024.	1,051.	127.
	49 <sup>1</sup> / <sub>2</sub> "	48"	3"	<b>DP7CBBRR5048</b>	931.	962.	1,008.	1,026.	1,054.	1,073.	1,094.	1,121.	132.
	49 <sup>1</sup> / <sub>2</sub> "	60"	3"	<b>DP7CBBRR5060</b>	1,059.	1,091.	1,143.	1,164.	1,197.	1,218.	1,239.	1,270.	132.

Dimensions listed under h w d are actual to the nearest 1/16"



Ordering Information	Order Code	Included with:	Options
<b>Beltway Panel with Standard Base Raceway:</b> 1. Pattern Number 2. Top cap type 3. Top cap finish 4. Base raceway knockout option 5. Base raceway finish 6. Beltway finish 7. Panel fabric	<b>Beltway Panel with Standard Base Raceway</b> <i>Example:</i> <b>DP7CBBRR4218</b> <b>4/117/K/117/117/B191</b> <hr/> <b>DP7CBB</b> Pattern number <hr/> <b>RR4218</b> <hr/> <b>4</b> Radius Metal top cap <hr/> <b>117</b> Soft Grey top cap finish <hr/> <b>K</b> Base Raceway with knockouts both sides <hr/> <b>117</b> Soft Grey base raceway finish <hr/> <b>117</b> Beltway finish <hr/> <b>B191</b> Fairfield light fabric	<b>Beltway Panel with Standard Base Raceway:</b> <ul style="list-style-type: none"> <li>Panel frame</li> <li>Acoustic panel inserts</li> <li>Base raceway covers</li> <li>Beltway covers</li> <li>Top cap</li> <li>Connection hardware</li> </ul>	<b>Beltway Panel with Standard Raceway Options:</b> <b>Full View Frame Option:</b> To specify full view frames for window or stacking applications, replace the "C" in pattern number with "V". No upcharge. <b>Monolithic Side Option:</b> To specify monolithic on side one of panel, change "BB" in pattern number to "MB" and deduct amount in far right column. <b>Top Cap Options:</b> <b>(2)</b> = Extruded Plastic (Smooth Radius) <b>(3)</b> = No Top Cap <b>(4)</b> = Radius Metal, add \$38 P1, \$40 P2, \$42 P3 paint grades <b>(5)</b> = Flat Metal, add \$38 P1, \$40 P2, \$42 P3 paint grades <b>Raceway Knockout Options:</b> <b>(K)</b> = Knockouts on raceway side <b>(N)</b> = No Knockouts

# Beltway Panels

## Standard Base Raceway

### 57", 64" and 78" High

Dividends Horizon

description	h	w	d	pattern no.	grade									Deduct for Monolithic on side 2
					10	15	20	25	30	35	40	45		
 57" Beltway Panels with Standard Base Raceway	56 <sup>13</sup> / <sub>16</sub> "	18"	3"	<b>DP7CBRR5718</b>	\$641.	\$661.	\$691.	\$703.	\$723.	\$736.	\$751.	\$768.	\$88.	
	56 <sup>13</sup> / <sub>16</sub> "	24"	3"	<b>DP7CBRR5724</b>	726.	751.	787.	801.	821.	836.	851.	873.	112.	
	56 <sup>13</sup> / <sub>16</sub> "	30"	3"	<b>DP7CBRR5730</b>	787.	810.	849.	864.	889.	902.	920.	942.	116.	
	56 <sup>13</sup> / <sub>16</sub> "	36"	3"	<b>DP7CBRR5736</b>	864.	890.	933.	950.	977.	994.	1,011.	1,036.	121.	
	56 <sup>13</sup> / <sub>16</sub> "	42"	3"	<b>DP7CBRR5742</b>	927.	956.	1,002.	1,021.	1,049.	1,067.	1,086.	1,113.	127.	
	56 <sup>13</sup> / <sub>16</sub> "	48"	3"	<b>DP7CBRR5748</b>	995.	1,024.	1,074.	1,095.	1,125.	1,143.	1,163.	1,195.	132.	
	56 <sup>13</sup> / <sub>16</sub> "	60"	3"	<b>DP7CBRR5760</b>	1,120.	1,153.	1,211.	1,233.	1,266.	1,288.	1,311.	1,344.	132.	
 64" Beltway Panels with Standard Base Raceway	64 <sup>1</sup> / <sub>16</sub> "	18"	3"	<b>DP7CBRR6418</b>	680.	700.	734.	752.	767.	784.	796.	817.	95.	
	64 <sup>1</sup> / <sub>16</sub> "	24"	3"	<b>DP7CBRR6424</b>	766.	791.	828.	847.	866.	884.	897.	922.	117.	
	64 <sup>1</sup> / <sub>16</sub> "	30"	3"	<b>DP7CBRR6430</b>	824.	851.	891.	905.	930.	949.	965.	991.	117.	
	64 <sup>1</sup> / <sub>16</sub> "	36"	3"	<b>DP7CBRR6436</b>	920.	947.	992.	1,010.	1,036.	1,055.	1,073.	1,101.	134.	
	64 <sup>1</sup> / <sub>16</sub> "	42"	3"	<b>DP7CBRR6442</b>	984.	1,012.	1,060.	1,079.	1,109.	1,130.	1,147.	1,177.	142.	
	64 <sup>1</sup> / <sub>16</sub> "	48"	3"	<b>DP7CBRR6448</b>	1,056.	1,090.	1,141.	1,162.	1,195.	1,216.	1,236.	1,268.	154.	
	64 <sup>1</sup> / <sub>16</sub> "	60"	3"	<b>DP7CBRR6460</b>	1,194.	1,229.	1,288.	1,313.	1,348.	1,371.	1,396.	1,433.	154.	
 78" Beltway Panels with Standard Base Raceway	78 <sup>9</sup> / <sub>16</sub> "	18"	3"	<b>DP7CBRR7818</b>	855.	882.	924.	938.	967.	985.	1,000.	1,025.	86.	
	78 <sup>9</sup> / <sub>16</sub> "	24"	3"	<b>DP7CBRR7824</b>	960.	988.	1,035.	1,053.	1,080.	1,101.	1,121.	1,147.	99.	
	78 <sup>9</sup> / <sub>16</sub> "	30"	3"	<b>DP7CBRR7830</b>	1,028.	1,059.	1,112.	1,133.	1,163.	1,183.	1,203.	1,236.	102.	
	78 <sup>9</sup> / <sub>16</sub> "	36"	3"	<b>DP7CBRR7836</b>	1,139.	1,174.	1,230.	1,252.	1,288.	1,311.	1,334.	1,367.	119.	
	78 <sup>9</sup> / <sub>16</sub> "	42"	3"	<b>DP7CBRR7842</b>	1,225.	1,262.	1,320.	1,345.	1,385.	1,408.	1,434.	1,468.	122.	
	78 <sup>9</sup> / <sub>16</sub> "	48"	3"	<b>DP7CBRR7848</b>	1,348.	1,391.	1,457.	1,485.	1,523.	1,552.	1,580.	1,619.	151.	

Dimensions listed under h w d are actual to the nearest 1/16"

Ordering Information	Order Code	Included with:	Options
<b>Beltway Panel with Standard Base Raceway:</b> 1. Pattern Number 2. Top cap type 3. Top cap finish 4. Base raceway knockout option 5. Base raceway finish 6. Beltway finish 7. Panel fabric	<b>Beltway Panel with Standard Base Raceway</b> <i>Example:</i> <b>DP7CBRR4218</b> <b>4/117/K/117/117/B191</b> <hr/> <b>DP7CBB</b> Pattern number <b>RR4218</b> <hr/> <b>4</b> Radius Metal top cap <hr/> <b>117</b> Soft Grey top cap finish <hr/> <b>K</b> Base Raceway with knockouts both sides <hr/> <b>117</b> Soft Grey base raceway finish <hr/> <b>117</b> Beltway finish <hr/> <b>B191</b> Fairfield light fabric	<b>Beltway Panel with Standard Base Raceway:</b> <ul style="list-style-type: none"> <li>Panel frame</li> <li>Acoustic panel inserts</li> <li>Base raceway covers</li> <li>Beltway covers</li> <li>Top cap</li> <li>Connection hardware</li> </ul>	<b>Beltway Panel with Standard Raceway Options:</b> <b>Full View Frame Option:</b> To specify full view frames for window or stacking applications, replace the "C" in pattern number with "V". No upcharge. <b>Monolithic Side Option:</b> To specify monolithic on side one of panel, change "BB" in pattern number to "MB" and deduct amount in far right column. <b>Top Cap Options:</b> <b>(2)</b> = Extruded Plastic (Smooth Radius) <b>(3)</b> = No Top Cap <b>(4)</b> = Radius Metal, add \$38 P1, \$40 P2, \$42 P3 paint grades <b>(5)</b> = Flat Metal, add \$38 P1, \$40 P2, \$42 P3 paint grades <b>Raceway Knockout Options:</b> <b>(K)</b> = Knockouts on raceway side <b>(N)</b> = No Knockouts

# Beltway Panels

## Tile to the Floor

### 42" and 50" High

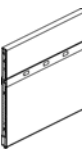
description	h	w	d	pattern no.	grade								Deduct for Monolithic side 1
					10	15	20	25	30	35	40	45	
 42" Beltway Panels with Tile to the Floor	42 <sup>3</sup> / <sub>16</sub> "	18"	3"	<b>DP7CBBFR4218</b>	\$609.	\$625.	\$656.	\$665.	\$684.	\$695.	\$706.	\$723.	\$89.
	42 <sup>3</sup> / <sub>16</sub> "	24"	3"	<b>DP7CBBFR4224</b>	687.	707.	738.	753.	771.	787.	797.	820.	111.
	42 <sup>3</sup> / <sub>16</sub> "	30"	3"	<b>DP7CBBFR4230</b>	751.	772.	810.	823.	846.	858.	871.	895.	119.
	42 <sup>3</sup> / <sub>16</sub> "	36"	3"	<b>DP7CBBFR4236</b>	821.	845.	884.	897.	923.	935.	954.	979.	132.
	42 <sup>3</sup> / <sub>16</sub> "	42"	3"	<b>DP7CBBFR4242</b>	887.	914.	956.	970.	999.	1,017.	1,032.	1,057.	138.
	42 <sup>3</sup> / <sub>16</sub> "	48"	3"	<b>DP7CBBFR4248</b>	946.	969.	1,019.	1,035.	1,061.	1,082.	1,099.	1,127.	149.
	42 <sup>3</sup> / <sub>16</sub> "	60"	3"	<b>DP7CBBFR4260</b>	1,068.	1,099.	1,151.	1,172.	1,203.	1,225.	1,245.	1,275.	149.
 50" Beltway Panels with Tile to the Floor	49 <sup>1</sup> / <sub>2</sub> "	18"	3"	<b>DP7CBBFR5018</b>	631.	649.	680.	692.	708.	721.	732.	751.	88.
	49 <sup>1</sup> / <sub>2</sub> "	24"	3"	<b>DP7CBBFR5024</b>	719.	738.	772.	788.	808.	822.	834.	855.	112.
	49 <sup>1</sup> / <sub>2</sub> "	30"	3"	<b>DP7CBBFR5030</b>	780.	798.	835.	852.	871.	888.	903.	926.	116.
	49 <sup>1</sup> / <sub>2</sub> "	36"	3"	<b>DP7CBBFR5036</b>	840.	863.	904.	921.	946.	960.	975.	1,001.	121.
	49 <sup>1</sup> / <sub>2</sub> "	42"	3"	<b>DP7CBBFR5042</b>	905.	932.	975.	995.	1,021.	1,038.	1,056.	1,083.	127.
	49 <sup>1</sup> / <sub>2</sub> "	48"	3"	<b>DP7CBBFR5048</b>	963.	994.	1,040.	1,058.	1,086.	1,105.	1,126.	1,153.	132.
	49 <sup>1</sup> / <sub>2</sub> "	60"	3"	<b>DP7CBBFR5060</b>	1,091.	1,123.	1,175.	1,196.	1,229.	1,250.	1,271.	1,302.	132.

Dimensions listed under h w c are actual to the nearest 1/16"

Ordering Information	Order Code	Included with:	Options
<b>Beltway Panel with Tile to the Floor:</b> 1. Pattern Number 2. Top cap type 3. Top cap finish 4. Base raceway knockout option 5. Base raceway finish 6. Beltway finish 7. Panel fabric	<b>Beltway Panel with Tile to the Floor:</b> <i>Example:</i> <b>DP7CBBFR4218</b> <b>4/117/K/117/117/B191</b> <hr/> <b>DP7CBB</b> Pattern number <hr/> <b>FR4218</b> <hr/> <b>4</b> Radius Metal top cap <hr/> <b>117</b> Soft Grey top cap finish <hr/> <b>K</b> Base raceway with knockouts both sides <hr/> <b>117</b> Soft Grey base raceway finish <hr/> <b>117</b> Soft Grey beltway cover finish <hr/> <b>B191</b> Fairfield light fabric	<b>Beltway Panel with Tile to the Floor:</b> <ul style="list-style-type: none"> <li>Panel frame</li> <li>Acoustic panel inserts</li> <li>Top cap</li> <li>Connection hardware</li> <li>Base raceway side 2</li> <li>Beltway with covers</li> <li>Tile to the floor side 1</li> </ul>	<b>Beltway Panel with Tile to the Floor:</b> <b>Full View Frame Option:</b> To specify full view frames for window or stacking applications, replace the "C" in pattern number with "V". No upcharge.  <b>Monolithic Side Option:</b> For side 1 monolithic, side 2 beltway, change "BB" in pattern number to "MB" and deduct amount in far right column.  <b>Tile to Floor Side Option:</b> Panels are standard with tile to floor side 1, raceway side 2. To specify raceway side one and tile to floor side 2, change "FR" in pattern number to "RF".  <b>Top Cap Options:</b> <b>(2)</b> = Extruded Plastic (Smooth Radius) <b>(3)</b> = No Top Cap <b>(4)</b> = Radius Metal, add \$38 P1, \$40 P2, \$42 P3 paint grades <b>(5)</b> = Flat Metal, add \$38 P1, \$40 P2, \$42 P3 paint grades  <b>Raceway Knockout Options:</b> <b>(K)</b> = Knockouts on raceway side <b>(N)</b> = No Knockouts

# Beltway Panels

## Tile to the Floor

### 57" and 64" High

description	height	width	depth	pattern number									Deduct for Monolithic side 1
					10	15	20	25	30	35	40	45	
57" Beltway Panels with Tile to the Floor	56 <sup>13</sup> / <sub>16</sub> "	18"	3"	<b>DP7CBBFR5718</b>	\$673.	\$693.	\$723.	\$735.	\$755.	\$768.	\$783.	\$800.	\$88.
	56 <sup>13</sup> / <sub>16</sub> "	24"	3"	<b>DP7CBBFR5724</b>	758.	783.	819.	833.	853.	868.	883.	905.	112.
	56 <sup>13</sup> / <sub>16</sub> "	30"	3"	<b>DP7CBBFR5730</b>	820.	843.	882.	897.	922.	935.	953.	975.	116.
	56 <sup>13</sup> / <sub>16</sub> "	36"	3"	<b>DP7CBBFR5736</b>	897.	923.	966.	983.	1,010.	1,027.	1,044.	1,069.	121.
	56 <sup>13</sup> / <sub>16</sub> "	42"	3"	<b>DP7CBBFR5742</b>	960.	989.	1,035.	1,054.	1,082.	1,100.	1,119.	1,146.	127.
	56 <sup>13</sup> / <sub>16</sub> "	48"	3"	<b>DP7CBBFR5748</b>	1,028.	1,057.	1,107.	1,128.	1,158.	1,176.	1,196.	1,228.	132.
	56 <sup>13</sup> / <sub>16</sub> "	60"	3"	<b>DP7CBBFR5760</b>	1,153.	1,186.	1,244.	1,266.	1,299.	1,320.	1,344.	1,377.	132.



64" Beltway Panels with Tile to the Floor	64 <sup>1</sup> / <sub>16</sub> "	18"	3"	<b>DP7CBBFR6418</b>	713.	733.	767.	785.	800.	817.	829.	850.	95.
	64 <sup>1</sup> / <sub>16</sub> "	24"	3"	<b>DP7CBBFR6424</b>	799.	824.	861.	880.	899.	917.	930.	955.	117.
	64 <sup>1</sup> / <sub>16</sub> "	30"	3"	<b>DP7CBBFR6430</b>	857.	884.	924.	938.	963.	982.	998.	1,024.	117.
	64 <sup>1</sup> / <sub>16</sub> "	36"	3"	<b>DP7CBBFR6436</b>	953.	980.	1,025.	1,043.	1,069.	1,088.	1,106.	1,134.	134.
	64 <sup>1</sup> / <sub>16</sub> "	42"	3"	<b>DP7CBBFR6442</b>	1,017.	1,045.	1,093.	1,112.	1,142.	1,163.	1,180.	1,210.	142.
	64 <sup>1</sup> / <sub>16</sub> "	48"	3"	<b>DP7CBBFR6448</b>	1,089.	1,123.	1,174.	1,195.	1,228.	1,249.	1,269.	1,301.	154.
	64 <sup>1</sup> / <sub>16</sub> "	60"	3"	<b>DP7CBBFR6460</b>	1,227.	1,262.	1,320.	1,346.	1,381.	1,404.	1,429.	1,466.	154.



Dimensions listed under h w c are actual to the nearest 1/16"

Ordering Information	Order Code	Included with:	Options
<b>Beltway Panel with Tile to the Floor:</b> 1. Pattern Number 2. Top cap type 3. Top cap finish 4. Base raceway knockout option 5. Base raceway finish 6. Beltway finish 7. Panel fabric	<b>Beltway Panel with Tile to the Floor:</b> <i>Example:</i> <b>DP7CBBFR5718</b> <b>4/117/K/117/117/B191</b> <hr/> <b>DP7CBB</b> Pattern number <hr/> <b>FR5718</b> <hr/> <b>4</b> Radius Metal top cap <hr/> <b>117</b> Soft Grey top cap finish <hr/> <b>K</b> Base raceway with knockouts both sides <hr/> <b>117</b> Soft Grey base raceway finish <hr/> <b>117</b> Soft Grey beltway cover finish <hr/> <b>B191</b> Fairfield light fabric	<b>Beltway Panel with Tile to the Floor:</b> <ul style="list-style-type: none"> <li>Panel frame</li> <li>Acoustic panel inserts</li> <li>Top cap</li> <li>Connection hardware</li> <li>Base raceway</li> <li>Beltway with covers</li> <li>Tile to the floor side 1</li> </ul>	<b>Beltway Panel with Tile to the Floor:</b> <b>Full View Frame Option:</b> To specify full view frames for window or stacking applications, replace the "C" in pattern number with "V". No upcharge.  <b>Monolithic Side Option:</b> For side 1 monolithic, side 2 beltway, change "BB" in pattern number to "MB" and deduct amount in far right column.  <b>Tile to Floor Side Option:</b> Panels are standard with tile to floor side 1, raceway side 2. To specify raceway side one and tile to floor side 2, change "FR" in pattern number to "RF".  <b>Top Cap Options:</b> <b>(2)</b> = Extruded Plastic (Smooth Radius) <b>(3)</b> = No Top Cap <b>(4)</b> = Radius Metal, add \$38 P1, \$40 P2, \$42 P3 paint grades <b>(5)</b> = Flat Metal, add \$38 P1, \$40 P2, \$42 P3 paint grades  <b>Raceway Knockout Options:</b> <b>(K)</b> = Knockouts on raceway side <b>(N)</b> = No Knockouts

# Beltway Panels

## Tile to the Floor

### 78" High

description	height	width	depth	pattern number									Deduct for Monolithic side 1
					10	15	20	25	30	35	40	45	
78" Beltway Panels with Tile to the Floor	78 <sup>1</sup> / <sub>16</sub> "	18"	3"	<b>DP7CBBFR7818</b>	\$887.	\$914.	\$956.	\$970.	\$999.	\$1,017.	\$1,032.	\$1,057.	\$86.
	78 <sup>1</sup> / <sub>16</sub> "	24"	3"	<b>DP7CBBFR7824</b>	992.	1,020.	1,067.	1,085.	1,112.	1,133.	1,153.	1,179.	99.
	78 <sup>1</sup> / <sub>16</sub> "	30"	3"	<b>DP7CBBFR7830</b>	1,060.	1,091.	1,144.	1,165.	1,195.	1,215.	1,235.	1,268.	102.
	78 <sup>1</sup> / <sub>16</sub> "	36"	3"	<b>DP7CBBFR7836</b>	1,171.	1,206.	1,262.	1,284.	1,320.	1,343.	1,366.	1,399.	119.
	78 <sup>1</sup> / <sub>16</sub> "	42"	3"	<b>DP7CBBFR7842</b>	1,257.	1,294.	1,352.	1,377.	1,417.	1,440.	1,466.	1,500.	122.
	78 <sup>1</sup> / <sub>16</sub> "	48"	3"	<b>DP7CBBFR7848</b>	1,381.	1,423.	1,490.	1,518.	1,556.	1,585.	1,613.	1,652.	151.



Dimensions listed under h w c are actual to the nearest 1/16"

Ordering Information	Order Code	Included with:	Options
<b>Beltway Panel with Tile to the Floor:</b> 1. Pattern Number 2. Top cap type 3. Top cap finish 4. Base raceway knockout option 5. Base raceway finish 6. Beltway finish 7. Panel fabric	<b>Beltway Panel with Tile to the Floor:</b> <i>Example:</i> <b>DP7CBBFR7818</b> <b>4/117/K/117/117/B191</b> <hr/> <b>DP7CBB</b> Pattern number <hr/> <b>FR7818</b> <hr/> <b>4</b> Radius Metal top cap <hr/> <b>117</b> Soft Grey top cap finish <hr/> <b>K</b> Base raceway with knockouts both sides <hr/> <b>117</b> Soft Grey base raceway finish <hr/> <b>117</b> Soft Grey beltway cover finish <hr/> <b>B191</b> Fairfield light fabric	<b>Beltway Panel with Tile to the Floor:</b> <ul style="list-style-type: none"> <li>Panel frame</li> <li>Acoustic panel inserts</li> <li>Top cap</li> <li>Connection hardware</li> <li>Base raceway</li> <li>Beltway with covers</li> <li>Tile to the floor side 1</li> </ul>	<b>Beltway Panel with Tile to the Floor:</b> <b>Full View Frame Option:</b> To specify full view frames for window or stacking applications, replace the "C" in pattern number with "V". No upcharge.  <b>Monolithic Side Option:</b> For side 1 monolithic, side 2 beltway, change "BB" in pattern number to "MB" and deduct amount in far right column.  <b>Tile to Floor Side Option:</b> Panels are standard with tile to floor side 1, raceway side 2. To specify raceway side one and tile to floor side 2, change "FR" in pattern number to "RF".  <b>Top Cap Options:</b> (2) = Extruded Plastic (Smooth Radius) (3) = No Top Cap (4) = Radius Metal, add \$38 P1, \$40 P2, \$42 P3 paint grades (5) = Flat Metal, add \$38 P1, \$40 P2, \$42 P3 paint grades  <b>Raceway Knockout Options:</b> (K) = Knockouts on raceway side (N) = No Knockouts

## Panel Frame Options

Dividends Horizon offers two panel frame options, which are selected depending on customer's aesthetic and functional needs. Both frames are available in preconfigured and build-to-spec panels, and may also be specified in CAP.

Dividends Horizon panel frames may be specified separately for "Build-to-Spec" applications. These include when panel inserts are only required on one side or when a beltway is required on one side and tiled inserts are on the other.

Panel frames may be specified with a standard base raceway, an open base or a tile to the floor. Panel frames ship complete with the base components, top cap and universal connection hardware. Raceway cover knockouts are standard with standard base raceway. If not required raceway covers without knockouts may be specified.

**Topway panel frames** feature an integral top cable trough, and are used with D1 style stack panels.

**Full View frames** have no top trough, leaving a larger window opening in the top position. Full view panels frames are designed for use with windows in the top position. They are also required when stacking with D2 style stack frames or DP7 stacking screens.

Topway and full view panel frames are offered in worksurface height, 36", 42", 50", 57", 64" and 78" high.

### Three Top Cap Options Available:

- Smooth Radius Plastic
- Radius Metal
- Flat Metal

### Top Cap Construction

Smooth radiused plastic top caps are made from extruded plastic. Radius and flat metal top caps are made from steel.

## Top Cap Attachment

Full view frames ordered with top caps include top cap attachment clips on the panel frame.

If top caps are ordered separately, top cap attachment clips ship with the top cap and must be field-installed to the panel frame.

## Open Position Planner

Open Position Planner allows specifiers to design and order factory assembled panels in virtually any configuration. Open Position Planner is available only through CAP, and is not available in this price list.

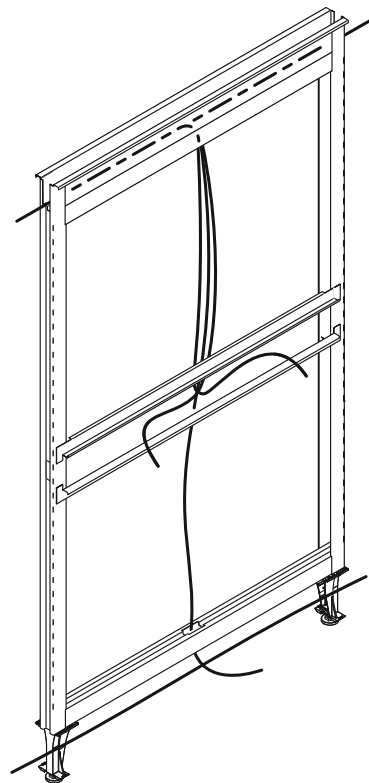

Topway Panel Frame

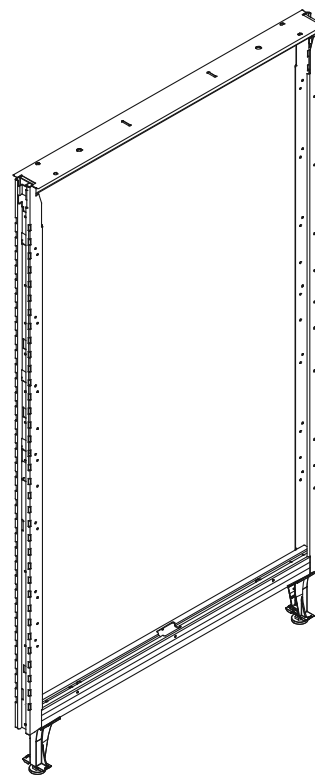

Full View Panel Frame

## Panel Base Options

Dividends Horizon panels are available with three base options:

- Base Raceway
- Open Base
- Tile-to-Floor.

Overall panel heights, tile configurations and application rules are the same for all three base options.

## Base Raceway

Provides duplex receptacle and data port access at base height. Base Raceway panels feature two roll formed steel raceway covers, which are available with or without electrical/data knockouts.

- Exterior dimension: 5"H x 2 15/16"D
- Interior dimension: 5"H x 2 7/8"D
- Dataport Knockout dimension: 1 3/8"H x 2 5/8"D
- Construction: Paint-colored 22-gauge roll-form steel cover
- Duplex access: 24" and wider base raceway covers have two duplex knockouts per panel side (18"W panels do not have duplex knockouts)
- Duplex location: 9" on center from each end

## Panel Base Options

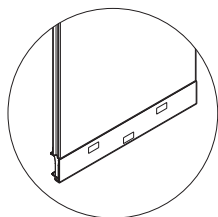

Base Raceway

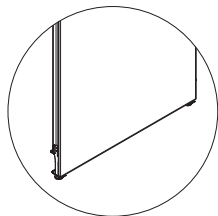

Tile-to-Floor  
(single-sided only)

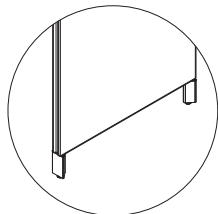

Open Base

- Data access: All base raceway covers have one center-located data port knockout
- Additional data access: In panels 24" and wider, the outer knockouts can be used as additional data ports when the raceway is not used for duplex receptacles
- Power capacity: One power module or jumper

**Note:** Knockouts are standard unless specified without.

**Open Base** panels feature two extruded aluminum feet positioned at the end of each panel. A horizontal trim is located below the bottom tile.

**Tile-To-Floor** panels eliminate the raceway cover and access on one side, replaced by a fabric tile extended to the floor. A heavy gauge steel internal raceway cover protects the raceway contents and the tile from deflecting when hit by shoes or vacuum cleaners. The other side of the panel features a raceway cover, available with or without electrical/data knockouts. If needed, use one-sided electrical and one-sided base cable trays with this base option.

**Note:** Worksurface height monolithic tiles are to be used with worksurface height panel frames only.

**Note:** 24"H inserts are to only be used below beltways.

## Monolithic and Tiled Panel Standard Configuration

### Worksurface Height



- Monolithic
- One worksurface height monolithic insert

### 36"H Panel Frames



- Monolithic
- One 28"H monolithic insert



- Tiled
- Two 14"H tiled inserts

### 42"H Panel Frames



- Monolithic
- One 35"H monolithic insert



- Tiled
- One 7"H tiled insert
  - Two 14"H tiled inserts



- Beltway
- One 7"H upper insert
  - One 4"H beltway cover
  - One 24"H lower insert

### 50"H Panel Frames



- Monolithic
- One 42"H monolithic insert



- Tiled
- Three 14"H tiled inserts



- Beltway
- One 14"H upper insert
  - One 4"H beltway cover
  - One 24"H lower insert

### 57"H Panel Frames



- Monolithic
- One 49"H monolithic insert



- Tiled
- One 7"H tiled inserts
  - Three 14"H tiled inserts

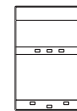

- Beltway
- One 7"H tiled insert
  - One 14"H tiled insert
  - One 4"H beltway cover
  - One 24"H lower insert

### 64"H Panel Frames



- Monolithic
- One 56"H monolithic insert

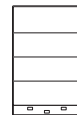

- Tiled
- Four 14" H tiled inserts

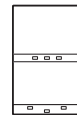

- Beltway
- One 28"H upper insert
  - One 4"H beltway cover
  - One 24"H lower insert

### 78"H Panel Frames

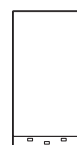

- Monolithic
- One 70"H monolithic insert



- Tiled
- Five 14"H tiled inserts



- Beltway
- One 50"H Upper insert
  - One 4"H Beltway cover
  - One 24"H Lower insert

**Note:** Insert dimensions are nominal. Inserts are for one side only.

# Topway and Full View Panel Frame Assemblies

## Worksurface Height, 36" and 42" High

Dividends Horizon

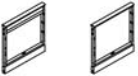
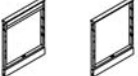
description	h	w	d	pattern no.	list
Worksurface Height	28 1/2"	15"	3"	<b>DP7()</b> RRWH15	\$215.
Panel Frame Assembly	28 1/2"	18"	3"	<b>DP7()</b> RRWH18	215.
	28 1/2"	24"	3"	<b>DP7()</b> RRWH24	221.
	28 1/2"	30"	3"	<b>DP7()</b> RRWH30	230.
	28 1/2"	36"	3"	<b>DP7()</b> RRWH36	245.
	28 1/2"	42"	3"	<b>DP7()</b> RRWH42	273.
	28 1/2"	48"	3"	<b>DP7()</b> RRWH48	273.
	28 1/2"	60"	3"	<b>DP7()</b> RRWH60	315.
	36" High Panel Frame Assembly	35 1/8"	15"	3"	<b>DP7()</b> RR3615
 <p>(topway and full view shown)</p>	35 1/8"	18"	3"	<b>DP7()</b> RR3618	215.
	35 1/8"	24"	3"	<b>DP7()</b> RR3624	221.
	35 1/8"	30"	3"	<b>DP7()</b> RR3630	230.
	35 1/8"	36"	3"	<b>DP7()</b> RR3636	245.
	35 1/8"	42"	3"	<b>DP7()</b> RR3642	273.
	35 1/8"	48"	3"	<b>DP7()</b> RR3648	273.
	35 1/8"	60"	3"	<b>DP7()</b> RR3660	315.
42" High Panel Frame Assembly	42 3/16"	15"	3"	<b>DP7()</b> RR4215	193.
 <p>(topway and full view shown)</p>	42 3/16"	18"	3"	<b>DP7()</b> RR4218	193.
	42 3/16"	24"	3"	<b>DP7()</b> RR4224	199.
	42 3/16"	30"	3"	<b>DP7()</b> RR4230	215.
	42 3/16"	36"	3"	<b>DP7()</b> RR4236	230.
	42 3/16"	42"	3"	<b>DP7()</b> RR4242	249.
	42 3/16"	48"	3"	<b>DP7()</b> RR4248	261.
	42 3/16"	60"	3"	<b>DP7()</b> RR4260	300.

Dimensions listed under h w d are actual to the nearest 1/16"

Ordering Information	Order Code	Included with:	Options
<b>Panel Frame Assembly</b> 1. Pattern Number 2. Top cap type 3. Top cap trim finish 4. Raceway knockout option 5. Base raceway finish if required	<b>Topway Panel Frame Assembly</b> <i>Example:</i> <b>DP7CRR6448</b> <b>4/117K/117</b> <hr/> <b>DP7CRR</b> Topway Panel Frame <b>6448</b> Assemblies with Base Raceway <hr/> <b>4</b> Radius metal topcap <hr/> <b>117</b> Soft Grey top cap finish <hr/> <b>K</b> Raceway knockouts <hr/> <b>117</b> Soft Grey raceway finish	<b>Panel Frame Assembly:</b> <ul style="list-style-type: none"> <li>• Panel frame</li> <li>• Top cap (optional)</li> <li>• Connection hardware</li> <li>• Base raceway</li> </ul> <b>Note:</b> Worksurface Height panel frame assemblies are not available with plastic top caps.  <b>Note:</b> 15" wide panels are only available with standard base raceway or tile to floor.	<b>Panel Frame Assembly:</b>  <b>Option:</b> <b>(C)</b> = Topway Panel Frame <b>(V)</b> = Full View Panel Frame  <b>Panel Base Options</b>  <b>Open Panel Base Option:</b> For open panel base, change 'RR' to 'LL'.  <b>Tile to Floor Option:</b> For tile to floor on one side and base raceway on the other side change 'RR' to 'FR' and add \$32 to list price.  <b>Top Cap Options:</b> <b>(2)</b> = Extruded Plastic (Smooth Radius) <b>(3)</b> = No Top Cap <b>(4)</b> = Radius Metal, add \$38 P1, \$40 P2, \$42 P3 paint grades <b>(5)</b> = Flat Metal, add \$38 P1, \$40 P2, \$42 P3 paint grades  <b>Base Raceway Knockout Options:</b> (for RR and RF bases only) <b>(K)</b> = Knockouts on raceway side <b>(N)</b> = No knockouts



# Topway and Full View Panel Frame Assemblies

## 50", 57" and 64" High

Dividends Horizon

Panels, Build-To-Spec

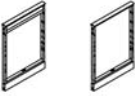
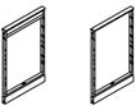
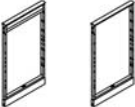
description	h	w	d	pattern no.	list
50" High Panel Frame Assembly Standard Base Raceway  (topway and full view shown)	49 1/2"	15"	3"	<b>DP7( )RR5015</b>	\$199.
	49 1/2"	18"	3"	<b>DP7( )RR5018</b>	199.
	49 1/2"	24"	3"	<b>DP7( )RR5024</b>	208.
	49 1/2"	30"	3"	<b>DP7( )RR5030</b>	224.
	49 1/2"	36"	3"	<b>DP7( )RR5036</b>	236.
	49 1/2"	42"	3"	<b>DP7( )RR5042</b>	254.
	49 1/2"	48"	3"	<b>DP7( )RR5048</b>	267.
	49 1/2"	60"	3"	<b>DP7( )RR5060</b>	290.
57" High Panel Frame Assembly Standard Base Raceway  (topway and full view shown)	56 13/16"	15"	3"	<b>DP7( )RR5715</b>	199.
	56 13/16"	18"	3"	<b>DP7( )RR5718</b>	199.
	56 13/16"	24"	3"	<b>DP7( )RR5724</b>	208.
	56 13/16"	30"	3"	<b>DP7( )RR5730</b>	219.
	56 13/16"	36"	3"	<b>DP7( )RR5736</b>	234.
	56 13/16"	42"	3"	<b>DP7( )RR5742</b>	248.
	56 13/16"	48"	3"	<b>DP7( )RR5748</b>	262.
	56 13/16"	60"	3"	<b>DP7( )RR5760</b>	277.
64" High Panel Frame Assembly Standard Base Raceway  (topway and full view shown)	64 1/16"	15"	3"	<b>DP7( )RR6415</b>	210.
	64 1/16"	18"	3"	<b>DP7( )RR6418</b>	210.
	64 1/16"	24"	3"	<b>DP7( )RR6424</b>	227.
	64 1/16"	30"	3"	<b>DP7( )RR6430</b>	236.
	64 1/16"	36"	3"	<b>DP7( )RR6436</b>	251.
	64 1/16"	42"	3"	<b>DP7( )RR6442</b>	267.
	64 1/16"	48"	3"	<b>DP7( )RR6448</b>	282.
	64 1/16"	60"	3"	<b>DP7( )RR6460</b>	327.

Dimensions listed under h w d are actual to the nearest 1/16"

Ordering Information	Order Code	Included with:	Options
<b>Panel Frame Assembly</b> 1. Pattern Number 2. Top cap type 3. Top cap trim finish 4. Raceway knockout option 5. Base raceway finish if required	<b>Topway Panel Frame Assembly</b> <i>Example:</i> <b>DP7CRR6448</b> <b>4/117K/117</b> <hr/> <b>DP7CRR</b> Topway Panel Frame <b>6448</b> Assembly with Base Raceway <hr/> <b>4</b> Radius metal topcap <hr/> <b>117</b> Soft Grey top cap finish <hr/> <b>K</b> Raceway knockouts <hr/> <b>117</b> Soft Grey raceway finish	<b>Panel Frame Assembly:</b> <ul style="list-style-type: none"> <li>• Panel frame</li> <li>• Top cap (optional)</li> <li>• Connection hardware</li> <li>• Base raceway</li> </ul> <b>Note:</b> 15" wide panels are only available with a standard base raceway or tile to floor.	<b>Panel Frame Assembly:</b> <b>Option:</b> <b>(C)</b> = Topway Panel Frame <b>(V)</b> = Full View Panel Frame <b>Panel Base Options</b> <b>Open Panel Base Option:</b> For open panel base, change 'RR' to 'LL'. <b>Tile to Floor Option:</b> For tile to floor on one side and base raceway on the other side change 'RR' to 'FR' and add \$32 to list price. <b>Top Cap Options:</b> <b>(2)</b> = Extruded Plastic (Smooth Radius) <b>(3)</b> = No Top Cap <b>(4)</b> = Radius Metal, add \$38 P1, \$40 P2, \$42 P3 paint grades <b>(5)</b> = Flat Metal, add \$38 P1, \$40 P2, \$42 P3 paint grades <b>Base Raceway Knockout Options:</b> (for RR and RF base only) <b>(K)</b> = Knockouts on raceway side <b>(N)</b> = No knockouts

# Topway and Full View Panel Frame Assemblies 78" High

Dividends Horizon

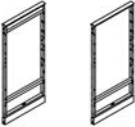
description	h	w	d	pattern no.	list
78" High Panel Frame Assembly Standard Base Raceway  	78 <sup>9</sup> / <sub>16</sub> "	15"	3"	<b>DP7( )RR7815</b>	\$322.
	78 <sup>9</sup> / <sub>16</sub> "	18"	3"	<b>DP7( )RR7818</b>	322.
	78 <sup>9</sup> / <sub>16</sub> "	24"	3"	<b>DP7( )RR7824</b>	341.
	78 <sup>9</sup> / <sub>16</sub> "	30"	3"	<b>DP7( )RR7830</b>	354.
	78 <sup>9</sup> / <sub>16</sub> "	36"	3"	<b>DP7( )RR7836</b>	381.
	78 <sup>9</sup> / <sub>16</sub> "	42"	3"	<b>DP7( )RR7842</b>	402.
	78 <sup>9</sup> / <sub>16</sub> "	48"	3"	<b>DP7( )RR7848</b>	419.

(topway and full view shown)

Dimensions listed under h w d are actual to the nearest <sup>1</sup>/<sub>16</sub>"

Ordering Information	Order Code	Included with:	Options
<b>Panel Frame Assembly</b> 1. Pattern Number 2. Top cap type 3. Top cap trim finish 4. Raceway knockout option 5. Base raceway finish if required	<b>Topway Panel Frame Assembly</b> <i>Example:</i> <b>DP7CRR7848</b> <b>4/117K/117</b> <hr/> <b>DP7CRR</b> Topway Panel Frame <b>7848</b> Assembly with Base Raceway <hr/> <b>4</b> Radius metal topcap <hr/> <b>117</b> Soft Grey top cap finish <hr/> <b>K</b> Raceway knockouts <hr/> <b>117</b> Soft Grey raceway finish	<b>Panel Frame Assembly:</b> <ul style="list-style-type: none"> <li>Panel frame</li> <li>Top cap (optional)</li> <li>Connection hardware</li> <li>Base raceway</li> </ul> <b>Note:</b> 15" wide panels are only available with a standard base raceway or tile to floor.	<b>Panel Frame Assembly:</b>  <b>Option:</b> <b>(C)</b> = Topway Panel Frame <b>(V)</b> = Full View Panel Frame  <b>Panel Base Options</b>  <b>Open Panel Base Option:</b> For open panel base, change 'RR' to 'LL'.  <b>Tile to Floor Option:</b> For tile to floor on one side and base raceway on the other side change 'RR' to 'FR' and add \$31 to list price.  <b>Top Cap Options:</b> <b>(2)</b> = Extruded Plastic (Smooth Radius) <b>(3)</b> = No Top Cap <b>(4)</b> = Radius Metal, add \$38 P1, \$40 P2, \$42 P3 paint grades <b>(5)</b> = Flat Metal, add \$38 P1, \$40 P2, \$42 P3 paint grades  <b>Base Raceway Knockout Options:</b> (for RR and RF base only) <b>(K)</b> = Knockouts on raceway side <b>(N)</b> = No knockouts

**This page intentionally left blank**

## Stack Frames

Dividends Horizon stack frames provide the flexibility to increase the overall height of a standard Dividends Horizon panel.

Stack frames are available in three panel heights, 14", 21" and 28" all capable of attaching to any panel height. Maximum stacking height above the "base" standard panel is 28". This can be accomplished with one 28" high stack panel or by stacking two 14" high panels on each other.

21" stack panel frames may be attached to 42" standard Dividends Horizon panels allowing the overall panel height to be 64" or to 57" panels for an overall height of 78."

The 28" high stack panel frame is prepunched to accept tile insert support rails to provide a tiled look if required.

### Stack Frame Options

Dividends Horizon offers two stack panel frame options, which are selected depending on customer's aesthetic and functional needs.

#### D1 Style Stack Frame Planning

D1 style stack frames feature a D1 style painted aluminum horizontal trim at the bottom of each stack frame. D1 style stack frames mount on top of Dividends Horizon topway panel frames only. D1 style stack panels are load bearing on the first tier only.

**Note:** When stacking (2) D1 style stack frames, the stack frame in the first tier position must have a topway to be able to accept the second tier stack frame.

#### D2 Style Stack Frame Planning

D2 style stack frames feature a D2 style black recessed horizontal reveal at the bottom of each stack frame. D2 style stack frames mount on top of Dividends Horizon DP7V full view panel frames only. D2 style stack frames are load bearing on the first or second tier, and are designed to align overhead storage components hung at 64" with overhead components hung off 64" full height panels. Components hung on stack panels at 50" or 57" will not align with components hung off 50" or 57" full height panels.

D2 style stack frames also have the option to be used with tiled or monolithic tiles on one or both side of the base/stack panel assembly. See options on panel pricing page.

**Note:** The single and double pane window insert kits are not compatible with the D2 style stack frame. Use D1 style stack frames with single or double pane window insert kits.

**Note:** D2 style stack frames are not compatible with slatwall tiles.

### Stack Panel Dimensions

- Widths: 18", 24", 30", 36", 42", and 48"
- Heights: 14", 21" and 28"
- Thickness: 3"

### Construction

The stack panel frame is an all-welded steel construction.

- Topway: 22-gauge roll-formed steel (if applicable)
- Vertical channels: 16-gauge roll-formed steel
- Horizontal rails: 16-gauge steel tubing

### Panel Trim

When stack panels are installed, the "base" standard panel's top cap is utilized by attaching to the top of the stack panel.

Panel end trim is ordered separately from the stack panel. To specify panel end trim for the end of a panel run, simply add the stack panel and base panel frame height (i.e., a 50" high base panel frame with one 14" high stack panel will require a 64" high panel end trim kit).

In a high-to-low panel-to-panel application where stack panels are used, simply deduct the panel height difference between the two panels to determine size of the high-to-low panel end trim required.

## Post Trim

Post trim covers must match the overall height of the "base" standard post and stack post.

### Stack Post (Same-height panels)

When two or more stack panels are connected together in a 2-way "L", 3-way "T" or a 4-way "X" condition, and all the panel heights are of the same height, a stack panel post kit may be used.

The stack post kit attaches to the top of a base universal post and is available in a 14" or 28" height and ships with connecting hardware.

### Stack Post (Multi-height panels)

When stack panels are used in a high-to-low panel-to-post applications, high-to-low post trim must be ordered separately.

**Note:** A universal post must match the height of the tallest base standard panel being connected.

### Construction

Posts are 3" square extruded aluminum construction.

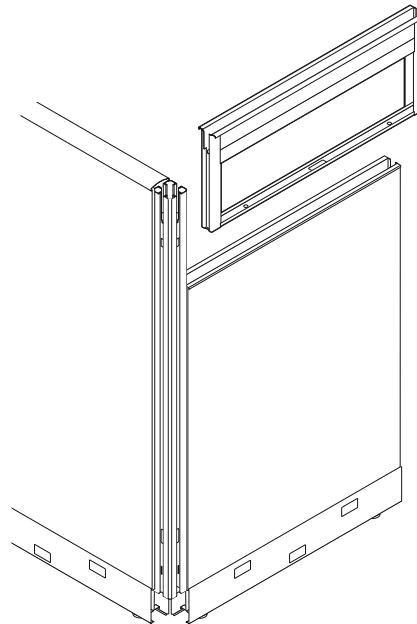

Stack Frame

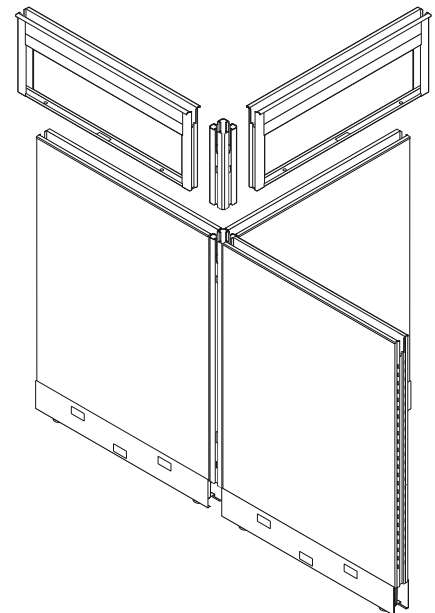

Stack Post (Same-Height Panels)

# Stack Frames

## D1 Style With External Reveal

(For Use With Topway Panels Only)



description	h	w	d	pattern no.	with topway	full view (without topway)
28" High Stack Panel Frame Only (full view shown)	29 1/4"	18"	3"	<b>DP2S(T/N)F 2818</b>	\$168.	\$201.
	29 1/4"	24"	3"	<b>DP2S(T/N)F 2824</b>	171.	212.
	29 1/4"	30"	3"	<b>DP2S(T/N)F 2830</b>	186.	225.
	29 1/4"	36"	3"	<b>DP2S(T/N)F 2836</b>	209.	243.
	29 1/4"	42"	3"	<b>DP2S(T/N)F 2842</b>	224.	262.
	29 1/4"	48"	3"	<b>DP2S(T/N)F 2848</b>	236.	271.
21" High Stack Panel Frame Only	21 7/8"	18"	3"	<b>DP2STF 2118</b>	172.	n/a
	21 7/8"	24"	3"	<b>DP2STF 2124</b>	184.	n/a
	21 7/8"	30"	3"	<b>DP2STF 2130</b>	199.	n/a
	21 7/8"	36"	3"	<b>DP2STF 2136</b>	217.	n/a
	21 7/8"	42"	3"	<b>DP2STF 2142</b>	239.	n/a
	21 7/8"	48"	3"	<b>DP2STF 2148</b>	249.	n/a
14" High Stack Panel, load bearing	14"	18"	3"	<b>DP2 STFL1418</b>	140.	n/a
	14"	24"	3"	<b>DP2 STFL1424</b>	145.	n/a
	14"	30"	3"	<b>DP2 STFL1430</b>	168.	n/a
	14"	36"	3"	<b>DP2 STFL1436</b>	185.	n/a
	14"	42"	3"	<b>DP2 STFL1442</b>	206.	n/a
	14"	48"	3"	<b>DP2 STFL1448</b>	220.	n/a
14" High Stack Panel non-load bearing	14"	18"	3"	<b>DP2S(T/N)F 1418</b>	140.	168.
	14"	24"	3"	<b>DP2S(T/N)F 1424</b>	145.	171.
	14"	30"	3"	<b>DP2S(T/N)F 1430</b>	168.	186.
	14"	36"	3"	<b>DP2S(T/N)F 1436</b>	185.	209.
	14"	42"	3"	<b>DP2S(T/N)F 1442</b>	206.	224.
	14"	48"	3"	<b>DP2S(T/N)F 1448</b>	220.	236.

Panels, Build-To-Spec

**NOTE:** D1 Stack Frames may be used with Topway Panels only.

Ordering Information	Order Code	Included with:	Options
<b>Stack Panel Frame</b> 1. Pattern Number 2. Trim Finish	<b>Stack Panel Frame</b> <i>Example:</i> <b>DP2STF 1448, 113</b> <b>DP1STF</b> Pattern Number <b>1448</b> <b>113</b> Dark grey paint finish <b>Stack Panel Post</b> <i>Example:</i> <b>DP2ASPO 14</b> <b>DP2ASPO</b> Pattern Number <b>14</b>	<b>Stack Panel Frame</b> <b>Note:</b> When stacking (2) D1 style stack frames, the stack frame in the first tier position must have a topway trough to be able to accept the second tier stack frame.	<b>Stack Panel Frame</b> Stack frame option: <b>(T)</b> = with topway <b>(N)</b> = without topway  <b>Note:</b> 21" stack panel frame not available without a topway.  <b>Note:</b> D1 Stack Frames are load bearing on first tier only.

Stack Frames  
*D2 Style With Recessed Reveal*  
*(For Use With DP7 Full View Panels Only)*

description	w	h	d	pattern no.	list
 14" High Dividends Stack Frame	18"	14 <sup>5</sup> / <sub>8</sub> "	3"	<b>DPS7V1418( )</b>	\$212.
	24"	14 <sup>5</sup> / <sub>8</sub> "	3"	<b>DPS7V1424( )</b>	215.
	30"	14 <sup>5</sup> / <sub>8</sub> "	3"	<b>DPS7V1430( )</b>	234.
	36"	14 <sup>5</sup> / <sub>8</sub> "	3"	<b>DPS7V1436( )</b>	254.
	42"	14 <sup>5</sup> / <sub>8</sub> "	3"	<b>DPS7V1442( )</b>	262.
	48"	14 <sup>5</sup> / <sub>8</sub> "	3"	<b>DPS7V1448( )</b>	270.
 21" High Dividends Stack Frame	18"	21 <sup>7</sup> / <sub>8</sub> "	3"	<b>DPS7V2118( )</b>	246.
	24"	21 <sup>7</sup> / <sub>8</sub> "	3"	<b>DPS7V2124( )</b>	259.
	30"	21 <sup>7</sup> / <sub>8</sub> "	3"	<b>DPS7V2130( )</b>	271.
	36"	21 <sup>7</sup> / <sub>8</sub> "	3"	<b>DPS7V2136( )</b>	288.
	42"	21 <sup>7</sup> / <sub>8</sub> "	3"	<b>DPS7V2142( )</b>	298.
	48"	21 <sup>7</sup> / <sub>8</sub> "	3"	<b>DPS7V2148( )</b>	307.
 28" High Dividends Stack Frame	18"	29 <sup>1</sup> / <sub>4</sub> "	3"	<b>DPS7V2818( )</b>	235.
	24"	29 <sup>1</sup> / <sub>4</sub> "	3"	<b>DPS7V2824( )</b>	248.
	30"	29 <sup>1</sup> / <sub>4</sub> "	3"	<b>DPS7V2830( )</b>	263.
	36"	29 <sup>1</sup> / <sub>4</sub> "	3"	<b>DPS7V2836( )</b>	284.
	42"	29 <sup>1</sup> / <sub>4</sub> "	3"	<b>DPS7V2842( )</b>	298.
	48"	29 <sup>1</sup> / <sub>4</sub> "	3"	<b>DPS7V2848( )</b>	308.

**NOTE: D2 Stack Frames may be used with DP7 Full View Panels only.**

Ordering Information	Order Code	Included with:	Options
<b>Stack Frames:</b> 1. Pattern Number 2. Tile Support Configuration	<b>Stack Panel Frame Assembly</b> <i>Example:</i> <b>DPS7V1418TT</b> <hr/> <b>DPS7</b> Stack Panel Frame <hr/> <b>V</b> Full View <hr/> <b>14</b> Height <hr/> <b>18</b> Width <hr/> <b>TT</b> Segmented Tile Supports Both Side	<b>Stack Panel Frame:</b> <ul style="list-style-type: none"> <li>Stack Frame</li> </ul> <p><b>Note:</b> Slatwall tiles, single pane and double pane window kits cannot be used with D2 stack frames.</p> <p><b>Note:</b> D2 Stack Frames are load bearing on first and second tier.</p>	<b>Tile Options/Pattern Number Suffix:</b> <p><b>(TT)</b> = Tile support located at the base of stacker to support segmented tiles on both sides of a panel.</p> <p><b>(TM)</b> = Tile support located at the base of the stacker to support segmented tiles on one side and a monolithic tile on the other side of the panel.</p> <p><b>(MM)</b> = Monolithic tiles on both sides of the panel.</p>

**This page intentionally left blank**

### Monolithic Fabric Inserts

Dividends Horizon monolithic inserts are available by component for use with panel frames or wall mount tracks for "Build-to-Spec" applications. These applications include when inserts are only required on one panel side, when a different fabric is required on each panel side, or when wall mount tracks are being used.

Tile to floor option available for worksurface height, 36", 42", 50", 57", 64" and 78" panel heights.

### Monolithic Fabric Insert Construction

Fabric laminated with adhesive, heat-cured to 7/16" thick tackable acoustical board.

### Monolithic Fabric Insert Ratings

Noise Reduction Coefficient (NRC) rating: .70  
Sound Transmission Class (STC) rating: 11

The materials in Dividends Horizon panels meet the flame spread and smoke generation criteria established in UL1286 safety standard for office furniture.

### Monolithic Fabric Insert Attachment

Panel inserts flex to attach to the troughs in the upper and lower horizontal panel frame supports or to the bottom tile channel in a wall mount track application. Mounting clips are attached to panel inserts for connection to the vertical frame or wall mount tracks for additional support. No tools are required for insert attachment.

**Note:** If additional mid-span support for monolithic panel inserts is required, a beltway cable tray can be installed.

**Note:** Insert dimensions are nominal. Inserts are for one side only.

**Note:** Worksurface height monolithic tiles are to be used with worksurface height panel frames only.

### Monolithic Fabric Insert

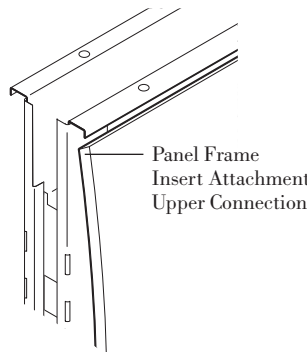
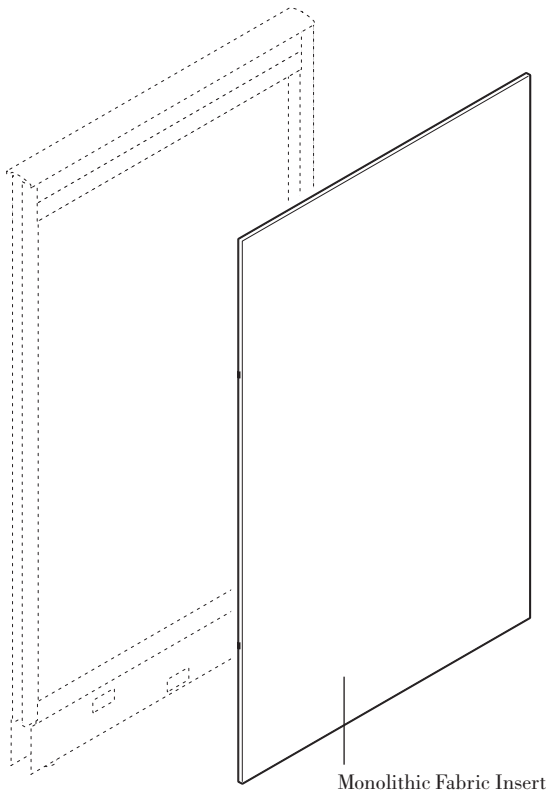

Monolithic Fabric Insert Attachment

### Monolithic Fabric Insert Configurations



**Worksurface Height**  
• One worksurface height monolithic insert



**36"H Panel Frames**  
• One 28"H monolithic insert



**42"H Panel Frames**  
• One 35"H monolithic insert



**50"H Panel Frames**  
• One 42"H monolithic insert



**57"H Panel Frames**  
• One 49"H monolithic insert

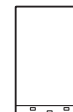

**64"H Panel Frames**  
• One 56"H monolithic insert

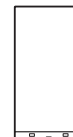





**78"H Panel Frames**  
• One 70"H monolithic insert



# Monolithic Panel Fabric Inserts

## For Worksurface Height, 36", 42" and 50" High Panel Frames

Dividends Horizon

description	w*	w	h	d	pattern no.	grade								
						10	15	20	25	30	35	40	45	
Worksurface Height Individual Monolithic Fabric Insert (For worksurface height Panel Frame only) 	15"	14 <sup>5</sup> / <sub>8</sub> "	22 <sup>1</sup> / <sub>2</sub> "	3"	<b>DP1SOWH15</b>	\$89.	\$97.	\$102.	\$109.	\$113.	\$117.	\$123.	\$127.	
	18"	17 <sup>5</sup> / <sub>8</sub> "	22 <sup>1</sup> / <sub>2</sub> "	3"	<b>DP1SOWH18</b>	89.	97.	102.	109.	113.	117.	123.	127.	
	24"	23 <sup>5</sup> / <sub>8</sub> "	22 <sup>1</sup> / <sub>2</sub> "	3"	<b>DP1SOWH24</b>	111.	115.	127.	133.	138.	141.	146.	158.	
	30"	29 <sup>5</sup> / <sub>8</sub> "	22 <sup>1</sup> / <sub>2</sub> "	3"	<b>DP1SOWH30</b>	121.	127.	138.	144.	150.	158.	162.	171.	
	36"	35 <sup>5</sup> / <sub>8</sub> "	22 <sup>1</sup> / <sub>2</sub> "	3"	<b>DP1SOWH36</b>	132.	138.	150.	159.	168.	174.	178.	184.	
	42"	41 <sup>5</sup> / <sub>8</sub> "	22 <sup>1</sup> / <sub>2</sub> "	3"	<b>DP1SOWH42</b>	137.	143.	152.	160.	170.	175.	182.	190.	
	48"	47 <sup>5</sup> / <sub>8</sub> "	22 <sup>1</sup> / <sub>2</sub> "	3"	<b>DP1SOWH48</b>	143.	150.	162.	171.	176.	183.	193.	203.	
	60"	59 <sup>5</sup> / <sub>8</sub> "	22 <sup>1</sup> / <sub>2</sub> "	3"	<b>DP1SOWH60</b>	163.	168.	175.	178.	184.	187.	197.	208.	
28" High Individual Monolithic Fabric Insert (For 36"H Panel Frame) 	15"	14 <sup>5</sup> / <sub>8</sub> "	29"	7 <sup>1</sup> / <sub>16</sub> "	<b>DP1SO2815</b>	93.	97.	100.	107.	109.	114.	119.	124.	
	18"	17 <sup>5</sup> / <sub>8</sub> "	29"	7 <sup>1</sup> / <sub>16</sub> "	<b>DP1SO2818</b>	93.	97.	100.	107.	109.	114.	119.	124.	
	24"	23 <sup>5</sup> / <sub>8</sub> "	29"	7 <sup>1</sup> / <sub>16</sub> "	<b>DP1SO2824</b>	108.	114.	124.	129.	135.	138.	142.	152.	
	30"	29 <sup>5</sup> / <sub>8</sub> "	29"	7 <sup>1</sup> / <sub>16</sub> "	<b>DP1SO2830</b>	118.	124.	135.	140.	146.	152.	157.	166.	
	36"	35 <sup>5</sup> / <sub>8</sub> "	29"	7 <sup>1</sup> / <sub>16</sub> "	<b>DP1SO2836</b>	128.	135.	146.	153.	164.	170.	174.	179.	
	42"	41 <sup>5</sup> / <sub>8</sub> "	29"	7 <sup>1</sup> / <sub>16</sub> "	<b>DP1SO2842</b>	133.	139.	147.	156.	165.	171.	177.	184.	
	48"	47 <sup>5</sup> / <sub>8</sub> "	29"	7 <sup>1</sup> / <sub>16</sub> "	<b>DP1SO2848</b>	139.	146.	157.	166.	172.	178.	185.	199.	
	60"	59 <sup>5</sup> / <sub>8</sub> "	29"	7 <sup>1</sup> / <sub>16</sub> "	<b>DP1SO2860</b>	164.	168.	176.	179.	183.	187.	193.	197.	
35" High Individual Monolithic Fabric Insert (For 42"H Panel Frame) 	15"	14 <sup>5</sup> / <sub>8</sub> "	36 <sup>3</sup> / <sub>8</sub> "	7 <sup>1</sup> / <sub>16</sub> "	<b>DP1SO4215</b>	103.	109.	118.	125.	130.	132.	138.	142.	
	18"	17 <sup>5</sup> / <sub>8</sub> "	36 <sup>3</sup> / <sub>8</sub> "	7 <sup>1</sup> / <sub>16</sub> "	<b>DP1SO4218</b>	103.	109.	118.	125.	130.	132.	138.	142.	
	24"	23 <sup>5</sup> / <sub>8</sub> "	36 <sup>3</sup> / <sub>8</sub> "	7 <sup>1</sup> / <sub>16</sub> "	<b>DP1SO4224</b>	118.	124.	133.	138.	144.	150.	153.	161.	
	30"	29 <sup>5</sup> / <sub>8</sub> "	36 <sup>3</sup> / <sub>8</sub> "	7 <sup>1</sup> / <sub>16</sub> "	<b>DP1SO4230</b>	130.	138.	150.	153.	164.	167.	171.	177.	
	36"	35 <sup>5</sup> / <sub>8</sub> "	36 <sup>3</sup> / <sub>8</sub> "	7 <sup>1</sup> / <sub>16</sub> "	<b>DP1SO4236</b>	144.	152.	166.	171.	173.	183.	187.	197.	
	42"	41 <sup>5</sup> / <sub>8</sub> "	36 <sup>3</sup> / <sub>8</sub> "	7 <sup>1</sup> / <sub>16</sub> "	<b>DP1SO4242</b>	165.	171.	184.	193.	200.	205.	210.	219.	
	48"	47 <sup>5</sup> / <sub>8</sub> "	36 <sup>3</sup> / <sub>8</sub> "	7 <sup>1</sup> / <sub>16</sub> "	<b>DP1SO4248</b>	173.	180.	199.	203.	213.	219.	225.	234.	
	60"	59 <sup>5</sup> / <sub>8</sub> "	36 <sup>3</sup> / <sub>8</sub> "	7 <sup>1</sup> / <sub>16</sub> "	<b>DP1SO4260</b>	180.	185.	196.	200.	204.	207.	210.	216.	
42" High Individual Monolithic Fabric Insert (For 50"H Panel Frame) 	15"	14 <sup>5</sup> / <sub>8</sub> "	43 <sup>11</sup> / <sub>16</sub> "	7 <sup>1</sup> / <sub>16</sub> "	<b>DP1SO5015</b>	115.	121.	130.	133.	140.	144.	150.	156.	
	18"	17 <sup>5</sup> / <sub>8</sub> "	43 <sup>11</sup> / <sub>16</sub> "	7 <sup>1</sup> / <sub>16</sub> "	<b>DP1SO5018</b>	115.	121.	130.	133.	140.	144.	150.	156.	
	24"	23 <sup>5</sup> / <sub>8</sub> "	43 <sup>11</sup> / <sub>16</sub> "	7 <sup>1</sup> / <sub>16</sub> "	<b>DP1SO5024</b>	128.	135.	146.	150.	156.	164.	167.	173.	
	30"	29 <sup>5</sup> / <sub>8</sub> "	43 <sup>11</sup> / <sub>16</sub> "	7 <sup>1</sup> / <sub>16</sub> "	<b>DP1SO5030</b>	144.	152.	166.	171.	177.	183.	187.	196.	
	36"	35 <sup>5</sup> / <sub>8</sub> "	43 <sup>11</sup> / <sub>16</sub> "	7 <sup>1</sup> / <sub>16</sub> "	<b>DP1SO5036</b>	166.	173.	185.	193.	200.	204.	212.	220.	
	42"	41 <sup>5</sup> / <sub>8</sub> "	43 <sup>11</sup> / <sub>16</sub> "	7 <sup>1</sup> / <sub>16</sub> "	<b>DP1SO5042</b>	183.	194.	208.	213.	222.	228.	235.	244.	
	48"	47 <sup>5</sup> / <sub>8</sub> "	43 <sup>11</sup> / <sub>16</sub> "	7 <sup>1</sup> / <sub>16</sub> "	<b>DP1SO5048</b>	202.	213.	227.	235.	244.	250.	256.	268.	
	60"	59 <sup>5</sup> / <sub>8</sub> "	43 <sup>11</sup> / <sub>16</sub> "	7 <sup>1</sup> / <sub>16</sub> "	<b>DP1SO5060</b>	232.	240.	251.	255.	263.	267.	271.	279.	

w\* = nominal width  
 Dimensions listed under w h d are actual to the nearest 1/16"

Ordering Information	Order Code	Included with:	Options
<b>Monolithic Fabric Inserts</b> 1. Pattern Number 2. Fabric	<b>Monolithic Fabric Inserts</b> <i>Example:</i> <b>DP1 SO6442, W351-3</b> <b>DP1</b> Pattern Number <b>SO6442</b> <b>W351-3</b> Foundation Corn Silk Fabric	<b>Monolithic Fabric Inserts</b> • Attachment clips Note: Worksurface height monolithic tiles are to be used with worksurface height panel frames only.	<b>Monolithic Fabric Inserts</b> <b>Tile to Floor Option:</b> To specify tile to floor for use with panel frames, add an "F" suffix to the pattern number and add \$10 to the list price.

**Note:** Tile to floor option available for Worksurface Heights, 36", 42", 50", 57", 64" and 78" panel heights.

Panels, Build-To-Spec

# Monolithic Panel Fabric Inserts

## For 57", 64" and 78" High Panel Frames

Dividends Horizon

description	w*	w	h	d	pattern no.	grade								
						10	15	20	25	30	35	40	45	
49" High Individual Monolithic Fabric Insert (For 57"H Panel Frame)	15"	14 <sup>3</sup> / <sub>8</sub> "	50 <sup>1</sup> / <sub>16</sub> "	7 <sup>1</sup> / <sub>16</sub> "	<b>DP1SO5715</b>	\$127.	\$130.	\$138.	\$140.	\$144.	\$146.	\$149.	\$152.	
	18"	17 <sup>3</sup> / <sub>8</sub> "	50 <sup>1</sup> / <sub>16</sub> "	7 <sup>1</sup> / <sub>16</sub> "	<b>DP1SO5718</b>	127.	130.	138.	140.	144.	146.	149.	152.	
	24"	23 <sup>3</sup> / <sub>8</sub> "	50 <sup>1</sup> / <sub>16</sub> "	7 <sup>1</sup> / <sub>16</sub> "	<b>DP1SO5724</b>	141.	144.	151.	155.	159.	163.	166.	170.	
	30"	29 <sup>3</sup> / <sub>8</sub> "	50 <sup>1</sup> / <sub>16</sub> "	7 <sup>1</sup> / <sub>16</sub> "	<b>DP1SO5730</b>	163.	167.	175.	177.	181.	185.	188.	195.	
	36"	35 <sup>3</sup> / <sub>8</sub> "	50 <sup>1</sup> / <sub>16</sub> "	7 <sup>1</sup> / <sub>16</sub> "	<b>DP1SO5736</b>	181.	187.	198.	201.	205.	209.	213.	219.	
	42"	41 <sup>3</sup> / <sub>8</sub> "	50 <sup>1</sup> / <sub>16</sub> "	7 <sup>1</sup> / <sub>16</sub> "	<b>DP1SO5742</b>	201.	206.	216.	220.	226.	230.	235.	241.	
	48"	47 <sup>3</sup> / <sub>8</sub> "	50 <sup>1</sup> / <sub>16</sub> "	7 <sup>1</sup> / <sub>16</sub> "	<b>DP1SO5748</b>	219.	225.	234.	241.	246.	251.	254.	263.	
	60"	59 <sup>3</sup> / <sub>8</sub> "	50 <sup>1</sup> / <sub>16</sub> "	7 <sup>1</sup> / <sub>16</sub> "	<b>DP1SO5760</b>	252.	260.	271.	278.	285.	291.	296.	302.	
56" High Individual Monolithic Fabric Insert (For 64"H Panel Frame)	15"	14 <sup>3</sup> / <sub>8</sub> "	58 <sup>1</sup> / <sub>4</sub> "	7 <sup>1</sup> / <sub>16</sub> "	<b>DP1SO6415</b>	140.	147.	161.	166.	172.	177.	180.	188.	
	18"	17 <sup>3</sup> / <sub>8</sub> "	58 <sup>1</sup> / <sub>4</sub> "	7 <sup>1</sup> / <sub>16</sub> "	<b>DP1SO6418</b>	140.	147.	161.	166.	172.	177.	180.	188.	
	24"	23 <sup>3</sup> / <sub>8</sub> "	58 <sup>1</sup> / <sub>4</sub> "	7 <sup>1</sup> / <sub>16</sub> "	<b>DP1SO6424</b>	152.	161.	174.	178.	185.	194.	197.	205.	
	30"	29 <sup>3</sup> / <sub>8</sub> "	58 <sup>1</sup> / <sub>4</sub> "	7 <sup>1</sup> / <sub>16</sub> "	<b>DP1SO6430</b>	178.	187.	202.	209.	217.	222.	228.	238.	
	36"	35 <sup>3</sup> / <sub>8</sub> "	58 <sup>1</sup> / <sub>4</sub> "	7 <sup>1</sup> / <sub>16</sub> "	<b>DP1SO6436</b>	199.	209.	225.	229.	241.	245.	252.	262.	
	42"	41 <sup>3</sup> / <sub>8</sub> "	58 <sup>1</sup> / <sub>4</sub> "	7 <sup>1</sup> / <sub>16</sub> "	<b>DP1SO6442</b>	216.	226.	243.	250.	260.	265.	273.	285.	
	48"	47 <sup>3</sup> / <sub>8</sub> "	58 <sup>1</sup> / <sub>4</sub> "	7 <sup>1</sup> / <sub>16</sub> "	<b>DP1SO6448</b>	236.	245.	264.	272.	284.	291.	298.	309.	
	60"	59 <sup>3</sup> / <sub>8</sub> "	58 <sup>1</sup> / <sub>4</sub> "	7 <sup>1</sup> / <sub>16</sub> "	<b>DP1SO6460</b>	244.	251.	264.	268.	274.	281.	287.	294.	
70" High Individual Monolithic Fabric Insert (For 78"H Panel Frame)	15"	14 <sup>3</sup> / <sub>8</sub> "	72 <sup>7</sup> / <sub>8</sub> "	7 <sup>1</sup> / <sub>16</sub> "	<b>DP1SO7815</b>	164.	167.	174.	177.	183.	185.	188.	196.	
	18"	17 <sup>3</sup> / <sub>8</sub> "	72 <sup>7</sup> / <sub>8</sub> "	7 <sup>1</sup> / <sub>16</sub> "	<b>DP1SO7818</b>	164.	167.	174.	177.	183.	185.	188.	196.	
	24"	23 <sup>3</sup> / <sub>8</sub> "	72 <sup>7</sup> / <sub>8</sub> "	7 <sup>1</sup> / <sub>16</sub> "	<b>DP1SO7824</b>	193.	197.	205.	209.	214.	219.	222.	228.	
	30"	29 <sup>3</sup> / <sub>8</sub> "	72 <sup>7</sup> / <sub>8</sub> "	7 <sup>1</sup> / <sub>16</sub> "	<b>DP1SO7830</b>	216.	222.	234.	238.	244.	249.	252.	259.	
	36"	35 <sup>3</sup> / <sub>8</sub> "	72 <sup>7</sup> / <sub>8</sub> "	7 <sup>1</sup> / <sub>16</sub> "	<b>DP1SO7836</b>	241.	246.	259.	264.	271.	274.	283.	289.	
	42"	41 <sup>3</sup> / <sub>8</sub> "	72 <sup>7</sup> / <sub>8</sub> "	7 <sup>1</sup> / <sub>16</sub> "	<b>DP1SO7842</b>	268.	277.	290.	296.	302.	309.	315.	323.	
	48"	47 <sup>3</sup> / <sub>8</sub> "	72 <sup>7</sup> / <sub>8</sub> "	7 <sup>1</sup> / <sub>16</sub> "	<b>DP1SO7848</b>	294.	302.	319.	324.	333.	340.	344.	351.	

w\* = nominal width  
Dimensions listed under w h d are actual to the nearest 1/16"

Ordering Information	Order Code	Included with:	Options
<b>Monolithic Fabric Inserts</b>	<b>Monolithic Fabric Inserts</b>	<b>Monolithic Fabric Inserts</b>	<b>Monolithic Fabric Inserts</b>
1. Pattern Number	<i>Example:</i> <b>DP1 SO6442, W351-3</b>	• <b>Attachment clips</b>	<b>Tile to Floor Option:</b>
2. Fabric	<b>DP1</b> Pattern Number	<b>Note:</b> Worksurface height monolithic tiles are to be used with worksurface height panel frames only.	To specify tile to floor for use with panel frames, add an "F" suffix to the pattern number and add \$10 to the list price.
	<b>SO6442</b>		<b>Note:</b> Tile to floor option available for Worksurface Heights, 36", 42", 50" 57", 64" and 78" panel heights.
	<b>W351-3</b> Foundation Corn Silk Fabric		

**This page intentionally left blank**

## Monolithic Laminate Inserts

Dividends Horizon monolithic laminate inserts provide another material option for Dividends Horizon panels and wall mount applications. Monolithic tile sizes are for use with frames from worksurface height to 57", and widths of up to 48" in tile to raceway, open base and tile to floor applications. Monolithic laminate tiles may also be wall mounted using wall mount tracks. Monolithic laminate inserts with matching surface and edge are available in the following finishes:

- (114) Folkstone Grey
- (117) Soft Grey
- (118) Bright White
- (119) Pumice

Legacy finishes are not available.

## Monolithic Laminate Insert Construction

Surface material: laminate on front and back surface

Edge material: .5mm edgeband

Core material: particle board

Thickness: 7/16 inches

## Monolithic Laminate Insert Attachment

Laminate tiles are installed on one side or both sides of a panel frame, or attach to wall mount tracks. Mounting clips are attached to laminate inserts for connection to the panel frame or vertical wall mount tracks.

**Note:** Insert dimensions are nominal. Insert configurations shown below are for one side only.

**Note:** Laminate inserts are not compatible with the slotted standard coat hook (DP2CHTP).

**Note:** Worksurface height monolithic tiles are to be used with worksurface height panel frames only.

## Monolithic Laminate Insert

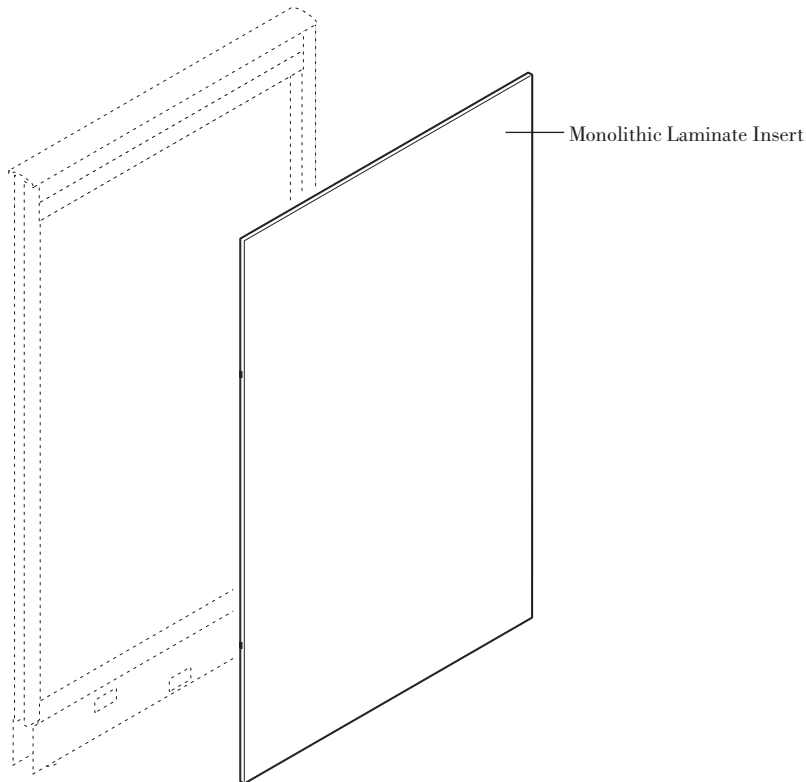

## Monolithic Laminate Insert Configurations



**Worksurface Height**  
• One worksurface height monolithic insert



**36"H Panel Frames**  
• One 28"H monolithic insert



**42"H Panel Frames**  
• One 35"H monolithic insert



**50"H Panel Frames**  
• One 42"H monolithic insert





**57"H Panel Frames**  
• One 49"H monolithic insert

# Monolithic Laminate Inserts

## For Worksurface Height, 36" and 42" High Panel Frames

### Base Raceway or Open Base

description	w *	w	h	d	pattern no.	List
Worksurface Height Individual Monolithic Laminate Insert Base Raceway or Open Base (For worksurface height panel frame only) 	15"	14 <sup>5</sup> / <sub>8</sub> "	22 <sup>1</sup> / <sub>2</sub> "	7 <sup>1</sup> / <sub>16</sub> "	<b>DP3L1WH15</b>	\$160.
	18"	17 <sup>5</sup> / <sub>8</sub> "	22 <sup>1</sup> / <sub>2</sub> "	7 <sup>1</sup> / <sub>16</sub> "	<b>DP3L1WH18</b>	169.
	24"	23 <sup>5</sup> / <sub>8</sub> "	22 <sup>1</sup> / <sub>2</sub> "	7 <sup>1</sup> / <sub>16</sub> "	<b>DP3L1WH24</b>	194.
	30"	29 <sup>5</sup> / <sub>8</sub> "	22 <sup>1</sup> / <sub>2</sub> "	7 <sup>1</sup> / <sub>16</sub> "	<b>DP3L1WH30</b>	226.
	36"	35 <sup>5</sup> / <sub>8</sub> "	22 <sup>1</sup> / <sub>2</sub> "	7 <sup>1</sup> / <sub>16</sub> "	<b>DP3L1WH36</b>	244.
	42"	41 <sup>5</sup> / <sub>8</sub> "	22 <sup>1</sup> / <sub>2</sub> "	7 <sup>1</sup> / <sub>16</sub> "	<b>DP3L1WH42</b>	291.
	48"	47 <sup>5</sup> / <sub>8</sub> "	22 <sup>1</sup> / <sub>2</sub> "	7 <sup>1</sup> / <sub>16</sub> "	<b>DP3L1WH48</b>	296.
28" High Individual Monolithic Laminate Insert Base Raceway or Open Base (For 36"H Panel Frame) 	15"	14 <sup>5</sup> / <sub>8</sub> "	29"	7 <sup>1</sup> / <sub>16</sub> "	<b>DP3L12815</b>	160.
	18"	17 <sup>5</sup> / <sub>8</sub> "	29"	7 <sup>1</sup> / <sub>16</sub> "	<b>DP3L12818</b>	169.
	24"	23 <sup>5</sup> / <sub>8</sub> "	29"	7 <sup>1</sup> / <sub>16</sub> "	<b>DP3L12824</b>	194.
	30"	29 <sup>5</sup> / <sub>8</sub> "	29"	7 <sup>1</sup> / <sub>16</sub> "	<b>DP3L12830</b>	226.
	36"	35 <sup>5</sup> / <sub>8</sub> "	29"	7 <sup>1</sup> / <sub>16</sub> "	<b>DP3L12836</b>	244.
	42"	41 <sup>5</sup> / <sub>8</sub> "	29"	7 <sup>1</sup> / <sub>16</sub> "	<b>DP3L12842</b>	291.
	48"	47 <sup>5</sup> / <sub>8</sub> "	29"	7 <sup>1</sup> / <sub>16</sub> "	<b>DP3L12848</b>	296.
35" High Individual Monolithic Laminate Insert Base Raceway or Open Base (For 42"H Panel Frame) 	15"	14 <sup>5</sup> / <sub>8</sub> "	36 <sup>3</sup> / <sub>8</sub> "	7 <sup>1</sup> / <sub>16</sub> "	<b>DP3L14215</b>	193.
	18"	17 <sup>5</sup> / <sub>8</sub> "	36 <sup>3</sup> / <sub>8</sub> "	7 <sup>1</sup> / <sub>16</sub> "	<b>DP3L14218</b>	211.
	24"	23 <sup>5</sup> / <sub>8</sub> "	36 <sup>3</sup> / <sub>8</sub> "	7 <sup>1</sup> / <sub>16</sub> "	<b>DP3L14224</b>	241.
	30"	29 <sup>5</sup> / <sub>8</sub> "	36 <sup>3</sup> / <sub>8</sub> "	7 <sup>1</sup> / <sub>16</sub> "	<b>DP3L14230</b>	288.
	36"	35 <sup>5</sup> / <sub>8</sub> "	36 <sup>3</sup> / <sub>8</sub> "	7 <sup>1</sup> / <sub>16</sub> "	<b>DP3L14236</b>	391.
	42"	41 <sup>5</sup> / <sub>8</sub> "	36 <sup>3</sup> / <sub>8</sub> "	7 <sup>1</sup> / <sub>16</sub> "	<b>DP3L14242</b>	412.
	48"	47 <sup>5</sup> / <sub>8</sub> "	36 <sup>3</sup> / <sub>8</sub> "	7 <sup>1</sup> / <sub>16</sub> "	<b>DP3L14248</b>	416.

Panels, Build-To-Spec



w\* = nominal width  
 Dimensions listed under w h d are actual to the nearest 1/16"

Ordering Information	Order Code	Included with:	Options
<b>Monolithic Laminate Inserts</b> 1. Pattern Number 2. Laminate Finish 3. Edgeband Finish	<b>Monolithic Laminate Inserts</b> <i>Example:</i> <b>DP3L14224</b> <hr/> <b>DP3L1</b> Pattern Number <hr/> <b>4224</b> <hr/> <b>118</b> Bright White Laminate <hr/> <b>118</b> Bright White Edgeband	<b>Monolithic Laminate Inserts</b> • <b>Attachment clips</b>  <b>Note:</b> Worksurface height monolithic tiles are to be used with worksurface height panel frames only.	<b>Monolithic Laminate Inserts Finish Options:</b> <b>114</b> Folkstone Grey <b>117</b> Soft Grey <b>118</b> Bright White <b>119</b> Pumice

# Monolithic Laminate Inserts

Dividends Horizon

## For Worksurface Height, 36" and 42" High Panel Frames Tile To Floor

description	w*	w	d	pattern no.	List
Worksurface Height Individual Monolithic Laminate Insert Tile To Floor (For worksurface height panel frame only) 	15"	14 <sup>5</sup> / <sub>8</sub> "	7 <sup>1</sup> / <sub>6</sub> "	<b>DP3L1WH15F</b>	\$160.
	18"	17 <sup>3</sup> / <sub>8</sub> "	7 <sup>1</sup> / <sub>6</sub> "	<b>DP3L1WH18F</b>	169.
	24"	23 <sup>3</sup> / <sub>8</sub> "	7 <sup>1</sup> / <sub>6</sub> "	<b>DP3L1WH24F</b>	194.
	30"	29 <sup>3</sup> / <sub>8</sub> "	7 <sup>1</sup> / <sub>6</sub> "	<b>DP3L1WH30F</b>	226.
	36"	35 <sup>3</sup> / <sub>8</sub> "	7 <sup>1</sup> / <sub>6</sub> "	<b>DP3L1WH36F</b>	244.
	42"	41 <sup>3</sup> / <sub>8</sub> "	7 <sup>1</sup> / <sub>6</sub> "	<b>DP3L1WH42F</b>	291.
	48"	47 <sup>3</sup> / <sub>8</sub> "	7 <sup>1</sup> / <sub>6</sub> "	<b>DP3L1WH48F</b>	296.
36" High Individual Monolithic Laminate Insert Tile To Floor (For 36"H panel frame) 	15"	14 <sup>5</sup> / <sub>8</sub> "	7 <sup>1</sup> / <sub>6</sub> "	<b>DP3L12815F</b>	160.
	18"	17 <sup>3</sup> / <sub>8</sub> "	7 <sup>1</sup> / <sub>6</sub> "	<b>DP3L12818F</b>	169.
	24"	23 <sup>3</sup> / <sub>8</sub> "	7 <sup>1</sup> / <sub>6</sub> "	<b>DP3L12824F</b>	194.
	30"	29 <sup>3</sup> / <sub>8</sub> "	7 <sup>1</sup> / <sub>6</sub> "	<b>DP3L12830F</b>	226.
	36"	35 <sup>3</sup> / <sub>8</sub> "	7 <sup>1</sup> / <sub>6</sub> "	<b>DP3L12836F</b>	244.
	42"	41 <sup>3</sup> / <sub>8</sub> "	7 <sup>1</sup> / <sub>6</sub> "	<b>DP3L12842F</b>	291.
	48"	47 <sup>3</sup> / <sub>8</sub> "	7 <sup>1</sup> / <sub>6</sub> "	<b>DP3L12848F</b>	296.
42" High Individual Monolithic Laminate Insert Tile To Floor (For 42"H panel frame) 	15"	14 <sup>5</sup> / <sub>8</sub> "	7 <sup>1</sup> / <sub>6</sub> "	<b>DP3L14215F</b>	196.
	18"	17 <sup>3</sup> / <sub>8</sub> "	7 <sup>1</sup> / <sub>6</sub> "	<b>DP3L14218F</b>	226.
	24"	23 <sup>3</sup> / <sub>8</sub> "	7 <sup>1</sup> / <sub>6</sub> "	<b>DP3L14224F</b>	252.
	30"	29 <sup>3</sup> / <sub>8</sub> "	7 <sup>1</sup> / <sub>6</sub> "	<b>DP3L14230F</b>	291.
	36"	35 <sup>3</sup> / <sub>8</sub> "	7 <sup>1</sup> / <sub>6</sub> "	<b>DP3L14236F</b>	394.
	42"	41 <sup>3</sup> / <sub>8</sub> "	7 <sup>1</sup> / <sub>6</sub> "	<b>DP3L14242F</b>	416.
	48"	47 <sup>3</sup> / <sub>8</sub> "	7 <sup>1</sup> / <sub>6</sub> "	<b>DP3L14248F</b>	419.

w\* = nominal width

Dimensions listed under w h d are actual to the nearest 1/16"

### Ordering Information

#### Monolithic Laminate Inserts

1. Pattern Number
2. Laminate Finish
3. Edgeband Finish

### Order Code

#### Monolithic Laminate Inserts

*Example:* **DP3L14224F**

<b>DP3L1</b>	Pattern Number
<b>4224F</b>	
<b>118</b>	Bright White Laminate
<b>118</b>	Bright White Edgeband

### Included with:

#### Monolithic Laminate Inserts

- Attachment clips
- Note:** Worksurface height monolithic tiles are to be used with worksurface height panel frames only.

### Options

#### Monolithic Laminate Inserts

- Finish Options:**
- |            |                |
|------------|----------------|
| <b>114</b> | Folkstone Grey |
| <b>117</b> | Soft Grey      |
| <b>118</b> | Bright White   |
| <b>119</b> | Pumice         |

# Monolithic Laminate Inserts

## For 50" and 57" High Panel Frames

### Base Raceway or Open Base

description	w*	w	h	d	pattern no.	List
42" High Individual Monolithic Laminate Insert Base Raceway or Open Base (For 50"H Panel Frame)	15"	14 <sup>5</sup> / <sub>8</sub> "	43 <sup>11</sup> / <sub>16</sub> "	7 <sup>7</sup> / <sub>16</sub> "	<b>DP3L15015</b>	\$198.
	18"	17 <sup>5</sup> / <sub>8</sub> "	43 <sup>11</sup> / <sub>16</sub> "	7 <sup>7</sup> / <sub>16</sub> "	<b>DP3L15018</b>	228.
	24"	23 <sup>5</sup> / <sub>8</sub> "	43 <sup>11</sup> / <sub>16</sub> "	7 <sup>7</sup> / <sub>16</sub> "	<b>DP3L15024</b>	254.
	30"	29 <sup>5</sup> / <sub>8</sub> "	43 <sup>11</sup> / <sub>16</sub> "	7 <sup>7</sup> / <sub>16</sub> "	<b>DP3L15030</b>	294.
	36"	35 <sup>5</sup> / <sub>8</sub> "	43 <sup>11</sup> / <sub>16</sub> "	7 <sup>7</sup> / <sub>16</sub> "	<b>DP3L15036</b>	396.
	42"	41 <sup>5</sup> / <sub>8</sub> "	43 <sup>11</sup> / <sub>16</sub> "	7 <sup>7</sup> / <sub>16</sub> "	<b>DP3L15042</b>	417.
	48"	47 <sup>5</sup> / <sub>8</sub> "	43 <sup>11</sup> / <sub>16</sub> "	7 <sup>7</sup> / <sub>16</sub> "	<b>DP3L15048</b>	421.
49" High Individual Monolithic Laminate Insert Base Raceway or Open Base (For 57"H Panel Frame)	15"	14 <sup>5</sup> / <sub>8</sub> "	50 <sup>1</sup> / <sub>16</sub> "	7 <sup>7</sup> / <sub>16</sub> "	<b>DP3L15715</b>	230.
	18"	17 <sup>5</sup> / <sub>8</sub> "	50 <sup>1</sup> / <sub>16</sub> "	7 <sup>7</sup> / <sub>16</sub> "	<b>DP3L15718</b>	247.
	24"	23 <sup>5</sup> / <sub>8</sub> "	50 <sup>1</sup> / <sub>16</sub> "	7 <sup>7</sup> / <sub>16</sub> "	<b>DP3L15724</b>	295.
	30"	29 <sup>5</sup> / <sub>8</sub> "	50 <sup>1</sup> / <sub>16</sub> "	7 <sup>7</sup> / <sub>16</sub> "	<b>DP3L15730</b>	370.
	36"	35 <sup>5</sup> / <sub>8</sub> "	50 <sup>1</sup> / <sub>16</sub> "	7 <sup>7</sup> / <sub>16</sub> "	<b>DP3L15736</b>	401.
	42"	41 <sup>5</sup> / <sub>8</sub> "	50 <sup>1</sup> / <sub>16</sub> "	7 <sup>7</sup> / <sub>16</sub> "	<b>DP3L15742</b>	491.
	48"	47 <sup>5</sup> / <sub>8</sub> "	50 <sup>1</sup> / <sub>16</sub> "	7 <sup>7</sup> / <sub>16</sub> "	<b>DP3L15748</b>	495.



Panels, Build-To-Spec

w\* = nominal width  
 Dimensions listed under w h d are actual to the nearest 1/16"



Ordering Information	Order Code	Included with:	Options
<b>Monolithic Laminate Inserts</b> 1. Pattern Number 2. Laminate Finish 3. Edgeband Finish	<b>Monolithic Laminate Inserts</b> <i>Example:</i> <b>DP3L15024</b> <hr/> <b>DP3L1</b> Pattern Number <hr/> <b>5024</b> <hr/> <b>118</b> Bright White Laminate <hr/> <b>118</b> Bright White Edgeband	<b>Monolithic Laminate Inserts</b> • Attachment clips  <b>Note:</b> Worksurface height monolithic tiles are to be used with worksurface height panel frames only.	<b>Monolithic Laminate Inserts</b> <b>Finish Options:</b> <b>114</b> Folkstone Grey <b>117</b> Soft Grey <b>118</b> Bright White <b>119</b> Pumice

# Monolithic Laminate Inserts

## For 50" and 57" High Panel Frames

### Tile To Floor

Dividends Horizon

description	w *	w	d	pattern no.	List
50" High Individual Monolithic Laminate Insert Tile To Floor (For 50"H panel frame) 	15"	14 <sup>5</sup> / <sub>8</sub> "	7 <sup>1</sup> / <sub>16</sub> "	<b>DP3L15015F</b>	\$229.
	18"	17 <sup>5</sup> / <sub>8</sub> "	7 <sup>1</sup> / <sub>16</sub> "	<b>DP3L15018F</b>	245.
	24"	23 <sup>5</sup> / <sub>8</sub> "	7 <sup>1</sup> / <sub>16</sub> "	<b>DP3L15024F</b>	293.
	30"	29 <sup>5</sup> / <sub>8</sub> "	7 <sup>1</sup> / <sub>16</sub> "	<b>DP3L15030F</b>	368.
	36"	35 <sup>5</sup> / <sub>8</sub> "	7 <sup>1</sup> / <sub>16</sub> "	<b>DP3L15036F</b>	399.
	42"	41 <sup>5</sup> / <sub>8</sub> "	7 <sup>1</sup> / <sub>16</sub> "	<b>DP3L15042F</b>	488.
	48"	47 <sup>5</sup> / <sub>8</sub> "	7 <sup>1</sup> / <sub>16</sub> "	<b>DP3L15048F</b>	492.
57" High Individual Monolithic Laminate Insert Tile To Floor (for 57"H panel frame) 	15"	14 <sup>5</sup> / <sub>8</sub> "	7 <sup>1</sup> / <sub>16</sub> "	<b>DP3L15715F</b>	234.
	18"	17 <sup>5</sup> / <sub>8</sub> "	7 <sup>1</sup> / <sub>16</sub> "	<b>DP3L15718F</b>	250.
	24"	23 <sup>5</sup> / <sub>8</sub> "	7 <sup>1</sup> / <sub>16</sub> "	<b>DP3L15724F</b>	298.
	30"	29 <sup>5</sup> / <sub>8</sub> "	7 <sup>1</sup> / <sub>16</sub> "	<b>DP3L15730F</b>	373.
	36"	35 <sup>5</sup> / <sub>8</sub> "	7 <sup>1</sup> / <sub>16</sub> "	<b>DP3L15736F</b>	405.
	42"	41 <sup>5</sup> / <sub>8</sub> "	7 <sup>1</sup> / <sub>16</sub> "	<b>DP3L15742F</b>	493.
	48"	47 <sup>5</sup> / <sub>8</sub> "	7 <sup>1</sup> / <sub>16</sub> "	<b>DP3L15748F</b>	497.

w\* = nominal width  
 Dimensions listed under w h d are actual to the nearest 1/16"

Ordering Information	Order Code	Included with:	Options
<b>Monolithic Laminate Inserts</b> 1. Pattern Number 2. Laminate Finish 3. Edgeband Finish	<b>Monolithic Laminate Inserts</b> <i>Example:</i> <b>DP3L15024F</b> <hr/> <b>DP3L1</b> Pattern Number <hr/> <b>5024F</b> <hr/> <b>118</b> Bright White Laminate <hr/> <b>118</b> Bright White Edgeband	<b>Monolithic Laminate Inserts</b> • Attachment clips  <b>Note:</b> Worksurface height monolithic tiles are to be used with worksurface height panel frames only.	<b>Monolithic Laminate Inserts</b> <b>Finish Options:</b> <b>114</b> Folkstone Grey <b>117</b> Soft Grey <b>118</b> Bright White <b>119</b> Pumice



**This page intentionally left blank**

## Tiled Inserts

Dividends Horizon tiled inserts are available by component for use with panel frames or wall mount tracks for "Build-to-Spec" applications. These applications include when inserts are only required on one panel side, when fabrics are mixed tile-to-tile or side-to-side, or when wall mount tracks are being used.

Tiled inserts are also included in "Preconfigured" tiled panel assemblies.

## Tiled Insert Construction

Fabric laminated with web adhesive, heat-cured to  $\frac{7}{16}$ " thick tackable acoustical board.

## Tiled Insert Supports

All Dividends Horizon panel frames and wall mount tracks are pre-punched to accept tiled panel insert supports which span horizontally across the panel frame.

Tiled panel insert supports are mounted above each tiled insert with the exception of the uppermost insert which attaches to the upper panel frame. D1 style insert supports are trim finish to match top caps and raceway covers.

## D2 Tile Support Mounting Brackets

D2 tile supports require the use of D2 tile support mounting brackets. One pair of mounting brackets can be used to attach D2 tile supports on one or both sides of a panel at the installed height.

## Tiled Insert Attachment

Tiled inserts attach to the troughs in the horizontal panel frame and tiled insert supports or to the bottom tile channel in a wall mount track application. Mounting clips are attached to inserts for connection to the vertical frame or wall mount tracks for additional support. No tools are required for insert attachment.

**Note:** When attaching cantilevers to tiled panels, they can only be hung at the 28  $\frac{1}{2}$ " worksurface height.

**Note:** Insert dimensions are nominal. Inserts and tiled supports are for one side only.

**Note:** Overheads can only be attached to the uppermost position of tiled panels. On 78" H panels the overhead may be positioned on the 4th or 5th tile location from the bottom, but not both locations of a single panel.

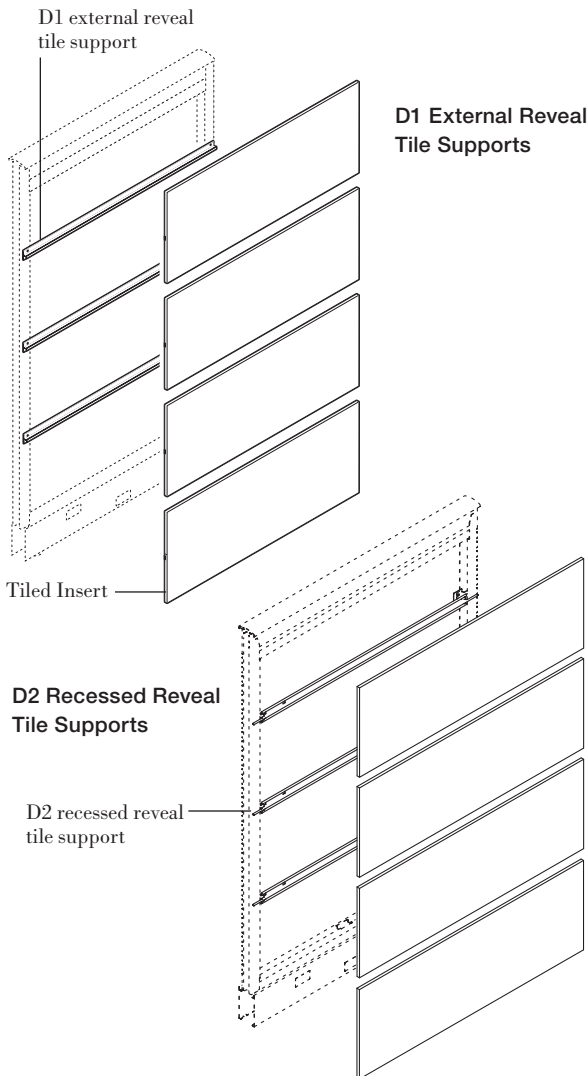

## Tiled Insert Configurations



- 36"H Panels**
- Two 14"H tiled inserts
  - One tile support

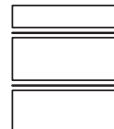

- 42"H Panels**
- One 7"H tiled insert
  - Two 14"H tiled inserts
  - Two tile supports

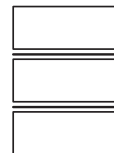

- 50"H Panels**
- Three 14"H tiled inserts
  - Two tile supports

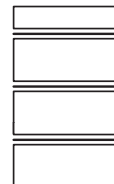

- 57"H Panels**
- One 7"H tiled insert
  - Three 14"H tiled inserts
  - Three tile supports

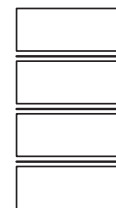

- 64"H Panels**
- Four 14"H tiled inserts
  - Three tile supports



- 78"H Panels**
- Five 14"H tiled inserts
  - Four tile supports

## Tiled Insert Attachment (D1 Style)

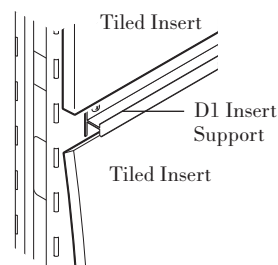

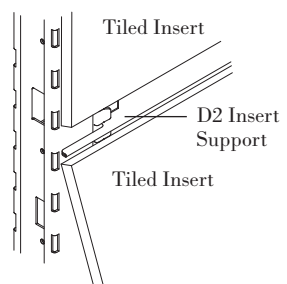

## Tiled Insert Attachment (D2 Style)



# Tiled Fabric Inserts

## 7", 10" and 14" High

Dividends Horizon

description	w*	w	h	d	pattern no.	grade							
						10	15	20	25	30	35	40	45
7" High Individual Tiled Fabric Insert 	15"	14 <sup>5</sup> / <sub>8</sub> "	7 <sup>3</sup> / <sub>16</sub> "	<sup>7</sup> / <sub>16</sub> "	<b>DP1SO715</b>	\$41.	\$44.	\$48.	\$53.	\$58.	\$59.	\$61.	\$66.
	18"	17 <sup>5</sup> / <sub>8</sub> "	7 <sup>3</sup> / <sub>16</sub> "	<sup>7</sup> / <sub>16</sub> "	<b>DP1SO718</b>	41.	44.	48.	53.	58.	59.	61.	66.
	24"	23 <sup>5</sup> / <sub>8</sub> "	7 <sup>3</sup> / <sub>16</sub> "	<sup>7</sup> / <sub>16</sub> "	<b>DP1SO724</b>	44.	47.	56.	58.	60.	64.	65.	67.
	30"	29 <sup>5</sup> / <sub>8</sub> "	7 <sup>3</sup> / <sub>16</sub> "	<sup>7</sup> / <sub>16</sub> "	<b>DP1SO730</b>	50.	56.	61.	64.	67.	69.	72.	76.
	36"	35 <sup>5</sup> / <sub>8</sub> "	7 <sup>3</sup> / <sub>16</sub> "	<sup>7</sup> / <sub>16</sub> "	<b>DP1SO736</b>	58.	60.	67.	69.	72.	73.	76.	79.
	42"	41 <sup>5</sup> / <sub>8</sub> "	7 <sup>3</sup> / <sub>16</sub> "	<sup>7</sup> / <sub>16</sub> "	<b>DP1SO742</b>	61.	66.	71.	73.	77.	79.	81.	87.
	48"	47 <sup>5</sup> / <sub>8</sub> "	7 <sup>3</sup> / <sub>16</sub> "	<sup>7</sup> / <sub>16</sub> "	<b>DP1SO748</b>	66.	70.	74.	77.	81.	84.	93.	96.
	60"	59 <sup>5</sup> / <sub>8</sub> "	7 <sup>3</sup> / <sub>16</sub> "	<sup>7</sup> / <sub>16</sub> "	<b>DP1SO760</b>	72.	74.	78.	79.	82.	83.	84.	87.
10" High Individual Tiled Fabric Insert 	15"	14 <sup>5</sup> / <sub>8</sub> "	10 <sup>7</sup> / <sub>8</sub> "	<sup>7</sup> / <sub>16</sub> "	<b>DP1SO1015</b>	59.	61.	66.	67.	70.	72.	73.	76.
	18"	17 <sup>5</sup> / <sub>8</sub> "	10 <sup>7</sup> / <sub>8</sub> "	<sup>7</sup> / <sub>16</sub> "	<b>DP1SO1018</b>	59.	61.	66.	67.	70.	72.	73.	76.
	24"	23 <sup>5</sup> / <sub>8</sub> "	10 <sup>7</sup> / <sub>8</sub> "	<sup>7</sup> / <sub>16</sub> "	<b>DP1SO1024</b>	64.	66.	71.	72.	74.	77.	79.	83.
	30"	29 <sup>5</sup> / <sub>8</sub> "	10 <sup>7</sup> / <sub>8</sub> "	<sup>7</sup> / <sub>16</sub> "	<b>DP1SO1030</b>	66.	69.	73.	76.	78.	81.	83.	87.
	36"	35 <sup>5</sup> / <sub>8</sub> "	10 <sup>7</sup> / <sub>8</sub> "	<sup>7</sup> / <sub>16</sub> "	<b>DP1SO1036</b>	70.	73.	78.	79.	84.	87.	95.	96.
	42"	41 <sup>5</sup> / <sub>8</sub> "	10 <sup>7</sup> / <sub>8</sub> "	<sup>7</sup> / <sub>16</sub> "	<b>DP1SO1042</b>	73.	76.	83.	84.	93.	96.	98.	100.
	48"	47 <sup>5</sup> / <sub>8</sub> "	10 <sup>7</sup> / <sub>8</sub> "	<sup>7</sup> / <sub>16</sub> "	<b>DP1SO1048</b>	78.	79.	89.	95.	98.	99.	101.	108.
	60"	59 <sup>5</sup> / <sub>8</sub> "	10 <sup>7</sup> / <sub>8</sub> "	<sup>7</sup> / <sub>16</sub> "	<b>DP1SO1060</b>	83.	85.	90.	91.	94.	95.	97.	99.
14" High Individual Tiled Fabric Insert 	15"	14 <sup>5</sup> / <sub>8</sub> "	14 <sup>3</sup> / <sub>16</sub> "	<sup>7</sup> / <sub>16</sub> "	<b>DP1SO1415</b>	59.	61.	66.	67.	70.	72.	73.	76.
	18"	17 <sup>5</sup> / <sub>8</sub> "	14 <sup>3</sup> / <sub>16</sub> "	<sup>7</sup> / <sub>16</sub> "	<b>DP1SO1418</b>	59.	61.	66.	67.	70.	72.	73.	76.
	24"	23 <sup>5</sup> / <sub>8</sub> "	14 <sup>3</sup> / <sub>16</sub> "	<sup>7</sup> / <sub>16</sub> "	<b>DP1SO1424</b>	64.	66.	71.	72.	74.	77.	79.	83.
	30"	29 <sup>5</sup> / <sub>8</sub> "	14 <sup>3</sup> / <sub>16</sub> "	<sup>7</sup> / <sub>16</sub> "	<b>DP1SO1430</b>	66.	69.	73.	76.	78.	81.	83.	87.
	36"	35 <sup>5</sup> / <sub>8</sub> "	14 <sup>3</sup> / <sub>16</sub> "	<sup>7</sup> / <sub>16</sub> "	<b>DP1SO1436</b>	70.	73.	78.	79.	84.	87.	95.	96.
	42"	41 <sup>5</sup> / <sub>8</sub> "	14 <sup>3</sup> / <sub>16</sub> "	<sup>7</sup> / <sub>16</sub> "	<b>DP1SO1442</b>	73.	76.	83.	84.	93.	96.	98.	100.
	48"	47 <sup>5</sup> / <sub>8</sub> "	14 <sup>3</sup> / <sub>16</sub> "	<sup>7</sup> / <sub>16</sub> "	<b>DP1SO1448</b>	78.	79.	89.	95.	98.	99.	101.	108.
	60"	59 <sup>5</sup> / <sub>8</sub> "	14 <sup>3</sup> / <sub>16</sub> "	<sup>7</sup> / <sub>16</sub> "	<b>DP1SO1460</b>	83.	85.	90.	91.	94.	95.	97.	99.

Panels, Build-To-Spec

w\* = nominal width  
Dimensions listed under w h d are actual to the nearest 1/16"

### Ordering Information

- Tiled Inserts**  
1. Pattern Number  
2. Fabric

### Order Code

**Tiled Inserts**  
*Example:* **DP1 SO1436, W234-5**  
**DP1** Pattern Number  
**SO1436**  
**W234-5** Peano Sand fabric

### Included with:

- Tiled Inserts**  
• Attachment clips

Note: Tiled insert supports must be ordered separately (see opposite page for quantities required).



### Options

**Tiled Inserts**  
**Tile to Floor Option:**  
To specify tile to floor for use with panel frames, add an "F" suffix to the pattern number and add \$10 to the list price.  
**Note:** Tile to floor option available for 14" and 28" High inserts.

# Tiled Fabric Inserts

## 21" and 28" High

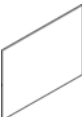
Dividends Horizon

description	w*	w	h	d	pattern no.	grade							
						10	15	20	25	30	35	40	45
21" High Individual Tiled Fabric Insert 	15"	14 <sup>5/8</sup> "	21 <sup>3/16</sup> "	7/16"	<b>DP1SO2115</b>	\$85.	\$94.	\$99.	\$103.	\$109.	\$114.	\$118.	\$123.
	18"	17 <sup>5/8</sup> "	21 <sup>3/16</sup> "	7/16"	<b>DP1SO2118</b>	85.	94.	99.	103.	109.	114.	118.	123.
	24"	23 <sup>5/8</sup> "	21 <sup>3/16</sup> "	7/16"	<b>DP1SO2124</b>	107.	111.	123.	128.	133.	136.	141.	151.
	30"	29 <sup>5/8</sup> "	21 <sup>3/16</sup> "	7/16"	<b>DP1SO2130</b>	116.	123.	133.	139.	144.	151.	156.	165.
	36"	35 <sup>5/8</sup> "	21 <sup>3/16</sup> "	7/16"	<b>DP1SO2136</b>	127.	133.	144.	152.	161.	168.	173.	178.
	42"	41 <sup>5/8</sup> "	21 <sup>3/16</sup> "	7/16"	<b>DP1SO2142</b>	132.	138.	146.	153.	164.	170.	176.	183.
	48"	47 <sup>5/8</sup> "	21 <sup>3/16</sup> "	7/16"	<b>DP1SO2148</b>	138.	144.	156.	165.	171.	177.	184.	197.
	60"	59 <sup>5/8</sup> "	21 <sup>3/16</sup> "	7/16"	<b>DP1SO2160</b>	151.	156.	164.	167.	172.	175.	177.	181.
28" High Individual Tiled Fabric Insert 	15"	14 <sup>5/8</sup> "	29"	7/16"	<b>DP1SO2815</b>	93.	97.	100.	107.	109.	114.	119.	124.
	18"	17 <sup>5/8</sup> "	29"	7/16"	<b>DP1SO2818</b>	93.	97.	100.	107.	109.	114.	119.	124.
	24"	23 <sup>5/8</sup> "	29"	7/16"	<b>DP1SO2824</b>	108.	114.	124.	129.	135.	138.	142.	152.
	30"	29 <sup>5/8</sup> "	29"	7/16"	<b>DP1SO2830</b>	118.	124.	135.	140.	146.	152.	157.	166.
	36"	35 <sup>5/8</sup> "	29"	7/16"	<b>DP1SO2836</b>	128.	135.	146.	153.	164.	170.	174.	179.
	42"	42 <sup>7/8</sup> "	29"	7/16"	<b>DP1SO2842</b>	133.	139.	147.	156.	165.	171.	177.	184.
	48"	47 <sup>5/8</sup> "	29"	7/16"	<b>DP1SO2848</b>	139.	146.	157.	166.	172.	178.	185.	199.
	60"	59 <sup>5/8</sup> "	29"	7/16"	<b>DP1SO2860</b>	164.	168.	176.	179.	183.	187.	193.	197.

w\* = nominal width  
Dimensions listed under w h d are actual to the nearest 1/16"

Ordering Information	Order Code	Included With:	Options
<b>Tiled Inserts</b> 1. Pattern Number 2. Fabric	<b>Tiled Inserts</b> <i>Example:</i> <b>DP1 SO1436, W234-5</b> <b>DP1</b> Pattern Number <b>SO1436</b> <b>W234-5</b> Peano Sand fabric	<b>Tiled Inserts</b> • Attachment clips  <b>Note:</b> Tiled insert supports must be ordered separately (see opposite page for quantities required).	<b>Tiled Inserts</b>  <b>Tile to Floor Option:</b> To specify tile to floor for use with panel frames, add an "F" suffix to the pattern number and add \$10 to the list price.  <b>Note:</b> Tile to floor option available for 14" and 28" High inserts.

# Tiled Fabric Inserts

## Tile Supports

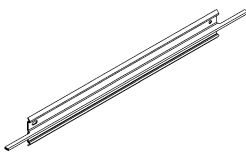
description	w*	d	pattern no.	list
 D1 Tile Support/ External Reveal	15"	5/8"	<b>DP1SOS15</b>	\$28.
	18"	5/8"	<b>DP1SOS18</b>	28.
	24"	5/8"	<b>DP1SOS24</b>	29.
	30"	5/8"	<b>DP1SOS30</b>	32.
	36"	5/8"	<b>DP1SOS36</b>	33.
	42"	5/8"	<b>DP1SOS42</b>	35.
	48"	5/8"	<b>DP1SOS48</b>	35.
	60"	5/8"	<b>DP1SOS60</b>	38.
 D2 Tile Support/ Recessed Reveal	15"		<b>DP2SOS15</b>	25.
	18"		<b>DP2SOS18</b>	25.
	24"		<b>DP2SOS24</b>	26.
	30"		<b>DP2SOS30</b>	28.
	36"		<b>DP2SOS36</b>	29.
	42"		<b>DP2SOS42</b>	32.
	48"		<b>DP2SOS48</b>	32.
	60"		<b>DP2SOS60</b>	35.
D2 Tile Support Mounting Brackets (pair)			<b>DP2SOSC</b>	7.

Panels, Build-To-Spec

w\* = nominal width  
 Dimensions listed under w h d are actual to the nearest 1/16"

Ordering Information	Order Code	Included with:	Options
<b>D1 Tile Support / External Reveal</b> 1. Pattern Number 2. Trim Finish	<b>D1 Tile Support / External Reveal Supports</b> <i>Example:</i> <b>DP1 SOS18, 117</b>	Note: D2 insert supports require mounting brackets.	<b>Tiled Insert Supports</b>
<b>D2 Tile Support / Recessed Reveal</b> 1. Pattern Number	<b>DP1</b> Pattern Number <b>SOS18</b> <b>117</b> Soft Grey trim finish		

## Tiled Laminate Inserts

Dividends Horizon tiled laminate inserts provide another material option for Dividends Horizon panels and wall mount applications. Tiled sizes are for use with frames from 36" to 78" high, and widths of up to 48" in tile to raceway, open base and tile to floor applications. Tiled laminate inserts may also be wall mounted using wall mount tracks. Tiled laminate inserts with matching surface and edge are available in the following finishes:

- (114) Folkstone Grey
- (117) Soft Grey
- (118) Bright White
- (119) Pumice

Legacy finishes are not available.

## Tiled Laminate Insert Construction

- Surface material: laminate on front and back surface
- Edge material: .5 mm edgeband
- Core material: particle board
- Thickness: 7/16"

## Tiled Insert Supports

All Dividends Horizon panel frames are pre-punched to accept tiled panel insert supports, which span horizontally across the panel frame. Tiled panel insert supports are mounted above each tiled insert with the exception of the uppermost insert which attaches to the upper panel frame. D1 style insert supports are trim finish to match top caps and raceway covers.

## D2 Tile Support Mounting Brackets

D2 tile supports require the use of D2 tile support mounting brackets. One pair of mounting brackets can be used to attach D2 tile supports on one or both sides of a panel at the installed height.

## Tiled Laminate Insert Attachment

Laminate tiles are installed on one side or both sides of a panel frame or attached to wall mount tracks. Mounting clips are attached to laminate inserts for connection to the panel frame or vertical wall mount tracks.

## Tiled Laminate Insert Planning Guidelines

Insert dimensions are nominal. Insert configurations shown below are for one side only. Laminate inserts are not compatible with the slotted standard coat hook (DP2CHTP). When attaching cantilevers to tiled panels, they can only be hung at 28-1/2" worksurface height. Overheads can only be attached to the uppermost position of tiled panels. On 78"-high panels the overhead may be positioned on the 4th or 5th tile location from the bottom, but not both locations of a single panel.

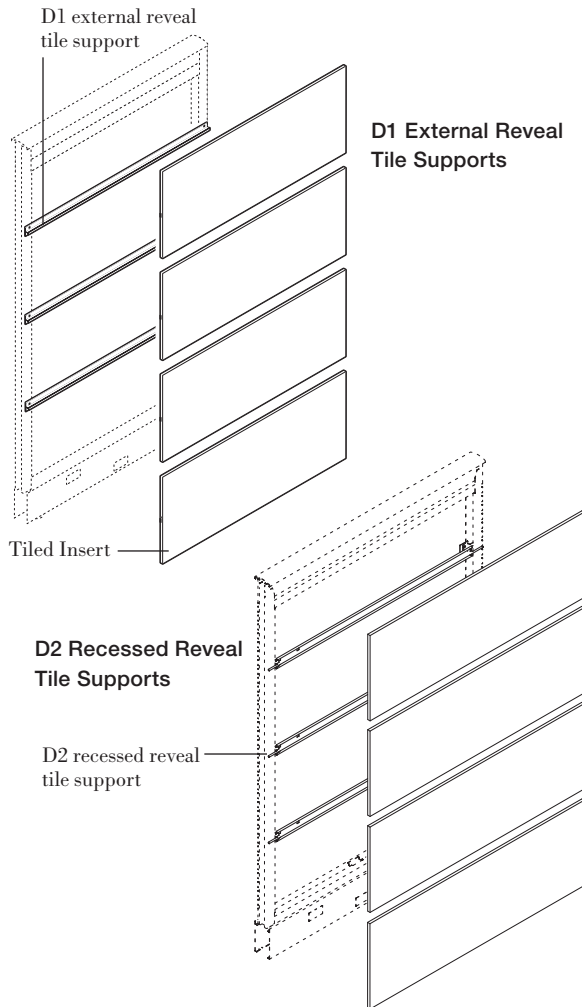



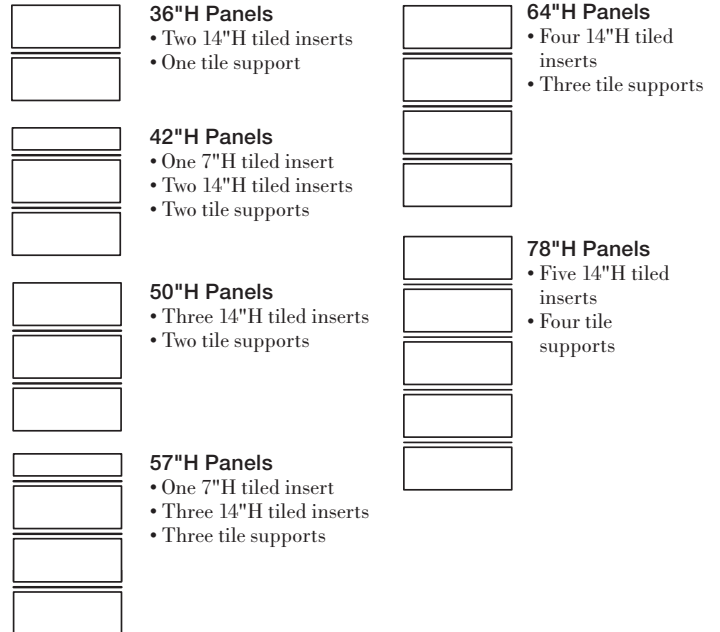

## Tiled Insert Configurations



# Tiled Laminate Inserts

## 7", 10", 14", 21" and 28" High

### Base Raceway or Open Base

description	w*	w	h	d	pattern no.	list
 7" High Individual Tiled Laminate Insert Base Raceway or Open Base	15"	14 <sup>5</sup> / <sub>8</sub> "	7 <sup>3</sup> / <sub>16</sub> "	7 <sup>1</sup> / <sub>16</sub> "	<b>DP3L10715</b>	\$107.
	18"	17 <sup>5</sup> / <sub>8</sub> "	7 <sup>3</sup> / <sub>16</sub> "	7 <sup>1</sup> / <sub>16</sub> "	<b>DP3L10718</b>	109.
	24"	23 <sup>5</sup> / <sub>8</sub> "	7 <sup>3</sup> / <sub>16</sub> "	7 <sup>1</sup> / <sub>16</sub> "	<b>DP3L10724</b>	112.
	30"	29 <sup>5</sup> / <sub>8</sub> "	7 <sup>3</sup> / <sub>16</sub> "	7 <sup>1</sup> / <sub>16</sub> "	<b>DP3L10730</b>	116.
	36"	35 <sup>5</sup> / <sub>8</sub> "	7 <sup>3</sup> / <sub>16</sub> "	7 <sup>1</sup> / <sub>16</sub> "	<b>DP3L10736</b>	131.
	42"	41 <sup>5</sup> / <sub>8</sub> "	7 <sup>3</sup> / <sub>16</sub> "	7 <sup>1</sup> / <sub>16</sub> "	<b>DP3L10742</b>	135.
	48"	47 <sup>5</sup> / <sub>8</sub> "	7 <sup>3</sup> / <sub>16</sub> "	7 <sup>1</sup> / <sub>16</sub> "	<b>DP3L10748</b>	139.
 10" High Individual Tiled Laminate Insert Base Raceway or Open Base	15"	14 <sup>5</sup> / <sub>8</sub> "	10 <sup>3</sup> / <sub>16</sub> "	7 <sup>1</sup> / <sub>16</sub> "	<b>DP3L11015</b>	110.
	18"	17 <sup>5</sup> / <sub>8</sub> "	10 <sup>3</sup> / <sub>16</sub> "	7 <sup>1</sup> / <sub>16</sub> "	<b>DP3L11018</b>	112.
	24"	23 <sup>5</sup> / <sub>8</sub> "	10 <sup>3</sup> / <sub>16</sub> "	7 <sup>1</sup> / <sub>16</sub> "	<b>DP3L11024</b>	116.
	30"	29 <sup>5</sup> / <sub>8</sub> "	10 <sup>3</sup> / <sub>16</sub> "	7 <sup>1</sup> / <sub>16</sub> "	<b>DP3L11030</b>	128.
	36"	35 <sup>5</sup> / <sub>8</sub> "	10 <sup>3</sup> / <sub>16</sub> "	7 <sup>1</sup> / <sub>16</sub> "	<b>DP3L11036</b>	146.
	42"	41 <sup>5</sup> / <sub>8</sub> "	10 <sup>3</sup> / <sub>16</sub> "	7 <sup>1</sup> / <sub>16</sub> "	<b>DP3L11042</b>	151.
	48"	47 <sup>5</sup> / <sub>8</sub> "	10 <sup>3</sup> / <sub>16</sub> "	7 <sup>1</sup> / <sub>16</sub> "	<b>DP3L11048</b>	156.
 14" High Individual Tiled Laminate Insert Base Raceway or Open Base	15"	14 <sup>5</sup> / <sub>8</sub> "	14 <sup>3</sup> / <sub>16</sub> "	7 <sup>1</sup> / <sub>16</sub> "	<b>DP3L11415</b>	112.
	18"	17 <sup>5</sup> / <sub>8</sub> "	14 <sup>3</sup> / <sub>16</sub> "	7 <sup>1</sup> / <sub>16</sub> "	<b>DP3L11418</b>	114.
	24"	23 <sup>5</sup> / <sub>8</sub> "	14 <sup>3</sup> / <sub>16</sub> "	7 <sup>1</sup> / <sub>16</sub> "	<b>DP3L11424</b>	125.
	30"	29 <sup>5</sup> / <sub>8</sub> "	14 <sup>3</sup> / <sub>16</sub> "	7 <sup>1</sup> / <sub>16</sub> "	<b>DP3L11430</b>	138.
	36"	35 <sup>5</sup> / <sub>8</sub> "	14 <sup>3</sup> / <sub>16</sub> "	7 <sup>1</sup> / <sub>16</sub> "	<b>DP3L11436</b>	162.
	42"	41 <sup>5</sup> / <sub>8</sub> "	14 <sup>3</sup> / <sub>16</sub> "	7 <sup>1</sup> / <sub>16</sub> "	<b>DP3L11442</b>	166.
	48"	47 <sup>5</sup> / <sub>8</sub> "	14 <sup>3</sup> / <sub>16</sub> "	7 <sup>1</sup> / <sub>16</sub> "	<b>DP3L11448</b>	169.
 21" High Individual Tiled Laminate Insert Base Raceway or Open Base	15"	14 <sup>5</sup> / <sub>8</sub> "	21 <sup>3</sup> / <sub>16</sub> "	7 <sup>1</sup> / <sub>16</sub> "	<b>DP3L12115</b>	123.
	18"	17 <sup>5</sup> / <sub>8</sub> "	21 <sup>3</sup> / <sub>16</sub> "	7 <sup>1</sup> / <sub>16</sub> "	<b>DP3L12118</b>	135.
	24"	23 <sup>5</sup> / <sub>8</sub> "	21 <sup>3</sup> / <sub>16</sub> "	7 <sup>1</sup> / <sub>16</sub> "	<b>DP3L12124</b>	159.
	30"	29 <sup>5</sup> / <sub>8</sub> "	21 <sup>3</sup> / <sub>16</sub> "	7 <sup>1</sup> / <sub>16</sub> "	<b>DP3L12130</b>	163.
	36"	35 <sup>5</sup> / <sub>8</sub> "	21 <sup>3</sup> / <sub>16</sub> "	7 <sup>1</sup> / <sub>16</sub> "	<b>DP3L12136</b>	234.
	42"	41 <sup>5</sup> / <sub>8</sub> "	21 <sup>3</sup> / <sub>16</sub> "	7 <sup>1</sup> / <sub>16</sub> "	<b>DP3L12142</b>	237.
	48"	47 <sup>5</sup> / <sub>8</sub> "	21 <sup>3</sup> / <sub>16</sub> "	7 <sup>1</sup> / <sub>16</sub> "	<b>DP3L12148</b>	241.
 28" High Individual Tiled Laminate Insert Base Raceway or Open Base	15"	14 <sup>5</sup> / <sub>8</sub> "	29"	7 <sup>1</sup> / <sub>16</sub> "	<b>DP3L12815</b>	160.
	18"	17 <sup>5</sup> / <sub>8</sub> "	29"	7 <sup>1</sup> / <sub>16</sub> "	<b>DP3L12818</b>	169.
	24"	23 <sup>5</sup> / <sub>8</sub> "	29"	7 <sup>1</sup> / <sub>16</sub> "	<b>DP3L12824</b>	194.
	30"	29 <sup>5</sup> / <sub>8</sub> "	29"	7 <sup>1</sup> / <sub>16</sub> "	<b>DP3L12830</b>	226.
	36"	35 <sup>5</sup> / <sub>8</sub> "	29"	7 <sup>1</sup> / <sub>16</sub> "	<b>DP3L12836</b>	244.
	42"	41 <sup>5</sup> / <sub>8</sub> "	29"	7 <sup>1</sup> / <sub>16</sub> "	<b>DP3L12842</b>	291.
	48"	47 <sup>5</sup> / <sub>8</sub> "	29"	7 <sup>1</sup> / <sub>16</sub> "	<b>DP3L12848</b>	296.

w\* = nominal width  
Dimensions listed under w h d are actual to the nearest 1/16"

Ordering Information	Order Code	Included with:	Options
<b>Tiled Laminate Inserts</b> 1. Pattern Number 2. Laminate Finish 3. Edgeband Finish	<b>Tiled Laminate Inserts</b> <i>Example:</i> <b>DP3L10724</b> <b>DP3L1</b> Pattern Number <b>0724</b> <b>118</b> Bright White Laminate <b>118</b> Bright White Edgeband	<b>Tiled Laminate Inserts</b> • Attachment clips <b>Note:</b> Tiled insert supports must be ordered separately (see opposite page for quantities required)	<b>Tiled Laminate Inserts</b> Finish Options: 114 Folkstone Grey 117 Soft Grey 118 Bright White 119 Pumice

Tiled Laminate Inserts  
 14" and 28" High  
 Tile To Floor

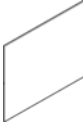
description	w*	w	d	pattern no.	list
14" High Individual Tiled Laminate Insert Tile to Floor 	15"	14 <sup>5</sup> / <sub>8</sub> "	<sup>7</sup> / <sub>16</sub> "	<b>DP3L11415F</b>	\$118.
	18"	17 <sup>5</sup> / <sub>8</sub> "	<sup>7</sup> / <sub>16</sub> "	<b>DP3L11418F</b>	126.
	24"	23 <sup>5</sup> / <sub>8</sub> "	<sup>7</sup> / <sub>16</sub> "	<b>DP3L11424F</b>	137.
	30"	29 <sup>5</sup> / <sub>8</sub> "	<sup>7</sup> / <sub>16</sub> "	<b>DP3L11430F</b>	155.
	36"	35 <sup>5</sup> / <sub>8</sub> "	<sup>7</sup> / <sub>16</sub> "	<b>DP3L11436F</b>	183.
	42"	41 <sup>5</sup> / <sub>8</sub> "	<sup>7</sup> / <sub>16</sub> "	<b>DP3L11442F</b>	197.
	48"	47 <sup>5</sup> / <sub>8</sub> "	<sup>7</sup> / <sub>16</sub> "	<b>DP3L11448F</b>	200.
28" High Individual Tiled Laminate Insert Tile to Floor 	15"	14 <sup>5</sup> / <sub>8</sub> "	<sup>7</sup> / <sub>16</sub> "	<b>DP3L12815F</b>	160.
	18"	17 <sup>5</sup> / <sub>8</sub> "	<sup>7</sup> / <sub>16</sub> "	<b>DP3L12818F</b>	169.
	24"	23 <sup>5</sup> / <sub>8</sub> "	<sup>7</sup> / <sub>16</sub> "	<b>DP3L12824F</b>	194.
	30"	29 <sup>5</sup> / <sub>8</sub> "	<sup>7</sup> / <sub>16</sub> "	<b>DP3L12830F</b>	226.
	36"	35 <sup>5</sup> / <sub>8</sub> "	<sup>7</sup> / <sub>16</sub> "	<b>DP3L12836F</b>	244.
	42"	41 <sup>5</sup> / <sub>8</sub> "	<sup>7</sup> / <sub>16</sub> "	<b>DP3L12842F</b>	291.
	48"	47 <sup>5</sup> / <sub>8</sub> "	<sup>7</sup> / <sub>16</sub> "	<b>DP3L12848F</b>	296.

w\* = nominal width  
 Dimensions listed under w h d are actual to the nearest <sup>1</sup>/<sub>16</sub>"

Ordering Information	Order Code	Included with:	Options
<b>Tiled Laminate Inserts</b>	<b>Tiled Laminate Inserts</b>	<b>Tiled Laminate Inserts</b>	<b>Tiled Laminate Inserts</b>
1. Pattern Number	<i>Example:</i> <b>DP3L11424F</b>	• <b>Attachment clips</b>	Finish Options:
2. Laminate Finish	<b>DP3L1</b> Pattern Number	<b>Note:</b> Tiled insert supports must be ordered separately (see opposite page for quantities required)	114 Folkstone Grey
3. Edgeband Finish	<b>1424F</b>		117 Soft Grey
	<b>118</b> Bright White Laminate		118 Bright White
	<b>118</b> Bright White Edgeband		119 Pumice



**This page intentionally left blank**

#### Beltway Inserts

Dividends Horizon beltway panel inserts are available by component for use with panel frames for "build-to-spec" applications. These applications include when inserts are only required on one panel side and when fabrics or materials are mixed insert-to-insert or side-to-side.

Beltway inserts are also included in "Preconfigured" beltway panel assemblies.

#### Beltway Insert Construction

Fabric inserts are constructed of fabric laminated with web adhesive and heat-cured to 7/16" thick acoustical board. Laminate inserts are constructed of a particle laminate on the front and back. Steel tiles are constructed of formed steel that is painted in any Knoll core paint finish. 24" high inserts are to only be used below beltways.

#### Beltway Insert Attachment

Beltway panel inserts attach to the troughs in the upper and lower horizontal frame supports and beltway insert supports. Beltway top and bottom panel inserts require beltway cover and insert supports. Mounting clips attach to panel inserts and connect to vertical frame for additional support. No tools are required for insert attachment.

**Note:** Slatwall tiles may not be specified or installed with beltway.

#### Beltway Cover

Beltway covers snap into the beltway supports and are constructed of extruded plastic. Beltway covers include knockouts with covers for duplex receptacles centered 12" from each panel end (except for 18 and 24" wide). A single communications knockout cover in the center of the beltway is included on all beltways except for 30" wide. Electrical knockouts are the same size as communications

knockouts and can be used for communications cables and data ports if terminal blocks are not installed within the beltway.

Beltway covers and insert supports can be installed on one or both sides of panels. Beltway cover and insert supports require top and bottom beltway panel inserts.

#### Beltway Cover Construction

Color injected plastic extrusion that is available in smooth finish.

#### Electrical

Beltways 30" and wider accept two duplex receptacles per beltway. 18" and 24" wide beltways provide pass-through electrical only. All electrical components are ordered separately and must be field-installed.

#### One-Sided Beltway Panel

Beltway panels are available with one beltway per panel or per panel side.

**Note:** Insert dimensions are nominal. Inserts and beltway cover/supports are for one side only.

#### Beltway Insert Locations

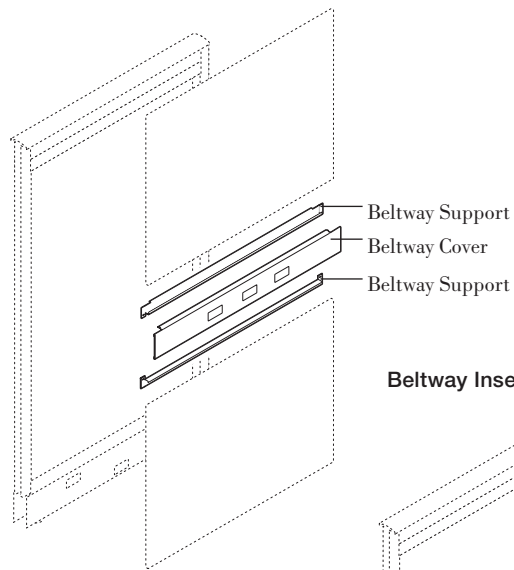

#### Beltway Insert Locations

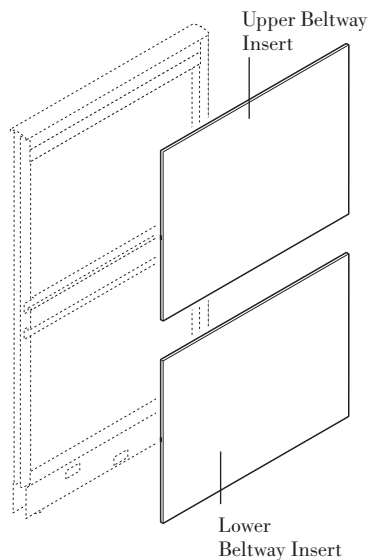

#### Beltway Insert Attachment

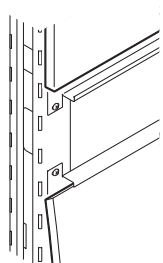

#### Beltway Insert Configurations

##### 42"H Panels

- One 7"H upper insert
- One 4"H beltway cover and insert support
- One 24"H lower insert

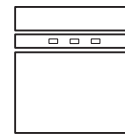

##### 50"H Panels

- One 14"H upper panel insert
- One 4"H beltway cover and insert support
- One 24"H lower insert

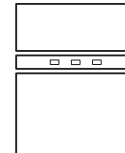

##### 57"H Panels

- One 21"H upper insert
- One 4"H beltway cover and insert support
- One 24"H lower insert

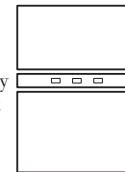

##### 78"H Panels

- One 50"H upper insert
- One 4"H beltway cover and insert support
- One 24"H lower panel insert



##### 64"H Panels

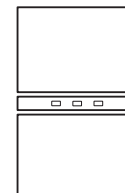

- One 28"H upper insert
- One 4"H beltway cover and insert support
- One 24"H lower insert



# Beltway Inserts

## Lower Fabric Inserts

### Beltway Cover and Insert Supports

description	w*	w	h	d	pattern no.	grade							
						10	15	20	25	30	35	40	45
 24" High Fabric Beltway Lower Insert, (For Beltway Panels only)	18"	17 <sup>5</sup> / <sub>8</sub> "	25 <sup>1</sup> / <sub>2</sub> "	7 <sup>1</sup> / <sub>16</sub> "	DP1SO2418	\$89.	\$97.	\$102.	\$109.	\$113.	\$117.	\$123.	\$127.
	24"	23 <sup>5</sup> / <sub>8</sub> "	25 <sup>1</sup> / <sub>2</sub> "	7 <sup>1</sup> / <sub>16</sub> "	DP1SO2424	111.	115.	127.	133.	138.	141.	146.	158.
	30"	29 <sup>5</sup> / <sub>8</sub> "	25 <sup>1</sup> / <sub>2</sub> "	7 <sup>1</sup> / <sub>16</sub> "	DP1SO2430	121.	127.	138.	144.	150.	158.	162.	171.
	36"	35 <sup>5</sup> / <sub>8</sub> "	25 <sup>1</sup> / <sub>2</sub> "	7 <sup>1</sup> / <sub>16</sub> "	DP1SO2436	132.	138.	150.	159.	168.	174.	178.	184.
	42"	41 <sup>5</sup> / <sub>8</sub> "	25 <sup>1</sup> / <sub>2</sub> "	7 <sup>1</sup> / <sub>16</sub> "	DP1SO2442	137.	143.	152.	160.	170.	175.	182.	190.
	48"	47 <sup>5</sup> / <sub>8</sub> "	25 <sup>1</sup> / <sub>2</sub> "	7 <sup>1</sup> / <sub>16</sub> "	DP1SO2448	143.	150.	162.	171.	176.	183.	193.	203.
	60"	59 <sup>5</sup> / <sub>8</sub> "	25 <sup>1</sup> / <sub>2</sub> "	7 <sup>1</sup> / <sub>16</sub> "	DP1SO2460	163.	168.	175.	178.	184.	187.	197.	208.
 Beltway Cover and Insert Supports	18"			7 <sup>1</sup> / <sub>16</sub> "	DP2BC18K	97.	n/a	n/a	n/a	n/a	n/a	n/a	n/a
	24"			7 <sup>1</sup> / <sub>16</sub> "	DP2BC24K	113.	n/a	n/a	n/a	n/a	n/a	n/a	n/a
	30"			7 <sup>1</sup> / <sub>16</sub> "	DP2BC30K	125.	n/a	n/a	n/a	n/a	n/a	n/a	n/a
	36"			7 <sup>1</sup> / <sub>16</sub> "	DP2BC36K	137.	n/a	n/a	n/a	n/a	n/a	n/a	n/a
	42"			7 <sup>1</sup> / <sub>16</sub> "	DP2BC42K	152.	n/a	n/a	n/a	n/a	n/a	n/a	n/a
	48"			7 <sup>1</sup> / <sub>16</sub> "	DP2BC48K	170.	n/a	n/a	n/a	n/a	n/a	n/a	n/a
 Beltway Knockout Replacement Cover for Electrical and Data	Pkg of 10				DE1 KCBW	44.	n/a	n/a	n/a	n/a	n/a	n/a	n/a

Panels, Build-To-Spec

w\* = nominal width  
Dimensions listed under w h d are actual to the nearest 1/16"

Ordering Information	Order Code	Included with:	Options
<b>Beltway Cover/Insert Supports</b> 1. Pattern Number 2. Beltway Cover/Trim Finish	<b>Beltway Inserts</b> <i>Example:</i> <b>DP1 SO2442, W257-6</b> <b>DP1</b> Pattern Number <b>SO2442</b> <b>W257-6</b> Solid Crepe Blue Pine fabric	<b>Beltway Inserts</b> <b>Beltway Cover/Insert Supports</b> <ul style="list-style-type: none"> <li>Individual beltway cover</li> <li>Insert supports (top and bottom rail)</li> <li>Attachment hardware</li> <li>Beltway knockout covers</li> </ul> <b>Note:</b> 24"H inserts are to only be used below beltways.	<b>Beltway Panel Inserts</b> <b>Beltway Cover/Insert Supports</b> Beltway cover has a smooth finish  <b>Tile to Floor Option:</b> To specify tile to floor, add an "F" suffix to the pattern number and add \$10 to the list price.  <b>Note:</b> Tile to floor option available for 24" high inserts.
<b>Beltway Inserts</b> 1. Pattern Number 2. Fabric	<b>Beltway Cover/Insert Supports</b> <i>Example:</i> <b>DP2 BC42K, 117</b> <b>DP2</b> Pattern Number <b>BC42K</b> <b>117</b> Soft Grey Beltway Cover Trim		

# Beltway Inserts

## Lower Steel Inserts

Dividends Horizon

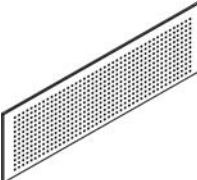
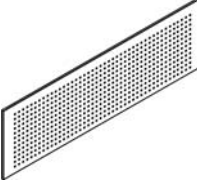
description	w*	w	h	d	pattern no.	1 pack P1	1 pack P2	1 pack P3	2 pack P1	2 pack P2	2 pack P3
24" High Solid Steel Insert 	18"	17 <sup>5</sup> / <sub>8</sub> "	25 <sup>1</sup> / <sub>2</sub> "	7/16"	<b>DP3SS( )2418</b>	\$98.	\$118.	\$127.	\$171.	\$201.	\$219.
	24"	23 <sup>5</sup> / <sub>8</sub> "	25 <sup>1</sup> / <sub>2</sub> "	7/16"	<b>DP3SS( )2424</b>	123.	140.	153.	214.	244.	266.
	30"	29 <sup>5</sup> / <sub>8</sub> "	25 <sup>1</sup> / <sub>2</sub> "	7/16"	<b>DP3SS( )2430</b>	130.	152.	165.	228.	266.	288.
	36"	35 <sup>5</sup> / <sub>8</sub> "	25 <sup>1</sup> / <sub>2</sub> "	7/16"	<b>DP3SS( )2436</b>	146.	166.	184.	253.	288.	321.
	42"	41 <sup>5</sup> / <sub>8</sub> "	25 <sup>1</sup> / <sub>2</sub> "	7/16"	<b>DP3SS( )2442</b>	151.	167.	185.	264.	293.	325.
	48"	47 <sup>5</sup> / <sub>8</sub> "	25 <sup>1</sup> / <sub>2</sub> "	7/16"	<b>DP3SS( )2448</b>	155.	177.	194.	273.	313.	342.
24" High Perforated Steel Insert 	18"	17 <sup>5</sup> / <sub>8</sub> "	25 <sup>1</sup> / <sub>2</sub> "	7/16"	<b>DP3PSB( )2418</b>	149.	176.	193.	256.	302.	328.
	24"	23 <sup>5</sup> / <sub>8</sub> "	25 <sup>1</sup> / <sub>2</sub> "	7/16"	<b>DP3PSB( )2424</b>	183.	210.	230.	321.	368.	402.
	30"	29 <sup>5</sup> / <sub>8</sub> "	25 <sup>1</sup> / <sub>2</sub> "	7/16"	<b>DP3PSB( )2430</b>	198.	228.	246.	344.	402.	433.
	36"	35 <sup>5</sup> / <sub>8</sub> "	25 <sup>1</sup> / <sub>2</sub> "	7/16"	<b>DP3PSB( )2436</b>	220.	248.	277.	381.	433.	480.
	42"	41 <sup>5</sup> / <sub>8</sub> "	25 <sup>1</sup> / <sub>2</sub> "	7/16"	<b>DP3PSB( )2442</b>	227.	250.	278.	397.	440.	488.
	48"	47 <sup>5</sup> / <sub>8</sub> "	25 <sup>1</sup> / <sub>2</sub> "	7/16"	<b>DP3PSB( )2448</b>	232.	265.	289.	413.	470.	512.
24" High Embossed Steel Insert 	18"	17 <sup>5</sup> / <sub>8</sub> "	25 <sup>1</sup> / <sub>2</sub> "	7/16"	<b>DP3ESB( )2418</b>	149.	176.	193.	256.	302.	328.
	24"	23 <sup>5</sup> / <sub>8</sub> "	25 <sup>1</sup> / <sub>2</sub> "	7/16"	<b>DP3ESB( )2424</b>	183.	210.	230.	321.	368.	402.
	30"	29 <sup>5</sup> / <sub>8</sub> "	25 <sup>1</sup> / <sub>2</sub> "	7/16"	<b>DP3ESB( )2430</b>	198.	228.	246.	344.	402.	433.
	36"	35 <sup>5</sup> / <sub>8</sub> "	25 <sup>1</sup> / <sub>2</sub> "	7/16"	<b>DP3ESB( )2436</b>	220.	248.	277.	381.	433.	480.
	42"	41 <sup>5</sup> / <sub>8</sub> "	25 <sup>1</sup> / <sub>2</sub> "	7/16"	<b>DP3ESB( )2442</b>	227.	250.	278.	397.	440.	488.
	48"	47 <sup>5</sup> / <sub>8</sub> "	25 <sup>1</sup> / <sub>2</sub> "	7/16"	<b>DP3ESB( )2448</b>	232.	265.	289.	413.	470.	512.

w\* = nominal width

Dimensions listed under w h d are actual to the nearest 1/16"

### Ordering Information

#### Steel Insert

1. Pattern number
2. Paint finish

### Order Code

#### Steel Insert

Example: **DP3SS( )2418 115**

**DP3** Pattern number

**SS22418**

**115** Medium Grey paint

### Included with:

#### Steel Insert

**Note:** 24"H inserts are to only be used below beltways.

### Options

#### Steel Insert

Insert pack quantity into parenthesis in pattern number

#### Tile to Floor Option:

To specify tile to floor, add an 'F' suffix to the pattern number and add \$16 for a single pack or \$31 for a double pack.

**Note:** Tile to Floor option available for 24" high inserts.

# Beltway Inserts

## Lower Laminate Inserts

Dividends Horizon

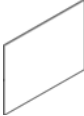
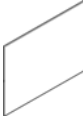
description	w*	w	d	pattern no.	list
24" High Laminate Beltway Lower Insert Base Raceway or Open Base 	15"	14 7/8"	7/16"	<b>DP3L12415</b>	\$135.
	18"	17 7/8"	7/16"	<b>DP3L12418</b>	144.
	24"	23 7/8"	7/16"	<b>DP3L12424</b>	161.
	30"	29 7/8"	7/16"	<b>DP3L12430</b>	193.
	36"	35 7/8"	7/16"	<b>DP3L12436</b>	236.
	42"	41 7/8"	7/16"	<b>DP3L12442</b>	240.
	48"	47 7/8"	7/16"	<b>DP3L12448</b>	243.
24" High Laminate Beltway Lower Insert Tile to Floor 	15"	14 7/8"	7/16"	<b>DP3L12415F</b>	135.
	18"	17 7/8"	7/16"	<b>DP3L12418F</b>	144.
	24"	23 7/8"	7/16"	<b>DP3L12424F</b>	161.
	30"	29 7/8"	7/16"	<b>DP3L12430F</b>	193.
	36"	35 7/8"	7/16"	<b>DP3L12436F</b>	236.
	42"	41 7/8"	7/16"	<b>DP3L12442F</b>	240.
	48"	47 7/8"	7/16"	<b>DP3L12448F</b>	243.

Panels, Build-To-Spec

w\* = nominal width  
Dimensions listed under w h d are actual to the nearest 1/16"

Ordering Information	Order Code	Included with:	Options:
<b>Beltway Laminate Inserts</b>	<b>Beltway Laminate Inserts</b>	<b>Beltway Laminate Inserts</b>	<b>Beltway Laminate Inserts Finish</b>
1. Pattern Number	<i>Example:</i> <b>DP3L12436</b>	• Attachment clips	<b>Options:</b>
2. Laminate Finish	<b>DP3L1</b> Pattern Number	<b>Note:</b> 24"H inserts are to only be used below beltways.	<b>114 Folkstone Grey</b>
3. Edgeband Finish	<b>2436</b>		<b>117 Soft Grey</b>
	<b>118</b> Bright White Laminate		<b>118 Bright White</b>
	<b>118</b> Bright White Edgeband		<b>119 Pumice</b>

## High Acoustic Core Inserts and Sound Transmission Septum Inserts

Optional high acoustic core inserts or sound transmission septum inserts combine with tiles to provide enhanced acoustics.

High acoustic core inserts can be installed in monolithic and tiled panels but must be field-cut to be installed in beltway panels.

Sound transmission septum inserts can be installed in monolithic and tiled panels and single-sided beltway panels.

### High Acoustic Core Insert Construction

1 1/2" thick, three-ply insert with an inner septum and outer fiberglass with polywrap.

### Sound Transmission Septum Insert Construction

1/16" thick black asphalt paper.

### Core Insert Attachment

High acoustic core inserts and sound transmission septum inserts are inserted into the center of the panel frame. Core inserts are sized to fit into the panel frame without the use of fasteners. In-field installation is required.

### High Acoustic Core Insert Panel Ratings

Noise Reduction Coefficient (NRC) rating: .80 when combined with tiles.

Sound Transmission Class (STC) rating: 26 when combined with tiles.

### Sound Transmission Septum Insert Panel Ratings

Noise Reduction Coefficient (NRC) rating: .60 when combined with tiles.

Sound Transmission Class (STC) rating: 17 when combined with tiles.

### Available Sizes

High acoustic core inserts and sound transmission septum inserts are available for all widths of 50", 64" and 78" high monolithic and tiled panels.

Beltway electrical panels require the high acoustic core inserts or the sound transmission septum inserts to be field-cut prior to installation.

### Packaging

High acoustic cores and sound transmission septum inserts are shipped in separate containers.

## High Acoustic Core Insert

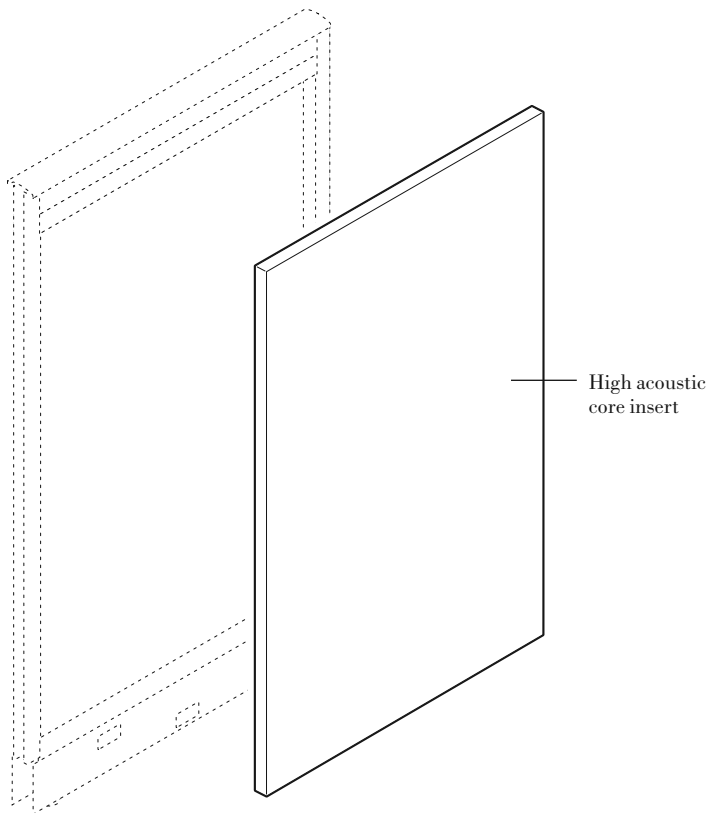

## High Acoustic Core Insert Construction

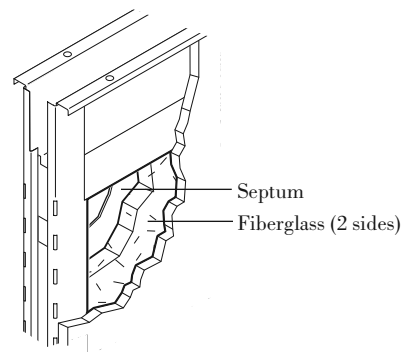

## Sound Transmission Septum Insert Construction

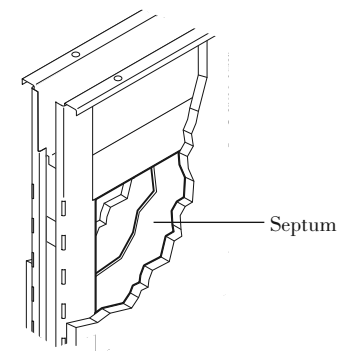

# High Acoustic Core Inserts

## Sound Transmission Septum Inserts

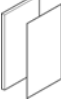
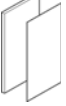
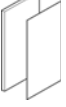
description	type	pattern no.	High Acoustic Core Insert	Sound Transmission Septum Insert
 50" High	For 18" panel width	<b>DP1() 5018</b>	\$27.	\$13.
	For 24" panel width	<b>DP1() 5024</b>	32.	13.
	For 30" panel width	<b>DP1() 5030</b>	35.	13.
	For 36" panel width	<b>DP1() 5036</b>	39.	22.
	For 42" panel width	<b>DP1() 5042</b>	44.	22.
	For 48" panel width	<b>DP1() 5048</b>	53.	22.
 64" High	For 18" panel width	<b>DP1() 6418</b>	36.	13.
	For 24" panel width	<b>DP1() 6424</b>	41.	13.
	For 30" panel width	<b>DP1() 6430</b>	47.	13.
	For 36" panel width	<b>DP1() 6436</b>	56.	22.
	For 42" panel width	<b>DP1() 6442</b>	65.	22.
	For 48" panel width	<b>DP1() 6448</b>	72.	22.
 78" High	For 18" panel width	<b>DP1() 7818</b>	47.	25.
	For 24" panel width	<b>DP1() 7824</b>	56.	25.
	For 30" panel width	<b>DP1() 7830</b>	64.	25.
	For 36" panel width	<b>DP1() 7836</b>	70.	27.
	For 42" panel width	<b>DP1() 7842</b>	79.	27.
	For 48" panel width	<b>DP1() 7848</b>	93.	27.

Panels, Build-To-Spec

### Ordering Information

#### Inserts

1. Pattern Number

### Order Code

#### Inserts

*Example:* **DP1(AC) 6448**  
**DP1(AC)** Pattern Number  
**6448**

### Included with:

#### Inserts

- High Acoustic Core Insert
- Sound Transmission Septum Insert

### Options

#### Inserts

Insert the appropriate letters for insert required within the parentheses of the pattern number.  
**(AC)** = High Acoustic  
**(ST)** = Sound Transmission

### Single Pane Window Insert Kit

Single pane windows are available for three applications:

- Top position, with topway - for use in the top position of panels and D1 style stack frame with a topway trough.
- Top position, full view - for use in the top position of full view panels and D1 style stack frames.
- Middle position - for use in the middle positions of topway and full view panels.

**Note:** Window insert kits may not be specified in the bottom position of panels. Specify D2 tile supports and insert support mounting brackets separately.

**Note:** Single and double pane window insert kits are not compatible with the D2 style stack frame. Use D1 style stack frames with top position single or double pane window insert kits.

### Construction

Single pane windows are shipped in two components - an "open" frame, and a "window" frame. Each frame snaps onto a Dividends Horizon panel frame. Both frames are constructed of extruded, then robotically-welded aluminum. Single pane windows have 1/4" tempered glass inserts with PVC glazing strip.

### Single Pane Window Insert Kit

#### Available Sizes

- Heights: 14", 21" and 28"
- Widths: 24", 30", 36", 42", and 48"

#### Attachment

Window insert kits are installed on each side of a panel frame. Glazed insert kits consist of two inserts. Individual tile support rails must be ordered separately.

**Note:** Window types are aesthetically different, and are not designed to be mixed together within a single installation.

Single Pane Window Insert Kit

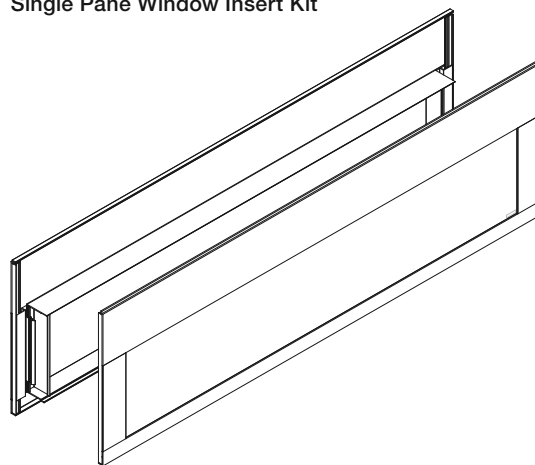





# Window Insert Kits

## Single Pane Windows

Dividends Horizon

description	h	w	pattern no.	P1	P2	P3
Window, top position with topway 	14"	24"	<b>D2P1( )T1424</b>	\$377.	\$399.	\$417.
	14"	30"	<b>D2P1( )T1430</b>	438.	458.	481.
	14"	36"	<b>D2P1( )T1436</b>	493.	518.	544.
	14"	42"	<b>D2P1( )T1442</b>	586.	616.	645.
	14"	48"	<b>D2P1( )T1448</b>	599.	630.	661.
	21"	24"	<b>D2P1( )T2124</b>	440.	462.	483.
	21"	30"	<b>D2P1( )T2130</b>	518.	545.	571.
	21"	36"	<b>D2P1( )T2136</b>	557.	586.	613.
	21"	42"	<b>D2P1( )T2142</b>	666.	700.	731.
	21"	48"	<b>D2P1( )T2148</b>	741.	781.	817.
	28"	24"	<b>D2P1( )T2824</b>	483.	508.	535.
	28"	30"	<b>D2P1( )T2830</b>	571.	599.	629.
	28"	36"	<b>D2P1( )T2836</b>	613.	645.	675.
	28"	42"	<b>D2P1( )T2842</b>	731.	770.	808.
28"	48"	<b>D2P1( )T2848</b>	817.	857.	898.	
Window, top position full view 	14"	24"	<b>D2P1( )VT1424</b>	377.	399.	417.
	14"	30"	<b>D2P1( )VT1430</b>	438.	458.	481.
	14"	36"	<b>D2P1( )VT1436</b>	493.	518.	544.
	14"	42"	<b>D2P1( )VT1442</b>	586.	616.	645.
	14"	48"	<b>D2P1( )VT1448</b>	599.	630.	661.
	21"	24"	<b>D2P1( )VT2124</b>	440.	462.	483.
	21"	30"	<b>D2P1( )VT2130</b>	518.	545.	571.
	21"	36"	<b>D2P1( )VT2136</b>	557.	586.	613.
	21"	42"	<b>D2P1( )VT2142</b>	666.	700.	731.
	21"	48"	<b>D2P1( )VT2148</b>	741.	781.	817.
	28"	24"	<b>D2P1( )VT2824</b>	483.	508.	535.
	28"	30"	<b>D2P1( )VT2830</b>	571.	599.	629.
	28"	36"	<b>D2P1( )VT2836</b>	613.	645.	675.
	28"	42"	<b>D2P1( )VT2842</b>	731.	770.	808.
28"	48"	<b>D2P1( )VT2848</b>	817.	857.	898.	
Window, middle position 	14"	24"	<b>D2P1( )VL1424</b>	377.	399.	417.
	14"	30"	<b>D2P1( )VL1430</b>	438.	458.	481.
	14"	36"	<b>D2P1( )VL1436</b>	493.	518.	544.
	14"	42"	<b>D2P1( )VL1442</b>	586.	616.	645.
	14"	48"	<b>D2P1( )VL1448</b>	599.	630.	661.

Panels, Build-To-Spec

### Ordering Information

#### Single Pane Window Kit

1. Pattern number
2. Paint finish

### Order Code

#### Single Pane Window Kit

Example:	<b>D2P1GT1448, 117</b>
<b>D2P1</b>	Single Pane Window w/
<b>GT1448</b>	Clear Glass
<b>117</b>	Soft Grey Paint

### Included with:

#### Single Pane Window Kit

**Note:** The single pane window insert kit is not compatible with the D2 style stack frame. Use D1 style stack frames with single pane window insert kits.

**Note:** Use top position window insert kits when using with D1 style stack frames.

### Options

#### Single Pane Window Kit

**Note: Single Pane Window Kit must be used with D2 Style Supports**

**Glass Options:**  
(G) = Clear Tempered Glass

### Markerboard Tiles

Markerboard tiles may be attached to any Dividends Horizon universal panel frame or wall mount tracks.

### Construction

Markerboard tiles are constructed of 20 gauge steel, powder coated with paint suitable for use with standard dry erase markers.

### Available Sizes

- Heights: 7", 10", 14", 21", 24" and 28"
- Widths: 18", 24", 30", 36", 42", and 48"

### Attachment

Markerboard tiles are installed on one side or both sides of a panel frame or attached to wall mount tracks. Individual D1 or D2 tile support rails must be ordered separately.

### Markerboard Trays

Markerboard trays are positioned directly below markerboard tiles, and are designed to hold dry erase markers and erasers. Trays mount to the outside of tile frames, and replace a D1 or D2 tile support.

Markerboard trays may not be positioned directly above or below a beltway raceway and may not be used with stack frames.

**Note:** Markerboard tiles can use D1 or D2 tile supports. Legacy D1 and D2 Markerboard tiles use D1 tile supports only.

### Markerboard Tile

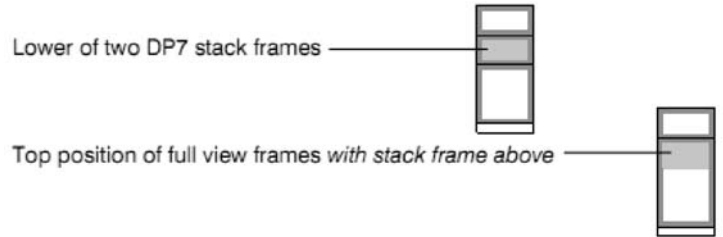
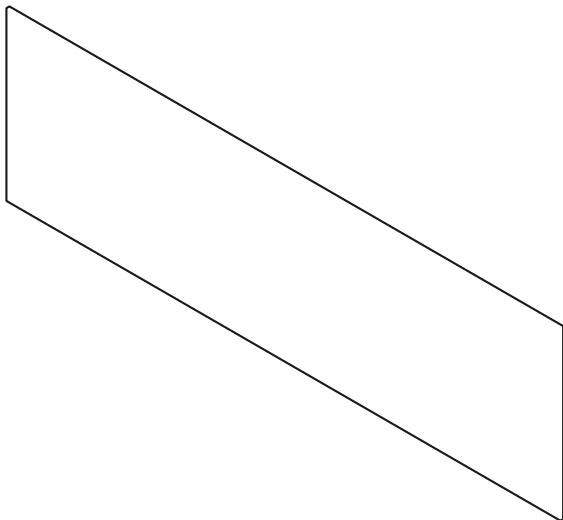

### DP7 Stack Frame/Steel Tile Planning Note

When planning steel or markerboard tiles in the lower of two stack frames, or the upper position of full view panels with stack frames above them, different attachment clips are required. Specify pattern number DP7 SSTK (\$10 list) for each steel or markerboard tile used in these applications. This hardware kit is not required for any other tiles, or for steel and markerboard tiles in other locations.

---

Proper use and regular cleaning of your markerboard surface is essential for preventing permanent stains and/or ghosting typically associated with dry erase markers. By following the care and use instructions below, you will minimize the possibility of permanent stains and ghosting.

### Initial Cleaning of Markerboards Before First Use:

- Using a clean, dry cloth and a nonabrasive cleaner, gently clean the entire board to loosen any residue
- Using a dry cloth, wipe the entire surface to remove all dirt and residue from the prior step
- Rinse the entire board with clean water
- Using a dry cloth, wipe dry the entire surface

### Daily Use, Care and Maintenance:





- *Use the proper markers.* All dry erase markers will write legibly on the marker board surface, but not all will erase properly due to their composition. Do not use low odor dry erase markers or permanent (indelible) markers. Use of these markers will lead to staining or ghosting, even with regular cleaning.
- *Clean the markerboard regularly.* It is recommended that markerboards be erased daily using an eraser designated for use with dry erase markers. If the markerboard is used daily, we recommend that a complete cleaning is performed at least 2-3 times a week using EXPO® whiteboard cleaner.
- *Remove ghosting.* Using EXPO® whiteboard cleaner and a paper towel, wipe the entire surface and let dry. Mix Joy® dishwashing detergent with warm water and apply to the board using a paper towel, then wipe dry with a clean cloth. Repeat as necessary.
- *Remove permanent marker.* Using a dry erase marker, write on top of the permanent marker, erase with a dry eraser, and then clean with EXPO® whiteboard cleaner.

**Note:** Do not use other painted tiles as markerboards or product damage will occur and the tile warranty will be voided.

# Markerboard Tiles

## 7", 10", 14" and 21" High

Dividends Horizon

description	h	w	pattern no.	1 pack	6 pack
D3 7" Markerboard tile 	7"	18"	<b>DP3MB( )718</b>	\$72.	\$319.
	7"	24"	<b>DP3MB( )724</b>	76.	339.
	7"	30"	<b>DP3MB( )730</b>	83.	376.
	7"	36"	<b>DP3MB( )736</b>	99.	437.
	7"	42"	<b>DP3MB( )742</b>	108.	467.
	7"	48"	<b>DP3MB( )748</b>	111.	495.
D3 10" Markerboard tile 	10"	18"	<b>DP3MB( )1018</b>	99.	446.
	10"	24"	<b>DP3MB( )1024</b>	108.	474.
	10"	30"	<b>DP3MB( )1030</b>	109.	495.
	10"	36"	<b>DP3MB( )1036</b>	121.	525.
	10"	42"	<b>DP3MB( )1042</b>	125.	555.
	10"	48"	<b>DP3MB( )1048</b>	132.	594.
D3 14" Markerboard tile 	14"	18"	<b>DP3MB( )1418</b>	99.	446.
	14"	24"	<b>DP3MB( )1424</b>	108.	474.
	14"	30"	<b>DP3MB( )1430</b>	109.	495.
	14"	36"	<b>DP3MB( )1436</b>	121.	525.
	14"	42"	<b>DP3MB( )1442</b>	125.	555.
	14"	48"	<b>DP3MB( )1448</b>	132.	594.
D3 21" Markerboard tile 	21"	18"	<b>DP3MB( )2118</b>	128.	665.
	21"	24"	<b>DP3MB( )2124</b>	159.	832.
	21"	30"	<b>DP3MB( )2130</b>	171.	893.
	21"	36"	<b>DP3MB( )2136</b>	193.	992.
	21"	42"	<b>DP3MB( )2142</b>	198.	1,029.
	21"	48"	<b>DP3MB( )2148</b>	202.	1,071.

### Ordering Information

**Markerboard Tiles**  
1. Pattern Number

### Order Code

**Markerboard Tiles**  
*Example:* **DP3MB(1) 1436**  
**DP3MB(1)** Pattern Number  
**1436**

### Included with:



**Markerboard Tiles**

### Options

**Markerboard Tiles**  
**(1)** = 1 Pack  
**(6)** = 6 Pack

# Markerboard Tiles

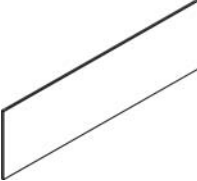
## 24" and 28" High and Markerboard Tray

description	height	width	pattern number	1 pack	2 pack	P1	P2	P3
 D3 24" Markerboard tile	24"	18"	<b>DP3MB( )2418</b>	\$128.	\$221.			
	24"	24"	<b>DP3MB( )2424</b>	159.	277.			
	24"	30"	<b>DP3MB( )2430</b>	171.	297.			
	24"	36"	<b>DP3MB( )2436</b>	193.	331.			
	24"	42"	<b>DP3MB( )2442</b>	198.	344.			
	24"	48"	<b>DP3MB( )2448</b>	202.	356.			
 D3 28" Markerboard tile	28"	18"	<b>DP3MB( )2818</b>	139.	242.			
	28"	24"	<b>DP3MB( )2824</b>	161.	281.			
	28"	30"	<b>DP3MB( )2830</b>	172.	303.			
	28"	36"	<b>DP3MB( )2836</b>	193.	337.			
	28"	42"	<b>DP3MB( )2842</b>	198.	347.			
	28"	48"	<b>DP3MB( )2848</b>	202.	358.			
 Markerboard Tray		24"	<b>DP1MBT24</b>			111.	117.	122.
		30"	<b>DP1MBT30</b>			114.	119.	125.
		36"	<b>DP1MBT36</b>			116.	122.	127.
		42"	<b>DP1MBT42</b>			118.	124.	129.
		48"	<b>DP1MBT48</b>			121.	126.	132.

Panels, Build-To-Spec

Ordering Information	Order Code	Included with:	Options
<b>Markerboard Tiles</b> 1. Pattern Number	<b>Markerboard Tiles</b> <i>Example:</i> <b>DP3MB(1) 1436</b>	<b>Markerboard Tiles</b>	<b>Markerboard Tiles</b> <b>(1)</b> = 1 Pack <b>(2)</b> = 2 Pack
<b>Markerboard Tray</b> 1. Pattern Number 2. Paint Finish	<b>DP3MB(1)</b> Pattern Number <b>1436</b>		

### Solid Steel Inserts

Solid steel tiles are painted solid steel formed inserts that may be inserted into any Dividends Horizon universal panel frame or attached to wall mount tracks.

#### Construction

Steel tiles are made of 20-gauge formed steel that is painted in any Dividends Horizon paint color.

### Embossed Steel Inserts

Embossed steel tiles are painted embossed steel formed inserts that may be inserted into any Dividends Horizon universal panel frame or attached to wall mount tracks.

#### Construction

Embossed steel tiles are made of 18-gauge formed steel that is painted in any Dividends Horizon paint color

### Perforated Steel Inserts

Perforated steel tiles are painted perforated steel formed inserts that may be inserted into any Dividends Horizon universal panel frame or attached to wall mount tracks.

#### Construction

Perforated steel tiles are made of 18-gauge formed steel that is painted in any Dividends Horizon paint color.

#### Available Sizes

- Height: 7", 10", 14", 21", 24" and 28"
- Widths: 15", 18", 24", 30", 36", 42" and 48"

#### Attachment

Steel tiles are installed on one side or both sides of a panel frame or attached to wall mount tracks. Individual D1 or D2 tile support rails must be ordered separately.

### One-sided Attachment

For applications with perforated inserts on one side of panel only, specify sound transmission septums.

### Tile-to-Floor Option

14" and 28" high steel tiles are available to be specified Tile-to-Floor.

Solid Steel Tile Insert

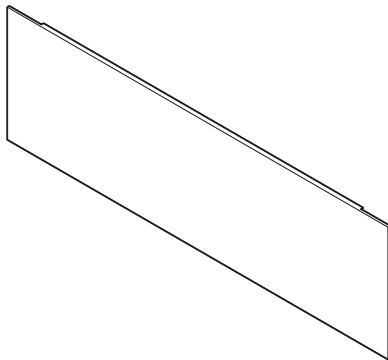

Perforated and Embossed Steel Tile Inserts

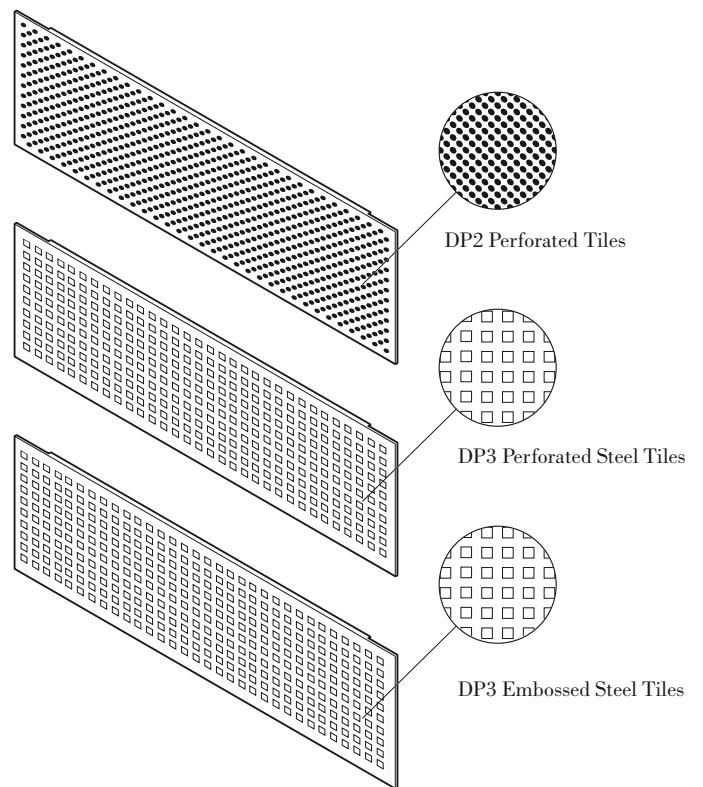

Lower of two DP7 stack frames



Top position of full view frames with stack frame above







### DP7 Stack Frame/Steel Tile Planning Note

When planning steel or markerboard tiles in the lower of two stack frames, or the upper position of full view panels with stack frames above them, different attachment clips are required. Specify pattern number DP7 SSTK (\$10 list) for each steel or markerboard tile used in these applications. This hardware kit is not required for any other tiles, or for steel and markerboard tiles in other locations.

# Steel Insert Kits

## 7", 10", 14" and 21" High Solid Steel Insert

Dividends Horizon

description	w*	w	h	d	pattern no.	1 pack P1	1 pack P2	1 pack P3	6 pack P1	6 pack P2	6 pack P3
 D3 7" High Solid Steel Insert	15"	14 5/8"	7 3/16"	7/16"	<b>DP3SS( )715</b>	\$55.	\$65.	\$76.	\$244.	\$283.	\$338.
	18"	17 5/8"	7 3/16"	7/16"	<b>DP3SS( )718</b>	55.	65.	76.	244.	283.	338.
	24"	23 5/8"	7 3/16"	7/16"	<b>DP3SS( )724</b>	58.	72.	78.	259.	321.	350.
	30"	29 5/8"	7 3/16"	7/16"	<b>DP3SS( )730</b>	66.	80.	88.	290.	357.	388.
	36"	35 5/8"	7 3/16"	7/16"	<b>DP3SS( )736</b>	77.	91.	96.	338.	388.	419.
	42"	41 5/8"	7 3/16"	7/16"	<b>DP3SS( )742</b>	82.	94.	102.	357.	413.	449.
	48"	47 5/8"	7 3/16"	7/16"	<b>DP3SS( )748</b>	85.	97.	104.	381.	436.	472.
 D3 10" High Solid Steel Insert	15"	14 5/8"	10 3/16"	7/16"	<b>DP3SS( )1015</b>	77.	89.	92.	344.	388.	406.
	18"	17 5/8"	10 3/16"	7/16"	<b>DP3SS( )1018</b>	77.	89.	92.	344.	388.	406.
	24"	23 5/8"	10 3/16"	7/16"	<b>DP3SS( )1024</b>	82.	93.	96.	368.	419.	436.
	30"	29 5/8"	10 3/16"	7/16"	<b>DP3SS( )1030</b>	83.	96.	100.	381.	442.	457.
	36"	35 5/8"	10 3/16"	7/16"	<b>DP3SS( )1036</b>	92.	104.	111.	406.	466.	488.
	42"	41 5/8"	10 3/16"	7/16"	<b>DP3SS( )1042</b>	95.	109.	121.	426.	488.	535.
	48"	47 5/8"	10 3/16"	7/16"	<b>DP3SS( )1048</b>	100.	122.	126.	457.	549.	572.
 D3 14" High Solid Steel Insert	15"	14 5/8"	14 3/16"	7/16"	<b>DP3SS( )1415</b>	77.	89.	92.	344.	388.	406.
	18"	17 5/8"	14 3/16"	7/16"	<b>DP3SS( )1418</b>	77.	89.	92.	344.	388.	406.
	24"	23 5/8"	14 3/16"	7/16"	<b>DP3SS( )1424</b>	82.	93.	96.	368.	419.	436.
	30"	29 5/8"	14 3/16"	7/16"	<b>DP3SS( )1430</b>	83.	96.	100.	381.	442.	457.
	36"	35 5/8"	14 3/16"	7/16"	<b>DP3SS( )1436</b>	92.	104.	111.	406.	466.	488.
	42"	41 5/8"	14 3/16"	7/16"	<b>DP3SS( )1442</b>	95.	109.	121.	426.	488.	535.
	48"	47 5/8"	14 3/16"	7/16"	<b>DP3SS( )1448</b>	100.	122.	126.	457.	549.	572.
 D3 21" High Solid Steel Insert	15	14 5/8"	21 3/16"	7/16"	<b>DP3SS( )2115</b>	98.	118.	127.	512.	603.	656.
	18"	17 5/8"	21 3/16"	7/16"	<b>DP3SS( )2118</b>	98.	118.	127.	512.	603.	656.
	24"	23 5/8"	21 3/16"	7/16"	<b>DP3SS( )2124</b>	123.	140.	153.	641.	730.	801.
	30"	29 5/8"	21 3/16"	7/16"	<b>DP3SS( )2130</b>	130.	152.	165.	687.	801.	862.
	36"	35 5/8"	21 3/16"	7/16"	<b>DP3SS( )2136</b>	146.	166.	184.	763.	862.	962.
	42"	41 5/8"	21 3/16"	7/16"	<b>DP3SS( )2142</b>	151.	167.	185.	793.	878.	977.
	48"	47 5/8"	21 3/16"	7/16"	<b>DP3SS( )2148</b>	155.	177.	194.	823.	937.	1,022.

Panels, Build-To-Spec

### Ordering Information

#### Solid Steel Insert

1. Pattern number
2. Paint finish

### Order Code

#### Solid Steel Insert

Example: **DP3SS( )1418 115**

**DP3** Pattern number

**SS21418**

**115** Medium Grey paint

### Included with:

#### Solid Steel Insert

### Options

Insert pack quantity into parenthesis in pattern number

#### Tile to Floor Option:

Tile to Floor available in heights of 14", Worksurface Height, 24" and 28". To specify tile to floor, add an 'F' suffix to the pattern number and add \$16 for a single pack, \$31 for a double pack and \$95 for a 6 pack to the list price.

*Worksurface Height and 28" High Solid Steel Insert*

description	w*	w	h	d	pattern no.	1 pack P1	1 pack P2	1 pack P3	2 pack P1	2 pack P2	2 pack P3
D3 Worksurface Height Solid Steel Insert 	15"	14 5/8"	22 1/2"	7/16"	<b>DP3SS( )WH15</b>	\$98.	\$118.	\$127.	\$171.	\$201.	\$219.
	18"	17 5/8"	22 1/2"	7/16"	<b>DP3SS( )WH18</b>	98.	118.	127.	171.	201.	219.
	24"	23 5/8"	22 1/2"	7/16"	<b>DP3SS( )WH24</b>	123.	140.	153.	214.	244.	266.
	30"	29 5/8"	22 1/2"	7/16"	<b>DP3SS( )WH30</b>	130.	152.	165.	228.	266.	288.
	36"	35 5/8"	22 1/2"	7/16"	<b>DP3SS( )WH36</b>	146.	166.	184.	253.	288.	321.
	42"	41 5/8"	22 1/2"	7/16"	<b>DP3SS( )WH42</b>	151.	167.	185.	264.	293.	325.
	48"	47 5/8"	22 1/2"	7/16"	<b>DP3SS( )WH48</b>	155.	177.	194.	273.	313.	342.

D3 28" High Solid Steel Insert	w*	w	h	d	pattern no.	1 pack P1	1 pack P2	1 pack P3	2 pack P1	2 pack P2	2 pack P3
	15"	14 5/8"	29"	7/16"	<b>DP3SS( )2815</b>	107.	107.	126.	185.	203.	219.
	18"	17 5/8"	29"	7/16"	<b>DP3SS( )2818</b>	107.	107.	126.	185.	203.	219.
	24"	23 5/8"	29"	7/16"	<b>DP3SS( )2824</b>	124.	124.	153.	216.	246.	268.
	30"	29 5/8"	29"	7/16"	<b>DP3SS( )2830</b>	132.	152.	166.	234.	268.	293.
	36"	35 5/8"	29"	7/16"	<b>DP3SS( )2836</b>	146.	166.	184.	256.	293.	325.
	42"	41 5/8"	29"	7/16"	<b>DP3SS( )2842</b>	151.	168.	184.	266.	295.	328.
	48"	47 5/8"	29"	7/16"	<b>DP3SS( )2848</b>	155.	177.	195.	277.	315.	344.

**Ordering Information**

**Solid Steel Insert**

1. Pattern number
2. Paint finish

**Order Code**

**Solid Steel Insert**

Example: **DP3SS( )2118 115**

<b>DP3</b>	Pattern number
<b>SS22118</b>	
<b>115</b>	Medium Grey paint

**Included with:**

**Solid Steel Insert**

**Options**

**Solid Steel Insert**

Insert pack quantity into parenthesis in pattern number

**Tile to Floor Option:**

Tile to Floor available in heights of 14", Worksurface Height, 24" and 28". To specify tile to floor, add an 'F' suffix to the pattern number and add \$16 for a single pack, \$31 for a double pack and \$95 for a 6 pack to the list price.

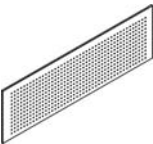
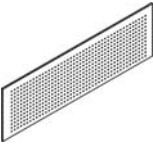
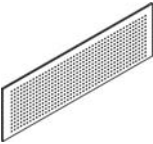
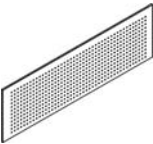

7", 10", 14" and 21" High Perforated Steel Insert

description	w*	w	h	d	pattern no.	1 pack P1	1 pack P2	1 pack P3	6 pack P1	6 pack P2	6 pack P3
 <p>D3 7" High Perforated Steel Insert</p>	15"	14 <sup>5</sup> / <sub>8</sub> "	7 <sup>3</sup> / <sub>16</sub> "	<sup>7</sup> / <sub>16</sub> "	<b>DP3PSB( )715</b>	\$83.	\$95.	\$116.	\$368.	\$426.	\$503.
	18"	17 <sup>5</sup> / <sub>8</sub> "	7 <sup>3</sup> / <sub>16</sub> "	<sup>7</sup> / <sub>16</sub> "	<b>DP3PSB( )718</b>	83.	95.	116.	368.	426.	503.
	24"	23 <sup>5</sup> / <sub>8</sub> "	7 <sup>3</sup> / <sub>16</sub> "	<sup>7</sup> / <sub>16</sub> "	<b>DP3PSB( )724</b>	89.	109.	119.	388.	480.	526.
	30"	29 <sup>5</sup> / <sub>8</sub> "	7 <sup>3</sup> / <sub>16</sub> "	<sup>7</sup> / <sub>16</sub> "	<b>DP3PSB( )730</b>	97.	122.	129.	436.	543.	587.
	36"	35 <sup>5</sup> / <sub>8</sub> "	7 <sup>3</sup> / <sub>16</sub> "	<sup>7</sup> / <sub>16</sub> "	<b>DP3PSB( )736</b>	118.	136.	145.	503.	587.	633.
	42"	41 <sup>5</sup> / <sub>8</sub> "	7 <sup>3</sup> / <sub>16</sub> "	<sup>7</sup> / <sub>16</sub> "	<b>DP3PSB( )742</b>	125.	141.	155.	543.	617.	678.
	48"	47 <sup>5</sup> / <sub>8</sub> "	7 <sup>3</sup> / <sub>16</sub> "	<sup>7</sup> / <sub>16</sub> "	<b>DP3PSB( )748</b>	128.	147.	159.	572.	656.	708.
 <p>D3 10" High Perforated Steel Insert</p>	15"	14 <sup>5</sup> / <sub>8</sub> "	10 <sup>3</sup> / <sub>16</sub> "	<sup>7</sup> / <sub>16</sub> "	<b>DP3PSB( )1015</b>	118.	132.	138.	518.	587.	610.
	18"	17 <sup>5</sup> / <sub>8</sub> "	10 <sup>3</sup> / <sub>16</sub> "	<sup>7</sup> / <sub>16</sub> "	<b>DP3PSB( )1018</b>	118.	132.	138.	518.	587.	610.
	24"	23 <sup>5</sup> / <sub>8</sub> "	10 <sup>3</sup> / <sub>16</sub> "	<sup>7</sup> / <sub>16</sub> "	<b>DP3PSB( )1024</b>	125.	140.	145.	549.	633.	656.
	30"	29 <sup>5</sup> / <sub>8</sub> "	10 <sup>3</sup> / <sub>16</sub> "	<sup>7</sup> / <sub>16</sub> "	<b>DP3PSB( )1030</b>	126.	145.	152.	572.	664.	687.
	36"	35 <sup>5</sup> / <sub>8</sub> "	10 <sup>3</sup> / <sub>16</sub> "	<sup>7</sup> / <sub>16</sub> "	<b>DP3PSB( )1036</b>	138.	159.	167.	610.	701.	730.
	42"	41 <sup>5</sup> / <sub>8</sub> "	10 <sup>3</sup> / <sub>16</sub> "	<sup>7</sup> / <sub>16</sub> "	<b>DP3PSB( )1042</b>	144.	165.	179.	641.	730.	801.
	48"	47 <sup>5</sup> / <sub>8</sub> "	10 <sup>3</sup> / <sub>16</sub> "	<sup>7</sup> / <sub>16</sub> "	<b>DP3PSB( )1048</b>	152.	181.	192.	687.	823.	862.
 <p>D3 14" High Perforated Steel Insert</p>	15"	14 <sup>5</sup> / <sub>8</sub> "	14 <sup>3</sup> / <sub>16</sub> "	<sup>7</sup> / <sub>16</sub> "	<b>DP3PSB( )1415</b>	118.	132.	138.	518.	587.	610.
	18"	17 <sup>5</sup> / <sub>8</sub> "	14 <sup>3</sup> / <sub>16</sub> "	<sup>7</sup> / <sub>16</sub> "	<b>DP3PSB( )1418</b>	118.	132.	138.	518.	587.	610.
	24"	23 <sup>5</sup> / <sub>8</sub> "	14 <sup>3</sup> / <sub>16</sub> "	<sup>7</sup> / <sub>16</sub> "	<b>DP3PSB( )1424</b>	125.	140.	145.	549.	633.	656.
	30"	29 <sup>5</sup> / <sub>8</sub> "	14 <sup>3</sup> / <sub>16</sub> "	<sup>7</sup> / <sub>16</sub> "	<b>DP3PSB( )1430</b>	126.	145.	152.	572.	664.	687.
	36"	35 <sup>5</sup> / <sub>8</sub> "	14 <sup>3</sup> / <sub>16</sub> "	<sup>7</sup> / <sub>16</sub> "	<b>DP3PSB( )1436</b>	138.	159.	167.	610.	701.	730.
	42"	41 <sup>5</sup> / <sub>8</sub> "	14 <sup>3</sup> / <sub>16</sub> "	<sup>7</sup> / <sub>16</sub> "	<b>DP3PSB( )1442</b>	144.	165.	179.	641.	730.	801.
	48"	47 <sup>5</sup> / <sub>8</sub> "	14 <sup>3</sup> / <sub>16</sub> "	<sup>7</sup> / <sub>16</sub> "	<b>DP3PSB( )1448</b>	152.	181.	192.	687.	823.	862.
 <p>D3 21" High Perforated Steel Insert</p>	15"	14 <sup>5</sup> / <sub>8</sub> "	21 <sup>3</sup> / <sub>16</sub> "	<sup>7</sup> / <sub>16</sub> "	<b>DP3PSB( )2115</b>	149.	176.	193.	770.	906.	985.
	18"	17 <sup>5</sup> / <sub>8</sub> "	21 <sup>3</sup> / <sub>16</sub> "	<sup>7</sup> / <sub>16</sub> "	<b>DP3PSB( )2118</b>	149.	176.	193.	770.	906.	985.
	24"	23 <sup>5</sup> / <sub>8</sub> "	21 <sup>3</sup> / <sub>16</sub> "	<sup>7</sup> / <sub>16</sub> "	<b>DP3PSB( )2124</b>	183.	210.	230.	962.	1,099.	1,204.
	30"	29 <sup>5</sup> / <sub>8</sub> "	21 <sup>3</sup> / <sub>16</sub> "	<sup>7</sup> / <sub>16</sub> "	<b>DP3PSB( )2130</b>	198.	228.	246.	1,028.	1,204.	1,298.
	36"	35 <sup>5</sup> / <sub>8</sub> "	21 <sup>3</sup> / <sub>16</sub> "	<sup>7</sup> / <sub>16</sub> "	<b>DP3PSB( )2136</b>	220.	248.	277.	1,143.	1,298.	1,442.
	42"	41 <sup>5</sup> / <sub>8</sub> "	21 <sup>3</sup> / <sub>16</sub> "	<sup>7</sup> / <sub>16</sub> "	<b>DP3PSB( )2142</b>	227.	250.	278.	1,191.	1,319.	1,465.
	48"	47 <sup>5</sup> / <sub>8</sub> "	21 <sup>3</sup> / <sub>16</sub> "	<sup>7</sup> / <sub>16</sub> "	<b>DP3PSB( )2148</b>	232.	265.	289.	1,236.	1,411.	1,534.

Panels, Build-To-Spec

**Ordering Information**

**Perforated Steel Insert**

1. Pattern number
2. Paint finish

**Order Code**

**Perforated Steel Insert**

Example: **DP3PBS21430 117**  
**DP3**      Pattern number  
**PSB21430**  
**117**      Soft Grey paint

**Included with:**

**Perforated Steel Insert**

**Options**

**Perforated Steel Insert**

Insert pack quantity into parenthesis in pattern number

**Tile to Floor Option:**

Tile to Floor available in heights of 14", Worksurface Height, 24" and 28". To specify tile to floor, add an 'F' suffix to the pattern number and add \$16 for a single pack, \$31 for a double pack and \$95 for a 6 pack to the list price.

Tile to Floor Option not available on DP2 perforated steel tile insert.

14", Worksurface Height and 28" High Perforated Steel Insert

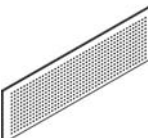
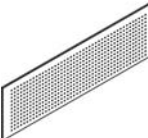
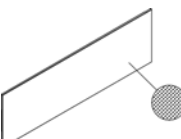
description	w*	w	h	d	pattern no.	1 pack P1	1 pack P2	1 pack P3	2 pack P1	2 pack P2	2 pack P3
 <p>D3 Worksurface Height Perforated Steel Insert</p>	15"	14 5/8"	22 1/2"	7/16"	DP3PSB( )WH15	\$149.	\$176.	\$193.	\$256.	\$302.	\$328.
	18"	17 5/8"	22 1/2"	7/16"	DP3PSB( )WH18	149.	176.	193.	256.	302.	328.
	24"	23 5/8"	22 1/2"	7/16"	DP3PSB( )WH24	183.	210.	230.	321.	368.	402.
	30"	29 5/8"	22 1/2"	7/16"	DP3PSB( )WH30	198.	228.	246.	344.	402.	433.
	36"	35 5/8"	22 1/2"	7/16"	DP3PSB( )WH36	220.	248.	277.	381.	433.	480.
	42"	41 5/8"	22 1/2"	7/16"	DP3PSB( )WH42	227.	250.	278.	397.	440.	488.
	48"	47 5/8"	22 1/2"	7/16"	DP3PSB( )WH48	232.	265.	289.	413.	470.	512.
 <p>D3 28" High Perforated Steel Insert</p>	15"	14 5/8"	29"	7/16"	DP3PSB( )2815	161.	161.	192.	279.	306.	328.
	18"	17 5/8"	29"	7/16"	DP3PSB( )2818	161.	161.	192.	279.	306.	328.
	24"	24 5/8"	29"	7/16"	DP3PSB( )2824	185.	185.	230.	325.	372.	406.
	30"	29 5/8"	29"	7/16"	DP3PSB( )2830	199.	228.	248.	350.	406.	440.
	36"	35 5/8"	29"	7/16"	DP3PSB( )2836	220.	248.	277.	386.	440.	488.
	42"	41 5/8"	29"	7/16"	DP3PSB( )2842	227.	251.	277.	402.	442.	493.
	48"	47 5/8"	29"	7/16"	DP3PSB( )2848	232.	265.	290.	417.	472.	516.
 <p>D2 14" High Perforated Steel Insert</p>	18"	17 5/8"	14 3/16"	7/16"	DP2PS( )1418	102.	114.	119.	193.	208.	217.
	24"	23 5/8"	14 3/16"	7/16"	DP2PS( )1424	136.	147.	157.	254.	283.	295.
	30"	29 5/8"	14 3/16"	7/16"	DP2PS( )1430	138.	151.	159.	260.	285.	298.
	36"	35 5/8"	14 3/16"	7/16"	DP2PS( )1436	140.	153.	163.	263.	289.	300.
	42"	41 5/8"	14 3/16"	7/16"	DP2PS( )1442	140.	156.	163.	266.	294.	307.
	48"	47 5/8"	14 3/16"	7/16"	DP2PS( )1448	144.	159.	166.	271.	298.	312.

Ordering Information

Perforated Steel Insert

1. Pattern number
2. Paint finish

Order Code

Perforated Steel Insert

Example: **DP3PSB21430 117**

**DP3** Pattern number

**PSB21430**

**117** Soft Grey paint

Included with:

Perforated Steel Insert

Options

Perforated Steel Insert

Insert pack quantity into parenthesis in pattern number

**Tile to Floor Option:**

Tile to Floor available in heights of 14", Worksurface Height, 24" and 28". To specify tile to floor, add an 'F' suffix to the pattern number and add \$16 for a single pack, \$31 for a double pack and \$95 for a 6 pack to the list price.

Tile to Floor Option not available on DP2 perforated steel tile insert.

7", 10", 14" and 21" High Embossed Steel Insert

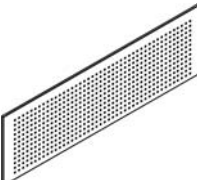
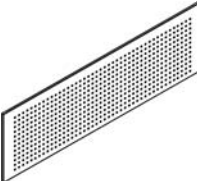
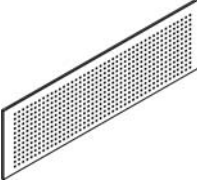
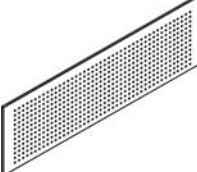
description	w*	w	h	d	pattern no.	1 pack P1	1 pack P2	1 pack P3	6 pack P1	6 pack P2	6 pack P3
 <p>D3 7" High Embossed Steel Insert</p>	15"	14 5/8"	7 3/16"	7/16"	<b>DP3ESB( )715</b>	\$83.	\$95.	\$116.	\$368.	\$426.	\$503.
	18"	17 5/8"	7 3/16"	7/16"	<b>DP3ESB( )718</b>	83.	95.	116.	368.	426.	503.
	24"	23 5/8"	7 3/16"	7/16"	<b>DP3ESB( )724</b>	89.	109.	119.	388.	480.	526.
	30"	30 5/8"	7 3/16"	7/16"	<b>DP3ESB( )730</b>	97.	122.	129.	436.	543.	587.
	36"	35 5/8"	7 3/16"	7/16"	<b>DP3ESB( )736</b>	118.	136.	145.	503.	587.	633.
	42"	41 5/8"	7 3/16"	7/16"	<b>DP3ESB( )742</b>	125.	141.	155.	543.	617.	678.
	48"	47 5/8"	7 3/16"	7/16"	<b>DP3ESB( )748</b>	128.	147.	159.	572.	656.	708.
 <p>D3 10" High Embossed Steel Insert</p>	15"	14 5/8"	10 3/16"	7/16"	<b>DP3ESB( )1015</b>	118.	132.	138.	518.	587.	610.
	18"	17 5/8"	10 3/16"	7/16"	<b>DP3ESB( )1018</b>	118.	132.	138.	518.	587.	610.
	24"	23 5/8"	10 3/16"	7/16"	<b>DP3ESB( )1024</b>	125.	140.	145.	549.	633.	656.
	30"	29 5/8"	10 3/16"	7/16"	<b>DP3ESB( )1030</b>	126.	145.	152.	572.	664.	687.
	36"	35 5/8"	10 3/16"	7/16"	<b>DP3ESB( )1036</b>	138.	159.	167.	610.	701.	730.
	42"	41 5/8"	10 3/16"	7/16"	<b>DP3ESB( )1042</b>	144.	165.	179.	641.	730.	801.
	48"	47 5/8"	10 3/16"	7/16"	<b>DP3ESB( )1048</b>	152.	181.	192.	687.	823.	862.
 <p>D3 14" High Embossed Steel Insert</p>	15"	14 5/8"	14 3/16"	7/16"	<b>DP3ESB( )1415</b>	118.	132.	138.	518.	587.	610.
	18"	17 5/8"	14 3/16"	7/16"	<b>DP3ESB( )1418</b>	118.	132.	138.	518.	587.	610.
	24"	23 5/8"	14 3/16"	7/16"	<b>DP3ESB( )1424</b>	125.	140.	145.	549.	633.	656.
	30"	29 5/8"	14 3/16"	7/16"	<b>DP3ESB( )1430</b>	126.	145.	152.	572.	664.	687.
	36"	35 5/8"	14 3/16"	7/16"	<b>DP3ESB( )1436</b>	138.	159.	167.	610.	701.	730.
	42"	41 5/8"	14 3/16"	7/16"	<b>DP3ESB( )1442</b>	144.	165.	179.	641.	730.	801.
	48"	47 5/8"	14 3/16"	7/16"	<b>DP3ESB( )1448</b>	152.	181.	192.	687.	823.	862.
 <p>D3 21" Embossed Steel Insert</p>	15"	14 5/8"	21"	7/16"	<b>DP3ESB( )2115</b>	149.	176.	193.	770.	906.	985.
	18"	17 5/8"	21"	7/16"	<b>DP3ESB( )2118</b>	149.	176.	193.	770.	906.	985.
	24"	23 5/8"	21"	7/16"	<b>DP3ESB( )2124</b>	183.	210.	230.	962.	1,099.	1,204.
	30"	29 5/8"	21"	7/16"	<b>DP3ESB( )2130</b>	198.	228.	246.	1,028.	1,204.	1,298.
	36"	35 5/8"	21"	7/16"	<b>DP3ESB( )2136</b>	220.	248.	277.	1,143.	1,298.	1,442.
	42"	41 5/8"	21"	7/16"	<b>DP3ESB( )2142</b>	227.	250.	278.	1,191.	1,319.	1,465.
	48"	47 5/8"	21"	7/16"	<b>DP3ESB( )2148</b>	232.	265.	289.	1,236.	1,411.	1,534.

Panels, Build-To-Spec

**Ordering Information**

**Embossed Steel Insert**

1. Pattern number
2. Paint finish

**Order Code**

**Embossed Steel Insert**

Example: **DP3ESB21430 117**

**DP3** Pattern number

**ESB21430**

**117** Soft Grey paint

**Included with:**

**Embossed Steel Insert**

**Options**

**Embossed Steel Insert**

Insert pack quantity into parenthesis in pattern number

**Tile to Floor Option:**

Tile to Floor available in heights of 14", Worksurface Height, 24" and 28". To specify tile to floor, add an 'F' suffix to the pattern number and add \$16 for a single pack, \$31 for a double pack and \$95 for a 6 pack to the list price.

*Worksurface Height and 28" High Embossed Steel Insert*

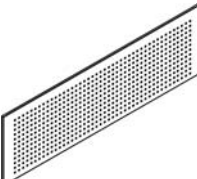
description	w*	w	h	d	pattern no.	1 pack P1	1 pack P2	1 pack P3	2 pack P1	2 pack P2	2 pack P3
 D3 Worksurface Height Embossed Steel Insert	15"	14 5/8"	22 1/2"	7/16"	<b>DP3ESB( )WH15</b>	\$149.	\$176.	\$193.	\$256.	\$302.	\$328.
	18"	17 5/8"	22 1/2"	7/16"	<b>DP3ESB( )WH18</b>	149.	176.	193.	256.	302.	328.
	24"	23 5/8"	22 1/2"	7/16"	<b>DP3ESB( )WH24</b>	183.	210.	230.	321.	368.	402.
	30"	39 5/8"	22 1/2"	7/16"	<b>DP3ESB( )WH30</b>	198.	228.	246.	344.	402.	433.
	36"	35 5/8"	22 1/2"	7/16"	<b>DP3ESB( )WH36</b>	220.	248.	277.	381.	433.	480.
	42"	41 5/8"	22 1/2"	7/16"	<b>DP3ESB( )WH42</b>	227.	250.	278.	397.	440.	488.
	48"	47 5/8"	22 1/2"	7/16"	<b>DP3ESB( )WH48</b>	232.	265.	289.	413.	470.	512.

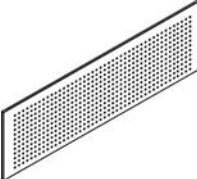
description	w*	w	h	d	pattern no.	1 pack P1	1 pack P2	1 pack P3	2 pack P1	2 pack P2	2 pack P3
 D3 28" High Embossed Steel Insert	15"	14 5/8"	29"	7/16"	<b>DP3ESB( )2815</b>	161.	161.	192.	279.	306.	328.
	18"	17 5/8"	29"	7/16"	<b>DP3ESB( )2818</b>	161.	161.	192.	279.	306.	328.
	24"	23 5/8"	29"	7/16"	<b>DP3ESB( )2824</b>	185.	185.	230.	325.	372.	406.
	30"	29 5/8"	29"	7/16"	<b>DP3ESB( )2830</b>	199.	228.	248.	350.	406.	440.
	36"	35 5/8"	29"	7/16"	<b>DP3ESB( )2836</b>	220.	248.	277.	386.	440.	488.
	42"	41 5/8"	29"	7/16"	<b>DP3ESB( )2842</b>	227.	251.	277.	402.	442.	493.
	48"	47 5/8"	29"	7/16"	<b>DP3ESB( )2848</b>	232.	265.	290.	417.	472.	516.

**Ordering Information**

**Embossed Steel Insert**

1. Pattern number
2. Paint finish

**Order Code**

**Embossed Steel Insert**

Example: **DP3ESB22130 117**

**DP3** Pattern number

**ESB22130**

**117** Soft Grey paint

**Included with:**

**Embossed Steel Insert**

**Options**

**Embossed Steel Insert**

Insert pack quantity into parenthesis in pattern number

**Tile to Floor Option:**

Tile to Floor available in heights of 14", Worksurface Height, 24" and 28". To specify tile to floor, add an 'F' suffix to the pattern number and add \$16 for a single pack, \$31 for a double pack and \$95 for a 6 pack to the list price.

**This page intentionally left blank**

## Slatwall Tiles

Slatwall tiles are designed to support KnollExtra Orchestra work tools. Slatwall tiles will support flat panel monitor arms with varying weight limitations based on mounting and application. Please refer to the KnollExtra price list for comprehensive mounting and weight limitation information by application. Slatwall kits include all mounting brackets and hardware for installation, and are fully assembled. SLATWALL TILES INCLUDE INTEGRAL TILE SUPPORT(S).

Slatwall tiles are field installed on Dividends Horizon DP7 panel frames. To specify, select the slatwall width to match the width of the panel frame, in either top or middle position locations.

Specify slatwall tiles along with built-to-spec panel frames and other tiles for a complete panel. Slatwall tiles may not be specified directly above or below other slatwall tiles, beltway, stack frames, or stacking screens. Slatwall tiles may not be specified on stack frames

## Construction

Slatwall is constructed of heat treated extruded aluminum, powder coated in any Knoll Core paint color. 16 gauge steel reinforcements with integral hooks and tri-lobular screws on the back of slatwall provide reinforcement for heavy loads.

**Note:** Due to design improvements with the slatwall tile, monitor arm reinforcements are no longer required when hanging monitor arms from Dividends Horizon slatwall.

## Top Position Slatwall Tiles

Top position slatwall tiles may be installed at the top of any Dividends Horizon DP7 panel frame, and include all required hardware. Top position slatwall is available in heights of 7, 14, 21 and 28 inches.

TOP POSITION SLATWALL TILES FEATURE AN INTEGRAL TILE SUPPORT AT THE BOTTOM, REPLACING THE SEPARATE D1 OR D2 TILE SUPPORT TYPICALLY REQUIRED BETWEEN TILES.

## Middle Position Slatwall Tiles

Middle position slatwall tiles may be installed at the middle of any Dividends Horizon DP7 panel frame, and include all necessary hardware. Middle position slatwall is available in heights of 7, 14 and 21 inches.

MIDDLE POSITION SLATWALL TILES FEATURE AN INTEGRAL TILE SUPPORT AT THE TOP AND BOTTOM, REPLACING D1 OR D2 TILE SUPPORT TYPICALLY REQUIRED BETWEEN TILES.

Top Position Slatwall

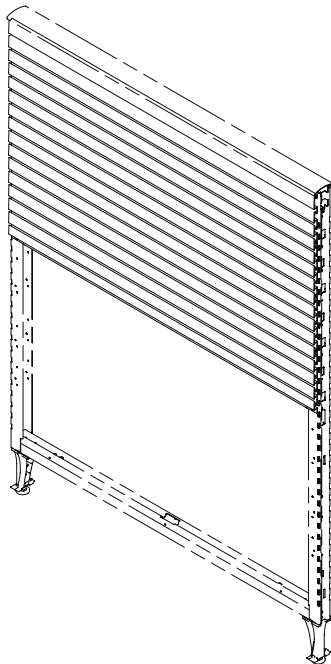

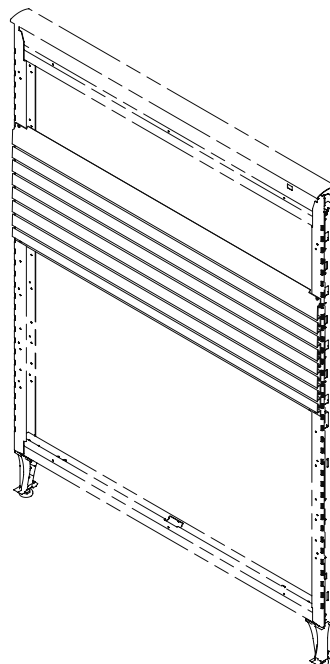

Middle Position Slatwall



# Slatwall Tiles

## 7", 14", 21" and 28" High

Dividends Horizon

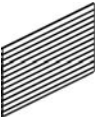
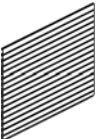
description	w	h	d	pattern no.	P1	P2	P3
7" High Slatwall Tile 	24"	7"	7/16"	<b>DP1SW0724()</b>	\$206.	\$226.	\$236.
	30"	7"	7/16"	<b>DP1SW0730()</b>	219.	243.	252.
	36"	7"	7/16"	<b>DP1SW0736()</b>	236.	259.	269.
	42"	7"	7/16"	<b>DP1SW0742()</b>	249.	273.	285.
	48"	7"	7/16"	<b>DP1SW0748()</b>	263.	289.	301.
14" High Slatwall Tile 	24"	14"	7/16"	<b>DP1SW1424()</b>	276.	304.	333.
	30"	14"	7/16"	<b>DP1SW1430()</b>	325.	357.	388.
	36"	14"	7/16"	<b>DP1SW1436()</b>	373.	410.	448.
	42"	14"	7/16"	<b>DP1SW1442()</b>	407.	448.	486.
	48"	14"	7/16"	<b>DP1SW1448()</b>	441.	484.	531.
21" High Slatwall Tile 	24"	21"	7/16"	<b>DP1SW2124()</b>	366.	402.	439.
	30"	21"	7/16"	<b>DP1SW2130()</b>	440.	482.	526.
	36"	21"	7/16"	<b>DP1SW2136()</b>	513.	565.	616.
	42"	21"	7/16"	<b>DP1SW2142()</b>	567.	623.	680.
	48"	21"	7/16"	<b>DP1SW2148()</b>	618.	681.	744.
28" Top Position Slatwall Tile 	24"	28"	7/16"	<b>DP1SW2824()</b>	454.	501.	546.
	30"	28"	7/16"	<b>DP1SW2830()</b>	553.	608.	663.
	36"	28"	7/16"	<b>DP1SW2836()</b>	652.	716.	782.
	42"	28"	7/16"	<b>DP1SW2842()</b>	723.	794.	866.
	48"	28"	7/16"	<b>DP1SW2848()</b>	793.	873.	952.

Panels, Build-To-Spec

### Ordering Information

#### Post Assemblies

1. Pattern Number
2. Paint Finish

### Order Code

#### Post Assemblies

*Example:* **DP1 S2824T, 111**  
**DP1 S2824**Pattern Number  
**T**  
**111** Jet Black Paint

### Included with:

**Note:** Middle position slatwall tiles are able to be used on topway or full view panels.

### Options

#### Panel Options:

**(T)** = for topway panel top position  
**(F)** = for full view panel top position  
**(M)** = for middle position

## Technology Tile

Dividends Horizon technology tiles are 14", worksurface height or 28" high fabric or painted steel tiles with a factory installed technology port for above worksurface power and/or data access. Technology ports may be specified on the left, right, or both sides of technology tiles.

Each technology port has two openings: duplex power receptacles are positioned to the outside of the panel, while data ports may be positioned in either of the two positions. For applications where only one of the two openings is used, a knockout filler is included with each data port to fill this opening.

Technology tiles with one port accommodate one power and one data or two data outlets. Technology tiles with two ports accommodate up to two power receptacles and two data outlets, or four data outlets.

Specify vertical power modules, power receptacles, and data components separately.

## Construction

Steel inserts are made of 20-gauge formed painted steel. Fabric inserts are made with a roll-coat adhesive, heat-cured to  $\frac{7}{16}$ " thick tackable acoustical board.

## Available Sizes

Heights: 14", worksurface height, 28"  
Widths: 18", 24", 30", 42", 48" and 60"

**Note:** Steel technology tiles are only available in Knoll Core finishes

**Note:** Technology tiles are not able to be specified in the top position of 36" high topway panel.

14" High Technology Tile

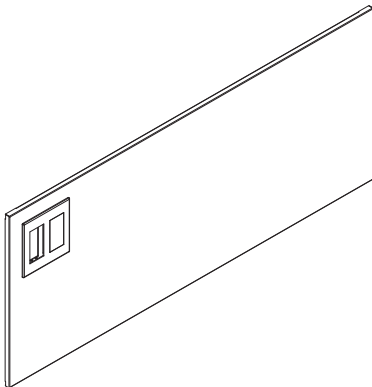

Worksurface Height Technology Tile

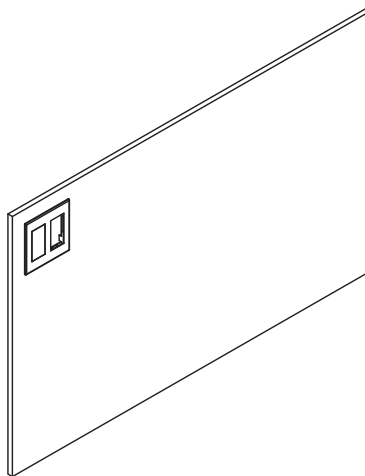

28" High Technology Tile

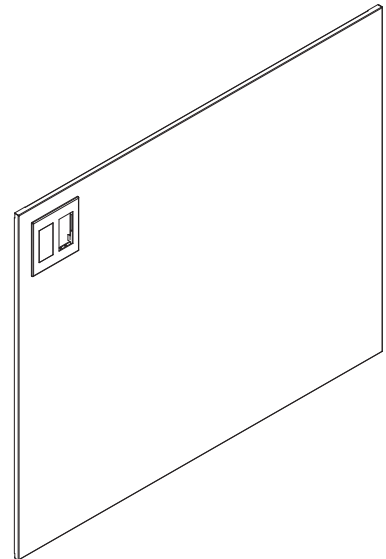

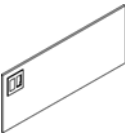
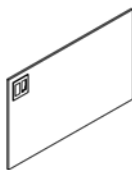
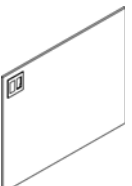

description	h	w	pattern no.	grade							
				10	15	20	25	30	35	40	45
14" High, Technology Tile Fabric 	14"	18"	<b>DP6TF( )1418</b>	\$153.	\$157.	\$163.	\$164.	\$167.	\$170.	\$171.	\$175.
	14"	24"	<b>DP6TF( )1424</b>	160.	163.	168.	170.	172.	177.	179.	184.
	14"	30"	<b>DP6TF( )1430</b>	163.	165.	171.	175.	178.	181.	184.	188.
	14"	36"	<b>DP6TF( )1436</b>	167.	171.	178.	179.	185.	188.	200.	201.
	14"	42"	<b>DP6TF( )1442</b>	171.	175.	184.	185.	197.	201.	204.	207.
	14"	48"	<b>DP6TF( )1448</b>	178.	179.	193.	200.	204.	205.	208.	214.
	14"	60"	<b>DP6TF( )1460</b>	184.	186.	194.	195.	198.	200.	202.	205.
	Worksurface Height, Technology Tile Fabric 	22 1/2"	18"	<b>DP6TF( )WH18</b>	201.	207.	211.	218.	221.	227.	235.
22 1/2"		24"	<b>DP6TF( )WH24</b>	219.	227.	241.	248.	256.	260.	266.	279.
22 1/2"		30"	<b>DP6TF( )WH30</b>	234.	241.	256.	263.	271.	279.	285.	297.
22 1/2"		36"	<b>DP6TF( )WH36</b>	246.	256.	271.	281.	294.	301.	307.	314.
22 1/2"		42"	<b>DP6TF( )WH42</b>	253.	261.	273.	283.	296.	303.	311.	323.
22 1/2"		48"	<b>DP6TF( )WH48</b>	261.	271.	285.	297.	304.	312.	324.	341.
22 1/2"		60"	<b>DP6TF( )WH60</b>	276.	286.	299.	312.	314.	325.	340.	367.
28" High, Technology Tile Fabric 		28"	18"	<b>DP6TF( )2818</b>	201.	207.	211.	218.	221.	227.	235.
	28"	24"	<b>DP6TF( )2824</b>	219.	227.	241.	248.	256.	260.	266.	279.
	28"	30"	<b>DP6TF( )2830</b>	234.	241.	256.	263.	271.	279.	285.	297.
	28"	36"	<b>DP6TF( )2836</b>	246.	256.	271.	281.	294.	301.	307.	314.
	28"	42"	<b>DP6TF( )2842</b>	253.	261.	273.	283.	296.	303.	311.	323.
	28"	48"	<b>DP6TF( )2848</b>	261.	271.	285.	297.	304.	312.	324.	341.
	28"	60"	<b>DP6TF( )2860</b>	294.	300.	310.	314.	321.	327.	332.	338.

**Ordering Information**
**Technology Tile Fabric:**

1. Pattern Number
2. Fabric
3. Bezel location

**Order Code**
**Technology Tile Fabric**
*Example:* **DP3TFL1418/ W352-4**
**DP3TF** Technology Tile Fabric

**L** Left Hand Bezel Location

**14** Height

**18** Width

**W352-4** Labrynth Sage Fabric

**Included with:**
**Technology Tile Fabric**

- Fabric Technology Tile
- Bezel

**Options**
**Technology Tile Fabric**
**Bezel Location Options:**

- (L)** = Left Hand Bezel
- (R)** = Right Hand Bezel
- (D)** = Double Bezel - add \$43

**Tile to Floor Options:**

Tile to Floor available in heights of 14", Worksurface Height, and 28". To specify tile to floor, add an "F" suffix to the pattern number and add \$10 to the list price.

# Technology Tiles Steel

Dividends Horizon

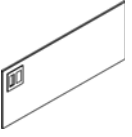
description	h	w	pattern no.	P1	P2	P3
 14" High, Technology Tile Steel	14"	18"	<b>DP6TS( )1418</b>	\$134.	\$142.	\$145.
	14"	24"	<b>DP6TS( )1424</b>	140.	147.	152.
	14"	30"	<b>DP6TS( )1430</b>	141.	149.	153.
	14"	36"	<b>DP6TS( )1436</b>	149.	158.	164.
	14"	42"	<b>DP6TS( )1442</b>	152.	163.	167.
	14"	48"	<b>DP6TS( )1448</b>	158.	169.	173.
	14"	60"	<b>DP6TS( )1460</b>	168.	178.	182.

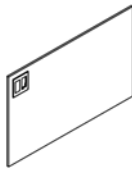
description	h	w	pattern no.	P1	P2	P3
 Worksurface Height, Technology Tile Steel	22 1/2"	18"	<b>DP6TS( )WH18</b>	164.	173.	178.
	22 1/2"	24"	<b>DP6TS( )WH24</b>	179.	194.	199.
	22 1/2"	30"	<b>DP6TS( )WH30</b>	188.	201.	207.
	22 1/2"	36"	<b>DP6TS( )WH36</b>	203.	218.	225.
	22 1/2"	42"	<b>DP6TS( )WH42</b>	207.	222.	230.
	22 1/2"	48"	<b>DP6TS( )WH48</b>	211.	226.	234.
	22 1/2"	60"	<b>DP6TS( )WH60</b>	211.	226.	234.

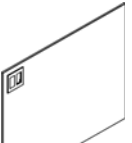
description	h	w	pattern no.	P1	P2	P3
 28" High, Technology Tile Steel	28"	18"	<b>DP6TS( )2818</b>	164.	173.	178.
	28"	24"	<b>DP6TS( )2824</b>	179.	194.	199.
	28"	30"	<b>DP6TS( )2830</b>	188.	201.	207.
	28"	36"	<b>DP6TS( )2836</b>	203.	218.	225.
	28"	42"	<b>DP6TS( )2842</b>	207.	222.	230.
	28"	48"	<b>DP6TS( )2848</b>	211.	226.	234.

## Ordering Information

### Technology Tile Steel

1. Pattern Number
2. Paint
3. Bezel location

## Order Code

### Technology Tile Steel

*Example:* **DP3TSL1418/ 113**

**DPSTS** Technology Tile Steel

**L** Left Hand Bezel Location

**14** Height

**18** Width

**113** Dark Grey Paint Finish

## Included with:

### Technology Tile Steel

- Steel Technology Tile
- Bezel

**Note:** Steel technology tiles are only available in Knoll core finishes.

## Options

### Technology Tile Steel

#### Bezel Location Options:

- (L)** = Left Hand Bezel
- (R)** = Right Hand Bezel
- (D)** = Double Bezel - add \$43

#### Tile to Floor Options:

Tile to Floor available in heights of 14", Worksurface Height, and 28". To specify tile to floor, add an "F" suffix to the pattern number and add \$16 to the list price.

**This page intentionally left blank**

Dividends Horizon rolling doors were developed for clients desiring increased privacy for focused work.

Rolling doors are available in 57, 64 and 78" overall heights, and widths to accommodate panel openings of 36 and 42 inches.

### Planning

Rolling doors must be mounted to the end of an equal height Dividends Horizon panel or run of panels of equal or greater width. Doors may not be mounted to Dividends Horizon screens or universal posts.

Door jamb may be mounted directly to DP7 series universal posts – specify jamb to post attachment kit separately.

When fully open, the door will extend 2" beyond the end of the panel end trim on a panel of corresponding width.

Thresholds are included with door pattern number, and are required in all installations. The Dividends Horizon rolling door meets ADA 5 lb pull test requirements when used with the supplied threshold.

### Specifying 57" and 64" Rolling Doors

57" and 64" rolling doors include:

- Rolling door
- Mounting brackets
- Door jamb (for door side opposite to mounting brackets)
- Threshold

To complete the specification, specify an end trim for the panel to which the door is mounted, and a jamb-compatible top cap for the panel to which the door jamb is attached.

### Specifying 78" Rolling Doors

78" rolling doors include:

- Rolling door
- Header
- Mounting brackets,
- Door jamb (for door side opposite to mounting brackets)
- Panel end trim
- Threshold

78" high doors include a header, with vertical clearance of 76 1/2" from height of finished floor. Specify a top cap for the header separately. Extended length top caps are recommended in this application.

No additional end trim is required for 78" high doors, as it is included in the door pattern number.

### Construction

Rolling door and door jamb are constructed of extruded aluminum, powder coated in any Knoll Core paint finish. Threshold is anodized extruded aluminum.

Door inserts are available in clear, powder or bronze frosted glass.

Locks are optional, and engage with door jamb. Standard KnollKey system keying guidelines apply.

# Rolling Door

## 57", 64" and 78" High

Dividends Horizon

description	type	w	d	h	pattern no.	Temp	GL13 GL25	Plastic	Metal P1	Metal P2	Metal P3	
 <p>right hand shown</p>	57" High with lock	36"	3"	57"	<b>DPRD15736(L/R)L</b>	\$2,454.	\$2,528.					
		42"	3"	57"	<b>DPRD15742(L/R)L</b>	2,666.	2,739.					
	57" High no lock	36"	3"	57"	<b>DPRD15736(L/R)N</b>	2,377.	2,450.					
		42"	3"	57"	<b>DPRD15742(L/R)N</b>	2,588.	2,662.					
	64" High with lock	36"	3"	64"	<b>DPRD16436(L/R)L</b>	2,554.	2,645.					
		42"	3"	64"	<b>DPRD16442(L/R)L</b>	2,766.	2,856.					
	64" High no lock	36"	3"	64"	<b>DPRD16436(L/R)N</b>	2,477.	2,568.					
		42"	3"	64"	<b>DPRD16442(L/R)N</b>	2,688.	2,779.					
	78" High with lock	36"	3"	78"	<b>DPRD17836(L/R)L</b>	2,969.	3,093.					
		42"	3"	78"	<b>DPRD17842(L/R)L</b>	3,181.	3,304.					
	78" High no lock	36"	3"	78"	<b>DPRD17836(L/R)N</b>	2,892.	3,016.					
		42"	3"	78"	<b>DPRD17842(L/R)N</b>	3,103.	3,227.					
Panel Top Caps for Jamb Side	18"			<b>DP( )PT18RD</b>				34.	61.	63.	65.	
	24"			<b>DP( )PT24RD</b>				36.	61.	63.	65.	
	30"			<b>DP( )PT30RD</b>				40.	61.	63.	65.	
	36"			<b>DP( )PT36RD</b>				42.	61.	63.	65.	
	42"			<b>DP( )PT42RD</b>				42.	61.	63.	65.	
	48"			<b>DP( )PT48RD</b>				43.	61.	63.	65.	
	54"			<b>DP( )PT54RD</b>				n/a	65.	67.	69.	
	60"			<b>DP( )PT60RD</b>				47.	68.	70.	72.	
	66"			<b>DP( )PT66RD</b>				n/a	72.	75.	78.	
	72"			<b>DP( )PT72RD</b>				n/a	77.	81.	85.	
	78"			<b>DP( )PT78RD</b>				n/a	84.	88.	91.	
Door Jamb Kit to mount to DP7 Post	84"			<b>DP( )PT84RD</b>				n/a	90.	93.	97.	
	90"			<b>DP( )PT90RD</b>				n/a	96.	100.	103.	
	96"			<b>DP( )PT96RD</b>				n/a	101.	106.	110.	
				<b>DPRD1JPM</b>					21.	0.	0.	0.

### Ordering Information

#### Rolling Door

1. Pattern Number
2. Glass type

#### Top Cap

1. Pattern Number
2. Paint finish

### Order Code

#### Rolling Door

*Example:* **DPRD1 5736 RL**

**DPRD1** Rolling Door

**57** Height

**36** Width

**R** Right

**L** Lock

**118T** Bright White Textured

**GL13** Frosted Glass

### Included With:

#### Rolling Door

##### 57" and 64" High

- Rolling Door
- Mounting Brackets
- Door jamb
- Threshold

##### 78" High

- Rolling Door
- Header
- Mounting Brackets
- Door jamb
- Panel end trim
- Threshold

#### Top Cap

- Top Cap
- End Plug

### Options

#### Rolling Door

##### Mounting Options:

- L** = Left Hand
- R** = Right Hand

##### Paint Finish:

All Core paint finishes

##### Glass Type:

- Temp** = Clear Glass
- GL13** = Frosted Glass
- GL25** = Bronze Glass

#### Top Cap

##### Top Cap Options:

- (2)** = Extruded Plastic (Smooth Radius)
- (4)** = Radius Metal
- (5)** = Flat Metal

## Open Weave Screens

Open Weave screens are designed to allow light and transparency into the workstation, while providing limited visual privacy.

When combined with Dividends Horizon freestanding components, open weave screen provide a layered aesthetic to the office.

## Open Weave Screen Construction

Open weave screens feature Warp Net, a new open textile structure designed by Suzanne Tick. Warp net is constructed of 100% Earthtex, made from Olefin. Earthtex has passed the prestigious McDonough Braungart Design Chemistry Sustainability Protocol, and is fully recyclable.

Open weave screens have a triangular profile frame, made from extruded aluminum frame members, powder coated in any Knoll Core paint finish.

## Open Weave Screen Dimensions:

Widths: 24, 30, 36, 42, and 48 inches  
Heights: 36, 42, 50, 57, and 64 inches  
Thickness: 3 inches

## Glass Screens

Glass Screens, available in both triangular and rectangular profile frames, provide territorial privacy, while transmitting light into the office.

## Glass Screen Construction

Glass screens are available in both triangular and rectangular frame profiles, made from extruded aluminum frame members, powder coated in any Knoll Core paint finish. Glass is 4mm thick tempered glass.

## Glass Screen Dimensions

Widths: 24, 30, 36, 42 and 48 inches  
Heights: 42, 50, 57 and 64 inches  
Thickness: 3 inches

## Planning With Screens

Dividends Horizon open weave and glass screens are primarily designed to divide space and let light into the office. Screens do not have a slotted standard, and do not support overhead storage components. Screens feature slots to allow use of a mid-span worksurface support at the standard 28 1/2" H worksurface height.

Screens attach to Dividends Horizon panels or connecting posts of the same or greater height, or other screens of the same height. In a "high/low" situation, screens do not attach to higher or lower screens, or lower panels. Screens ship with attachment hardware and topcap, if specified.

Open Weave Screen with Triangular Frame and Open Base Option

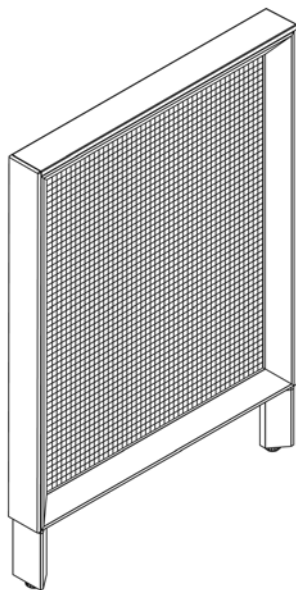

Glass Screen with Rectangular Frame and Open Base Option

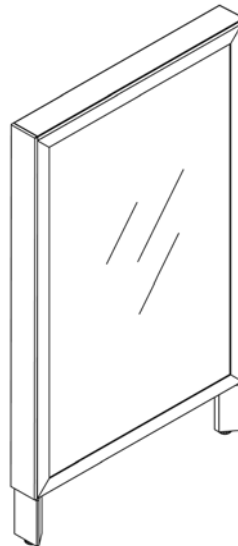

## Screen Base Options

Open weave screens are available with three base options: base raceway, open base, or frame to floor. Triangular frame glass screens are available with three base options: base raceway, open base, or frame to floor. Rectangular frame glass screens are available with two base options: base raceway or open base. All bases feature leveling glides with 2" of vertical travel. Raceway covers are standard without knockouts. Screens support electrical pass-thru's, but do not support power modules or electrical receptacles.

**Note:** 36"H screen may not be connected to a Legacy post.

**Note:** 64" open weave screen "L" or "U" configurations require minimum 36" wide panel return(s).

**Note:** Raceway covers are not available with knockouts.

**Note:** Screens are only available in Knoll core finishes.

## Freestanding Open Weave Screen Kits

When used with Open Weave Screens with frame-to-floor (FF) option, new Freestanding Open Weave Screen kits allow open weave screens to be used in freestanding applications, creating a sense of enclosure without the need for conventional panel or screen planning.

Freestanding Open Weave Screen Kits may be used with open weave screens only, and are not compatible with panels or glass screens.

A single open weave screen of any height or width may become freestanding by specifying the appropriately sized freestanding open weave screen kit. Freestanding open weave screen kits for single screen applications include (2) flat steel feet and (1) ballast plate. The width of the screen determines which freestanding open weave screen kit is specified. For example, a 48" wide open weave screen would use DP7SWTFK48.

Two open weave screens of the same height and width may be attached together to create a double freestanding open weave screen. There is a single pattern number (DP7SWTFKD) for the freestanding open weave screen kit that should be specified to create a double freestanding open weave screen. The double freestanding open weave screen kit includes (3) flat steel feet.

**Note:** Freestanding open weave screen kits are finished with textured paint, including 613 silver.

## Freestanding Open Weave Screen Kit Dimensions

### Flat Steel Feet

Width: 4 inches

Thickness: 7/16 inches

Depth: 20 inches

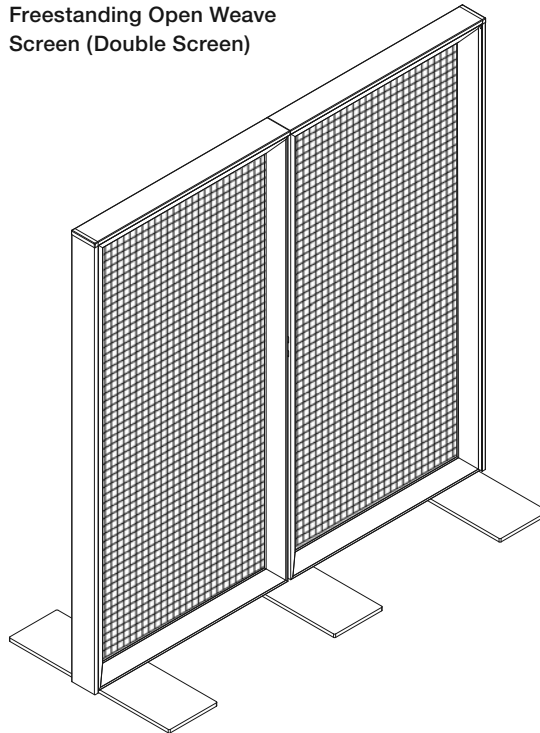

Freestanding Open Weave Screen (Double Screen)



# Open Weave and Glass Screens

Dividends Horizon

## Open Weave Screens 36", 42", 50" and 57" High

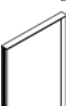
description	h	w	t	pattern no.	P1	P2	P3
 36" High Open Weave Screen	36"	24"	3"	<b>DP7SWT( )3624</b>	\$957.	\$975.	\$995.
	36"	30"	3"	<b>DP7SWT( )3630</b>	1,053.	1,073.	1,095.
	36"	36"	3"	<b>DP7SWT( )3636</b>	1,054.	1,074.	1,096.
	36"	42"	3"	<b>DP7SWT( )3642</b>	1,102.	1,123.	1,146.
	36"	48"	3"	<b>DP7SWT( )3648</b>	1,149.	1,174.	1,197.
 42" High Open Weave Screen	42"	24"	3"	<b>DP7SWT( )4224</b>	1,032.	1,053.	1,073.
	42"	30"	3"	<b>DP7SWT( )4230</b>	1,099.	1,121.	1,143.
	42"	30"	3"	<b>DP7SWT( )4236</b>	1,169.	1,190.	1,214.
	42"	42"	3"	<b>DP7SWT( )4242</b>	1,178.	1,202.	1,226.
	42"	48"	3"	<b>DP7SWT( )4248</b>	1,189.	1,213.	1,236.
 50" High Open Weave Screen	50"	24"	3"	<b>DP7SWT( )5024</b>	1,108.	1,129.	1,152.
	50"	30"	3"	<b>DP7SWT( )5030</b>	1,146.	1,171.	1,194.
	50"	36"	3"	<b>DP7SWT( )5036</b>	1,185.	1,208.	1,232.
	50"	42"	3"	<b>DP7SWT( )5042</b>	1,256.	1,279.	1,305.
	50"	48"	3"	<b>DP7SWT( )5048</b>	1,324.	1,350.	1,377.
 57" High Open Weave Screen	57"	24"	3"	<b>DP7SWT( )5724</b>	1,129.	1,152.	1,175.
	57"	30"	3"	<b>DP7SWT( )5730</b>	1,201.	1,226.	1,248.
	57"	36"	3"	<b>DP7SWT( )5736</b>	1,272.	1,298.	1,323.
	57"	42"	3"	<b>DP7SWT( )5742</b>	1,298.	1,324.	1,349.
	57"	48"	3"	<b>DP7SWT( )5748</b>	1,324.	1,350.	1,377.

\*Note: Frame to the floor shown

Ordering Information	Order Code	Included with:	Options
<b>Open Weave Screen:</b> 1. Pattern number 2. Frame finish 3. Top cap style 4. Top cap finish 5. Base finish 6. Fabric finish	<b>Open Weave Screen:</b> <i>Example:</i> <b>DP7SWTFF3636</b> <b>117/4/117/117/W1113-1</b> <b>DP7SWT</b> Triangular open weave screen <b>FF</b> Screen to Floor <b>117</b> Frame finish <b>4</b> Radius metal top cap <b>117</b> Top cap finish <b>117</b> Raceway finish <b>W1113-1</b> Warp Net White	<b>Open Weave Screen</b> <b>Note:</b> 36" screens are not compatible with Legacy post connectors. <b>Note:</b> Screens are only available in Knoll core finishes.	<b>Open Weave Screen</b> <b>Top Cap Options:</b> <b>(2)</b> = Extruded Plastic (Smooth Radius) <b>(3)</b> = No Top Cap <b>(4)</b> = Radius Metal, add \$38 P1, \$40 P2, \$42 P3 <b>(5)</b> = Flat Metal, add \$38 P1, \$40 P2, \$42 P3 paint grade <b>Raceway Type:</b> <b>(FF)</b> = Frame to the Floor both sides <b>(RR)</b> = Raceway covers no knockouts <b>(LL)</b> = Open base Note: Raceway covers are not available with knockouts.



Open Weave Screens

64" High and Freestanding Open Weave Screen Kits

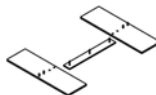
description	type	h	w	d	pattern no.	P1	P2	P3
 <p>64" High Open Weave Screen</p>		64"	24"	3"	<b>DP7SWT( )6424</b>	\$1,149.	\$1,174.	\$1,197.
		64"	30"	3"	<b>DP7SWT( )6430</b>	1,257.	1,280.	1,306.
		64"	36"	3"	<b>DP7SWT( )6436</b>	1,323.	1,349.	1,375.
		64"	42"	3"	<b>DP7SWT( )6442</b>	1,341.	1,367.	1,395.
		64"	48"	3"	<b>DP7SWT( )6448</b>	1,359.	1,387.	1,413.
 <p>Freestanding Open Weave Screen Kit</p> <p>(single screen kit shown)</p>	For use with 2 open weave screens				<b>DP7SWTFKD</b>	446.	490.	509.
	For use with 24" wide open weave screen				<b>DP7SWTFK24</b>	416.	457.	475.
	For use with 30" wide open weave screen				<b>DP7SWTFK30</b>	421.	464.	481.
	For use with 36" wide open weave screen				<b>DP7SWTFK36</b>	432.	475.	494.
	For use with 42" wide open weave screen				<b>DP7SWTFK42</b>	446.	490.	509.
	For use with 48" wide open weave screen				<b>DP7SWTFK48</b>	446.	490.	509.

Panels, Build-To-Spec

**Ordering Information**

**Open Weave Screen:**

1. Pattern number
2. Frame finish
3. Top cap style
4. Top cap finish
5. Base finish
6. Fabric finish

**Freestanding Open Weave Screen Kits**

1. Pattern number
2. Paint finish

**Order Code**

**Open Weave Screen:**

- Example:* **DP7SWTFF3636**  
**117/4/117/117/W1113-1**
- DP7SWT** Triangular open weave screen
- FF** Screen to Floor
- 117** Frame finish
- 4** Radius metal top cap
- 117** Top cap finish
- 117** Raceway finish
- W1113-1** Warp Net White

**Included with:**

**Open Weave Screen**

- Note:** Freestanding open weave screen kits are finished with textured paint, including 613 Silver.
- Note:** Freestanding open weave screen kits only work with open weave screens with frame-to-floor (FF) base option.

**Options:**

**Open Weave Screen**

- Top Cap Options:**
- (2)** = Extruded Plastic (Smooth Radius)
- (3)** = No Top Cap
- (4)** = Radius Metal, add \$38 P1, \$40 P2, \$42 P3
- (5)** = Flat Metal, add \$38 P1, \$40 P2, \$42 P3 paint grade

**Raceway Type:**

- (FF)** = Frame to the Floor both sides
- (RR)** = Raceway covers no knockouts
- (LL)** = Open base

Note: Raceway covers are not available with knockouts.

# Open Weave and Glass Screens

## Triangular Frame Screen with Glass

### 42" and 50" High

description	h	w	t	pattern no.	P1	P2	P3
42" High Triangular Frame Screen with Glass 	42"	24"	3"	<b>DP7S(J)( )4224</b>	\$971.	\$991.	\$1,010.
	42"	30"	3"	<b>DP7S(J)( )4230</b>	1,028.	1,050.	1,069.
	42"	36"	3"	<b>DP7S(J)( )4236</b>	1,088.	1,109.	1,130.
	42"	42"	3"	<b>DP7S(J)( )4242</b>	1,110.	1,133.	1,154.
	42"	48"	3"	<b>DP7S(J)( )4248</b>	1,133.	1,154.	1,177.

50" High Triangular Frame Screen with Glass 	50"	24"	3"	<b>DP7S(J)( )5024</b>	1,044.	1,065.	1,087.
	50"	30"	3"	<b>DP7S(J)( )5030</b>	1,071.	1,093.	1,113.
	50"	36"	3"	<b>DP7S(J)( )5036</b>	1,098.	1,119.	1,141.
	50"	42"	3"	<b>DP7S(J)( )5042</b>	1,190.	1,213.	1,236.
	50"	48"	3"	<b>DP7S(J)( )5048</b>	1,277.	1,304.	1,329.

\*Note: Frame with raceway covers shown

Ordering Information	Order Code	Included with:	Options
<b>Triangular Frame Screen with Glass:</b> 1. Pattern number 2. Frame finish 3. Glass type 4. Top cap style 5. Top cap finish 6. Raceway finish	<b>Triangular Frame with Glass:</b> <i>Example:</i> <b>DP7SGTRR4236</b> <b>117/4/117/117</b> <hr/> <b>DP7SGT</b> Triangular frame with clear glass <hr/> <b>RR</b> Raceway type <hr/> <b>117</b> Frame finish <hr/> <b>4</b> Radius metal top cap <hr/> <b>117</b> Top cap finish <hr/> <b>117</b> Raceway finish	<b>Triangular Frame with Glass</b> <ul style="list-style-type: none"> <li>• Topcap (when specified)</li> <li>• Connecting hardware</li> </ul> <b>Note:</b> Screens are only available in Knoll core finishes.	<b>Glass Options:</b> <b>(G)</b> = Clear Tempered Glass <b>(F)</b> = Powder Glass  <b>Top Cap Options:</b> <b>(2)</b> = Extruded Plastic (Smooth Radius) <b>(3)</b> = No Top Cap <b>(4)</b> = Radius Metal, add \$38 P1, \$40 P2, \$42 P3 <b>(5)</b> = Flat Metal, add \$38 P1, \$40 P2, \$42 P3 paint grades  <b>Raceway Type:</b> <b>(FF)</b> = Frame to the Floor both sides <b>(RR)</b> = Raceway covers no knockouts <b>(LL)</b> = Open base  Frame to floor option not available on Triangular glass screens.  <b>Note:</b> Raceway covers are not available with knockouts.

# Open Weave and Glass Screens

## Triangular Frame Screen with Glass

### 57" and 64" High

description	h	w	t	pattern no.	P1	P2	P3
57" High Triangular Frame Screen with Glass	57"	24"	3"	<b>DP7S( )T( )5724</b>	\$1,071.	\$1,093.	\$1,113.
	57"	30"	3"	<b>DP7S( )T( )5730</b>	1,130.	1,152.	1,175.
	57"	36"	3"	<b>DP7S( )T( )5736</b>	1,191.	1,214.	1,238.
	57"	42"	3"	<b>DP7S( )T( )5742</b>	1,238.	1,262.	1,286.
	57"	48"	3"	<b>DP7S( )T( )5748</b>	1,283.	1,310.	1,335.



64" High Triangular Frame Screen with Glass	64"	24"	3"	<b>DP7S( )T( )6424</b>	1,097.	1,118.	1,140.
	64"	30"	3"	<b>DP7S( )T( )6430</b>	1,190.	1,213.	1,236.
	64"	36"	3"	<b>DP7S( )T( )6436</b>	1,279.	1,307.	1,332.
	64"	42"	3"	<b>DP7S( )T( )6442</b>	1,284.	1,311.	1,337.
	64"	48"	3"	<b>DP7S( )T( )6448</b>	1,289.	1,315.	1,341.



Panels, Build-To-Spec

\*Note: Frame to the floor shown

Ordering Information	Order Code	Included with:	Options
<b>Triangular Frame Screen with Glass:</b> 1. Pattern number 2. Frame finish 3. Glass type 4. Top cap style 5. Top cap finish 6. Raceway finish	<b>Triangular Frame with Glass:</b> <i>Example:</i> <b>DP7SGTRR5736</b> <b>117/4/117/117</b> <hr/> <b>DP7SGT</b> Triangular frame with clear glass <hr/> <b>RR</b> Raceway type <hr/> <b>117</b> Frame finish <hr/> <b>4</b> Radius metal top cap <hr/> <b>117</b> Top cap finish <hr/> <b>117</b> Raceway finish	<b>Triangular Frame with Glass</b> <ul style="list-style-type: none"> <li>• Topcap (when specified)</li> <li>• Connecting hardware</li> </ul> <b>Note:</b> Screens are only available in Knoll core finishes.	<b>Glass Options:</b> <b>(G)</b> = Clear Tempered Glass <b>(F)</b> = Powder Glass  Top Cap Options: <b>(2)</b> = Extruded Plastic (Smooth Radius) <b>(3)</b> = No Top Cap <b>(4)</b> = Radius Metal, add \$38 P1, \$40 P2, \$42 P3 <b>(5)</b> = Flat Metal, add \$38 P1, \$40 P2, \$42 P3 paint grades  <b>Raceway Type:</b> <b>(FF)</b> = Frame to the Floor both sides <b>(RR)</b> = Raceway covers no knockouts <b>(LL)</b> = Open base  <b>Note:</b> Raceway covers are not available with knockouts.

# Open Weave and Glass Screens

## Rectangular Frame Screen with Glass

### 42" and 50" High

description	h	w	t	pattern no.	P1	P2	P3
42" High Rectangular Frame Screen with Glass 	42"	24"	3"	<b>DP7S( )R( )4224</b>	\$977.	\$996.	\$1,017.
	42"	30"	3"	<b>DP7S( )R( )4230</b>	1,036.	1,056.	1,077.
	42"	36"	3"	<b>DP7S( )R( )4236</b>	1,096.	1,117.	1,139.
	42"	42"	3"	<b>DP7S( )R( )4242</b>	1,118.	1,140.	1,162.
	42"	48"	3"	<b>DP7S( )R( )4248</b>	1,141.	1,164.	1,189.

50" High Rectangular Frame Screen with Glass 	50"	24"	3"	<b>DP7S( )R( )5024</b>	1,053.	1,074.	1,096.
	50"	30"	3"	<b>DP7S( )R( )5030</b>	1,080.	1,103.	1,125.
	50"	36"	3"	<b>DP7S( )R( )5036</b>	1,108.	1,130.	1,152.
	50"	42"	3"	<b>DP7S( )R( )5042</b>	1,200.	1,225.	1,247.
	50"	48"	3"	<b>DP7S( )R( )5048</b>	1,291.	1,317.	1,343.

#### Ordering Information

##### Rectangular Frame Screen with Glass:

1. Pattern number
2. Frame finish
3. Glass type
4. Top cap style
5. Top cap finish
6. Raceway finish

#### Order Code

##### Rectangular Frame with Glass:

Example: **DP7SGRRR4236**  
**117/4/117/117**

<b>DP7SGR</b>	Rectangular frame screen with clear glass
<b>RR</b>	Raceway type
<b>117</b>	Frame finish
<b>4</b>	Radius metal top cap
<b>117</b>	Top cap finish
<b>117</b>	Raceway finish

#### Included with:

##### Rectangular Frame Glass

- Topcap (when specified)
- Connecting hardware

**Note:** Screens are only available in Knoll core finishes.

#### Options

##### Glass Options:

- (G)**= Clear Tempered Glass
- (F)** = Powder Glass

##### Top Cap Options:

- (2)** = Extruded Plastic (Smooth Radius)
- (3)** = No Top Cap
- (4)** = Radius Metal, add \$38 P1, \$40 P2, \$42 P3
- (5)** = Flat Metal, add \$38 P1, \$40 P2, \$42 P3 paint grades

##### Raceway Type:

- (RR)** = Raceway covers no knockouts
- (LL)** = Open base

Frame to floor option not available on Rectangular glass screens.

**Note:** Raceway covers are not available with knockouts.

# Open Weave and Glass Screens

## Rectangular Frame Screen with Glass

### 57" and 64" High

description	h	w	t	pattern no.	P1	P2	P3
57" High Rectangular Frame Screen with Glass	57"	24"	3"	<b>DP7S( )R( )5724</b>	\$1,078.	\$1,101.	\$1,122.
	57"	30"	3"	<b>DP7S( )R( )5730</b>	1,140.	1,163.	1,188.
	57"	36"	3"	<b>DP7S( )R( )5736</b>	1,201.	1,226.	1,248.
	57"	42"	3"	<b>DP7S( )R( )5742</b>	1,248.	1,273.	1,300.
	57"	48"	3"	<b>DP7S( )R( )5748</b>	1,298.	1,321.	1,348.



64" High Rectangular Frame Screen with Glass	64"	24"	3"	<b>DP7S( )R( )6424</b>	1,104.	1,127.	1,147.
	64"	30"	3"	<b>DP7S( )R( )6430</b>	1,199.	1,224.	1,246.
	64"	36"	3"	<b>DP7S( )R( )6436</b>	1,292.	1,318.	1,344.
	64"	42"	3"	<b>DP7S( )R( )6442</b>	1,298.	1,321.	1,348.
	64"	48"	3"	<b>DP7S( )R( )6448</b>	1,301.	1,326.	1,351.



#### Ordering Information

##### Rectangular Frame Screen with Glass:

1. Pattern number
2. Frame finish
3. Glass type
4. Top cap style
5. Top cap finish
6. Raceway finish

#### Order Code

##### Rectangular Frame with Glass:

*Example:* **DP7SGRRR5736**  
**117/4/117/117**

<b>DP7SGR</b>	Rectangular frame screen with clear glass
<b>RR</b>	Raceway type
<b>117</b>	Frame finish
<b>4</b>	Radius metal top cap
<b>117</b>	Top cap finish
<b>117</b>	Raceway finish

#### Included with:

##### Rectangular Frame Glass

- Topcap (when specified)
- Connecting hardware

**Note:** Screens are only available in Knoll core finishes.

#### Options

##### Glass Options:

**(G)** = Clear Tempered Glass  
**(F)** = Powder Glass

##### Top Cap Options:

**(2)** = Extruded Plastic (Smooth Radius)  
**(3)** = No Top Cap  
**(4)** = Radius Metal, add \$38 P1, \$40 P2, \$42 P3  
**(5)** = Flat Metal, add \$38 P1, \$40 P2, \$42 P3 paint grades

##### Raceway Type:

**(RR)** = Raceway covers no knockouts  
**(LL)** = Open base

Frame to floor option not available on Rectangular glass screens.

**Note:** Raceway covers are not available with knockouts.

## Stacking Open Weave Screens

Stacking open weave screens are designed to allow light and transparency into the workstation, while providing limited visual privacy. When combined with Dividends Horizon freestanding components, open weave screens provide a layered aesthetic to the office.

### Stacking Open Weave Screen Construction

Open weave screens feature Warp Net, a new open textile structure designed by Suzanne Tick. Warp Net is constructed of 100% Earthtex, made from Olefin. Earthtex has passed the prestigious McDonough Braungart Design Chemistry Sustainability Protocol, and is fully recyclable.

Open weave screens have a triangular profile frame, made from extruded aluminum frame members, powder coated in any Knoll Core paint finish.

## Stacking Glass Screens

Stacking glass screens, available in both triangular and rectangular profile frames, provide territorial privacy, while transmitting light into the office.

### Stacking Glass Screen Construction

Stacking glass screens are constructed of extruded aluminum frame members, powder coated in any Knoll Core paint finish. Clear glass is 4mm tempered glass.

### Stacking Screen Dimensions:

Widths: 24, 30, 36, 42, and 48 inches

Heights: 14, 21 and 28 inches

Thickness: 3 inches

## Planning With Stacking Screens

Dividends Horizon open weave and glass screens are primarily designed to divide space and let light into the office. Screens do not have a slotted standard, and do not support overhead storage components.

Stacking screens attach to any Dividends Horizon DP7V series full view panel frame, and may be stacked one tier high. Stacking screens do not stack on topway panel frames.

Stacking screens attach to Dividends Horizon DP7V panels or connecting posts of the same or greater height, or other screens of the same height.

**Note:** Stacking screens may be used with DP7 full view panel frames only.

**Note:** Screens are only available in Knoll core finishes.

**Note:** Knoll's three window types are aesthetically and functionally different, and are not designed to be mixed together within a single installation.

Triangular Stack Panel Screen with Open Weave Fabric insert

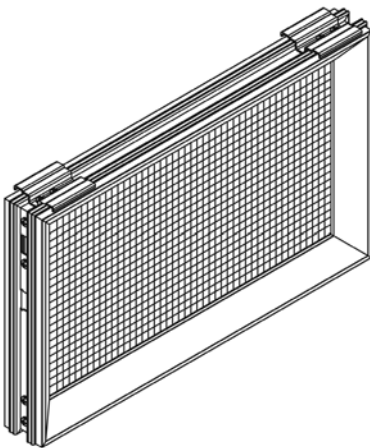

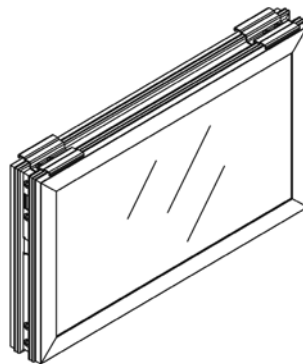

Rectangular Stack Panel Screen with Glass insert



# Open Weave and Glass Stacking Screens

## Triangular Frame Stacking Screen with Open Weave Fabric

Dividends Horizon

description	h	w	t	pattern no.	P1	P2	P3
14" High Triangular Frame Stacking Screen with Open Weave Fabric 	14"	24"	3"	<b>DP7SSWT1424</b>	\$553.	\$564.	\$576.
	14"	30"	3"	<b>DP7SSWT1430</b>	585.	597.	608.
	14"	36"	3"	<b>DP7SSWT1436</b>	618.	630.	642.
	14"	42"	3"	<b>DP7SSWT1442</b>	642.	655.	667.
	14"	48"	3"	<b>DP7SSWT1448</b>	665.	678.	691.
21" High Triangular Frame Stacking Screen with Open Weave Fabric 	21"	24"	3"	<b>DP7SSWT2124</b>	593.	605.	617.
	21"	30"	3"	<b>DP7SSWT2130</b>	631.	643.	656.
	21"	36"	3"	<b>DP7SSWT2136</b>	670.	683.	695.
	21"	42"	3"	<b>DP7SSWT2142</b>	695.	712.	724.
	21"	48"	3"	<b>DP7SSWT2148</b>	721.	735.	752.
28" High Triangular Frame Stacking Screen with Open Weave Fabric 	28"	24"	3"	<b>DP7SSWT2824</b>	632.	644.	658.
	28"	30"	3"	<b>DP7SSWT2830</b>	677.	690.	703.
	28"	36"	3"	<b>DP7SSWT2836</b>	721.	735.	752.
	28"	42"	3"	<b>DP7SSWT2842</b>	752.	765.	781.
	28"	48"	3"	<b>DP7SSWT2848</b>	779.	794.	811.

Panels, Build-To-Spec

### Ordering Information

#### Triangular Frame Stacking Screen with Open Weave Fabric:

1. Pattern number
2. Frame finish
3. Fabric finish

### Order Code

#### Triangular Frame Stacking Screen with Open Weave Fabric:

*Example:* **DP7SSWT1436**  
**117/W1113-1**

**DP7SSWT** Stack, triangular frame, open weave

**117** Frame finish

**W1113-1** Fabric finish

### Included with:

#### Triangular Frame Stacking Screen with Open Weave Fabric

- Attachment hardware



**Note:** Screens are only available in Knoll core finishes.

**NOTE:** Stacking screens are compatible with DP7 Full View panels only.

# Open Weave and Glass Stacking Screens

## Triangular Frame Stacking Screen with Glass

Dividends Horizon

description	h	w	t	pattern no.	P1	P2	P3
14" High Triangular Frame Stacking Screen with Glass 	14"	24"	3"	DP7SS( )T1424	\$554.	\$565.	\$577.
	14"	30"	3"	DP7SS( )T1430	582.	593.	605.
	14"	36"	3"	DP7SS( )T1436	610.	622.	636.
	14"	42"	3"	DP7SS( )T1442	639.	650.	664.
	14"	48"	3"	DP7SS( )T1448	666.	678.	692.
	14"	54"	3"	DP7SS( )T1454	699.	720.	741.
	14"	60"	3"	DP7SS( )T1460	734.	756.	778.
	14"	66"	3"	DP7SS( )T1466	774.	794.	820.
	14"	72"	3"	DP7SS( )T1472	810.	834.	859.
	14"	78"	3"	DP7SS( )T1478	851.	877.	902.
	14"	84"	3"	DP7SS( )T1484	894.	921.	948.
	14"	90"	3"	DP7SS( )T1490	939.	967.	995.
14"	96"	3"	DP7SS( )T1496	986.	1,016.	1,045.	
21" High Triangular Frame Stacking Screen with Glass 	21"	24"	3"	DP7SS( )T2124	598.	610.	623.
	21"	30"	3"	DP7SS( )T2130	632.	645.	658.
	21"	36"	3"	DP7SS( )T2136	665.	677.	691.
	21"	42"	3"	DP7SS( )T2142	697.	712.	725.
	21"	48"	3"	DP7SS( )T2148	730.	749.	762.
	21"	54"	3"	DP7SS( )T2154	767.	789.	812.
	21"	60"	3"	DP7SS( )T2160	805.	829.	853.
	21"	66"	3"	DP7SS( )T2166	845.	870.	896.
	21"	72"	3"	DP7SS( )T2172	887.	914.	941.
	21"	78"	3"	DP7SS( )T2178	932.	960.	988.
	21"	84"	3"	DP7SS( )T2184	978.	1,008.	1,037.
	21"	90"	3"	DP7SS( )T2190	1,027.	1,058.	1,089.
21"	96"	3"	DP7SS( )T2196	1,079.	1,111.	1,143.	
28" High Triangular Frame Stacking Screen with Glass 	28"	24"	3"	DP7SS( )T2824	643.	655.	668.
	28"	30"	3"	DP7SS( )T2830	681.	695.	708.
	28"	36"	3"	DP7SS( )T2836	719.	731.	750.
	28"	42"	3"	DP7SS( )T2842	760.	775.	790.
	28"	48"	3"	DP7SS( )T2848	798.	815.	830.
	28"	54"	3"	DP7SS( )T2854	838.	863.	888.
	28"	60"	3"	DP7SS( )T2860	880.	906.	933.
	28"	66"	3"	DP7SS( )T2866	924.	951.	979.
	28"	72"	3"	DP7SS( )T2872	970.	999.	1,028.
	28"	78"	3"	DP7SS( )T2878	1,018.	1,049.	1,080.
	28"	84"	3"	DP7SS( )T2884	1,069.	1,101.	1,134.
	28"	90"	3"	DP7SS( )T2890	1,123.	1,157.	1,190.

### Ordering Information

#### Triangular Frame Stacking Screen

1. Pattern number
2. Frame finish
3. Glass

### Order Code

#### Triangular Frame Stacking Screen

*Example:* **DP7SSGT1424 / 117**  
**DP7SSGT** Stack, Triangular Frame, w/ clear tempered glass  
**117** Frame finish

### Included with:

#### Triangular Frame Stacking Screen

- Attachment hardware
- Note:** Screens are only available in Knoll core finishes.

### Options

**NOTE: Stacking screens are compatible with DP7 Full View panels only.**

#### Glass Options:

**(G)**= Clear Tempered Glass  
**(F)** = Powder Glass



# Open Weave and Glass Stacking Screens

## *Triangular Frame Stacking Screen with Glass*

Dividends Horizon

description	h	w	t	pattern no.	P1	P2	P3
28" High Triangular Frame Stacking Screen with Glass	28"	96"	3"	<b>DP7SS( )T2896</b>	\$1,179.	\$1,214.	\$1,250.



Panels, Build-To-Spec

### Ordering Information

#### Triangular Frame Stacking Screen

1. Pattern number
2. Frame finish
3. Glass

### Order Code

#### Triangular Frame Stacking Screen

*Example:* **DP7SSGT1424 / 117**  
**DP7SSGT** Stack, Triangular Frame,  
w/ clear tempered glass  
**117** Frame finish

### Included with:

#### Triangular Frame Stacking Screen

- Attachment hardware
- Note:** Screens are only available in Knoll core finishes.

### Options

**NOTE: Stacking screens are compatible with DP7 Full View panels only.**



#### Glass Options:

**(G)**= Clear Tempered Glass  
**(F)** = Powder Glass

# Open Weave and Glass Stacking Screens

## Rectangular Frame Stacking Screen with Glass

Dividends Horizon

description	h*	w	t	pattern no.	P1	P2	P3
14" High Rectangular Frame Stacking Screen with Glass 	14"	24"	3"	DP7SS( )R1424	\$546.	\$555.	\$567.
	14"	30"	3"	DP7SS( )R1430	575.	586.	597.
	14"	36"	3"	DP7SS( )R1436	602.	613.	627.
	14"	42"	3"	DP7SS( )R1442	631.	644.	656.
	14"	48"	3"	DP7SS( )R1448	660.	672.	686.
	14"	54"	3"	DP7SS( )R1454	693.	714.	735.
	14"	60"	3"	DP7SS( )R1460	728.	749.	771.
	14"	66"	3"	DP7SS( )R1466	764.	787.	810.
	14"	72"	3"	DP7SS( )R1472	802.	826.	850.
	14"	78"	3"	DP7SS( )R1478	842.	868.	893.
	14"	84"	3"	DP7SS( )R1484	884.	911.	938.
	14"	90"	3"	DP7SS( )R1490	929.	957.	984.
	14"	96"	3"	DP7SS( )R1496	975.	1,004.	1,034.
21" High Rectangular Frame Stacking Screen with Glass 	21"	24"	3"	DP7SS( )R2124	590.	602.	613.
	21"	30"	3"	DP7SS( )R2130	624.	638.	648.
	21"	36"	3"	DP7SS( )R2136	658.	671.	685.
	21"	42"	3"	DP7SS( )R2142	692.	706.	720.
	21"	48"	3"	DP7SS( )R2148	725.	740.	756.
	21"	54"	3"	DP7SS( )R2154	761.	784.	807.
	21"	60"	3"	DP7SS( )R2160	799.	823.	847.
	21"	66"	3"	DP7SS( )R2166	839.	864.	890.
	21"	72"	3"	DP7SS( )R2172	881.	908.	934.
	21"	78"	3"	DP7SS( )R2178	925.	953.	981.
	21"	84"	3"	DP7SS( )R2184	972.	1,001.	1,030.
	21"	90"	3"	DP7SS( )R2190	1,020.	1,051.	1,081.
	21"	96"	3"	DP7SS( )R2196	1,071.	1,103.	1,135.
28" High Rectangular Frame Stacking Screen with Glass 	28"	24"	3"	DP7SS( )R2824	637.	648.	662.
	28"	30"	3"	DP7SS( )R2830	674.	688.	700.
	28"	36"	3"	DP7SS( )R2836	714.	726.	745.
	28"	42"	3"	DP7SS( )R2842	755.	769.	786.
	28"	48"	3"	DP7SS( )R2848	794.	811.	824.
	28"	54"	3"	DP7SS( )R2854	834.	859.	884.
	28"	60"	3"	DP7SS( )R2860	875.	902.	928.
	28"	66"	3"	DP7SS( )R2866	919.	947.	974.
	28"	72"	3"	DP7SS( )R2872	965.	994.	1,023.
	28"	78"	3"	DP7SS( )R2878	1,013.	1,044.	1,074.
	28"	84"	3"	DP7SS( )R2884	1,064.	1,096.	1,128.
	28"	90"	3"	DP7SS( )R2890	1,117.	1,151.	1,184.

### Ordering Information

#### Rectangular Frame Stacking Screen:

1. Pattern number
2. Frame finish
3. Glass

### Order Code

#### Rectangular Frame Stacking Screen:

*Example:* DP7SSGR1424/117

DP7SSGR Stack, Rectangular Frame, w/clear tempered glass

117 Raceway finish

### Included with:

#### Rectangular Frame Stacking Screen:

- Attachment hardware

**Note:** Screens are only available in Knoll core finishes.

### Options

**NOTE:** Stacking screens are compatible with DP7 Full View panels only.

#### Glass Options:

(G)= Clear Tempered Glass  
(F) = Powder Glass

# Open Weave and Glass Stacking Screens

## *Rectangular Frame Stacking Screen with Glass*

Dividends Horizon

description	h*	w	t	pattern no.	P1	P2	P3
28" High Rectangular Frame Stacking Screen with Glass	28"	96"	3"	<b>DP7SS( )R2896</b>	\$1,173.	\$1,208.	\$1,243.



Panels, Build-To-Spec

Ordering Information	Order Code	Included with:	Options
<b>Rectangular Frame Stacking Screen:</b> 1. Pattern number 2. Frame finish 3. Glass	<b>Rectangular Frame Stacking Screen:</b> <u>Example: DP7SSGR1424 /117</u> <b>DP7SSGR</b> Stack, Rectangular Frame, w/clear tempered glass <u>117</u> Raceway finish	<b>Rectangular Frame Stacking Screen:</b> <ul style="list-style-type: none"> <li>Attachment hardware</li> </ul> <b>Note:</b> Screens are only available in Knoll core finishes.	<b>NOTE: Stacking screens are compatible with DP7 Full View panels only.</b>  <b>Glass Options:</b> <b>(G)</b> = Clear Tempered Glass <b>(F)</b> = Powder Glass

## Frameless Add Up

Frameless add ups provide additional privacy between workstations, while creating a lighter and more transparent space. Combining frameless glass add ups with Dividends Horizon panels provides a clean, light aesthetic.

Frameless add ups are available in clear or powder glass. 7" and 14" heights are available, which is consistent with Dividends Horizon panel frame height increments.

Frameless add ups replace flat top caps on panels, bolting onto the panel frame. Add ups are not available in radius profile.

## Frameless Glass Add Up Construction

Frameless glass add ups feature an extruded aluminum base and are available in any Knoll Core paint finish. Legacy finishes are not available.

Clear tempered or powder glass is ½" thick with polished edge.

## Frameless Glass Add Up Dimensions

- Widths: 15, 18, 24, 30, 36, 42, 48, 54, 60, 66, and 72 inches
- Heights: 7 and 14 inches
- Thickness: 3 inches

## Planning with Frameless Add Ups

Frameless add ups attach to the top of any height Dividends or Dividends Horizon topway or full view panel frame or stack frame, regardless of production date.

Frameless add ups replace the panel top cap and can span over one or more panels up to 72" wide.

Dividends Horizon frameless add ups are designed for use in same-height panel applications, and also support change of height applications involving a post connection.

Use shortened frameless add ups in change of height applications with DP5 end trims. Frameless add ups are not compatible with DP6 thin profile end trims.

End caps are specified for each end of a run of add ups. End caps must be specified separately and are available in packages of ten.

## Frameless Add Up Alignment Clip

A clear polycarbonate alignment clip maintains alignment between frameless add up inserts. One alignment clip is included with every frameless add up. Alignment clips do not need to be specified separately.

14" High Frameless Add Up

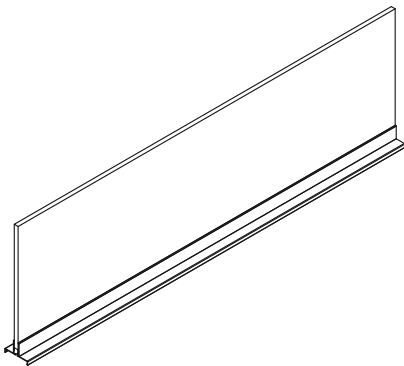

7" High Frameless Add Up

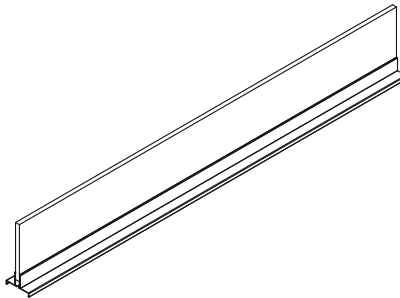

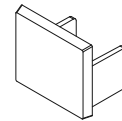

Frameless Add Up End Cap



# Frameless Add Up

## Clear, Powder and Bronze Glass

Dividends Horizon

description	w	d	h	pattern no.	list	Clear (TEMP)	Powder (GL13) Bronze (GL25)
 <p>Frameless Add Up, 7" High</p>	15"	1/2"	7"	DP1AU0715( )L			
	15"	1/2"	7"	DP1AU0715( )G		206.	220.
	18"	1/2"	7"	DP1AU0718( )G		229.	248.
	24"	1/2"	7"	DP1AU0724( )G		251.	277.
	30"	1/2"	7"	DP1AU0730( )G		274.	304.
	36"	1/2"	7"	DP1AU0736( )G		310.	346.
	42"	1/2"	7"	DP1AU0742( )G		346.	387.
	48"	1/2"	7"	DP1AU0748( )G		382.	428.
	54"	1/2"	7"	DP1AU0754( )G		415.	468.
	60"	1/2"	7"	DP1AU0760( )G		449.	506.
	66"	1/2"	7"	DP1AU0766( )G		481.	546.
	72"	1/2"	7"	DP1AU0772( )G		514.	585.
	78"	1/2"	7"	DP1AU0778( )G		555.	632.
	84"	1/2"	7"	DP1AU0784( )G		599.	683.
90"	1/2"	7"	DP1AU0790( )G		647.	738.	
96"	1/2"	7"	DP1AU0796( )G		699.	797.	
 <p>Shortened Frameless Add Up, 7" High</p>	14"	1/2"	7"	DP1AU0714( )G		206.	220.
	17"	1/2"	7"	DP1AU0717( )G		229.	248.
	23"	1/2"	7"	DP1AU0723( )G		251.	277.
	29"	1/2"	7"	DP1AU0729( )G		274.	304.
	35"	1/2"	7"	DP1AU0735( )G		310.	346.
	41"	1/2"	7"	DP1AU0741( )G		346.	387.
	47"	1/2"	7"	DP1AU0747( )G		382.	428.
	53"	1/2"	7"	DP1AU0753( )G		415.	468.
	59"	1/2"	7"	DP1AU0759( )G		449.	506.
	65"	1/2"	7"	DP1AU0765( )G		481.	546.
	71"	1/2"	7"	DP1AU0771( )G		514.	585.
	77"	1/2"	7"	DP1AU0777( )G		555.	632.
	83"	1/2"	7"	DP1AU0783( )G		599.	683.
	89"	1/2"	7"	DP1AU0789( )G		647.	738.
95"	1/2"	7"	DP1AU0795( )G		699.	797.	

Panels, Build-To-Spec

### Ordering Information

#### Frameless Add Up with Clear Glass

1. Pattern number
2. Frame finish
3. Glass finish

#### End Cap

1. Pattern number
2. Paint finish

### Order Code

#### Frameless Add Up with Clear Glass

*Example:* **DP1AU0736VG**

**DP1AU** Frameless Add Up

**07** 7" High

**36** 36" Wide

**V** Full view

**G** Glass

**117** Frame finish

**TEMP** Clear glass finish

### Included with:

#### Frameless Add Up with Clear Glass

- Attachment hardware
- Topway Trough Spacer (Topway only)
- Alignment Clip

### Options

**Frame Options:**  
(V) = Full view  
(C) = Topway

**Glass Options:**  
(TEMP) = Clear  
(GL13) = Powder  
(GL25) = Bronze

# Frameless Add Up

## Clear, Powder and Bronze Glass

Dividends Horizon

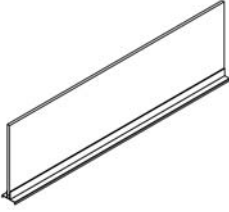
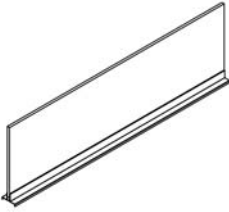
description	w	d	h	pattern no.	list	Clear (TEMP)	Powder (GL13) Bronze (GL25)
 Frameless Add Up, 14" High	15"	1/2"	14"	DP1AU1415( )L			
	15"	1/2"	14"	DP1AU1415( )G		254.	283.
	18"	1/2"	14"	DP1AU1418( )G		294.	333.
	24"	1/2"	14"	DP1AU1424( )G		334.	382.
	30"	1/2"	14"	DP1AU1430( )G		373.	431.
	36"	1/2"	14"	DP1AU1436( )G		427.	497.
	42"	1/2"	14"	DP1AU1442( )G		481.	563.
	48"	1/2"	14"	DP1AU1448( )G		538.	630.
	54"	1/2"	14"	DP1AU1454( )G		590.	693.
	60"	1/2"	14"	DP1AU1460( )G		642.	759.
	66"	1/2"	14"	DP1AU1466( )G		694.	822.
	72"	1/2"	14"	DP1AU1472( )G		748.	887.
	78"	1/2"	14"	DP1AU1478( )G		808.	958.
	84"	1/2"	14"	DP1AU1484( )G		873.	1,035.
	90"	1/2"	14"	DP1AU1490( )G		943.	1,118.
96"	1/2"	14"	DP1AU1496( )G		1,018.	1,207.	
 Shortened Frameless Add Up, 14" High	14"	1/2"	14"	DP1AU1414( )G		254.	283.
	17"	1/2"	14"	DP1AU1417( )G		294.	333.
	23"	1/2"	14"	DP1AU1423( )G		334.	382.
	29"	1/2"	14"	DP1AU1429( )G		373.	431.
	35"	1/2"	14"	DP1AU1435( )G		427.	497.
	41"	1/2"	14"	DP1AU1441( )G		481.	563.
	47"	1/2"	14"	DP1AU1447( )G		538.	630.
	53"	1/2"	14"	DP1AU1453( )G		590.	693.
	59"	1/2"	14"	DP1AU1459( )G		642.	759.
	65"	1/2"	14"	DP1AU1465( )G		694.	822.
	71"	1/2"	14"	DP1AU1471( )G		748.	887.
	77"	1/2"	14"	DP1AU1477( )G		808.	958.
	83"	1/2"	14"	DP1AU1483( )G		873.	1,035.
	89"	1/2"	14"	DP1AU1489( )G		943.	1,118.
	95"	1/2"	14"	DP1AU1495( )G		1,018.	1,207.
End Cap	Package of Ten			DP1AUECTP	36.		

Ordering Information	Order Code	Included with:	Options
<b>Frameless Add Up with Clear Glass</b> 1. Pattern number 2. Frame finish 3. Glass finish	<b>Frameless Add Up with Clear Glass</b> <i>Example:</i> <b>DP1AU0736VG</b> <b>DP1AU</b> Frameless Add Up <b>07</b> 7" High <b>36</b> 36" Wide <b>V</b> Full view <b>G</b> Glass <b>117</b> Frame finish <b>TEMP</b> Clear glass finish	<b>Frameless Add Up with Clear Glass</b> <ul style="list-style-type: none"> <li>Attachment hardware</li> <li>Topway Trough Spacer (Topway only)</li> <li>Alignment Clip</li> </ul>	<b>Frame Options:</b> <b>(V)</b> = Full view <b>(C)</b> = Topway <b>Glass Options:</b> <b>(TEMP)</b> = Clear <b>(GL13)</b> = Powder <b>(GL25)</b> = Bronze

**This page intentionally left blank**

## Dividends Horizon DP7 Post Assemblies

Post assemblies are required for all "L", "T", and "X" applications involving same-height panels. Included with post assemblies are the appropriate post, post cover, top cap and inside corner raceway filler.

Posts use the universal panel connection hardware, which is included with the post, for attachment.

For high-low and post-to-panel applications, posts and covers must be ordered separately by component.

## Dividends Horizon Post and Trim Construction

Posts are 3" square extruded aluminum construction. Post covers are powder-coated 20 gauge steel.

Posts have cut-outs for electrical and data access that match the wire and cable channels provided by panel frames. This allows cables to be routed through the post at the topway and base raceway. Refer to the Beltway Electrical Specification page for cable routing information.

The illustrations that follow are common same-height post assembly configurations. Choose the post assembly that matches the required application.

**Note:** Worksurface height panels do not attach to any other panel height.

## Post "L" Configuration

"L" post assembly includes:

- Universal post
- Two-way top cap
- Corner post cover
- Inside corner raceway filler

## Post "T" Configuration

"T" post assembly includes:

- Universal post
- Three-way top cap
- Straight post cover
- Inside corner raceway filler

## Post "X" Configuration

"X" post assembly includes:

- Universal post
- Four-way top cap
- Inside corner raceway filler

## Post "X" Configuration

Trim options available:

- Radius
- Flat

Two-way Post Connection

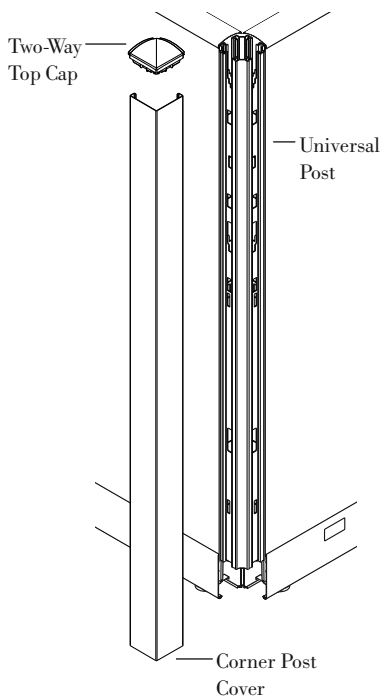

Post and Cover Plan Views

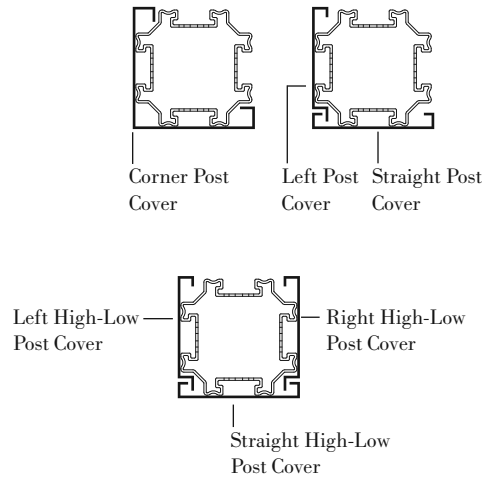

Post "L" Configuration

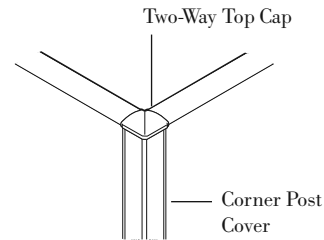

Post "T" Configuration

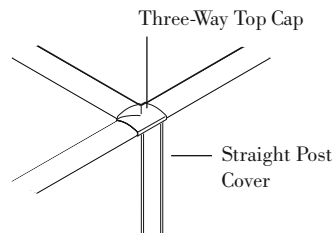

Post "X" Configuration

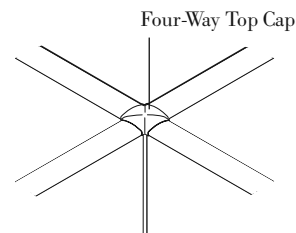





# Dividends Horizon DP7 Post Assemblies

## L, T and X Configurations

Dividends Horizon

description	h	w	d	pattern no.	Metal P1	Metal P2	Metal P3	Veneer
Dividends Horizon Two-Way Post Assembly ("L")	28 1/2"	3"	3"	<b>DP7PAWH2( )</b>	\$144.	\$152.	\$161.	\$460.
	36"	3"	3"	<b>DP7PA362( )</b>	144.	152.	161.	462.
	42"	3"	3"	<b>DP7PA422( )</b>	144.	152.	161.	476.
	50"	3"	3"	<b>DP7PA502( )</b>	157.	166.	173.	519.
	57"	3"	3"	<b>DP7PA572( )</b>	184.	196.	203.	603.
	64"	3"	3"	<b>DP7PA642( )</b>	184.	196.	203.	626.
	78"	3"	3"	<b>DP7PA782( )</b>	267.	283.	296.	752.

Dividends Horizon Three-Way Post Assembly ("T")	28 1/2"	3"	3"	<b>DP7PAWH3( )</b>	150.	159.	166.	437.
	36"	3"	3"	<b>DP7PA363( )</b>	150.	159.	166.	465.
	42"	3"	3"	<b>DP7PA423( )</b>	150.	159.	166.	474.
	50"	3"	3"	<b>DP7PA503( )</b>	161.	168.	176.	496.
	57"	3"	3"	<b>DP7PA573( )</b>	184.	197.	203.	536.
	64"	3"	3"	<b>DP7PA643( )</b>	184.	197.	203.	585.
	78"	3"	3"	<b>DP7PA783( )</b>	265.	278.	294.	673.

Dividends Horizon Four-Way Post Assembly ("X")	28 1/2"	3"	3"	<b>DP7PAWH4( )</b>	139.	146.	153.	255.
	36"	3"	3"	<b>DP7PA364( )</b>	139.	146.	153.	259.
	42"	3"	3"	<b>DP7PA424( )</b>	139.	146.	153.	260.
	50"	3"	3"	<b>DP7PA504( )</b>	146.	156.	164.	272.
	57"	3"	3"	<b>DP7PA574( )</b>	168.	177.	185.	285.
	64"	3"	3"	<b>DP7PA644( )</b>	168.	177.	185.	296.
	78"	3"	3"	<b>DP7PA784( )</b>	243.	254.	267.	345.

Post Connectors/End Trim

### Ordering Information

#### Post Assemblies

1. Pattern Number
2. Finish

### Order Code

#### Post Assemblies

*Example:* **DP7PA362,5,113**  
 613 Silver Paint Finish

### Included with:

#### Post Assemblies

- Post
- Post top cap
- Post cover
- Connecting hardware
- Base inside corner fillers

### Options

#### Post Assemblies

- (4)** = Radius Metal
- (5)** = Flat Metal
- (V4)** = Radius Veneer
- (V5)** = Flat Veneer

Note: Plastic versions not available.

### High-Low Post Components

High-Low panel-to-post configurations require ordering the post covers by components.

Shown are common high-low panel-to-post configurations. Choose the high-low panel-to-post configuration that matches the required application.

Posts use the universal panel connection hardware for attachment, which is included with the post.

**NOTE: 28½"H panels do not attach to 36"H posts in a high-low application. Panel-to-panel high-low applications are not affected.**

### High-Low "L" Post Connector Configuration (see Figure 1)

High-Low "L" components required:

- 1 One, universal post that matches height of tallest panel DP7PO(64)
- 2 One, "one-way" post top cap DP7PT1(5)
- 3 One corner post covers that match height of tallest panel. DP7PC(64)2
- 4 One, high-low right hand post cover that matches high-low panel-to-post dimension. DP7PC(14)(R)H - Mirrored configuration would require left hand cover DP7PC(14)(L)H

### High-Low "T" Post Connector Configuration A (see Figure 2)

High-Low "T" components required:

- 1 One, universal post that matches height of tallest panel DP7PO(64)
- 2 One, "two-way" top cap DP7PT2(5)
- 3 One, straight post cover that matches height of tallest panel DP7PC(64)
- 4 One, high-low right hand post cover that matches high-low panel-to-post dimension DP7PC(14)(R)H - Mirrored configuration would require a left hand cover DP7PC(14)(L)H

### High-Low "T" Post Connector Configuration B (see Figure 3)

High-Low "T" components required:

- 1 One, universal post that matches height of tallest panel DP7PO(64)
- 2 One, "in-line" top cap DP7PTS(5)
- 3 One, straight post cover that matches height of tallest panel DP7PC(64)
- 4 One, high-low straight post cover that matches high-low panel-to-post dimension DP7PC(14)H

### Hi-Low "T" Post Connector Configuration C (see Figure 4)

High-Low "T" components required:

- 1 One, universal post that matches height of tallest panel DP7PO(64)
- 2 One, "one-way" top cap DP7PT1(5)
- 3 One, straight post cover that matches height of tallest panel DP7PC(64)
- 4 Two, high-low right hand post covers that match high-low panel-to-post dimension DP7PC(14)(R)H - Mirrored configuration would require left hand covers DP7PC(14)(L)H

Figure 1

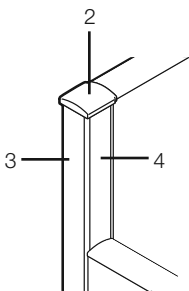

Figure 2

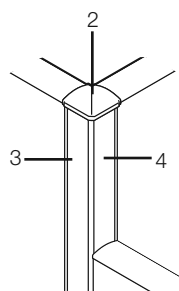

Figure 3

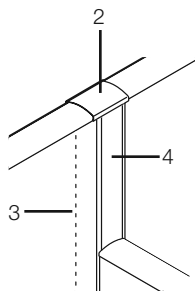
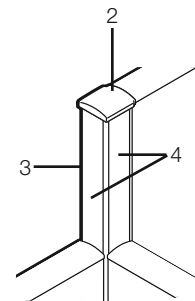

Figure 4



### Post Top Caps



### High-Low "X" Post Connector Configuration A (see Figure 5)

High-Low "X" components required (best method of various options):

- 1 One universal post that matches height of tallest panel DP7PO(64)
- 2 One, "one-way" top cap DP7PT1(5)
- 3 One, high-low straight post cover that matches high-low panel-to-post dimensions DP7PC(14)H
- 4 Two, high-low right hand post covers that match high-low panel-to-post dimensions DP7PC(14)(R)H - Mirrored configuration would require left hand covers DP7PC(14)(L)H

### High-Low "X" Post Connector Configuration B (see Figure 6)

High-Low "X" components required:

- 1 One, universal post that matches height of tallest panel DP7PO(64)
- 2 One, "in-line" top cap DP7PTS(5)
- 3 Two, high-low straight post covers that match high-low panel-to-post dimensions DP7PC(14)H

### High-Low "X" Post Connector Configuration C (see Figure 7)

High-Low "X" components required:

- 1 One, universal post that matches height of tallest panel DP7PO(64)
- 2 One, "two-way" top cap DP7PT2(5)
- 3 One, high-low straight post cover that matches high-low panel-to-post dimension. DP7PC(14)H
- 4 One, high-low right hand post cover that matches high-low panel-to-post dimension. DP7PC(14)(R)H - Mirrored configuration would require left hand cover DP7PC(14)(L)H

### High-Low "X" Post Connector Configuration D (see Figure 8)

High-Low "X" components required:

- 1 One, universal post that matches height of tallest panel DP7PO(64)
- 2 One, "three-way" top cap DP7PT3(5)
- 3 One, high-low straight post cover that matches high-low panel-to-post dimension DP7PC(14)H

Figure 5

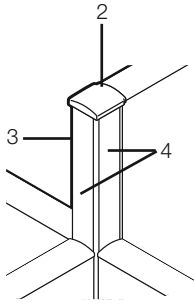

Figure 6

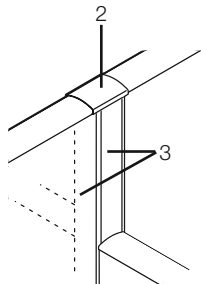

Figure 7

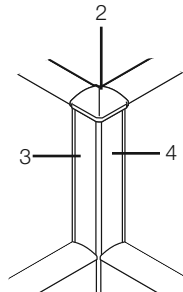
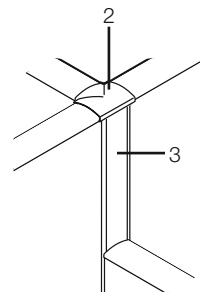
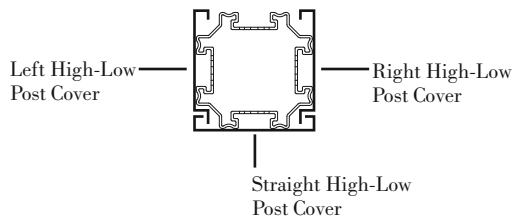

Figure 8













### Post Plan View



# Dividends Horizon DP7 Post Components

Dividends Horizon

## *Post, Stack Panel Post, Post Top Caps and Inside Corner Raceway Filler*

description	type	h	w	d	pattern no.	list price	P1	P2	P3	Veneer
Dividends Horizon Universal Post		28 <sup>1</sup> / <sub>2</sub> "	3"	3"	<b>DP7POWH</b>	\$77.				
		36"	3"	3"	<b>DP7PO36</b>	77.				
		42"	3"	3"	<b>DP7PO42</b>	77.				
		42"	3"	3"	<b>DP7PO50</b>	89.				
		57"	3"	3"	<b>DP7PO57</b>	107.				
		64"	3"	3"	<b>DP7PO64</b>	107.				
		78"	3"	3"	<b>DP7PO78</b>	183.				
14" High Dividends Horizon Stack Panel Post		14 <sup>5</sup> / <sub>8</sub> "	3"	3"	<b>DP7SPO14</b>	80.				
										
21" High Dividends Horizon Stack Panel Post		21 <sup>15</sup> / <sub>16</sub> "	3"	3"	<b>DP7SPO21</b>	81.				
										
28" High Dividends Horizon Stack Panel Post		29 <sup>1</sup> / <sub>4</sub> "	3"	3"	<b>DP7SPO28</b>	92.				
										
Worksurface Height Panel Change of Height Kit					<b>DP7HLCWH</b>		30.	33.	34.	
Dividends Horizon Post Top Caps	Four-Way	<sup>1</sup> / <sub>2</sub> "	3"	3"	<b>DP7PT4( )</b>		8.	9.	9.	101.
	In-line Straght	<sup>1</sup> / <sub>2</sub> "	3"	3"	<b>DP7PTS( )</b>		8.	9.	9.	97.
	One-Way	<sup>1</sup> / <sub>2</sub> "	3"	3"	<b>DP7PT1( )</b>		8.	9.	9.	87.
	Three-Way	<sup>1</sup> / <sub>2</sub> "	3"	3"	<b>DP7PT3( )</b>		8.	9.	9.	98.
	Two-Way	<sup>1</sup> / <sub>2</sub> "	3"	3"	<b>DP7PT2( )</b>		8.	9.	9.	99.
	 Four-way  In-line									
 One-way  Two-way										
 Three-way										
Inside Corner Raceway Filler					<b>DP7BF</b>	10.				
										

### Ordering Information

#### Post Top Cap

1. Pattern number
2. Finish

### Order Code

#### Post Top Caps

*Example:* **DP7PT45**

613 Silver Paint Finish

### Included with:

### Options

#### Post Top Caps Options



- (4)** = Radius Metal
- (5)** = Flat Metal
- (V4)** = Radius Veneer
- (V5)** = Flat Veneer

An inside corner raceway filler is used to block the light leak created when two raceway covers meet at a 90° connection.

# Dividends Horizon DP7 Post Components

## Post Covers and High Low Post Covers

Dividends Horizon

description	h	pattern no.	Metal P1	Metal P2	Metal P3	Veneer
Dividends Horizon Post Covers Full Height "T" 	28 1/2" + 14"	<b>DP7PCWHS14</b>	\$102.	\$114.	\$118.	n/a
	28 1/2" + 21"	<b>DP7PCWHS21</b>	113.	125.	130.	n/a
	28 1/2" + 28"	<b>DP7PCWHS28</b>	119.	131.	136.	n/a
	28 1/2"	<b>DP7PCWH</b>	45.	48.	61.	178.
	42"	<b>DP7PC42</b>	45.	48.	61.	211.
	50"	<b>DP7PC50</b>	46.	50.	54.	220.
	57"	<b>DP7PC57</b>	53.	55.	58.	247.
	64"	<b>DP7PC64</b>	53.	55.	58.	285.
	78"	<b>DP7PC78</b>	58.	64.	66.	324.
Dividends Horizon Post Covers Full Height "L" 	28 1/2" + 14"	<b>DP7PCWHS142</b>	108.	118.	123.	n/a
	28 1/2" + 21"	<b>DP7PCWHS212</b>	115.	127.	132.	n/a
	28 1/2" + 28"	<b>DP7PCWHS282</b>	121.	132.	137.	n/a
	28 1/2"	<b>DP7PCWH2</b>	69.	72.	75.	244.
	36"	<b>DP7PC362</b>	69.	72.	75.	243.
	42"	<b>DP7PC422</b>	69.	72.	75.	255.
	50"	<b>DP7PC502</b>	72.	76.	80.	287.
	57"	<b>DP7PC572</b>	78.	83.	90.	357.
	64"	<b>DP7PC642</b>	78.	83.	90.	370.
Dividends Horizon High Low Post Covers 	28 1/2" - 42"	<b>DP7PCWH42()</b>	88.	96.	100.	n/a
	28 1/2" - 50"	<b>DP7PCWH50()</b>	100.	112.	116.	n/a
	28 1/2" - 57"	<b>DP7PCWH57()</b>	101.	113.	117.	n/a
	28 1/2" - 64"	<b>DP7PCWH64()</b>	102.	114.	118.	n/a
	28 1/2" - 78"	<b>DP7PCWH78()</b>	107.	117.	122.	n/a
	36" - 42"	<b>DP7PC07()</b>	9.	11.	11.	138.
	36" - 50"	<b>DP7PC14()</b>	15.	20.	22.	157.
	36" - 57"	<b>DP7PC21()</b>	23.	24.	25.	170.
	36" - 64"	<b>DP7PC28()</b>	36.	39.	40.	186.
	36" - 78"	<b>DP7PC42()</b>	54.	57.	59.	243.
	42" - 50"	<b>DP7PC07()</b>	9.	11.	11.	138.
	42" - 57"	<b>DP7PC14()</b>	15.	20.	22.	157.
	42" - 64"	<b>DP7PC21()</b>	23.	24.	25.	170.
	42" - 78"	<b>DP7PC36()</b>	48.	53.	55.	222.
	50" - 57"	<b>DP7PC07()</b>	9.	11.	11.	138.
	50" - 64"	<b>DP7PC14()</b>	15.	20.	22.	157.
	50" - 78"	<b>DP7PC28()</b>	36.	39.	40.	186.
	57" - 64"	<b>DP7PC07()</b>	9.	11.	11.	138.
	57" - 78"	<b>DP7PC21()</b>	23.	24.	25.	170.

Post Connectors/End Trim

### Ordering Information

#### Post Covers

1. Pattern number
2. Finish

### Order Code

#### Post Top Caps

Example: **DP7PT45**

613 Silver Paint Finish

### Included with:

### Options

#### Post Covers

Add a "V" suffix to the base pattern number for a veneer finish.

#### High Low Post Covers Options

**(H)** = Straight Condition  
**(RH)** = Right Hand Condition  
**(LH)** = Left Hand Condition

# Dividends Horizon DP7 Post Components

## *Post Covers and High Low Post Covers*

Dividends Horizon

description	h	pattern no.	Metal P1	Metal P2	Metal P3	Veneer
Dividends Horizon High Low Post Covers	64" - 78"	<b>DP7PC14( )</b>	\$15.	\$20.	\$22.	\$157.
<hr/>						
Dividends Horizon Post Covers Full Height Double Underlap	28 1/2"	<b>DP7PCWHU</b>	113.	125.	130.	230.
	36"	<b>DP7PC36U</b>	118.	130.	135.	249.
	42"	<b>DP7PC42U</b>	122.	133.	138.	271.
	50"	<b>DP7PC50U</b>	134.	147.	155.	308.
	57"	<b>DP7PC57U</b>	135.	149.	156.	333.
	64"	<b>DP7PC64U</b>	147.	163.	169.	371.
	78"	<b>DP7PC78U</b>	203.	222.	231.	473.
<hr/>						
Dividends Horizon High Low Post Covers Double Underlap	36"-42"	<b>DP7PC07UH</b>	88.	96.	100.	175.
	36"-50"	<b>DP7PC14UH</b>	92.	101.	107.	187.
	36"-57"	<b>DP7PC21UH</b>	91.	100.	104.	182.
	36"-64"	<b>DP7PC28UH</b>	98.	109.	113.	198.
	42"-50"	<b>DP7PC07UH</b>	88.	96.	100.	175.
	42"-57"	<b>DP7PC14UH</b>	92.	101.	107.	187.
	42"-64"	<b>DP7PC28UH</b>	98.	109.	113.	198.
	42"-78"	<b>DP7PC36UH</b>	108.	118.	123.	249.
	50"-57"	<b>DP7PC07UH</b>	88.	96.	100.	175.
	50"-64"	<b>DP7PC14UH</b>	92.	101.	107.	187.
	50"-78"	<b>DP7PC28UH</b>	98.	109.	113.	198.
	57"-64"	<b>DP7PC07UH</b>	88.	96.	100.	175.
	57"-78"	<b>DP7PC21UH</b>	91.	100.	104.	182.
	64"-78"	<b>DP7PC14UH</b>	92.	101.	107.	187.

### Ordering Information

#### Post Covers

1. Pattern number
2. Finish

### Order Code

#### Post Top Caps

*Example:* **DP7PT45**  
613 Silver Paint Finish

### Included with:

### Options

#### Post Covers

Add a "V" suffix to the base pattern number for a veneer finish.

#### High Low Post Covers Options

**(H)** = Straight Condition  
**(RH)** = Right Hand Condition  
**(LH)** = Left Hand Condition

**This page intentionally left blank**

## Legacy Post Assemblies

Post assemblies are required for all "L", "T", and "X" applications involving same-height panels. Included with post assemblies are the appropriate post, post cover and top cap.

Post connectors use the universal panel connection hardware for attachment, which is included with the post.

For high-low and post-to-panel applications, posts and covers must be ordered separately by component.

**NOTE: LEGACY POSTS ARE FOR EXISTING CUSTOMERS ONLY.**

## Legacy Post and Trim Construction

Posts are 3" square extruded aluminum construction. Post covers are flat or radius profile, metal or smooth textured plastic extrusion with softly-radiused molded plastic top cap. Metal post covers are powder-coated 20 ga. steel.

Posts have cut-outs for electrical and data access that match the wire and cable channels provided by panel frames. This allows cables to be routed through the post at the topway and base raceway. Refer to the Beltway Electrical Specification page for cable routing information.

The illustrations that follow are common same-height post assembly configurations. Choose the post assembly that matches the required application.

## Post "L" Configuration

"L" assembly includes:

- Universal post
- Two-way top cap
- Corner post cover

## Post "L" Configuration

"L" post assembly includes:

- Universal post
- Two-way top cap
- Corner post cover

## Post "T" Configuration

"T" post assembly includes:

- Universal post
- Three-way top cap
- Straight post cover

## Trim options available:

- Smooth Radius Plastic
- Radius Metal
- Flat Metal

**Note:** Not available with fabric covered post covers.

### Through-Post Access for Power and Data

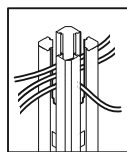

Topway Cable Access

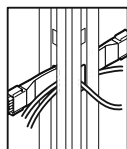

Beltway Power and Cable

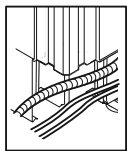

Base Raceway Power and Cable

### Two-Way Post Connection

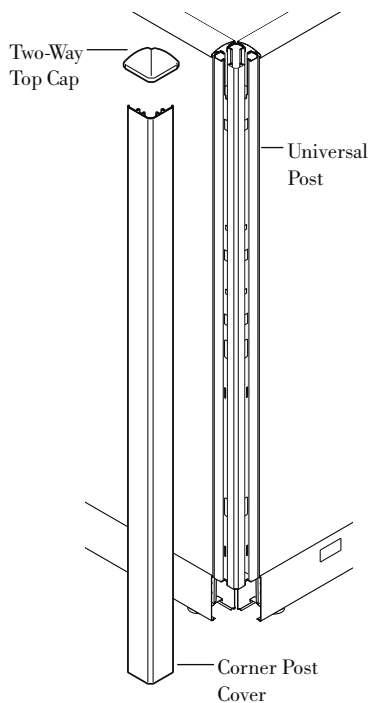

### Post Top Cap for Enhanced Smooth Trim

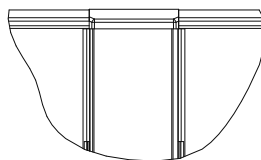

### Post and Cover Top Views

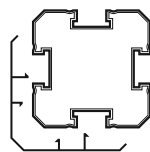

Corner Post Cover

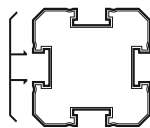

Straight Post Cover

### Post "L" Configurations

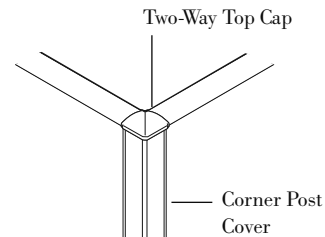

### Post "T" Configurations

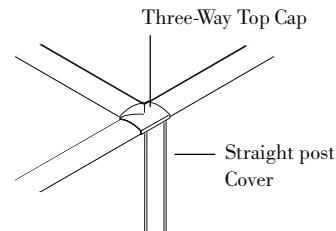

### Post "X" Configurations

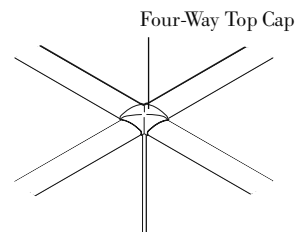





# Legacy Post Assemblies

## L, T and X Configurations

Dividends Horizon

description	h *	w	d	pattern no.	Plastic list	Metal P1	Metal P2	Metal P3
 Two-Way Post Assembly ("L")	36"	3"	3"	<b>DP( )PA362</b>	\$122.	\$156.	\$164.	\$174.
	42"	3"	3"	<b>DP( )PA422</b>	122.	156.	164.	174.
	50"	3"	3"	<b>DP( )PA502</b>	137.	169.	178.	185.
	57"	3"	3"	<b>DP( )PA572</b>	168.	200.	209.	218.
	64"	3"	3"	<b>DP( )PA642</b>	168.	200.	209.	218.
	78"	3"	3"	<b>DP( )PA782</b>	269.	287.	305.	318.
 Three-Way Post Assembly ("T")	36"	3"	3"	<b>DP( )PA363</b>	112.	162.	171.	178.
	42"	3"	3"	<b>DP( )PA423</b>	112.	162.	171.	178.
	50"	3"	3"	<b>DP( )PA503</b>	124.	174.	180.	190.
	57"	3"	3"	<b>DP( )PA573</b>	152.	200.	209.	218.
	64"	3"	3"	<b>DP( )PA643</b>	152.	200.	209.	218.
	78"	3"	3"	<b>DP( )PA783</b>	249.	285.	300.	316.
 Four-Way Post Assembly ("X")	36"	3"	3"	<b>DP( )PA364</b>	99.	150.	158.	166.
	42"	3"	3"	<b>DP( )PA424</b>	99.	150.	158.	166.
	50"	3"	3"	<b>DP( )PA504</b>	110.	158.	168.	176.
	57"	3"	3"	<b>DP( )PA574</b>	133.	180.	191.	201.
	64"	3"	3"	<b>DP( )PA644</b>	133.	180.	191.	201.
	78"	3"	3"	<b>DP( )PA784</b>	222.	262.	274.	287.

Post Connectors/End Trim

h = nominal height

### Ordering Information

#### Post Assemblies

1. Pattern Number
2. Trim Finish

### Order Code

#### Post Assemblies

*Example:* **DP(2A)PA 642, 113**  
**DP(2A)PA** Pattern Number  
**642**  
**113** Dark grey trim finish

### Included with:

#### Post Assemblies

- Post assemblies
- Post top cap
- Post cover
- Connecting hardware

### Options

#### Post Assemblies

**Post Assembly Trim Options**  
**(2A)** = Plastic, Enhanced Smooth Radius  
**(4)** = Metal, Radius  
**(5)** = Metal, Flat

## High-Low Post Components

High-Low panel-to-post configurations require ordering the post covers by components.

Shown are common high-low panel-to-post configurations. Choose the high-low panel-to-post configuration that matches the required application.

Post connectors use the universal panel connection hardware for attachment, which is included with the post.

## Universal Post and High-Low Trim Construction

- Posts: 3" square extruded aluminum.
- Post covers: Flat-profile, plastic extrusion with a smooth finish
- Top cap: Softly-radiused injection molded plastic

## High-Low "L" Post Connector Configuration (see Figure 1)

High-Low "L" components required:

- 1 One, universal post that matches height of tallest panel
- 2 One, "one-way" post top cap

- 3 Two straight post covers that match height of tallest panel

- 4 One, high-low straight post cover that matches high-low panel-to-post dimension

## High-Low "T" Post Connector Configuration A (see Figure 2)

High-Low "T" components required:

- 1 One, universal post that matches height of tallest panel
- 2 One, "two-way" top cap
- 3 One, straight post cover that matches height of tallest panel
- 4 One, high-low straight post cover that matches high-low panel-to-post dimension

## High-Low "T" Post Connector Configuration B (see Figure 3)

High-Low "T" components required:

- 1 One, universal post that matches height of tallest panel
- 2 One, "in-line" top cap
- 3 One, straight post cover that matches height of tallest panel

- 4 One, high-low straight post cover that matches high-low panel-to-post dimension

## Hi-Lo "T" Post Connector Configuration C (see Figure 4)

High-Low "T" components required:

- 1 One, universal post that matches height of tallest panel
- 2 One, "one-way" top cap
- 3 One, straight post cover that matches height of tallest panel
- 4 Two, high-low straight post covers that match high-low panel-to-post dimensions

## High-Low "X" Post Connector Configuration A (see Figure 5)

High-Low "X" components required:

- 1 One universal post that matches height of tallest panel
- 2 One, "one-way" top cap
- 3 Three, high-low straight post covers that match high-low panel-to-post dimensions

## High-Low "X" Post Connector Configuration B (see Figure 6)

High-Low "X" components required:

- 1 One, universal post that matches height of tallest panel
- 2 One, "in-line" top cap
- 3 Two, high-low straight post covers that match high-low panel-to-post dimensions

## High-Low "X" Post Connector Configuration C (see Figure 7)

High-Low "X" components required:

- 1 One, universal post that matches height of tallest panel
- 2 One, "two-way" top cap
- 3 Two, high-low straight post covers that match high-low panel-to-post dimensions

## High-Low "X" Post Connector Configuration D (see Figure 8)

High-Low "X" components required:

- 1 One, universal post that matches height of tallest panel
- 2 One, "three-way" top cap
- 3 One, high-low straight post cover that matches high-low panel to-post dimension

Figure 1

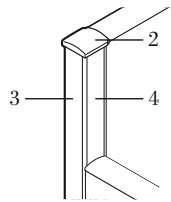

Figure 2

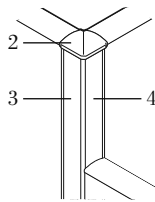

Figure 3

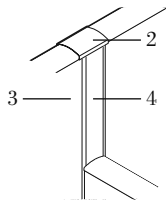

Figure 4

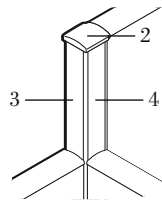

Figure 5

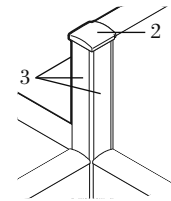

Figure 6

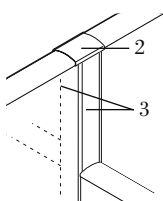

Figure 7

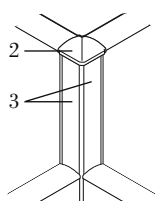
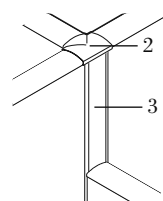

Figure 8







## Post Top Caps

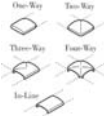

# Legacy Post Components

## Post, Post Top Caps and Post Covers

Dividends Horizon

description	type	h	w	d	pattern no.	Price list	Metal P1	Metal P2	Metal P3
 Universal Post (Post Only)		36"	3"	3"	DP2APO36	\$92.			
		42"	3"	3"	DP2APO42	92.			
		50"	3"	3"	DP2APO50	105.			
		57"	3"	3"	DP2APO57	126.			
		64"	3"	3"	DP2APO64	126.			
		78"	3"	3"	DP2APO78	217.			
 Post Top Caps	Two-Way	1/2"	3"	3"	DP( )PT2	5.	10.	11.	11.
	Three-Way	1/2"	3"	3"	DP( )PT3	5.	10.	11.	11.
	Four-Way	1/2"	3"	3"	DP( )PT4	5.	10.	11.	11.
	One-Way	1/2"	3"	3"	DP( )PT1	5.	10.	11.	11.
	In-Line (Straight)	1/2"	3"	3"	DP( )PTS	5.	10.	11.	11.
 Post Covers (Straight)		36"			DP( )PC36SF	11.	49.	53.	59.
		42"			DP( )PC42S	11.	49.	53.	59.
		50"			DP( )PC50S	12.	50.	56.	60.
		57"			DP( )PC57S	19.	59.	61.	63.
		64"			DP( )PC64S	19.	59.	61.	63.
		78"			DP( )PC78S	28.	63.	67.	69.
 Post Covers (Corner)		36"			DP( )PC36L	26.	74.	77.	80.
		42"			DP( )PC42L	26.	74.	77.	80.
		50"			DP( )PC50L	29.	77.	81.	88.
		57"			DP( )PC57L	35.	84.	91.	97.
		64"			DP( )PC64L	35.	84.	91.	97.
		78"			DP( )PC78L	45.	97.	101.	105.
 Post Covers (Straight) High-Low Connection	36" - 42"	8"			DP( )PC08S	4.	11.	13.	13.
	42" - 50"	8"			DP( )PC08S	4.	11.	13.	13.
	36" - 50"	14"			DP( )PC14S	5.	16.	22.	23.
	50" - 64"	14"			DP( )PC14S	5.	16.	22.	23.
	64" - 78"	14"			DP( )PC14S	5.	16.	22.	23.
	42" - 64"	22"			DP( )PC22S	6.	25.	26.	27.
	50" - 78"	28"			DP( )PC28S	12.	40.	42.	43.
	36" - 64"	28"			DP( )PC28S	12.	40.	42.	43.
	42" - 78"	36"			DP( )PC36S	19.	53.	59.	61.
	36" - 78"	42"			DP( )PC42SH	25.	60.	62.	64.



Post Connectors/End Trim

Ordering Information	Order Code	Included with:	Options
<b>Universal Post</b> 1. Pattern Number	<b>Universal Post</b> <i>Example:</i> DP2A P050 <hr/> DP2A Pattern Number P050	<b>Universal Post</b>  Connecting hardware	<b>Universal Post</b>  <b>Panel Top Cap and Post Cover Options:</b> (2A)= Plastic, Enhanced Smooth Radius (4) = Metal, Radius (5) = Metal, Flat
<b>Post Top Cap</b> 1. Pattern Number 2. Trim finish	<b>Post Top Cap</b> <i>Example:</i> DP2A PT4, V04 <hr/> DP2A PT4 Pattern Number 117 Soft grey	<b>Panel Top Cap</b>  <b>Post Covers</b>	
<b>Post Covers</b> 1. Pattern Number 2. Trim finish	<b>Post Covers</b> <i>Example:</i> DP2A PC50S, 117 <hr/> DP(2A) Pattern Number PC50S 117 Soft grey		

# Legacy Post Components

## Stack Panel Posts

Dividends Horizon

description	h	w	d	pattern no.	List Price
14" High Stack Panel Posts 	14 <sup>5</sup> / <sub>8</sub> "	3"	3"	<b>DP2ASPO 14</b>	\$88.
21" High Stack Panel Posts 	21 <sup>15</sup> / <sub>16</sub> "	3"	3"	<b>DP2ASPO 21</b>	89.
28" High Stack Panel Posts 	29 <sup>1</sup> / <sub>4</sub> "	3"	3"	<b>DP2ASPO 28</b>	99.

Ordering Information	Order Code	Included with:	Options
<b>Stack Panel Frame</b>	<b>Stack Panel Frame</b>	<b>Stack Panel Frame</b>	<b>Stack Panel Post</b>
1. Pattern Number	<i>Example:</i> <b>DP2STF 1448, 113</b>	<b>Stack Panel Post</b>	
2. Trim Finish	<b>DP1STF</b> Pattern Number		
<b>Stack Panel Post</b>	<b>1448</b>		
1. Pattern Number	<b>113</b> Dark grey paint finish		
	<b>Stack Panel Post</b>		
	<i>Example:</i> <b>DP2ASPO 14</b>		
	<b>DP2ASPO</b> Pattern Number		
	<b>14</b>		

**This page intentionally left blank**

## Panel End Trim

Panel end trim in one of three trim types ends a panel run.

Trim options available:

- Smooth Radius Plastic
- Metal Radius
- Metal Flat

Metal trim is constructed of extruded aluminum, powder coated.

End trim includes the appropriate attachment hardware and the panel end cap for transition to panel top trim.

## Thin Profile Panel End Trim

The thin profile panel end trim is an extruded aluminum end cover that is designed to attach to panel ends to provide a smooth end condition for the end of panel runs. The thin profile end trim and high low end trims are constructed of extruded aluminum with a powder coated finish. Thin profile panel end trim may only be used with panels that have been selected with the number 5 (flat metal) trim option.

## High-Low Panel-to-Panel End Trim

High-low panel-to-panel end trim is used to complete straight, high-low panel-to-panel connections.

Construction and attachment is identical to panel end trim and includes attachment hardware and top/bottom end caps.

Up to ten, category 5 cables can be laid-in to carry data from the upper panel topway to the lower panel topway.

## High-Low Thin Profile End Trim

High-low panel to panel end trim is used to complete straight, high-low panel to panel connections. Construction and attachment is identical to the thin profile panel end trim and includes attachment hardware. High-low thin profile end trim may only be used with panels that have been selected with the number 5 (flat metal) trim option.

**Note:** When using the high-low thin profile end trim, the higher and lower panels continue to use the standard full-width top cap.

## Panel Top Caps

Smooth plastic and metal panel top caps are available in all panel widths.

**Construction:** Plastic top caps are constructed of injection molded colored plastic. Metal caps are powder coated steel.

Top caps with retainer clips must be ordered when using top caps on full view panels.

## Shortened High-Low Panel Top Caps

When specifying the enhanced smooth or metal panel trim for a high-low panel end trim condition, the top cap on the lower panel must be shortened by 1 inch. Panel top caps can be field cut to the new length, or shortened top caps may be ordered separately.

**Note:** Thin profile end trim and high low end trim are available in Knoll core finishes only.

Panel End Trim

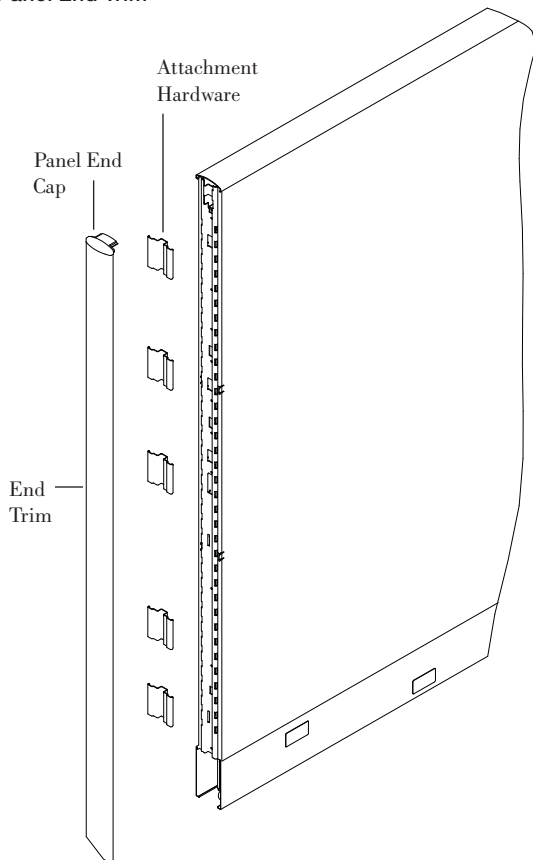

Enhanced High-Low Panel End Trim

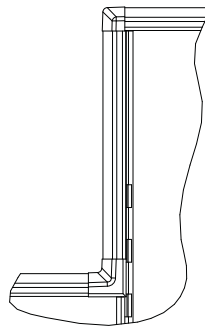

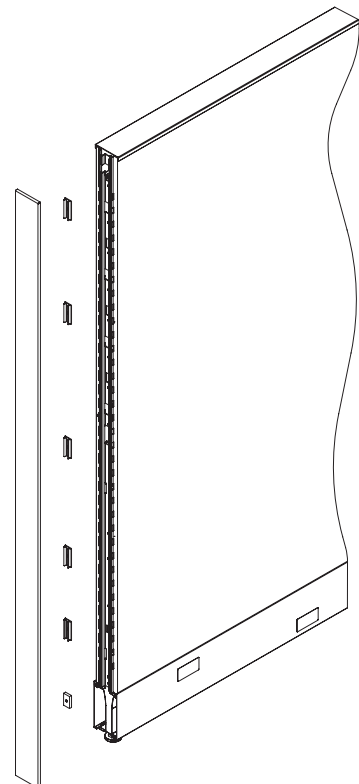

Thin Profile End Trim



# Panel End Trim and Panel Top Caps

## Panel End and High-Low Panel End

Dividends Horizon

description	type	h *	w	d	pattern no.	Plastic	Metal P1	Metal P2	Metal P3	Veneer
 Panel End	28 1/2"	28 1/2"	3"	5/8"	DP( )PEWH	\$20.	\$59.	\$65.	\$67.	\$205.
	28 1/2" + 14"	42 1/2"	3"	5/8"	DP( )PEWHS14	0.	67.	73.	76.	n/a
	28 1/2" + 21"	49 1/2"	3"	5/8"	DP( )PEWHS21	0.	70.	77.	80.	n/a
	28 1/2" + 28"	56 1/2"	3"	5/8"	DP( )PEWHS28	0.	72.	79.	82.	n/a
	36"	36"	3"	5/8"	DP( )PE36F	20.	59.	65.	67.	215.
	42"	42"	3"	5/8"	DP( )PE42	22.	61.	66.	68.	230.
	50"	50"	3"	5/8"	DP( )PE50	23.	64.	67.	69.	258.
	57"	57"	3"	5/8"	DP( )PE57	25.	66.	69.	71.	288.
	64"	64"	3"	5/8"	DP( )PE64	25.	66.	69.	71.	312.
	78"	78"	3"	5/8"	DP( )PE78	30.	71.	75.	78.	341.
 Panel End, High-Low	28 1/2" - 36"	7 1/2"	3"	3/8"	DP( )PEWH36	0.	49.	55.	57.	n/a
	28 1/2" - 42"	13 1/2"	3"	3/8"	DP( )PEWH42	0.	53.	58.	60.	n/a
	28 1/2" - 50"	21 1/2"	3"	3/8"	DP( )PEWH50	0.	56.	61.	64.	n/a
	28 1/2" - 57"	28 1/2"	3"	3/8"	DP( )PEWH57	0.	59.	66.	68.	n/a
	28 1/2" - 64"	35 1/2"	3"	3/8"	DP( )PEWH64	0.	61.	68.	71.	n/a
	28 1/2" - 78"	49 1/2"	3"	3/8"	DP( )PEWH78	0.	68.	74.	77.	n/a
	36" - 42"	6"	3"	3/8"	DP( )PE08	7.	36.	39.	40.	159.
	36" - 50"	14"	3"	3/8"	DP( )PE14	9.	39.	41.	42.	183.
	36" - 57"	21"	3"	3/8"	DP( )PE22	13.	41.	44.	46.	195.
	36" - 64"	28"	3"	3/8"	DP( )PE28	25.	50.	54.	57.	203.
	36" - 78"	42"	3"	3/8"	DP( )PE42H	32.	61.	66.	68.	234.
	42" - 50"	8"	3"	3/8"	DP( )PE08	7.	36.	39.	40.	159.
	42" - 57"	15"	3"	3/8"	DP( )PE14	9.	39.	41.	42.	183.
	42" - 64"	22"	3"	3/8"	DP( )PE22	13.	41.	44.	46.	195.
	42" - 78"	36"	3"	3/8"	DP( )PE36	31.	59.	65.	67.	217.
	50" - 57"	7"	3"	3/8"	DP( )PE08	7.	36.	39.	40.	159.
	50" - 64"	14"	3"	3/8"	DP( )PE14	9.	39.	41.	42.	183.
	50" - 78"	28"	3"	3/8"	DP( )PE28	25.	50.	54.	57.	203.
	57" - 64"	7"	3"	3/8"	DP( )PE08	7.	36.	39.	40.	159.
	57" - 78"	21"	3"	3/8"	DP( )PE22	13.	41.	44.	46.	195.
64" - 78"	14"	3"	3/8"	DP( )PE14	9.	39.	41.	42.	183.	

h\* = Nominal height  
Dimensions listed under h w d are actual to the nearest 1/16"

### Ordering Information

#### Panel End

1. Pattern Number
2. Trim Finish

#### High-Low Panel End

1. Pattern Number
2. Trim Finish

### Order Code

#### Panel End

Example: **DP2A PE42, 117**

**DP2A** Pattern Number

**PE42**

**117** Soft grey

#### High-Low Panel End

Example: **DP2A PE42 117**

**DP2A** Pattern Number

**PE42**

**117** Soft Grey

### Included with:

#### Panel End

- Panel end cover
- Connecting hardware

#### High-Low Panel End

- Panel end cover
- Connecting hardware
- Lower transition cap



### Options

#### Panel End, High-Low Panel End and Top Caps

#### Trim options

- (2A)** = Enhanced Smooth Radius Plastic
- (4)** = Radius Metal
- (5)** = Flat Metal
- (V4)** = Radius Veneer
- (V5)** = Flat Veneer

*Thin Profile Panel End Trim and High-Low Panel End*

description	type	h*	w	d	pattern no.	P1	P2	P3
Thin Profile Panel End 	28 1/2"	28 1/2"	3"	5/8"	<b>DP6PEWH</b>	\$92.	\$92.	\$92.
	28 1/2" + 14"	42 1/2"	3"	5/8"	<b>DP6PEWHS14</b>	109.	119.	124.
	28 1/2" + 21"	49 1/2"	3"	5/8"	<b>DP6PEWHS21</b>	117.	129.	134.
	28 1/2" + 28"	56 1/2"	3"	5/8"	<b>DP6PEWHS28</b>	126.	138.	143.
	36"	36"	3"	5/8"	<b>DP6PE36F</b>	92.	92.	92.
	42"	42"	3"	5/8"	<b>DP6PE42</b>	99.	99.	99.
	50"	50"	3"	5/8"	<b>DP6PE50</b>	110.	110.	110.
	57"	57"	3"	5/8"	<b>DP6PE57</b>	119.	119.	119.
	64"	64"	3"	5/8"	<b>DP6PE64</b>	129.	129.	129.
	78"	78"	3"	5/8"	<b>DP6PE78</b>	150.	150.	150.
Thin Profile Panel End High-Low 	28 1/2"-36"	36"	3"	5/8"	<b>DP6PEWH36</b>	64.	70.	73.
	28 1/2"-42"	42"	3"	5/8"	<b>DP6PEWH42</b>	72.	79.	82.
	28 1/2"-50"	50"	3"	5/8"	<b>DP6PEWH50</b>	79.	88.	91.
	28 1/2"-57"	57"	3"	5/8"	<b>DP6PEWH57</b>	87.	95.	99.
	28 1/2"-64"	64"	3"	5/8"	<b>DP6PEWH64</b>	96.	107.	111.
	28 1/2"-78"	78"	3"	5/8"	<b>DP6PEWH78</b>	116.	128.	133.
	36"-42"	6"	3"	5/8"	<b>DP6PE08</b>	46.	48.	48.
	36"-50"	14"	3"	5/8"	<b>DP6PE14</b>	58.	61.	61.
	36"-57"	21"	3"	5/8"	<b>DP6PE22</b>	70.	74.	74.
	36"-64"	28"	3"	5/8"	<b>DP6PE28</b>	81.	85.	85.
	36"-78"	42"	3"	5/8"	<b>DP6PE42H</b>	99.	107.	107.
	42"-50"	8"	3"	5/8"	<b>DP6PE08</b>	46.	48.	48.
	42"-57"	15"	3"	5/8"	<b>DP6PE14</b>	58.	61.	61.
	42"-64"	22"	3"	5/8"	<b>DP6PE22</b>	70.	74.	74.
	42"-78"	36"	3"	5/8"	<b>DP6PE36</b>	92.	96.	96.
	50"-57"	7"	3"	5/8"	<b>DP6PE08</b>	46.	48.	48.
	50"-64"	14"	3"	5/8"	<b>DP6PE14</b>	58.	61.	61.
	50"-78"	28"	3"	5/8"	<b>DP6PE28</b>	81.	85.	85.
	57"-64"	7"	3"	5/8"	<b>DP6PE08</b>	46.	48.	48.
	57"-78"	21"	3"	5/8"	<b>DP6PE22</b>	70.	74.	74.
64"-78"	14"	3"	5/8"	<b>DP6PE14</b>	58.	61.	61.	

h\* = Nominal height  
Dimensions listed under h w d are actual to the nearest 1/16"

Ordering Information	Order Code	Included with:	Options
<b>Thin Profile End Trim</b>	<b>Thin Profile End Trim</b>	<b>Thin Panel End Trim</b>	
1. Pattern Number	<i>Example:</i> <b>DP6PE42 117</b>	Attachment hardware	
2. Finish	<b>DP</b> Dividends Panel	<b>Note:</b> Thin profile end trim is only available in Knoll core paint finishes.	
	<b>6</b> Thin Profile		
	<b>PE</b> Panel End		
	<b>42</b> Height		
	<b>117</b> Finish		



# Panel End Trim and Panel Top Caps

## Topway and Full View Frame Top Caps

Dividends Horizon

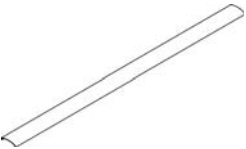
description	w	pattern no.	Plastic	Metal P1	Metal P2	Metal P3	Veneer
Panel Top Caps 	15"	<b>DP( )PT15</b>	\$13.	\$40.	\$42.	\$44.	\$83.
	18"	<b>DP( )PT18</b>	13.	40.	42.	44.	91.
	24"	<b>DP( )PT24</b>	15.	40.	42.	44.	104.
	30"	<b>DP( )PT30</b>	20.	40.	42.	44.	118.
	36"	<b>DP( )PT36</b>	22.	40.	42.	44.	133.
	42"	<b>DP( )PT42</b>	22.	40.	42.	44.	149.
	48"	<b>DP( )PT48</b>	23.	40.	42.	44.	168.
	54"	<b>DP( )PT54</b>	n/a	44.	46.	48.	187.
	60"	<b>DP( )PT60</b>	27.	47.	49.	52.	210.
	66"	<b>DP( )PT66</b>	n/a	52.	55.	58.	231.
	72"	<b>DP( )PT72</b>	n/a	57.	61.	65.	244.
	78"	<b>DP( )PT78</b>	n/a	64.	67.	70.	258.
	84"	<b>DP( )PT84</b>	n/a	69.	72.	76.	272.
	90"	<b>DP( )PT90</b>	n/a	75.	79.	82.	288.
	96"	<b>DP( )PT96</b>	n/a	80.	85.	90.	306.

Post Connectors/End Trim

### Ordering Information

- Panel Top Cap**  
 1. Pattern Number  
 2. Trim Finish

### Order Code

**Panel Top Cap**  
*Example:* **DP5PT18, 117**  
**DP5PT18** Pattern number  
**117** Soft Grey trim finish

### Included with:

- Panel Top Cap**  
 • Panel Top Cap

### Options

- Panel Top Caps**  
**Trim options**  
**(2A)** = Enhanced Smooth Radius Plastic  
**(4)** = Radius Metal  
**(5)** = Flat Metal  
**(V4)** = Radius Veneer  
**(V5)** = Flat Veneer

# Panel End Trim and Panel Top Caps

## Shortened Panel Top Caps

Dividends Horizon

description	w	pattern no.	Plastic	Metal P1	Metal P2	Metal P3	Veneer
Shortened Panel Top Caps (for lower panel on high-low panel to panel application) Not for use with DP6 Thin profile panel ends	14"	<b>DP( )PT14</b>	\$13.	\$40.	\$42.	\$44.	\$83.
	17"	<b>DP( )PT17</b>	13.	40.	42.	44.	91.
	23"	<b>DP( )PT23</b>	15.	40.	42.	44.	104.
	29"	<b>DP( )PT29</b>	20.	40.	42.	44.	118.
	35"	<b>DP( )PT35</b>	22.	40.	42.	44.	133.
	41"	<b>DP( )PT41</b>	22.	40.	42.	44.	149.
	47"	<b>DP( )PT47</b>	23.	40.	42.	44.	168.
	53"	<b>DP( )PT53</b>	n/a	44.	46.	48.	187.
	59"	<b>DP( )PT59</b>	27.	47.	49.	52.	210.
	65"	<b>DP( )PT65</b>	n/a	52.	55.	58.	231.
	71"	<b>DP( )PT71</b>	n/a	57.	61.	65.	244.
	77"	<b>DP( )PT77</b>	n/a	64.	67.	70.	258.
	83"	<b>DP( )PT83</b>	n/a	69.	72.	76.	272.
	89"	<b>DP( )PT89</b>	n/a	75.	79.	82.	288.
	95"	<b>DP( )PT95</b>	n/a	80.	85.	90.	306.

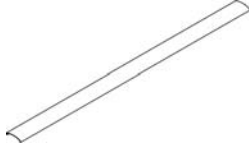

h\* = Nominal height  
 Dimensions listed under h w d are actual to the nearest 1/16"

Ordering Information	Order Code	Included with:	Options
<b>Panel Top Cap</b> 1. Pattern Number 2. Trim Finish	<b>Panel Top Cap</b> <i>Example:</i> <b>DP5PT18, 117</b> <b>DP5PT18</b> Pattern number	<b>Panel Top Cap</b> • Panel Top Cap	<b>Panel Top Caps</b>  <b>Trim options</b> <b>(2A)</b> = Enhanced Smooth Radius Plastic <b>(4)</b> = Radius Metal <b>(5)</b> = Flat Metal <b>(V4)</b> = Radius Veneer <b>(V5)</b> = Flat Veneer
<b>Panel-to-Panel Top Cap Transition</b> 1. Pattern Number 2. Trim Finish	<b>117</b> Soft Grey trim finish		

**This page intentionally left blank**

# Panel Wall Starter, Panel-to-Panel Top Cap Transition

## *Off-Module Panel Connector*

### *Specifications*

#### Panel Wall Starter

Panel wall starters mount to reinforced building walls to begin a perpendicular topway or full view panel run. Wall starters consist of a wall bracket and upper and lower panel-mounting brackets. Wall fasteners are not included or supplied by Knoll. Choice of wall fasteners is critical and must be selected to match the wall construction, wall surface and loading conditions.

Wall starters are available in all Dividends Horizon panel heights. Black finish only.

**NOTE: KNOLL, INC. ASSUMES NO RESPONSIBILITY FOR WALL CONSTRUCTION OR PERFORMANCE OF FASTENERS USED.**

#### Off-Module Panel Connector

The off-module connector allows for panel attachment anywhere along the width of the perpendicular panel. The off-module connector can be used with same height topway or full view panels only. The connector consists of a height specific connector and attaching hardware. The 3-way (DP1PT3) or 4-way (DP1PT4) post top cap must be ordered separately when radius metal top caps are being used. Specify connector height to match panel height. Black finish only.

When using the off-module panel connector, the attached connector will deface the perpendicular fabric panel insert.

Electrical components and data cables cannot be routed through the off-module panel.

#### Panel-to-Panel Top Cap Transition

Top cap transitions fill the gap between panel top cap sections in straight panel-to-panel configurations.

- Construction: Trim-colored, softly-radiused molded plastic
- Size: 1" wide by 3" deep
- Attachment: Snaps between top cap sections in straight, same-height panel configurations

**NOTE: PANEL-TO-PANEL TOP CAP TRANSITIONS ARE ORDERED SEPARATELY FROM PANELS.**

Panel Wall Starter Connection

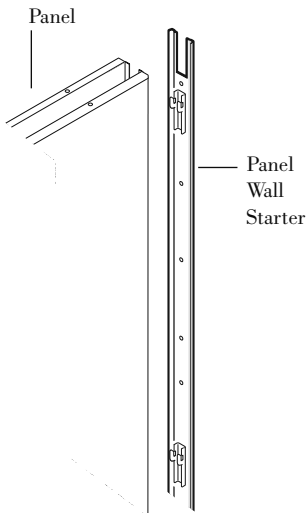

Off-Module Panel Connector

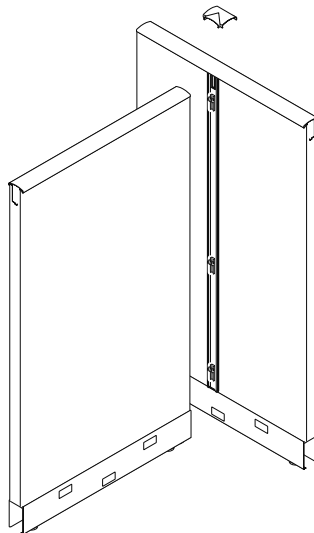

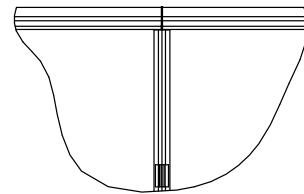

Panel-To-Panel Transition for Enhanced Smooth Panel Trim



# Panel Wall Starter, Panel-to-Panel Top Cap Transition and Off-Module Panel Connector

Dividends Horizon

description	type	h *	h	w	d	pattern no.	Single pack list	10 pack list
 Panel/Screen Wall Starter		36"	28"	2"	3/4"	<b>DP3PWS36</b>	\$94.	n/a
		42"	35 3/8"	2"	3/4"	<b>DP3PWS42</b>	98.	n/a
		50"	42 11/16"	2"	3/4"	<b>DP3PWS50</b>	102.	n/a
		57"	50"	2"	3/4"	<b>DP3PWS57</b>	105.	n/a
		64"	57 1/4"	2"	3/4"	<b>DP3PWS64</b>	111.	n/a
		78"	71 7/8"	2"	3/4"	<b>DP3PWS78</b>	116.	n/a
Panel-to-Panel Top Cap Transition		3/4"	1"	3"		<b>DP( ) TCT( )</b>	3.	25.
 Off-Module Panel Connector		36"	28"	2"	3/4"	<b>DP2PMS36</b>	61.	n/a
		42"	35 3/8"	2"	3/4"	<b>DP2PMS42</b>	61.	n/a
		50"	42 11/16"	2"	3/4"	<b>DP2PMS50</b>	69.	n/a
		57"	50"	2"	3/4"	<b>DP2PMS57</b>	72.	n/a
		64"	57 1/4"	2"	3/4"	<b>DP2PMS64</b>	74.	n/a
		78"	71 7/8"	2"	3/4"	<b>DP2PMS78</b>	89.	n/a
Radius Post Top Cap (for use with off-module panel connector when radius metal top caps are used)	three-way		1/2"	3"	3"	<b>DP1PT3</b>	5.	n/a
	four-way		1/2"	3"	3"	<b>DP1PT4</b>	5.	n/a

h\* = nominal height

Dimensions listed under h w d are actual to the nearest 1/16"

Ordering Information	Order Code	Included with:	Options
<b>Panel Wall Starter</b>	<b>Panel Wall Starter</b>	<b>Panel Wall Starter</b>	<b>Panel Wall Starter</b>
1. Pattern Number	<i>Example:</i> <b>DP1 PWS 64</b>	<b>Off-Module Panel Connector</b>	<b>Off-Module Panel Connector</b>
<b>Off-Module Panel Connector</b>	<b>DP1 PW</b> Pattern Number	<b>Panel-to-Panel Top Cap Transition</b>	<b>Panel-to-Panel Top Cap Transition</b>
1. Pattern Number	<b>64</b>	<b>Note:</b> Three-way or four-way post top cap must be ordered separately when radius metal panel top caps are being used.	<b>Trim Option:</b>
<b>Panel-to-Panel Top Cap Transition</b>	<b>Off-Module Panel Connector</b>		<b>(2A)</b> = Enhanced Smooth Radius Plastic
1. Pattern Number	<i>Example:</i> <b>DP1 PMS50</b>		<b>(4)</b> = Radius Metal
2. Trim Finish	<b>DP1</b> Pattern Number		<b>(5)</b> = Flat Metal
	<b>PMS50</b>		<b>(V4)</b> = Radius Veneer
	<b>Panel-to-Panel Top Cap Transition</b>		<b>(V5)</b> = Flat Veneer
	<i>Example:</i> <b>DP1 TCT, 117</b>		<b>Panel-to-Panel Top Cap Transition</b>
	<b>DP1 TCT</b> Pattern Number		Add an 'SP' suffix to the base pattern number for single pack or 'TP' suffix for a 10 pack.
	<b>117</b> Soft Grey		

Post Connectors/End Trim

## **Dividends Horizon Wall System**

The Dividends Horizon Wall System allows designers to transform the aesthetic and function of private offices.

With the use of vertical wall tracks, building walls can support worksurfaces and storage, while fabric, slatwall, and marker board tiles improve aesthetic and function.

## **Wall System Dimensions**

The Dividends Horizon wall system is available in heights of 57, 64, 71 and 78" from the finished floor. Wall tracks are designed to be positioned 5" from top of finished floor to accommodate building base molding and uneven floors.

Horizontal elements like bottom trim channels and top trims are available on 6" increments, from 24" to 48" wide. The maximum distance between wall tracks is 48".

## **Wall Tracks**

Wall tracks work like the vertical elements of a Dividends Horizon panel frame, and are shipped in pairs which include a left and right track. Tracks feature slotted standards on the standard Dividends Horizon 1 1/2" increment.

Wall tracks are attached to building walls at 7" height increments. Available in all Knoll Core paint finishes.

## **End Trim**

While wall tracks are painted, end trims are available for applications where a finished end is desired. Match end trim height to wall track height.

## **Top Cap**

Top caps are available for applications with a lower horizon height, and are optional. Top caps conceal the space between tiles and the finished wall, and the top of the wall tracks.

## **Bottom Channel**

The bottom channel is a "J" shaped channel that supports the bottom of the lowest tile. Bottom channels are also used during the installation process to accurately set the width between left and right wall tracks.

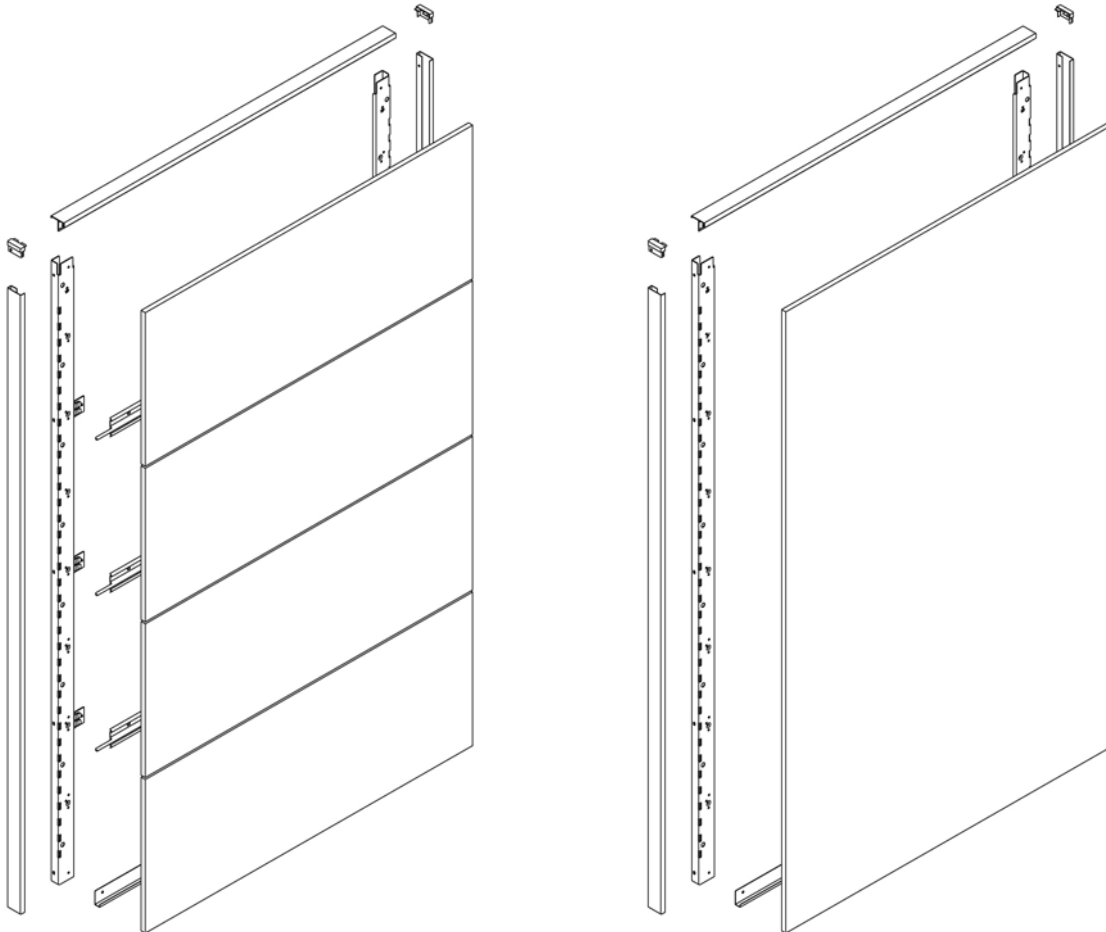

### Tile Supports

Tile supports are specified in the same manner as with Dividends Horizon panels, and are not required at the top or bottom of wall tracks, or with Slatwall. Specify Wall Track tile support mounting brackets for each tile support.

### Tiles

Standard Dividends Horizon tiles are specified with Wall Tracks.

Wall tracks support monolithic or tiled applications, using standard fabric, steel, or Slatwall tiles. Specify bottom channels at the bottom of the lowest tile.

Unlike panels, Wall Tracks accommodate tile supports at 7" inch increments, increasing design flexibility. Both D1 and D2 tile supports may be used with Wall Tracks.

For tiled applications, specify standard tile supports, and DP1WTTSB tile support mounting brackets for D2 tile supports.

### Worksurface Planning

Dividends Horizon worksurfaces up to 24" deep may be mounted to wall tracks, using the same cantilevers, end supports and end panels used in panel planning, and follow the same planning rules.

### Wall Track Planning

Wall tracks may be positioned on 6" width increments, from 24" to a maximum of 48".

Worksurfaces are supported with standard supports, including cantilevers, end supports, and end panels. Maximum worksurface depth when cantilever supported is 24".

One overhead may be mounted on each wall track section.

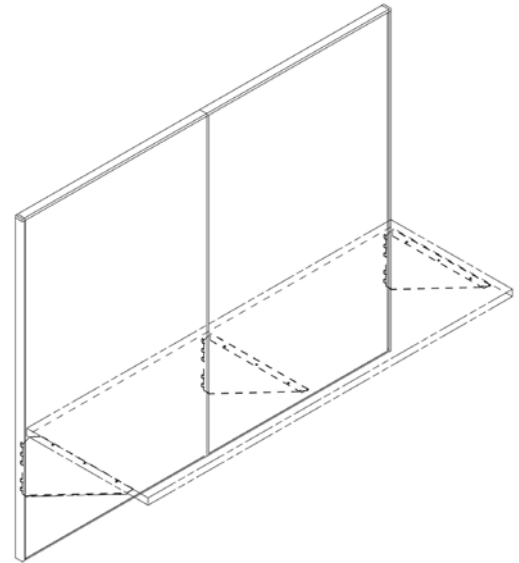



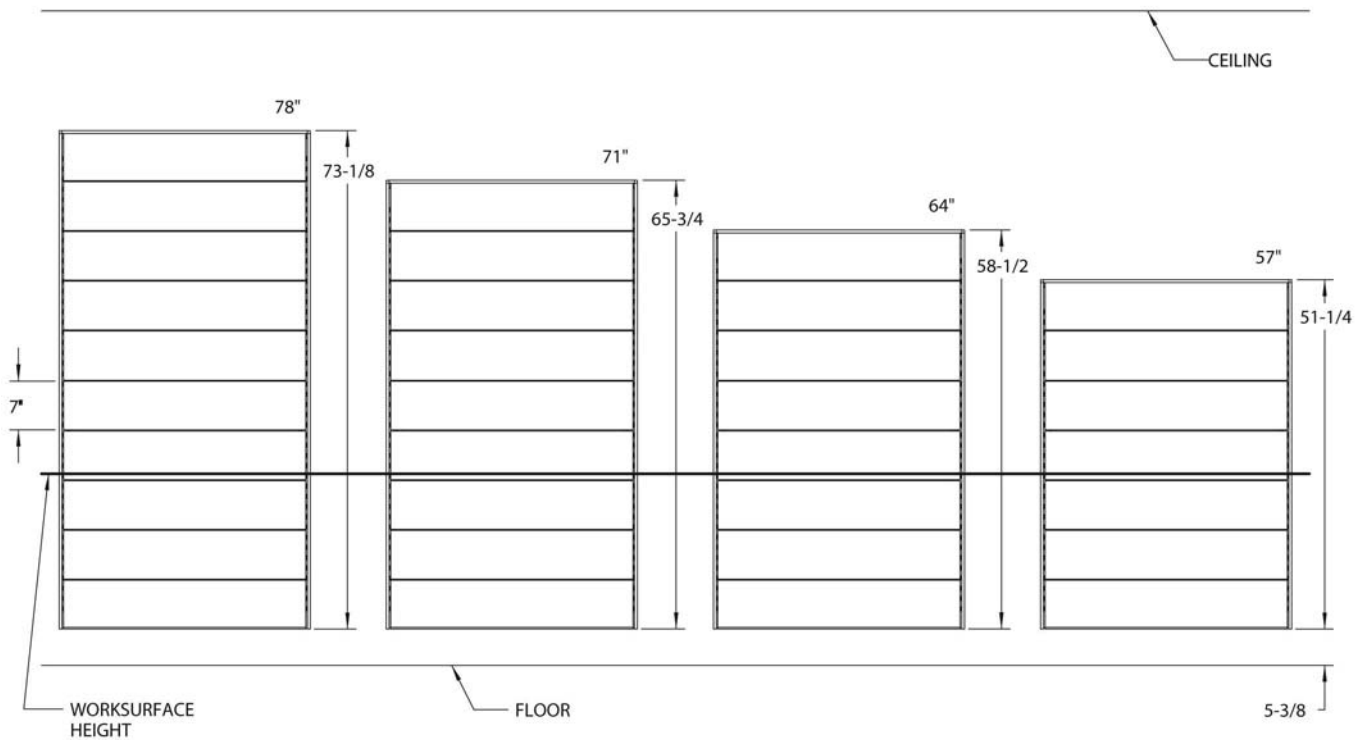

Post Connectors/End Trim



# Wall Mount Tracks and Components

## 57", 64", 71" and 78" High

Dividends Horizon

description	w	h	d	pattern no.	NA Black	P1	P2	P3
 Wall Mount Tracks (pair)	1 1/2"	57"	1 1/2"	<b>DP1WT57</b>	\$213.	\$213.	\$235.	\$244.
	1 1/2"	64"	1 1/2"	<b>DP1WT64</b>	221.	221.	244.	253.
	1 1/2"	71"	1 1/2"	<b>DP1WT71</b>	230.	230.	253.	264.
	1 1/2"	78"	1 1/2"	<b>DP1WT78</b>	239.	239.	263.	273.
 End Trim for Wall Mount Tracks	1 1/2"	57"	5/8"	<b>DP1WTET57</b>	n/a	78.	85.	89.
	1 1/2"	64"	5/8"	<b>DP1WTET64</b>	n/a	85.	94.	98.
	1 1/2"	71"	5/8"	<b>DP1WTET71</b>	n/a	85.	94.	98.
	1 1/2"	78"	5/8"	<b>DP1WTET78</b>	n/a	85.	94.	98.
 Top Cap for Wall Mount Tracks	15"	3/4"	1 1/2"	<b>DP1WTTC15</b>	n/a	62.	69.	72.
	18"	3/4"	1 1/2"	<b>DP1WTTC18</b>	n/a	66.	72.	75.
	24"	3/4"	1 1/2"	<b>DP1WTTC24</b>	n/a	69.	76.	79.
	30"	3/4"	1 1/2"	<b>DP1WTTC30</b>	n/a	77.	84.	88.
	36"	3/4"	1 1/2"	<b>DP1WTTC36</b>	n/a	87.	95.	99.
	42"	3/4"	1 1/2"	<b>DP1WTTC42</b>	n/a	94.	103.	109.
	48"	3/4"	1 1/2"	<b>DP1WTTC48</b>	n/a	94.	103.	109.
	54"	3/4"	1 1/2"	<b>DP1WTTC54</b>	n/a	112.	124.	129.
	60"	3/4"	1 1/2"	<b>DP1WTTC60</b>	n/a	113.	125.	130.
	66"	3/4"	1 1/2"	<b>DP1WTTC66</b>	n/a	113.	125.	130.
	72"	3/4"	1 1/2"	<b>DP1WTTC72</b>	n/a	113.	125.	130.
	78"	3/4"	1 1/2"	<b>DP1WTTC78</b>	n/a	118.	130.	135.
	84"	3/4"	1 1/2"	<b>DP1WTTC84</b>	n/a	159.	174.	181.
90"	3/4"	1 1/2"	<b>DP1WTTC90</b>	n/a	163.	178.	185.	
96"	3/4"	1 1/2"	<b>DP1WTTC96</b>	n/a	167.	183.	192.	
 Bottom Tile Channel for Wall Mount Tracks	15"			<b>DP1WTBTC15</b>	n/a	45.	49.	52.
	18"			<b>DP1WTBTC18</b>	n/a	46.	50.	53.
	24"			<b>DP1WTBTC24</b>	n/a	49.	55.	57.
	30"			<b>DP1WTBTC30</b>	n/a	52.	57.	59.
	36"			<b>DP1WTBTC36</b>	n/a	62.	69.	72.
	42"			<b>DP1WTBTC42</b>	n/a	71.	78.	81.
48"			<b>DP1WTBTC48</b>	n/a	81.	90.	93.	

### Ordering Information

#### Wall Mount Tracks

1. Pattern Number
2. Paint Finish

#### End Trim for Wall Mount Tracks

1. Pattern Number
2. Paint Finish

#### Top Cap for Wall Mount Tracks

1. Pattern Number
2. Paint Finish

#### Bottom Tile Channel for Wall Mount Tracks

1. Pattern Number
2. Paint Finish

#### Tile Support Brackets

1. Pattern Number

### Order Code

#### Wall Mount Tracks

*Example:* **DP1WT57613**

**DP1WT57** Pattern Number

**613** Paint Finish

#### Tile Support Brackets

*Example:* **DP1WTTSB**

**DP1WT** Pattern Number

**TSB**

### Included with:

#### Wall Mount Tracks

Wall fasteners are not included or supplied by Knoll.

#### Bottom Tile Channel for Wall Mount Tracks

- Hardware

#### Tile Support Brackets for Wall Mount Tracks

- Hardware

### Options



# Wall Mount Tracks and Components

## 57", 64", 71" and 78" High

Dividends Horizon

description	w	h	d	pattern no.	NA Black	P1	P2	P3
Tile Support Brackets for Wall Mount Tracks (pair)				<b>DP1WTTSB</b>	\$11.	n/a	n/a	n/a



Post Connectors/End Trim

Ordering Information	Order Code	Included with:	Options
<b>Wall Mount Tracks</b> 1. Pattern Number 2. Paint Finish	<b>Wall Mount Tracks</b> <i>Example:</i> <b>DP1WT57613</b> <b>DP1WT57</b> Pattern Number	<b>Wall Mount Tracks</b> Wall fasteners are not included or supplied by Knoll.	
<b>End Trim for Wall Mount Tracks</b> 1. Pattern Number 2. Paint Finish	<b>613</b> Paint Finish <b>Tile Support Brackets</b> <i>Example:</i> <b>DP1WTTSB</b>	<b>Bottom Tile Channel for Wall Mount Tracks</b> • Hardware	
<b>Top Cap for Wall Mount Tracks</b> 1. Pattern Number 2. Paint Finish	<b>DP1WT</b> Pattern Number <b>TSB</b>	<b>Tile Support Brackets for Wall Mount Tracks</b> • Hardware	
<b>Bottom Tile Channel for Wall Mount Tracks</b> 1. Pattern Number 2. Paint Finish			
<b>Tile Support Brackets</b> 1. Pattern Number			

### Panel Rigidizer Brackets

Panel rigidizer brackets are used to reduce panel connection flex where panel to worksurface brackets cannot be used.

Panel rigidizer brackets are unnecessary if a panel can be properly secured with the use of a panel to worksurface bracket.

Rigidizer brackets are available for inline (straight), 2-way (L), 3-way (T) and 4-way (X) panel conditions.

High-low panel to post conditions cannot accommodate the panel rigidizer brackets. Full view panel frames without a topway cannot accommodate a panel rigidizer bracket.

Carpet grippers are recommended for use with panel rigidizer brackets.

Specify panel rigidizer brackets for appropriate panel attachment condition.

- 2-way (L) for panels of the same height in a 90 degree application

- 3-way (T) for 3 panels of the same height attached to a universal post.
- 4-way (X) for 4 panels of the same height attached to a universal post.

### Carpet Grippers

Carpet grippers should be specified to increase rigidity of unsupported panel runs. The carpet grippers snap onto leveling glides to prevent panel runs from shifting on carpet. The glides rotate in carpet grippers to permit leveling. Available in black finish only.

### Panel-Mounted Coat Hook

The Dividends Horizon panel-mounted coat hook is made of extruded aluminum and is available in an anodized black finish or matte aluminum finish. The coat hook attaches to any Dividends Horizon panel by connecting over the top of the Dividends Horizon radius plastic and metal panel top caps only.

### Slotted Standard Coat Hook

Independent of the top cap, the slotted standard coat hook attaches to the left or right vertical slotted standard of any Dividends Horizon panel. The die cast slotted standard

coat hook is available in any of the Knoll Core paint finishes. The slotted standard coat hook is sold in packages of ten and is not compatible with laminate tiles or screens.

### Panel Reveal Fillers

Panel reveal filler strips are used to cover unused vertical panel slots. Panel reveal fillers are designed to only be used with Legacy post panel applications. Panel reveal fillers should not be used with panel applications that are using DP7 posts. Panel reveal fillers are available in two thickness:

- 1/2" for panel-to-panel and panel to end trim attachment.
- 1/4" for panel-to-post attachment.

Panel reveal fillers are offered in a 74" length and are field cut to install into any Dividends Horizon panel height.

To determine the correct amount of reveal fillers to be specified, use the following formulas: For panels and end trim-2 x the number of straight panel connections plus the number of panel end trims. For panel to post connections, 4x the number of posts.

### Panel Rigidizer Brackets

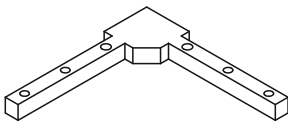

Two-way "L"

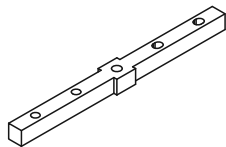

Inline (straight)

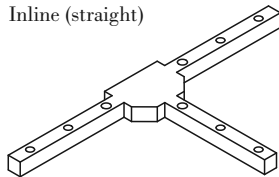

Three-way "T"

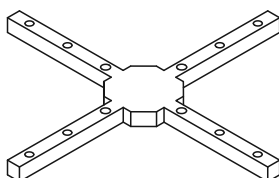

Four-way "X"

### Carpet Gripper



### Panel-Mounted Coat Hook (for radius plastic and metal trim only)



### Slotted Standard Coat Hook

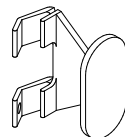

### Panel Reveal Fillers

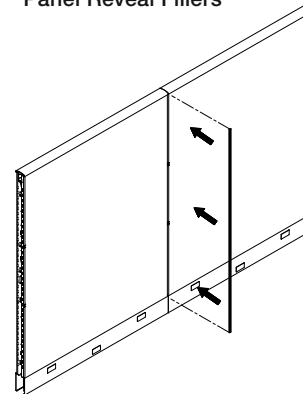

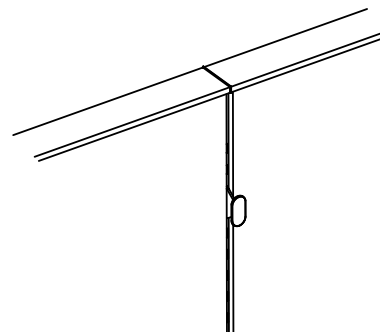

### Slotted Standard Coat Hook Application



# Panel Rigidizer Brackets, Coat Hooks and Reveal Fillers

## Carpet Grippers

Dividends Horizon

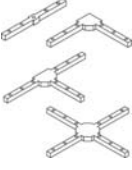
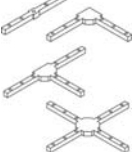
description	type	h	w	d	pattern no.	list	P1	P2	P3
Carpet Grippers 	Package of 10				<b>DP1 CG</b>	\$13.			
Coat Hook (For Panel Slotted Standard) 	Package of 10				<b>DP2CHTP</b>		139.	139.	139.
Coat Hook (For radius metal and plastic trim only) (Package of 4) 	Anodized Black Finish				<b>DP1 CHB</b>	121.			
	Matte Aluminum Finish				<b>DP1 CHP</b>	115.			
Panel Rigidizer Brackets for topway panel frames 	2-way-L	1/2"	5 1/2"	5 1/2"	<b>DP1PRBL</b>	89.			
	3-way-T	1/2"	5 1/2"	5 1/2"	<b>DP1PRBT</b>	107.			
	4-way-X	1/2"	5 1/2"	5 1/2"	<b>DP1PRBX</b>	178.			
	Straight	1/2"	5 1/2"	5/8"	<b>DP1PRBS</b>	76.			
Panel Rigidizer Brackets for full view panel frames 	2-way-L	1/2"	5 1/2"	5 1/2"	<b>DP1FPRBL</b>	25.			
	3-way-T	1/2"	5 1/2"	5 1/2"	<b>DP1FPRBT</b>	43.			
	4-way-X	1/2"	5 1/2"	5 1/2"	<b>DP1FPRBX</b>	63.			
	Straight	1/2"	5 1/2"	5 1/2"	<b>DP1FPRBS</b>	30.			

Post Connectors/End Trim

### Ordering Information

#### Panel Rigidizer Bracket

1. Pattern Number

#### Panel Reveal Filler

1. Pattern Number

#### Slotted Standard Coat Hook

1. Pattern Number
2. Paint Finish

### Order Code

#### Panel Rigidizer Bracket

*Example:* **DP1 PRBL**

#### Panel Reveal Filler

*Example:* **DP1PRF N15**

#### Slotted Standard Coat Hook

*Example:* **DP2CH**

118 Bright White

### Included with:

#### Panel Rigidizer Bracket

- Rigidizer Bracket
- Set Screws

#### Panel Reveal Filler

- Reveal Fillers (15 qty)

### Options

#### Panel Rigidizer Bracket

#### Panel Reveal Filler

**Note:** Two narrow panel reveal fillers are required for inside corner on DP2/4/5 posts. They are used only on the outside of DP7 posts.

# Panel Rigidizer Brackets, Coat Hooks and Reveal Fillers

## Carpet Grippers

Dividends Horizon

description	type	h	w	d	pattern no.	list	P1	P2	P3
Panel Reveal Filler (for panel-to-post attachment) for pre-DP7 panels/posts	15 Fillers	74"			<b>DP1PRFN15</b>	\$44.			
	250 Fillers	74"			<b>DP1PRFN250</b>	324.			
	70 Fillers	74"			<b>DP1PRFN70</b>	116.			
Wide Panel Reveal Filler (for panel-to-panel and panel-to-DP2/4/5 end trim)	15 Fillers	74"			<b>DP2PRFW15</b>	57.			
	70 Fillers	74"			<b>DP2PRFW70</b>	165.			
Narrow Panel Reveal Filler (for panel-to-post attachment and panel-to-DP6 end trim)	15 Fillers	74"			<b>DP2PRFN15</b>	44.			
	70 Fillers	74"			<b>DP2PRFN70</b>	116.			
Corner Panel Reveal Filler (for inside corner of DP7 post)	15 Fillers	74"			<b>DP2PRFIC15</b>	165.			
	70 Fillers	74"			<b>DP2PRFIC70</b>	740.			

### Ordering Information

#### Panel Rigidizer Bracket

1. Pattern Number

#### Panel Reveal Filler

1. Pattern Number

#### Slotted Standard Coat Hook

1. Pattern Number  
2. Paint Finish

### Order Code

#### Panel Rigidizer Bracket

*Example:* **DP1 PRBL**

#### Panel Reveal Filler

*Example:* **DP1PRF N15**

#### Slotted Standard Coat Hook

*Example:* **DP2CH**

118 Bright White

### Included with:

#### Panel Rigidizer Bracket

- Rigidizer Bracket
- Set Screws

#### Panel Reveal Filler

- Reveal Fillers (15 qty)

### Options

#### Panel Rigidizer Bracket

#### Panel Reveal Filler

**Note:** Two narrow panel reveal fillers are required for inside corner on DP2/4/5 posts. They are used only on the outside of DP7 posts.

**This page intentionally left blank**

# Concealed Post Planning Guidelines Specifications

## Concealed Post

Concealed posts eliminate visible post covers, creating a seamless aesthetic at three-way post connections. Larger widths of fabric or laminate tile-to-floor tiles are used to hide the concealed post. Panel top caps, up to 99" long, span concealed posts, which eliminate the need for post top caps. Concealed post applications are specified by individual components through "Build-to-Spec".

## Planning with Concealed Posts

Concealed posts are to be used in three-way post conditions where straight post covers want to be eliminated. The concealed post should be specified in place of a standard Dividends Horizon DP7 or Legacy post. Concealed post fabric or laminate tiles must be specified in the tile location that is covering the post. (See illustration below) Concealed post, half post or centered fabric and laminate tiles are designed to cover the concealed post with the edge

of the tile ending in the center of the concealed post. Only concealed post fabric and laminate tile sizes are compatible with concealed posts.

A high low condition may be created by having a perpendicular panel at a lower height than the concealed post. Specify the height of the concealed post to be at the same height as the higher panels. A concealed post high low top cap must be specified in this situation. Panel top caps that span concealed posts are not designed for use in high-low concealed post applications, standard width panel top caps and a concealed post high low top cap should be used instead. A DP7 straight high low post cover should be specified in a concealed post high low application.

The two panels on the straight side of the three-way concealed post intersection must always be the same height. The concealed post is not designed to change height on the concealed post side of the three-way connection.

Concealed post panel top caps and frameless add ups are 3" wider than standard sizes, for applications wanting to span the concealed post. Panel top caps are available in lengths up to 99". Any concealed post application requiring panel top caps longer than 99" must specify panel top caps equal to the width of a panel or combination of panels and a concealed post same height top cap. Concealed post fabric and laminate tiles, post top caps, panel top caps, and frameless add ups are designed for use with the concealed post only.

**Note:** Concealed posts and corresponding components are not compatible with Dividends Horizon DP7 posts, Legacy posts, standard post top caps, or standard fabric or laminate tile sizes.

Concealed Post Connection Plan View

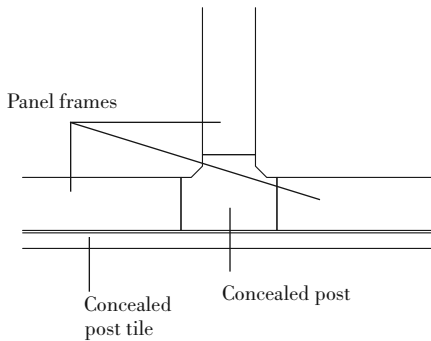

Concealed Post Application

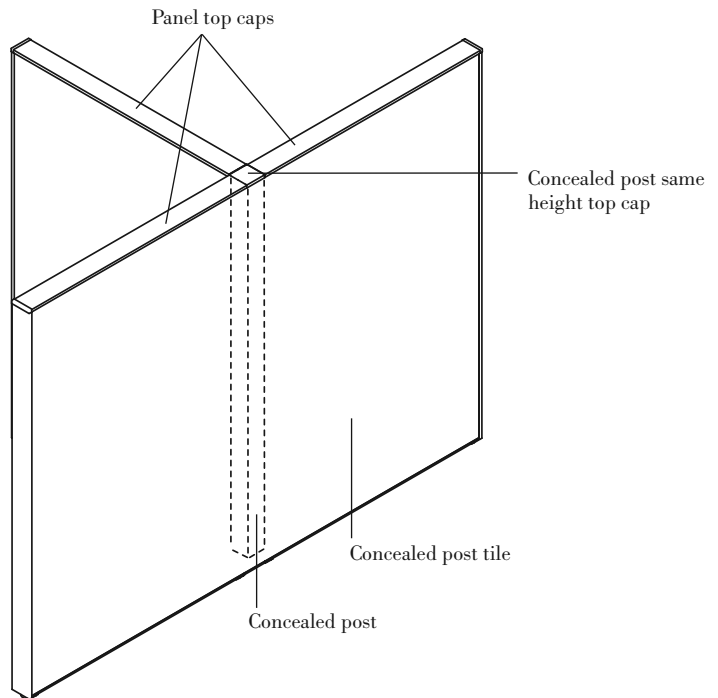

### Concealed Post Construction

Concealed posts are a square extruded aluminum construction. They have cut-outs for electrical and data access that match the wire and cable channels provided by panel frames. This allows cables to be routed through the post at the topway and base raceway.

### Concealed Post Same Height Top Cap

When all three panels in a concealed post application are the same height and standard length panel top caps are used, a concealed post same height top cap must be specified. A concealed post same height top cap covers the top of a concealed post and connects three panel top caps at the same height. (See illustration below)

### Concealed Post High Low Top Cap

When the perpendicular panel in a three-way concealed post application is a lower height than the concealed post, a concealed post high low top cap must be specified. A concealed post high low top

cap covers the top of the concealed post and connects the two same height panel top caps. (See illustration below) A DP7 high low straight post cover should be specified in a concealed post high low application.

### Concealed Post Top Cap Construction

Concealed post flat and radius profile top caps are constructed of injection molded colored plastic.

### Concealed Post Panel Top Caps

Concealed post panel top caps are 3" longer than standard panel top cap widths, so they can span over a concealed post. Panel top caps must be specified according to the panel type, either full view or topway, they are attaching to. Concealed post panel top caps are available in flat profile metal. Concealed post panel top caps are not compatible with a Dividends Horizon DP7 or Legacy post. Concealed post panel top caps that span a concealed post must be used in same height applications only. High low concealed post conditions must use concealed post high low top caps. (See illustration below)

### Concealed Post Shortened Panel Top Caps



Concealed post shortened panel tops are 3" longer than standard shortened panel top cap widths, so they can span over a concealed post. A concealed post shortened panel top cap must be specified for the lower panel in a high low panel-to-panel condition when the panel top cap of the lower panel is spanning over the concealed post. (See illustration below) When the lower panel top cap is not spanning over the concealed post because a concealed post top cap is being used, specify standard shortened panel top cap widths. Standard DP5 high low panel end trim should be specified with concealed post shortened panel top caps in high low panel-to-panel applications.

### Concealed Post Panel Top Cap Construction

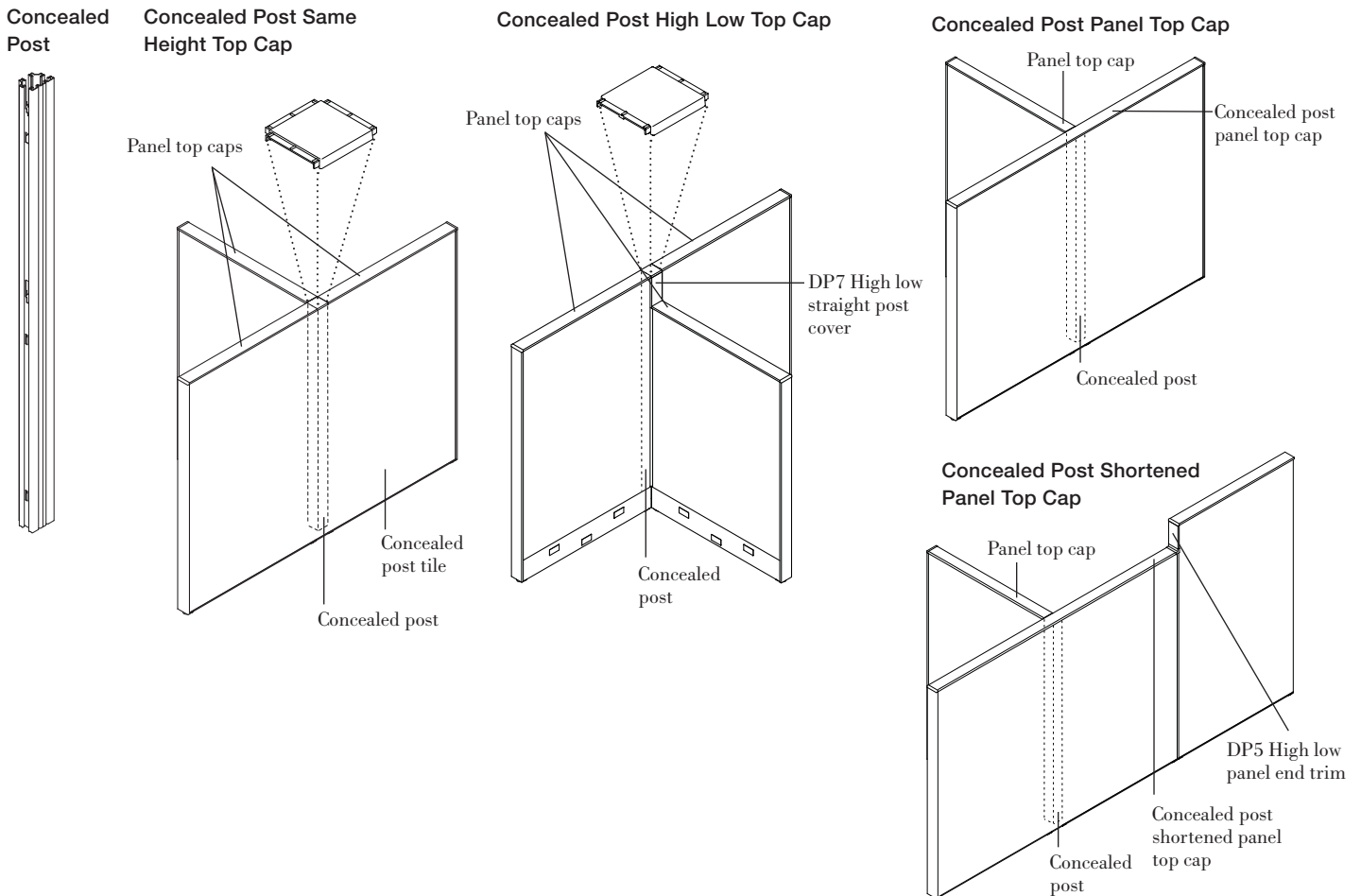
Concealed post panel top caps are constructed of roll-formed steel.



Concealed Post  
 Post Components  
 Post and Post Top Caps

description	w	h	d	pattern no.	list	P1	P2	P3
Concealed Post 	3"	28 1/2"	3"	<b>DP7POWHCPF</b>	\$126.			
	3"	36"	3"	<b>DP7PO36CPF</b>	142.			
	3"	42"	3"	<b>DP7PO42CPF</b>	153.			
	3"	50"	3"	<b>DP7PO50CPF</b>	166.			
	3"	57"	3"	<b>DP7PO57CPF</b>	179.			
	3"	64"	3"	<b>DP7PO64CPF</b>	200.			
Concealed Post Same Height Top Caps 	3"	1/2"	3"	<b>DP7PTCP()</b>		12.	13.	14.
Concealed Post High Low Top Caps 	3"	1/2"	3"	<b>DP7PTCPH()</b>		12.	13.	14.

**Ordering Information**

**Concealed Post**

1. Pattern Number
2. Paint Finish Code

**Concealed Post Top Caps**

1. Pattern Number
2. Paint Finish Code

**Order Code**

**Concealed Post**

*Example:* **DP7PO42CPF**  
**DP7PO42** Pattern Number  
**CPF**

**Concealed Post Top Caps**

*Example:* **DP7PTCP5**  
**DP7PTCP** Pattern Number  
**5** Flat profile  
**613** Silver paint finish

**Included with:**

- Concealed Post**
- Tile to floor filler
- Concealed Post Top Caps**

**Options:**

**Post Top Cap Option:**

- (4)** = Radius Profile
- (5)** = Flat Profile



Concealed Post  
 Post Components  
 Panel Top Caps

description	w	h	d	pattern no.	P1	P2	P3
Concealed Post Panel Top Caps for use with Topway Frames 	33"	1/2"	3"	<b>DP( )PT30CP</b>	\$61.	\$68.	\$71.
	39"	1/2"	3"	<b>DP( )PT36CP</b>	62.	69.	72.
	51"	1/2"	3"	<b>DP( )PT48CP</b>	64.	70.	73.
	63"	1/2"	3"	<b>DP( )PT60CP</b>	65.	71.	74.
	75"	1/2"	3"	<b>DP( )PT72CP</b>	67.	73.	76.
	87"	1/2"	3"	<b>DP( )PT84CP</b>	69.	76.	79.
	99"	1/2"	3"	<b>DP( )PT96CP</b>	70.	77.	80.

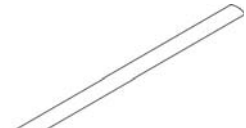
Concealed Post Shortened Panel Top Caps for use with Topway Frames 	32"	1/2"	3"	<b>DP( )PT29CP</b>	61.	68.	71.
	38"	1/2"	3"	<b>DP( )PT35CP</b>	62.	69.	72.
	50"	1/2"	3"	<b>DP( )PT47CP</b>	64.	70.	73.
	62"	1/2"	3"	<b>DP( )PT59CP</b>	65.	71.	74.
	74"	1/2"	3"	<b>DP( )PT71CP</b>	67.	73.	76.
	86"	1/2"	3"	<b>DP( )PT83CP</b>	69.	76.	79.
	98"	1/2"	3"	<b>DP( )PT95CP</b>	70.	77.	80.

Ordering Information	Order Code	Included with:	Options:
<b>Concealed Post Panel Top Caps</b> 1. Pattern Number 2. Paint Finish Code	<b>Concealed Post Panel Top Caps</b> <i>Example:</i> <b>DP5PT48CP</b> <b>DP5PT48</b> Pattern Number <b>CP</b> <b>117</b> Soft Grey paint finish	<b>Concealed Post Panel Top Caps</b> • Panel Top Caps	<b>Trim Option:</b> <b>(5)</b> = Metal, Flat

# Concealed Post Monolithic Panel Inserts Specifications

## Concealed Post Monolithic Inserts

Concealed post monolithic inserts are designed to cover a concealed post and eliminate the need for a post cover. Concealed post monolithic tile-to-floor fabric inserts create a seamless aesthetic at a three-way connection. There are three types of concealed post monolithic tiles: half post, centered, and double with post. Concealed post monolithic inserts can be fabric or laminate and are only available tile-to-floor. Concealed post applications are specified by individual components through "Build-to-Spec".

## Concealed Post Monolithic Insert Construction

### Fabric Tiles

Fabric laminated with adhesive and heat-cured to 7/18" thick acoustical board.

### Laminate Tiles

The surface material is laminate on the front and back of a particle board core. Overall thickness is 7/16" with a 0.5 edgeband.

## Concealed Post Monolithic Insert Attachment

### Fabric Tiles

Panel inserts flex to attach to the troughs in the upper and lower horizontal frame supports. Mounting clips are attached to panel inserts for connection to the vertical frame for additional support. No tools are required for insert attachment.

### Laminate Tiles

Laminate tiles are installed one side or both sides of a panel frame. Mounting clips are attached to laminate inserts for connection to the panel frame.

## Planning with Concealed Post Half Post Tiles

Half post tiles attach to a panel frame or combination of panel frames that are connected to a concealed post. This type of tile covers the entire width of the panel frame(s) and half of the concealed post. Half post tiles are 1-1/2" wider than standard tile widths

to cover half of the concealed post. Half post tiles are handed, either left or right.

The left edge of a left half post tile ends in the middle of a concealed post and the right edge of the tile ends on the furthest right edge of the panel(s). The right edge of a right half post tile ends in the middle of a concealed post and the left edge of the tile ends on the left side of the panel(s). (See illustration below) A half post tile must be used with either another half post tile or a centered tile, so the other half of the post is concealed by a tile.

Half Post Tile Application

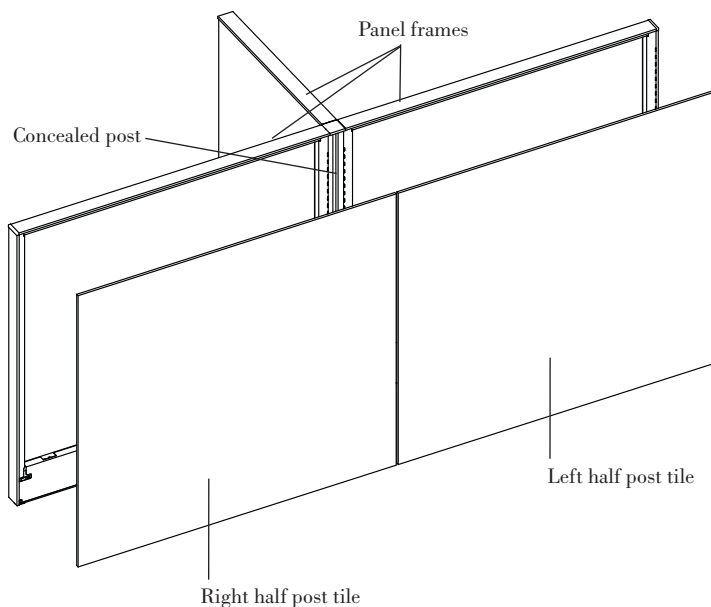

Half Post Tile Plan View

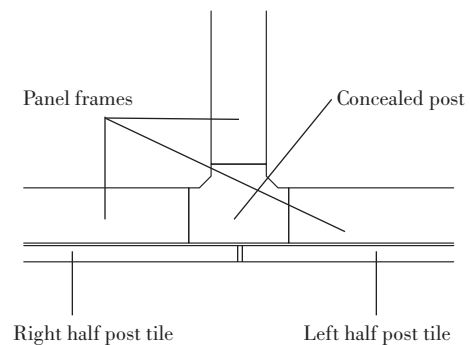

# Concealed Post

## Monolithic Panel Inserts and Frameless Add Ups

### Specifications

#### Planning with Concealed Post Centered Tiles

Centered tiles attach to a panel frame or combination of panel frames that are connected to concealed posts. Centered tiles are centered on a panel frame(s) between two concealed posts. The left and right edge of the tile ends in the center of a concealed post. A centered tile is 3" wider than standard tile widths. Centered tiles must be centered on the panel frame(s) between the concealed posts. Neither the right nor left edge of a centered tile is able to end anywhere other than the center of a concealed post. (See illustration below) A centered tile must be used with either a half post tile or another centered tile, so the other half of the post is concealed by a tile.

#### Planning with Concealed Post Double with Post Tiles

A double with post tile attaches to two panel frames that are connected by a concealed post. The tile attaches to the panels and hides the concealed post connection. The concealed post must be between the panel frames. Double with post tiles are 3" wider than standard tile widths, so that they are able to cover a concealed post. (See illustration below) Neither the right nor left edge of a double with post tile is able to end anywhere other than the right or left edge of a panel frame.

#### Concealed Post Frameless Add Ups

Concealed post frameless add ups are 3" longer than standard frameless add up lengths, so they can span over a concealed post. Concealed post frameless add ups are not compatible with Dividends Horizon DP7 or Legacy posts.

**Note:** Concealed posts and corresponding components are not compatible with Dividends Horizon DP7 posts, Legacy posts, standard post top caps, or standard fabric or laminate tile sizes.

Double With Post Tile Application

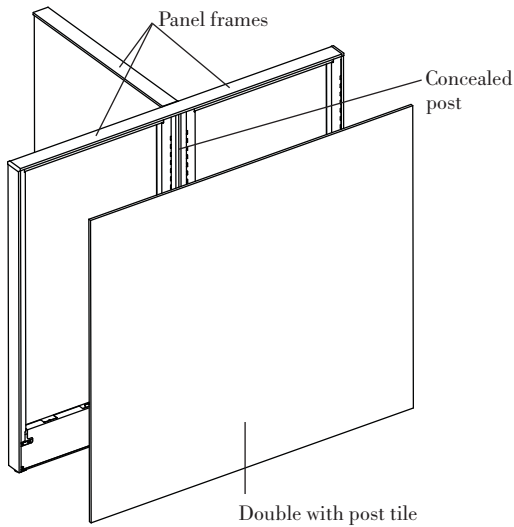

Centered Tile Application

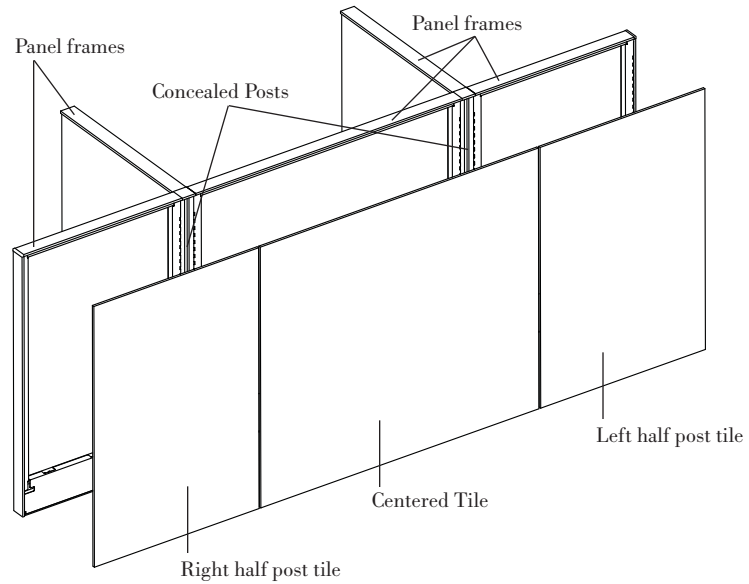

Double With Post Tile Plan View

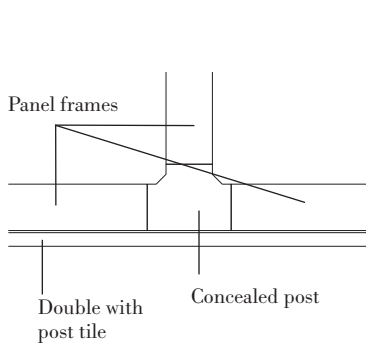

Centered Tile Plan View

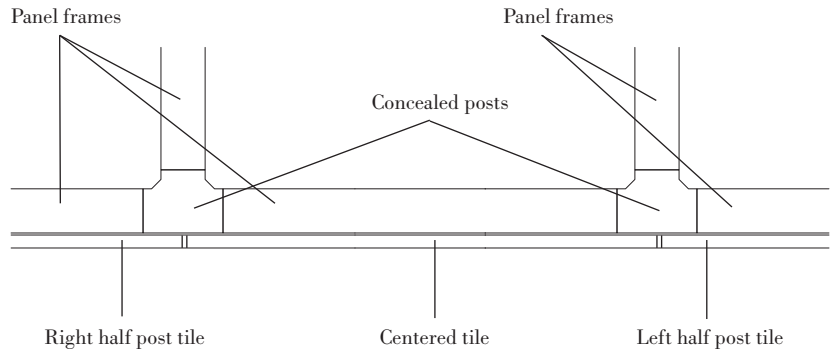



# Concealed Post

## *Monolithic Panel Half Post Fabric Inserts*

### *Worksurface Height, 28" and 42" High*



Dividends Horizon

description	w*	w	h	d	pattern no.	10	15	20	25	30	35	40	45
Worksurface Height Concealed Post Monolithic Panel Half Post Fabric Inserts 	15"	16 1/2"	27 1/4"	7/16"	<b>DP1SOWH15( )F</b>	\$99.	\$102.	\$108.	\$111.	\$112.	\$115.	\$116.	\$119.
	18"	19 1/2"	27 1/4"	7/16"	<b>DP1SOWH18( )F</b>	112.	115.	121.	124.	125.	128.	130.	133.
	24"	25 1/2"	27 1/4"	7/16"	<b>DP1SOWH24( )F</b>	123.	127.	132.	135.	138.	141.	142.	146.
	30"	31 1/2"	27 1/4"	7/16"	<b>DP1SOWH30( )F</b>	134.	138.	144.	147.	151.	155.	157.	161.
	36"	37 1/2"	27 1/4"	7/16"	<b>DP1SOWH36( )F</b>	145.	150.	158.	161.	164.	167.	170.	174.
	42"	43 1/2"	27 1/4"	7/16"	<b>DP1SOWH42( )F</b>	157.	162.	169.	172.	177.	180.	182.	187.
	48"	49 1/2"	27 1/4"	7/16"	<b>DP1SOWH48( )F</b>	168.	173.	181.	184.	190.	194.	197.	202.
60"	61 1/2"	27 1/4"	7/16"	<b>DP1SOWH60( )F</b>	177.	182.	192.	196.	201.	204.	207.	212.	
28" High Concealed Post Monolithic Panel Half Post Fabric Inserts (For 36"H Panel Frame) 	15"	16 1/2"	33 13/16"	7/16"	<b>DP1SO2815( )F</b>	100.	103.	87.	89.	92.	94.	94.	96.
	18"	19 1/2"	33 13/16"	7/16"	<b>DP1SO2818( )F</b>	115.	119.	110.	113.	116.	118.	119.	123.
	24"	25 1/2"	33 13/16"	7/16"	<b>DP1SO2824( )F</b>	130.	133.	133.	135.	139.	142.	143.	146.
	30"	31 1/2"	33 13/16"	7/16"	<b>DP1SO2830( )F</b>	143.	147.	156.	159.	163.	166.	168.	172.
	36"	37 1/2"	33 13/16"	7/16"	<b>DP1SO2836( )F</b>	158.	163.	177.	181.	185.	188.	193.	198.
	42"	43 1/2"	33 13/16"	7/16"	<b>DP1SO2842( )F</b>	172.	176.	201.	204.	209.	213.	216.	221.
	48"	49 1/2"	33 13/16"	7/16"	<b>DP1SO2848( )F</b>	185.	192.	201.	205.	210.	213.	217.	222.
60"	61 1/2"	33 13/16"	7/16"	<b>DP1SO2860( )F</b>	198.	203.	213.	216.	222.	227.	230.	237.	
42" High Concealed Post Monolithic Panel Half Post Fabric Inserts 	15"	16 1/2"	41 3/16"	7/16"	<b>DP1SO4215( )F</b>	103.	107.	113.	113.	118.	121.	123.	125.
	18"	19 1/2"	41 3/16"	7/16"	<b>DP1SO4218( )F</b>	122.	125.	131.	132.	137.	139.	142.	144.
	24"	25 1/2"	41 3/16"	7/16"	<b>DP1SO4224( )F</b>	138.	141.	150.	151.	157.	160.	162.	166.
	30"	31 1/2"	41 3/16"	7/16"	<b>DP1SO4230( )F</b>	156.	160.	168.	170.	175.	178.	181.	185.
	36"	37 1/2"	41 3/16"	7/16"	<b>DP1SO4236( )F</b>	172.	177.	185.	188.	195.	198.	202.	206.
	42"	43 1/2"	41 3/16"	7/16"	<b>DP1SO4242( )F</b>	188.	195.	205.	208.	213.	217.	220.	227.
	48"	49 1/2"	41 3/16"	7/16"	<b>DP1SO4248( )F</b>	206.	212.	222.	227.	232.	237.	241.	247.
60"	61 1/2"	41 3/16"	7/16"	<b>DP1SO4260( )F</b>	219.	227.	238.	242.	248.	253.	258.	264.	

w\* = nominal width  
 Dimensions listed under w h d are actual to the nearest 1/16"

Ordering Information	Order Code	Included with:	Options
<b>Concealed Post Monolithic Panel Fabric Inserts</b> 1. Pattern Number 2. Fabric	<b>Concealed Post Monolithic Panel Fabric Inserts</b> <i>Example:</i> <b>DP1SO2818CEF</b> <hr/> <b>DP1SO</b> Pattern Number <hr/> <b>2818</b> <hr/> <b>CE</b> Center left, End Right <hr/> <b>F</b> Tile to Floor <hr/> <b>W351-3</b> Foundation Corn Silk Fabric	<b>Concealed Post Monolithic Panel Fabric Inserts</b> • Attachment Clips	<b>Concealed Post Monolithic Panel Fabric Inserts</b> <b>Configuration:</b> <b>(CE)</b> = Left Half Post: Tile ends in the center of the post on the left and at the right side of the panel frame. <b>(EC)</b> = Right Half Post: Tile ends in the center of the post on the right and at the left side of the panel frame.



# Concealed Post Monolithic Panel Half Post Fabric Inserts 50", 57" and 64" High

description	w*	w	h	d	pattern no.	10	15	20	25	30	35	40	45
50" High Concealed Post Monolithic Panel Half Post Fabric Inserts 	15"	16 1/2"	48 1/2"	7/16"	<b>DP1SO5015( )F</b>	\$108.	\$110.	\$115.	\$117.	\$121.	\$123.	\$125.	\$128.
	18"	19 1/2"	48 1/2"	7/16"	<b>DP1SO5018( )F</b>	128.	130.	136.	139.	142.	145.	147.	152.
	24"	25 1/2"	48 1/2"	7/16"	<b>DP1SO5024( )F</b>	146.	151.	159.	161.	166.	168.	171.	175.
	30"	31 1/2"	48 1/2"	7/16"	<b>DP1SO5030( )F</b>	167.	171.	179.	182.	187.	192.	195.	200.
	36"	37 1/2"	48 1/2"	7/16"	<b>DP1SO5036( )F</b>	186.	192.	201.	205.	210.	214.	217.	224.
	42"	43 1/2"	48 1/2"	7/16"	<b>DP1SO5042( )F</b>	206.	212.	222.	226.	234.	237.	241.	247.
	48"	49 1/2"	48 1/2"	7/16"	<b>DP1SO5048( )F</b>	226.	232.	244.	248.	255.	260.	264.	271.
	60"	61 1/2"	48 1/2"	7/16"	<b>DP1SO5060( )F</b>	243.	249.	262.	266.	273.	279.	283.	290.
57" High Concealed Post Monolithic Panel Half Post Fabric Inserts 	15"	16 1/2"	55 3/8"	7/16"	<b>DP1SO5715( )F</b>	111.	114.	119.	121.	124.	127.	129.	132.
	18"	19 1/2"	55 3/8"	7/16"	<b>DP1SO5718( )F</b>	133.	137.	143.	145.	149.	153.	156.	160.
	24"	25 1/2"	55 3/8"	7/16"	<b>DP1SO5724( )F</b>	157.	161.	168.	170.	175.	178.	181.	185.
	30"	31 1/2"	55 3/8"	7/16"	<b>DP1SO5730( )F</b>	178.	183.	193.	196.	201.	205.	208.	213.
	36"	37 1/2"	55 3/8"	7/16"	<b>DP1SO5736( )F</b>	201.	207.	216.	220.	226.	231.	235.	241.
	42"	43 1/2"	55 3/8"	7/16"	<b>DP1SO5742( )F</b>	224.	230.	241.	245.	252.	256.	261.	267.
	48"	49 1/2"	55 3/8"	7/16"	<b>DP1SO5748( )F</b>	246.	253.	265.	270.	278.	283.	287.	295.
	60"	61 1/2"	55 3/8"	7/16"	<b>DP1SO5760( )F</b>	265.	272.	286.	291.	299.	304.	309.	319.
64" High Concealed Post Monolithic Panel Half Post Fabric Inserts 	15"	16 1/2"	63 1/16"	7/16"	<b>DP1SO6415( )F</b>	112.	114.	121.	124.	126.	129.	130.	135.
	18"	19 1/2"	63 1/16"	7/16"	<b>DP1SO6418( )F</b>	137.	140.	147.	152.	156.	159.	161.	166.
	24"	25 1/2"	63 1/16"	7/16"	<b>DP1SO6424( )F</b>	164.	168.	176.	179.	183.	187.	190.	197.
	30"	31 1/2"	63 1/16"	7/16"	<b>DP1SO6430( )F</b>	188.	195.	204.	208.	213.	217.	220.	227.
	36"	37 1/2"	63 1/16"	7/16"	<b>DP1SO6436( )F</b>	214.	220.	231.	237.	243.	247.	251.	258.
	42"	43 1/2"	63 1/16"	7/16"	<b>DP1SO6442( )F</b>	241.	248.	260.	264.	271.	277.	281.	288.
	48"	49 1/2"	63 1/16"	7/16"	<b>DP1SO6448( )F</b>	266.	274.	287.	293.	301.	306.	311.	320.
	60"	61 1/2"	63 1/16"	7/16"	<b>DP1SO6460( )F</b>	288.	297.	310.	316.	327.	332.	338.	346.

w\* = nominal width  
Dimensions listed under w h d are actual to the nearest 1/16"

Ordering Information	Order Code	Included with:	Options
<b>Concealed Post Monolithic Panel Fabric Inserts</b> 1. Pattern Number 2. Fabric	<b>Concealed Post Monolithic Panel Fabric Inserts</b> <i>Example:</i> <b>DP1SO5718CEF</b>	<b>Concealed Post Monolithic Panel Fabric Inserts</b> • Attachment Clips	<b>Concealed Post Monolithic Panel Fabric Inserts</b> <b>Configuration:</b> (CE) = Left Half Post: Tile ends in the center of the post on the left and at the right side of the panel frame. (EC) = Right Half Post: Tile ends in the center of the post on the right and at the left side of the panel frame.
	<b>DP1SO</b> Pattern Number <b>5718</b>		
	<b>CE</b> Center left, End Right		
	<b>F</b> Tile to Floor		
	<b>W351-3</b> Foundation Corn Silk Fabric		

*Monolithic Panel Half Post Laminate Inserts*  
*Worksurface Height, 28" and 42" High*

description	w*	w	h	d	pattern no.	list
Worksurface Height Concealed Post	15"	16 1/2"	27 1/4"	7/16"	<b>DP3L1WH15( )F</b>	\$169.
Monolithic Panel Half Post	18"	19 1/2"	27 1/4"	7/16"	<b>DP3L1WH18( )F</b>	194.
Laminate Inserts	24"	25 1/2"	27 1/4"	7/16"	<b>DP3L1WH24( )F</b>	226.
	30"	31 1/2"	27 1/4"	7/16"	<b>DP3L1WH30( )F</b>	244.
	36"	37 1/2"	27 1/4"	7/16"	<b>DP3L1WH36( )F</b>	291.
	42"	43 1/2"	27 1/4"	7/16"	<b>DP3L1WH42( )F</b>	296.
	48"	49 1/2"	27 1/4"	7/16"	<b>DP3L1WH48( )F</b>	390.
<hr/>						
28" High Concealed Post	15"	16 1/2"	33 13/16"	7/16"	<b>DP3L12815( )F</b>	169.
Monolithic Panel Half Post	18"	19 1/2"	33 13/16"	7/16"	<b>DP3L12818( )F</b>	194.
Laminate Inserts	24"	25 1/2"	33 13/16"	7/16"	<b>DP3L12824( )F</b>	226.
(For 36"H Panel Frame)	30"	31 1/2"	33 13/16"	7/16"	<b>DP3L12830( )F</b>	244.
	36"	37 1/2"	33 13/16"	7/16"	<b>DP3L12836( )F</b>	291.
	42"	43 1/2"	33 13/16"	7/16"	<b>DP3L12842( )F</b>	296.
	48"	49 1/2"	33 13/16"	7/16"	<b>DP3L12848( )F</b>	390.
<hr/>						
42" High Concealed Post	15"	16 1/2"	41 3/16"	7/16"	<b>DP3L14215( )F</b>	226.
Monolithic Panel Half Post	18"	19 1/2"	41 3/16"	7/16"	<b>DP3L14218( )F</b>	252.
Laminate Inserts	24"	25 1/2"	41 3/16"	7/16"	<b>DP3L14224( )F</b>	291.
	30"	31 1/2"	41 3/16"	7/16"	<b>DP3L14230( )F</b>	394.
	36"	37 1/2"	41 3/16"	7/16"	<b>DP3L14236( )F</b>	416.
	42"	43 1/2"	41 3/16"	7/16"	<b>DP3L14242( )F</b>	419.
	48"	49 1/2"	41 3/16"	7/16"	<b>DP3L14248( )F</b>	461.

w\* = nominal width



Dimensions listed under w h d are actual to the nearest 1/16"

Ordering Information	Order Code	Included with:	Options
<b>Concealed Post Monolithic Panel Laminate Inserts</b>	<b>Concealed Post Monolithic Panel Laminate Inserts</b>	<b>Concealed Post Monolithic Panel Laminate Inserts</b>	<b>Concealed Post Monolithic Panel Laminate Inserts</b>
1. Pattern Number	<i>Example:</i> <b>DP3L14236CEF</b>	• Attachment Clips	<b>Finish Options:</b>
2. Laminate Finish	<b>DP3L1</b> Pattern Number		<b>114 Folkstone Grey</b>
3. Edgeband Finish	<b>4236</b>		<b>117 Soft Grey</b>
	<b>CE</b> Center left, End Right		<b>118 Bright White</b>
	<b>F</b> Tile to Floor		<b>119 Pumice</b>
	<b>118</b> Bright White Laminate		<b>Configuration:</b>
	<b>118</b> Bright White Edgeband		<b>(CE)</b> = Left Half Post: Tile ends in the center of the post on the left and at the right side of the panel frame.
			<b>(EC)</b> = Right Half Post: Tile ends in the center of the post on the right and at the left side of the panel frame.

# Concealed Post

## Monolithic Panel Half Post Laminate Inserts

### 50" and 57" High

description	w*	w	h	d	pattern no.	list
 50" High Concealed Post Monolithic Panel Half Post Laminate Inserts	15"	16 1/2"	48 1/2"	7/16"	<b>DP3L15015( )F</b>	\$245.
	18"	19 1/2"	48 1/2"	7/16"	<b>DP3L15018( )F</b>	293.
	24"	25 1/2"	48 1/2"	7/16"	<b>DP3L15024( )F</b>	368.
	30"	31 1/2"	48 1/2"	7/16"	<b>DP3L15030( )F</b>	399.
	36"	37 1/2"	48 1/2"	7/16"	<b>DP3L15036( )F</b>	488.
	42"	43 1/2"	48 1/2"	7/16"	<b>DP3L15042( )F</b>	492.
	48"	49 1/2"	48 1/2"	7/16"	<b>DP3L15048( )F</b>	637.
 57" High Concealed Post Monolithic Panel Half Post Laminate Inserts	15"	16 1/2"	55 3/8"	7/16"	<b>DP3L15715( )F</b>	250.
	18"	19 1/2"	55 3/8"	7/16"	<b>DP3L15718( )F</b>	298.
	24"	25 1/2"	55 3/8"	7/16"	<b>DP3L15724( )F</b>	373.
	30"	31 1/2"	55 3/8"	7/16"	<b>DP3L15730( )F</b>	405.
	36"	37 1/2"	55 3/8"	7/16"	<b>DP3L15736( )F</b>	493.
	42"	43 1/2"	55 3/8"	7/16"	<b>DP3L15742( )F</b>	497.
	48"	49 1/2"	55 3/8"	7/16"	<b>DP3L15748( )F</b>	641.

w\* = nominal width  
 Dimensions listed under w h d are actual to the nearest 1/16"



Ordering Information	Order Code	Included with:	Options
<b>Concealed Post Monolithic Panel Laminate Inserts</b> 1. Pattern Number 2. Laminate Finish 3. Edgeband Finish	<b>Concealed Post Monolithic Panel Laminate Inserts</b> <i>Example:</i> <b>DP3L15736CEF</b> <b>DP3L1</b> Pattern Number <b>5736</b> <b>CE</b> Center left, End Right <b>F</b> Tile to Floor <b>118</b> Bright White Laminate <b>118</b> Bright White Edgeband	<b>Concealed Post Monolithic Panel Laminate Inserts</b> • Attachment Clips	<b>Concealed Post Monolithic Panel Fabric Inserts</b>  <b>Finish Options:</b> <b>114</b> Folkstone Grey <b>117</b> Soft Grey <b>118</b> Bright White <b>119</b> Pumice  <b>Configuration:</b> <b>(CE)</b> = Left Half Post: Tile ends in the center of the post on the left and at the right side of the panel frame. <b>(EC)</b> = Right Half Post: Tile ends in the center of the post on the right and at the left side of the panel frame.

# Concealed Post

## *Monolithic Panel Centered Fabric Inserts*

### *Worksurface Height, 28" and 42" High*

Dividends Horizon

description	w*	w	d	h	pattern no.	10	15	20	25	30	35	40	45
Worksurface Height Concealed Post	15"	18"	7/16"	27 1/4"	<b>DP1SOWH15CCF</b>	\$139.	\$142.	\$151.	\$152.	\$159.	\$161.	\$164.	\$168.
Monolithic Panel Centered Fabric Insert	18"	21"	7/16"	27 1/4"	<b>DP1SOWH18CCF</b>	143.	147.	157.	158.	164.	166.	179.	173.
	24"	27"	7/16"	27 1/4"	<b>DP1SOWH24CCF</b>	149.	152.	161.	163.	168.	171.	174.	178.
	30"	33"	7/16"	27 1/4"	<b>DP1SOWH30CCF</b>	153.	158.	166.	168.	173.	176.	179.	183.
	36"	39"	7/16"	27 1/4"	<b>DP1SOWH36CCF</b>	158.	163.	171.	173.	178.	181.	184.	188.
	42"	45"	7/16"	27 1/4"	<b>DP1SOWH42CCF</b>	163.	167.	175.	178.	182.	186.	190.	195.
	48"	51"	7/16"	27 1/4"	<b>DP1SOWH48CCF</b>	167.	172.	180.	183.	187.	193.	196.	200.
	60"	63"	7/16"	27 1/4"	<b>DP1SOWH60CCF</b>	176.	181.	190.	195.	200.	203.	206.	211.
28" High Concealed Post	15"	18"	7/16"	33 3/16"	<b>DP1SO2815CCF</b>	150.	156.	164.	166.	171.	173.	176.	181.
Monolithic Panel Centered Fabric Insert	18"	21"	7/16"	33 3/16"	<b>DP1SO2818CCF</b>	157.	162.	170.	172.	177.	179.	182.	187.
(For 36"H Panel Frame)	24"	27"	7/16"	33 3/16"	<b>DP1SO2824CCF</b>	162.	167.	175.	178.	183.	186.	190.	196.
	30"	33"	7/16"	33 3/16"	<b>DP1SO2830CCF</b>	168.	173.	181.	184.	190.	194.	197.	202.
	36"	39"	7/16"	33 3/16"	<b>DP1SO2836CCF</b>	174.	179.	187.	192.	197.	200.	203.	208.
	42"	45"	7/16"	33 3/16"	<b>DP1SO2842CCF</b>	179.	184.	194.	198.	203.	207.	210.	215.
	48"	51"	7/16"	33 3/16"	<b>DP1SO2848CCF</b>	185.	192.	200.	204.	209.	213.	216.	221.
	60"	63"	7/16"	33 3/16"	<b>DP1SO2860CCF</b>	197.	203.	212.	216.	221.	226.	230.	236.
42" High Concealed Post	15"	18"	7/16"	41 3/16"	<b>DP1SO4215CCF</b>	164.	168.	176.	178.	183.	187.	190.	197.
Monolithic Panel Centered Fabric Insert	18"	21"	7/16"	41 3/16"	<b>DP1SO4218CCF</b>	171.	175.	183.	186.	193.	197.	199.	205.
	24"	27"	7/16"	41 3/16"	<b>DP1SO4224CCF</b>	177.	182.	193.	195.	200.	204.	207.	213.
	30"	33"	7/16"	41 3/16"	<b>DP1SO4230CCF</b>	184.	190.	200.	203.	208.	212.	215.	221.
	36"	39"	7/16"	41 3/16"	<b>DP1SO4236CCF</b>	193.	198.	207.	211.	216.	220.	224.	230.
	42"	45"	7/16"	41 3/16"	<b>DP1SO4242CCF</b>	199.	205.	215.	218.	224.	228.	232.	239.
	48"	51"	7/16"	41 3/16"	<b>DP1SO4248CCF</b>	206.	212.	222.	227.	232.	237.	241.	247.
	60"	63"	7/16"	41 3/16"	<b>DP1SO4260CCF</b>	219.	227.	238.	242.	248.	253.	258.	264.

w\* = nominal width

Dimensions listed under w h d are actual to the nearest 1/16"



Ordering Information	Order Code	Included with:	Options
<b>Concealed Post Monolithic Panel Fabric Inserts</b>	<b>Concealed Post Monolithic Panel Fabric Inserts</b>	<b>Concealed Post Monolithic Panel Fabric Inserts</b>	<b>Concealed Post Monolithic Panel Fabric Inserts</b>
1. Pattern Number	<i>Example:</i> <b>DP1SO2818CCF</b>	• Attachment Clips	
2. Fabric	<b>DP1SO</b> Pattern Number		
	<b>2818</b>		
	<b>CC</b> Center Left, Center Right		
	<b>F</b> Tile to Floor		
	<b>W351-3</b> Foundation Corn Silk Fabric		



# Concealed Post

## *Monolithic Panel Centered Fabric Inserts*

### *50", 57" and 64" High*

description	w*	w	h	d	pattern no.	10	15	20	25	30	35	40	45
50" High Concealed Post	15"	18"	48 1/2"	7/16"	<b>DP1SO5015CCF</b>	\$177.	\$180.	\$192.	\$195.	\$199.	\$203.	\$206.	\$212.
Monolithic Panel Centered Fabric Insert	18"	21"	48 1/2"	7/16"	<b>DP1SO5018CCF</b>	185.	188.	200.	204.	208.	212.	215.	221.
	24"	27"	48 1/2"	7/16"	<b>DP1SO5024CCF</b>	194.	199.	209.	212.	217.	221.	226.	232.
	30"	33"	48 1/2"	7/16"	<b>DP1SO5030CCF</b>	202.	207.	217.	221.	227.	231.	236.	242.
	36"	39"	48 1/2"	7/16"	<b>DP1SO5036CCF</b>	210.	215.	226.	231.	237.	241.	245.	251.
	42"	45"	48 1/2"	7/16"	<b>DP1SO5042CCF</b>	217.	225.	236.	240.	246.	250.	255.	262.
	48"	45"	48 1/2"	7/16"	<b>DP1SO5048CCF</b>	226.	234.	244.	249.	255.	260.	265.	271.
	60"	63"	48 1/2"	7/16"	<b>DP1SO5060CCF</b>	243.	250.	262.	267.	274.	279.	284.	291.
57" High Concealed Post	15"	18"	55 3/8"	7/16"	<b>DP1SO5715CCF</b>	187.	195.	205.	208.	213.	217.	220.	226.
Monolithic Panel Centered Fabric Insert	18"	21"	55 3/8"	7/16"	<b>DP1SO5718CCF</b>	198.	204.	215.	218.	224.	228.	232.	238.
	24"	27"	55 3/8"	7/16"	<b>DP1SO5724CCF</b>	208.	214.	225.	229.	236.	240.	243.	249.
	30"	33"	55 3/8"	7/16"	<b>DP1SO5730CCF</b>	217.	224.	236.	240.	246.	250.	254.	261.
	36"	39"	55 3/8"	7/16"	<b>DP1SO5736CCF</b>	227.	234.	246.	250.	256.	261.	266.	272.
	42"	45"	55 3/8"	7/16"	<b>DP1SO5742CCF</b>	238.	244.	255.	261.	268.	272.	277.	284.
	48"	51"	55 3/8"	7/16"	<b>DP1SO5748CCF</b>	247.	253.	266.	271.	279.	283.	288.	296.
	60"	63"	55 3/8"	7/16"	<b>DP1SO5760CCF</b>	266.	273.	287.	293.	300.	305.	310.	320.
64" High Concealed Post	15"	18"	63 1/16"	7/16"	<b>DP1SO6415CCF</b>	204.	208.	218.	224.	228.	234.	237.	244.
Monolithic Panel Centered Fabric Insert	18"	21"	63 1/16"	7/16"	<b>DP1SO6418CCF</b>	214.	219.	230.	236.	241.	246.	249.	256.
	24"	27"	63 1/16"	7/16"	<b>DP1SO6424CCF</b>	225.	230.	242.	247.	252.	258.	262.	269.
	30"	33"	63 1/16"	7/16"	<b>DP1SO6430CCF</b>	236.	242.	253.	259.	265.	270.	274.	282.
	36"	39"	63 1/16"	7/16"	<b>DP1SO6436CCF</b>	246.	253.	265.	270.	278.	283.	287.	295.
	42"	45"	63 1/16"	7/16"	<b>DP1SO6442CCF</b>	256.	264.	277.	282.	289.	295.	300.	307.
	48"	51"	63 1/16"	7/16"	<b>DP1SO6448CCF</b>	267.	276.	288.	294.	302.	307.	312.	321.
	60"	63"	63 1/16"	7/16"	<b>DP1SO6460CCF</b>	288.	298.	311.	319.	328.	333.	339.	347.



w\* = nominal width  
Dimensions listed under w h d are actual to the nearest 1/16"

Ordering Information	Order Code	Included with:	Options
<b>Concealed Post Monolithic Panel Fabric Inserts</b>	<b>Concealed Post Monolithic Panel Fabric Inserts</b>	<b>Concealed Post Monolithic Panel Fabric Inserts</b>	<b>Concealed Post Monolithic Panel Fabric Inserts</b>
1. Pattern Number	<i>Example:</i> <b>DP1SO5718CCF</b>	• Attachment Clips	
2. Fabric	<b>DP1SO</b> Pattern Number		
	<b>5718</b>		
	<b>CC</b> Center Left, Center Right		
	<b>F</b> Tile to Floor		
	<b>W351-3</b> Foundation Corn Silk Fabric		

# Concealed Post

## Monolithic Panel Centered Laminate Inserts



### Worksurface Height, 28" and 42" High

description	w *	w	h	d	pattern no.	list
 Worksurface Height Concealed Post Monolithic Panel Centered Laminate Insert	15"	18"	27 1/4"	7/16"	<b>DP3L1WH15CCF</b>	\$169.
	18"	21"	27 1/4"	7/16"	<b>DP3L1WH18CCF</b>	194.
	24"	27"	27 1/4"	7/16"	<b>DP3L1WH24CCF</b>	226.
	30"	33"	27 1/4"	7/16"	<b>DP3L1WH30CCF</b>	244.
	36"	39"	27 1/4"	7/16"	<b>DP3L1WH36CCF</b>	291.
	42"	45"	27 1/4"	7/16"	<b>DP3L1WH42CCF</b>	296.
	48"	51"	27 1/4"	7/16"	<b>DP3L1WH48CCF</b>	390.
 28" High Concealed Post Monolithic Panel Centered Laminate Insert (For 36"H Panel Frame)	15"	18"	33 13/16"	7/16"	<b>DP3L12815CCF</b>	169.
	18"	21"	33 13/16"	7/16"	<b>DP3L12818CCF</b>	194.
	24"	27"	33 13/16"	7/16"	<b>DP3L12824CCF</b>	226.
	30"	33"	33 13/16"	7/16"	<b>DP3L12830CCF</b>	244.
	36"	39"	33 13/16"	7/16"	<b>DP3L12836CCF</b>	291.
	42"	45"	33 13/16"	7/16"	<b>DP3L12842CCF</b>	296.
	48"	51"	33 13/16"	7/16"	<b>DP3L12848CCF</b>	390.
 42" High Concealed Post Monolithic Panel Centered Laminate Insert	15"	18"	41 3/16"	7/16"	<b>DP3L14215CCF</b>	226.
	18"	21"	41 3/16"	7/16"	<b>DP3L14218CCF</b>	252.
	24"	27"	41 3/16"	7/16"	<b>DP3L14224CCF</b>	291.
	30"	33"	41 3/16"	7/16"	<b>DP3L14230CCF</b>	394.
	36"	39"	41 3/16"	7/16"	<b>DP3L14236CCF</b>	416.
	42"	45"	41 3/16"	7/16"	<b>DP3L14242CCF</b>	419.
	48"	51"	41 3/16"	7/16"	<b>DP3L14248CCF</b>	461.

w\* = nominal width  
 Dimensions listed under w h d are actual to the nearest 1/16"

Ordering Information	Order Code	Included with:	Options
<b>Concealed Post Monolithic Panel Laminate Inserts</b> 1. Pattern Number 2. Laminate Finish 3. Edgeband Finish	<b>Concealed Post Monolithic Panel Laminate Inserts</b> <i>Example:</i> <b>DP3L14236CCF</b> <b>DP3L1</b> Pattern Number <b>4236</b> <b>CC</b> Center Left, Center Right <b>F</b> Tile to Floor <b>118</b> Bright White Laminate <b>118</b> Bright White Edgeband	<b>Concealed Post Monolithic Panel Laminate Inserts</b> • Attachment Clips	<b>Concealed Post Monolithic Panel Laminate Inserts</b> <b>Finish Options:</b> <b>114</b> Folkstone Grey <b>117</b> Soft Grey <b>118</b> Bright White <b>119</b> Pumice

Concealed Post  
*Monolithic Panel Centered Laminate Inserts*  
 50" and 57" High

description	w *	w	h	d	pattern no.	list
50" High Concealed Post Monolithic Panel Centered Laminate Insert 	15"	18"	48 1/2"	7/16"	<b>DP3L15015CCF</b>	\$245.
	18"	21"	48 1/2"	7/16"	<b>DP3L15018CCF</b>	293.
	24"	27"	48 1/2"	7/16"	<b>DP3L15024CCF</b>	368.
	30"	33"	48 1/2"	7/16"	<b>DP3L15030CCF</b>	399.
	36"	39"	48 1/2"	7/16"	<b>DP3L15036CCF</b>	488.
	42"	45"	48 1/2"	7/16"	<b>DP3L15042CCF</b>	492.
	48"	51"	48 1/2"	7/16"	<b>DP3L15048CCF</b>	637.
57" High Concealed Post Monolithic Panel Centered Laminate Insert 	15"	18"	55 3/8"	7/16"	<b>DP3L15715CCF</b>	250.
	18"	21"	55 3/8"	7/16"	<b>DP3L15718CCF</b>	298.
	24"	27"	55 3/8"	7/16"	<b>DP3L15724CCF</b>	373.
	30"	33"	55 3/8"	7/16"	<b>DP3L15730CCF</b>	405.
	36"	39"	55 3/8"	7/16"	<b>DP3L15736CCF</b>	493.
	42"	45"	55 3/8"	7/16"	<b>DP3L15742CCF</b>	497.
	48"	51"	55 3/8"	7/16"	<b>DP3L15748CCF</b>	641.

w\* = nominal width  
 Dimensions listed under w h d are actual to the nearest 1/16"

Ordering Information	Order Code	Included with:	Options
<b>Concealed Post Monolithic Panel Laminate Inserts</b> 1. Pattern Number 2. Laminate Finish 3. Edgeband Finish	<b>Concealed Post Monolithic Panel Laminate Inserts</b> <i>Example:</i> <b>DP3L15736CCF</b> <b>DP3L1</b> Pattern Number <b>5736</b> <b>CC</b> Center Left, Center Right <b>F</b> Tile to Floor <b>118</b> Bright White Laminate <b>118</b> Bright White Edgeband	<b>Concealed Post Monolithic Panel Laminate Inserts</b> • Attachment Clips	<b>Concealed Post Monolithic Panel Laminate Inserts</b> <b>Finish Options:</b> <b>114</b> Folkstone Grey <b>117</b> Soft Grey <b>118</b> Bright White <b>119</b> Pumice

# Concealed Post

Dividends Horizon

## Monolithic Panel Double with Post Fabric Inserts Worksurface Height, 28" and 42" High

description	w*	w	h	d	pattern no.	10	15	20	25	30	35	40	45
Worksurface Height Concealed Post	30"	33"	27 1/4"	7/16"	<b>DP1SOWH30EPEF</b>	\$139.	\$144.	\$151.	\$153.	\$159.	\$161.	\$163.	\$167.
Monolithic Panel Double with	36"	39"	27 1/4"	7/16"	<b>DP1SOWH36EPEF</b>	156.	161.	168.	170.	175.	178.	180.	185.
Post Fabric Insert	48"	51"	27 1/4"	7/16"	<b>DP1SOWH48EPEF</b>	170.	175.	183.	186.	193.	196.	199.	204.
	60"	63"	27 1/4"	7/16"	<b>DP1SOWH60EPEF</b>	185.	192.	201.	204.	209.	213.	216.	222.



28" High Concealed Post	30"	33"	33 13/16"	7/16"	<b>DP1SO2830EPEF</b>	110.	112.	118.	122.	124.	127.	128.	131.
Monolithic Panel Double with	36"	39"	33 13/16"	7/16"	<b>DP1SO2836EPEF</b>	149.	152.	161.	164.	168.	171.	173.	177.
Post Fabric Insert	48"	51"	33 13/16"	7/16"	<b>DP1SO2848EPEF</b>	186.	193.	202.	206.	211.	215.	218.	224.
(For 36" h panel frame)	60"	63"	33 13/16"	7/16"	<b>DP1SO2860EPEF</b>	226.	232.	244.	248.	255.	260.	264.	270.



42" High Concealed Post	30"	33"	41 3/16"	7/16"	<b>DP1SO4230EPEF</b>	136.	140.	147.	151.	153.	157.	159.	163.
Monolithic Panel Double with	36"	39"	41 3/16"	7/16"	<b>DP1SO4236EPEF</b>	173.	178.	186.	192.	195.	199.	202.	207.
Post Fabric Insert	48"	51"	41 3/16"	7/16"	<b>DP1SO4248EPEF</b>	209.	215.	226.	230.	236.	240.	244.	250.
	60"	63"	41 3/16"	7/16"	<b>DP1SO4260EPEF</b>	246.	253.	265.	270.	277.	282.	287.	295.



w\* = nominal width

Dimensions listed under w h d are actual to the nearest 1/16"

Ordering Information	Order Code	Included with:	Options
<b>Concealed Post Monolithic Panel Fabric Inserts</b>	<b>Concealed Post Monolithic Panel Fabric Inserts</b>	<b>Concealed Post Monolithic Panel Fabric Inserts</b>	<b>Concealed Post Monolithic Panel Fabric Inserts</b>
1. Pattern Number	<i>Example:</i> <b>DP1SO2836EPEF</b>	• Attachment Clips	
2. Fabric	<b>DP1SO</b> Pattern Number		
	<b>2836</b>		
	<b>EPE</b> End, Post, End		
	<b>F</b> Tile to Floor		
	<b>W351-3</b> Foundation Corn Silk Fabric		

# Concealed Post

## Monolithic Panel Double with Post Fabric Inserts

### 50", 57" and 64" High

description	w*	w	h	d	pattern no.	10	15	20	25	30	35	40	45
50" High Concealed Post	30"	33"	48 1/2"	7/16"	<b>DP1SO5030EPEF</b>	\$162.	\$165.	\$173.	\$178.	\$181.	\$184.	\$188.	\$194.
Monolithic Panel Double with	36"	39"	48 1/2"	7/16"	<b>DP1SO5036EPEF</b>	196.	201.	210.	215.	220.	224.	229.	235.
Post Fabric Insert	48"	51"	48 1/2"	7/16"	<b>DP1SO5048EPEF</b>	229.	236.	247.	252.	259.	263.	268.	274.
	60"	63"	48 1/2"	7/16"	<b>DP1SO5060EPEF</b>	263.	271.	284.	289.	298.	302.	308.	315.



57" High Concealed Post	30"	33"	55 3/8"	7/16"	<b>DP1SO5730EPEF</b>	186.	193.	202.	206.	211.	213.	218.	224.
Monolithic Panel Double with	36"	39"	55 3/8"	7/16"	<b>DP1SO5736EPEF</b>	218.	225.	236.	241.	247.	250.	255.	262.
Post Fabric Insert	48"	51"	55 3/8"	7/16"	<b>DP1SO5748EPEF</b>	249.	256.	269.	274.	282.	286.	291.	299.
	60"	63"	55 3/8"	7/16"	<b>DP1SO5760EPEF</b>	281.	289.	303.	309.	319.	324.	330.	338.



64" High Concealed Post	30"	33"	63 1/16"	7/16"	<b>DP1SO6430EPEF</b>	238.	244.	256.	261.	268.	272.	278.	284.
Monolithic Panel Double with	36"	39"	63 1/16"	7/16"	<b>DP1SO6436EPEF</b>	253.	261.	274.	279.	287.	291.	297.	304.
Post Fabric Insert	48"	51"	63 1/16"	7/16"	<b>DP1SO6448EPEF</b>	269.	278.	291.	297.	305.	310.	315.	324.





w\* = nominal width

Dimensions listed under w h d are actual to the nearest 1/16"

Ordering Information	Order Code	Included with:	Options
<b>Concealed Post Monolithic Panel Fabric Inserts</b>	<b>Concealed Post Monolithic Panel Fabric Inserts</b>	<b>Concealed Post Monolithic Panel Fabric Inserts</b>	<b>Concealed Post Monolithic Panel Fabric Inserts</b>
1. Pattern Number	<i>Example:</i> <b>DP1SO5736EPEF</b>	• Attachment Clips	
2. Fabric	<b>DP1SO</b> Pattern Number		
	<b>5736</b>		
	<b>EPE</b> End, Post, End		
	<b>F</b> Tile to Floor		
	<b>W351-3</b> Foundation Corn Silk Fabric		

*Monolithic Panel Double with Post Laminate Inserts*  
*Worksurface Height, 28" and 42" High*

description	w*	w	h	d	pattern no.	list
Worksurface Height Concealed Post	30"	33"	27 1/4"	7/16"	<b>DP3L1WH30EPEF</b>	\$244.
 Monolithic Panel Double with Post Laminate Insert	36"	39"	27 1/4"	7/16"	<b>DP3L1WH36EPEF</b>	291.
	48"	51"	27 1/4"	7/16"	<b>DP3L1WH48EPEF</b>	300.
	60"	63"	27 1/4"	7/16"	<b>DP3L1WH60EPEF</b>	393.
	72"	75"	27 1/4"	7/16"	<b>DP3L1WH72EPEF</b>	402.
	84"	87"	27 1/4"	7/16"	<b>DP3L1WH84EPEF</b>	410.

28" High Concealed Post	30"	33"	33 13/16"	7/16"	<b>DP3L12830EPEF</b>	365.
 Monolithic Panel Double with Post Laminate Insert (For 36" h panel frame)	36"	39"	33 13/16"	7/16"	<b>DP3L12836EPEF</b>	369.
	48"	51"	33 13/16"	7/16"	<b>DP3L12848EPEF</b>	390.
	60"	63"	33 13/16"	7/16"	<b>DP3L12860EPEF</b>	634.
	72"	75"	33 13/16"	7/16"	<b>DP3L12872EPEF</b>	643.
	84"	87"	33 13/16"	7/16"	<b>DP3L12884EPEF</b>	650.

42" High Concealed Post	30"	33"	41 3/16"	7/16"	<b>DP3L14230EPEF</b>	394.
 Monolithic Panel Double with Post Laminate Insert	36"	39"	41 3/16"	7/16"	<b>DP3L14236EPEF</b>	416.
	48"	51"	41 3/16"	7/16"	<b>DP3L14248EPEF</b>	430.
	60"	63"	41 3/16"	7/16"	<b>DP3L14260EPEF</b>	640.
	72"	75"	41 3/16"	7/16"	<b>DP3L14272EPEF</b>	647.
	84"	87"	41 3/16"	7/16"	<b>DP3L14284EPEF</b>	655.

w\* = nominal width

Dimensions listed under w h d are actual to the nearest 1/16"

Ordering Information	Order Code	Included with:	Options
<b>Concealed Post Monolithic Panel Laminate Inserts</b> 1. Pattern Number 2. Laminate Finish 3. Edgeband Finish	<b>Concealed Post Monolithic Panel Laminate Inserts</b> <i>Example:</i> <b>DP3L14236EPEF</b> <hr/> <b>DP3L1</b> Pattern Number <hr/> <b>4236</b> <hr/> <b>EPE</b> End, Post, End <hr/> <b>F</b> Tile to Floor <hr/> <b>118</b> Bright White Laminate <hr/> <b>118</b> Bright White Edgeband	<b>Concealed Post Monolithic Panel Laminate Inserts</b> <ul style="list-style-type: none"> <li>Attachment Clips</li> </ul>	<b>Concealed Post Monolithic Panel Laminate Inserts</b> <b>Finish Options:</b> <b>114</b> Folkstone Grey <b>117</b> Soft Grey <b>118</b> Bright White <b>119</b> Pumice

# Concealed Post

## Monolithic Panel Double with Post Laminate Inserts

### 50" and 57" High

description	w *	w	h	d	pattern no.	list
50" High Concealed Post Monolithic Panel Double with Post Laminate Insert 	30"	33"	48 1/2"	7/16"	<b>DP3L15030EPEF</b>	\$399.
	36"	39"	48 1/2"	7/16"	<b>DP3L15036EPEF</b>	488.
	48"	51"	48 1/2"	7/16"	<b>DP3L15048EPEF</b>	637.
	60"	63"	48 1/2"	7/16"	<b>DP3L15060EPEF</b>	644.
	72"	75"	48 1/2"	7/16"	<b>DP3L15072EPEF</b>	652.
	84"	87"	48 1/2"	7/16"	<b>DP3L15084EPEF</b>	660.

57" High Concealed Post Monolithic Panel Double with Post Laminate Insert 	30"	33"	55 3/8"	7/16"	<b>DP3L15730EPEF</b>	405.
	36"	39"	55 3/8"	7/16"	<b>DP3L15736EPEF</b>	493.
	48"	51"	55 3/8"	7/16"	<b>DP3L15748EPEF</b>	641.
	60"	63"	55 3/8"	7/16"	<b>DP3L15760EPEF</b>	649.
	72"	75"	55 3/8"	7/16"	<b>DP3L15772EPEF</b>	656.
	84"	87"	55 3/8"	7/16"	<b>DP3L15784EPEF</b>	665.

w\* = nominal width  
Dimensions listed under w h d are actual to the nearest 1/16"

Ordering Information	Order Code	Included with:	Options
<b>Concealed Post Monolithic Panel Laminate Inserts</b> 1. Pattern Number 2. Laminate Finish 3. Edgeband Finish	<b>Concealed Post Monolithic Panel Laminate Inserts</b> Example: <b>DP3L15736EPEF</b> <hr/> <b>DP3L1</b> Pattern Number <hr/> <b>5736</b> <hr/> <b>EPE</b> End, Post, End <hr/> <b>F</b> Tile to Floor <hr/> <b>118</b> Bright White Laminate <hr/> <b>118</b> Bright White Edgeband	<b>Concealed Post Monolithic Panel Laminate Inserts</b> • Attachment Clips	<b>Concealed Post Monolithic Panel Laminate Inserts</b> <b>Finish Options:</b> <b>114</b> Folkstone Grey <b>117</b> Soft Grey <b>118</b> Bright White <b>119</b> Pumice

Concealed Post  
 Frameless Add Up  
 Clear, Powder and Bronze Glass

description	w	d	h	pattern no.	list	Clear (TEMP)	Powder (GL13) Bronze (GL25)
Frameless Add Up, 7" High (For use with concealed post only) 	51"	3/4"	7"	<b>DP1AU0751( )G</b>		\$399.	\$448.
	57"	3/4"	7"	<b>DP1AU0757( )G</b>		432.	486.
	63"	3/4"	7"	<b>DP1AU0763( )G</b>		465.	525.
	69"	3/4"	7"	<b>DP1AU0769( )G</b>		499.	564.
	75"	3/4"	7"	<b>DP1AU0775( )G</b>		533.	604.

Shortened Frameless Add Up, 7" High (For use with concealed post only) 	50"	3/4"	7"	<b>DP1AU0750( )G</b>		399.	448.
	56"	3/4"	7"	<b>DP1AU0756( )G</b>		432.	486.
	62"	3/4"	7"	<b>DP1AU0762( )G</b>		465.	525.
	68"	3/4"	7"	<b>DP1AU0768( )G</b>		499.	564.
	74"	3/4"	7"	<b>DP1AU0774( )G</b>		533.	604.

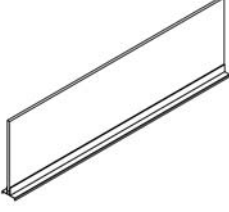
Frameless Add Up, 14" High (For use with concealed post only) 	51"	3/4"	14"	<b>DP1AU1451( )G</b>		563.	662.
	57"	3/4"	14"	<b>DP1AU1457( )G</b>		616.	726.
	63"	3/4"	14"	<b>DP1AU1463( )G</b>		668.	791.
	69"	3/4"	14"	<b>DP1AU1469( )G</b>		720.	855.
	75"	3/4"	14"	<b>DP1AU1475( )G</b>		774.	919.

**Ordering Information**

**Frameless Add Up with Glass**

1. Pattern number
2. Frame finish
3. Glass finish

**End Cap**

1. Pattern number
2. Paint finish

**Order Code**

**Frameless Add Up with Glass**

*Example:* **DP1AU0757VG**

**DP1AU** Frameless Add Up

**07** 7" High

**57** 57" Wide

**V** Full view

**G** Glass

**117** Frame finish

**TEMP** Clear glass finish

**Included with:**

**Frameless Add Up with Glass**

- Attachment hardware
- Topway Trough Spacer (Topway only)
- Alignment Clip

**Options**

**Frame Options:**

- (V)**= Full view  
**(C)** = Topway

**Glass Options:**

- (TEMP)**= Clear  
**(GL13)** = Powder  
**(GL25)** = Bronze



Concealed Post  
 Frameless Add Up  
 Clear, Powder and Bronze Glass

description	w	d	h	pattern no.	list	Clear (TEMP)	Powder (GL13) Bronze (GL25)
Shortened Frameless Add Up, 14" High (For use with concealed post only)	50"	3/4"	14"	<b>DP1AU1450( )G</b>		\$563.	\$662.
	56"	3/4"	14"	<b>DP1AU1456( )G</b>		616.	726.
	62"	3/4"	14"	<b>DP1AU1462( )G</b>		668.	791.
	68"	3/4"	14"	<b>DP1AU1468( )G</b>		720.	855.
	74"	3/4"	14"	<b>DP1AU1474( )G</b>		774.	919.

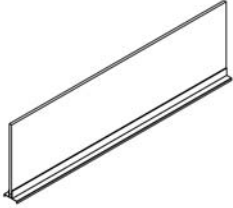

End Cap				<b>DP1AUECTP</b>	36.		
---------	--	--	--	------------------	-----	--	--



Ordering Information	Order Code	Included with:	Options
<b>Frameless Add Up with Glass</b> 1. Pattern number 2. Frame finish 3. Glass finish  <b>End Cap</b> 1. Pattern number 2. Paint finish	<b>Frameless Add Up with Glass</b>  <i>Example:</i> <b>DP1AU0757VG</b> <b>DP1AU</b> Frameless Add Up <b>07</b> 7" High <b>57</b> 57" Wide <b>V</b> Full view <b>G</b> Glass <b>117</b> Frame finish <b>TEMP</b> Clear glass finish	<b>Frameless Add Up with Glass</b> <ul style="list-style-type: none"> <li>Attachment hardware</li> <li>Topway Trough Spacer (Topway only)</li> <li>Alignment Clip</li> </ul>	<b>Frame Options:</b> <b>(V)</b> = Full view <b>(C)</b> = Topway  <b>Glass Options:</b> <b>(TEMP)</b> = Clear <b>(GL13)</b> = Powder <b>(GL25)</b> = Bronze

The 120-degree planning model provides comparable or greater square footage per workstation than typical cubicle layouts (comparisons are illustrated on this page). At the same time, Dividends Horizon 120° allows for a more natural space, creating a more comfortable place to work. Maintaining a consistent 48" module promotes improved asset management and a reduction of reconfiguration costs.

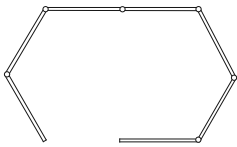

**Big House**  
Sq. Feet = 69.8'  
7 Panels

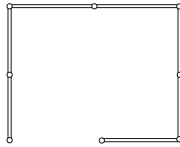

**8' x 8'**  
Sq. Feet = 64'  
7 Panels

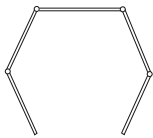

**Full House**  
Sq. Feet = 42.1'  
5 Panels

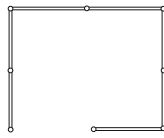

**6' x 7'**  
Sq. Feet = 42'  
7 Panels

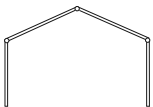

**Open House**  
Sq. Feet = 35.5'  
4 Panels

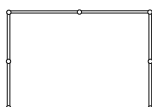

**6' x 6'**  
Sq. Feet = 36'  
6 Panels



**Townhouse**  
Sq. Feet = 34.1'  
3 Panels

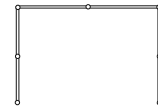

**6' x 6'**  
Sq. Feet = 36'  
6 Panels

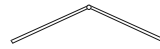

**Apartment**  
Sq. Feet = 32.1'  
2 Panels

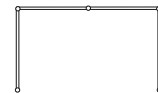

**4' x 6'**  
Sq. Feet = 24'  
4 Panels

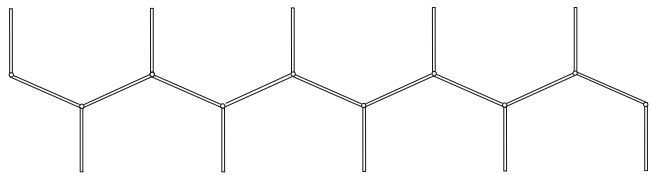

**8 Open House Stations**  
Sq. Feet = 284'  
19 Panels

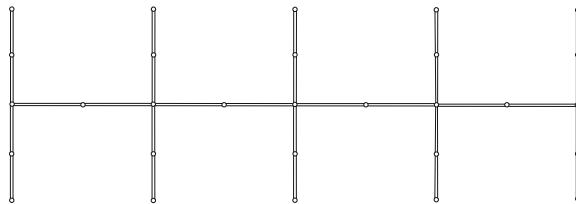

**8 Station Cluster**  
Each station 6' x 6'  
Sq. Feet = 288'  
28 Panels

These worksurfaces are designed specifically for Dividends Horizon 120. The (L/R) suffix at the end of a pattern number indicates a defined pedestal location. If the worksurface has no defined pedestal location, the (L/R) represents the curved side of the top. All tops and tables are available with 2mm edge band or a 1" ergonomic edge.

**Worksurface: W3**

This worksurface, combined with the T3 Transition top, works best with the "apartment" layout. This application allows for stations on both sides of the spine, and is ideal for high density layouts. Available in extended versions for placement directly next to another worksurface.

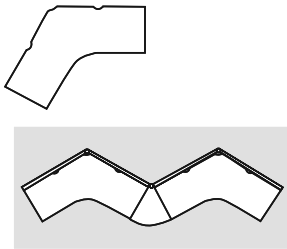

**Worksurface: W3**

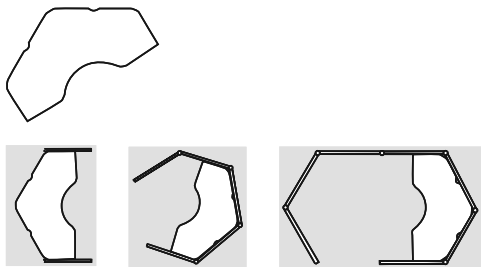

**Worksurface: W4**

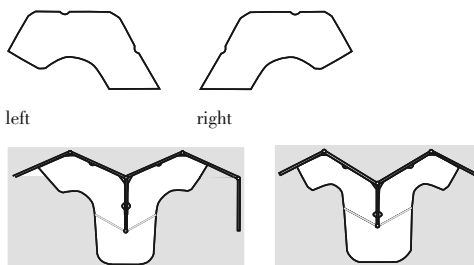

**Worksurface: W5 (L/R)**

**Worksurface: W4**

This top works well in the "open house," "full house," and "big house" layouts for call center, professional, and managerial applications.

**Worksurface: W5 (L/R)**

With transition top T5 and this worksurface, teaming is made easy using the "townhouse" or "open house" layout. The shared space allows for call center, professional, or technical applications.

**Worksurface: W6 (L/R)**

In the "big house," "full house" or "open house", this worksurface allows for a pedestal on one side (determined by the L/R). Applications for this top include a call center with the "open house," technical applications with the "full house," and managerial layouts with the "big house."

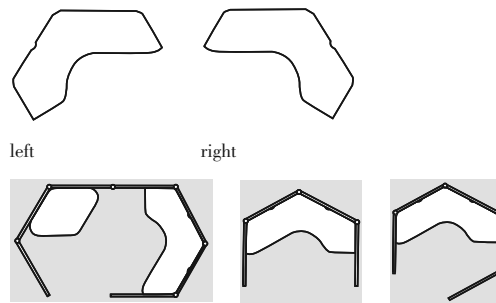

**Worksurface: W6 (L/R)**

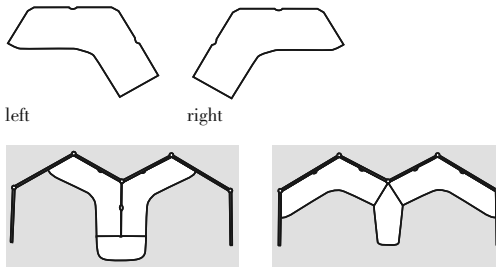

**Worksurface: W7 (L/R)**

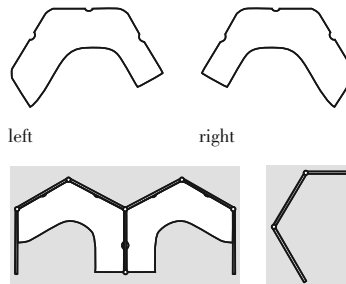

**Worksurface: W11 / W1118 (L/R)**

**Worksurface: W7 (L/R)**

Used in conjunction with a T4 transition top, the W7 worksurface provides a great teaming space when the "townhouse" layout is used. The "open house" layout incorporates the T2 transition top for professional or technical stations with shared space for conferencing. Available in extended versions for placement directly next to another worksurface.

**Worksurface: W11 / W1118 (L/R)**

This top is a spacious option for a technical station in the "open house" layout. Adding a T2 transition top provides additional teaming space. The W11 surface also fits nicely in a private managerial office or a "full house" professional application.

**Worksurface: W12 / W1218 (L/R)**

This top, with the T5/T518 transition top provides a technical office with shared conferencing space in the “open house” layout. The 18” return allows ample space in the supervisory application of the “full house.”

**Worksurface: W13 / W1318 (L/R)**

This surface provides a teaming space with the T2/T218 transition in the “open house” layout. The W13/W1318 creates generous worksurface space in the “full house” as well as the management layout of the “big house.”

**Transition Tops**

Transition tops require columns (not included) for support. Flat brackets (not included) are required to attach transition tops to adjacent worksurfaces.

**Application Notes**

Dividends Horizon 120° worksurfaces use cantilevers as their main form of support. A cantilever must be used at each post location to support worksurfaces properly. A pedestal may be used for support, where applicable, in conjunction with cantilevers.

**Worksurface: W12 / W1218 (L/R)**

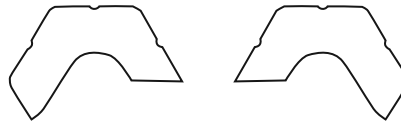

left

right



**Worksurface: W13 / W1318 (L/R)**

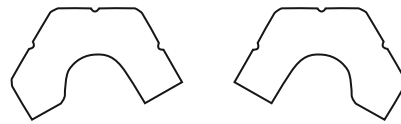

left

right

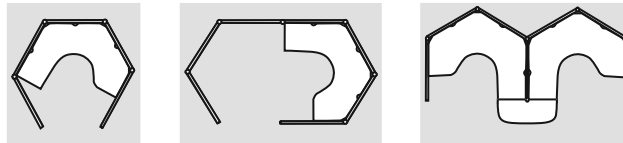

**Transition Tops**



Transition top: T2



Transition top: T218

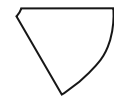

Transition top: T3



Transition top: T4







Transition top: T5



Transition top: T518

# 120° Planning

## 120° Post Assemblies

description	h*	w	d	pattern no.	Black	Metal P1	Metal P2	Metal P3
 120° Two-Way Post Assembly	36"	3"	3"	<b>DP( )120PA362</b>		\$260.	\$268.	\$277.
	42"	3"	3"	<b>DP( )120PA422</b>		260.	268.	277.
	50"	3"	3"	<b>DP( )120PA502</b>		272.	281.	289.
	57"	3"	3"	<b>DP( )120PA572</b>		301.	311.	320.
	64"	3"	3"	<b>DP( )120PA642</b>		301.	311.	320.
	78"	3"	3"	<b>DP( )120PA782</b>		383.	400.	413.
 120° Three-Way Post Assembly	36"	3"	3"	<b>DP( )120PA363</b>		266.	274.	281.
	42"	3"	3"	<b>DP( )120PA423</b>		266.	274.	281.
	50"	3"	3"	<b>DP( )120PA503</b>		277.	284.	293.
	57"	3"	3"	<b>DP( )120PA573</b>		301.	311.	320.
	64"	3"	3"	<b>DP( )120PA643</b>		301.	311.	320.
	78"	3"	3"	<b>DP( )120PA783</b>		381.	396.	410.
 14" High 120° Stack Panel Posts	14 <sup>5/8</sup> "	3"	3"	<b>DP120SPO 14</b>	80.			
 21" High 120° Stack Panel Posts	21 <sup>15/16</sup> "	3"	3"	<b>DP120SPO 21</b>	81.			
 28" High 120° Stack Panel Posts	29 <sup>1/4</sup> "	3"	3"	<b>DP120SPO 28</b>	92.			

h = nominal height

### Ordering Information

- Post Assemblies**
1. Pattern Number
  2. Trim Finish

### Order Code

**Post Assemblies**  
*Example:* **DP(4)120PA 642, 113**  
**DP(4)120** Pattern Number  
**PA 642**  
**113** Dark grey trim finish

### Included with:

- Post Assemblies**
- Post assemblies
  - Post top cap
  - Post cover
  - Connecting hardware





### Options

- Post assembly trim options**
- (4)** = Metal, Radius
  - (5)** = Metal, Flat

# 120° Planning

## 120° Post Components

Dividends Horizon

description	type	h	w	d	pattern no.	Metal P1	Metal P2	Metal P3
Post Covers (Straight) High-Low Connection 	36" - 42"	8"			<b>DP120PC08S</b>	\$9.	\$11.	\$11.
	36" - 50"	14"			<b>DP120PC14S</b>	15.	20.	22.
	36" - 64"	28"			<b>DP120PC28S</b>	36.	39.	40.
	36" - 78"	42"			<b>DP120PC42SH</b>	54.	57.	59.
	42" - 50"	8"			<b>DP120PC08S</b>	9.	11.	11.
	42" - 64"	22"			<b>DP120PC22S</b>	23.	24.	25.
	42" - 78"	36"			<b>DP120PC36S</b>	48.	53.	55.
	50" - 64"	14"			<b>DP120PC14S</b>	15.	20.	22.
	50" - 78"	28"			<b>DP120PC28S</b>	36.	39.	40.
	64" - 78"	14"			<b>DP120PC14S</b>	15.	20.	22.
Post Top Caps 	One-Way	1/2"	3"	3"	<b>DP( )120PT1</b>	8.	9.	9.
	Three-Way	1/2"	3"	3"	<b>DP( )120PT3</b>	8.	9.	9.
	Two-Way	1/2"	3"	3"	<b>DP( )120PT2</b>	8.	9.	9.
Post Covers (Straight) 	36"				<b>DP120PC36SF</b>	45.	48.	53.
	42"				<b>DP120PC42S</b>	45.	48.	53.
	50"				<b>DP120PC50S</b>	46.	50.	54.
	57"				<b>DP120PC57S</b>	53.	55.	58.
	64"				<b>DP120PC64S</b>	53.	55.	58.
	78"				<b>DP120PC78S</b>	58.	64.	66.
Universal Post (Post Only) 	36"	3"	3"		<b>DP120PO36</b>	195.		
	42"	3"	3"		<b>DP120PO42</b>	195.		
	50"	3"	3"		<b>DP120PO50</b>	205.		
	57"	3"	3"		<b>DP120PO57</b>	222.		
	64"	3"	3"		<b>DP120PO64</b>	222.		
	78"	3"	3"		<b>DP120PO78</b>	300.		
Inside Panel Shroud for 120° posts 	5"				<b>DP120S</b>	10.	13.	15.

Ordering Information	Order Code	Included with:	Options
<b>Universal Post</b> 1. Pattern Number	<b>Universal Post</b> <i>Example:</i> <b>DP2A P050</b>	<b>Universal Post</b>	<b>120° Post</b>
<b>Panel Top Cap</b> 1. Pattern Number 2. Trim finish	<b>DP2A</b> Pattern Number <b>P050</b>	Connecting hardware	<b>Panel Top Cap and Post Covers</b>
<b>Post Covers</b> 1. Pattern Number 2. Trim finish	<b>Panel Top Cap</b> <i>Example:</i> <b>DPV1 PT4, V04</b> <b>DPV1 PT4</b> Pattern Number <b>V04</b> Maple trim finish	<b>Panel Top Cap</b> <b>Post Covers</b>	(4) = Metal, Radius (5) = Metal, Flat
	<b>Post Covers</b> <i>Example:</i> <b>DP2A PC50S, 117</b> <b>DP(2A)</b> Pattern Number <b>PC50S</b> <b>117</b> Soft grey trim finish		

**This page intentionally left blank**

120° Planning  
120° Worksurface and Transition Tops  
Grain Direction

Grain Direction

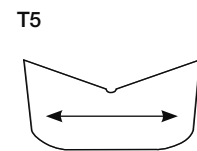
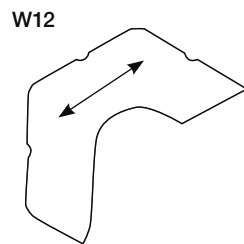
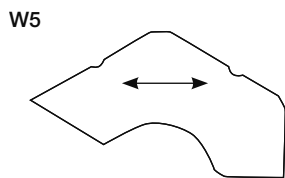
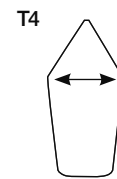
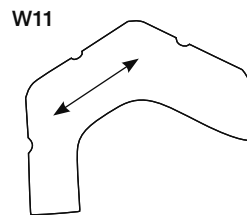
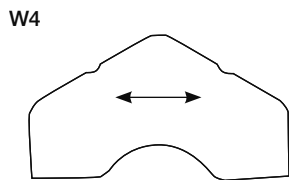
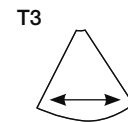
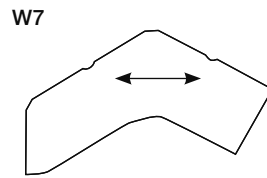
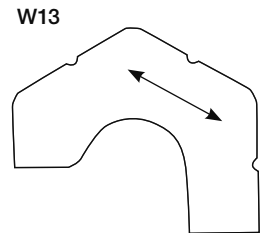
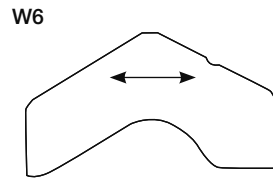
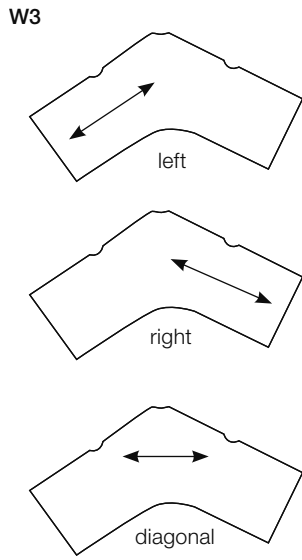



# 120° Planning

## 120° Worksurface and Transition Tops

Dividends Horizon

description	top name	w	return depth	d	pattern no.	2 mm	woodgrain edge	metal edge
Worksurface	W11L	48"	18"L-24"R		<b>D1WW11481824</b>	\$1,035.	\$1,137.	\$1,241.
	W11L	48"	24"L-18"R		<b>D1WW11482418</b>	1,035.	1,137.	1,241.
	W12L	48"	24"		<b>D1WW124824L</b>	1,080.	1,191.	1,298.
	W12R	48"	24"		<b>D1WW124824R</b>	1,080.	1,191.	1,298.
	W1318L	48"	24"L-18"R		<b>D1WW13482418</b>	1,035.	1,137.	1,241.
	W1318R	48"	18"L-24"R		<b>D1WW13481824</b>	1,035.	1,137.	1,241.
	W13L	48"	24"		<b>D1WW134824L</b>	1,035.	1,137.	1,241.
	W13R	48"	24"		<b>D1WW134824R</b>	1,035.	1,137.	1,241.
	W218L	48"	24"L-18"R		<b>D1WW12482418</b>	1,080.	1,191.	1,298.
	W218R	48"	18"L-24"R		<b>D1WW12481824</b>	1,080.	1,191.	1,298.
	W3	48"	24"		<b>D1WW34824</b>	789.	866.	943.
	W4	48"	24"		<b>D1WW44824</b>	811.	892.	973.
	W5L	48"	24"		<b>D1WW54824L</b>	652.	718.	786.
	W5R	48"	24"		<b>D1WW54824R</b>	652.	718.	786.
	W6L	48"	24"		<b>D1WW64824L</b>	877.	964.	1,051.
	W6R	48"	24"		<b>D1WW64824R</b>	877.	964.	1,051.
	W7L	48"	24"		<b>D1WW74824L</b>	873.	962.	1,048.
	W7R	48"	24"		<b>D1WW74824R</b>	873.	962.	1,048.
Transition tops	T2	50"	24"		<b>D1WT224</b>	525.	579.	632.
	T218	37 1/2"	18"		<b>D1WT218</b>	492.	544.	591.
	T3	26"	24"		<b>D1WT324</b>	501.	553.	604.
	T4	26"	24"		<b>D1WT424</b>	603.	663.	722.
	T5	50"	24"		<b>D1WT524</b>	610.	672.	729.
	T518	37 1/2"	18"		<b>D1WT518</b>	547.	600.	653.

Alternative Planning

### Ordering Information

#### Worksurface

1. Pattern number
2. Finish

### Order Code

Example:	<b>D1WW134824L, 118, 118</b>
<b>D1W</b>	Dividends 120 w/s 2mm edge
<b>W13</b>	Worksurface #13
<b>4824</b>	Side width/return depth
<b>L</b>	Pedestal on left side
<b>118</b>	Bright White laminate
<b>118</b>	Bright White edge

### Included with:

**Worksurface**

- Worksurface

Worksurface supports must be ordered separately.

For all tops, specify laminate and edge color.

Transition and peninsula tops require a column base for support.

**Note:** An upcharge applies when specifying Legacy laminates. See Legacy finish page.

### Options

Refer to the worksurface planning page for worksurface drawings and applications.

**Note:** W3 worksurfaces have a grain direction option. Specify left, right or diagonal. Add \$25 to the list price when specifying diagonal.

### 3+1 Circuit Electrical

The Dividends Horizon 3+1 electrical system is designed for areas where power usage is significant and sensitive electronic equipment requiring a single isolated circuit is required.

The wire configuration of the 8-wire/4 circuit electrical system is (see chart):

- Hot "A" (black)
- Hot "B" (red)
- Hot "C" (blue)
- Shared neutral "N1" (white/black) for circuits #1, 2 and 3
- Shared ground "G1" (green) for circuits #1, 2 and 3
- Hot "X" (pink)
- Isolated neutral "N2" (white/ red) for circuit 4
- Isolated ground "G2" (green/ yellow) for circuit 4

Circuits 1, 2 and 3 have shared neutral and grounds for convenience power while circuit 4 has a separate ground and neutral for designated/isolated power or to support uninterrupted power supply (UPS).

### Compatibility

All Dividends Horizon power systems use components that appear similar. However, components from the three different power systems are not functionally, fully interchangeable. 3+1 components can be connected to 3+3 wire systems, however only 3+1 will function.

### 3+1 Duplex Receptacles

Duplex receptacles used in 3+1 electrical systems are:

- Convenience duplex circuit number 1 (pattern number DE1DR1)
- Convenience duplex circuit number 2 (pattern number DE1DR2)
- Convenience duplex circuit number 3 (pattern number DE1DR3)
- Isolated duplex circuit number 4 (pattern number DE1DR4)

Isolated duplex receptacle number 4 has an orange-colored triangle on black background to identify an isolated duplex.

An optional orange-colored isolated duplex is also available. It has the isolated identifying triangle outlined in black.

- Isolated orange-colored duplex circuit number 4 (pattern number DE1DOR4)

### 3+1 Electrical System Technical Specifications

The 3+1 electrical system consists of four 20 amp, 120 volt, 60-Hertz circuits. The circuits will accommodate 120 volt single phase, 120/240 volt split phase and 120/208 volt three phase power. System components are 20 amp capacity. The National Electric Code (NEC) limits continuous loads to 80% of capacity or 16 amps.

Typically, each circuit can power 8-10 duplex convenience outlets with normal loads. In heavier load situations, such as computer systems, each circuit will power 3-5 duplex outlets. If each workstation has two convenience duplex outlets and one protected duplex, the 8-wire (4-circuit) system can supply a cluster of 6 - 10 workstations from each infeed.

### Surge Suppressors

Dividends Horizon surge suppressors (pattern number DE1SS) plug into any terminal block position to provide surge protection for all duplexes on that circuit.

**Note:** When connected, surge suppressors take the place of a duplex receptacle resulting in the elimination of one duplex position from the circuit.

### Independent Neutral Electrical Systems

Dividends Horizon offers a 2+1 electrical system with independent neutrals as a standard special. It is our belief that independent neutrals are not required. However, if a customer desires an independent neutral electrical system, a Dividends Horizon solution can be provided. For further information, list pricing and schematic drawings, contact Knoll Customer Service.

### SPECIFYING ELECTRICAL COMPONENTS

#### Panel Power Module

Specify one panel power module per panel that matches the width of the panel where duplexes or infeeds are required.

#### Power Connector

Specify one power connector (with or without post) to connect panel power modules in adjacent panels.

#### Power Jumper

Specify one power jumper that matches the width of the panel(s) being passed through to connect to panel power modules in nonadjacent panels.

### Wiring Diagram (3+1)

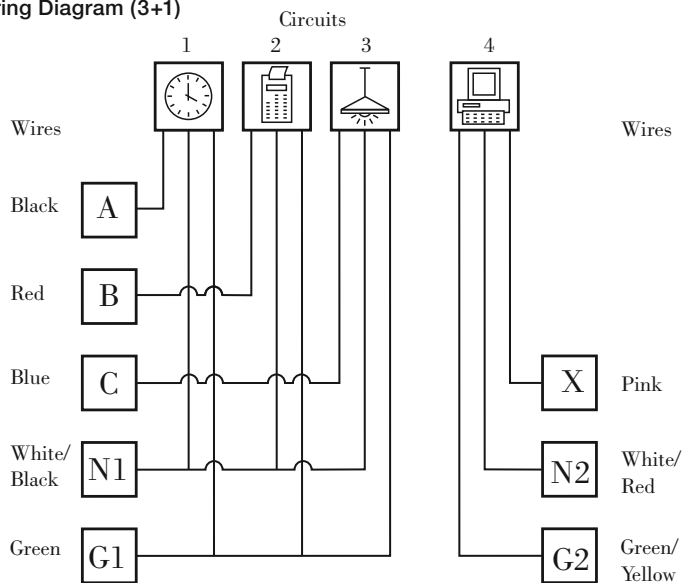

### 2+2 Electrical System

The Dividends Horizon 2+2 electrical system is designed for areas where power usage is significant and sensitive electronic equipment requiring two isolated circuits are required.

The wiring configuration of the (2+2) electrical system is (see chart):

- Hot "A" (black)
- Hot "B" (red)
- Shared neutral "N1" (white/black) for circuits #1 and 2
- Shared ground "G1" (green) for circuits #1 and 2
- Hot "Y" (tan)
- Hot "X" (pink)
- Isolated Shared Neutral "N2" (white/red) for circuits #4 and 5
- Isolated Shared ground "G2" (green/yellow) for circuits #4 and 5

Circuits 1 and 2 share common neutral and ground. Circuits 4 and 5 share a separate common neutral and ground.

### Compatibility

All Dividends Horizon power systems use components that appear similar. However, components from the three different power systems are not functionally, fully interchangeable.

### 2+2 Duplex Receptacles

Duplex receptacles used in 8-wire (2+2) electrical systems are:

- Convenience duplex circuit number 1 (pattern number DE1DR1)
- Convenience duplex circuit number 2 (pattern number DE1DR2)
- Isolated duplex circuit number 4 (pattern number DE1DR4)
- Isolated duplex circuit number 5 (pattern number DE1DR5)

### 2+2 Electrical System Technical Specifications

The 2+2 electrical system consists of four 20 amp, 120 volt, 60-Hertz circuits. The circuits will accommodate 120 volt single phase, 120/240 volt split phase, and 120/208 volt three phase power. System components are 20 amp capacity. The National Electric

Code (NEC) limits continuous loads up to 80% of capacity or 16 amps. Typically, each circuit can power 8-10 duplex convenience outlets with normal loads. In heavier load situations, such as computer systems, each circuit will power 3-5 duplex outlets.

### Surge Suppressors

Dividends Horizon surge suppressors (pattern number DE1 SS) plug into any terminal block position to provide surge protection for all duplexes on that circuit.

**Note:** When connected, surge suppressors take the place of a duplex receptacle resulting in the elimination of one duplex position from the circuit.

### SPECIFYING ELECTRICAL COMPONENTS

#### Panel Power Module

Specify one panel power module per panel that matches the width of the panel where duplexes or infeeds are required.

#### Power Connector

Specify one power connector (with or without post) to connect power modules in adjacent panels.

#### Power Jumper

Specify one power jumper that matches the width of the panel(s) being passed through to connect to panel power modules in nonadjacent panels.

### Wiring Diagram (2+2)

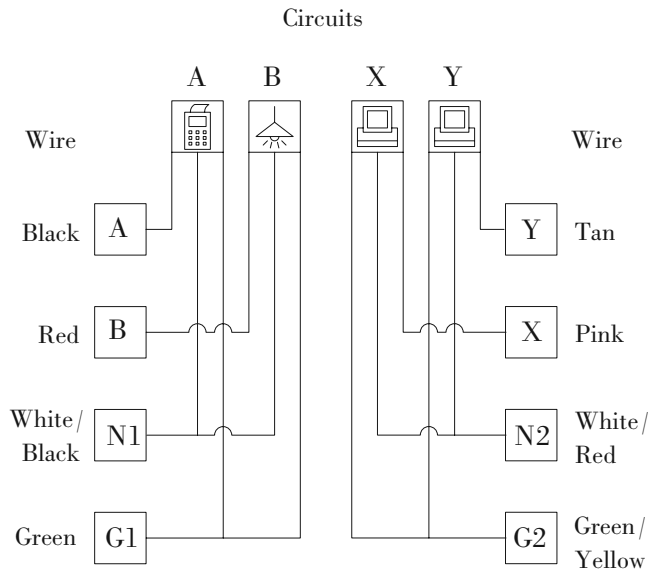

### 3+3 Electrical System

The Dividends Horizon 3+3 electrical system is designed for areas where power usage is significant and sensitive electronic equipment requiring multiple isolated circuits is required.

The wiring configuration of the 3+3 electrical system is (see chart):

- Hot "A" (black)
- Hot "B" (red)
- Hot "C" (blue)
- Shared neutral "N1" (white/black) for circuits #1, 2 and 3
- Shared ground "G1" (green) for circuits #1, 2 and 3
- Hot "Z" (orange)
- Hot "X" (pink)
- Hot "Y" (tan)
- Isolated neutral "N2" (white/ red for circuits 4, 5 and 6
- Isolated ground "G2" (green/yellow) for circuits 4, 5 and 6

Circuits 1, 2 and 3 are for convenience power while circuits 4, 5 and 6 are for designated/ isolated power or for supporting uninterrupted power supply (UPS).

### Compatibility

All Dividends Horizon power systems use components that appear similar. However, components from the three different power systems are not functionally, fully interchangeable. 3+3 components can be connected to 3+1 systems, however only 8-wires will function.

### Wiring Diagram (3+3)

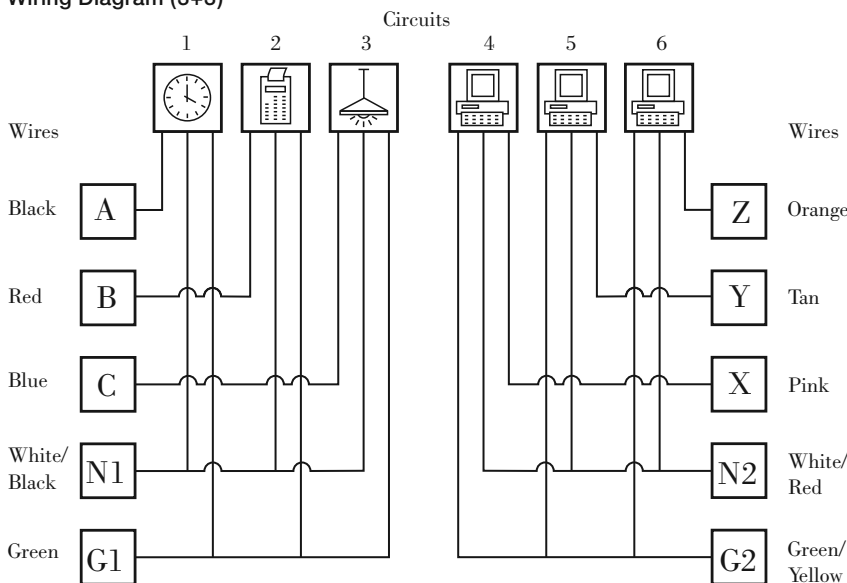

### 3+3 Duplex Receptacles

Duplex receptacles used in 3+3 electrical systems are:

- Convenience duplex circuit number 1 (pattern number DE1DR1)
- Convenience duplex circuit number 2 (pattern number DE1DR2)
- Convenience duplex circuit number 3 (pattern number DE1DR3)
- Isolated duplex circuit number 4 (pattern number DE1DR4)
- Isolated duplex circuit number 5 (pattern number DE1DR5)
- Isolated duplex circuit number 6 (pattern number DE1DR6)

Isolated duplex receptacles number 4, 5 and 6 have an orange-colored triangle on black background to signify as an isolated duplex.

Optional orange-colored isolated duplexes are also available. They have the isolated identifying triangle outlined in black.

- Isolated orange-colored duplex circuit number 4 (pattern number DE1DOR4)
- Isolated orange-colored duplex circuit number 5 (pattern number DE1DOR5)
- Isolated orange-colored duplex circuit number 6 (pattern number DE1DOR6)

### 3+3 Electrical System Technical Specifications

The 3+3 electrical system consists of six 20 amp, 120 volt, 60-Hertz circuits. The circuits will accommodate 120 volt single phase, 120/240 volt split phase and 120/208 volt three phase power. System components are 20 amp capacity. The National Electric Code (NEC) limits continuous loads to 80% of capacity or 16 amps. Typically, each circuit can power 8-10 duplex convenience outlets with normal loads. In heavier load situations, such as computer systems, each circuit will power 3-5 duplex outlets. If each workstation has two convenience duplex outlets and one protected duplex, the 10-wire (6-circuit) system can supply a cluster of 9 - 15 workstations from each infeed.

### Surge Suppressors

Dividends Horizon surge suppressors (pattern number DE1SS) plug into any terminal block position to provide surge protection for all duplexes on that circuit.

**Note:** When connected, surge suppressors take the place of a duplex receptacle resulting in the elimination of one duplex position from the circuit.

### Independent Neutral Electrical Systems

Dividends Horizon offers a 10-wire/2+2 electrical system with independent neutrals as a standard special. It is our belief that independent neutrals are not required. However, if a customer desires an independent neutral electrical system, a Dividends Horizon solution can be provided. For further information, list pricing and schematic drawings, contact Knoll Customer Service.

### SPECIFYING ELECTRICAL COMPONENTS

#### Panel Power Module

Specify one panel power module per panel that matches the width of the panel where duplexes or infeeds are required.

#### Power Connector

Specify one power connector (with or without post) to connect panel power modules in adjacent panels.

#### Power Jumper

Specify one power jumper that matches the width of the panel(s) being passed through to connect to panel power modules in nonadjacent panels.

# Base Raceway Electrical Power Modules, Power Jumpers Specifications

## Base Raceway Electrical

Power can be distributed through the base raceway.

Three systems are available:

- 3 + 1
- 2 + 2
- 3 + 3

Modular components are used to distribute power through the base raceway and consist of:

- Power modules
- Power connectors
- Power jumpers
- Duplex receptacles
- Power infeeds

All electrical components and data cables are field-installed.

**CAUTION: DO NOT CONNECT POWER UNTIL INSTALLATION IS COMPLETE. CONNECTION TO THE BUILDING POWER SOURCE MUST BE PERFORMED BY A LICENSED ELECTRICIAN.**

## Power Modules

Power modules are the primary electrical components for distributing electrical within panels. They are also the only components that accept duplex receptacles and power infeeds for access.

Panels 24" and wider can accept power modules. 18" wide panels only accept power jumpers.

Power modules consist of terminal blocks at each end connected by a hard-wired metal conduit. The terminal blocks accept duplex receptacles or power infeeds. Power modules snap into integral channels in base raceways and can be accessed on one or both panel sides.

## Power Jumpers

Power jumpers connect between power modules in non-adjacent panels. Power jumpers take the place of power modules in panels not requiring duplexes to provide pass-through power.

Three versions are available:

- Single panel power jumpers
- Single panel power jumpers with post
- Multiple panel power jumpers

Single panel power jumpers carry power from a panel with a power module through a single non-electrified panel to an adjacent panel with a power module when a post connector is not involved.

Single panel power jumpers with post carry power from a panel with a power module through a single non-electrified panel and post connector to an adjacent panel with a power module.

Multiple panel power jumpers carry power from a panel with a power module through multiple panels with or without a post to the next available power module.

## Base Raceway Electrical

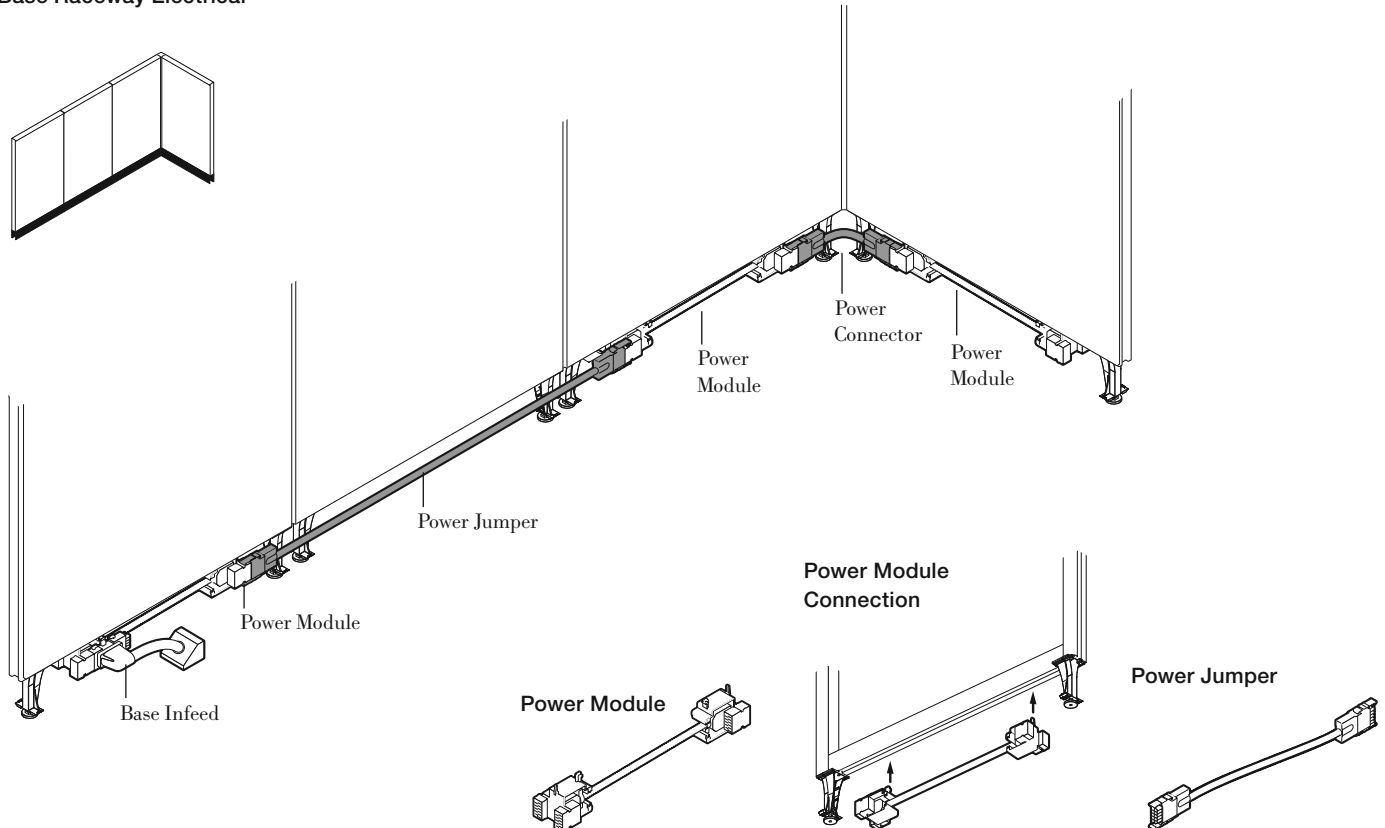

# Base Raceway Electrical 3+1, 2+2 and 3+3 Systems Specifications

## Power Connectors

Power connectors carry power from power module to power module in adjacent panels.

Two versions are available:

- 12" no post
- 15" with post

12" power connectors connect adjacent power modules in straight configurations when no post connector is involved.

15" power connectors are used in applications involving adjacent power modules separated by post connectors.

## Duplex Receptacles

Duplex receptacles provide access to power along the base raceway.

Two duplex receptacles can be installed per panel side in base raceways 24" and wider. 18" wide panels cannot accept duplex receptacles.

Receptacles insert into terminal blocks in outlet positions at either end of power modules and attach with a single screw.

Duplexes are available in (3+1), (2+2) and (3+3) systems. Each system engages a different combination of circuit wiring within the power module. For detailed wiring diagrams, refer to the electrical system required:

- 3 + 1
- 2 + 2
- 3 + 3

## 3+1, 2+2 and 3+3 Electrical Systems

Each electrical system is designed for different usage.

The (2+2) electrical system is for areas requiring 2 circuits for standard power usage and 2 circuits for isolated power usage.

The (3+1) electrical system is for areas requiring significant power usage and an isolated circuit.

The (3+3) electrical system is for areas with significant power usage and a need for multiple isolated circuits.

## Base Power Infeeds

Base power infeeds route power from the building's electrical source to the panel base raceway.

Power infeeds plug into any terminal block position on panel power modules.

## Power Connector

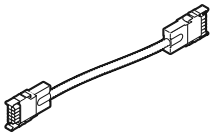

## Duplex Receptacle

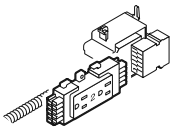

## Base Infeed

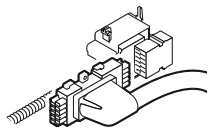

## Legend

- Power Module
- ⋯ Power Jumper
- Power Connector

Note: Power connectors or power jumpers can only plug into power modules

## Power Connectors

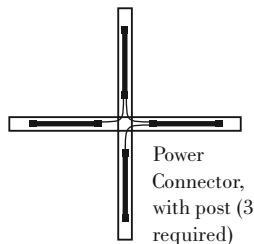
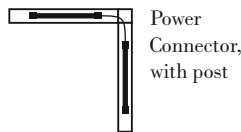
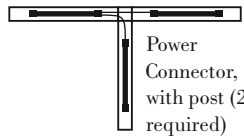
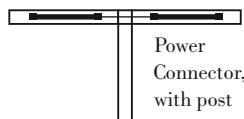

## Single Panel Power Jumpers

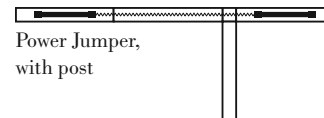
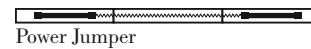

## Multiple Panel Power Jumpers

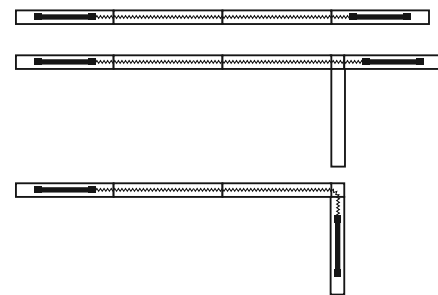

## Multiple Panel Power Jumper and Power Connector

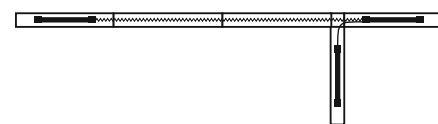





# Base Raceway Electrical

## Power Modules, Connectors and Jumpers

### (3+1), (2+2) and (3+3)

Dividends Horizon

description	type	pattern no.	E	8	T
Power Module - Double sided for raceway on both sides 	24" W Panel	<b>DE1(E,8,T) PM24</b>	\$108.	\$119.	\$123.
	30" W Panel	<b>DE1(E,8,T) PM30</b>	115.	127.	127.
	36" W Panel	<b>DE1(E,8,T) PM36</b>	119.	130.	133.
	42" W Panel	<b>DE1(E,8,T) PM42</b>	128.	140.	139.
	48" W Panel	<b>DE1(E,8,T) PM48</b>	135.	147.	146.
	60" W Panel	<b>DE1(E,8,T) PM60</b>	151.	166.	166.
Power Module - Single sided for raceway on one side 	24" W Panel	<b>DE1(E,8,T) PMS24</b>	108.	119.	123.
	30" W Panel	<b>DE1(E,8,T) PMS30</b>	115.	127.	127.
	36" W Panel	<b>DE1(E,8,T) PMS36</b>	119.	130.	133.
	42" W Panel	<b>DE1(E,8,T) PMS42</b>	128.	140.	139.
	48" W Panel	<b>DE1(E,8,T) PMS48</b>	135.	147.	146.
	60" W Panel	<b>DE1(E,8,T) PMS60</b>	151.	166.	166.
Power Connector - (power module-to-power module) 	12" no post	<b>DE1(E,8,T) PCNP</b>	70.	76.	85.
	15" with post	<b>DE1(E,8,T) PCWP</b>	72.	78.	92.
Power Jumper 	15" Panel	<b>DE1(E,8,T) PJ15NP</b>	81.	94.	119.
	18" Panel	<b>DE1(E,8,T) PJ18NP</b>	81.	94.	119.
	24" Panel	<b>DE1(E,8,T) PJ24NP</b>	93.	99.	125.
	30" Panel	<b>DE1(E,8,T) PJ30NP</b>	96.	104.	129.
	36" Panel	<b>DE1(E,8,T) PJ36NP</b>	99.	109.	136.
	42" Panel	<b>DE1(E,8,T) PJ42NP</b>	104.	116.	140.
	48" Panel	<b>DE1(E,8,T) PJ48NP</b>	111.	124.	146.
Power Jumper (with post) 	15" Panel + Post	<b>DE1(E,8,T) PJ15WP</b>	90.	97.	123.
	18" Panel + Post	<b>DE1(E,8,T) PJ18WP</b>	90.	97.	123.
	24" Panel + Post	<b>DE1(E,8,T) PJ24WP</b>	94.	102.	128.
	30" Panel + Post	<b>DE1(E,8,T) PJ30WP</b>	97.	107.	132.
	36" Panel + Post	<b>DE1(E,8,T) PJ36WP</b>	102.	114.	139.
	42" Panel + Post	<b>DE1(E,8,T) PJ42WP</b>	108.	119.	142.
	48" Panel + Post	<b>DE1(E,8,T) PJ48WP</b>	115.	127.	150.

#### Ordering Information

**Power Jumper**  
1. Pattern Number

#### Order Code

**Power Jumper**  
*Example:* **DE1E PJ42NP**  
**DE1E** Pattern Number  
**PJ42NP**

#### Included with:

Power Jumper

#### Options

Power Jumper

**Options**  
(E) = 3+1  
(8) = 2+2  
(T) = 3+3

**Note:** Double-sided power module will not fit in a panel base raceway with tile to the floor on one side.

Base Raceway Electrical  
*Power Modules, Connectors and Jumpers*  
*(3+1), (2+2) and (3+3)*

Dividends Horizon

description	type	pattern no.	E	8	T
Multiple Panel Power Jumper (with or without post) 	54" Panel Run	<b>DE1(E,8,T) PJ54WP</b>	\$121.	\$132.	\$156.
	60" Panel Run	<b>DE1(E,8,T) PJ60WP</b>	124.	136.	156.
	66" Panel Run	<b>DE1(E,8,T) PJ66WP</b>	130.	142.	167.
	72" Panel Run	<b>DE1(E,8,T) PJ72WP</b>	133.	146.	172.
	78" Panel Run	<b>DE1(E,8,T) PJ78WP</b>	139.	153.	176.
	84" Panel Run	<b>DE1(E,8,T) PJ84WP</b>	144.	161.	180.
	96" Panel Run	<b>DE1(E,8,T) PJ96WP</b>	152.	168.	194.

**Ordering Information**

**Power Jumper**

1. Pattern Number

**Order Code**

**Power Jumper**

*Example:* **DE1E PJ42NP**

**DE1E** Pattern Number

**PJ42NP**

**Included with:**

**Power Jumper**

**Options**

**Power Jumper**

**Options**

(E) = 3+1

(8) = 2+2

(T) = 3+3

**Note:** Double-sided power module will not fit in a panel base raceway with tile to the floor on one side.



**This page intentionally left blank**

## Duplex Receptacles

Duplexes are field-installed into power modules within beltway and base raceways. Duplex receptacles insert into panel power module terminal block positions and attach with a single screw.

### Identification of Duplexes

Duplexes are clearly marked to indicate which circuits they access. Convenience duplex receptacles are black in color with the circuit identification in white.

Isolated duplexes are black in color with the circuit identification in white and an orange triangle located in the lower right corner.

Orange isolated duplexes are also available for ease of identification. In orange-colored duplexes the identifying triangle is outlined in black.

### Types of Duplex Receptacles

Several types of duplex outlets are available. Each is specific to the circuit it accesses and is listed by power system.

Specify the duplex receptacle related to the power system being used (example: 8-wire) and circuit accessed (example: circuit 4). Black or orange finish.

### 3+1 Duplex Receptacles

Receptacles in a 3+1 electrical system can access circuits 1, 2 and 3 (convenience power) and circuit 4 (isolated power)

### 2+2 Duplex Receptacles

Receptacles in a 2+2 electrical system can access circuits 1 and 2 (convenience power) and circuits 4 and 5 (isolated power)

Please note that circuit 3 is not available in a 2+2 electrical system.

### 3+3 Duplex Receptacles

Receptacles in a 3+3 electrical system can access circuits 1, 2 and 3 (convenience power) and circuits 4, 5 and 6 (isolated power)

### Power Capacity

Each duplex circuit has a capacity of 20 amps. The National Electrical Code (NEC) requires that each circuit does not exceed 80% of capacity or 16 amps continuous use on each 20 amp circuit.

### Duplex Receptacle Dimensions

- Overall dimensions: 4 <sup>5</sup>/<sub>8</sub>" wide, 2 <sup>1</sup>/<sub>16</sub>" high, 1" deep
- Face dimensions: 2 <sup>5</sup>/<sub>8</sub>" wide, 1 <sup>1</sup>/<sub>4</sub>" high

### Access

Non-electrified panels can accept data ports in any raceway cover knockout. Panels with power modules can only accept data ports in the center knockout due to the location of the terminal block.

## Typical Power Requirements of Various Equipment

Equipment	Amp (approx.)
Calculator	.25
Coffee maker*	8.5-15
Desktop copier*	10-15
Fan	1
Fax (plain paper)	5-8
Heater*	8.5-15
Laser printer	6-10
Lighting	.5-1.5
Microwave*	10-20
PC	4-8
Refrigerator*	10-15
Terminal	1-3
Typewriter	1-2
Scanner	.25-.5

\*Requires separate circuit

**Note:** The above amperage chart is based on the estimated average amount of power required and is intended as a general guide only. For precise amperage requirements, refer to the equipment manufacturer's amperage specifications and compare to the available amperage on each circuit.

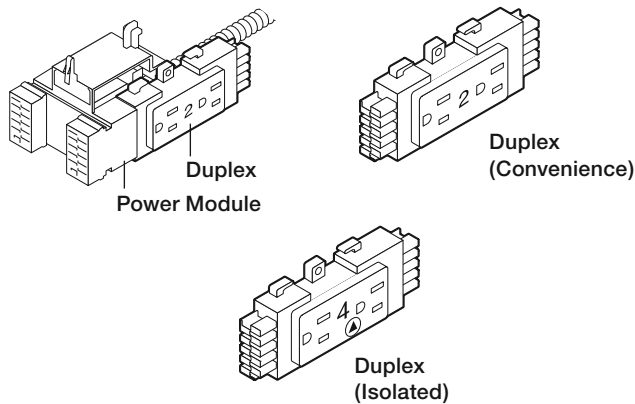

### Base Raceway Covers (knockout locations)

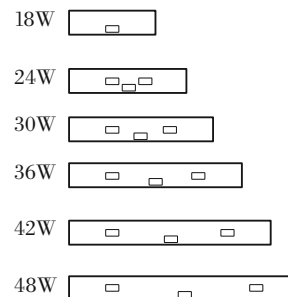



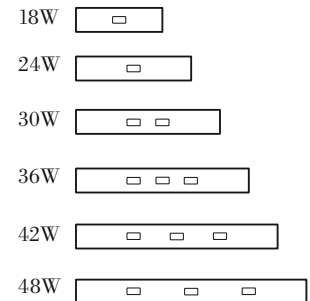

### Beltway Covers (knockout locations)



# Receptacles

## Knockout Replacement Covers

description	type	pattern no.	Single pack list	Ten pack list
Receptacle, (3+1)(Black) 	Duplex circuit 1	<b>DE1DR1 ( )</b>	\$37.	\$298.
	Duplex circuit 2	<b>DE1DR2 ( )</b>	37.	298.
	Duplex circuit 3	<b>DE1DR3 ( )</b>	37.	298.
	Duplex circuit 4	<b>DE1DR4 ( )</b>	37.	298.
Receptacle, (2+2)(Black) 	Duplex circuit 1	<b>DE1DR1 ( )</b>	37.	298.
	Duplex circuit 2	<b>DE1DR2 ( )</b>	37.	298.
	Duplex circuit 4	<b>DE1DR4 ( )</b>	37.	298.
	Duplex circuit 5	<b>DE1DR5 ( )</b>	37.	298.
Receptacle, (3+3)(Black) 	Duplex circuit 1	<b>DE1DR1 ( )</b>	37.	298.
	Duplex circuit 2	<b>DE1DR2 ( )</b>	37.	298.
	Duplex circuit 3	<b>DE1DR3 ( )</b>	37.	298.
	Duplex circuit 4	<b>DE1DR4 ( )</b>	37.	298.
	Duplex circuit 5	<b>DE1DR5 ( )</b>	37.	298.
	Duplex circuit 6	<b>DE1DR6 ( )</b>	37.	298.
Receptacle, (Orange) 	Duplex circuit 4	<b>DE1DOR4( )</b>	37.	298.
	Duplex circuit 5	<b>DE1DOR5( )</b>	37.	298.
	Duplex circuit 6	<b>DE1DOR6( )</b>	37.	298.
Base Raceway Knockout Replacement Cover (for electrical or data) 	Package of 10	<b>DE1KC</b>	n/a	40.

### Ordering Information

#### Receptacle

1. Pattern Number

### Order Code

#### Receptacle

*Example:* **DE1 DR4**

**DE1 DR4** Pattern Number

### Included with:

#### Receptacle

### Options

#### Receptacle

**Quantity Option:**  
 (SP) = Single Pack  
 (TP) = Ten Pack

# Vertical Electrical

## *Power Module, Electrical Receptacle and Trim Plate Specifications*

### Vertical Power Module

A vertical power module is an alternative to using beltway electrical. The use of a vertical power module allows for electrical access within a panel without having to order a beltway panel. Vertical power modules can be installed below a worksurface, at desk height or even within a panel-mounted overhead cabinet.

A panel's left-hand or right-hand vertical rail (see below) allows for installation of a vertical power module. Vertical power modules may be installed with 1-sided or 2-sided access, allowing users of both panel faces access to an electrical receptacle.

### Base Power Jumpers

Base raceway power jumpers are used to connect the adjacent panel's base power module to the vertical power module.

Additional vertical power modules may be "daisy-chained" together with base power jumpers. If one vertical power module is installed, an additional vertical power module may be added within the same panel. A base power jumper connects between the two vertical power modules.

Vertical power modules can also be daisy-chained in adjacent panels. A base power jumper passes through the beltway panel frame opening to connect to the additional vertical power module.

### Vertical Electrical Receptacle

Please note that base raceway receptacles are not compatible with vertical power modules.

Vertical electrical receptacles must be ordered separately from the vertical power module. Vertical electrical receptacles consist of one vertical receptacle. One vertical power module can also accommodate back-to-back vertical electrical receptacles.

To provide back-to-back vertical electrical power, two vertical receptacles must be specified. Vertical electrical receptacles must be ordered separately.

Specify the vertical receptacle that relates to the circuit specified.

### Desktop Power module

Desktop power modules (DE3WSME) provide two low-profile outlets at worksurface height. The desktop power module also helps meet ADA requirements regarding power access at worksurface height.

A mounting bracket and attachment screw allow the desktop power module to be installed at any point along the rear of a worksurface without tools or the removal of the worksurface. An 8 1/2" power cord plugs into any duplex receptacle in the base raceway and accesses the circuit it is connected to. Desktop power module dimensions are 3 3/4" wide and 4 1/2" high.

### Base Raceway Power Jumpers

To specify a base power jumper that connects a desk height vertical power module to an adjacent panel's base power module, specify a 48" base power jumper for panel widths of 36" or less. Use a 54" base power jumper for panel widths of 42" or 48". If a vertical power module is to be installed higher than worksurface height within a 64" high panel, a 66" base power jumper is required and an 84" base power jumper is required for 78" high panels.

To specify a base power jumper to span the width of two vertical power modules within two adjacent panels, identify the base power jumper length by combining the panel widths and height differences between the two vertical power modules.

**Note:** The base power jumper passes through the panel's beltway opening that is at a height of 33".

The panel's beltway opening (at 33" high) must not be obstructed as to allow for the base power jumper to pass through.

**Note:** 36" high panel frames do not have beltway openings and do not support horizontal power pass through at 33".

**Note:** Vertical electrical components can be used with a technology tile or field installed into a fabric tile.

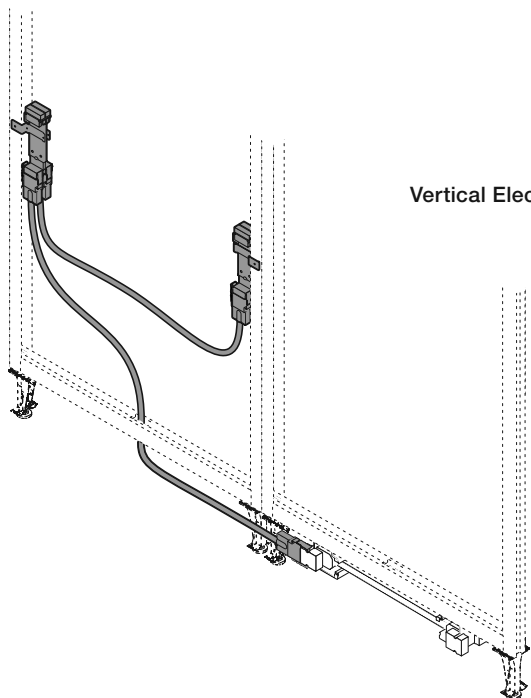

Vertical Electrical Power Jumpers

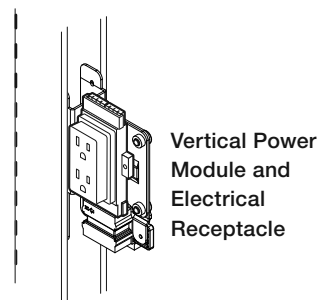
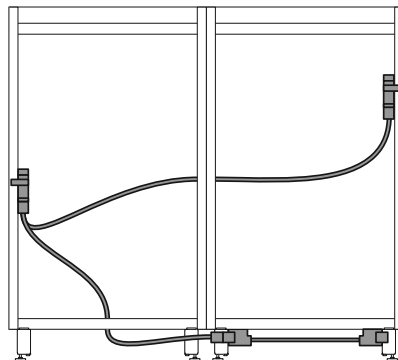

Vertical Power Module and Electrical Receptacle

# Vertical Electrical

## Power Module, Electrical Receptacle and Trim Plate Specifications

### Communications and Data Distribution

Dividends Horizon panels can accommodate communications and data cables horizontally in three ways:

- Along the top cableway
- Along the beltway (with optional cable tray)
- Along the base raceway (with optional cable tray)

Vertical cable distribution is through the panel's internal panel cavity which is accessed by cable slots located in both the upper and lower horizontal panel frame. Since cables are distributed internally within Dividends Horizon panels, no external cable managers are required.

Raceway cover data knockouts have an opening of 1<sup>3</sup>/<sub>8</sub>" high x 2<sup>11</sup>/<sub>16</sub>" wide. Data port covers are no longer available from Knoll and must be supplied from a communications vendor.

### Data Port Access

Non-electrified panels can accept data ports in any raceway cover knockout.

Panels with power modules can only accept data ports in the center knockout due to the location of the terminal blocks.

### Single Floating Data Port

Dividends Horizon floating data ports allow data and communications to be mounted in any location on the panel surface.

Floating data ports include front and back mounting plates and attachment screws. All data port kits must be specified separately for floating data ports. Floating data ports involve field-cutting the panel insert for installation.

Includes front and back mounting plates and two mounting screws. Data ports kits or data port components must be specified separately from a communications vendor. Black finish.

### Desktop Modules

The desktop data module provides up to two data/communication ports at worksurface height. The desktop power module provides two convenient electrical outlets at worksurface height. The desktop power and data module includes two data/communication ports and two electrical outlets at worksurface height. The thumbscrew on the bracket allows user adjustability if desired. Black finish.

Data modules do not include data jacks. Data jacks need to be purchased separately. This data module has two openings that can accept most standard jack sizes. The data module comes with adapter pieces that can accommodate most standard data jacks.

### Topway Panel Cable Routing

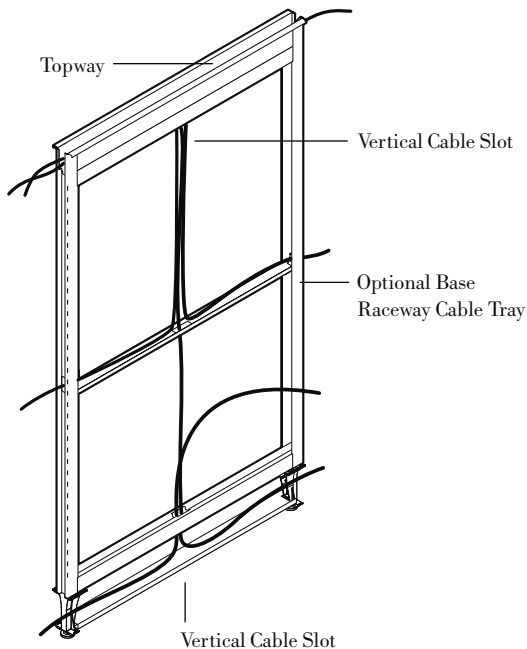

### Floating Data Port

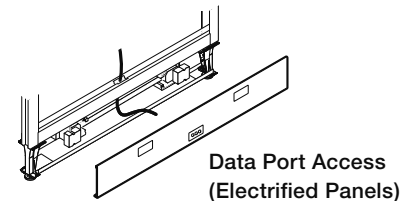
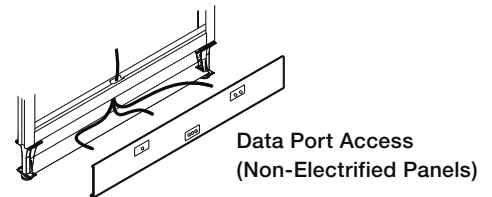
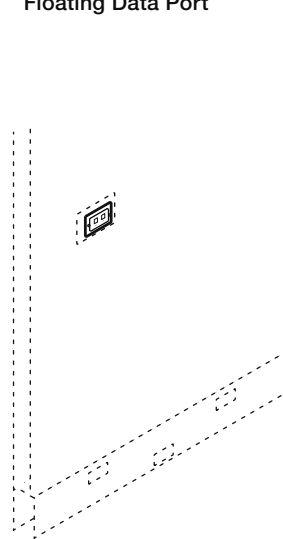

### Desktop Data Module

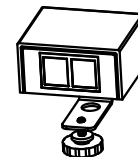

### Desktop Power and Data Module

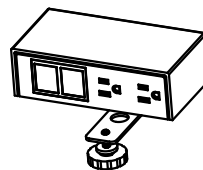

### Desktop Power Module

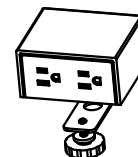

# Vertical Electrical

## Power Module, Electrical Receptacle and Trim Plate

### Double and Single Ports

description	type	pattern no.	Single pack	Ten pack	3+1	2+2	3+3
Vertical Power Module	Vertical Power Module	<b>DE6 VPM</b>	\$195.	n/a			



Vertical Electrical Receptacle (3+1)(Black)	Duplex circuit 1	<b>DE6 VDR1()</b>	37.	298.
	Duplex circuit 2	<b>DE6 VDR2()</b>	37.	298.
	Duplex circuit 3	<b>DE6 VDR3()</b>	37.	298.
	Duplex circuit 4	<b>DE6 VDR4()</b>	37.	298.

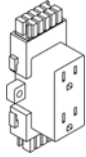

Vertical Electrical Receptacle (2+2)(Black)	Duplex circuit 1	<b>DE6 VDR1()</b>	37.	298.
	Duplex circuit 2	<b>DE6 VDR2()</b>	37.	298.
	Duplex circuit 4	<b>DE6 VDR4()</b>	37.	298.
	Duplex circuit 5	<b>DE6 VDR5()</b>	37.	298.

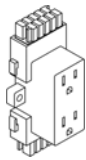

Vertical Electrical Receptacle (3+3)(Black)	Duplex circuit 1	<b>DE6 VDR1()</b>	37.	298.
	Duplex circuit 2	<b>DE6 VDR2()</b>	37.	298.
	Duplex circuit 3	<b>DE6 VDR3()</b>	37.	298.
	Duplex circuit 4	<b>DE6 VDR4()</b>	37.	298.
	Duplex circuit 5	<b>DE6 VDR5()</b>	37.	298.
	Duplex circuit 6	<b>DE6 VDR6()</b>	37.	298.

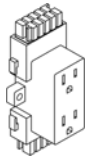

Ordering Information	Order Code	Included with:	Options
<b>Vertical Power Module</b> 1. Pattern Number	<b>Vertical Power Module</b> <i>Example:</i> <b>DE5 VPM</b> <b>DE5 VPM</b> Pattern Number	<b>Vertical Power Module</b>	<b>Vertical Power Module</b>
<b>Base Raceway Power Jumper</b> 1. Pattern Number	<b>Base Raceway Power Jumper</b> <i>Example:</i> <b>DE1(E) BPJ30</b> <b>DE1(E)</b> Pattern Number <b>BPJ30</b>	<b>Base Raceway Power Jumper</b>	<b>Base Raceway Power Jumper</b> Insert appropriate letter for type of wiring required within the parentheses of the pattern number. <b>(E)</b> = 3+1 <b>(8)</b> = 2+2 <b>(T)</b> = 3+3

**Receptacle Quantity Option:**

(SP) = Single Pack  
(TP) = Ten Pack

**Note:** Trim plate filler for use with technology tile trim plate only.

# Vertical Electrical

## Power Module, Electrical Receptacle and Trim Plate

### Double and Single Ports

description	type	pattern no.	Single pack	Ten pack	3+1	2+2	3+3
Trim Plate Filler	Package of 10	<b>DE6 FDPF</b>	n/a	\$39.			

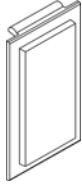

Single Floating Data Port Trim Plate (field install kit)	Faceplate, backplate and hardware	<b>DE1 FDP</b>	46.	n/a			
--	-----------------------------------	----------------	-----	-----	--	--	--

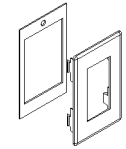

Technology Tile Trim Plate (field install kit)	Faceplate, backplate filler and hardware	<b>DE6 FDP</b>	50.	n/a			
--	--	----------------	-----	-----	--	--	--

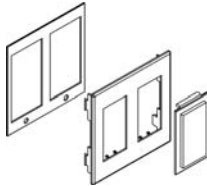

Base Raceway Power Jumpers	48" Jumper	<b>DE1(E,8,T) PJ48WP</b>		115.	127.	150.
	54" Jumper	<b>DE1(E,8,T) PJ54WP</b>		121.	132.	156.
	60" Jumper	<b>DE1(E,8,T) PJ60WP</b>		124.	136.	156.
	66" Jumper	<b>DE1(E,8,T) PJ66WP</b>		130.	142.	167.
	72" Jumper	<b>DE1(E,8,T) PJ72WP</b>		133.	146.	172.
	78" Jumper	<b>DE1(E,8,T) PJ78WP</b>		139.	153.	176.
	84" Jumper	<b>DE1(E,8,T) PJ84WP</b>		144.	161.	180.



Ordering Information	Order Code	Included with:	Options
<b>Vertical Power Module</b> 1. Pattern Number	<b>Vertical Power Module</b> <i>Example:</i> <b>DE5 VPM</b> <b>DE5 VPM</b> Pattern Number	<b>Vertical Power Module</b>	<b>Vertical Power Module</b>
<b>Base Raceway Power Jumper</b> 1. Pattern Number	<b>Base Raceway Power Jumper</b> <i>Example:</i> <b>DE1(E) BPJ30</b> <b>DE1(E)</b> Pattern Number <b>BPJ30</b>	<b>Base Raceway Power Jumper</b>	<b>Base Raceway Power Jumper</b> Insert appropriate letter for type of wiring required within the parentheses of the pattern number. <b>(E)</b> = 3+1 <b>(8)</b> = 2+2 <b>(T)</b> = 3+3  <b>Receptacle Quantity Option:</b> (SP) = Single Pack (TP) = Ten Pack  <b>Note:</b> Trim plate filler for use with technology tile trim plate only.

description	type	w	d	h	pattern no.	list
Desktop Power Module, clamp mount	With 108" Cord	3 3/4"	4 1/2"	2 1/2"	<b>DE4WSME108</b>	\$135.
	With 72" Cord	3 3/4"	4 1/2"	2 1/2"	<b>DE4WSME72</b>	109.



Desktop Power + Data Module, clamp mount	With 108" Cord	6 1/8"	4 1/2"	2 1/2"	<b>DE4WSMED108</b>	289.
	With 72" Cord	6 1/8"	4 1/2"	2 1/2"	<b>DE4WSMED72</b>	262.



Desktop Data Module, clamp mount		3 3/4"	4 1/2"	2 1/2"	<b>DE4WSMC</b>	95.
-------------------------------------	--	--------	--------	--------	----------------	-----



Ordering Information	Order Code	Included with	Options
Desktop Power Module	Desktop Power Module		
1. Pattern Number	<i>Example:</i> <b>DE4 WSME108</b>		



**This page intentionally left blank**

## Beltway Electrical

Power can be distributed through the beltway

Three systems are available:

- 3+1
- 2+2
- 3+3

Modular components are used to distribute power within beltways and consist of:

- Beltway power modules
- Beltway power connectors
- Beltway power jumpers
- Beltway vertical power jumpers
- Duplex receptacles

All electrical components and data cables are field-installed.

**WARNING: DO NOT CONNECT POWER UNTIL INSTALLATION IS COMPLETE. CONNECTING TO THE BUILDING POWER SOURCE MUST BE PERFORMED BY A LICENSED ELECTRICIAN.**

Beltway modules accept duplex receptacles and vertical power jumpers for bringing the power to the beltway from the base raceway. Another alternative for desk height electrical is a vertical power module.

Depending on the number of desk height receptacles required in each panel, consider the list price of both beltway electrical and vertical power module in each application.

## Beltway Power Modules

Power modules are the primary electrical components for distributing power within beltways. Beltway power modules are also components that accept duplex receptacles and vertical power jumpers for bringing the power to the beltway from the base raceway.

Beltway raceways 30" and wider can accept beltway power modules while 18" and 24" wide panels can accept power jumpers for pass-through power only.

Beltway power modules screw into the vertical channels of panel frames and include a steel horizontal mounting support.

Specify one beltway power module per panel that matches the width of the panel where duplexes are required. Available one- or two-sided.

Just like base raceway power modules, beltway power modules consist of a terminal block at each end connected by a hard-wired metal conduit.

Beltway power modules are one- or two-sided. This allows planning options such as beltway one side and monolithic or tiled inserts on the other, or beltway one side and no inserts on the other for against-the-wall applications. The terminal blocks accept either duplex receptacles or vertical power jumpers.

## Beltway Power Connectors

Beltway power connectors carry power from power module to power module in adjacent panels.

Two versions are available:

- no post
- with post.

Beltway power connectors, no post, connect adjacent power modules in straight configurations when a post connector is not involved.

Beltway power connectors, with post, are used in applications involving adjacent power modules separated by post connectors in straight through post configurations only.

Specify one beltway power connector (with or without post) to connect beltway power module or beltway power jumper in adjacent panels. In straight line configurations only.

## Beltway Electrical

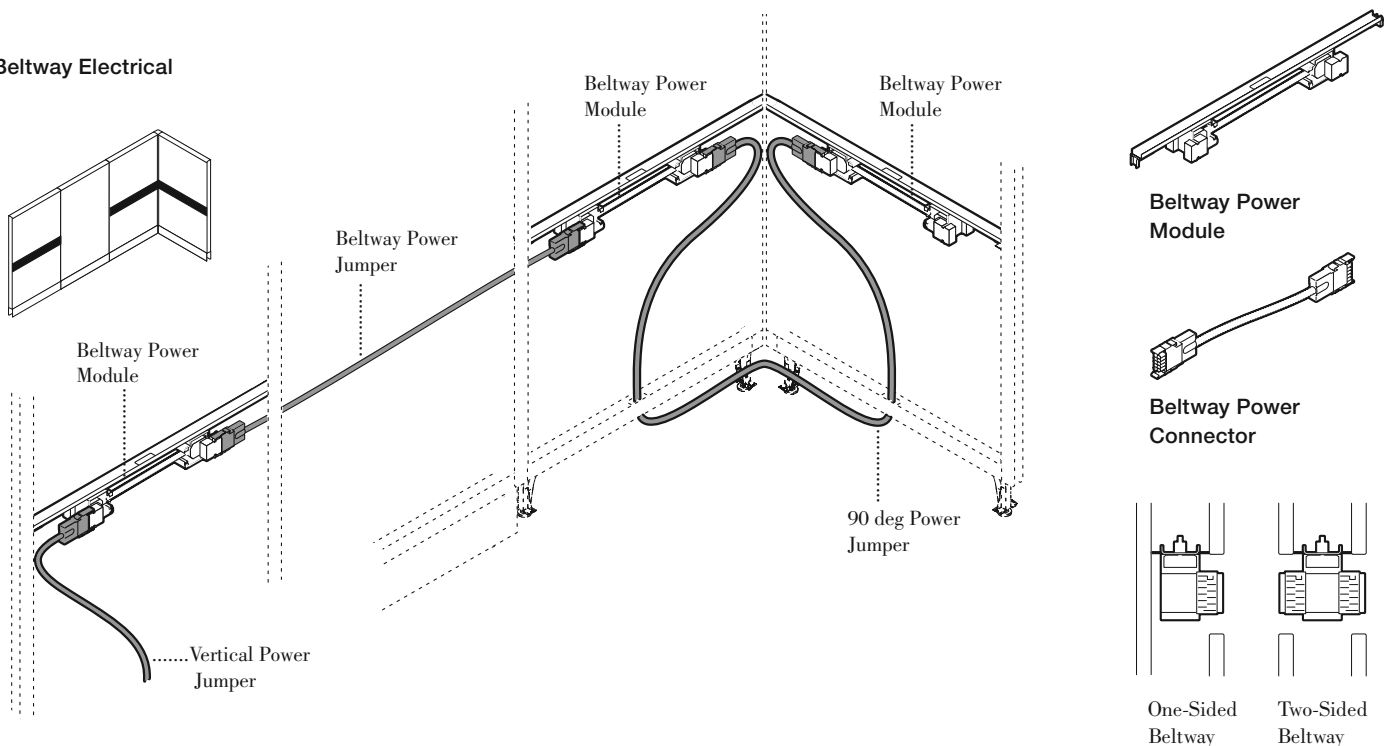

**Beltway Profiles**

## Beltway Power Jumpers

Beltway power jumpers connect between power modules in nonadjacent panels. Beltway power jumpers take the place of power modules in panels not requiring duplexes to provide pass-through power.

Three versions are available:

- Single panel jumpers
- Single panel jumpers with post
- Multiple panel jumpers

Single panel beltway jumpers carry power from a panel with a beltway power module through a single non-electrified panel to an adjacent panel with a beltway power module when a post is not involved in straight line configurations only.

Single beltway panel jumpers with post carry power from a panel with a power module through a single non-electrified panel and post connector to an adjacent panel with a beltway power module in straight through post configurations only.

Multiple beltway panel jumpers carry power from a panel with a power module through multiple panels with or without a post to the next available beltway power module in straight line configurations only.

Specify one beltway power jumper per panel that matches the width of the panel for pass-through electrical where duplexes are not required for straight line configurations only.

### 90° Beltway Power Jumper

A 90° beltway power jumper connects adjacent beltway power modules at a 90° “L” panel connection.

The following illustrations outline the various components required for beltway applications with a post.

**Note:** A 90° beltway power jumper can only be used with adjacent panels in a “X”, “T” or “L” conditions. The 90° jumper cannot be used to span multiple panels.

To specify correct jumper length, determine the largest panel width between the two adjacent corner panels in which jumper is to be installed.

### Vertical Power Jumpers

To carry power from the base raceway to the beltway located in the same panel requires a vertical power jumper. Vertical power jumpers function as an extension of the base raceway power system.

Attachment is from any unused outlet position in the base raceway to the end terminal block connection in the beltway power module. The vertical power jumper cable is concealed in the cavity of the panel frame.

Power can also be carried to a beltway run from the base raceway of an adjacent panel with a power module. This is accomplished by using a panel power jumper.

Specify one vertical power jumper per beltway electrical run not to exceed the electrical systems capacity. See the technical specifications for the electrical system being utilized.

**Note:** Length of power jumper allows for connections with or without post conditions.

### Power Infeeds

A ceiling infeed may also be used to bring power directly to the beltway power module without having to go directly to a base raceway power module.

### Duplex Receptacles

Duplex receptacles provide access to power along the beltway. Duplexes used in the beltway are the same as the duplexes used in the base raceway.

Two duplex receptacles can be installed per panel side in beltway raceways 30" and wider. 24"W panels will accept beltway power jumpers for pass-through power only.



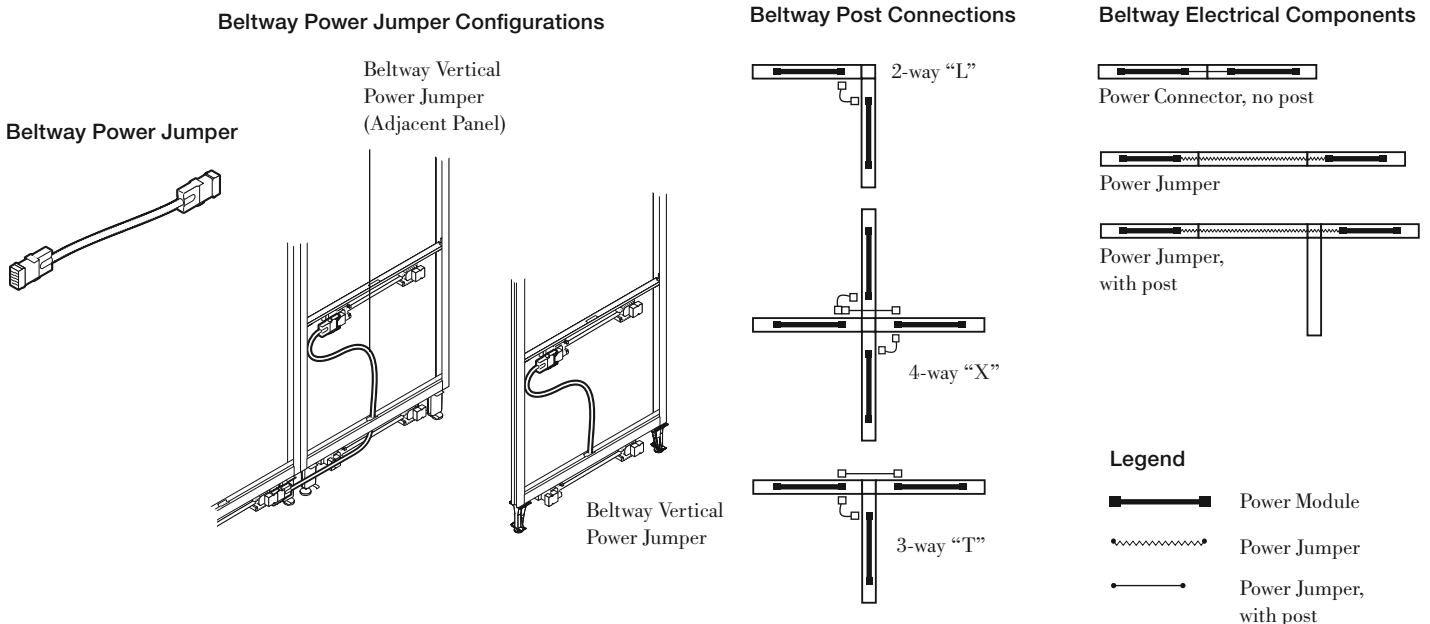



Receptacles insert into terminal blocks in outlet positions at either end of power modules and attach with a single screw.



# Beltway Electrical

## Power Modules, Power Connectors and Power Jumpers

Dividends Horizon



description	type	length	pattern no.	3+1	2+2	3+3
 Beltway Power Module - 1-Side		30"	<b>DE1() BPM301</b>	\$151.	\$167.	\$167.
		36"	<b>DE1() BPM361</b>	159.	174.	170.
		42"	<b>DE1() BPM421</b>	167.	180.	178.
		48"	<b>DE1() BPM481</b>	174.	194.	185.
		60"	<b>DE1() BPM601</b>	197.	202.	202.
 Beltway Power Module - 2-Side		30"	<b>DE1() BPM302</b>	151.	167.	167.
		36"	<b>DE1() BPM362</b>	159.	174.	170.
		42"	<b>DE1() BPM422</b>	167.	180.	178.
		48"	<b>DE1() BPM482</b>	174.	194.	185.
		60"	<b>DE1() BPM602</b>	197.	202.	202.
 Beltway Power Connector	17" No Post		<b>DE2() BPCNP</b>	75.	81.	93.
	20" With Post		<b>DE2() BPCWP</b>	77.	89.	96.
 Beltway Power Jumper (No post)		18"	<b>DE2() BPJ18NP</b>	93.	99.	125.
		24"	<b>DE2() BPJ24NP</b>	96.	104.	129.
		30"	<b>DE2() BPJ30NP</b>	99.	109.	136.
		36"	<b>DE2() BPJ36NP</b>	104.	116.	140.
		42"	<b>DE2() BPJ42NP</b>	111.	124.	146.
		48"	<b>DE2() BPJ48NP</b>	115.	127.	150.
 Beltway Power Jumper (With post)		18"	<b>DE2() BPJ18WP</b>	94.	102.	128.
		24"	<b>DE2() BPJ24WP</b>	97.	107.	132.
		30"	<b>DE2() BPJ30WP</b>	102.	114.	139.
		36"	<b>DE2() BPJ36WP</b>	108.	121.	142.
		42"	<b>DE2() BPJ42WP</b>	115.	127.	150.
		48"	<b>DE2() BPJ48WP</b>	124.	129.	152.
 Multiple Panel Power Jumper (with or without post)		54" Panel Run	<b>DE2() BPJ54WP</b>	124.	136.	156.
		60" Panel Run	<b>DE2() BPJ60WP</b>	130.	142.	167.
		66" Panel Run	<b>DE2() BPJ66WP</b>	133.	145.	172.
		72" Panel Run	<b>DE2() BPJ72WP</b>	139.	152.	176.
		78" Panel Run	<b>DE2() BPJ78WP</b>	144.	159.	180.
		84" Panel Run	<b>DE2() BPJ84WP</b>	152.	170.	194.
		96" Panel Run	<b>DE2() BPJ96WP</b>	164.	177.	201.

Ordering Information	Order Code	Included with:	Options
<b>Beltway Power Jumper</b> 1. Pattern Number  Note: Insert appropriate letter for type of wiring required within the parentheses of the pattern number.	<b>Beltway Power Jumper</b> <i>Example:</i> <b>DE1(E) BPJ30</b> <b>DE1(E)</b> Pattern Number <b>BPJ30</b>	<b>Beltway Power Jumper</b>	<b>Beltway Power Jumper</b> Insert appropriate letter for type of wiring required within the parentheses of the pattern number. <ul style="list-style-type: none"> <li>• E= 3+1</li> <li>• 8= 2+2</li> <li>• T= 3+3</li> </ul>

# Beltway Electrical

## Power Modules, Power Connectors and Power Jumpers

Dividends Horizon

description	type	length	pattern no.	3+1	2+2	3+3
90° Beltway Power Jumper 		30" Beltway Panel	<b>DE1( ) PJ120WP</b>	\$199.	\$217.	\$249.
		36" Beltway Panel	<b>DE1( ) PJ126WP</b>	205.	226.	259.
		42" Beltway Panel	<b>DE1( ) PJ138WP</b>	214.	236.	268.
		48" Beltway Panel	<b>DE1( ) PJ144WP</b>	221.	244.	278.
Vertical Power Jumper (Within Same Panel)			<b>DE1( ) VPJ</b>	170.	185.	176.
Vertical Power Jumper (From Adjacent Panel) 		30" Beltway Panel	<b>DE1(E,8,T) PJ48WP</b>	115.	127.	150.
		36" Beltway Panel	<b>DE1(E,8,T) PJ54WP</b>	121.	132.	156.
		42" Beltway Panel	<b>DE1(E,8,T) PJ54WP</b>	121.	132.	156.
		48" Beltway Panel	<b>DE1(E,8,T) PJ60WP</b>	124.	136.	156.

Ordering Information	Order Code	Included with:	Options
<b>Beltway Power Jumper</b> 1. Pattern Number  Note: Insert appropriate letter for type of wiring required within the parentheses of the pattern number.	<b>Beltway Power Jumper</b> <i>Example:</i> <b>DE1(E) BPJ30</b> <b>DE1(E)</b> Pattern Number <b>BPJ30</b>	<b>Beltway Power Jumper</b>	<b>Beltway Power Jumper</b> Insert appropriate letter for type of wiring required within the parentheses of the pattern number. <ul style="list-style-type: none"> <li>• E= 3+1</li> <li>• 8= 2+2</li> <li>• T= 3+3</li> </ul>

### Power Infeeds

Power infeeds carry power from the building's electrical source to the panel system's base raceway. Two styles are available:

- Base power infeeds
- Ceiling infeeds

### Base Power Infeed

Dividends Horizon base power infeeds route power from floor monuments or electrical boxes to any terminal block duplex position on base raceway power modules. Two screws secure the base power infeed to the power module.

**Note:** When connected, a base power infeed takes the place of one duplex outlet.

Base power infeeds have a 56" long liquid tight conduit and pigtail for connection to the building's power supply.

Infeeds are specified either right- or left-handed. This allows the conduit to enter the outlet position from either the left or right side.

In addition to right- or left handed base power infeeds is a reversible base power infeed with a 56" long liquid tight conduit. The reversible infeed rotates to provide either a right- or left-hand power entry.

Specify the base infeed that matches the power system accessed and left or right cable entry (example: (3+1), left-hand entry).

### Ceiling Infeeds

Raceway-to-ceiling infeeds route power from a ceiling-located power source to the panel system's base raceway. Unlike base infeeds which plug into any terminal block outlet position, ceiling infeeds must plug into the end of a base raceway power module. Ceiling infeeds have a 19 1/2' long metal conduit and pigtail.

Two components are required for installation:

- Raceway to ceiling infeed
- Power pole

Ceiling infeed may be installed directly into a beltway power module for beltway electrical only.

Specify the ceiling infeed that matches the power system accessed.

### Power Poles

Power poles can accommodate one raceway-to-ceiling infeed along with data cables. The power pole can also be used to route data cables only, if required. Cable capacity for power poles with the electrical conduit installed is 30, category 5 cables and without an electrical conduit is 40, category 5 cables.

Power poles integrate within the panel system footprint by mounting atop existing post connectors in "L", "T" or "X" configurations.

Power poles are available in three lengths in order to accommodate all three heights of post connectors. All power poles measure 126" or 144" when added to the height of the post connector. For ceilings less than 126" or 144" high, field-cut the power pole to the required height. Power poles include ceiling trim plate, connecting hardware and post/power pole trim covers.

### Legacy Power Pole Construction

Power pole is extruded aluminum powder coated, with four PVC trim covers.

### Dividends Horizon DP7 Power Pole Construction

Power pole is extruded aluminum, with removable cover, powder coated in any Knoll Core or Dividends Horizon Legacy finish. One side of the power pole is open, allowing cables to be inserted or removed when the cover is removed.

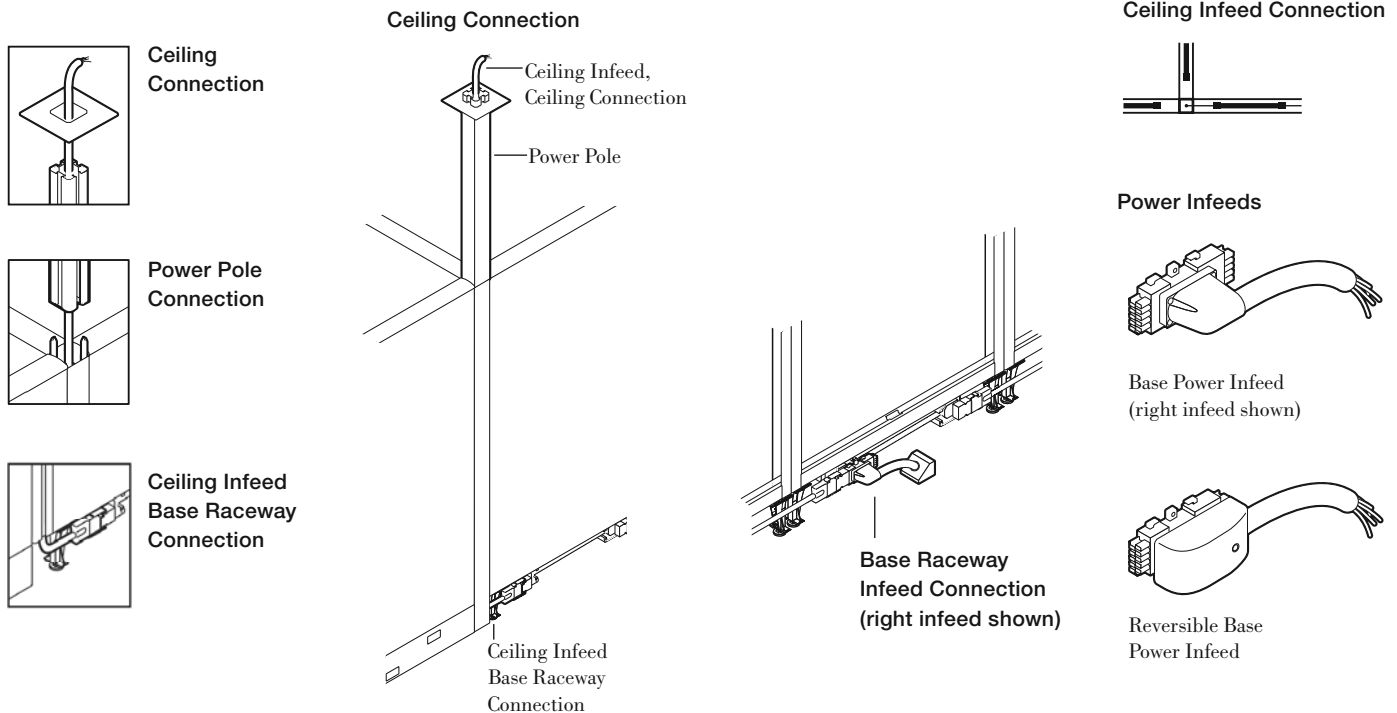

**CAUTION: DO NOT CONNECT POWER UNTIL INSTALLATION IS COMPLETE. CONNECTION TO BUILDING POWER SOURCE MUST BE PERFORMED BY A LICENSED ELECTRICIAN.**



# Electrical Infeeds and Power Poles

## Base Power and Raceway-to-Ceiling Infeeds

Dividends Horizon

description	type	length	pattern no.	list	P1	P2	P3
Base Power Infeed (specify left or right) (right shown) 	2+2	56"	<b>DE18 BI56(L/R)</b>	\$212.			
	3+1	56"	<b>DE1E BI56(L/R)</b>	194.			
	3+3	56"	<b>DE1T BI56(L/R)</b>	249.			
Base Power Infeed (reversible) 	2+2	56"	<b>DE18 RBI56</b>	256.			
	3+1	56"	<b>DE1E RBI56</b>	235.			
	3+3	56"	<b>DE1T RBI56</b>	308.			
Raceway-to-Ceiling Infeed 	2+2	19 1/2'	<b>DE18 CI144</b>	311.			
	3+1	19 1/2'	<b>DE1E CI144</b>	282.			
	3+3	19 1/2'	<b>DE1T CI144</b>	358.			

### Ordering Information

#### Base Power Infeed (L/R)

1. Pattern Number

#### Power Pole

1. Pattern Number
2. Trim Finish

Note: Power poles mount atop existing post connectors in "L", "T" and "X" configurations

### Order Code

#### Base Power Infeed (L/R)

*Example:* **DE18 BI56(L)**

**DE18** Pattern Number (left entry)  
**BI56(L)**

#### Power Pole

*Example:* **DE(1) PP64S, 117**

**DE(1)** Pattern Number

**PP64S**

**117** Soft Grey trim finish

### Included with:

#### Base Power Infeed (L/R)

#### Power Pole

- Power pole
- Ceiling trim plate
- Connecting hardware
- Post/power pole trim cover

Note: Power pole does not include raceway-to-ceiling infeed which must be ordered separately.

### Options

#### Base Power Infeed (L/R)

- To specify direction of entry, add either an "L" or "R" suffix to the pattern number.

#### Legacy Power Pole

- Post cover

**(1)**= Grooved  
**(2)**= Smooth  
Insert appropriate number for post cover option within the parentheses of the pattern number

#### Dividends Horizon Power Pole

- Post cover

# Electrical Infeeds and Power Poles

## DP7 and Legacy Power Poles

Dividends Horizon

description	type	length	pattern no.	list	P1	P2	P3
Dividends Horizon Power Pole for use with DP7 Series Posts only (does not include Raceway-to-Ceiling Infeed) For 126" ceiling height	For 36"H DP7 Post	90"	<b>DP7PP36S</b>		\$400.	\$420.	\$440.
	For 42"H DP7 Post	84"	<b>DP7PP42S</b>		368.	384.	405.
	For 50"H DP7 Post	76"	<b>DP7PP50S</b>		339.	354.	372.
	For 57"H DP7 Post	69"	<b>DP7PP57S</b>		299.	314.	330.
	For 64"H DP7 Post	62"	<b>DP7PP64S</b>		294.	308.	324.
	For 78"H DP7 Post	48"	<b>DP7PP78S</b>		294.	308.	324.
Dividends Horizon Power Pole for use with DP7 Series Posts only (does not include Raceway-to-Ceiling Infeed) For 144" ceiling height	For 36"H DP7 Post	108"	<b>DP7PP36T</b>		408.	428.	448.
	For 42"H DP7 Post	102"	<b>DP7PP42T</b>		374.	393.	413.
	For 50"H DP7 Post	94"	<b>DP7PP50T</b>		339.	354.	372.
	For 57"H DP7 Post	86"	<b>DP7PP57T</b>		299.	314.	330.
	For 64"H DP7 Post	80"	<b>DP7PP64T</b>		294.	308.	324.
	For 78"H DP7 Post	66"	<b>DP7PP78T</b>		294.	308.	324.
Legacy Power Pole for use with Legacy Posts only (does not include Raceway-to-Ceiling Infeed) For 126" ceiling height	For 36"H Post	90"	<b>DE2PP36S</b>	400.			
	For 42"H Post	84"	<b>DE2PP42S</b>	368.			
	For 50"H Post	76"	<b>DE2PP50S</b>	339.			
	For 64"H Post	62"	<b>DE2PP64S</b>	299.			
	For 78"H Post	48"	<b>DE2PP78S</b>	294.			
Legacy Power Pole for use with Legacy Posts only (does not include Raceway-to-Ceiling Infeed) For 144" ceiling height	For 36"H Post	108"	<b>DE2PP36T</b>	301.			
	For 42"H Post	102"	<b>DE2PP42T</b>	267.			
	For 50"H Post	94"	<b>DE2PP50T</b>	346.			
	For 64"H Post	80"	<b>DE2PP64T</b>	308.			
	For 78"H Post	66"	<b>DE2PP78T</b>	299.			

### Ordering Information

#### Base Power Infeed (L/R)

1. Pattern Number

#### Power Pole

1. Pattern Number  
2. Trim Finish

### Order Code

#### Base Power Infeed (L/R)

*Example:* **DE18 BI56(L)**

**DE18** Pattern Number (left entry)  
**BI56(L)**

#### Power Pole

*Example:* **DE2 PP64S, 117**

**DE2** Pattern Number

**PP64S**

**117** Soft Grey trim finish

### Included with:

#### Base Power Infeed (L/R)

#### Power Pole

- Power pole
- Ceiling trim plate
- Connecting hardware
- Post/power pole trim cover

**Note:** Power pole does not include raceway-to-ceiling infeed which must be ordered separately.

**Note:** Power poles mount atop existing post connectors in "L", "T" and "X" configurations

### Options

#### Base Power Infeed (L/R)

- To specify direction of entry, add either an "L" or "R" suffix to the pattern number.

#### Legacy Power Pole

- Post cover has a smooth finish

#### Dividends Horizon Power Pole



**This page intentionally left blank**

## New York City Hardwire Infeeds

The New York City hardwire infeed is comprised of a junction box and a power connector exiting from one side.

New York City infeeds are available in one size which mount within any base raceway 24" or wider.

The New York City infeed takes the place of a power module and prevents the installation of duplex receptacles in the panel housing the infeed. The hardwire infeed's power connector plugs into a power module which must be located in the adjacent panel.

The New York City infeed can be rotated to either the right or left side of the base raceway to provide power to either the adjacent left or right panel.

If power is required in both directions, specify a separate power jumper the length of the panel containing the infeed. The power jumper connects panel power modules located at either side of the panel containing the NYC hardwire infeed and is routed within the same raceway as the NYC hardwire infeed.

The power jumper is then routed in the opposite direction and connects to a power module located in the adjacent panel on the panel's other side (refer to the diagram below).

The panel containing the NYC hardwire infeed must be specified without base raceway cover knockouts.

A template for drilling the base raceway cover to accept the NYC hardwire infeed conduit is included.

## Chicago Hardwire

Pre-wired modular electrical systems are not permitted in the City of Chicago. All electrical must be hard-wired by a qualified electrician.

In order to conform to City of Chicago electrical codes, a hardwire receptacle raceway kit(s) must be installed in all panel base raceways that require duplex receptacles. In order to conform to the City of Chicago electrical code for base power infeed, the hardwire infeed raceway kit must be installed within the panel base raceway. Hardwire receptacle raceway kit(s) and hardwire infeed raceway kit(s) mount in the base raceway between the panel feet and are available in 24" to 48" widths.

Hardwire receptacle raceway kits are secured by four screws. In addition, the base raceway covers on both sides of a panel with hardwire receptacle raceway kits must be secured with two screws each. A template for drilling attachment holes in base raceway covers is included with the hardwire receptacle raceway kit.

Optional Chicago base raceway covers can be ordered separately to replace existing covers if pre-drilled covers are desired.

When passing (jumping) hardwired power through panels, panels must be specified without knockouts in the base raceway to conform to the City of Chicago electrical code. All panels containing hardwire receptacle raceway kits must be specified with base raceway knockouts.

**Note:** Dividends Horizon beltway electrical is not available with Chicago hardwire.

## New York Electrical Configurations

NYC Infeeds are reversible and one direction

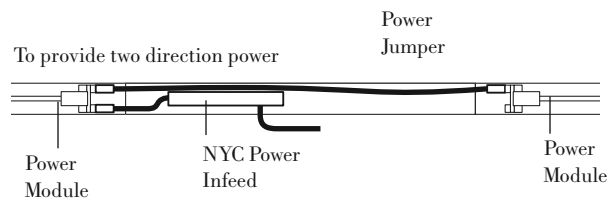
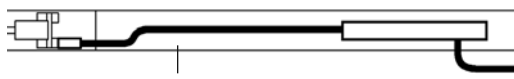

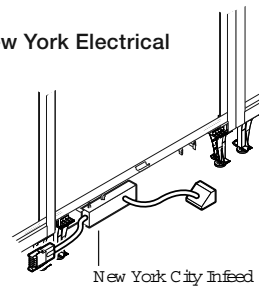

## New York Electrical

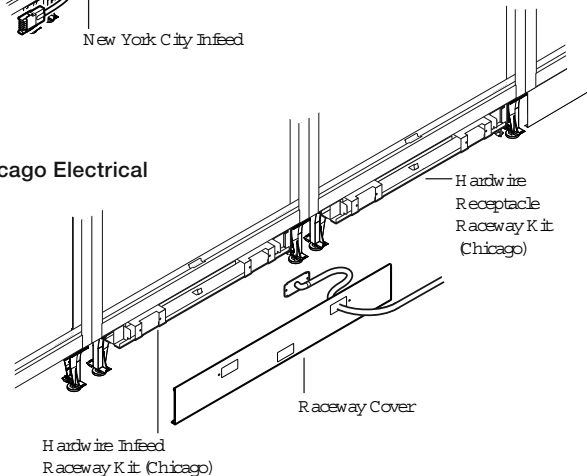

## Chicago Electrical





description	type	l	pattern no.	list
 Hardwire Infeed (NYC) - 1 Direction	2+2		DE18 B1NY1	\$586.
	3+1		DE1E B1NY1	509.
	3+3		DE1T B1NY1	655.
 Base Power Infeed (San Francisco)	2+2	56"	DE18 BI56( )SF	201.
	3+1	56"	DE1E BI56( )SF	182.
	3+3	56"	DE1T BI56( )SF	237.
 Reversible Base Power Infeed (San Francisco)	2+2	56"	DE18 RBI56SF	244.
	3+1	56"	DE1E RBI56SF	222.
	3+3	56"	DE1T RBI56SF	293.
Electrical Retrofit Kit (Chicago) (for electrical on new panel base raceway)			DP7CERK	64.

Ordering Information	Order Code	Included with:	Options
<b>Hardwire Infeed (NYC)</b> 1. Pattern Number	<b>Hardwire Infeed (NYC)</b> <b>Example: DE1E B1NY1</b> <b>DE1E      Pattern Number</b> <b>B1NY1</b>	<b>Hardwire Infeed (NYC)</b> <ul style="list-style-type: none"> <li>• Junction box with power connector and infeed</li> <li>• Ceiling trim plate</li> <li>• Attachment screws</li> </ul>	<b>Hardwire Infeed (NYC)</b> Power System <ul style="list-style-type: none"> <li>• 3+1</li> <li>• 2+2</li> <li>• 3+3</li> </ul> <b>San Francisco Infeed direction option</b> (L) = Left (R) = Right <b>Note:</b> The electrical retrofit kit provides brackets that connect Chicago Electrical components that were manufactured prior to June 2008 to DP7 panel base raceways.

# New York City, San Francisco and Chicago Electrical Infeeds, Receptacle Kits and Replacement Kits

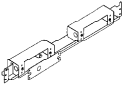
Dividends Horizon

description	type	l	pattern no.	list
 Hardwire Infeed Raceway Kit (Chicago)	Double Sided	24"	<b>DP7HIRKD24</b>	\$359.
	Double Sided	30"	<b>DP7HIRKD30</b>	610.
	Double Sided	36"	<b>DP7HIRKD36</b>	616.
	Double Sided	42"	<b>DP7HIRKD42</b>	619.
	Double Sided	48"	<b>DP7HIRKD48</b>	623.
	Double Sided	60"	<b>DP7HIRKD60</b>	634.
	Single Sided	24"	<b>DP7HIRKS24</b>	506.
	Single Sided	30"	<b>DP7HIRKS30</b>	719.
	Single Sided	36"	<b>DP7HIRKS36</b>	724.
	Single Sided	42"	<b>DP7HIRKS42</b>	727.
	Single Sided	48"	<b>DP7HIRKS48</b>	731.
Single Sided	60"	<b>DP7HIRKS60</b>	744.	
 Hardwire Receptacle Raceway Kit (Chicago)	Double Sided	24"	<b>DP7HRRKD24</b>	277.
	Double Sided	30"	<b>DP7HRRKD30</b>	464.
	Double Sided	36"	<b>DP7HRRKD36</b>	469.
	Double Sided	42"	<b>DP7HRRKD42</b>	472.
	Double Sided	48"	<b>DP7HRRKD48</b>	477.
	Double Sided	60"	<b>DP7HRRKD60</b>	489.
	Single Sided	24"	<b>DP7HRRKS24</b>	320.
	Single Sided	30"	<b>DP7HRRKS30</b>	451.
	Single Sided	36"	<b>DP7HRRKS36</b>	456.
	Single Sided	42"	<b>DP7HRRKS42</b>	456.
	Single Sided	48"	<b>DP7HRRKS48</b>	461.
Single Sided	60"	<b>DP7HRRKS60</b>	471.	
 Pre-Drilled Replacement Covers, Pair (Chicago)	24" Wide Panel	24"	<b>DP7RCCH24</b>	39.
	30" Wide Panel	30"	<b>DP7RCCH30</b>	43.
	36" Wide Panel	36"	<b>DP7RCCH36</b>	46.
	42" Wide Panel	42"	<b>DP7RCCH42</b>	53.
	48" Wide Panel	48"	<b>DP7RCCH48</b>	55.
	60" Wide Panel	60"	<b>DP7RCCH60</b>	64.

## Ordering Information

### Hardwire Infeed (NYC)

1. Pattern Number

## Order Code

### Hardwire Infeed (NYC)

**Example: DE1E B1NY1**

**DE1E**      **Pattern Number**  
**B1NY1**

## Included with:

### Hardwire Infeed (NYC)

- Junction box with power connector and infeed
- Ceiling trim plate
- Attachment screws

## Options

### Hardwire Infeed (NYC)

Power System

- 3+1
- 2+2
- 3+3

### San Francisco Infeed direction option

(L) = Left  
(R) = Right

**Note:** The electrical retrofit kit provides brackets that connect Chicago Electrical components that were manufactured prior to June 2008 to DP7 panel base raceways.

**This page intentionally left blank**

### Base Raceway Cable Tray

Optional steel cable trays are available for installations requiring the use of data and communications cables within the base raceway. The cable tray mounts between the panel feet.

Cable trays are field-installed and accessible from either side of the base raceway. A single sided base raceway cable tray should be specified when attaching to a tile-to-floor panel base.

**Note:** Cables should not be installed in base raceways without cable trays.

### Beltway Cable Tray

An optional cable tray is available for data and communications cables within the beltway. Beltway cable trays should be used when wires are being routed horizontally from panel-to-panel at the beltway. The cable tray mounts into slots located on the vertical panel frame.

Cable trays are 1<sup>1</sup>/<sub>4</sub>" high, 1<sup>5</sup>/<sub>16</sub>" deep and are field-installed. Construction is 20-gauge steel with black finish.

**Note:** Beltway cable trays can be installed in monolithic panels to provide additional mid span insert support when required.

### Worksurface Cable Management Basket

Constructed of black finished steel wire, the worksurface cable management basket mounts to the underside of worksurfaces to provide management of excess cords and cables. Once installed, the cable management basket slides forward to a position abutting the panel face to allow the passage of cords and cables.

Specify by width available between worksurface supports. Black finish.

Worksurface cable management baskets are 1<sup>1</sup>/<sub>2</sub>" high, 3<sup>1</sup>/<sub>2</sub>" deep and 19<sup>1</sup>/<sub>2</sub>" to 41<sup>1</sup>/<sub>2</sub>" wide.

### Vertical Wire Pathway Grommet

An optional plastic grommet that snaps into the vertical wire pathway on the horizontal panel frame to separate cables from the panel frame. Located in center of topway and base raceway.

### Topway Cable Grommet

The primary location for cable management for Dividends Horizon is in the topway. In order to utilize the topway channel effectively, the outside knockouts must be removed by using pliers. When the knockouts are removed the cables can be easily managed in the channel.

If required, a topway knockout grommet may be installed inside of the topway channel. Four grommets would be required per panel topway.





### Worksurface Cable Management Clip

An optional cable management clip. 3/4" x 1/2" (internal dimension) plastic clip manages cables on the underside of worksurfaces.

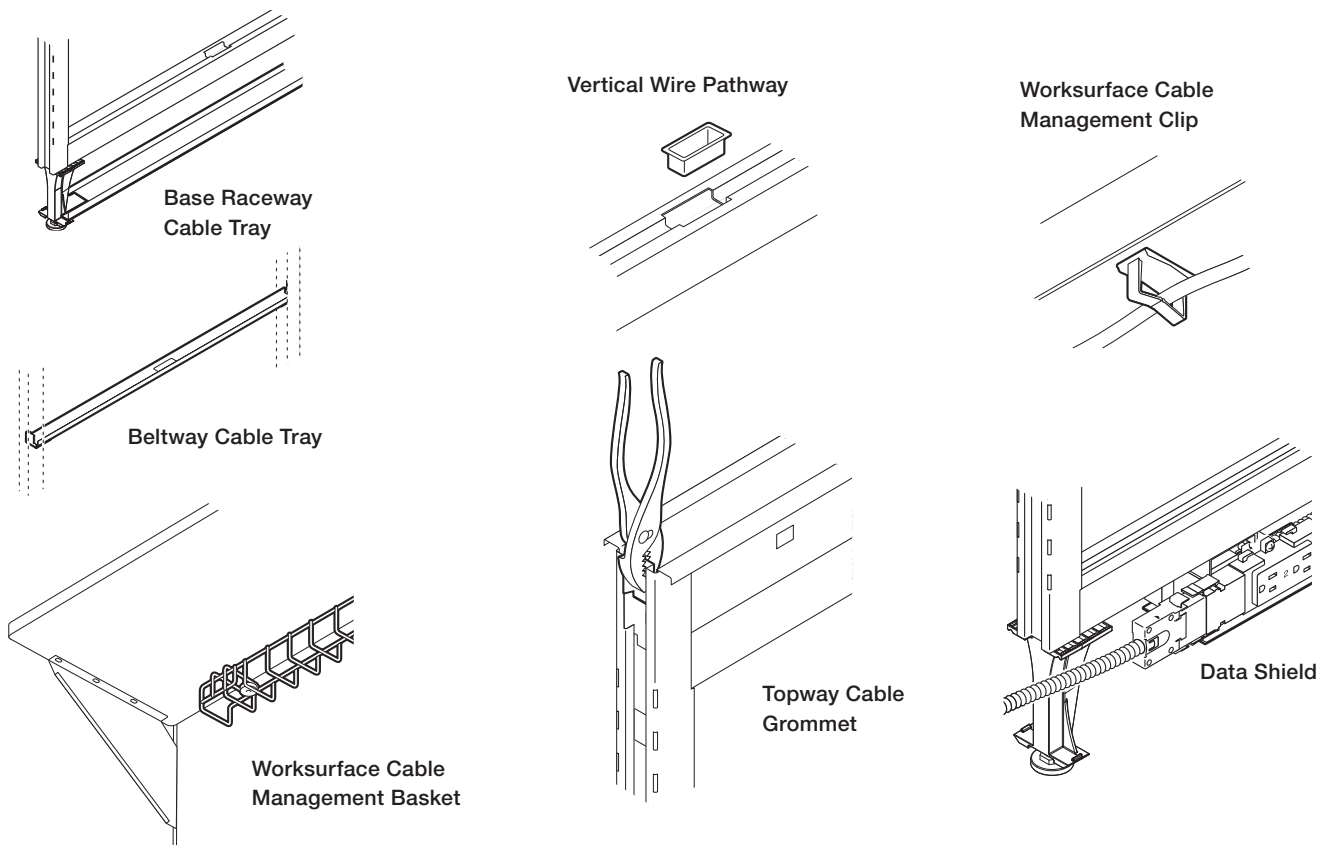
### Data Shield

If separation of cabling and electrical wires is required within the base raceway, a data shield can be attached below a base raceway power module at either end. Data shields are field-installed. The data shield should be used with base raceway panels or tile to floor panels only.

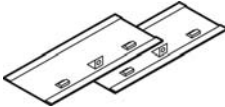

description	type	pattern no.	list
 Worksurface Cable Management Basket	19 1/2" wide	<b>D1WB20</b>	\$40.
	25 1/2" wide	<b>D1WB26</b>	42.
	31 1/2" wide	<b>D1WB32</b>	53.
	35" wide	<b>D1WB36</b>	58.
	41" wide	<b>D1WB42</b>	61.
 Vertical Wire Pathway Grommet (optional)	Package of 10	<b>DP1 VWG</b>	170.
 Topway Cable Grommet	Package of 40	<b>DP1 TKC</b>	59.
 Worksurface Cable Management Clip	Package of 10	<b>D1WC</b>	38.
 Data Shield	1 Pair for use with base raceway	<b>DE1DATSHD</b>	30.
	1 Pair for use with tile to floor	<b>DE1DATSHDF</b>	30.

### Ordering Information

#### Base Raceway Cable Tray

1. Pattern Number

### Order Code

#### Base Raceway Cable Tray

*Example:* **DP1 RCT24**

**DP1** Pattern Number  
**RCT24**

### Included with:

#### Base Raceway Cable Tray

### Options



#### Base Raceway Cable Tray

**Note:** DP7 cable trays are for use with all DP7 series panels and all panels produced prior to November 2007.

**Note:** Data Shield is not compatible with open base panels.

# Cable Management

## Base Raceway and Beltway Cable Trays

description	type	pattern no.	list
Base Raceway Cable Tray - double sided for use with raceway on both sides (optional) 	18" Panel Width	<b>DP72RCT18</b>	\$24.
	24" Panel Width	<b>DP72RCT24</b>	26.
	30" Panel Width	<b>DP72RCT30</b>	30.
	36" Panel Width	<b>DP72RCT36</b>	32.
	42" Panel Width	<b>DP72RCT42</b>	34.
	48" Panel Width	<b>DP72RCT48</b>	38.
	60" Panel Width	<b>DP72RCT60</b>	41.
Base Raceway Cable Tray - single sided for use with raceway on one side (optional) 	18" Panel Width	<b>DP71RCT18</b>	24.
	24" Panel Width	<b>DP71RCT24</b>	26.
	30" Panel Width	<b>DP71RCT30</b>	30.
	36" Panel Width	<b>DP71RCT36</b>	32.
	42" Panel Width	<b>DP71RCT42</b>	34.
	48" Panel Width	<b>DP71RCT48</b>	38.
	60" Panel Width	<b>DP71RCT60</b>	41.
Beltway Cable Tray (optional) 	18" Panel Width	<b>DP1BCT18</b>	26.
	24" Panel Width	<b>DP1BCT24</b>	27.
	30" Panel Width	<b>DP1BCT30</b>	31.
	36" Panel Width	<b>DP1BCT36</b>	33.
	42" Panel Width	<b>DP1BCT42</b>	36.
	48" Panel Width	<b>DP1BCT48</b>	39.
	60" Panel Width	<b>DP1BCT60</b>	57.

### Ordering Information

**Base Raceway Cable Tray**  
1. Pattern Number

### Order Code

**Base Raceway Cable Tray**  
*Example:* **DP1 RCT24**  
**DP1**      Pattern Number  
**RCT24**

### Included with:

**Base Raceway Cable Tray**

### Options

**Base Raceway Cable Tray**  
**Note:** DP7 cable trays are for use with all DP7 series panels and all panels produced prior to November 2007.



**This page intentionally left blank**

# Flip-Up Door Overheads

## Panel- and Wall-Mounted

### Dividends Series 1, Series 2 and Series 3 Overheads - Specifications

#### Flip-Up Door Overheads

Flip-up overheads mount to the integral vertical channels on Dividends Horizon panels or wall mount tracks to provide overhead storage within workstations or private offices.

Flip-up overhead cabinets consist of a top, shelf, end panels, overhead door with or without lock and required assembly screws. 30" to 48" wide cabinets have single doors while cabinets 54", 60", 66" and 72" wide have double doors. 54" wide overhead cabinets will ship with one 24" and one 30" door. 66" wide overhead cabinets will ship with one 30" and one 36" door. 54" and 66" overhead doors may be removed and reversed.

Overheads must match the width of single or multiple panels and cannot be mounted off-module. All cabinets are shipped knocked-down.

#### Series 1 Flip-up Door Overhead

Series 1 flip-up overhead cabinets match the aesthetics of the original Dividends Horizon system. The radiused fronts and molded plastic end trim match the radiused profile trim used on panel topcaps and end trim. Series 1 cabinets are offered with steel doors.

#### Series 2 Flip-up Door Overhead

Series 2 overhead cabinets offer an alternative aesthetic to the original Dividends Horizon Series 1 overhead. Unlike the radiused door profile of the Series 1 overhead door, the Series 2 door profile is rectilinear with soft radiused corners (see door profile drawing below). The Series 2 overhead offers a painted steel or veneer overhead door front.

#### Series 3 Flip-up Door Overhead

Series 3 cabinets offer a third aesthetic choice for flip-up overhead cabinets. The series 3 door profile is similar to the rectilinear door of the Series 2 cabinet, but the corners have a sharper radius to complement Dividends Horizon flat profile trim. Series 3 cabinets are offered with steel, laminate or veneer doors.

**Note:** Horizon Series 3 overheads are designed to complement and work next to other Series 3 overheads only.

#### Available Sizes

- Height: 15"
- Depth: 14<sup>1</sup>/<sub>8</sub>"
- Widths: 24", 30", 36", 42", 48", 54" 60", 66" and 72"

#### Construction:

- **Horizontal top and shelf:** 18-gauge (30" to 48" wide), 16-gauge (60" to 72" wide) painted roll-formed steel
- **Overhead door:**
  - Steel: 20-gauge painted steel
  - Laminate: 3/4" particle board with high pressure laminate on the outside and a paper backer on the inside. 1mm edgeband.
  - Veneer: 3/4" thick particle board with 0.6mm thick veneer on the top and edge.
- **Overhead door end trim:** Color injected, molded plastic (on Series 1 only)
- **End panels:** 16-gauge painted steel with integral mounting hooks
- **Overhead door suspension:** Steel ball bearing

#### Interior Dimensions

The interior dimensions of overhead cabinets and shelves are:

- Depth: 12"
- Usable interior height: 12<sup>5</sup>/<sub>8</sub>"
- Width: 1/8" shorter than the exterior width

#### Cabinet Door Clearance

Cabinet doors open over the tops of cabinets. Required clearance is 16<sup>1</sup>/<sub>4</sub>" total height (height of cabinet plus top clearance required).

#### Touchdown Overhead Cabinets

Touchdown overhead cabinets are equipped with hydraulic assist cylinders that allow the overhead cabinet front to gently fall to a closed position.

Retrofit mechanisms may be field added to any flip-up overhead cabinet with a steel door.

**Note:** Touchdown mechanisms are not available with laminate or veneer doors.

#### Task Lights

All Dividends cabinets and shelves will accept task lights. Task lights must be specified separately.

#### Locks

Locks are standard on overhead cabinets and keyed randomly unless otherwise specified. Other keying options include keyed alike or keyed with lock cores K001-K250. All locks are factory-installed and are black finish. Cabinets can also be specified without locks if required. When locks are not specified on Series 1 and Series 2 overheads, a plug is located in the lock position. Lock retrofit kits are available for field installation at a later date for Series 1 and Series 2 overheads only.

**Note:** Horizon Series 3 flip-up overheads are only available in Knoll Core finishes.

#### Flip-up Door Overhead Configurations

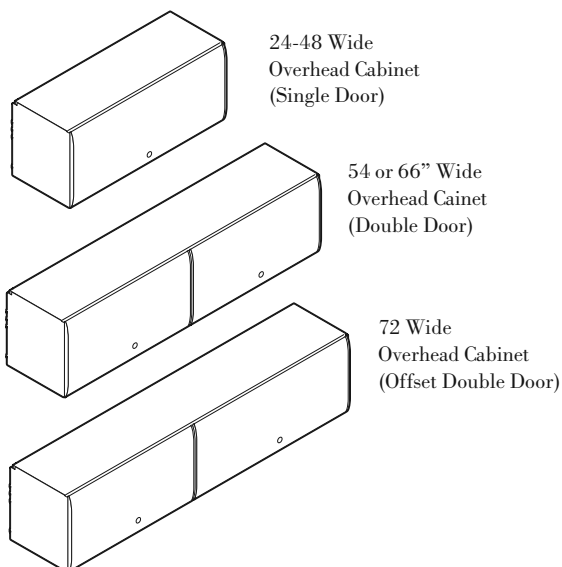

#### Interior Dimensions

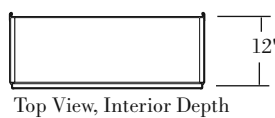
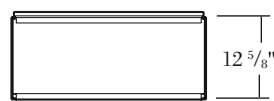

#### Cabinet Door Clearance

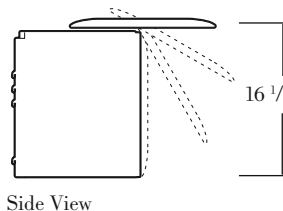

#### Flip-up Door Overhead Profiles

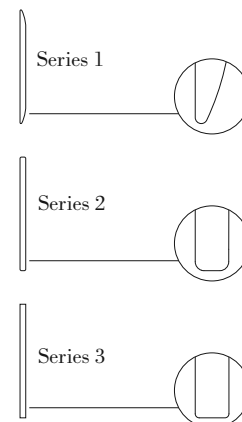

# Flip-Up Door Overheads

## Panel- and Wall-Mounted

### Dividends Series 1, Series 2 and Horizon Series 3

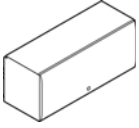
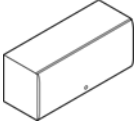
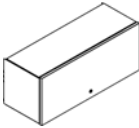
description	w*	w	d	h	pattern no.	P1	P2	P3	V1-P1	V1-P2	V1-P3
Dividends Series 1 Flip-Up Overhead w/Steel Door 	24"	23 7/8"	14 1/8"	15"	<b>DS1O24L</b>	\$369.	\$405.	\$421.	n/a	n/a	n/a
	30"	29 7/8"	14 1/8"	15"	<b>DS1O30L</b>	369.	405.	421.	n/a	n/a	n/a
	36"	35 7/8"	14 1/8"	15"	<b>DS1O36L</b>	388.	425.	446.	n/a	n/a	n/a
	42"	41 7/8"	14 1/8"	15"	<b>DS1O42L</b>	411.	453.	473.	n/a	n/a	n/a
	48"	47 7/8"	14 1/8"	15"	<b>DS1O48L</b>	424.	470.	489.	n/a	n/a	n/a
	54"	53 7/8"	14 1/8"	15"	<b>DS1O54L</b>	626.	687.	719.	n/a	n/a	n/a
	60"	59 7/8"	14 1/8"	15"	<b>DS1O60L</b>	626.	687.	719.	n/a	n/a	n/a
	66"	65 7/8"	14 1/8"	15"	<b>DS1O66L</b>	646.	712.	744.	n/a	n/a	n/a
	72"	71 7/8"	14 1/8"	15"	<b>DS1O72L</b>	646.	712.	744.	n/a	n/a	n/a
Series 2 Flip-Up Overhead w/ Steel or Veneer Door 	24"	23 7/8"	14 1/8"	15"	<b>DS2PM24L</b>	477.	551.	576.	749.	822.	844.
	30"	29 7/8"	14 1/8"	15"	<b>DS2PM30L</b>	477.	551.	576.	749.	822.	844.
	36"	35 7/8"	14 1/8"	15"	<b>DS2PM36L</b>	519.	598.	623.	757.	834.	861.
	42"	41 7/8"	14 1/8"	15"	<b>DS2PM42L</b>	568.	651.	678.	775.	862.	890.
	48"	47 7/8"	14 1/8"	15"	<b>DS2PM48L</b>	623.	716.	749.	832.	925.	958.
	54"	53 7/8"	14 1/8"	15"	<b>DS2PM54L</b>	740.	852.	890.	1,185.	1,295.	1,333.
	60"	59 7/8"	14 1/8"	15"	<b>DS2PM60L</b>	740.	852.	890.	1,185.	1,295.	1,333.
	66"	65 7/8"	14 1/8"	15"	<b>DS2PM66L</b>	825.	949.	990.	1,240.	1,364.	1,406.
	72"	71 7/8"	14 1/8"	15"	<b>DS2PM72L</b>	825.	949.	990.	1,240.	1,364.	1,406.
Dividends "touchdown" retro-fit (two kits required for 54"w - 72"w)					<b>DS1EAKIT</b>	252.					
Series 3 Flip-Up Overhead w/ Steel Door 	30"	29 7/8"	14 1/2"	15"	<b>DS3PMS30L</b>	471.	519.	544.			
	36"	35 7/8"	14 1/2"	15"	<b>DS3PMS36L</b>	485.	535.	558.			
	42"	41 7/8"	14 1/2"	15"	<b>DS3PMS42L</b>	500.	551.	577.			
	48"	47 7/8"	14 1/2"	15"	<b>DS3PMS48L</b>	517.	569.	594.			
	60"	59 7/8"	14 1/2"	15"	<b>DS3PMS60L</b>	651.	717.	751.			
	66"	65 7/8"	14 1/2"	15"	<b>DS3PMS66L</b>	710.	781.	817.			
	72"	71 7/8"	14 1/2"	15"	<b>DS3PMS72L</b>	710.	781.	817.			

w\* = nominal width  
 Dimensions listed under w h d are actual to the nearest 1/16"

Ordering Information	Order Code	Included with:	Options
<b>Dividends Series 1 Flip-Up Door Overhead</b> 1. Pattern Number 2. Paint Finish 3. Door End Cap Finish  <b>Series 2 Flip-Up Door Overhead</b> 1. Pattern Number 2. Paint Finish 3. Door Finish (veneer door only)  <b>Series 3 Flip-Up Door Overhead</b> 1. Pattern Number 2. Paint Finish case 3. Door Finish (laminated and veneer door only) 4. Door Edge Finish (laminated door only)	<b>Dividends Series 1 Flip-Up Door Overhead</b> <i>Example:</i> <b>DS1O 30L, 113, 113</b> <b>DS1O 30L</b> Pattern Number <b>113</b> Dark grey paint finish <b>113</b> Dark grey End cap finish  <b>Series 2 Flip-Up Overhead w/ Steel Door</b> <i>Example:</i> <b>DS2PM 30L, 115</b> <b>DS2PM 30L</b> Pattern Number <b>115</b> Medium grey paint finish	<b>Dividends Series 1 Flip-Up Door Overhead</b>  <b>Series 2 Flip-Up Overhead</b>  <b>Series 3 Flip-Up Overhead</b>  <b>Note:</b> Touchdown mechanism not available on veneer or laminate front Flip-Up overheads.  <b>Note:</b> Series 3 Horizon overheads are only available in Knoll core finishes.  Wallmount bracket specified separately.	<b>Flip-Up Door Door Overhead</b> <b>To specify overhead cabinet without locks replace the "L" suffix from the pattern number with "N" Deduct \$20. For 54", 60", 66" and 72" overhead cabinets Deduct \$40</b>  <b>To specify Touchdown overhead cabinet, add "E" as the 2nd to last digit of the pattern number</b> <i>Example:</i> <b>DS3PML48EL</b> <b>(Add \$157 for cabinet widths of 48" or less. Add \$314 for cabinet widths of 54" or greater).</b>  <b>Series 2 and Series 3 Flip-Up Door Overhead Finish Option:</b> Add a "Y" to the end of the pattern number to specify a different finish for the door versus the case. Use P3 pricing for this dual finish option.

Storage Components

# Flip-Up Door Overheads

## Panel- and Wall-Mounted

### Dividends Series 1, Series 2 and Horizon Series 3

Dividends Horizon

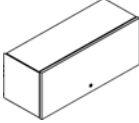
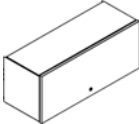
description	w *	w	d	h	pattern no.	P1	P2	P3	V1-P1	V1-P2	V1-P3
Series 3 Flip-Up Overhead w/ Laminate Door 	30"	29 <sup>7</sup> / <sub>8</sub> "	14 <sup>1</sup> / <sub>2</sub> "	15"	<b>DS3PML30L</b>	\$712.	\$794.	\$828.			
	36"	35 <sup>7</sup> / <sub>8</sub> "	14 <sup>1</sup> / <sub>2</sub> "	15"	<b>DS3PML36L</b>	745.	815.	851.			
	42"	41 <sup>7</sup> / <sub>8</sub> "	14 <sup>1</sup> / <sub>2</sub> "	15"	<b>DS3PML42L</b>	766.	839.	877.			
	48"	47 <sup>7</sup> / <sub>8</sub> "	14 <sup>1</sup> / <sub>2</sub> "	15"	<b>DS3PML48L</b>	813.	891.	930.			
	60"	59 <sup>7</sup> / <sub>8</sub> "	14 <sup>1</sup> / <sub>2</sub> "	15"	<b>DS3PML60L</b>	1,216.	1,332.	1,391.			
	66"	65 <sup>7</sup> / <sub>8</sub> "	14 <sup>1</sup> / <sub>2</sub> "	15"	<b>DS3PML66L</b>	1,233.	1,354.	1,424.			
	72"	71 <sup>7</sup> / <sub>8</sub> "	14 <sup>1</sup> / <sub>2</sub> "	15"	<b>DS3PML72L</b>	1,269.	1,396.	1,457.			
Series 3 Flip-Up Overhead w/ Veneer Door 	30"	29 <sup>7</sup> / <sub>8</sub> "	14 <sup>1</sup> / <sub>2</sub> "	15"	<b>DS3PMV30L</b>	984.	1,078.	1,127.			
	36"	35 <sup>7</sup> / <sub>8</sub> "	14 <sup>1</sup> / <sub>2</sub> "	15"	<b>DS3PMV36L</b>	1,006.	1,104.	1,153.			
	42"	41 <sup>7</sup> / <sub>8</sub> "	14 <sup>1</sup> / <sub>2</sub> "	15"	<b>DS3PMV42L</b>	1,030.	1,131.	1,182.			
	48"	47 <sup>7</sup> / <sub>8</sub> "	14 <sup>1</sup> / <sub>2</sub> "	15"	<b>DS3PMV48L</b>	1,075.	1,169.	1,221.			
	60"	59 <sup>7</sup> / <sub>8</sub> "	14 <sup>1</sup> / <sub>2</sub> "	15"	<b>DS3PMV60L</b>	1,733.	1,903.	1,987.			
	66"	65 <sup>7</sup> / <sub>8</sub> "	14 <sup>1</sup> / <sub>2</sub> "	15"	<b>DS3PMV66L</b>	1,780.	1,957.	2,055.			
	72"	71 <sup>7</sup> / <sub>8</sub> "	14 <sup>1</sup> / <sub>2</sub> "	15"	<b>DS3PMV72L</b>	1,795.	1,969.	2,059.			

w\* = nominal width

Dimensions listed under w h d are actual to the nearest 1/16"

Ordering Information	Order Code	Included with:	Options
<b>Dividends Series 1 Flip-Up Door Overhead</b> 1. Pattern Number 2. Paint Finish 3. Door End Cap Finish  <b>Series 2 Flip-Up Door Overhead</b> 1. Pattern Number 2. Paint Finish 3. Door Finish (veneer door only)  <b>Series 3 Flip-Up Door Overhead</b> 1. Pattern Number 2. Paint Finish case 3. Door Finish (laminated and veneer door only) 4. Door Edge Finish (laminated door only)	<b>Dividends Series 1 Flip-Up Door Overhead</b> <i>Example:</i> <b>DS1O 30L, 113, 113</b> <b>DS1O 30L</b> Pattern Number <b>113</b> Dark grey paint finish <b>113</b> Dark grey End cap finish  <b>Series 2 Flip-Up Overhead w/ Steel Door</b> <i>Example:</i> <b>DS2PM 30L, 115</b> <b>DS2PM 30L</b> Pattern Number <b>115</b> Medium grey paint finish	<b>Dividends Series 1 Flip-Up Door Overhead</b>  <b>Series 2 Flip-Up Overhead</b>  <b>Series 3 Flip-Up Overhead</b>  <b>Note:</b> Touchdown mechanism not available on veneer or laminate front Flip-Up overheads.  <b>Note:</b> Series 3 Horizon overheads are only available in Knoll core finishes.  Wallmount bracket specified separately.	<b>Flip-Up Door Door Overhead</b> <b>To specify overhead cabinet without locks replace the "L" suffix from the pattern number with "N" Deduct \$20. For 54", 60", 66" and 72" overhead cabinets Deduct \$40</b>  To specify Touchdown overhead cabinet, add "E" as the 2nd to last digit of the pattern number <i>Example:</i> <b>DS3PML48EL</b> <b>(Add \$157 for cabinet widths of 48" or less. Add \$314 for cabinet widths of 54" or greater).</b>  <b>Series 2 and Series 3 Flip-Up Door Overhead Finish Option:</b> Add a "Y" to the end of the pattern number to specify a different finish for the door versus the case. Use P3 pricing for this dual finish option.

**This page intentionally left blank**

# Sliding Door Overheads

## Panel-, Center- and Wall-Mounted Specifications

### Sliding Door Overheads

Sliding door overheads complement the aesthetic of the Dividends Horizon system. The rectilinear door profile was designed to match Dividends Horizon flat profile trim details.

Dividends Horizon sliding door overhead cabinets mount to integral vertical channels on Dividends Horizon panels or wall mount tracks to provide overhead storage within workstations or private offices.

Sliding door overhead cabinets consist of a top, shelf, mid cabinet septum, end panels and a door with handle. Units are available with or without locks.

Overheads must match the width of single or multiple panels and cannot be mounted off-module. All cabinets are shipped knocked-down.

**Note:** Series 3 overheads are designed to complement and work next to other Series 3 overheads only.

#### Available Sizes

- Height: 14" and 21"
- Depth: 13<sup>1</sup>/<sub>2</sub>"
- Widths: 30", 36", 42", 48", 54", 60", 66" and 72"

### Construction:

- **Horizontal top and shelf:** 18-gauge (30" to 48" wide), 16-gauge (60" to 72" wide) painted roll-formed steel
- **Sliding door:**
  - Steel: 20-gauge painted steel
  - Laminate: 3/4" particle board with high pressure laminate on the outside and a paper backer on the inside. 1mm edgeband.
  - Veneer: 3/4" thick particle board with 0.6mm thick veneer on the top and edge.
- **Fixed shelf:** 16-gauge painted steel
- **End panels:** 16-gauge painted steel with integral mounting hooks
- **Sliding door mechanism:** Integral track in top and bottom shelves with full length abs plastic extrusion. Door brackets are injection molded nylon.
- **Door handle:** painted aluminum (same color as case)

### Interior Dimensions

The interior dimensions of overhead cabinets and shelves are:

- Depth: 12<sup>1</sup>/<sub>4</sub>"
- Usable interior height: 12<sup>5</sup>/<sub>8</sub>"
- Width: 1/8" shorter than the exterior width

### Task Lights

All Dividends Horizon cabinets and shelves will accept task lights. Task lights must be ordered separately.

### Locks

Locks are standard on overhead cabinets and keyed randomly unless otherwise specified. All locks are factory-installed and are black finish. Cabinets can also be specified without locks if required.

**Note:** Horizon sliding door overheads are only available in Knoll Core finishes.

### Sliding Door Overhead Configurations

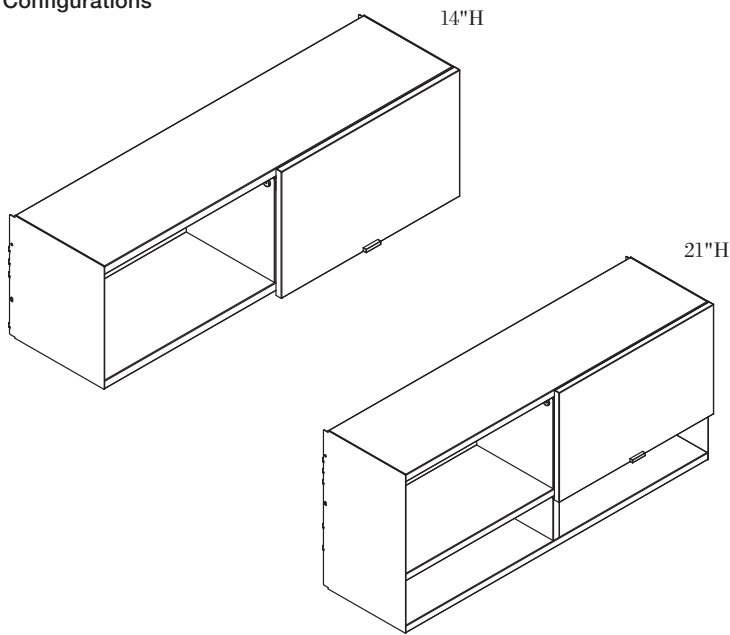

### Interior Dimensions for 14"H Overhead

#### Front View, Interior Height

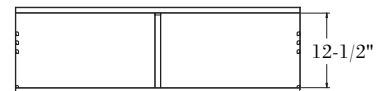

#### Top View, Interior Height

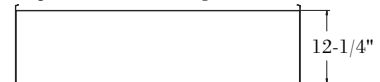

### Interior Dimensions for 21"H Overhead

#### Front View, Interior Height

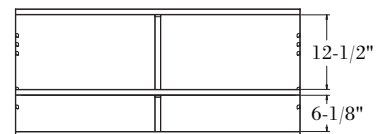

#### Top View, Interior Height

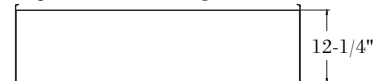



# Sliding Door Overheads

## 14" High Panel-Mounted

### Dividends Horizon and Template Doors

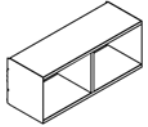
Dividends Horizon

description	w*	w	d	h	pattern no.	P1	P2	P3
 Dividends Horizon Panel-Mounted Overhead without Door	29 <sup>7</sup> / <sub>8</sub> "	30"	12 <sup>1</sup> / <sub>2</sub> "	14"	<b>DS3PMNS3014</b>	\$280.	\$308.	\$323.
	35 <sup>7</sup> / <sub>8</sub> "	36"	12 <sup>1</sup> / <sub>2</sub> "	14"	<b>DS3PMNS3614</b>	291.	321.	337.
	41 <sup>7</sup> / <sub>8</sub> "	42"	12 <sup>1</sup> / <sub>2</sub> "	14"	<b>DS3PMNS4214</b>	300.	331.	346.
	47 <sup>7</sup> / <sub>8</sub> "	48"	12 <sup>1</sup> / <sub>2</sub> "	14"	<b>DS3PMNS4814</b>	311.	343.	356.
	59 <sup>7</sup> / <sub>8</sub> "	60"	12 <sup>1</sup> / <sub>2</sub> "	14"	<b>DS3PMNS6014</b>	354.	390.	409.
	65 <sup>7</sup> / <sub>8</sub> "	66"	12 <sup>1</sup> / <sub>2</sub> "	14"	<b>DS3PMNS6614</b>	367.	402.	420.
	71 <sup>7</sup> / <sub>8</sub> "	72"	12 <sup>1</sup> / <sub>2</sub> "	14"	<b>DS3PMNS7214</b>	376.	414.	432.

 Template Panel-Mounted Sliding Door Overhead with Steel Doors	35 <sup>7</sup> / <sub>8</sub> "	36"	15"	14"	<b>DS3PMTS3614L</b>	609.	670.	700.
	41 <sup>7</sup> / <sub>8</sub> "	42"	15"	14"	<b>DS3PMTS4214L</b>	631.	694.	725.
	47 <sup>7</sup> / <sub>8</sub> "	48"	15"	14"	<b>DS3PMTS4814L</b>	650.	715.	748.
	59 <sup>7</sup> / <sub>8</sub> "	60"	15"	14"	<b>DS3PMTS6014L</b>	928.	1,022.	1,067.
	71 <sup>7</sup> / <sub>8</sub> "	72"	15"	14"	<b>DS3PMT7S214L</b>	983.	1,080.	1,130.

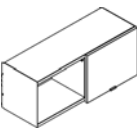
 Dividends Horizon Panel-Mounted Sliding Door Overhead w/Steel Door	29 <sup>7</sup> / <sub>8</sub> "	30"	13 <sup>1</sup> / <sub>2</sub> "	14"	<b>DS3PMSS3014L</b>	464.	511.	534.
	35 <sup>7</sup> / <sub>8</sub> "	36"	13 <sup>1</sup> / <sub>2</sub> "	14"	<b>DS3PMSS3614L</b>	476.	524.	550.
	41 <sup>7</sup> / <sub>8</sub> "	42"	13 <sup>1</sup> / <sub>2</sub> "	14"	<b>DS3PMSS4214L</b>	492.	543.	565.
	47 <sup>7</sup> / <sub>8</sub> "	48"	13 <sup>1</sup> / <sub>2</sub> "	14"	<b>DS3PMSS4814L</b>	500.	551.	577.
	59 <sup>7</sup> / <sub>8</sub> "	60"	13 <sup>1</sup> / <sub>2</sub> "	14"	<b>DS3PMSS6014L</b>	565.	623.	650.
	65 <sup>7</sup> / <sub>8</sub> "	66"	13 <sup>1</sup> / <sub>2</sub> "	14"	<b>DS3PMSS6614L</b>	581.	640.	668.
	71 <sup>7</sup> / <sub>8</sub> "	72"	13 <sup>1</sup> / <sub>2</sub> "	14"	<b>DS3PMSS7214L</b>	590.	649.	678.

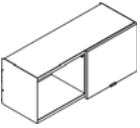
 Dividends Horizon Panel-Mounted Sliding Door Overhead w/ Laminate Door	29 <sup>7</sup> / <sub>8</sub> "	30"	13 <sup>1</sup> / <sub>2</sub> "	14"	<b>DS3PMSL3014L</b>	801.	880.	919.
	35 <sup>7</sup> / <sub>8</sub> "	36"	13 <sup>1</sup> / <sub>2</sub> "	14"	<b>DS3PMSL3614L</b>	823.	903.	943.
	41 <sup>7</sup> / <sub>8</sub> "	42"	13 <sup>1</sup> / <sub>2</sub> "	14"	<b>DS3PMSL4214L</b>	847.	928.	971.
	47 <sup>7</sup> / <sub>8</sub> "	48"	13 <sup>1</sup> / <sub>2</sub> "	14"	<b>DS3PMSL4814L</b>	868.	952.	995.
	59 <sup>7</sup> / <sub>8</sub> "	60"	13 <sup>1</sup> / <sub>2</sub> "	14"	<b>DS3PMSL6014L</b>	891.	979.	1,021.
	65 <sup>7</sup> / <sub>8</sub> "	66"	13 <sup>1</sup> / <sub>2</sub> "	14"	<b>DS3PMSL6614L</b>	914.	1,003.	1,046.
	71 <sup>7</sup> / <sub>8</sub> "	72"	13 <sup>1</sup> / <sub>2</sub> "	14"	<b>DS3PMSL7214L</b>	935.	1,026.	1,072.

w\* = nominal width  
 Dimensions listed under w h d are actual to the nearest 1/16"

Ordering Information	Order Code	Included With	Options
<b>Sliding Door Overheads:</b> 1. Pattern number 2. Paint finish case 3. Door finish (laminated and veneer door only) 4. Door edge finish (laminated door only)	<b>Sliding Door Overhead w/ Steel Door</b> <i>Example:</i> <b>DS3PMSS3014L</b> <b>/117/117</b> <b>DS3PMSS</b> Pattern Number <b>3014L</b> <b>117</b> Dark grey paint finish case	<b>Sliding Door Overhead</b> <b>Note:</b> Sliding door overheads are only available in Knoll core finishes.	<b>Sliding Door Overhead</b> Lock/No lock For non-locking units substitute the "L" suffix with a "N" and deduct \$20.00 from the list price. <b>Paint Configuration Option:</b> Add "Y" at the end of the pattern number to specify a different paint finish on the case and sliding door. P3 pricing applies to all products with dual paint finishes.

Storage Components

# Sliding Door Overheads

## *14" High Panel-Mounted*

### *Dividends Horizon and Template Doors*

Dividends Horizon

description	w*	w	d	h	pattern no.	P1	P2	P3
Dividends Horizon Panel-Mounted	29 <sup>7</sup> / <sub>8</sub> "	30"	13 <sup>1</sup> / <sub>2</sub> "	14"	<b>DS3PMSV3014L</b>	\$885.	\$971.	\$1,015.
Sliding Door Overhead w/ Veneer Door	35 <sup>7</sup> / <sub>8</sub> "	36"	13 <sup>1</sup> / <sub>2</sub> "	14"	<b>DS3PMSV3614L</b>	914.	1,002.	1,046.
	41 <sup>7</sup> / <sub>8</sub> "	42"	13 <sup>1</sup> / <sub>2</sub> "	14"	<b>DS3PMSV4214L</b>	940.	1,033.	1,078.
	47 <sup>7</sup> / <sub>8</sub> "	48"	13 <sup>1</sup> / <sub>2</sub> "	14"	<b>DS3PMSV4814L</b>	970.	1,064.	1,111.
	59 <sup>7</sup> / <sub>8</sub> "	60"	13 <sup>1</sup> / <sub>2</sub> "	14"	<b>DS3PMSV6014L</b>	999.	1,096.	1,144.
	65 <sup>7</sup> / <sub>8</sub> "	66"	13 <sup>1</sup> / <sub>2</sub> "	14"	<b>DS3PMSV6614L</b>	1,026.	1,127.	1,177.
	71 <sup>7</sup> / <sub>8</sub> "	72"	13 <sup>1</sup> / <sub>2</sub> "	14"	<b>DS3PMSV7214L</b>	1,055.	1,158.	1,211.

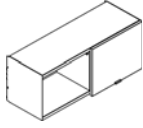

w\* = nominal width

Dimensions listed under w h d are actual to the nearest 1/16"

Ordering Information	Order Code	Included With	Options
<b>Sliding Door Overheads:</b> 1. Pattern number 2. Paint finish case 3. Door finish (laminate and veneer door only) 4. Door edge finish (laminate door only)	<b>Sliding Door Overhead w/ Steel Door</b> <hr/> <i>Example:</i> <b>DS3PMSS3014L</b> <b>/117/117</b> <hr/> <b>DS3PMSS</b> Pattern Number <b>3014L</b> <hr/> <b>117</b> Dark grey paint finish case <hr/>	<b>Sliding Door Overhead</b> <hr/> <b>Note:</b> Sliding door overheads are only available in Knoll core finishes.	<b>Sliding Door Overhead</b> <hr/> Lock/No lock For non-locking units substitute the "L" suffix with a "N" and deduct \$20.00 from the list price. <hr/> <b>Paint Configuration Option:</b> <hr/> Add "Y" at the end of the pattern number to specify a different paint finish on the case and sliding door. P3 pricing applies to all products with dual paint finishes.



# Sliding Door Overheads 21" High Panel-Mounted Dividends Horizon Full Height Door

Dividends Horizon

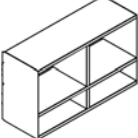
description	w*	w	d	h	pattern no.	P1	P2	P3
Dividends Horizon Panel-Mounted Overhead without Door 	29 <sup>7</sup> / <sub>8</sub> "	30"	12 <sup>1</sup> / <sub>2</sub> "	21"	<b>DS3PMNS3021</b>	\$387.	\$426.	\$446.
	35 <sup>7</sup> / <sub>8</sub> "	36"	12 <sup>1</sup> / <sub>2</sub> "	21"	<b>DS3PMNS3621</b>	404.	443.	464.
	41 <sup>7</sup> / <sub>8</sub> "	42"	12 <sup>1</sup> / <sub>2</sub> "	21"	<b>DS3PMNS4221</b>	417.	458.	478.
	47 <sup>7</sup> / <sub>8</sub> "	48"	12 <sup>1</sup> / <sub>2</sub> "	21"	<b>DS3PMNS4821</b>	432.	474.	496.
	59 <sup>7</sup> / <sub>8</sub> "	60"	12 <sup>1</sup> / <sub>2</sub> "	21"	<b>DS3PMNS6021</b>	492.	543.	565.
	65 <sup>7</sup> / <sub>8</sub> "	66"	12 <sup>1</sup> / <sub>2</sub> "	21"	<b>DS3PMNS6621</b>	402.	442.	462.
	71 <sup>7</sup> / <sub>8</sub> "	72"	12 <sup>1</sup> / <sub>2</sub> "	21"	<b>DS3PMNS7221</b>	521.	575.	599.

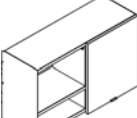
Dividends Horizon Panel-Mounted Sliding Door Overhead w/ Steel Door 	29 <sup>7</sup> / <sub>8</sub> "	30"	13 <sup>1</sup> / <sub>2</sub> "	21"	<b>DS3PMSS3021FL</b>	603.	664.	693.
	35 <sup>7</sup> / <sub>8</sub> "	36"	13 <sup>1</sup> / <sub>2</sub> "	21"	<b>DS3PMSS3621FL</b>	623.	686.	716.
	41 <sup>7</sup> / <sub>8</sub> "	42"	13 <sup>1</sup> / <sub>2</sub> "	21"	<b>DS3PMSS4221FL</b>	644.	707.	740.
	47 <sup>7</sup> / <sub>8</sub> "	48"	13 <sup>1</sup> / <sub>2</sub> "	21"	<b>DS3PMSS4821FL</b>	661.	725.	760.
	59 <sup>7</sup> / <sub>8</sub> "	60"	13 <sup>1</sup> / <sub>2</sub> "	21"	<b>DS3PMSS6021FL</b>	757.	832.	871.
	65 <sup>7</sup> / <sub>8</sub> "	66"	13 <sup>1</sup> / <sub>2</sub> "	21"	<b>DS3PMSS6621FL</b>	778.	855.	894.
	71 <sup>7</sup> / <sub>8</sub> "	72"	13 <sup>1</sup> / <sub>2</sub> "	21"	<b>DS3PMSS7221FL</b>	793.	872.	911.

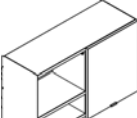
Dividends Horizon Panel-Mounted Sliding Door Overhead w/ Laminate Door 	29 <sup>7</sup> / <sub>8</sub> "	30"	13 <sup>1</sup> / <sub>2</sub> "	21"	<b>DS3PMSL3021FL</b>	999.	1,096.	1,143.
	35 <sup>7</sup> / <sub>8</sub> "	36"	13 <sup>1</sup> / <sub>2</sub> "	21"	<b>DS3PMSL3621FL</b>	1,027.	1,128.	1,178.
	41 <sup>7</sup> / <sub>8</sub> "	42"	13 <sup>1</sup> / <sub>2</sub> "	21"	<b>DS3PMSL4221FL</b>	1,058.	1,160.	1,214.
	47 <sup>7</sup> / <sub>8</sub> "	48"	13 <sup>1</sup> / <sub>2</sub> "	21"	<b>DS3PMSL4821FL</b>	1,089.	1,195.	1,246.
	59 <sup>7</sup> / <sub>8</sub> "	60"	13 <sup>1</sup> / <sub>2</sub> "	21"	<b>DS3PMSL6021FL</b>	1,117.	1,227.	1,281.
	65 <sup>7</sup> / <sub>8</sub> "	66"	13 <sup>1</sup> / <sub>2</sub> "	21"	<b>DS3PMSL6621FL</b>	1,146.	1,260.	1,316.
	71 <sup>7</sup> / <sub>8</sub> "	72"	13 <sup>1</sup> / <sub>2</sub> "	21"	<b>DS3PMSL7221FL</b>	1,177.	1,292.	1,349.

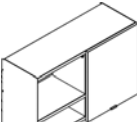
Dividends Horizon Panel-Mounted Sliding Door Overhead w/ Veneer Door 	29 <sup>7</sup> / <sub>8</sub> "	30"	13 <sup>1</sup> / <sub>2</sub> "	21"	<b>DS3PMSV3021FL</b>	1,087.	1,193.	1,245.
	35 <sup>7</sup> / <sub>8</sub> "	36"	13 <sup>1</sup> / <sub>2</sub> "	21"	<b>DS3PMSV3621FL</b>	1,126.	1,237.	1,291.
	41 <sup>7</sup> / <sub>8</sub> "	42"	13 <sup>1</sup> / <sub>2</sub> "	21"	<b>DS3PMSV4221FL</b>	1,168.	1,281.	1,339.
	47 <sup>7</sup> / <sub>8</sub> "	48"	13 <sup>1</sup> / <sub>2</sub> "	21"	<b>DS3PMSV4821FL</b>	1,208.	1,326.	1,386.
	59 <sup>7</sup> / <sub>8</sub> "	60"	13 <sup>1</sup> / <sub>2</sub> "	21"	<b>DS3PMSV6021FL</b>	1,248.	1,371.	1,434.
	65 <sup>7</sup> / <sub>8</sub> "	66"	13 <sup>1</sup> / <sub>2</sub> "	21"	<b>DS3PMSV6621FL</b>	1,289.	1,417.	1,479.
	71 <sup>7</sup> / <sub>8</sub> "	72"	13 <sup>1</sup> / <sub>2</sub> "	21"	<b>DS3PMSV7221FL</b>	1,331.	1,462.	1,526.

w\* = nominal width  
Dimensions listed under w h d are actual to the nearest 1/16"

Ordering Information	Order Code	Included With	Options
<b>Sliding Door Overheads:</b> 1. Pattern number 2. Paint finish case 3. Door finish (laminated and veneer door only) 4. Door edge finish (laminated door only)	<b>Sliding Door Overhead w/ Steel Door</b> <i>Example:</i> <b>DS3PMSS3021FL</b> <b>/117/117</b> <b>DS3PMSS</b> Pattern Number <b>3021FL</b> <b>117</b> Dark grey paint finish case	<b>Sliding Door Overhead</b> <b>Note:</b> Sliding door overheads are only available in Knoll core finishes.	<b>Sliding Door Overhead</b> Lock/No lock For non-locking units substitute the "L" suffix with a "N" and deduct \$20.00 from the list price.  <b>Paint Configuration Option:</b> Add "Y" at the end of the pattern number to specify a different paint finish on the case and sliding door. P3 pricing applies to all products with dual paint finishes.

# Sliding Door Overheads 21" High Panel-Mounted Dividends Horizon Partial Height Door

Dividends Horizon

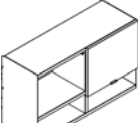
description	w*	w	d	h	pattern number	P1	P2	P3
Dividends Horizon Panel-Mounted Sliding Door Overhead w/ Steel Door  	29 <sup>7</sup> / <sub>8</sub> "	30"	13 <sup>1</sup> / <sub>2</sub> "	21"	<b>DS3PMSS3021PL</b>	\$599.	\$661.	\$689.
	35 <sup>7</sup> / <sub>8</sub> "	36"	13 <sup>1</sup> / <sub>2</sub> "	21"	<b>DS3PMSS3621PL</b>	619.	680.	712.
	41 <sup>7</sup> / <sub>8</sub> "	42"	13 <sup>1</sup> / <sub>2</sub> "	21"	<b>DS3PMSS4221PL</b>	639.	701.	731.
	47 <sup>7</sup> / <sub>8</sub> "	48"	13 <sup>1</sup> / <sub>2</sub> "	21"	<b>DS3PMSS4821PL</b>	653.	719.	753.
	59 <sup>7</sup> / <sub>8</sub> "	60"	13 <sup>1</sup> / <sub>2</sub> "	21"	<b>DS3PMSS6021PL</b>	724.	797.	834.
	65 <sup>7</sup> / <sub>8</sub> "	66"	13 <sup>1</sup> / <sub>2</sub> "	21"	<b>DS3PMSS6621PL</b>	748.	820.	857.
	71 <sup>7</sup> / <sub>8</sub> "	72"	13 <sup>1</sup> / <sub>2</sub> "	21"	<b>DS3PMSS7221PL</b>	761.	836.	874.

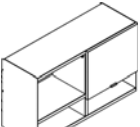
Dividends Horizon Panel-Mounted Sliding Door Overhead w/ Laminate Door  	29 <sup>7</sup> / <sub>8</sub> "	30"	13 <sup>1</sup> / <sub>2</sub> "	21"	<b>DS3PMSL3021PL</b>	990.	1,087.	1,134.
	35 <sup>7</sup> / <sub>8</sub> "	36"	13 <sup>1</sup> / <sub>2</sub> "	21"	<b>DS3PMSL3621PL</b>	1,019.	1,118.	1,168.
	41 <sup>7</sup> / <sub>8</sub> "	42"	13 <sup>1</sup> / <sub>2</sub> "	21"	<b>DS3PMSL4221PL</b>	1,048.	1,149.	1,202.
	47 <sup>7</sup> / <sub>8</sub> "	48"	13 <sup>1</sup> / <sub>2</sub> "	21"	<b>DS3PMSL4821PL</b>	1,077.	1,183.	1,236.
	59 <sup>7</sup> / <sub>8</sub> "	60"	13 <sup>1</sup> / <sub>2</sub> "	21"	<b>DS3PMSL6021PL</b>	1,107.	1,216.	1,269.
	65 <sup>7</sup> / <sub>8</sub> "	66"	13 <sup>1</sup> / <sub>2</sub> "	21"	<b>DS3PMSL6621PL</b>	1,136.	1,247.	1,304.
	71 <sup>7</sup> / <sub>8</sub> "	72"	13 <sup>1</sup> / <sub>2</sub> "	21"	<b>DS3PMSL7221PL</b>	1,165.	1,279.	1,338.

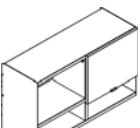
Dividends Horizon Panel-Mounted Sliding Door Overhead w/ Veneer Door  	29 <sup>7</sup> / <sub>8</sub> "	30"	13 <sup>1</sup> / <sub>2</sub> "	21"	<b>DS3PMSV3021PL</b>	1,087.	1,193.	1,244.
	35 <sup>7</sup> / <sub>8</sub> "	36"	13 <sup>1</sup> / <sub>2</sub> "	21"	<b>DS3PMSV3621PL</b>	1,118.	1,228.	1,282.
	41 <sup>7</sup> / <sub>8</sub> "	42"	13 <sup>1</sup> / <sub>2</sub> "	21"	<b>DS3PMSV4221PL</b>	1,151.	1,265.	1,320.
	47 <sup>7</sup> / <sub>8</sub> "	48"	13 <sup>1</sup> / <sub>2</sub> "	21"	<b>DS3PMSV4821PL</b>	1,186.	1,301.	1,359.
	59 <sup>7</sup> / <sub>8</sub> "	60"	13 <sup>1</sup> / <sub>2</sub> "	21"	<b>DS3PMSV6021PL</b>	1,218.	1,338.	1,397.
	65 <sup>7</sup> / <sub>8</sub> "	66"	13 <sup>1</sup> / <sub>2</sub> "	21"	<b>DS3PMSV6621PL</b>	1,249.	1,372.	1,436.
	71 <sup>7</sup> / <sub>8</sub> "	72"	13 <sup>1</sup> / <sub>2</sub> "	21"	<b>DS3PMSV7221PL</b>	1,283.	1,411.	1,473.

w\* = nominal width  
Dimensions listed under w h d are actual to the nearest 1/16"

Ordering Information	Order Code	Included With	Options
<b>Sliding Door Overheads:</b> 1. Pattern number 2. Paint finish case 3. Door finish (laminite and veneer door only) 4. Door edge finish (laminite door only)	<b>Sliding Door Overhead w/ Steel Door</b> Example: <b>DS3PMSS3021PL</b> /117/117 <b>DS3PMSS</b> Pattern Number <b>3021PL</b> <b>117</b> Dark grey paint finish case	<b>Sliding Door Overhead</b> <b>Note:</b> Sliding door overheads are only available in Knoll core finishes.	<b>Sliding Door Overhead</b> Lock/No lock For non-locking units substitute the "L" suffix with a "N" and deduct \$20.00 from the list price. <b>Paint Configuration Option:</b> Add "Y" at the end of the pattern number to specify a different paint finish on the case and sliding door. P3 pricing applies to all products with dual paint finishes.

# Sliding Door Overheads

## 14" High Wall-Mounted

### Dividends Horizon and Template Doors

Dividends Horizon

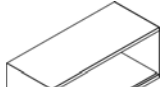
description	w *	w	d	h	pattern no.	P1	P2	P3
 Dividends Horizon Wall-Mounted Sliding Door Overhead without Door	35 <sup>7</sup> / <sub>8</sub> "	36"	14"	14"	<b>DS3WMN3614</b>	\$677.	\$746.	\$779.
	42 <sup>7</sup> / <sub>8</sub> "	42"	14"	14"	<b>DS3WMN4214</b>	716.	789.	823.
	47 <sup>7</sup> / <sub>8</sub> "	48"	14"	14"	<b>DS3WMN4814</b>	752.	825.	863.
	59 <sup>7</sup> / <sub>8</sub> "	60"	14"	14"	<b>DS3WMN6014</b>	1,027.	1,130.	1,182.
	71 <sup>7</sup> / <sub>8</sub> "	72"	14"	14"	<b>DS3WMN7214</b>	1,113.	1,226.	1,281.

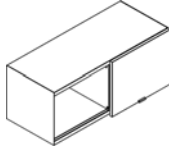
 Dividends Horizon Wall-Mounted Sliding Door Overhead w/ Steel Door	35 <sup>7</sup> / <sub>8</sub> "	36"	15"	14"	<b>DS3WMSS3614L</b>	851.	935.	979.
	42 <sup>7</sup> / <sub>8</sub> "	42"	15"	14"	<b>DS3WMSS4214L</b>	893.	984.	1,028.
	47 <sup>7</sup> / <sub>8</sub> "	48"	15"	14"	<b>DS3WMSS4814L</b>	930.	1,024.	1,069.
	59 <sup>7</sup> / <sub>8</sub> "	60"	15"	14"	<b>DS3WMSS6014L</b>	1,214.	1,335.	1,397.
	71 <sup>7</sup> / <sub>8</sub> "	72"	15"	14"	<b>DS3WMSS7214L</b>	1,306.	1,437.	1,502.

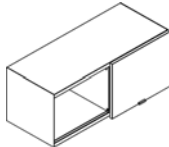
 Dividends Horizon Wall-Mounted Sliding Door Overhead w/ Laminate Door	35 <sup>7</sup> / <sub>8</sub> "	36"	15"	14"	<b>DS3WMSL3614L</b>	n/a	n/a	1,136.
	42 <sup>7</sup> / <sub>8</sub> "	42"	15"	14"	<b>DS3WMSL4214L</b>	n/a	n/a	1,178.
	47 <sup>7</sup> / <sub>8</sub> "	48"	15"	14"	<b>DS3WMSL4814L</b>	n/a	n/a	1,218.
	59 <sup>7</sup> / <sub>8</sub> "	60"	15"	14"	<b>DS3WMSL6014L</b>	n/a	n/a	1,513.
	71 <sup>7</sup> / <sub>8</sub> "	72"	15"	14"	<b>DS3WMSL7214L</b>	n/a	n/a	1,613.

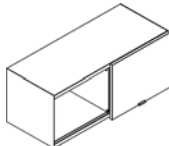
 Dividends Horizon Wall-Mounted Sliding Door Overhead w/ Veneer Door	35 <sup>7</sup> / <sub>8</sub> "	36"	15"	14"	<b>DS3WMSV3614L</b>	n/a	n/a	1,318.
	41 <sup>7</sup> / <sub>8</sub> "	42"	15"	14"	<b>DS3WMSV4214L</b>	n/a	n/a	1,365.
	47 <sup>7</sup> / <sub>8</sub> "	48"	15"	14"	<b>DS3WMSV4814L</b>	n/a	n/a	1,422.
	59 <sup>7</sup> / <sub>8</sub> "	60"	15"	14"	<b>DS3WMSV6014L</b>	n/a	n/a	1,721.
	71 <sup>7</sup> / <sub>8</sub> "	72"	15"	14"	<b>DS3WMSV7214L</b>	n/a	n/a	1,839.

#### Ordering Information

##### Sliding Door Overheads:

1. Pattern number
2. Paint finish case
3. Door finish (laminated and veneer door only)
4. Door edge finish (laminated door only)

#### Order Code

##### Sliding Door Overhead

*Example:* **DS3WMSS4214N**  
**/118/118**

**DS3WM** Pattern Number

**SS** Steel Door

**42** Width

**14** Height

**N** No lock

**118** Bright White Paint Finish

**118** Bright White Paint Finish

#### Included With

##### Sliding Door Overhead

Wall mount cleat  
Hardware

#### Options

##### Sliding Door Overhead

###### Lock Option:

For non-locking units substitute the "L" suffix with a "N" and deduct \$20.00 from the list price.

###### Paint Configuration Option:

Add "Y" at the end of the pattern number to specify a different paint finish on the case and sliding door. P3 pricing applies to all products with dual paint finishes.

**Note:** Sliding door overheads are only available in Knoll core finishes.

# Sliding Door Overheads

## 14" High Wall-Mounted

### Dividends Horizon and Template Doors

Dividends Horizon

description	w*	w	d	h	pattern no.	P1	P2	P3
Template Wall-Mounted	35 <sup>7</sup> / <sub>8</sub> "	36"	15"	14"	<b>DS3WMTS3614L</b>	\$836.	\$920.	\$963.
Sliding Door Overhead w/Steel Doors	42 <sup>7</sup> / <sub>8</sub> "	42"	15"	14"	<b>DS3WMTS4214L</b>	883.	971.	1,015.
	47 <sup>7</sup> / <sub>8</sub> "	48"	15"	14"	<b>DS3WMTS4814L</b>	920.	1,011.	1,058.
	59 <sup>7</sup> / <sub>8</sub> "	60"	15"	14"	<b>DS3WMTS6014L</b>	1,211.	1,331.	1,393.
	71 <sup>7</sup> / <sub>8</sub> "	72"	15"	14"	<b>DS3WMTS7214L</b>	1,310.	1,441.	1,507.

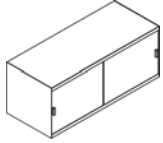

#### Ordering Information

##### Sliding Door Overheads:

1. Pattern number
2. Paint finish case
3. Door finish  
(laminated and veneer door only)
4. Door edge finish  
(laminated door only)

#### Order Code

##### Sliding Door Overhead

*Example:* **DS3WMSS4214N**  
**/118/118**

**DS3WM** Pattern Number

**SS** Steel Door

**42** Width

**14** Height

**N** No lock

**118** Bright White Paint  
Finish

**118** Bright White Paint  
Finish

#### Included With

##### Sliding Door Overhead

Wall mount cleat  
Hardware

#### Options

##### Sliding Door Overhead

###### Lock Option:

For non-locking units substitute the "L" suffix with a "N" and deduct \$20.00 from the list price.

###### Paint Configuration Option:

Add "Y" at the end of the pattern number to specify a different paint finish on the case and sliding door. P3 pricing applies to all products with dual paint finishes.

**Note:** Sliding door overheads are only available in Knoll core finishes.

# Sliding Door Overheads

## 14" High Shared Center-Mounted

### Dividends Horizon and Template Doors

Dividends Horizon

description	w*	w	d	h	pattern no.	P1	P2	P3
Dividends Horizon Shared Top-Mounted Sliding Door Overhead without Door	35 <sup>7</sup> / <sub>8</sub> "	36"	14"	14"	<b>DS3SMN3614</b>	\$908.	\$1,000.	\$1,045.
	42 <sup>7</sup> / <sub>8</sub> "	42"	14"	14"	<b>DS3SMN4214</b>	947.	1,043.	1,090.
	47 <sup>7</sup> / <sub>8</sub> "	48"	14"	14"	<b>DS3SMN4814</b>	976.	1,073.	1,122.
	59 <sup>7</sup> / <sub>8</sub> "	60"	14"	14"	<b>DS3SMN6014</b>	1,155.	1,271.	1,329.
	71 <sup>7</sup> / <sub>8</sub> "	72"	14"	14"	<b>DS3SMN7214</b>	1,206.	1,326.	1,387.

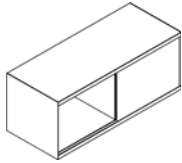

Template Shared Top-Mounted Sliding Door Overhead with Steel Doors	35 <sup>7</sup> / <sub>8</sub> "	36"	15"	14"	<b>DS3SMT3614L</b>	1,074.	1,183.	1,236.
	42 <sup>7</sup> / <sub>8</sub> "	42"	15"	14"	<b>DS3SMT4214L</b>	1,118.	1,230.	1,285.
	47 <sup>7</sup> / <sub>8</sub> "	47"	15"	14"	<b>DS3SMT4814L</b>	1,144.	1,260.	1,316.
	59 <sup>7</sup> / <sub>8</sub> "	60"	15"	14"	<b>DS3SMT6014L</b>	1,335.	1,470.	1,535.
	71 <sup>7</sup> / <sub>8</sub> "	72"	15"	14"	<b>DS3SMT7214L</b>	1,412.	1,553.	1,623.

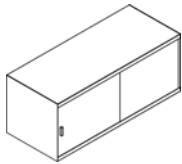

Dividends Horizon Shared Top-Mounted Sliding Door Overhead with Steel Door	35 <sup>7</sup> / <sub>8</sub> "	36"	15"	14"	<b>DS3SMSS3614L</b>	1,134.	1,247.	1,305.
	42 <sup>7</sup> / <sub>8</sub> "	42"	15"	14"	<b>DS3SMSS4214L</b>	1,179.	1,297.	1,354.
	47 <sup>7</sup> / <sub>8</sub> "	48"	15"	14"	<b>DS3SMSS4814L</b>	1,206.	1,326.	1,387.
	59 <sup>7</sup> / <sub>8</sub> "	60"	15"	14"	<b>DS3SMSS6014L</b>	1,394.	1,533.	1,603.
	71 <sup>7</sup> / <sub>8</sub> "	72"	15"	14"	<b>DS3SMSS7214L</b>	1,470.	1,616.	1,689.

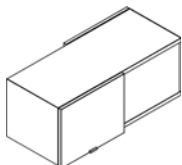

Dividends Horizon Shared Top-Mounted Sliding Door Overhead with Laminate Door	35 <sup>7</sup> / <sub>8</sub> "	36"	15"	14"	<b>DS3MSML3614L</b>	n/a	n/a	1,740.
	42 <sup>7</sup> / <sub>8</sub> "	42"	15"	14"	<b>DS3MSML4214L</b>	n/a	n/a	1,782.
	47 <sup>7</sup> / <sub>8</sub> "	48"	15"	14"	<b>DS3MSML4814L</b>	n/a	n/a	1,815.
	59 <sup>7</sup> / <sub>8</sub> "	60"	15"	14"	<b>DS3MSML6014L</b>	n/a	n/a	2,007.
	71 <sup>7</sup> / <sub>8</sub> "	72"	15"	14"	<b>DS3MSML7214L</b>	n/a	n/a	2,095.

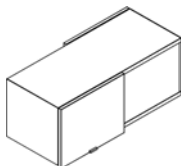

Ordering Information	Order Code	Included With	Options
<b>Sliding Door Overheads:</b>	<b>Sliding Door Overhead</b>	<b>Sliding Door Overhead</b>	<b>Sliding Door Overhead</b>
1. Pattern number	<i>Example:</i> <b>DS3SMSS4214N</b>	Hardware	<b>Lock Option:</b> For non-locking units substitute the "L" suffix with a "N" and deduct \$20.00 from the list price.
2. Case paint finish	<b>/118/118</b>		
3. Door finish (laminated and veneer door only)	<b>DS3SM</b> Pattern Number		<b>Paint Configuration Option:</b> Add "Y" at the end of the pattern number to specify a different paint finish on the case and sliding door. P3 pricing applies to all products with dual paint finishes.
4. Door edge finish (laminated door only)	<b>SS</b> Steel Door		
	<b>42</b> Width		
	<b>14</b> Height		
	<b>N</b> No lock		
	<b>118</b> Bright White Paint Finish		<b>Note:</b> Sliding door overheads are only available in Knoll core finishes.
	<b>118</b> Bright White Paint Finish		

**Note:** Center-mounted sliding door overheads mount on full view panels only and must mount on module with panel widths.

# Sliding Door Overheads

## 14" High Shared Center-Mounted

### Dividends Horizon and Template Doors

Dividends Horizon

description	w*	w	d	h	pattern no.	P1	P2	P3
Dividends Horizon Shared Top-Mounted Sliding Door Overhead with Veneer Door	35 <sup>7</sup> / <sub>8</sub> "	36"	15"	14"	<b>DS3SMSV3614L</b>	n/a	n/a	\$2,106.
	42 <sup>7</sup> / <sub>8</sub> "	42"	15"	14"	<b>DS3SMSV4214L</b>	n/a	n/a	2,158.
	47 <sup>7</sup> / <sub>8</sub> "	48"	15"	14"	<b>DS3SMSV4814L</b>	n/a	n/a	2,220.
	59 <sup>7</sup> / <sub>8</sub> "	60"	15"	14"	<b>DS3SMSV6014L</b>	n/a	n/a	2,424.
	71 <sup>7</sup> / <sub>8</sub> "	72"	15"	14"	<b>DS3SMSV7214L</b>	n/a	n/a	2,548.

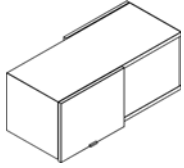

Ordering Information	Order Code	Included With	Options
<b>Sliding Door Overheads:</b>	<b>Sliding Door Overhead</b>	<b>Sliding Door Overhead</b>	<b>Sliding Door Overhead</b>
1. Pattern number	<i>Example:</i> <b>DS3SMSS4214N</b>	Hardware	<b>Lock Option:</b>
2. Case paint finish	<b>/118/118</b>		For non-locking units substitute the "L" suffix with a "N" and deduct \$20.00 from the list price.
3. Door finish (laminated and veneer door only)	<b>DS3SM</b> Pattern Number		<b>Paint Configuration Option:</b>
4. Door edge finish (laminated door only)	<b>SS</b> Steel Door		Add "Y" at the end of the pattern number to specify a different paint finish on the case and sliding door. P3 pricing applies to all products with dual paint finishes.
	<b>42</b> Width		
	<b>14</b> Height		
	<b>N</b> No lock		
	<b>118</b> Bright White Paint Finish		
	<b>118</b> Bright White Paint Finish		

**Note:** Sliding door overheads are only available in Knoll core finishes.

**Note:** Center-mounted sliding door overheads mount on full view panels only and must mount on module with panel widths.

# Sliding Door Overheads

## 14" High Individual Center-Mounted

### Dividends Horizon Doors / Template Doors

Dividends Horizon

description	w *	w	d	h	pattern no.	P1	P2	P3	LAM	V1
Dividends Horizon Individual Center-Mounted Overhead without Door	35 7/8"	36"	14"	14"	<b>DS3CMN3614</b>	\$727.	\$800.	\$836.		
	41 7/8"	42"	14"	14"	<b>DS3CMN4214</b>	759.	835.	873.		
	47 7/8"	48"	14"	14"	<b>DS3CMN4814</b>	778.	855.	894.		
	59 7/8"	60"	14"	14"	<b>DS3CMN6014</b>	1,084.	1,192.	1,245.		
	71 7/8"	72"	14"	14"	<b>DS3CMN7214</b>	1,140.	1,256.	1,311.		

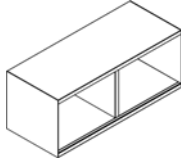

Template Individual Center-Mounted Sliding Door Overhead with Steel Doors	35 7/8"	36"	15"	14"	<b>DS3CMTS3614L</b>	870.	958.	1,001.		
	42 7/8"	42"	15"	14"	<b>DS3CMTS4214L</b>	907.	999.	1,044.		
	47 7/8"	48"	15"	14"	<b>DS3CMTS4814L</b>	930.	1,024.	1,069.		
	59 7/8"	60"	15"	14"	<b>DS3CMTS6014L</b>	1,265.	1,393.	1,454.		
	71 7/8"	72"	15"	14"	<b>DS3CMTS7214L</b>	1,337.	1,471.	1,537.		

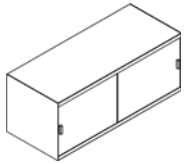

Dividends Horizon Individual Center-Mounted Sliding Door Overhead with Steel Doors	35 7/8"	36"	15"	14"	<b>DS3CMSS4214L</b>	1,960.	1,056.	1,104.		
	41 7/8"	42"	15"	14"	<b>DS3CMSS4814L</b>	987.	1,097.	1,147.		
	47 7/8"	48"	15"	14"	<b>DS3CMSS6014L</b>	1,024.	1,126.	1,178.		
	59 7/8"	60"	15"	14"	<b>DS3CMSS7214L</b>	1,226.	1,348.	1,410.		

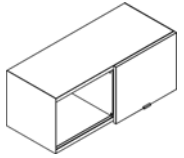

Ordering Information	Order Code	Included With	Options
<b>Sliding Door Overheads:</b>	<b>Sliding Door Overhead</b>	<b>Sliding Door Overhead</b>	<b>Sliding Door Overhead</b>
1. Pattern number	<i>Example:</i> <b>DS3CMTS4214N</b>	Hardware	<b>Lock Option:</b> For non-locking units substitute the "L" suffix with a "N" and deduct \$20.00 from the list price.
2. Case paint finish	<b>/118/118</b>		
3. Door finish	<b>DS3CM</b> Pattern Number		<b>Paint Configuration Option:</b> Add "Y" at the end of the pattern number to specify a different paint finish on the case and sliding door. P3 pricing applies to all products with dual paint finishes.
4. Door edge finish (laminated door only)	<b>T</b> Template Style Door		
	<b>S</b> Steel Door		
	<b>42</b> Width		
	<b>14</b> Height		
	<b>N</b> No lock		<b>Note:</b> Sliding door overheads are only available in Knoll core finishes.
	<b>118</b> Bright White Paint Finish		
	<b>118</b> Bright White Paint Finish		<b>Note:</b> Center-mounted sliding door overheads mount on full view panels only and must mount on module with panel widths.

Storage Components

Sliding Door Overheads  
*14" High Individual Center-Mounted  
 Dividends Horizon Doors / Template Doors*

Dividends Horizon

description	w *	w	d	h	pattern no.	P1	P2	P3	LAM	V1
Dividends Horizon Individual Center-Mounted Sliding Door Overhead with Laminate Doors	35 <sup>7</sup> / <sub>8</sub> "	36"	15"	14"	<b>DS3CM SL3614L</b>				\$1,249.	
	35 <sup>7</sup> / <sub>8</sub> "	36"	15"	14"	<b>DS3CM SS3614L</b>				1,249.	
	41 <sup>7</sup> / <sub>8</sub> "	42"	15"	14"	<b>DS3CM SL4214L</b>				1,286.	
	47 <sup>7</sup> / <sub>8</sub> "	48"	15"	14"	<b>DS3CM SL4814L</b>				1,316.	
	59 <sup>7</sup> / <sub>8</sub> "	60"	15"	14"	<b>DS3CM SL6014L</b>				1,528.	
	71 <sup>7</sup> / <sub>8</sub> "	72"	15"	14"	<b>DS3CM SL7214L</b>				1,603.	

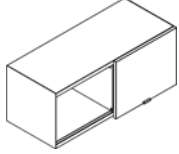



# Sliding Door Overheads

## 14" High Individual Center-Mounted

### Dividends Horizon Doors / Template Doors

Dividends Horizon

description	w *	w	d	h	pattern no.	P1	P2	P3	LAM	V1
Dividends Horizon Individual Center-Mounted Sliding Door Overhead with Veneer Doors	35 <sup>7</sup> / <sub>8</sub> "	36"	15"	14"	<b>DS3CMSV3614L</b>					\$1,431.
	41 <sup>7</sup> / <sub>8</sub> "	42"	15"	14"	<b>DS3CMSV4214L</b>					1,474.
	47 <sup>7</sup> / <sub>8</sub> "	48"	15"	14"	<b>DS3CMSV4814L</b>					1,519.
	59 <sup>7</sup> / <sub>8</sub> "	60"	15"	14"	<b>DS3CMSV6014L</b>					1,734.
	71 <sup>7</sup> / <sub>8</sub> "	72"	15"	14"	<b>DS3CMSV7214L</b>					1,829.

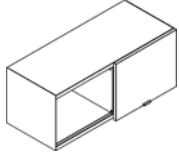

Ordering Information	Order Code	Included With	Options
<b>Sliding Door Overheads:</b>	<b>Sliding Door Overhead</b>	<b>Sliding Door Overhead</b>	<b>Sliding Door Overhead</b>
1. Pattern number	<i>Example:</i> <b>DS3CMTS4214N</b>	Hardware	<b>Lock Option:</b>
2. Case paint finish	<b>/118/118</b>		For non-locking units substitute the "L" suffix with a "N" and deduct \$20.00 from the list price.
3. Door finish	<b>DS3CM</b> Pattern Number		<b>Paint Configuration Option:</b>
4. Door edge finish (laminated door only)	<b>T</b> Template Style Door		Add "Y" at the end of the pattern number to specify a different paint finish on the case and sliding door. P3 pricing applies to all products with dual paint finishes.
	<b>S</b> Steel Door		<b>Note:</b> Sliding door overheads are only available in Knoll core finishes.
	<b>42</b> Width		
	<b>14</b> Height		
	<b>N</b> No lock		
	<b>118</b> Bright White Paint Finish		
	<b>118</b> Bright White Paint Finish		

Storage Components

### Panel Up Mounted Overhead Cabinets

Up mounted cabinets mount to 50" or 57" high panels only to provide overhead storage within workstations and are an alternative to overheads panel-mounted on 64" high panels. Up mounted cabinets have full finished backs and require up mount brackets for mounting.

When installed on 50" high panels, up mounted cabinets match up to the overall 64" height of panel-mounted overhead cabinets and freestanding overdesks to provide a consistent height within the facility.

Overhead cabinets consist of a top, shelf, end panels, enclosed back, overhead door with or without lock and required assembly screws. 30" to 48" wide cabinets have single doors while cabinets 54", 60", 66" and 72" wide have double doors. 54" wide overhead cabinets will ship with one 24" and one 30" door. 66" wide overhead cabinets will ship with one 30" and one 36" door. 54" and 66" overhead doors may be removed and reversed.

Up mounted cabinets are shipped knocked-down.

Up mounted overheads must match the width of single or multiple panels and cannot be mounted off module.

### Series 1 Flip-up Overhead Cabinets

Series 1 flip-up overhead cabinets match the aesthetics of the original Dividends Horizon system. The radiused fronts and molded plastic end trim match the radiused profile trim used on panel topcaps and end trim. Series 1 cabinets are offered with steel doors.

### Series 2 Flip-up Overhead Cabinets

Series 2 overhead cabinets offer an alternative aesthetic to the Dividends Horizon Series 1 overhead. Unlike the radiused door profile of the Series 1 overhead door, the Series 2 door profile is rectilinear with soft radiused corners (see door profile drawing below). The Series 2 overhead offers a painted steel or veneer overhead door front.

#### Available Sizes

- Height: 15"
- Depth: 13<sup>1</sup>/<sub>2</sub>"
- Widths: 30", 36", 42", 48", 54", 60", 66" and 72"

#### Construction:

- Horizontal top and shelf: 18-gauge (30" to 48" wide), 16-gauge (60" to 72" wide) painted roll-formed steel
- Overhead door: 20-gauge painted
- Overhead door suspension: Steel ball-bearing
- Overhead door end trim: Color injected, molded plastic (Series 1 only)
- End panels: 16-gauge painted steel with integral mounting hooks
- Up mount brackets: 14-gauge steel

#### Interior Dimensions

Up mounted cabinet interiors measure:

- Depth 12"
- Usable interior height: 12<sup>5</sup>/<sub>8</sub>"
- Width: 1/8" shorter than the exterior width.

#### Cabinet Door Clearance

Cabinet doors open over the tops of cabinets. Required clearance is: 16<sup>1</sup>/<sub>4</sub>" total height (height of cabinet plus top clearance required).

### Panel Up Mounted Overhead for Stack Frames

Dividends Horizon non-load bearing stacking frames do not allow for panel-mount hanging components. To provide overhead storage, a panel up mounted overhead cabinet with enclosed back can be utilized.

#### Up mount brackets

Cabinet up mount brackets are required for up mounted applications.

Up mount brackets are ordered separately in pairs. Up mount brackets can be used on both Dividends Horizon Series 1 and Series 2 up mounted cabinets.

#### Touchdown Overhead Cabinets

Touchdown overhead cabinets are equipped with hydraulic assist cylinders that allows the overhead cabinet front to gently fall to a closed position.

Retrofit mechanisms may be field added to any flip-up overhead cabinet with a steel door.

**Note:** Touchdown mechanisms are not available with laminate or veneer doors.

#### Locks

Locks are standard on overhead cabinets and keyed randomly unless otherwise specified. Other keying options include keyed alike or keyed with lock cores K001-K250. All locks are factory-installed and are black finish. Cabinets can also be specified without locks if required.

When locks are not specified a plug is located in the lock position.

Optional lock retrofit kits are available for field-installation at a later date if required.

#### Task Lights

All Dividends up mounted cabinets will accept task lights. Task lights must be ordered separately.

### Panel Up Mounted Cabinet

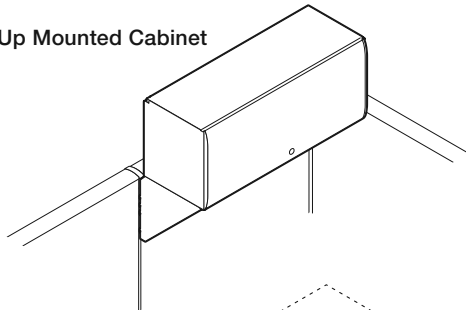

### Up Mount Brackets

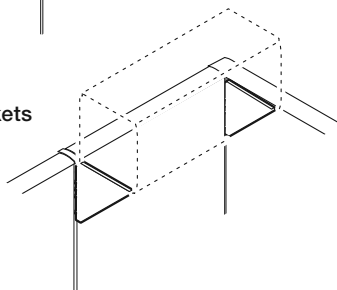

### Interior Dimensions

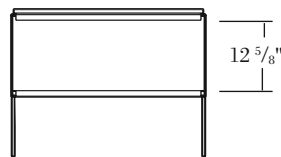

Front View, Interior Height

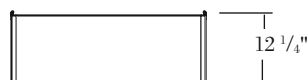

Top View, Interior Depth



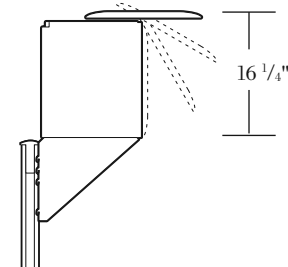

### Cabinet Door Clearance



# Up Mounted Overheads

## Dividends and Series 2

Dividends Horizon

description	w*	w	d	h	pattern no.	P1	P2	P3	V1-P1	V1-P2	V1-P3
Dividends Overhead Cabinet with Enclosed Back and Lock 	30"	29 <sup>7</sup> / <sub>8</sub> "	14 <sup>1</sup> / <sub>8</sub> "	15"	<b>DS1E30L</b>	\$489.	\$541.	\$563.	n/a	n/a	n/a
	36"	35 <sup>7</sup> / <sub>8</sub> "	14 <sup>1</sup> / <sub>8</sub> "	15"	<b>DS1E36L</b>	508.	560.	584.	n/a	n/a	n/a
	42"	41 <sup>7</sup> / <sub>8</sub> "	14 <sup>1</sup> / <sub>8</sub> "	15"	<b>DS1E42L</b>	549.	604.	631.	n/a	n/a	n/a
	48"	47 <sup>7</sup> / <sub>8</sub> "	14 <sup>1</sup> / <sub>8</sub> "	15"	<b>DS1E48L</b>	574.	631.	659.	n/a	n/a	n/a
	54"	53 <sup>7</sup> / <sub>8</sub> "	14 <sup>1</sup> / <sub>8</sub> "	15"	<b>DS1E54L</b>	751.	823.	861.	n/a	n/a	n/a
	60"	59 <sup>7</sup> / <sub>8</sub> "	14 <sup>1</sup> / <sub>8</sub> "	15"	<b>DS1E60L</b>	751.	823.	861.	n/a	n/a	n/a
	66"	65 <sup>7</sup> / <sub>8</sub> "	14 <sup>1</sup> / <sub>8</sub> "	15"	<b>DS1E66L</b>	774.	852.	891.	n/a	n/a	n/a
	72"	71 <sup>7</sup> / <sub>8</sub> "	14 <sup>1</sup> / <sub>8</sub> "	15"	<b>DS1E72L</b>	774.	852.	891.	n/a	n/a	n/a
Series 2 Overhead Cabinet With Enclosed Back and Lock 	30"	29 <sup>7</sup> / <sub>8</sub> "	14 <sup>1</sup> / <sub>8</sub> "	15"	<b>DS2UM30L</b>	650.	749.	780.	879.	976.	1,010.
	36"	35 <sup>7</sup> / <sub>8</sub> "	14 <sup>1</sup> / <sub>8</sub> "	15"	<b>DS2UM36L</b>	671.	773.	806.	905.	1,008.	1,043.
	42"	41 <sup>7</sup> / <sub>8</sub> "	14 <sup>1</sup> / <sub>8</sub> "	15"	<b>DS2UM42L</b>	693.	796.	832.	940.	1,046.	1,078.
	48"	47 <sup>7</sup> / <sub>8</sub> "	14 <sup>1</sup> / <sub>8</sub> "	15"	<b>DS2UM48L</b>	706.	812.	846.	991.	1,098.	1,132.
	54"	53 <sup>7</sup> / <sub>8</sub> "	14 <sup>1</sup> / <sub>8</sub> "	15"	<b>DS2UM54L</b>	949.	1,091.	1,137.	1,386.	1,530.	1,574.
	60"	59 <sup>7</sup> / <sub>8</sub> "	14 <sup>1</sup> / <sub>8</sub> "	15"	<b>DS2UM60L</b>	949.	1,091.	1,137.	1,386.	1,530.	1,574.
	66"	65 <sup>7</sup> / <sub>8</sub> "	14 <sup>1</sup> / <sub>8</sub> "	15"	<b>DS2UM66L</b>	991.	1,139.	1,190.	1,447.	1,599.	1,646.
	72"	71 <sup>7</sup> / <sub>8</sub> "	14 <sup>1</sup> / <sub>8</sub> "	15"	<b>DS2UM72L</b>	991.	1,139.	1,190.	1,447.	1,599.	1,646.
Overhead Upmount Brackets (Pair)		<sup>7</sup> / <sub>8</sub> "	12 <sup>3</sup> / <sub>16</sub> "	11 <sup>3</sup> / <sub>4</sub> "	<b>DB1U18</b>	71.	77.	82.	n/a	n/a	n/a
											
	Reuter Upmount Brackets (Pair)		<sup>7</sup> / <sub>8</sub> "	12 <sup>3</sup> / <sub>16</sub> "	11 <sup>3</sup> / <sub>4</sub> "	<b>DB1RU18</b>	96.	103.	110.	n/a	n/a
											

w\* = nominal width

Dimensions listed under w h d are actual to the nearest <sup>1</sup>/<sub>16</sub>"

Ordering Information	Order Code	Included with:	Options
<b>Upmount Overhead Cabinet</b> 1. Pattern Number 2. Paint Finish 3. Door End Cap Finish	<b>Upmount Overhead Cabinet</b> <i>Example:</i> <b>DS1E 30L, 113, 113</b> <b>DS1E 30L</b> Pattern Number <b>113</b> Dark grey paint finish <b>113</b> Dark grey end cap finish	<b>Upmount Overhead Cabinet</b> <b>Series 2 Overhead Cabinet</b> Up Mount overheads include an enclosed back. Up Mount brackets are required and must be ordered separately.	<b>Upmount Overhead Cabinet</b> To specify overhead cabinet without locks, replace the "L" suffix from the pattern number with "N" <b>Deduct \$20</b> for 54", 60", 66" and 72" overhead cabinets <b>Deduct \$40</b> To specify Touchdown overhead cabinet, add "E" as the 2nd to last digit of the pattern number <i>Example:</i> <b>DS3PML48EL</b> <b>(Add \$157 for cabinet widths of 48" or less. Add \$314 for cabinet widths of 54" or greater).</b>
<b>Series 2 Overhead Cabinet</b> 1. Pattern Number 2. Paint Finish	<b>Series 2 Overhead Cabinet</b> <i>Example:</i> <b>DS2UM 30L, 115</b> <b>DS2UM 30L</b> Pattern Number <b>115</b> Medium grey paint finish		<b>Series 2 Up Mount Overhead Finish Option:</b> Add a "Y" to the end of the pattern number to specify a front color that is different than the case color. Use P3 pricing for this dual finish option.

Storage Components

## Overhead Book Shelves

Dividends Horizon bookshelves mount to the integral vertical channels on Dividends Horizon panels or to wall mount tracks to provide overhead storage within workstations or private offices.

Bookshelves include a shelf, end panels, open back and required assembly screws.

Shelves must match the width of single or multiple panels and cannot be mounted off-module.

All book shelves are shipped knocked-down.

### Available Sizes

- Height: shelf 8"
- Depth: 14<sup>1</sup>/<sub>8</sub>"
- Widths: 24", 30", 36", 42", 48", 54", 60", 66" and 72"

### Construction:

- Horizontal shelf: 18-gauge (24" to 48" wide), 16-gauge (60" to 72" wide) painted roll-formed steel
- End panels: 16-gauge painted steel with integral mounting hooks

### Corner Shelf

Dividends Horizon corner shelves mount to the integral vertical channels of Dividends Horizon panels to provide overhead storage in corner applications. Panels supporting the corner shelf must be of the same width. Corner shelf consists of shelf, end panels and rear corner support bracket.

**Note:** Corner shelves do not accept task lights.

**Note:** Corner shelves may not be mounted on load bearing stack frames.

### Available Sizes

- Height: 8"
- Depth: 12"
- Widths: 36", 42", and 48"

### Construction:

- Shelf: <sup>7</sup>/<sub>8</sub>" wood core construction with laminate on both sides and t-mold edge
- End panels: 16-gauge painted steel with integral mounting hooks

### Task Lights

All Dividends Horizon shelves will accept task lights. Task lights must be ordered separately.

Bookshelf

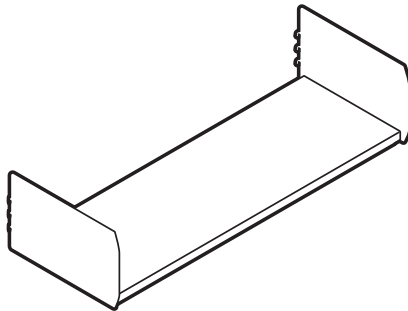

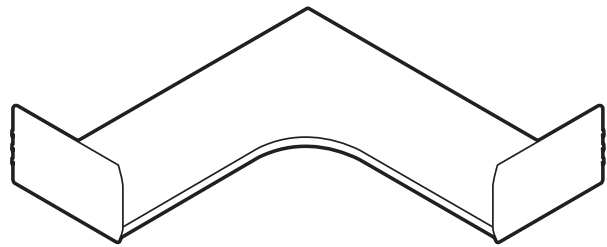

Corner Shelf

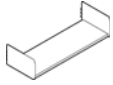

# Overhead Bookshelf and Corner Shelf

## 7 1/4" High

description	w *	w	d	h	pattern no.	P1	P2	P3
 Overhead Bookshelf	24"	23 7/8"	14 1/8"	7 1/4"	<b>DS1S 24</b>	\$149.	\$165.	\$172.
	30"	29 7/8"	14 1/8"	7 1/4"	<b>DS1S 30</b>	149.	165.	172.
	36"	35 7/8"	14 1/8"	7 1/4"	<b>DS1S 36</b>	157.	165.	173.
	42"	41 7/8"	14 1/8"	7 1/4"	<b>DS1S 42</b>	164.	173.	180.
	48"	47 7/8"	14 1/8"	7 1/4"	<b>DS1S 48</b>	171.	179.	187.
	54"	53 7/8"	14 1/8"	7 1/4"	<b>DS1S 54</b>	183.	195.	204.
	60"	59 7/8"	14 1/8"	7 1/4"	<b>DS1S 60</b>	183.	195.	204.
	66"	65 7/8"	14 1/8"	7 1/4"	<b>DS1S 66</b>	200.	210.	221.
	72"	71 7/8"	14 1/8"	7 1/4"	<b>DS1S 72</b>	200.	210.	221.
 Overhead Corner Shelf	36"	35 7/8"	12"	7 1/4"	<b>DS1CS 36</b>	386.	409.	424.
	42"	41 7/8"	12"	7 1/4"	<b>DS1CS 42</b>	420.	443.	465.
	48"	47 7/8"	12"	7 1/4"	<b>DS1CS 48</b>	457.	483.	506.

w\* = nominal width  
 Dimensions listed under w h d are actual to the nearest 1/16"

### Ordering Information

#### Overhead Bookshelf

1. Pattern Number
2. Paint Finish

#### Overhead Corner Shelf

1. Pattern Number
2. Laminate Finish
3. Edge Band Finish
4. Paint Finish

### Order Code

#### Overhead Bookshelf

*Example:* **DS1S 60, 113**

**DS1S 60** Pattern Number

**113** Dark Grey Finish

#### Overhead Corner Shelf

*Example:* **DS1CS36, M42, 117, 117**

**DS1CS36** Pattern Number

**M42** Soft Grey Laminate

**117** Soft Grey Edge Band

**117** Soft Grey Paint

### Included with:

#### Overhead Bookshelf

#### Overhead Corner Shelf

- Rear Corner Support Bracket

**Note:** An upcharge applies when specifying a Legacy laminate. See Legacy finish page for more information.

# Mounting Brackets and Accessories

## *Backstop, Wall-Mount and Panel Mount Specifications*

### Optional Overhead Back Stop

Panel-mounted overhead cabinet and bookshelf backs are open and use the panel face as the back. When required, an optional field-installed back stop is available. Attachment can be made to an assembled unit. Construction is dark grey extruded plastic.

Specify the overhead back stop width to match the width of the shelf or overhead cabinet.

### Overhead Cabinet Wall-Mount Brackets

Wall-mount brackets allow Dividends Horizon panel-mounted overheads to be wall-mounted to dry-wall construction. Wall-mounting brackets are available in sizes 30", 36", 42" and 48".

Specify the width of wall-mount bracket to match the width of the panel-mounted overhead cabinet. If cabinet width is 60" or 72" wide, specify two 30" or two 36" wall-mount brackets respectively.

If a 60" cabinet is desired, two (2) 30" wide wall-mount brackets may be installed side-by-side to support the overhead cabinet. When a 72" cabinet is used, two (2) 36" wall-mount brackets may be used.

### Shelf Wall-Mount Brackets

Wall-mount brackets allow Dividends Horizon panel-mounted shelves to be wall-mounted to dry-wall construction. Wallmounting brackets are painted black, and are available in sizes 30", 42" and 48".

Specify the width of wall-mount bracket to match the width of the panel-mounted overhead shelf. Specify paint finish to match the shelf paint finish.

A metal shelf back will ship with the wall-mount bracket, which is painted to match the shelf color. Overhead shelves larger than 48" wide cannot be wall mounted using the Dividends Horizon wall-mount bracket.

**NOTE: WALL-MOUNT BRACKETS MUST ONLY BE USED WITH STRUCTURAL WALLS. TO ENSURE PROPER INSTALLATION, PLEASE FOLLOW THE INSTALLATION INSTRUCTIONS ENCLOSED WITH THE BRACKETS.**

### Up mount brackets

Cabinet up mount brackets are required for up mounted applications.

Up mount brackets are ordered separately in pairs. Up mount brackets can be used on both Dividends Horizon Series 1 and Series 2 up mounted cabinets.

### Currents Downmount Bracket

This downmount bracket allows for Dividends Horizon or Series 2 panel mounted overhead cabinets to be mounted into Currents spine wall. This downmount bracket can only be used with Currents 64"H spine wall only.

Specify to match the overhead cabinet width. Specify paint finish to match the overhead cabinet finish.

### Reuter Panel-Mount Brackets

Reuter panel-mount brackets are available to allow Reuter overheads and shelves to be panel-mounted on Dividends Horizon 57" or 64" high panels. Reuter overhead panel-mount brackets allow overhead sizes up to 72" to be panel-mounted. Reuter shelf panel-mount brackets allow shelves up to 48" to be panel-mounted. Finish black.

### Vertical Dividers

Optional vertical dividers attach to the shelves within overhead cabinets and bookshelves to provide inner cabinet organization. Construction is 18-gauge steel with dark grey finish.

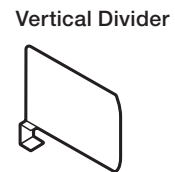
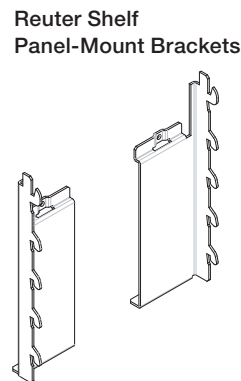
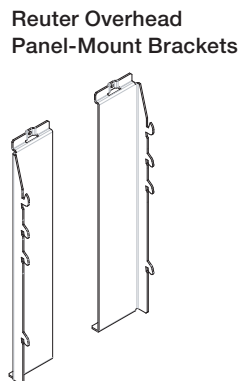
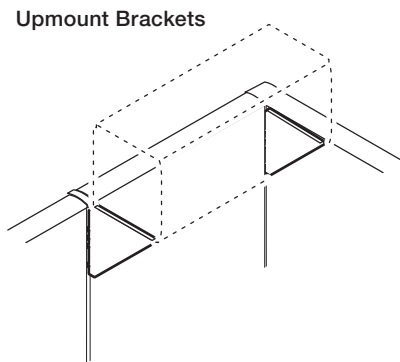
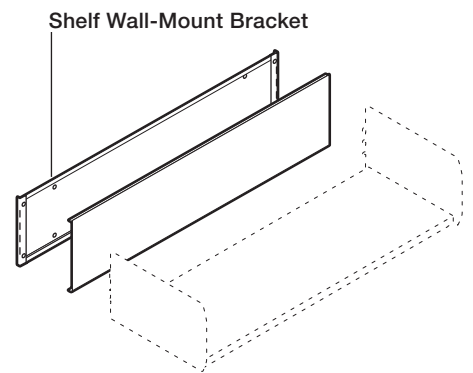
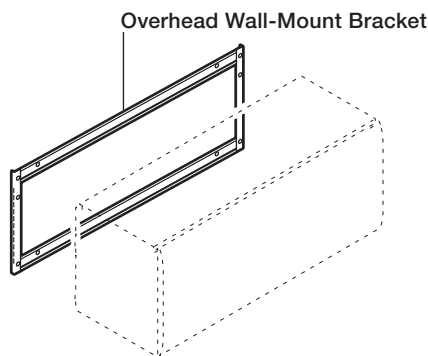
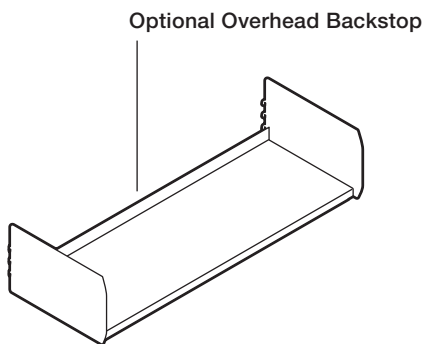

### Overhead Cabinet Lock Retrofit Kit

The overhead cabinet lock retrofit kit allows non-locking Series 1 and Series 2 flip-up overhead cabinets to be converted to locking overhead cabinets.



# Mounting Brackets and Accessories

## Overhead Backstop, Wall-mount Brackets and Currents Downmount Brackets

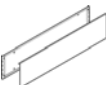
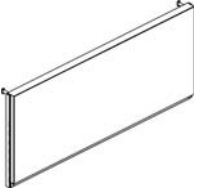
description	w*	w	d	h	pattern no.	black	P1	P2	P3
 Overhead Back Stop (Dark Grey Only)	24"	23 <sup>11/16</sup> "	5/8"	1 <sup>7/16</sup> "	<b>DS1BS 24</b>		\$4.	n/a	n/a
	30"	29 <sup>11/16</sup> "	5/8"	1 <sup>7/16</sup> "	<b>DS1BS 30</b>		4.	n/a	n/a
	36"	35 <sup>11/16</sup> "	5/8"	1 <sup>7/16</sup> "	<b>DS1BS 36</b>		4.	n/a	n/a
	42"	41 <sup>11/16</sup> "	5/8"	1 <sup>7/16</sup> "	<b>DS1BS 42</b>		7.	n/a	n/a
	48"	47 <sup>11/16</sup> "	5/8"	1 <sup>7/16</sup> "	<b>DS1BS 48</b>		7.	n/a	n/a
	54"	53 <sup>11/16</sup> "	5/8"	1 <sup>7/16</sup> "	<b>DS1BS 54</b>		10.	n/a	n/a
	60"	59 <sup>11/16</sup> "	5/8"	1 <sup>7/16</sup> "	<b>DS1BS 60</b>		10.	n/a	n/a
	66"	65 <sup>11/16</sup> "	5/8"	1 <sup>7/16</sup> "	<b>DS1BS 66</b>		10.	n/a	n/a
72"	71 <sup>11/16</sup> "	5/8"	1 <sup>7/16</sup> "	<b>DS1BS 72</b>		10.	n/a	n/a	
 14" H Overhead Wall-Mount Bracket	24"	24"	1/2"	1 4 1/4"	<b>DS1WM 24</b>	72.	75.	79.	82.
	30"	30"	1/2"	1 4 1/4"	<b>DS1WM 30</b>	72.	75.	79.	82.
	36"	36"	1/2"	1 4 1/4"	<b>DS1WM 36</b>	76.	80.	83.	88.
	42"	42"	1/2"	1 4 1/4"	<b>DS1WM 42</b>	84.	89.	93.	97.
	48"	48"	1/2"	1 4 1/4"	<b>DS1WM 48</b>	91.	96.	100.	104.
 Overhead Shelf-Mount Bracket	30"	30"	1/2"	7"	<b>DS1SWM 30</b>		72.	78.	84.
	36"	36"	1/2"	7"	<b>DS1SWM 36</b>		76.	85.	89.
	42"	42"	1/2"	7"	<b>DS1SWM 42</b>		84.	93.	96.
	48"	48"	1/2"	7"	<b>DS1SWM 48</b>		91.	99.	102.
 Dividends Series 2 Downmount Brackets (For Currents spine use)	24"				<b>DSCSWDB24</b>		238.	n/a	n/a
	30"				<b>DSCSWDB30</b>		245.	n/a	n/a
	36"				<b>DSCSWDB36</b>		251.	n/a	n/a
	42"				<b>DSCSWDB42</b>		259.	n/a	n/a
	48"				<b>DSCSWDB48</b>		264.	n/a	n/a







w\* = nominal width  
 Dimensions listed under w h d are actual to the nearest 1/16"

Ordering Information	Order Code	Included with:	Options
<b>Overhead Wall-Mount Bracket</b>	<b>Overhead Wall-Mount Bracket</b>	<b>Overhead Wall-Mount Bracket</b>	<b>Overhead Wall-Mount Bracket</b>
1. Pattern Number	<i>Example:</i> <b>DS1WM 30</b>	<b>Overhead Back Stop</b>	<b>Overhead Back Stop</b>
<b>Overhead Back Stop</b>	<b>DS1WM</b> Pattern Number		
1. Pattern Number	<b>30</b>		
	<b>Overhead Back Stop</b>		
	<i>Example:</i> <b>DB1BS 30</b>		
	<b>DB1BS 30</b> Pattern Number		

# Mounting Brackets and Accessories

## *Upmount Brackets, Vertical Dividers and Lock Retrofit Kit*

Dividends Horizon

description	pattern no.	black	P1	P2	P3
Vertical Dividers Package of 4 	<b>DS1 VD</b>	\$93.	\$97.	\$102.	\$108.
Overhead Cabinet Lock Retrofit Kit 	<b>DS1 OHL</b>	56.	n/a	n/a	n/a
Overhead Upmount Brackets (Pair) 	<b>DB1U18</b>	n/a	71.	77.	82.
Reuter Upmount Brackets (Pair) 	<b>DB1RU18</b>	n/a	96.	103.	110.
Reuter Overhead Panel Bracket (pair) 	<b>RO1 DPB</b>	55.	n/a	n/a	n/a
Reuter Shelf Panel-Mount Bracket (pair) 	<b>RS1 DPB</b>	55.	n/a	n/a	n/a

### Ordering Information

#### Vertical Dividers

1. Pattern Number

#### Reuter Overhead Panel-Mount Bracket

1. Pattern Number

### Order Code

#### Vertical Dividers

*Example:* **DS1 VD**

#### Reuter Overhead Panel-Mount Bracket

*Example:* **RO1 DPB**

### Included with:

**Vertical Dividers**  
(4) Vertical dividers

**Reuter Overhead Panel-Mount Bracket**  
Brackets (pair)

### Options

#### Vertical Dividers

#### Reuter Overhead Panel-Mount Bracket

Overhead cabinet lock retrofit kit is for Dividends Series 1 and Series 2 Flip-up Overhead only.



**This page intentionally left blank**

## Task Lights

Dividends Horizon offers T5 and LED task lights. T5 task lights are available in standard and advanced models. Task lights must be ordered separately from shelves, overhead cabinets, and overdesk units.

Task lights are TCLP compliant and meet requirements of California Title 20 and Title 24. T5 advanced task lights are fitted with ballasts and lamps compliant with LEED requirements. All task lights are approved for New York City installations.

### T5 Task Lights

T5 task lights include T5 cool white (4100K) fluorescent lamp, electronic ballast, 9 foot grounded cordset, prismatic lens, rocker switch, one cord exit management clip and mounting hardware. T5 task light housings are painted black.

The T5 task light cordset is a center exit. On smaller units the cord exit is off-center, but still not handed, allowing the cordset to be positioned either to the right or left of the task light for easy access to the closest available duplex.

All T5 task lights include mounting hardware for attachment to overhead cabinets, shelves, up mounted cabinets and freestanding overdesks. Specify task lights one size or less than the overall cabinet or overdesk width. T5 task lights have adjustable mounting brackets that lock into integral channels in the underside of the cabinet's lower shelf. The spring steel adjustable mounting brackets flex to install without requiring tools and allow the light to be positioned at any position side-to-side and front-to-back.

City of Chicago T5 task lights have a 9 foot power cord with a resettable circuit breaker built into the plug.

### LED Task Lights

LED task lights include LED's, a power supply with 12' cord and mounting hardware. Housings are clear anodized aluminum with grey color end-caps. Cord management clips must be ordered separately. The power supply cord attaches to either end of the fixture, allowing for easier access to the closest available duplex.

LED task lights mount into the recess in the underside of overhead cabinets and shelves at least 5" wider than the task light width..

### Cord Management Clips

Cord management clips attach to the integral slotted channels on panel frames to manage task light cordsets. Clips are 3/8" high black molded plastic construction.

## Task Light Specifications

Model Number	Fixture Length	Lamp Length	Lamp Part Number	Lamp Watts	Input Watts
<b>T5 Standard Task Lights</b>					
DL3T5E19S	19"	12"	FULHAM F8T5/CW	8	8
DL3T5E25S	25"	21.6"	FULHAM F14T5/41K	14	15
DL3T5E37S	37"	33.4"	FULHAM F21T5/41K	21	24
DL3T5E49S	49"	45.2"	FULHAM F28T5/41K	28	31
<b>T5 Advanced Task Lights</b>					
DL3T5E25A	25"	22.2"	PHILIPS F14T5/841/ALTO	14	18
DL3T5E37A	37"	33.98"	PHILIPS F21T5/841/ALTO	21	24
DL3T5E49A	49"	45.8"	PHILIPS F28T5/841/ALTO	28	31
<b>LED Task Lights</b>					
DL3L193M	19"	18.34"	N/A	4.9	5.58
DL3L196M	19"	18.34"	N/A	9.8	10.95
DL3L199M	19"	18.34"	N/A	14.7	16.3
DL3L376M	37"	36.46"	N/A	9.8	11.1
DL3L3712M	37"	36.46"	N/A	19.6	21.9
DL3L3718M	37"	36.46"	N/A	29.4	32.6

T5 Task Light

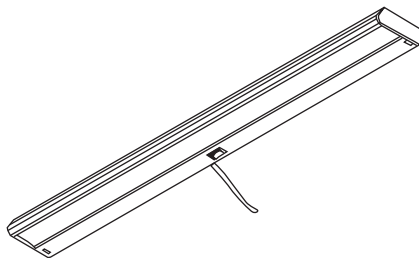

LED Task Light

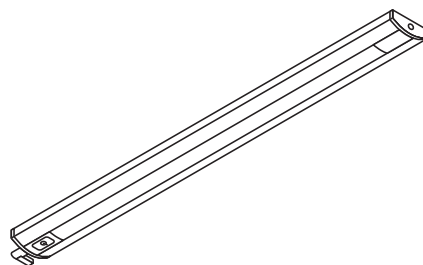



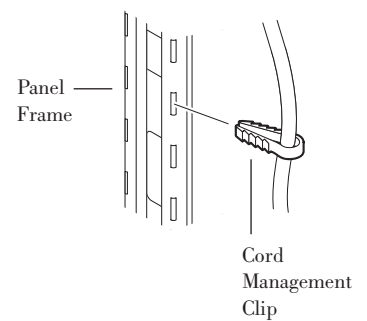

Cord Management Clip Attachment



# Task Lights

## Cord Management Clip

description	type	w	d	h	pattern no.	list
 T5 Standard Task Light	Use with 24" and wider overhead	19"	4"	1 1/2"	<b>DL3T5E19S</b>	\$180.
	Use with 30" and wider overhead	25"	4"	1 1/2"	<b>DL3T5E25S</b>	195.
	Use with 42" and wider overhead	37"	4"	1 1/2"	<b>DL3T5E37S</b>	199.
	Use with 60" and wider overhead	49"	4"	1 1/2"	<b>DL3T5E49S</b>	226.
 T5 Advanced Task Light	Use with 30" and wider overhead	25"	4"	1 1/2"	<b>DL3T5E25A</b>	456.
	Use with 42" and wider overhead	37"	4"	1 1/2"	<b>DL3T5E37A</b>	480.
	Use with 60" and wider overhead	49"	4"	1 1/2"	<b>DL3T5E49A</b>	499.
 LED Task Light	Use with 24" and wider overheads (3 LED's)	19"	2"	5/8"	<b>DL3L193M</b>	301.
	Use with 24" and wider overheads (6 LED's)	19"	2"	5/8"	<b>DL3L196M</b>	380.
	Use with 24" and wider overheads (9 LED's)	19"	2"	5/8"	<b>DL3L199M</b>	517.
	Use with 42" and wider overheads (6 LED's)	37"	2"	5/8"	<b>DL3L376M</b>	607.
	Use with 42" and wider overheads (12 LED's)	37"	2"	5/8"	<b>DL3L3712M</b>	686.
	Use with 42" and wider overheads (18 LED's)	37"	2"	5/8"	<b>DL3L3718M</b>	850.
 LED Task Light (for use with corner shelf only)	Use with 24" and wider overheads (3 LED's)	19"	2"	5/8"	<b>DL3L193W</b>	301.
	Use with 24" and wider overheads (6 LED's)	19"	2"	5/8"	<b>DL3L196W</b>	380.
	Use with 24" and wider overheads (9 LED's)	19"	2"	5/8"	<b>DL3L199W</b>	517.
	Use with 42" and wider overheads (6 LED's)	37"	2"	5/8"	<b>DL3L376W</b>	607.
	Use with 42" and wider overheads (12 LED's)	37"	2"	5/8"	<b>DL3L3712W</b>	686.
	Use with 42" and wider overheads (18 LED's)	37"	2"	5/8"	<b>DL3L3718W</b>	850.
 Cord management clip	(package of 50)				<b>DL3TC</b>	45.

### Ordering Information

#### Task Lights

1. Pattern Number

#### Cord Management Clip

1. Pattern Number

### Order Code

#### T5 Standard Task Light

Example: **DL3T5E25S**

DL3 Task Light

T5 T5 lamp

E Electronic ballast

25 Width

S Standard

#### LED Task Light

Example: **DL3L193M**

DL3 Task Light

L LED

19 Width

3 # of LED's

M Metal Overhead

Attachment

### Included with:

#### T5 Task Lights:

120v and includes T5 cool white (4100K) fluorescent lamp, electronic ballast, 9' grounded cordset, prismatic lens, rocker switch, one cord exit management clip and mounting hardware. Housings are black.

#### LED Task Lights:

Includes LED's, power supply with 12' cord and mounting hardware. Housings are clear anodized aluminum with grey color end-caps.

#### Cord Management Clips:

Additional clips must be ordered separately.

### Options

#### T5 Task Lights:

Specify suffix -CH and add \$45 list for City of Chicago installations. Example: DL3T5E25S-CH

Cordset is center exit. On smaller units cord exit is off-center, but still not handed.

T5 advanced task lights are fitted with ballasts and lamps compliant with LEED requirements, meeting the LEED EB standard for mercury content.

#### LED Task Lights:

Power cord is able to attach to either end of fixture.

#### Notes:

All task lights mount into the recess in the underside of overhead cabinets and shelves at least 6" wider than task light width.

All task lights are TCLP compliant and meet requirements of California Title 20 and Title 24.

# Pedestals

## *Dividends Floorstanding, Doublewide and Mobile Specifications*

### Floorstanding Pedestals

Dividends Series 1 floorstanding pedestals are used to support worksurfaces in both panel-wrap and freestanding desk applications. No cantilevers or other supports are required at the end of the worksurface supported by a pedestal.

For panel-wrap applications, three depths are available in order to mount beneath 18", 24" and 30" deep worksurfaces.

In floorstanding desks, pedestals can either be specified "Preconfigured" with floorstanding desks or ordered by component for "Build-to-Spec" applications.

Two drawer configurations are available: box/box/file and file/file. Pedestals can be specified with or without locks.

### Mobile Pedestals

Dividends Series 1 mobile pedestals provide moveable storage within workstations and tuck beneath worksurfaces when not in use. Available drawer configurations are box/box/file, box/file, and file/file.

Mobile pedestals roll on four corner-mounted swivel casters and one bottom drawer-mounted caster for stability when the lower drawer is in the open position. The front corner casters are locking.

Mobile pedestals may be specified with an optional handle allowing easy mobility. All mobile pedestals include 13-gauge finished tops. All other construction and drawer dimensions are the same as freestanding pedestals.

Mobile pedestals measure 20<sup>5</sup>/<sub>8</sub>" and 26<sup>5</sup>/<sub>8</sub>" high, 15" wide and 18" or 24" deep. All mobile pedestals include locks.

### Available Sizes

Depths: 18", 24" and 30"  
Width: 15"  
Height: 20<sup>5</sup>/<sub>8</sub>" and 26<sup>7</sup>/<sub>8</sub>"

### Doublewide Pedestals

The doublewide pedestal incorporates two 12" high drawers in a 30" width (18<sup>3</sup>/<sub>4</sub>" depth) and is intended for below worksurface applications only. The doublewide's design allows for side-to-side letter or legal filing and front-to-back letter filing.

Doublewide pedestal can be used below 19", 24", or 36" deep worksurfaces, not 18" deep worksurfaces.

### Available Size

Depth: 18<sup>3</sup>/<sub>4</sub>" (floorstanding pedestal only)  
Width: 30"  
Height: 26<sup>7</sup>/<sub>8</sub>"

### Construction

Floorstanding mobile and doublewide pedestals match the aesthetics and dimensions of Dividends Horizon panel components.

- Outer wrapper: 20-gauge seamless steel wrapper, includes finished back and full dust pan
- Inner frame: 20-gauge steel uprights and 16-gauge cross rails
- Drawer front: 20-gauge steel, gently radiused (double wide front: 18-gauge)
- Drawer top cap trim: Color injected, molded plastic
- Box drawer suspension (floorstanding pedestal only): 3/4" extension, ball-bearing slides

- File drawer suspension: Full extension, ball-bearing slides
- Drawer pulls: Color injected, molded plastic
- Leveling glides: 3/8" diameter steel stem with 1 1/2" of height adjustment (double wide pedestal: 5/16" diameter steel stem with a 1 9/16" of height adjustment)

### Internal Drawer Dimensions (DS1)

#### Box drawer

- Internal height: 4<sup>5</sup>/<sub>16</sub>"
- Internal width: 12<sup>9</sup>/<sub>16</sub>"
- Internal depths: 18" = 15<sup>15</sup>/<sub>16</sub>", 24" = 21<sup>1</sup>/<sub>4</sub>", 30" = 27<sup>1</sup>/<sub>4</sub>"

#### File drawer

- Internal height: 9<sup>1</sup>/<sub>4</sub>"
- Internal width: 12<sup>1</sup>/<sub>8</sub>"
- Internal depths: 18" = 15<sup>15</sup>/<sub>16</sub>", 24" = 21<sup>1</sup>/<sub>4</sub>", 30" = 27<sup>1</sup>/<sub>4</sub>"

#### File drawer (doublewide pedestal)

- Internal height: 9<sup>3</sup>/<sub>4</sub>"
- Internal width: 26<sup>3</sup>/<sub>4</sub>"
- Internal depth: 15<sup>3</sup>/<sub>4</sub>"

### Locks

Pedestals can be ordered with or without locks. When specified without locks, a lock plug is included. An optional lock retrofit kit is available for field installation of locks at a later date if required.

Locks are keyed randomly unless otherwise specified. Other keying options include keyed alike or keyed with lock cores K001-K250. All random keyed locks are factory-installed and have a black finish.

### Pedestal Accessories

A hanging file bar for front-to-back or side-to-side filing is included with Series 1 pedestals.

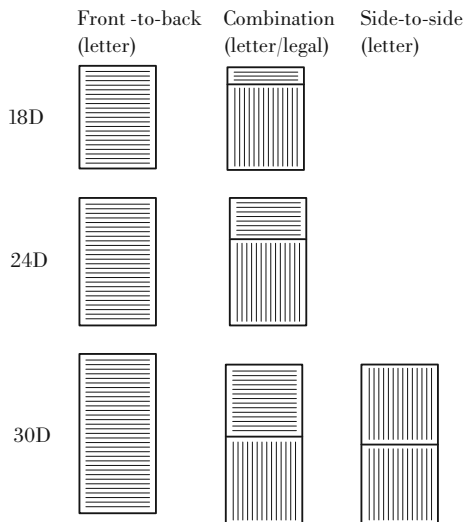

Pedestal Filing Configurations

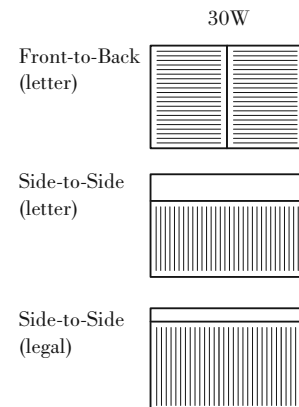

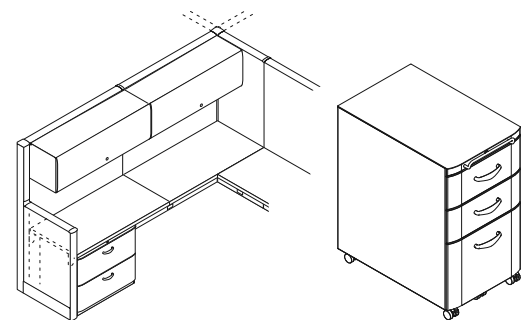

Doublewide Pedestal Filing Configurations



Doublewide Pedestal

Mobile Pedestal

*Dividends Floorstanding, Doublewide and Mobile  
18", 24" and 30" Depths*

description	type	d*	d	w	h	pattern no.	P1	P2	P3	
	Floorstanding Pedestals with Locks	12/12	18"	17 1/2"	14 7/8"	26 7/8"	<b>DS1PF L18B</b>	\$555.	\$610.	\$639.
		6/6/12	18"	17 1/2"	14 7/8"	26 7/8"	<b>DS1PF L18A</b>	578.	634.	664.
		12/12	24"	23 1/2"	14 7/8"	26 7/8"	<b>DS1PF L24B</b>	609.	671.	698.
		6/6/12	24"	23 1/2"	14 7/8"	26 7/8"	<b>DS1PF L24A</b>	634.	697.	729.
		12/12	30"	29 1/2"	14 7/8"	26 7/8"	<b>DS1PF L30B</b>	638.	698.	730.
	6/6/12	30"	29 1/2"	14 7/8"	26 7/8"	<b>DS1PF L30A</b>	666.	731.	766.	
	Mobile Pedestals with Locks	12/12	18"	16 3/4"	14 7/8"	26 3/8"	<b>DS1PM L18B</b>	924.	1,018.	1,064.
		6/6/12	18"	16 3/4"	14 7/8"	26 3/8"	<b>DS1PM L18A</b>	953.	981.	1,096.
		6/12	18"	17 1/2"	14 7/8"	20 5/8"	<b>DS1PM L18F</b>	848.	932.	976.
		6/12	24"	22 3/4"	14 7/8"	20 5/8"	<b>DS1PM L24F</b>	918.	1,010.	1,055.
		12/12	24"	22 3/4"	14 7/8"	26 3/8"	<b>DS1PM L24B</b>	998.	1,096.	1,146.
		6/6/12	24"	22 3/4"	14 7/8"	26 3/8"	<b>DS1PM L24A</b>	1,026.	1,130.	1,181.
	Doublewide Pedestals with Locks	12/12	19"	18 3/4"	30"	26 7/8"	<b>DS1DW 30L</b>	877.	965.	1,008.

d\* = nominal depth  
Dimensions listed under d w h are actual to the nearest 1/16"

Ordering Information	Order Code	Included with:	Options
<b>Floorstanding Pedestals</b> 1. Pattern Number 2. Paint Finish 3. Pull Finish 4. Drawer Top Cap Finish  <b>Mobile Pedestals</b> 1. Pattern Number 2. Paint Finish 3. Pull Finish 4. Drawer Top Cap Finish  <b>Doublewide Pedestals</b> 1. Pattern Number 2. Paint Finish 3. Pull Finish 4. Drawer Top Cap Finish	<b>Floorstanding Pedestals</b> <i>Example:</i> <b>DS1PF L24A, 117, 117, 117</b> <hr/> <b>DS1PF</b> Pattern Number <b>24A</b> <hr/> <b>117</b> Soft Grey paint finish <hr/> <b>117</b> Soft Grey pull finish <hr/> <b>117</b> Soft Grey top cap finish <hr/> <b>Doublewide Pedestals</b> <i>Example:</i> <b>DS1DW 30L, 117, 117, 117</b> <hr/> <b>DS1DW</b> Pattern Number <b>30L</b> <hr/> <b>117</b> Soft Grey paint finish <hr/> <b>117</b> Soft Grey pull finish <hr/> <b>117</b> Soft Grey top cap finish <hr/> <b>Mobile Pedestals</b> <i>Example:</i> <b>DS1PM L24A, 117, 117, 117</b> <hr/> <b>DS1PM</b> Pattern Number <b>L24A</b> <hr/> <b>117</b> Soft Grey paint finish <hr/> <b>117</b> Soft Grey pull finish <hr/> <b>117</b> Soft Grey drawer top cap finish	<b>Floorstanding Pedestals</b> <ul style="list-style-type: none"> <li>• Hanging file bar (file drawer)</li> </ul> <b>Mobile Pedestals</b> <ul style="list-style-type: none"> <li>• Hanging file bar (file drawer)</li> </ul> <b>Doublewide Pedestals</b> <ul style="list-style-type: none"> <li>• Hanging file bar (front-to-back)</li> <li>• Hanging file rail (side-to-side)</li> </ul> Doublewide pedestals are not intended for freestanding use and must be secured beneath a panel supported worksurface	<b>Floorstanding Pedestals</b> <ul style="list-style-type: none"> <li>• To specify pedestals without locks, replace the "L" (6th character) in the pattern number with an "N". <b>Deduct \$20</b></li> </ul> <b>Doublewide Pedestals</b> <ul style="list-style-type: none"> <li>• To specify pedestals without locks, replace the "L" (6th character) in the pattern number with an "N". <b>Deduct \$20</b></li> </ul> <b>Mobile Pedestals</b> Mobile pedestals are available with lock only.  To specify a Dividends mobile pedestal with a handle, add "P" as the 7th character of the pattern number ie. <b>DS1PML(P)24 add \$53</b>  <b>Full Extension Drawer Slide Option</b> To specify full extension drawer slides for box drawers, add "F" at the end of the pattern number and add \$25 to the list price.

## Series 2 Floorstanding, Doublewide and Mobile Specifications

### Series 2 Floorstanding Pedestals

Series 2 floorstanding pedestals are used to support worksurfaces in both panel wrapped and freestanding applications. No cantilevers or other supports are required at the end of the worksurface supported by a pedestal.

Two drawer configurations are available: box/box/file and file/ file. Mobile pedestals are not available without locks.

The Series 2 24" deep pedestal design offers case without a back. In panel applications or in freestanding desking applications where the desk is against the wall, a back is not necessary.

In desking applications where the back of the case is exposed, an optional back is used to conceal the pedestals contents.

The 18" and 30" deep Series 2 pedestals include a back with each case.

### Mobile Pedestals

Series 2 mobile pedestals provide moveable storage within a workstation and tuck beneath worksurfaces when not in use. Available drawer configurations are box/file, box/box/file and file/file.

Mobile pedestals roll on four corner-mounted swivel casters and one bottom drawer-mounted caster for stability when the lower drawer is in the open position. The front corner casters are locking.

Mobile pedestals may be specified with an optional handle allowing easy mobility.

All mobile pedestals include 13-gauge finished tops. A back is included with all Series 2 mobile pedestals.

Pedestals may be specified without the top for attachment of a pedestal cushion. Pedestal cushion may be ordered through the Knoll Currents product line.

### Available Sizes

Depths: 18", 24" and 30" (Floorstanding pedestal only)

Width: 15"

Height: 26 <sup>7</sup>/<sub>8</sub>"

### Series 2 Doublewide Pedestals

The doublewide pedestal incorporates two 12" high drawers in a 30" or 36" width (18 <sup>3</sup>/<sub>4</sub>" depth) and is intended for below worksurface applications only. The doublewide's design allows for side-to-side letter or legal filing and front-to-back letter filing.

Doublewide pedestals can be used below 19", 24", 30" or 36" deep worksurfaces, not 18" deep worksurfaces.

### Available Sizes

Depth: 18 <sup>3</sup>/<sub>4</sub>" (floorstanding pedestal only)

Width: 30" and 36"

Height: 26 <sup>7</sup>/<sub>8</sub>"

### Construction:

- Outer wrapper: 20-gauge steel
- Drawer front: 20-gauge steel (double wide front: 18-gauge)
- Pedestal back: 20-gauge
- <sup>3</sup>/<sub>4</sub>" extension ball bearing slides on 6" box drawers

- Full extension ball bearing slides on 12" file drawers
- Leveling glides: <sup>3</sup>/<sub>8</sub>" diameter steel stem with 1 <sup>1</sup>/<sub>2</sub>" of height adjustment (double wide ped: <sup>5</sup>/<sub>16</sub>" diameter steel stem with a 1 <sup>9</sup>/<sub>16</sub>" of height adjustment

### Internal Drawer Dimensions (DS2, 24"d)

#### Box drawer

- Internal height: 4<sup>5</sup>/<sub>16</sub>"
- Internal width: 12<sup>1</sup>/<sub>16</sub>"
- Internal depths: 18<sup>3</sup>/<sub>8</sub>"

#### File drawer

- Internal height: 9<sup>1</sup>/<sub>4</sub>"
- Internal width: 12<sup>1</sup>/<sub>8</sub>"
- Internal depths: 18<sup>3</sup>/<sub>8</sub>"

#### File drawer (doublewide pedestal)

- Internal height: 9<sup>3</sup>/<sub>4</sub>"
- Internal width: 26<sup>3</sup>/<sub>4</sub>" and 32 <sup>3</sup>/<sub>4</sub>"
- Internal depth: 15<sup>3</sup>/<sub>4</sub>"

### Locks

Series 2 mobile pedestals are available not available without locks. Series 2 doublewide pedestals can be ordered with or without locks.

Locks are randomly keyed unless otherwise specified. Other keying options include keyed alike or keyed with lock cores K001-K250. All locks are factory-installed and have a black finish.

### Pedestal Accessories

All Series 2 freestanding pedestal accessories including the hanging file bar must be specified separately. Series 2 double wide pedestals are shipped with hanging file bars.

Interior drawer dimensions for DS2 are 18" deep and 30" deep. Pedestals are the same as DS1 dimensions listed on page 228.

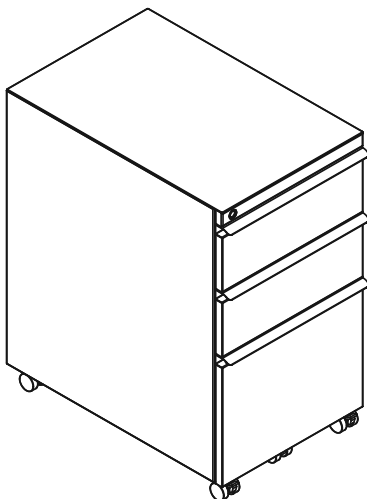

Mobile Pedestal

# Pedestals

## Series 2 Floorstanding, Doublewide and Mobile

### 18", 24" and 30" Depths

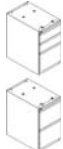
description	type	d*	d	w	h	pattern no.	P1	P2	P3	
	Series 2 Floorstanding Pedestals with Locks	12/12 w/back	18"	17 1/2"	14 7/8"	26 7/8"	<b>DS2PF L18B</b>	\$559.	\$644.	\$672.
	6/6/12 w/back	18"	17 1/2"	14 7/8"	26 7/8"	<b>DS2PF L18A</b>	582.	670.	697.	
	12/12 no back	24"	23 1/2"	14 7/8"	26 7/8"	<b>DS2PF L24B</b>	472.	545.	567.	
	6/6/12 no back	24"	23 1/2"	14 7/8"	26 7/8"	<b>DS2PF L24A</b>	499.	575.	598.	
	6/6/12 w/back	30"	24 1/2"	14 7/8"	26 7/8"	<b>DS2PF L30A</b>	672.	773.	810.	
	12/12 w/back	30"	29 1/2"	14 7/8"	26 7/8"	<b>DS2PF L30B</b>	643.	736.	769.	

Series 2 Floorstanding Case Back (For 24" deep units only)				14 7/8"	26 7/8"	<b>DS2XPB</b>	85.	96.	99.
--	--	--	--	---------	---------	---------------	-----	-----	-----

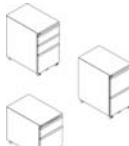

	Series 2 Mobile Pedestals with Locks	6/12	18"	16 3/4"	14 7/8"	20 5/8"	<b>DS2PM L18F</b>	854.	984.	1,026.
	12/12	18"	16 3/4"	14 7/8"	26 3/8"	<b>DS2PM L18B</b>	931.	1,072.	1,118.	
	6/6/12	18"	16 3/4"	14 7/8"	26 3/8"	<b>DS2PM L18A</b>	962.	1,104.	1,152.	
	6/12	24"	22 3/4"	14 7/8"	20 5/8"	<b>DS2PM L24F</b>	612.	703.	732.	
	6/6/12	24"	22 3/4"	14 7/8"	26 3/8"	<b>DS2PM L24A</b>	682.	787.	820.	
	12/12	24"	22 3/4"	14 7/8"	26 3/8"	<b>DS2PM L24B</b>	682.	787.	820.	

d\* = nominal depth  
 Dimensions listed under d w h are actual to the nearest 1/16"

Ordering Information	Order Code	Included with:	Options
<b>Pedestals</b> 1. Pattern Number 2. Paint Finish	<b>Floorstanding Pedestals</b> <i>Example:</i> <b>DS2PF L24A, 117</b> <hr/> <b>DS2PF</b> Pattern Number <b>L24A</b> <hr/> <b>117</b> Soft Grey paint finish <hr/> <b>Doublewide Pedestals</b> <i>Example:</i> <b>DS2DW 30L, 113</b> <hr/> <b>DS2DW</b> Pattern Number <b>30L</b> <hr/> <b>113</b> Dark grey paint finish	<b>Floorstanding Pedestals</b> <ul style="list-style-type: none"> <li>Hanging file bar not included</li> </ul> <b>Note:</b> 24" deep floorstanding pedestals do not include a back panel. Back panels must be ordered separately. 18" and 30" deep floorstanding pedestals have backs.  <b>Mobile Pedestals</b> <ul style="list-style-type: none"> <li>Hanging file bar not included</li> </ul> <b>Doublewide Pedestals</b> <ul style="list-style-type: none"> <li>Hanging File Bar (front-to-back)</li> <li>Hanging file rail (side-to-side)</li> </ul> Doublewide pedestals are not intended for freestanding use and must be secured beneath a panel supported worksurface.	<b>Floorstanding Pedestals</b> <ul style="list-style-type: none"> <li>To specify pedestals without locks, replace the "L" suffix with an "N". <b>Deduct \$15</b></li> </ul> <b>Doublewide Pedestals</b> <ul style="list-style-type: none"> <li>To specify pedestals without locks, replace the "L" suffix with an "N". <b>Deduct \$20</b></li> </ul> <b>Mobile Pedestals</b> <ul style="list-style-type: none"> <li>To specify a Series 2 mobile pedestal without a steel top, replace "M" character with "O" in the pattern number ie. DS2P(O)L24A <b>Deduct \$35</b></li> <li>Add \$53 list for mobile handle. Add a "P" between the "L" lock code and the case size to designate the handle option, example (DS2PMLP24A)</li> </ul> <b>Finish Option:</b> Add a "Y" to the end of the pattern number to specify a different finish for the door versus the case. Use P3 pricing for this dual finish option.  <b>Full Extension Drawer Slide Option</b> To specify full extension drawer slides for box drawers, add "F" at the end of the pattern number and add \$25 to the list price.

# Pedestals

## Series 2 Floorstanding, Doublewide and Mobile

### 18", 24" and 30" Depths

description	type	d*	d	w	h	pattern no.	P1	P2	P3
Series 2 Doublewide Pedestals with Locks	12/12	19"	18 <sup>3</sup> / <sub>4</sub> "	30"	26 <sup>7</sup> / <sub>8</sub> "	<b>DS2DW 30L</b>	\$883.	\$1,016.	\$1,059.
	12/12	19"	18 <sup>3</sup> / <sub>4</sub> "	36"	26 <sup>7</sup> / <sub>8</sub> "	<b>DS2DW 36L</b>	932.	1,073.	1,119.



d\* = nominal depth  
 Dimensions listed under d w h are actual to the nearest 1/16"

Ordering Information	Order Code	Included with:	Options
<b>Pedestals</b> 1. Pattern Number 2. Paint Finish	<b>Floorstanding Pedestals</b> <i>Example:</i> <b>DS2PF L24A, 117</b> <hr/> <b>DS2PF</b> Pattern Number <b>L24A</b> <hr/> <b>117</b> Soft Grey paint finish <hr/> <b>Doublewide Pedestals</b> <i>Example:</i> <b>DS2DW 30L, 113</b> <hr/> <b>DS2DW</b> Pattern Number <b>30L</b> <hr/> <b>113</b> Dark grey paint finish	<b>Floorstanding Pedestals</b> <ul style="list-style-type: none"> <li>Hanging file bar not included</li> </ul> <p><b>Note:</b> 24" deep floorstanding pedestals do not include a back panel. Back panels must be ordered separately. 18" and 30" deep floorstanding pedestals have backs.</p> <b>Mobile Pedestals</b> <ul style="list-style-type: none"> <li>Hanging file bar not included</li> </ul> <b>Doublewide Pedestals</b> <ul style="list-style-type: none"> <li>Hanging File Bar (front-to-back)</li> <li>Hanging file rail (side-to-side)</li> </ul> <p>Doublewide pedestals are not intended for freestanding use and must be secured beneath a panel supported worksurface.</p>	<b>Floorstanding Pedestals</b> <ul style="list-style-type: none"> <li>To specify pedestals without locks, replace the "L" suffix with an "N". <b>Deduct \$15</b></li> </ul> <b>Doublewide Pedestals</b> <ul style="list-style-type: none"> <li>To specify pedestals without locks, replace the "L" suffix with an "N". <b>Deduct \$20</b></li> </ul> <b>Mobile Pedestals</b> <ul style="list-style-type: none"> <li>To specify a Series 2 mobile pedestal without a steel top, replace "M" character with "O" in the pattern number ie. DS2P(O)L24A <b>Deduct \$35</b></li> <li>Add \$53 list for mobile handle. Add a "P" between the "L" lock code and the case size to designate the handle option, example (DS2PMLP24A)</li> </ul> <p><b>Finish Option:</b>                      Add a "Y" to the end of the pattern number to specify a different finish for the door versus the case. Use P3 pricing for this dual finish option.</p> <p><b>Full Extension Drawer Slide Option</b>                      To specify full extension drawer slides for box drawers, add "F" at the end of the pattern number and add \$25 to the list price.</p>



**This page intentionally left blank**

**Pencil Tray**

Five section tray rides on drawer sides of box drawers. Plastic injection molded construction. 13<sup>1</sup>/<sub>4</sub>" wide, 5<sup>7</sup>/<sub>16</sub>" deep and 7/8" high. Black or clear finish available.

**Hanging File Bar**

Allows for side-to-side hanging folders. 20-gauge steel construction. Set of two. Black finish.

A hanging file bar is included with each file drawer when ordering Series 1 desks or pedestals. Hanging file bars are not included with Series 2 pedestals or desks - order separately.

**Drawer Dividers**

Two styles available: box drawer and file drawer sizes. 18-gauge steel construction. Black finish.

**Stationery Inserts**

Set of four trays for use in box drawers. 18-gauge steel construction. Can accommodate letter-and legal-sized stationery. Black finish.

**Pencil Drawer**

For use with freestanding desks or panel-mounted worksurfaces with depths of 24" or more. 24" wide, 17 5/8" deep and 2" high. Black finish.

**Attachment:** Mounts on underside of worksurface with included mounting hardware

**Pedestal Lock Retrofit Kit**

Allows existing nonlocking pedestals to be field-retrofitted with locks. Includes lock housing, lock core and lock rod assembly (must be specified box/box/file or file/file).

**Worksurface Edge Grommet**

Available factory-installed when ordering worksurfaces or as a kit for field installation. Can be installed in any location along the rear edge of worksurfaces. Includes a cutting template, grommet and cover. Dark grey finish.

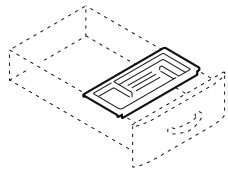

Pencil Tray

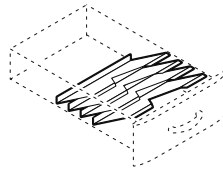

Stationery Inserts

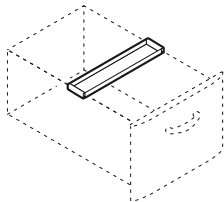

Hanging File Bar

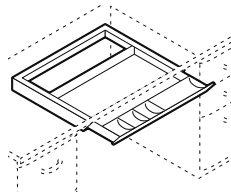

Pencil Drawer

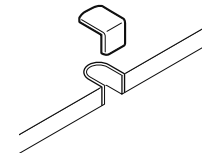

Worksurface Edge Grommet

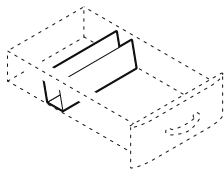



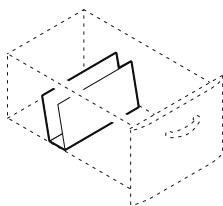



Drawer Divider, Box



Drawer Divider, File Drawer

Accessories

Drawer Organizers, Grommet Kits and Lock Retrofit Kits

description	type	w	d	h	pattern no.	list
 Pencil Tray	Black finish	13 1/4"	5 7/8"	7/8"	<b>DS2PPTN</b>	\$37.
	Clear finish	13 1/4"	5 7/8"	7/8"	<b>DS2PPTC</b>	44.
 Hanging File Bar		12 3/16"	2 15/16"	1/2"	<b>DS1PFS</b>	32.
 Drawer Divider, Box		12 3/8"	3"	3 1/8"	<b>DS1PBD</b>	32.
 Drawer Divider, File		10	3 5/8"	6 3/8"	<b>DS1PFD</b>	32.
 Stationary Inserts, box (4 trays)		13	15 1/16"	8 7/8"	<b>DS1PST</b>	170.
 Pencil Drawer		24"	17 5/8"	2"	<b>DS1PCD</b>	231.
 Worksurface Grommet Kit (Dark Grey)		2 3/16"	2 3/16"	1 3/8"	<b>D1WSG</b>	23.
Dividends Floorstanding Pedestal Lock Retrofit Kit					<b>DS1LKKT</b>	71.
Series 2 Floorstanding Pedestal Lock Retrofit Kit					<b>DS2LKKT</b>	58.
Dividends Doublewide Pedestal Lock Retrofit Kit					<b>DS1DWDPL</b>	64.
Series 2 Doublewide Pedestal Lock Retrofit Kit		30"			<b>DS2DWDPL30</b>	61.
		36"			<b>DS2DWDPL36</b>	64.

Ordering Information	Order Code	Included with:	Options
<b>Pencil Tray</b>	<b>Pencil Tray</b>	<b>Pencil Tray</b>	
1. Pattern Number	<i>Example:</i> <b>DS2PPT</b> <b>DS2PPT</b> Pattern Number		

**Single Depth Credenzas**

Dividends Horizon single depth credenzas increase planning and design options by blending residential furniture attributes within systems furniture applications. Credenzas offer a practical solution for functional under worksurface storage, while increasing the overall aesthetics of an office.

Credenzas consist of a metal, laminate, or veneer top option with a shelf and binder storage area. Single depth credenzas have four configuration options: sliding door only, drawer only, sliding door and drawer combination, and open shelves without a sliding door or a drawer.

The sliding door is a single steel, laminate, or veneer door with a handle that conceals half the width of the binder storage area. A single drawer may be specified for the location above the shelf. The drawer may be installed in either the right or left location, the drawer location does not need to be specified when ordered. When a drawer is specified along with a sliding door, the drawer front and sliding door finishes are the same. Units that include a drawer have a full back and those without a drawer have a partial back that encloses the binder storage area below the shelf.

Shorter width credenzas, 24, 30, and 36 inches wide, are available with a laminate or veneer top only. 24 inch wide credenzas do not include a center vertical septum and are only available as open shelf units, without a sliding door or drawer. Units are shipped knocked down and may be specified with or without locks. Dividends Horizon credenzas are available in all Knoll Core finishes. Legacy finishes are not available.

**Available Sizes**

Heights: 24 inches  
Depth: 13-5/16 inches  
Widths: 24 – 72 inches

**Construction**

- **Top:**
  - Steel: 16-gauge painted steel
  - Laminate: 1-1/4 inch thick particle board with high pressure laminate on top and a paper backer on the underside with 2mm edgeband
  - Veneer: 1-1/4 inch thick particle board with 0.6mm veneer on top and edge.
- **End Panels:** 16-gauge painted steel
- **Back Panel:** 20-gauge painted steel

• **Door:**

- Steel: 20-gauge panted steel
- Laminate: 3/4 inch thick particle board with high pressure laminate on the outside and a paper backer on the inside with 1mm edgeband
- Veneer 3/4 inch thick particle board with 0.6mm thick veneer on top and edge

• **Fixed Shelf:** 16-gauge painted steel

• **Door Handle:** painted aluminum (same color as case)

**Interior Dimensions**

Heights: 12-1/2 inches for the lower section, 5-7/8 inches for the upper section  
Depth: 12-1/16 inches

**Locks**

Locks are standard on credenzas with doors and/or drawers and are keyed randomly unless otherwise specified. All locks are factory installed and have a black finish. Credenzas can also be specified without locks if required.

**Single Depth Credenza with Open Shelves**

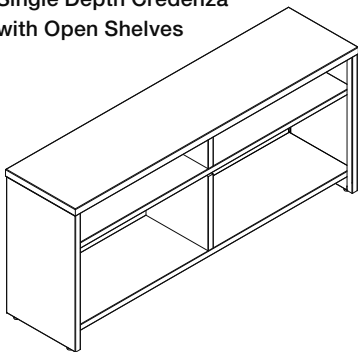

**Single Depth Credenza with a Drawer**

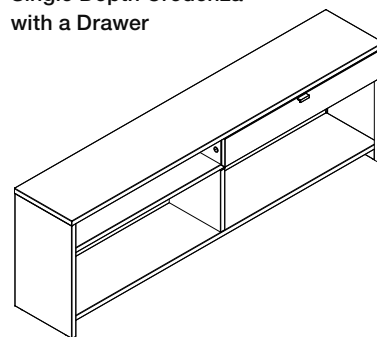

**Single Depth Credenza with a Sliding Door**

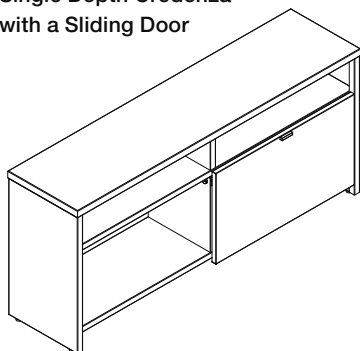



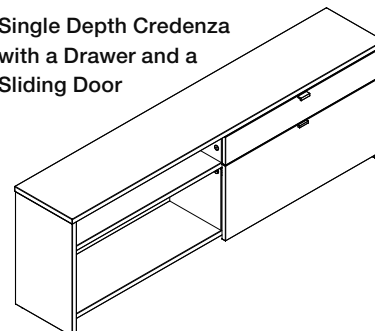

**Single Depth Credenza with a Drawer and a Sliding Door**

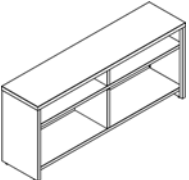

# Credenzas

## Single Depth with Steel Top

### With or Without a Sliding Door

description	w	h	d	pattern no.	P1	P2	P3
 Credenza without Door	42"	24"	13 <sup>5</sup> / <sub>16</sub> "	<b>DS4LC1ANS42N</b>	\$640.	\$702.	\$734.
	48"	24"	13 <sup>5</sup> / <sub>16</sub> "	<b>DS4LC1ANS48N</b>	655.	720.	754.
	54"	24"	13 <sup>5</sup> / <sub>16</sub> "	<b>DS4LC1ANS54N</b>	730.	805.	842.
	60"	24"	13 <sup>5</sup> / <sub>16</sub> "	<b>DS4LC1ANS60N</b>	739.	814.	850.
	66"	24"	13 <sup>5</sup> / <sub>16</sub> "	<b>DS4LC1ANS66N</b>	761.	836.	874.
	72"	24"	13 <sup>5</sup> / <sub>16</sub> "	<b>DS4LC1ANS72N</b>	791.	870.	908.
 Credenza with Steel Sliding Door	42"	24"	13 <sup>5</sup> / <sub>16</sub> "	<b>DS4LC1BSS42L</b>	790.	868.	906.
	48"	24"	13 <sup>5</sup> / <sub>16</sub> "	<b>DS4LC1BSS48L</b>	806.	887.	927.
	54"	24"	13 <sup>5</sup> / <sub>16</sub> "	<b>DS4LC1BSS54L</b>	896.	987.	1,030.
	60"	24"	13 <sup>5</sup> / <sub>16</sub> "	<b>DS4LC1BSS60L</b>	901.	993.	1,037.
	66"	24"	13 <sup>5</sup> / <sub>16</sub> "	<b>DS4LC1BSS66L</b>	929.	1,023.	1,069.
	72"	24"	13 <sup>5</sup> / <sub>16</sub> "	<b>DS4LC1BSS72L</b>	961.	1,054.	1,103.
 Credenza with Laminate Sliding Door	42"	24"	13 <sup>5</sup> / <sub>16</sub> "	<b>DS4LC1BLS42L</b>	1,282.	1,410.	1,472.
	48"	24"	13 <sup>5</sup> / <sub>16</sub> "	<b>DS4LC1BLS48L</b>	1,314.	1,443.	1,508.
	54"	24"	13 <sup>5</sup> / <sub>16</sub> "	<b>DS4LC1BLS54L</b>	1,344.	1,476.	1,542.
	60"	24"	13 <sup>5</sup> / <sub>16</sub> "	<b>DS4LC1BLS60L</b>	1,374.	1,511.	1,577.
	66"	24"	13 <sup>5</sup> / <sub>16</sub> "	<b>DS4LC1BLS66L</b>	1,406.	1,544.	1,614.
	72"	24"	13 <sup>5</sup> / <sub>16</sub> "	<b>DS4LC1BLS72L</b>	1,438.	1,577.	1,649.
 Credenza with Veneer Sliding Door	42"	24"	13 <sup>5</sup> / <sub>16</sub> "	<b>DS4LC1BVS42L</b>	1,367.	1,502.	1,570.
	48"	24"	13 <sup>5</sup> / <sub>16</sub> "	<b>DS4LC1BVS48L</b>	1,406.	1,544.	1,613.
	54"	24"	13 <sup>5</sup> / <sub>16</sub> "	<b>DS4LC1BVS54L</b>	1,444.	1,585.	1,657.
	60"	24"	13 <sup>5</sup> / <sub>16</sub> "	<b>DS4LC1BVS60L</b>	1,482.	1,626.	1,700.
	66"	24"	13 <sup>5</sup> / <sub>16</sub> "	<b>DS4LC1BVS66L</b>	1,518.	1,669.	1,743.
	72"	24"	13 <sup>5</sup> / <sub>16</sub> "	<b>DS4LC1BVS72L</b>	1,557.	1,710.	1,787.

Dimensions listed under w h d are actual to the nearest 1/16"

Ordering Information	Order Code	Included with:	Options
<b>Credenza with Sliding Door:</b> 1. Pattern number 2. Paint finish 3. Door finish (laminite and veneer only) 4. Door edge finish (laminite only)	<b>Credenza with Sliding Door:</b> <i>Example:</i> <b>DS4LC1BSS42L/117</b> <b>DS4LC1B</b> Pattern Number <b>SS42L</b> <b>117</b> Dark grey paint	<b>Credenza with or without Sliding Door:</b>  <b>Note:</b> Credenzas are only available in Knoll core finishes.	<b>Credenza with or without Sliding Door:</b>  <b>Lock/No lock option</b> For non-locking credenzas with a sliding door or a drawer, substitute the "L" suffix with an "N" and deduct \$20 from the list price.  <b>Note:</b> Credenzas with a drawer have a full back. Credenzas without a drawer have a partial back that encloses the binder storage area below the shelf.
<b>Credenza without Sliding Door:</b> 1. Pattern number 2. Paint finish	<i>Example:</i> <b>DS4LC1ANS42N/117</b> <b>DS4LC1A</b> Pattern Number <b>NS42N</b> <b>117</b> Dark grey paint		<b>Paint Configuration Option:</b> Add "Y" at the end of the pattern number to specify a different paint finish on the case and fronts. P3 pricing applies on all product with dual paint finishes.

Credenzas  
*Single Depth with Steel Top*  
*Without a Sliding Door and with a Drawer*

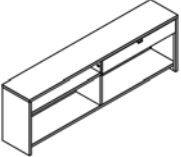
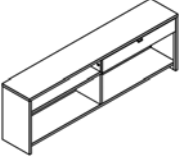
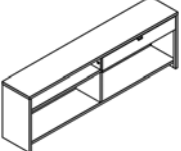
description	w	h	d	pattern no.	P1	P2	P3
 Credenza with Steel Drawer	42"	24"	13 <sup>5</sup> / <sub>16</sub> "	<b>DS4LC1CSS42L</b>	\$959.	\$1,021.	\$1,054.
	48"	24"	13 <sup>5</sup> / <sub>16</sub> "	<b>DS4LC1CSS48L</b>	974.	1,038.	1,071.
	54"	24"	13 <sup>5</sup> / <sub>16</sub> "	<b>DS4LC1CSS54L</b>	1,050.	1,123.	1,159.
	60"	24"	13 <sup>5</sup> / <sub>16</sub> "	<b>DS4LC1CSS60L</b>	1,058.	1,132.	1,169.
	66"	24"	13 <sup>5</sup> / <sub>16</sub> "	<b>DS4LC1CSS66L</b>	1,078.	1,154.	1,193.
	72"	24"	13 <sup>5</sup> / <sub>16</sub> "	<b>DS4LC1CSS72L</b>	1,108.	1,189.	1,228.
 Credenza with Laminate Drawer	42"	24"	13 <sup>5</sup> / <sub>16</sub> "	<b>DS4LC1CLS42L</b>	1,136.	1,199.	1,232.
	48"	24"	13 <sup>5</sup> / <sub>16</sub> "	<b>DS4LC1CLS48L</b>	1,152.	1,217.	1,249.
	54"	24"	13 <sup>5</sup> / <sub>16</sub> "	<b>DS4LC1CLS54L</b>	1,228.	1,302.	1,338.
	60"	24"	13 <sup>5</sup> / <sub>16</sub> "	<b>DS4LC1CLS60L</b>	1,236.	1,310.	1,346.
	66"	24"	13 <sup>5</sup> / <sub>16</sub> "	<b>DS4LC1CLS66L</b>	1,258.	1,332.	1,370.
	72"	24"	13 <sup>5</sup> / <sub>16</sub> "	<b>DS4LC1CLS72L</b>	1,286.	1,366.	1,406.
 Credenza with Veneer Drawer	42"	24"	13 <sup>5</sup> / <sub>16</sub> "	<b>DS4LC1CVS42L</b>	1,175.	1,237.	1,270.
	48"	24"	13 <sup>5</sup> / <sub>16</sub> "	<b>DS4LC1CVS48L</b>	1,191.	1,256.	1,288.
	54"	24"	13 <sup>5</sup> / <sub>16</sub> "	<b>DS4LC1CVS54L</b>	1,266.	1,340.	1,375.
	60"	24"	13 <sup>5</sup> / <sub>16</sub> "	<b>DS4LC1CVS60L</b>	1,274.	1,348.	1,385.
	66"	24"	13 <sup>5</sup> / <sub>16</sub> "	<b>DS4LC1CVS66L</b>	1,296.	1,370.	1,409.
	72"	24"	13 <sup>5</sup> / <sub>16</sub> "	<b>DS4LC1CVS72L</b>	1,325.	1,405.	1,444.

Dimensions listed under w h d are actual to the nearest <sup>1</sup>/<sub>16</sub>"

Ordering Information	Order Code	Included with:	Options
<b>Credenza with a Drawer:</b> 1. Pattern number 2. Paint finish 3. Drawer front finish (laminated and veneer only) 4. Drawer front edge finish (laminated only)	<b>Credenza with a Drawer:</b> <i>Example:</i> <b>DS4LC1CLS42L</b> <b>/117/118/118</b> <b>DS4LC1C</b> Pattern Number <b>LS42L</b> <b>117</b> Dark grey paint <b>118</b> Bright white drawer front <b>118</b> Bright white drawer front edge	<b>Credenza with a Drawer:</b> <b>Note:</b> Credenzas are only available in Knoll core finishes.	<b>Credenza with a Drawer:</b> <b>Lock/No lock option</b> For non-locking credenzas with a sliding door or a drawer, substitute the "L" suffix with an "N" and deduct \$20 from the list price. <b>Note:</b> Credenzas with a drawer have a full back. Credenzas without a drawer have a partial back that encloses the binder storage area below the shelf.
			<b>Paint Configuration Option:</b> Add "Y" at the end of the pattern number to specify a different paint finish on the case and fronts. P3 pricing applies on all product with dual paint finishes.

# Credenzas

## Single Depth with Steel Top

### With a Sliding Door and with a Drawer

Dividends Horizon

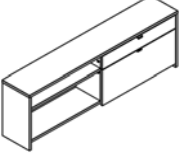
description	w	h	d	pattern no.	P1	P2	P3
Credenza with Steel Sliding Door and Drawer 	42"	24"	13 <sup>5</sup> / <sub>16</sub> "	<b>DS4LC1DSS42L</b>	\$1,107.	\$1,188.	\$1,226.
	48"	24"	13 <sup>5</sup> / <sub>16</sub> "	<b>DS4LC1DSS48L</b>	1,125.	1,205.	1,245.
	54"	24"	13 <sup>5</sup> / <sub>16</sub> "	<b>DS4LC1DSS54L</b>	1,215.	1,305.	1,348.
	60"	24"	13 <sup>5</sup> / <sub>16</sub> "	<b>DS4LC1DSS60L</b>	1,221.	1,311.	1,355.
	66"	24"	13 <sup>5</sup> / <sub>16</sub> "	<b>DS4LC1DSS66L</b>	1,247.	1,341.	1,388.
	72"	24"	13 <sup>5</sup> / <sub>16</sub> "	<b>DS4LC1DSS72L</b>	1,278.	1,371.	1,422.

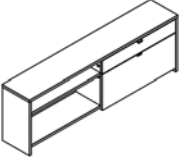
Credenza with Laminate Sliding Door and Drawer 	42"	24"	13 <sup>5</sup> / <sub>16</sub> "	<b>DS4LC1DLS42L</b>	1,602.	1,728.	1,789.
	48"	24"	13 <sup>5</sup> / <sub>16</sub> "	<b>DS4LC1DLS48L</b>	1,633.	1,761.	1,826.
	54"	24"	13 <sup>5</sup> / <sub>16</sub> "	<b>DS4LC1DLS54L</b>	1,662.	1,793.	1,861.
	60"	24"	13 <sup>5</sup> / <sub>16</sub> "	<b>DS4LC1DLS60L</b>	1,693.	1,829.	1,896.
	66"	24"	13 <sup>5</sup> / <sub>16</sub> "	<b>DS4LC1DLS66L</b>	1,724.	1,863.	1,932.
	72"	24"	13 <sup>5</sup> / <sub>16</sub> "	<b>DS4LC1DLS72L</b>	1,755.	1,896.	1,966.

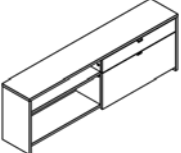
Credenza with Veneer Sliding Door and Drawer 	42"	24"	13 <sup>5</sup> / <sub>16</sub> "	<b>DS4LC1DVS42L</b>	1,686.	1,821.	1,889.
	48"	24"	13 <sup>5</sup> / <sub>16</sub> "	<b>DS4LC1DVS48L</b>	1,724.	1,863.	1,931.
	54"	24"	13 <sup>5</sup> / <sub>16</sub> "	<b>DS4LC1DVS54L</b>	1,762.	1,904.	1,976.
	60"	24"	13 <sup>5</sup> / <sub>16</sub> "	<b>DS4LC1DVS60L</b>	1,799.	1,945.	2,019.
	66"	24"	13 <sup>5</sup> / <sub>16</sub> "	<b>DS4LC1DVS66L</b>	1,836.	1,987.	2,062.
	72"	24"	13 <sup>5</sup> / <sub>16</sub> "	<b>DS4LC1DVS72L</b>	1,876.	2,029.	2,106.

Dimensions listed under w h d are actual to the nearest <sup>1</sup>/<sub>16</sub>"

Ordering Information	Order Code	Included with:	Options
<b>Credenza with a Sliding Door and a Drawer:</b> 1. Pattern number 2. Paint finish 3. Drawer/Door finish (laminated and veneer only) 4. Drawer/Door edge finish (laminated only)	<b>Credenza with a Sliding Door and a Drawer:</b> <i>Example:</i> <b>DS4LC1DSS42L/117</b> <b>DS4LC1D</b> Pattern Number <b>SS42L</b> <b>117</b> Dark grey paint	<b>Credenza with a Sliding Door and a Drawer:</b> <b>Note:</b> Credenzas are only available in Knoll core finishes.	<b>Credenza with a Sliding Door and a Drawer:</b> <b>Lock/No lock option</b> For non-locking credenzas with a sliding door or a drawer, substitute the "L" suffix with an "N" and deduct \$40 from the list price.  <b>Note:</b> Credenzas with a drawer have a full back. Credenzas without a drawer have a partial back that encloses the binder storage area below the shelf.  <b>Paint Configuration Option:</b> Add "Y" at the end of the pattern number to specify a different paint finish on the case and fronts. P3 pricing applies on all product with dual paint finishes.

# Credenzas

## Single Depth with Laminate Top With or without a Sliding Door

Dividends Horizon

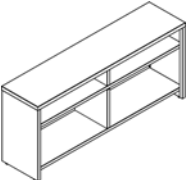
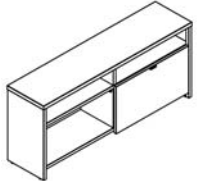
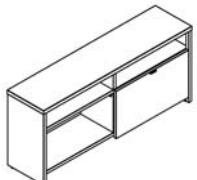
description	w	h	d	pattern no.	P1	P2	P3
 Credenza without Door	24"	24"	13 <sup>3</sup> / <sub>16</sub> "	<b>DS4LC1ANL24N</b>	\$860.	\$943.	\$989.
	30"	24"	13 <sup>3</sup> / <sub>16</sub> "	<b>DS4LC1ANL30N</b>	860.	943.	989.
	36"	24"	13 <sup>3</sup> / <sub>16</sub> "	<b>DS4LC1ANL36N</b>	860.	943.	989.
	42"	24"	13 <sup>3</sup> / <sub>16</sub> "	<b>DS4LC1ANL42N</b>	860.	943.	989.
	48"	24"	13 <sup>3</sup> / <sub>16</sub> "	<b>DS4LC1ANL48N</b>	884.	972.	1,017.
	54"	24"	13 <sup>3</sup> / <sub>16</sub> "	<b>DS4LC1ANL54N</b>	952.	1,049.	1,097.
	60"	24"	13 <sup>3</sup> / <sub>16</sub> "	<b>DS4LC1ANL60N</b>	953.	1,050.	1,098.
	66"	24"	13 <sup>3</sup> / <sub>16</sub> "	<b>DS4LC1ANL66N</b>	987.	1,086.	1,134.
	72"	24"	13 <sup>3</sup> / <sub>16</sub> "	<b>DS4LC1ANL72N</b>	1,020.	1,122.	1,172.
 Credenza with Steel Sliding Door	30"	24"	13 <sup>3</sup> / <sub>16</sub> "	<b>DS4LC1BSL30L</b>	1,000.	1,100.	1,149.
	36"	24"	13 <sup>3</sup> / <sub>16</sub> "	<b>DS4LC1BSL36L</b>	1,000.	1,100.	1,149.
	42"	24"	13 <sup>3</sup> / <sub>16</sub> "	<b>DS4LC1BSL42L</b>	1,000.	1,100.	1,149.
	48"	24"	13 <sup>3</sup> / <sub>16</sub> "	<b>DS4LC1BSL48L</b>	1,025.	1,128.	1,179.
	54"	24"	13 <sup>3</sup> / <sub>16</sub> "	<b>DS4LC1BSL54L</b>	1,112.	1,225.	1,278.
	60"	24"	13 <sup>3</sup> / <sub>16</sub> "	<b>DS4LC1BSL60L</b>	1,113.	1,226.	1,281.
	66"	24"	13 <sup>3</sup> / <sub>16</sub> "	<b>DS4LC1BSL66L</b>	1,149.	1,265.	1,321.
	72"	24"	13 <sup>3</sup> / <sub>16</sub> "	<b>DS4LC1BSL72L</b>	1,182.	1,301.	1,359.
 Credenza with Laminate Sliding Door	30"	24"	13 <sup>3</sup> / <sub>16</sub> "	<b>DS4LC1BLL30L</b>	1,394.	1,531.	1,600.
	36"	24"	13 <sup>3</sup> / <sub>16</sub> "	<b>DS4LC1BLL36L</b>	1,394.	1,531.	1,600.
	42"	24"	13 <sup>3</sup> / <sub>16</sub> "	<b>DS4LC1BLL42L</b>	1,394.	1,531.	1,600.
	48"	24"	13 <sup>3</sup> / <sub>16</sub> "	<b>DS4LC1BLL48L</b>	1,438.	1,577.	1,650.
	54"	24"	13 <sup>3</sup> / <sub>16</sub> "	<b>DS4LC1BLL54L</b>	1,481.	1,625.	1,698.
	60"	24"	13 <sup>3</sup> / <sub>16</sub> "	<b>DS4LC1BLL60L</b>	1,524.	1,674.	1,749.
	66"	24"	13 <sup>3</sup> / <sub>16</sub> "	<b>DS4LC1BLL66L</b>	1,568.	1,722.	1,798.
	72"	24"	13 <sup>3</sup> / <sub>16</sub> "	<b>DS4LC1BLL72L</b>	1,612.	1,771.	1,850.

Dimensions listed under w h d are actual to the nearest 1/16"

Ordering Information	Order Code	Included with:	Options
<b>Credenza with Sliding Door:</b> 1. Pattern number 2. Paint finish 3. Top finish 4. Top edge finish 5. Door finish (laminated and veneer only) 6. Door edge finish (laminated only)	<b>Credenza with Sliding Door:</b> <i>Example:</i> <b>DS4LC1BLL42L</b> <b>/117/118/117/118/118</b> <b>DS4LC1B</b> Pattern Number <b>LL42L</b> <hr/> <b>117</b> Dark grey paint <hr/> <b>118</b> Bright white top <hr/> <b>117</b> Dark grey top edge <hr/> <b>118</b> Bright white door <hr/> <b>118</b> Bright white door edge	<b>Credenza with or without Sliding Door:</b> <b>Note:</b> Credenzas are only available in Knoll core finishes.	<b>Credenza with or without Sliding Door:</b> <b>Lock/No lock option</b> For non-locking credenzas with sliding door or a drawer, substitute the "L" suffix with a "N" and deduct \$20. from the list price.  <b>Note:</b> Credenzas with a drawer have a full back. Credenzas without a drawer have a partial back that encloses the binder storage area below the shelf.
<b>Credenza without Sliding Door:</b> 1. Pattern number 2. Paint finish 3. Top finish 4. Top edge finish	<b>Credenza without a Sliding Door:</b> <i>Example:</i> <b>DS4LC1ANL42N/117</b> <b>DS4LC1A</b> Pattern Number <b>NL42N</b> <hr/> <b>117</b> Dark grey paint <hr/> <b>118</b> Bright white top <hr/> <b>117</b> Dark grey top edge		<b>Paint Configuration Option:</b> Add "Y" at the end of the pattern number to specify a different paint finish on the case and fronts. P3 pricing applies on all product with dual paint finishes.



# Credenzas

## Single Depth with Laminate Top

### With or without a Sliding Door

Dividends Horizon

description	w	h	d	pattern no.	P1	P2	P3
 Credenza with Veneer Sliding Door	30"	24"	13 <sup>5</sup> / <sub>16</sub> "	<b>DS4LC1BVL30L</b>	\$1,481.	\$1,625.	\$1,700.
	36"	24"	13 <sup>5</sup> / <sub>16</sub> "	<b>DS4LC1BVL36L</b>	1,481.	1,625.	1,700.
	42"	24"	13 <sup>5</sup> / <sub>16</sub> "	<b>DS4LC1BVL42L</b>	1,481.	1,625.	1,700.
	48"	24"	13 <sup>5</sup> / <sub>16</sub> "	<b>DS4LC1BVL48L</b>	1,532.	1,683.	1,757.
	54"	24"	13 <sup>5</sup> / <sub>16</sub> "	<b>DS4LC1BVL54L</b>	1,581.	1,737.	1,816.
	60"	24"	13 <sup>5</sup> / <sub>16</sub> "	<b>DS4LC1BVL60L</b>	1,632.	1,792.	1,874.
	66"	24"	13 <sup>5</sup> / <sub>16</sub> "	<b>DS4LC1BVL66L</b>	1,683.	1,848.	1,932.
	72"	24"	13 <sup>5</sup> / <sub>16</sub> "	<b>DS4LC1BVL72L</b>	1,732.	1,904.	1,989.

Dimensions listed under w h d are actual to the nearest 1/16"

Ordering Information	Order Code	Included with:	Options
<b>Credenza with Sliding Door:</b> 1. Pattern number 2. Paint finish 3. Top finish 4. Top edge finish 5. Door finish (laminated and veneer only) 6. Door edge finish (laminated only)	<b>Credenza with Sliding Door:</b> <i>Example:</i> <b>DS4LC1BLL42L</b> <b>/117/118/117/118/118</b> <b>DS4LC1B</b> Pattern Number <b>LL42L</b> <b>117</b> Dark grey paint <b>118</b> Bright white top <b>117</b> Dark grey top edge <b>118</b> Bright white door <b>118</b> Bright white door edge	<b>Credenza with or without Sliding Door:</b> <b>Note:</b> Credenzas are only available in Knoll core finishes.	<b>Credenza with or without Sliding Door:</b> <b>Lock/No lock option</b> For non-locking credenzas with sliding door or a drawer, substitute the "L" suffix with a "N" and deduct \$20. from the list price. <b>Note:</b> Credenzas with a drawer have a full back. Credenzas without a drawer have a partial back that encloses the binder storage area below the shelf.
<b>Credenza without Sliding Door:</b> 1. Pattern number 2. Paint finish 3. Top finish 4. Top edge finish	<b>Credenza without a Sliding Door:</b> <i>Example:</i> <b>DS4LC1ANL42N/117</b> <b>DS4LC1A</b> Pattern Number <b>NL42N</b> <b>117</b> Dark grey paint <b>118</b> Bright white top <b>117</b> Dark grey top edge		<b>Paint Configuration Option:</b> Add "Y" at the end of the pattern number to specify a different paint finish on the case and fronts. P3 pricing applies on all product with dual paint finishes.

Storage Components

Credenzas  
*Single Depth with Laminate Top  
 Without a Sliding Door and with a Drawer*

Dividends Horizon

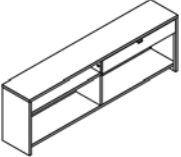
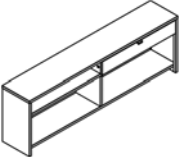
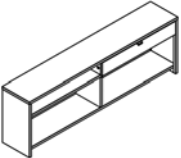
description	w	h	d	pattern no.	P1	P2	P3
Credenza with Steel Drawer 	30"	24"	13 <sup>5</sup> / <sub>16</sub> "	<b>DS4LC1CSL30L</b>	\$1,179.	\$1,263.	\$1,307.
	36"	24"	13 <sup>5</sup> / <sub>16</sub> "	<b>DS4LC1CSL36L</b>	1,179.	1,263.	1,307.
	42"	24"	13 <sup>5</sup> / <sub>16</sub> "	<b>DS4LC1CSL42L</b>	1,179.	1,263.	1,307.
	48"	24"	13 <sup>5</sup> / <sub>16</sub> "	<b>DS4LC1CSL48L</b>	1,202.	1,290.	1,334.
	54"	24"	13 <sup>5</sup> / <sub>16</sub> "	<b>DS4LC1CSL54L</b>	1,271.	1,366.	1,415.
	60"	24"	13 <sup>5</sup> / <sub>16</sub> "	<b>DS4LC1CSL60L</b>	1,272.	1,367.	1,416.
	66"	24"	13 <sup>5</sup> / <sub>16</sub> "	<b>DS4LC1CSL66L</b>	1,305.	1,404.	1,452.
	72"	24"	13 <sup>5</sup> / <sub>16</sub> "	<b>DS4LC1CSL72L</b>	1,338.	1,441.	1,489.
Credenza with Laminate Drawer 	30"	24"	13 <sup>5</sup> / <sub>16</sub> "	<b>DS4LC1CLL30L</b>	1,357.	1,441.	1,485.
	36"	24"	13 <sup>5</sup> / <sub>16</sub> "	<b>DS4LC1CLL36L</b>	1,357.	1,441.	1,485.
	42"	24"	13 <sup>5</sup> / <sub>16</sub> "	<b>DS4LC1CLL42L</b>	1,357.	1,441.	1,485.
	48"	24"	13 <sup>5</sup> / <sub>16</sub> "	<b>DS4LC1CLL48L</b>	1,381.	1,469.	1,513.
	54"	24"	13 <sup>5</sup> / <sub>16</sub> "	<b>DS4LC1CLL54L</b>	1,449.	1,544.	1,594.
	60"	24"	13 <sup>5</sup> / <sub>16</sub> "	<b>DS4LC1CLL60L</b>	1,450.	1,545.	1,595.
	66"	24"	13 <sup>5</sup> / <sub>16</sub> "	<b>DS4LC1CLL66L</b>	1,483.	1,581.	1,630.
	72"	24"	13 <sup>5</sup> / <sub>16</sub> "	<b>DS4LC1CLL72L</b>	1,516.	1,619.	1,668.
Credenza with Veneer Drawer 	30"	24"	13 <sup>5</sup> / <sub>16</sub> "	<b>DS4LC1CVL30L</b>	1,396.	1,479.	1,523.
	36"	24"	13 <sup>5</sup> / <sub>16</sub> "	<b>DS4LC1CVL36L</b>	1,396.	1,479.	1,523.
	42"	24"	13 <sup>5</sup> / <sub>16</sub> "	<b>DS4LC1CVL42L</b>	1,396.	1,479.	1,523.
	48"	24"	13 <sup>5</sup> / <sub>16</sub> "	<b>DS4LC1CVL48L</b>	1,418.	1,507.	1,551.
	54"	24"	13 <sup>5</sup> / <sub>16</sub> "	<b>DS4LC1CVL54L</b>	1,487.	1,582.	1,632.
	60"	24"	13 <sup>5</sup> / <sub>16</sub> "	<b>DS4LC1CVL60L</b>	1,488.	1,583.	1,633.
	66"	24"	13 <sup>5</sup> / <sub>16</sub> "	<b>DS4LC1CVL66L</b>	1,521.	1,620.	1,669.
	72"	24"	13 <sup>5</sup> / <sub>16</sub> "	<b>DS4LC1CVL72L</b>	1,554.	1,657.	1,706.

Dimensions listed under w h d are actual to the nearest 1/16"

Ordering Information	Order Code	Included with:	Options
<b>Credenza with a Drawer:</b> 1. Pattern number 2. Paint finish 3. Top finish 4. Top edge finish 5. Drawer finish (laminated and veneer only) 6. Drawer edge finish (laminated only)	<b>Credenza with a Drawer:</b> <i>Example:</i> <b>DS4LC1CSL42L</b> <b>/117/118/117</b> <b>DS4LC1C</b> Pattern Number <b>SL42L</b> <b>117</b> Dark grey paint <b>118</b> Bright white top <b>117</b> Dark grey top edge	<b>Credenza with a Drawer:</b> <b>Note:</b> Credenzas are only available in Knoll core finishes.	<b>Credenza with a Drawer:</b> <b>Lock/No lock option</b> For non-locking credenzas with a sliding door or a drawer, substitute the "L" suffix with an "N" and deduct \$20 from the list price.  <b>Note:</b> Credenzas with a drawer have a full back. Credenzas without a drawer have a partial back that encloses the binder storage area below the shelf.  <b>Paint Configuration Option:</b> Add "Y" at the end of the pattern number to specify a different paint finish on the case and fronts. P3 pricing applies on all product with dual paint finishes.

# Credenzas

## Single Depth with Laminate Top With a Sliding Door and with a Drawer

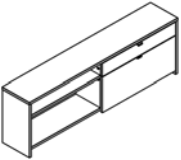
description	w	d	h	pattern no.	P1	P2	P3
 Credenza with Steel Sliding Door and Drawer	30"	13 <sup>3</sup> / <sub>16</sub> "	24"	<b>DS4LC1DSL30L</b>	\$1,317.	\$1,418.	\$1,469.
	36"	13 <sup>3</sup> / <sub>16</sub> "	24"	<b>DS4LC1DSL36L</b>	1,317.	1,418.	1,469.
	42"	13 <sup>3</sup> / <sub>16</sub> "	24"	<b>DS4LC1DSL42L</b>	1,317.	1,418.	1,469.
	48"	13 <sup>3</sup> / <sub>16</sub> "	24"	<b>DS4LC1DSL48L</b>	1,343.	1,446.	1,497.
	54"	13 <sup>3</sup> / <sub>16</sub> "	24"	<b>DS4LC1DSL54L</b>	1,432.	1,542.	1,598.
	60"	13 <sup>3</sup> / <sub>16</sub> "	24"	<b>DS4LC1DSL60L</b>	1,433.	1,543.	1,601.
	66"	13 <sup>3</sup> / <sub>16</sub> "	24"	<b>DS4LC1DSL66L</b>	1,469.	1,582.	1,641.
	72"	13 <sup>3</sup> / <sub>16</sub> "	24"	<b>DS4LC1DSL72L</b>	1,500.	1,619.	1,678.

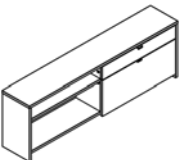
 Credenza with Laminate Sliding Door and Drawer	30"	13 <sup>3</sup> / <sub>16</sub> "	24"	<b>DS4LC1DLL30L</b>	1,711.	1,850.	1,917.
	36"	13 <sup>3</sup> / <sub>16</sub> "	24"	<b>DS4LC1DLL36L</b>	1,711.	1,850.	1,917.
	42"	13 <sup>3</sup> / <sub>16</sub> "	24"	<b>DS4LC1DLL42L</b>	1,711.	1,850.	1,917.
	48"	13 <sup>3</sup> / <sub>16</sub> "	24"	<b>DS4LC1DLL48L</b>	1,755.	1,896.	1,967.
	54"	13 <sup>3</sup> / <sub>16</sub> "	24"	<b>DS4LC1DLL54L</b>	1,798.	1,944.	2,018.
	60"	13 <sup>3</sup> / <sub>16</sub> "	24"	<b>DS4LC1DLL60L</b>	1,843.	1,992.	2,068.
	66"	13 <sup>3</sup> / <sub>16</sub> "	24"	<b>DS4LC1DLL66L</b>	1,886.	2,040.	2,118.
	72"	13 <sup>3</sup> / <sub>16</sub> "	24"	<b>DS4LC1DLL72L</b>	1,929.	2,089.	2,167.

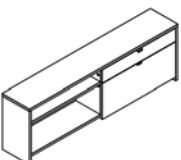
 Credenza with Veneer Sliding Door and Drawer	30"	13 <sup>3</sup> / <sub>16</sub> "	24"	<b>DS4LC1DVL30L</b>	1,798.	1,944.	2,019.
	36"	13 <sup>3</sup> / <sub>16</sub> "	24"	<b>DS4LC1DVL36L</b>	1,798.	1,944.	2,019.
	42"	13 <sup>3</sup> / <sub>16</sub> "	24"	<b>DS4LC1DVL42L</b>	1,798.	1,944.	2,019.
	48"	13 <sup>3</sup> / <sub>16</sub> "	24"	<b>DS4LC1DVL48L</b>	1,851.	2,000.	2,076.
	54"	13 <sup>3</sup> / <sub>16</sub> "	24"	<b>DS4LC1DVL54L</b>	1,900.	2,055.	2,133.
	60"	13 <sup>3</sup> / <sub>16</sub> "	24"	<b>DS4LC1DVL60L</b>	1,950.	2,112.	2,192.
	66"	13 <sup>3</sup> / <sub>16</sub> "	24"	<b>DS4LC1DVL66L</b>	2,000.	2,165.	2,251.
	72"	13 <sup>3</sup> / <sub>16</sub> "	24"	<b>DS4LC1DVL72L</b>	2,051.	2,222.	2,307.

Dimensions listed under w h d are actual to the nearest 1/16"

Ordering Information	Order Code	Included with:	Options
<b>Credenza with a Sliding Door and a Drawer:</b> 1. Pattern number 2. Paint finish 3. Top finish 4. Top edge finish 5. Drawer/Door finish (laminated and veneer only) 6. Drawer/Door edge finish (laminated only)	<b>Credenza with a Sliding Door and a Drawer:</b> <i>Example:</i> <b>DS4LC1DSL42L</b> <b>/117/118/117</b> <b>DS4LC1D</b> Pattern Number <b>SL42L</b> <b>117</b> Dark grey paint <b>118</b> Bright white top <b>117</b> Dark grey top edge	<b>Credenza with a Sliding Door and a Drawer:</b> <b>Note:</b> Credenzas are only available in Knoll core finishes.	<b>Credenza with a Sliding Door and a Drawer:</b> <b>Lock/No lock option</b> For non-locking credenzas with a sliding door or a drawer substitute the "L" suffix with an "N" and deduct \$40 from the list price.  <b>Note:</b> Credenzas with a drawer have a full back. Credenzas without a drawer have a partial back that encloses the binder storage area below the shelf.  <b>Paint Configuration Option:</b> Add "Y" at the end of the pattern number to specify a different paint finish on the case and fronts. P3 pricing applies on all product with dual paint finishes.

# Credenzas

## Single Depth with Veneer Top

### With or without a Sliding Door

Dividends Horizon

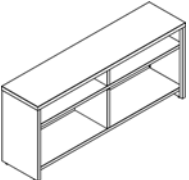
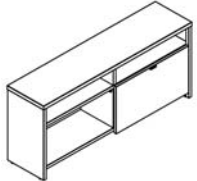
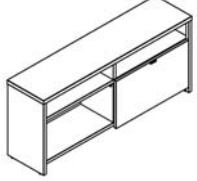
description	w	h	d	pattern no.	P1	P2	P3
 Credenza without Door	24"	24"	13 <sup>5</sup> / <sub>16</sub> "	<b>DS4LC1ANV24N</b>	\$1,316.	\$1,448.	\$1,514.
	30"	24"	13 <sup>5</sup> / <sub>16</sub> "	<b>DS4LC1ANV30N</b>	1,316.	1,448.	1,514.
	36"	24"	13 <sup>5</sup> / <sub>16</sub> "	<b>DS4LC1ANV36N</b>	1,316.	1,448.	1,514.
	42"	24"	13 <sup>5</sup> / <sub>16</sub> "	<b>DS4LC1ANV42N</b>	1,316.	1,448.	1,514.
	48"	24"	13 <sup>5</sup> / <sub>16</sub> "	<b>DS4LC1ANV48N</b>	1,347.	1,483.	1,550.
	54"	24"	13 <sup>5</sup> / <sub>16</sub> "	<b>DS4LC1ANV54N</b>	1,380.	1,517.	1,586.
	60"	24"	13 <sup>5</sup> / <sub>16</sub> "	<b>DS4LC1ANV60N</b>	1,412.	1,552.	1,622.
	66"	24"	13 <sup>5</sup> / <sub>16</sub> "	<b>DS4LC1ANV66N</b>	1,443.	1,586.	1,660.
	72"	24"	13 <sup>5</sup> / <sub>16</sub> "	<b>DS4LC1ANV72N</b>	1,475.	1,621.	1,695.
 Credenza with Steel Sliding Door	30"	24"	13 <sup>5</sup> / <sub>16</sub> "	<b>DS4LC1BSV30L</b>	1,389.	1,525.	1,594.
	36"	24"	13 <sup>5</sup> / <sub>16</sub> "	<b>DS4LC1BSV36L</b>	1,389.	1,525.	1,594.
	42"	24"	13 <sup>5</sup> / <sub>16</sub> "	<b>DS4LC1BSV42L</b>	1,389.	1,525.	1,594.
	48"	24"	13 <sup>5</sup> / <sub>16</sub> "	<b>DS4LC1BSV48L</b>	1,423.	1,563.	1,632.
	54"	24"	13 <sup>5</sup> / <sub>16</sub> "	<b>DS4LC1BSV54L</b>	1,456.	1,600.	1,671.
	60"	24"	13 <sup>5</sup> / <sub>16</sub> "	<b>DS4LC1BSV60L</b>	1,489.	1,638.	1,710.
	66"	24"	13 <sup>5</sup> / <sub>16</sub> "	<b>DS4LC1BSV66L</b>	1,523.	1,673.	1,748.
	72"	24"	13 <sup>5</sup> / <sub>16</sub> "	<b>DS4LC1BSV72L</b>	1,557.	1,710.	1,787.
 Credenza with Laminate Sliding Door	30"	24"	13 <sup>5</sup> / <sub>16</sub> "	<b>DS4LC1BLV30L</b>	1,687.	1,854.	1,936.
	36"	24"	13 <sup>5</sup> / <sub>16</sub> "	<b>DS4LC1BLV36L</b>	1,687.	1,854.	1,936.
	42"	24"	13 <sup>5</sup> / <sub>16</sub> "	<b>DS4LC1BLV42L</b>	1,687.	1,854.	1,936.
	48"	24"	13 <sup>5</sup> / <sub>16</sub> "	<b>DS4LC1BLV48L</b>	1,721.	1,891.	1,976.
	54"	24"	13 <sup>5</sup> / <sub>16</sub> "	<b>DS4LC1BLV54L</b>	1,755.	1,928.	2,014.
	60"	24"	13 <sup>5</sup> / <sub>16</sub> "	<b>DS4LC1BLV60L</b>	1,789.	1,965.	2,055.
	66"	24"	13 <sup>5</sup> / <sub>16</sub> "	<b>DS4LC1BLV66L</b>	1,823.	2,003.	2,094.
	72"	24"	13 <sup>5</sup> / <sub>16</sub> "	<b>DS4LC1BLV72L</b>	1,858.	2,041.	2,133.

Dimensions listed under w h d are actual to the nearest <sup>1</sup>/<sub>16</sub>"

Ordering Information	Order Code	Included with:	Options
<b>Credenza with Sliding Door:</b> 1. Pattern number 2. Paint finish 3. Top finish 4. Door finish (laminated and veneer) 5. Door edge finish (laminated only)	<b>Credenza with Sliding Door:</b> <i>Example:</i> <b>DS4LC1BSV42L</b> <b>/117/Y319</b> <b>DS4LC1B</b> Pattern Number <b>SV42L</b> <b>117</b> Dark grey paint <b>Y319</b> Cherry Techwood top	<b>Credenza with or without Sliding Door:</b>  <b>Note:</b> Credenzas are only available in Knoll core finishes.	<b>Credenza with or without a Sliding Door:</b>  <b>Lock/No lock option</b> For non-locking credenzas with a sliding door or a drawer, substitute the "L" suffix with an "N" and deduct \$20 from the list price.  <b>Note:</b> Credenzas with a drawer have a full back. Credenzas without a drawer have a partial back that encloses the binder storage area below the shelf.
<b>Credenza without a Sliding Door:</b> 1. Pattern number 2. Paint finish 3. Top finish	<b>Credenza without a Sliding Door:</b> <i>Example:</i> <b>DS4LC1ANV42N</b> <b>/117/Y319</b> <b>DS4LC1A</b> Pattern Number <b>NV42N</b> <b>117</b> Dark grey paint <b>Y319</b> Cherry Techwood top		<b>Paint Configuration Option:</b> Add "Y" at the end of the pattern number to specify a different paint finish on the case and fronts. P3 pricing applies on all product with dual paint finishes.

Credenzas  
*Single Depth with Veneer Top*  
*With or without a Sliding Door*

description	w	h	d	pattern no.	P1	P2	P3
 Credenza with Veneer Sliding Door	30"	24"	13 <sup>5</sup> / <sub>16</sub> "	<b>DS4LC1BVV30L</b>	\$1,775.	\$1,949.	\$2,038.
	36"	24"	13 <sup>5</sup> / <sub>16</sub> "	<b>DS4LC1BVV36L</b>	1,775.	1,949.	2,038.
	42"	24"	13 <sup>5</sup> / <sub>16</sub> "	<b>DS4LC1BVV42L</b>	1,775.	1,949.	2,038.
	48"	24"	13 <sup>5</sup> / <sub>16</sub> "	<b>DS4LC1BVV48L</b>	1,816.	1,995.	2,085.
	54"	24"	13 <sup>5</sup> / <sub>16</sub> "	<b>DS4LC1BVV54L</b>	1,857.	2,040.	2,132.
	60"	24"	13 <sup>5</sup> / <sub>16</sub> "	<b>DS4LC1BVV60L</b>	1,898.	2,085.	2,178.
	66"	24"	13 <sup>5</sup> / <sub>16</sub> "	<b>DS4LC1BVV66L</b>	1,938.	2,130.	2,226.
	72"	24"	13 <sup>5</sup> / <sub>16</sub> "	<b>DS4LC1BVV72L</b>	1,981.	2,174.	2,273.

Dimensions listed under w h d are actual to the nearest 1/16"

Ordering Information	Order Code	Included with:	Options
<b>Credenza with Sliding Door:</b> 1. Pattern number 2. Paint finish 3. Top finish 4. Door finish (laminated and veneer) 5. Door edge finish (laminated only)	<b>Credenza with Sliding Door:</b> <i>Example:</i> <b>DS4LC1BSV42L</b> <b>/117/Y319</b> <hr/> <b>DS4LC1B</b> Pattern Number <b>SV42L</b> <hr/> <b>117</b> Dark grey paint <hr/> <b>Y319</b> Cherry Techwood top <hr/>	<b>Credenza with or without Sliding Door:</b>  <b>Note:</b> Credenzas are only available in Knoll core finishes.	<b>Credenza with or without a Sliding Door:</b>  <b>Lock/No lock option</b> For non-locking credenzas with a sliding door or a drawer, substitute the "L" suffix with an "N" and deduct \$20 from the list price.  <b>Note:</b> Credenzas with a drawer have a full back. Credenzas without a drawer have a partial back that encloses the binder storage area below the shelf.  <b>Paint Configuration Option:</b> Add "Y" at the end of the pattern number to specify a different paint finish on the case and fronts. P3 pricing applies on all product with dual paint finishes.
<b>Credenza without a Sliding Door:</b> 1. Pattern number 2. Paint finish 3. Top finish	<b>Credenza without a Sliding Door:</b> <i>Example:</i> <b>DS4LC1ANV42N</b> <b>/117/Y319</b> <hr/> <b>DS4LC1A</b> Pattern Number <b>NV42N</b> <hr/> <b>117</b> Dark grey paint <hr/> <b>Y319</b> Cherry Techwood top <hr/>		

Credenzas  
Single Depth with Veneer Top  
Without a Sliding Door and with a Drawer

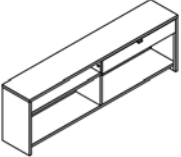
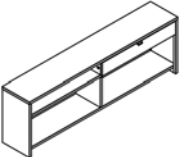
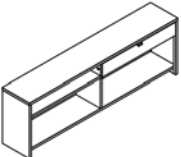
description	w	h	d	pattern no.	P1	P2	P3
	30"	24"	13 5/16"	<b>DS4LC1CSV30L</b>	\$1,636.	\$1,766.	\$1,832.
	36"	24"	13 5/16"	<b>DS4LC1CSV36L</b>	1,636.	1,766.	1,832.
	42"	24"	13 5/16"	<b>DS4LC1CSV42L</b>	1,636.	1,766.	1,832.
	48"	24"	13 5/16"	<b>DS4LC1CSV48L</b>	1,666.	1,800.	1,868.
	54"	24"	13 5/16"	<b>DS4LC1CSV54L</b>	1,697.	1,835.	1,906.
	60"	24"	13 5/16"	<b>DS4LC1CSV60L</b>	1,730.	1,870.	1,941.
	66"	24"	13 5/16"	<b>DS4LC1CSV66L</b>	1,761.	1,906.	1,979.
	72"	24"	13 5/16"	<b>DS4LC1CSV72L</b>	1,792.	1,939.	2,013.
	30"	24"	13 5/16"	<b>DS4LC1CLV30L</b>	1,814.	1,945.	2,010.
	36"	24"	13 5/16"	<b>DS4LC1CLV36L</b>	1,814.	1,945.	2,010.
	42"	24"	13 5/16"	<b>DS4LC1CLV42L</b>	1,814.	1,945.	2,010.
	48"	24"	13 5/16"	<b>DS4LC1CLV48L</b>	1,844.	1,980.	2,047.
	54"	24"	13 5/16"	<b>DS4LC1CLV54L</b>	1,876.	2,013.	2,084.
	60"	24"	13 5/16"	<b>DS4LC1CLV60L</b>	1,909.	2,049.	2,119.
	66"	24"	13 5/16"	<b>DS4LC1CLV66L</b>	1,939.	2,084.	2,157.
	72"	24"	13 5/16"	<b>DS4LC1CLV72L</b>	1,970.	2,118.	2,192.
	30"	24"	13 5/16"	<b>DS4LC1CVV30L</b>	1,852.	1,983.	2,049.
	36"	24"	13 5/16"	<b>DS4LC1CVV36L</b>	1,852.	1,983.	2,049.
	42"	24"	13 5/16"	<b>DS4LC1CVV42L</b>	1,852.	1,983.	2,049.
	48"	24"	13 5/16"	<b>DS4LC1CVV48L</b>	1,882.	2,019.	2,085.
	54"	24"	13 5/16"	<b>DS4LC1CVV54L</b>	1,914.	2,052.	2,122.
	60"	24"	13 5/16"	<b>DS4LC1CVV60L</b>	1,947.	2,087.	2,157.
	66"	24"	13 5/16"	<b>DS4LC1CVV66L</b>	1,978.	2,122.	2,195.
	72"	24"	13 5/16"	<b>DS4LC1CVV72L</b>	2,009.	2,156.	2,231.

Dimensions listed under w h d are actual to the nearest 1/16"

Ordering Information	Order Code	Included with:	Options
<b>Credenza with a Drawer:</b> 1. Pattern number 2. Paint finish 3. Top finish 4. Door finish (laminated and veneer only) 5. Door edge finish (laminated only)	<b>Credenza with a Drawer:</b> <i>Example:</i> <b>DS4LC1CSV42L /117/ Y319</b> <hr/> <b>DS4LC1C</b> Pattern Number <b>SV42L</b> <hr/> <b>117</b> Dark grey paint <hr/> <b>Y319</b> Cherry Techwood top	<b>Credenza with a Drawer:</b> <b>Note:</b> Credenzas are only available in Knoll core finishes.	<b>Credenza with a Drawer:</b> <b>Lock/No lock option</b> For non-locking credenzas with a sliding door or a drawer, substitute the "L" suffix with an "N" and deduct \$20 from the list price.  <b>Note:</b> Credenzas with a drawer have a full back. Credenzas without a drawer have a partial back that encloses the binder storage area below the shelf.  <b>Paint Configuration Option:</b> Add "Y" at the end of the pattern number to specify a different paint finish on the case and fronts. P3 pricing applies on all product with dual paint finishes.

Single Depth with Veneer Top  
With a Sliding Door and with a Drawer

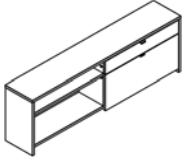
description	w	h	d	pattern no.	P1	P2	P3
 <p>Credenza with Steel Sliding Door and Drawer</p>	30"	24"	13 <sup>5</sup> / <sub>16</sub> "	<b>DS4LC1DSV30L</b>	\$1,707.	\$1,844.	\$1,912.
	36"	24"	13 <sup>5</sup> / <sub>16</sub> "	<b>DS4LC1DSV36L</b>	1,707.	1,844.	1,912.
	42"	24"	13 <sup>5</sup> / <sub>16</sub> "	<b>DS4LC1DSV42L</b>	1,707.	1,844.	1,912.
	48"	24"	13 <sup>5</sup> / <sub>16</sub> "	<b>DS4LC1DSV48L</b>	1,741.	1,881.	1,950.
	54"	24"	13 <sup>5</sup> / <sub>16</sub> "	<b>DS4LC1DSV54L</b>	1,775.	1,917.	1,989.
	60"	24"	13 <sup>5</sup> / <sub>16</sub> "	<b>DS4LC1DSV60L</b>	1,809.	1,955.	2,029.
	66"	24"	13 <sup>5</sup> / <sub>16</sub> "	<b>DS4LC1DSV66L</b>	1,842.	1,991.	2,067.
	72"	24"	13 <sup>5</sup> / <sub>16</sub> "	<b>DS4LC1DSV72L</b>	1,876.	2,029.	2,106.

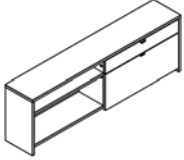
 <p>Credenza with Laminate Sliding Door and Drawer</p>	30"	24"	13 <sup>5</sup> / <sub>16</sub> "	<b>DS4LC1DLV30L</b>	2,004.	2,171.	2,255.
	36"	24"	13 <sup>5</sup> / <sub>16</sub> "	<b>DS4LC1DLV36L</b>	2,004.	2,171.	2,255.
	42"	24"	13 <sup>5</sup> / <sub>16</sub> "	<b>DS4LC1DLV42L</b>	2,004.	2,171.	2,255.
	48"	24"	13 <sup>5</sup> / <sub>16</sub> "	<b>DS4LC1DLV48L</b>	2,039.	2,208.	2,294.
	54"	24"	13 <sup>5</sup> / <sub>16</sub> "	<b>DS4LC1DLV54L</b>	2,074.	2,247.	2,333.
	60"	24"	13 <sup>5</sup> / <sub>16</sub> "	<b>DS4LC1DLV60L</b>	2,108.	2,285.	2,373.
	66"	24"	13 <sup>5</sup> / <sub>16</sub> "	<b>DS4LC1DLV66L</b>	2,140.	2,323.	2,412.
	72"	24"	13 <sup>5</sup> / <sub>16</sub> "	<b>DS4LC1DLV72L</b>	2,175.	2,360.	2,452.

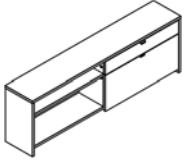
 <p>Credenza with Veneer Sliding Door and Drawer</p>	30"	24"	13 <sup>5</sup> / <sub>16</sub> "	<b>DS4LC1DVV30L</b>	2,093.	2,267.	2,357.
	36"	24"	13 <sup>5</sup> / <sub>16</sub> "	<b>DS4LC1DVV36L</b>	2,093.	2,267.	2,357.
	42"	24"	13 <sup>5</sup> / <sub>16</sub> "	<b>DS4LC1DVV42L</b>	2,093.	2,267.	2,357.
	48"	24"	13 <sup>5</sup> / <sub>16</sub> "	<b>DS4LC1DVV48L</b>	2,133.	2,314.	2,403.
	54"	24"	13 <sup>5</sup> / <sub>16</sub> "	<b>DS4LC1DVV54L</b>	2,174.	2,359.	2,451.
	60"	24"	13 <sup>5</sup> / <sub>16</sub> "	<b>DS4LC1DVV60L</b>	2,216.	2,403.	2,498.
	66"	24"	13 <sup>5</sup> / <sub>16</sub> "	<b>DS4LC1DVV66L</b>	2,257.	2,449.	2,545.
	72"	24"	13 <sup>5</sup> / <sub>16</sub> "	<b>DS4LC1DVV72L</b>	2,299.	2,494.	2,590.

Dimensions listed under w h d are actual to the nearest 1/16"

Ordering Information	Order Code	Included with:	Options
<p><b>Credenza with a Sliding Door and a Drawer:</b></p> <ol style="list-style-type: none"> <li>1. Pattern number</li> <li>2. Paint finish</li> <li>3. Top finish</li> <li>4. Drawer/Door finish (laminated and veneer only)</li> <li>5. Drawer/Door edge finish (laminated only)</li> </ol>	<p><b>Credenza with a Sliding Door and a Drawer:</b></p> <p><i>Example:</i> <b>DS4LC1SV42L /117/Y319</b></p> <hr/> <p><b>DS4LC1</b> Pattern Number</p> <hr/> <p><b>SV42L</b></p> <hr/> <p><b>117</b> Dark grey paint</p> <hr/> <p><b>Y319</b> Cherry Techwood top</p>	<p><b>Credenza with a Sliding Door and a Drawer:</b></p> <p><b>Note:</b> Credenzas are only available in Knoll core finishes.</p>	<p><b>Credenza with a Sliding Door and a Drawer:</b></p> <p><b>Lock/No lock option</b> For non-locking credenzas with a sliding door or a drawer, substitute the "L" suffix with an "N" and deduct \$40 from the list price.</p> <p><b>Note:</b> Credenzas with a drawer have a full back. Credenzas without a drawer have a partial back that encloses the binder storage area below the shelf.</p> <p><b>Paint Configuration Option:</b> Add "Y" at the end of the pattern number to specify a different paint finish on the case and fronts. P3 pricing applies on all product with dual paint finishes.</p>

# Credenzas

## Double Depth - Specifications

### Double Depth Credenzas

Dividends Horizon double depth credenzas are designed for use in various applications, including personal storage in shared workstations, space division in the open plan, and impromptu collaboration areas. Double depth credenzas offer a more unified aesthetic option, with the seamless top and end panels, when back-to-back credenzas are required.

Double depth credenzas consist of a seamless laminate or veneer top option with a shelf and binder storage area. Credenzas have four configuration options: sliding door only, drawer only, sliding door and drawer combination, and open shelves without a sliding door or a drawer. Double depth credenzas have the same configuration on both sides.

The sliding door is a single steel, laminate, or veneer door with a handle that conceals half the width of the binder storage area. A single drawer may be specified for the location above the shelf. The drawer may be installed in either the right or left location, the drawer location does not need to be specified when ordered. When a drawer is specified along with a sliding door, the drawer front and sliding door finishes are the same. A single full back panel divides the front and back sections of the credenza.

24 inch wide credenzas do not include a center vertical septum and are only available as open shelf units, without a sliding door or drawer. Units are shipped knocked down and may be specified with or without locks. Dividends Horizon credenzas are available in all Knoll Core finishes. Legacy finishes are not available.

### Available Sizes

Heights: 24 inches

Depth: 26-5/8 inches

Widths: 24 – 72 inches

### Construction

#### • Top:

- Laminate: 1-1/4 inch thick particle board with high pressure laminate on top and a paper backer on the underside with 2mm edgeband

- Veneer: 1-1/4 inch thick particle board with 0.6mm veneer on top and edge.

#### • End Panels: 16-gauge painted steel

#### • Back Panel: 20-gauge painted steel

#### • Door:

- Steel: 20-gauge panted steel

- Laminate: 3/4 inch thick particle board with high pressure laminate on the outside and a paper backer on the inside with 1mm edgeband

- Veneer 3/4 inch thick particle board with 0.6mm thick veneer on top and edge

#### • Fixed Shelf: 16-gauge painted steel

#### • Door Handle: painted aluminum (same color as case)

### Interior Dimensions

Heights: 12-1/2 inches for the lower section,

5-7/8 inches for the upper section

Depth: 12-1/16 inches

### Locks

Locks are standard on credenzas with doors and/or drawers and are keyed randomly unless otherwise specified. All locks are factory installed and have a black finish. Credenzas can also be specified without locks if required.

Double Depth Credenza  
with Open Shelves

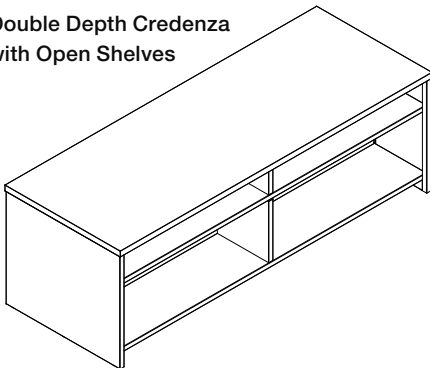

Double Depth Credenza  
with a Drawer

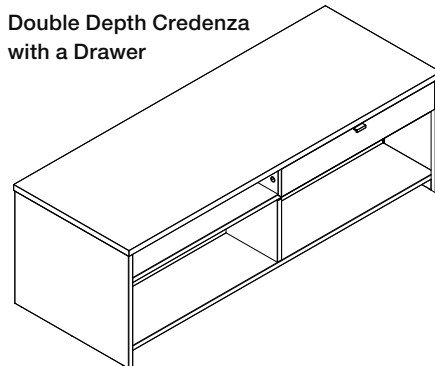

Double Depth Credenza  
with a Sliding Door

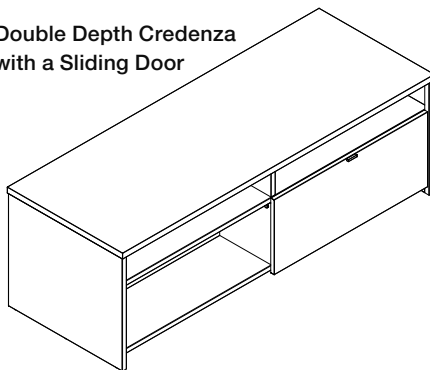

Double Depth Credenza  
with a Drawer and a  
Sliding Door

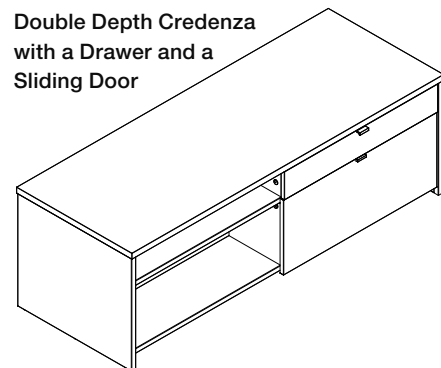





# Credenzas

## Double Depth with Laminate Top

### With or without a Sliding Door

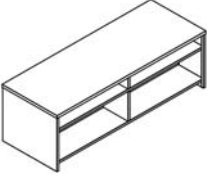
Dividends Horizon

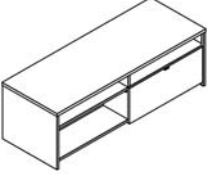
description	w	h	d	pattern no.	P1	P2	P3
 Credenza without Door	24"	24"	26 <sup>5</sup> / <sub>8</sub> "	<b>DS4LC2ANL24N</b>	\$1,721.	\$1,889.	\$1,978.
	30"	24"	26 <sup>5</sup> / <sub>8</sub> "	<b>DS4LC2ANL30N</b>	1,721.	1,889.	1,978.
	36"	24"	26 <sup>5</sup> / <sub>8</sub> "	<b>DS4LC2ANL36N</b>	1,721.	1,889.	1,978.
	42"	24"	26 <sup>5</sup> / <sub>8</sub> "	<b>DS4LC2ANL42N</b>	1,721.	1,889.	1,978.
	48"	24"	26 <sup>5</sup> / <sub>8</sub> "	<b>DS4LC2ANL48N</b>	1,767.	1,944.	2,033.
	54"	24"	26 <sup>5</sup> / <sub>8</sub> "	<b>DS4LC2ANL54N</b>	1,906.	2,096.	2,194.
	60"	24"	26 <sup>5</sup> / <sub>8</sub> "	<b>DS4LC2ANL60N</b>	1,908.	2,098.	2,196.
	66"	24"	26 <sup>5</sup> / <sub>8</sub> "	<b>DS4LC2ANL66N</b>	1,973.	2,170.	2,268.
	72"	24"	26 <sup>5</sup> / <sub>8</sub> "	<b>DS4LC2ANL72N</b>	2,039.	2,245.	2,342.
 Credenza with Steel Sliding Door	30"	24"	26 <sup>5</sup> / <sub>8</sub> "	<b>DS4LC2BSL30L</b>	1,998.	2,200.	2,300.
	36"	24"	26 <sup>5</sup> / <sub>8</sub> "	<b>DS4LC2BSL36L</b>	1,998.	2,200.	2,300.
	42"	24"	26 <sup>5</sup> / <sub>8</sub> "	<b>DS4LC2BSL42L</b>	1,998.	2,200.	2,300.
	48"	24"	26 <sup>5</sup> / <sub>8</sub> "	<b>DS4LC2BSL48L</b>	2,050.	2,256.	2,358.
	54"	24"	26 <sup>5</sup> / <sub>8</sub> "	<b>DS4LC2BSL54L</b>	2,225.	2,449.	2,556.
	60"	24"	26 <sup>5</sup> / <sub>8</sub> "	<b>DS4LC2BSL60L</b>	2,229.	2,451.	2,563.
	66"	24"	26 <sup>5</sup> / <sub>8</sub> "	<b>DS4LC2BSL66L</b>	2,300.	2,530.	2,643.
	72"	24"	26 <sup>5</sup> / <sub>8</sub> "	<b>DS4LC2BSL72L</b>	2,364.	2,601.	2,718.
 Credenza with Laminate Sliding Door	30"	24"	26 <sup>5</sup> / <sub>8</sub> "	<b>DS4LC2BLL30L</b>	2,786.	3,061.	3,197.
	36"	24"	26 <sup>5</sup> / <sub>8</sub> "	<b>DS4LC2BLL36L</b>	2,786.	3,061.	3,197.
	42"	24"	26 <sup>5</sup> / <sub>8</sub> "	<b>DS4LC2BLL42L</b>	2,786.	3,061.	3,197.
	48"	24"	26 <sup>5</sup> / <sub>8</sub> "	<b>DS4LC2BLL48L</b>	2,876.	3,155.	3,300.
	54"	24"	26 <sup>5</sup> / <sub>8</sub> "	<b>DS4LC2BLL54L</b>	2,962.	3,251.	3,397.
	60"	24"	26 <sup>5</sup> / <sub>8</sub> "	<b>DS4LC2BLL60L</b>	3,049.	3,349.	3,498.
	66"	24"	26 <sup>5</sup> / <sub>8</sub> "	<b>DS4LC2BLL66L</b>	3,136.	3,443.	3,599.
	72"	24"	26 <sup>5</sup> / <sub>8</sub> "	<b>DS4LC2BLL72L</b>	3,223.	3,541.	3,698.

Dimensions listed under w h d are actual to the nearest 1/16"

Ordering Information	Order Code	Included with:	Options
<b>Credenza with a Sliding Door:</b> 1. Pattern number 2. Paint finish 3. Top finish 4. Top edge finish 5. Door finish (laminite and veneer only) 6. Door edge finish (laminite only)	<b>Credenza with a Sliding Door:</b> Example: <b>DS4LC2BSL42L</b> <b>/117/118/117</b> <hr/> <b>DS4LC2B</b> Pattern Number <b>LL42L</b> <hr/> <b>117</b> Dark grey paint <hr/> <b>118</b> Bright white top <hr/> <b>117</b> Dark grey top edge	<b>Credenza with a Sliding Door:</b> <b>Note:</b> Credenzas are only available in Knoll core finishes.	<b>Credenza with a Sliding Door:</b> <b>Lock/No lock option</b> For non-locking credenzas with a sliding door or a drawer, substitute the "L" suffix with a "N" and deduct \$40 from the list price.  <b>Paint Configuration Option:</b> Add "Y" at the end of the pattern number to specify a different paint finish on the case and fronts. P3 pricing applies on all product with dual paint finishes.
<b>Credenza without a Sliding Door:</b> 1. Pattern number 2. Paint finish 3. Top finish 4. Top edge finish	<b>Credenza without a Sliding Door:</b> Example: <b>DS4LC2ANL42N</b> <b>/117/118/117</b> <hr/> <b>DS4LC2A</b> Pattern Number <b>NL42N</b> <hr/> <b>117</b> Dark grey paint <hr/> <b>118</b> Bright white top <hr/> <b>117</b> Dark grey top edge		

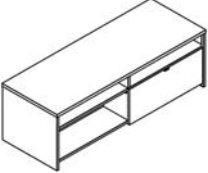

Credenzas  
*Double Depth with Laminate Top*  
*With or without a Sliding Door*

description	w	h	d	pattern no.	P1	P2	P3
	30"	24"	26 <sup>5</sup> / <sub>8</sub> "	<b>DS4LC2BVL30L</b>	\$2,962.	\$3,251.	\$3,399.
	36"	24"	26 <sup>5</sup> / <sub>8</sub> "	<b>DS4LC2BVL36L</b>	2,962.	3,251.	3,399.
	42"	24"	26 <sup>5</sup> / <sub>8</sub> "	<b>DS4LC2BVL42L</b>	2,962.	3,251.	3,399.
	48"	24"	26 <sup>5</sup> / <sub>8</sub> "	<b>DS4LC2BVL48L</b>	3,063.	3,365.	3,516.
	54"	24"	26 <sup>5</sup> / <sub>8</sub> "	<b>DS4LC2BVL54L</b>	3,164.	3,473.	3,631.
	60"	24"	26 <sup>5</sup> / <sub>8</sub> "	<b>DS4LC2BVL60L</b>	3,263.	3,586.	3,747.
	66"	24"	26 <sup>5</sup> / <sub>8</sub> "	<b>DS4LC2BVL66L</b>	3,365.	3,694.	3,864.
	72"	24"	26 <sup>5</sup> / <sub>8</sub> "	<b>DS4LC2BVL72L</b>	3,465.	3,809.	3,979.

Dimensions listed under w h d are actual to the nearest 1/16"

Ordering Information	Order Code	Included with:	Options
<b>Credenza with a Sliding Door:</b> 1. Pattern number 2. Paint finish 3. Top finish 4. Top edge finish 5. Door finish (laminated and veneer only) 6. Door edge finish (laminated only)	<b>Credenza with a Sliding Door:</b> <i>Example:</i> <b>DS4LC2BSL42L</b> <b>/117/118/117</b> <hr/> <b>DS4LC2B</b> Pattern Number <b>LL42L</b> <hr/> <b>117</b> Dark grey paint <hr/> <b>118</b> Bright white top <hr/> <b>117</b> Dark grey top edge	<b>Credenza with a Sliding Door:</b> <b>Note:</b> Credenzas are only available in Knoll core finishes.	<b>Credenza with a Sliding Door:</b> <b>Lock/No lock option</b> For non-locking credenzas with a sliding door or a drawer, substitute the "L" suffix with a "N" and deduct \$40 from the list price.  <b>Paint Configuration Option:</b> Add "Y" at the end of the pattern number to specify a different paint finish on the case and fronts. P3 pricing applies on all product with dual paint finishes.
<b>Credenza without a Sliding Door:</b> 1. Pattern number 2. Paint finish 3. Top finish 4. Top edge finish	<b>Credenza without a Sliding Door:</b> <i>Example:</i> <b>DS4LC2ANL42N</b> <b>/117/118/117</b> <hr/> <b>DS4LC2A</b> Pattern Number <b>NL42N</b> <hr/> <b>117</b> Dark grey paint <hr/> <b>118</b> Bright white top <hr/> <b>117</b> Dark grey top edge		

*Double Depth with Laminate Top  
Without a Sliding Door and with a Drawer*

description	w	h	d	pattern no.	P1	P2	P3
 <p>Credenza with Steel Drawer</p>	30"	24"	26 <sup>5</sup> / <sub>8</sub> "	DS4LC2CSL30L	\$2,358.	\$2,526.	\$2,614.
	36"	24"	26 <sup>5</sup> / <sub>8</sub> "	DS4LC2CSL36L	2,358.	2,526.	2,614.
	42"	24"	26 <sup>5</sup> / <sub>8</sub> "	DS4LC2CSL42L	2,358.	2,526.	2,614.
	48"	24"	26 <sup>5</sup> / <sub>8</sub> "	DS4LC2CSL48L	2,404.	2,580.	2,670.
	54"	24"	26 <sup>5</sup> / <sub>8</sub> "	DS4LC2CSL54L	2,542.	2,733.	2,830.
	60"	24"	26 <sup>5</sup> / <sub>8</sub> "	DS4LC2CSL60L	2,544.	2,735.	2,833.
	66"	24"	26 <sup>5</sup> / <sub>8</sub> "	DS4LC2CSL66L	2,610.	2,807.	2,905.
	72"	24"	26 <sup>5</sup> / <sub>8</sub> "	DS4LC2CSL72L	2,676.	2,882.	2,979.
 <p>Credenza with Laminate Drawer</p>	30"	24"	26 <sup>5</sup> / <sub>8</sub> "	DS4LC2CLL30L	2,714.	2,882.	2,971.
	36"	24"	26 <sup>5</sup> / <sub>8</sub> "	DS4LC2CLL36L	2,714.	2,882.	2,971.
	42"	24"	26 <sup>5</sup> / <sub>8</sub> "	DS4LC2CLL42L	2,714.	2,882.	2,971.
	48"	24"	26 <sup>5</sup> / <sub>8</sub> "	DS4LC2CLL48L	2,760.	2,937.	3,025.
	54"	24"	26 <sup>5</sup> / <sub>8</sub> "	DS4LC2CLL54L	2,898.	3,090.	3,187.
	60"	24"	26 <sup>5</sup> / <sub>8</sub> "	DS4LC2CLL60L	2,900.	3,092.	3,189.
	66"	24"	26 <sup>5</sup> / <sub>8</sub> "	DS4LC2CLL66L	2,966.	3,164.	3,261.
	72"	24"	26 <sup>5</sup> / <sub>8</sub> "	DS4LC2CLL72L	3,031.	3,237.	3,336.
 <p>Credenza with Veneer Drawer</p>	30"	24"	26 <sup>5</sup> / <sub>8</sub> "	DS4LC2CVL30L	2,790.	2,958.	3,047.
	36"	24"	26 <sup>5</sup> / <sub>8</sub> "	DS4LC2CVL36L	2,790.	2,958.	3,047.
	42"	24"	26 <sup>5</sup> / <sub>8</sub> "	DS4LC2CVL42L	2,790.	2,958.	3,047.
	48"	24"	26 <sup>5</sup> / <sub>8</sub> "	DS4LC2CVL48L	2,837.	3,013.	3,102.
	54"	24"	26 <sup>5</sup> / <sub>8</sub> "	DS4LC2CVL54L	2,975.	3,166.	3,263.
	60"	24"	26 <sup>5</sup> / <sub>8</sub> "	DS4LC2CVL60L	2,977.	3,168.	3,265.
	66"	24"	26 <sup>5</sup> / <sub>8</sub> "	DS4LC2CVL66L	3,043.	3,239.	3,338.
	72"	24"	26 <sup>5</sup> / <sub>8</sub> "	DS4LC2CVL72L	3,109.	3,315.	3,411.

Dimensions listed under w h d are actual to the nearest 1/16"

Ordering Information	Order Code	Included with:	Options
<p><b>Credenza with a Drawer:</b></p> <ol style="list-style-type: none"> <li>1. Pattern number</li> <li>2. Paint finish</li> <li>3. Top finish</li> <li>4. Top edge finish</li> <li>5. Drawer finish (laminated and veneer only)</li> <li>6. Drawer edge finish (laminated only)</li> </ol>	<p><b>Credenza with a Drawer:</b></p> <p><i>Example:</i> <b>DS4LC2CSL42L</b> <b>/117/118/117</b></p> <hr/> <p><b>DS4LC2C</b> Pattern Number</p> <hr/> <p><b>SL42L</b></p> <hr/> <p><b>117</b> Dark grey paint</p> <hr/> <p><b>118</b> Bright white top</p> <hr/> <p><b>117</b> Dark grey top edge</p>	<p><b>Credenza with a Drawer:</b></p> <p><b>Note:</b> Credenzas are only available in Knoll core finishes.</p>	<p><b>Credenza with a Drawer:</b></p> <p><b>Lock/No lock option</b> For non-locking credenzas with a sliding door or a drawer, substitute the "L" suffix with a "N" and deduct \$40 from the list price.</p> <p><b>Paint Configuration Option:</b> Add "Y" at the end of the pattern number to specify a different paint finish on the case and fronts. P3 pricing applies on all product with dual paint finishes.</p>

*Double Depth with Laminate Top  
With a Sliding Door and with a Drawer*

description	w	h	d	pattern no.	P1	P2	P3
	30"	24"	26 <sup>5</sup> / <sub>8</sub> "	<b>DS4LC2DSL30L</b>	\$2,635.	\$2,837.	\$2,937.
	36"	24"	26 <sup>5</sup> / <sub>8</sub> "	<b>DS4LC2DSL36L</b>	2,635.	2,837.	2,937.
	42"	24"	26 <sup>5</sup> / <sub>8</sub> "	<b>DS4LC2DSL42L</b>	2,635.	2,837.	2,937.
	48"	24"	26 <sup>5</sup> / <sub>8</sub> "	<b>DS4LC2DSL48L</b>	2,686.	2,892.	2,994.
	54"	24"	26 <sup>5</sup> / <sub>8</sub> "	<b>DS4LC2DSL54L</b>	2,861.	3,086.	3,193.
	60"	24"	26 <sup>5</sup> / <sub>8</sub> "	<b>DS4LC2DSL60L</b>	2,865.	3,088.	3,199.
	66"	24"	26 <sup>5</sup> / <sub>8</sub> "	<b>DS4LC2DSL66L</b>	2,937.	3,166.	3,280.
	72"	24"	26 <sup>5</sup> / <sub>8</sub> "	<b>DS4LC2DSL72L</b>	3,000.	3,237.	3,355.

	30"	24"	26 <sup>5</sup> / <sub>8</sub> "	<b>DS4LC2DLL30L</b>	3,423.	3,698.	3,834.
	36"	24"	26 <sup>5</sup> / <sub>8</sub> "	<b>DS4LC2DLL36L</b>	3,423.	3,698.	3,834.
	42"	24"	26 <sup>5</sup> / <sub>8</sub> "	<b>DS4LC2DLL42L</b>	3,423.	3,698.	3,834.
	48"	24"	26 <sup>5</sup> / <sub>8</sub> "	<b>DS4LC2DLL48L</b>	3,512.	3,791.	3,937.
	54"	24"	26 <sup>5</sup> / <sub>8</sub> "	<b>DS4LC2DLL54L</b>	3,599.	3,887.	4,033.
	60"	24"	26 <sup>5</sup> / <sub>8</sub> "	<b>DS4LC2DLL60L</b>	3,685.	3,985.	4,134.
	66"	24"	26 <sup>5</sup> / <sub>8</sub> "	<b>DS4LC2DLL66L</b>	3,773.	4,080.	4,235.
	72"	24"	26 <sup>5</sup> / <sub>8</sub> "	<b>DS4LC2DLL72L</b>	3,859.	4,178.	4,334.

	30"	24"	26 <sup>5</sup> / <sub>8</sub> "	<b>DS4LC2DVL30L</b>	3,599.	3,887.	4,036.
	36"	24"	26 <sup>5</sup> / <sub>8</sub> "	<b>DS4LC2DVL36L</b>	3,599.	3,887.	4,036.
	42"	24"	26 <sup>5</sup> / <sub>8</sub> "	<b>DS4LC2DVL42L</b>	3,599.	3,887.	4,036.
	48"	24"	26 <sup>5</sup> / <sub>8</sub> "	<b>DS4LC2DVL48L</b>	3,700.	4,002.	4,153.
	54"	24"	26 <sup>5</sup> / <sub>8</sub> "	<b>DS4LC2DVL54L</b>	3,801.	4,110.	4,267.
	60"	24"	26 <sup>5</sup> / <sub>8</sub> "	<b>DS4LC2DVL60L</b>	3,900.	4,223.	4,384.
	66"	24"	26 <sup>5</sup> / <sub>8</sub> "	<b>DS4LC2DVL66L</b>	4,002.	4,330.	4,500.
	72"	24"	26 <sup>5</sup> / <sub>8</sub> "	<b>DS4LC2DVL72L</b>	4,101.	4,445.	4,615.

Dimensions listed under w h d are actual to the nearest 1/16"



Ordering Information	Order Code	Included with:	Options
<b>Credenza with a Sliding Door and a Drawer:</b> 1. Pattern number 2. Paint finish 3. Top finish 4. Top edge finish 5. Drawer/Door finish (laminated and veneer only) 6. Drawer/Door edge finish (laminated only)	<b>Credenza with a Sliding Door and a Drawer:</b> <i>Example:</i> <b>DS4LC2DSL42L /117/118/117</b> <b>DS4LC2D</b> Pattern Number <b>SL42L</b> <b>117</b> Dark grey paint <b>118</b> Bright white top <b>117</b> Dark grey top edge	<b>Credenza with a Sliding Door and a Drawer:</b> <b>Note:</b> Credenzas are only available in Knoll core finishes.	<b>Credenza with a Sliding Door and a Drawer:</b> <b>Lock/No lock option</b> For non-locking credenzas with a sliding door or a drawer, substitute the "L" suffix with a "N" and deduct \$80 from the list price. <b>Paint Configuration Option:</b> Add "Y" at the end of the pattern number to specify a different paint finish on the case and fronts. P3 pricing applies on all product with dual paint finishes.

# Credenzas

## Double Depth with Veneer Top

### With or without a Sliding Door

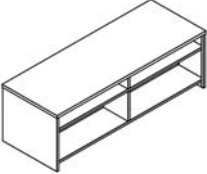
Dividends Horizon

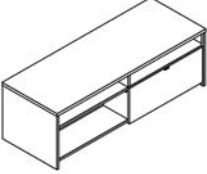
description	w	h	d	pattern no.	P1	P2	P3
 Credenza without Door	24"	24"	26 <sup>3</sup> / <sub>8</sub> "	<b>DS4LC2ANV24N</b>	\$2,633.	\$2,896.	\$3,027.
	30"	24"	26 <sup>3</sup> / <sub>8</sub> "	<b>DS4LC2ANV30N</b>	2,633.	2,896.	3,027.
	36"	24"	26 <sup>3</sup> / <sub>8</sub> "	<b>DS4LC2ANV36N</b>	2,633.	2,896.	3,027.
	42"	24"	26 <sup>3</sup> / <sub>8</sub> "	<b>DS4LC2ANV42N</b>	2,633.	2,896.	3,027.
	48"	24"	26 <sup>3</sup> / <sub>8</sub> "	<b>DS4LC2ANV48N</b>	2,696.	2,966.	3,100.
	54"	24"	26 <sup>3</sup> / <sub>8</sub> "	<b>DS4LC2ANV54N</b>	2,758.	3,034.	3,174.
	60"	24"	26 <sup>3</sup> / <sub>8</sub> "	<b>DS4LC2ANV60N</b>	2,824.	3,104.	3,243.
	66"	24"	26 <sup>3</sup> / <sub>8</sub> "	<b>DS4LC2ANV66N</b>	2,886.	3,174.	3,321.
	72"	24"	26 <sup>3</sup> / <sub>8</sub> "	<b>DS4LC2ANV72N</b>	2,950.	3,241.	3,391.
 Credenza with Steel Sliding Door	30"	24"	26 <sup>3</sup> / <sub>8</sub> "	<b>DS4LC2BSV30L</b>	2,777.	3,051.	3,187.
	36"	24"	26 <sup>3</sup> / <sub>8</sub> "	<b>DS4LC2BSV36L</b>	2,777.	3,051.	3,187.
	42"	24"	26 <sup>3</sup> / <sub>8</sub> "	<b>DS4LC2BSV42L</b>	2,777.	3,051.	3,187.
	48"	24"	26 <sup>3</sup> / <sub>8</sub> "	<b>DS4LC2BSV48L</b>	2,845.	3,126.	3,263.
	54"	24"	26 <sup>3</sup> / <sub>8</sub> "	<b>DS4LC2BSV54L</b>	2,914.	3,197.	3,342.
	60"	24"	26 <sup>3</sup> / <sub>8</sub> "	<b>DS4LC2BSV60L</b>	2,979.	3,273.	3,421.
	66"	24"	26 <sup>3</sup> / <sub>8</sub> "	<b>DS4LC2BSV66L</b>	3,047.	3,346.	3,496.
	72"	24"	26 <sup>3</sup> / <sub>8</sub> "	<b>DS4LC2BSV72L</b>	3,115.	3,421.	3,575.
 Credenza with Laminate Sliding Door	30"	24"	26 <sup>3</sup> / <sub>8</sub> "	<b>DS4LC2BLV30L</b>	3,374.	3,706.	3,872.
	36"	24"	26 <sup>3</sup> / <sub>8</sub> "	<b>DS4LC2BLV36L</b>	3,374.	3,706.	3,872.
	42"	24"	26 <sup>3</sup> / <sub>8</sub> "	<b>DS4LC2BLV42L</b>	3,374.	3,706.	3,872.
	48"	24"	26 <sup>3</sup> / <sub>8</sub> "	<b>DS4LC2BLV48L</b>	3,441.	3,781.	3,951.
	54"	24"	26 <sup>3</sup> / <sub>8</sub> "	<b>DS4LC2BLV54L</b>	3,512.	3,857.	4,029.
	60"	24"	26 <sup>3</sup> / <sub>8</sub> "	<b>DS4LC2BLV60L</b>	3,579.	3,933.	4,110.
	66"	24"	26 <sup>3</sup> / <sub>8</sub> "	<b>DS4LC2BLV66L</b>	3,645.	4,008.	4,189.
	72"	24"	26 <sup>3</sup> / <sub>16</sub> "	<b>DS4LC2BLV72L</b>	3,716.	4,082.	4,267.

Dimensions listed under w h d are actual to the nearest 1/16"

Ordering Information	Order Code	Included with:	Options
<b>Credenza with a Sliding Door:</b> 1. Pattern number 2. Paint finish 3. Top finish 4. Door finish (laminate and veneer) 5. Door edge finish (laminate only)	<b>Credenza with a Sliding Door:</b> <i>Example:</i> <b>DS4LC2BSV42L</b> <b>/117/Y319</b> <hr/> <b>DS4LC2B</b> Pattern Number <b>SV42L</b> <hr/> <b>117</b> Dark grey paint <hr/> <b>Y319</b> Cherry Techwood top	<b>Credenza with or without Sliding Door:</b>  <b>Note:</b> Credenzas are only available in Knoll core finishes.	<b>Credenza with or without a Sliding Drawer:</b>  <b>Lock/No lock option</b> For non-locking credenzas with a sliding door or a drawer, substitute the "L" suffix with a "N" and deduct \$40 from the list price.  <b>Paint Configuration Option:</b> Add "Y" at the end of the pattern number to specify a different paint finish on the case and fronts. P3 pricing applies on all product with dual paint finishes.
<b>Credenza without a Sliding Door:</b> 1. Pattern number 2. Paint finish 3. Top finish	<b>Credenza without a Sliding Door:</b> <i>Example:</i> <b>DS4LC2ASV42L</b> <b>/117/Y319</b> <hr/> <b>DS4LC2A</b> Pattern Number <b>SV42L</b> <hr/> <b>117</b> Dark grey paint <hr/> <b>Y319</b> Cherry Techwood top		

Storage Components

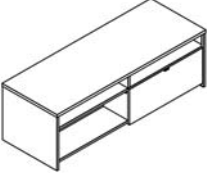

Credenzas  
*Double Depth with Veneer Top*  
*With or without a Sliding Door*

description	w	h	d	pattern no.	P1	P2	P3
 Credenza with Veneer Sliding Door	30"	24"	26 5/8"	<b>DS4LC2BVV30L</b>	\$3,550.	\$3,898.	\$4,076.
	36"	24"	26 5/8"	<b>DS4LC2BVV36L</b>	3,550.	3,898.	4,076.
	42"	24"	26 5/8"	<b>DS4LC2BVV42L</b>	3,550.	3,898.	4,076.
	48"	24"	26 5/8"	<b>DS4LC2BVV48L</b>	3,631.	3,991.	4,169.
	54"	24"	26 5/8"	<b>DS4LC2BVV54L</b>	3,714.	4,080.	4,265.
	60"	24"	26 5/8"	<b>DS4LC2BVV60L</b>	3,796.	4,169.	4,359.
	66"	24"	26 5/8"	<b>DS4LC2BVV66L</b>	3,876.	4,260.	4,454.
	72"	24"	26 5/8"	<b>DS4LC2BVV72L</b>	3,961.	4,351.	4,544.

Dimensions listed under w h d are actual to the nearest 1/16"

Ordering Information	Order Code	Included with:	Options
<b>Credenza with a Sliding Door:</b> 1. Pattern number 2. Paint finish 3. Top finish 4. Door finish (laminate and veneer) 5. Door edge finish (laminate only)	<b>Credenza with a Sliding Door:</b> <i>Example:</i> <b>DS4LC2BSV42L</b> <b>/117/Y319</b> <hr/> <b>DS4LC2B</b> Pattern Number <b>SV42L</b> <hr/> <b>117</b> Dark grey paint <hr/> <b>Y319</b> Cherry Techwood top	<b>Credenza with or without Sliding Door:</b>  <b>Note:</b> Credenzas are only available in Knoll core finishes.	<b>Credenza with or without a Sliding Drawer:</b>  <b>Lock/No lock option</b> For non-locking credenzas with a sliding door or a drawer, substitute the "L" suffix with a "N" and deduct \$40 from the list price.  <b>Paint Configuration Option:</b> Add "Y" at the end of the pattern number to specify a different paint finish on the case and fronts. P3 pricing applies on all product with dual paint finishes.
<b>Credenza without a Sliding Door:</b> 1. Pattern number 2. Paint finish 3. Top finish	<b>Credenza without a Sliding Door:</b> <i>Example:</i> <b>DS4LC2ASV42L</b> <b>/117/Y319</b> <hr/> <b>DS4LC2A</b> Pattern Number <b>SV42L</b> <hr/> <b>117</b> Dark grey paint <hr/> <b>Y319</b> Cherry Techwood top		

*Double Depth with Veneer Top  
Without a Sliding Door and with a Drawer*

description	w	h	d	pattern no.	P1	P2	P3
 <p>Credenza with Steel Drawer</p>	30"	24"	26 5/8"	<b>DS4LC2CSV30L</b>	\$3,269.	\$3,533.	\$3,664.
	36"	24"	26 5/8"	<b>DS4LC2CSV36L</b>	3,269.	3,533.	3,664.
	42"	24"	26 5/8"	<b>DS4LC2CSV42L</b>	3,269.	3,533.	3,664.
	48"	24"	26 5/8"	<b>DS4LC2CSV48L</b>	3,332.	3,603.	3,737.
	54"	24"	26 5/8"	<b>DS4LC2CSV54L</b>	3,395.	3,671.	3,811.
	60"	24"	26 5/8"	<b>DS4LC2CSV60L</b>	3,461.	3,741.	3,880.
	66"	24"	26 5/8"	<b>DS4LC2CSV66L</b>	3,523.	3,811.	3,957.
	72"	24"	26 5/8"	<b>DS4LC2CSV72L</b>	3,586.	3,878.	4,027.
 <p>Credenza with Laminate Drawer</p>	30"	24"	26 5/8"	<b>DS4LC2CLV30L</b>	3,626.	3,889.	4,021.
	36"	24"	26 5/8"	<b>DS4LC2CLV36L</b>	3,626.	3,889.	4,021.
	42"	24"	26 5/8"	<b>DS4LC2CLV42L</b>	3,626.	3,889.	4,021.
	48"	24"	26 5/8"	<b>DS4LC2CLV48L</b>	3,687.	3,959.	4,092.
	54"	24"	26 5/8"	<b>DS4LC2CLV54L</b>	3,751.	4,027.	4,167.
	60"	24"	26 5/8"	<b>DS4LC2CLV60L</b>	3,817.	4,097.	4,237.
	66"	24"	26 5/8"	<b>DS4LC2CLV66L</b>	3,878.	4,167.	4,314.
	72"	24"	26 5/8"	<b>DS4LC2CLV72L</b>	3,943.	4,235.	4,384.
 <p>Credenza with Veneer Drawer</p>	30"	24"	26 5/8"	<b>DS4LC2CVV30L</b>	3,702.	3,966.	4,097.
	36"	24"	26 5/8"	<b>DS4LC2CVV36L</b>	3,702.	3,966.	4,097.
	42"	24"	26 5/8"	<b>DS4LC2CVV42L</b>	3,702.	3,966.	4,097.
	48"	24"	26 5/8"	<b>DS4LC2CVV48L</b>	3,765.	4,036.	4,169.
	54"	24"	26 5/8"	<b>DS4LC2CVV54L</b>	3,827.	4,104.	4,244.
	60"	24"	26 5/8"	<b>DS4LC2CVV60L</b>	3,893.	4,174.	4,314.
	66"	24"	26 5/8"	<b>DS4LC2CVV66L</b>	3,955.	4,244.	4,390.
	72"	24"	26 5/8"	<b>DS4LC2CVV72L</b>	4,019.	4,312.	4,460.

Dimensions listed under w h d are actual to the nearest 1/16"

Ordering Information	Order Code	Included with:	Options
<p><b>Credenza with a Drawer:</b></p> <ol style="list-style-type: none"> <li>1. Pattern number</li> <li>2. Paint finish</li> <li>3. Top finish</li> <li>4. Door finish</li> <li>5. Door edge finish (laminates and veneer only)</li> <li>5. Door edge finish (laminates only)</li> </ol>	<p><b>Credenza with a Drawer:</b></p> <p><i>Example:</i> <b>DS4LC2CSV42L</b> <b>/117/Y319</b></p> <hr/> <p><b>DS4LC2C</b> Pattern Number <b>SV42L</b></p> <hr/> <p><b>117</b> Dark grey paint</p> <hr/> <p><b>Y319</b> Cherry Techwood top</p>	<p><b>Credenza with a Drawer:</b></p> <p><b>Note:</b> Credenzas are only available in Knoll core finishes.</p>	<p><b>Credenza with a Drawer:</b></p> <p><b>Lock/No lock option</b> For non-locking credenzas with a sliding door or a drawer, substitute the "L" suffix with a "N" and deduct \$40 from the list price.</p> <p><b>Paint Configuration Option:</b> Add "Y" at the end of the pattern number to specify a different paint finish on the case and fronts. P3 pricing applies on all product with dual paint finishes.</p>

*Double Depth with Veneer Top  
With a Sliding Door and with a Drawer*

description	w	h	d	pattern no.	P1	P2	P3
	30"	24"	26 <sup>5</sup> / <sub>8</sub> "	<b>DS4LC2DSV30L</b>	\$3,413.	\$3,687.	\$3,823.
	36"	24"	26 <sup>5</sup> / <sub>8</sub> "	<b>DS4LC2DSV36L</b>	3,413.	3,687.	3,823.
	42"	24"	26 <sup>5</sup> / <sub>8</sub> "	<b>DS4LC2DSV42L</b>	3,413.	3,687.	3,823.
	48"	24"	26 <sup>5</sup> / <sub>8</sub> "	<b>DS4LC2DSV48L</b>	3,481.	3,763.	3,900.
	54"	24"	26 <sup>5</sup> / <sub>8</sub> "	<b>DS4LC2DSV54L</b>	3,550.	3,834.	3,979.
	60"	24"	26 <sup>5</sup> / <sub>8</sub> "	<b>DS4LC2DSV60L</b>	3,615.	3,910.	4,057.
	66"	24"	26 <sup>5</sup> / <sub>8</sub> "	<b>DS4LC2DSV66L</b>	3,683.	3,983.	4,132.
	72"	24"	26 <sup>5</sup> / <sub>8</sub> "	<b>DS4LC2DSV72L</b>	3,751.	4,057.	4,212.

	30"	24"	26 <sup>5</sup> / <sub>8</sub> "	<b>DS4LC2DLV30L</b>	4,011.	4,342.	4,508.
	36"	24"	26 <sup>5</sup> / <sub>8</sub> "	<b>DS4LC2DLV36L</b>	4,011.	4,342.	4,508.
	42"	24"	26 <sup>5</sup> / <sub>8</sub> "	<b>DS4LC2DLV42L</b>	4,011.	4,342.	4,508.
	48"	24"	26 <sup>5</sup> / <sub>8</sub> "	<b>DS4LC2DLV48L</b>	4,078.	4,418.	4,588.
	54"	24"	26 <sup>5</sup> / <sub>8</sub> "	<b>DS4LC2DLV54L</b>	4,149.	4,494.	4,666.
	60"	24"	26 <sup>5</sup> / <sub>8</sub> "	<b>DS4LC2DLV60L</b>	4,216.	4,569.	4,746.
	66"	24"	26 <sup>5</sup> / <sub>8</sub> "	<b>DS4LC2DLV66L</b>	4,282.	4,644.	4,826.
	72"	24"	26 <sup>5</sup> / <sub>8</sub> "	<b>DS4LC2DLV72L</b>	4,353.	4,718.	4,904.

	30"	24"	26 <sup>5</sup> / <sub>8</sub> "	<b>DS4LC2DVV30L</b>	4,187.	4,534.	4,712.
	36"	24"	26 <sup>5</sup> / <sub>8</sub> "	<b>DS4LC2DVV36L</b>	4,187.	4,534.	4,712.
	42"	24"	26 <sup>5</sup> / <sub>8</sub> "	<b>DS4LC2DVV42L</b>	4,187.	4,534.	4,712.
	48"	24"	26 <sup>5</sup> / <sub>8</sub> "	<b>DS4LC2DVV48L</b>	4,267.	4,628.	4,806.
	54"	24"	26 <sup>5</sup> / <sub>8</sub> "	<b>DS4LC2DVV54L</b>	4,351.	4,716.	4,902.
	60"	24"	26 <sup>5</sup> / <sub>8</sub> "	<b>DS4LC2DVV60L</b>	4,432.	4,806.	4,996.
	66"	24"	26 <sup>5</sup> / <sub>8</sub> "	<b>DS4LC2DVV66L</b>	4,512.	4,897.	5,090.
	72"	24"	26 <sup>5</sup> / <sub>8</sub> "	<b>DS4LC2DVV72L</b>	4,598.	4,987.	5,181.

Dimensions listed under w h d are actual to the nearest 1/16"

Ordering Information	Order Code	Included with:	Options
<b>Credenza with a Sliding Door and a Drawer:</b> 1. Pattern number 2. Paint finish 3. Top finish 4. Drawer/Door finish (laminated and veneer only) 5. Drawer/Door edge finish (laminated only)	<b>Credenza with a Sliding Door and a Drawer:</b> <i>Example:</i> <b>DS4LC2SV42L /117/Y319</b> <b>DS4LC2D</b> Pattern Number <b>SV42L</b> <b>117</b> Dark grey paint <b>Y319</b> Cherry Techwood top	<b>Credenza with a Sliding Door and a Drawer:</b> <b>Note:</b> Credenzas are only available in Knoll core finishes.	<b>Credenza with a Sliding Door and a Drawer:</b> <b>Lock/No lock option</b> For non-locking credenzas with a sliding door or a drawer, substitute the "L" suffix with a "N" and deduct \$80 from the list price.  <b>Paint Configuration Option:</b> Add "Y" at the end of the pattern number to specify a different paint finish on the case and fronts. P3 pricing applies on all product with dual paint finishes.



**This page intentionally left blank**

### Flip-up Door Overdesk Units

Series 1 and Series 2 freestanding flip-up door overdesk units mount atop freestanding desks to provide overhead storage.

Pass-through communications or visual privacy can be obtained with a removeable privacy screen. When installed on freestanding desks, overdesks match up to 64" high panels to provide a consistent height within the facility.

Flip-up door overdesk units consist of an overhead cabinet with or without lock and enclosed back along with desk-mount stanchions. Tackable privacy screens are optional and mount between the stanchions. Overdesks 30" to 48" wide have single overhead doors while units 60" and 72" wide have double doors.

### Available Sizes

- Height: 37½"
- Depth: 13½"
- Widths: 36", 42", 48", 54", 60", 66" and 72"

### Flip-up Door Overdesk Attachment

Flip-up door overdesks can be mounted to both single and double pedestal desks. The stanchion design provides attachment directly through the top of the worksurface. In addition, overdesks can be attached virtually anywhere along the worksurface provided that proper floorstanding worksurface support is used.

### NOTE: ATTACHMENT REQUIRES DRILLING TOP OF WORKSURFACES.

### Construction

- Outer cabinet: 20-gauge steel
- Cabinet top and lower shelf: 18-gauge for 36", 42" and 48" widths and 16-gauge for 60" and 72" widths
- Overhead doors: 20-gauge painted steel
- Door end trim: Color injected, molded plastic
- Overhead door suspension: Steel ball-bearing
- Outer stanchions: 14-gauge steel
- Inner stanchions: 20-gauge steel

### Wire Management

Vertical wire management channels for task light wires are located inside stanchions and are concealed by the inner stanchion.

### Locks

Locks are standard on overdesks and keyed randomly unless otherwise specified. Other keying options include keyed alike or keyed with lock cores (K001-K250). All locks are factory-installed and are black finish. Overdesks can also be specified without locks if required.

Optional lock retrofit kits are available for field installation in flip-up door overdesks without locks at a later date if required.

### Tackable Privacy Screen

Flip-up door overdesk privacy screen provides visual privacy and a tackable surface. Privacy screens mount between flip-up door overdesk stanchions and are available in all overdesk widths.

Privacy screen construction is similar to the fabric insert used on Dividends panel frames. Two fabric wrapped inserts sandwich a honeycomb core providing both tackable and acoustic features.

**Note:** Tackable privacy screens are for use with Series 1 and Series 2 flip-up door overdesks only. They are not compatible with sliding door overdesks.

### “Touchdown” Overhead Cabinets

Touchdown overhead cabinets are equipped with hydraulic assist cylinders that allows the overhead cabinet front to gently fall to a closed position.

Retrofit mechanisms may be field added to any flip-up door overdesk.

### Task Lights

Series 1 and 2 flip-up door overdesks will accept task lights. Task lights must be ordered separately.

### Flip-Up Door Overdesk Applications

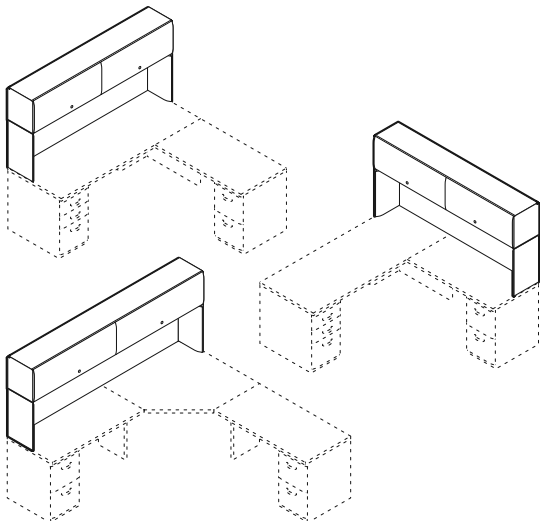

Overdesk units can span a single worksurface or two worksurfaces in “L” configuration.

### Flip-Up Door Overdesk Unit Components

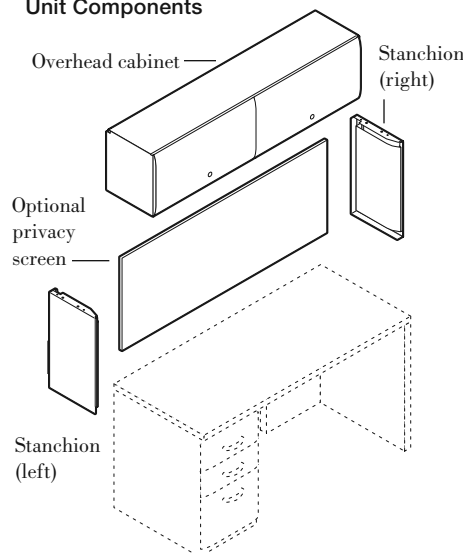

### Flip-Up Door Overdesk Size Configurations

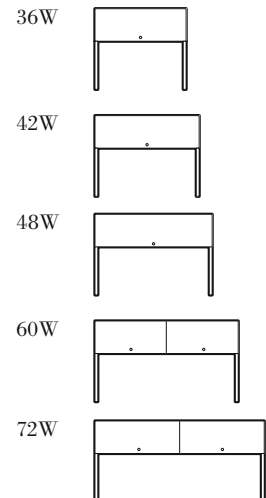

# Flip-up Door Overdesk and Tackboards

## Dividends and Series 2

Dividends Horizon

description	w	d	h	pattern no.	black	P1	P2	P3	V1-P1	V1-P2	V1-P3
Flip-Up Door Overdesk with Enclosed Back and Lock (includes Stanchions)	36"	13 1/2"	15"	<b>DD2OD 36L</b>	n/a	\$755.	\$835.	\$874.	n/a	n/a	n/a
	42"	13 1/2"	15"	<b>DD2OD 42L</b>	n/a	795.	877.	919.	n/a	n/a	n/a
	48"	13 1/2"	15"	<b>DD2OD 48L</b>	n/a	819.	903.	948.	n/a	n/a	n/a
	54"	13 1/2"	15"	<b>DD2OD 54L</b>	n/a	1,000.	1,099.	1,155.	n/a	n/a	n/a
	60"	13 1/2"	15"	<b>DD2OD 60L</b>	n/a	1,000.	1,099.	1,155.	n/a	n/a	n/a
	66"	13 1/2"	15"	<b>DD2OD 66L</b>	n/a	1,026.	1,129.	1,187.	n/a	n/a	n/a
	72"	13 1/2"	15"	<b>DD2OD 72L</b>	n/a	1,026.	1,129.	1,187.	n/a	n/a	n/a

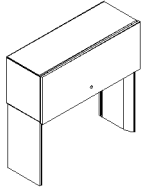

Series 2 Flip-Up Door Overdesk with Enclosed Back and Lock (includes Stanchions)	36"	13 1/2"	15"	<b>DS2OD 36L</b>	n/a	1,070.	1,231.	1,285.	1,306.	1,470.	1,521.
	42"	13 1/2"	15"	<b>DS2OD 42L</b>	n/a	1,092.	1,256.	1,310.	1,342.	1,504.	1,560.
	48"	13 1/2"	15"	<b>DS2OD 48L</b>	n/a	1,106.	1,271.	1,325.	1,391.	1,558.	1,610.
	54"	13 1/2"	15"	<b>DS2OD 54L</b>	n/a	1,347.	1,549.	1,619.	1,785.	1,989.	2,055.
	60"	13 1/2"	15"	<b>DS2OD 60L</b>	n/a	1,347.	1,549.	1,619.	1,785.	1,989.	2,055.
	66"	13 1/2"	15"	<b>DS2OD 66L</b>	n/a	1,391.	1,601.	1,668.	1,848.	2,057.	2,125.
	72"	13 1/2"	15"	<b>DS2OD 72L</b>	n/a	1,391.	1,601.	1,668.	1,848.	2,057.	2,125.

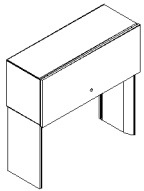

Vertical Dividers Package of 4				<b>DS1 VD</b>	93.	97.	102.	108.			
-----------------------------------	--	--	--	---------------	-----	-----	------	------	--	--	--



Ordering Information	Order Code	Included with:	Options
<b>Overdesk Cabinet</b> 1. Pattern Number 2. Paint Finish 3. Door End Cap Finish	<b>Overdesk Cabinet</b> <i>Example:</i> <b>DD2OD 48L, 613, 113</b> <b>DD2OD</b> Pattern Number <b>48L</b> <hr/> <b>613</b> Silver paint finish <hr/> <b>113</b> Dark grey door end cap finish	<b>Overdesk Cabinet</b> Stanchion mount overdesk cabinets include an enclosed back.	<b>Overdesk Cabinet</b> To specify overhead cabinet without locks, replace the "L" suffix from the pattern number with "N". For 30" to 48" wide overdesk units, <b>Deduct \$20</b> For 54", 60", 66" and 72" wide overdesk units, <b>Deduct \$40</b>  To specify Touchdown overhead cabinet, add "E" as the 2nd to last digit of the pattern number <i>Example:</i> <b>DS3PML48EL</b> <b>(Add \$157 for cabinet widths of 48" or less. Add \$314 for cabinet widths of 54" or greater).</b>  Add a "Y" to the end of the pattern number to specify a different finish for the door versus the case. Use P3 pricing for this dual finish option.

Storage Components

# Flip-up Door Overdesk and Tackboards

## *Dividends and Series 2 Tackboard*

Dividends Horizon

description	w	d	h	pattern no.	grade							
					10	15	20	25	30	35	40	45
Flip-Up Door Overdesk	36"	18"	20"	<b>DD3 PS36</b>	\$269.	\$277.	\$291.	\$296.	\$303.	\$308.	\$314.	\$323.
Tackable Privacy Screen	42"	24"	20"	<b>DD3 PS42</b>	281.	291.	304.	309.	320.	325.	330.	339.
(for Dividends and Series 2 Overdesks)	48"	30"	20"	<b>DD3 PS48</b>	293.	301.	314.	322.	330.	337.	342.	350.
	54"	36"	20"	<b>DD3 PS54</b>	313.	323.	339.	345.	353.	358.	368.	375.
	60"	42"	20"	<b>DD3 PS60</b>	313.	323.	339.	345.	353.	358.	368.	375.
	66"	42"	20"	<b>DD3 PS66</b>	339.	347.	366.	371.	381.	387.	397.	405.
	72"	48"	20"	<b>DD3 PS72</b>	339.	347.	366.	371.	381.	387.	397.	405.

### Ordering Information

#### Overdesk Tackable Privacy Screen

1. Pattern Number
2. Fabric

### Order Code

#### Overdesk Tackable Privacy Screen

*Example:* **DD3 PS48, W351-3**

**DD3 PS48** Pattern Number

**W351-3** Foundation Corn Silk

### Included with:

#### Overdesk Tackable Privacy Screen

### Options

**Note:** Flip-up Door overdesk tackable privacy screen is for use with Dividends and Series 2 Flip-up door overheads.

**This page intentionally left blank**

## Sliding Door Overdesks

The rectilinear door profile of the sliding door overdesk was designed to complement the flat profile trim details of the Dividends Horizon system. Sliding door overdesks can be used in paneled workstation configurations or freestanding office applications.

Sliding door overdesks mount atop worksurfaces to provide overhead storage. When installed on a worksurface, sliding door overdesks match up to 57" and 64" high panels to provide a consistent height within the facility. 14" or 21" high sliding door overdesks consist of a top, shelf, mid cabinet septum, end panels/stanchions, and a door with a handle.

14" high cabinets and 21" high cabinets with full doors are standard with fully enclosed backs behind the storage area. No door units and 21" high cabinets with partial doors have a partial or full back option available. Partial backs cover the upper storage section of the cabinet. Full backs enclose both the upper and lower storage section of the cabinet.

21" high cabinets are able to be specified with a full or partial door. A partial door covers the upper section of the cabinet. A full door covers both the upper and lower section of the cabinet.

### Available Sizes

- Height: 14" and 21"
- Depth: 13-1/2"
- Widths: 30", 36", 42", 48", 60", 66", and 72"

## Sliding Door Overdesks

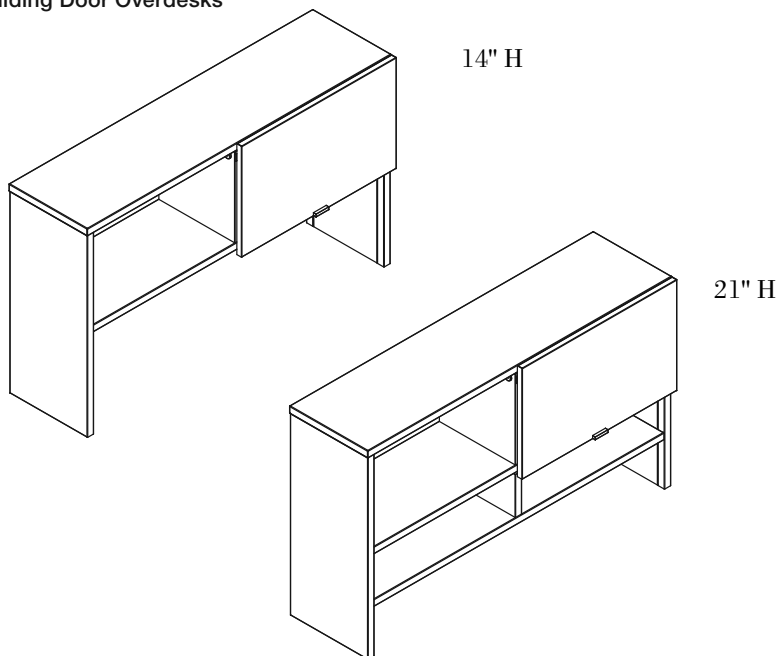

## Construction

- **Horizontal top and shelf:** 18-gauge (30" to 48" wide), 16-gauge (60" to 72" wide) painted steel
- **Sliding door:**
  - Steel: 20-gauge painted steel
  - Laminate: 3/4" particle board with high pressure laminate on the outside and a paper backer on the inside. 1mm edgeband.
  - Veneer: 3/4" thick particle board with 0.6mm thick veneer on top and edge.
- **End panels/stanchions:** 16-gauge painted steel
- **Sliding door mechanism:** integral track in top and bottom shelves with full length abs plastic extrusion. Door brackets are injection molded nylon.
- **Fixed Shelf:** 16-gauge painted steel
- **Door handle:** painted aluminum (same color as case)
- **Back panel:** 20-gauge painted steel

## Interior Dimensions

The interior dimensions of sliding door overdesks are:

- Depth: 12 1/4"
- Usable interior height: 12-1/2" high for 14"H cabinets and upper portion of 21"H cabinets; 6-1/8"H for lower portion of 21"H cabinets.
- Width: 1" shorter than exterior width

## Overdesk Attachment

Overdesks can be mounted to both single and double pedestal desks as well as panel hung worksurfaces. The stanchion design provides attachment directly through the top of the worksurface. In addition, overdesks can be attached virtually anywhere along the worksurface provided that proper worksurface support is used.

Dividends Horizon Series 3 Overdesk units are sized to the nominal dimension, and are designed for use on the width dimension of Dividends Horizon rectangular worksurfaces.

Series 3 overheads are not compatible with use on extended corner worksurfaces, or a combination of other worksurfaces that are less than the nominal dimension.

### NOTE: ATTACHMENT REQUIRES DRILLING TOP OF WORKSURFACES.

### Task Lights

Sliding door overdesks will accept task lights. Task lights must be ordered separately.

### Locks

Locks are standard on overhead cabinets and keyed randomly unless otherwise specified. All locks are factory-installed and are a black finish. Overdesks can also be specified without locks if required.

**Note:** Sliding door overdesks are only available in Knoll Core finishes.

## Interior Dimensions for 14"H Overhead

Front View, Interior Height

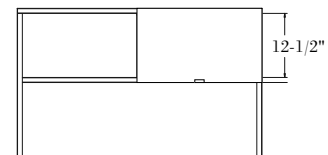

Top View, Interior Height



## Interior Dimensions for 21"H Overhead

Front View, Interior Height

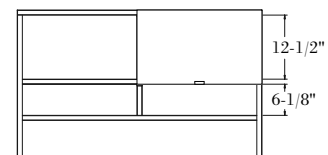

Top View, Interior Height

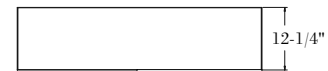

# Sliding Door Overdesks

## 57" High Cabinet with 14" High Storage, 14" High Door

Dividends Horizon

description	w	pattern no.	P1	P2	P3
57" h Overdesk without Door with 14" Tall Cabinet	30"	<b>DS3ODNS1573014</b>	\$898.	\$989.	\$1,031.
	36"	<b>DS3ODNS1573614</b>	916.	1,008.	1,053.
	42"	<b>DS3ODNS1574214</b>	933.	1,026.	1,073.
	48"	<b>DS3ODNS1574814</b>	967.	1,061.	1,110.
	60"	<b>DS3ODNS1576014</b>	1,049.	1,153.	1,205.
	66"	<b>DS3ODNS1576614</b>	1,073.	1,182.	1,235.
	72"	<b>DS3ODNS1577214</b>	1,090.	1,199.	1,252.

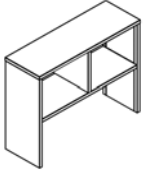

57" h Overdesk with Steel Sliding Door and 14" Tall Cabinet	30"	<b>DS3ODSS1573014L</b>	971.	1,066.	1,112.
	36"	<b>DS3ODSS1573614L</b>	993.	1,090.	1,138.
	42"	<b>DS3ODSS1574214L</b>	1,016.	1,113.	1,163.
	48"	<b>DS3ODSS1574814L</b>	1,048.	1,149.	1,201.
	60"	<b>DS3ODSS1576014L</b>	1,145.	1,260.	1,315.
	66"	<b>DS3ODSS1576614L</b>	1,175.	1,290.	1,348.
	72"	<b>DS3ODSS1577214L</b>	1,191.	1,307.	1,364.

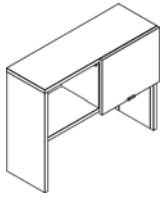

57" h Overdesk with Laminate Sliding Door and 14" Tall Cabinet	30"	<b>DS3ODSL1573014L</b>	1,282.	1,408.	1,472.
	36"	<b>DS3ODSL1573614L</b>	1,316.	1,446.	1,511.
	42"	<b>DS3ODSL1574214L</b>	1,349.	1,483.	1,549.
	48"	<b>DS3ODSL1574814L</b>	1,385.	1,519.	1,587.
	60"	<b>DS3ODSL1576014L</b>	1,418.	1,558.	1,626.
	66"	<b>DS3ODSL1576614L</b>	1,451.	1,595.	1,667.
	72"	<b>DS3ODSL1577214L</b>	1,485.	1,632.	1,706.

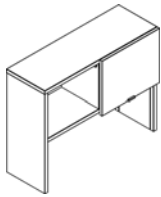

57" h Overdesk with Veneer Sliding Door and 14" Tall Cabinet	30"	<b>DS3ODSV1573014L</b>	1,350.	1,484.	1,550.
	36"	<b>DS3ODSV1573614L</b>	1,392.	1,527.	1,597.
	42"	<b>DS3ODSV1574214L</b>	1,432.	1,571.	1,643.
	48"	<b>DS3ODSV1574814L</b>	1,471.	1,615.	1,688.
	60"	<b>DS3ODSV1576014L</b>	1,511.	1,660.	1,733.
	66"	<b>DS3ODSV1576614L</b>	1,550.	1,703.	1,780.
	72"	<b>DS3ODSV1577214L</b>	1,589.	1,746.	1,825.

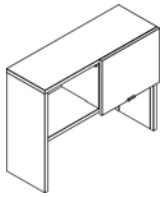

### Ordering Information

#### Sliding Door Overdesk

1. Pattern number
2. Case finish
3. Door finish

### Order Code

#### Sliding Door Overdesk

*Example:* **DS3ODSS 1573014FL, 613**

**DS3ODSS** Pattern Number  
**1573014FL**

**613** Silver Paint Finish

### Included with:

#### Sliding Door Overdesk

**Note:** Overheads are only available in Knoll core finishes.

No lock - substitute "N" for "L" at the end of pattern number, subtract \$20.

#### Paint Configuration Option:

Add "Y" at the end of the pattern number to specify a different paint finish on the case and fronts. P3 pricing applies on all product with dual paint finishes.

# Sliding Door Overdesks 57" High Cabinet with 21" High Storage (Full Height Door)

Dividends Horizon

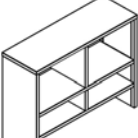
description	w	pattern no.	P1	P2	P3
 57" h without Sliding Door Overdesk with 21" Tall Cabinet	30"	<b>DS3ODNS( )573021</b>	\$968.	\$1,065.	\$1,112.
	36"	<b>DS3ODNS( )573621</b>	991.	1,090.	1,139.
	42"	<b>DS3ODNS( )574221</b>	1,015.	1,114.	1,164.
	48"	<b>DS3ODNS( )574821</b>	1,053.	1,159.	1,213.
	60"	<b>DS3ODNS( )576021</b>	1,152.	1,268.	1,326.
	66"	<b>DS3ODNS( )576621</b>	1,183.	1,302.	1,360.
	72"	<b>DS3ODNS( )577221</b>	1,202.	1,321.	1,384.

 57" h Steel Sliding Door Overdesk with 21" Tall Cabinet	30"	<b>DS3ODSS2573021FL</b>	1,105.	1,215.	1,268.
	36"	<b>DS3ODSS2573621FL</b>	1,127.	1,238.	1,292.
	42"	<b>DS3ODSS2574221FL</b>	1,159.	1,272.	1,329.
	48"	<b>DS3ODSS2574821FL</b>	1,223.	1,342.	1,402.
	60"	<b>DS3ODSS2576021FL</b>	1,343.	1,475.	1,541.
	66"	<b>DS3ODSS2576621FL</b>	1,387.	1,521.	1,592.
	72"	<b>DS3ODSS2577221FL</b>	1,416.	1,553.	1,623.

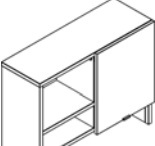
 57" h Laminate Sliding Door Overdesk with 21" Tall Cabinet	30"	<b>DS3ODSL2573021FL</b>	1,449.	1,592.	1,663.
	36"	<b>DS3ODSL2573621FL</b>	1,498.	1,647.	1,720.
	42"	<b>DS3ODSL2574221FL</b>	1,547.	1,700.	1,776.
	48"	<b>DS3ODSL2574821FL</b>	1,597.	1,754.	1,832.
	60"	<b>DS3ODSL2576021FL</b>	1,646.	1,809.	1,890.
	66"	<b>DS3ODSL2576621FL</b>	1,694.	1,863.	1,945.
	72"	<b>DS3ODSL2577221FL</b>	1,743.	1,916.	2,002.

 57" h Veneer Sliding Door Overdesk with 21" Tall Cabinet	30"	<b>DS3ODSV2573021FL</b>	1,523.	1,673.	1,748.
	36"	<b>DS3ODSV2573621FL</b>	1,582.	1,739.	1,818.
	42"	<b>DS3ODSV2574221FL</b>	1,644.	1,807.	1,886.
	48"	<b>DS3ODSV2574821FL</b>	1,702.	1,870.	1,954.
	60"	<b>DS3ODSV2576021FL</b>	1,763.	1,936.	2,024.
	66"	<b>DS3ODSV2576621FL</b>	1,822.	2,002.	2,092.
	72"	<b>DS3ODSV2577221FL</b>	1,882.	2,068.	2,161.

### Ordering Information

#### Sliding Door Overdesk

1. Pattern number
2. Case finish
3. Door finish

### Order Code

#### Sliding Door Overdesk

*Example:* **DS3ODSS 2573021FL, 613**

**DS3ODSS** Pattern Number  
**2573021FL**

**613** Silver Paint Finish

### Included with:

#### Sliding Door Overdesk

**Note:** Overheads are only available in Knoll core finishes.

### Options

No lock - substitute "N" for "L" at the end of pattern number, subtract \$20.

#### Back option for No Door units

**(1)** = Back covering overhead only  
**(2)** = Back covering overhead and shelf section

#### Paint Configuration Option:

Add "Y" at the end of the pattern number to specify a different paint finish on the case and fronts. P3 pricing applies on all product with dual paint finishes.



# Sliding Door Overdesks 57" High Cabinet with 21" High Storage (Partial Height Door)

Dividends Horizon

description	w	pattern no.	P1	P2	P3
57" h Steel Sliding Door Overdesk with 21" Tall Cabinet	30"	<b>DS3ODSS( )573021PL</b>	\$1,105.	\$1,215.	\$1,268.
	36"	<b>DS3ODSS( )573621PL</b>	1,127.	1,238.	1,292.
	42"	<b>DS3ODSS( )574221PL</b>	1,159.	1,272.	1,329.
	48"	<b>DS3ODSS( )574821PL</b>	1,223.	1,342.	1,402.
	60"	<b>DS3ODSS( )576021PL</b>	1,343.	1,475.	1,541.
	66"	<b>DS3ODSS( )576621PL</b>	1,387.	1,521.	1,592.
	72"	<b>DS3ODSS( )577221PL</b>	1,416.	1,553.	1,623.

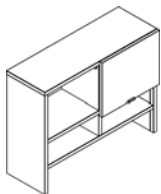

57" h Laminate Sliding Door Overdesk with 21" Tall Cabinet	30"	<b>DS3ODSL( )573021PL</b>	1,441.	1,582.	1,653.
	36"	<b>DS3ODSL( )573621PL</b>	1,489.	1,638.	1,709.
	42"	<b>DS3ODSL( )574221PL</b>	1,538.	1,689.	1,765.
	48"	<b>DS3ODSL( )574821PL</b>	1,585.	1,742.	1,821.
	60"	<b>DS3ODSL( )576021PL</b>	1,637.	1,795.	1,877.
	66"	<b>DS3ODSL( )576621PL</b>	1,684.	1,850.	1,933.
	72"	<b>DS3ODSL( )577221PL</b>	1,732.	1,903.	1,989.

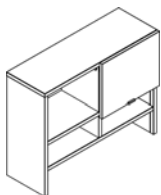

57" h Veneer Sliding Door Overdesk with 21" Tall Cabinet	30"	<b>DS3ODSV( )573021PL</b>	1,512.	1,661.	1,735.
	36"	<b>DS3ODSV( )573621PL</b>	1,566.	1,720.	1,796.
	42"	<b>DS3ODSV( )574221PL</b>	1,620.	1,781.	1,861.
	48"	<b>DS3ODSV( )574821PL</b>	1,675.	1,841.	1,923.
	60"	<b>DS3ODSV( )576021PL</b>	1,730.	1,900.	1,987.
	66"	<b>DS3ODSV( )576621PL</b>	1,785.	1,960.	2,049.
	72"	<b>DS3ODSV( )577221PL</b>	1,839.	2,022.	2,113.

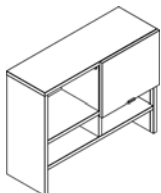

### Ordering Information

#### Sliding Door Overdesk

1. Pattern number
2. Case finish
3. Door finish

### Order Code

#### Sliding Door Overdesk

*Example:* **DS3ODSS 2573021PL, 613**

**DS3ODSS** Pattern Number  
**2573021PL**

**613** Silver Paint Finish

### Included with:

#### Sliding Door Overdesk

**Note:** Overheads are only available in Knoll core finishes.

### Options

No lock - substitute "N" for "L" at the end of pattern number, subtract \$20.

#### Back option

**(1)**= Back covering overhead only  
**(2)** = Back covering overhead and shelf section

#### Paint Configuration Option:

Add "Y" at the end of the pattern number to specify a different paint finish on the case and fronts. P3 pricing applies on all product with dual paint finishes.

# Sliding Door Overdesks 64" High Cabinet with 14" High Storage

Dividends Horizon

description	w	pattern no.	P1	P2	P3
64"h without Sliding Door Overdesk with 14" Tall Cabinet	30"	<b>DS3ODNS1643014</b>	\$930.	\$1,022.	\$1,067.
	36"	<b>DS3ODNS1643614</b>	938.	1,030.	1,076.
	42"	<b>DS3ODNS1644214</b>	968.	1,061.	1,108.
	48"	<b>DS3ODNS1644814</b>	1,052.	1,154.	1,205.
	60"	<b>DS3ODNS1646014</b>	1,084.	1,190.	1,242.
	66"	<b>DS3ODNS1646614</b>	1,108.	1,217.	1,271.
	72"	<b>DS3ODNS1647214</b>	1,123.	1,233.	1,286.

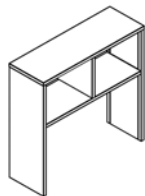

64"h Steel Sliding Door Overdesk with 14" Tall Cabinet	30"	<b>DS3ODSS1643014L</b>	981.	1,075.	1,123.
	36"	<b>DS3ODSS1643614L</b>	1,002.	1,100.	1,147.
	42"	<b>DS3ODSS1644214L</b>	1,024.	1,123.	1,173.
	48"	<b>DS3ODSS1644814L</b>	1,056.	1,160.	1,213.
	60"	<b>DS3ODSS1646014L</b>	1,155.	1,269.	1,326.
	66"	<b>DS3ODSS1646614L</b>	1,187.	1,302.	1,360.
	72"	<b>DS3ODSS1647214L</b>	1,199.	1,316.	1,373.

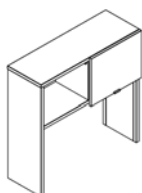

64"h Laminate Sliding Door Overdesk with 14" Tall Cabinet	30"	<b>DS3ODSL1643014L</b>	1,292.	1,419.	1,483.
	36"	<b>DS3ODSL1643614L</b>	1,327.	1,457.	1,521.
	42"	<b>DS3ODSL1644214L</b>	1,362.	1,495.	1,563.
	48"	<b>DS3ODSL1644814L</b>	1,396.	1,534.	1,603.
	60"	<b>DS3ODSL1646014L</b>	1,432.	1,571.	1,643.
	66"	<b>DS3ODSL1646614L</b>	1,466.	1,610.	1,683.
	72"	<b>DS3ODSL1647214L</b>	1,499.	1,648.	1,721.

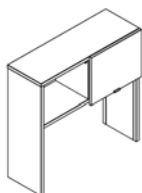

## Ordering Information

### Sliding Door Overdesk

1. Pattern number
2. Case finish
3. Door finish

## Order Code

### Sliding Door Overdesk

*Example:* **DS3ODSS 2643014FL, 613**

**DS3ODSS** Pattern Number  
**2643014FL**

**613** Silver Paint Finish

## Included with:

### Sliding Door Overdesk

**Note:** Overheads are only available in Knoll core finishes.

## Options

No lock - substitute "N" for "L" at the end of pattern number, subtract \$20.

### Paint Configuration Option:

Add "Y" at the end of the pattern number to specify a different paint finish on the case and fronts. P3 pricing applies on all product with dual paint finishes.

# Sliding Door Overdesks 64" High Cabinet with 14" High Storage

Dividends Horizon

description	w	pattern no.	P1	P2	P3
64" h Veneer Sliding Door Overdesk with 14" Tall Cabinet	30"	<b>DS3ODSV1643014L</b>	\$1,362.	\$1,496.	\$1,564.
	36"	<b>DS3ODSV1643614L</b>	1,402.	1,541.	1,610.
	42"	<b>DS3ODSV1644214L</b>	1,444.	1,585.	1,657.
	48"	<b>DS3ODSV1644814L</b>	1,484.	1,629.	1,703.
	60"	<b>DS3ODSV1646014L</b>	1,525.	1,674.	1,750.
	66"	<b>DS3ODSV1646614L</b>	1,566.	1,719.	1,796.
	72"	<b>DS3ODSV1647214L</b>	1,607.	1,763.	1,844.

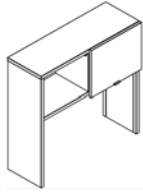

## Ordering Information

### Sliding Door Overdesk

1. Pattern number
2. Case finish
3. Door finish

## Order Code

### Sliding Door Overdesk

*Example:* **DS3ODSS 2643014FL, 613**

**DS3ODSS** Pattern Number  
**2643014FL**

**613** Silver Paint Finish

## Included with:

### Sliding Door Overdesk

**Note:** Overheads are only available in Knoll core finishes.

## Options

No lock - substitute "N" for "L" at the end of pattern number, subtract \$20.

### Paint Configuration Option:

Add "Y" at the end of the pattern number to specify a different paint finish on the case and fronts. P3 pricing applies on all product with dual paint finishes.

# Sliding Door Overdesks

## 64" High Cabinet with 21" High Storage (Full Height Door)

Dividends Horizon

description	w	pattern no.	P1	P2	P3
64"h without Sliding Door Overdesk with 21" Tall Cabinet	30"	<b>DS3ODNS( )643021</b>	\$989.	\$1,088.	\$1,136.
	36"	<b>DS3ODNS( )643621</b>	1,005.	1,105.	1,155.
	42"	<b>DS3ODNS( )644221</b>	1,030.	1,135.	1,188.
	48"	<b>DS3ODNS( )644821</b>	1,097.	1,205.	1,261.
	60"	<b>DS3ODNS( )646021</b>	1,203.	1,323.	1,385.
	66"	<b>DS3ODNS( )646621</b>	1,242.	1,365.	1,429.
	72"	<b>DS3ODNS( )647221</b>	1,270.	1,398.	1,461.

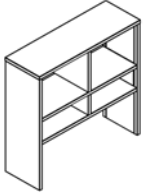

64"h Steel Sliding Door Overdesk with 21" Tall Cabinet	30"	<b>DS3ODSS2643021FL</b>	1,112.	1,222.	1,275.
	36"	<b>DS3ODSS2643621FL</b>	1,135.	1,245.	1,302.
	42"	<b>DS3ODSS2644221FL</b>	1,165.	1,279.	1,338.
	48"	<b>DS3ODSS2644821FL</b>	1,229.	1,349.	1,411.
	60"	<b>DS3ODSS2646021FL</b>	1,349.	1,483.	1,549.
	66"	<b>DS3ODSS2646621FL</b>	1,394.	1,532.	1,600.
	72"	<b>DS3ODSS2647221FL</b>	1,423.	1,563.	1,632.

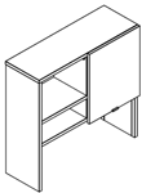

64"h Laminate Sliding Door Overdesk with 21" Tall Cabinet	30"	<b>DS3ODSL2643021FL</b>	1,463.	1,608.	1,680.
	36"	<b>DS3ODSL2643621FL</b>	1,512.	1,661.	1,735.
	42"	<b>DS3ODSL2644221FL</b>	1,561.	1,714.	1,791.
	48"	<b>DS3ODSL2644821FL</b>	1,610.	1,769.	1,848.
	60"	<b>DS3ODSL2646021FL</b>	1,659.	1,823.	1,906.
	66"	<b>DS3ODSL2646621FL</b>	1,708.	1,877.	1,960.
	72"	<b>DS3ODSL2647221FL</b>	1,757.	1,931.	2,019.

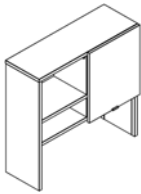

### Ordering Information

#### Sliding Door Overdesk

1. Pattern number
2. Case finish
3. Door finish

### Order Code

#### Sliding Door Overdesk

*Example:* **DS3ODSS 2643021FL, 613**

**DS3ODSS** Pattern Number  
**2643021FL**

**613** Silver Paint Finish

### Included with:

#### Sliding Door Overdesk

**Note:** Overheads are only available in Knoll core finishes.

### Options

No lock - substitute "N" for "L" at the end of pattern number, subtract \$20.

**Back option for No Door units**  
**(1)**= Back covering overhead only  
**(2)** = Back covering overhead and shelf section

#### Paint Configuration Option:

Add "Y" at the end of the pattern number to specify a different paint finish on the case and fronts. P3 pricing applies on all product with dual paint finishes.

# Sliding Door Overdesks

## 64" High Cabinet with 21" High Storage (Full Height Door)

Dividends Horizon

description	w	pattern no.	P1	P2	P3
64" h Veneer Sliding Door Overdesk with 21" Tall Cabinet	30"	<b>DS3ODSV2643021FL</b>	\$1,537.	\$1,688.	\$1,764.
	36"	<b>DS3ODSV2643621FL</b>	1,597.	1,754.	1,832.
	42"	<b>DS3ODSV2644221FL</b>	1,657.	1,820.	1,901.
	48"	<b>DS3ODSV2644821FL</b>	1,715.	1,886.	1,968.
	60"	<b>DS3ODSV2646021FL</b>	1,776.	1,950.	2,039.
	66"	<b>DS3ODSV2646621FL</b>	1,835.	2,018.	2,108.
	72"	<b>DS3ODSV2647221FL</b>	1,895.	2,083.	2,174.

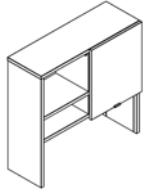

### Ordering Information

#### Sliding Door Overdesk

1. Pattern number
2. Case finish
3. Door finish

### Order Code

#### Sliding Door Overdesk

*Example:* **DS3ODSS 2643021FL, 613**

**DS3ODSS** Pattern Number  
**2643021FL**

**613** Silver Paint Finish

### Included with:

#### Sliding Door Overdesk

**Note:** Overheads are only available in Knoll core finishes.

### Options

No lock - substitute "N" for "L" at the end of pattern number, subtract \$20.

**Back option for No Door units**  
**(1)**= Back covering overhead only  
**(2)** = Back covering overhead and shelf section

**Paint Configuration Option:**  
Add "Y" at the end of the pattern number to specify a different paint finish on the case and fronts. P3 pricing applies on all product with dual paint finishes.

# Sliding Door Overdesks 64" High Cabinet with 21" High Storage (Partial Height Door)

Dividends Horizon

description	w	pattern no.	P1	P2	P3
 64" h Steel Sliding Door Overdesk with 21" Tall Cabinet	30"	<b>DS3ODSS( )643021PL</b>	\$1,112.	\$1,222.	\$1,275.
	36"	<b>DS3ODSS( )643621PL</b>	1,135.	1,245.	1,302.
	42"	<b>DS3ODSS( )644221PL</b>	1,165.	1,279.	1,338.
	48"	<b>DS3ODSS( )644821PL</b>	1,229.	1,349.	1,411.
	60"	<b>DS3ODSS( )646021PL</b>	1,349.	1,483.	1,549.
	66"	<b>DS3ODSS( )646621PL</b>	1,394.	1,532.	1,600.
	72"	<b>DS3ODSS( )647221PL</b>	1,423.	1,563.	1,632.

 64" h Laminate Sliding Door Overdesk with 21" Tall Cabinet	30"	<b>DS3ODSL( )643021PL</b>	1,453.	1,598.	1,669.
	36"	<b>DS3ODSL( )643621PL</b>	1,502.	1,651.	1,724.
	42"	<b>DS3ODSL( )644221PL</b>	1,551.	1,705.	1,781.
	48"	<b>DS3ODSL( )644821PL</b>	1,600.	1,757.	1,836.
	60"	<b>DS3ODSL( )646021PL</b>	1,649.	1,812.	1,893.
	66"	<b>DS3ODSL( )646621PL</b>	1,696.	1,865.	1,948.
	72"	<b>DS3ODSL( )647221PL</b>	1,745.	1,918.	2,004.

 64" h Veneer Sliding Door Overdesk with 21" Tall Cabinet	30"	<b>DS3ODSV( )643021PL</b>	1,525.	1,675.	1,750.
	36"	<b>DS3ODSV( )643621PL</b>	1,578.	1,736.	1,814.
	42"	<b>DS3ODSV( )644221PL</b>	1,635.	1,794.	1,876.
	48"	<b>DS3ODSV( )644821PL</b>	1,689.	1,856.	1,938.
	60"	<b>DS3ODSV( )646021PL</b>	1,743.	1,916.	2,000.
	66"	<b>DS3ODSV( )646621PL</b>	1,797.	1,976.	2,065.
	72"	<b>DS3ODSV( )647221PL</b>	1,852.	2,036.	2,128.

### Ordering Information

#### Sliding Door Overdesk

1. Pattern number
2. Case finish
3. Door finish

### Order Code

#### Sliding Door Overdesk

*Example:* **DS3ODSS 2643021PL, 613**

**DS3ODSS** Pattern Number  
**2643021PL**

**613** Silver Paint Finish

### Included with:

#### Sliding Door Overdesk

**Note:** Overheads are only available in Knoll core finishes.

### Options

No lock - substitute "N" for "L" at the end of pattern number, subtract \$20.

#### Back option

**(1)** = Back covering overhead only  
**(2)** = Back covering overhead and shelf section

#### Paint Configuration Option:

Add "Y" at the end of the pattern number to specify a different paint finish on the case and fronts. P3 pricing applies on all product with dual paint finishes.

# Sliding Door Overdesks with Tackboard

## 57" High Cabinet with 14" High Storage, 14" High Door

Dividends Horizon

description	w	pattern no.	P1	P2	P3
57" h Overdesk without Door with 14" Tall Cabinet with tackboard	30"	<b>DS3ODNS1573014T</b>	\$1,185.	\$1,276.	\$1,318.
	36"	<b>DS3ODNS1573614T</b>	1,210.	1,302.	1,347.
	42"	<b>DS3ODNS1574214T</b>	1,244.	1,337.	1,384.
	48"	<b>DS3ODNS1574814T</b>	1,287.	1,381.	1,430.
	60"	<b>DS3ODNS1576014T</b>	1,392.	1,496.	1,548.
	66"	<b>DS3ODNS1576614T</b>	1,416.	1,525.	1,578.
	72"	<b>DS3ODNS1577214T</b>	1,460.	1,569.	1,622.

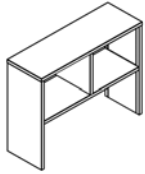

57" h Overdesk with Steel Sliding Door and 14" Tall Cabinet with tackboard	30"	<b>DS3ODSS1573014LT</b>	1,258.	1,353.	1,399.
	36"	<b>DS3ODSS1573614LT</b>	1,287.	1,384.	1,432.
	42"	<b>DS3ODSS1574214LT</b>	1,327.	1,424.	1,474.
	48"	<b>DS3ODSS1574814LT</b>	1,368.	1,469.	1,521.
	60"	<b>DS3ODSS1576014LT</b>	1,488.	1,603.	1,658.
	66"	<b>DS3ODSS1576614LT</b>	1,518.	1,633.	1,691.
	72"	<b>DS3ODSS1577214LT</b>	1,561.	1,677.	1,734.

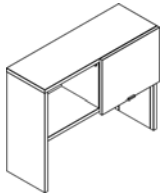

57" h Overdesk with Laminate Sliding Door and 14" Tall Cabinet with tackboard	30"	<b>DS3ODSL1573014LT</b>	1,569.	1,695.	1,759.
	36"	<b>DS3ODSL1573614LT</b>	1,610.	1,739.	1,805.
	42"	<b>DS3ODSL1574214LT</b>	1,660.	1,794.	1,860.
	48"	<b>DS3ODSL1574814LT</b>	1,705.	1,839.	1,907.
	60"	<b>DS3ODSL1576014LT</b>	1,761.	1,901.	1,969.
	66"	<b>DS3ODSL1576614LT</b>	1,794.	1,938.	2,010.
	72"	<b>DS3ODSL1577214LT</b>	1,855.	2,002.	2,076.

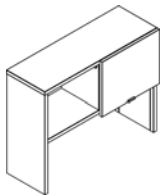

### Ordering Information

#### Sliding Door Overdesk

1. Pattern number
2. Case finish
3. Door finish
4. Tackboard fabric

### Order Code

#### Sliding Door Overdesk

*Example:* **DS3ODSS 1573014FL, 613**

**DS3ODSS** Pattern Number  
**1573014FL**

**613** Silver Paint Finish

### Included with:

#### Sliding Door Overdesk

**Note:** Overheads are only available in Knoll core finishes.

**Note:** Fabric tackboard covers from top of worksurface to bottom of lower shelf.

### Options

No lock - substitute "N" for "L" at the end of pattern number, subtract \$20.

#### Paint Configuration Option:

Add "Y" at the end of the pattern number to specify a different paint finish on the case and fronts. P3 pricing applies on all product with dual paint finishes.

# Sliding Door Overdesks with Tackboard

## 57" High Cabinet with 14" High Storage, 14" High Door

Dividends Horizon

description	w	pattern no.	P1	P2	P3
57" h Overdesk with Veneer Sliding Door and 14" Tall Cabinet with tackboard	30"	<b>DS3ODSV1573014LT</b>	\$1,637.	\$1,771.	\$1,837.
	36"	<b>DS3ODSV1573614LT</b>	1,686.	1,821.	1,891.
	42"	<b>DS3ODSV1574214LT</b>	1,743.	1,882.	1,954.
	48"	<b>DS3ODSV1574814LT</b>	1,791.	1,935.	2,008.
	60"	<b>DS3ODSV1576014LT</b>	1,854.	2,003.	2,076.
	66"	<b>DS3ODSV1576614LT</b>	1,893.	2,046.	2,123.
	72"	<b>DS3ODSV1577214LT</b>	1,959.	2,116.	2,195.

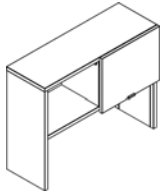

### Ordering Information

#### Sliding Door Overdesk

1. Pattern number
2. Case finish
3. Door finish
4. Tackboard fabric

### Order Code

#### Sliding Door Overdesk

*Example:* **DS3ODSS 1573014FL, 613**

**DS3ODSS** Pattern Number  
**1573014FL**

**613** Silver Paint Finish

### Included with:

#### Sliding Door Overdesk

**Note:** Overheads are only available in Knoll core finishes.

**Note:** Fabric tackboard covers from top of worksurface to bottom of lower shelf.

### Options

No lock - substitute "N" for "L" at the end of pattern number, subtract \$20.

#### Paint Configuration Option:

Add "Y" at the end of the pattern number to specify a different paint finish on the case and fronts. P3 pricing applies on all product with dual paint finishes.



# Sliding Door Overdesks with Tackboard

## 57" High Cabinet with 21" High Storage (Full Height Door)

Dividends Horizon

description	w	pattern no.	P1	P2	P3
57" h without Sliding Door Overdesk with 21" Tall Cabinet with tackboard	30"	DS3ODNS( )573021T	\$1,168.	\$1,265.	\$1,312.
	36"	DS3ODNS( )573621T	1,198.	1,297.	1,346.
	42"	DS3ODNS( )574221T	1,239.	1,338.	1,388.
	48"	DS3ODNS( )574821T	1,286.	1,392.	1,446.
	60"	DS3ODNS( )576021T	1,408.	1,524.	1,582.
	66"	DS3ODNS( )576621T	1,439.	1,558.	1,616.
	72"	DS3ODNS( )577221T	1,485.	1,604.	1,667.

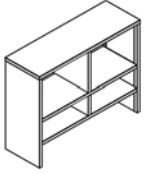

57" h Steel Sliding Door Overdesk with 21" Tall Cabinet with tackboard	30"	DS3ODSS2573021FLT	1,305.	1,415.	1,468.
	36"	DS3ODSS2573621FLT	1,334.	1,445.	1,499.
	42"	DS3ODSS2574221FLT	1,383.	1,496.	1,553.
	48"	DS3ODSS2574821FLT	1,456.	1,575.	1,635.
	60"	DS3ODSS2576021FLT	1,599.	1,731.	1,797.
	66"	DS3ODSS2576621FLT	1,643.	1,777.	1,848.
	72"	DS3ODSS2577221FLT	1,699.	1,836.	1,906.

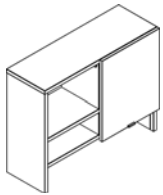

57" h Laminate Sliding Door Overdesk with 21" Tall Cabinet with tackboard	30"	DS3ODSL2573021FLT	1,649.	1,792.	1,863.
	36"	DS3ODSL2573621FLT	1,705.	1,854.	1,927.
	42"	DS3ODSL2574221FLT	1,771.	1,924.	2,000.
	48"	DS3ODSL2574821FLT	1,830.	1,987.	2,065.
	60"	DS3ODSL2576021FLT	1,902.	2,065.	2,146.
	66"	DS3ODSL2576621FLT	1,950.	2,119.	2,201.
	72"	DS3ODSL2577221FLT	2,026.	2,199.	2,285.

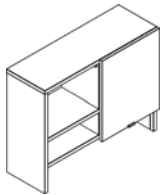

### Ordering Information

#### Sliding Door Overdesk

1. Pattern number
2. Case finish
3. Door finish
4. Tackboard fabrics

### Order Code

#### Sliding Door Overdesk

*Example:* DS3ODSS 2573021FLT, 613

DS3ODSS Pattern Number  
2573021FLT

613 Silver Paint Finish

### Included with:

#### Sliding Door Overdesk

**Note:** Overheads are only available in Knoll core finishes.

**Note:** Fabric tackboard covers from top of work surface to bottom of lower shelf.

### Options

No lock - substitute "N" for "L" at the end of pattern number, subtract \$20.

**Back option for No Door units**  
(1) = Back covering overhead only  
(2) = Back covering overhead and shelf section

#### Paint Configuration Option:

Add "Y" at the end of the pattern number to specify a different paint finish on the case and fronts. P3 pricing applies on all product with dual paint finishes.

# Sliding Door Overdesks with Tackboard

## *57" High Cabinet with 21" High Storage (Full Height Door)*

Dividends Horizon

description	w	pattern no.	P1	P2	P3
57" h Veneer Sliding Door Overdesk with 21" Tall Cabinet with tackboard	30"	<b>DS3ODSV2573021FLT</b>	\$1,723.	\$1,873.	\$1,948.
	36"	<b>DS3ODSV2573621FLT</b>	1,789.	1,946.	2,025.
	42"	<b>DS3ODSV2574221FLT</b>	1,868.	2,031.	2,110.
	48"	<b>DS3ODSV2574821FLT</b>	1,935.	2,103.	2,187.
	60"	<b>DS3ODSV2576021FLT</b>	2,019.	2,192.	2,280.
	66"	<b>DS3ODSV2576621FLT</b>	2,078.	2,258.	2,348.
	72"	<b>DS3ODSV2577221FLT</b>	2,165.	2,351.	2,444.

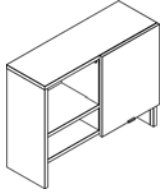

### Ordering Information

#### Sliding Door Overdesk

1. Pattern number
2. Case finish
3. Door finish
4. Tackboard fabrics

### Order Code

#### Sliding Door Overdesk

*Example:* **DS3ODSS 2573021FLT, 613**

**DS3ODSS** Pattern Number  
**2573021FLT**

**613** Silver Paint Finish

### Included with:

#### Sliding Door Overdesk

**Note:** Overheads are only available in Knoll core finishes.

**Note:** Fabric tackboard covers from top of worksurface to bottom of lower shelf.

### Options

No lock - substitute "N" for "L" at the end of pattern number, subtract \$20.

**Back option for No Door units**  
**(1)** = Back covering overhead only  
**(2)** = Back covering overhead and shelf section

**Paint Configuration Option:**  
 Add "Y" at the end of the pattern number to specify a different paint finish on the case and fronts. P3 pricing applies on all product with dual paint finishes.

# Sliding Door Overdesks with Tackboard

## 57" High Cabinet with 21" High Storage (Partial Height Door)

Dividends Horizon

description	w	pattern no.	P1	P2	P3
57" h Steel Sliding Door Overdesk with 21" Tall Cabinet with tackboard	36"	<b>DS3ODSS( )573021PLT</b>	\$1,334.	\$1,445.	\$1,499.
	36"	<b>DS3ODSS( )573621PLT</b>	1,334.	1,445.	1,499.
	42"	<b>DS3ODSS( )574221PLT</b>	1,383.	1,496.	1,553.
	48"	<b>DS3ODSS( )574821PLT</b>	1,456.	1,575.	1,635.
	60"	<b>DS3ODSS( )576021PLT</b>	1,599.	1,731.	1,797.
	66"	<b>DS3ODSS( )576621PLT</b>	1,643.	1,777.	1,848.
	72"	<b>DS3ODSS( )577221PLT</b>	1,699.	1,836.	1,906.

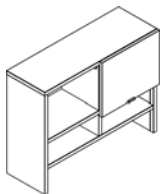

57" h Laminate Sliding Door Overdesk with 21" Tall Cabinet with tackboard	30"	<b>DS3ODSL( )573021PLT</b>	1,641.	1,782.	1,853.
	36"	<b>DS3ODSL( )573621PLT</b>	1,696.	1,845.	1,916.
	42"	<b>DS3ODSL( )574221PLT</b>	1,762.	1,913.	1,989.
	48"	<b>DS3ODSL( )574821PLT</b>	1,818.	1,975.	2,054.
	60"	<b>DS3ODSL( )576021PLT</b>	1,893.	2,051.	2,133.
	66"	<b>DS3ODSL( )576621PLT</b>	1,940.	2,106.	2,189.
	72"	<b>DS3ODSL( )577221PLT</b>	2,015.	2,186.	2,272.

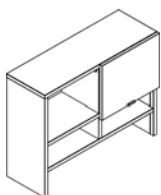

57" h Veneer Sliding Door Overdesk with 21" Tall Cabinet with tackboard	30"	<b>DS3ODSV( )573021PLT</b>	1,712.	1,861.	1,935.
	36"	<b>DS3ODSV( )573621PLT</b>	1,773.	1,927.	2,003.
	42"	<b>DS3ODSV( )574221PLT</b>	1,844.	2,005.	2,085.
	48"	<b>DS3ODSV( )574821PLT</b>	1,908.	2,074.	2,156.
	60"	<b>DS3ODSV( )576021PLT</b>	1,986.	2,156.	2,243.
	66"	<b>DS3ODSV( )576621PLT</b>	2,041.	2,216.	2,305.
	72"	<b>DS3ODSV( )577221PLT</b>	2,122.	2,305.	2,396.

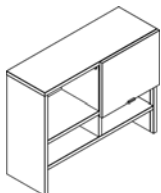

### Ordering Information

#### Sliding Door Overdesk

1. Pattern number
2. Case finish
3. Door finish
4. Tackboard fabric

### Order Code

#### Sliding Door Overdesk

*Example:* **DS3ODSS 2573021PLF, 613**

**DS3ODSS** Pattern Number  
**2573021PLF**

**613** Silver Paint Finish

### Included with:

#### Sliding Door Overdesk

**Note:** Overheads are only available in Knoll core finishes.

**Note:** Fabric tackboard covers from top of worksurface to bottom of lower shelf.

### Options

No lock - substitute "N" for "L" at the end of pattern number, subtract \$20.

**Back option for No Door units**  
**(1)** = Back covering overhead only  
**(2)** = Back covering overhead and shelf section

#### Paint Configuration Option:

Add "Y" at the end of the pattern number to specify a different paint finish on the case and fronts. P3 pricing applies on all product with dual paint finishes.

# Sliding Door Overdesks with Tackboard

## 64" High Cabinet with 14" High Storage

Dividends Horizon

description	w	pattern no.	P1	P2	P3
64" h without Sliding Door Overdesk with 14" Tall Cabinet with tackboard	30"	<b>DS3ODNS1643014T</b>	\$1,246.	\$1,338.	\$1,383.
	36"	<b>DS3ODNS1643614T</b>	1,261.	1,353.	1,399.
	42"	<b>DS3ODNS1644214T</b>	1,310.	1,403.	1,450.
	48"	<b>DS3ODNS1644814T</b>	1,404.	1,506.	1,557.
	60"	<b>DS3ODNS1646014T</b>	1,461.	1,567.	1,619.
	66"	<b>DS3ODNS1646614T</b>	1,485.	1,594.	1,648.
	72"	<b>DS3ODNS1647214T</b>	1,530.	1,640.	1,693.

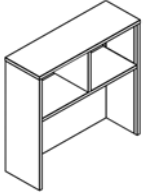

64" h Steel Sliding Door Overdesk with 14" Tall Cabinet with tackboard	30"	<b>DS3ODSS1643014LT</b>	1,297.	1,391.	1,439.
	36"	<b>DS3ODSS1643614LT</b>	1,325.	1,423.	1,470.
	42"	<b>DS3ODSS1644214LT</b>	1,366.	1,465.	1,515.
	48"	<b>DS3ODSS1644814LT</b>	1,408.	1,512.	1,565.
	60"	<b>DS3ODSS1646014LT</b>	1,532.	1,646.	1,703.
	66"	<b>DS3ODSS1646614LT</b>	1,564.	1,679.	1,737.
	72"	<b>DS3ODSS1647214LT</b>	1,606.	1,723.	1,780.

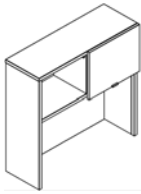

64" h Laminate Sliding Door Overdesk with 14" Tall Cabinet with tackboard	30"	<b>DS3ODSL1643014LT</b>	1,608.	1,735.	1,799.
	36"	<b>DS3ODSL1643614LT</b>	1,650.	1,780.	1,844.
	42"	<b>DS3ODSL1644214LT</b>	1,704.	1,837.	1,905.
	48"	<b>DS3ODSL1644814LT</b>	1,748.	1,886.	1,955.
	60"	<b>DS3ODSL1646014LT</b>	1,809.	1,948.	2,020.
	66"	<b>DS3ODSL1646614LT</b>	1,843.	1,987.	2,060.
	72"	<b>DS3ODSL1647214LT</b>	1,906.	2,055.	2,128.

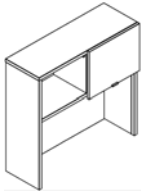

### Ordering Information

#### Sliding Door Overdesk

1. Pattern number
2. Case finish
3. Door finish
4. Tackboard fabric

### Order Code

#### Sliding Door Overdesk

*Example:* **DS3ODSS 2643014FLT, 613**

**DS3ODSS** Pattern Number  
**2643014FLT**

**613** Silver Paint Finish

### Included with:

#### Sliding Door Overdesk

**Note:** Overheads are only available in Knoll core finishes.

**Note:** Fabric tackboard covers from top of worksurface to bottom of lower shelf.

### Options

No lock - substitute "N" for "L" at the end of pattern number, subtract \$20.

#### Paint Configuration Option:

Add "Y" at the end of the pattern number to specify a different paint finish on the case and fronts. P3 pricing applies on all product with dual paint finishes.

# Sliding Door Overdesks with Tackboard

## 64" High Cabinet with 14" High Storage

Dividends Horizon

description	w	pattern no.	P1	P2	P3
64"h Veneer Sliding Door Overdesk with 14" Tall Cabinet with tackboard	30"	<b>DS3ODSV1643014LT</b>	\$1,678.	\$1,812.	\$1,880.
	36"	<b>DS3ODSV1643614LT</b>	1,725.	1,864.	1,933.
	42"	<b>DS3ODSV1644214LT</b>	1,786.	1,927.	1,999.
	48"	<b>DS3ODSV1644814LT</b>	1,836.	1,981.	2,055.
	60"	<b>DS3ODSV1646014LT</b>	1,902.	2,051.	2,127.
	66"	<b>DS3ODSV1646614LT</b>	1,943.	2,096.	2,173.
	72"	<b>DS3ODSV1647214LT</b>	2,014.	2,170.	2,251.

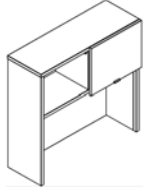

### Ordering Information

#### Sliding Door Overdesk

1. Pattern number
2. Case finish
3. Door finish
4. Tackboard fabric

### Order Code

#### Sliding Door Overdesk

*Example:* **DS3ODSS 2643014FLT, 613**

**DS3ODSS** Pattern Number  
**2643014FLT**

**613** Silver Paint Finish

### Included with:

#### Sliding Door Overdesk

**Note:** Overheads are only available in Knoll core finishes.

**Note:** Fabric tackboard covers from top of worksurface to bottom of lower shelf.

### Options

No lock - substitute "N" for "L" at the end of pattern number, subtract \$20.

#### Paint Configuration Option:

Add "Y" at the end of the pattern number to specify a different paint finish on the case and fronts. P3 pricing applies on all product with dual paint finishes.

# Sliding Door Overdesks with Tackboard

## 64" High Cabinet with 21" High Storage (Full Height Door)

Dividends Horizon

description	w	pattern no.	P1	P2	P3
64"h without Sliding Door Overdesk with 21" Tall Cabinet with tackboard	30"	<b>DS3ODNS( )643021T</b>	\$1,276.	\$1,375.	\$1,423.
	36"	<b>DS3ODNS( )643621T</b>	1,299.	1,399.	1,449.
	42"	<b>DS3ODNS( )644221T</b>	1,341.	1,446.	1,499.
	48"	<b>DS3ODNS( )644821T</b>	1,417.	1,525.	1,581.
	60"	<b>DS3ODNS( )646021T</b>	1,546.	1,666.	1,728.
	66"	<b>DS3ODNS( )646621T</b>	1,585.	1,708.	1,772.
	72"	<b>DS3ODNS( )647221T</b>	1,640.	1,768.	1,831.

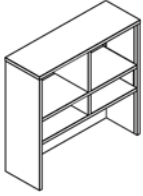

64"h Steel Sliding Door Overdesk with 21" Tall Cabinet with tackboard	30"	<b>DS3ODSS2643021FLT</b>	1,399.	1,509.	1,562.
	36"	<b>DS3ODSS2643621FLT</b>	1,429.	1,539.	1,596.
	42"	<b>DS3ODSS2644221FLT</b>	1,476.	1,590.	1,649.
	48"	<b>DS3ODSS2644821FLT</b>	1,549.	1,669.	1,731.
	60"	<b>DS3ODSS2646021FLT</b>	1,692.	1,826.	1,892.
	66"	<b>DS3ODSS2646621FLT</b>	1,737.	1,875.	1,943.
	72"	<b>DS3ODSS2647221FLT</b>	1,793.	1,933.	2,002.

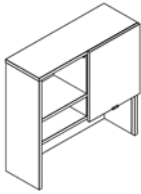

64"h Laminate Sliding Door Overdesk with 21" Tall Cabinet with tackboard	30"	<b>DS3ODSL2643021FLT</b>	1,750.	1,895.	1,967.
	36"	<b>DS3ODSL2643621FLT</b>	1,806.	1,955.	2,029.
	42"	<b>DS3ODSL2644221FLT</b>	1,872.	2,025.	2,102.
	48"	<b>DS3ODSL2644821FLT</b>	1,930.	2,089.	2,168.
	60"	<b>DS3ODSL2646021FLT</b>	2,002.	2,166.	2,249.
	66"	<b>DS3ODSL2646621FLT</b>	2,051.	2,220.	2,303.
	72"	<b>DS3ODSL2647221FLT</b>	2,127.	2,301.	2,389.

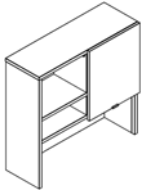

Ordering Information	Order Code	Included with:	Options
<b>Sliding Door Overdesk</b> 1. Pattern number 2. Case finish 3. Door finish 4. Tackboard fabric	<b>Sliding Door Overdesk</b> <i>Example:</i> <b>DS3ODSS 2643021FLT, 613</b> <hr/> <b>DS3ODSS</b> Pattern Number <b>2643021FLT</b> <hr/> <b>613</b> Silver Paint Finish	<b>Sliding Door Overdesk</b> <b>Note:</b> Overheads are only available in Knoll core finishes.  <b>Note:</b> Fabric tackboard covers from top of worksurface to bottom of lower shelf.	No lock - substitute "N" for "L" at the end of pattern number, subtract \$20.  <b>Back option for No Door units</b> <b>(1)</b> = Back covering overhead only <b>(2)</b> = Back covering overhead and shelf section  <b>Paint Configuration Option:</b> Add "Y" at the end of the pattern number to specify a different paint finish on the case and fronts. P3 pricing applies on all product with dual paint finishes.

# Sliding Door Overdesks with Tackboard

## 64" High Cabinet with 21" High Storage (Full Height Door)

Dividends Horizon

description	w	pattern no.	P1	P2	P3
64" h Veneer Sliding Door Overdesk with 21" Tall Cabinet with tackboard	30"	<b>DS3ODSV2643021FLT</b>	\$1,824.	\$1,975.	\$2,051.
	36"	<b>DS3ODSV2643621FLT</b>	1,891.	2,048.	2,126.
	42"	<b>DS3ODSV2644221FLT</b>	1,968.	2,131.	2,212.
	48"	<b>DS3ODSV2644821FLT</b>	2,035.	2,206.	2,288.
	60"	<b>DS3ODSV2646021FLT</b>	2,119.	2,293.	2,382.
	66"	<b>DS3ODSV2646621FLT</b>	2,178.	2,361.	2,451.
	72"	<b>DS3ODSV2647221FLT</b>	2,265.	2,453.	2,544.

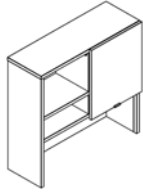

### Ordering Information

#### Sliding Door Overdesk

1. Pattern number
2. Case finish
3. Door finish
4. Tackboard fabric

### Order Code

#### Sliding Door Overdesk

*Example:* **DS3ODSS 2643021FLT, 613**

**DS3ODSS** Pattern Number  
**2643021FLT**

**613** Silver Paint Finish

### Included with:

#### Sliding Door Overdesk

**Note:** Overheads are only available in Knoll core finishes.

**Note:** Fabric tackboard covers from top of worksurface to bottom of lower shelf.

### Options

No lock - substitute "N" for "L" at the end of pattern number, subtract \$20.

**Back option for No Door units**  
**(1)** = Back covering overhead only  
**(2)** = Back covering overhead and shelf section

**Paint Configuration Option:**  
Add "Y" at the end of the pattern number to specify a different paint finish on the case and fronts. P3 pricing applies on all product with dual paint finishes.

# Sliding Door Overdesks with Tackboard

## 64" High Cabinet with 21" High Storage (Partial Height Door)

Dividends Horizon

description	w	pattern no.	P1	P2	P3
64" h Steel Sliding Door Overdesk with 21" Tall Cabinet with tackboard	30"	<b>DS3ODSS( )643021PLT</b>	\$1,399.	\$1,509.	\$1,562.
	36"	<b>DS3ODSS( )643621PLT</b>	1,429.	1,539.	1,596.
	42"	<b>DS3ODSS( )644221PLT</b>	1,476.	1,590.	1,649.
	48"	<b>DS3ODSS( )644821PLT</b>	1,549.	1,669.	1,731.
	60"	<b>DS3ODSS( )646021PLT</b>	1,692.	1,826.	1,892.
	66"	<b>DS3ODSS( )646621PLT</b>	1,737.	1,875.	1,943.
	72"	<b>DS3ODSS( )647221PLT</b>	1,793.	1,933.	2,002.

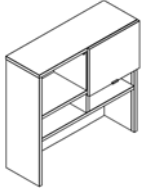

64" h Laminate Sliding Door Overdesk with 21" Tall Cabinet with tackboard	30"	<b>DS3ODSL( )643021PLT</b>	1,740.	1,885.	1,956.
	36"	<b>DS3ODSL( )643621PLT</b>	1,796.	1,945.	2,018.
	42"	<b>DS3ODSL( )644221PLT</b>	1,862.	2,016.	2,092.
	48"	<b>DS3ODSL( )644821PLT</b>	1,920.	2,077.	2,156.
	60"	<b>DS3ODSL( )646021PLT</b>	1,992.	2,155.	2,236.
	66"	<b>DS3ODSL( )646621PLT</b>	2,039.	2,208.	2,291.
	72"	<b>DS3ODSL( )647221PLT</b>	2,115.	2,288.	2,374.

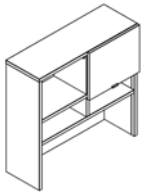

64" h Veneer Sliding Door Overdesk with 21" Tall Cabinet with tackboard	30"	<b>DS3ODSV( )643021PLT</b>	1,812.	1,962.	2,037.
	36"	<b>DS3ODSV( )643621PLT</b>	1,872.	2,030.	2,108.
	42"	<b>DS3ODSV( )644221PLT</b>	1,946.	2,105.	2,187.
	48"	<b>DS3ODSV( )644821PLT</b>	2,009.	2,176.	2,258.
	60"	<b>DS3ODSV( )646021PLT</b>	2,086.	2,259.	2,343.
	66"	<b>DS3ODSV( )646621PLT</b>	2,140.	2,319.	2,408.
	72"	<b>DS3ODSV( )647221PLT</b>	2,222.	2,406.	2,498.

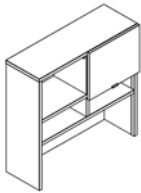

Ordering Information	Order Code	Included with:	Options
<b>Sliding Door Overdesk</b> 1. Pattern number 2. Case finish 3. Door finish 4. Tackboard fabric	<b>Sliding Door Overdesk</b> <i>Example:</i> <b>DS3ODSS 2643021PLT, 613</b> <hr/> <b>DS3ODSS</b> Pattern Number <b>2643021PLT</b> <hr/> <b>613</b> Silver Paint Finish	<b>Sliding Door Overdesk</b> <b>Note:</b> Overheads are only available in Knoll core finishes.  <b>Note:</b> Fabric tackboard covers from top of worksurface to bottom of lower shelf.	No lock - substitute "N" for "L" at the end of pattern number, subtract \$20.  <b>Back option for No Door units</b> <b>(1)</b> = Back covering overhead only <b>(2)</b> = Back covering overhead and shelf section  <b>Paint Configuration Option:</b> Add "Y" at the end of the pattern number to specify a different paint finish on the case and fronts. P3 pricing applies on all product with dual paint finishes.



**This page intentionally left blank**

### Available Worksurface Styles

- Rectangular
- Rectilinear corner
- Split top corner
- Curvilinear corner
- Trapezoid
- Smooth wave
- Curvilinear wave end
- Half-round
- Quarter-round
- Blended "D" shape
- "D" shape peninsula
- "P" and "G" shape peninsula
- Counter Worksurfaces
- Transition

### Universal Applications

The undersides of worksurfaces are pre-drilled to accept various panel-hung and freestanding supports. Cascade edge worksurfaces do not have pre-drilled holes.

All supports must be ordered separately.

In panel-hung applications, worksurfaces are supported by:

- Cantilevers
- Pedestals
- Panel-to-worksurface brackets
- Flat brackets
- Panel-mounted C-leg support
- Open support legs

In peninsula applications, worksurfaces are supported by panels on one end and the other end is supported by:

- Support column
- A leg
- T support base

For freestanding applications, worksurface support is provided by:

- Pedestals
- End units
- Flat brackets

### Construction

#### Laminate

- Surface material: .028 high-pressure laminate on top surface with a paper backer on under side
- Edge material: 2mm ABS on straight and curved surfaces
- Core material: 45 lb. density particle board
- Thickness: 1 1/4"

#### Techwood

- Surface material: 0.6mm veneer
- Edge material: 0.6mm veneer on straight and curved surfaces
- Core material: 45 lb. density particle board
- Thickness: 1 1/4"

For available sizes, refer to the individual worksurface categories within this section.

### Optional Edge Grommets

Edge grommets are optional and can be specified factory-installed centered along the

rear edge of rectangular, rectilinear corner, curvilinear wave end, and curvilinear corner worksurfaces. Grommets can also be retrofitted to worksurfaces by ordering an edge grommet kit (pattern number D1WSG). The edge grommet kit allows grommets to be field-installed in any location along the rear edge of worksurfaces.

**Note:** Edge grommets on 'D', 'G', and 'P' peninsula worksurfaces are located on the panel hung side.

### Cable Management

A 1/2" reveal is provided between the worksurface and panel for cable management. When edge grommets are specified, the grommet works in conjunction with the 1/2" reveal to allow plugs to be inserted through the grommet and cables to be positioned anywhere along the rear edge of the worksurface.

### Loading Capacities

Maximum weight allowed for worksurfaces:

- 24"-42" wide: 200 lbs.
- 48" wide: 216 lbs.
- 54" wide: 243 lbs.
- 60" wide: 270 lbs.
- 66" wide: 297 lbs.
- 72" wide: 324 lbs.
- 78" wide: 351 lbs.
- 84" wide: 378 lbs.
- 90" wide: 405 lbs.
- 96" wide: 432 lbs.

**Note:** Installations which violate these requirements will not be covered by the Knoll, Inc. warranty.

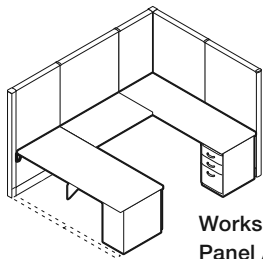

Worksurfaces and Supports, Panel Application

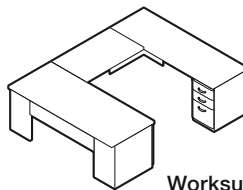

Worksurfaces and Supports, Freestanding Application

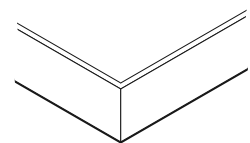

2mm ABS Edge Detail

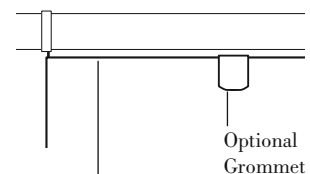
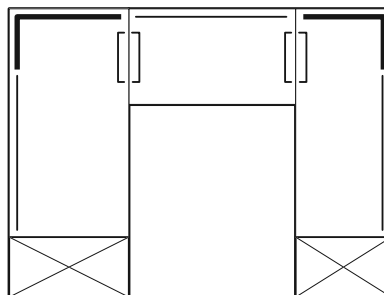
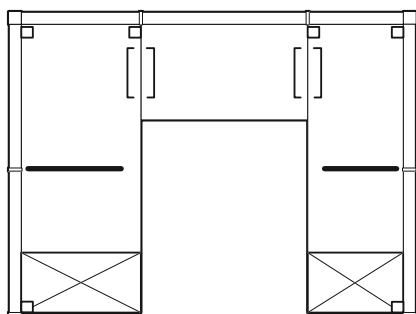

1/2" Cable Management Reveal  
Optional Grommet  
Worksurface Cable Management

### Laminate Worksurface Grain Direction

The standard grain direction for wood grain or brushed laminates for each worksurface shape is shown below.

When wood grain or brushed laminates are specified on Dividends Horizon corner worksurfaces, a left, right or diagonal grain direction option must be specified as shown below. Insert the desired grain direction option (L, R or D) after the laminate finish code. The diagonal option is an upcharge. This option applies only to corner worksurfaces with the same dimension on each rear side.

### Techwood Worksurface Grain Direction

The standard grain direction for Techwood worksurfaces for each worksurface shape is shown below.

Techwood corner worksurfaces with the same dimension on each rear side have a diagonal grain direction.

### Laminate Worksurface Grain Direction

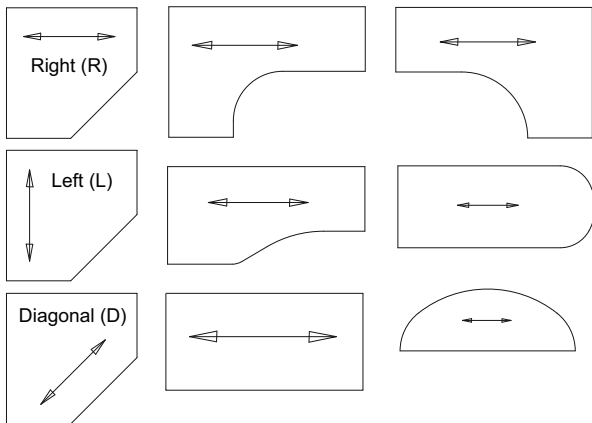

### Techwood Worksurface Grain Direction

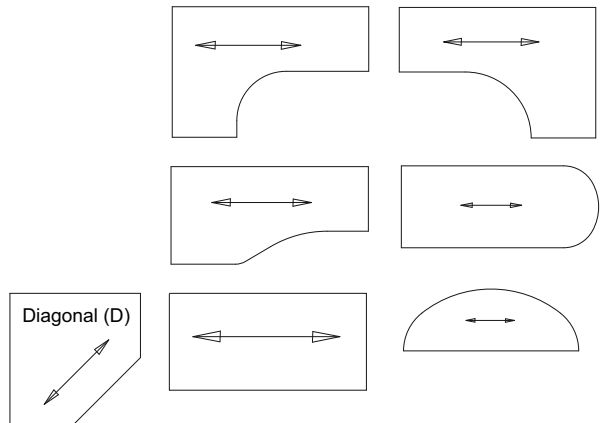

### Panel-Hung Worksurface Support

All worksurfaces require support every 48" in width. In panel-hung applications, mid-span support must be provided by cantilevers, panel-mounted C-legs or open support legs.

When worksurfaces are mounted perpendicular to panels, the worksurface depth must equal the width of the panel when using panel-to-worksurface brackets.

Cantilevers are available in three depths to match worksurface depths.

- 18" deep worksurfaces are supported by 18" deep cantilevers.
- 24" deep worksurfaces are supported by 24" deep cantilevers.
- 30" deep worksurfaces are not recommended to be supported by cantilevers. 30" deep cantilevers are used for mid-span support.
- 36" deep worksurfaces cannot be supported by cantilevers.

Panel-mounted C-leg supports are available to support 24" and 30" worksurface depths in heavier worksurface load applications.

Open support legs are available to support 18", 24" and 30" worksurfaces depths.

### Freestanding Worksurface Support

For freestanding desk applications, specify freestanding pedestals, end units and/or intermediate support every 48" in width.

- 18" deep worksurfaces can be supported by 18" deep pedestals and end units only
- 24" deep worksurfaces can be supported by either 18" or 24" deep pedestals or end units
- 30" deep worksurfaces can be supported by either 24" or 30" deep pedestals or end units
- 36" deep worksurfaces can only be supported by 30" deep pedestals or end units and provide a 6" front overhang for desk applications.

### Maximum Width Between Panel-Hung Worksurface Supports

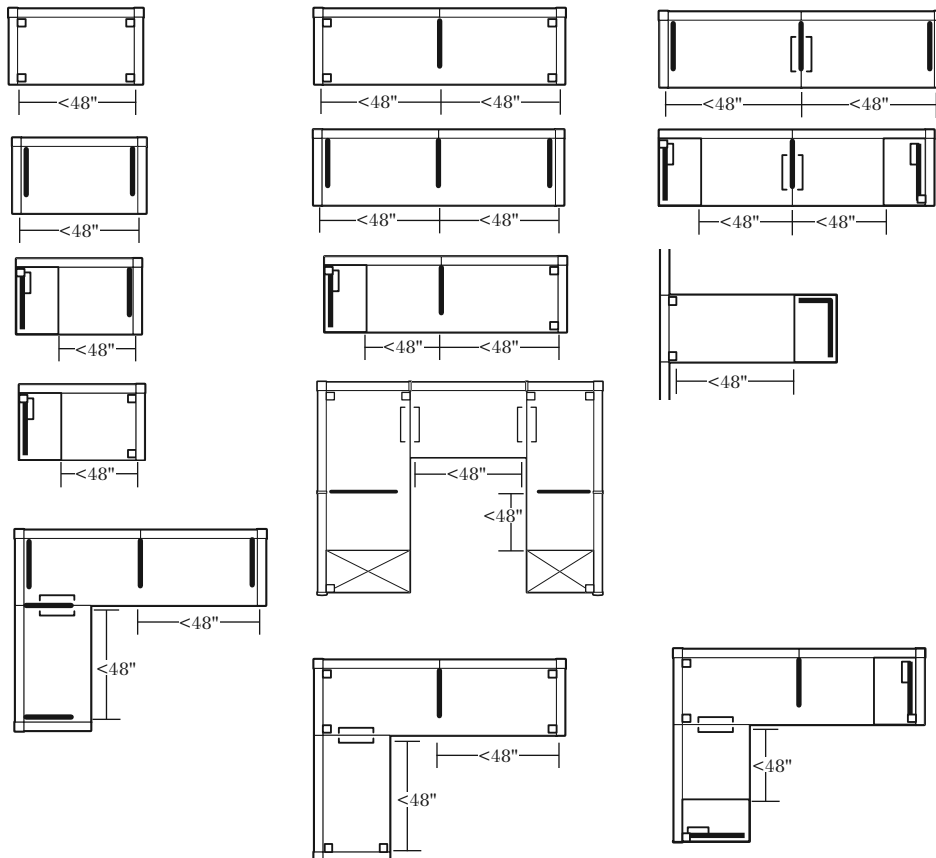

### Maximum Width Between Freestanding Worksurface Supports

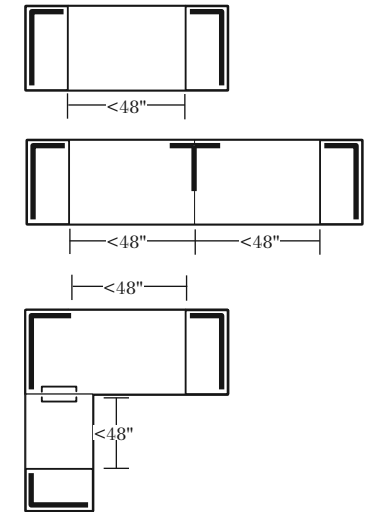









### Worksurface Reinforcement

Worksurface reinforcements are required for worksurface spans greater than 48 inches. This includes freestanding desk worksurfaces over 48 inches using desk end units. Worksurface reinforcements have a black paint finish.

### Notes:

- Whenever using pedestals they should be connected to panels with panel-to-worksurface brackets
- Panel runs must be floor-supported every 8 feet (i.e., pedestal with panel-to-worksurface brackets or panel-mounted C-leg)
- When a panel mounted C-leg is used, unsupported worksurface span is not to exceed 48".

### Legend

-  Pedestal or End Unit
-  Panel Mounted C-leg Support
-  Cantilever or C-leg
-  Flat Bracket
-  Flat Bracket with Cantilever or Shared C-leg
-  Panel-to-worksurface Bracket
-  Pedestal or C-leg
-  End Unit
-  Intermediate

### Worksurface Reinforcement Panel Hung Application

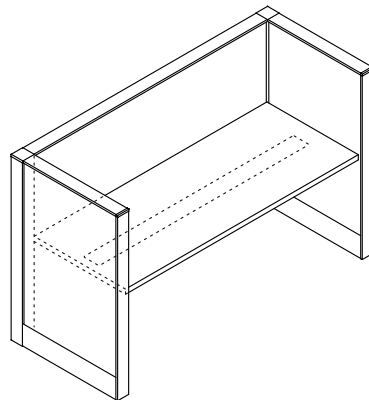
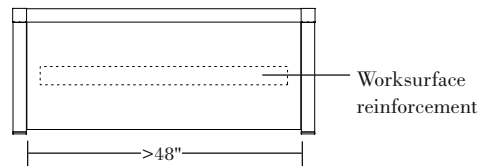

### Worksurface Reinforcement Freestanding Desk Application

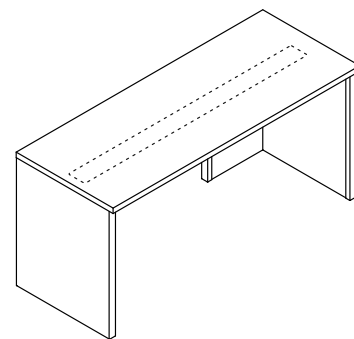
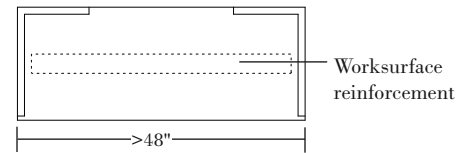

# Rectangular Worksurfaces

## 18" and 24" Deep Specifications

### Rectangular Worksurfaces

Dividends Horizon rectangular worksurfaces are universal and may be used in:

- Panel-hung applications
- Freestanding applications

### Available Sizes

- Depths: 18" and 24"
- Widths: 24" to 96"

### Panel-Hung Applications

When a worksurface spans multiple panels a cantilever or freestanding support is required every 48" of width.

### Freestanding Applications

Rectangular worksurfaces in "build-to-spec" applications use pedestals and end units as the primary support for freestanding desks. Back panels are optional and can be specified as required.

The most common freestanding applications involve desks, returns and bridge units in "L" and "U" configurations.

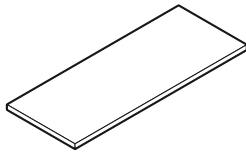

24"D Rectangular Worksurface

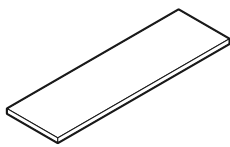

18"D Rectangular Worksurface

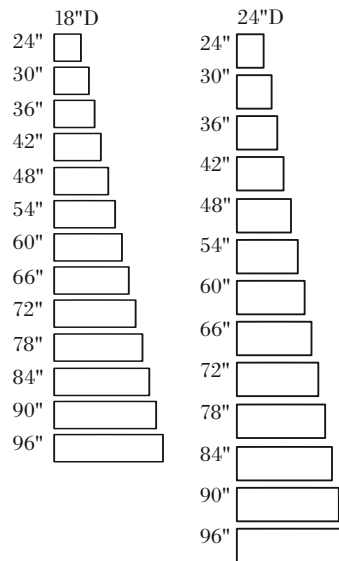

Rectangular Sizes Available

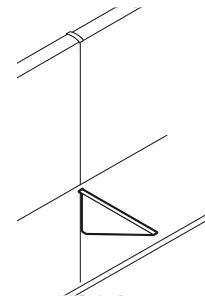

Worksurfaces over 48" W require mid-span support

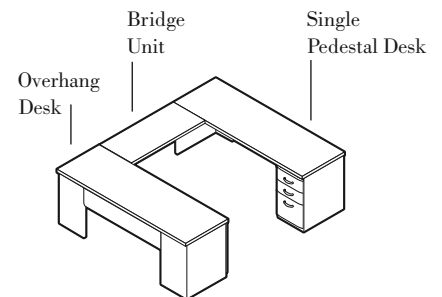
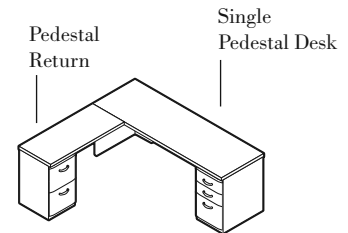



Freestanding Desk Applications

# Rectangular Worksurfaces

## 18" and 24" Deep

Dividends Horizon

description	w *	w	d	t	pattern no.	laminate w/ ABS edge	laminate w/ woodgrain edge	laminate w/ metal edge	techwood w/ techwood edge
18" Deep Rectangular No Grommets 	24"	23 13/16"	17 1/2"	1 1/4"	<b>D1R 2418N</b>	\$157.	\$173.	\$188.	\$386.
	30"	29 13/16"	17 1/2"	1 1/4"	<b>D1R 3018N</b>	166.	183.	200.	407.
	36"	35 13/16"	17 1/2"	1 1/4"	<b>D1R 3618N</b>	185.	205.	224.	426.
	42"	41 13/16"	17 1/2"	1 1/4"	<b>D1R 4218N</b>	215.	236.	256.	447.
	48"	47 13/16"	17 1/2"	1 1/4"	<b>D1R 4818N</b>	239.	263.	288.	466.
	54"	53 13/16"	17 1/2"	1 1/4"	<b>D1R 5418N</b>	254.	280.	306.	482.
	60"	59 13/16"	17 1/2"	1 1/4"	<b>D1R 6018N</b>	277.	304.	332.	501.
	66"	65 13/16"	17 1/2"	1 1/4"	<b>D1R 6618N</b>	298.	328.	357.	519.
	72"	71 13/16"	17 1/2"	1 1/4"	<b>D1R 7218N</b>	314.	346.	377.	539.
	78"	77 13/16"	17 1/2"	1 1/4"	<b>D1R 7818N</b>	338.	371.	405.	560.
	84"	83 13/16"	17 1/2"	1 1/4"	<b>D1R 8418N</b>	355.	390.	425.	582.
	90"	89 13/16"	17 1/2"	1 1/4"	<b>D1R 9018N</b>	396.	436.	472.	604.
	96"	95 13/16"	17 1/2"	1 1/4"	<b>D1R 9618N</b>	438.	480.	524.	626.
24" Deep Rectangular No Grommets 	24"	23 13/16"	23 1/2"	1 1/4"	<b>D1R 2424N</b>	167.	184.	202.	399.
	30"	29 13/16"	23 1/2"	1 1/4"	<b>D1R 3024N</b>	193.	210.	229.	422.
	36"	35 13/16"	23 1/2"	1 1/4"	<b>D1R 3624N</b>	213.	234.	254.	444.
	42"	41 13/16"	23 1/2"	1 1/4"	<b>D1R 4224N</b>	244.	267.	295.	468.
	48"	47 13/16"	23 1/2"	1 1/4"	<b>D1R 4824N</b>	272.	301.	329.	490.
	54"	53 13/16"	23 1/2"	1 1/4"	<b>D1R 5424N</b>	296.	325.	354.	516.
	60"	59 13/16"	23 1/2"	1 1/4"	<b>D1R 6024N</b>	320.	350.	382.	542.
	66"	65 13/16"	23 1/2"	1 1/4"	<b>D1R 6624N</b>	345.	379.	414.	565.
	72"	71 13/16"	23 1/2"	1 1/4"	<b>D1R 7224N</b>	359.	397.	432.	590.
	78"	77 13/16"	23 1/2"	1 1/4"	<b>D1R 7824N</b>	386.	424.	462.	618.
	84"	83 13/16"	23 1/2"	1 1/4"	<b>D1R 8424N</b>	409.	452.	491.	645.
	90"	89 13/16"	23 1/2"	1 1/4"	<b>D1R 9024N</b>	461.	506.	553.	672.
	96"	95 13/16"	23 1/2"	1 1/4"	<b>D1R 9624N</b>	502.	554.	605.	697.

w\* = nominal width

Dimensions listed under w d t are actual to the nearest 1/16"

### Ordering Information

#### Worksurfaces

1. Pattern Number
2. Top Finish Type
3. Edge Finish

### Order Code

#### Worksurfaces

*Example:* **D1R 4818N, 114, 114**

**D1R** Pattern Number

**4818N**

**114** Folkstone Grey  
Laminate

**114** Folkstone Grey Edge  
Band

### Included with:

#### Worksurfaces

**Note:** An upcharge applies when specifying Legacy laminates. See Legacy finish page.

### Options

#### Worksurfaces

- Center-Located Edge Grommet
- Woodgrain ABS edge
- Metal edge
- Techwood edge

To specify edge grommet, replace the "N" suffix from the pattern number with "G".  
**Add \$18.**

# Rectangular Worksurfaces

## 19" Deep Specifications

### Rectangular Worksurfaces

The 19" deep rectangular worksurface aligns with the depth of a doublewide pedestal.

Dividends Horizon worksurfaces provide a 1/2" reveal between the worksurface and panel for cable management.

Dividends Horizon 19" deep rectangular worksurfaces are universal and may be used in:

- Panel-hung applications
- Freestanding applications

### Available Sizes

- Depths: 19"
- Widths: 24" to 96"

### Panel-Hung Applications

When a worksurface spans multiple panels, a cantilever or freestanding support is required every 48" of width.

### Freestanding Applications

Rectangular worksurfaces in "build-to-spec" applications use pedestals and end units as the primary support for freestanding desks. Back panels are optional and can be specified as required.

The most common freestanding applications involve desks, returns and bridge units in "L" and "U" configurations.

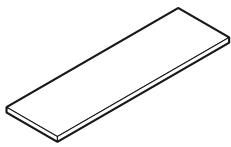

19"D Rectangular Worksurface

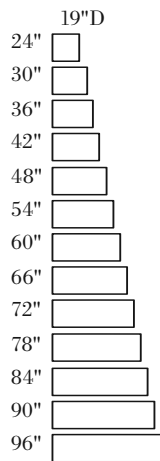

Rectangular Sizes Available

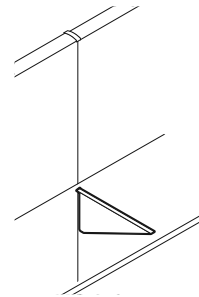

Worksurfaces over 48" W require mid-span support

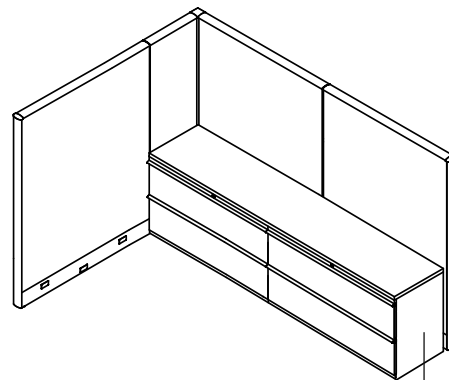

19" Deep Worksurface Application

Doublewide Pedestal



# Rectangular Worksurfaces

## 19" Deep

Dividends Horizon

description	w*	w	d	t	pattern no.	laminate w/ ABS edge	laminate w/ woodgrain edge	laminate w/ metal edge	techwood w/ techwood edge
19" Deep Rectangular - No Grommets (for use with doublewide pedestals)	24"	23 <sup>13/16"</sup>	18 <sup>3/4"</sup>	1 <sup>1/4"</sup>	<b>D1R2419N</b>	\$159.	\$175.	\$192.	\$388.
	30"	29 <sup>13/16"</sup>	18 <sup>3/4"</sup>	1 <sup>1/4"</sup>	<b>D1R3019N</b>	171.	187.	204.	409.
	36"	35 <sup>13/16"</sup>	18 <sup>3/4"</sup>	1 <sup>1/4"</sup>	<b>D1R3619N</b>	192.	209.	228.	430.
	42"	41 <sup>13/16"</sup>	18 <sup>3/4"</sup>	1 <sup>1/4"</sup>	<b>D1R4219N</b>	219.	242.	263.	450.
	48"	47 <sup>13/16"</sup>	18 <sup>3/4"</sup>	1 <sup>1/4"</sup>	<b>D1R4819N</b>	244.	268.	294.	470.
	54"	53 <sup>13/16"</sup>	18 <sup>3/4"</sup>	1 <sup>1/4"</sup>	<b>D1R5419N</b>	262.	288.	314.	489.
	60"	59 <sup>13/16"</sup>	18 <sup>3/4"</sup>	1 <sup>1/4"</sup>	<b>D1R6019N</b>	284.	312.	342.	508.
	66"	65 <sup>13/16"</sup>	18 <sup>3/4"</sup>	1 <sup>1/4"</sup>	<b>D1R6619N</b>	305.	337.	368.	526.
	72"	71 <sup>13/16"</sup>	18 <sup>3/4"</sup>	1 <sup>1/4"</sup>	<b>D1R7219N</b>	323.	354.	387.	547.
	78"	77 <sup>13/16"</sup>	18 <sup>3/4"</sup>	1 <sup>1/4"</sup>	<b>D1R7819N</b>	345.	379.	415.	570.
	84"	83 <sup>13/16"</sup>	18 <sup>3/4"</sup>	1 <sup>1/4"</sup>	<b>D1R8419N</b>	366.	402.	438.	592.
	90"	89 <sup>13/16"</sup>	18 <sup>3/4"</sup>	1 <sup>1/4"</sup>	<b>D1R9019N</b>	407.	447.	488.	616.
	96"	95 <sup>13/16"</sup>	18 <sup>3/4"</sup>	1 <sup>1/4"</sup>	<b>D1R9619N</b>	449.	493.	540.	639.

w\* = nominal width

Dimensions listed under w d t are actual to the nearest 1/16"

### Ordering Information

#### Worksurfaces

1. Pattern Number
2. Top Finish Type
3. Edge Finish

### Order Code

#### Worksurfaces

*Example:* **D1R 4819N, 114, 114**

**D1R** Pattern Number  
**4819N**

**114** Folkstone Grey  
Laminate

**114** Folkstone Grey Edge  
Band

### Included with:

#### Worksurfaces

**Note:** An upcharge applies when specifying Legacy laminates. See Legacy finish page.

### Options

#### Worksurfaces

- Center-Located Edge Grommet
- Woodgrain ABS edge
- Metal edge
- Techwood edge

To specify edge grommet, replace the "N" suffix from the pattern number with "G".  
**Add \$18.**

### Rectangular Worksurfaces

Dividends Horizon rectangular worksurfaces are universal and can be used in:

- Panel-hung applications
- Freestanding applications

See page 166 for the following:

- Worksurface construction
- Optional edge grommets
- Loading capacities

### Available Sizes

- Depths: 30" and 36"
- Widths: 24" to 96" (30"D), 60" to 72" (36"D)

### Panel-Hung Applications

When a worksurface spans multiple panels a cantilever or freestanding floor support is required every 48". 36" deep worksurfaces cannot be supported by cantilevers. Worksurfaces over 48" W require mid-span support

### Freestanding Applications

Refer to the freestanding desk section for "preconfigured" applications. Rectangular worksurfaces in "build-to-spec" applications use pedestals and end units as the primary support for freestanding desks. Back panels are optional and can be specified as required.

The most common freestanding applications involve desks, returns and bridge units in "L" and "U" configurations.

### Overhang Desks

Overhang desks can be ordered by component by specifying desk supports and worksurfaces separately. To specify, select either a 30" or 36" deep worksurface in 60", 66" or 72" widths. Back panels should be specified to match the worksurface width while supports (pedestals or end units) should be one size smaller than the worksurface depth to provide a 6" front overhang. Example: 36" deep worksurface with 30" deep pedestals or end units.

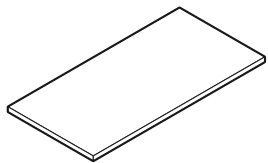

30"D Rectangular Worksurface

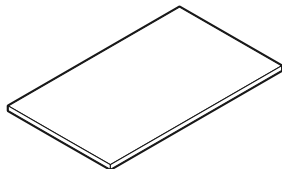

36"D Rectangular Worksurface

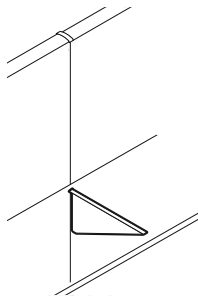

Worksurfaces over 48"W require mid-span support

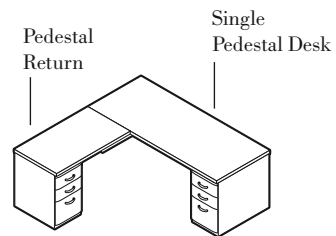
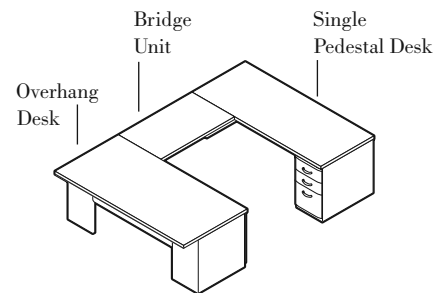



Freestanding Desk Applications

# Rectangular Worksurfaces

## 30" and 36" Deep

Dividends Horizon

description	w	w	d	t	pattern no.	laminate w/ ABS edge	laminate w/ woodgrain edge	laminate w/ metal edge	techwood w/ techwood edge
30" Deep Rectangular No Grommets 	24"	23 <sup>13</sup> / <sub>16</sub> "	29 <sup>1</sup> / <sub>2</sub> "	1 <sup>1</sup> / <sub>4</sub> "	<b>D1R 2430N</b>	\$214.	\$235.	\$255.	\$414.
	30"	29 <sup>13</sup> / <sub>16</sub> "	29 <sup>1</sup> / <sub>2</sub> "	1 <sup>1</sup> / <sub>4</sub> "	<b>D1R 3030N</b>	239.	263.	288.	446.
	36"	35 <sup>13</sup> / <sub>16</sub> "	29 <sup>1</sup> / <sub>2</sub> "	1 <sup>1</sup> / <sub>4</sub> "	<b>D1R 3630N</b>	264.	291.	319.	476.
	42"	41 <sup>13</sup> / <sub>16</sub> "	29 <sup>1</sup> / <sub>2</sub> "	1 <sup>1</sup> / <sub>4</sub> "	<b>D1R 4230N</b>	288.	316.	344.	508.
	48"	47 <sup>13</sup> / <sub>16</sub> "	29 <sup>1</sup> / <sub>2</sub> "	1 <sup>1</sup> / <sub>4</sub> "	<b>D1R 4830N</b>	320.	350.	382.	541.
	54"	53 <sup>13</sup> / <sub>16</sub> "	29 <sup>1</sup> / <sub>2</sub> "	1 <sup>1</sup> / <sub>4</sub> "	<b>D1R 5430N</b>	363.	398.	434.	563.
	60"	59 <sup>13</sup> / <sub>16</sub> "	29 <sup>1</sup> / <sub>2</sub> "	1 <sup>1</sup> / <sub>4</sub> "	<b>D1R 6030N</b>	399.	439.	477.	587.
	66"	65 <sup>13</sup> / <sub>16</sub> "	29 <sup>1</sup> / <sub>2</sub> "	1 <sup>1</sup> / <sub>4</sub> "	<b>D1R 6630N</b>	443.	488.	534.	610.
	72"	71 <sup>13</sup> / <sub>16</sub> "	29 <sup>1</sup> / <sub>2</sub> "	1 <sup>1</sup> / <sub>4</sub> "	<b>D1R 7230N</b>	461.	506.	553.	632.
	78"	77 <sup>13</sup> / <sub>16</sub> "	29 <sup>1</sup> / <sub>2</sub> "	1 <sup>1</sup> / <sub>4</sub> "	<b>D1R 7830N</b>	492.	544.	592.	662.
	84"	83 <sup>13</sup> / <sub>16</sub> "	29 <sup>1</sup> / <sub>2</sub> "	1 <sup>1</sup> / <sub>4</sub> "	<b>D1R 8430N</b>	522.	575.	628.	690.
	90"	89 <sup>13</sup> / <sub>16</sub> "	29 <sup>1</sup> / <sub>2</sub> "	1 <sup>1</sup> / <sub>4</sub> "	<b>D1R 9030N</b>	562.	618.	675.	719.
96"	95 <sup>13</sup> / <sub>16</sub> "	29 <sup>1</sup> / <sub>2</sub> "	1 <sup>1</sup> / <sub>4</sub> "	<b>D1R 9630N</b>	603.	663.	723.	749.	
36" Deep Rectangular No Grommets 	60"	59 <sup>13</sup> / <sub>16</sub> "	35 <sup>1</sup> / <sub>2</sub> "	1 <sup>1</sup> / <sub>4</sub> "	<b>D1R 6036N</b>	511.	561.	612.	696.
	66"	65 <sup>13</sup> / <sub>16</sub> "	35 <sup>1</sup> / <sub>2</sub> "	1 <sup>1</sup> / <sub>4</sub> "	<b>D1R 6636N</b>	564.	622.	677.	720.
	72"	71 <sup>13</sup> / <sub>16</sub> "	35 <sup>1</sup> / <sub>2</sub> "	1 <sup>1</sup> / <sub>4</sub> "	<b>D1R 7236N</b>	622.	685.	747.	748.
	78"	77 <sup>13</sup> / <sub>16</sub> "	35 <sup>1</sup> / <sub>2</sub> "	1 <sup>1</sup> / <sub>4</sub> "	<b>D1R 7836N</b>	662.	705.	752.	755.
	84"	83 <sup>13</sup> / <sub>16</sub> "	35 <sup>1</sup> / <sub>2</sub> "	1 <sup>1</sup> / <sub>4</sub> "	<b>D1R 8436N</b>	702.	722.	758.	763.
	90"	89 <sup>13</sup> / <sub>16</sub> "	35 <sup>1</sup> / <sub>2</sub> "	1 <sup>1</sup> / <sub>4</sub> "	<b>D1R 9036N</b>	755.	778.	808.	821.
	96"	95 <sup>13</sup> / <sub>16</sub> "	35 <sup>1</sup> / <sub>2</sub> "	1 <sup>1</sup> / <sub>4</sub> "	<b>D1R 9636N</b>	809.	832.	855.	879.

w\* = nominal width

Dimensions listed under w h t are actual to the nearest <sup>1</sup>/<sub>16</sub>"

### Ordering Information

#### Worksurfaces

1. Pattern Number
2. Top Finish Type
3. Edge Finish

### Order Code

#### Worksurfaces

*Example:* **D1R 6030N, 114, 114**

**D1R** Pattern Number  
**6030N**

**114** Folkstone Grey  
Laminate

**114** Folkstone Grey Edge  
Band

### Included with:

#### Worksurfaces

**Note:** An upcharge applies when specifying Legacy laminates. See Legacy finish page.

### Options

#### Worksurfaces

- Center-Located Edge Grommet
- Woodgrain ABS edge
- Metal edge
- Techwood edge

To specify edge grommet, replace the "N" suffix from the pattern number with "G".  
**Add \$18.**

## Curvilinear Wave End Worksurfaces

Dividends Horizon curvilinear wave end worksurfaces are primarily used in panel-hung applications.

### Available Sizes

Curvilinear wave end worksurfaces are handed with one side deeper than the other.

- Depths: 24"/30", 18"/30", 24"/36"
- Widths: 36" to 72"

### Curvilinear Wave End Applications

36" to 48" wide wave ends are generally used as worksurface returns attached to curvilinear corners.

72" wide wave ends are used as primary worksurfaces with returns attached at the deep end.

**Note:** Only 18" and 24" deep returns can be attached to 72" wide wave end worksurfaces.

## Curvilinear Wave End Support

In applications where worksurface ends are mounted perpendicular to panels, panel-to-worksurface brackets or a cantilever and a panel-to-worksurface bracket can be used as shown below.

72" wide curvilinear wave ends always require mid-span cantilever support including applications involving pedestal support at one end.

### Pedestal Support Applications

Pedestals can be used as supports in the following locations:

- The deep end of all curvilinear wave ends
- The shallow end of all 48" and 72" wide curvilinear wave end worksurfaces

## Recommended Pedestal Depths

- 18" deep wave ends require 18" deep pedestals
- 24" deep wave ends can use either a 18" or 24" deep pedestal
- 30" deep wave ends can use either a 24" or 30" deep pedestal
- 36" deep wave ends require a 30" deep pedestal

**Note:** When the pedestal depth is less than the worksurface depth, a panel-to-worksurface bracket must be used in the rear corner of the worksurface to the panel.

### Freestanding Applications

Curvilinear wave end worksurfaces can be used to create unique freestanding workstations supported by pedestals and end units. The most common application is a 72" wide wave end worksurface with a single pedestal and end unit attached to a freestanding return.

## Curvilinear Wave End Worksurface

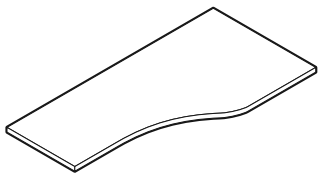

## Curvilinear Wave End Worksurface Sizes

72"W	30"/18"D	18"/30"D
72"W	30"/24"D	24"/30"D
72"W	36"/24"D	24"/36"D

## Curvilinear Wave End Applications

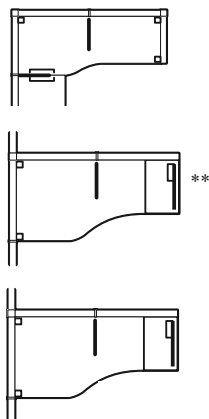
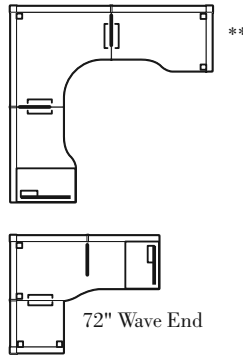

\*\* Requires a return panel, panel-mounted C-leg support, open support leg, or a pedestal with a panel-to-worksurface bracket for support.

## Pedestal Support Applications

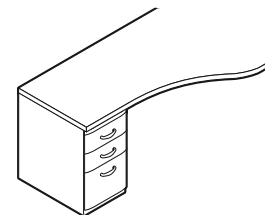
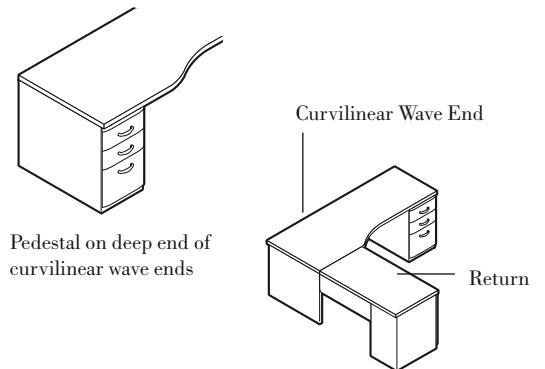



Pedestal on shallow end of curvilinear wave ends

# Curvilinear Wave End Worksurfaces

## Mixed Depths

Dividends Horizon

description	w*							t	pattern no.	laminate w/	laminate w/	techwood w/
		1	2	3	A	B	ABS edge			woodgrain edge	laminate w/ metal edge	techwood edge
Curvilinear Wave End Left No Grommets 	36"	35 <sup>13/16"</sup>	23 <sup>1/2"</sup>	29 <sup>1/2"</sup>	14 <sup>15/16"</sup>	2 <sup>15/16"</sup>	1 <sup>1/4"</sup>	<b>D1W 363024N</b>	\$450.	\$493.	\$542.	\$862.
	42"	41 <sup>13/16"</sup>	23 <sup>1/2"</sup>	29 <sup>1/2"</sup>	14 <sup>15/16"</sup>	8 <sup>15/16"</sup>	1 <sup>1/4"</sup>	<b>D1W 423024N</b>	471.	520.	565.	888.
	48"	47 <sup>13/16"</sup>	23 <sup>1/2"</sup>	29 <sup>1/2"</sup>	14 <sup>15/16"</sup>	14 <sup>15/16"</sup>	1 <sup>1/4"</sup>	<b>D1W 483024N</b>	503.	555.	606.	913.
	72"	71 <sup>13/16"</sup>	17 <sup>1/2"</sup>	29 <sup>1/2"</sup>	23 <sup>7/16"</sup>	14 <sup>15/16"</sup>	1 <sup>1/4"</sup>	<b>D1W 723018N</b>	624.	686.	749.	937.
	72"	71 <sup>13/16"</sup>	23 <sup>1/2"</sup>	29 <sup>1/2"</sup>	23 <sup>7/16"</sup>	30 <sup>7/16"</sup>	1 <sup>1/4"</sup>	<b>D1W 723024N</b>	643.	706.	773.	964.
	72"	71 <sup>13/16"</sup>	23 <sup>1/2"</sup>	35 <sup>1/2"</sup>	23 <sup>7/16"</sup>	14 <sup>15/16"</sup>	1 <sup>1/4"</sup>	<b>D1W 723624N</b>	664.	728.	796.	989.
Curvilinear Wave End Right No Grommets 	36"	35 <sup>13/16"</sup>	29 <sup>1/2"</sup>	23 <sup>1/2"</sup>	2 <sup>15/16"</sup>	14 <sup>15/16"</sup>	1 <sup>1/4"</sup>	<b>D1W 362430N</b>	450.	493.	542.	862.
	42"	41 <sup>13/16"</sup>	29 <sup>1/2"</sup>	23 <sup>1/2"</sup>	8 <sup>15/16"</sup>	14 <sup>15/16"</sup>	1 <sup>1/4"</sup>	<b>D1W 422430N</b>	471.	520.	565.	888.
	48"	47 <sup>13/16"</sup>	29 <sup>1/2"</sup>	23 <sup>1/2"</sup>	14 <sup>15/16"</sup>	14 <sup>15/16"</sup>	1 <sup>1/4"</sup>	<b>D1W 482430N</b>	503.	555.	606.	913.
	72"	71 <sup>13/16"</sup>	29 <sup>1/2"</sup>	17 <sup>1/2"</sup>	14 <sup>15/16"</sup>	23 <sup>7/16"</sup>	1 <sup>1/4"</sup>	<b>D1W 721830N</b>	624.	686.	749.	937.
	72"	71 <sup>13/16"</sup>	29 <sup>1/2"</sup>	23 <sup>1/2"</sup>	30 <sup>7/16"</sup>	23 <sup>7/16"</sup>	1 <sup>1/4"</sup>	<b>D1W 722430N</b>	643.	706.	773.	964.
	72"	71 <sup>13/16"</sup>	35 <sup>1/2"</sup>	23 <sup>1/2"</sup>	14 <sup>15/16"</sup>	23 <sup>7/16"</sup>	1 <sup>1/4"</sup>	<b>D1W 722436N</b>	664.	728.	796.	989.

w\* = nominal width  
 A and B = straight edge length  
 Dimensions listed under 1, 2 and 3 are actual to nearest 1/16"

### Ordering Information

#### Worksurfaces

1. Pattern Number
2. Top Finish Type
3. Edge Finish

### Order Code

#### Worksurfaces

*Example:* **D1R 6030N, 114, 114**

**D1R** Pattern Number  
**6030N**

**114** Folkstone  
 Grey Laminate

**114** Folkstone Grey Edge  
 Band

### Included with:

#### Worksurfaces

**Note:** An upcharge applies when specifying Legacy laminates. See Legacy finish page.

### Options

#### Worksurfaces

- Center-Located Edge Grommet
- Woodgrain ABS edge
- Metal edge
- Techwood edge

To specify edge grommet, replace the "N" suffix from the pattern number with "G".  
**Add \$18.**

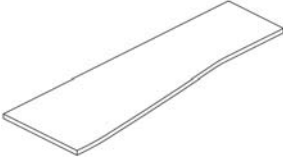
description	w*	w	depth left	depth right	t	pattern no.	laminate w/ ABS edge	laminate w/ woodgrain edge	laminate w/ metal edge	techwood w/ techwood edge
Smooth Wave 	48"	47 13/16"	17 1/2"	23 1/2"	1 1/4"	<b>D1W S481824N</b>	\$503.	\$555.	\$606.	\$878.
	48"	47 13/16"	17 1/2"	29 1/2"	1 1/4"	<b>D1W S481830N</b>	503.	555.	606.	881.
	48"	47 13/16"	23 1/2"	17 1/2"	1 1/4"	<b>D1W S482418N</b>	503.	555.	606.	886.
	48"	47 13/16"	23 1/2"	29 1/2"	1 1/4"	<b>D1W S482430N</b>	503.	555.	606.	889.
	48"	47 13/16"	29 1/2"	17 1/2"	1 1/4"	<b>D1W S483018N</b>	503.	555.	606.	893.
	48"	47 13/16"	29 1/2"	23 1/2"	1 1/4"	<b>D1W S483024N</b>	503.	555.	606.	896.
	60"	59 13/16"	17 1/2"	23 1/2"	1 1/4"	<b>D1W S601824N</b>	584.	643.	700.	900.
	60"	59 13/16"	17 1/2"	29 1/2"	1 1/4"	<b>D1W S601830N</b>	584.	643.	700.	903.
	60"	59 13/16"	23 1/2"	17 1/2"	1 1/4"	<b>D1W S602418N</b>	584.	643.	700.	908.
	60"	59 13/16"	23 1/2"	29 1/2"	1 1/4"	<b>D1W S602430N</b>	584.	643.	700.	913.
	60"	59 13/16"	29 1/2"	17 1/2"	1 1/4"	<b>D1W S603018N</b>	584.	643.	700.	917.
	60"	59 13/16"	29 1/2"	23 1/2"	1 1/4"	<b>D1W S603024N</b>	584.	643.	700.	920.
	66"	65 13/16"	17 1/2"	23 1/2"	1 1/4"	<b>D1W S661824N</b>	624.	687.	750.	924.
	66"	65 13/16"	17 1/2"	29 1/2"	1 1/4"	<b>D1W S661830N</b>	624.	687.	750.	927.
	66"	65 13/16"	23 1/2"	17 1/2"	1 1/4"	<b>D1W S662418N</b>	624.	687.	750.	931.
	66"	65 13/16"	23 1/2"	29 1/2"	1 1/4"	<b>D1W S662430N</b>	624.	687.	750.	935.
	66"	65 13/16"	29 1/2"	17 1/2"	1 1/4"	<b>D1W S663018N</b>	624.	687.	750.	939.
	66"	65 13/16"	29 1/2"	23 1/2"	1 1/4"	<b>D1W S663024N</b>	624.	687.	750.	942.
	72"	71 13/16"	17 1/2"	23 1/2"	1 1/4"	<b>D1W S721824N</b>	664.	728.	796.	947.
	72"	71 13/16"	17 1/2"	29 1/2"	1 1/4"	<b>D1W S721830N</b>	664.	728.	796.	950.
	72"	71 13/16"	23 1/2"	17 1/2"	1 1/4"	<b>D1W S722418N</b>	664.	728.	796.	956.
	72"	71 13/16"	23 1/2"	29 1/2"	1 1/4"	<b>D1W S722430N</b>	664.	728.	796.	961.
	72"	71 13/16"	29 1/2"	17 1/2"	1 1/4"	<b>D1W S723018N</b>	664.	728.	796.	965.
	72"	71 13/16"	29 1/2"	23 1/2"	1 1/4"	<b>D1W S723024N</b>	664.	728.	796.	968.
	78"	77 13/16"	17 1/2"	23 1/2"	1 1/4"	<b>D1W S781824N</b>	702.	774.	844.	972.
	78"	77 13/16"	17 1/2"	29 1/2"	1 1/4"	<b>D1W S781830N</b>	702.	774.	844.	974.
	78"	77 13/16"	23 1/2"	17 1/2"	1 1/4"	<b>D1W S782418N</b>	702.	774.	844.	975.
	78"	77 13/16"	23 1/2"	29 1/2"	1 1/4"	<b>D1W S782430N</b>	702.	774.	844.	980.
	78"	77 13/16"	29 1/2"	17 1/2"	1 1/4"	<b>D1W S783018N</b>	702.	774.	844.	984.
	78"	77 13/16"	29 1/2"	23 1/2"	1 1/4"	<b>D1W S783024N</b>	702.	774.	844.	988.
	84"	83 13/16"	17 1/2"	23 1/2"	1 1/4"	<b>D1W S841824N</b>	745.	817.	892.	991.
	84"	83 13/16"	17 1/2"	29 1/2"	1 1/4"	<b>D1W S841830N</b>	745.	817.	892.	995.
84"	83 13/16"	23 1/2"	17 1/2"	1 1/4"	<b>D1W S842418N</b>	745.	817.	892.	999.	
84"	83 13/16"	23 1/2"	29 1/2"	1 1/4"	<b>D1W S842430N</b>	745.	817.	892.	1,003.	
84"	83 13/16"	29 1/2"	17 1/2"	1 1/4"	<b>D1W S843018N</b>	745.	817.	892.	1,006.	
84"	83 13/16"	29 1/2"	23 1/2"	1 1/4"	<b>D1W S843024N</b>	745.	817.	892.	1,011.	

**Ordering Information**

**Worksurfaces**

1. Pattern Number
2. Top Finish Type
3. Edge Finish

**Order Code**

**Worksurfaces**

*Example:* **D1R 6030N, 114, 114**

<b>D1W</b>	Dividends Worksurface
<b>S</b>	Smooth Wave Shape
<b>72</b>	Overall width in inches
<b>30</b>	Nominal depth at user's left side
<b>24</b>	Nominal depth at user's right side
<b>N</b>	No grommet
<b>114</b>	Folkstone Grey Laminate
<b>114</b>	Folkstone Grey Edge Band

**Included with:**

**Worksurfaces**

**Note:** An upcharge applies when specifying Legacy laminates. See Legacy finish page.

**Options**

**Worksurfaces**

- 1 Center-Located Edge Grommets
- Woodgrain ABS edge
- Metal edge
- Techwood edge

To specify edge grommets, replace the "N" suffix from the pattern number with a "G".

**Add \$28**

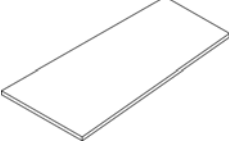
description	w*	w	depth left	depth right	t	pattern no.	laminate w/ ABS edge	laminate w/ woodgrain edge	laminate w/ metal edge	techwood w/ techwood edge
Trapezoidal 	48"	47 <sup>13/16</sup> "	23 <sup>1/2</sup> "	29 <sup>1/2</sup> "	1 <sup>1/4</sup> "	<b>D1W T482430N</b>	\$503.	\$555.	\$606.	\$628.
	48"	47 <sup>13/16</sup> "	29 <sup>1/2</sup> "	23 <sup>1/2</sup> "	1 <sup>1/4</sup> "	<b>D1W T483024N</b>	503.	555.	606.	628.
	60"	59 <sup>13/16</sup> "	23 <sup>1/2</sup> "	29 <sup>1/2</sup> "	1 <sup>1/4</sup> "	<b>D1W T602430N</b>	584.	643.	700.	664.
	60"	59 <sup>13/16</sup> "	29 <sup>1/2</sup> "	23 <sup>1/2</sup> "	1 <sup>1/4</sup> "	<b>D1W T603024N</b>	584.	643.	700.	664.
	66"	65 <sup>13/16</sup> "	23 <sup>1/2</sup> "	29 <sup>1/2</sup> "	1 <sup>1/4</sup> "	<b>D1W T662430N</b>	624.	687.	750.	698.
	66"	65 <sup>13/16</sup> "	29 <sup>1/2</sup> "	23 <sup>1/2</sup> "	1 <sup>1/4</sup> "	<b>D1W T663024N</b>	624.	687.	750.	698.
	72"	71 <sup>13/16</sup> "	23 <sup>1/2</sup> "	29 <sup>1/2</sup> "	1 <sup>1/4</sup> "	<b>D1W T722430N</b>	664.	728.	796.	734.
	72"	71 <sup>13/16</sup> "	29 <sup>1/2</sup> "	23 <sup>1/2</sup> "	1 <sup>1/4</sup> "	<b>D1W T723024N</b>	664.	728.	796.	734.

**Ordering Information**

**Worksurfaces**

1. Pattern Number
2. Top Finish Type
3. Edge Finish

**Order Code**

**Worksurfaces**

*Example:* **D1W T482430N**

<b>D1W</b>	Dividends Worksurface
<b>T</b>	Trapezoidal Shape
<b>48</b>	Overall Width, inches
<b>24</b>	Nominal depth at user's left side
<b>30</b>	Nominal depth at user's right side
<b>N</b>	No grommet
114	Folkstone Grey Laminate
114	Folkstone Grey Edge Band

**Included with:**

**Worksurface**

**Note:** An upcharge applies when specifying Legacy laminates. See Legacy finish page.

**Options**

**Worksurfaces**

- 1 Center-Located Edge Grommets
- Woodgrain ABS edge
- Metal edge
- Techwood edge

To specify edge grommets replace the "N" suffix from the pattern number with a "G".

**Add \$28**

# Corner Worksurfaces

## Rectilinear and Split Top Corner Specifications

### Rectilinear Corner Worksurfaces

Dividends Horizon rectilinear corner worksurfaces are used in panel-hung and freestanding applications.

### Split Top Corner Worksurfaces

Split top corner worksurfaces allow for height and angle adjustment on the front work surface.

The depth of the front keyboard work surface is 10 <sup>5</sup>/<sub>8</sub>". The front surface adjusts from a - 5 <sup>3</sup>/<sub>4</sub>" below the work surface to a + 7" above. The mechanism has a tilt feature of ±10 degrees.

Included with the split top work surface is the back corner work surface, the front corner work surface, the split top mechanism, one rear corner panel-to-work surface bracket and two flat brackets for attachment to return work surfaces. Cantilevers must be ordered separately and are specified to the size return

work surface depth (i.e 24" cantilevers for 24" deep return work surfaces). Panel-mounted C-leg or Open Leg work surface supports may be used in place of cantilevers.

### Available Sizes

- Widths: 36", 42" and 48"
- Returns: 18", 24" and 30"
- Thickness: 1 <sup>1</sup>/<sub>4</sub>"

### Corner Worksurface Support

Corner worksurfaces must be supported by cantilevers at each end and a panel-to-work surface bracket at the rear corner. Panel-mounted C-leg or Open Leg work surface supports may be used instead of cantilevers for corner work surface support. Cantilevers and panel-mounted C-leg or Open Leg supports are ordered separately. Panel-to-work surface bracket is included.

### Corner Worksurface Applications

Corner worksurfaces attach to adjacent work surfaces with cantilevers and flat brackets. Suggested applications are illustrated below.

**Note:** All dimensions are nominal except for front edge dimension.

**Note:** Series 3 overdesk units are not compatible with corner work surfaces.

### Rectilinear Corner Worksurface

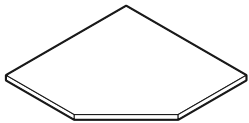

### Rectilinear Split-Top Corner Worksurface

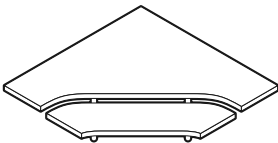

### Rectilinear and Split Top Corner Worksurface Sizes Available

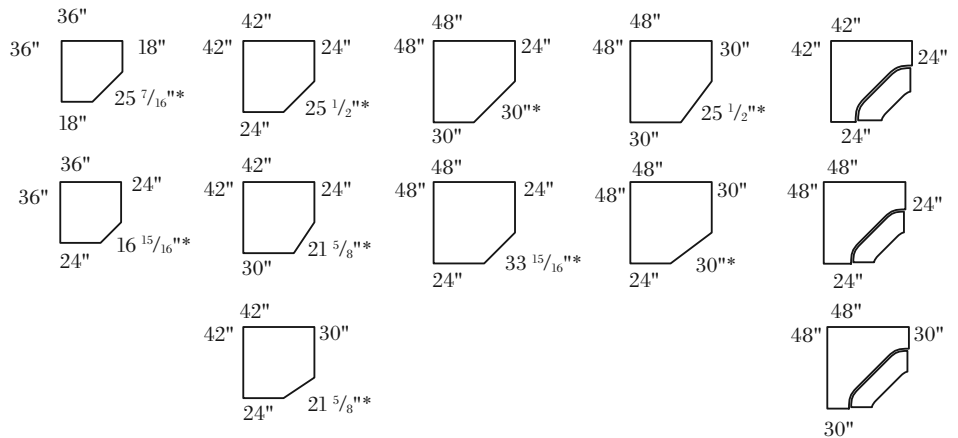

### Corner Worksurface Support

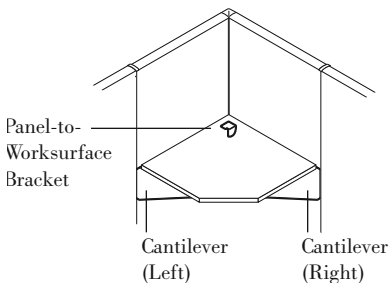

### Corner Worksurface Applications

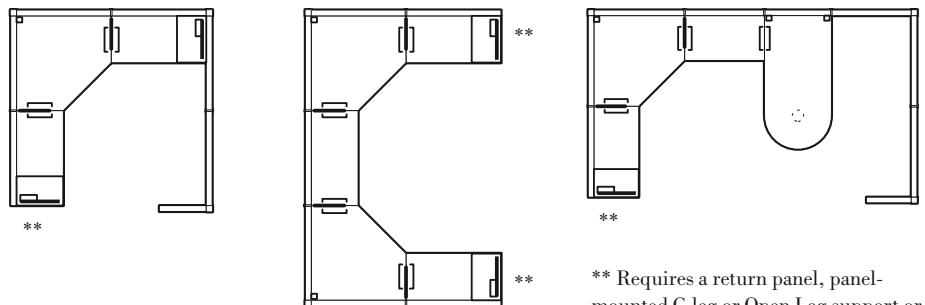





\*\* Requires a return panel, panel-mounted C-leg or Open Leg support or a pedestal with a panel-to-work surface bracket for support.



# Corner Worksurfaces

## Rectilinear and Split Top Corner

### Mixed Depths

description	1	2	3	4	t	pattern no.	laminate w/ ABS edge	laminate w/ woodgrain edge	laminate w/ metal edge	techwood w/ techwood edge
Rectilinear Corner Worksurface No Grommets 	36"	36"	18"	18"	1 1/4"	<b>D1C 3618N</b>	\$384.	\$423.	\$461.	\$781.
	36"	36"	24"	24"	1 1/4"	<b>D1C 3624N</b>	391.	432.	470.	854.
	42"	42"	24"	24"	1 1/4"	<b>D1C 4224N</b>	441.	485.	528.	926.
	48"	48"	24"	24"	1 1/4"	<b>D1C 4824N</b>	504.	556.	607.	1,000.
	48"	48"	30"	30"	1 1/4"	<b>D1C 4830N</b>	520.	572.	624.	1,073.
Rectilinear Corner Worksurface. 24" Deep Return Left 30" Deep Return Right No Grommets 	42"	42"	24"	30"	1 1/4"	<b>D1C 422430N</b>	462.	508.	555.	1,006.
	48"	48"	24"	30"	1 1/4"	<b>D1C 482430N</b>	524.	578.	631.	1,073.
Rectilinear Corner Worksurface. 30" Deep Return Left 24" Deep Return Right No Grommets 	42"	42"	30"	24"	1 1/4"	<b>D1C 423024N</b>	462.	508.	555.	1,006.
	48"	48"	30"	24"	1 1/4"	<b>D1C 483024N</b>	524.	578.	631.	1,073.
Split Top Corner Worksurface No Grommets 	42"	42"	24"	24"	1 1/4"	<b>D1CS 4224N</b>	1,568.	1,724.	1,883.	2,666.
	48"	48"	24"	24"	1 1/4"	<b>D1CS 4824N</b>	1,616.	1,775.	1,937.	2,755.
	48"	48"	30"	30"	1 1/4"	<b>D1CS 4830N</b>	1,626.	1,788.	1,953.	2,844.

Note: Above 1, 2, 3, and 4 dimensions are all nominal  
Actual dimensions are 1/2" less than shown above.

Ordering Information	Order Code	Included with:	Options
<b>Worksurfaces</b> 1. Pattern Number 2. Top Finish Type 3. Edge Finish	<b>Worksurfaces</b> <i>Example:</i> <b>D1C 423024N, 117, 115</b> <b>D1C</b> Pattern Number <b>423024N</b>	<b>Worksurfaces</b> <ul style="list-style-type: none"> <li>• Worksurface</li> <li>• Panel-to-Worksurface Bracket</li> </ul>	<b>Worksurfaces</b> <ul style="list-style-type: none"> <li>• 2 Center-Located Edge Grommets</li> <li>• Woodgrain PVC edge</li> <li>• Metal edge</li> <li>• Techwood edge</li> </ul>
<b>Split Top Corner Worksurfaces</b> 1. Pattern Number 2. Top Finish Type 3. Edge Finish	<b>117</b> Soft Grey Laminate <b>115</b> Medium Grey Edge Band <b>Split Top Corner Worksurfaces</b> <i>Example:</i> <b>D1CS 4224N, 117, 117</b> <b>D1CS</b> Pattern Number <b>4224N</b> <b>117</b> Soft Grey Laminate <b>117</b> Soft Grey Edge Band	<b>Split Top Corner Worksurfaces</b> <ul style="list-style-type: none"> <li>• Front Worksurface</li> <li>• Back Worksurface</li> <li>• Split Top Mechanism</li> <li>• Flat Brackets</li> <li>• Panel-to-Worksurface Bracket</li> </ul> <p><b>Note:</b> When wood grain or brushed laminates are specified on corner worksurfaces where side 1 and 2 are of equal length, one of three grain direction options must be specified. Insert the desired grain direction option (L,R or D) after the laminate code. Please add \$25 to the list price for diagonal grain (D) selection.</p> <p><b>Note:</b> Techwood corner worksurfaces with the same dimension on side 1 and side 2 have a diagonal grain direction. See grain direction page for more information.</p> <p><b>Note:</b> An upcharge applies when specifying Legacy laminates. See Legacy finish page.</p>	<p>To specify edge grommets, replace the "N" suffix from the pattern number with a "G". <b>Add \$28</b></p> <p><b>Split Top Corner Worksurfaces</b></p> <ul style="list-style-type: none"> <li>• 2 Center-Located Edge Grommets</li> <li>• Woodgrain PVC edge</li> <li>• Metal edge</li> <li>• Techwood edge</li> </ul> <p><b>Note:</b> Overdesk units are not compatible with corner worksurfaces.</p>

# Corner Worksurfaces

## Curvilinear Corner "L" Shape - 24" Depths Specifications

### Curvilinear Corner L Shape Worksurfaces

Dividends Horizon curvilinear corner "L" shape worksurfaces are specified for panel-hung applications only and provide a continuous flow when used in conjunction with other curvilinear worksurfaces.

### Curvilinear Corner Worksurface Support

Curvilinear corner "L" shape worksurfaces must be supported by cantilevers at each end and a panel-to-worksurface bracket at the rear corner. Panel-mounted C-leg or open leg worksurface supports may be used instead of cantilevers for corner worksurface support.

Cantilevers, panel-mounted c-leg and open support legs are ordered separately. A panel-to-worksurface bracket is included.

**Note:** Worksurfaces greater than 48" wide require an additional mid-span cantilever support along the 60" or 72" side.

**Note:** A pedestal, panel-mounted C-leg or Open Leg Support can be substituted for a cantilever in the following locations:

- The long end of 60" and 72" wide curvilinear "L" shape corner worksurfaces

**Note:** Series 3 overdesk units are not compatible with corner worksurfaces.

Curvilinear Corner Worksurface

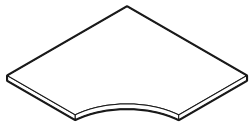

Curvilinear Corner Worksurface Support Options

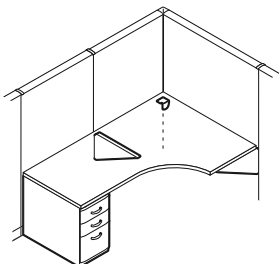
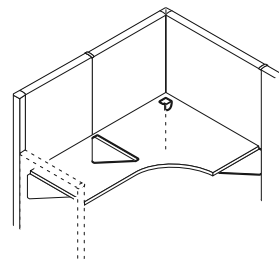
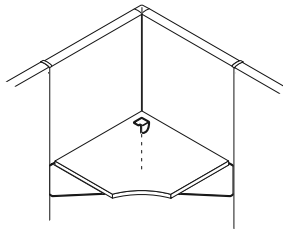

Curvilinear Corner "L" Shape Worksurface

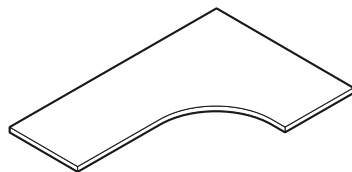

Curvilinear Corner Worksurface Applications

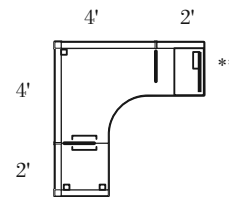
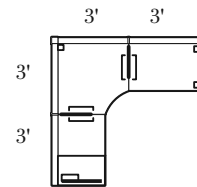

\*\* Requires a return panel or pedestal/panel-mounted C-leg or Open Support Leg with panel-to-worksurface bracket for support

# Corner Worksurfaces

## Curvilinear Corner "L" Shape - 24" Depths

### 24" Depths

Dividends Horizon

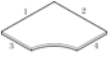
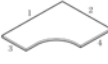
description	1	2	3	4	t	pattern no.	laminates w/	laminates w/	laminates w/	techwood w/
							ABS edge	woodgrain edge	metal edge	techwood edge
Curvilinear Corner "L" Shape Worksurface 24" Deep Returns Left and Right	36"	36"	24"	24"	1 1/4"	<b>D1L 3636SSN</b>	\$418.	\$453.	\$500.	\$962.
	42"	42"	24"	24"	1 1/4"	<b>D1L 4242SSN</b>	502.	554.	605.	1,021.
	42"	60"	24"	24"	1 1/4"	<b>D1L 4260SSN</b>	692.	762.	830.	1,140.
	42"	66"	24"	24"	1 1/4"	<b>D1L 4266SSN</b>	711.	787.	855.	1,170.
	42"	72"	24"	24"	1 1/4"	<b>D1L 4272SSN</b>	737.	812.	887.	1,228.
	42"	78"	24"	24"	1 1/4"	<b>D1L 4278SSN</b>	747.	821.	895.	1,285.
	48"	48"	24"	24"	1 1/4"	<b>D1L 4848SSN</b>	565.	624.	678.	1,079.
	48"	60"	24"	24"	1 1/4"	<b>D1L 4860SSN</b>	700.	770.	839.	1,199.
	48"	66"	24"	24"	1 1/4"	<b>D1L 4866SSN</b>	725.	798.	870.	1,258.
	48"	72"	24"	24"	1 1/4"	<b>D1L 4872SSN</b>	753.	826.	899.	1,315.
	48"	78"	24"	24"	1 1/4"	<b>D1L 4878SSN</b>	830.	913.	995.	1,344.
	48"	84"	24"	24"	1 1/4"	<b>D1L 4884SSN</b>	931.	1,025.	1,118.	1,372.
	60"	42"	24"	24"	1 1/4"	<b>D1L 6042SSN</b>	692.	762.	830.	1,140.
	60"	48"	24"	24"	1 1/4"	<b>D1L 6048SSN</b>	700.	770.	839.	1,199.
	66"	42"	24"	24"	1 1/4"	<b>D1L 6642SSN</b>	711.	787.	855.	1,170.
	66"	48"	24"	24"	1 1/4"	<b>D1L 6648SSN</b>	725.	798.	870.	1,258.
	72"	42"	24"	24"	1 1/4"	<b>D1L 7242SSN</b>	737.	812.	887.	1,228.
	72"	48"	24"	24"	1 1/4"	<b>D1L 7248SSN</b>	753.	826.	899.	1,315.
	78"	42"	24"	24"	1 1/4"	<b>D1L 7842SSN</b>	747.	821.	895.	1,285.
	78"	48"	24"	24"	1 1/4"	<b>D1L 7848SSN</b>	830.	913.	995.	1,344.
	84"	48"	24"	24"	1 1/4"	<b>D1L 8448SSN</b>	931.	1,025.	1,118.	1,372.

Note: Above 1, 2, 3, and 4 dimensions are all nominal  
Actual dimensions are 1/2" less than shown above.

#### Ordering Information

1. Worksurfaces
2. Pattern Number
3. Top Finish Type
4. Edge Finish

#### Order Code

##### Worksurfaces

Example: **D1L 4860SSN, 117, 117**

**D1L** Pattern Number

**4860SSN**

**117** Soft Grey laminate

**117** Soft Grey Edge Band

#### Included with:

##### Worksurfaces

- Worksurface
- Panel-to-Worksurface Bracket

**Note:** When wood grain or brushed laminates are specified on corner worksurfaces where side 1 and 2 are of equal length, one of three grain direction options must be specified. Insert the desired grain direction option (L,R or D) after the laminate code. Please add \$25 to the list price for diagonal grain (D) selection.

**Note:** Techwood corner worksurfaces with the same dimension on side 1 and side 2 have a diagonal grain direction. See grain direction page for more information.

**Note:** An upcharge applies when specifying Legacy laminates. See Legacy finish page.

#### Options

##### Worksurfaces

- 2 center-located edge grommets
- Woodgrain ABS edge
- Metal edge
- Techwood

To specify edge grommets, replace the "N" suffix from the pattern number with "G"

**Add \$28**

**Note:** Overdesk units are not compatible with corner worksurfaces.

# Corner Worksurfaces

## Curvilinear Corner "L" shape-Mixed Depths Specifications

### Curvilinear Corner "L" Shape Worksurfaces

Dividends Horizon curvilinear corner, "L" shape worksurfaces are specified for panel-hung applications only and provide a continuous flow when used in conjunction with other curvilinear worksurfaces.

### Curvilinear Corner Worksurface Support

Curvilinear corner "L" shape worksurfaces must be supported by cantilevers at each end and a panel-to-worksurface bracket at the rear corner. Panel-mounted C-leg or open leg worksurface supports may be used instead of cantilevers for corner worksurface support.

Cantilevers and panel-mounted C-leg or open leg supports are ordered separately. A panel-to-worksurface bracket is included.

**Note:** 60" and 72" wide curvilinear corners require an additional mid-span cantilever support along the 60" or 72" side.

**Note:** A pedestal or panel-mounted C-leg can be substituted for a cantilever in the following locations:

- The long end of 60" and 72" wide curvilinear "L" shape corner worksurfaces

### Curvilinear Corner Worksurface Applications

Curvilinear "L" shape corner worksurfaces are primarily used with wave end and rectangular worksurface returns.

Curvilinear Corner Worksurface

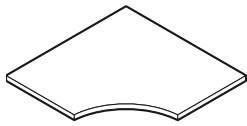

Curvilinear Corner "L" Shape Worksurface

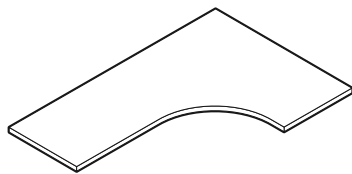

Curvilinear Corner Worksurface Support Options

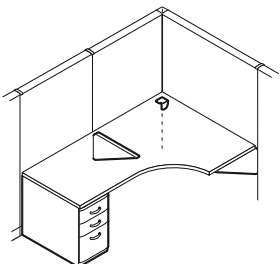
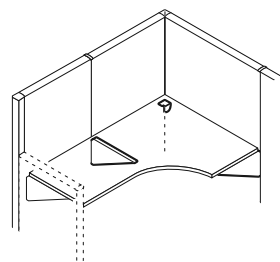
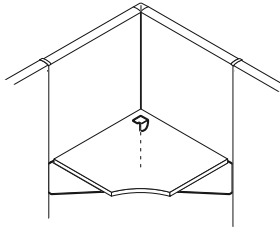

Curvilinear Corner Worksurface Applications

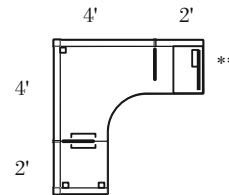
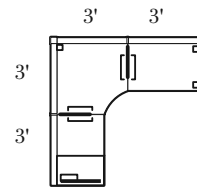

\*\* Requires a return panel or pedestal/panel-mounted C-leg or Open Leg Support with panel-to-worksurface bracket for support

# Corner Worksurfaces

## Curvilinear Corner "L" shape-Mixed Depths

### Mixed Depths

Dividends Horizon

description	1	2	3	4	t	pattern no.	laminate w/ ABS edge	laminate w/ woodgrain edge	laminate w/ metal edge	techwood w/ techwood edge
Curvilinear Corner "L" Shape Worksurface. 30" Deep Returns Left and Right	48"	48"	30"	30"	1 1/4"	<b>D1L 4848DDN</b>	\$610.	\$672.	\$730.	\$1,092.
Curvilinear Corner "L" Shape Worksurface 24" Deep Return Left 30" Deep Return Right	48"	48"	24"	30"	1 1/4"	<b>D1L 4848SDN</b>	603.	663.	723.	1,092.
	48"	60"	24"	30"	1 1/4"	<b>D1L 4860SDN</b>	688.	758.	823.	1,120.
	48"	66"	24"	30"	1 1/4"	<b>D1L 4866SDN</b>	722.	794.	866.	1,148.
	48"	72"	24"	30"	1 1/4"	<b>D1L 4872SDN</b>	758.	832.	906.	1,178.
	60"	48"	24"	30"	1 1/4"	<b>D1L 6048SDN</b>	675.	741.	810.	1,208.
	66"	48"	24"	30"	1 1/4"	<b>D1L 6648SDN</b>	708.	779.	853.	1,237.
	72"	48"	24"	30"	1 1/4"	<b>D1L 7248SDN</b>	745.	819.	893.	1,266.
Curvilinear Corner "L" Shape Worksurface 30" Deep Return Left 24" Deep Return Right	48"	48"	30"	24"	1 1/4"	<b>D1L 4848DSN</b>	603.	663.	723.	1,092.
	48"	60"	30"	24"	1 1/4"	<b>D1L 4860DSN</b>	675.	741.	810.	1,120.
	48"	66"	30"	24"	1 1/4"	<b>D1L 4866DSN</b>	708.	779.	853.	1,148.
	48"	72"	30"	24"	1 1/4"	<b>D1L 4872DSN</b>	745.	819.	893.	1,178.
	60"	48"	30"	24"	1 1/4"	<b>D1L 6048DSN</b>	688.	758.	823.	1,208.
	66"	48"	30"	24"	1 1/4"	<b>D1L 6648DSN</b>	722.	794.	866.	1,237.
	72"	48"	30"	24"	1 1/4"	<b>D1L 7248DSN</b>	758.	832.	906.	1,266.

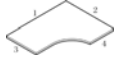
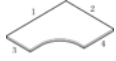

Note: Above 1, 2, 3, and 4 dimensions are all nominal  
Actual dimensions are 1/2" less than shown above.

Ordering Information	Order Code	Included with:	Options
<b>Worksurfaces</b>	<b>Worksurfaces</b>	<b>Worksurfaces</b>	<b>Worksurfaces</b>
1. Pattern Number	<i>Example:</i> <b>D1L 4860SDN, 117, 117</b>	• Worksurface	• 2 center-located edge grommets
2. Top Finish Type	<b>D1L</b> Pattern Number	• Panel-to-worksurface bracket	• Woodgrain ABS edge
3. Edge Band Finish	<b>4860SDN</b>	<b>Note:</b> An upcharge applies when specifying Legacy laminates. See Legacy finish page.	• Metal edge
	<b>117</b> Soft Grey Laminate		• Techwood
	<b>117</b> Soft Grey edge band		

To specify edge grommets, replace the "N" suffix from the pattern number with "G"

**Add \$28**

**Note:** An overdesk unit will not align with the width of a corner worksurface due to the 1/2" wire drop gap. The overdesk will be 1/2" too wide.

# Peninsula Worksurfaces

## "D", "P", "9" and Blended "D" Specifications

### "D", Blended "D", Conferencing, "P" and "9" Shape Peninsula Worksurfaces

Dividends Horizon peninsula worksurfaces mount perpendicular to panels of the same width to provide conferencing area within a workstation.

"D", "P" and "9" tops are supported by panel-to-worksurface brackets on the flat end and a support column, T leg or A leg support at the free end. Adjacent worksurfaces can attach to peninsula tops with flat brackets.

All brackets and supports are ordered separately. "D", "P" and "9" shape peninsula worksurfaces may be used in freestanding applications.

### "D" Shaped Peninsula

#### Available Sizes

- Depths: 24", 30" and 36"
- Widths: 48", 60", 66" and 72"
- Thickness: 1 1/4"

### "P" and "9" Shaped Peninsula

#### Available Sizes

- Depth: 30" panel depth
- Widths: 66", 72" and 78"
- Conferencing diameter: 36" and 42"
- Thickness: 1 1/4"

### Blended "D" Peninsula

#### Available Sizes

- Depths: 48"
- Widths: 72" and 66"
- Thickness: 1 1/4"

### Conferencing Worksurfaces

- Depth: 48"
- Width: 60"
- Thickness: 1 1/4"

"D" and "P" Shape Peninsula Worksurfaces

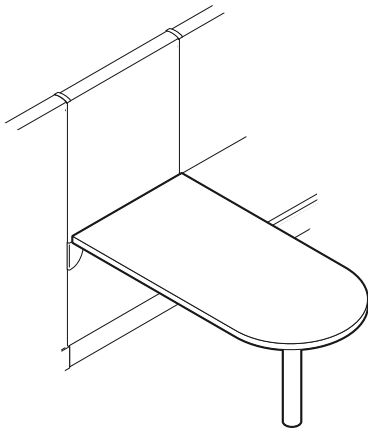

Blended "D" Shape Peninsula Worksurface

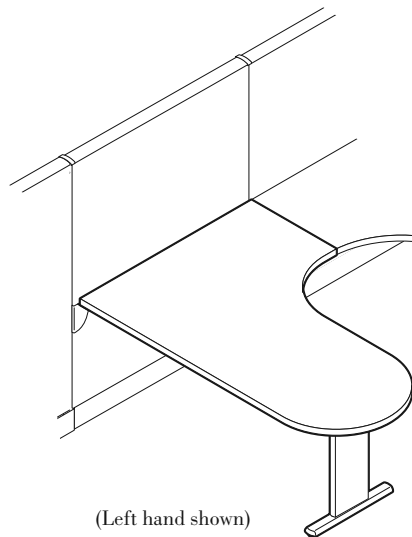

Conferencing Worksurface Dimensions

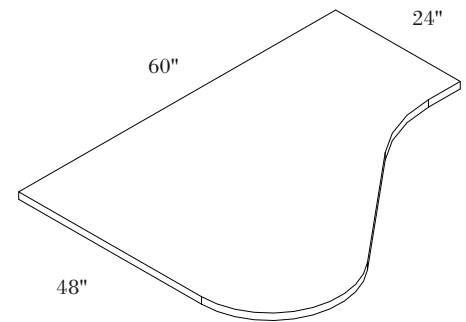





# Peninsula Worksurfaces

## “D”, “P”, “9” and Blended “D”

### Mixed Depths

Dividends Horizon

description	type	w *	w	d	dia.	t	pattern no.	laminata w/	laminata w/	laminata w/	techwood w/	
								ABS edge	woodgrain edge	metal edge	techwood edge	
“D” Peninsula Worksurface Laminate No Grommets 		48"	47 <sup>13/16</sup> "	23 <sup>13/16</sup> "		1 <sup>1/4</sup> "	<b>D1D 4824N</b>	\$414.	\$456.	\$496.	\$1,026.	
		48"	47 <sup>13/16</sup> "	29 <sup>13/16</sup> "		1 <sup>1/4</sup> "	<b>D1D 4830N</b>	456.	500.	548.	1,060.	
		60"	59 <sup>13/16</sup> "	29 <sup>13/16</sup> "		1 <sup>1/4</sup> "	<b>D1D 6030N</b>	582.	641.	698.	1,094.	
		66"	65 <sup>13/16</sup> "	29 <sup>13/16</sup> "		1 <sup>1/4</sup> "	<b>D1D 6630N</b>	636.	697.	762.	1,128.	
		72"	71 <sup>13/16</sup> "	29 <sup>13/16</sup> "		1 <sup>1/4</sup> "	<b>D1D 7230N</b>	668.	734.	802.	1,161.	
		72"	71 <sup>13/16</sup> "	35 <sup>13/16</sup> "		1 <sup>1/4</sup> "	<b>D1D 7236N</b>	730.	804.	878.	1,196.	
Blended “D” Peninsula Worksurface (Left hand shown) 	LH w/ 24" return depth	66"	65 <sup>13/16</sup> "	47 <sup>13/16</sup> "		1 <sup>1/4</sup> "	<b>D1BD6648SL</b>	676.	745.	811.	2,394.	
		72"	71 <sup>13/16</sup> "	47 <sup>13/16</sup> "		1 <sup>1/4</sup> "	<b>D1BD7248SL</b>	690.	761.	828.	2,416.	
	LH w/ 30" return depth	66"	65 <sup>13/16</sup> "	47 <sup>13/16</sup> "		1 <sup>1/4</sup> "	<b>D1BD6648DL</b>	711.	787.	855.	2,394.	
		72"	71 <sup>13/16</sup> "	47 <sup>13/16</sup> "		1 <sup>1/4</sup> "	<b>D1BD7248DL</b>	736.	811.	886.	2,416.	
	RH w/ 24" return depth	66"	65 <sup>13/16</sup> "	47 <sup>13/16</sup> "		1 <sup>1/4</sup> "	<b>D1BD6648SR</b>	676.	745.	811.	2,394.	
		72"	71 <sup>13/16</sup> "	47 <sup>13/16</sup> "		1 <sup>1/4</sup> "	<b>D1BD7248SR</b>	690.	761.	828.	2,416.	
	RH w/ 30" return depth	66"	65 <sup>13/16</sup> "	47 <sup>13/16</sup> "		1 <sup>1/4</sup> "	<b>D1BD6648DR</b>	711.	787.	855.	2,394.	
		72"	71 <sup>13/16</sup> "	47 <sup>13/16</sup> "		1 <sup>1/4</sup> "	<b>D1BD7248DR</b>	736.	811.	886.	2,416.	
	Conferencing worksurface (left hand shown) 		60"	59 <sup>13/16</sup> "	48"	24"	1 <sup>1/4</sup> "	<b>DB1BD48SL</b>	930.	1,024.	1,117.	2,370.
			60"	59 <sup>13/16</sup> "	48"	24"	1 <sup>1/4</sup> "	<b>DB1BD48SR</b>	930.	1,024.	1,117.	2,370.
	Peninsula Worksurface-Laminate No Grommets (9-shaped shown) 	P-shaped	66"	65 <sup>13/16</sup> "	29 <sup>13/16</sup> "	36"	1 <sup>1/4</sup> "	<b>D1P 6630N</b>	664.	728.	796.	1,533.
			72"	71 <sup>13/16</sup> "	29 <sup>13/16</sup> "	42"	1 <sup>1/4</sup> "	<b>D1P 7230N</b>	677.	746.	812.	1,576.
78"			77 <sup>13/16</sup> "	29 <sup>13/16</sup> "	42"	1 <sup>1/4</sup> "	<b>D1P 7830N</b>	760.	834.	908.	1,621.	
9-shaped		66"	65 <sup>13/16</sup> "	29 <sup>13/16</sup> "	36"	1 <sup>1/4</sup> "	<b>D19 6630N</b>	664.	728.	796.	1,533.	
		72"	71 <sup>13/16</sup> "	29 <sup>13/16</sup> "	42"	1 <sup>1/4</sup> "	<b>D19 7230N</b>	677.	746.	812.	1,576.	
		78"	77 <sup>13/16</sup> "	29 <sup>13/16</sup> "	42"	1 <sup>1/4</sup> "	<b>D19 7830N</b>	760.	834.	908.	1,621.	

w\* = nominal width

Dimensions listed under w d t are actual to the nearest 1/16"

#### Ordering Information

##### “D” Worksurface

1. Pattern Number
2. Top Finish Type
3. Edge Finish

#### Order Code

##### “D” Worksurface

*Example:* **D1H 6030, 114, 114**

**D1H 6030** Pattern Number

**114** Folkstone Grey  
Laminate

**114** Folkstone Grey Edge  
Band

#### Included with:

##### Worksurface

**Note:** Support column and panel-to-worksurface brackets must be ordered separately.

**Note:** An upcharge applies when specifying Legacy laminates. See Legacy finish page.

#### Options

##### Worksurfaces

- Woodgrain ABS edge
- Metal edge
- Techwood edge

To specify an edge grommet, replace “N” suffix from pattern number with “G”.

**Add \$18.**

## Curvilinear Half-Round Worksurfaces

Curvilinear half-round worksurfaces are sized to match up to the width of two back-to-back 24" deep or two back-to-back 30" deep freestanding desks.

Panel-supported half-round worksurfaces are notched along the flat end to accommodate the panel end trim.

Attachment is with a column support, T leg or A leg (must be ordered separately) at the free end of the worksurface and with flat brackets on the flat end of the half-round worksurface. The flat brackets attach to the adjacent freestanding desks. Flat brackets are black.

### Available Sizes

- Depths: 18" and 24"
- Widths: 48" and 63"
- Thickness: 1 1/4"

**Note:** All Dividends Horizon worksurfaces include a 1/2" wire drop at the rear edge. When used back to back with Half-Round worksurface, these two 1/2" wire drops will meet to form a 1" space between worksurfaces.

### Transition Worksurfaces

Attachment is with a column support, T leg or A leg (must be ordered separately) at the free end of the worksurface and with flat brackets on the flat end of the transition worksurface. The flat brackets attach to the adjacent freestanding desks. Flat brackets are black.

### Available Sizes

- Depths: 24", 36", 48"
- Widths: 48"
- Thickness: 1 1/4"

## Corner Round Worksurfaces

Corner-round worksurfaces are designed to "finish" a run of panel-mounted worksurfaces. Corner-round may be specified in two ways.

In a 90° "L" configuration, a notched corner-round worksurface is used to wrap around the panels. Two cantilevers and flat brackets (must be ordered separately) support the corner-round worksurface.

In an end run configuration, the corner-round worksurface is handed and must be specified as a left-hand or a right-hand top. One cantilever with a flat bracket and one panel-to-worksurface bracket (must be ordered separately) support the corner-round top.

### Available Sizes

- Depth: 24"
- Width: 24"
- Thickness: 1 1/4"

### Optional Edge Grommets

Grommets are not available for worksurfaces on this page.

Curvilinear Half-Round Worksurfaces (without panels)

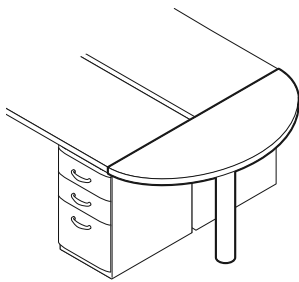

Curvilinear Half-Round Worksurfaces (with panels)

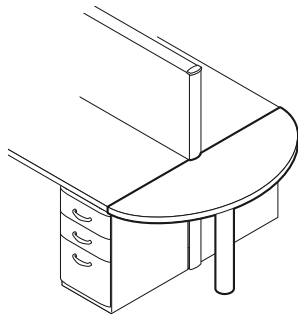

Corner-Round Worksurface

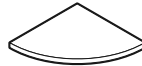

Notched Corner Worksurfae



Corner-Round Applications

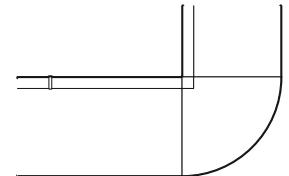

Corner-Round - Notched "L" Configuration

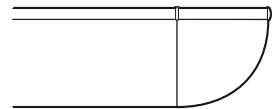



Corner-Round - End Run Configuration (right-hand shown) Quarter-round Surface



# Curvilinear Half- and Corner-Round Worksurfaces

## Mixed Depths

Dividends Horizon

description	type	w	return depth	t	pattern no.	laminate w/ ABS edge	laminate w/ woodgrain edge	laminate w/ metal edge	techwood w/ techwood edge
 Curvilinear Half-Round Worksurface	w/o panels	48"	18"	1 1/4"	<b>D1H4818</b>	\$359.	\$397.	\$432.	\$987.
	w/o panels	60"	24"	1 1/4"	<b>D1H6024</b>	495.	546.	595.	1,073.
	w/panels	51"	18"	1 1/4"	<b>D1H5118P</b>	367.	404.	439.	1,029.
	w/panels	63"	24"	1 1/4"	<b>D1H6324P</b>	501.	553.	604.	1,117.
 Transition Worksurface	w panels	51"	24"	1 1/4"	<b>D2H5124P</b>	441.	485.	528.	1,146.
	w panels	51"	36"	1 1/4"	<b>D2H5136P</b>	450.	493.	542.	1,186.
	w panels	51"	48"	1 1/4"	<b>D2H5148P</b>	458.	503.	551.	1,222.
	w/o panels	48"	24"	1 1/4"	<b>D2H4824</b>	436.	477.	521.	1,036.
	w/o panels	48"	36"	1 1/4"	<b>D2H4836</b>	442.	486.	533.	1,073.
	w/o panels	48"	48"	1 1/4"	<b>D2H4848</b>	453.	496.	544.	1,110.
 Corner Round Worksurface	left	23 13/16"	23 1/2"	1 1/4"	<b>D1CRL24</b>	193.	210.	229.	840.
	notched	23 1/2"	23 1/2"	1 1/4"	<b>D1CRN24</b>	193.	210.	229.	840.
	right	23 13/16"	23 1/2"	1 1/4"	<b>D1CRR24</b>	193.	210.	229.	840.

### Ordering Information

#### Half-Round Worksurface

1. Pattern Number
2. Top Finish Type
3. Edge Finish

#### Transition Worksurface

1. Pattern Number
2. Top Finish Type
3. Edge Finish

#### Corner-Round Worksurface

1. Pattern Number
2. Top Finish Type
3. Edge Finish

### Order Code

#### Half-Round Worksurface

*Example:* **D1H 5118P, 118, 118**

**D1H** Pattern Number  
**5118P**

**118** Bright White Laminate

**118** Bright White Edge Band

#### Transition Worksurface

*Example:* **D2H 5136P, 117, 117**

**D2H** Pattern Number  
**5136P**

**117** Soft Grey Laminate

**117** Soft Grey Edge Band

### Included with:

#### Half-Round Worksurface

- Worksurface
- 2 flat brackets

Note: Support column must be ordered separately.

#### Transition Worksurface

- Worksurface
- 2 flat brackets

Note: Support column must be ordered separately.

#### Corner Round Worksurface

- Worksurface

Note: 2 cantilevers must be ordered separately.

Note: An upcharge applies when specifying Legacy laminates. See Legacy finish page.

### Options

#### Half-Round Worksurface

- Woodgrain ABS edge
- Metal edge
- Techwood edge

#### Transition Worksurface

- Woodgrain ABS edge
- Metal edge
- Techwood edge

#### Corner-Round Worksurface

- Woodgrain ABS edge
- Metal edge
- Techwood edge

#### Curvilinear Half-Round and Transition Worksurface Option

Add an 'F' suffix to the pattern number when using with flat profile panel trim.

# Transaction Counter Worksurfaces

## 15" Deep Specifications

### 15"D Counter Worksurfaces

Dividends Horizon 15"D counter worksurfaces attach to the tops of 42" high panels to provide a transaction area within workstations. Three types are available:

- Straight
- Square corner
- Quarter-round corner

### Available Sizes

- Depth: 15"
- Widths: 24" to 96"
- Thickness: 1 1/4"

### Straight Counter Worksurface Support

Straight counter worksurfaces can span single or multiple panels. Counter worksurfaces are supported by four counter worksurface brackets which are included with the straight counter worksurfaces. Counter worksurface brackets are required at panel or post junctions for proper support.

**Note:** High-low panel end trim must be field cut when using countertops in a high-low straight panel run application.

**Note:** Counter worksurfaces may NOT be used with on any screens or 36H panels.

### Square and Quarter-Round Corner Counter Worksurfaces

Square corners allow rectilinear "L", "T" and "X" configurations while quarter-round corners allow radiused "L" configurations. When using corner counter worksurfaces, all adjoining straight counter worksurfaces must be 6" less than panel(s) width dimension. Square and quarter-round counter worksurfaces are supported by flat brackets which are included with corner worksurfaces. Additional support is provided by counter worksurface brackets from the adjoining straight counter worksurfaces.

Square-corner counter worksurfaces include three flat brackets while quarter-round counters include two flat brackets. Flat brackets are dark grey finish.

### Counter Worksurface Corner Applications

Suggested applications and configurations are illustrated below.

**Note:** When connecting a 15" deep counter worksurface with either corner counter worksurface, specify 6" shorter than the required width to accommodate the width of the corner counter worksurface.

### Counter Worksurface Supports

Straight counter worksurfaces 24" to 48" wide include four counter worksurface brackets while straight counters 54" to 96" wide include six counter worksurface brackets.

### 15"D Counter Worksurface

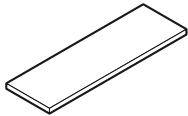

### 15"D Square-Shape Counter Worksurface



### 15"D Quarter Round Counter Worksurface



### 15"D Counter Worksurface Sizes Available

15D	
24	
30	
36	
42	
48	
54	
60	
66	
72	
78	
84	
90	
96	
15	
15	

### 15"D Counter Worksurface Applications

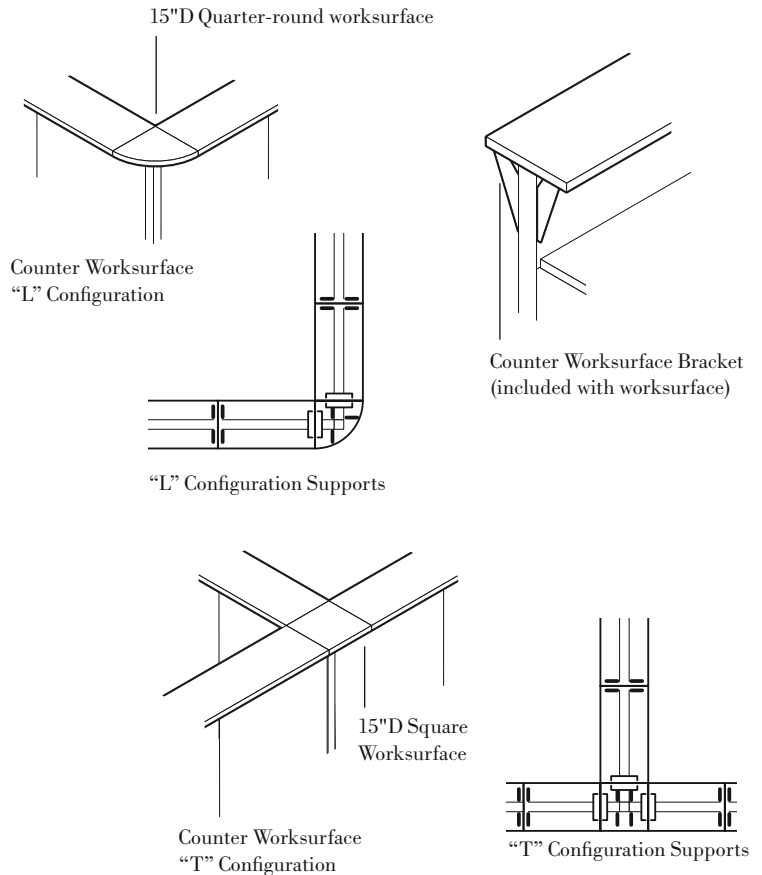



# Transaction Counter Worksurfaces

## Rectangular, Square Corner and Quarter-round Corner

### 15" Deep

Dividends Horizon

description	w *	w	d	t	pattern no.	laminata w/ ABS edge	laminata w/ woodgrain edge	laminata w/ metal edge	techwood w/ techwood edge
15" Deep Quarter-Round Shape Corner Counter Worksurface 	15"	14 <sup>13/16"</sup>	15"	1 <sup>1/4"</sup>	<b>D1R 1515C</b>	\$190.	\$210.	\$230.	\$769.
15" Deep Square-Shape Corner Counter Worksurface 	15"	14 <sup>13/16"</sup>	15"	1 <sup>1/4"</sup>	<b>D1R 1515S</b>	174.	194.	210.	482.
15" Deep Rectangular Counter Worksurface 	24"	23 <sup>13/16"</sup>	15"	1 <sup>1/4"</sup>	<b>D1R 2415</b>	218.	240.	262.	497.
	30"	29 <sup>13/16"</sup>	15"	1 <sup>1/4"</sup>	<b>D1R 3015</b>	236.	260.	282.	519.
	36"	35 <sup>13/16"</sup>	15"	1 <sup>1/4"</sup>	<b>D1R 3615</b>	242.	266.	290.	544.
	42"	41 <sup>13/16"</sup>	15"	1 <sup>1/4"</sup>	<b>D1R 4215</b>	243.	267.	291.	565.
	48"	47 <sup>13/16"</sup>	15"	1 <sup>1/4"</sup>	<b>D1R 4815</b>	243.	267.	291.	588.
	54"	54 <sup>13/16"</sup>	15"	1 <sup>1/4"</sup>	<b>D1R 5415</b>	252.	277.	305.	609.
	60"	59 <sup>13/16"</sup>	15"	1 <sup>1/4"</sup>	<b>D1R 6015</b>	267.	295.	322.	632.
	66"	65 <sup>13/16"</sup>	15"	1 <sup>1/4"</sup>	<b>D1R 6615</b>	277.	306.	334.	654.
	72"	71 <sup>13/16"</sup>	15"	1 <sup>1/4"</sup>	<b>D1R 7215</b>	304.	334.	364.	677.
	78"	77 <sup>13/16"</sup>	15"	1 <sup>1/4"</sup>	<b>D1R 7815</b>	322.	353.	386.	698.
	84"	83 <sup>13/16"</sup>	15"	1 <sup>1/4"</sup>	<b>D1R 8415</b>	338.	373.	406.	721.
	90"	89 <sup>13/16"</sup>	15"	1 <sup>1/4"</sup>	<b>D1R 9015</b>	355.	391.	425.	745.
	96"	95 <sup>13/16"</sup>	15"	1 <sup>1/4"</sup>	<b>D1R 9615</b>	373.	410.	446.	766.

w\* = nominal width

Dimensions listed under w d are actual to the nearest 1/16"

Ordering Information	Order Code	Included with:	Options
<b>15"D Counter Worksurface</b> 1. Pattern Number 2. Top Finish Type 3. Edge Finish 4. Counter Worksurface Bracket Finish  <b>Square-Shape Corner Counter Worksurface</b> 1. Pattern Number 2. Top Finish Type 3. Edge Finish  <b>Quarter-Round Shape Counter Worksurface</b> 1. Pattern Number 2. Top Finish Type 3. Edge Finish	<b>15"D Counter Worksurface</b> <i>Example:</i> <b>D1R 3615, 117, 117, 117</b> <b>D1R 3615</b> Pattern Number <b>117</b> Soft Grey Laminate <b>117</b> Soft Grey Edge Band <b>117</b> Soft Grey Bracket Finish  <b>Square-Shape Counter Worksurface</b> <i>Example:</i> <b>D1R 1515S, 117, 117</b> <b>D1R</b> Pattern Number <b>1515S</b> <b>117</b> Soft Grey Laminate <b>117</b> Soft Grey Edge Band  <b>Quarter-Round Shape Counter Worksurface</b> <i>Example:</i> <b>D1R 1515C, 117, 117</b> <b>D1R</b> Pattern Number <b>1515C</b> <b>117</b> Soft Grey Laminate <b>117</b> Soft Grey Edge Band	<b>15"D Counter Worksurface</b> <ul style="list-style-type: none"> <li>Four counter worksurface brackets</li> <li>Attachment hardware</li> </ul> <b>Square-Shape Counter Worksurface</b> <ul style="list-style-type: none"> <li>Three counter worksurface flat brackets</li> <li>Attachment hardware</li> </ul> <b>Quarter-Round Shape Counter Worksurface</b> <ul style="list-style-type: none"> <li>Two counter worksurface flat brackets</li> <li>Attachment hardware</li> </ul> <b>Note:</b> An upcharge applies when specifying Legacy laminates. See Legacy finish page.	<b>15"D Counter Worksurface</b> <ul style="list-style-type: none"> <li>Woodgrain ABS edge</li> <li>Metal edge</li> <li>Techwood edge</li> </ul> <b>Square-Shape Counter Worksurface</b> <ul style="list-style-type: none"> <li>Woodgrain ABS edge</li> <li>Metal edge</li> <li>Techwood edge</li> </ul> <b>Quarter-Round Shape Counter Worksurface</b> <ul style="list-style-type: none"> <li>Woodgrain ABS edge</li> <li>Metal edge</li> <li>Techwood edge</li> </ul>

# Rectangular with Cascade Edge 24" and 30" Deep

Dividends Horizon

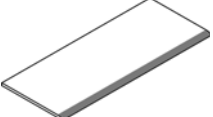
description	w	d	t	pattern no.	Solid	Woodgrain
24" D Rectangular 	24"	24"	1 1/4"	<b>DCE1R2424N</b>	\$213.	\$245.
	30"	24"	1 1/4"	<b>DCE1R3024N</b>	245.	282.
	36"	24"	1 1/4"	<b>DCE1R3624N</b>	270.	312.
	42"	24"	1 1/4"	<b>DCE1R4224N</b>	312.	359.
	48"	24"	1 1/4"	<b>DCE1R4824N</b>	350.	403.
	54"	24"	1 1/4"	<b>DCE1R5424N</b>	376.	432.
	60"	24"	1 1/4"	<b>DCE1R6024N</b>	408.	469.
	66"	24"	1 1/4"	<b>DCE1R6624N</b>	441.	506.
	72"	24"	1 1/4"	<b>DCE1R7224N</b>	461.	530.
	78"	24"	1 1/4"	<b>DCE1R7824N</b>	495.	568.
	84"	24"	1 1/4"	<b>DCE1R8424N</b>	523.	601.
	90"	24"	1 1/4"	<b>DCE1R9024N</b>	590.	677.
96"	24"	1 1/4"	<b>DCE1R9624N</b>	644.	740.	
30" D Rectangular 	24"	30"	1 1/4"	<b>DCE1R2430N</b>	271.	313.
	30"	30"	1 1/4"	<b>DCE1R3030N</b>	305.	350.
	36"	30"	1 1/4"	<b>DCE1R3630N</b>	339.	390.
	42"	30"	1 1/4"	<b>DCE1R4230N</b>	368.	422.
	48"	30"	1 1/4"	<b>DCE1R4830N</b>	408.	469.
	54"	30"	1 1/4"	<b>DCE1R5430N</b>	462.	531.
	60"	30"	1 1/4"	<b>DCE1R6030N</b>	508.	583.
	66"	30"	1 1/4"	<b>DCE1R6630N</b>	566.	651.
	72"	30"	1 1/4"	<b>DCE1R7230N</b>	590.	677.
	78"	30"	1 1/4"	<b>DCE1R7830N</b>	629.	723.
	84"	30"	1 1/4"	<b>DCE1R8430N</b>	669.	769.
	90"	30"	1 1/4"	<b>DCE1R9030N</b>	719.	827.
96"	30"	1 1/4"	<b>DCE1R9630N</b>	769.	884.	

## Ordering Information

1. Pattern Number
2. Top Finish Type

## Order Code

Worksurfaces	
Example: DCE1R4824N, 118	
DCE1	Dividends Cascade Edge Worksurface
R	Rectangular
48	Width
24	Depth
N	No Grommet
118	Bright White finish

## Included with:

Specify worksurface supports separately.

### Available Colors:

#### Solid:

- 114 Folkstone Grey
- 117 Soft Grey
- 118 Bright White
- 119 Pumice

#### Woodgrain:

- 124 Medium Cherry
- 125 Natural Maple
- 126 Natural Cherry
- 127 Walnut

## Options

### Worksurfaces

- Center-Located Edge Grommet  
To specify, replace the "N" suffix from the pattern number with "G".  
**Add \$21.**

Shaded area on worksurface drawings represents cascade edge detail.

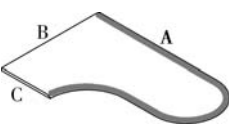
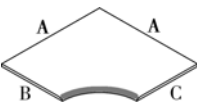
description	A	B	C	pattern no.	Solid	Woodgrain
Blended “D”  right hand shown	66"	48"	24"	<b>DCE1BD6648S(L/R)</b>	\$863.	\$992.
	66"	48"	30"	<b>DCE1BD6648D(L/R)</b>	907.	1,044.
	72"	48"	24"	<b>DCE1BD7248S(L/R)</b>	882.	1,016.
	72"	48"	30"	<b>DCE1BD7248D(L/R)</b>	940.	1,082.
	78"	48"	24"	<b>DCE1BD7848S(L/R)</b>	1,019.	1,172.
	78"	48"	30"	<b>DCE1BD7848D(L/R)</b>	1,054.	1,211.
	84"	48"	24"	<b>DCE1BD8448S(L/R)</b>	1,047.	1,204.
	84"	48"	30"	<b>DCE1BD8448D(L/R)</b>	1,113.	1,279.
Blended “L” 	36"	24"	24"	<b>DCE1L3636SSN</b>	533.	614.
	42"	24"	24"	<b>DCE1L4242SSN</b>	644.	740.
	42"	24"	30"	<b>DCE1L4242SDN</b>	765.	878.
	42"	30"	24"	<b>DCE1L4242DSN</b>	765.	878.
	48"	24"	24"	<b>DCE1L4848SSN</b>	723.	832.
	48"	24"	30"	<b>DCE1L4848SDN</b>	866.	996.
	48"	30"	24"	<b>DCE1L4848DSN</b>	866.	996.
	48"	30"	30"	<b>DCE1L4848DDN</b>	777.	894.

**Ordering Information**

1. Pattern Number
2. Top Finish Type

**Order Code**
**Worksurfaces**
*Example:* **DCE1BD7248SL, 118**

<b>DCE1</b>	Dividends Cascade Edge worksurface
<b>BD</b>	Blended “D”
<b>72</b>	Width
<b>48</b>	Depth
<b>S</b>	24”d return
<b>L</b>	Extended Left
<b>118</b>	Bright White

**Included with:**

Available Colors:

Solid:

114	Folkstone Grey
117	Soft Grey
118	Bright White
119	Pumice

Woodgrain:

124	Medium Cherry
125	Natural Maple
126	Natural Cherry
127	Walnut

**Options**
**Worksurfaces**

- Center-Located Edge Grommet (Blended “L” only) To specify, replace the “N” suffix from the pattern number with “G”.  
**Add \$42.**

**Note:** Support column and panel-to-worksurface brackets must be ordered separately.

Shaded area on worksurface drawings represents cascade edge detail.

**Note:** When wood grain or brushed laminates are specified on Cascade corner worksurfaces with two “A” sides of equal length, one of three grain direction options must be specified. Insert the desired grain direction option (L,R or D) after the laminate code. Please add \$25 to the list price for diagonal grain (D) selection.

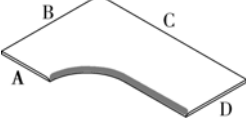
description	Width B	Width C	Width A	Width D	t	pattern no.	Solid	Woodgrain
Blended “L” 	42"	60"	24"	24"	1 1/4"	<b>DCE1L4260SSN</b>	\$884.	\$1,017.
	42"	66"	24"	24"	1 1/4"	<b>DCE1L4266SSN</b>	907.	1,044.
	42"	72"	24"	24"	1 1/4"	<b>DCE1L4272SSN</b>	941.	1,084.
	42"	78"	24"	24"	1 1/4"	<b>DCE1L4278SSN</b>	953.	1,094.
	48"	60"	24"	24"	1 1/4"	<b>DCE1L4860SSN</b>	896.	1,029.
	48"	60"	24"	30"	1 1/4"	<b>DCE1L4860SDN</b>	878.	1,012.
	48"	60"	30"	24"	1 1/4"	<b>DCE1L4860DSN</b>	878.	1,012.
	48"	66"	24"	24"	1 1/4"	<b>DCE1L4866SSN</b>	928.	1,066.
	48"	66"	24"	30"	1 1/4"	<b>DCE1L4866SDN</b>	924.	1,063.
	48"	66"	30"	24"	1 1/4"	<b>DCE1L4866DSN</b>	924.	1,063.
	48"	72"	24"	24"	1 1/4"	<b>DCE1L4872SSN</b>	962.	1,106.
	48"	72"	24"	30"	1 1/4"	<b>DCE1L4872SDN</b>	967.	1,113.
	48"	72"	30"	24"	1 1/4"	<b>DCE1L4872DSN</b>	967.	1,113.
	48"	78"	24"	24"	1 1/4"	<b>DCE1L4878SSN</b>	1,060.	1,219.
	48"	84"	24"	24"	1 1/4"	<b>DCE1L4884SSN</b>	1,191.	1,371.
	60"	42"	24"	24"	1 1/4"	<b>DCE1L6042SSN</b>	884.	1,017.
	60"	48"	24"	24"	1 1/4"	<b>DCE1L6048SSN</b>	896.	1,029.
	60"	48"	24"	30"	1 1/4"	<b>DCE1L6048SDN</b>	878.	1,012.
	60"	48"	30"	24"	1 1/4"	<b>DCE1L6048DSN</b>	878.	1,012.
	66"	42"	24"	24"	1 1/4"	<b>DCE1L6642SSN</b>	907.	1,044.
	66"	48"	24"	24"	1 1/4"	<b>DCE1L6648SSN</b>	928.	1,066.
	66"	48"	24"	30"	1 1/4"	<b>DCE1L6648SDN</b>	924.	1,063.
	66"	48"	30"	24"	1 1/4"	<b>DCE1L6648DSN</b>	924.	1,063.
	72"	42"	24"	24"	1 1/4"	<b>DCE1L7242SSN</b>	941.	1,084.
	72"	48"	24"	24"	1 1/4"	<b>DCE1L7248SSN</b>	962.	1,106.
	72"	48"	24"	30"	1 1/4"	<b>DCE1L7248SDN</b>	967.	1,113.
	72"	48"	30"	24"	1 1/4"	<b>DCE1L7248DSN</b>	967.	1,113.
	78"	42"	24"	24"	1 1/4"	<b>DCE1L7842SSN</b>	953.	1,094.
78"	48"	24"	24"	1 1/4"	<b>DCE1L7848SSN</b>	1,060.	1,219.	
84"	48"	24"	24"	1 1/4"	<b>DCE1L8448SSN</b>	1,191.	1,371.	

**Ordering Information**

1. Pattern Number
2. Top Finish Type

**Order Code**





Worksurfaces	
Example:	DCE1L4872SDG,114
DCE1	Dividends Cascade Edge worksurface
L	Blended “L”
48	Width
72	Depth
S	24”d, left side
D	30”d, right side
G	Grommet
114	Folkstone Grey

**Included with:**

Available Colors:	
Solid:	
114	Folkstone Grey
117	Soft Grey
118	Bright White
119	Pumice
Woodgrain:	
124	Medium Cherry
125	Natural Maple
126	Natural Cherry
127	Walnut

**Options**

- Worksurfaces**
- Center-Located Edge Grommet To specify, replace the “N” suffix from the pattern number with “G”. **Add \$42.**
- Note:** Specify the panel-to-worksurface brackets separately.
- Shaded area on worksurface drawings represents cascade edge detail.

description	w	d	t	pattern no.	Solid	Woodgrain
	48"	18"	1 1/4"	<b>DCE1H4818</b>	\$461.	\$530.
	48"	18"	1 1/4"	<b>DCE1H4818P</b>	461.	530.
	60"	24"	1 1/4"	<b>DCE1H6024</b>	634.	731.
	60"	24"	1 1/4"	<b>DCE1H6024P</b>	634.	731.
LH Corner Round	24"	24"	1 1/4"	<b>DCE1CR24L</b>	245.	282.
						
RH Corner Round	24"	24"	1 1/4"	<b>DCE1CR24R</b>	245.	282.
						
Notched Corner Round	24"	24"	1 1/4"	<b>DCE1CR24N</b>	245.	282.
						

### Ordering Information

1. Pattern Number
2. Top Finish Type

### Order Code

Worksurfaces	
Example:	DCE1H4818P,117
DCE1	Dividends Cascade Edge worksurface
H	Half Round
48	Width
18	Depth
P	Notched for panel
117	Soft Grey

### Included with:

Available Colors:	
Solid:	
114	Folkstone Grey
117	Soft Grey
118	Bright White
119	Pumice
Woodgrain:	
124	Medium Cherry
125	Natural Maple
126	Natural Cherry
127	Walnut

### Options

P= Notched for panel

**Note:** Specify all support brackets separately.

Shaded area on worksurface drawings represents cascade edge detail.

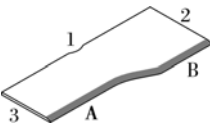
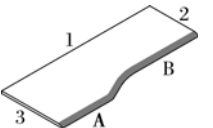
description	1	2	3	A	B	t	pattern no.	Solid	Woodgrain
Wave End, RH 	36"	30"	24"	3"	15"	1 1/4"	<b>DCE1W362430N</b>	\$573.	\$659.
	42"	30"	24"	9"	15"	1 1/4"	<b>DCE1W422430N</b>	602.	693.
	48"	30"	24"	15"	15"	1 1/4"	<b>DCE1W482430N</b>	645.	742.
	72"	30"	24"	30 1/2"	23 1/2"	1 1/4"	<b>DCE1W722430N</b>	821.	942.
<i>shown with grommet</i>									
Wave End, LH 	36"	24"	30"	15"	3"	1 1/4"	<b>DCE1W363024N</b>	573.	659.
	42"	24"	30"	15"	9"	1 1/4"	<b>DCE1W423024N</b>	602.	693.
	48"	24"	30"	15"	15"	1 1/4"	<b>DCE1W483024N</b>	645.	742.
	72"	24"	30"	23 1/2"	30 1/2"	1 1/4"	<b>DCE1W723024N</b>	821.	942.

**Ordering Information**

1. Pattern Number
2. Top Finish Type

**Order Code**

Worksurfaces	
Example:	DCE1W483024N,118
DCE1	Dividends Cascade Edge worksurface
W	Wave End
48	Width
30	30"d, left side
24	24"d, right side
N	No grommet
118	Bright White

**Included with:**

Available Colors:	
Solid:	
114	Folkstone Grey
117	Soft Grey
118	Bright White
119	Pumice
Woodgrain:	
124	Medium Cherry
125	Natural Maple
126	Natural Cherry
127	Walnut

**Options**

- Worksurfaces**
- Center-Located Edge Grommet  
To specify, replace the "N" suffix from the pattern number with "G".  
**Add \$21.**
- Note:** Specify all support brackets separately.
- Shaded area on worksurface drawings represents cascade edge detail.



**This page intentionally left blank**

### Worksurface Supports

Worksurfaces are shipped without supports which must be ordered separately.

A variety of worksurface supports are available. They include:

- Cantilevers
- Flat brackets
- Panel-to-worksurface brackets

In addition, freestanding pedestals and end units can also be used for worksurface support.

Cantilevers and panel-to-worksurface brackets are used strictly in panel-mount applications while flat brackets, pedestals and end units can be used in both panel-mounted and freestanding applications.

### Cantilevers

Cantilevers provide panel-hung worksurface support when the worksurface width runs parallel to the panel run.

Primary cantilever applications include:

- Corner worksurfaces
- Worksurface mid-span support
- 18" and 24" deep rectangular worksurface support in moderate load situations

**Note:** For heavy load applications, panel-to-worksurface brackets, freestanding pedestal, panel-mount C-leg, or open support leg is recommended. In applications involving 30" deep worksurfaces, cantilevers are only recommended for mid-span support.

Cantilevers are left- and right-handed and are available in three depths (18", 24" and 30") to support 18", 24" and 30" deep worksurfaces.

**Note:** 36" deep worksurfaces cannot be supported by cantilevers.

• **Attachment:** Cantilevers lock into the panel's slotted standard and adjust vertically in 1 1/2" increments. Cantilevers are left- or right-handed

• **Construction:** 14-gauge, black painted steel

### Flat Brackets

Flat brackets are used to join a primary worksurface with an adjacent return or bridge unit worksurface at the same height.

Flat brackets are available in three depths to support 18", 24" and 30" deep worksurface returns.

• **Attachment:** Flat brackets attach to pre-drilled positions on the undersides of worksurfaces with provided screws

• **Construction:** 14-gauge painted steel

### Shared Cantilevers

Adjacent worksurfaces can share a single cantilever if the appropriate flat bracket is used in conjunction with the appropriate cantilever (i.e. 18" cantilever with 18" flat bracket).

### Panel-to-Worksurface Brackets, Worksurface Support

Panel-to-worksurface brackets are used to:

- Mount worksurfaces perpendicular to panels
- Anchor the rear corner of corner worksurfaces to panels
- Secure a panel to a pedestal

Panel-to-worksurface brackets provide the most secure panel-hung support for heavily loaded worksurfaces.

Panel worksurface brackets are handed left or right.

**Note:** The panel width must match the worksurface depth for panel-to-worksurface brackets to connect worksurfaces perpendicular to panels.

• **Attachment:** Panel-to-worksurface brackets lock into the panel's slotted standard and adjust vertically in 1 1/2" increments

• **Construction:** 14-gauge painted steel

### Panel-to-Worksurface Brackets, Stabilizing Support

Panel-to-worksurface brackets are also used in conjunction with pedestals to stabilize panel runs.

In applications where the worksurface is "wrapped" with a return panel and a pedestal is installed below the worksurface at the "wrapped" end, a panel-to-worksurface bracket is used at the front corner of the worksurface. In pedestal applications, the panel-to-worksurface bracket connects the pedestal at the rear corner of the pedestal to the panel (as shown in the illustration below) or front corner of the pedestal to the panel when a return wing panel is used.

### Panel-to-Worksurface Brackets, Off-Module Support

For applications where the width of the panel exceeds the depth of the worksurface, specify off-module panel-to-worksurface brackets which allow off module worksurface support.

### Worksurface Reinforcement

Worksurface reinforcements are required for worksurface spans greater than 48 inches. This includes freestanding desk worksurfaces over 48 inches using desk end units. Worksurface reinforcements have a black paint finish.

Panel Mounted Worksurface Bracket Application

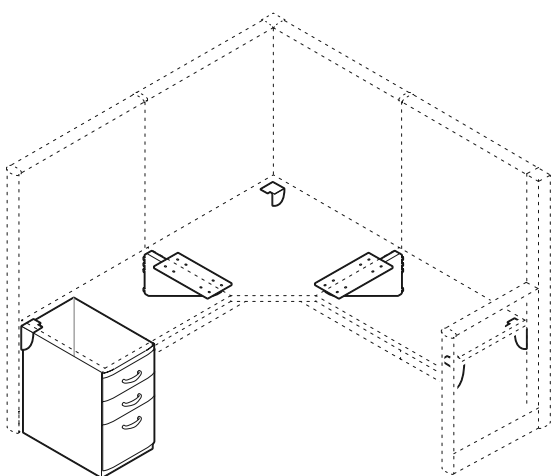

Flat Bracket Application

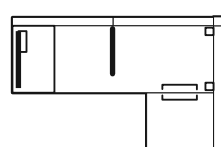

Shared Cantilever Application

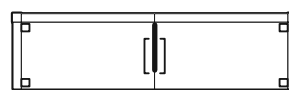

Stabilizing Support

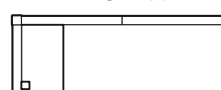

Off-Module Support

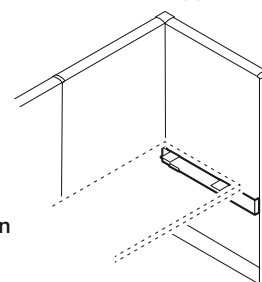



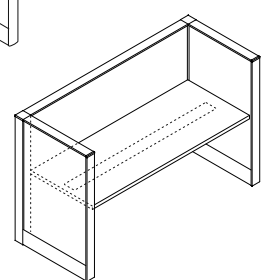

Worksurface Reinforcement Panel Hung Application



# Panel Mounted Worksurface Brackets

## *Cantilevers, Flat Brackets and Panel-to-Worksurface Brackets*

Dividends Horizon

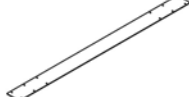
description	type	w	d	h	pattern no.	black	P1	P2	P3
Cantilever Bracket Left or Right (Left Shown) (package of 10) 	For 18"D WS	1 <sup>5</sup> / <sub>16</sub> "	12 <sup>3</sup> / <sub>16</sub> "	11 <sup>13</sup> / <sub>16</sub> "	<b>DB1C 18 (L or R) 10</b>	\$378.	\$397.	\$416.	\$434.
	For 24"D WS	1 <sup>5</sup> / <sub>16</sub> "	20 <sup>5</sup> / <sub>8</sub> "	10 <sup>1</sup> / <sub>2</sub> "	<b>DB1C 24 (L or R) 10</b>	471.	494.	517.	543.
	For 30"D WS	1 <sup>5</sup> / <sub>16</sub> "	26 <sup>15</sup> / <sub>16</sub> "	10 <sup>1</sup> / <sub>2</sub> "	<b>DB1C 30 (L or R) 10</b>	673.	707.	739.	774.
Cantilever Brackets, Left or Right (Left Shown) (single pack) 	For 18"D WS	1 <sup>5</sup> / <sub>16</sub> "	12 <sup>3</sup> / <sub>16</sub> "	11 <sup>13</sup> / <sub>16</sub> "	<b>DB1C 18 (L or R)</b>	38.	40.	42.	43.
	For 24"D WS	1 <sup>5</sup> / <sub>16</sub> "	20 <sup>5</sup> / <sub>8</sub> "	10 <sup>1</sup> / <sub>2</sub> "	<b>DB1C 24 (L or R)</b>	49.	52.	55.	57.
	For 30"D WS	1 <sup>5</sup> / <sub>16</sub> "	26 <sup>15</sup> / <sub>16</sub> "	10 <sup>1</sup> / <sub>2</sub> "	<b>DB1C 30 (L or R)</b>	69.	72.	76.	79.
Cantilever Brackets for 120° Planning (Left Shown)(single pack) 		20 <sup>5</sup> / <sub>8</sub> "		1 <sup>5</sup> / <sub>16</sub> "	<b>DB120C (L or R)</b>	49.	52.	55.	57.
Flat Bracket (single pack) 	For 18"D WS	3 <sup>3</sup> / <sub>4</sub> "	8 <sup>5</sup> / <sub>16</sub> "		<b>DB1F18SP</b>	15.	n/a	n/a	n/a
	For 24"D WS	3 <sup>3</sup> / <sub>4</sub> "	14 <sup>5</sup> / <sub>8</sub> "		<b>DB1F24SP</b>	27.	n/a	n/a	n/a
	For 30"D WS	3 <sup>3</sup> / <sub>4</sub> "	20 <sup>15</sup> / <sub>16</sub> "		<b>DB1F30SP</b>	31.	n/a	n/a	n/a
Flat Bracket (package of 10) 	For 18"D WS	3 <sup>3</sup> / <sub>4</sub> "	8 <sup>5</sup> / <sub>16</sub> "		<b>DB1F18TP</b>	128.	n/a	n/a	n/a
	For 24"D WS	3 <sup>3</sup> / <sub>4</sub> "	14 <sup>5</sup> / <sub>16</sub> "		<b>DB1F24TP</b>	212.	n/a	n/a	n/a
	For 30"D WS	3 <sup>3</sup> / <sub>4</sub> "	20 <sup>5</sup> / <sub>16</sub> "		<b>DB1F30TP</b>	244.	n/a	n/a	n/a
Worksurface Reinforcement 		54"	4"		<b>DB1WR54</b>	61.	n/a	n/a	n/a
		60"	4"		<b>DB1WR60</b>	62.	n/a	n/a	n/a
		66"	4"		<b>DB1WR66</b>	65.	n/a	n/a	n/a
		72"	4"		<b>DB1WR72</b>	67.	n/a	n/a	n/a

Worksurface Supports

### Ordering Information

#### Panel-to-Worksurface Bracket, Off Module

1. Pattern Number
2. Trim Finish

### Order Code

#### Panel-to-Worksurface Bracket, Off Module

*Example:* **DB1P WS36, 113**

---

**DB1P**      Pattern Number

---

**WS36**

---

**113**      Dark Grey Finish

---

### Included with:

#### Panel-to-Worksurface Bracket, Off Module

- Trim finish mounting rail
- Worksurface brackets

### Options

#### Panel-to-Worksurface Bracket, Off Module

# Panel Mounted Worksurface Brackets

## *Cantilevers, Flat Brackets and Panel-to-Worksurface Brackets*

description	type	w	d	h	pattern no.	black	P1	P2	P3
 Panel-to-Worksurface Brackets	Left (Shown)	3"	3"	4 <sup>11</sup> / <sub>16</sub> "	<b>DB1PWSL</b>	\$7.	\$7.	\$8.	\$9.
	Pair	3"	3"	4 <sup>11</sup> / <sub>16</sub> "	<b>DB1PWSP</b>	14.	14.	16.	18.
	Right	3"	3"	4 <sup>11</sup> / <sub>16</sub> "	<b>DB1PWSR</b>	7.	7.	8.	9.

 Panel-to-Worksurface Brackets for use with Worksurface Height Panels ONLY	Left	3"	3"	4 <sup>11</sup> / <sub>16</sub> "	<b>DB1PWSLWH</b>	22.	24.	26.	28.
	Pair	3"	3"	4 <sup>11</sup> / <sub>16</sub> "	<b>DB1PWSPWH</b>	44.	48.	52.	56.
	Right	3"	3"	4 <sup>11</sup> / <sub>16</sub> "	<b>DB1PWSRWH</b>	22.	24.	26.	28.

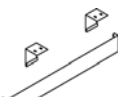
 Panel-to-Worksurface Brackets (Off Module)	For 24" Wide Panel				<b>DB1PWS24</b>	n/a	65.	70.	72.
	For 30" Wide Panel				<b>DB1PWS30</b>	n/a	68.	74.	78.
	For 36" Wide Panel				<b>DB1PWS36</b>	n/a	71.	78.	82.
	For 42" Wide Panel				<b>DB1PWS42</b>	n/a	76.	85.	91.
	For 48" Wide Panel				<b>DB1PWS48</b>	n/a	82.	91.	94.

### Ordering Information

#### Panel-to-Worksurface Bracket, Off Module

1. Pattern Number
2. Trim Finish

### Order Code

#### Panel-to-Worksurface Bracket, Off Module

*Example:* **DB1P WS36, 113**

---

**DB1P**      Pattern Number

---

**WS36**

---

**113**      Dark Grey Finish

---

### Included with:

#### Panel-to-Worksurface Bracket, Off Module

- Trim finish mounting rail
- Worksurface brackets

### Options

#### Panel-to-Worksurface Bracket, Off Module

**This page intentionally left blank**

## Screen-to-Worksurface Brackets, Worksurface Support

Screen-to-worksurface brackets are used to:

- Mount worksurfaces perpendicular to screens
- Anchor the rear corner of corner worksurfaces to screens

Screen-to-worksurface brackets provide the most secure screen-hung support for heavily loaded worksurfaces.

Screen worksurface brackets are handed left or right.

**Note:** The screen width must match the worksurface depth for screen-to-worksurface brackets to connect worksurfaces perpendicular to screens.

- **Attachment:** Screen-to-worksurface brackets lock into the screen's slotted standard and adjust vertically in 1 1/2" increments
- **Construction:** 14-gauge painted steel

## Screen-to-Worksurface Support Application

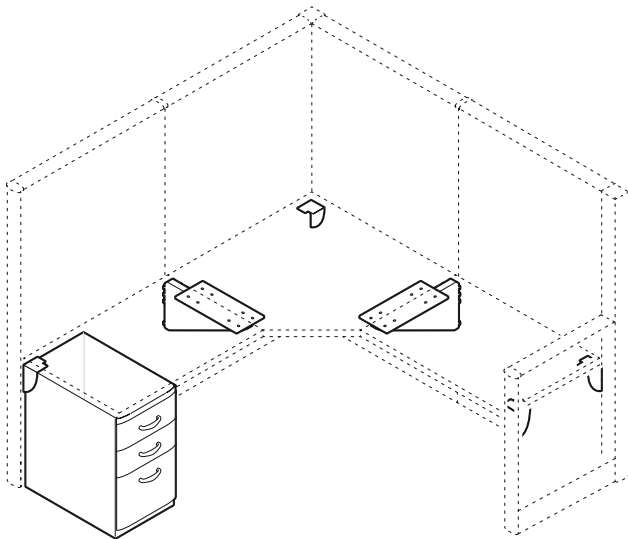

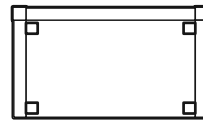

## Screen-to-Worksurface Brackets



# Screen-to-Worksurface Brackets

## Screen mid-span worksurface support

description	type	w	d	h	pattern no.	P1	P2	P3
Screen-to-Worksurface Brackets (Individual)	Left				<b>DB1SWSL</b>	\$7.	\$9.	\$12.
	Right				<b>DB1SWSR</b>	7.	9.	12.
								
Screen-to-Worksurface Brackets (Pair)	Left/Right				<b>DB1SWSP</b>	14.	18.	24.
Screen Mid-Span Worksurface Support	left hand				<b>DBSMLH</b>	24.	25.	26.
	right hand				<b>DBSMRH</b>	24.	25.	26.
								

### Ordering Information

#### Panel-to-Worksurface Bracket, Off Module

1. Pattern Number
2. Trim Finish

### Order Code

#### Panel-to-Worksurface Bracket, Off Module

*Example:* **DB1P WS36, 113**

---

**DB1P**      Pattern Number

---

**WS36**

---

**113**      Dark Grey Finish

---

### Included with:

#### Panel-to-Worksurface Bracket, Off Module

- Trim finish mounting rail
- Worksurface brackets

### Options

#### Panel-to-Worksurface Bracket, Off Module

## Panel-Mounted C-Legs, Open Support Legs, and Worksurface End Panels

Panel-mounted C-legs, open support legs, and worksurface end panels provide panel-hung worksurface support when the worksurface width runs parallel to the panel run.

Primary panel-mounted support applications include:

- Rectangular worksurface end support for 24" and 30" depth worksurfaces
- Mid span worksurface support for 24" and 30" depth worksurfaces
- Corner and split top corner worksurface support
- Support for heavier worksurface load applications
- Shared support between two adjacent worksurfaces

**Note:** 18" deep and 36" worksurface may not be used with panel-mounted C-leg worksurface support.

### Construction

C-leg support:

- Support foot: die cast aluminum
- Support leg: extruded aluminum
- Mounting bracket:  $\frac{3}{16}$ " steel plate

Open Support Leg:

- Vertical members: extruded aluminum
- Top plate and spanner bar: 0.025" cold rolled steel
- Mounting brackets:  $\frac{3}{16}$ " steel plate

Worksurface End Panel:

- Panel: 20 gauge steel
- Mounting brackets: 14 gauge steel

**Note:** Open support legs and worksurface end panels are only available in Knoll Core finishes

**Note:** The shared open support leg is designed for use where 2 panels meet. It cannot be used on the end of a panel run.

**Note:** Worksurface end panels are for use with panels only and are non-handed.

Panel-Mounted C-Leg Support

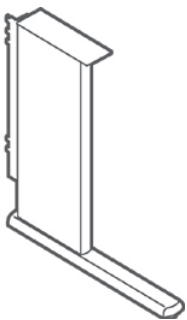

Panel-Mounted C-Leg Support (radiused foot)

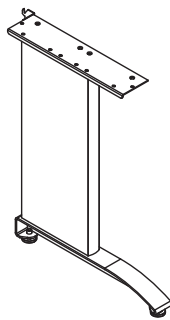

Open Support Leg

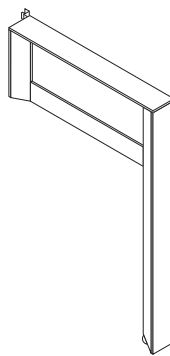

Worksurface End Panel

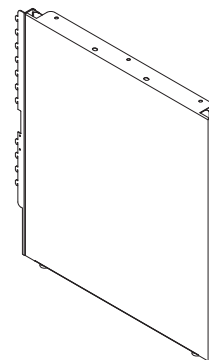



# Panel Mounted Worksurface Supports

## Open Support Leg, C-Leg and Worksurface End Panel

Dividends Horizon

Worksurface Supports

description	type	w	d	h	pattern no.	P1	P2	P3
Panel Mounted C-Leg Worksurface Support (Left-hand shown)	Left-hand C-Leg			26 <sup>7</sup> / <sub>8</sub> "	<b>DB1CL24L</b>	\$327.	\$358.	\$375.
	Right-hand C-Leg			26 <sup>7</sup> / <sub>8</sub> "	<b>DB1CL 24R</b>	327.	358.	375.
	Shared C-Leg			26 <sup>7</sup> / <sub>8</sub> "	<b>DB1CL24S</b>	346.	380.	399.
Panel Mounted C-Leg Worksurface Support Radiused Foot (Right-hand shown)	LH Shared Worksurface C-Leg			26 <sup>7</sup> / <sub>8</sub> "	<b>DB2CL24LS</b>	410.	453.	471.
	LH Single Worksurface C-Leg			26 <sup>7</sup> / <sub>8</sub> "	<b>DB2CL24L</b>	388.	426.	447.
	RH Shared Worksurface C-Leg			26 <sup>7</sup> / <sub>8</sub> "	<b>DB2CL24RS</b>	410.	453.	471.
	RH Single Worksurface C-Leg			26 <sup>7</sup> / <sub>8</sub> "	<b>DB2CL24R</b>	388.	426.	447.
Open Support Leg Panel Attachment		3"	15"	26 <sup>7</sup> / <sub>8</sub> "	<b>DB1LSP15()</b>	312.	331.	345.
		3"	18"	26 <sup>7</sup> / <sub>8</sub> "	<b>DB1LSP18()</b>	312.	331.	345.
		3"	24"	26 <sup>7</sup> / <sub>8</sub> "	<b>DB1LSP24()</b>	308.	325.	341.
		3"	30"	26 <sup>7</sup> / <sub>8</sub> "	<b>DB1LSP30()</b>	323.	338.	355.
		3"	36"	26 <sup>7</sup> / <sub>8</sub> "	<b>DB1LSP36()</b>	342.	358.	375.
Open Support Leg Screen Attachment		3"	15"	26 <sup>7</sup> / <sub>8</sub> "	<b>DB1LSS15()</b>	312.	331.	345.
		3"	18"	26 <sup>7</sup> / <sub>8</sub> "	<b>DB1LSS18()</b>	312.	331.	345.
		3"	24"	26 <sup>7</sup> / <sub>8</sub> "	<b>DB1LSS24()</b>	308.	325.	341.
		3"	30"	26 <sup>7</sup> / <sub>8</sub> "	<b>DB1LSS30()</b>	323.	338.	355.
		3"	36"	26 <sup>7</sup> / <sub>8</sub> "	<b>DB1LSS36()</b>	342.	358.	375.
Worksurface End Panel Panel Attachment		1 <sup>1</sup> / <sub>4</sub> "	15"	26 <sup>7</sup> / <sub>8</sub> "	<b>DB1PSP15</b>	284.	311.	328.
		1 <sup>1</sup> / <sub>4</sub> "	18"	26 <sup>7</sup> / <sub>8</sub> "	<b>DB1PSP18</b>	296.	327.	341.
		1 <sup>1</sup> / <sub>4</sub> "	24"	26 <sup>7</sup> / <sub>8</sub> "	<b>DB1PSP24</b>	325.	357.	374.
		1 <sup>1</sup> / <sub>4</sub> "	30"	26 <sup>7</sup> / <sub>8</sub> "	<b>DB1PSP30</b>	349.	384.	402.
		1 <sup>1</sup> / <sub>4</sub> "	36"	26 <sup>7</sup> / <sub>8</sub> "	<b>DB1PSP36</b>	373.	410.	427.

### Ordering Information

#### Panel-Mounted C-Leg Worksurface Support

1. Pattern Number
2. Paint Finish

#### Worksurface End Panel

1. Pattern Number
2. Paint Finish

#### Open Support Leg

1. Pattern Number
2. Paint Finish

### Order Code

#### Panel Mounted C-Leg Worksurface Support

*Example:* **DB1 CL24R, 117**

**DB1** Pattern Number

**CL24R**

**117** Soft Grey finish

#### Worksurface End Panel

*Example:* **DB1 PSP 24**

**DB1 PSP** Pattern Number

**24**

**117** Soft Grey finish

### Included with:

#### Panel-Mounted C-Leg Worksurface Support

- C-leg foot
- C-leg column
- Panel attachment bracket
- C-leg flat bracket
- Leveling glides

#### Worksurface End Panel

- Panel attachment bracket
- Leveling glides

**Note:** Open Support Legs are only available in Knoll core finishes.

**Note:** The shared open support leg is designed for use where 2 panels meet. It cannot be used at the end of a panel run.

### Options

#### Open Support Leg Option

(R) = Right-hand leg  
(L) = Left-hand leg  
(S) = Shared leg

**Note:** Worksurface end panels are for use with panels only.

## Round Support Column

4" diameter round column may be used to support the rounded end of panel-mounted curvilinear half-round, "D", "P", "9", and blended "D" peninsula tops. Column is available in all Knoll core paint finishes

### Construction

- Material: 4" diameter steel tube
- Mounting bracket: heavy gauge steel plate, 6 x 6

## T-Support Column

The T-support column may be used to support the rounded end of a panel-mounted curvilinear half-round, "D", "P", "9", and blended "D" peninsula tops. The T-support column is recommended for use with "D" peninsula worksurfaces used in freestanding applications. The T-support column is available in all Dividends paint finishes.

## Construction

T-support column specifications:

- Support foot: die cast aluminum
- Support leg: extruded aluminum
- Mounting bracket: heavy gauge steel plate

## T-End Unit

The T-end unit is used on the end of a freestanding "D" peninsula worksurface top. The T-end is available in a depth of 24" and 30" for use with "D", "P" and "9" top depths of 24" and 30".

### Construction

- Outer skin: 21-gauge steel
- Inner frame: 20-gauge steel
- Mounting brackets: 11-gauge steel

## A Leg

An A leg may be used to support panel mounted curvilinear half-round, "D", "P", "9" and blended "D" peninsula tops. A legs are available in any Knoll Core paint finish.

### Construction

- Vertical members: extruded aluminum
- Top plate and spanner bar: 0.025" cold rolled steel
- Mounting brackets: 14 gauge steel

**Note:** A legs are only available in Knoll Core finishes

Round Column with Panel  
"D" Worksurface

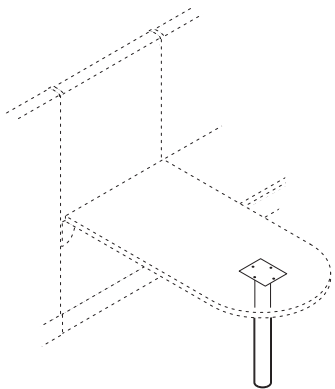

T-Support Base with Panel  
"D" Worksurface

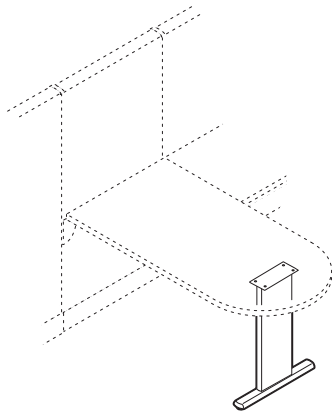

T-End Unit with Freestanding  
"D" Worksurface

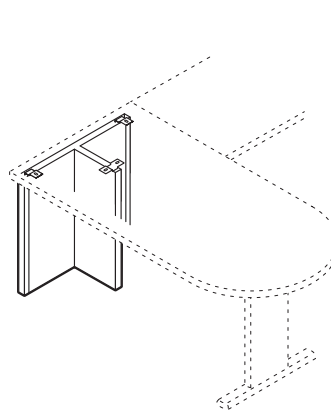



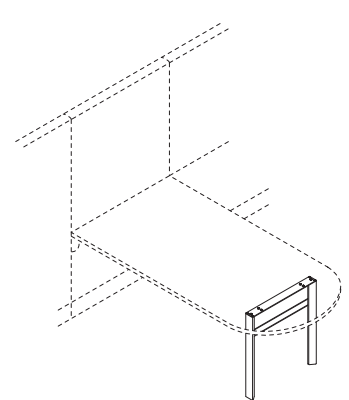

A-Leg with Panel  
"D" Worksurface



# Peninsula Worksurface Supports

## Round Support Column, T-Support Base and A Leg

Dividends Horizon

description	w	d	h	pattern no.	Black (NA)	P1	P2	P3
 T-End Unit	21 <sup>13</sup> / <sub>16</sub> "	12"	26 <sup>7</sup> / <sub>8</sub> "	<b>DD1TEU24</b>		\$308.	\$340.	\$355.
	27 <sup>13</sup> / <sub>16</sub> "	12"	26 <sup>7</sup> / <sub>8</sub> "	<b>DD1TEU30</b>		338.	371.	387.
 T-Support Base	23 <sup>1</sup> / <sub>2</sub> "	12"	26 <sup>7</sup> / <sub>8</sub> "	<b>DB1TB</b>		290.	320.	333.
 Round Support Column	4"	4"	26 <sup>7</sup> / <sub>8</sub> "	<b>DB1S CR</b>	228.	250.	262.	281.
 A Leg	3"	15"	26 <sup>7</sup> / <sub>8</sub> "	<b>DB1LS15A</b>		330.	363.	377.
	3"	18"	26 <sup>7</sup> / <sub>8</sub> "	<b>DB1LS18A</b>		341.	375.	389.
	3"	24"	26 <sup>7</sup> / <sub>8</sub> "	<b>DB1LS24A</b>		351.	386.	402.
	3"	30"	26 <sup>7</sup> / <sub>8</sub> "	<b>DB1LS30A</b>		364.	399.	415.
	3"	36"	26 <sup>7</sup> / <sub>8</sub> "	<b>DB1LS36A</b>		373.	410.	425.

Worksurface Supports

Dimensions listed under w d t are actual to the nearest 1/16"

Ordering Information	Order Code	Included with:	Options
<b>T-End Unit</b> 1. Pattern Number 2. Paint Finish	<b>T-End Unit</b> <i>Example:</i> <b>DD1TEU24, 115</b> <b>DD1TEU24</b> Pattern Number	<b>T-End Unit</b> • Worksurface	<b>T-End Unit</b> <b>T-Support Base</b> <b>A Leg</b> <b>Round Support Column</b>
<b>T-Support Base</b> 1. Pattern Number 2. Paint Finish	<b>115</b> Medium Grey Paint Finish <b>T-Support Base</b> <i>Example:</i> <b>DB1TB, 115</b> <b>DB1TB</b> Pattern Number	<b>T-Support Base</b> <b>Note:</b> The A leg is for use in peninsula worksurface applications only. It is not to be used in freestanding applications.	
<b>A Leg</b> 1. Pattern Number 2. Paint Finish	<b>115</b> Medium Grey Paint Finish	<b>Note:</b> A Legs are only available in Knoll core finishes.	
<b>Round Support Column</b> 1. Pattern Number 2. Paint Finish	<b>Round Support Column</b> <i>Example:</i> <b>DB1SCR, 118</b> <b>DB1SCR</b> Pattern Number <b>118</b> Bright White Paint Finish		

# Y Leg Tables

## *Freestanding and Credenza Supported Specifications*

### Dividends Horizon Tables

The design details of Dividends Horizon tables are consistent with the scale and visual language of the Dividends Horizon system. This design consistency makes Dividends Horizon tables appropriate for use in conference, meeting, private office and open plan office applications.

Dividends Horizon Y Leg tables are available in two versions:

- Freestanding Y Leg
- Credenza Supported Y Leg

### Freestanding Y Leg Tables

Freestanding Y Leg tables include a worksurface and base assembly. All freestanding table sizes are available with two Y legs and a horizontal stretcher connecting the two columns.

In addition, 24 and 30 inch deep tables are available without a stretcher. Tables without stretcher include an integral worksurface support plate. 36 and 42 inch deep tables are available only with a stretcher.

### Available Sizes

- Width: 60-96 inches
- Depth: 24-42 inches
- Height: 28-1/2 inches

### Credenza Supported Y Leg Tables

The unique Dividends Horizon Credenza Supported Y Leg tables are designed to be used in concert with Dividends Horizon low credenzas, specified separately.

Credenza Supported Tables include one Y Leg, credenza support spacer, and a worksurface with integral stiffening plate.

**Note:** Credenza supported tables may be used with laminate or veneer top credenzas only, and are not compatible with steel top credenzas.

### Available Sizes

- Width: 60-96 inches
- Depth: 24-36 inches
- Height: 28-1/2 inches

### Optional Edge Grommet

Edge grommets are optional and can be factory installed centered along the rear edge of rectangular or racetrack freestanding or credenza supported Y Leg tables.

### Construction

- **Worksurface:**
  - Material: 0.028 inch thick high pressure laminate or 0.6mm thick veneer on 1-1/8" particle board core
  - Edge: plastic laminate tops have a 2mm edgeband; Techwood tops have a 3/16 inch thick Techwood edge
- **Bases:**
  - Stretcher: extruded aluminum
  - Stiffening plate: 4 inch deep 12 gauge steel plate (length varies)
  - Foot: die cast aluminum
  - Column: extruded aluminum with 3/16 inch thick structural plate
  - Credenza support spacer: 2-15/16 inches high x 9-5/8 inches wide x 1-9/16 inches deep steel box with a flat bracket on top

**Note:** Dividends Horizon tables are only available in Knoll Core paint, laminate, and Techwood finishes. Legacy finishes are not available. All paint finishes have the Dividends Horizon textured paint finish; this includes 613 Silver, which is a smooth paint on all other Dividends Horizon products.

**Note:** The stiffening plate on tables without a stretcher prevents the field installation of a grommet or plexus box. (see illustration below)

24" Deep Freestanding Racetrack Y Leg Table with Stretcher



24" Deep Credenza Supported Racetrack Y Leg Table

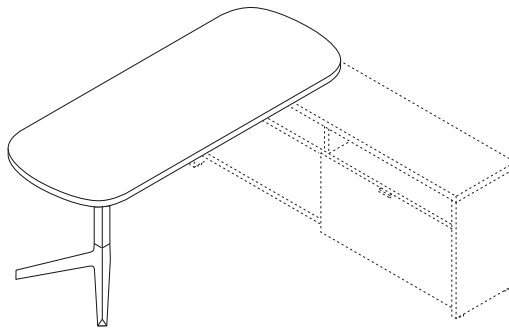

24" Deep Freestanding Racetrack Y Leg Table without Stretcher

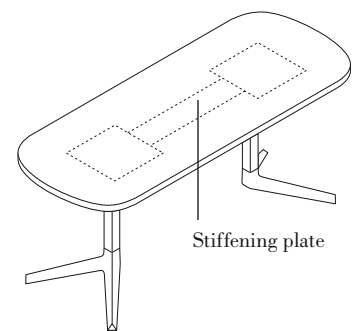

# Y Leg Tables

## Freestanding Rectangular Table Top

### 24" and 30" Deep

description	w*	w	d	t	h	pattern no.	Laminate	Laminate	Laminate	Techgrain	Techgrain	Techgrain
							Top P1 Paint	Top P2 Paint	Top P3 Paint	Top P1 Paint	Top P2 Paint	Top P3 Paint
24" Deep Rectangular with (2) Y-Legs, No Grommet	60"	59 <sup>13/16"</sup>	23 <sup>1/2"</sup>	1 <sup>1/4"</sup>	28 <sup>1/2"</sup>	<b>DT1ARY6024NS</b>	\$1,546.	\$1,702.	\$1,770.	\$1,772.	\$1,949.	\$2,028.
	66"	65 <sup>13/16"</sup>	23 <sup>1/2"</sup>	1 <sup>1/4"</sup>	28 <sup>1/2"</sup>	<b>DT1ARY6624NS</b>	1,564.	1,721.	1,788.	1,799.	1,982.	2,061.
	72"	71 <sup>13/16"</sup>	23 <sup>1/2"</sup>	1 <sup>1/4"</sup>	28 <sup>1/2"</sup>	<b>DT1ARY7224NS</b>	1,580.	1,739.	1,810.	1,830.	2,013.	2,094.
	78"	77 <sup>13/16"</sup>	23 <sup>1/2"</sup>	1 <sup>1/4"</sup>	28 <sup>1/2"</sup>	<b>DT1ARY7824NS</b>	1,599.	1,757.	1,828.	1,860.	2,047.	2,128.
	84"	83 <sup>13/16"</sup>	23 <sup>1/2"</sup>	1 <sup>1/4"</sup>	28 <sup>1/2"</sup>	<b>DT1ARY8424NS</b>	1,627.	1,789.	1,862.	1,890.	2,079.	2,162.
	90"	89 <sup>13/16"</sup>	23 <sup>1/2"</sup>	1 <sup>1/4"</sup>	28 <sup>1/2"</sup>	<b>DT1ARY9024NS</b>	1,656.	1,823.	1,895.	1,918.	2,112.	2,195.
	96"	95 <sup>13/16"</sup>	23 <sup>1/2"</sup>	1 <sup>1/4"</sup>	28 <sup>1/2"</sup>	<b>DT1ARY9624NS</b>	1,686.	1,855.	1,928.	1,948.	2,143.	2,230.



(with stretcher shown)

30" Deep Rectangular with (2) Y-Legs, No Grommet	60"	59 <sup>13/16"</sup>	29 <sup>1/2"</sup>	1 <sup>1/4"</sup>	28 <sup>1/2"</sup>	<b>DT1ARY6030NS</b>	1,585.	1,745.	1,816.	1,811.	1,991.	2,071.
	66"	65 <sup>13/16"</sup>	29 <sup>1/2"</sup>	1 <sup>1/4"</sup>	28 <sup>1/2"</sup>	<b>DT1ARY6630NS</b>	1,609.	1,770.	1,841.	1,845.	2,029.	2,110.
	72"	71 <sup>13/16"</sup>	29 <sup>1/2"</sup>	1 <sup>1/4"</sup>	28 <sup>1/2"</sup>	<b>DT1ARY7230NS</b>	1,629.	1,792.	1,865.	1,879.	2,067.	2,150.
	78"	77 <sup>13/16"</sup>	29 <sup>1/2"</sup>	1 <sup>1/4"</sup>	28 <sup>1/2"</sup>	<b>DT1ARY7830NS</b>	1,652.	1,818.	1,891.	1,914.	2,105.	2,189.
	84"	83 <sup>13/16"</sup>	29 <sup>1/2"</sup>	1 <sup>1/4"</sup>	28 <sup>1/2"</sup>	<b>DT1ARY8430NS</b>	1,684.	1,853.	1,926.	1,948.	2,143.	2,230.
	90"	89 <sup>13/16"</sup>	29 <sup>1/2"</sup>	1 <sup>1/4"</sup>	28 <sup>1/2"</sup>	<b>DT1ARY9030NS</b>	1,714.	1,886.	1,961.	1,983.	2,179.	2,268.
	96"	95 <sup>13/16"</sup>	29 <sup>1/2"</sup>	1 <sup>1/4"</sup>	28 <sup>1/2"</sup>	<b>DT1ARY9630NS</b>	1,746.	1,921.	1,997.	2,018.	2,218.	2,307.



(with stretcher shown)

w\* = nominal width  
 Dimensions listed under w d t h are actual to the nearest 1/16"

Ordering Information	Order Code	Included with:	Options
<b>Freestanding Y Leg Table:</b> 1. Pattern number 2. Base/Stretcher Paint Finish 3. Top Finish 4. Edge Finish	<b>Freestanding Y Leg Table:</b> <i>Example:</i> <b>DT1ARY6024NS, 114, 114</b> <hr/> <b>DT1</b> Dividends Horizon Table <hr/> <b>A</b> 2 Leg table assembly <hr/> <b>R</b> Rectangular shape <hr/> <b>Y</b> Y Leg Base <hr/> <b>60</b> Overall width in inches <hr/> <b>24</b> Overall depth in inches <hr/> <b>N</b> No grommet <hr/> <b>S</b> Stretcher <hr/> <b>114</b> Base/ stretcher paint finish <hr/> <b>114</b> Laminate top finish <hr/> <b>114</b> Edgeband finish	<b>Freestanding Y Leg Table:</b> <ul style="list-style-type: none"> <li>(2) Y Legs</li> <li>Hardware kit</li> <li>Table top</li> <li>Stretcher or stiffening plate</li> </ul> <b>Note:</b> Y Leg tables are finished with textured paint, including 613 Silver.  <b>Note:</b> Y Leg Tables are only available in Knoll core finishes.	<b>Grommet Option:</b> <ul style="list-style-type: none"> <li>To specify an edge grommet, replace the "N" suffix from the pattern number with an "E" and add \$17.</li> </ul> <b>Stretcher Option:</b> <ul style="list-style-type: none"> <li>A stretcher is optional on 24" and 30" deep tables ONLY. To specify a table without a stretcher replace the "S" suffix from the pattern number with an "N". Stretchers are required on 36" and 42" depths.</li> </ul>

# Y Leg Tables

## Freestanding Rectangular Table Top

### 36" and 42" Deep

description	w*	w	d	t	h	pattern no.	Laminate	Laminate	Laminate	Techgrain	Techgrain	Techgrain
							Top P1 Paint	Top P2 Paint	Top P3 Paint	Top P1 Paint	Top P2 Paint	Top P3 Paint
36" Deep Rectangular with (2) Y-Legs, No Grommet	60"	59 <sup>13/16"</sup>	35 <sup>1/2"</sup>	1 <sup>1/4"</sup>	28 <sup>1/2"</sup>	<b>DT1ARY6036N</b>	\$1,639.	\$1,800.	\$1,874.	\$1,891.	\$2,080.	\$2,162.
	66"	65 <sup>13/16"</sup>	35 <sup>1/2"</sup>	1 <sup>1/4"</sup>	28 <sup>1/2"</sup>	<b>DT1ARY6636N</b>	1,667.	1,833.	1,907.	1,927.	2,121.	2,204.
	72"	71 <sup>13/16"</sup>	35 <sup>1/2"</sup>	1 <sup>1/4"</sup>	28 <sup>1/2"</sup>	<b>DT1ARY7236N</b>	1,695.	1,865.	1,941.	1,964.	2,161.	2,247.
	78"	77 <sup>13/16"</sup>	35 <sup>1/2"</sup>	1 <sup>1/4"</sup>	28 <sup>1/2"</sup>	<b>DT1ARY7836N</b>	1,724.	1,897.	1,973.	2,001.	2,202.	2,290.
	84"	83 <sup>13/16"</sup>	35 <sup>1/2"</sup>	1 <sup>1/4"</sup>	28 <sup>1/2"</sup>	<b>DT1ARY8436N</b>	1,752.	1,928.	2,005.	2,039.	2,243.	2,332.
	90"	89 <sup>13/16"</sup>	35 <sup>1/2"</sup>	1 <sup>1/4"</sup>	28 <sup>1/2"</sup>	<b>DT1ARY9036N</b>	1,781.	1,959.	2,038.	2,076.	2,285.	2,374.
	96"	95 <sup>13/16"</sup>	35 <sup>1/2"</sup>	1 <sup>1/4"</sup>	28 <sup>1/2"</sup>	<b>DT1ARY9636N</b>	1,811.	1,991.	2,071.	2,114.	2,325.	2,416.



42" Deep Rectangular with (2) Y-Legs, No Grommet	84"	83 <sup>13/16"</sup>	42 <sup>1/2"</sup>	1 <sup>1/4"</sup>	28 <sup>1/2"</sup>	<b>DT1ARY8442N</b>	1,797.	1,979.	2,059.	2,282.	2,510.	2,611.
	90"	89 <sup>13/16"</sup>	42 <sup>1/2"</sup>	1 <sup>1/4"</sup>	28 <sup>1/2"</sup>	<b>DT1ARY9042N</b>	1,836.	2,021.	2,101.	2,314.	2,545.	2,646.
	96"	95 <sup>13/16"</sup>	42 <sup>1/2"</sup>	1 <sup>1/4"</sup>	28 <sup>1/2"</sup>	<b>DT1ARY9642N</b>	1,864.	2,051.	2,132.	2,344.	2,579.	2,682.



w\* = nominal width  
 Dimensions listed under w d t h are actual to the nearest 1/16"

Ordering Information	Order Code	Included with:	Options
<b>Freestanding Y Leg Table:</b> 1. Pattern number 2. Base/Stretcher Paint Finish 3. Top Finish 4. Edge Finish	<b>Freestanding Y Leg Table:</b> <i>Example:</i> <b>DT1ARY6024NS, 114, 114</b> <hr/> <b>DT1</b> Dividends Horizon Table <hr/> <b>A</b> 2 Leg table assembly <hr/> <b>R</b> Rectangular shape <hr/> <b>Y</b> Y Leg Base <hr/> <b>60</b> Overall width in inches <hr/> <b>24</b> Overall depth in inches <hr/> <b>N</b> No grommet <hr/> <b>S</b> Stretcher <hr/> <b>114</b> Base/ stretcher paint finish <hr/> <b>114</b> Laminate top finish <hr/> <b>114</b> Edgeband finish	<b>Freestanding Y Leg Table:</b> <ul style="list-style-type: none"> <li>• (2) Y Legs</li> <li>• Hardware kit</li> <li>• Table top</li> <li>• Stretcher or stiffening plate</li> </ul> <b>Note:</b> Y Leg tables are finished with textured paint, including 613 Silver.  <b>Note:</b> Y Leg Tables are only available in Knoll core finishes.	<b>Grommet Option:</b> <ul style="list-style-type: none"> <li>• To specify an edge grommet, replace the "N" suffix from the pattern number with an "E" and add \$17.</li> </ul> <b>Stretcher Option:</b> <ul style="list-style-type: none"> <li>• A stretcher is optional on 24" and 30" deep tables ONLY. To specify a table without a stretcher replace the "S" suffix from the pattern number with an "N". Stretchers are required on 36" and 42" depths.</li> </ul>

# Y Leg Tables

## Freestanding Racetrack Table Top

### 24" and 30" Deep

description	w*	w	d	t	h	pattern number	Laminate	Laminate	Laminate	Techgrain	Techgrain	Techgrain
							Top P1 Paint	Top P2 Paint	Top P3 Paint	Top P1 Paint	Top P2 Paint	Top P3 Paint
24" Deep Racetrack with (2) Y-Legs, No Grommet	60"	59 <sup>13/16"</sup>	23 <sup>1/2"</sup>	1 <sup>1/4"</sup>	28 <sup>1/2"</sup>	<b>DT1ATY6024NS</b>	\$1,545.	\$1,701.	\$1,769.	\$2,758.	\$3,035.	\$3,157.
	66"	65 <sup>13/16"</sup>	23 <sup>1/2"</sup>	1 <sup>1/4"</sup>	28 <sup>1/2"</sup>	<b>DT1ATY6624NS</b>	1,594.	1,752.	1,823.	2,784.	3,062.	3,186.
	72"	71 <sup>13/16"</sup>	23 <sup>1/2"</sup>	1 <sup>1/4"</sup>	28 <sup>1/2"</sup>	<b>DT1ATY7224NS</b>	1,641.	1,806.	1,877.	2,809.	3,092.	3,216.
	78"	77 <sup>13/16"</sup>	23 <sup>1/2"</sup>	1 <sup>1/4"</sup>	28 <sup>1/2"</sup>	<b>DT1ATY7824NS</b>	1,688.	1,857.	1,931.	2,835.	3,120.	3,243.
	84"	83 <sup>13/16"</sup>	23 <sup>1/2"</sup>	1 <sup>1/4"</sup>	28 <sup>1/2"</sup>	<b>DT1ATY8424NS</b>	1,717.	1,889.	1,964.	2,859.	3,147.	3,272.
	90"	89 <sup>13/16"</sup>	23 <sup>1/2"</sup>	1 <sup>1/4"</sup>	28 <sup>1/2"</sup>	<b>DT1ATY9024NS</b>	1,746.	1,921.	1,997.	2,886.	3,175.	3,303.
	96"	95 <sup>13/16"</sup>	23 <sup>1/2"</sup>	1 <sup>1/4"</sup>	28 <sup>1/2"</sup>	<b>DT1ATY9624NS</b>	1,776.	1,953.	2,032.	2,912.	3,202.	3,332.



(with stretcher shown)

30" Deep Racetrack with (2) Y-Legs, No Grommet	60"	59 <sup>13/16"</sup>	29 <sup>1/2"</sup>	1 <sup>1/4"</sup>	28 <sup>1/2"</sup>	<b>DT1ATY6030NS</b>	1,607.	1,766.	1,838.	2,800.	3,081.	3,204.
	66"	65 <sup>13/16"</sup>	29 <sup>1/2"</sup>	1 <sup>1/4"</sup>	28 <sup>1/2"</sup>	<b>DT1ATY6630NS</b>	1,651.	1,817.	1,889.	2,827.	3,111.	3,235.
	72"	71 <sup>13/16"</sup>	29 <sup>1/2"</sup>	1 <sup>1/4"</sup>	28 <sup>1/2"</sup>	<b>DT1ATY7230NS</b>	1,696.	1,865.	1,941.	2,854.	3,140.	3,266.
	78"	77 <sup>13/16"</sup>	29 <sup>1/2"</sup>	1 <sup>1/4"</sup>	28 <sup>1/2"</sup>	<b>DT1ATY7830NS</b>	1,741.	1,915.	1,991.	2,883.	3,171.	3,299.
	84"	83 <sup>13/16"</sup>	29 <sup>1/2"</sup>	1 <sup>1/4"</sup>	28 <sup>1/2"</sup>	<b>DT1ATY8430NS</b>	1,774.	1,951.	2,029.	2,911.	3,201.	3,330.
	90"	89 <sup>13/16"</sup>	29 <sup>1/2"</sup>	1 <sup>1/4"</sup>	28 <sup>1/2"</sup>	<b>DT1ATY9030NS</b>	1,807.	1,986.	2,066.	2,938.	3,231.	3,361.
	96"	95 <sup>13/16"</sup>	29 <sup>1/2"</sup>	1 <sup>1/4"</sup>	28 <sup>1/2"</sup>	<b>DT1ATY9630NS</b>	1,839.	2,023.	2,103.	2,965.	3,262.	3,393.



(with stretcher shown)

w\* = nominal width  
 Dimensions listed under w d t h are actual to the nearest 1/16"

Ordering Information	Order Code	Included with:	Options
<b>Freestanding Y Leg Table:</b> 1. Pattern number 2. Base/Stretcher Paint Finish 3. Top Finish 4. Edge Finish	<b>Freestanding Y Leg Table:</b> <i>Example:</i> <b>DT1ATY6024NS, 114, 114</b> <hr/> <b>DT1</b> Dividends Horizon Table <hr/> <b>A</b> 2 Leg table assembly <hr/> <b>T</b> Racetrack shape <hr/> <b>Y</b> Y Leg Base <hr/> <b>60</b> Overall width in inches <hr/> <b>24</b> Overall depth in inches <hr/> <b>N</b> No grommet <hr/> <b>S</b> Stretcher <hr/> <b>114</b> Base/ stretcher paint finish <hr/> <b>114</b> Laminate top finish <hr/> <b>114</b> Edgeband finish	<b>Freestanding Y Leg Table:</b> <ul style="list-style-type: none"> <li>• (2) Y Legs</li> <li>• Hardware kit</li> <li>• Table top</li> <li>• Stretcher or stiffening plate</li> </ul> <b>Note:</b> Y Leg tables are finished with textured paint, including 613 Silver.  <b>Note:</b> Y Leg Tables are only available in Knoll core finishes.	<b>Grommet Option:</b> <ul style="list-style-type: none"> <li>• To specify an edge grommet, replace the "N" suffix from the pattern number with an "E" and add \$17.</li> </ul> <b>Stretcher Option:</b> <ul style="list-style-type: none"> <li>• A stretcher is optional on 24" and 30" deep tables ONLY. To specify a table without a stretcher replace the "S" suffix from pattern number with an "N". Stretchers are required on 36" and 42" depths.</li> </ul>

# Y Leg Tables

## Freestanding Racetrack Table Top

### 36" and 42" Deep

description	w*	w	d	t	h	pattern no.	Laminate	Laminate	Laminate	Techgrain	Techgrain	Techgrain
							Top P1 Paint	Top P2 Paint	Top P3 Paint	Top P1 Paint	Top P2 Paint	Top P3 Paint
 36" Deep Racetrack with (2) Y-Legs, No Grommet	60"	59 <sup>13/16"</sup>	35 <sup>1/2"</sup>	1 <sup>1/4"</sup>	28 <sup>1/2"</sup>	<b>DT1ATY6036N</b>	\$1,661.	\$1,828.	\$1,901.	\$2,841.	\$3,125.	\$3,251.
	66"	65 <sup>13/16"</sup>	35 <sup>1/2"</sup>	1 <sup>1/4"</sup>	28 <sup>1/2"</sup>	<b>DT1ATY6636N</b>	1,713.	1,884.	1,959.	2,872.	3,157.	3,284.
	72"	71 <sup>13/16"</sup>	35 <sup>1/2"</sup>	1 <sup>1/4"</sup>	28 <sup>1/2"</sup>	<b>DT1ATY7236N</b>	1,764.	1,942.	2,020.	2,900.	3,190.	3,319.
	78"	77 <sup>13/16"</sup>	35 <sup>1/2"</sup>	1 <sup>1/4"</sup>	28 <sup>1/2"</sup>	<b>DT1ATY7836N</b>	1,817.	1,997.	2,078.	2,930.	3,223.	3,353.
	84"	83 <sup>13/16"</sup>	35 <sup>1/2"</sup>	1 <sup>1/4"</sup>	28 <sup>1/2"</sup>	<b>DT1ATY8436N</b>	1,845.	2,030.	2,110.	2,960.	3,256.	3,387.
	90"	89 <sup>13/16"</sup>	35 <sup>1/2"</sup>	1 <sup>1/4"</sup>	28 <sup>1/2"</sup>	<b>DT1ATY9036N</b>	1,875.	2,062.	2,144.	2,989.	3,290.	3,421.
	96"	95 <sup>13/16"</sup>	35 <sup>1/2"</sup>	1 <sup>1/4"</sup>	28 <sup>1/2"</sup>	<b>DT1ATY9636N</b>	1,903.	2,093.	2,176.	3,019.	3,322.	3,454.

 42" Deep Racetrack with (2) Y-Legs, No Grommet	84"	83 <sup>13/16"</sup>	42 <sup>1/2"</sup>	1 <sup>1/4"</sup>	28 <sup>1/2"</sup>	<b>DT1ATY8442N</b>	1,889.	2,078.	2,160.	3,012.	3,314.	3,445.
	90"	89 <sup>13/16"</sup>	42 <sup>1/2"</sup>	1 <sup>1/4"</sup>	28 <sup>1/2"</sup>	<b>DT1ATY9042N</b>	1,925.	2,119.	2,203.	3,044.	3,349.	3,481.
	96"	95 <sup>13/16"</sup>	42 <sup>1/2"</sup>	1 <sup>1/4"</sup>	28 <sup>1/2"</sup>	<b>DT1ATY9642N</b>	1,959.	2,156.	2,242.	3,074.	3,383.	3,518.

w\* = nominal width  
 Dimensions listed under w d t h are actual to the nearest 1/16"

Ordering Information	Order Code	Included with:	Options
<b>Freestanding Y Leg Table:</b> 1. Pattern number 2. Base/Stretcher Paint Finish 3. Top Finish 4. Edge Finish	<b>Freestanding Y Leg Table:</b> <i>Example:</i> <b>DT1ATY6024NS, 114, 114</b> <hr/> <b>DT1</b> Dividends Horizon Table <hr/> <b>A</b> 2 Leg table assembly <hr/> <b>T</b> Racetrack shape <hr/> <b>Y</b> Y Leg Base <hr/> <b>60</b> Overall width in inches <hr/> <b>24</b> Overall depth in inches <hr/> <b>N</b> No grommet <hr/> <b>S</b> Stretcher <hr/> <b>114</b> Base/ stretcher paint finish <hr/> <b>114</b> Laminate top finish <hr/> <b>114</b> Edgeband finish	<b>Freestanding Y Leg Table:</b> <ul style="list-style-type: none"> <li>(2) Y Legs</li> <li>Hardware kit</li> <li>Table top</li> <li>Stretcher or stiffening plate</li> </ul> <b>Note:</b> Y Leg tables are finished with textured paint, including 613 Silver.  <b>Note:</b> Y Leg Tables are only available in Knoll core finishes.	<b>Grommet Option:</b> <ul style="list-style-type: none"> <li>To specify an edge grommet, replace the "N" suffix from the pattern number with an "E" and add \$17.</li> </ul> <b>Stretcher Option:</b> <ul style="list-style-type: none"> <li>A stretcher is optional on 24" and 30" deep tables ONLY. To specify a table without a stretcher replace the "S" suffix from pattern number with an "N". Stretchers are required on 36" and 42" depths.</li> </ul>



# Y Leg Tables

## Credenza Supported Rectangular Table Top

### 24", 30" and 36" Deep

description	w*	w	d	t	h	pattern no"	Laminate	Laminate	Laminate	Techgrain	Techgrain	Techgrain
							Top P1 Paint	Top P2 Paint	Top P3 Paint	Top P1 Paint	Top P2 Paint	Top P3 Paint
24" Deep Rectangular with (1) Y-Leg and (1) Spacer - No Grommet	60"	59 <sup>13</sup> / <sub>16</sub> "	23 <sup>1</sup> / <sub>2</sub> "	1 <sup>1</sup> / <sub>4</sub> "	28 <sup>1</sup> / <sub>2</sub> "	<b>DT1CRY6024N</b>	\$1,292.	\$1,422.	\$1,479.	\$1,515.	\$1,666.	\$1,732.
	66"	65 <sup>13</sup> / <sub>16</sub> "	23 <sup>1</sup> / <sub>2</sub> "	1 <sup>1</sup> / <sub>4</sub> "	28 <sup>1</sup> / <sub>2</sub> "	<b>DT1CRY6624N</b>	1,309.	1,440.	1,498.	1,543.	1,698.	1,765.
	72"	71 <sup>13</sup> / <sub>16</sub> "	23 <sup>1</sup> / <sub>2</sub> "	1 <sup>1</sup> / <sub>4</sub> "	28 <sup>1</sup> / <sub>2</sub> "	<b>DT1CRY7224N</b>	1,325.	1,458.	1,517.	1,573.	1,730.	1,798.
	78"	77 <sup>13</sup> / <sub>16</sub> "	23 <sup>1</sup> / <sub>2</sub> "	1 <sup>1</sup> / <sub>4</sub> "	28 <sup>1</sup> / <sub>2</sub> "	<b>DT1CRY7824N</b>	1,342.	1,477.	1,536.	1,604.	1,763.	1,833.
	84"	83 <sup>13</sup> / <sub>16</sub> "	23 <sup>1</sup> / <sub>2</sub> "	1 <sup>1</sup> / <sub>4</sub> "	28 <sup>1</sup> / <sub>2</sub> "	<b>DT1CRY8424N</b>	1,371.	1,510.	1,570.	1,633.	1,794.	1,867.
	90"	89 <sup>13</sup> / <sub>16</sub> "	23 <sup>1</sup> / <sub>2</sub> "	1 <sup>1</sup> / <sub>4</sub> "	28 <sup>1</sup> / <sub>2</sub> "	<b>DT1CRY9024N</b>	1,402.	1,541.	1,604.	1,661.	1,828.	1,900.
	96"	95 <sup>13</sup> / <sub>16</sub> "	23 <sup>1</sup> / <sub>2</sub> "	1 <sup>1</sup> / <sub>4</sub> "	28 <sup>1</sup> / <sub>2</sub> "	<b>DT1CRY9624N</b>	1,432.	1,574.	1,638.	1,691.	1,860.	1,934.

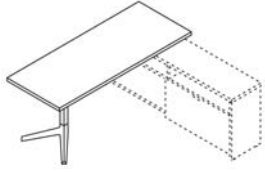

(credenza not included)

30" Deep Rectangular with (1) Y-Leg and (1) Spacer - No Grommet	60"	59 <sup>13</sup> / <sub>16</sub> "	29 <sup>1</sup> / <sub>2</sub> "	1 <sup>1</sup> / <sub>4</sub> "	28 <sup>1</sup> / <sub>2</sub> "	<b>DT1CRY6030N</b>	1,329.	1,462.	1,520.	1,554.	1,709.	1,777.
	66"	65 <sup>13</sup> / <sub>16</sub> "	29 <sup>1</sup> / <sub>2</sub> "	1 <sup>1</sup> / <sub>4</sub> "	28 <sup>1</sup> / <sub>2</sub> "	<b>DT1CRY6630N</b>	1,351.	1,486.	1,545.	1,587.	1,747.	1,817.
	72"	71 <sup>13</sup> / <sub>16</sub> "	29 <sup>1</sup> / <sub>2</sub> "	1 <sup>1</sup> / <sub>4</sub> "	28 <sup>1</sup> / <sub>2</sub> "	<b>DT1CRY7230N</b>	1,372.	1,511.	1,571.	1,622.	1,784.	1,856.
	78"	77 <sup>13</sup> / <sub>16</sub> "	29 <sup>1</sup> / <sub>2</sub> "	1 <sup>1</sup> / <sub>4</sub> "	28 <sup>1</sup> / <sub>2</sub> "	<b>DT1CRY7830N</b>	1,396.	1,535.	1,598.	1,656.	1,823.	1,895.
	84"	83 <sup>13</sup> / <sub>16</sub> "	29 <sup>1</sup> / <sub>2</sub> "	1 <sup>1</sup> / <sub>4</sub> "	28 <sup>1</sup> / <sub>2</sub> "	<b>DT1CRY8430N</b>	1,428.	1,570.	1,633.	1,691.	1,860.	1,934.
	90"	89 <sup>13</sup> / <sub>16</sub> "	29 <sup>1</sup> / <sub>2</sub> "	1 <sup>1</sup> / <sub>4</sub> "	28 <sup>1</sup> / <sub>2</sub> "	<b>DT1CRY9030N</b>	1,458.	1,606.	1,670.	1,725.	1,898.	1,973.
	96"	95 <sup>13</sup> / <sub>16</sub> "	29 <sup>1</sup> / <sub>2</sub> "	1 <sup>1</sup> / <sub>4</sub> "	28 <sup>1</sup> / <sub>2</sub> "	<b>DT1CRY9630N</b>	1,490.	1,641.	1,706.	1,758.	1,935.	2,012.

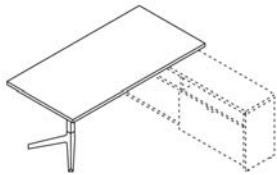

(credenza not included)

36" Deep Rectangular with (1) Y-Leg and (1) Spacer - No Grommet	60"	59 <sup>13</sup> / <sub>16</sub> "	35 <sup>1</sup> / <sub>2</sub> "	1 <sup>1</sup> / <sub>4</sub> "	28 <sup>1</sup> / <sub>2</sub> "	<b>DT1CRY6036N</b>	1,410.	1,551.	1,613.	1,660.	1,827.	1,900.
	66"	65 <sup>13</sup> / <sub>16</sub> "	35 <sup>1</sup> / <sub>2</sub> "	1 <sup>1</sup> / <sub>4</sub> "	28 <sup>1</sup> / <sub>2</sub> "	<b>DT1CRY6636N</b>	1,437.	1,579.	1,644.	1,695.	1,865.	1,939.
	72"	71 <sup>13</sup> / <sub>16</sub> "	35 <sup>1</sup> / <sub>2</sub> "	1 <sup>1</sup> / <sub>4</sub> "	28 <sup>1</sup> / <sub>2</sub> "	<b>DT1CRY7236N</b>	1,463.	1,610.	1,673.	1,729.	1,902.	1,979.
	78"	77 <sup>13</sup> / <sub>16</sub> "	35 <sup>1</sup> / <sub>2</sub> "	1 <sup>1</sup> / <sub>4</sub> "	28 <sup>1</sup> / <sub>2</sub> "	<b>DT1CRY7836N</b>	1,489.	1,639.	1,704.	1,764.	1,941.	2,019.
	84"	83 <sup>13</sup> / <sub>16</sub> "	35 <sup>1</sup> / <sub>2</sub> "	1 <sup>1</sup> / <sub>4</sub> "	28 <sup>1</sup> / <sub>2</sub> "	<b>DT1CRY8436N</b>	1,526.	1,680.	1,746.	1,797.	1,978.	2,057.
	90"	89 <sup>13</sup> / <sub>16</sub> "	35 <sup>1</sup> / <sub>2</sub> "	1 <sup>1</sup> / <sub>4</sub> "	28 <sup>1</sup> / <sub>2</sub> "	<b>DT1CRY9036N</b>	1,564.	1,720.	1,788.	1,833.	2,017.	2,096.
	96"	95 <sup>13</sup> / <sub>16</sub> "	35 <sup>1</sup> / <sub>2</sub> "	1 <sup>1</sup> / <sub>4</sub> "	28 <sup>1</sup> / <sub>2</sub> "	<b>DT1CRY9636N</b>	1,602.	1,761.	1,831.	1,867.	2,053.	2,135.

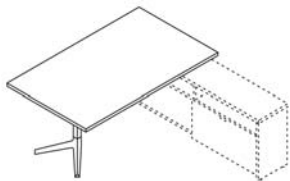

(credenza not included)

w\* = nominal width

Dimensions listed under w d t h are actual to the nearest<sup>1</sup>/<sub>16</sub>"

#### Ordering Information

##### Credenza Supported Y Leg Table:

1. Pattern number
2. Base/Stretcher Paint Finish
3. Top Finish
4. Edge Finish

#### Order Code

##### Credenza Supported Y Leg Table:

*Example:* **DT1CRY6024N, 114, 114**

<b>DT1</b>	Dividends Horizon Table
<b>C</b>	Credenza support assembly
<b>R</b>	Rectangular shape
<b>Y</b>	Y Leg Base
<b>60</b>	Overall width in inches
<b>24</b>	Overall depth in inches
<b>N</b>	No grommet
<b>114</b>	Base/ stretcher paint finish
<b>114</b>	Laminate top finish
<b>114</b>	Edgeband finish

#### Included with:

##### Credenza Supported Y leg Table:

- (1) Y Leg
- (1) Credenza support spacer
- Hardware kit
- Table top
- Stiffening plate

Credenza must be specified separately

**Note:** Y Leg tables are finished with textured paint, including 613 Silver.

**Note:** Y Leg Tables are only available in Knoll core finishes.

#### Options

##### Grommet Option:

- To specify an edge grommet, replace the "N" suffix from the pattern number with an "E" and add \$17.

**Note:** Credenza supported tables may be used with laminate or veneer top credenzas only and are not compatible with steel top credenzas.

# Y Leg Tables

## Credenza Supported Racetrack Table Top

### 24", 30" and 36" Deep

description	w*	w	d	h	pattern no.	Laminate	Laminate	Laminate	Techgrain	Techgrain	Techgrain
						Top P1 Paint	Top P2 Paint	Top P3 Paint	Top P1 Paint	Top P2 Paint	Top P3 Paint
24" Deep Racetrack with (1) Y-Leg and (1) Spacer - No Grommet	60"	59 <sup>13/16"</sup>	23 <sup>1/2"</sup>	28 <sup>1/2"</sup>	<b>DT1CTY6024N</b>	\$1,290.	\$1,419.	\$1,477.	\$2,526.	\$2,778.	\$2,853.
	66"	65 <sup>13/16"</sup>	23 <sup>1/2"</sup>	28 <sup>1/2"</sup>	<b>DT1CTY6624N</b>	1,338.	1,472.	1,531.	2,539.	2,794.	2,877.
	72"	71 <sup>13/16"</sup>	23 <sup>1/2"</sup>	28 <sup>1/2"</sup>	<b>DT1CTY7224N</b>	1,386.	1,524.	1,584.	2,553.	2,809.	2,897.
	78"	77 <sup>13/16"</sup>	23 <sup>1/2"</sup>	28 <sup>1/2"</sup>	<b>DT1CTY7824N</b>	1,434.	1,576.	1,640.	2,568.	2,825.	2,920.
	84"	83 <sup>13/16"</sup>	23 <sup>1/2"</sup>	28 <sup>1/2"</sup>	<b>DT1CTY8424N</b>	1,449.	1,594.	1,657.	2,581.	2,841.	2,942.
	90"	89 <sup>13/16"</sup>	23 <sup>1/2"</sup>	28 <sup>1/2"</sup>	<b>DT1CTY9024N</b>	1,465.	1,612.	1,675.	2,596.	2,855.	2,963.
	96"	95 <sup>13/16"</sup>	23 <sup>1/2"</sup>	28 <sup>1/2"</sup>	<b>DT1CTY9624N</b>	1,480.	1,628.	1,693.	2,610.	2,873.	2,985.

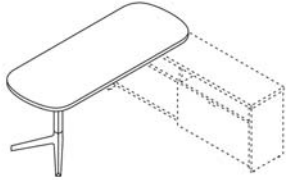

(credenza not included)

30" Deep Racetrack with (1) Y-Leg and (1) Spacer - No Grommet	60"	59 <sup>13/16"</sup>	29 <sup>1/2"</sup>	28 <sup>1/2"</sup>	<b>DT1CTY6030N</b>	1,351.	1,486.	1,545.	2,541.	2,795.	2,889.
	66"	65 <sup>13/16"</sup>	29 <sup>1/2"</sup>	28 <sup>1/2"</sup>	<b>DT1CTY6630N</b>	1,397.	1,536.	1,599.	2,570.	2,826.	2,924.
	72"	71 <sup>13/16"</sup>	29 <sup>1/2"</sup>	28 <sup>1/2"</sup>	<b>DT1CTY7230N</b>	1,442.	1,584.	1,649.	2,597.	2,857.	2,960.
	78"	77 <sup>13/16"</sup>	29 <sup>1/2"</sup>	28 <sup>1/2"</sup>	<b>DT1CTY7830N</b>	1,486.	1,636.	1,701.	2,625.	2,889.	2,995.
	84"	83 <sup>13/16"</sup>	29 <sup>1/2"</sup>	28 <sup>1/2"</sup>	<b>DT1CTY8430N</b>	1,518.	1,670.	1,738.	2,655.	2,920.	3,029.
	90"	89 <sup>13/16"</sup>	29 <sup>1/2"</sup>	28 <sup>1/2"</sup>	<b>DT1CTY9030N</b>	1,551.	1,706.	1,774.	2,682.	2,952.	3,065.
	96"	95 <sup>13/16"</sup>	29 <sup>1/2"</sup>	28 <sup>1/2"</sup>	<b>DT1CTY9630N</b>	1,582.	1,741.	1,812.	2,711.	2,982.	3,101.

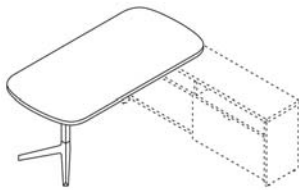

(credenza not included)

36" Deep Racetrack with (1) Y-Leg and (1) Spacer - No Grommet	60"	59 <sup>13/16"</sup>	35 <sup>1/2"</sup>	28 <sup>1/2"</sup>	<b>DT1CTY6036N</b>	1,431.	1,573.	1,637.	2,556.	2,812.	2,924.
	66"	65 <sup>13/16"</sup>	35 <sup>1/2"</sup>	28 <sup>1/2"</sup>	<b>DT1CTY6636N</b>	1,480.	1,628.	1,693.	2,599.	2,858.	2,973.
	72"	71 <sup>13/16"</sup>	35 <sup>1/2"</sup>	28 <sup>1/2"</sup>	<b>DT1CTY7236N</b>	1,531.	1,684.	1,751.	2,641.	2,906.	3,021.
	78"	77 <sup>13/16"</sup>	35 <sup>1/2"</sup>	28 <sup>1/2"</sup>	<b>DT1CTY7836N</b>	1,580.	1,739.	1,810.	2,684.	2,953.	3,069.
	84"	83 <sup>13/16"</sup>	35 <sup>1/2"</sup>	28 <sup>1/2"</sup>	<b>DT1CTY8436N</b>	1,617.	1,779.	1,851.	2,726.	2,999.	3,120.
	90"	89 <sup>13/16"</sup>	35 <sup>1/2"</sup>	28 <sup>1/2"</sup>	<b>DT1CTY9036N</b>	1,654.	1,819.	1,892.	2,769.	3,046.	3,168.
	96"	95 <sup>13/16"</sup>	35 <sup>1/2"</sup>	28 <sup>1/2"</sup>	<b>DT1CTY9636N</b>	1,690.	1,859.	1,933.	2,811.	3,093.	3,217.

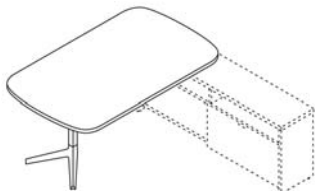

(credenza not included)

w\* = nominal width

Dimensions listed under w d t h are actual to the nearest 1/16"

Ordering Information	Order Code	Included with:	Options
<b>Credenza Supported Y Leg Table:</b>	<b>Credenza Supported Y Leg Table:</b>	<b>Credenza Supported Y Leg Table:</b>	<b>Grommet Option:</b>
1. Pattern number	<i>Example:</i> <b>DT1CTY6024N, 114, 114</b>	<ul style="list-style-type: none"> <li>(1) Y Leg</li> <li>(1) Credenza support spacer</li> <li>Hardware kit</li> <li>Table top</li> <li>Stiffening plate</li> </ul>	<ul style="list-style-type: none"> <li>To specify an edge grommet, replace the "N" suffix from the pattern number with an "E" and add \$17.</li> </ul>
2. Base/Stretcher Paint Finish	<b>DT1</b> Dividends Horizon Table	Credenza must be specified separately	<b>Note:</b> Credenza supported tables may be used with laminate or veneer top credenzas only and are not compatible with steel top credenzas.
3. Top Finish	<b>C</b> Credenza support assembly	<b>Note:</b> Y Leg tables are finished with textured paint, including 613 Silver.	
4. Edge Finish	<b>T</b> Racetrack shape		
	<b>Y</b> Y Leg Base	<b>Note:</b> Y Leg Tables are only available in Knoll core finishes.	
	<b>60</b> Overall width in inches		
	<b>24</b> Overall depth in inches		
	<b>N</b> No grommet		
	<b>114</b> Base/ stretcher paint finish		
	<b>114</b> Laminate top finish		
	<b>114</b> Edgeband finish		

**This page intentionally left blank**

#### X Base Tables

Dividends Horizon X base tables are designed to be used along with the Dividends Horizon system to create a consistent aesthetic throughout the entire office. With various height and width options, X base tables can be used in a multitude of applications, including collaboration areas in the open plan, break rooms, and lounge areas.

Available with a round, square or rounded square top shape with either a laminate or veneer finish, a Dividends Horizon X base table is appropriate for use in a vast array of applications from the private office to the open plan and even to lounge areas. The five height options allow for the same table base to be used in various applications while maintaining visual consistency throughout the space.

X base tables include a top, support column, and X base.

#### Available Sizes

- Width: 30 - 48 inches
- Depth: 30 - 48 inches
- Heights: 17, 21, 28-1/2, 36, and 42 inches

#### Construction

##### • Worksurface:

- Material: 0.028" thick high pressure laminate or 0.6mm thick veneer on 1-1/8" particle board core
- Edge: plastic laminate tops have a 2mm edgeband; Techwood tops have a 3/16" thick Techwood edge.

##### • Base:

- Foot: die cast aluminum
- Column: extruded aluminum with 3/16" thick structural plate

#### Table Supports

X bases may be specified separately for use with an alternative table top. The appropriate X base size must be selected according to the width of the table top being used. X bases are available in five heights and may be used with table tops that are 30 to 48 inches wide.

#### Available Sizes

Heights: 17, 21, 28-1/2, 36, and 42 inches

#### Construction

##### • Base:

- Foot: die cast aluminum
- Column: extruded aluminum with 3/16" thick structural plate

**Note:** Dividends Horizon tables are only available in Knoll Core paint and laminate finishes. Legacy finishes are not available. All paint finishes have the Dividends Horizon textured paint finish; this includes 613 Silver, which is a smooth paint on all other Dividends Horizon products.

Square X Base Table



Round X Base Table







Rounded Square X Base Table



# X Base Tables

## Square Table Tops

### 17", 21", 28", 36" and 42" High

description	w*	w	d	t	h	pattern no.	Laminate Top P1 Paint	Laminate Top P2 Paint	Laminate Top P3 Paint	Techgrain Top P1 Paint	Techgrain Top P2 Paint	Techgrain Top P3 Paint
 17" High Square X Base Table	30"	29 <sup>13/16"</sup>	29 <sup>13/16"</sup>	1 <sup>1/4"</sup>	17"	<b>DT1ASX303017</b>	\$940.	\$1,037.	\$1,079.	\$1,389.	\$1,535.	\$1,597.
	36"	35 <sup>13/16"</sup>	35 <sup>13/16"</sup>	1 <sup>1/4"</sup>	17"	<b>DT1ASX363617</b>	982.	1,083.	1,127.	1,468.	1,616.	1,682.
	42"	41 <sup>13/16"</sup>	41 <sup>13/16"</sup>	1 <sup>1/4"</sup>	17"	<b>DT1ASX424217</b>	1,089.	1,200.	1,248.	1,553.	1,710.	1,779.
	48"	47 <sup>13/16"</sup>	47 <sup>13/16"</sup>	1 <sup>1/4"</sup>	17"	<b>DT1ASX484817</b>	1,142.	1,260.	1,310.	1,615.	1,778.	1,851.
 21" High Square X Base Table	30"	29 <sup>13/16"</sup>	29 <sup>13/16"</sup>	1 <sup>1/4"</sup>	21"	<b>DT1ASX303021</b>	940.	1,037.	1,079.	1,389.	1,535.	1,597.
	36"	35 <sup>13/16"</sup>	35 <sup>13/16"</sup>	1 <sup>1/4"</sup>	21"	<b>DT1ASX363621</b>	982.	1,083.	1,127.	1,468.	1,616.	1,682.
	42"	41 <sup>13/16"</sup>	41 <sup>13/16"</sup>	1 <sup>1/4"</sup>	21"	<b>DT1ASX424221</b>	1,089.	1,200.	1,248.	1,553.	1,710.	1,779.
	48"	47 <sup>13/16"</sup>	47 <sup>13/16"</sup>	1 <sup>1/4"</sup>	21"	<b>DT1ASX484821</b>	1,142.	1,260.	1,310.	1,615.	1,778.	1,851.
 28" High Square X Base Table	30"	29 <sup>13/16"</sup>	29 <sup>13/16"</sup>	1 <sup>1/4"</sup>	28 <sup>1/2"</sup>	<b>DT1ASX3030</b>	963.	1,059.	1,101.	1,410.	1,556.	1,617.
	36"	35 <sup>13/16"</sup>	35 <sup>13/16"</sup>	1 <sup>1/4"</sup>	28 <sup>1/2"</sup>	<b>DT1ASX3636</b>	1,003.	1,103.	1,147.	1,488.	1,638.	1,703.
	42"	41 <sup>13/16"</sup>	41 <sup>13/16"</sup>	1 <sup>1/4"</sup>	28 <sup>1/2"</sup>	<b>DT1ASX4242</b>	1,109.	1,222.	1,270.	1,574.	1,731.	1,799.
	48"	47 <sup>13/16"</sup>	47 <sup>13/16"</sup>	1 <sup>1/4"</sup>	28 <sup>1/2"</sup>	<b>DT1ASX4848</b>	1,163.	1,280.	1,331.	1,637.	1,798.	1,872.
 36" High Square X Base Table	30"	29 <sup>13/16"</sup>	29 <sup>13/16"</sup>	1 <sup>1/4"</sup>	36"	<b>DT1ASX303036</b>	1,016.	1,111.	1,154.	1,463.	1,610.	1,670.
	36"	35 <sup>13/16"</sup>	35 <sup>13/16"</sup>	1 <sup>1/4"</sup>	36"	<b>DT1ASX363636</b>	1,056.	1,156.	1,201.	1,541.	1,690.	1,755.
	42"	41 <sup>13/16"</sup>	41 <sup>13/16"</sup>	1 <sup>1/4"</sup>	36"	<b>DT1ASX424236</b>	1,162.	1,274.	1,323.	1,627.	1,784.	1,854.
	48"	47 <sup>13/16"</sup>	47 <sup>13/16"</sup>	1 <sup>1/4"</sup>	36"	<b>DT1ASX484836</b>	1,217.	1,333.	1,385.	1,689.	1,853.	1,924.
 42" High Square X Base Table	30"	29 <sup>13/16"</sup>	29 <sup>13/16"</sup>	1 <sup>1/4"</sup>	42"	<b>DT1ASX303042</b>	1,036.	1,133.	1,176.	1,484.	1,630.	1,691.
	36"	35 <sup>13/16"</sup>	35 <sup>13/16"</sup>	1 <sup>1/4"</sup>	42"	<b>DT1ASX363642</b>	1,076.	1,178.	1,223.	1,563.	1,711.	1,777.
	42"	41 <sup>13/16"</sup>	41 <sup>13/16"</sup>	1 <sup>1/4"</sup>	42"	<b>DT1ASX424242</b>	1,185.	1,296.	1,344.	1,649.	1,807.	1,875.
	48"	47 <sup>13/16"</sup>	47 <sup>13/16"</sup>	1 <sup>1/4"</sup>	42"	<b>DT1ASX484842</b>	1,238.	1,354.	1,406.	1,710.	1,874.	1,946.

w\* = nominal width  
 Dimensions listed under w d t h are actual to the nearest 1/16"





Ordering Information	Order Code	Included with:	Options
<b>X Base Table:</b> 1. Pattern number 2. Base Paint Finish 3. Top Finish 4. Edge Finish	<b>X Base Table:</b> <i>Example:</i> <b>DT1ASX3030, 114, 114, 114</b> <hr/> <b>DT1</b> Dividends Horizon Table <hr/> <b>A</b> Table assembly <hr/> <b>S</b> Square shape <hr/> <b>X</b> X Base <hr/> <b>30</b> Overall width in inches <hr/> <b>30</b> Overall depth in inches <hr/> <b>114</b> Base finish <hr/> <b>114</b> Laminate top finish <hr/> <b>114</b> Edgeband finish	<b>X Base Table:</b> <ul style="list-style-type: none"> <li>• (1) X Base</li> <li>• Hardware kit</li> <li>• Table top</li> </ul> <p><b>Note:</b> X Base Tables are finished with textured paint, including 613 Silver.</p> <p><b>Note:</b> X Base Tables are only available in Knoll core finishes.</p>	

Tables

# X Base Tables

## Round Table Tops

### 17", 21", 28", 36" and 42" High

description	w*	w	d	t	h	pattern no.	Laminate Top P1 Paint	Laminate Top P2 Paint	Laminate Top P3 Paint	Techgrain Top P1 Paint	Techgrain Top P2 Paint	Techgrain Top P3 Paint
 17" High Round X Base Table	30"	29 <sup>13/16"</sup>	29 <sup>13/16"</sup>	1 <sup>1/4"</sup>	17"	<b>DT1ACX3017</b>	\$950.	\$1,049.	\$1,091.	\$2,122.	\$2,334.	\$2,429.
	36"	35 <sup>13/16"</sup>	35 <sup>13/16"</sup>	1 <sup>1/4"</sup>	17"	<b>DT1ACX3617</b>	989.	1,090.	1,134.	2,205.	2,428.	2,527.
	42"	41 <sup>13/16"</sup>	41 <sup>13/16"</sup>	1 <sup>1/4"</sup>	17"	<b>DT1ACX4217</b>	1,094.	1,205.	1,255.	2,311.	2,545.	2,647.
	48"	47 <sup>13/16"</sup>	47 <sup>13/16"</sup>	1 <sup>1/4"</sup>	17"	<b>DT1ACX4817</b>	1,147.	1,265.	1,315.	2,374.	2,614.	2,719.
 21" High Round X Base Table	30"	29 <sup>13/16"</sup>	29 <sup>13/16"</sup>	1 <sup>1/4"</sup>	21"	<b>DT1ACX3021</b>	950.	1,049.	1,091.	2,122.	2,334.	2,429.
	36"	35 <sup>13/16"</sup>	35 <sup>13/16"</sup>	1 <sup>1/4"</sup>	21"	<b>DT1ACX3621</b>	989.	1,090.	1,134.	2,205.	2,428.	2,527.
	42"	41 <sup>13/16"</sup>	41 <sup>13/16"</sup>	1 <sup>1/4"</sup>	21"	<b>DT1ACX4221</b>	1,094.	1,205.	1,255.	2,311.	2,545.	2,647.
	48"	47 <sup>13/16"</sup>	47 <sup>13/16"</sup>	1 <sup>1/4"</sup>	21"	<b>DT1ACX4821</b>	1,147.	1,265.	1,315.	2,374.	2,614.	2,719.
 28" High Round X Base Table	30"	29 <sup>13/16"</sup>	29 <sup>13/16"</sup>	1 <sup>1/4"</sup>	28 <sup>1/2"</sup>	<b>DT1ACX30</b>	972.	1,069.	1,111.	2,143.	2,356.	2,451.
	36"	35 <sup>13/16"</sup>	35 <sup>13/16"</sup>	1 <sup>1/4"</sup>	28 <sup>1/2"</sup>	<b>DT1ACX36</b>	1,010.	1,110.	1,155.	2,226.	2,450.	2,547.
	42"	41 <sup>13/16"</sup>	41 <sup>13/16"</sup>	1 <sup>1/4"</sup>	28 <sup>1/2"</sup>	<b>DT1ACX42</b>	1,114.	1,227.	1,275.	2,333.	2,566.	2,670.
	48"	47 <sup>13/16"</sup>	47 <sup>13/16"</sup>	1 <sup>1/4"</sup>	28 <sup>1/2"</sup>	<b>DT1ACX48</b>	1,170.	1,285.	1,337.	2,395.	2,635.	2,741.
 36" High Round X Base Table	30"	29 <sup>13/16"</sup>	29 <sup>13/16"</sup>	1 <sup>1/4"</sup>	36"	<b>DT1ACX3036</b>	1,025.	1,122.	1,164.	2,196.	2,408.	2,504.
	36"	35 <sup>13/16"</sup>	35 <sup>13/16"</sup>	1 <sup>1/4"</sup>	36"	<b>DT1ACX3636</b>	1,063.	1,163.	1,208.	2,280.	2,503.	2,600.
	42"	41 <sup>13/16"</sup>	41 <sup>13/16"</sup>	1 <sup>1/4"</sup>	36"	<b>DT1ACX4236</b>	1,169.	1,279.	1,328.	2,385.	2,619.	2,722.
	48"	47 <sup>13/16"</sup>	47 <sup>13/16"</sup>	1 <sup>1/4"</sup>	36"	<b>DT1ACX4836</b>	1,223.	1,339.	1,391.	2,449.	2,688.	2,793.
 42" High Round X Base Table	30"	29 <sup>13/16"</sup>	29 <sup>13/16"</sup>	1 <sup>1/4"</sup>	42"	<b>DT1ACX3042</b>	1,046.	1,143.	1,187.	2,217.	2,429.	2,526.
	36"	35 <sup>13/16"</sup>	35 <sup>13/16"</sup>	1 <sup>1/4"</sup>	42"	<b>DT1ACX3642</b>	1,085.	1,186.	1,230.	2,301.	2,524.	2,621.
	42"	41 <sup>13/16"</sup>	41 <sup>13/16"</sup>	1 <sup>1/4"</sup>	42"	<b>DT1ACX4242</b>	1,190.	1,301.	1,349.	2,407.	2,640.	2,744.
	48"	47 <sup>13/16"</sup>	47 <sup>13/16"</sup>	1 <sup>1/4"</sup>	42"	<b>DT1ACX4842</b>	1,243.	1,360.	1,411.	2,470.	2,710.	2,814.

w\* = nominal width  
 Dimensions listed under w d t h are actual to the nearest 1/16"





Ordering Information	Order Code	Included with:	Options
<b>X Base Table:</b> 1. Pattern number 2. Base Paint Finish 3. Top Finish 4. Edge Finish	<b>X Base Table:</b> <i>Example:</i> <b>DT1ACX3030, 114, 114, 114</b> <b>DT1</b> Dividends Horizon Table <b>A</b> Table assembly <b>C</b> Round shape <b>X</b> X Base <b>30</b> Overall width in inches <b>30</b> Overall depth in inches <b>114</b> Base finish <b>114</b> Laminate top finish <b>114</b> Edgeband finish	<b>X Base Table:</b> <ul style="list-style-type: none"> <li>(1) X Base</li> <li>Hardware kit</li> <li>Table top</li> </ul> <b>Note:</b> X Base Tables are finished with textured paint, including 613 Silver.  <b>Note:</b> X Base Tables are only available in Knoll core finishes.	

# X Base Tables

## Rounded Square Table Tops

### 17", 21", 28", 36" and 42" High

Dividends Horizon

description	w*	w	d	t	h	pattern no.	Laminate	Laminate	Laminate	Techgrain	Techgrain	Techgrain
							Top P1 Paint	Top P2 Paint	Top P3 Paint	Top P1 Paint	Top P2 Paint	Top P3 Paint
 17" High Rounded Square X Base Table	30"	29 <sup>13/16"</sup>	29 <sup>13/16"</sup>	1 <sup>1/4"</sup>	17"	<b>DT1ADX303017</b>	\$950.	\$1,049.	\$1,091.	\$2,122.	\$2,334.	\$2,429.
	36"	35 <sup>13/16"</sup>	35 <sup>13/16"</sup>	1 <sup>1/4"</sup>	17"	<b>DT1ADX363617</b>	989.	1,090.	1,134.	2,205.	2,428.	2,527.
	42"	41 <sup>13/16"</sup>	41 <sup>13/16"</sup>	1 <sup>1/4"</sup>	17"	<b>DT1ADX424217</b>	1,094.	1,205.	1,255.	2,311.	2,545.	2,647.
	48"	47 <sup>13/16"</sup>	47 <sup>13/16"</sup>	1 <sup>1/4"</sup>	17"	<b>DT1ADX484817</b>	1,147.	1,265.	1,315.	2,374.	2,614.	2,719.
 21" High Rounded Square X Base Table	30"	29 <sup>13/16"</sup>	29 <sup>13/16"</sup>	1 <sup>1/4"</sup>	21"	<b>DT1ADX303021</b>	950.	1,049.	1,091.	2,122.	2,334.	2,429.
	36"	35 <sup>13/16"</sup>	35 <sup>13/16"</sup>	1 <sup>1/4"</sup>	21"	<b>DT1ADX363621</b>	989.	1,090.	1,134.	2,205.	2,428.	2,527.
	42"	41 <sup>13/16"</sup>	41 <sup>13/16"</sup>	1 <sup>1/4"</sup>	21"	<b>DT1ADX424221</b>	1,094.	1,205.	1,255.	2,311.	2,545.	2,647.
	48"	47 <sup>13/16"</sup>	47 <sup>13/16"</sup>	1 <sup>1/4"</sup>	21"	<b>DT1ADX484821</b>	1,147.	1,265.	1,315.	2,374.	2,614.	2,719.
 28" High Rounded Square X Base Table	30"	29 <sup>13/16"</sup>	29 <sup>13/16"</sup>	1 <sup>1/4"</sup>	28 <sup>1/2"</sup>	<b>DT1ADX3030</b>	972.	1,069.	1,111.	2,143.	2,356.	2,451.
	36"	35 <sup>13/16"</sup>	35 <sup>13/16"</sup>	1 <sup>1/4"</sup>	28 <sup>1/2"</sup>	<b>DT1ADX3636</b>	1,010.	1,110.	1,155.	2,226.	2,450.	2,547.
	42"	41 <sup>13/16"</sup>	41 <sup>13/16"</sup>	1 <sup>1/4"</sup>	28 <sup>1/2"</sup>	<b>DT1ADX4242</b>	1,114.	1,227.	1,275.	2,333.	2,566.	2,670.
	48"	47 <sup>13/16"</sup>	47 <sup>13/16"</sup>	1 <sup>1/4"</sup>	28 <sup>1/2"</sup>	<b>DT1ADX4848</b>	1,170.	1,285.	1,337.	2,395.	2,635.	2,741.
 36" High Rounded Square X Base Table	30"	29 <sup>13/16"</sup>	29 <sup>13/16"</sup>	1 <sup>1/4"</sup>	36"	<b>DT1ADX303036</b>	1,025.	1,122.	1,164.	2,196.	2,408.	2,504.
	36"	35 <sup>13/16"</sup>	35 <sup>13/16"</sup>	1 <sup>1/4"</sup>	36"	<b>DT1ADX363636</b>	1,063.	1,163.	1,208.	2,280.	2,503.	2,600.
	42"	41 <sup>13/16"</sup>	41 <sup>13/16"</sup>	1 <sup>1/4"</sup>	36"	<b>DT1ADX424236</b>	1,169.	1,279.	1,328.	2,385.	2,619.	2,722.
	48"	47 <sup>13/16"</sup>	47 <sup>13/16"</sup>	1 <sup>1/4"</sup>	36"	<b>DT1ADX484836</b>	1,223.	1,339.	1,391.	2,449.	2,688.	2,793.

Tables

w\* = nominal width  
 Dimensions listed under w d t h are actual to the nearest 1/16"

Ordering Information	Order Code	Included with:	Options
<b>X Base Table:</b>	<b>X Base Table:</b>	<b>X Base Table:</b>	
1. Pattern number	<i>Example:</i> <b>DT1ADX3030, 114, 114,</b>	• (1) X Base	
2. Base Paint Finish	<b>114</b>	• Hardware kit	
3. Top Finish	<b>DT1</b> Dividends Horizon	• Table top	
4. Edge Finish	Table	<b>Note:</b> X Base Tables are finished with textured paint, including 613 Silver.	
	<b>A</b> Table assembly	<b>Note:</b> X Base Tables are only available in Knoll core finishes.	
	<b>D</b> Rounded Square shape		
	<b>X</b> X Base		
	<b>30</b> Overall width in inches		
	<b>30</b> Overall depth in inches		
	<b>114</b> Base finish		
	<b>114</b> Laminate top finish		
	<b>114</b> Edgeband finish		

# X Base Tables

## Rounded Square Table Tops

### 17", 21", 28", 36" and 42" High

Dividends Horizon

description	w*	w	d	t	h	pattern no.	Laminate	Laminate	Laminate	Techgrain	Techgrain	Techgrain
							Top P1 Paint	Top P2 Paint	Top P3 Paint	Top P1 Paint	Top P2 Paint	Top P3 Paint
 42" High Rounded Square X Base Table	30"	29 <sup>13/16"</sup>	29 <sup>13/16"</sup>	1 <sup>1/4"</sup>	42"	<b>DT1ADX303042</b>	\$1,046.	\$1,143.	\$1,187.	\$2,217.	\$2,429.	\$2,526.
	36"	35 <sup>13/16"</sup>	35 <sup>13/16"</sup>	1 <sup>1/4"</sup>	42"	<b>DT1ADX363642</b>	1,085.	1,186.	1,230.	2,301.	2,524.	2,621.
	42"	41 <sup>13/16"</sup>	41 <sup>13/16"</sup>	1 <sup>1/4"</sup>	42"	<b>DT1ADX424242</b>	1,190.	1,301.	1,349.	2,407.	2,640.	2,744.
	48"	47 <sup>13/16"</sup>	47 <sup>13/16"</sup>	1 <sup>1/4"</sup>	42"	<b>DT1ADX484842</b>	1,243.	1,360.	1,411.	2,470.	2,710.	2,814.

w\* = nominal width

Dimensions listed under w d t h are actual to the nearest<sup>1/16"</sup>

Ordering Information	Order Code	Included with:	Options
<b>X Base Table:</b> 1. Pattern number 2. Base Paint Finish 3. Top Finish 4. Edge Finish	<b>X Base Table:</b> <i>Example:</i> <b>DT1ADX3030, 114, 114, 114</b> <hr/> <b>DT1</b> Dividends Horizon Table <hr/> <b>A</b> Table assembly <hr/> <b>D</b> Rounded Square shape <hr/> <b>X</b> X Base <hr/> <b>30</b> Overall width in inches <hr/> <b>30</b> Overall depth in inches <hr/> <b>114</b> Base finish <hr/> <b>114</b> Laminate top finish <hr/> <b>114</b> Edgeband finish	<b>X Base Table:</b> <ul style="list-style-type: none"> <li>• (1) X Base</li> <li>• Hardware kit</li> <li>• Table top</li> </ul> <b>Note:</b> X Base Tables are finished with textured paint, including 613 Silver.  <b>Note:</b> X Base Tables are only available in Knoll core finishes.	



# Table Supports

## X Bases

### Credenza Support Spacer

description	w	h	d	pattern no.	P1	P2	P3
Small X-Base, for use with 30" or 36" wide round, square or rounded square table tops		17"		<b>DT1BXS17</b>	\$505.	\$558.	\$582.
		21"		<b>DT1BXS21</b>	505.	558.	582.
		28"		<b>DT1BXS</b>	525.	580.	603.
		36"		<b>DT1BXS36</b>	580.	632.	655.
		42"		<b>DT1BXS42</b>	600.	653.	677.



Large X Base, for use with 42" or 48" wide round, square or rounded square table tops		17"		<b>DT1BXL17</b>	557.	616.	641.
		21"		<b>DT1BXL21</b>	557.	616.	641.
		28"		<b>DT1BXL</b>	579.	637.	662.
		36"		<b>DT1BXL36</b>	631.	689.	715.
		42"		<b>DT1BXL42</b>	652.	711.	735.



Credenza Support Spacer For use with Dividends Horizon Credenza	9 <sup>5</sup> / <sub>8</sub> "	2 <sup>15</sup> / <sub>16</sub> "	1 <sup>9</sup> / <sub>16</sub> "	<b>DT1S</b>	140.	155.	161.
--	---------------------------------	-----------------------------------	----------------------------------	-------------	------	------	------



Small T-Base, for use with 24" or 30" deep tops		28"		<b>DT1BTS</b>	525.	580.	603.
---	--	-----	--	---------------	------	------	------



Large T-Base, for use with 24" or 30" deep tops		28"		<b>DT1BTL</b>	579.	637.	662.
---	--	-----	--	---------------	------	------	------



#### Ordering Information

##### Table Supports:

1. Pattern number
2. Paint Finish

#### Order Code

##### X Base:

*Example:* **DT1BXS, 114**

**DT1** Dividends Horizon Table

**B** Base

**S** X Shape

**114** Paint finish

##### Credenza Support Spacer:

*Example:* **DT1S, 114**

**DT1** Dividends Horizon Table

**S** Support Spacer

**114** Paint finish

#### Included with:

##### X Base:

- X Base
- Hardware kit

##### T Base:

- T Base
- Hardware kit

##### Credenza Support spacer:

- Support spacer
- Hardware Kit

**Note:** X and T bases are painted with textured paint, including 613 Silver.

**Note:** Table supports are only available in Knoll core finishes.

#### Options

Casters are designed for use on X- and Y-bases only.

Tables with casters may not exceed 28"h, 84"w or 42"d.

Table Supports  
*X Bases*  
*Credenza Support Spacer*

Dividends Horizon

description	w	h	d	pattern no.	P1	P2	P3
Caster Kit (set of 4) black only 		1"		<b>DT1CK4</b>	\$36.		

**Ordering Information**

**Table Supports:**

1. Pattern number
2. Paint Finish

**Order Code**

**X Base:**

*Example:* **DT1BXS, 114**

**DT1** Dividends Horizon Table

**B** Base

**S** X Shape

**114** Paint finish

**Credenza Support Spacer:**

*Example:* **DT1S, 114**

**DT1** Dividends Horizon Table

**S** Support Spacer

**114** Paint finish

**Included with:**

**X Base:**

- X Base
- Hardware kit

**T Base:**

- T Base
- Hardware kit

**Credenza Support spacer:**

- Support spacer
- Hardware Kit

**Note:** X and T bases are painted with textured paint, including 613 Silver.

**Note:** Table supports are only available in Knoll core finishes.

**Options**

Casters are designed for use on X- and Y-bases only.

Tables with casters may not exceed 28"h, 84"w or 42"d.

**This page intentionally left blank**

## Dividends Horizon Conference Tables

Dividends Horizon conference tables are designed with a scale and visual language consistent with the full scope of Dividends Horizon products. This design consistency makes Dividends Horizon tables appropriate for use in conference, meeting, private office and open plan office applications.

Dividends Horizon conference tables are available in racetrack, rectangular, or boat shape and in all standard Dividends Horizon finishes.

Conference tables include a table top and base assembly. A conference table base assembly includes two Y legs, one center support T base, and two horizontal stretchers that connect the three bases. Top sizes up to 120 inches are produced in one piece, while tops longer than 120 inches are produced in two pieces.

## Available Sizes

Width: 102- 144 inches

Depth: 36- 48 inches

Height: 28-1/2 inches

## Construction

Worksurface:

- Material: 0.028 inch thick high pressure laminate or 0.6mm thick veneer on 1-1/8 inch thick particle board core
- Edge: plastic laminate tops have a 2mm edgeband; Techwood tops have a 3/16" thick Techwood edge

Base:

- Stretcher: extruded aluminum
- Foot: die cast aluminum
- Column: extruded aluminum with 3/16 inch thick structural plate

**Note:** Dividends Horizon conference tables are only available in Knoll Core paint, laminate, and Techwood finishes. Legacy finishes are not available. All paint finishes have the Dividends Horizon textured paint finish; this includes 613 Silver, which is a smooth paint on all other Dividends Horizon products.

**Note:** Grain patterns on woodgrain laminate and veneer tops will not match at the seam in the middle of tables longer than 120 inches.

Rectangular Conference Table

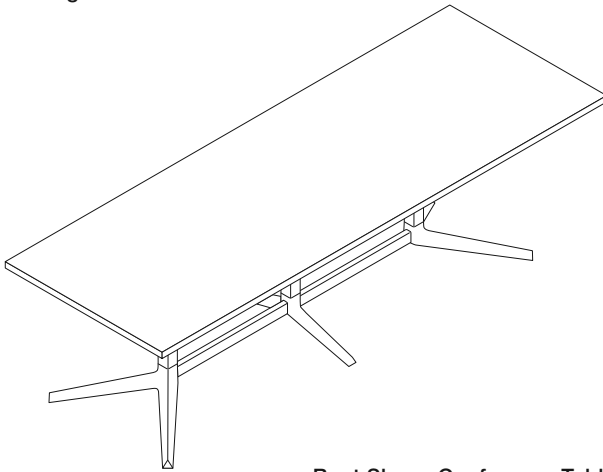

Racetrack Conference Table

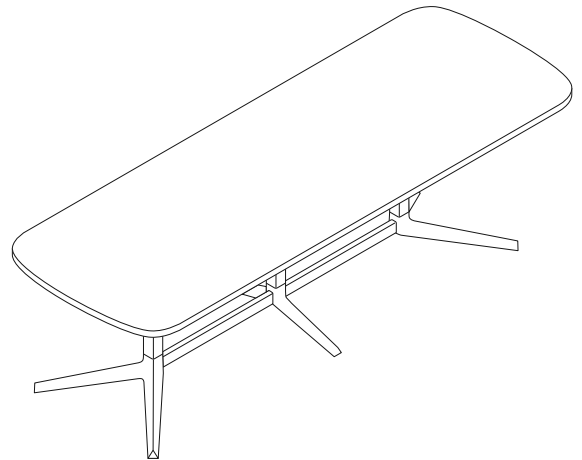

Boat Shape Conference Table



# Conference Tables

## Rectangular Table Top

### 36", 42" and 48" Deep

description	w*	w	d	t	h	pattern no.	Laminate	Laminate	Laminate	Techgrain	Techgrain	Techgrain
							Top P1 Paint	Top P2 Paint	Top P3 Paint	Top P1 Paint	Top P2 Paint	Top P3 Paint
36" Deep Rectangular Conference Table	102"	101 <sup>13/16"</sup>	35 <sup>1/2"</sup>	1 <sup>1/4"</sup>	28 <sup>1/2"</sup>	<b>DT1ARY10236N</b>	\$2,229.	\$2,281.	\$2,334.	\$2,546.	\$2,653.	\$2,865.
	108"	107 <sup>13/16"</sup>	35 <sup>1/2"</sup>	1 <sup>1/4"</sup>	28 <sup>1/2"</sup>	<b>DT1ARY10836N</b>	2,281.	2,334.	2,387.	2,599.	2,858.	2,974.

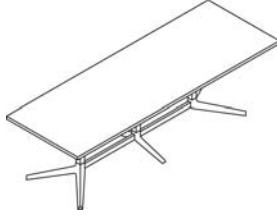

42" Deep Rectangular Conference Table	102"	101 <sup>13/16"</sup>	41 <sup>1/2"</sup>	1 <sup>1/4"</sup>	28 <sup>1/2"</sup>	<b>DT1ARY10242N</b>	2,281.	2,334.	2,387.	2,599.	2,706.	2,918.
	108"	107 <sup>13/16"</sup>	41 <sup>1/2"</sup>	1 <sup>1/4"</sup>	28 <sup>1/2"</sup>	<b>DT1ARY10842N</b>	2,334.	2,387.	2,441.	2,625.	2,918.	3,062.
	120"	119 <sup>13/16"</sup>	41 <sup>1/2"</sup>	1 <sup>1/4"</sup>	28 <sup>1/2"</sup>	<b>DT1ARY12042N</b>	2,496.	2,548.	2,601.	2,727.	3,000.	3,121.
	132"	131 <sup>13/16"</sup>	41 <sup>1/2"</sup>	1 <sup>1/4"</sup>	28 <sup>1/2"</sup>	<b>DT1ARY13242N</b>	2,601.	2,655.	2,708.	3,171.	3,488.	3,629.
	144"	143 <sup>13/16"</sup>	41 <sup>1/2"</sup>	1 <sup>1/4"</sup>	28 <sup>1/2"</sup>	<b>DT1ARY14442N</b>	2,708.	2,760.	2,813.	3,614.	3,977.	4,134.



48" Deep Rectangular Conference Table	102"	101 <sup>13/16"</sup>	47 <sup>1/2"</sup>	1 <sup>1/4"</sup>	28 <sup>1/2"</sup>	<b>DT1ARY10248N</b>	2,334.	2,387.	2,441.	2,653.	2,811.	3,023.
	108"	107 <sup>13/16"</sup>	47 <sup>1/2"</sup>	1 <sup>1/4"</sup>	28 <sup>1/2"</sup>	<b>DT1ARY10848N</b>	2,387.	2,441.	2,494.	2,732.	2,997.	3,130.
	120"	119 <sup>13/16"</sup>	47 <sup>1/2"</sup>	1 <sup>1/4"</sup>	28 <sup>1/2"</sup>	<b>DT1ARY12048N</b>	2,555.	2,608.	2,663.	2,807.	3,089.	3,212.
	132"	131 <sup>13/16"</sup>	47 <sup>1/2"</sup>	1 <sup>1/4"</sup>	28 <sup>1/2"</sup>	<b>DT1ARY13248N</b>	2,663.	2,715.	2,768.	3,259.	3,584.	3,729.
	144"	143 <sup>13/16"</sup>	47 <sup>1/2"</sup>	1 <sup>1/4"</sup>	28 <sup>1/2"</sup>	<b>DT1ARY14448N</b>	2,768.	2,820.	2,875.	3,709.	4,081.	4,245.

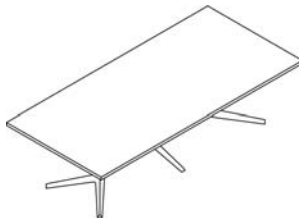

w\* = nominal width  
Dimensions listed under w d t h are actual to the nearest 1/16"

Ordering Information	Order Code	Included with:	Options
<b>Conference Tables:</b>	<b>Conference Table:</b>	<b>Conference Table:</b>	<b>Conference Tables</b>
1. Pattern number	<i>Example:</i> <b>DT1ARY10836N</b>	• (2) Y Legs	
2. Base/Stretcher Paint Finish	<b>DT1</b> Dividends Horizon Table	• (1) T leg	
3. Top Finish	<b>A</b> Table Assembly	• (2) Stretchers	
4. Edge Finish	<b>R</b> Rectangular shape	• Table Top	
	<b>Y</b> Y Leg Base	• Hardware Kit	
	<b>108</b> Overall width in inches		
	<b>36</b> Overall depth in inches		
	<b>N</b> No grommet		
	<b>114</b> Base/ stretcher paint finish		
	<b>114</b> Laminate top finish		
	<b>114</b> Edgeband finish		

# Conference Tables

## Racetrack Table Top

### 36", 42" and 48" Deep

description	w	w	d	t	h	pattern no.	Laminate	Laminate	Laminate	Techgrain	Techgrain	Techgrain
							Top P1 Paint	Top P2 Paint	Top P3 Paint	Top P1 Paint	Top P2 Paint	Top P3 Paint
36" Deep Racetrack Conference Table	102"	101 <sup>13/16"</sup>	35 <sup>1/2"</sup>	1 <sup>1/4"</sup>	28 <sup>1/2"</sup>	<b>DT1ATY10236N</b>	\$2,229.	\$2,281.	\$2,334.	\$3,290.	\$3,607.	\$3,714.
	108"	107 <sup>13/16"</sup>	35 <sup>1/2"</sup>	1 <sup>1/4"</sup>	28 <sup>1/2"</sup>	<b>DT1ATY10836N</b>	2,281.	2,334.	2,387.	3,337.	3,671.	3,817.



42" Deep Racetrack Conference Table	102"	101 <sup>13/16"</sup>	41 <sup>1/2"</sup>	1 <sup>1/4"</sup>	28 <sup>1/2"</sup>	<b>DT1ATY10242N</b>	2,281.	2,334.	2,387.	3,316.	3,660.	3,819.
	108"	107 <sup>13/16"</sup>	41 <sup>1/2"</sup>	1 <sup>1/4"</sup>	28 <sup>1/2"</sup>	<b>DT1ATY10842N</b>	2,334.	2,387.	2,441.	3,395.	3,714.	3,872.
	120"	119 <sup>13/16"</sup>	41 <sup>1/2"</sup>	1 <sup>1/4"</sup>	28 <sup>1/2"</sup>	<b>DT1ATY12042N</b>	2,496.	2,548.	2,601.	3,465.	3,812.	3,964.
	132"	131 <sup>13/16"</sup>	41 <sup>1/2"</sup>	1 <sup>1/4"</sup>	28 <sup>1/2"</sup>	<b>DT1ATY13242N</b>	2,601.	2,655.	2,708.	3,979.	4,376.	4,551.
	144"	143 <sup>13/16"</sup>	41 <sup>1/2"</sup>	1 <sup>1/4"</sup>	28 <sup>1/2"</sup>	<b>DT1ATY14442N</b>	2,708.	2,760.	2,813.	4,491.	4,939.	5,137.



48" Deep Racetrack Conference Table	102"	101 <sup>13/16"</sup>	47 <sup>1/2"</sup>	1 <sup>1/4"</sup>	28 <sup>1/2"</sup>	<b>DT1ATY10248N</b>	2,334.	2,387.	2,441.	3,395.	3,686.	3,846.
	108"	107 <sup>13/16"</sup>	47 <sup>1/2"</sup>	1 <sup>1/4"</sup>	28 <sup>1/2"</sup>	<b>DT1ATY10848N</b>	2,387.	2,441.	2,494.	3,502.	3,767.	3,926.
	120"	119 <sup>13/16"</sup>	47 <sup>1/2"</sup>	1 <sup>1/4"</sup>	28 <sup>1/2"</sup>	<b>DT1ATY12048N</b>	2,555.	2,608.	2,663.	3,542.	3,896.	4,053.
	132"	131 <sup>13/16"</sup>	47 <sup>1/2"</sup>	1 <sup>1/4"</sup>	28 <sup>1/2"</sup>	<b>DT1ATY13248N</b>	2,663.	2,715.	2,768.	4,064.	4,470.	4,650.
	144"	143 <sup>13/16"</sup>	47 <sup>1/2"</sup>	1 <sup>1/4"</sup>	28 <sup>1/2"</sup>	<b>DT1ATY14448N</b>	2,768.	2,820.	2,875.	4,587.	5,045.	5,247.



w\* = nominal width  
 Dimensions listed under w d t h are actual to the nearest 1/16"

Ordering Information	Order Code	Included with:	Options
<b>Conference Tables:</b>	<b>Conference Table:</b>	<b>Conference Table:</b>	<b>Conference Tables</b>
1. Pattern number	<i>Example:</i> <b>DT1ARY10836N</b>	• (2) Y Legs	
2. Base/Stretcher Paint Finish	<b>DT1</b> Dividends Horizon Table	• (1) T leg	
3. Top Finish	<b>A</b> Table Assembly	• (2) Stretchers	
4. Edge Finish	<b>R</b> Rectangular shape	• Table Top	
	<b>Y</b> Y Leg Base	• Hardware Kit	
	<b>108</b> Overall width in inches		
	<b>36</b> Overall depth in inches		
	<b>N</b> No grommet		
	<b>114</b> Base/ stretcher paint finish		
	<b>114</b> Laminate top finish		
	<b>114</b> Edgeband finish		

# Conference Tables

## Boat Shape Table Top

### 42" and 48" Deep

description	w*	w	d	t	h	pattern no.	Laminate	Laminate	Laminate	Techgrain	Techgrain	Techgrain
							Top P1 Paint	Top P2 Paint	Top P3 Paint	Top P1 Paint	Top P2 Paint	Top P3 Paint
42" Deep Boat Shape Conference Table	102"	101 13/16"	41 1/2"	1 1/4"	28 1/2"	<b>DT1ABY10242N</b>	\$2,281.	\$2,334.	\$2,387.	\$3,316.	\$3,660.	\$3,819.
	108"	107 13/16"	41 1/2"	1 1/4"	28 1/2"	<b>DT1ABY10842N</b>	2,334.	2,387.	2,441.	3,395.	3,714.	3,872.
	120"	119 13/16"	41 1/2"	1 1/4"	28 1/2"	<b>DT1ABY12042N</b>	2,496.	2,548.	2,601.	3,465.	3,812.	3,964.
	132"	131 13/16"	41 1/2"	1 1/4"	28 1/2"	<b>DT1ABY13242N</b>	2,601.	2,655.	2,708.	3,979.	4,376.	4,551.
	144"	143 13/16"	41 1/2"	1 1/4"	28 1/2"	<b>DT1ABY14442N</b>	2,708.	2,760.	2,813.	4,491.	4,939.	5,137.



48" Deep Boat Shape Conference Table	102"	101 13/16"	47 1/2"	1 1/4"	28 1/2"	<b>DT1ABY10248N</b>	2,334.	2,387.	2,441.	3,395.	3,686.	3,846.
	108"	107 13/16"	47 1/2"	1 1/4"	28 1/2"	<b>DT1ABY10848N</b>	2,387.	2,441.	2,494.	3,502.	3,767.	3,926.
	120"	119 13/16"	47 1/2"	1 1/4"	28 1/2"	<b>DT1ABY12048N</b>	2,555.	2,608.	2,663.	3,542.	3,896.	4,053.
	132"	131 13/16"	47 1/2"	1 1/4"	28 1/2"	<b>DT1ABY13248N</b>	2,663.	2,715.	2,768.	4,064.	4,470.	4,650.
	144"	143 13/16"	47 1/2"	1 1/4"	28 1/2"	<b>DT1ABY14448N</b>	2,768.	2,820.	2,875.	4,587.	5,045.	5,247.



Tables

w\* = nominal width  
Dimensions listed under w d t h are actual to the nearest 1/16"

Ordering Information	Order Code	Included with:	Options
<b>Conference Tables:</b>	<b>Conference Table:</b>	<b>Conference Table:</b>	<b>Conference Tables</b>
1. Pattern number	<i>Example:</i> <b>DT1ARY10836N</b>	• (2) Y Legs	
2. Base/Stretcher Paint Finish	<b>DT1</b> Dividends Horizon Table	• (1) T leg	
3. Top Finish	<b>A</b> Table Assembly	• (2) Stretchers	
4. Edge Finish	<b>R</b> Rectangular shape	• Table Top	
	<b>Y</b> Y Leg Base	• Hardware Kit	
	<b>108</b> Overall width in inches		
	<b>36</b> Overall depth in inches		
	<b>N</b> No grommet		
	<b>114</b> Base/ stretcher paint finish		
	<b>114</b> Laminate top finish		
	<b>114</b> Edgeband finish		

# Preconfigured Desks

## Series 2 Single and Double Pedestal Specifications

### Series 2 Single and Double Pedestal Desks

Series 2 freestanding single and double pedestal desks can be specified “Preconfigured” or by component for “Build-to-Spec” applications. These applications include when a different pedestal drawer configuration is required, or when back panels are not needed.

“Preconfigured” single pedestal desks consist of a worksurface, Series 2 box/box/file pedestal, “L” shaped end panel and full height back panel.

“Preconfigured” double pedestal desks consist of a worksurface, two pedestals (file/file and box/ box/file) and full height back panel.

### Available Sizes

- Height: 28½"
- Depths: 24", 30" and 36"  
(double pedestal desk only)
- Widths: 60", 66" and 72"
- Worksurface thickness: 1¼"

### “Build-to-Spec” Desks

For “Build-to-Spec” desks specify by component. Refer to individual component category for information.

### Construction

All freestanding desks match the aesthetics and dimensions of Dividends Horizon panel components.

Drawers overlay the cabinet front and feature softly-radiused integral pulls, drawer fronts and drawer trim. Series 2 desks include full-height modesty panels.

Worksurface support is provided by pedestals and end units which are non-handed and shipped knocked down. This allows pedestals and end units to be positioned at either end of worksurfaces.

### Optional Edge Grommets

Edge grommets are optional for all desks except overhang desks and can be specified factory-installed, centered along the rear edge of worksurfaces. Grommets can also be ordered as a kit (pattern number D1WSG) for field installation in any position along the rear edge of the worksurface. When grommets are specified, a reveal of ½" is provided between the rear of the worksurface and the back panel for repositioning cables anywhere along the back panel.

### Locks

Desk pedestals can be ordered with or without locks. When specified without locks, a lock plug is included. An optional lock retrofit kit is available for field-installation of locks at a later date if required. Locks are keyed randomly unless otherwise specified. Other keying options include keyed alike or keyed with lock cores K001-K250.

All locks are factory-installed and have a black finish.

### Desk Accessory

All Series 2 pedestal accessories including the hanging file bar must be specified separately.

Series 2 Single Pedestal Desk

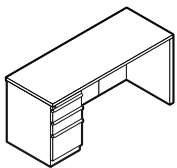

Series 2 Double Pedestal Desk

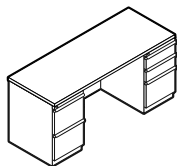

Series 2 Desk Components

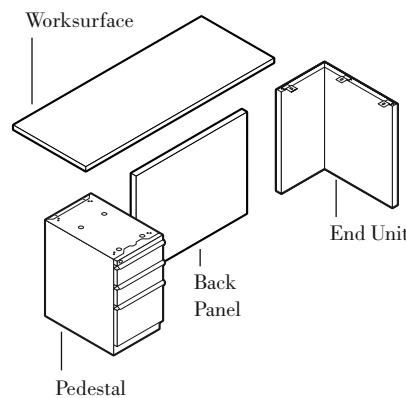

Optional Edge Grommet

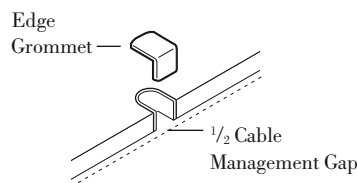

Series 2 Freestanding Desk Configurations

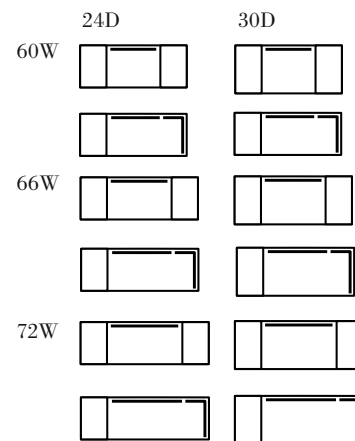





# Preconfigured Desks

## Series 2 Single and Double Pedestal

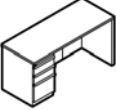
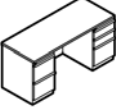
### 24", 30" and 36" Deep

description	w*	w	d	h	pattern no.	P1	P2	P3
 Single Pedestal Desk with Locks	60"	59 <sup>13/16"</sup>	23 <sup>1/2"</sup>	28 <sup>1/2"</sup>	<b>DD2S L6024N</b>	\$1,544.	\$1,668.	\$1,727.
	60"	59 <sup>13/16"</sup>	29 <sup>1/2"</sup>	28 <sup>1/2"</sup>	<b>DD2S L6030N</b>	1,693.	1,821.	1,885.
	66"	65 <sup>13/16"</sup>	23 <sup>1/2"</sup>	28 <sup>1/2"</sup>	<b>DD2S L6624N</b>	1,582.	1,706.	1,767.
	66"	65 <sup>13/16"</sup>	29 <sup>1/2"</sup>	28 <sup>1/2"</sup>	<b>DD2S L6630N</b>	1,749.	1,880.	1,944.
	72"	71 <sup>13/16"</sup>	23 <sup>1/2"</sup>	28 <sup>1/2"</sup>	<b>DD2S L7224N</b>	1,609.	1,733.	1,795.
	72"	71 <sup>13/16"</sup>	29 <sup>1/2"</sup>	28 <sup>1/2"</sup>	<b>DD2S L7230N</b>	1,777.	1,910.	1,975.
 Double Pedestal Desk with Locks	60"	59 <sup>13/16"</sup>	23 <sup>1/2"</sup>	28 <sup>1/2"</sup>	<b>DD2D L6024N</b>	1,776.	1,922.	1,995.
	60"	59 <sup>13/16"</sup>	29 <sup>1/2"</sup>	28 <sup>1/2"</sup>	<b>DD2D L6030N</b>	1,917.	2,068.	2,143.
	66"	65 <sup>13/16"</sup>	23 <sup>1/2"</sup>	28 <sup>1/2"</sup>	<b>DD2D L6624N</b>	1,815.	1,960.	2,035.
	66"	65 <sup>13/16"</sup>	29 <sup>1/2"</sup>	28 <sup>1/2"</sup>	<b>DD2D L6630N</b>	1,975.	2,127.	2,203.
	72"	71 <sup>13/16"</sup>	23 <sup>1/2"</sup>	28 <sup>1/2"</sup>	<b>DD2D L7224N</b>	1,840.	1,988.	2,063.
	72"	71 <sup>13/16"</sup>	29 <sup>1/2"</sup>	28 <sup>1/2"</sup>	<b>DD2D L7230N</b>	2,003.	2,155.	2,235.
 Double Pedestal Desk with Locks and 6" Front Overhang	60"	59 <sup>13/16"</sup>	35 <sup>1/2"</sup>	28 <sup>1/2"</sup>	<b>DD2O L6036N</b>	2,033.	2,182.	2,259.
	66"	65 <sup>13/16"</sup>	35 <sup>1/2"</sup>	28 <sup>1/2"</sup>	<b>DD2O L6636N</b>	2,098.	2,251.	2,327.
	72"	71 <sup>13/16"</sup>	35 <sup>1/2"</sup>	28 <sup>1/2"</sup>	<b>DD2O L7236N</b>	2,168.	2,322.	2,395.

w\* = nominal width  
 Dimensions listed under w d h are actual to the nearest 1/16"

Ordering Information	Order Code	Included with:	Options
<b>Single Pedestal Desk</b> 1. Pattern Number 2. Laminate Finish 3. Edge Band Finish 4. Paint Finish  <b>Double Pedestal Desk</b> 1. Pattern Number 2. Laminate Finish 3. Edge Band Finish 4. Paint Finish	<b>Single Pedestal Desk</b> <i>Example:</i> <b>DD2S L7230N, 117, 117, 117</b> <hr/> <b>DD2S</b> Pattern Number <b>L7230N</b> <hr/> <b>117</b> Soft Grey laminate <hr/> <b>117</b> Soft Grey edge finish <hr/> <b>117</b> Soft Grey paint finish <hr/> <b>Double Pedestal Desk</b> <i>Example:</i> <b>DD2D L7230N, 117, 117, 117</b> <hr/> <b>DD2D</b> Pattern Number <b>L7230N</b> <hr/> <b>117</b> Soft Grey laminate <hr/> <b>117</b> Soft Grey edge finish <hr/> <b>117</b> Soft Grey paint finish	<b>Single Pedestal Desk</b>  <b>Double Pedestal Desk</b>  <b>Note:</b> An upcharge applies when specifying Legacy laminates. See Legacy finish page.	<b>Single Pedestal Desk</b> <ul style="list-style-type: none"> <li>To specify desk with center located edge grommet, replace the suffix letter "N" with a "G".</li> </ul> <b>Add \$18</b> (Grommets not available for overhang desks) <ul style="list-style-type: none"> <li>To specify pedestals without locks, replace the fifth character "L" with an "N".</li> </ul> <b>Deduct \$21</b>  <b>Double Pedestal Desk</b> <ul style="list-style-type: none"> <li>To specify desk with center located edge grommet, replace the suffix letter "N" with a "G".</li> </ul> <b>Add \$18</b> (Grommets not available for overhang desks) <ul style="list-style-type: none"> <li>To specify pedestals without locks, replace the fifth character "L" with an "N".</li> </ul> <b>Deduct \$42</b>

# Preconfigured Desks

## Single and Double Pedestal Specifications

### Single and Double Pedestal Desks

Dividends freestanding single and double pedestal desks can be specified "Preconfigured" or by component for "Build-to-Spec" applications. These applications include when a different pedestal drawer configuration is required, or when back panels are not needed. "Preconfigured" single pedestal desks consist of a worksurface, box/box/file pedestal, "L" shaped end panel and half-height back panel. "Preconfigured" double pedestal desks consist of a worksurface, two pedestals (file/file and box/ box/file) and half-height back panel.

#### Available Sizes

- Height: 28½"
- Depths: 24", 30" and 36"  
(Double pedestal desk only)
- Widths: 60", 66" and 72"
- Worksurface thickness: 1¼"

### "Build-to-Spec" Desks

For "Build-to-Spec" desks specify by component. Refer to individual component category for information.

#### Construction

All freestanding desks match the aesthetics and dimensions of Dividends panel components.

Drawers overlay the cabinet front and feature softly-radiused pulls, drawer fronts and drawer trim.

Half-height back panels extend 11" from the bottom of the worksurface, are inset ¾" from the pedestal backs and match the softly-radiused aesthetics of other Dividends components.

Worksurface support is provided by pedestals and end units which are non-handed and shipped knocked down. This allows pedestals and end units to be positioned at either end of worksurfaces.

### Locks

Desk pedestals can be ordered with or without locks. When specified without locks, a lock plug is included. An optional lock retrofit kit is available for field-installation of locks at a later date if required. Locks are keyed randomly unless otherwise specified. Other keying options include keyed alike or keyed with lock cores K001-K250 All locks are factory-installed and have a black finish.

#### Accessory

Hanging file bars for front-to-back or side-to-side filing are included with pedestals.

### Single Pedestal Desk

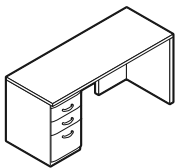

### Double Pedestal Desk

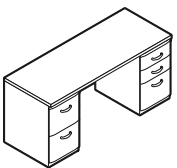

### Desk Components

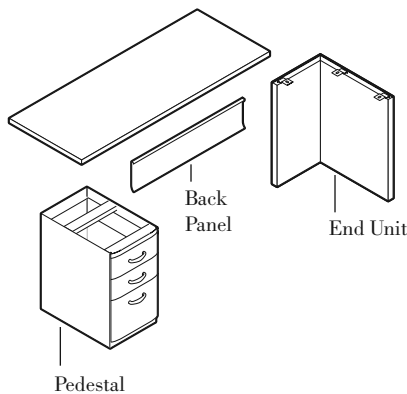

### Freestanding Desk Configurations

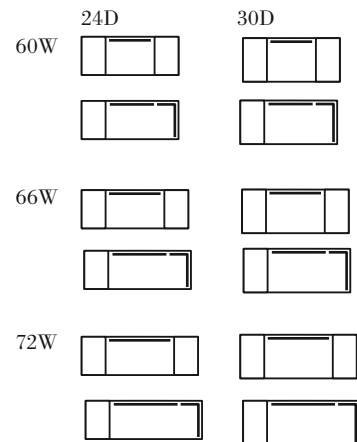

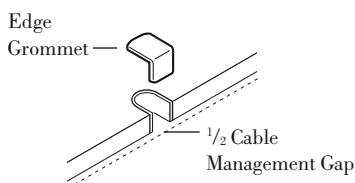

### Optional Edge Grommet



# Preconfigured Desks

## Single and Double Pedestal

### 24", 30" and 36" Deep

description	w*	w	d	h	pattern no.	P1	P2	P3
 Single Pedestal Desk with Locks	60"	59 <sup>13/16"</sup>	23 <sup>1/2"</sup>	28 <sup>1/2"</sup>	<b>DD1S L6024N</b>	\$1,544.	\$1,668.	\$1,727.
	60"	59 <sup>13/16"</sup>	29 <sup>1/2"</sup>	28 <sup>1/2"</sup>	<b>DD1S L6030N</b>	1,693.	1,821.	1,885.
	66"	65 <sup>13/16"</sup>	23 <sup>1/2"</sup>	28 <sup>1/2"</sup>	<b>DD1S L6624N</b>	1,582.	1,706.	1,767.
	66"	65 <sup>13/16"</sup>	29 <sup>1/2"</sup>	28 <sup>1/2"</sup>	<b>DD1S L6630N</b>	1,749.	1,880.	1,944.
	72"	71 <sup>13/16"</sup>	23 <sup>1/2"</sup>	28 <sup>1/2"</sup>	<b>DD1S L7224N</b>	1,609.	1,733.	1,795.
	72"	71 <sup>13/16"</sup>	29 <sup>1/2"</sup>	28 <sup>1/2"</sup>	<b>DD1S L7230N</b>	1,777.	1,910.	1,975.
 Double Pedestal Desk with Locks	60"	59 <sup>13/16"</sup>	23 <sup>1/2"</sup>	28 <sup>1/2"</sup>	<b>DD1D L6024N</b>	1,776.	1,922.	1,995.
	60"	59 <sup>13/16"</sup>	29 <sup>1/2"</sup>	28 <sup>1/2"</sup>	<b>DD1D L6030N</b>	1,917.	2,068.	2,143.
	66"	65 <sup>13/16"</sup>	23 <sup>1/2"</sup>	28 <sup>1/2"</sup>	<b>DD1D L6624N</b>	1,815.	1,960.	2,035.
	66"	65 <sup>13/16"</sup>	29 <sup>1/2"</sup>	28 <sup>1/2"</sup>	<b>DD1D L6630N</b>	1,975.	2,127.	2,203.
	72"	71 <sup>13/16"</sup>	23 <sup>1/2"</sup>	28 <sup>1/2"</sup>	<b>DD1D L7224N</b>	1,840.	1,988.	2,063.
	72"	71 <sup>13/16"</sup>	29 <sup>1/2"</sup>	28 <sup>1/2"</sup>	<b>DD1D L7230N</b>	2,003.	2,155.	2,235.
 Double Pedestal Desk with Locks and 6" Front Overhang	60"	59 <sup>13/16"</sup>	35 <sup>1/2"</sup>	28 <sup>1/2"</sup>	<b>DD1O L6036N</b>	2,033.	2,182.	2,259.
	66"	65 <sup>13/16"</sup>	35 <sup>1/2"</sup>	28 <sup>1/2"</sup>	<b>DD1O L6636N</b>	2,098.	2,251.	2,327.
	72"	71 <sup>13/16"</sup>	35 <sup>1/2"</sup>	28 <sup>1/2"</sup>	<b>DD1O L7236N</b>	2,168.	2,322.	2,395.

w\* = nominal width  
 Dimensions listed under w d h are actual to the nearest 1/16"

Ordering Information	Order Code	Included with:	Options
<b>Single Pedestal Desk</b> 1. Pattern Number 2. Laminate Finish 3. Edge Band Finish 4. Paint Finish 5. Pull Finish 6. Drawer Top Cap Finish	<b>Single Pedestal Desk</b> <i>Example:</i> <b>DD1S L7230N, 117, 117, 117, 117, 117</b> <hr/> <b>DD1S</b> Pattern Number <b>L7230N</b> <hr/> <b>117</b> Soft Grey laminate <hr/> <b>117</b> Soft Grey edge finish <hr/> <b>117</b> Soft Grey paint finish <hr/> <b>117</b> Soft Grey pull finish <hr/> <b>Y3</b> Dark Grey top cap finish	<b>Single Pedestal Desk</b> <b>Double Pedestal Desk</b> <b>Note:</b> An upcharge applies when specifying Legacy laminates. See Legacy finish page.	<b>Single Pedestal Desk</b> <ul style="list-style-type: none"> <li>To specify desk with center located edge grommet, replace the suffix letter "N" with a "G".</li> </ul> <b>Add \$18</b> (Grommets not available for overhang desks) <ul style="list-style-type: none"> <li>To specify pedestals without locks, replace the fifth character "L" with an "N".</li> </ul> <b>Deduct \$21</b> <b>Double Pedestal Desk</b> <ul style="list-style-type: none"> <li>To specify desk with center located edge grommet, replace the suffix letter "N" with a "G".</li> </ul> <b>Add \$18</b> (Grommets not available for overhang desks) <ul style="list-style-type: none"> <li>To specify pedestals without locks, replace the fifth character "L" with an "N".</li> </ul> <b>Deduct \$42</b>
<b>Double Pedestal Desk</b> 1. Pattern Number 2. Laminate Finish 3. Edge Band Finish 4. Paint Finish 5. Pull Finish 6. Drawer Top Cap Finish	<b>Double Pedestal Desk</b> <i>Example:</i> <b>DD1D L7230N, 117, 117, 117, 117, 117</b> <hr/> <b>DD1D</b> Pattern Number <b>L7230N</b> <hr/> <b>117</b> Soft Grey laminate <hr/> <b>117</b> Soft Grey edge finish <hr/> <b>117</b> Soft Grey paint finish <hr/> <b>117</b> Soft Grey pull finish <hr/> <b>117</b> Soft Grey top cap finish		

# Preconfigured Desks

## Series 2 Freestanding Corner Unit Specifications

### Series 2 Freestanding Corner Units (Assembly)

Dividends Horizon Series 2 freestanding corner units are available "Preconfigured" and can also be specified by component for "Build-to-Spec" applications.

"Preconfigured" freestanding corners consist of a worksurface, three "L" shaped end units and two full height back panels.

#### Available Sizes

- Height: 28½"
- Widths: 36", 42" and 48"
- Returns: 24" depth

#### Construction

##### Corner Unit:

- Worksurface: 1¼" thick, 45 lb. density particle board core with high pressure laminate surface and 2mm vinyl edge banding
- Back panels: 20-gauge steel
- Series 2 Freestanding Corner Units include full height back panels

##### Rear Corner End Unit

- Outer skin: 21-gauge steel
- Inner frame: 20-gauge steel
- Leveling glide: ¾" 16-gauge steel with 1½" of height adjustment
- Attachment bracket: 11-gauge steel

##### Side Corner End Unit

- Outer skin: 21-gauge
- Inner frame: 20-gauge
- Leveling glide: ¾" 16-gauge steel with 1½" of height adjustment
- Attachment bracket: 11-gauge steel

##### Freestanding Corner End Units (Components)

Freestanding corner end units have mounting brackets that allow attachment to corner worksurfaces. A 6" wide rear corner end unit is used in the rear corner to support the worksurface top. A 12" wide non-handed side corner end unit is attached to both sides of a corner worksurface for support.

##### Optional Edge Grommets

Edge grommets are optional and can be specified factory-installed on center on both edges along the rear edge of the worksurface. Grommets can also be ordered as a kit (pattern number D1WSG) for field installation in any position along the rear edge of the worksurface.

Series 2 Freestanding Corner Unit Components

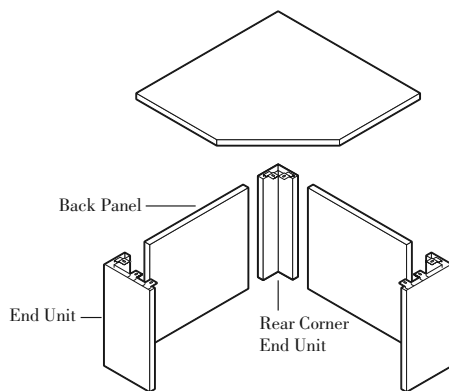

Edge Grommet Locations

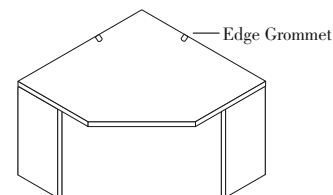

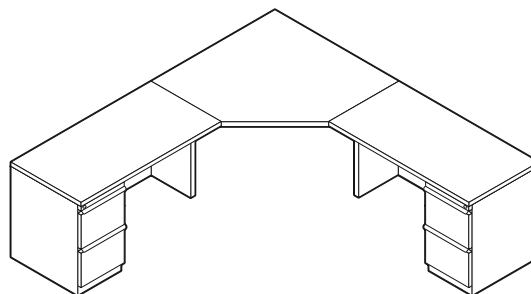

Series 2 Freestanding Corner Unit Attached to Return to Form a "L" Shaped Workstation



# Preconfigured Desks

## Series 2 Freestanding Corner Unit

### 24" Deep

description	type	w*	w	d	h	pattern no.	P1	P2	P3
 Freestanding Corner Unit (Assembly)		36"	35 1/2"	23 1/2"	28 1/2"	<b>DD2VD 3624 N</b>	\$1,305.	\$1,437.	\$1,502.
		42"	41 1/2"	23 1/2"	28 1/2"	<b>DD2VD 4224 N</b>	1,349.	1,484.	1,551.
		48"	47 1/2"	23 1/2"	28 1/2"	<b>DD2VD 4824 N</b>	1,416.	1,556.	1,627.
 Freestanding Curved Corner Unit (Assembly)		36"	35 1/2"	23 1/2"	28 1/2"	<b>DD2VL 3624 N</b>	1,333.	1,467.	1,535.
		42"	41 1/2"	23 1/2"	28 1/2"	<b>DD2VL 4224 N</b>	1,415.	1,555.	1,626.
		48"	47 1/2"	23 1/2"	28 1/2"	<b>DD2VL 4824 N</b>	1,477.	1,626.	1,698.
 Freestanding Corner End Unit (Component)			6 9/16"	6 9/16"	26 7/8"	<b>DD1R CU6</b>	274.	303.	316.

w\* = nominal width  
 Dimensions listed under w d h are actual to the nearest 1/16"

Ordering Information	Order Code	Included with:	Options
<b>Freestanding Corner</b> 1. Pattern Number 2. Laminate Finish 3. Edge Band Finish 4. Paint Finish	<b>Freestanding Corner</b> <i>Example:</i> <b>DD2VD 3624 N, 117, 117</b> <hr/> <b>DD2VD</b> Pattern Number <b>3624</b> <hr/> <b>N</b> No Grommets <hr/> <b>117</b> Soft Grey laminate <hr/> <b>117</b> Soft Grey edge finish <hr/> <b>117</b> Soft Grey paint finish <hr/> <b>Freestanding Corner End Unit</b> <i>Example:</i> <b>DD1RCU6, 117</b> <hr/> <b>DD1RCU6</b> Pattern Number <hr/> <b>117</b> Soft Grey paint finish	<b>Freestanding Corner</b> <ul style="list-style-type: none"> <li>• Corner supports (3)</li> <li>• Back panels (2)</li> <li>• Corner worksurface</li> <li>• Connecting hardware</li> </ul> <b>Freestanding Corner End Unit</b> <b>Note:</b> Series 2 freestanding corner units have full height modesty panels.  <b>Note:</b> An upcharge applies when specifying Legacy laminates. See Legacy finish page.	<b>Freestanding Corner</b> <ul style="list-style-type: none"> <li>• To specify two center-mounted edge grommets, replace the suffix letter "N" with a "G".</li> </ul> <b>Add \$28.</b> <b>Freestanding Corner End Unit</b>

# Preconfigured Desks

## *Freestanding Corner Unit Specifications*

### Freestanding Corner Units (Assembly)

Dividends freestanding corner units are available "Preconfigured" and can also be specified by component for "Build-to-Spec" applications. "Preconfigured" freestanding corners consist of a worksurface, three "L" shaped end units and two 11" high back panels.

### Available Sizes

- Height: 28½"
- Widths: 36", 42" and 48"
- Returns: 24" depth

### Construction

#### Corner Unit Specifications

- Worksurface: 1¼" thick, 45 lb. density particle board core with high pressure laminate surface and 2mm vinyl edge banding
- Back panels: 20-gauge steel

### Rear Corner End Unit

- Outer skin: 21-gauge steel
- Inner frame: 20-gauge steel
- Leveling glide: ¾" 16-gauge steel with 1½" of height adjustment
- Attachment bracket: 11-gauge steel

### Side Corner End Unit

- Outer skin: 21-gauge steel
- Inner frame: 20-gauge steel
- Leveling glide: ¾" 16-gauge steel
- Attachment bracket: 11-gauge steel

### Freestanding Corner End Units (Components)

Freestanding corner end units have mounting brackets that allow attachment to corner worksurfaces. A 6" wide rear corner end unit is used in the rear corner to support the worksurface top. A 12" wide non-handed side corner end unit is attached to both sides of a corner worksurface for support.

### Optional Edge Grommets

Edge grommets are optional and can be specified factory-installed on center on both edges along the rear edge of the worksurface. Grommets can also be ordered as a kit (pattern number D1WSG) for field installation in any position along the rear edge of the worksurface.

### Freestanding Corner Unit Components

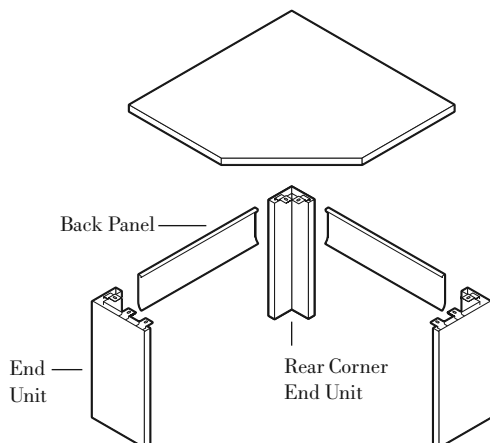

### Edge Grommet Locations

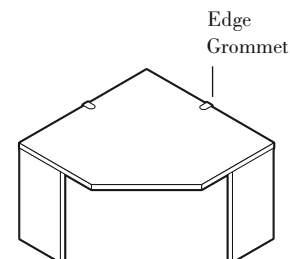

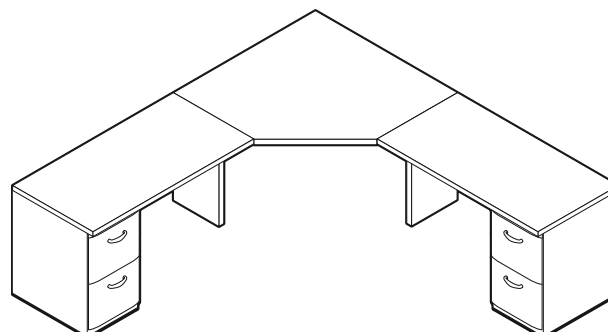

### Freestanding Corner Unit attached to returns to form an "L" shaped workstation



# Preconfigured Desks

## Freestanding Corner Unit

### 24" Deep

description	type	w*	w	d	h	pattern no.	P1	P2	P3
 Freestanding Corner Unit (Assembly)		36"	35 1/2"	23 1/2"	28 1/2"	<b>DD1VD 3624 N</b>	\$1,305.	\$1,437.	\$1,502.
		42"	41 1/2"	23 1/2"	28 1/2"	<b>DD1VD 4224 N</b>	1,349.	1,484.	1,551.
		48"	47 1/2"	23 1/2"	28 1/2"	<b>DD1VD 4824 N</b>	1,416.	1,556.	1,627.
 Freestanding Curved Corner Unit (Assembly)		36"	35 1/2"	23 1/2"	28 1/2"	<b>DD1VL 3624 N</b>	1,333.	1,467.	1,535.
		42"	41 1/2"	23 1/2"	28 1/2"	<b>DD1VL 4224 N</b>	1,415.	1,555.	1,626.
		48"	47 1/2"	23 1/2"	28 1/2"	<b>DD1VL 4824 N</b>	1,477.	1,626.	1,698.
Freestanding Corner End Unit (Component)			6 9/16"	6 9/16"	26 7/8"	<b>DD1R CU6</b>	274.	303.	316.
Freestanding Corner Unit (Component)			6 9/16"	12 9/16"	26 7/8"	<b>DD1S CU12</b>	323.	354.	372.
 Back Panels for Freestanding Corner Unit (Component)	full height	36"	20 15/16"	26 5/8"		<b>DD1 FBPV36</b>	195.	212.	222.
	full height	42"	26 15/16"	26 5/8"		<b>DD1 FBPV42</b>	197.	215.	226.
	full height	48"	32 15/16"	26 5/8"		<b>DD1 FBPV48</b>	200.	219.	229.
	half height	36"	20 15/16"	11"		<b>DD1 BPV36</b>	163.	178.	185.
	half height	42"	26 15/16"	11"		<b>DD1 BPV42</b>	171.	188.	197.
	half height	48"	32 15/16"	11"		<b>DD1 BPV48</b>	179.	199.	207.

w\* = nominal width  
 Dimensions listed under w d h are actual to the nearest 1/16"

Ordering Information	Order Code	Included with:	Options
<b>Freestanding Corner</b> 1. Pattern Number 2. Laminate Finish 3. Edge Band Finish 4. Paint Finish	<b>Freestanding Corner</b> <i>Example:</i> <b>DD1VD 3624 N, 117, 117</b> <b>DD1VD</b> Pattern Number <b>3624</b>	<b>Freestanding Corner</b> <ul style="list-style-type: none"> <li>• Corner supports (3)</li> <li>• Back panels (2)</li> <li>• Corner worksurface</li> <li>• Connecting hardware</li> </ul>	<b>Freestanding Corner</b> <ul style="list-style-type: none"> <li>• To specify two center-mounted edge grommets, replace the suffix letter "N" with a "G".</li> </ul> <b>Add \$28.</b>
<b>Freestanding Corner End Unit</b> 1. Pattern Number 2. Paint Finish	<b>N</b> No Grommets <b>117</b> Soft Grey laminate <b>117</b> Soft Grey edge finish	<b>Freestanding Corner End Unit</b>	<b>Freestanding Corner End Unit</b>
<b>Freestanding Corner Back Panel</b> 1. Pattern Number 2. Paint Finish	<b>117</b> Soft Grey paint finish <b>Freestanding Corner End Unit</b> <i>Example:</i> <b>DD1R CU6, 117</b> <b>DD1R</b> Pattern Number <b>CU6</b> <b>117</b> Soft Grey paint finish <b>Freestanding Corner Back Panel</b> <i>Example:</i> <b>DD1 BPV42, 115</b> <b>DD1</b> Pattern Number <b>BPV42</b> <b>115</b> Medium grey paint finish	<b>Freestanding Corner Back Panel</b> <b>Note:</b> Series 1 freestanding corner units have a curved half modesty panel. <b>Note:</b> An upcharge applies when specifying Legacy laminates. See Legacy finish page.	<b>Freestanding Corner Back Panel</b>

# Preconfigured Desks

## Series 2 Returns and Bridge Units

### Specifications

#### Series 2 End Panel and Pedestal Returns

Dividends Horizon freestanding returns can be specified "Preconfigured" or can be ordered by component for "Build-to-Spec" applications. These applications include when a different pedestal drawer combination is required or when back panels are not needed.

"Preconfigured" pedestal returns consist of a worksurface, file/file pedestal, and full-height back panel. "Preconfigured" end panel returns consist of a worksurface, "L" shaped end panel and full height back panel.

#### Available Sizes

- Height: 28 1/2"
- Widths: 36", 42" and 48"
- Depths: 18" and 24"

#### Attachment

Returns attach to adjacent desks or freestanding corner units with flat brackets, which are included.

#### Construction

All freestanding returns match the aesthetics of the Dividends Horizon panel system.

Drawers overlay the cabinet front and feature softly-radiused integral pulls, drawer fronts and drawer trim. Series 2 Desk components include full-height back panels.

Worksurface support is provided by pedestals and end units which are non-handed and shipped knocked down.

This allows pedestals and end units to be positioned at either end of worksurfaces.

#### "Build-to-Spec" Returns and Bridges

For "Build-to-Spec" returns and bridges, specify by component. Refer to the individual component categories for information.

#### Accessory

Hanging file bars for front-to-back or side-to-side filing are included with pedestals.

#### Bridge Units

Bridge units are used to form freestanding "U" shaped workstations.

Bridge units consist of a worksurface and back panel and connect to adjacent freestanding components with flat brackets which are included.

#### Available Sizes

- Height: 28 1/2"
- Widths: 30", 36", 42" and 48"
- Depths: 18" and 24"

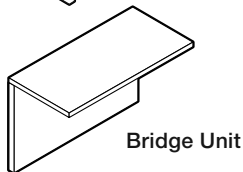
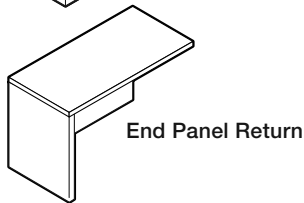
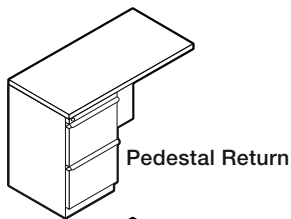

#### Series 2 Return Sizes Available

	18"D	24"D
30"W		
42"W		
48"W		

#### Series 2 Bridge Unit Sizes Available

30"W		
42"W		
42"W		
48"W		

#### Series 2 Desk Configurations

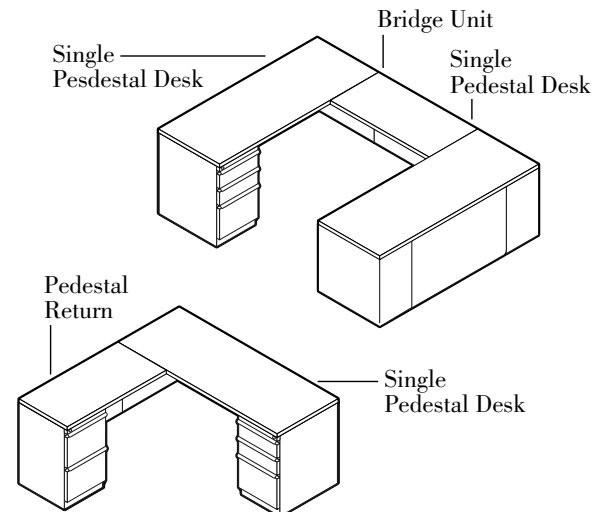





# Preconfigured Desks

## Series 2 Returns and Bridge Units

### 18" and 24" Deep

description	w*	w	d	h	pattern no.	P1	P2	P3
 End Panel Return	36"	35 <sup>13</sup> / <sub>16</sub> "	17 <sup>1</sup> / <sub>2</sub> "	28 <sup>1</sup> / <sub>2</sub> "	<b>DD2E 3618N</b>	\$720.	\$775.	\$796.
	36"	35 <sup>13</sup> / <sub>16</sub> "	23 <sup>1</sup> / <sub>2</sub> "	28 <sup>1</sup> / <sub>2</sub> "	<b>DD2E 3624N</b>	787.	842.	871.
	42"	41 <sup>13</sup> / <sub>16</sub> "	17 <sup>1</sup> / <sub>2</sub> "	28 <sup>1</sup> / <sub>2</sub> "	<b>DD2E 4218N</b>	758.	812.	839.
	42"	41 <sup>13</sup> / <sub>16</sub> "	23 <sup>1</sup> / <sub>2</sub> "	28 <sup>1</sup> / <sub>2</sub> "	<b>DD2E 4224N</b>	824.	882.	911.
 Pedestal Return	36"	35 <sup>13</sup> / <sub>16</sub> "	17 <sup>1</sup> / <sub>2</sub> "	28 <sup>1</sup> / <sub>2</sub> "	<b>DD2P (L)3618N</b>	931.	1,006.	1,042.
	36"	35 <sup>13</sup> / <sub>16</sub> "	23 <sup>1</sup> / <sub>2</sub> "	28 <sup>1</sup> / <sub>2</sub> "	<b>DD2P (L)3624N</b>	1,018.	1,095.	1,134.
	42"	41 <sup>13</sup> / <sub>16</sub> "	17 <sup>1</sup> / <sub>2</sub> "	28 <sup>1</sup> / <sub>2</sub> "	<b>DD2P (L)4218N</b>	972.	1,045.	1,080.
	42"	41 <sup>13</sup> / <sub>16</sub> "	23 <sup>1</sup> / <sub>2</sub> "	28 <sup>1</sup> / <sub>2</sub> "	<b>DD2P (L)4224N</b>	1,058.	1,137.	1,176.
	48"	47 <sup>13</sup> / <sub>16</sub> "	17 <sup>1</sup> / <sub>2</sub> "	28 <sup>1</sup> / <sub>2</sub> "	<b>DD2P (L)4818N</b>	1,008.	1,080.	1,118.
	48"	47 <sup>13</sup> / <sub>16</sub> "	23 <sup>1</sup> / <sub>2</sub> "	28 <sup>1</sup> / <sub>2</sub> "	<b>DD2P (L)4824N</b>	1,099.	1,179.	1,220.
 Bridge Unit	30"	29 <sup>13</sup> / <sub>16</sub> "	17 <sup>1</sup> / <sub>2</sub> "	28 <sup>1</sup> / <sub>2</sub> "	<b>DD2B 3018N</b>	351.	368.	374.
	36"	35 <sup>13</sup> / <sub>16</sub> "	17 <sup>1</sup> / <sub>2</sub> "	28 <sup>1</sup> / <sub>2</sub> "	<b>DD2B 3618N</b>	387.	405.	414.
	36"	35 <sup>13</sup> / <sub>16</sub> "	23 <sup>1</sup> / <sub>2</sub> "	28 <sup>1</sup> / <sub>2</sub> "	<b>DD2B 3624N</b>	416.	432.	440.
	42"	41 <sup>13</sup> / <sub>16</sub> "	17 <sup>1</sup> / <sub>2</sub> "	28 <sup>1</sup> / <sub>2</sub> "	<b>DD2B 4218N</b>	420.	438.	447.
	42"	41 <sup>13</sup> / <sub>16</sub> "	23 <sup>1</sup> / <sub>2</sub> "	28 <sup>1</sup> / <sub>2</sub> "	<b>DD2B 4224N</b>	455.	473.	481.
	48"	47 <sup>13</sup> / <sub>16</sub> "	17 <sup>1</sup> / <sub>2</sub> "	28 <sup>1</sup> / <sub>2</sub> "	<b>DD2B 4818N</b>	455.	473.	481.
	48"	47 <sup>13</sup> / <sub>16</sub> "	23 <sup>1</sup> / <sub>2</sub> "	28 <sup>1</sup> / <sub>2</sub> "	<b>DD2B 4824N</b>	496.	515.	523.

w\* = nominal width  
 Dimensions listed under w d h are actual to the nearest 1/16"

Ordering Information	Order Code	Included with:	Options
<b>Pedestal Return</b> 1. Pattern Number 2. Laminate Finish 3. Edge Band Finish 4. Paint Finish	<b>Pedestal Return</b> <i>Example:</i> <b>DD2P L4824N, 117, 117, 117</b> <b>DP2P</b> Pattern Number <b>L4824N</b>	<b>Pedestal Return</b> <ul style="list-style-type: none"> <li>• Worksurface</li> <li>• Pedestal</li> <li>• Back panel</li> <li>• Half height flat bracket (1)</li> <li>• Connecting hardware</li> </ul>	<b>Pedestal Return</b> <ul style="list-style-type: none"> <li>• To specify center-mounted edge grommet, replace the "N" suffix from the pattern number with "G". <b>Add \$18</b></li> <li>• To specify pedestal without locks, replace the 5th digit "L" from the pattern number with "N". <b>Deduct \$21</b></li> </ul>
<b>End Panel Return or Bridge Unit</b> 1. Pattern Number 2. Laminate Finish 3. Edge Band Finish 4. Paint Finish	<b>117</b> Soft Grey laminate <b>117</b> Soft Grey edge finish <b>117</b> Soft Grey paint finish <b>End Panel Return or Bridge Unit</b> <i>Example:</i> <b>DD2B 4224N, 117, 117, 117</b> <b>DD2B</b> Pattern Number <b>4424</b> <b>117</b> Soft Grey laminate <b>117</b> Soft Grey finish <b>117</b> Soft Grey finish	<b>End Panel Return or Bridge Unit</b> <ul style="list-style-type: none"> <li>• Worksurface</li> <li>• Back panel</li> <li>• Half height flat brackets (2)</li> <li>• Connecting hardware</li> </ul> <b>Note:</b> An upcharge applies when specifying Legacy laminates. See Legacy finish page.	<b>End Panel Return or Bridge Unit</b> <ul style="list-style-type: none"> <li>• To specify center-mounted edge grommet, replace the "N" suffix from the pattern number with "G". <b>Add \$18</b></li> </ul>

# Preconfigured Desks

## Returns and Bridge Units

### Specifications

#### End Panel and Pedestal Returns

Dividends freestanding returns can be specified "Preconfigured" or can be ordered by component for "Build-to-Spec" applications. These applications include when a different pedestal drawer combination is required or when back panels are not needed.

"Preconfigured" pedestal returns consist of a worksurface, file/file pedestal, and half-height back panel. "Preconfigured" end panel returns consist of a worksurface, "L" shaped end panel and half-height back panel.

#### Available Sizes

- Height: 28 1/2"
- Widths: 36", 42" and 48"
- Depths: 18" and 24"

#### Attachment

Returns attach to adjacent desks or freestanding corner units with flat brackets, which are included.

#### Construction

All freestanding returns match the aesthetics of the Dividends panel system.

Drawers overlay the cabinet front and feature softly-radiused pulls, drawer fronts and drawer trim.

Half-height back panels extend 11" from the bottom of the worksurface, are inset 3/4" from the pedestal backs and match the softly radiused aesthetics of other Dividends components.

Worksurface support is provided by pedestals and end units which are non-handed and shipped knocked down. This allows pedestals and end units to be positioned at either end of worksurfaces.

#### "Build-to-Spec" Returns and Bridges

For "Build-to-Spec" returns and bridges, specify by component. Refer to the individual component categories for information.

#### Accessory

Hanging file bars for front-to-back or side-to-side filing are included with pedestals.

#### Bridge Units

Bridge units are used to form freestanding "U" shaped workstations.

Bridge units consist of a worksurface and back panel and connect to adjacent freestanding components with flat brackets which are included.

#### Available Sizes

- Height: 28 1/2"
- Widths: 30", 36", 42" and 48"
- Depths: 18" and 24"

Pedestal Return

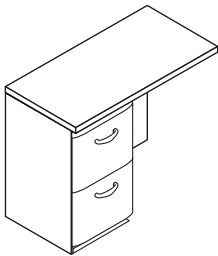

End Panel Return

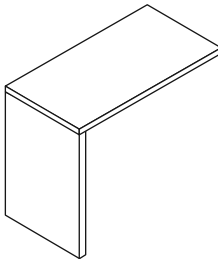

Bridge Unit



Return Sizes Available

	18D	24D
30W		
30W		
42W		
42W		
48W		

Bridge Unit Sizes Available

30W		
42W		
42W		
48W		

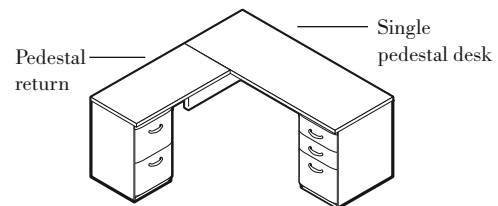
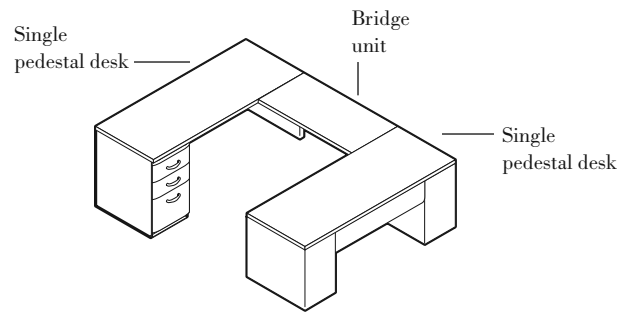

Freestanding Configuration



# Preconfigured Desks

## Returns and Bridge Units

### 18" and 24" Deep

description	w*	w	d	h	pattern no.	P1	P2	P3
 End Panel Return	36"	35 <sup>13</sup> / <sub>16</sub> "	17 <sup>1</sup> / <sub>2</sub> "	28 <sup>1</sup> / <sub>2</sub> "	<b>DD1E 3618N</b>	\$720.	\$775.	\$796.
	36"	35 <sup>13</sup> / <sub>16</sub> "	23 <sup>1</sup> / <sub>2</sub> "	28 <sup>1</sup> / <sub>2</sub> "	<b>DD1E 3624N</b>	787.	842.	871.
	42"	41 <sup>13</sup> / <sub>16</sub> "	17 <sup>1</sup> / <sub>2</sub> "	28 <sup>1</sup> / <sub>2</sub> "	<b>DD1E 4218N</b>	758.	812.	839.
	42"	41 <sup>13</sup> / <sub>16</sub> "	23 <sup>1</sup> / <sub>2</sub> "	28 <sup>1</sup> / <sub>2</sub> "	<b>DD1E 4224N</b>	824.	882.	911.
 Pedestal Return	36"	35 <sup>13</sup> / <sub>16</sub> "	17 <sup>1</sup> / <sub>2</sub> "	28 <sup>1</sup> / <sub>2</sub> "	<b>DD1P (L)3618N</b>	931.	1,006.	1,042.
	36"	35 <sup>13</sup> / <sub>16</sub> "	23 <sup>1</sup> / <sub>2</sub> "	28 <sup>1</sup> / <sub>2</sub> "	<b>DD1P (L)3624N</b>	1,018.	1,095.	1,134.
	42"	41 <sup>13</sup> / <sub>16</sub> "	17 <sup>1</sup> / <sub>2</sub> "	28 <sup>1</sup> / <sub>2</sub> "	<b>DD1P (L)4218N</b>	972.	1,045.	1,080.
	42"	41 <sup>13</sup> / <sub>16</sub> "	23 <sup>1</sup> / <sub>2</sub> "	28 <sup>1</sup> / <sub>2</sub> "	<b>DD1P (L)4224N</b>	1,058.	1,137.	1,176.
	48"	47 <sup>13</sup> / <sub>16</sub> "	17 <sup>1</sup> / <sub>2</sub> "	28 <sup>1</sup> / <sub>2</sub> "	<b>DD1P (L)4818N</b>	1,008.	1,080.	1,118.
	48"	47 <sup>13</sup> / <sub>16</sub> "	23 <sup>1</sup> / <sub>2</sub> "	28 <sup>1</sup> / <sub>2</sub> "	<b>DD1P (L)4824N</b>	1,099.	1,179.	1,220.
 Bridge Unit	30"	29 <sup>13</sup> / <sub>16</sub> "	17 <sup>1</sup> / <sub>2</sub> "	28 <sup>1</sup> / <sub>2</sub> "	<b>DD1B 3018N</b>	351.	368.	374.
	36"	35 <sup>13</sup> / <sub>16</sub> "	17 <sup>1</sup> / <sub>2</sub> "	28 <sup>1</sup> / <sub>2</sub> "	<b>DD1B 3618N</b>	387.	405.	414.
	36"	35 <sup>13</sup> / <sub>16</sub> "	23 <sup>1</sup> / <sub>2</sub> "	28 <sup>1</sup> / <sub>2</sub> "	<b>DD1B 3624N</b>	416.	432.	440.
	42"	41 <sup>13</sup> / <sub>16</sub> "	17 <sup>1</sup> / <sub>2</sub> "	28 <sup>1</sup> / <sub>2</sub> "	<b>DD1B 4218N</b>	420.	438.	447.
	42"	41 <sup>13</sup> / <sub>16</sub> "	23 <sup>1</sup> / <sub>2</sub> "	28 <sup>1</sup> / <sub>2</sub> "	<b>DD1B 4224N</b>	455.	473.	481.
	48"	47 <sup>13</sup> / <sub>16</sub> "	17 <sup>1</sup> / <sub>2</sub> "	28 <sup>1</sup> / <sub>2</sub> "	<b>DD1B 4818N</b>	455.	473.	481.
	48"	47 <sup>13</sup> / <sub>16</sub> "	23 <sup>1</sup> / <sub>2</sub> "	28 <sup>1</sup> / <sub>2</sub> "	<b>DD1B 4824N</b>	496.	515.	523.

w\* = nominal width  
 Dimensions listed under w d h are actual to the nearest 1/16"

Ordering Information	Order Code	Included with:	Options
<b>Pedestal Return</b> 1. Pattern Number 2. Laminate Finish 3. Edge Band Finish 4. Paint Finish 5. Pull Finish 6. Drawer Top Cap Finish  <b>End Panel Return or Bridge Unit</b> 1. Pattern Number 2. Laminate Finish 3. Edge Band Finish 4. Paint Finish	<b>Pedestal Return</b> <i>Example:</i> <b>DD1P L4824N, 117, 117, 117, 117, 117</b> <hr/> <b>DP1P</b> Pattern Number <hr/> <b>L4824N</b> <hr/> <b>117</b> Soft Grey laminate <hr/> <b>117</b> Soft Grey edge finish <hr/> <b>117</b> Soft Grey paint finish <hr/> <b>117</b> Soft Grey pull finish <hr/> <b>117</b> Soft Grey top cap finish <hr/> <b>End Panel Return or Bridge Unit</b> <i>Example:</i> <b>DD1B 4224N, 117, 117, 117</b> <hr/> <b>DD1B</b> Pattern Number <hr/> <b>4424</b> <hr/> <b>117</b> Soft Grey laminate <hr/> <b>117</b> Soft Grey edge band <hr/> <b>117</b> Soft Grey finish	<b>Pedestal Return</b> <ul style="list-style-type: none"> <li>• Worksurface</li> <li>• Pedestal</li> <li>• Back panel</li> <li>• Half height flat bracket (1)</li> <li>• Connecting hardware</li> </ul> <b>End Panel Return or Bridge Unit</b> <ul style="list-style-type: none"> <li>• Worksurface</li> <li>• Back panel</li> <li>• Half height flat brackets (2)</li> <li>• Connecting hardware</li> </ul> <b>Note:</b> An upcharge applies when specifying Legacy laminates. See Legacy finish page.	<b>Pedestal Return</b> <ul style="list-style-type: none"> <li>• To specify center-mounted edge grommet, replace the "N" suffix from the pattern number with "G". <b>Add \$18</b></li> <li>• To specify pedestal without locks, replace the 5th digit "L" from the pattern number with "N". <b>Deduct \$21</b></li> </ul> <b>End Panel Return or Bridge Unit</b> <ul style="list-style-type: none"> <li>• To specify center-mounted edge grommet, replace the "N" suffix from the pattern number with "G". <b>Add \$18</b></li> </ul>

# Desk Components

## End Units

### Planning Guidelines

#### Desk End Units

Dividends desk end units are an "L" shaped, non-handed design that can be used on either end of a worksurface in freestanding and panel applications. Desk end units have the same footprint (outside dimension) as pedestals and can be interchanged with pedestals.

End units are used in "Preconfigured" single pedestal desks and end panel returns.

They can also be specified by component for "Build-to-Spec" applications.

These include when an end panel is required on one end and a desk integration unit is required on the other, or when an end unit is required on both ends of the worksurface.

#### Available Sizes

Depths: 18", 24" and 30"

Width: 15"

Height: 26<sup>7</sup>/<sub>8</sub>"

#### Desk End Unit Attachment

Desk end units have mounting brackets that allow attachment to worksurfaces with supplied screws. Dividends worksurfaces are pre-drilled for end unit attachment.

#### Construction

##### End unit specifications:

- Outer skin: 21-gauge steel
- Inner frame: 20-gauge steel
- Leveling glides: <sup>3</sup>/<sub>8</sub>" 16-gauge steel with 1<sup>1</sup>/<sub>2</sub>" of height adjustment
- Attachment bracket: 11-gauge steel

##### Desk Integration End Units

If a back panel (modesty) is required in a systems application, a desk integration end unit can be used in place of an end unit.

Panel-to-worksurface brackets are included and make the connection between the worksurface and Dividends Horizon panels. Desk integration end units are 15" wide.

**Note:** The desk integration end unit is a non-structural support. Panel-to-work surface brackets provide the actual support for the worksurface.

**Note:** Panel width must match the depth of the connecting worksurface.

#### Construction

##### Desk integration end unit specifications:

- Outer skin: 20-gauge steel
- Panel-to-worksurface brackets: 14-gauge steel

##### Intermediate End Units

Intermediate end units are freestanding "T" shaped end units used to support two desks in an in-line configuration.

Units attach to 18", 24" and 30" deep worksurfaces in place of desk end units. Mounting brackets and a front worksurface alignment plate are included with intermediate end units.

##### Available Size

- Depth: 14"
- Width: 30"
- Height: 26<sup>7</sup>/<sub>8</sub>"

##### Construction

Intermediate end unit specifications:

- Outer skin: 20-gauge steel
- Inner frame: 20-gauge steel
- Mounting brackets: 11-gauge steel

Desk End Unit

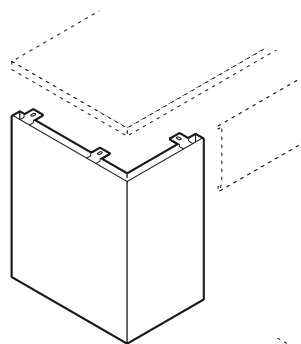

Intermediate End Unit

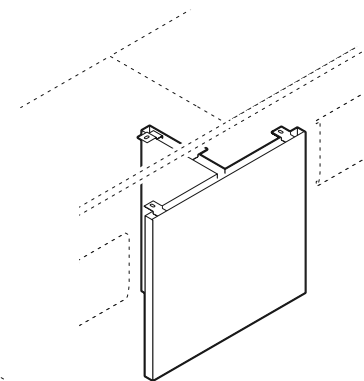

Desk Integration End Unit (Non-structural)

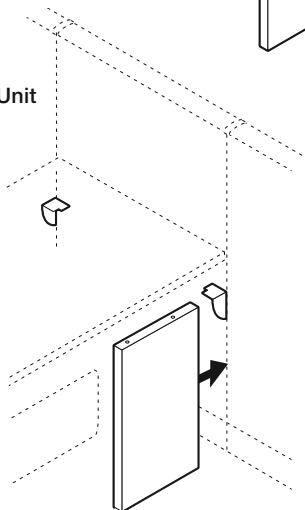

Desk End Unit Available Sizes

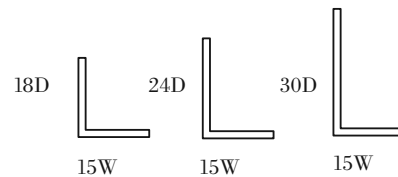

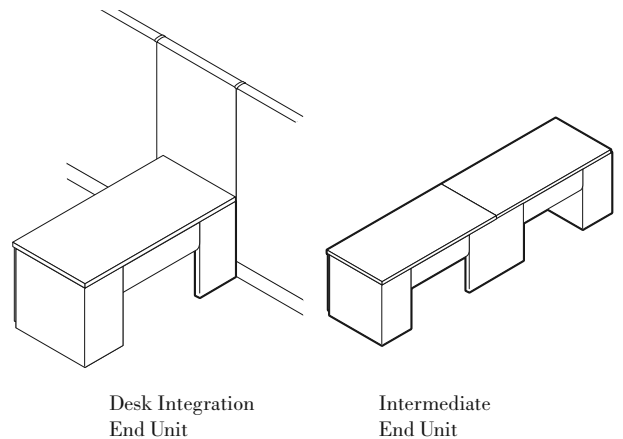

End Unit Configurations



*End Units*

*Desk End, Desk Integration and Intermediate*

description	d*	d	w	h	pattern no.	P1	P2	P3
 Desk End Unit	18"	16 <sup>3</sup> / <sub>8</sub> "	14 <sup>7</sup> / <sub>8</sub> "	26 <sup>7</sup> / <sub>8</sub> "	<b>DD1 EU18</b>	\$345.	\$379.	\$398.
	24"	22 <sup>3</sup> / <sub>8</sub> "	14 <sup>7</sup> / <sub>8</sub> "	26 <sup>7</sup> / <sub>8</sub> "	<b>DD1 EU24</b>	380.	418.	437.
	30"	28 <sup>3</sup> / <sub>8</sub> "	14 <sup>7</sup> / <sub>8</sub> "	26 <sup>7</sup> / <sub>8</sub> "	<b>DD1 EU30</b>	415.	454.	476.
 Desk Integration End Unit (Non-structural)	1 <sup>1</sup> / <sub>2</sub> "	1 <sup>1</sup> / <sub>2</sub> "	14 <sup>7</sup> / <sub>8</sub> "	26 <sup>7</sup> / <sub>8</sub> "	<b>DD1 DIEU</b>	192.	208.	217.
 Intermediate End Unit	14"	12"	31 <sup>9</sup> / <sub>16</sub> "	26 <sup>7</sup> / <sub>8</sub> "	<b>DD1 IE30</b>	345.	379.	398.

d\* = nominal depth

Dimensions listed under d w h are actual to the nearest 1/16"

Ordering Information	Order Code	Included with:	Options
<b>Desk End Unit</b> 1. Pattern Number 2. Paint Finish	<b>Desk End Unit</b> <i>Example:</i> <b>DD1 EU18, 117</b> <b>DD1 EU18</b> Pattern Number <b>117</b> Soft Grey Paint Finish	<b>Desk End Unit</b> <b>Desk Integration End Unit</b> • Panel-to-Worksurface Brackets (2) <b>Intermediate End Unit</b>	<b>Desk End Unit</b> <b>Desk Integration End Unit</b> <b>Intermediate End Unit</b>
<b>Desk Integration End Unit</b> 1. Pattern Number 2. Paint Finish	<b>Desk Integration End Unit</b> <i>Example:</i> <b>DD1 DIEU, 117</b> <b>DD1 DIEU</b> Pattern Number <b>117</b> Soft Grey Paint Finish		
<b>Intermediate End Unit</b> 1. Pattern Number 2. Paint Finish	<b>Intermediate End Unit</b> <i>Example:</i> <b>DD1 IE30, 117</b> <b>DD1 IE30</b> Pattern Number <b>117</b> Soft Grey Paint Finish		

# Desk Components

## Half Height Back Panels

### Planning Guidelines

#### Half Height Back Panels

Dividends back panels extend between pedestals, end units or desk integration end units in freestanding desks. They also extend between end units in returns and along the rear surface of bridge units. Back panels are softly-radiused to match the aesthetics of the Dividends Horizon system and extend 11" down from the worksurface to provide a half-height modesty.

Back panels are used in "Preconfigured" desks or can be specified separately by component for "Build-to-Spec" applications.

#### Available Sizes

- Widths: 19<sup>5</sup>/<sub>8</sub>" to 48<sup>1</sup>/<sub>4</sub>" see compatibility chart (below)
- Height: 11"

#### Back Panel Attachment

Back panels attach to the undersides of worksurfaces with mounting brackets and do not require attachment to adjacent pedestals or end units. Dividends Horizon worksurfaces are pre-drilled for back panel attachment.

#### Construction

- Back panel specifications:
- Outer skin: 22-gauge steel
  - Mounting Brace: 16-gauge

#### Back Panel Compatibility

The chart below shows which back panels are specified for various configurations.

#### Optional Grommets/Wire Management

When installed, back panels provide a 1/2" reveal between the back panel and worksurface for wire management. Optional edge grommets are required to provide access.

#### Desk Configurations

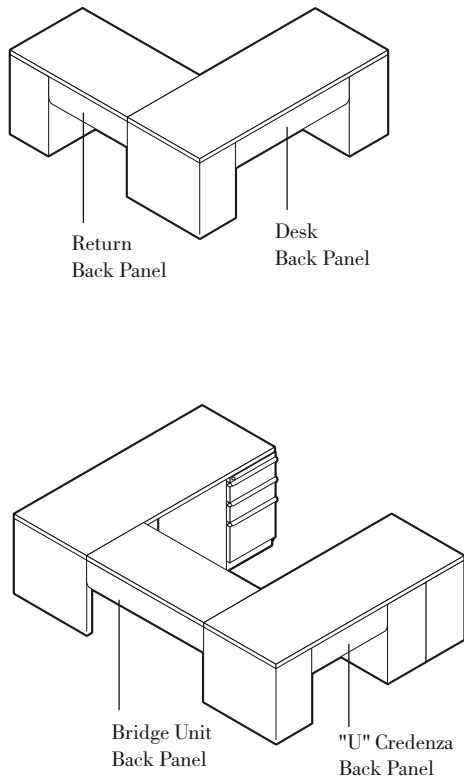

#### Back Panel Compatibility

Product	Work-surface Width	Back Panel Width	Back Panel Pattern No.	No. of Required Peds/End Units
Desks	54	23 7/8"	DD1 BPD54	2
	60	29 7/8"	DD1 BPD60	2
	66	35 7/8"	DD1 BPD66	2
	72	41 7/8"	DD1 BPD72	2
Returns	36	21 5/8"	DD1 BPR36	1
	42	27 5/8"	DD1 BPR42	1
	48	33 5/8"	DD1 BPR48	1
	60	45 5/8"	DD1 BPR60	1
Bridge Units	30	31 3/8"	DD1 BPB30	0
	36	37 3/8"	DD1 BPB36	0
	42	43 3/8"	DD1 BPB42	0
	48	49 3/8"	DD1 BPB48	0
"U" Credenza w/2 peds	72	26 15/16"	DD1 BPU72	3
Freestanding Corner Unit (needs two back panels)	36	20 15/16"	DD1 BPV36	3
	42	26 15/16"	DD1 BPV42	3
	48	32 15/16"	DD1 BPV48	3





Note: Specify "desk" back panels from category (above) for use with desk integration end units and intermediate end units.

# Desk Components

## Half Height Back Panels

### For Desks, Returns, Bridges and 2 Pedestal Configuration

Dividends Horizon

description	top width	w *	h	pattern no.	P1	P2	P3
 Half Height Back panels for Desks	54"	29 <sup>7</sup> / <sub>8</sub> "	11"	<b>DD1 BPD54</b>	\$193.	\$209.	\$219.
	60"	29 <sup>7</sup> / <sub>8</sub> "	11"	<b>DD1 BPD60</b>	202.	222.	231.
	66"	35 <sup>7</sup> / <sub>8</sub> "	11"	<b>DD1 BPD66</b>	212.	234.	243.
	72"	41 <sup>7</sup> / <sub>8</sub> "	11"	<b>DD1 BPD72</b>	224.	244.	258.
 Half Height Back panels for Returns	36"	21 <sup>5</sup> / <sub>8</sub> "	11"	<b>DD1 BPR36</b>	171.	188.	197.
	42"	27 <sup>5</sup> / <sub>8</sub> "	11"	<b>DD1 BPR42</b>	178.	197.	206.
	48"	33 <sup>3</sup> / <sub>8</sub> "	11"	<b>DD1 BPR48</b>	192.	208.	217.
	60"	45 <sup>3</sup> / <sub>8</sub> "	11"	<b>DD1 BPR60</b>	212.	234.	243.
 Half Height Back panels for Bridges	30"	31 <sup>3</sup> / <sub>8</sub> "	11"	<b>DD1 BPB30</b>	151.	166.	175.
	36"	37 <sup>3</sup> / <sub>8</sub> "	11"	<b>DD1 BPB36</b>	163.	178.	185.
	42"	43 <sup>3</sup> / <sub>8</sub> "	11"	<b>DD1 BPB42</b>	171.	188.	197.
	48"	49 <sup>3</sup> / <sub>8</sub> "	11"	<b>DD1 BPB48</b>	181.	200.	208.
 Half Height Back panels for 2 Pedestal "U" Credenza	72"	26 <sup>15</sup> / <sub>16</sub> "	11"	<b>DD1 BPU72</b>	171.	188.	197.

Dimensions listed under w h are actual to the nearest<sup>1</sup>/<sub>16</sub>"

Ordering Information	Order Code	Included with:	Options
<b>Back Panels for Bridges</b> 1. Pattern Number 2. Paint Finish	<b>Back Panels for Bridges</b> <i>Example:</i> <b>DD1 BPB36 , 117</b> <hr/> <b>DD1</b> Pattern Number <b>BPB36</b> <hr/> <b>117</b> Soft Grey Paint Finish	<b>Back Panels for Bridges</b> • Attachment Hardware	<b>Back Panels for Bridges</b>

# Desk Components

## Full Back Panels

### Planning Guidelines

#### Full Back Panels

Dividends full back panels extend between pedestals, end units or desk integration end units in freestanding desks. They also extend between end units in returns and along the rear surface of bridge units.

Full back panels are specified separately by component for "Build-to-Spec" applications.

#### Available Sizes

- Widths: 19<sup>5</sup>/<sub>8</sub>" to 48<sup>1</sup>/<sub>4</sub>" see compatibility chart (above)
- Height: 26<sup>5</sup>/<sub>8</sub>"

#### Full Back Panel Attachment

Back panels attach to the undersides of pedestals or end units with mounting brackets.

#### Construction

Back panel specifications:

- Outer skin: 20-gauge steel
- Mounting Brace: 16-gauge

#### Back Panel Compatibility

The chart below shows which back panels are specified for various configurations.

#### Optional Grommets/Wire Management

When installed, back panels provide a 1/2" reveal between the back panel and worksurface for wire management. Optional edge grommets are required to provide access.

#### Desk Configurations

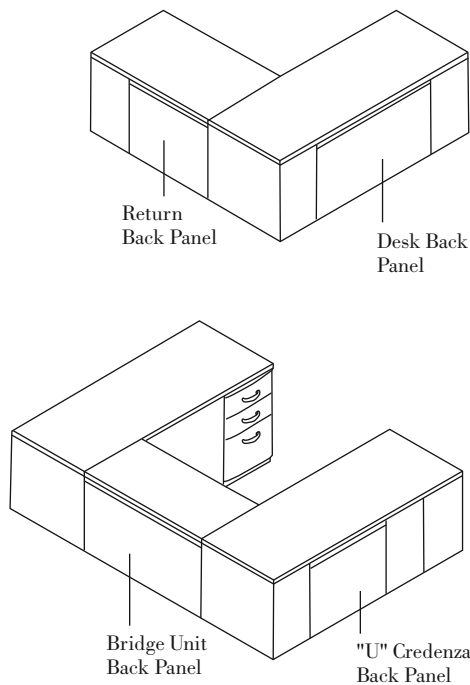

#### Back Panel Compatibility





Product	Work-surface Width	Back Panel Width	Back Panel Pattern No.	No. of Required Peds/End Units
Desks	54	23 <sup>7</sup> / <sub>8</sub> "	DD1 FFBDP54	2
	60	29 <sup>7</sup> / <sub>8</sub> "	DD1 FFBDP60	2
	66	35 <sup>7</sup> / <sub>8</sub> "	DD1 FBPD66	2
	72	41 <sup>7</sup> / <sub>8</sub> "	DD1 FBPD72	2
Returns	36	21 <sup>5</sup> / <sub>8</sub> "	DD1 FBPR36	1
	42	27 <sup>5</sup> / <sub>8</sub> "	DD1 FBPR42	1
	48	33 <sup>5</sup> / <sub>8</sub> "	DD1 FBPR48	1
	60	45 <sup>5</sup> / <sub>8</sub> "	DD1 FBPR60	1
Bridge Units	30	31 <sup>5</sup> / <sub>8</sub> "	DD1 FBPB30	0
	36	37 <sup>5</sup> / <sub>8</sub> "	DD1 FBPB36	0
	42	43 <sup>5</sup> / <sub>8</sub> "	DD1 FBPB42	0
	48	49 <sup>5</sup> / <sub>8</sub> "	DD1 FBPB48	0
"U" Credenza w/2 peds	72	26 <sup>15</sup> / <sub>16</sub> "	DD1 FBPU72	3
Freestanding Corner Unit (needs two back panels)	36	20 <sup>15</sup> / <sub>16</sub> "	DD1 FBPV36	3
	42	26 <sup>15</sup> / <sub>16</sub> "	DD1 FBPV42	3
	48	32 <sup>15</sup> / <sub>16</sub> "	DD1 FBPV48	3

Note: Specify "desk" back panels from category (above) for use with desk integration end units and intermediate end units.



Full Back Panels

For Desks, Returns, Bridges and 2 Pedestal Configuration

description	top width	w *	h	pattern no.	P1	P2	P3
Full Back panels for Desks 	54"	23 <sup>7</sup> / <sub>8</sub> "	26 <sup>5</sup> / <sub>8</sub> "	<b>DD1 FBPD54</b>	\$228.	\$250.	\$262.
	60"	29 <sup>7</sup> / <sub>8</sub> "	26 <sup>5</sup> / <sub>8</sub> "	<b>DD1 FBPD60</b>	232.	255.	268.
	66"	35 <sup>7</sup> / <sub>8</sub> "	26 <sup>5</sup> / <sub>8</sub> "	<b>DD1 FBPD66</b>	239.	263.	272.
	72"	41 <sup>7</sup> / <sub>8</sub> "	26 <sup>5</sup> / <sub>8</sub> "	<b>DD1 FBPD72</b>	246.	270.	283.
Full Back panels for Returns 	36"	21 <sup>5</sup> / <sub>8</sub> "	26 <sup>5</sup> / <sub>8</sub> "	<b>DD1 FBPR36</b>	214.	235.	246.
	42"	27 <sup>5</sup> / <sub>8</sub> "	26 <sup>5</sup> / <sub>8</sub> "	<b>DD1 FBPR42</b>	219.	241.	251.
	48"	33 <sup>5</sup> / <sub>8</sub> "	26 <sup>5</sup> / <sub>8</sub> "	<b>DD1 FBPR48</b>	229.	251.	263.
	60"	45 <sup>5</sup> / <sub>8</sub> "	26 <sup>5</sup> / <sub>8</sub> "	<b>DD1 FBPR60</b>	250.	273.	289.
Full Back panels for Bridges 	30"	31 <sup>3</sup> / <sub>8</sub> "	26 <sup>5</sup> / <sub>8</sub> "	<b>DD1 FBPB30</b>	201.	220.	230.
	36"	37 <sup>3</sup> / <sub>8</sub> "	26 <sup>5</sup> / <sub>8</sub> "	<b>DD1 FBPB36</b>	210.	232.	242.
	42"	43 <sup>3</sup> / <sub>8</sub> "	26 <sup>5</sup> / <sub>8</sub> "	<b>DD1 FBPB42</b>	229.	251.	263.
	48"	49 <sup>3</sup> / <sub>8</sub> "	26 <sup>5</sup> / <sub>8</sub> "	<b>DD1 FBPB48</b>	235.	259.	270.
Full Back panels for 2 Pedestal "U" Credenza 	72"	26 <sup>15</sup> / <sub>16</sub> "	26 <sup>5</sup> / <sub>8</sub> "	<b>DD1 FBPU72</b>	219.	241.	251.

Dimensions listed under w h are actual to the nearest<sup>1</sup>/<sub>16</sub>"

Ordering Information	Order Code	Included with:	Options
<b>Back Panels for Bridges</b> 1. Pattern Number 2. Paint Finish	<b>Back Panels for Bridges</b> <i>Example:</i> <b>DD1 FBPB36 , 117</b> <hr/> <b>DD1</b> Pattern Number <b>FBPB36</b> <hr/> <b>117</b> Soft Grey Paint Finish	<b>Back Panels for Bridges</b> • Attachment Hardware	<b>Back Panels for Bridges</b>

**Pencil Tray**

Five section tray rides on drawer sides of box drawers. Plastic injection molded construction. 13<sup>1</sup>/<sub>4</sub> wide, 5<sup>7</sup>/<sub>16</sub> deep and <sup>7</sup>/<sub>8</sub> high. Black or clear finish available.

**Hanging File Bar**

Allows for side-to-side hanging folders. 20-gauge steel construction. Set of two. Black finish.

**Note:** A hanging file bar is included with each file drawer when ordering desks or pedestals.

**Drawer Dividers**

Two styles available: box drawer and file drawer sizes. 18-gauge steel construction. Black finish.

**Stationery Inserts**

Set of four trays for use in box drawers. 18-gauge steel construction. Can accommodate letter- and legal-sized stationery. Black finish.

**Pencil Drawer**

For use with freestanding desks or panel-mounted worksurfaces with depths of 24 or more. 24 wide, 17 <sup>5</sup>/<sub>8</sub> deep and 2 high. Black finish.

**Attachment:** Mounts on underside of worksurface with included mounting hardware

**Pedestal Lock Retrofit Kit**

Allows existing nonlocking pedestals to be field-retrofitted with locks. Includes lock housing, lock core (keyed randomly unless specified keyed alike) and lock rod assembly (must be specified box/box/file or file/file).

**Flat Brackets**

Allow same-height worksurfaces to be joined in perpendicular configurations. All flat brackets are 3 <sup>3</sup>/<sub>4</sub> wide. Black finish.

Three sizes available to support the following worksurface depths:

- 18 deep worksurfaces
- 24 deep worksurfaces
- 30 deep worksurfaces
- Construction: 14-gauge steel
- Attachment: Mounts on underside of worksurfaces in pre-drilled locations with included mounting hardware

**Worksurface Cable Management Clips**

Self-adhesive, injection-molded clips adhere to any flat, nonporous surface to route cables along and beneath worksurfaces. <sup>3</sup>/<sub>4</sub> x <sup>1</sup>/<sub>2</sub> internal dimension.

**Worksurface Cable Management Basket**

Steel wire basket attaches to the underside of worksurfaces to provide management of excess cords and cables. Once installed, the cable basket slides forward to a position abutting the panel face to allow the passage of cords and cables. Black finish.

**Worksurface Edge Grommet**

Available factory-installed when ordering worksurfaces or as a kit for field installation. Can be installed in any location along the rear edge of worksurfaces. Includes a cutting template, grommet and cover. Dark grey finish.

**Worksurface Reinforcement**

Worksurface reinforcements are required for worksurface spans greater than 48 inches. This includes freestanding desk worksurfaces over 48 inches using desk end units. Worksurface reinforcements have a black paint finish.

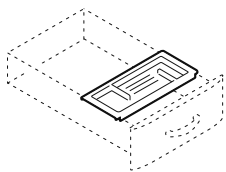

Pencil Tray

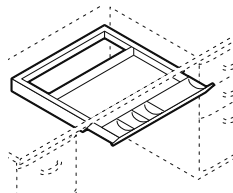

Pencil Drawer

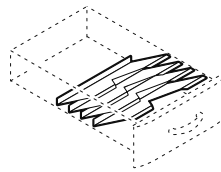

Stationery Inserts

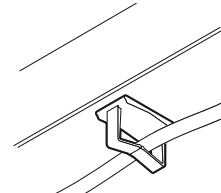

Worksurface Cable Management Clip

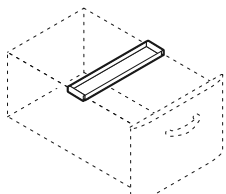

Hanging File Bar

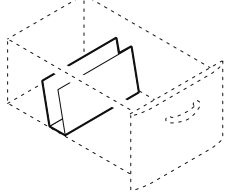

Drawer Divider, File Drawer

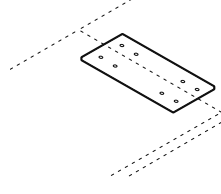

Flat Bracket

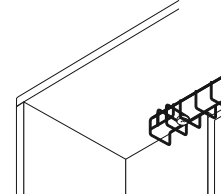

Worksurface Cable Management Basket

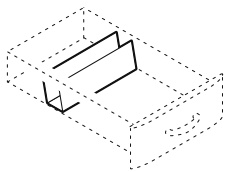

Drawer Divider, Box Drawer

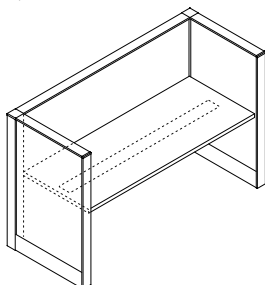



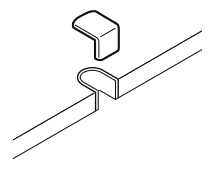





Worksurface Reinforcement Panel Hung Application



Worksurface Edge Grommet

*Drawer Organizers, Cable Management and Grommet Kits*

description	type	w	d	h	pattern no.	list
 Pencil Tray	Black finish	13 1/4"	5 7/8"	7/8"	<b>DS2PPTN</b>	\$37.
	Clear finish	13 1/4"	5 7/8"	7/8"	<b>DS2PPTC</b>	44.
 Hanging File Bar		12 3/16"	2 15/16"	1/2"	<b>DS1PFS</b>	32.
 Drawer Divider, Box		12 3/8"	3"	3 1/8"	<b>DS1PBD</b>	32.
 Drawer Divider, File		10	3 5/8"	6 3/8"	<b>DS1PFD</b>	32.
 Stationary Inserts, box (4 trays)		13	15 1/16"	8 7/8"	<b>DS1PST</b>	170.
 Pencil Drawer		24"	17 3/8"	2"	<b>DS1PCD</b>	231.
 Workspace Cable Management Clip	Package of 10	3/4"	1/2"		<b>D1WC</b>	38.
 Workspace Cable Management Basket	19 1/2" wide	16 1/2"	3 1/2"	1 1/2"	<b>D1WB20</b>	40.
	25 1/2" wide	25 1/2"	3 1/2"	1 1/2"	<b>D1WB26</b>	42.
	31 1/2" wide	31 1/2"	3 1/2"	1 1/2"	<b>D1WB32</b>	53.
	35" wide	35"	3 1/2"	1 1/2"	<b>D1WB36</b>	58.
	41" wide	41"	3 1/2"	1 1/2"	<b>D1WB42</b>	61.
 Workspace Grommet Kit (Dark Grey)		2 3/16"	2 5/16"	1 3/8"	<b>D1WSG</b>	23.



Freestanding Desks

Ordering Information	Order Code	Included with:	Options
<b>Pencil Tray</b> 1. Pattern Number	<b>Pencil Tray</b> <i>Example:</i> <b>DS1 PPT</b> <b>DS1 PPT</b> Pattern Number	<b>Pencil Tray</b>	

# Desk Accessories

## *Flat Brackets and Worksurface Reinforcements*

Dividends Horizon

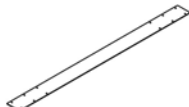
description	w	d	pattern no.	list
Flat Bracket (single pack) 	3 3/4"	8 5/16"	<b>DB1F18SP</b>	\$15.
	3 3/4"	14 5/8"	<b>DB1F24SP</b>	27.
	3 3/4"	20 15/16"	<b>DB1F30SP</b>	31.
Flat Bracket (package of 10) 	3 3/4"	8 5/16"	<b>DB1F18TP</b>	128.
	3 3/4"	14 5/8"	<b>DB1F24TP</b>	212.
	3 3/4"	20 3/16"	<b>DB1F30TP</b>	244.
Worksurface Reinforcement 	54"	4"	<b>DB1WR54</b>	61.
	60"	4"	<b>DB1WR60</b>	62.
	66"	4"	<b>DB1WR66</b>	65.
	72"	4"	<b>DB1WR72</b>	67.

### Ordering Information

**Flat Bracket**  
1. Pattern Number

### Order Code

**Flat Bracket**  
*Example:* **DB1PWSP**  
**DB1PWSP** Pattern Number

### Included with:

**Flat Bracket**

### Options

**Flat Bracket**

# Alpha-Numeric Index

<i>pattern no.</i>	<i>page</i>	<i>pattern no.</i>	<i>page</i>	<i>pattern no.</i>	<i>page</i>	<i>pattern no.</i>	<i>page</i>
D19 6630N	311	D1L 6642SSN	307	DIR 8418N	295	D1W S723018N	302
D19 7230N	311	D1L 6648DSN	309	DIR 8424N	295	D1W S723024N	302
D19 7830N	311	D1L 6648SDN	309	DIR 8430N	299	D1W S781824N	302
D1BD6648DL	311	D1L 6648SSN	307	DIR 8436N	299	D1W S781830N	302
D1BD6648DR	311	D1L 7242SSN	307	DIR 9015	315	D1W S782418N	302
D1BD6648SL	311	D1L 7248DSN	309	DIR 9018N	295	D1W S782430N	302
D1BD6648SR	311	D1L 7248SDN	309	DIR 9024N	295	D1W S783018N	302
D1BD7248DL	311	D1L 7248SSN	307	DIR 9030N	299	D1W S783024N	302
D1BD7248DR	311	D1L 7842SSN	307	DIR 9036N	299	D1W S841824N	302
D1BD7248SL	311	D1L 7848SSN	307	DIR 9615	315	D1W S841830N	302
D1BD7248SR	311	D1L 8448SSN	307	DIR 9618N	295	D1W S842418N	302
D1C 3618N	305	D1P 6630N	311	DIR 9624N	295	D1W S842430N	302
D1C 3624N	305	D1P 7230N	311	DIR 9630N	299	D1W S843018N	302
D1C 422430N	305	D1P 7830N	311	DIR 9636N	299	D1W S843024N	302
D1C 4224N	305	DIR 1515C	315	DIR2419N	297	D1W T482430N	303
D1C 423024N	305	DIR 1515S	315	DIR3019N	297	D1W T483024N	303
D1C 482430N	305	DIR 2415	315	DIR3619N	297	D1W T602430N	303
D1C 4824N	305	DIR 2418N	295	DIR4219N	297	D1W T603024N	303
D1C 483024N	305	DIR 2424N	295	DIR4819N	297	D1W T662430N	303
D1C 4830N	305	DIR 2430N	299	DIR5419N	297	D1W T663024N	303
D1CRL24	313	DIR 3015	315	DIR6019N	297	D1W T722430N	303
D1CRN24	313	DIR 3018N	295	DIR6619N	297	D1W T723024N	303
D1CRR24	313	DIR 3024N	295	DIR7219N	297	D1WB20	207, 371
D1CS 4224N	305	DIR 3030N	299	DIR7819N	297	D1WB26	207, 371
D1CS 4824N	305	DIR 3615	315	DIR8419N	297	D1WB32	207, 371
D1CS 4830N	305	DIR 3618N	295	DIR9019N	297	D1WB36	207, 371
D1D 4824N	311	DIR 3624N	295	DIR9619N	297	D1WB42	207, 371
D1D 4830N	311	DIR 3630N	299	D1W 362430N	301	D1WC	207, 371
D1D 6030N	311	DIR 4215	315	D1W 363024N	301	D1WSC	243, 371
D1D 6630N	311	DIR 4218N	295	D1W 422430N	301	D1WT218	177
D1D 7230N	311	DIR 4224N	295	D1W 423024N	301	D1WT224	177
D1D 7236N	311	DIR 4230N	299	D1W 482430N	301	D1WT324	177
D1H4818	313	DIR 4815	315	D1W 483024N	301	D1WT424	177
D1H5118P	313	DIR 4818N	295	D1W 721830N	301	D1WT518	177
D1H6024	313	DIR 4824N	295	D1W 722430N	301	D1WT524	177
D1H6324P	313	DIR 4830N	299	D1W 722436N	301	D1WW11481824	177
D1L 3636SSN	307	DIR 5415	315	D1W 723018N	301	D1WW11482418	177
D1L 4242SSN	307	DIR 5418N	295	D1W 723024N	301	D1WW12481824	177
D1L 4260SSN	307	DIR 5424N	295	D1W 723624N	301	D1WW12482418	177
D1L 4266SSN	307	DIR 5430N	299	D1W S481824N	302	D1WW124824L	177
D1L 4272SSN	307	DIR 6015	315	D1W S481830N	302	D1WW124824R	177
D1L 4278SSN	307	DIR 6018N	295	D1W S482418N	302	D1WW13481824	177
D1L 4848DDN	309	DIR 6024N	295	D1W S482430N	302	D1WW13482418	177
D1L 4848DSN	309	DIR 6030N	299	D1W S483018N	302	D1WW134824L	177
D1L 4848SDN	309	DIR 6036N	299	D1W S483024N	302	D1WW134824R	177
D1L 4848SSN	307	DIR 6615	315	D1W S601824N	302	D1WW34824	177
D1L 4860DSN	309	DIR 6618N	295	D1W S601830N	302	D1WW44824	177
D1L 4860SDN	309	DIR 6624N	295	D1W S602418N	302	D1WW54824L	177
D1L 4860SSN	307	DIR 6630N	299	D1W S602430N	302	D1WW54824R	177
D1L 4866DSN	309	DIR 6636N	299	D1W S603018N	302	D1WW64824L	177
D1L 4866SDN	309	DIR 7215	315	D1W S603024N	302	D1WW64824R	177
D1L 4866SSN	307	DIR 7218N	295	D1W S661824N	302	D1WW74824L	177
D1L 4872DSN	309	DIR 7224N	295	D1W S661830N	302	D1WW74824R	177
D1L 4872SDN	309	DIR 7230N	299	D1W S662418N	302	D2H4824	313
D1L 4872SSN	307	DIR 7236N	299	D1W S662430N	302	D2H4836	313
D1L 4878SSN	307	DIR 7815	315	D1W S663018N	302	D2H4848	313
D1L 4884SSN	307	DIR 7818N	295	D1W S663024N	302	D2H5124P	313
D1L 6042SSN	307	DIR 7824N	295	D1W S721824N	302	D2H5136P	313
D1L 6048DSN	309	DIR 7830N	299	D1W S721830N	302	D2H5148P	313
D1L 6048SDN	309	DIR 7836N	299	D1W S722418N	302	D2P1	81
D1L 6048SSN	307	DIR 8415	315	D1W S722430N	302	DB120C (L or R)	323

<i>pattern no.</i>	<i>page</i>	<i>pattern no.</i>	<i>page</i>	<i>pattern no.</i>	<i>page</i>	<i>pattern no.</i>	<i>page</i>
DB1BD48SL	311	DCE1BD6648D(L/R)	317	DCE1R6024N	316	DD1B 4824N	363
DB1BD48SR	311	DCE1BD6648S(L/R)	317	DCE1R6030N	316	DD1D L6024N	355
DB1C 18 (L or R)	323	DCE1BD7248D(L/R)	317	DCE1R6624N	316	DD1D L6030N	355
DB1C 18 (L or R) 10	323	DCE1BD7248S(L/R)	317	DCE1R6630N	316	DD1D L6624N	355
DB1C 24 (L or R)	323	DCE1BD7848D(L/R)	317	DCE1R7224N	316	DD1D L6630N	355
DB1C 24 (L or R) 10	323	DCE1BD7848S(L/R)	317	DCE1R7230N	316	DD1D L7224N	355
DB1C 30 (L or R)	323	DCE1BD8448D(L/R)	317	DCE1R7824N	316	DD1D L7230N	355
DB1C 30 (L or R) 10	323	DCE1BD8448S(L/R)	317	DCE1R7830N	316	DD1E 3618N	363
DB1CL 24R	329	DCE1CR24L	319	DCE1R8424N	316	DD1E 3624N	363
DB1CL24L	329	DCE1CR24N	319	DCE1R8430N	316	DD1E 4218N	363
DB1CL24S	329	DCE1CR24R	319	DCE1R9024N	316	DD1E 4224N	363
DB1F18SP	323, 372	DCE1H4818	319	DCE1R9030N	316	DD1O L6036N	355
DB1F18TP	323, 372	DCE1H4818P	319	DCE1R9624N	316	DD1O L6636N	355
DB1F24SP	323, 372	DCE1H6024	319	DCE1R9630N	316	DD1O L7236N	355
DB1F24TP	323, 372	DCE1H6024P	319	DCE1W362430N	320	DD1P (L)3618N	363
DB1F30SP	323, 372	DCE1L3636SSN	317	DCE1W363024N	320	DD1P (L)3624N	363
DB1F30TP	323, 372	DCE1L4242DSN	317	DCE1W422430N	320	DD1P (L)4218N	363
DB1LS15A	331	DCE1L4242SDN	317	DCE1W423024N	320	DD1P (L)4224N	363
DB1LS18A	331	DCE1L4242SSN	317	DCE1W482430N	320	DD1P (L)4818N	363
DB1LS24A	331	DCE1L4260SSN	318	DCE1W483024N	320	DD1P (L)4824N	363
DB1LS30A	331	DCE1L4266SSN	318	DCE1W722430N	320	DD1R CU6	357, 359
DB1LS36A	331	DCE1L4272SSN	318	DCE1W723024N	320	DD1S CU12	359
DB1LSP15	329	DCE1L4278SSN	318	DD1 BPB30	367	DD1S L6024N	355
DB1LSP18	329	DCE1L4848DDN	317	DD1 BPB36	367	DD1S L6030N	355
DB1LSP24	329	DCE1L4848DSN	317	DD1 BPB42	367	DD1S L6624N	355
DB1LSP30	329	DCE1L4848SDN	317	DD1 BPB48	367	DD1S L6630N	355
DB1LSP36	329	DCE1L4848SSN	317	DD1 BPD54	367	DD1S L7224N	355
DB1LSS15	329	DCE1L4860DSN	318	DD1 BPD60	367	DD1S L7230N	355
DB1LSS18	329	DCE1L4860SDN	318	DD1 BPD66	367	DD1TEU24	331
DB1LSS24	329	DCE1L4860SSN	318	DD1 BPD72	367	DD1TEU30	331
DB1LSS30	329	DCE1L4866DSN	318	DD1 BPR36	367	DD1VD 3624 N	359
DB1LSS36	329	DCE1L4866SDN	318	DD1 BPR42	367	DD1VD 4224 N	359
DB1PSP15	329	DCE1L4866SSN	318	DD1 BPR48	367	DD1VD 4824 N	359
DB1PSP18	329	DCE1L4872DSN	318	DD1 BPR60	367	DD1VL 3624 N	359
DB1PSP24	329	DCE1L4872SDN	318	DD1 BPU72	367	DD1VL 4224 N	359
DB1PSP30	329	DCE1L4872SSN	318	DD1 BPV36	359	DD1VL 4824 N	359
DB1PSP36	329	DCE1L4878SSN	318	DD1 BPV42	359	DD2B 3018N	361
DB1PWS24	324	DCE1L4884SSN	318	DD1 BPV48	359	DD2B 3618N	361
DB1PWS30	324	DCE1L6042SSN	318	DD1 DIEU	365	DD2B 3624N	361
DB1PWS36	324	DCE1L6048DSN	318	DD1 EU18	365	DD2B 4218N	361
DB1PWS42	324	DCE1L6048SDN	318	DD1 EU24	365	DD2B 4224N	361
DB1PWS48	324	DCE1L6048SSN	318	DD1 EU30	365	DD2B 4818N	361
DB1PWSL	324	DCE1L6642SSN	318	DD1 FBPB30	369	DD2B 4824N	361
DB1PWSLWH	324	DCE1L6648DSN	318	DD1 FBPB36	369	DD2D L6024N	353
DB1PWSP	324	DCE1L6648SDN	318	DD1 FBPB42	369	DD2D L6030N	353
DB1PWSPWH	324	DCE1L6648SSN	318	DD1 FBPB48	369	DD2D L6624N	353
DB1PWSR	324	DCE1L7242SSN	318	DD1 FBPD54	369	DD2D L6630N	353
DB1PWSRWH	324	DCE1L7248DSN	318	DD1 FBPD60	369	DD2D L7224N	353
DB1RU18	227, 232	DCE1L7248SDN	318	DD1 FBPD66	369	DD2D L7230N	353
DB1S CR	331	DCE1L7248SSN	318	DD1 FBPD72	369	DD2E 3618N	361
DB1SWSL	327	DCE1L7842SSN	318	DD1 FBPR36	369	DD2E 3624N	361
DB1SWSP	327	DCE1L7848SSN	318	DD1 FBPR42	369	DD2E 4218N	361
DB1SWSR	327	DCE1L8448SSN	318	DD1 FBPR48	369	DD2E 4224N	361
DB1TB	331	DCE1R2424N	316	DD1 FBPR60	369	DD2O L6036N	353
DB1U18	227, 232	DCE1R2430N	316	DD1 FBPU72	369	DD2O L6636N	353
DB1WR54	323, 372	DCE1R3024N	316	DD1 FBPV36	359	DD2O L7236N	353
DB1WR60	323, 372	DCE1R3030N	316	DD1 FBPV42	359	DD2OD 36L	267
DB1WR66	323, 372	DCE1R3624N	316	DD1 FBPV48	359	DD2OD 42L	267
DB1WR72	323, 372	DCE1R3630N	316	DD1 IE30	365	DD2OD 48L	267
DB2CL24L	329	DCE1R4224N	316	DD1B 3018N	363	DD2OD 54L	267
DB2CL24LS	329	DCE1R4230N	316	DD1B 3618N	363	DD2OD 60L	267
DB2CL24R	329	DCE1R4824N	316	DD1B 3624N	363	DD2OD 66L	267
DB2CL24RS	329	DCE1R4830N	316	DD1B 4218N	363	DD2OD 72L	267
DBSMLH	327	DCE1R5424N	316	DD1B 4224N	363	DD2P (L)3618N	361
DBSMRH	327	DCE1R5430N	316	DD1B 4818N	363	DD2P (L)3624N	361

<i>pattern no.</i>	<i>page</i>	<i>pattern no.</i>	<i>page</i>	<i>pattern no.</i>	<i>page</i>	<i>pattern no.</i>	<i>page</i>
DD2P (L)4218N	361	DE1(E,8,T) PJ54WP	184, 191, 197	DL3T5E25S	235	DP1AU0774	168
DD2P (L)4224N	361	DE1(E,8,T) PJ60WP	184, 191, 197	DL3T5E37A	235	DP1AU0775	168
DD2P (L)4818N	361	DE1(E,8,T) PJ66WP	184, 191	DL3T5E37S	235	DP1AU0777	117
DD2P (L)4824N	361	DE1(E,8,T) PJ72WP	184, 191	DL3T5E49A	235	DP1AU0778	117
DD2S L6024N	353	DE1(E,8,T) PJ78WP	184, 191	DL3T5E49S	235	DP1AU0783	117
DD2S L6030N	353	DE1(E,8,T) PJ84WP	184, 191	DL3TC	235	DP1AU0784	117
DD2S L6624N	353	DE1(E,8,T) PJ96WP	184	DP 101, 129, 131, 135, 137, 138, 141, 153, 173, 174		DP1AU0789	117
DD2S L6630N	353	DE1(E,8,T) PM24	183	DP1	79	DP1AU0790	117
DD2S L7224N	353	DE1(E,8,T) PM30	183	DP1 CG	147	DP1AU0795	117
DD2S L7230N	353	DE1(E,8,T) PM36	183	DP1 CHB	147	DP1AU0796	117
DD2VD 3624 N	357	DE1(E,8,T) PM42	183	DP1 CHP	147	DP1AU1414	118
DD2VD 4224 N	357	DE1(E,8,T) PM48	183	DP1 TKC	207	DP1AU1415	118
DD2VD 4824 N	357	DE1(E,8,T) PM60	183	DP1 VWG	207	DP1AU1417	118
DD2VL 3624 N	357	DE1(E,8,T) PMS24	183	DP120PC08S	174	DP1AU1418	118
DD2VL 4224 N	357	DE1(E,8,T) PMS30	183	DP120PC14S	174	DP1AU1423	118
DD2VL 4824 N	357	DE1(E,8,T) PMS36	183	DP120PC22S	174	DP1AU1424	118
DD3 PS36	268	DE1(E,8,T) PMS42	183	DP120PC28S	174	DP1AU1429	118
DD3 PS42	268	DE1(E,8,T) PMS48	183	DP120PC36S	174	DP1AU1430	118
DD3 PS48	268	DE1(E,8,T) PMS60	183	DP120PC36SF	174	DP1AU1435	118
DD3 PS54	268	DE1KC	187	DP120PC42S	174	DP1AU1436	118
DD3 PS60	268	DE1T B1NY1	203	DP120PC42SH	174	DP1AU1441	118
DD3 PS66	268	DE1T BI56	203	DP120PC50S	174	DP1AU1442	118
DD3 PS72	268	DE1T BI56(L/R)	199	DP120PC57S	174	DP1AU1447	118
DE1	196, 197	DE1T CI144	199	DP120PC64S	174	DP1AU1448	118
DE1 FDP	191	DE1T RBI56	199	DP120PC78S	174	DP1AU1450	169
DE1 KCBW	75	DE1T RBI56SF	203	DP120PO36	174	DP1AU1451	168
DE18 B1NY1	203	DE2	196	DP120PO42	174	DP1AU1453	118
DE18 BI56	203	DE2PP36S	200	DP120PO50	174	DP1AU1454	118
DE18 BI56(L/R)	199	DE2PP36T	200	DP120PO57	174	DP1AU1456	169
DE18 CI144	199	DE2PP42S	200	DP120PO64	174	DP1AU1457	168
DE18 RBI56	199	DE2PP42T	200	DP120PO78	174	DP1AU1459	118
DE18 RBI56SF	203	DE2PP50S	200	DP120S	174	DP1AU1460	118
DE1DATSHD	207	DE2PP50T	200	DP120SPO 14	173	DP1AU1462	169
DE1DATSHDF	207	DE2PP64S	200	DP120SPO 21	173	DP1AU1463	168
DE1DOR4	187	DE2PP64T	200	DP120SPO 28	173	DP1AU1465	118
DE1DOR5	187	DE2PP78S	200	DP1AU0714	117	DP1AU1466	118
DE1DOR6	187	DE2PP78T	200	DP1AU0715	117	DP1AU1468	169
DE1DR1	187	DE4WSMC	192	DP1AU0717	117	DP1AU1469	168
DE1DR2	187	DE4WSME108	192	DP1AU0718	117	DP1AU1471	118
DE1DR3	187	DE4WSME72	192	DP1AU0723	117	DP1AU1472	118
DE1DR4	187	DE4WSMED108	192	DP1AU0724	117	DP1AU1474	169
DE1DR5	187	DE4WSMED72	192	DP1AU0729	117	DP1AU1475	168
DE1DR6	187	DE6 FDP	191	DP1AU0730	117	DP1AU1477	118
DE1E B1NY1	203	DE6 FDPF	191	DP1AU0735	117	DP1AU1478	118
DE1E BI56	203	DE6 VDR1	190	DP1AU0736	117	DP1AU1483	118
DE1E BI56(L/R)	199	DE6 VDR2	190	DP1AU0741	117	DP1AU1484	118
DE1E CI144	199	DE6 VDR3	190	DP1AU0742	117	DP1AU1489	118
DE1E RBI56	199	DE6 VDR4	190	DP1AU0747	117	DP1AU1490	118
DE1E RBI56SF	203	DE6 VDR5	190	DP1AU0748	117	DP1AU1495	118
DE1(E,8,T) PCNP	183	DE6 VDR6	190	DP1AU0750	168	DP1AU1496	118
DE1(E,8,T) PCWP	183	DE6 VPM	190	DP1AU0751	168	DP1AUECTP	118, 169
DE1(E,8,T) PJ15NP	183	DL3L193M	235	DP1AU0753	117	DP1BCT18	208
DE1(E,8,T) PJ15WP	183	DL3L193W	235	DP1AU0754	117	DP1BCT24	208
DE1(E,8,T) PJ18NP	183	DL3L196M	235	DP1AU0756	168	DP1BCT30	208
DE1(E,8,T) PJ18WP	183	DL3L196W	235	DP1AU0757	168	DP1BCT36	208
DE1(E,8,T) PJ24NP	183	DL3L199M	235	DP1AU0759	117	DP1BCT42	208
DE1(E,8,T) PJ24WP	183	DL3L199W	235	DP1AU0760	117	DP1BCT48	208
DE1(E,8,T) PJ30NP	183	DL3L3712M	235	DP1AU0762	168	DP1BCT60	208
DE1(E,8,T) PJ30WP	183	DL3L3712W	235	DP1AU0763	168	DP1FPRBL	147
DE1(E,8,T) PJ36NP	183	DL3L3718M	235	DP1AU0765	117	DP1FPRBS	147
DE1(E,8,T) PJ36WP	183	DL3L3718W	235	DP1AU0766	117	DP1FPRBT	147
DE1(E,8,T) PJ42NP	183	DL3L376M	235	DP1AU0768	168	DP1FPRBX	147
DE1(E,8,T) PJ42WP	183	DL3L376W	235	DP1AU0769	168	DP1MBT24	85
DE1(E,8,T) PJ48NP	183	DL3T5E19S	235	DP1AU0771	117	DP1MBT30	85
DE1(E,8,T) PJ48WP	183, 191, 197	DL3T5E25A	235	DP1AU0772	117	DP1MBT36	85

<i>pattern no.</i>	<i>page</i>	<i>pattern no.</i>	<i>page</i>	<i>pattern no.</i>	<i>page</i>	<i>pattern no.</i>	<i>page</i>
DP1MBT42	85	DP1SO4218CCF	160	DP1SO6430EPEF	165	DP1SW2130	95
DP1MBT48	85	DP1SO4224	57, 156	DP1SO6436	58, 157	DP1SW2136	95
DP1PRBL	147	DP1SO4224CCF	160	DP1SO6436CCF	161	DP1SW2142	95
DP1PRBS	147	DP1SO4230	57, 156	DP1SO6436EPEF	165	DP1SW2148	95
DP1PRBT	147	DP1SO4230CCF	160	DP1SO6442	58, 157	DP1SW2824	95
DP1PRBX	147	DP1SO4230EPEF	164	DP1SO6442CCF	161	DP1SW2830	95
DP1PRFN15	148	DP1SO4236	57, 156	DP1SO6448	58, 157	DP1SW2836	95
DP1PRFN250	148	DP1SO4236CCF	160	DP1SO6448CCF	161	DP1SW2842	95
DP1PRFN70	148	DP1SO4236EPEF	164	DP1SO6448EPEF	165	DP1SW2848	95
DP1PT3	141	DP1SO4242	57, 156	DP1SO6460	58, 157	DP1WT57	144
DP1PT4	141	DP1SO4242CCF	160	DP1SO6460CCF	161	DP1WT64	144
DP1SO1015	67	DP1SO4248	57, 156	DP1SO715	67	DP1WT71	144
DP1SO1018	67	DP1SO4248CCF	160	DP1SO718	67	DP1WT78	144
DP1SO1024	67	DP1SO4248EPEF	164	DP1SO724	67	DP1WTBTC15	144
DP1SO1030	67	DP1SO4260	57, 156	DP1SO730	67	DP1WTBTC18	144
DP1SO1036	67	DP1SO4260CCF	160	DP1SO736	67	DP1WTBTC24	144
DP1SO1042	67	DP1SO4260EPEF	164	DP1SO742	67	DP1WTBTC30	144
DP1SO1048	67	DP1SO5015	57, 157	DP1SO748	67	DP1WTBTC36	144
DP1SO1060	67	DP1SO5015CCF	161	DP1SO760	67	DP1WTBTC42	144
DP1SO1415	67	DP1SO5018	57, 157	DP1SO7815	58	DP1WTBTC48	144
DP1SO1418	67	DP1SO5018CCF	161	DP1SO7818	58	DP1WTET57	144
DP1SO1424	67	DP1SO5024	57, 157	DP1SO7824	58	DP1WTET64	144
DP1SO1430	67	DP1SO5024CCF	161	DP1SO7830	58	DP1WTET71	144
DP1SO1436	67	DP1SO5030	57, 157	DP1SO7836	58	DP1WTET78	144
DP1SO1442	67	DP1SO5030CCF	161	DP1SO7842	58	DP1WTTC15	144
DP1SO1448	67	DP1SO5030EPEF	165	DP1SO7848	58	DP1WTTC18	144
DP1SO1460	67	DP1SO5036	57, 157	DP1SOS15	69	DP1WTTC24	144
DP1SO2115	68	DP1SO5036CCF	161	DP1SOS18	69	DP1WTTC30	144
DP1SO2118	68	DP1SO5036EPEF	165	DP1SOS24	69	DP1WTTC36	144
DP1SO2124	68	DP1SO5042	57, 157	DP1SOS30	69	DP1WTTC42	144
DP1SO2130	68	DP1SO5042CCF	161	DP1SOS36	69	DP1WTTC48	144
DP1SO2136	68	DP1SO5048	57, 157	DP1SOS42	69	DP1WTTC54	144
DP1SO2142	68	DP1SO5048CCF	161	DP1SOS48	69	DP1WTTC60	144
DP1SO2148	68	DP1SO5048EPEF	165	DP1SOS60	69	DP1WTTC66	144
DP1SO2160	68	DP1SO5060	57, 157	DP1SOWH15	57, 156	DP1WTTC72	144
DP1SO2418	75	DP1SO5060CCF	161	DP1SOWH15CCF	160	DP1WTTC78	144
DP1SO2424	75	DP1SO5060EPEF	165	DP1SOWH18	57, 156	DP1WTTC84	144
DP1SO2430	75	DP1SO5715	58, 157	DP1SOWH18CCF	160	DP1WTTC90	144
DP1SO2436	75	DP1SO5715CCF	161	DP1SOWH24	57, 156	DP1WTTC96	144
DP1SO2442	75	DP1SO5718	58, 157	DP1SOWH24CCF	160	DP1WTTSB	145
DP1SO2448	75	DP1SO5718CCF	161	DP1SOWH30	57, 156	DP2 STFL1418	53
DP1SO2460	75	DP1SO5724	58, 157	DP1SOWH30CCF	160	DP2 STFL1424	53
DP1SO2815	57, 68, 156	DP1SO5724CCF	161	DP1SOWH30EPEF	164	DP2 STFL1430	53
DP1SO2815CCF	160	DP1SO5730	58, 157	DP1SOWH36	57, 156	DP2 STFL1436	53
DP1SO2818	57, 68, 156	DP1SO5730CCF	161	DP1SOWH36CCF	160	DP2 STFL1442	53
DP1SO2818CCF	160	DP1SO5730EPEF	165	DP1SOWH36EPEF	164	DP2 STFL1448	53
DP1SO2824	57, 68, 156	DP1SO5736	58, 157	DP1SOWH42	57, 156	DP2APO36	131
DP1SO2824CCF	160	DP1SO5736CCF	161	DP1SOWH42CCF	160	DP2APO42	131
DP1SO2830	57, 68, 156	DP1SO5736EPEF	165	DP1SOWH48	57, 156	DP2APO50	131
DP1SO2830CCF	160	DP1SO5742	58, 157	DP1SOWH48CCF	160	DP2APO57	131
DP1SO2830EPEF	164	DP1SO5742CCF	161	DP1SOWH48EPEF	164	DP2APO64	131
DP1SO2836	57, 68, 156	DP1SO5748	58, 157	DP1SOWH60	57, 156	DP2APO78	131
DP1SO2836CCF	160	DP1SO5748CCF	161	DP1SOWH60CCF	160	DP2ASPO 14	132
DP1SO2836EPEF	164	DP1SO5748EPEF	165	DP1SOWH60EPEF	164	DP2ASPO 21	132
DP1SO2842	57, 68, 156	DP1SO5760	58, 157	DP1SW0724	95	DP2ASPO 28	132
DP1SO2842CCF	160	DP1SO5760CCF	161	DP1SW0730	95	DP2BC18K	75
DP1SO2848	57, 68, 156	DP1SO5760EPEF	165	DP1SW0736	95	DP2BC24K	75
DP1SO2848CCF	160	DP1SO6415	58, 157	DP1SW0742	95	DP2BC30K	75
DP1SO2848EPEF	164	DP1SO6415CCF	161	DP1SW0748	95	DP2BC36K	75
DP1SO2860	57, 68, 156	DP1SO6418	58, 157	DP1SW1424	95	DP2BC42K	75
DP1SO2860CCF	160	DP1SO6418CCF	161	DP1SW1430	95	DP2BC48K	75
DP1SO2860EPEF	164	DP1SO6424	58, 157	DP1SW1436	95	DP2BC60K	75
DP1SO4215	57, 156	DP1SO6424CCF	161	DP1SW1442	95	DP2CHTP	147
DP1SO4215CCF	160	DP1SO6430	58, 157	DP1SW1448	95	DP2PMS36	141
DP1SO4218	57, 156	DP1SO6430CCF	161	DP1SW2124	95	DP2PMS42	141



<i>pattern no.</i>	<i>page</i>	<i>pattern no.</i>	<i>page</i>	<i>pattern no.</i>	<i>page</i>	<i>pattern no.</i>	<i>page</i>
DP2PMS50	141	DP3L11448	71	DP3L14236EPEF	166	DP3L15784EPEF	167
DP2PMS57	141	DP3L11448F	72	DP3L14236F	62	DP3L1WH15	61, 158
DP2PMS64	141	DP3L12115	71	DP3L14242	61, 158	DP3L1WH15CCF	162
DP2PMS78	141	DP3L12118	71	DP3L14242CCF	162	DP3L1WH15F	62
DP2PRFIC15	148	DP3L12124	71	DP3L14242F	62	DP3L1WH18	61, 158
DP2PRFIC70	148	DP3L12130	71	DP3L14248	61, 158	DP3L1WH18CCF	162
DP2PRFN15	148	DP3L12136	71	DP3L14248CCF	162	DP3L1WH18F	62
DP2PRFN70	148	DP3L12142	71	DP3L14248EPEF	166	DP3L1WH24	61, 158
DP2PRFW15	148	DP3L12148	71	DP3L14248F	62	DP3L1WH24CCF	162
DP2PRFW70	148	DP3L12415	77	DP3L14260EPEF	166	DP3L1WH24F	62
DP2PS	90	DP3L12415F	77	DP3L14272EPEF	166	DP3L1WH30	61, 158
DP2SOS15	69	DP3L12418	77	DP3L14284EPEF	166	DP3L1WH30CCF	162
DP2SOS18	69	DP3L12418F	77	DP3L15015	63, 159	DP3L1WH30EPEF	166
DP2SOS24	69	DP3L12424	77	DP3L15015CCF	163	DP3L1WH30F	62
DP2SOS30	69	DP3L12424F	77	DP3L15015F	64	DP3L1WH36	61, 158
DP2SOS36	69	DP3L12430	77	DP3L15018	63, 159	DP3L1WH36CCF	162
DP2SOS42	69	DP3L12430F	77	DP3L15018CCF	163	DP3L1WH36EPEF	166
DP2SOS48	69	DP3L12436	77	DP3L15018F	64	DP3L1WH36F	62
DP2SOS60	69	DP3L12436F	77	DP3L15024	63, 159	DP3L1WH42	61, 158
DP2SOSC	69	DP3L12442	77	DP3L15024CCF	163	DP3L1WH42CCF	162
DP2STF 2118	53	DP3L12442F	77	DP3L15024F	64	DP3L1WH42F	62
DP2STF 2124	53	DP3L12448	77	DP3L15030	63, 159	DP3L1WH48	61, 158
DP2STF 2130	53	DP3L12448F	77	DP3L15030CCF	163	DP3L1WH48CCF	162
DP2STF 2136	53	DP3L12815	61, 71, 158	DP3L15030EPEF	167	DP3L1WH48EPEF	166
DP2STF 2142	53	DP3L12815CCF	162	DP3L15030F	64	DP3L1WH48F	62
DP2STF 2148	53	DP3L12815F	62, 72	DP3L15036	63, 159	DP3L1WH60EPEF	166
DP2S(T/N)F 1418	53	DP3L12818	61, 71, 158	DP3L15036CCF	163	DP3L1WH72EPEF	166
DP2S(T/N)F 1424	53	DP3L12818CCF	162	DP3L15036EPEF	167	DP3L1WH84EPEF	166
DP2S(T/N)F 1430	53	DP3L12818F	62, 72	DP3L15036F	64	DP3MB	84, 85
DP2S(T/N)F 1436	53	DP3L12824	61, 71, 158	DP3L15042	63, 159	DP3PSB	76, 89, 90
DP2S(T/N)F 1442	53	DP3L12824CCF	162	DP3L15042CCF	163	DP3PWS36	141
DP2S(T/N)F 1448	53	DP3L12824F	62, 72	DP3L15042F	64	DP3PWS42	141
DP2S(T/N)F 2818	53	DP3L12830	61, 71, 158	DP3L15048	63, 159	DP3PWS50	141
DP2S(T/N)F 2824	53	DP3L12830CCF	162	DP3L15048CCF	163	DP3PWS57	141
DP2S(T/N)F 2830	53	DP3L12830EPEF	166	DP3L15048EPEF	167	DP3PWS64	141
DP2S(T/N)F 2836	53	DP3L12830F	62, 72	DP3L15048F	64	DP3PWS78	141
DP2S(T/N)F 2842	53	DP3L12836	61, 71, 158	DP3L15060EPEF	167	DP3SS	76, 87, 88
DP2S(T/N)F 2848	53	DP3L12836CCF	162	DP3L15072EPEF	167	DP6PE08	136
DP3ESB	76, 91, 92	DP3L12836EPEF	166	DP3L15084EPEF	167	DP6PE14	136
DP3L10715	71	DP3L12836F	62, 72	DP3L15715	63, 159	DP6PE22	136
DP3L10718	71	DP3L12842	61, 71, 158	DP3L15715CCF	163	DP6PE28	136
DP3L10724	71	DP3L12842CCF	162	DP3L15715F	64	DP6PE36	136
DP3L10730	71	DP3L12842F	62, 72	DP3L15718	63, 159	DP6PE36F	136
DP3L10736	71	DP3L12848	61, 71, 158	DP3L15718CCF	163	DP6PE42	136
DP3L10742	71	DP3L12848CCF	162	DP3L15718F	64	DP6PE42H	136
DP3L10748	71	DP3L12848EPEF	166	DP3L15724	63, 159	DP6PE50	136
DP3L11015	71	DP3L12848F	62, 72	DP3L15724CCF	163	DP6PE57	136
DP3L11018	71	DP3L12860EPEF	166	DP3L15724F	64	DP6PE64	136
DP3L11024	71	DP3L12872EPEF	166	DP3L15730	63, 159	DP6PE78	136
DP3L11030	71	DP3L12884EPEF	166	DP3L15730CCF	163	DP6PEWH	136
DP3L11036	71	DP3L14215	61, 158	DP3L15730EPEF	167	DP6PEWH36	136
DP3L11042	71	DP3L14215CCF	162	DP3L15730F	64	DP6PEWH42	136
DP3L11048	71	DP3L14215F	62	DP3L15736	63, 159	DP6PEWH50	136
DP3L11415	71	DP3L14218	61, 158	DP3L15736CCF	163	DP6PEWH57	136
DP3L11415F	72	DP3L14218CCF	162	DP3L15736EPEF	167	DP6PEWH64	136
DP3L11418	71	DP3L14218F	62	DP3L15736F	64	DP6PEWH78	136
DP3L11418F	72	DP3L14224	61, 158	DP3L15742	63, 159	DP6PEWHHS14	136
DP3L11424	71	DP3L14224CCF	162	DP3L15742CCF	163	DP6PEWHHS21	136
DP3L11424F	72	DP3L14224F	62	DP3L15742F	64	DP6PEWHHS28	136
DP3L11430	71	DP3L14230	61, 158	DP3L15748	63, 159	DP6TF	97
DP3L11430F	72	DP3L14230CCF	162	DP3L15748CCF	163	DP6TS	98
DP3L11436	71	DP3L14230EPEF	166	DP3L15748EPEF	167	DP7	48, 49, 50
DP3L11436F	72	DP3L14230F	62	DP3L15748F	64	DP71RCT18	208
DP3L11442	71	DP3L14236	61, 158	DP3L15760EPEF	167	DP71RCT24	208
DP3L11442F	72	DP3L14236CCF	162	DP3L15772EPEF	167	DP71RCT30	208

<i>pattern no.</i>	<i>page</i>	<i>pattern no.</i>	<i>page</i>	<i>pattern no.</i>	<i>page</i>	<i>pattern no.</i>	<i>page</i>
DP71RCT36	208	DP7CBBRR5748	42	DP7CMMFRWH24	19	DP7CMMRR4230	15
DP71RCT42	208	DP7CBBRR5760	42	DP7CMMFRWH30	19	DP7CMMRR4236	15
DP71RCT48	208	DP7CBBRR6418	42	DP7CMMFRWH36	19	DP7CMMRR4242	15
DP71RCT60	208	DP7CBBRR6424	42	DP7CMMFRWH42	19	DP7CMMRR4248	15
DP72RCT18	208	DP7CBBRR6430	42	DP7CMMFRWH48	19	DP7CMMRR4260	15
DP72RCT24	208	DP7CBBRR6436	42	DP7CMMFRWH60	19	DP7CMMRR5015	15
DP72RCT30	208	DP7CBBRR6442	42	DP7CMMLL3618	17	DP7CMMRR5018	15
DP72RCT36	208	DP7CBBRR6448	42	DP7CMMLL3624	17	DP7CMMRR5024	15
DP72RCT42	208	DP7CBBRR6460	42	DP7CMMLL3630	17	DP7CMMRR5030	15
DP72RCT48	208	DP7CBBRR7818	42	DP7CMMLL3636	17	DP7CMMRR5036	15
DP72RCT60	208	DP7CBBRR7824	42	DP7CMMLL3642	17	DP7CMMRR5042	15
DP7BF	124	DP7CBBRR7830	42	DP7CMMLL3648	17	DP7CMMRR5048	15
DP7CBBFR4218	43	DP7CBBRR7836	42	DP7CMMLL3660	17	DP7CMMRR5060	15
DP7CBBFR4224	43	DP7CBBRR7842	42	DP7CMMLL4218	17	DP7CMMRR5715	16
DP7CBBFR4230	43	DP7CBBRR7848	42	DP7CMMLL4224	17	DP7CMMRR5718	16
DP7CBBFR4236	43	DP7CERK	203	DP7CMMLL4230	17	DP7CMMRR5724	16
DP7CBBFR4242	43	DP7CMMFR3615	19	DP7CMMLL4236	17	DP7CMMRR5730	16
DP7CBBFR4248	43	DP7CMMFR3618	19	DP7CMMLL4242	17	DP7CMMRR5736	16
DP7CBBFR4260	43	DP7CMMFR3624	19	DP7CMMLL4248	17	DP7CMMRR5742	16
DP7CBBFR5018	43	DP7CMMFR3630	19	DP7CMMLL4260	17	DP7CMMRR5748	16
DP7CBBFR5024	43	DP7CMMFR3636	19	DP7CMMLL5018	17	DP7CMMRR5760	16
DP7CBBFR5030	43	DP7CMMFR3642	19	DP7CMMLL5024	17	DP7CMMRR6415	16
DP7CBBFR5036	43	DP7CMMFR3648	19	DP7CMMLL5030	17	DP7CMMRR6418	16
DP7CBBFR5042	43	DP7CMMFR3660	19	DP7CMMLL5036	17	DP7CMMRR6424	16
DP7CBBFR5048	43	DP7CMMFR4215	19	DP7CMMLL5042	17	DP7CMMRR6430	16
DP7CBBFR5060	43	DP7CMMFR4218	19	DP7CMMLL5048	17	DP7CMMRR6436	16
DP7CBBFR5718	44	DP7CMMFR4224	19	DP7CMMLL5060	17	DP7CMMRR6442	16
DP7CBBFR5724	44	DP7CMMFR4230	19	DP7CMMLL5718	18	DP7CMMRR6448	16
DP7CBBFR5730	44	DP7CMMFR4236	19	DP7CMMLL5724	18	DP7CMMRR6460	16
DP7CBBFR5736	44	DP7CMMFR4242	19	DP7CMMLL5730	18	DP7CMMRR7815	16
DP7CBBFR5742	44	DP7CMMFR4248	19	DP7CMMLL5736	18	DP7CMMRR7818	16
DP7CBBFR5748	44	DP7CMMFR4260	19	DP7CMMLL5742	18	DP7CMMRR7824	16
DP7CBBFR5760	44	DP7CMMFR5015	20	DP7CMMLL5748	18	DP7CMMRR7830	16
DP7CBBFR6418	44	DP7CMMFR5018	20	DP7CMMLL5760	18	DP7CMMRR7836	16
DP7CBBFR6424	44	DP7CMMFR5024	20	DP7CMMLL6418	18	DP7CMMRR7842	16
DP7CBBFR6430	44	DP7CMMFR5030	20	DP7CMMLL6424	18	DP7CMMRR7848	16
DP7CBBFR6436	44	DP7CMMFR5036	20	DP7CMMLL6430	18	DP7CMMRRWH15	15
DP7CBBFR6442	44	DP7CMMFR5042	20	DP7CMMLL6436	18	DP7CMMRRWH18	15
DP7CBBFR6448	44	DP7CMMFR5048	20	DP7CMMLL6442	18	DP7CMMRRWH24	15
DP7CBBFR6460	44	DP7CMMFR5060	20	DP7CMMLL6448	18	DP7CMMRRWH30	15
DP7CBBFR7818	45	DP7CMMFR5715	20	DP7CMMLL6460	18	DP7CMMRRWH36	15
DP7CBBFR7824	45	DP7CMMFR5718	20	DP7CMMLL7818	18	DP7CMMRRWH42	15
DP7CBBFR7830	45	DP7CMMFR5724	20	DP7CMMLL7824	18	DP7CMMRRWH48	15
DP7CBBFR7836	45	DP7CMMFR5730	20	DP7CMMLL7830	18	DP7CMMRRWH60	15
DP7CBBFR7842	45	DP7CMMFR5736	20	DP7CMMLL7836	18	DP7CPPFR4215	37
DP7CBBFR7848	45	DP7CMMFR5742	20	DP7CMMLL7842	18	DP7CPPFR4218	37
DP7CBBRR4218	41	DP7CMMFR5748	20	DP7CMMLL7848	18	DP7CPPFR4224	37
DP7CBBRR4224	41	DP7CMMFR5760	20	DP7CMMLLWH18	17	DP7CPPFR4230	37
DP7CBBRR4230	41	DP7CMMFR6415	20	DP7CMMLLWH24	17	DP7CPPFR4236	37
DP7CBBRR4236	41	DP7CMMFR6418	20	DP7CMMLLWH30	17	DP7CPPFR4242	37
DP7CBBRR4242	41	DP7CMMFR6424	20	DP7CMMLLWH36	17	DP7CPPFR4248	37
DP7CBBRR4248	41	DP7CMMFR6430	20	DP7CMMLLWH42	17	DP7CPPFR4260	37
DP7CBBRR4260	41	DP7CMMFR6436	20	DP7CMMLLWH48	17	DP7CPPFR5015	37
DP7CBBRR5018	41	DP7CMMFR6442	20	DP7CMMLLWH60	17	DP7CPPFR5018	37
DP7CBBRR5024	41	DP7CMMFR6448	20	DP7CMMRR3615	15	DP7CPPFR5024	37
DP7CBBRR5030	41	DP7CMMFR6460	20	DP7CMMRR3618	15	DP7CPPFR5030	37
DP7CBBRR5036	41	DP7CMMFR7815	21	DP7CMMRR3624	15	DP7CPPFR5036	37
DP7CBBRR5042	41	DP7CMMFR7818	21	DP7CMMRR3630	15	DP7CPPFR5042	37
DP7CBBRR5048	41	DP7CMMFR7824	21	DP7CMMRR3636	15	DP7CPPFR5048	37
DP7CBBRR5060	41	DP7CMMFR7830	21	DP7CMMRR3642	15	DP7CPPFR5060	37
DP7CBBRR5718	42	DP7CMMFR7836	21	DP7CMMRR3648	15	DP7CPPFR5715	38
DP7CBBRR5724	42	DP7CMMFR7842	21	DP7CMMRR3660	15	DP7CPPFR5718	38
DP7CBBRR5730	42	DP7CMMFR7848	21	DP7CMMRR4215	15	DP7CPPFR5724	38
DP7CBBRR5736	42	DP7CMMFRWH15	19	DP7CMMRR4218	15	DP7CPPFR5730	38
DP7CBBRR5742	42	DP7CMMFRWH18	19	DP7CMMRR4224	15	DP7CPPFR5736	38

<i>pattern no.</i>	<i>page</i>	<i>pattern no.</i>	<i>page</i>	<i>pattern no.</i>	<i>page</i>	<i>pattern no.</i>	<i>page</i>
DP7CPPFR5742	38	DP7CPPRR5042	31	DP7CTTFR6460	30	DP7CTTRR5015	24
DP7CPPFR5748	38	DP7CPPRR5048	31	DP7CTTFR7815	30	DP7CTTRR5018	24
DP7CPPFR5760	38	DP7CPPRR5060	31	DP7CTTFR7818	30	DP7CTTRR5024	24
DP7CPPFR6415	38	DP7CPPRR5715	32	DP7CTTFR7824	30	DP7CTTRR5030	24
DP7CPPFR6418	38	DP7CPPRR5718	32	DP7CTTFR7830	30	DP7CTTRR5036	24
DP7CPPFR6424	38	DP7CPPRR5724	32	DP7CTTFR7836	30	DP7CTTRR5042	24
DP7CPPFR6430	38	DP7CPPRR5730	32	DP7CTTFR7842	30	DP7CTTRR5048	24
DP7CPPFR6436	38	DP7CPPRR5736	32	DP7CTTFR7848	30	DP7CTTRR5060	24
DP7CPPFR6442	38	DP7CPPRR5742	32	DP7CTTLL3618	26	DP7CTTRR5715	25
DP7CPPFR6448	38	DP7CPPRR5748	32	DP7CTTLL3624	26	DP7CTTRR5718	25
DP7CPPFR6460	38	DP7CPPRR5760	32	DP7CTTLL3630	26	DP7CTTRR5724	25
DP7CPPFR7815	39	DP7CPPRR6415	32	DP7CTTLL3636	26	DP7CTTRR5730	25
DP7CPPFR7818	39	DP7CPPRR6418	32	DP7CTTLL3642	26	DP7CTTRR5736	25
DP7CPPFR7824	39	DP7CPPRR6424	32	DP7CTTLL3648	26	DP7CTTRR5742	25
DP7CPPFR7830	39	DP7CPPRR6430	32	DP7CTTLL3660	26	DP7CTTRR5748	25
DP7CPPFR7836	39	DP7CPPRR6436	32	DP7CTTLL4218	26	DP7CTTRR5760	25
DP7CPPFR7842	39	DP7CPPRR6442	32	DP7CTTLL4224	26	DP7CTTRR6415	25
DP7CPPFR7848	39	DP7CPPRR6448	32	DP7CTTLL4230	26	DP7CTTRR6418	25
DP7CPPLL4218	34	DP7CPPRR6460	32	DP7CTTLL4236	26	DP7CTTRR6424	25
DP7CPPLL4224	34	DP7CPPRR7815	33	DP7CTTLL4242	26	DP7CTTRR6430	25
DP7CPPLL4230	34	DP7CPPRR7818	33	DP7CTTLL4248	26	DP7CTTRR6436	25
DP7CPPLL4236	34	DP7CPPRR7824	33	DP7CTTLL4260	26	DP7CTTRR6442	25
DP7CPPLL4242	34	DP7CPPRR7830	33	DP7CTTLL5018	26	DP7CTTRR6448	25
DP7CPPLL4248	34	DP7CPPRR7836	33	DP7CTTLL5024	26	DP7CTTRR6460	25
DP7CPPLL4260	34	DP7CPPRR7842	33	DP7CTTLL5030	26	DP7CTTRR7815	25
DP7CPPLL5018	34	DP7CPPRR7848	33	DP7CTTLL5036	26	DP7CTTRR7818	25
DP7CPPLL5024	34	DP7CTTFR3615	28	DP7CTTLL5042	26	DP7CTTRR7824	25
DP7CPPLL5030	34	DP7CTTFR3618	28	DP7CTTLL5048	26	DP7CTTRR7830	25
DP7CPPLL5036	34	DP7CTTFR3624	28	DP7CTTLL5060	26	DP7CTTRR7836	25
DP7CPPLL5042	34	DP7CTTFR3630	28	DP7CTTLL5718	27	DP7CTTRR7842	25
DP7CPPLL5048	34	DP7CTTFR3636	28	DP7CTTLL5724	27	DP7CTTRR7848	25
DP7CPPLL5060	34	DP7CTTFR3642	28	DP7CTTLL5730	27	DP7HIRKD24	204
DP7CPPLL5718	35	DP7CTTFR3648	28	DP7CTTLL5736	27	DP7HIRKD30	204
DP7CPPLL5724	35	DP7CTTFR3660	28	DP7CTTLL5742	27	DP7HIRKD36	204
DP7CPPLL5730	35	DP7CTTFR4215	28	DP7CTTLL5748	27	DP7HIRKD42	204
DP7CPPLL5736	35	DP7CTTFR4218	28	DP7CTTLL5760	27	DP7HIRKD48	204
DP7CPPLL5742	35	DP7CTTFR4224	28	DP7CTTLL6418	27	DP7HIRKD60	204
DP7CPPLL5748	35	DP7CTTFR4230	28	DP7CTTLL6424	27	DP7HIRKS24	204
DP7CPPLL5760	35	DP7CTTFR4236	28	DP7CTTLL6430	27	DP7HIRKS30	204
DP7CPPLL6418	35	DP7CTTFR4242	28	DP7CTTLL6436	27	DP7HIRKS36	204
DP7CPPLL6424	35	DP7CTTFR4248	28	DP7CTTLL6442	27	DP7HIRKS42	204
DP7CPPLL6430	35	DP7CTTFR4260	28	DP7CTTLL6448	27	DP7HIRKS48	204
DP7CPPLL6436	35	DP7CTTFR5015	29	DP7CTTLL6460	27	DP7HIRKS60	204
DP7CPPLL6442	35	DP7CTTFR5018	29	DP7CTTLL7818	27	DP7HLCWH	124
DP7CPPLL6448	35	DP7CTTFR5024	29	DP7CTTLL7824	27	DP7HRRKD24	204
DP7CPPLL6460	35	DP7CTTFR5030	29	DP7CTTLL7830	27	DP7HRRKD30	204
DP7CPPLL7818	36	DP7CTTFR5036	29	DP7CTTLL7836	27	DP7HRRKD36	204
DP7CPPLL7824	36	DP7CTTFR5042	29	DP7CTTLL7842	27	DP7HRRKD42	204
DP7CPPLL7830	36	DP7CTTFR5048	29	DP7CTTLL7848	27	DP7HRRKD48	204
DP7CPPLL7836	36	DP7CTTFR5060	29	DP7CTTRR3615	24	DP7HRRKD60	204
DP7CPPLL7842	36	DP7CTTFR5715	29	DP7CTTRR3618	24	DP7HRRKS24	204
DP7CPPLL7848	36	DP7CTTFR5718	29	DP7CTTRR3624	24	DP7HRRKS30	204
DP7CPPRR4215	31	DP7CTTFR5724	29	DP7CTTRR3630	24	DP7HRRKS36	204
DP7CPPRR4218	31	DP7CTTFR5730	29	DP7CTTRR3636	24	DP7HRRKS42	204
DP7CPPRR4224	31	DP7CTTFR5736	29	DP7CTTRR3642	24	DP7HRRKS48	204
DP7CPPRR4230	31	DP7CTTFR5742	29	DP7CTTRR3648	24	DP7HRRKS60	204
DP7CPPRR4236	31	DP7CTTFR5748	29	DP7CTTRR3660	24	DP7PA362	121
DP7CPPRR4242	31	DP7CTTFR5760	29	DP7CTTRR4215	24	DP7PA363	121
DP7CPPRR4248	31	DP7CTTFR6415	30	DP7CTTRR4218	24	DP7PA364	121
DP7CPPRR4260	31	DP7CTTFR6418	30	DP7CTTRR4224	24	DP7PA422	121
DP7CPPRR5015	31	DP7CTTFR6424	30	DP7CTTRR4230	24	DP7PA423	121
DP7CPPRR5018	31	DP7CTTFR6430	30	DP7CTTRR4236	24	DP7PA424	121
DP7CPPRR5024	31	DP7CTTFR6436	30	DP7CTTRR4242	24	DP7PA502	121
DP7CPPRR5030	31	DP7CTTFR6442	30	DP7CTTRR4248	24	DP7PA503	121
DP7CPPRR5036	31	DP7CTTFR6448	30	DP7CTTRR4260	24	DP7PA504	121

<i>pattern no.</i>	<i>page</i>	<i>pattern no.</i>	<i>page</i>	<i>pattern no.</i>	<i>page</i>	<i>pattern no.</i>	<i>page</i>
DP7PA572	121	DP7POWHCPF	152	DPRD1JPM	101	DS1PM L18B	237
DP7PA573	121	DP7PP36S	200	DPS7V1418	54	DS1PM L18F	237
DP7PA574	121	DP7PP36T	200	DPS7V1424	54	DS1PM L24A	237
DP7PA642	121	DP7PP42S	200	DPS7V1430	54	DS1PM L24B	237
DP7PA643	121	DP7PP42T	200	DPS7V1436	54	DS1PM L24F	237
DP7PA644	121	DP7PP50S	200	DPS7V1442	54	DS1PST	243, 371
DP7PA782	121	DP7PP50T	200	DPS7V1448	54	DS1S 24	229
DP7PA783	121	DP7PP57S	200	DPS7V2118	54	DS1S 30	229
DP7PA784	121	DP7PP57T	200	DPS7V2124	54	DS1S 36	229
DP7PAWH2	121	DP7PP64S	200	DPS7V2130	54	DS1S 42	229
DP7PAWH3	121	DP7PP64T	200	DPS7V2136	54	DS1S 48	229
DP7PAWH4	121	DP7PP78S	200	DPS7V2142	54	DS1S 54	229
DP7PC07	125	DP7PP78T	200	DPS7V2148	54	DS1S 60	229
DP7PC07UH	126	DP7PT1	124	DPS7V2818	54	DS1S 66	229
DP7PC14	125, 126	DP7PT2	124	DPS7V2824	54	DS1S 72	229
DP7PC14UH	126	DP7PT3	124	DPS7V2830	54	DS1SWM 30	231
DP7PC21	125	DP7PT4	124	DPS7V2836	54	DS1SWM 36	231
DP7PC21UH	126	DP7PTCP	152	DPS7V2842	54	DS1SWM 42	231
DP7PC28	125	DP7PTCPH	152	DPS7V2848	54	DS1SWM 48	231
DP7PC28UH	126	DP7PTS	124	DS1 OHL	232	DS1WM 24	231
DP7PC36	125	DP7RCCH24	204	DS1 VD	232, 267	DS1WM 30	231
DP7PC362	125	DP7RCCH30	204	DS1BS 24	231	DS1WM 36	231
DP7PC36U	126	DP7RCCH36	204	DS1BS 30	231	DS1WM 42	231
DP7PC36UH	126	DP7RCCH42	204	DS1BS 36	231	DS1WM 48	231
DP7PC42	125	DP7RCCH48	204	DS1BS 42	231	DS2DW 30L	240
DP7PC422	125	DP7RCCH60	204	DS1BS 48	231	DS2DW 36L	240
DP7PC42U	126	DP7S	106, 107, 108, 109	DS1BS 54	231	DS2DWDPL30	243
DP7PC50	125	DP7SPO14	124	DS1BS 60	231	DS2DWDPL36	243
DP7PC502	125	DP7SPO21	124	DS1BS 66	231	DS2LKKT	243
DP7PC50U	126	DP7SPO28	124	DS1BS 72	231	DS2OD 36L	267
DP7PC57	125	DP7SS	112, 113, 114, 115	DS1CS 36	229	DS2OD 42L	267
DP7PC572	125	DP7SSWT1424	111	DS1CS 42	229	DS2OD 48L	267
DP7PC57U	126	DP7SSWT1430	111	DS1CS 48	229	DS2OD 54L	267
DP7PC64	125	DP7SSWT1436	111	DS1DW 30L	237	DS2OD 60L	267
DP7PC642	125	DP7SSWT1442	111	DS1DWDPL	243	DS2OD 66L	267
DP7PC64U	126	DP7SSWT1448	111	DS1E30L	227	DS2OD 72L	267
DP7PC78	125	DP7SSWT2124	111	DS1E36L	227	DS2PF L18A	239
DP7PC782	125	DP7SSWT2130	111	DS1E42L	227	DS2PF L18B	239
DP7PC78U	126	DP7SSWT2136	111	DS1E48L	227	DS2PF L24A	239
DP7PCWH	125	DP7SSWT2142	111	DS1E54L	227	DS2PF L24B	239
DP7PCWH2	125	DP7SSWT2148	111	DS1E60L	227	DS2PF L30A	239
DP7PCWH42	125	DP7SSWT2824	111	DS1E66L	227	DS2PF L30B	239
DP7PCWH50	125	DP7SSWT2830	111	DS1E72L	227	DS2PM L18A	239
DP7PCWH57	125	DP7SSWT2836	111	DS1EAKIT	211	DS2PM L18B	239
DP7PCWH64	125	DP7SSWT2842	111	DS1LKKT	243	DS2PM L18F	239
DP7PCWH78	125	DP7SSWT2848	111	DS1O24L	211	DS2PM L24A	239
DP7PCWHS14	125	DP7SWT	104, 105	DS1O30L	211	DS2PM L24B	239
DP7PCWHS142	125	DP7SWTFK24	105	DS1O36L	211	DS2PM L24F	239
DP7PCWHS21	125	DP7SWTFK30	105	DS1O42L	211	DS2PM24L	211
DP7PCWHS212	125	DP7SWTFK36	105	DS1O48L	211	DS2PM30L	211
DP7PCWHS28	125	DP7SWTFK42	105	DS1O54L	211	DS2PM36L	211
DP7PCWHS282	125	DP7SWTFK48	105	DS1O60L	211	DS2PM42L	211
DP7PCWHU	126	DP7SWTFKD	105	DS1O66L	211	DS2PM48L	211
DP7PO36	124	DPRD15736(L/R)L	101	DS1O72L	211	DS2PM54L	211
DP7PO36CPF	152	DPRD15736(L/R)N	101	DS1PBD	243, 371	DS2PM60L	211
DP7PO42	124	DPRD15742(L/R)L	101	DS1PCD	243, 371	DS2PM66L	211
DP7PO42CPF	152	DPRD15742(L/R)N	101	DS1PF L18A	237	DS2PM72L	211
DP7PO50	124	DPRD16436(L/R)L	101	DS1PF L18B	237	DS2PPTC	243, 371
DP7PO50CPF	152	DPRD16436(L/R)N	101	DS1PF L24A	237	DS2PPTN	243, 371
DP7PO57	124	DPRD16442(L/R)L	101	DS1PF L24B	237	DS2UM30L	227
DP7PO57CPF	152	DPRD16442(L/R)N	101	DS1PF L30A	237	DS2UM36L	227
DP7PO64	124	DPRD17836(L/R)L	101	DS1PF L30B	237	DS2UM42L	227
DP7PO64CPF	152	DPRD17836(L/R)N	101	DS1PFD	243, 371	DS2UM48L	227
DP7PO78	124	DPRD17842(L/R)L	101	DS1PFS	243, 371	DS2UM54L	227
DP7POWH	124	DPRD17842(L/R)N	101	DS1PM L18A	237	DS2UM60L	227

<i>pattern no.</i>	<i>page</i>	<i>pattern no.</i>	<i>page</i>	<i>pattern no.</i>	<i>page</i>	<i>pattern no.</i>	<i>page</i>
DS2UM66L	227	DS3ODSL1574814LT	279	DS3ODSS1643014LT	284	DS3ODSV1646014LT	285
DS2UM72L	227	DS3ODSL1576014L	271	DS3ODSS1643614L	274	DS3ODSV1646614L	275
DS2XPB	239	DS3ODSL1576014LT	279	DS3ODSS1643614LT	284	DS3ODSV1646614LT	285
DS3CMN3614	223	DS3ODSL1576614L	271	DS3ODSS1644214L	274	DS3ODSV1647214L	275
DS3CMN4214	223	DS3ODSL1576614LT	279	DS3ODSS1644214LT	284	DS3ODSV1647214LT	285
DS3CMN4814	223	DS3ODSL1577214L	271	DS3ODSS1644814L	274	DS3ODSV2573021FL	272
DS3CMN6014	223	DS3ODSL1577214LT	279	DS3ODSS1644814LT	284	DS3ODSV2573021FLT	282
DS3CMN7214	223	DS3ODSL1643014L	274	DS3ODSS1646014L	274	DS3ODSV2573621FL	272
DS3CMSL3614L	224	DS3ODSL1643014LT	284	DS3ODSS1646014LT	284	DS3ODSV2573621FLT	282
DS3CMSL4214L	224	DS3ODSL1643614L	274	DS3ODSS1646614L	274	DS3ODSV2574221FL	272
DS3CMSL4814L	224	DS3ODSL1643614LT	284	DS3ODSS1646614LT	284	DS3ODSV2574221FLT	282
DS3CMSL6014L	224	DS3ODSL1644214L	274	DS3ODSS1647214L	274	DS3ODSV2574821FL	272
DS3CMSL7214L	224	DS3ODSL1644214LT	284	DS3ODSS1647214LT	284	DS3ODSV2574821FLT	282
DS3CMSS3614L	224	DS3ODSL1644814L	274	DS3ODSS2573021FL	272	DS3ODSV2576021FL	272
DS3CMSS4214L	223	DS3ODSL1644814LT	284	DS3ODSS2573021FLT	281	DS3ODSV2576021FLT	282
DS3CMSS4814L	223	DS3ODSL1646014L	274	DS3ODSS2573621FL	272	DS3ODSV2576621FL	272
DS3CMSS6014L	223	DS3ODSL1646014LT	284	DS3ODSS2573621FLT	281	DS3ODSV2576621FLT	282
DS3CMSS7214L	223	DS3ODSL1646614L	274	DS3ODSS2574221FL	272	DS3ODSV2577221FL	272
DS3CMSS7214L	223	DS3ODSL1646614LT	284	DS3ODSS2574221FLT	281	DS3ODSV2577221FLT	282
DS3CMSV3614L	225	DS3ODSL1647214L	274	DS3ODSS2574821FL	272	DS3ODSV2643021FL	277
DS3CMSV4214L	225	DS3ODSL1647214LT	284	DS3ODSS2574821FLT	281	DS3ODSV2643021FLT	287
DS3CMSV4814L	225	DS3ODSL2573021FL	272	DS3ODSS2576021FL	272	DS3ODSV2643621FL	277
DS3CMSV6014L	225	DS3ODSL2573021FLT	281	DS3ODSS2576021FLT	281	DS3ODSV2643621FLT	287
DS3CMSV7214L	225	DS3ODSL2573621FL	272	DS3ODSS2576621FL	272	DS3ODSV2644221FL	277
DS3CMTS3614L	223	DS3ODSL2573621FLT	281	DS3ODSS2576621FLT	281	DS3ODSV2644221FLT	287
DS3CMTS4214L	223	DS3ODSL2574221FL	272	DS3ODSS2577221FL	272	DS3ODSV2644821FL	277
DS3CMTS4814L	223	DS3ODSL2574221FLT	281	DS3ODSS2577221FLT	281	DS3ODSV2644821FLT	287
DS3CMTS6014L	223	DS3ODSL2574821FL	272	DS3ODSS2643021FL	276	DS3ODSV2646021FL	277
DS3CMTS7214L	223	DS3ODSL2574821FLT	281	DS3ODSS2643021FLT	286	DS3ODSV2646021FLT	287
DS3ODNS	272, 276, 281, 286	DS3ODSL2576021FL	272	DS3ODSS2643621FL	276	DS3ODSV2646621FL	277
DS3ODNS1573014	271	DS3ODSL2576021FLT	281	DS3ODSS2646621FL	276	DS3ODSV2646621FLT	287
DS3ODNS1573014T	279	DS3ODSL2576621FL	272	DS3ODSS2644221FL	276	DS3ODSV2647221FL	277
DS3ODNS1573614	271	DS3ODSL2576621FLT	281	DS3ODSS2644221FLT	286	DS3ODSV2647221FLT	287
DS3ODNS1573614T	279	DS3ODSL2577221FL	272	DS3ODSS2644821FL	276	DS3PML30L	212
DS3ODNS1574214	271	DS3ODSL2577221FLT	281	DS3ODSS2644821FLT	286	DS3PML36L	212
DS3ODNS1574214T	279	DS3ODSL2643021FL	276	DS3ODSS2646021FL	276	DS3PML42L	212
DS3ODNS1574814	271	DS3ODSL2643021FLT	286	DS3ODSS2646021FLT	286	DS3PML48L	212
DS3ODNS1574814T	279	DS3ODSL2643621FL	276	DS3ODSS2646621FL	276	DS3PML60L	212
DS3ODNS1576014	271	DS3ODSL2643621FLT	286	DS3ODSS2646621FLT	286	DS3PML66L	212
DS3ODNS1576014T	279	DS3ODSL2644221FL	276	DS3ODSS2647221FL	276	DS3PML72L	212
DS3ODNS1576614	271	DS3ODSL2644221FLT	286	DS3ODSS2647221FLT	286	DS3PMNS3014	215
DS3ODNS1576614T	279	DS3ODSL2644821FL	276	DS3ODSV	273, 278, 283, 288	DS3PMNS3021	217
DS3ODNS1577214	271	DS3ODSL2644821FLT	286	DS3ODSV1573014L	271	DS3PMNS3614	215
DS3ODNS1577214T	279	DS3ODSL2646021FL	276	DS3ODSV1573014LT	280	DS3PMNS3621	217
DS3ODNS1643014	274	DS3ODSL2646021FLT	286	DS3ODSV1573614L	271	DS3PMNS4214	215
DS3ODNS1643014T	284	DS3ODSL2646621FL	276	DS3ODSV1573614LT	280	DS3PMNS4221	217
DS3ODNS1643614	274	DS3ODSL2646621FLT	286	DS3ODSV1574214L	271	DS3PMNS4814	215
DS3ODNS1643614T	284	DS3ODSL2647221FL	276	DS3ODSV1574214LT	280	DS3PMNS4821	217
DS3ODNS1644214	274	DS3ODSL2647221FLT	286	DS3ODSV1574814L	271	DS3PMNS6014	215
DS3ODNS1644214T	284	DS3ODSS	273, 278, 283, 288	DS3ODSV1574814LT	280	DS3PMNS6021	217
DS3ODNS1644814	274	DS3ODSS1573014L	271	DS3ODSV1576014L	271	DS3PMNS6614	215
DS3ODNS1644814T	284	DS3ODSS1573014LT	279	DS3ODSV1576014LT	280	DS3PMNS6621	217
DS3ODNS1646014	274	DS3ODSS1573614L	271	DS3ODSV1576614L	271	DS3PMNS7214	215
DS3ODNS1646014T	284	DS3ODSS1573614LT	279	DS3ODSV1576614LT	280	DS3PMNS7221	217
DS3ODNS1646614	274	DS3ODSS1574214L	271	DS3ODSV1577214L	271	DS3PMS30L	211
DS3ODNS1646614T	284	DS3ODSS1574214LT	279	DS3ODSV1577214LT	280	DS3PMS36L	211
DS3ODNS1647214	274	DS3ODSS1574814L	271	DS3ODSV1643014L	275	DS3PMS42L	211
DS3ODNS1647214T	284	DS3ODSS1574814LT	279	DS3ODSV1643014LT	285	DS3PMS48L	211
DS3ODSL	273, 278, 283, 288	DS3ODSS1576014L	271	DS3ODSV1643614L	275	DS3PMS60L	211
DS3ODSL1573014L	271	DS3ODSS1576014LT	279	DS3ODSV1643614LT	285	DS3PMS66L	211
DS3ODSL1573014LT	279	DS3ODSS1576614L	271	DS3ODSV1644214L	275	DS3PMS72L	211
DS3ODSL1573614L	271	DS3ODSS1576614LT	279	DS3ODSV1644814L	285	DS3PMSL3014L	215
DS3ODSL1573614LT	279	DS3ODSS1577214L	271	DS3ODSV1644814LT	275	DS3PMSL3021FL	217
DS3ODSL1574214L	271	DS3ODSS1577214LT	279	DS3ODSV1644814LT	285	DS3PMSL3021PL	218
DS3ODSL1574214LT	279	DS3ODSS1643014L	274	DS3ODSV1646014L	275	DS3PMSL3614L	215
DS3ODSL1574814L	271						

<i>pattern no.</i>	<i>page</i>	<i>pattern no.</i>	<i>page</i>	<i>pattern no.</i>	<i>page</i>	<i>pattern no.</i>	<i>page</i>
DS3PMSL3621FL	217	DS3PMV36L	212	DS4LC1ANS42N	245	DS4LC1BVL66L	249
DS3PMSL3621PL	218	DS3PMV42L	212	DS4LC1ANS48N	245	DS4LC1BVL72L	249
DS3PMSL4214L	215	DS3PMV48L	212	DS4LC1ANS54N	245	DS4LC1BVS42L	245
DS3PMSL4221FL	217	DS3PMV60L	212	DS4LC1ANS60N	245	DS4LC1BVS48L	245
DS3PMSL4221PL	218	DS3PMV66L	212	DS4LC1ANS66N	245	DS4LC1BVS54L	245
DS3PMSL4814L	215	DS3PMV72L	212	DS4LC1ANS72N	245	DS4LC1BVS60L	245
DS3PMSL4821FL	217	DS3SMN3614	221	DS4LC1ANV24N	252	DS4LC1BVS66L	245
DS3PMSL4821PL	218	DS3SMN4214	221	DS4LC1ANV30N	252	DS4LC1BVS72L	245
DS3PMSL6014L	215	DS3SMN4814	221	DS4LC1ANV36N	252	DS4LC1BVV30L	253
DS3PMSL6021FL	217	DS3SMN6014	221	DS4LC1ANV42N	252	DS4LC1BVV36L	253
DS3PMSL6021PL	218	DS3SMN7214	221	DS4LC1ANV48N	252	DS4LC1BVV42L	253
DS3PMSL6614L	215	DS3SMSL3614L	221	DS4LC1ANV54N	252	DS4LC1BVV48L	253
DS3PMSL6621FL	217	DS3SMSL4214L	221	DS4LC1ANV60N	252	DS4LC1BVV54L	253
DS3PMSL6621PL	218	DS3SMSL4814L	221	DS4LC1ANV66N	252	DS4LC1BVV60L	253
DS3PMSL7214L	215	DS3SMSL6014L	221	DS4LC1ANV72N	252	DS4LC1BVV66L	253
DS3PMSL7221FL	217	DS3SMSL7214L	221	DS4LC1BLL30L	248	DS4LC1BVV72L	253
DS3PMSL7221PL	218	DS3SMSS3614L	221	DS4LC1BLL36L	248	DS4LC1CLL30L	250
DS3PMSS3014L	215	DS3SMSS4214L	221	DS4LC1BLL42L	248	DS4LC1CLL36L	250
DS3PMSS3021FL	217	DS3SMSS4814L	221	DS4LC1BLL48L	248	DS4LC1CLL42L	250
DS3PMSS3021PL	218	DS3SMSS6014L	221	DS4LC1BLL54L	248	DS4LC1CLL48L	250
DS3PMSS3614L	215	DS3SMSS7214L	221	DS4LC1BLL60L	248	DS4LC1CLL54L	250
DS3PMSS3621FL	217	DS3SMSV3614L	222	DS4LC1BLL66L	248	DS4LC1CLL60L	250
DS3PMSS3621PL	218	DS3SMSV4214L	222	DS4LC1BLL72L	248	DS4LC1CLL66L	250
DS3PMSS4214L	215	DS3SMSV4814L	222	DS4LC1BLS42L	245	DS4LC1CLL72L	250
DS3PMSS4221FL	217	DS3SMSV6014L	222	DS4LC1BLS48L	245	DS4LC1CLS42L	246
DS3PMSS4221PL	218	DS3SMSV7214L	222	DS4LC1BLS54L	245	DS4LC1CLS48L	246
DS3PMSS4814L	215	DS3SMT3614L	221	DS4LC1BLS60L	245	DS4LC1CLS54L	246
DS3PMSS4821FL	217	DS3SMT4214L	221	DS4LC1BLS66L	245	DS4LC1CLS60L	246
DS3PMSS4821PL	218	DS3SMT4814L	221	DS4LC1BLS72L	245	DS4LC1CLS66L	246
DS3PMSS6014L	215	DS3SMT6014L	221	DS4LC1BLV30L	252	DS4LC1CLS72L	246
DS3PMSS6021FL	217	DS3SMT7214L	221	DS4LC1BLV36L	252	DS4LC1CLV30L	254
DS3PMSS6021PL	218	DS3WMN3614	219	DS4LC1BLV42L	252	DS4LC1CLV36L	254
DS3PMSS6614L	215	DS3WMN4214	219	DS4LC1BLV48L	252	DS4LC1CLV42L	254
DS3PMSS6621FL	217	DS3WMN4814	219	DS4LC1BLV54L	252	DS4LC1CLV48L	254
DS3PMSS6621PL	218	DS3WMN6014	219	DS4LC1BLV60L	252	DS4LC1CLV54L	254
DS3PMSS7214L	215	DS3WMN7214	219	DS4LC1BLV66L	252	DS4LC1CLV60L	254
DS3PMSS7221FL	217	DS3WMSL3614L	219	DS4LC1BLV72L	252	DS4LC1CLV66L	254
DS3PMSS7221PL	218	DS3WMSL4214L	219	DS4LC1BSL30L	248	DS4LC1CLV72L	254
DS3PMSV3014L	216	DS3WMSL4814L	219	DS4LC1BSL36L	248	DS4LC1CSL30L	250
DS3PMSV3021FL	217	DS3WMSL6014L	219	DS4LC1BSL42L	248	DS4LC1CSL36L	250
DS3PMSV3021PL	218	DS3WMSL7214L	219	DS4LC1BSL48L	248	DS4LC1CSL42L	250
DS3PMSV3614L	216	DS3WMSS3614L	219	DS4LC1BSL54L	248	DS4LC1CSL48L	250
DS3PMSV3621FL	217	DS3WMSS4214L	219	DS4LC1BSL60L	248	DS4LC1CSL54L	250
DS3PMSV3621PL	218	DS3WMSS4814L	219	DS4LC1BSL66L	248	DS4LC1CSL60L	250
DS3PMSV4214L	216	DS3WMSS6014L	219	DS4LC1BSL72L	248	DS4LC1CSL66L	250
DS3PMSV4221FL	217	DS3WMSS7214L	219	DS4LC1BSS42L	245	DS4LC1CSL72L	250
DS3PMSV4221PL	218	DS3WMSV3614L	219	DS4LC1BSS48L	245	DS4LC1CSS42L	246
DS3PMSV4814L	216	DS3WMSV4214L	219	DS4LC1BSS54L	245	DS4LC1CSS48L	246
DS3PMSV4821FL	217	DS3WMSV4814L	219	DS4LC1BSS60L	245	DS4LC1CSS54L	246
DS3PMSV4821PL	218	DS3WMSV6014L	219	DS4LC1BSS66L	245	DS4LC1CSS60L	246
DS3PMSV6014L	216	DS3WMSV7214L	219	DS4LC1BSS72L	245	DS4LC1CSS66L	246
DS3PMSV6021FL	217	DS3WMTS3614L	220	DS4LC1BSV30L	252	DS4LC1CSS72L	246
DS3PMSV6021PL	218	DS3WMTS4214L	220	DS4LC1BSV36L	252	DS4LC1CSV30L	254
DS3PMSV6614L	216	DS3WMTS4814L	220	DS4LC1BSV42L	252	DS4LC1CSV36L	254
DS3PMSV6621FL	217	DS3WMTS6014L	220	DS4LC1BSV48L	252	DS4LC1CSV42L	254
DS3PMSV6621PL	218	DS3WMTS7214L	220	DS4LC1BSV54L	252	DS4LC1CSV48L	254
DS3PMSV7214L	216	DS4LC1ANL24N	248	DS4LC1BSV60L	252	DS4LC1CSV54L	254
DS3PMSV7221FL	217	DS4LC1ANL30N	248	DS4LC1BSV66L	252	DS4LC1CSV60L	254
DS3PMSV7221PL	218	DS4LC1ANL36N	248	DS4LC1BSV72L	252	DS4LC1CSV66L	254
DS3PMT7S214L	215	DS4LC1ANL42N	248	DS4LC1BVL30L	249	DS4LC1CSV72L	254
DS3PMTS3614L	215	DS4LC1ANL48N	248	DS4LC1BVL36L	249	DS4LC1CVL30L	250
DS3PMTS4214L	215	DS4LC1ANL54N	248	DS4LC1BVL42L	249	DS4LC1CVL36L	250
DS3PMTS4814L	215	DS4LC1ANL60N	248	DS4LC1BVL48L	249	DS4LC1CVL42L	250
DS3PMTS6014L	215	DS4LC1ANL66N	248	DS4LC1BVL54L	249	DS4LC1CVL48L	250
DS3PMV30L	212	DS4LC1ANL72N	248	DS4LC1BVL60L	249	DS4LC1CVL54L	250

<i>pattern no.</i>	<i>page</i>	<i>pattern no.</i>	<i>page</i>	<i>pattern no.</i>	<i>page</i>	<i>pattern no.</i>	<i>page</i>
DS4LC1CVL60L	250	DS4LC1DVL54L	251	DS4LC2BSV60L	261	DS4LC2CVV66L	263
DS4LC1CVL66L	250	DS4LC1DVL60L	251	DS4LC2BSV66L	261	DS4LC2CVV72L	263
DS4LC1CVL72L	250	DS4LC1DVL66L	251	DS4LC2BSV72L	261	DS4LC2DLL30L	260
DS4LC1CVS42L	246	DS4LC1DVL72L	251	DS4LC2BVL30L	258	DS4LC2DLL36L	260
DS4LC1CVS48L	246	DS4LC1DVS42L	247	DS4LC2BVL36L	258	DS4LC2DLL42L	260
DS4LC1CVS54L	246	DS4LC1DVS48L	247	DS4LC2BVL42L	258	DS4LC2DLL48L	260
DS4LC1CVS60L	246	DS4LC1DVS54L	247	DS4LC2BVL48L	258	DS4LC2DLL54L	260
DS4LC1CVS66L	246	DS4LC1DVS60L	247	DS4LC2BVL54L	258	DS4LC2DLL60L	260
DS4LC1CVS72L	246	DS4LC1DVS66L	247	DS4LC2BVL60L	258	DS4LC2DLL66L	260
DS4LC1CVV30L	254	DS4LC1DVS72L	247	DS4LC2BVL66L	258	DS4LC2DLL72L	260
DS4LC1CVV36L	254	DS4LC1DVV30L	255	DS4LC2BVL72L	258	DS4LC2DLV30L	264
DS4LC1CVV42L	254	DS4LC1DVV36L	255	DS4LC2BVV30L	262	DS4LC2DLV36L	264
DS4LC1CVV48L	254	DS4LC1DVV42L	255	DS4LC2BVV36L	262	DS4LC2DLV42L	264
DS4LC1CVV54L	254	DS4LC1DVV48L	255	DS4LC2BVV42L	262	DS4LC2DLV48L	264
DS4LC1CVV60L	254	DS4LC1DVV54L	255	DS4LC2BVV48L	262	DS4LC2DLV54L	264
DS4LC1CVV66L	254	DS4LC1DVV60L	255	DS4LC2BVV54L	262	DS4LC2DLV60L	264
DS4LC1CVV72L	254	DS4LC1DVV66L	255	DS4LC2BVV60L	262	DS4LC2DLV66L	264
DS4LC1DLL30L	251	DS4LC1DVV72L	255	DS4LC2BVV66L	262	DS4LC2DLV72L	264
DS4LC1DLL36L	251	DS4LC2ANL24N	257	DS4LC2BVV72L	262	DS4LC2DSL30L	260
DS4LC1DLL42L	251	DS4LC2ANL30N	257	DS4LC2CCL30L	259	DS4LC2DSL36L	260
DS4LC1DLL48L	251	DS4LC2ANL36N	257	DS4LC2CCL36L	259	DS4LC2DSL42L	260
DS4LC1DLL54L	251	DS4LC2ANL42N	257	DS4LC2CCL42L	259	DS4LC2DSL48L	260
DS4LC1DLL60L	251	DS4LC2ANL48N	257	DS4LC2CCL48L	259	DS4LC2DSL54L	260
DS4LC1DLL66L	251	DS4LC2ANL54N	257	DS4LC2CCL54L	259	DS4LC2DSL60L	260
DS4LC1DLL72L	251	DS4LC2ANL60N	257	DS4LC2CCL60L	259	DS4LC2DSL66L	260
DS4LC1DLS42L	247	DS4LC2ANL66N	257	DS4LC2CCL66L	259	DS4LC2DSL72L	260
DS4LC1DLS48L	247	DS4LC2ANL72N	257	DS4LC2CCL72L	259	DS4LC2DSV30L	264
DS4LC1DLS54L	247	DS4LC2ANV24N	261	DS4LC2CLV30L	263	DS4LC2DSV36L	264
DS4LC1DLS60L	247	DS4LC2ANV30N	261	DS4LC2CLV36L	263	DS4LC2DSV42L	264
DS4LC1DLS66L	247	DS4LC2ANV36N	261	DS4LC2CLV42L	263	DS4LC2DSV48L	264
DS4LC1DLS72L	247	DS4LC2ANV42N	261	DS4LC2CLV48L	263	DS4LC2DSV54L	264
DS4LC1DLV30L	255	DS4LC2ANV48N	261	DS4LC2CLV54L	263	DS4LC2DSV60L	264
DS4LC1DLV36L	255	DS4LC2ANV54N	261	DS4LC2CLV60L	263	DS4LC2DSV66L	264
DS4LC1DLV42L	255	DS4LC2ANV60N	261	DS4LC2CLV66L	263	DS4LC2DSV72L	264
DS4LC1DLV48L	255	DS4LC2ANV66N	261	DS4LC2CLV72L	263	DS4LC2DVL30L	260
DS4LC1DLV54L	255	DS4LC2ANV72N	261	DS4LC2CSL30L	259	DS4LC2DVL36L	260
DS4LC1DLV60L	255	DS4LC2BLL30L	257	DS4LC2CSL36L	259	DS4LC2DVL42L	260
DS4LC1DLV66L	255	DS4LC2BLL36L	257	DS4LC2CSL42L	259	DS4LC2DVL48L	260
DS4LC1DLV72L	255	DS4LC2BLL42L	257	DS4LC2CSL48L	259	DS4LC2DVL54L	260
DS4LC1DSL30L	251	DS4LC2BLL48L	257	DS4LC2CSL54L	259	DS4LC2DVL60L	260
DS4LC1DSL36L	251	DS4LC2BLL54L	257	DS4LC2CSL60L	259	DS4LC2DVL66L	260
DS4LC1DSL42L	251	DS4LC2BLL60L	257	DS4LC2CSL66L	259	DS4LC2DVL72L	260
DS4LC1DSL48L	251	DS4LC2BLL66L	257	DS4LC2CSL72L	259	DS4LC2DVV30L	264
DS4LC1DSL54L	251	DS4LC2BLL72L	257	DS4LC2CSV30L	263	DS4LC2DVV36L	264
DS4LC1DSL60L	251	DS4LC2BLV30L	261	DS4LC2CSV36L	263	DS4LC2DVV42L	264
DS4LC1DSL66L	251	DS4LC2BLV36L	261	DS4LC2CSV42L	263	DS4LC2DVV48L	264
DS4LC1DSL72L	251	DS4LC2BLV42L	261	DS4LC2CSV48L	263	DS4LC2DVV54L	264
DS4LC1DSS42L	247	DS4LC2BLV48L	261	DS4LC2CSV54L	263	DS4LC2DVV60L	264
DS4LC1DSS48L	247	DS4LC2BLV54L	261	DS4LC2CSV60L	263	DS4LC2DVV66L	264
DS4LC1DSS54L	247	DS4LC2BLV60L	261	DS4LC2CSV66L	263	DS4LC2DVV72L	264
DS4LC1DSS60L	247	DS4LC2BLV66L	261	DS4LC2CSV72L	263	DSCSWDB24	231
DS4LC1DSS66L	247	DS4LC2BLV72L	261	DS4LC2CVL30L	259	DSCSWDB30	231
DS4LC1DSS72L	247	DS4LC2BSL30L	257	DS4LC2CVL36L	259	DSCSWDB36	231
DS4LC1DSV30L	255	DS4LC2BSL36L	257	DS4LC2CVL42L	259	DSCSWDB42	231
DS4LC1DSV36L	255	DS4LC2BSL42L	257	DS4LC2CVL48L	259	DSCSWDB48	231
DS4LC1DSV42L	255	DS4LC2BSL48L	257	DS4LC2CVL54L	259	DT1ABY10242N	351
DS4LC1DSV48L	255	DS4LC2BSL54L	257	DS4LC2CVL60L	259	DT1ABY10248N	351
DS4LC1DSV54L	255	DS4LC2BSL60L	257	DS4LC2CVL66L	259	DT1ABY10842N	351
DS4LC1DSV60L	255	DS4LC2BSL66L	257	DS4LC2CVL72L	259	DT1ABY10848N	351
DS4LC1DSV66L	255	DS4LC2BSL72L	257	DS4LC2CVV30L	263	DT1ABY12042N	351
DS4LC1DSV72L	255	DS4LC2BSV30L	261	DS4LC2CVV36L	263	DT1ABY12048N	351
DS4LC1DVL30L	251	DS4LC2BSV36L	261	DS4LC2CVV42L	263	DT1ABY13242N	351
DS4LC1DVL36L	251	DS4LC2BSV42L	261	DS4LC2CVV48L	263	DT1ABY13248N	351
DS4LC1DVL42L	251	DS4LC2BSV48L	261	DS4LC2CVV54L	263	DT1ABY14442N	351
DS4LC1DVL48L	251	DS4LC2BSV54L	261	DS4LC2CVV60L	263	DT1ABY14448N	351

<i>pattern no.</i>	<i>page</i>	<i>pattern no.</i>	<i>page</i>	<i>pattern no.</i>	<i>page</i>
DT1ACX30	342	DT1ARY8430NS	333	DT1ATY9636N	336
DT1ACX3017	342	DT1ARY8436N	334	DT1ATY9642N	336
DT1ACX3021	342	DT1ARY8442N	334	DT1BTL	345
DT1ACX3036	342	DT1ARY9024NS	333	DT1BTS	345
DT1ACX3042	342	DT1ARY9030NS	333	DT1BXL	345
DT1ACX36	342	DT1ARY9036N	334	DT1BXL17	345
DT1ACX3617	342	DT1ARY9042N	334	DT1BXL21	345
DT1ACX3621	342	DT1ARY9624NS	333	DT1BXL36	345
DT1ACX3636	342	DT1ARY9630NS	333	DT1BXL42	345
DT1ACX3642	342	DT1ARY9636N	334	DT1BXS	345
DT1ACX42	342	DT1ARY9642N	334	DT1BXS17	345
DT1ACX4217	342	DT1ASX3030	341	DT1BXS21	345
DT1ACX4221	342	DT1ASX303017	341	DT1BXS36	345
DT1ACX4236	342	DT1ASX303021	341	DT1BXS42	345
DT1ACX4242	342	DT1ASX303036	341	DT1CK4	346
DT1ACX48	342	DT1ASX303042	341	DT1CRY6024N	337
DT1ACX4817	342	DT1ASX3636	341	DT1CRY6030N	337
DT1ACX4821	342	DT1ASX363617	341	DT1CRY6036N	337
DT1ACX4836	342	DT1ASX363621	341	DT1CRY6624N	337
DT1ACX4842	342	DT1ASX363636	341	DT1CRY6630N	337
DT1ADX3030	343	DT1ASX363642	341	DT1CRY6636N	337
DT1ADX303017	343	DT1ASX4242	341	DT1CRY7224N	337
DT1ADX303021	343	DT1ASX424217	341	DT1CRY7230N	337
DT1ADX303036	343	DT1ASX424221	341	DT1CRY7236N	337
DT1ADX303042	344	DT1ASX424236	341	DT1CRY7824N	337
DT1ADX3636	343	DT1ASX424242	341	DT1CRY7830N	337
DT1ADX363617	343	DT1ASX4848	341	DT1CRY7836N	337
DT1ADX363621	343	DT1ASX484817	341	DT1CRY8424N	337
DT1ADX363636	343	DT1ASX484821	341	DT1CRY8430N	337
DT1ADX363642	344	DT1ASX484836	341	DT1CRY8436N	337
DT1ADX4242	343	DT1ASX484842	341	DT1CRY9024N	337
DT1ADX424217	343	DT1ATY10236N	350	DT1CRY9030N	337
DT1ADX424221	343	DT1ATY10242N	350	DT1CRY9036N	337
DT1ADX424236	343	DT1ATY10248N	350	DT1CRY9624N	337
DT1ADX424242	344	DT1ATY10836N	350	DT1CRY9630N	337
DT1ADX4848	343	DT1ATY10842N	350	DT1CRY9636N	337
DT1ADX484817	343	DT1ATY10848N	350	DT1CTY6024N	338
DT1ADX484821	343	DT1ATY12042N	350	DT1CTY6030N	338
DT1ADX484836	343	DT1ATY12048N	350	DT1CTY6036N	338
DT1ADX484842	344	DT1ATY13242N	350	DT1CTY6624N	338
DT1ARY10236N	349	DT1ATY13248N	350	DT1CTY6630N	338
DT1ARY10242N	349	DT1ATY14442N	350	DT1CTY6636N	338
DT1ARY10248N	349	DT1ATY14448N	350	DT1CTY7224N	338
DT1ARY10836N	349	DT1ATY6024NS	335	DT1CTY7230N	338
DT1ARY10842N	349	DT1ATY6030NS	335	DT1CTY7236N	338
DT1ARY10848N	349	DT1ATY6036N	336	DT1CTY7824N	338
DT1ARY12042N	349	DT1ATY6624NS	335	DT1CTY7830N	338
DT1ARY12048N	349	DT1ATY6630NS	335	DT1CTY7836N	338
DT1ARY13242N	349	DT1ATY6636N	336	DT1CTY8424N	338
DT1ARY13248N	349	DT1ATY7224NS	335	DT1CTY8430N	338
DT1ARY14442N	349	DT1ATY7230NS	335	DT1CTY8436N	338
DT1ARY14448N	349	DT1ATY7236N	336	DT1CTY9024N	338
DT1ARY6024NS	333	DT1ATY7824NS	335	DT1CTY9030N	338
DT1ARY6030NS	333	DT1ATY7830NS	335	DT1CTY9036N	338
DT1ARY6036N	334	DT1ATY7836N	336	DT1CTY9624N	338
DT1ARY6624NS	333	DT1ATY8424NS	335	DT1CTY9630N	338
DT1ARY6630NS	333	DT1ATY8430NS	335	DT1CTY9636N	338
DT1ARY6636N	334	DT1ATY8436N	336	DT1S	345
DT1ARY7224NS	333	DT1ATY8442N	336	RO1 DPB	232
DT1ARY7230NS	333	DT1ATY9024NS	335	RS1 DPB	232
DT1ARY7236N	334	DT1ATY9030NS	335		
DT1ARY7824NS	333	DT1ATY9036N	336		
DT1ARY7830NS	333	DT1ATY9042N	336		
DT1ARY7836N	334	DT1ATY9624NS	335		
DT1ARY8424NS	333	DT1ATY9630NS	335		



# Selling Policy

	<p>This Selling Policy supercedes all previous selling policies. Prices, discounts and product offerings are subject to change without notice.</p>
<b>Terms &amp; Conditions of Sales</b>	<p>Sales by Knoll, Inc. or Knoll North America Corp. ("Seller") of Knoll Product Lines (hereinafter "Products") within the United States and Canada are made only on the terms which are contained in this Selling Policy. Seller hereby gives notice of its objection to any different or additional terms and conditions. This sale is expressly conditional upon Purchaser's assent to the terms and conditions set forth below. Additional terms and conditions may apply to KnollStudio and KnollTextiles orders. These terms and conditions may be modified or supplemented only by a written document signed by an authorized representative of Seller. These terms and conditions supercede any prior and/or contemporaneous agreements or correspondence between Purchaser and Seller. Written quotations expire thirty (30) days from the date of issuance and can be withdrawn by written notice anytime during that period. Where Purchaser and Seller have entered into the Knoll Electronic Terms and Conditions, all orders, acknowledgements, invoices and other business communications placed or transmitted in accordance with the Knoll Electronic Terms and Conditions shall be deemed to be in writing and signed and shall be valid for all purposes as if they were originated and maintained in documentary form.</p>
<b>Ordering Information</b>	<p>All orders must be in writing. The product pattern number(s) contained on Seller's order acknowledgement shall be the final expression of the order.</p>
<b>Order Confirmation</b>	<p>A purchase order is not binding on Seller until Purchaser has received Seller's order confirmation or acknowledgment.</p>
<b>Pricing Policies</b>	<p>List prices are subject to change without notice.</p> <p>List prices shall be those prices in effect on the date of receipt of a complete purchase order unless shipment is requested more than ninety (90) days after order entry in which case prices in effect on the date of shipment apply. List prices include specified freight costs. Unless specified in writing by Seller, no other charges are included in Seller's list prices.</p>
<b>Taxes</b>	<p>All sales, use, excise and other taxes applicable to the sale of the Products shall be paid by Purchaser. If Purchaser claims an exemption from any tax, Purchaser shall submit to Seller the appropriate exemption certificates.</p>
<b>Terms of Payment</b>	<p>Payment for one hundred percent (100%) of the net order amount is due within thirty (30) days of the date of invoice, which is issued upon shipment. In case of any discrepancies, such as shortages, and Seller is notified in writing within ten (10) days of receipt of Product, only that portion may be deducted and the balance paid. For orders greater than \$100,000 net, a fifty percent (50%) deposit is due at the time of order placement, with the remainder due within thirty (30) days of the date of invoice.</p> <p>KnollStudio orders less than \$2,000 require payment for one hundred percent (100%) of the net order amount (including any applicable sales tax and charges for inside delivery, special packaging, etc.), due at time of order placement. For KnollStudio orders greater than \$2,000, a one-half (50%) deposit is due at time of order placement with the remainder (including any applicable sales tax and charges for inside delivery, special packaging, etc.) due prior to shipment.</p> <p>If, in the judgment of Seller, Purchaser's financial condition does not justify the terms of the payment, Seller may require full or partial payment in advance.</p> <p>Past due accounts shall be charged one and one-half percent (1.5%) per month, or the highest rate permitted by law, whichever is less, and will be added to the outstanding balance. In the event Purchaser defaults on payment, Purchaser shall be liable for all collection costs, including reasonable attorney's fees and costs.</p>
<b>Changes and Cancellation</b>	<p>Purchase orders may not be changed or cancelled, in whole or in part, without prior written consent of Seller. Changes may effect delivery dates. Expenses incurred because of changes shall be charged to Purchaser. In the event of cancellations, Purchaser will be liable for reasonable cancellation charges established by Seller. Orders for special Product, orders including "COM" (hereinafter defined) material and orders pursuant to expedited delivery programs, may not be canceled.</p>
<b>Freight Prepaid</b>	<p>Freight is prepaid and included in the price of all Products, except KnollTextiles, within the 48 contiguous United States for orders placed with Knoll, Inc. and within Canada, excluding the Yukon, Northwest Territories, Nunavut and Newfoundland for orders placed with Knoll North America Corp. Packing is tested for rigorous motion and transportation but is not guaranteed to protect furniture from conditions over which the Seller has no control. If special packaging is required for any reason, please consult with your sales representative or dealer. Seller shall select the method of shipment and routing. All shipments shall be tailgate deliveries. Freight for all KnollTextiles orders is prepaid and added to the invoice.</p>
<b>Delivery/Freight Charges</b>	<p>Shipments outside the contiguous 48 United States and Canada shall be shipped F.O.B. Origin.</p> <p>For shipments outside the contiguous United States and Canada, Purchaser is responsible for the cost of freight from point of embarkation, including any handling and transportation charges incidental to loading at the point of departure and unloading at the final destination.</p> <p>Conditions beyond the control of Seller, including weather, available facilities and traffic conditions, may affect exact time of delivery. Seller shall not be responsible for specific carrier delivery date or time unless it has made a specific delivery commitment, in writing.</p> <p>Nonstandard methods of shipment and/or additional services are available upon request. Purchaser will be billed for the differential cost of any special services in excess of standard surface carrier freight costs. Premium charges, at Purchaser's request, will be added for airfreight, exclusive use of vehicle and extra, export or special packaging. Accessorial charges will be added for inside delivery, extra labor, reassignment and redelivery.</p> <p>Partial shipments may be made and invoiced by Seller.</p>
<b>Claims</b>	<p>All shipments for all Knoll Products within the contiguous United States and Canada are F.O.B. Origin. Risk of loss passes to Purchaser at time of delivery to carrier. Purchaser shall inspect all Products upon receipt and notify Seller within ten (10) working days after receipt of any damage or defects which are, or should be, apparent from an inspection of the Product and its packaging. Failure of Purchaser to make a claim against carrier or notify Seller during the ten (10) working day period shall constitute acceptance of the Products and waiver of any apparent defects, errors or shortages. Seller will agree to repair or replace Product damaged in shipment if Purchaser has notified Seller of freight damage within ten (10) working days after receipt and assigns its rights against the carrier.</p>
<b>Seller's Security Interest</b>	<p>Until Seller receives the full payment for the Product, Seller shall have a security interest in the Product. Purchaser agrees to perform all acts, including but not limited to the execution and filing of documentation, which may be necessary to perfect and assure the security interest of Seller.</p>
<b>Returns</b>	<p>The return of Products without a written authorization by Seller shall not be accepted. To receive authorization for Product return, please call Customer Service. All Products that are returned pursuant to a valid authorization shall be subject to a twenty-five percent (25%) of list restocking charge. Products not currently offered for sale by Seller (including COM) shall not be authorized for return. All returned Products must be unused, in original condition and in the original Seller packing cartons. No refund or credit shall be given for damaged Products.</p>
<b>Held Orders/Storage</b>	<p>If Purchaser requests that an order be held or delayed, prices and terms and conditions in effect at the time of shipment shall apply. If Purchaser requests a delay after the time when Seller can defer production, Purchaser will be invoiced for the Product, payable in accordance with standard terms, when the order is ready for shipment. Seller may transfer the Product to storage, in which case all expenses incurred in connection with storage, including demurrage, preparation for storage, storage charges and handling shall be payable by Purchaser upon submission of invoices by Seller. Risk of loss to the Product shall pass to the Purchaser upon delivery of the Product into storage.</p>

# Selling Policy

<b>Customer's Own Material</b>	A Purchaser who requests a fabric or other surface material not standard to Seller's line of Products ("COM") must submit samples of the requested material to Seller prior to entry of a purchaser order. Seller shall determine if the material is suitable to its manufacturing processes and meets any requirements of Underwriters Laboratories. If the COM is acceptable, Seller will then establish a price for using the COM or the Product in question. For a description of the procedures for submitting samples and testing, contact customer resources or your sales representative. Seller shall have no responsibility for the appearance, condition, performance, durability, colorfastness or any other physical attribute of the COM. Purchaser shall indemnify and hold Seller harmless for any damages, injuries or losses arising out of or related to use of the COM on the Product.
<b>Warranty</b>	<p>Seller warrants to the original Purchaser only that the Products Seller manufactures and sells to Purchaser are free of defects in workmanship and materials, during the applicable warranty period set forth below.</p> <p>Warranty period set forth below is for 24-hour, 7 days a week, multi shift use (includes parts and labor to repair).</p> <p>Should any failure to conform with this limited warranty appear to a Product listed below during the applicable warranty period from the date of shipment, Seller shall, upon prompt written notice, repair or replace, at its option and costs, the affected part or parts.</p> <p><i>Product and Period of Warranty</i></p> <p><i>Lifetime: Antenna Workspaces, AutoStrada, Calibre, Crinion Open Table, Currents, Dividends Horizon, Equity, Morrison, Reff Profiles laminate, Series 2 Storage, Template, Antenna Workspaces and other non-wood components (except cascade edge worksurfaces, operational parts, controls, electrical, Lighting, Series 2 Veneer Front Storage, special or custom products, see below)</i></p> <p><i>12 Years: Chadwick, Essentials Work Chairs, Generation by Knoll, Life, Moment, MultiGeneration by Knoll, RPM and Sapper seating (except seating upholstery, textiles, leathers and finishes, see below).</i></p> <p><i>10 Years: Antenna Workspaces, AutoStrada, Crinion Open Table, Reff Profiles wood components, Series 2 Veneer Front Storage, cascade edge worksurfaces, Wood Casegoods (Magnusson, The Graham Collection) (except wood casegoods upholstered surfaces, see below), Interaction tables (except height adjustment mechanisms for Counterforce, crank-adjustable, and split-top tables and worksurfaces, see below), Reuter overheads, Reuter vertical storage, KnollExtra Sapper Monitor Arm Collection, Adjustable keyboard mechanisms and platforms, Communication Boards (except fabric board textiles, see below), Smokador collection (except leathers, see below), and Orchestra Universal Systems Accessories.</i></p> <p><i>5 Years: Operational parts, controls, electrical, Lighting (except light ballasts, bulbs and power supply, see below), special or custom product, wood veneer products, Currents handcrank, Interaction Counterforce, Interaction crank-adjustable, and split-top mechanisms, KnollStudio, CPU storage and all universal storage drawers.</i></p> <p><i>3 Years: Seating upholstery, textiles, leathers and finishes. Fabric boards textiles and Smokador Collection leathers.</i></p> <p><i>2 Years: All other KnollExtra product</i></p> <p><i>1 Year: Light ballasts, bulbs and power supply, seating upholstered armpads and soft armpads, wood casegoods upholstered surfaces.</i></p> <p>This warranty does not apply to:</p> <ul style="list-style-type: none"><li>• Damage caused by a carrier other than the Seller.</li><li>• Normal wear and tear or acts or omissions of parties other than Seller (including user modification, improper use or installation of Products).</li><li>• COM or other third party materials applied to Products.</li><li>• Products not installed by or under the auspices of a Knoll Dealer.</li><li>• Dramatic temperature variations or exposure to unusual conditions.</li><li>• Changes in surface finishes, including colorfastness due to aging or exposure to light.</li><li>• Except as specifically noted above, textiles and upholstery supplied by <i>KnollTextiles</i> (consult current <i>KnollTextiles</i> price list for applicable warranty).</li></ul> <p>Natural variations occurring in wood, marble, and leather shall not be considered defects, and the Seller does not guarantee the colorfastness or matching of the colors, grains or textures, or surface hardness of such materials. The Seller also does not guarantee the colorfastness of fiberglass panel surfaces. THE EXPRESS WARRANTIES CONTAINED HEREIN ARE IN LIEU OF ALL OTHER WARRANTIES, EXPRESS OR IMPLIED, INCLUDING ANY WARRANTIES OF MERCHANTABILITY AND FITNESS FOR PARTICULAR PURPOSE AND ALL OTHER WARRANTIES ARISING FROM COURSE OF DEALING OR USAGE OF TRADE.</p> <p>The remedies provided above are the Purchaser's sole remedies for any failure of Seller to comply with its obligations regarding the workmanship of its Products. Correction of any nonconformity in the manner and for the period of time provided shall constitute complete fulfillment of all liabilities of Seller, with respect to or arising out of the Product furnished hereunder.</p>
<b>Delay/Force Majeure</b>	Seller shall not be liable for failure to perform or for delay in performance due to fire, flood, strike or other labor difficulty, act of God, act of any governmental authority or of the Purchaser, riot, embargo, fuel or energy shortage, wrecks or delay in transportation, inability to obtain necessary labor, materials or manufacturing facilities from usual sources or failure of suppliers to meet their contractual obligations, or due to any cause beyond its reasonable control. If any such event occurs, Seller may extend delivery dates by a period of time necessary to overcome the effect of such delay, allocate available Product or cancel any purchase order.
<b>Compliance with Law</b>	PURCHASER IS SOLELY RESPONSIBLE FOR COMPLIANCE WITH ALL APPLICABLE FEDERAL, STATE AND LOCAL LAWS, ORDINANCES, REGULATIONS, RULES AND STANDARDS RELATING TO THE INSTALLATION, MAINTENANCE, USE AND OPERATION OF THE PRODUCTS.
<b>Patents</b>	<p>Subject to the following provisions, Seller shall, at its own expense, defend or, at its option, settle any claim, suit or proceeding brought against the Purchaser, and/or its vendees, mediate and immediate, so far as based on an allegation that any Product or any part thereof furnished hereunder constitutes a direct or a contributory infringement of any claim of any patent of the United States or Canada. This obligation shall be effective only if Purchaser shall have made all payments then due hereunder and if Seller is notified promptly in writing and given authority, information and assistance for the defense of said claim, suit or proceeding. Seller shall pay all damages and costs awarded in such suit or proceedings so defended.</p> <p>The foregoing indemnity does not apply to the following:</p> <ul style="list-style-type: none"><li>• Products supplied according to a design other than that of Seller, and which is required by the Purchaser.</li><li>• Combination of the Product with another product not furnished hereunder unless Seller is a contributory infringer.</li><li>• Any settlements of a suit or proceeding made without Seller's written consent.</li></ul>
<b>Limitations of Liability</b>	<p><b>SELLER, ITS CONTRACTORS, AUTHORIZED DEALERS AND SUBCONTRACTORS OR SUPPLIERS OF ANY TIER SHALL NOT BE LIABLE TO PURCHASER FOR ANY SPECIAL, INDIRECT, INCIDENTAL OR CONSEQUENTIAL DAMAGES ARISING FROM A BREACH OF THIS AGREEMENT.</b></p> <p>Purchaser's remedies set forth herein are exclusive and the liability of Seller with respect to the breach of this agreement or any contract entered into between the parties pursuant hereto shall not exceed the price of the Product or part on which such liability is based.</p>

# KnollKey Lock Program

## KnollKey Lock Program General Information

Following is the KnollKey lock policy, applicable to all products.

Knoll furniture can be ordered keyed-alike or random keyed. Key-alike and random keying instructions cannot be mixed on any single order. Only one of the two instructions can be used on an individual order. When an order is submitted with mixed (key-alike and random) instructions, Knoll will release the order as key-alike only and lock cores will have to be specified separately.

### Key-alike

For the convenience of the user, furniture may be keyed alike at no charge. Write "Key-alike" in the description of your purchase order for any pedestal, overhead, file or other item you wish to have keyed alike.

Using the key-alike instructions, order cores and keys as line items on your purchase order. Do NOT submit a key-alike form. The Knoll East Greenville Lock Center will select key numbers from the standard range of K 001 - K 250. Key numbers will not be repeated unless over 250 sets are ordered. Lock cores keyed-alike will ship separately from the product, ready for field installation.

There is no charge for key-alike orders if placed with the furniture order.

**IF THE KEY-ALIKE ORDER IS NOT PLACED AT LEAST TWO WEEKS PRIOR TO THE FURNITURE SHIP DATE, A \$50 HANDLING CHARGE AND AIR FREIGHT CHARGES WILL APPLY.**

**If product is ordered and shipped random-keyed, additional lock cores for key-alike are billable.**

### Random-Keying

To specify product keyed-random, write "key-random" in the product description. Random-keyed product is shipped with the lock core factory installed. A shrouded key is included. Random means no effort has been made to match key numbers, or to make them different.

### Keys

A Knoll shrouded key is shipped with every lock core. 250 Key numbers are available. For numbers above 250, contact Custom Product Development. Additional keys and key blanks are available. See service parts for more information.

### Master Keying

Knoll locks can be controlled by means of a master key. There is no additional per-lock charge for master keying. A letter of approval from the client must accompany orders for master keys.

### Installing Lock Cores

Lock cores can be installed or removed in the field by using a change key. Cores must be in the unlocked position to be removed. See service parts for change key pattern number and pricing.

### Lock Distribution

All orders for key-alike lock cores/keys are packaged and shipped from the East Greenville Lock Center, regardless of where the pedestals, overhead, or other units are produced. Random keyed product will have cores factory-installed.

## How to Specify Key-Alike

Following is an example of how to specify key-alike for a cluster of 10 workstations.

**Step 1** - Using the project floorplan, count the number of locks in each workstation.

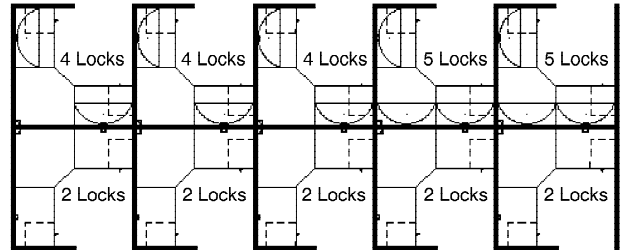

**Step 2** - Count the number of workstations with the same quantity of locks. Group together the workstations with a like number of locks.

5 workstations with 2 locks per station  
3 workstations with 4 locks per station  
2 workstations with 5 locks per station

**Step 3** - For the first group (5 sets of 2 locks), enter the number of workstations in the quantity column.

Qty	Pattern #	Description	Unit List	Ext. List
5				

**Step 4** - Then enter the pattern number "KSPEC\_ \_" and add a suffix for the number of locks for that group (i.e., for 2 locks per station, add the suffix "2"). Up to 30 lock cores are available in a set (i.e., KSPEC 30).

Qty	Pattern #	Description	Unit List	Ext. List
5	KSPEC 2	Set of 2 cores/keys	N / C	N / C

**Step 5** - Repeat for other groups.

Qty	Pattern #	Description	Unit List	Ext. List
5	KSPEC 2	Set of 2 cores/keys	N / C	N / C
3	KSPEC 4	Set of 4 cores/keys	N / C	N / C
2	KSPEC 5	Set of 5 cores/keys	N / C	N / C

Your Key instructions are complete.

Knoll will select key numbers for each set from 250 available numbers. Additional key numbers are available through Custom Product Development. **For additions to existing installations, specify desired key numbers in the description.**

## Service Parts

Pattern #	Description	List Price
KKEY_ _ _	Shrouded Key Specify key number desired	\$5
KBLANK	Shrouded Key Blank	\$5
KSPECB_ _ _	Retrofit Universal Core/Key Specify key number desired	\$22
KCHANGE	Change Key	\$5
HLKRKMASTER*	Master Key	\$7

\*Note: A letter of approval on company letterhead from the client must accompany all orders for master keys.

# General Ordering Information

---

## **The Products**

This guide encompasses all standard products for this product group.

## **Sizes**

Dimensions listed in this guide are indicated as:

H = height

W = width

D = depth

Dia. = diameter

Rad. = radius

## **Pricing**

All prices shown are list.

## **How to Order**

Select pattern numbers and quantities required for your complete installation. Product questions can be addressed in the specific sections of this guide or by contacting your sales representative or customer resource representative at 1-800-343-5665.

Next, select options (if required), along with colors and finishes appropriate to each product. Reference the Finishes and Fabrics pages for color designations.

On large installations, an item's "designated area" can be specified to assist in product organization and handling.

To expedite complete / correct entry of your order, be certain all pattern numbers, quantities, colors and area identifications are completely specified. Also, include complete purchase order numbers, bill-to and ship-to addresses, a contact name and specific factory shipping dates required.

## **Mail all orders to:**

Knoll, Inc.

1235 Water Street

P.O. Box 157

East Greenville, PA 18041

Attention: Order Entry

Once your order is entered at Knoll, an acknowledgment will be mailed to you. You will be advised of your scheduled shipping date within five days of the original acknowledgment. If it is necessary to revise your order, please contact your customer resource representative.

## Sustainability Statement

---

Sustainable design is a key component of Knoll's environmental focus. Our commitment to social responsibility and a healthy environment has prompted us to further articulate our longstanding environmental programs and, with encouragement and support from our colleagues in the industry, we have re-energized our focus on such "green" initiatives as life cycle analysis and LEED™ certification. Knoll is proud to have contributed to projects that have received LEED certification from the U.S. Green Building Council.

For the latest information on Knoll products that help our customers achieve LEED certification, log on to [knoll.com](http://knoll.com), click on "About Knoll" and then "Environmental Focus."