

Table of Contents

Introduction	Knoll and Sustainable Design	2
	Introduction	3
	Specifications	4
	Crinion Open Table Finishes	5
Worksurfaces	Worksurfaces with center hinged power access	7
	Worksurfaces with edge grommet	8
	Worksurfaces with cord drop	9
	End counters	10
	Extended end counters	11
File tops	File tops	13
Complete base assemblies	Complete base assemblies fixed height 24" D dual	14
	Complete base assemblies fixed height 24" D single sided	15
	Complete base assemblies fixed height 30" D dual	16
	Complete base assemblies fixed height 30" D single sided	17
	Complete base assemblies adjustable height 30" D dual	18
	Complete base assemblies adjustable height 30" D single sided	19
	Complete base assemblies fixed height 36" D dual	20
	Complete base assemblies fixed height 36" D single sided	21
	Complete base assemblies adjustable height 36" D dual	22
	Complete base assemblies adjustable height 36" D single sided	23
Base components	Top channels	24
	Beams for single sided or dual tables	25
	Beams for dual tables	26
	Beams for single sided tables	27
	End legs, intermediate leg sets for dual tables	28
	End legs, intermediate leg sets for single sided tables	30
	Beam trusses	31
	Worksurface support	32
Power components	Modular Raceway	34
	Hardwire Raceway	40
	Cable tray and cable clips	41
	Beam mounted cable trays and cable baskets	42
Screens	Center screens	43
	Shelves, adapters and buttresses for slatwall screens	45
	Side screens	46
	Return screens	48
	Dual end screens	50
	Single sided end screen	52
	Frameless glass Add up	54
Morrison Network privacy screens	55	
Alpha-Numeric Index		56
Selling Policy		59
General Ordering Information		61

Knoll and Sustainable Design

Each year Knoll sets key initiatives in our journey to sustainability. We are members of a global consortium on energy, have adopted a scientific, metrics-based approach to sustainable product design, and maintain a leadership position in establishing universal, verifiable, sustainability standards for our industry.

Knoll promotes independent third-party certification because it provides the most impartial and trustworthy foundation for industry-wide environmental compliance. Certification by established and respected third parties ensures that all manufacturers are held to the same high standards and that customers can trust a company's declaration about the environmental benefits of its products. Knoll third-party partners include: the International Standards Organization (ISO); Forest Stewardship Council (FSC); GREENGUARD® Environmental Institute; and Chicago Climate Exchange (CCX®).

In addition, Knoll is aligned with the U.S. Green Building Council and can help companies, healthcare organizations and educational institutions achieve Leadership in Energy and Environmental Design (LEED®) workplace certification.

1. Global Climate Change

- Knoll is a sponsor of the Clinton Global Initiative, which brings together a community of global leaders to devise and implement solutions to some of the world's most pressing challenges, including environmental change.
- Knoll is a member of the Chicago Climate Exchange, which promotes greenhouse gas reduction through the trading of credits earned for reducing emissions.
- Knoll has a comprehensive Energy Management Program to increase energy efficiency in products and processes.

2. Life Cycle Assessment (LCA) Tool

Life Cycle Assessment is a science-based measurement of a product's environmental impacts throughout its life cycle, from raw materials sourcing through manufacture, shipping, use, and re-use or end-of-life. LCA enables cradle-to-cradle implementation of sustainable practices.

- Knoll partners with The Green Standard.org (formerly the International Design Center for the Environment, or IDCE) to develop an affordable, universal, ISO-compliant computer-based LCA tool that can be used by the entire contract furniture industry.

An affordable universal LCA tool has enormous potential value to:

- Help stop dangerous and irreversible climate change
- Conserve natural resources and reduce waste
- Improve quality of life
- Eliminate market confusion about green products using real metrics and sound science
- Facilitate design innovation
- Advance the sustainability triple bottom line: environment, economics and social equity

3. Setting Industry Standards

- Knoll partners with MTS (Market Transformation to Sustainability) to develop the SMART® Standard, a set of consensus-based sustainable product standards based on the LEED® model, for all building products, fabric, apparel, flooring and carpet. MTS, the developer of the SMART Standard, is an accredited American National Standards Institute (ANSI) standard developer.
- Knoll also participates in an ongoing BIFMA (Business and Institutional Furniture Manufacturers Association) initiative to establish sustainability standards for the contract furniture industry.
- Our goal is to encourage all manufacturers in the contract furniture and related industries to adopt standards that will lead to sustainable products and practices.

For more information about Knoll environmental, health and safety programs, visit knoll.com/environment.

This Order Guide provides basic planning, specifications and pricing information for Crinion Open Tables.

Refer to KnollExtra price list for compatible accessories such as flat screen monitor supports, task lights, paper management accessories, keyboard and storage drawers.

Refer to Calibre, Reff or Currents price lists for shared and individual storage options. Additional information can be found at www.knoll.com.

Crinion Open Table is the straightforward alternative for open, collaborative work environments.

Crinion Open Table typically consists of deep worksurfaces end-to-end and back-to-back, cantilever supported by parallel beams between end legs. The beams form a technology corridor for flat screen monitor supports, outlets and power/data distribution. Also available is a single-sided configuration, with a single main beam and a smaller back beam, and a single beam configuration for tables with shallower (24" deep) worksurface.

The center of dual tables or back of single-sided tables features a top channel which supports privacy screens above the table and modular power distribution below the worksurface.

Crinion Open Table is appropriate for libraries and education environments, laboratories, finance and trading desks, teaming areas and design offices.

Crinion Open Table is unique in offering individual height-adjustability and extraordinarily deep worksurfaces. Overall dual table depth is 48", 60" or 72".

The table structure is strong enough to span 16 feet between end legs or intermediate supports to build tables of any length.

The continuous worksurfaces and clear kneespace enable varying numbers of workers to sit on each side. Storage is typically separated from the table in parallel, shared file-and-storage islands, perpendicular files as returns or mobile pedestals.

Crinion is distinguished by a minimalist, modern design, and details like square or tapered edge worksurfaces, plastic laminate, Techwood or natural veneers, and aluminum fittings.

Crinion Open Table simplifies the planning and specifications of an open office, and it can make a dramatic visual and functional statement of collaboration.

The quality and classic design of Crinion work well in virtually any interior.

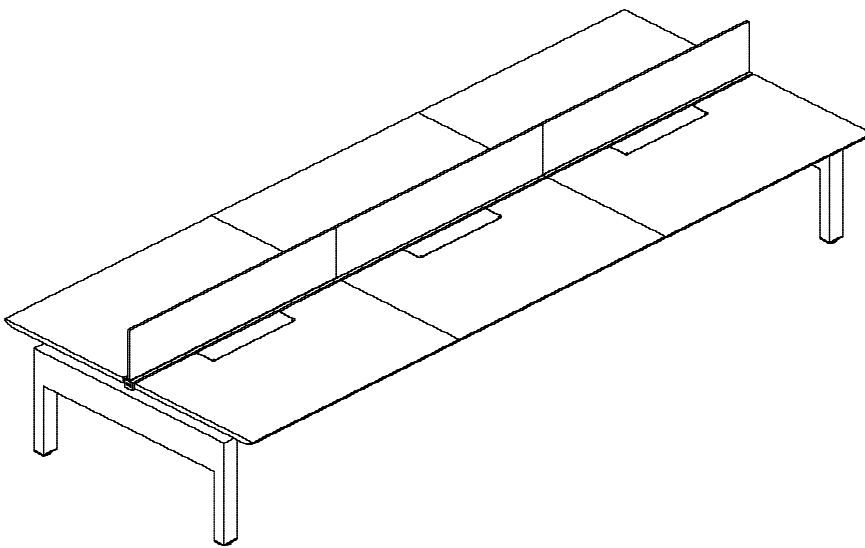

Crinion Open Tables are comprised of worksurfaces, table base assemblies, power components and screens.

Worksurfaces

Individual worksurfaces are available in four standard widths (48", 60", 72", 96") and three depths (nominal 24", 30", 36"), which may be combined to form single-sided or dual-sided groups of two to ten or more positions.

Worksurface edge options

Worksurfaces are 1 1/4" thick, with three front edge options: Tapered edge, laminate, veneer or mixed.

Square edge, veneer

Postformed edge, laminate only

Power and accessory options

Worksurfaces may be specified with hinged power access door and continuous 1/2" cord drop, or edge grommet and continuous cord drop, or just cord drop.

Hinged power access door is 24"W and 5"D, centered on worksurface width. Door hinges toward user for continuity between access opening and cord drop.

Any worksurface (except end counters) accepts clamp on KnollExtra accessories such as flat screen monitor arm or task light.

Other worksurface types

End counters have front edge detail on side edges as well and are designed to extend dual tables 24" or 30" beyond the endleg. End counters also include 3" wide center grommet. Extended end counters are 36"D surfaces with center grommet or hinged power access door. Base of the table must be extended 12" under the back of each extended end counter (although top channels should be specified only as wide as the worksurfaces on each side of the table).

All end counters must be supported by end counter cantilevers and endlegs for end counters.

Worksurface heights

Fixed height cantilevers support worksurfaces at 28 1/2"H, with 27" clear below the top (except directly below cantilevers).

Adjustable height cantilevers enable worksurfaces to be independently set at 27", 27 3/4", 28 1/2", 29 1/4", or 30"H.

Open Table base assemblies

Complete base assemblies simplify specifications for most common configurations of dual or single-sided open tables. Base assemblies include top channels and end caps, beams, end legs and intermediate legs (where required), trusses and top channel supports, cantilever brackets (specify fixed or adjustable height) and midspan supports. Specify worksurfaces, screens, power components, cable trays and accessories separately.

Complete base assemblies are available for the following typical tables, combinations of 60" or 72" worksurfaces.

Single-sided or dual, 24"D, 30"D, or 36"D, with continuous beam span between end legs

10' W two/four positions 60"W

12' W two/four positions 72"W

15' W three/six positions 60"W

Single sided or dual 24"D, 30"D, or 36"D, with intermediate leg

18' W three/six positions 72"W

20' W four/eight positions 60"W

24' W four/eight positions 72"W

25' W five/ten positions 60"W

Open Table base components

Base assemblies may also be specified by individual components to create configurations other than those listed above, or to create tables with end counters or frameless glass add ups.

In addition to worksurfaces Open tables require top channel, starter beams for spans up to 15', extension beams for additional spans of 4' to 15', intermediate legs every 16' or less, two end legs, trusses at every worksurface junction and at each end leg. Adjustable tables require two cantilevers per worksurface (or three for 96"W). Fixed height tables may be supported by a fixed height cantilever at each end, shared cantilevers at each worksurface joint, and a midspan support bracket at the center of each worksurface greater than 48" wide. For 96"W worksurfaces the midspan support should be a 24"D cantilever.

Power components, cable trays and screens are optional.

Power distribution

Optional modular raceway distributes 2+2 four circuit or 3+3 six circuit configuration from a single point of supply. Bundles of cables can be managed from the floor in a cable infeed shroud located at any intermediate leg. Raceway provides power outlets and data/communications outlet openings on one or both sides, accessed through hinged access doors in worksurfaces or from under table. Specify 30" raceway for two duplex outlets each side or 42" raceway for four duplex outlets each side. Specify compact power module for outlets under an extended end counter. Duplex outlets, power infeed and jumpers between raceways must be specified separately.

Privacy screens

There are four screen options for Crinion Open Table.

The standard screens are 14"H (42" horizon) or 21"H (49" horizon) in acrylic, slatwall or combination surfaces, tackable fabric, marker or veneer. Center screens include mounting hardware to attach to the standard top channel. Center screens are available full width, 48", 60" or 72", or shorter by 1" to leave space at either end of the table for a dual end screen. Side screens attach to the front and back of a worksurface at any point other than at a hinged access door. Mounting brackets are specified separately to correspond to each worksurface edge detail. Dual end screens span across the end of a table (or above an end counter) from worksurface front edges.

Frameless glass add ups are available in 12" height only, 48", 60", and 72"W. Add ups can only mount to a top channel for frameless glass add ups, which may be at the center of a dual table or back of a single-sided table.

Original Crinion privacy screens are 12"H or 19"H (41" or 48" horizons) and mount to a standard top channel only.

Morrison Network fabric screens (15"H or 22"H) can also be mounted to the standard top channel with Crinion Open Table mast kit.

Accessories and storage

All Crinion worksurfaces accept clamp base KnollExtra flat screen monitor arms and task lights at any point except behind the hinged power access door. Worksurfaces also accept suspended accessories like adjustable keyboard supports, BackPack center file or keyboard drawers, or CPU holders. Beam location under most tables prevents pedestals deeper than 20" underneath. However 36"D tops can be planned on 30"D table bases to create additional kneespace depth and room for 24"D pedestals.

Crinion Open Table file tops are available for 27"H Calibre files positioned perpendicular to the table to act as returns. Tapered front and back edges assure consistent detail with tapered worksurface edges. File tops are also available for pairs of files and back to back files.

Finishes

L - Laminate

Matching edge band unless noted otherwise

- 117 Soft Grey
- 118 Bright White
- 114 Folkstone Grey
- 111 Jet Black
- 119 Pumice
- 121 Micro Grey with 114 Folkstone grey edge band
- 122 Brushed Sand with 119 Pumice edge band
- 123 Brushed Grey with 128 Fog edge band
- 128 Fog
- 129 Micro Sand with 119 Pumice edge band

Additional wood grain laminates for application on postformed laminate tops only.

(not available on end counters or tapered edge tops):

- 125 Natural Maple
- 126 Natural Cherry
- 124 Medium Cherry
- 127 Walnut

V1 - Techwood Closed Pore

- Y319 Cherry
- Y326 Dark Mahogany
- Y316 Maple
- Y323 Medium Walnut
- Y311 Beech
- Y324 Ash
- Y325 Chestnut
- Y327 Light Oak
- Y328 Mahogany
- Y329 Medium Oak

V2 – Natural veneer

- V431 Mellow Cherry
 - V312 Bronze Cherry
 - V433 Light Fawn Cherry
 - V436 Medium Brown Cherry
 - V411 Light Walnut
 - V418 Smoked Walnut
 - V415 Peacock Green Walnut
 - V417 Old English Walnut
 - V316 Maple
- (all above V2's are flat cut)*

- V421 Chalk Oak
 - V423 Light Oak
 - V425 Amber Oak
 - V427 Brown Oak
- (all V2 Oaks are quarter cut)*

V3 – Exotic veneer

- V512 Quartered Figured Anigre
 - V514 Quartered Makore
 - V515 Quartered Sycamore
 - V513 Quartered Graphite Oak
 - V517 Natural Sapele
- (all V3s are quarter cut)*

Paint

P1

- 111 Jet Black
- 112 Brown
- 113 Dark Grey
- 114 Folkstone Grey
- 115 Medium Grey
- 116 Sandstone
- 117 Soft Grey

P2

- 611 Beige Mist Metallic
- 612 Medium Metallic Grey

P3

- 118 Bright White
- 613 Silver

Anodized

- AA Anodized Aluminum

Glass

- TEMP Clear Tempered

Acrylic

- O Opal
- T Translucent

Architectural

- GL13 Powder

Fabric Options

Grade 10

- Bailey II (W359)
- Broadcloth (W288)
- Element (W1077)
- Foundation (W351)
- Growth Spurt (W692)
- Newbury (W812)
- Solid Crepe (W257)
- Symbolic Detail (W693)
- Tailor Made (W133)
- Versatility (W432)

Grade 15

- Regency (W210)

Grade 20

- Banyan (W443)
- Bauhaus Block (W296A)
- Boardwalk (W911)
- Clarity (W281)
- Criss Cross (W305)
- Devon (W809)

Fabric Options

Grade 20 (continued)

- Frequency (W340)
- Melbourne (W228)
- Outback (W229)
- Reflect (W884)
- Resolution (W280)
- Walkabout (W230)
- Weave Three (W298)

Grade 30

- Basket Draft (W249)
- Flow (W565)
- Harmony (W232)
- Interknit (W1090)
- Micro (W465)*
- Progression (W403)
- Raku Cloth (W566)
- Relay (W1020)

Grade 35

- Saxony Plus (S)

Grade 40

(Monolithic panels and tackboards only)

- Eurythmic (W268)
- Hard Rock (W1007)
- Ornament (W1078)
- Palladium (W1030)
- Sierra (R)

Grade 45

- Casual Elegance (W920)
- Dristi (K872)*
- Mezzo (W543)

**with backing only*

Grade 50

- Glo (K757)
- Ingot (K531)
- Presto (K1000)
- Ricochet (K498)

Grade 55

- Transition (W816)

Customers Own Material

Prices for panels that are to be manufactured with a customer supplied fabric will follow Grade 10 panel pricing. COM fabrics are subject to a testing charge prior to acceptance for use on panels. Panels bearing COM fabrics are subject to extended leadtimes. It is the responsibility of the customer's purchasing agent to ensure COM fabric is supplied for testing and manufacturing. Delays in receiving COM fabric for manufacturing will result in rescheduled delivery dates.

Mixed Finish work surfaces:

To order mixed finishes, enter four digit finish code as follows:

Use 2 digit prefix to indicate surface finish (laminate)

- 11 Jet Black
- 14 Folkstone Grey
- 17 Soft Grey
- 18 Bright White
- 19 Pumice
- 21 Micro Grey
- 22 Brushed Sand
- 23 Brushed Grey
- 28 Fog
- 29 Micro Sand

Use 2 digit suffix to indicate edge finish (wood)

- 11 for Y311
- 12 for V312
- 16 for V316, Y316
- Y9 for Y319
- Y3 for Y323
- 24 for Y324
- 25 for Y325
- 26 for Y326
- 27 for Y327
- 28 for Y328
- 29 for Y329
- 41 for V431
- 43 for V433
- 45 for V415
- 46 for V436
- 47 for V417
- 48 for V418
- 52 for V512
- 53 for V513
- 54 for V514
- 55 for V515
- 57 for V517
- 61 for V411
- 71 for V421
- 73 for V423
- 75 for V425
- 77 for V427

Example:

For a Micro Grey laminate surface with Bronzed Cherry edge, enter finish code 2112

For a Jet Black laminate surface with Light Maple edge, enter finish code 1116

This page intentionally left blank

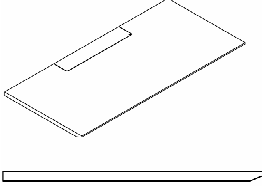
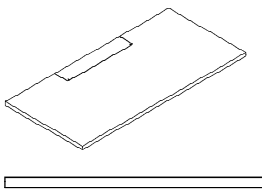
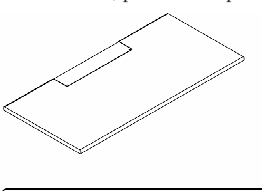
description	nominal depth	w	d	h	pattern number	L	M	V1	V2	V3
Worksurface, tapered edge 	24"	48"	22"	1 1/4"	XTTK4824A (L/M/1/2/3) () ()	\$706.	\$824.	\$824.	\$904.	\$1,093.
	24"	60"	22"	1 1/4"	XTTK6024A (L/M/1/2/3) () ()	732.	902.	902.	995.	1,211.
	24"	72"	22"	1 1/4"	XTTK7224A (L/M/1/2/3) () ()	782.	952.	952.	1,056.	1,291.
	24"	96"	22"	1 1/4"	XTTK9624A (L/M/1/2/3) () ()	871.	1,075.	1,075.	1,199.	1,476.
	30"	48"	28"	1 1/4"	XTTK4830A (L/M/1/2/3) () ()	716.	893.	893.	987.	1,201.
	30"	60"	28"	1 1/4"	XTTK6030A (L/M/1/2/3) () ()	755.	967.	967.	1,070.	1,308.
	30"	72"	28"	1 1/4"	XTTK7230A (L/M/1/2/3) () ()	809.	1,001.	1,001.	1,109.	1,359.
	30"	96"	28"	1 1/4"	XTTK9630A (L/M/1/2/3) () ()	902.	1,132.	1,132.	1,261.	1,555.
	36"	48"	34"	1 1/4"	XTTK4836A (L/M/1/2/3) () ()	751.	972.	972.	1,081.	1,323.
	36"	60"	34"	1 1/4"	XTTK6036A (L/M/1/2/3) () ()	772.	1,041.	1,041.	1,154.	1,416.
	36"	72"	34"	1 1/4"	XTTK7236A (L/M/1/2/3) () ()	843.	1,053.	1,053.	1,165.	1,432.
	36"	96"	34"	1 1/4"	XTTK9636A (L/M/1/2/3) () ()	960.	1,190.	1,190.	1,327.	1,642.
	Worksurface, veneer square edge 	24"	48"	22"	1 1/4"	XTTS4824A (1/2/3) () ()	n/a		674.	742.
24"		60"	22"	1 1/4"	XTTS6024A (1/2/3) () ()	n/a		707.	775.	878.
24"		72"	22"	1 1/4"	XTTS7224A (1/2/3) () ()	n/a		742.	810.	924.
24"		96"	22"	1 1/4"	XTTS9624A (1/2/3) () ()	n/a		798.	866.	1,003.
30"		48"	28"	1 1/4"	XTTS4830A (1/2/3) () ()	n/a		775.	844.	957.
30"		60"	28"	1 1/4"	XTTS6030A (1/2/3) () ()	n/a		798.	872.	1,004.
30"		72"	28"	1 1/4"	XTTS7230A (1/2/3) () ()	n/a		821.	901.	1,092.
30"		96"	28"	1 1/4"	XTTS9630A (1/2/3) () ()	n/a		866.	957.	1,242.
36"		48"	34"	1 1/4"	XTTS4836A (1/2/3) () ()	n/a		844.	929.	1,071.
36"		60"	34"	1 1/4"	XTTS6036A (1/2/3) () ()	n/a		878.	963.	1,097.
36"		72"	34"	1 1/4"	XTTS7236A (1/2/3) () ()	n/a		912.	1,015.	1,202.
36"		96"	34"	1 1/4"	XTTS9636A (1/2/3) () ()	n/a		980.	1,116.	1,389.
Worksurface, postformed plastic 		24"	48"	22"	1 1/4"	XTPP4824A (L) () ()	517.		n/a	n/a
	24"	60"	22"	1 1/4"	XTPP6024A (L) () ()	590.		n/a	n/a	n/a
	24"	72"	22"	1 1/4"	XTPP7224A (L) () ()	646.		n/a	n/a	n/a
	24"	96"	22"	1 1/4"	XTPP9624A (L) () ()	708.		n/a	n/a	n/a
	30"	48"	28"	1 1/4"	XTPP4830A (L) () ()	539.		n/a	n/a	n/a
	30"	60"	28"	1 1/4"	XTPP6030A (L) () ()	618.		n/a	n/a	n/a
	30"	72"	28"	1 1/4"	XTPP7230A (L) () ()	680.		n/a	n/a	n/a
	30"	96"	28"	1 1/4"	XTPP9630A (L) () ()	753.		n/a	n/a	n/a
	36"	48"	34"	1 1/4"	XTPP4836A (L) () ()	568.		n/a	n/a	n/a
	36"	60"	34"	1 1/4"	XTPP6036A (L) () ()	680.		n/a	n/a	n/a
	36"	72"	34"	1 1/4"	XTPP7236A (L) () ()	735.		n/a	n/a	n/a
	36"	96"	34"	1 1/4"	XTPP9636A (L) () ()	815.		n/a	n/a	n/a

Order Code	Specifications	Application Notes
Example: XTPP6030AL 118 118	Worksurfaces are 1 1/4" thick with square edge or tapered edge option tapering to 1/2" thick front edge.	Crinion 30"D worksurfaces correspond in width to table bases, which are specified separately. 48"W worksurfaces plan on 12' wide or 20' wide bases. 60"W worksurfaces plan on 5', 10', 15' and 20' wide bases. 72" W worksurfaces plan on 6', 12' and 18' wide bases.
XT Crinion Open Table		Power access door is 24" wide, 5" deep, centered at back edge of worksurface.
T Worksurface		
P Postformed plastic		Continous 1/2" wire drop accommodates clamp-on flat screen monitor arm or most power cords plugs.
60 Width	1. Specify finish group: L - Laminate M - Laminate/veneer edge	
30 Depth	1 - Veneer group 1 2 - Veneer group 2 3 - Veneer group 3	Actual worksurface depth is 22.35", 28.35" or 34.35".
A With center hinged power access	2. Specify worksurface finish.	
L Finish Type	3. Specify hinged access cover finish.	Worksurfaces with hinged power access enable access to suspended modular raceway.
118 Work Surface finish	AA anodized aluminum and all P1,P2 and P3 paint finishes are available except 613 Silver.	
118 Access door finish		

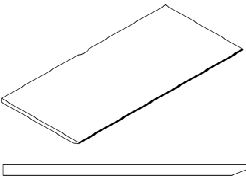
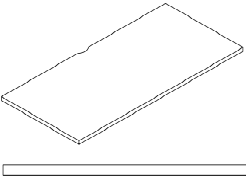
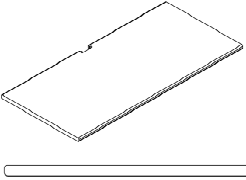
description	nominal depth	w	d	h	pattern number	L	M	V1	V2	V3
Worksurface, tapered edge 	24"	48"	22"	1 1/4"	XTTK4824U (L/M/1/2/3) () ()	\$461.	\$579.	\$579.	\$659.	\$848.
	24"	60"	22"	1 1/4"	XTTK6024U (L/M/1/2/3) () ()	487.	657.	657.	750.	966.
	24"	72"	22"	1 1/4"	XTTK7224U (L/M/1/2/3) () ()	537.	707.	707.	811.	1,046.
	24"	96"	22"	1 1/4"	XTTK9624U (L/M/1/2/3) () ()	626.	830.	830.	954.	1,231.
	30"	48"	28"	1 1/4"	XTTK4830U (L/M/1/2/3) () ()	471.	648.	648.	742.	956.
	30"	60"	28"	1 1/4"	XTTK6030U (L/M/1/2/3) () ()	510.	722.	722.	825.	1,063.
	30"	72"	28"	1 1/4"	XTTK7230U (L/M/1/2/3) () ()	564.	756.	756.	864.	1,114.
	30"	96"	28"	1 1/4"	XTTK9630U (L/M/1/2/3) () ()	657.	887.	887.	1,016.	1,310.
	36"	48"	34"	1 1/4"	XTTK4836U (L/M/1/2/3) () ()	506.	727.	727.	836.	1,078.
	36"	60"	34"	1 1/4"	XTTK6036U (L/M/1/2/3) () ()	527.	796.	796.	909.	1,171.
	36"	72"	34"	1 1/4"	XTTK7236U (L/M/1/2/3) () ()	598.	808.	808.	920.	1,187.
	36"	96"	34"	1 1/4"	XTTK9636U (L/M/1/2/3) () ()	715.	945.	945.	1,082.	1,397.
	Worksurface, veneer square edge 	24"	48"	22"	1 1/4"	XTTS4824U (1/2/3) () ()	n/a	n/a	429.	497.
24"		60"	22"	1 1/4"	XTTS6024U (1/2/3) () ()	n/a	n/a	462.	530.	633.
24"		72"	22"	1 1/4"	XTTS7224U (1/2/3) () ()	n/a	n/a	497.	565.	679.
24"		96"	22"	1 1/4"	XTTS9624U (1/2/3) () ()	n/a	n/a	553.	621.	758.
30"		48"	28"	1 1/4"	XTTS4830U (1/2/3) () ()	n/a	n/a	530.	599.	712.
30"		60"	28"	1 1/4"	XTTS6030U (1/2/3) () ()	n/a	n/a	553.	627.	759.
30"		72"	28"	1 1/4"	XTTS7230U (1/2/3) () ()	n/a	n/a	576.	656.	847.
30"		96"	28"	1 1/4"	XTTS9630U (1/2/3) () ()	n/a	n/a	621.	712.	997.
36"		48"	34"	1 1/4"	XTTS4836U (1/2/3) () ()	n/a	n/a	599.	684.	826.
36"		60"	34"	1 1/4"	XTTS6036U (1/2/3) () ()	n/a	n/a	633.	718.	852.
36"		72"	34"	1 1/4"	XTTS7236U (1/2/3) () ()	n/a	n/a	667.	770.	957.
36"		96"	34"	1 1/4"	XTTS9636U (1/2/3) () ()	n/a	n/a	735.	871.	1,144.
Worksurface, postformed plastic 		24"	48"	22"	1 1/4"	XTPP4824B (L) () ()	272.	n/a	n/a	n/a
	24"	60"	22"	1 1/4"	XTPP6024B (L) () ()	345.	n/a	n/a	n/a	n/a
	24"	72"	22"	1 1/4"	XTPP7224B (L) () ()	401.	n/a	n/a	n/a	n/a
	24"	96"	22"	1 1/4"	XTPP9624B (L) () ()	463.	n/a	n/a	n/a	n/a
	30"	48"	28"	1 1/4"	XTPP4830B (L) () ()	294.	n/a	n/a	n/a	n/a
	30"	60"	28"	1 1/4"	XTPP6030B (L) () ()	373.	n/a	n/a	n/a	n/a
	30"	72"	28"	1 1/4"	XTPP7230B (L) () ()	435.	n/a	n/a	n/a	n/a
	30"	96"	28"	1 1/4"	XTPP9630B (L) () ()	508.	n/a	n/a	n/a	n/a
	36"	48"	34"	1 1/4"	XTPP4836B (L) () ()	323.	n/a	n/a	n/a	n/a
	36"	60"	34"	1 1/4"	XTPP6036B (L) () ()	435.	n/a	n/a	n/a	n/a
	36"	72"	34"	1 1/4"	XTPP7236B (L) () ()	490.	n/a	n/a	n/a	n/a
	36"	96"	34"	1 1/4"	XTPP9636B (L) () ()	570.	n/a	n/a	n/a	n/a

Order Code	Specifications	Application Notes
Example: XTPP6030BL 118 812		
XT Crinion Open Table	Worksurfaces are 1 1/4" thick with square edge or tapered edge option tapering to 1/2" thick front edge.	Crinion 30"D worksurfaces correspond in width to table bases, which are specified separately.
T Worksurface	1. Specify finish group: L - Laminate M - Laminate/veneer edge	48"W worksurfaces plan on 12" wide or 20" wide bases. 60"W worksurfaces plan on 5', 10', 15' and 20' wide bases. 72" W worksurfaces plan on 6', 12' and 18' wide bases.
P Postformed plastic	1 - Veneer group 1 2 - Veneer group 2 3 - Veneer group 3	
60 Width	2. Specify worksurface finish.	
30 Depth	3. Specify grommet color: 812 - Easy grey 111 - Black	Edge grommet accommodates most power cord plugs up to 1" deep.
B With edge grommet		
L Finish type		
118 Surface finish		
812 Grommet finish		Actual worksurface depth is 21.85", 27.85" or 33.85".

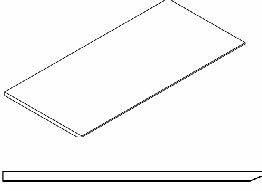
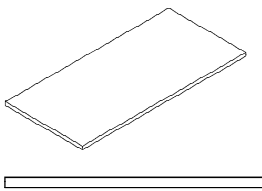
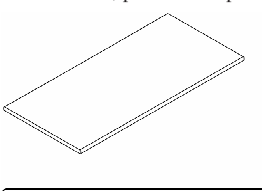
description	nominal depth	w	d	h	pattern number	L	M	V1	V2	V3
Worksurface, tapered edge 	24"	48"	22"	1 1/4"	XTTK4824C (L/M/1/2/3) ()	\$431.	\$549.	\$549.	\$629.	\$818.
	24"	60"	22"	1 1/4"	XTTK6024C (L/M/1/2/3) ()	457.	627.	627.	720.	936.
	24"	72"	22"	1 1/4"	XTTK7224C (L/M/1/2/3) ()	507.	677.	677.	781.	1,016.
	24"	96"	22"	1 1/4"	XTTK9624C (L/M/1/2/3) ()	596.	800.	800.	924.	1,201.
	30"	48"	28"	1 1/4"	XTTK4830C (L/M/1/2/3) ()	441.	618.	618.	712.	926.
	30"	60"	28"	1 1/4"	XTTK6030C (L/M/1/2/3) ()	480.	692.	692.	795.	1,033.
	30"	72"	28"	1 1/4"	XTTK7230C (L/M/1/2/3) ()	534.	726.	726.	834.	1,084.
	30"	96"	28"	1 1/4"	XTTK9630C (L/M/1/2/3) ()	627.	857.	857.	986.	1,280.
	36"	48"	34"	1 1/4"	XTTK4836C (L/M/1/2/3) ()	476.	697.	697.	806.	1,048.
	36"	60"	34"	1 1/4"	XTTK6036C (L/M/1/2/3) ()	497.	766.	766.	879.	1,141.
	36"	72"	34"	1 1/4"	XTTK7236C (L/M/1/2/3) ()	568.	778.	778.	890.	1,157.
	36"	96"	34"	1 1/4"	XTTK9636C (L/M/1/2/3) ()	685.	915.	915.	1,052.	1,367.
	Worksurface, veneer square edge 	24"	48"	22"	1 1/4"	XTTS4824C (1/2/3) ()	n/a	n/a	399.	467.
24"		60"	22"	1 1/4"	XTTS6024C (1/2/3) ()	n/a	n/a	432.	500.	603.
24"		72"	22"	1 1/4"	XTTS7224C (1/2/3) ()	n/a	n/a	467.	535.	649.
24"		96"	22"	1 1/4"	XTTS9624C (1/2/3) ()	n/a	n/a	523.	591.	728.
30"		48"	28"	1 1/4"	XTTS4830C (1/2/3) ()	n/a	n/a	500.	569.	682.
30"		60"	28"	1 1/4"	XTTS6030C (1/2/3) ()	n/a	n/a	523.	597.	729.
30"		72"	28"	1 1/4"	XTTS7230C (1/2/3) ()	n/a	n/a	546.	626.	817.
30"		96"	28"	1 1/4"	XTTS9630C (1/2/3) ()	n/a	n/a	591.	682.	967.
36"		48"	34"	1 1/4"	XTTS4836C (1/2/3) ()	n/a	n/a	569.	654.	796.
36"		60"	34"	1 1/4"	XTTS6036C (1/2/3) ()	n/a	n/a	603.	688.	822.
36"		72"	34"	1 1/4"	XTTS7236C (1/2/3) ()	n/a	n/a	637.	740.	927.
36"		96"	34"	1 1/4"	XTTS9636C (1/2/3) ()	n/a	n/a	705.	841.	1,114.
Worksurface, postformed plastic 		24"	48"	22"	1 1/4"	XTTP4824C (L) ()	242.	n/a	n/a	n/a
	24"	60"	22"	1 1/4"	XTTP6024C (L) ()	315.	n/a	n/a	n/a	n/a
	24"	72"	22"	1 1/4"	XTTP7224C (L) ()	371.	n/a	n/a	n/a	n/a
	24"	96"	22"	1 1/4"	XTTP9624C (L) ()	433.	n/a	n/a	n/a	n/a
	30"	48"	28"	1 1/4"	XTTP4830C (L) ()	264.	n/a	n/a	n/a	n/a
	30"	60"	28"	1 1/4"	XTTP6030C (L) ()	343.	n/a	n/a	n/a	n/a
	30"	72"	28"	1 1/4"	XTTP7230C (L) ()	405.	n/a	n/a	n/a	n/a
	30"	96"	28"	1 1/4"	XTTP9630C (L) ()	478.	n/a	n/a	n/a	n/a
	36"	48"	34"	1 1/4"	XTTP4836C (L) ()	293.	n/a	n/a	n/a	n/a
	36"	60"	34"	1 1/4"	XTTP6036C (L) ()	405.	n/a	n/a	n/a	n/a
	36"	72"	34"	1 1/4"	XTTP7236C (L) ()	460.	n/a	n/a	n/a	n/a
	36"	96"	34"	1 1/4"	XTTP9636C (L) ()	540.	n/a	n/a	n/a	n/a

Order Code

Example: XTTP6030CL 118
XT Crinion Open Table
T Worksurface
P Postformed plastic
60 Width
30 Depth
C With cord drop
L Finish type
118 Surface

Specifications

Worksurfaces are 1 1/4" thick with square edge or tapered edge option tapering to 1/2" thick front edge.

Specify finishes:
 L - Laminate
 M - Laminate/veneer edge
 1 - Veneer group 1
 2 - Veneer group 2
 3 - Veneer group 3

Application Notes

Crinion 30"D worksurfaces correspond in width to table bases, which are specified separately. 48"W worksurfaces plan on 12' wide or 20' wide bases. 60"W worksurfaces plan on 5', 10', 15' and 20' wide bases. 72" W worksurfaces plan on 6', 12' and 18' wide bases.

Continuous 1/2" cord drop accommodates clamp-on flat screen monitor arm or most power cords.

Actual worksurface depth is 21.85", 27.85" or 33.85".

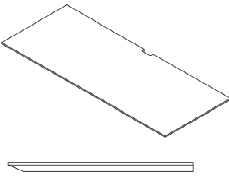
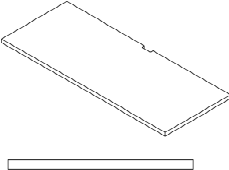
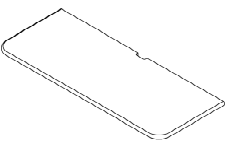
description	nominal depth	w	l	h	pattern number	L	M	V1	V2	V3
End counter, tapered edge 	24"	48"	24"	1 1/4"	XTTK4824E (L/M/1/2/3) ()	\$604.	\$777.	\$777.	\$857.	\$1,045.
	24"	60"	24"	1 1/4"	XTTK6024E (L/M/1/2/3) ()	714.	854.	854.	948.	1,163.
	24"	72"	24"	1 1/4"	XTTK7224E (L/M/1/2/3) ()	741.	904.	904.	1,008.	1,243.
	30"	48"	30"	1 1/4"	XTTK4830E (L/M/1/2/3) ()	675.	846.	846.	939.	1,153.
	30"	60"	30"	1 1/4"	XTTK6030E (L/M/1/2/3) ()	737.	919.	919.	1,022.	1,261.
	30"	72"	30"	1 1/4"	XTTK7230E (L/M/1/2/3) ()	768.	953.	953.	1,061.	1,312.
End counter, veneer square edge 	24"	48"	24"	1 1/4"	XTTS4824E (1/2/3) ()	n/a	n/a	399.	467.	558.
	24"	60"	24"	1 1/4"	XTTS6024E (1/2/3) ()	n/a	n/a	432.	500.	603.
	24"	72"	24"	1 1/4"	XTTS7224E (1/2/3) ()	n/a	n/a	467.	535.	649.
	30"	48"	30"	1 1/4"	XTTS4830E (1/2/3) ()	n/a	n/a	500.	569.	682.
	30"	60"	30"	1 1/4"	XTTS6030E (1/2/3) ()	n/a	n/a	523.	597.	729.
	30"	72"	30"	1 1/4"	XTTS7230E (1/2/3) ()	n/a	n/a	546.	626.	817.
End counter for postformed plastic 	24"	48"	24"	1 1/4"	XTPP4824E (L) ()	450.	n/a	n/a	n/a	n/a
	24"	60"	24"	1 1/4"	XTPP6024E (L) ()	535.	n/a	n/a	n/a	n/a
	24"	72"	24"	1 1/4"	XTPP7224E (L) ()	602.	n/a	n/a	n/a	n/a
	30"	48"	30"	1 1/4"	XTPP4830E (L) ()	506.	n/a	n/a	n/a	n/a
	30"	60"	30"	1 1/4"	XTPP6030E (L) ()	602.	n/a	n/a	n/a	n/a
	30"	72"	30"	1 1/4"	XTPP7230E (L) ()	720.	n/a	n/a	n/a	n/a

* Note

Order Code

Example: XTPP6024EL 118
XT Crinion Open Table
T Worksurface
P Postformed plastic
60 Width
24 Length
E End counter
L Finish Type
118 Surface

Specifications

End counters are 1 1/4" thick with square edge or tapered edge option tapering to 1/2" thick front edge. End counters are tapered front and side edges only.

Specify finishes:
 L - Laminate
 M - Laminate/veneer edge
 1 - Veneer group 1
 2 - Veneer group 2
 3 - Veneer group 3

Application Notes

End counters mount at the ends of dual tables with two end counter cantilever brackets. Specify dual end legs for end counters instead of standard dual end legs (tables with end counters must be specified from components, not assemblies).

Specify 48" W for dual 24" tables, 60" W for dual 30" tables and 72" W for dual 36" tables.

Specify added length of 24" or 30" beyond end leg for end counters.

* Note - End counters for postformed plastic are not available in these finishes:
 121 Micro grey
 129 Micro sand
 122 Brushed sand
 123 Brushed grey

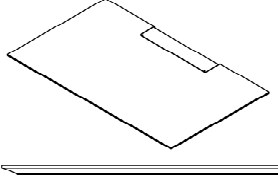
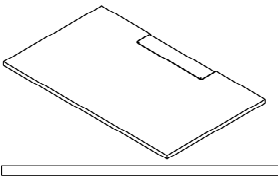
description	nominal depth	w	l	h	pattern no.	L	M	V1	V2	V3
Extended end counter, tapered edge with hinged power access 	36"	48"	36"	1 1/4"	XTTK4836D (L/M/1/2/3) () ()	\$1,024.	\$1,202.	\$1,202.	\$1,306.	\$1,541.
	36"	60"	36"	1 1/4"	XTTK6036D (L/M/1/2/3) () ()	1,052.	1,251.	1,251.	1,359.	1,609.
	36"	72"	36"	1 1/4"	XTTK7236D (L/M/1/2/3) () ()	1,127.	1,344.	1,344.	1,458.	1,736.
Extended end counter, tapered edge with grommet	36"	48"	36"	1 1/4"	XTTK4836E (L/M/1/2/3) ()	741.	904.	904.	1,008.	1,243.
	36"	60"	36"	1 1/4"	XTTK6036E (L/M/1/2/3) ()	768.	953.	953.	1,061.	1,312.
	36"	72"	36"	1 1/4"	XTTK7236E (L/M/1/2/3) ()	844.	1,046.	1,046.	1,160.	1,438.
Extended end counter, veneer square edge with hinged power access 	36"	48"	36"	1 1/4"	XTTS4836D (1/2/3) () ()	n/a	n/a	742.	807.	915.
	36"	60"	36"	1 1/4"	XTTS6036D (1/2/3) () ()	n/a	n/a	844.	924.	1,114.
	36"	72"	36"	1 1/4"	XTTS7236D (1/2/3) () ()	n/a	n/a	924.	1,008.	1,236.
Extended end counter, veneer square edge with grommet	36"	48"	36"	1 1/4"	XTTS4836E (1/2/3) ()	n/a	n/a	444.	509.	617.
	36"	60"	36"	1 1/4"	XTTS6036E (1/2/3) ()	n/a	n/a	546.	626.	817.
	36"	72"	36"	1 1/4"	XTTS7236E (1/2/3) ()	n/a	n/a	626.	710.	938.

Order Code	Specifications	Application Notes
Example: XTTP6036DL 118 AA		
XT Crinion Open Table	End counters are 1 1/4" thick with square edge or tapered edge option tapering to 1/2" thick front edge. End counters are tapered front and side edges only. 1. Specify finish group: L - Laminate M - Laminate/veneer edge 1 - Veneer group 1 2 - Veneer group 2 3 - Veneer group 3 2. Specify worksurface finish. 3. Specify hinged access cover finish.	End counters mount at the ends of dual tables with two end counter cantilever brackets. Specify dual end legs for end counters instead of standard dual end legs (tables with end counters must be specified from components, not assemblies). Specify 48" W for dual 24" tables, 60" W for dual 30" tables and 72" W for dual 36" tables.
T Worksurface		
P Postformed plastic		
60 Width		
36 Length		
D End counter, center hinged power access		
L Finish Type		
118 Surface finish		
AA Access door finish		

Hinged access covers are available in AA anodized aluminum and all standard paint finishes except 613 Silver.

description	nominal depth	w	l	h	pattern no.	L	M	V1	V2	V3
Extended end counter, postformed plastic with hinged power access	36"	48"	36"	1 1/4"	XTTP4836D (L) () ()	\$885.	n/a	n/a	n/a	n/a
	36"	60"	36"	1 1/4"	XTTP6036D (L) () ()	1,003.	n/a	n/a	n/a	n/a
	36"	72"	36"	1 1/4"	XTTP7236D (L) () ()	1,089.	n/a	n/a	n/a	n/a

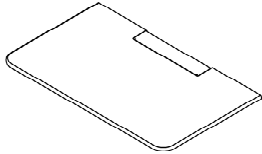

* Note

Extended end counter, postformed plastic with grommet	36"	48"	36"	1 1/4"	XTTP4836E (L) ()	602.	n/a	n/a	n/a	n/a
	36"	60"	36"	1 1/4"	XTTP6036E (L) ()	720.	n/a	n/a	n/a	n/a
	36"	72"	36"	1 1/4"	XTTP7236E (L) ()	805.	n/a	n/a	n/a	n/a

* Note

Order Code	Specifications	Application Notes
Example: XTTP6036DL 118 AA		
XT Crinion Open Table	End counters are 1 1/4" thick with square edge or tapered edge option tapering to 1/2" thick front edge. End counters are tapered front and side edges only.	End counters mount at the ends of dual tables with two end counter cantilever brackets. Specify dual end legs for end counters instead of standard dual end legs (tables with end counters must be specified from components, not assemblies).
T Worksurface		Each extended end counter requires base assembly 12" longer than worksurfaces on each side.
P Postformed plastic		* Note - End counters for postformed plastic are not available in these finishes:
60 Width	1. Specify finish group: L - Laminate M - Laminate/veneer edge	121 Micro grey
36 Length	1 - Veneer group 1 2 - Veneer group 2 3 - Veneer group 3	129 Micro sand
D End counter, center hinged power access	2. Specify worksurface finish.	122 Brushed sand
L Finish Type	3. Specify hinged access cover finish.	123 Brushed grey
118 Surface finish		
AA Access door finish		

Hinged access covers are available in AA anodized aluminum and all standard paint finishes except 613 Silver.

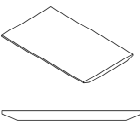
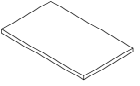
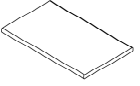
description	w	d	h	pattern number	L	M	V1	V2	V3
File top, tapered edge 	30"	18"	1 1/4"	XTTK3018F (L/M/1/2/3) ()	\$315.	\$535.	\$523.	\$558.	\$808.
	30"	36"	1 1/4"	XTTK3036F (L/M/1/2/3) ()	432.	674.	674.	756.	949.
	36"	18"	1 1/4"	XTTK3618F (L/M/1/2/3) ()	327.	546.	535.	563.	861.
	36"	36"	1 1/4"	XTTK3636F (L/M/1/2/3) ()	450.	738.	738.	827.	1,042.
	42"	18"	1 1/4"	XTTK4218F (L/M/1/2/3) ()	338.	558.	546.	574.	913.
	42"	36"	1 1/4"	XTTK4236F (L/M/1/2/3) ()	471.	767.	767.	866.	1,093.
	60"	18"	1 1/4"	XTTK6018F (L/M/1/2/3) ()	535.	824.	824.	910.	1,137.
	60"	36"	1 1/4"	XTTK6036F (L/M/1/2/3) ()	579.	879.	879.	993.	1,255.
	72"	18"	1 1/4"	XTTK7218F (L/M/1/2/3) ()	562.	853.	853.	955.	1,195.
	72"	36"	1 1/4"	XTTK7236F (L/M/1/2/3) ()	618.	891.	891.	1,004.	1,270.
84"	18"	1 1/4"	XTTK8418F (L/M/1/2/3) ()	608.	910.	910.	1,023.	1,251.	
84"	36"	1 1/4"	XTTK8436F (L/M/1/2/3) ()	662.	958.	958.	1,091.	1,384.	
File top, veneer square edge 	30"	18"	1 1/4"	XTTS3018F (1/2/3) ()	n/a	n/a	233.	256.	425.
	36"	18"	1 1/4"	XTTS3618F (1/2/3) ()	n/a	n/a	239.	262.	459.
	42"	18"	1 1/4"	XTTS4218F (1/2/3) ()	n/a	n/a	245.	268.	495.
File top, postformed plastic 	30"	18"	1 1/4"	XTPP3018F (L) ()	214.	n/a	n/a	n/a	n/a
	36"	18"	1 1/4"	XTPP3618F (L) ()	225.	n/a	n/a	n/a	n/a
	42"	18"	1 1/4"	XTPP4218F (L) ()	236.	n/a	n/a	n/a	n/a

Order Code	
Example: XTPP4218FL 118	
XT	Crinion Open Table
T	Worksurface
P	Postformed
42	Width
18	Depth
F	File top
L	Finish type
118	Surface

Specifications
File tops are 1 1/4" thick with square edge or tapered edge option tapering to 1/2" thick front edge. Tapered edge file tops are tapered front and back edges only.
Specify finishes: L - Laminate M - Laminate/veneer edge 1 - Veneer group 1 2 - Veneer group 2 3 - Veneer group 3

Application Notes
File tops correspond to 30", 36" or 42"W lateral files. File tops on 2 high Calibre files positioned perpendicular to the Crinion Open Table serve as a worksurface return.

Complete base assemblies fixed height 24" D dual

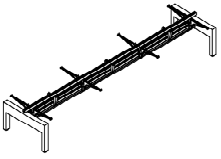
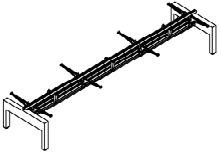
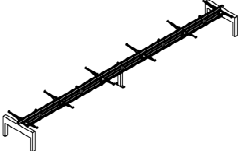
description	nominal	w	d	h	pattern number	P2	P3
 Base assembly, continuous	10' dual	120"	44"	28 1/2"	XTB1 BAS 24D10CF () ()	\$8,160.	\$8,376.
	12' dual	144"	44"	28 1/2"	XTB1 BAS 24D12CF () ()	8,502.	8,718.
	15' dual	180"	44"	28 1/2"	XTB1 BAS 24D15CF () ()	9,838.	10,062.
 Base assembly, segmented	10' + 5' dual	180"	44"	28 1/2"	XTB1 BAS 24D15SF () ()	10,553.	10,779.
 Base assembly, with intermediate leg	12' + 6' dual	216"	44"	28 1/2"	XTB1 BAS 24D18SF () ()	11,645.	11,870.
	10' + 10' dual	240"	44"	28 1/2"	XTB1 BAS 24D20SF () ()	12,727.	12,960.
	12' + 12' dual	288"	44"	28 1/2"	XTB1 BAS 24D24SF () ()	13,411.	13,644.
	15' + 10' dual	300"	44"	28 1/2"	XTB1 BAS 24D25SF () ()	14,405.	14,647.

Order Code

Example: **XTB1BAS24D10CF 613 AA**

XT	Crinion Open Table
B1	Base components
BAS	Assembly
24	Depth
D	Dual
10	Width
C	Continuous
F	Fixed height
613	Base finish
AA	Top channel finish

Specifications

Base assemblies include end legs, beams, trusses, cantilever brackets, channels and end caps.

Fixed height base assemblies have shared cantilever brackets for adjacent worksurfaces and midspan support brackets for every worksurface.

- Specify painted finish for base assembly.
For leg and cantilever brackets specify one paint finish for all.
- Specify finish for top channel.
AA anodized aluminum and all paint finishes are available except 613 Silver.
Beams are anodized aluminum only.



Application Notes

Complete base assemblies include all base components necessary to support worksurfaces. Specify screens, power components and cable trays separately. Base assemblies include end legs, intermediate leg (where required), beams, trusses, cantilever brackets, mid span support brackets, top channel and end caps.

Base assemblies correspond to:
 10': four 60"x24"D worksurfaces
 12': four 72"x24"D worksurfaces
 15': six 60"x24"D worksurfaces
 18': six 72"x24"D worksurfaces
 20': eight 60"x24"D worksurfaces
 24': eight 72"x24"D worksurfaces
 25': ten 60"x24"D worksurfaces

No table on this page has beams longer than 15'.

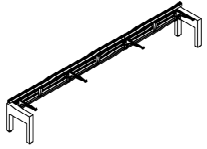
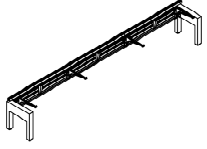
Complete base assemblies fixed height 24" D single sided

description	nominal	w	d	h	pattern number	P2	P3
 Base assembly, continuous	10' single sided	120"	24"	28 1/2"	XTB1 BAS 24S10CF () ()	\$7,342.	\$7,550.
	12' single sided	144"	24"	28 1/2"	XTB1 BAS 24S12CF () ()	7,684.	7,891.
	15' single sided	180"	24"	28 1/2"	XTB1 BAS 24S15CF () ()	8,716.	8,927.
 Base assembly, segmented	10' + 5' single sided	180"	24"	28 1/2"	XTB1 BAS 24S15SF () ()	9,432.	9,644.
 Base assembly, with intermediate leg	12' + 6' single sided	216"	24"	28 1/2"	XTB1 BAS 24S18SF () ()	10,522.	10,735.
	10' + 10' single sided	240"	24"	28 1/2"	XTB1 BAS 24S20SF () ()	11,301.	11,517.
	12' + 12' single sided	288"	24"	28 1/2"	XTB1 BAS 24S24SF () ()	11,984.	12,200.
	15' + 10' single sided	300"	24"	28 1/2"	XTB1 BAS 24S25SF () ()	12,674.	12,895.

Order Code

Example:	XTB1BAS24S10CF 613 118
XT	Crinion Open Table
B1	Base components
BAS	Assembly
24	Depth
S	Single
10	Width
C	Continuous
F	Fixed height
613	Base finish
118	Top channel finish

Specifications

Base assemblies include end legs, beams, trusses, cantilever brackets, channels and end caps.

Fixed height base assemblies have shared cantilever brackets for adjacent worksurfaces and midspan support brackets for every worksurface.

- Specify base finish for base assembly.
For legs and cantilever brackets specify one paint finish for all.
- Specify top channel finish.
AA anodized aluminum and all paint finishes are available except 613 Silver.
Beams are anodized aluminum only.

Application Notes

Complete base assemblies include all base components necessary to support worksurfaces. Specify screens, power components and cable trays separately. Base assemblies include end legs, intermediate leg (where required), beams, trusses, cantilever brackets, mid span support brackets, top channel and end caps.

No table on this page has beams longer than 15'.

Base assemblies correspond to:
 10': two 60"x24"D worksurfaces
 12': two 72"x24"D worksurfaces
 15': three 60"x24"D worksurfaces
 18': three 72"x24"D worksurfaces
 20': four 60"x24"D worksurfaces
 24': four 72"x24"D worksurfaces
 25': five 60"x24"D worksurfaces

Complete base assemblies fixed height 30" D dual

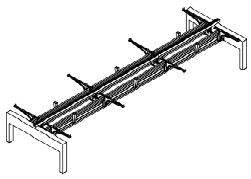
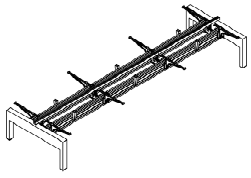
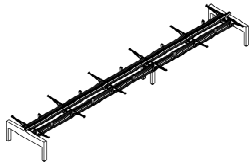
description	nominal	w	d	h	pattern number	P2	P3
	10' dual	120"	54"	28 1/2"	XTB1 BAS 30D10CF () ()	\$9,710.	\$9,985.
	12' dual	144"	54"	28 1/2"	XTB1 BAS 30D12CF () ()	10,106.	10,381.
	15' dual	180"	54"	28 1/2"	XTB1 BAS 30D15CF () ()	11,764.	12,069.
	10' + 5' dual	180"	54"	28 1/2"	XTB1 BAS 30D15SF () ()	12,756.	13,060.
	12' + 6' dual	216"	54"	28 1/2"	XTB1 BAS 30D18SF () ()	14,134.	14,482.
	10' + 10' dual	240"	54"	28 1/2"	XTB1 BAS 30D20SF () ()	15,758.	16,135.
	12' + 12' dual	288"	54"	28 1/2"	XTB1 BAS 30D24CF () ()	16,551.	16,928.
	15' + 10' dual	300"	54"	28 1/2"	XTB1 BAS 30D25CF () ()	17,812.	18,218.

Order Code

Example:	XTB1BAS30D18SF 613 111
XT	Crinion Open Table
B1	Base components
BAS	Assembly
30	Depth
D	Dual
18	Width
S	Segmented
F	Fixed height
613	Base finish
111	Top channel finish

Specifications

Base assemblies include end legs, beams, trusses, cantilever brackets, channels and end caps.

Fixed height base assemblies have shared cantilever brackets for adjacent worksurfaces and midspan support brackets for every worksurface.

- Specify base finish for base assembly.
For legs and cantilever brackets specify one paint finish for all.
- Specify top channel finish.
AA anodized aluminum and all paint finishes are available except 613 Silver.
Beams are anodized aluminum only.

Application Notes

Complete base assemblies include all base components necessary to support worksurfaces. Specify screens, power components and cable trays separately. Base assemblies include end legs, intermediate leg (where required), beams, trusses, cantilever brackets, mid span support brackets, top channel and end caps.

No table on this page has beams longer than 15'.

Base assemblies correspond to:
 10': four 60"x30"D worksurfaces
 12': four 72"x30"D worksurfaces
 15': six 60"x30"D worksurfaces
 18': six 72"x30"D worksurfaces
 20': eight 60"x30"D worksurfaces
 24': eight 72"x30"D worksurfaces
 25': ten 60"x30"D worksurfaces

Complete base assemblies fixed height 30" D single sided

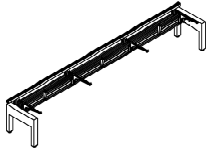
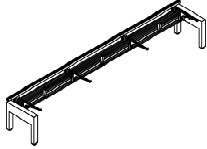
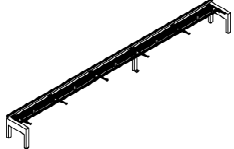
description	nominal	w	d	h	pattern number	P2	P3
 Base assembly, continuous	10' single sided	120"	28 ³ / ₄ "	28 ¹ / ₂ "	XTB1 BAS 30S10CF () ()	\$8,547.	\$8,784.
	12' single sided	144"	28 ³ / ₄ "	28 ¹ / ₂ "	XTB1 BAS 30S12CF () ()	8,943.	9,180.
	15' single sided	180"	28 ³ / ₄ "	28 ¹ / ₂ "	XTB1 BAS 30S15CF () ()	10,174.	10,426.
 Base assembly, segmented	10' + 5' single sided	180"	28 ³ / ₄ "	28 ¹ / ₂ "	XTB1 BAS 30S15SF () ()	9,513.	9,764.
 Base assembly, with intermediate leg	12' + 6' single sided	216"	28 ³ / ₄ "	28 ¹ / ₂ "	XTB1 BAS 30S18SF () ()	10,329.	10,580.
	10' + 10' single sided	240"	28 ³ / ₄ "	28 ¹ / ₂ "	XTB1 BAS 30S20SF () ()	11,747.	12,013.
	12' + 12' single sided	288"	28 ³ / ₄ "	28 ¹ / ₂ "	XTB1 BAS 30S24SF () ()	14,194.	14,459.
	15' + 10' single sided	300"	28 ³ / ₄ "	28 ¹ / ₂ "	XTB1 BAS 30S25SF () ()	15,029.	15,308.

Order Code

Example:	XTB1BAS30S15CF 613 115
XT	Crinion Open Table
B1	Base components
BAS	Assembly
30	Depth
S	Single
15	Width
C	Continuous
F	Fixed height
613	Base finish
115	Top channel finish

Specifications

Base assemblies include end legs, beams, trusses, cantilever brackets, channels and end caps.

Fixed height base assemblies have shared cantilever brackets for adjacent worksurfaces and midspan support brackets for every worksurface.

- Specify base finish for base assembly.
For legs and cantilever brackets specify one paint finish for all.
- Specify top channel finish.
AA anodized aluminum and all paint finishes are available except 613 Silver.
Beams are anodized aluminum only.

Application Notes

Complete base assemblies include all base components necessary to support worksurfaces. Specify screens, power components and cable trays separately. Base assemblies include end legs, intermediate leg (where required), beams, trusses, cantilever brackets, mid span support brackets, top channel and end caps.

No table on this page has beams longer than 15'.

Base assemblies correspond to:
 10': two 60"x30"D worksurfaces
 12': two 72"x30"D worksurfaces
 15': three 60"x30"D worksurfaces
 18': three 72"x30"D worksurfaces
 20': four 60"x30"D worksurfaces
 24': four 72"x30"D worksurfaces
 25': five 60"x30"D worksurfaces

Complete base assemblies adjustable height 30" D dual

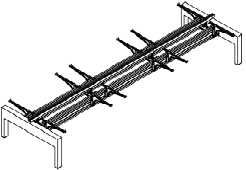
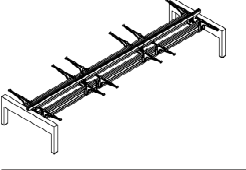
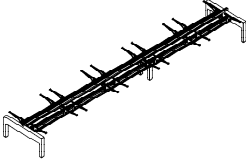
description	nominal	w	d	h	pattern number	P2	P3
 Base assembly, continuous	10' dual	120"	54"	28 1/2"	XTB1 BAS 30D10CA () ()	\$9,853.	\$10,139.
	12' dual	144"	54"	28 1/2"	XTB1 BAS 30D12CA () ()	10,250.	10,536.
	15' dual	180"	54"	28 1/2"	XTB1 BAS 30D15CA () ()	12,179.	12,509.
 Base assembly, segmented	10' + 5' dual	180"	54"	28 1/2"	XTB1 BAS 30D15SA () ()	13,171.	13,501.
 Base assembly, with intermediate leg	12' + 6' dual	216"	54"	28 1/2"	XTB1 BAS 30D18SA () ()	14,548.	14,923.
	10' + 10' dual	240"	54"	28 1/2"	XTB1 BAS 30D20SA () ()	16,443.	16,862.
	12' + 12' dual	288"	54"	28 1/2"	XTB1 BAS 30D24CA () ()	17,237.	17,655.
	15' + 10' dual	300"	54"	28 1/2"	XTB1 BAS 30D25CA () ()	18,769.	19,232.

Order Code	Specifications	Application Notes	
Example: XTB1BAS30D18SA 613 118	Base assemblies include end legs, beams, trusses, cantilever brackets, channels and end caps. <ol style="list-style-type: none"> Specify base finish for base assembly. For legs and cantilever brackets specify one paint finish for all. Specify top channel finish. AA anodized aluminum and all paint finishes are available except 613 Silver. Beams are anodized aluminum only. 	Complete base assemblies include all base components necessary to support worksurfaces. Specify screens, power components and cable trays separately. Base assemblies include end legs, intermediate leg (where required), beams, trusses, cantilever brackets, top channel and end caps. No table on this page has beams longer than 15'.	
XT Crinion Open Table			
B1 Base components			
BAS Assembly			
30 Depth			
D Dual			
18 Width			
S Segmented			
A Adjustable height			
613 Base finish			
118 Top channel finish			
			Base assemblies correspond to: 10': four 60"x30"D worksurfaces 12': four 72"x30"D worksurfaces 15': six 60"x30"D worksurfaces 18': six 72"x30"D worksurfaces 20': eight 60"x30"D worksurfaces 24': eight 72"x30"D worksurfaces 25': ten 60"x30"D worksurfaces

Complete base assemblies adjustable height 30" D single sided

Crinion Open Table

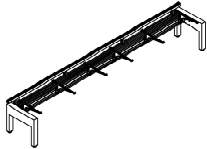
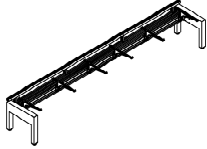
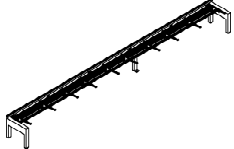
description	nominal	w	d	h	pattern number	P2	P3
 Base assembly, continuous	10' single sided	120"	28 ³ / ₄ "	28 ¹ / ₂ "	XTB1 BAS 30S10CA () ()	\$8,641.	\$8,883.
	12' single sided	144"	28 ³ / ₄ "	28 ¹ / ₂ "	XTB1 BAS 30S12CA () ()	9,037.	9,279.
	15' single sided	180"	28 ³ / ₄ "	28 ¹ / ₂ "	XTB1 BAS 30S15CA () ()	10,415.	10,679.
 Base assembly, segmented	10' +5' single sided	180"	28 ³ / ₄ "	28 ¹ / ₂ "	XTB1 BAS 30S15SA () ()	9,754.	10,018.
 Base assembly, with intermediate leg	12' + 6' single sided	216"	28 ³ / ₄ "	28 ¹ / ₂ "	XTB1 BAS 30S18SA () ()	10,789.	11,054.
	10' + 10' single sided	240"	28 ³ / ₄ "	28 ¹ / ₂ "	XTB1 BAS 30S20SA () ()	12,134.	12,421.
	12' + 12' single sided	288"	28 ³ / ₄ "	28 ¹ / ₂ "	XTB1 BAS 30S24SA () ()	14,581.	14,867.
	15' + 10' single sided	300"	28 ³ / ₄ "	28 ¹ / ₂ "	XTB1 BAS 30S25SA () ()	15,561.	15,870.

Order Code	Specifications	Application Notes	
Example: XTB1BAS30S18SA 613 AA	Base assemblies include end legs, beams, trusses, cantilever brackets, channels and end caps. <ol style="list-style-type: none"> Specify base finish for base assembly. For legs and cantilever brackets specify one paint finish for all. Specify top channel finish. AA anodized aluminum and all paint finishes are available except 613 Silver. Beams are anodized aluminum only. 	Complete base assemblies include all base components necessary to support worksurfaces. Specify screens, power components and cable trays separately. Base assemblies include end legs, intermediate leg (where required), beams, trusses, cantilever brackets, top channel and end caps. No table on this page has beams longer than 15'.	
XT Crinion Open Table			
B1 Base components			
BAS Assembly			
30 Depth			
S Single			
18 Width			
S Segmented			
A Adjustable height			
613 Base finish			
AA Top channel finish			
			Base assemblies correspond to: 10': two 60"x30"D worksurfaces 12': two 72"x30"D worksurfaces 15': three 60"x30"D worksurfaces 18': three 72"x30"D worksurfaces 20': four 60"x30"D worksurfaces 24': four 72"x30"D worksurfaces 25': five 60"x30"D worksurfaces

Complete base assemblies fixed height 36" D dual

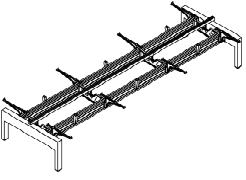
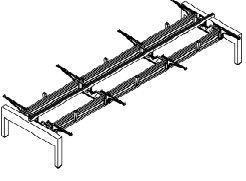
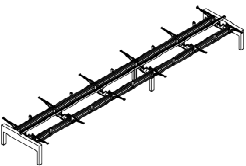
description	nominal	w	h	d	pattern number	P2	P3
	10' dual	120"	28½"	54"	XTB1 BAS 36D10CF () ()	\$9,842.	\$10,118.
	12' dual	144"	28½"	54"	XTB1 BAS 36D12CF () ()	10,238.	10,514.
	15' dual	180"	28½"	54"	XTB1 BAS 36D15CF () ()	11,940.	12,245.
	10' + 5' dual	180"	28½"	54"	XTB1 BAS 36D15SF () ()	12,932.	13,237.
	12' + 6' dual	216"	28½"	54"	XTB1 BAS 36D18SF () ()	14,310.	14,658.
	10' + 10' dual	240"	28½"	54"	XTB1 BAS 36D20SF () ()	15,978.	16,355.
	12' + 12' dual	288"	28½"	54"	XTB1 BAS 36D24CF () ()	16,771.	17,148.
	15' + 10' dual	300"	28½"	54"	XTB1 BAS 36D25CF () ()	18,077.	18,482.

Order Code	
Example: XTB1BAS36D18SF 613 111	
XT	Crinion Open Table
B1	Base components
BAS	Assembly
36	Depth
D	Dual
18	Width
S	Segmented
F	Fixed height
613	Base finish
111	Top channel finish

Specifications

Base assemblies include end legs, beams, trusses, cantilever brackets, channels and end caps.

Fixed height base assemblies have shared cantilever brackets for adjacent worksurfaces and midspan support brackets for every worksurface.

- Specify base finish for base assembly.
For legs and cantilever brackets specify one paint finish for all.
- Specify top channel finish.
AA anodized aluminum and all paint finishes are available except 613 Silver.
Beams are anodized aluminum only.

Application Notes

Complete base assemblies include all base components necessary to support worksurfaces. Specify screens, power components and cable trays separately. Base assemblies include end legs, intermediate leg (where required), beams, trusses, cantilever brackets, mid span support brackets, top channel and end caps.

No table on this page has beams longer than 15'.

Base assemblies correspond to:
 10': four 60"x36"D worksurfaces
 12': four 72"x36"D worksurfaces
 15': six 60"x36"D worksurfaces
 18': six 72"x36"D worksurfaces
 20': eight 60"x36"D worksurfaces
 24': eight 72"x36"D worksurfaces
 25': ten 60"x36"D worksurfaces

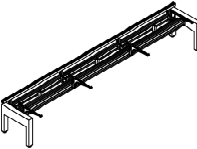
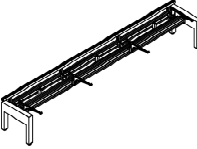
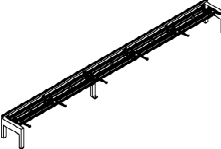

Complete base assemblies fixed height 36" D single sided

description	nominal	w	d	h	pattern number	P2	P3
 Base assembly, continuous	10' single sided	120"	28 ³ / ₄ "	28 ¹ / ₂ "	XTB1 BAS 36S10CF () ()	\$8,679.	\$8,916.
	12' single sided	144"	28 ³ / ₄ "	28 ¹ / ₂ "	XTB1 BAS 36S12CF () ()	9,075.	9,313.
	15' single sided	180"	28 ³ / ₄ "	28 ¹ / ₂ "	XTB1 BAS 36S15CF () ()	10,350.	10,602.
 Base assembly, segmented	10' + 5' single sided	180"	28 ³ / ₄ "	28 ¹ / ₂ "	XTB1 BAS 36S15SF () ()	9,689.	9,941.
 Base assembly, with intermediate leg	12' + 6' single sided	216"	28 ³ / ₄ "	28 ¹ / ₂ "	XTB1 BAS 36S18SF () ()	10,725.	10,977.
	10' + 10' single sided	240"	28 ³ / ₄ "	28 ¹ / ₂ "	XTB1 BAS 36S20SF () ()	11,968.	12,233.
	12' + 12' single sided	288"	28 ³ / ₄ "	28 ¹ / ₂ "	XTB1 BAS 36S24SF () ()	14,415.	14,680.
	15' + 10' single sided	300"	28 ³ / ₄ "	28 ¹ / ₂ "	XTB1 BAS 36S25SF () ()	15,292.	15,573.

Order Code	Specifications	Application Notes
Example: XTB1BAS36S18SF 613 AA	Base assemblies include end legs, beams, trusses, cantilever brackets, channels and end caps.	Complete base assemblies include all base components necessary to support worksurfaces. Specify screens, power components and cable trays separately. Base assemblies include end legs, intermediate leg (where required), beams, trusses, cantilever brackets, mid span support brackets, top channel and end caps.
XT Crinion Open Table	Fixed height base assemblies have shared cantilever brackets for adjacent worksurfaces and midspan support brackets for every worksurface.	
B1 Base components	<ol style="list-style-type: none"> Specify base finish for base assembly. For legs and cantilever brackets specify one paint finish for all. Specify top channel finish. AA anodized aluminum and all paint finishes are available except 613 Silver. Beams are anodized aluminum only. 	Base assemblies correspond to: 10': two 60"x36"D worksurfaces 12': two 72"x36"D worksurfaces 15': three 60"x36"D worksurfaces 18': three 72"x36"D worksurfaces 20': four 60"x36"D worksurfaces 24': four 72"x36"D worksurfaces 25': five 60"x36"D worksurfaces
BAS Assembly		
36 Depth		
S Single		
18 Width		
S Segmented		
F Fixed height		
613 Base finish		
AA Top channel finish		

Complete base assemblies adjustable height 36" D dual

Crinion Open Table

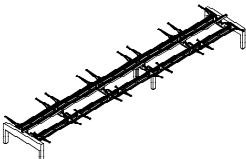
description	nominal	w	d	h	pattern number	P2	P3
 Base assembly, continuous	10' dual	120"	54"	28½"	XTB1 BAS 36D10CA () ()	\$9,985.	\$10,271.
	12' dual	144"	54"	28½"	XTB1 BAS 36D12CA () ()	10,381.	10,669.
	15' dual	180"	54"	28½"	XTB1 BAS 36D15CA () ()	12,355.	12,685.
 Base assembly, segmented	10' + 5' dual	180"	54"	28½"	XTB1 BAS 36D15SA () ()	13,347.	13,677.
 Base assembly, with intermediate leg	12' + 6' dual	216"	54"	28½"	XTB1 BAS 36D18SA () ()	14,724.	15,099.
	10' + 10' dual	240"	54"	28½"	XTB1 BAS 36D20SA () ()	16,663.	17,083.
	12' + 12' dual	288"	54"	28½"	XTB1 BAS 36D24CA () ()	17,457.	17,876.
	15' + 10' dual	300"	54"	28½"	XTB1 BAS 36D25CA () ()	19,033.	19,496.

Order Code	Specifications	Application Notes	
Example: XTB1BAS36D18SA 613 115	Base assemblies include end legs, beams, trusses, cantilever brackets, channels and end caps. <ol style="list-style-type: none"> Specify base finish for base assembly. For legs and cantilever brackets specify one paint finish for all. Specify top channel finish. AA anodized aluminum and all paint finishes are available except 613 Silver. Beams are anodized aluminum only. 	Complete base assemblies include all base components necessary to support worksurfaces. Specify screens, power components and cable trays separately. Base assemblies include end legs, intermediate leg (where required), beams, trusses, cantilever brackets, top channel and end caps. No table on this page has beams longer than 15'.	
XT Crinion Open Table			
B1 Base components			
BAS Assembly			
36 Depth			
D Dual			
18 Width			
S Segmented			
A Adjustable height			
613 Base finish			
115 Top channel finish			
			Base assemblies correspond to: 10': four 60"x36"D worksurfaces 12': four 72"x36"D worksurfaces 15': six 60"x36"D worksurfaces 18': six 72"x36"D worksurfaces 20': eight 60"x36"D worksurfaces 24': eight 72"x36"D worksurfaces 25': ten 60"x36"D worksurfaces

Complete base assemblies adjustable height 36" D single sided

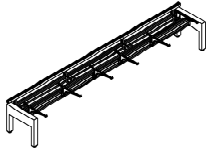
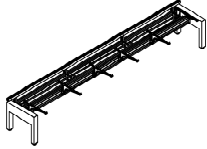
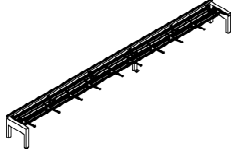
description	nominal	w	d	h	pattern number	P2	P3
 Base assembly, continuous	10' single sided	120"	28 ³ / ₄ "	28 ¹ / ₂ "	XTB1 BAS 36S10CA () ()	\$8,773.	\$9,016.
	12' single sided	144"	28 ³ / ₄ "	28 ¹ / ₂ "	XTB1 BAS 36S12CA () ()	9,169.	9,412.
	15' single sided	180"	28 ³ / ₄ "	28 ¹ / ₂ "	XTB1 BAS 36S15CA () ()	10,591.	10,856.
 Base assembly, segmented	10' + 5' single sided	180"	28 ³ / ₄ "	28 ¹ / ₂ "	XTB1 BAS 36S15SA () ()	9,930.	10,195.
 Base assembly, with intermediate leg	12' + 6' single sided	216"	28 ³ / ₄ "	28 ¹ / ₂ "	XTB1 BAS 36S18SA () ()	10,966.	11,230.
	10' + 10' single sided	240"	28 ³ / ₄ "	28 ¹ / ₂ "	XTB1 BAS 36S20SA () ()	12,355.	12,641.
	12' + 12' single sided	288"	28 ³ / ₄ "	28 ¹ / ₂ "	XTB1 BAS 36S24SA () ()	14,801.	15,087.
	15' + 10' single sided	300"	28 ³ / ₄ "	28 ¹ / ₂ "	XTB1 BAS 36S25SA () ()	15,826.	16,135.

Order Code	Specifications	Application Notes	
Example: XTB1BAS36S18SA 613 AA	Base assemblies include end legs, beams, trusses, cantilever brackets, channels and end caps. 1. Specify base finish for base assembly. For legs and cantilever brackets specify one paint finish for all. 2. Specify top channel finish. AA anodized aluminum and all paint finishes are available except 613 Silver. Beams are anodized aluminum only.	Complete base assemblies include all base components necessary to support worksurfaces. Specify screens, power components and cable trays separately. Base assemblies include end legs, intermediate leg (where required), beams, trusses, cantilever brackets, top channel and end caps. No table on this page has beams longer than 15'.	
XT Crinion Open Table			
B1 Base components			
BAS Assembly			
36 Depth			
S Single			
18 Width			
S Segmented			
A Adjustable height			
613 Base finish			
AA Top channel finish			
			Base assemblies correspond to: 10': two 60"x36"D worksurfaces 12': two 72"x36"D worksurfaces 15': three 60"x36"D worksurfaces 18': three 72"x36"D worksurfaces 20': four 60"x36"D worksurfaces 24': four 72"x36"D worksurfaces 25': five 60"x36"D worksurfaces

description	nominal	w	d	h	pattern number	list price
 <p>Top channel</p>	4'	48"	2 1/2"	2"	XTC1 48 ()	\$148.
	5'	60"	2 1/2"	2"	XTC1 60 ()	187.
	6'	72"	2 1/2"	2"	XTC1 72 ()	220.
	8'	96"	2 1/2"	2"	XTC1 96 ()	298.
	10'	120"	2 1/2"	2"	XTC1 120 AA	375.
	12'	144"	2 1/2"	2"	XTC1 144 AA	441.
Top channel end cap			2 1/2"	2"	XTC1 END ()	33.



 <p>Top channel for frameless glass addups</p>	4'	48"	2 1/2"	2"	XTCA1 48 ()	220.
	5'	60"	2 1/2"	2"	XTCA1 60 ()	265.
	6'	72"	2 1/2"	2"	XTCA1 72 ()	314.
	8'	96"	2 1/2"	2"	XTCA1 96 ()	408.
	10'	120"	2 1/2"	2"	XTCA1 120 AA	496.
	12'	144"	2 1/2"	2"	XTCA1 144 AA	617.

 <p>Top channel filler</p>		48"			XTCF 48 ()	28.
		60"			XTCF 60 ()	38.
		72"			XTCF 72 ()	38.

Order Code

Example:	XTC1120A
XT	Crinion open table
C1	Top channel
120	Width
AA	Finish

Specifications

Top channels are extruded aluminum with natural anodized finish AA or any standard painted finish except 613 Silver.

Top channel end caps are die cast aluminum AA or any standard painted finish except 613 Silver.

Top channel filler is 812 Easy Grey or 111 Black.

Application Notes

Crinion Open Table top channel supports privacy screens and suspended raceway components at any point. Top channel is required at the center of dual tables.

Top channels and end caps are included in complete base assemblies.

Top channels correspond in width to one or two worksurface widths.

Beams for single sided or dual tables 24" D

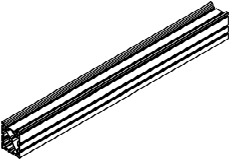
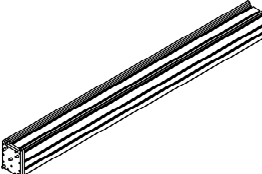
description	nominal	w	d	h	pattern number	list price
 Starter beam set for 24" D	5'	52"	3"	8"	XTB1TB5C	\$992.
	6'	64"	3"	8"	XTB1TB6C	1,102.
	8'	88"	3"	8"	XTB1TB8C	1,323.
	10'	112"	3"	8"	XTB1TB10C	1,599.
	12'	136"	3"	8"	XTB1TB12C	1,874.
	15'	172"	3"	8"	XTB1TB15C	2,314.
 Extension beam set for 24" D tables	4'	48"	3"	8"	XTB1TB4E	1,323.
	5'	60"	3"	8"	XTB1TB5E	1,433.
	6'	72"	3"	8"	XTB1TB6E	1,543.
	8'	96"	3"	8"	XTB1TB8E	1,763.
	10'	120"	3"	8"	XTB1TB10E	2,039.
	12'	144"	3"	8"	XTB1TB12E	2,314.
	15'	180"	3"	8"	XTB1TB15E	2,755.

Order Code

Example: XTB1TB15C	
XT	Crinion Open Table
B1	Base components
TB	Dual beam set
15	Width
C	Starter

Specifications

Beams are extruded aluminum with natural anodized finish.

Application Notes

Crinion Open Table bases are assembled from beams, end legs, intermediate legs and trusses.

Beam sets can be used with either dual or single sided tables. Table bases require one starter beam and extension beam adding up to the length as the sum of the worksurface widths on one side.

Extension beam sets are specified only to add on to starter sets or other extension beams.

Beam sets must be supported by intermediate legs at least every 16'. Intermediate leg must be positioned at beam truss location, where two worksurfaces meet.

Beams for dual tables

30" and 36" D

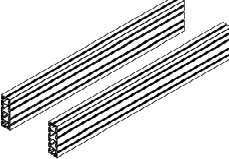
description	nominal	w		h	pattern number	list price
Starter beam set for dual table 30" or 36" (pair of beams) 	5'	52"	3"	8"	XTB1DB5C	\$1,323.
	6'	64"	3"	8"	XTB1DB6C	1,433.
	8'	88"	3"	8"	XTB1DB8C	1,874.
	10'	112"	3"	8"	XTB1DB10C	2,204.
	12'	136"	3"	8"	XTB1DB12C	2,535.
	15'	172"	3"	8"	XTB1DB15C	2,976.

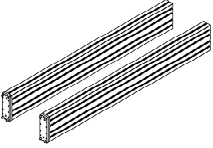
Extension beam set for dual table 30" or 36" (pair of beams) 	4'	48"	3"	8"	XTB1DB4E	1,763.
	5'	60"	3"	8"	XTB1DB5E	1,763.
	6'	72"	3"	8"	XTB1DB6E	1,874.
	8'	96"	3"	8"	XTB1DB8E	2,314.
	10'	120"	3"	8"	XTB1DB10E	2,645.
	12'	144"	3"	8"	XTB1DB12E	2,976.
	15'	180"	3"	8"	XTB1DB15E	3,417.

Order Code

Example: XTB1DB15C
XT Crinion Open Table
B1 Base components
DB Dual beam set
15 Width
C Starter

Specifications

Beams are extruded aluminum with natural anodized finish.

Beam sets are starter or extension.

Extension beam sets are specified only to add on to starter sets or other extension beams.

Application Notes

Crinion Open Table bases are assembled from beams, end legs, intermediate legs and trusses. Beam sets may be used with either worksurface depth. Dual tables require one pair of main beams of the same nominal width as the sum of the worksurfaces on each side.

Beam sets must be supported by intermediate legs at least every 16'. Intermediate leg must be positioned at beam truss location, where two worksurfaces meet.

Beams for single sided tables 30" and 36" D

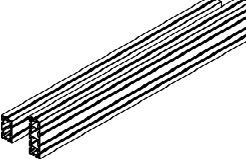
description	nominal	w	d	h	pattern number	P3
Starter beam set for single sided table 30" or 36" (main and back beam) 	5'	52"		8"	XTB1SB5C	\$1,158.
	6'	64"		8"	XTB1SB6C	1,212.
	8'	88"		8"	XTB1SB8C	1,599.
	10'	112"		8"	XTB1SB10C	1,874.
	12'	136"		8"	XTB1SB12C	2,204.
	15'	172"		8"	XTB1SB15C	2,535.

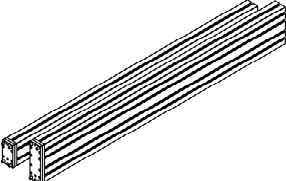
Extension beam set for single sided table 30" or 36" (main and back beam) 	4'	48"		8"	XTB1SB4E	1,543.
	5'	60"		8"	XTB1SB5E	1,599.
	6'	72"		8"	XTB1SB6E	1,653.
	8'	96"		8"	XTB1SB8E	2,039.
	10'	120"		8"	XTB1SB10E	2,314.
	12'	144"		8"	XTB1SB12E	2,645.
	15'	180"		8"	XTB1SB15E	2,976.

Order Code

Example: XTB1DB15C
XT Crinion Open Table
B1 Base components
DB Dual beam set
15 Width
C Starter

Specifications

Beams are extruded aluminum with natural anodized finish.

Beam sets are starter or extension.

Extension beam sets are specified only to add on to starter sets or other extension beams.

Application Notes

Crinion Open Table bases are assembled from beams, end legs, intermediate legs and trusses. Beam sets may be used with either worksurface depth. Single sided tables require one pair of main beams of the same nominal width as the sum of the worksurfaces on each side.

Beam sets must be supported by intermediate legs at least every 16'. Intermediate leg must be positioned at beam truss location, where two worksurfaces meet.

End legs, intermediate leg sets for dual tables

Crinion Open Table

description	application	w	d	h	pattern number	P2	P3
End leg for dual tables (pair of legs)	24" D worksurface	4"		24"	XTB1EDD24 ()	\$3,989.	\$4,188.
	30" D worksurface	4"	54"	24"	XTB1EDD30 ()	3,989.	4,188.
	36" D worksurface	4"	54"	24"	XTB1EDD36 ()	3,989.	4,188.

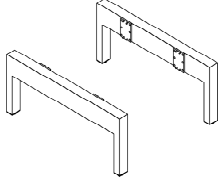

Intermediate leg for dual table (pair of legs for 30" and 36"D)	24" D worksurfaces	4"	2 1/8"	16"	XTB1LDD24 ()	579.	607.
	30"&36" D worksurfaces	4"	2 1/8"	16"	XTB1LDD ()	837.	882.

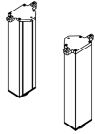

Shroud for intermediate leg infeed kit	24" D or single sided				XTB1 SLIK ()	150.	158.
	30" D				XTB1 SLIK30 ()	189.	199.
	36" D				XTB1 SLIK36 ()	222.	234.

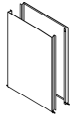

End leg for end counters both ends (pair of legs)	48" W end counter	4	44	24	XTB1XDD24 ()	4,265.	4,464.
	60" W end counter	4	54	24	XTB1XDD30 ()	4,265.	4,464.
	72" W end counter	4	54	24	XTB1XDD36 ()	4,265.	4,464.

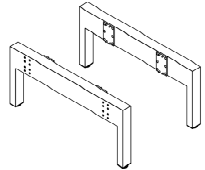

Order Code	Specifications	Application Notes
Example: XTB1EDD30 118		
XT Crinion Open Table	Specify paint finish code after pattern number.	Crinion Open Table bases are assembled from main beams, end legs, intermediate legs and trusses. After selecting starter or segmented beam sets, specify legs to support each end of beams. End legs support main beams at each end of a table.
B1 Base components		Dual end legs for end counters have threaded metal inserts on the outside of the leg to accept two fixed height or adjustable cantilevers for end counters.
E End leg		Intermediate legs must be specified to provide support under beam sets spanning longer than 12' for 24"D tables or 16' for 30"D or 36"D tables. Intermediate legs may be positioned under beams at any beam truss location. End legs include beam end plates and hardware.
D Dual		Shroud for intermediate leg kit encloses the space between legs to protect power, data and communication cables between floor and table base. Side covers may be removed for access.
D Desk height		Shroud for 24"d intermediate leg is U-shaped cover that attaches to side of intermediate leg for 24"d or any single sided intermediate leg.
30 Depth of tops		End legs for 24"D worksurfaces and end legs for 48"W end counters have only one end plate for attaching centered beam sets for 24"D tables.
118 Finish		

description	application	w	d	h	pattern number	P2	P3
End leg for end counters one end only (pair of legs)	48" W end counter	4	44	24	XTB1YDD24 ()	\$4,127.	\$4,326.
	60" W end counter	4	54	24	XTB1YDD30 ()	4,127.	4,326.
	72" W end counter	4	54	24	XTB1YDD36 ()	4,127.	4,326.

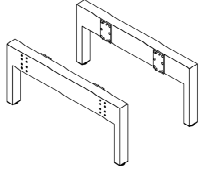

Order Code	Specifications	Application Notes
Example: XTB1EDD30 118	Specify paint finish code after pattern number.	<p>Crinion Open Table bases are assembled from main beams, end legs, intermediate legs and trusses. After selecting starter or segmented beam sets, specify legs to support each end of beams. End legs support main beams at each end of a table.</p> <p>Dual end legs for end counters have threaded metal inserts on the outside of the leg to accept two fixed height or adjustable cantilevers for end counters.</p> <p>Intermediate legs must be specified to provide support under beam sets spanning longer than 12' for 24"D tables or 16' for 30"D or 36"D tables. Intermediate legs may be positioned under beams at any beam truss location. End legs include beam end plates and hardware.</p>
XT Crinion Open Table		
B1 Base components		
E End leg		
D Dual		
D Desk height		
30 Depth of tops		
118 Finish	<p>Shroud for intermediate leg kit encloses the space between legs to protect power, data and communication cables between floor and table base. Side covers may be removed for access.</p> <p>Shroud for 24"d intermediate leg is U-shaped cover that attaches to side of intermediate leg for 24"d or any single sided intermediate leg.</p> <p>End legs for 24"D worksurfaces and end legs for 48"W end counters have only one end plate for attaching centered beam sets for 24"D tables.</p>	

description	application	width	depth	height	pattern number	P2	P3
End leg for single sided tables (pair of legs)	24" D worksurface	4"	24"	24"	XTB1ESD24 ()	\$3,989.	\$4,188.
	30" D worksurface	4"	28 ³ / ₄ "	24"	XTB1ESD30 ()	3,989.	4,188.
	36" D worksurface	4"	28 ³ / ₄ "	24"	XTB1ESD36 ()	3,989.	4,188.

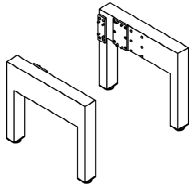

Intermediate leg for single sided table	24" D worksurfaces	4"	2 ¹ / ₈ "	16"	XTB1LSD24 ()	579.	607.
	30"&36" D worksurfaces	4"	2 ¹ / ₈ "	16"	XTB1LSD ()	579.	607.

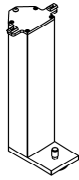

Order Code

Example:	XTB1ESD30 118
XT	Crinion Open Table
B1	Base components
E	End leg
S	Single
D	Desk height
30	Depth of tops
118	Finish

Specifications

Specify paint finish code after pattern number.

Application Notes

Crinion Open Table bases are assembled from main beams, end legs, intermediate legs and trusses. After selecting starter or segmented beam sets, specify legs to support each end of beams. End legs support main beams at each end of a table.

Dual end legs for end counters have threaded metal inserts on the outside of the leg to accept two fixed height or adjustable cantilevers for end counters.

Intermediate legs must be specified to provide support under beam sets spanning longer than 12'. Intermediate legs may be positioned under beams at any beam truss location. End legs include beam end plates and hardware.

Shroud for intermediate leg kit encloses the space between legs to protect power, data and communication cables between floor and table base. Side covers may be removed for access.

description	application	w	d	h	pattern number	P2/P3
Beam truss for dual tables	30" D worksurface	3"	11"	10"	XTB1XD30 ()	\$485.
	36" D worksurface	3"	23"	10"	XTB1XD36 ()	529.

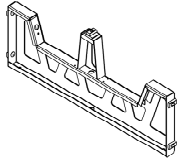

Top channel support	24" D worksurface				XTB1T24 ()	175.
---------------------	-------------------	--	--	--	--------------------	------



Beam truss for single sided tables	30" D worksurface	3"			XTB1XS30 ()	485.
	36" D worksurface	3"			XTB1XS36 ()	529.

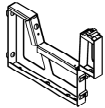

Beam truss for dual tables no top channel support	30" D worksurface	3"	11"	8"	XTB1XD30N ()	376.
	36" D worksurface	3"	23"	8"	XTB1XD36N ()	431.

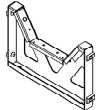

Beam truss for single sided tables no top channel support	30" D worksurface	3"			XTB1XS30N ()	376.
	36" D worksurface	3"			XTB1XS36N ()	431.

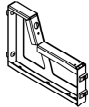

Order Code

Example: XTB1XD30 613	
XT	Crinion Open Table
B1	Base components
XD	Beam truss for dual table
30	Depth
613	Finish

Specifications

Beam trusses are available in all standard painted finishes.

Application Notes

Crinion Open Table bases are assembled from beams, end legs, intermediate legs and trusses. After selecting beams and leg kits, specify trusses between beams.



Specify beam trusses adjacent to each end leg and at each worksurface junction.

For 24"D tables specify top channel support instead of truss.

Beam trusses with no top channel support must be specified in combination with intermediate legs planned other than at worksurface junctions (as for cable infeed shrouds).

Worksurface support cantilever and mid span support

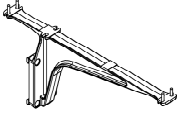
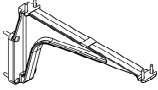
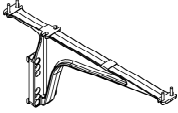
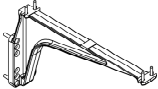
Crinion Open Table

description	w	d	h	pattern number	P2	P3
Cantilever, fixed height 30" or 36" D 	3"	24"	9"	XTB1FC ()	\$200.	\$209.
Cantilever, fixed height 24" D 	3"	19"	9"	XTB1FC24 ()	200.	209.
Cantilever, adjustable height 30" or 36" D 	3"	24"	9" - 12"	XTB1AC ()	220.	232.
Cantilever, adjustable height 24" D 	3"	24"	9" - 12"	XTB1AC24 ()	220.	232.
Mid span support 	2	2	8	XTB1MB ()	95.	99.

Order Code	Specifications	Application Notes
Example: XTB1FC 118	Specify paint finish code after pattern number.	Cantilever brackets are required to support each end of worksurfaces.
XT Crinion Open Table		
B1 Base components		Brackets can be positioned at ends of worksurface, or inset at legs or floorstanding pedestal locations.
FC Fixed height cantilever	48" worksurfaces: shared cantilevers each end or two adjustable per worksurface.	Fixed height cantilevers can be shared between adjacent worksurfaces. Mid span support bracket must be specified for worksurface spans exceeding 4'.
118 Finish	60" and 72" worksurfaces: shared cantilevers each end plus mid span support or two adjustable cantilevers inset 8".	Fixed height cantilever supports worksurface at 28 1/2" H.
	96" worksurfaces: shared cantilevers at ends plus one in center or three adjustable cantilevers.	Adjustable cantilevers enable worksurfaces to be set at 27", 27 3/4", 28 1/2", 29 1/4" or 30" H.
	96"x 24" with hinged door: shared cantilever each end plus two mid span supports.	
	96"x 30" with hinged door: shared cantilever each end plus 24"d cantilever as center support.	
	96"x 36" with hinged door: shared cantilever each end plus 24", 30" or 36"d cantilever as center support.	

Worksurface support *linking plate and cantilever for end counters*

Crinion Open Table

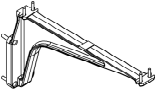
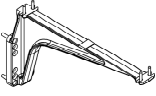
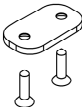
description	w	d	h	pattern no.	P2	P3
Cantilever for end counters, fixed height	3"	19"	9"	XTB1FCEND ()	\$200.	\$209.
						
Cantilever for end counters, adjustable height	3"	19"	9" - 12"	XTB1ACEND ()	220.	232.
						
Worksurface linking plate				XTB1LP		27.
						

Order Code	Specification	Application Notes
Example: XTB1FCEND 613	Specify paint finish code after pattern number.	Cantilever brackets are required to support each end of worksurface.
XT Crinion Open Table		Brackets attach to inserts on the outside face of end legs for end counters.
B1 Base components		Fixed height cantilever supports for end counter at 28 1/2" H.
FC Fixed height cantilever		Adjustable cantilevers for end counter enables end counter to be set at 28 1/2", 29 1/4" or 30" H.
END for end counter		A linking plate is recommended to join adjacent worksurfaces that are independently supported at the same height. Specify two linking plates at the junction of two worksurfaces, or four total for each end counter to two worksurfaces. A linking plate is not required where adjacent tops are supported by a shared fixed height cantilever bracket, as with complete fixed height base assemblies. Linking plates are recommended for complete adjustable height base assemblies in which tops are set at the same height.
613 Finish		

Modular Raceway

2 + 2 eight-wire Raceway with covers

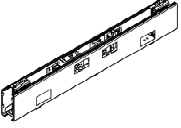
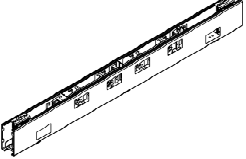
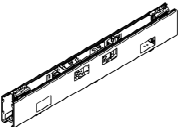
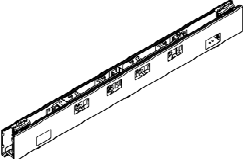
description	type	h	w	d	pattern number	list price
Dual raceway, two power + two data outlets each side 		4"	30"	2"	XTR1E30D ()	\$261.
Dual raceway, four power + two data outlets each side 		4"	42"	2"	XTR1E424D ()	375.
Flat end cover					XTR1FE ()	22.
Extended end cover					XTR1EE ()	22.
Single sided raceway two power + two data outlets each side 		4"	30"	2"	XTR1E30S ()	261.
Single sided raceway four power + two data outlets each side 		4"	42"	2"	XTR1E424S ()	375.

Order Code	Specifications	Applications notes
Example: XTR1E424D 613		
XT Crinion Open Table	Eight wire 2+2 has two sets of circuits, each set with a separate ground and neutral.	Raceway for Crinion Open Table is suspended from the top channel. For ideal access, worksurfaces should be specified with hinged power access.
R1 Raceway	Specify paint finish code after pattern number.	Each raceway requires four or eight duplex outlets, on any of four circuits.
E Eight wire system	Covers have two openings for data/com outlet modules (Decora-size, specified separately).	Jumpers connect power from one raceway to another.
42 Width		To join power between 30" raceways: specify 30" jumper for 60" desks and specify 42" jumper for 72" desks.
4 Extra outlets		
D Dual Raceway		
613 Finish		

To join power between 42" raceways: specify 18" jumper for 60" desks and 30" jumper for 72" desks.

Flat end covers enclose the end of a raceway at the end of a table.



Extended end covers enclose the end of a raceway at the end of a table where power infeed is located.

Specify outlet fillers separately for unused outlet openings.

Modular Raceway

2 + 2 eight-wire Raceway components

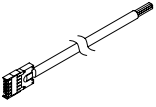
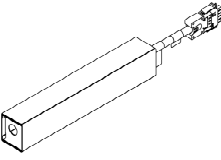
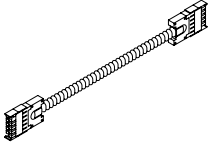
Crinion Open Table

description	type	h	w	d	pattern number	list price
Modular infeed					XTR1EPI	\$197.
						
NYC infeed kit					XTR1EPH	450.
						
Jumper			18"		XTR1EJ18	91.
			30"		XTR1EJ30	103.
			42"		XTR1EJ42	118.
Duplex outlet	Circuit A				XTR1DA	33.
	Circuit B				XTR1DB	33.
	Circuit X, orange				XTR1DXO	38.
	Circuit Y, orange				XTR1DYO	38.
Outlet filler	Set of 10				XTR1OF	28.
PDC module extension kit	Set of 10				XTR1PDCX	115.
Compact Power Module					XTR1ECPM ()	485.
						

Order Code	Specifications	Application Notes
Example: XTR1EJ18		
XT Crinion Open Table	Eight wire 2+2 has two sets of circuits, each set with a separate ground and neutral.	Raceway for Crinion Open Table is suspended from the top channel. For ideal access, worksurfaces should be specified with hinged power access.
R1 Raceway		
E Eight wire		
J Jumper		
18 Width		
	Each raceway requires four or eight duplex outlets, on any of four circuits.	<p>Jumper length is difference between worksurface width and specified raceway width.</p> <p>Compact power module is designed to supply power outlets under extended end counter worksurfaces, or additional outlets under desks.</p> <p>Compact power module can be suspended from top channel or attached to inside face of beams.</p> <p>Each face of compact power module accepts two duplex outlets.</p>
	Power infeed includes pigtail for connection to building power supply and connector to either end of any raceway.	
	NYC infeed kit includes junction box that mounts to inside face of beams in table base.	

Modular Raceway

3 + 3 ten-wire Raceway with covers

Crinion Open Table

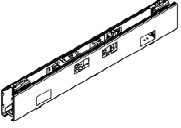
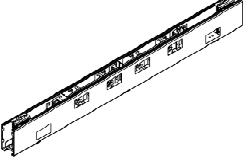
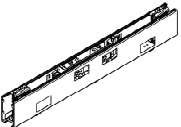
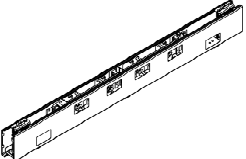

description	type	h	w	d	pattern number	list price
Dual raceway, two power + two data outlets each side		4"	30"	2"	XTR1T30D ()	\$274.
						
Dual raceway, four power + two data outlets each side		4"	42"	2"	XTR1T424D ()	387.
						
Flat end cover					XTR1FE ()	22.
Extended end cover					XTR1EE ()	22.
Single sided raceway two power + two data outlets each side		4"	30"	2"	XTR1T30S ()	274.
						
Single sided raceway four power + two data outlets each side		4"	42"	2"	XTR1T424S ()	387.
						

Order Code	Specifications	Application Notes
Example: XTR1T424D 613		
XT Crinion Open Table	Ten wire 3+3 has two sets of three circuits, each set with a separate ground and neutral.	Raceway for Crinion Open Table is suspended from the top channel. For ideal access, worksurfaces should be specified with hinged power access.
R1 Raceway	Specify paint finish code after pattern number.	Each raceway requires four or eight duplex outlets, on any of six circuits.
T Ten wire system	Covers have two openings for data/com outlet modules (Decora-size, specified separately).	Jumpers connect power from one raceway to another.
42 Width		To join power between 30" raceways: specify 30" jumper for 60" desks and specify 42" jumper for 72" desks.
4 Extra outlets		To join power between 42" raceways: specify 18" jumper for 60" desks and 30" jumper for 72" desks.
D Dual Raceway		Flat end covers enclose the end of a raceway at the end of a table.
613 Finish		Extended end covers enclose the end of a raceway at the end of a table where power infeed is located.
		Specify outlet fillers separately for unused outlet openings.

Modular Raceway

3 + 3 ten-wire Raceway components

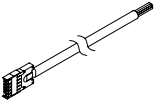
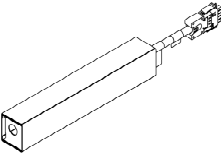
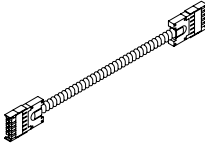
Crinion Open Table

description	type	h	w	d	pattern number	list pricing
Modular infeed					XTR1TPI	\$221.
						
NYC infeed kit					XTR1TPH	450.
						
Jumper			18"		XTR1TJ18	103.
			30"		XTR1TJ30	118.
			42"		XTR1TJ42	137.
Duplex outlet	Circuit A				XTR1DA	33.
	Circuit B				XTR1DB	33.
	Circuit C				XTR1DC	33.
	Circuit X, orange				XTR1DXO	38.
	Circuit Y, orange				XTR1DYO	38.
	Circuit Z, orange				XTR1DZO	38.
Outlet filler	Set of 10				XTR1OF	28.
PDC module extension kit	Set of 10				XTR1PDCX	115.
Compact Power Module					XTR1TCPM ()	500.
						

Order Code	Specifications	Application Notes
Example: XTR1TJ18		
XT Crinion Open Table	Ten wire 3+3 has two sets of three circuits, each set with a separate ground and neutral.	Raceway for Crinion Open Table is suspended from the top channel. For ideal access, worksurfaces should be specified with hinged power access.
R1 Raceway		Each raceway requires four or eight duplex outlets, on any of six circuits.
T Ten wire		Power infeed includes pigtail for connection to building power supply and connector to either end of any raceway.
J Jumper		NYC infeed kit includes junction box that mounts to inside face of beams in table base.
18 Width		Jumper length is difference between worksurface width and specified raceway width. Compact power module is designed to supply power outlets under extended end counter worksurfaces, or additional outlets under desks. Compact power module can be suspended from top channel or attached to inside face of beams. Each face of compact power module accepts two duplex outlets.

Modular Raceway

4-4-2 ten-wire Raceway with covers

Crinion Open Table

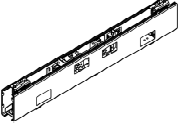
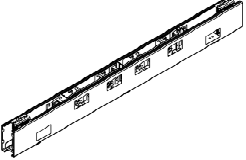
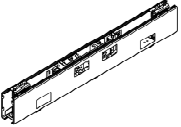
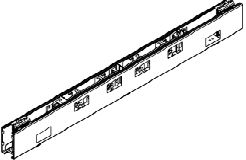
description	type	h	w	d	pattern number	list price
Dual raceway, two power + two data outlets each side 		4"	30"	2"	XTR1X30D ()	\$288.
Dual raceway, four power + two data outlets each side 		4"	42"	2"	XTR1X424D ()	407.
Single sided raceway two power + two data outlets each side 		4"	30"	2"	XTR1X30S ()	288.
Single sided raceway four power + two data outlets each side 		4"	42"	2"	XTR1X424S ()	407.

Order Code

Example: XTR1X424D 613
XT Crinion Open Table
R1 Raceway
X Ten wire 4-4-2
42 Width
4 Extra outlets
D Dual Raceway
613 Finish

Specifications

Ten wire 4-4-4 has four circuits each with a separate neutral, plus a ground wire for circuit 1 and 2 and another ground for circuit 3 and 4.

Specify paint finish code after pattern number.

Covers have two openings for data/com outlet modules (Decora-size, specified separately).

Application Notes

Raceway for Crinion Open Table is suspended from the top channel. For ideal access, worksurfaces should be specified with hinged power access.

Each raceway requires four or eight duplex outlets, on any of six circuits.

Jumpers connect power from one raceway to another.

To join power between 30" raceways: specify 30" jumper for 60" desks and specify 42" jumper for 72" desks.

To join power between 42" raceways: specify 18" jumper for 60" desks and 30" jumper for 72" desks.

Flat end covers enclose the end of a raceway at the end of a table.



Extended end covers enclose the end of a raceway at the end of a table where power infeed is located.

Specify outlet fillers separately for unused outlet openings.

Modular Raceway

4-4-2 ten-wire Raceway components

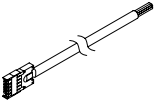
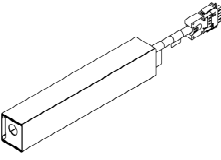
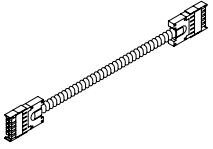

Crinion Open Table

description	type	h	w	d	pattern number	list price
Modular infeed					XTR1XPI	\$232.
						
NYC infeed kit					XTR1XPH	473.
						
Jumper			18"		XTR1XJ18	108.
			30"		XTR1XJ30	124.
			42"		XTR1XJ42	142.
Duplex outlet	Circuit 1				XTR1D1	35.
	Circuit 2				XTR1D2	35.
	Circuit 3				XTR1D3	35.
	Circuit 4				XTR1D4	35.
Compact Power Module					XTR1XCPM ()	500.
						



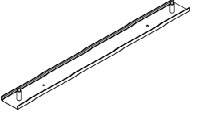

Order Code	Specifications	Application Notes
Example: XTR1XJ18		
XT Crinion Open Table	Ten wire 4-4-2 has four circuits each with a separate neutral, plus a ground wire for circuit 1 and 2 and another ground for circuit 3 and 4.	Raceway for Crinion Open Table is suspended from the top channel. For ideal access, worksurfaces should be specified with hinged power access.
R1 Raceway		
X Ten wire 4-4-2		
J Jumper	All duplex outlets are black.	Each raceway requires four or eight duplex outlets, on any of six circuits.
18 Width		Power infeed includes pigtail for connection to building power supply and connector to either end of any raceway.
		NYC infeed kit includes junction box that mounts to inside face of beams in table base.
		Jumper length is difference between worksurface width and specified raceway width.
		Compact power module is designed to supply power outlets under extended end counter worksurfaces, or additional outlets under desks.
		Compact power module can be suspended from top channel or attached to inside face of beams.
		Each face of compact power module accepts two duplex outlets.

description	type	h	w	d	pattern number	list price
Dual raceway, two power + two data outlets each side		4"	30"	2"	XTR1H30D ()	\$569.
Flat end cover					XTR1FE ()	22.
Extended end cover					XTR1EE ()	22.
Outlet filler	Set of 10				XTR1OF	28.

Order Code	Specifications	Application Notes
Example: XTR1H30D 613		
XT Crinion Open Table	Specify paint finish code after pattern number.	Raceway for Crinion Open Table is suspended from the top channel. For ideal access, worksurfaces should be specified with hinged power access.
R1 Raceway		
H Hard wire system	Hardwired raceway components are designed for use in City of Chicago installations.	
30 Width		
D Dual Raceway		
613 Finish	Covers have two openings for data/com outlet modules (Decora-size, by others).	Dual raceways are code-approved boxed with openings for two or four duplex outlets on each face, plus two additional openings for data/communications faceplates on each face. A continuous horizontal metal septum divides power wires and connections from data and communications cables. Each raceway requires Decora-type architectural power outlets, internal wiring and connecting cables, supplied by electrical contractor.
		Flat end covers enclose the raceway at the end of a table. Extended end covers provide an opening on the underside to permit cables to enter the raceway.
		Specify outlet filler plates for unused outlet openings. Specify PDC extenders to create space behind data/com for cable distribution inside dual raceway.

description	table size	w	d	pattern number	list price
 Cable trays, leg position, pair	5', 30"D	53"	1"	XTCT6030LD ()	\$236.
	5', 36"D	53"	4"	XTCT6036LD ()	322.
	6', 30"D	65"	1"	XTCT7230LD ()	256.
	6', 36"D	65"	4"	XTCT7236LD ()	374.
 Cable trays, full width, pair	5', 30"D	60"	1"	XTCT6030D ()	236.
	5', 36"D	60"	4"	XTCT6036D ()	322.
	6', 30"D	72"	1"	XTCT7230D ()	256.
	6', 36"D	72"	4"	XTCT7236D ()	374.
Data tray kit		42"		XTDT42 ()	166.
 Data + excess cable tray kit		42"		XTDTX42 ()	276.
Truss cable clips, set of 25				XTR1TCC25	15.
Beam cable clips, set of 50				XTR1BCC50	220.
Random attachment kit, set of 10				XTB1RAK	77.

Order Code	Specifications	Applications notes
Example: XTCT7230D 613 XT Crinion Open Table CT Cable tray 72 Width 30 Depth D Dual table 613 Finish	Cable trays and Data tray kits are available in all standard paint finishes.	Cable trays are optional kits to manage cables on each side of dual table bases. Specify cable trays for leg position at each end of the table. Specify cable trays, full width for other positions. Data tray kit provides 3" wide horizontal open cable tray directly below either 30" or 42"W raceway module (at center of 60" or 72" desks). Data + excess tray kit provides two open trays below either raceway module, one 3"W and one 5"W.
		Truss cable clips manage cables between raceway. Specify 2 clips per truss (one set of 10 for each five trusses). Beam cable clips manage cables along the inside faces of each beam set. Random attachment kit is a set of ten M8 slot nuts for attaching various products to the Crinion Open Table beams or top channel. Specify appropriate M8 screws separately.

description	application	w	d	h	pattern no.	list
	24"D tables	18"	2"	3/4"	XTBT18 ()	\$76.
	24"D tables	24"	2"	3/4"	XTBT24 ()	84.
	24"D tables	36"	2"	3/4"	XTBT36 ()	92.
	24"D tables	48"	2"	3/4"	XTBT48 ()	100.
	24"D tables	60"	2"	3/4"	XTBT60 ()	108.
Cable basket, 10'		120"	8"	1"	XTWB120	410.
Cable basket hangers	From truss 30/36D only				XTWTX ()	65.
						
	From truss at infeed shroud				XTWTBSLIK ()	200.
						
	From main beam, 24D only				XTWTB ()	65.
						
	From top channel, 30/36D only				XTWTC ()	85.

Order Code	Specifications	Application Notes
Example: XTBT36 118		
XT Crinion Open Table	Beam mounted cable trays are available in any standard painted finish.	Beam mounted cable trays may be inserted in slots on either face of Crinion Open Table main beams. On 24"D dual or single sided tables beam mounted cable trays are the only option for cable management other than the shallow channel on top of the beam or a cable basket. On 30"D and 36"D tables beam mounted trays may complement other cable tray options.
BT Beam mounted cable tray	Cable basket is zinc metal finish only.	For 96"W worksurfaces specify 36"W trays between supports. Specify 48"W trays for additional cable management between trusses on the inside face of beams on dual 30"D and 36"D tables with 60" worksurfaces. Specify 60"W trays on the inside face of beams on dual 30"D and 36"D tables with 72"W worksurfaces.
36 Width	Basket hangers can be specified in any standard painted finish.	Beam mounted cable trays must be segmented to fit between cantilever and midspan support brackets. Cable basket offers the most flexibility for managing large bundles of cables and for entering or exiting the tray at any point. Cable basket ships in 10' lengths and is cut to size in field. Specify cable basket hangers separately. Each hanger can suspend one end of a tray or two adjacent trays. Hanger from trusses is for 30" or 36"D dual or single sided tables. Hanger from main beam is for 24"D dual tables only. Hangers from top channel are for 30" or 36"D dual tables only.
118 Paint finish		For 48"W worksurfaces with shared cantilevers specify 36"W trays. For 60"W worksurfaces with shared cantilevers and midspan supports specify 24"W trays adjacent to end legs specify 18"W trays. For 72"W worksurfaces with shared cantilevers and midspan supports specify 24"W trays.

Center screens

Acrylic, slatwall, combination, marker or veneer surface

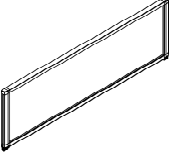
description	appl.	w	d	h	pattern no.	Opal acrylic	Trans. acrylic / Marker	slatwall	Comb. acrylic / slatwall	V1	V2	V3
Center screen to 43" H 	48"	48"	1 1/4"	14"	XTCS1 4814 () () ()	\$799.	\$825.	\$1,268.	n/a	\$1,102.	\$1,207.	\$1,414.
	60"	60"	1 1/4"	14"	XTCS1 6014 () () ()	1,048.	1,099.	1,378.	n/a	1,192.	1,316.	1,577.
	72"	72"	1 1/4"	14"	XTCS1 7214 () () ()	1,102.	1,154.	1,488.	n/a	1,252.	1,395.	1,707.

acrylic shown

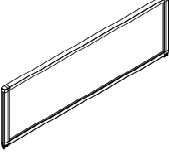
Center screen to 43" H adjacent to end screen 	48"	47"	1 1/4"	14"	XTCS1 4714 () () ()	799.	825.	1,268.	n/a	1,102.	1,207.	1,414.
	60"	59"	1 1/4"	14"	XTCS1 5914 () () ()	1,048.	1,099.	1,378.	n/a	1,192.	1,316.	1,577.
	72"	71"	1 1/4"	14"	XTCS1 7114 () () ()	1,102.	1,154.	1,488.	n/a	1,252.	1,395.	1,707.

acrylic shown

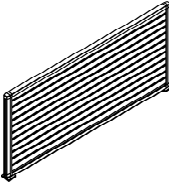
Center screen to 50" H 	48"	48"	1 1/4"	21"	XTCS1 4821 () () ()	937.	979.	1,488.	1,378.	1,208.	1,346.	1,644.
	60"	60"	1 1/4"	21"	XTCS1 6021 () () ()	1,212.	1,290.	1,653.	1,599.	1,300.	1,466.	1,839.
	72"	72"	1 1/4"	21"	XTCS1 7221 () () ()	1,268.	1,342.	1,819.	1,709.	1,347.	1,540.	1,990.

slatwall shown

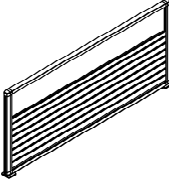
Center screen to 50" H adjacent to end screen 	48"	47"	1 1/4"	21"	XTCS1 4721 () () ()	937.	979.	1,488.	1,378.	1,208.	1,346.	1,644.
	60"	59"	1 1/4"	21"	XTCS1 5921 () () ()	1,212.	1,290.	1,653.	1,599.	1,300.	1,466.	1,839.
	72"	71"	1 1/4"	21"	XTCS1 7121 () () ()	1,268.	1,342.	1,819.	1,709.	1,347.	1,540.	1,990.

combination shown

Order Code

Example: XTCS16014A O 111
XT Crinion Open Table
CS1 Center screen
60 Width
14 Height
A Surface
O Opal
111 Frame finish

Specifications

Acrylic surface is AO opal or AT translucent.

For Marker surface both sides specify suffix M.

For Slatwall screens specify slatwall and frame finish.

For combination acrylic/slatwall screens specify suffixes CO (opal) or CT (translucent), slatwall and frame finish.

Slatwall surface is available in (AA) or any standard painted finish except 613 Silver.

For veneer surface specify suffix V and finish code from list on page 5.

Frame is clear anodized aluminum or any standard paint finish except 613 Silver.

Application Notes

Center screens mount to continuous channel at center of tables. Specify 14" H screens for a 42" horizon. Specify 21" H screens for a 49" horizon. Horizons are maintained regardless of worksurface height.

Combination screens include 14" high slatwall with acrylic above.

Center screens include mounting hardware for standard top channel only.

Center screens adjacent to end screens allow space for dual or single sided end screens.

Slatwall screens require buttresses to support Knoll Extra flat screen monitor arm. Specify one buttress per monitor arm, up to four buttresses per screen.

Veneer grain direction is horizontal.

Marker surface has wood core.

Center screens

Tackable fabric surface

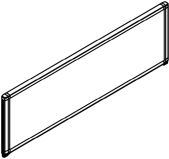
description	application	w	d	h	pattern no.	10	15	20	30	35	40	45
	48"	48"	1 1/4"	14"	XTCS1 4814F () () ()	\$844.	\$860.	\$863.	\$882.	\$895.	\$895.	\$926.
	60"	60"	1 1/4"	14"	XTCS1 6014F () () ()	921.	941.	945.	967.	984.	984.	1,022.
	72"	72"	1 1/4"	14"	XTCS1 7214F () () ()	943.	968.	972.	1,000.	1,020.	1,020.	1,066.

	48"	47"	1 1/4"	14"	XTCS1 4714F () () ()	835.	852.	855.	872.	886.	886.	917.
	60"	59"	1 1/4"	14"	XTCS1 5914F () () ()	921.	941.	945.	967.	984.	984.	1,022.
	72"	71"	1 1/4"	14"	XTCS1 7114F () () ()	943.	968.	972.	1,000.	1,020.	1,020.	1,066.

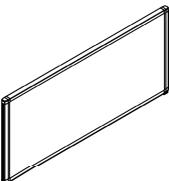

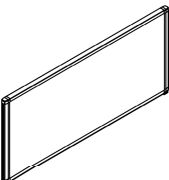

	48"	48"	1 1/4"	21"	XTCS1 4821F () () ()	894.	911.	914.	931.	945.	945.	975.
	60"	60"	1 1/4"	21"	XTCS1 6021F () () ()	998.	1,019.	1,022.	1,044.	1,062.	1,062.	1,100.
	72"	72"	1 1/4"	21"	XTCS1 7221F () () ()	1,008.	1,033.	1,038.	1,065.	1,086.	1,086.	1,131.

	48"	47"	1 1/4"	21"	XTCS1 4721F () () ()	894.	911.	914.	931.	945.	945.	975.
	60"	59"	1 1/4"	21"	XTCS1 5921F () () ()	998.	1,019.	1,022.	1,044.	1,062.	1,062.	1,100.
	72"	71"	1 1/4"	21"	XTCS1 7121F () () ()	1,008.	1,033.	1,038.	1,065.	1,086.	1,086.	1,131.

Order Code	
Example: XTCS16014F20 (W280) AA	
XT	Crinion Open Table
CS1	Center screen
60	Width
14	Height
F	Surface
20	Fabric grade
W280	Fabric
AA	Frame finish

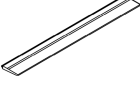
Specifications
1. Tackable fabric surface is suffix F.
2. Select fabric surface finish code from list on page 5.
Frame is clear anodized aluminum or any standard paint finish except 613 Silver.
Fabric is railroaded.

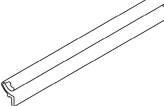
Application Notes
Fabric center screens mount to continuous channel at center of tables. Specify 14" H screens for a 43" horizon. Specify 21" H screens for a 50" horizon. Horizons are maintained regardless of worksurface height.
Center screens include mounting hardware for standard top channel only.
Center screens adjacent to end screens allow space for dual or single sided end screens.

description	application	w	d	h	pattern no.	list	AA/paint	L	V1	V2	V3
Display shelf 5"D aluminum only 	48" slatwall	45"	5"	1"	XT1DS4505 ()		\$245.				
	60" slatwall	57"	5"	1"	XT1DS5705 ()		275.				
	72" slatwall	69"	5"	1"	XT1DS6905 ()		296.				
Open shelf 9"D laminate or veneer only 	48" slatwall	45"	9"	1"	XT1LS4509 ()()			275.	358.	412.	555.
	60" slatwall	57"	9"	1"	XT1LS5709 ()()			316.	411.	472.	638.
	72" slatwall	69"	9"	1"	XT1LS6909 ()()			357.	464.	533.	719.
Slatwall adapters for applied wall accessories 		24"			XT1SA24 ()			25.			
			30"			XT1SA30 ()		30.			
			36"			XT1SA36 ()		35.			
			42"			XT1SA42 ()		40.			
			48"			XT1SA48 ()		45.			
			54"			XT1SA54 ()		50.			
			60"			XT1SA60 ()		55.			
			66"			XT1SA66 ()		60.			
		72"			XT1SA72 ()		65.				
Buttress for slatwall screen 					XTCS1 SBA ()			220.			

Order Code	Specifications	Application Notes
Example: XT1LS5709 118 AA		
XT1 Crinion Open Table	Display shelves are anodized aluminum (AA) or any standard painted finish except silver.	Open shelves and display shelves for slatwall are designed for use on Crinion Open Table center screens with slatwall inserts.
LS Open shelf		
57 Width	For open shelves specify any standard laminate or veneer finish, then platform finish.	Shelves include adapter that snaps into horizontal channels in slatwall, approximately every 2" vertically.
09 Depth	Shelf platform may be AA or any standard paint finish except silver.	Shelf width fits either full width center screens or screens adjacent to end screens.
118 Shelf finish		
AA Platform finish	Slatwall adapters are integral color 812 Easy grey or 111 Black only.	Slatwall adapters enable other Applied Wall System shelves and accessories to be mounted to Crinion Open Table slatwall. Adapter will also fit other Knoll system slatwalls, such as AutoStrada spine or panels, but use of shelves in these applications may not comply with ANSI/BIFMA safety standards for anti-dislodgment.

Side screens

Acrylic, Marker or veneer surface

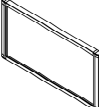
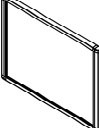
description	application	w	d	h	pattern no.	list	Opal acrylic	Trans. acrylic / Marker	V1	V2	V3	
	24" D worksurface	22"	1 1/4"	14"	XTSS1 2414 () () ()		\$579.	\$594.	\$872.	\$936.	\$1,030.	
	30" D worksurface	28"	1 1/4"	14"	XTSS1 3014 () () ()		607.	627.	899.	972.	1,093.	
	36" D worksurface	34"	1 1/4"	14"	XTSS1 3614 () () ()		661.	687.	923.	1,005.	1,153.	
	acrylic shown											
	24" D worksurface	22"	1 1/4"	21"	XTSS1 2421 () () ()		661.	687.	934.	1,012.	1,148.	
	30" D worksurface	28"	1 1/4"	21"	XTSS1 3021 () () ()		689.	720.	963.	1,055.	1,228.	
	36" D worksurface	34"	1 1/4"	21"	XTSS1 3621 () () ()		744.	780.	990.	1,097.	1,309.	
	acrylic shown											
Side screen brackets (pair)	postformed edge					XTSM1P ()		232.				
	squared edge					XTSM1S ()		165.				
	tapered edge					XTSM1K ()		165.				

Order Code

Example:	XTSS13014A O AA
XT	Crinion Open Table
SS1	Side screen
30	Width
14	Height
A	Surface
O	Opal
AA	Frame finish

Specifications

- Specify surface
A = Acrylic
V = Veneer
M = Marker
- For Acrylic surface specify
O = Opal
T = Translucent
 Veneer surfaces may be any standard AutoStrada V1, V2 or V3 veneer.
 Specify veneer finish code from page 5.

Frame is clear anodized aluminum or any standard paint finish except 613 Silver.

Brackets are available in all paint finishes

Application Notes

Side screens clamp to front and back edge of worksurface at any point (except at hinged access door). Specify side screen brackets separately. Specify 14" H screens for a 42" horizon. Specify 21" H screens for a 49" horizon. Side screens align in height with center screens when worksurfaces are set at 28 3/8" H.

Veneer grain direction is horizontal.

Side screens

Tackable fabric surface

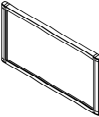
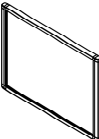
description	application	w	d	h	pattern no.	list	10	15	20	30	35	40	45
	Side screen to 43" H	24" D worksurface	22"	1 1/4"	14"	XTSS1 2414F () ()	\$657.	\$665.	\$667.	\$677.	\$683.	\$683.	\$698.
		30" D worksurface	28"	1 1/4"	14"	XTSS1 3014F () ()	677.	687.	689.	700.	709.	709.	727.
		36" D worksurface	34"	1 1/4"	14"	XTSS1 3614F () ()	696.	709.	724.	734.	734.	734.	757.
	Side screen to 50" H	24" D worksurface	22"	1 1/4"	21"	XTSS1 2421F () ()	686.	694.	695.	705.	712.	712.	727.
		30" D worksurface	28"	1 1/4"	21"	XTSS1 3021F () ()	716.	725.	727.	739.	747.	747.	766.
		36" D worksurface	34"	1 1/4"	21"	XTSS1 3621F () ()	729.	742.	744.	757.	767.	767.	790.
Side screen brackets (pair)	postformed edge				XTSM1P ()	232.							
	squared edge				XTSM1S ()	165.							
	tapered edge				XTSM1K ()	165.							

Order Code	Specifications	Application Notes
Example: XTSS13014F20 (W280) 115	1. Tackable fabric surface is suffix F.	Side screens clamp to front and back edge of worksurface at any point (except at hinged access door). Specify side screen brackets separately. Specify 14" H screens for a 43" horizon. Specify 21" H screens for a 50" horizon. Side screens align in height with center screens when worksurfaces are set at 28 3/8" H.
XT Crinion Open Table	2. Select fabric surface finish code from list on page 5.	
SS1 Side screen	3. Specify frame finish.	
30 Width	Frame is clear anodized aluminum or any standard paint finish except 613 Silver.	
14 Height	Fabric is railroaded.	
F Surface	Brackets are available in all paint finishes.	
20 Fabric grade		
W280 Fabric		
115 Frame finish		

Return screens

Acrylic, Marker or veneer surface

Crinion Open Table

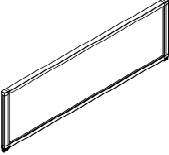
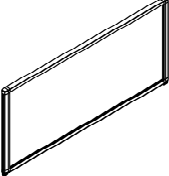
description	application	w	d	h	pattern no.	list	Opal acrylic	Trans. acrylic / Marker	V1	V2	V3
 Return screen to 43" H	54"	52"	1 1/4"	14"	XTRS1 5414 () ()		\$964.	\$1,016.	\$1,051.	\$1,162.	\$1,387.
	60"	58"	1 1/4"	14"	XTRS1 6014 () ()		964.	1,016.	1,065.	1,186.	1,437.
	66"	64"	1 1/4"	14"	XTRS1 6614 () ()		964.	1,016.	1,087.	1,216.	1,496.
	72"	70"	1 1/4"	14"	XTRS1 7214 () ()		964.	1,016.	1,101.	1,240.	1,546.
	78"	76"	1 1/4"	14"	XTRS1 7814 () ()		1,074.	1,126.	1,304.	1,421.	1,753.
 Return screen to 50" H	54"	52"	1 1/4"	21"	XTRS1 5421 () ()		1,130.	1,207.	1,152.	1,299.	1,624.
	60"	58"	1 1/4"	21"	XTRS1 6021 () ()		1,130.	1,207.	1,172.	1,334.	1,698.
	66"	64"	1 1/4"	21"	XTRS1 6621 () ()		1,130.	1,207.	1,192.	1,367.	1,769.
	72"	70"	1 1/4"	21"	XTRS1 7221 () ()		1,130.	1,207.	1,211.	1,400.	1,840.
	78"	76"	1 1/4"	21"	XTRS1 7821 () ()		1,268.	1,345.	1,419.	1,591.	2,067.
Side screen brackets (pair)	postformed edge				XTSM1P ()		232.				
	squared edge				XTSM1S ()		165.				

Order Code

Example:	XTRS16014A O 118
XT	Crinion Open Table
RS1	Return screen
60	Width
14	Height
A	Acrylic
O	Opal
118	Frame finish

Specifications

- Specify surface
A = Acrylic
V = Veneer
M = Marker
- For Acrylic surface specify
O = Opal
T = Translucent
 Veneer surfaces may be any standard AutoStrada V1, V2 or V3 veneer.
 Specify veneer finish code from page 5.
- Specify frame finish.

 Frame is clear anodized aluminum (AA) or any standard paint finish except 613 Silver.

 Brackets are available in all paint finishes.

Application Notes

Return screens span the depth of Crinion Open Table worksurfaces and the width of a 30", 36" or 42" worksurface planned as perpendicular return. Specify 14" H screens for 42" horizon. Specify 21" H screens for a 49" horizon. Returns (file tops or AutoStrada worksurfaces) must be at the same height as worksurface.

Specify side brackets separately.

Veneer grain direction is horizontal.

Return screens

Tackable fabric surface

Crinion Open Table

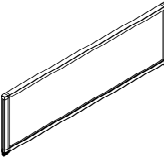
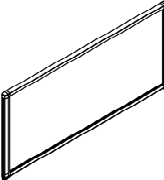
description	application	w	d	h	pattern no.	list	10	15	20	30	35	40	45
 Return screen to 43" H	54"	52"	1 1/4"	14"	XTRS1 5414F () ()	\$802.	\$821.	\$825.	\$845.	\$860.	\$860.	\$895.	
	60"	58"	1 1/4"	14"	XTRS1 6014F () ()	809.	828.	832.	855.	872.	872.	911.	
	66"	64"	1 1/4"	14"	XTRS1 6614F () ()	824.	847.	851.	876.	894.	894.	936.	
	72"	70"	1 1/4"	14"	XTRS1 7214F () ()	829.	854.	859.	887.	905.	905.	952.	
	78"	76"	1 1/4"	14"	XTRS1 7814F () ()	954.	981.	986.	1,015.	1,036.	1,036.	1,086.	
 Return screen to 50" H	54"	52"	1 1/4"	21"	XTRS1 5421F () ()	784.	802.	806.	827.	843.	843.	877.	
	60"	58"	1 1/4"	21"	XTRS1 6021F () ()	814.	834.	837.	861.	878.	878.	916.	
	66"	64"	1 1/4"	21"	XTRS1 6621F () ()	819.	842.	846.	870.	889.	889.	931.	
	72"	70"	1 1/4"	21"	XTRS1 7221F () ()	824.	849.	854.	881.	901.	901.	947.	
	78"	76"	1 1/4"	21"	XTRS1 7821F () ()	973.	1,000.	1,005.	1,034.	1,056.	1,056.	1,105.	
Side screen brackets (pair)	postformed edge				XTSM1P ()	232.							
	squared edge				XTSM1S ()	165.							

Order Code

Example:	XTRS16014F20 (W280) 611
XT	Crinion Open Table
RS1	Return screen
60	Width
14	Height
F	Surface
20	Fabric grade
W280	Fabric
611	Frame finish

Specifications

- Tackable fabric surface is suffix F.
 - Select fabric surface finish code from list on page 5.
 - Specify frame finish.
- Frame is clear anodized aluminum or any standard paint finish except 613 Silver.
- Fabric is railroaded.
- Brackets are available in all paint finishes.

Application Notes

Fabric return screens span the depth of Crinion Open Table worksurfaces and the width of a 30", 36" or 42" worksurface planned as perpendicular return. Specify 14" H screens for 43" horizon. Specify 21" H screens for a 50" horizon. Returns must be at the same height as worksurface.

Specify mounting brackets separately.

Dual end screens

Acrylic, Marker or veneer surface

description	application	w	d	h	pattern no.	list	Opal acrylic	Trans. acrylic / Marker	V1	V2	V3
	24" D dual	48"	1 1/4"	14"	XTES1 4814 () () ()		\$717.	\$743.	\$1,008.	\$1,113.	\$1,320.
	30" D dual	60"	1 1/4"	14"	XTES1 6014 () () ()		937.	989.	1,098.	1,223.	1,483.
	36" D dual	72"	1 1/4"	14"	XTES1 7214 () () ()		964.	1,016.	1,159.	1,301.	1,613.
	acrylic shown										

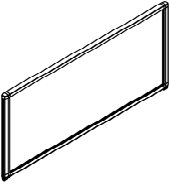
	24" D dual	48"	1 1/4"	21"	XTES1 4821 () () ()		854.	895.	1,114.	1,252.	1,550.
	30" D dual	60"	1 1/4"	21"	XTES1 6021 () () ()		1,102.	1,179.	1,206.	1,372.	1,745.
	36" D dual	72"	1 1/4"	21"	XTES1 7221 () () ()		1,130.	1,310.	1,254.	1,446.	1,896.
	acrylic shown										

Replacement mast Kit	acrylic center screen				XTSM1C ()		94.				
	slatwall center screen				XTSM1SLAT ()		248.				

End screen brackets (pair)	tapered edge				XTSM1KK ()		165.				
	worksurface										

Side screen brackets (pair)	postformed edge				XTSM1P ()		232.				
	squared edge				XTSM1S ()		165.				

Order Code

Example:	XTES16014A O AA
XT	Crinion Open Table
ES1	End screen
60	Width
14	Height
A	Surface
O	Opal
AA	Frame finish

Specifications

- Specify surface
A = Acrylic
V = Veneer
M = Marker
- For Acrylic surface specify
O = Opal
T = Translucent
 Veneer surfaces may be any standard AutoStrada V1, V2 or V3 veneer.
 Specify veneer finish code from page 5.
- Specify frame finish.

Frame is clear anodized aluminum or any standard paint finish except 613 Silver.

Brackets are available in all paint finishes.

Replacement mast kit is 812 Easy Grey or 111 Black.

Application Notes

Dual end screens clamp to front edge of worksurface on either side of table. Specify 14" H screens for a 42" horizon. Specify 21" H screens for a 49" horizon. Side screens align with center screens when worksurfaces are set at 28 3/8" H.

Specify end screen brackets separately for each screen.

Veneer grain direction is horizontal.

Dual end screens

Tackable fabric surface

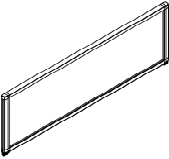
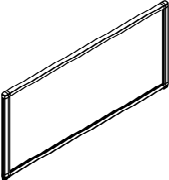
description	application	w	d	h	pattern no.	list	10	15	20	30	35	40	45
	Dual end screens to 43" H	24" D dual	48"	1 1/4"	14"	XTES1 4814F () ()	\$739.	\$756.	\$759.	\$778.	\$791.	\$822.	\$791.
		30" D dual	60"	1 1/4"	14"	XTES1 6014F () ()	809.	828.	832.	855.	872.	911.	872.
		36" D dual	72"	1 1/4"	14"	XTES1 7214F () ()	829.	854.	859.	886.	905.	952.	905.
	Dual end screens to 50" H	24" D dual	48"	1 1/4"	21"	XTES1 4821F () ()	798.	815.	819.	836.	851.	882.	851.
		30" D dual	60"	1 1/4"	21"	XTES1 6021F () ()	867.	888.	892.	915.	932.	970.	932.
		36" D dual	72"	1 1/4"	21"	XTES1 7221F () ()	879.	903.	907.	935.	955.	1,000.	955.
Replacement mast Kit	acrylic center screen				XTSM1C ()	94.							
	slatwall center screen				XTSM1SLAT ()	248.							
End screen brackets (pair)	tapered edge worksurface				XTSM1KK ()	165.							
Side screen brackets (pair)	postformed edge				XTSM1P ()	232.							
	squared edge				XTSM1S ()	165.							

Order Code

Example:	XTES16014F20 (W280)
	112
XT	Crinion Open Table
ES1	End screen
60	Width
14	Height
F	Surface
20	Fabric grade
W280	Fabric
112	Frame finish

Specifications

1. Tackable fabric surface is suffix F.
 2. Select fabric surface finish code from list on page 5.
 3. Specify frame finish.
- Frame is clear anodized aluminum or any standard paint finish except 613 Silver.
- Fabric is railroaded.
- Brackets are available in all paint finishes.
- Replacement mast kit is 812 Easy Grey or 111 Black.

Application Notes

Dual end screens clamp to front edge of worksurface on either side of table. Specify 14" H screens for a 43" horizon. Specify 21" H screens for a 50" horizon. Side screens align with center screens when worksurfaces are set at 28 3/8" H.

Specify end screen brackets separately for each screen.

Single sided end screen

Acrylic, Marker or veneer surface

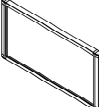
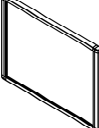
description	application	w	d	h	pattern no.	list	Opal	Trans.	V1	V2	V3	
							acrylic	acrylic / Marker				
	Single sided end screens to 43" H	24" D Single	24"	1 1/4"	14"	XTES1 2414 () () ()	\$579.	\$594.	\$872.	\$936.	\$1,030.	
		30" D Single	30"	1 1/4"	14"	XTES1 3014 () () ()	607.	627.	899.	972.	1,093.	
		36" D Single	36"	1 1/4"	14"	XTES1 3614 () () ()	661.	687.	923.	1,005.	1,153.	
	acrylic shown											
	Single sided end screen to 50" H	24" D single sided	24"	1 1/4"	21"	XTES1 2421 () () ()	661.	687.	934.	1,012.	1,148.	
		30" D single sided	30"	1 1/4"	21"	XTES1 3021 () () ()	689.	720.	963.	1,055.	1,228.	
		36" D single sided	36"	1 1/4"	21"	XTES1 3621 () () ()	744.	780.	990.	1,097.	1,309.	
	acrylic shown											
Single sided end screen brackets (set)	postformed edge					XTSM1PC ()	166.					
	square edge					XTSM1SC ()	122.					
	tapered edge					XTSM1KC ()	122.					

Order Code	Specifications	Application Notes
Example: XTES13614A O 114		
XT Crinion Open Table		
ES1 End screen		
36 Width		
14 Height		
A Surface		
O Opal		
114 Frame finish		
	<ol style="list-style-type: none"> Specify surface <i>A = Acrylic</i> <i>V = Veneer</i> <i>M = Marker</i> For Acrylic surface specify <i>O = Opal</i> <i>T = Translucent</i> Veneer surfaces may be any standard AutoStrada V1, V2 or V3 veneer. Specify veneer finish code from page 5. Specify frame finish. Frame is clear anodized aluminum or any standard paint finish except 613 Silver. Brackets are available in all paint finishes. 	Single sided end screens clamp to front edge of worksurface and attach to top of channel. Specify 14" H screens for a 42" horizon. Specify 21" H screens for a 49" horizon. Side screens align with center screens when worksurfaces are set at 28 3/8" H. Specify end screen brackets separately for each screen. Veneer grain direction is horizontal.

Single sided end screen

Tackable fabric surface

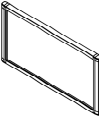
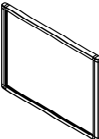
description	application	w	d	h	pattern no.	list	10	15	20	30	35	40	45
	24" D Single	24"	1 1/4"	14"	XTES1 2414F () ()	\$657.	\$665.	\$667.	\$677.	\$683.	\$683.	\$698.	
	30" D Single	30"	1 1/4"	14"	XTES1 3014F () ()	677.	687.	689.	700.	709.	709.	727.	
	36" D Single	36"	1 1/4"	14"	XTES1 3614F () ()	696.	709.	724.	734.	734.	734.	757.	
	24" D single sided	24"	1 1/4"	21"	XTES1 2421F () ()	686.	694.	695.	705.	712.	712.	727.	
	30" D single sided	30"	1 1/4"	21"	XTES1 3021F () ()	716.	725.	727.	739.	747.	747.	766.	
	36" D single sided	36"	1 1/4"	21"	XTES1 3621F () ()	729.	742.	744.	757.	767.	767.	790.	
Single sided end screen brackets (set)	postformed edge				XTSM1PC ()	166.							
	square edge				XTSM1SC ()	122.							
	tapered edge				XTSM1KC ()	122.							

Order Code	Specifications	Application Notes
Example: XTES13614F20 (W280) 111	1. Tackable fabric surface is suffix F.	Single sided end screens clamp to front edge of worksurface and attach to top of channel. Specify 14" H screens for a 43" horizon. Specify 21" H screens for a 50" horizon. Side screens align with center screens when worksurfaces are set at 28 3/8" H.
XT Crinion Open Table	2. Select fabric surface finish code from list on page 5.	
ES1 End screen	3. Specify frame finish.	
36 Width	Frame is clear anodized aluminum or any paint finish except 613 Silver.	Specify end screen brackets separately for each screen.
14 Height		
F Surface		
20 Fabric grade	Fabric is railroaded.	
W280 Fabric		
111 Frame finish	Brackets are available in all paint finishes.	

Frameless glass Add up for *Crinion Open Table*

description	w	d	h	pattern number	clear tempered	powder
Frameless glass Add ups	48"	1/2"	12"	XAUA 1248G () ()	\$491.	\$511.
	60"	1/2"	12"	XAUA 1260G () ()	601.	625.
	72"	1/2"	12"	XAUA 1272G () ()	710.	738.

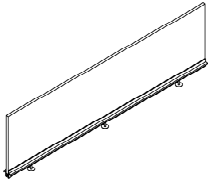

Order Code	Specifications	Application Notes
Example: XAUA 1248G TEMP AA	<i>Add up type:</i>	Frameless glass addups for Crinion Open Table match those available for the AutoStrada spine.
X Crinion Open Table	G Glass	Base extrusion is clear anodized aluminum or any standard painted finish except Silver.
AUA Frameless addup screen	Glass add-ups are available with the following glass options:	Tempered glass in clear or powered finish is 1/2" thick. Base frame is secured with bolts to top channel for frameless glass addups.
48 Width	TEMP Clear tempered	
12 Height	GL13 Powder	
G Glass	Specify base finish:	Frameless addups cannot be mounted to standard top channel included with base assemblies.
TEMP Finish	AA anodized aluminum and all standard painted finishes except 613 Silver.	
AA Base finish		

Morrison Network privacy screens mounting kit for Crinion Open Table

Crinion Open Table

description	w	d	h	pattern number	list price
Fabric screen mounting kit				XTPS1MZKIT	\$112.



Order Code	Specifications	Applications notes
Example: XTPS1MZKIT		
XT	Crinion Open Table	<p>Crinion Open Tables are designed to accept Morrison Network privacy screens with fabric screen mounting kit. Screens are tackable fabric, $\frac{3}{4}$" thick, in widths corresponding to Crinion worksurfaces 48", 60" or 72" wide. Specify screens MZ1-B4815F, MZ1B6015F or MZ1B7215F.</p> <p>Specify one mounting kit for each screen. Fabric screen mounting kits include two uprights that fasten to the top channel at any point. Uprights slide into internal channels in screens. Fabric screens do not align in height with acrylic privacy screens.</p>
PS1	Privacy Screen	
MZ	Fabric	
KIT	Kit	

Alpha-Numeric Index

<i>pattern no.</i>	<i>page</i>	<i>pattern no.</i>	<i>page</i>	<i>pattern no.</i>	<i>page</i>	<i>pattern no.</i>	<i>page</i>
XAUA 1248G	54	XTB1 BAS 30S20SF	17	XTB1ESD36	30	XTC1 72	24
XAUA 1260G	54	XTB1 BAS 30S24SA	19	XTB1FC	32	XTC1 96	24
XAUA 1272G	54	XTB1 BAS 30S24SF	17	XTB1FC24	32	XTC1 END	24
XT1DS4505	45	XTB1 BAS 30S25SA	19	XTB1FCEND	33	XTCA1 120 AA	24
XT1DS5705	45	XTB1 BAS 30S25SF	17	XTB1LDD	28	XTCA1 144 AA	24
XT1DS6905	45	XTB1 BAS 36D10CA	22	XTB1LDD24	28	XTCA1 48	24
XT1LS4509	45	XTB1 BAS 36D10CF	20	XTB1LP	33	XTCA1 60	24
XT1LS5709	45	XTB1 BAS 36D12CA	22	XTB1LSD	30	XTCA1 72	24
XT1LS6909	45	XTB1 BAS 36D12CF	20	XTB1LSD24	30	XTCA1 96	24
XT1SA24	45	XTB1 BAS 36D15CA	22	XTB1MB	32	XTCF 48	24
XT1SA30	45	XTB1 BAS 36D15CF	20	XTB1RAK	41	XTCF 60	24
XT1SA36	45	XTB1 BAS 36D15SA	22	XTB1SB10C	27	XTCF 72	24
XT1SA42	45	XTB1 BAS 36D15SF	20	XTB1SB10E	27	XTCS1 4714	43
XT1SA48	45	XTB1 BAS 36D18SA	22	XTB1SB12C	27	XTCS1 4714F	44
XT1SA54	45	XTB1 BAS 36D18SF	20	XTB1SB12E	27	XTCS1 4721	43
XT1SA60	45	XTB1 BAS 36D20SA	22	XTB1SB15C	27	XTCS1 4721F	44
XT1SA66	45	XTB1 BAS 36D20SF	20	XTB1SB15E	27	XTCS1 4814	43
XT1SA72	45	XTB1 BAS 36D24CA	22	XTB1SB4E	27	XTCS1 4814F	44
XTB1 BAS 24D10CF	14	XTB1 BAS 36D24CF	20	XTB1SB5C	27	XTCS1 4821	43
XTB1 BAS 24D12CF	14	XTB1 BAS 36D25CA	22	XTB1SB5E	27	XTCS1 4821F	44
XTB1 BAS 24D15CF	14	XTB1 BAS 36D25CF	20	XTB1SB6C	27	XTCS1 5914	43
XTB1 BAS 24D15SF	14	XTB1 BAS 36S10CA	23	XTB1SB6E	27	XTCS1 5914F	44
XTB1 BAS 24D18SF	14	XTB1 BAS 36S10CF	21	XTB1SB8C	27	XTCS1 5921	43
XTB1 BAS 24D20SF	14	XTB1 BAS 36S12CA	23	XTB1SB8E	27	XTCS1 5921F	44
XTB1 BAS 24D24SF	14	XTB1 BAS 36S12CF	21	XTB1T24	31	XTCS1 6014	43
XTB1 BAS 24D25SF	14	XTB1 BAS 36S15CA	23	XTB1TB10C	25	XTCS1 6014F	44
XTB1 BAS 24S10CF	15	XTB1 BAS 36S15CF	21	XTB1TB10E	25	XTCS1 6021	43
XTB1 BAS 24S12CF	15	XTB1 BAS 36S15SA	23	XTB1TB12C	25	XTCS1 6021F	44
XTB1 BAS 24S15CF	15	XTB1 BAS 36S15SF	21	XTB1TB12E	25	XTCS1 7114	43
XTB1 BAS 24S15SF	15	XTB1 BAS 36S18SA	23	XTB1TB15C	25	XTCS1 7114F	44
XTB1 BAS 24S18SF	15	XTB1 BAS 36S18SF	21	XTB1TB15E	25	XTCS1 7121	43
XTB1 BAS 24S20SF	15	XTB1 BAS 36S20SA	23	XTB1TB4E	25	XTCS1 7121F	44
XTB1 BAS 24S24SF	15	XTB1 BAS 36S20SF	21	XTB1TB5C	25	XTCS1 7214	43
XTB1 BAS 24S25SF	15	XTB1 BAS 36S24SA	23	XTB1TB5E	25	XTCS1 7214F	44
XTB1 BAS 30D10CA	18	XTB1 BAS 36S24SF	21	XTB1TB6C	25	XTCS1 7221	43
XTB1 BAS 30D10CF	16	XTB1 BAS 36S25SA	23	XTB1TB6E	25	XTCS1 7221F	44
XTB1 BAS 30D12CA	18	XTB1 BAS 36S25SF	21	XTB1TB8C	25	XTCS1 SBA	45
XTB1 BAS 30D12CF	16	XTB1 SLIK	28	XTB1TB8E	25	XTCT6030D	41
XTB1 BAS 30D15CA	18	XTB1 SLIK30	28	XTB1XD30	31	XTCT6030LD	41
XTB1 BAS 30D15CF	16	XTB1 SLIK36	28	XTB1XD30N	31	XTCT6036D	41
XTB1 BAS 30D15SA	18	XTB1 IAC	32	XTB1XD36	31	XTCT6036LD	41
XTB1 BAS 30D15SF	16	XTB1 IAC24	32	XTB1XD36N	31	XTCT7230D	41
XTB1 BAS 30D18SA	18	XTB1 IACEND	33	XTB1XDD24	28	XTCT7230LD	41
XTB1 BAS 30D18SF	16	XTB1DB10C	26	XTB1XDD30	28	XTCT7236D	41
XTB1 BAS 30D20SA	18	XTB1DB10E	26	XTB1XDD36	28	XTCT7236LD	41
XTB1 BAS 30D20SF	16	XTB1DB12C	26	XTB1XS30	31	XTDTX42	41
XTB1 BAS 30D24CA	18	XTB1DB12E	26	XTB1XS30N	31	XTDTX42	41
XTB1 BAS 30D24CF	16	XTB1DB15C	26	XTB1XS36	31	XTES1 2414	52
XTB1 BAS 30D25CA	18	XTB1DB15E	26	XTB1XS36N	31	XTES1 2414F	53
XTB1 BAS 30D25CF	16	XTB1DB4E	26	XTB1YDD24	29	XTES1 2421	52
XTB1 BAS 30S10CA	19	XTB1DB5C	26	XTB1YDD30	29	XTES1 2421F	53
XTB1 BAS 30S10CF	17	XTB1DB5E	26	XTB1YDD36	29	XTES1 3014	52
XTB1 BAS 30S12CA	19	XTB1DB6C	26	XTBT18	42	XTES1 3014F	53
XTB1 BAS 30S12CF	17	XTB1DB6E	26	XTBT24	42	XTES1 3021	52
XTB1 BAS 30S15CA	19	XTB1DB8C	26	XTBT36	42	XTES1 3021F	53
XTB1 BAS 30S15CF	17	XTB1DB8E	26	XTBT48	42	XTES1 3614	52
XTB1 BAS 30S15SA	19	XTB1EDD24	28	XTBT60	42	XTES1 3614F	53
XTB1 BAS 30S15SF	17	XTB1EDD30	28	XTC1 120 AA	24	XTES1 3621	52
XTB1 BAS 30S18SA	19	XTB1EDD36	28	XTC1 144 AA	24	XTES1 3621F	53
XTB1 BAS 30S18SF	17	XTB1ESD24	30	XTC1 48	24	XTES1 4814	50
XTB1 BAS 30S20SA	19	XTB1ESD30	30	XTC1 60	24	XTES1 4814F	51

<i>pattern no.</i>	<i>page</i>	<i>pattern no.</i>	<i>page</i>	<i>pattern no.</i>	<i>page</i>	<i>pattern no.</i>	<i>page</i>
XTES1 4821	50	XTRS1 6021F	49	XTTK6036E (L/M/1/2/3)	11	XTPP7230E (L)	10
XTES1 4821F	51	XTRS1 6614	48	XTTK6036F (L/M/1/2/3)	13	XTPP7236A (L)	7
XTES1 6014	50	XTRS1 6614F	49	XTTK6036U (L/M/1/2/3)	8	XTPP7236B (L)	8
XTES1 6014F	51	XTRS1 6621	48	XTTK7218F (L/M/1/2/3)	13	XTPP7236C (L)	9
XTES1 6021	50	XTRS1 6621F	49	XTTK7224A (L/M/1/2/3)	7	XTPP7236D (L)	12
XTES1 6021F	51	XTRS1 7214	48	XTTK7224C (L/M/1/2/3)	9	XTPP7236E (L)	12
XTES1 7214	50	XTRS1 7214F	49	XTTK7224E (L/M/1/2/3)	10	XTPP9624A (L)	7
XTES1 7214F	51	XTRS1 7221	48	XTTK7224U (L/M/1/2/3)	8	XTPP9624B (L)	8
XTES1 7221	50	XTRS1 7221F	49	XTTK7230A (L/M/1/2/3)	7	XTPP9624C (L)	9
XTES1 7221F	51	XTRS1 7814	48	XTTK7230C (L/M/1/2/3)	9	XTPP9630A (L)	7
XTPSMZMKIT	55	XTRS1 7814F	49	XTTK7230E (L/M/1/2/3)	10	XTPP9630B (L)	8
XTR1BCC50	41	XTRS1 7821	48	XTTK7230U (L/M/1/2/3)	8	XTPP9630C (L)	9
XTR1D1	39	XTRS1 7821F	49	XTTK7236A (L/M/1/2/3)	7	XTPP9636A (L)	7
XTR1D2	39	XTSM1C	50, 51	XTTK7236C (L/M/1/2/3)	9	XTPP9636B (L)	8
XTR1D3	39	XTSM1K	46, 47	XTTK7236D (L/M/1/2/3)	11	XTPP9636C (L)	9
XTR1D4	39	XTSM1KC	52, 53	XTTK7236E (L/M/1/2/3)	11	XTTS3018F (1/2/3)	13
XTR1DA	35, 37	XTSM1KK	50, 51	XTTK7236F (L/M/1/2/3)	13	XTTS3618F (1/2/3)	13
XTR1DB	35, 37	XTSM1P	46, 47, 48, 49, 50, 51	XTTK7236U (L/M/1/2/3)	8	XTTS4218F (1/2/3)	13
XTR1DC	37	XTSM1PC	52, 53	XTTK8418F (L/M/1/2/3)	13	XTTS4824A (1/2/3)	7
XTR1DXO	35, 37	XTSM1S	46, 47, 48, 49, 50, 51	XTTK8436F (L/M/1/2/3)	13	XTTS4824C (1/2/3)	9
XTR1DYO	35, 37	XTSM1SC	52, 53	XTTK9624A (L/M/1/2/3)	7	XTTS4824E (1/2/3)	10
XTR1DZO	37	XTSM1SLAT	50, 51	XTTK9624C (L/M/1/2/3)	9	XTTS4824U (1/2/3)	8
XTR1E30D	34	XTSS1 2414	46	XTTK9624U (L/M/1/2/3)	8	XTTS4830A (1/2/3)	7
XTR1E30S	34	XTSS1 2414F	47	XTTK9630A (L/M/1/2/3)	7	XTTS4830C (1/2/3)	9
XTR1E424D	34	XTSS1 2421	46	XTTK9630C (L/M/1/2/3)	9	XTTS4830E (1/2/3)	10
XTR1E424S	34	XTSS1 2421F	47	XTTK9630U (L/M/1/2/3)	8	XTTS4830U (1/2/3)	8
XTR1ECPM	35	XTSS1 3014	46	XTTK9636A (L/M/1/2/3)	7	XTTS4836A (1/2/3)	7
XTR1EE	34, 36, 40	XTSS1 3014F	47	XTTK9636C (L/M/1/2/3)	9	XTTS4836C (1/2/3)	9
XTR1EJ18	35	XTSS1 3021	46	XTTK9636U (L/M/1/2/3)	8	XTTS4836D (1/2/3)	11
XTR1EJ30	35	XTSS1 3021F	47	XTPP3018F (L)	13	XTTS4836E (1/2/3)	11
XTR1EJ42	35	XTSS1 3614	46	XTPP3618F (L)	13	XTTS4836U (1/2/3)	8
XTR1EPH	35	XTSS1 3614F	47	XTPP4218F (L)	13	XTTS6024A (1/2/3)	7
XTR1EPI	35	XTSS1 3621	46	XTPP4824A (L)	7	XTTS6024C (1/2/3)	9
XTR1FE	34, 36, 40	XTSS1 3621F	47	XTPP4824B (L)	8	XTTS6024E (1/2/3)	10
XTR1H30D	40	XTTK3018F (L/M/1/2/3)	13	XTPP4824C (L)	9	XTTS6024U (1/2/3)	8
XTR1OF	35, 37, 40	XTTK3036F (L/M/1/2/3)	13	XTPP4824E (L)	10	XTTS6030A (1/2/3)	7
XTR1PDCX	35, 37	XTTK3618F (L/M/1/2/3)	13	XTPP4830A (L)	7	XTTS6030C (1/2/3)	9
XTR1T30D	36	XTTK3636F (L/M/1/2/3)	13	XTPP4830B (L)	8	XTTS6030E (1/2/3)	10
XTR1T30S	36	XTTK4218F (L/M/1/2/3)	13	XTPP4830C (L)	9	XTTS6030U (1/2/3)	8
XTR1T424D	36	XTTK4236F (L/M/1/2/3)	13	XTPP4830E (L)	10	XTTS6036A (1/2/3)	7
XTR1T424S	36	XTTK4824A (L/M/1/2/3)	7	XTPP4836A (L)	7	XTTS6036C (1/2/3)	9
XTR1TCC25	41	XTTK4824C (L/M/1/2/3)	9	XTPP4836B (L)	8	XTTS6036D (1/2/3)	11
XTR1TCPM	37	XTTK4824E (L/M/1/2/3)	10	XTPP4836C (L)	9	XTTS6036E (1/2/3)	11
XTR1TJ18	37	XTTK4824U (L/M/1/2/3)	8	XTPP4836D (L)	12	XTTS6036U (1/2/3)	8
XTR1TJ30	37	XTTK4830A (L/M/1/2/3)	7	XTPP4836E (L)	12	XTTS7224A (1/2/3)	7
XTR1TJ42	37	XTTK4830C (L/M/1/2/3)	9	XTPP6024A (L)	7	XTTS7224C (1/2/3)	9
XTR1TPH	37	XTTK4830E (L/M/1/2/3)	10	XTPP6024B (L)	8	XTTS7224E (1/2/3)	10
XTR1TPI	37	XTTK4830U (L/M/1/2/3)	8	XTPP6024C (L)	9	XTTS7224U (1/2/3)	8
XTR1X30D	38	XTTK4836A (L/M/1/2/3)	7	XTPP6024E (L)	10	XTTS7230A (1/2/3)	7
XTR1X30S	38	XTTK4836C (L/M/1/2/3)	9	XTPP6030A (L)	7	XTTS7230C (1/2/3)	9
XTR1X424D	38	XTTK4836D (L/M/1/2/3)	11	XTPP6030B (L)	8	XTTS7230E (1/2/3)	10
XTR1X424S	38	XTTK4836E (L/M/1/2/3)	11	XTPP6030C (L)	9	XTTS7230U (1/2/3)	8
XTR1XCPM	39	XTTK4836U (L/M/1/2/3)	8	XTPP6030E (L)	10	XTTS7236A (1/2/3)	7
XTR1XJ18	39	XTTK6018F (L/M/1/2/3)	13	XTPP6036A (L)	7	XTTS7236C (1/2/3)	9
XTR1XJ30	39	XTTK6024A (L/M/1/2/3)	7	XTPP6036B (L)	8	XTTS7236D (1/2/3)	11
XTR1XJ42	39	XTTK6024C (L/M/1/2/3)	9	XTPP6036C (L)	9	XTTS7236E (1/2/3)	11
XTR1XPH	39	XTTK6024E (L/M/1/2/3)	10	XTPP6036D (L)	12	XTTS7236U (1/2/3)	8
XTR1XPI	39	XTTK6024U (L/M/1/2/3)	8	XTPP6036E (L)	12	XTTS9624A (1/2/3)	7
XTRS1 5414	48	XTTK6030A (L/M/1/2/3)	7	XTPP7224A (L)	7	XTTS9624C (1/2/3)	9
XTRS1 5414F	49	XTTK6030C (L/M/1/2/3)	9	XTPP7224B (L)	8	XTTS9624U (1/2/3)	8
XTRS1 5421	48	XTTK6030E (L/M/1/2/3)	10	XTPP7224C (L)	9	XTTS9630A (1/2/3)	7
XTRS1 5421F	49	XTTK6030U (L/M/1/2/3)	8	XTPP7224E (L)	10	XTTS9630C (1/2/3)	9
XTRS1 6014	48	XTTK6036A (L/M/1/2/3)	7	XTPP7230A (L)	7	XTTS9630U (1/2/3)	8
XTRS1 6014F	49	XTTK6036C (L/M/1/2/3)	9	XTPP7230B (L)	8	XTTS9636A (1/2/3)	7
XTRS1 6021	48	XTTK6036D (L/M/1/2/3)	11	XTPP7230C (L)	9	XTTS9636C (1/2/3)	9

<i>pattern no.</i>	<i>page</i>
XTTS9636U (1/2/3)	8
XTWB120	42
XTWTB	42
XTWTBSLIK	42
XTWTC	42
XTWTX	42

Selling Policy

	<p>This Selling Policy supercedes all previous selling policies. Prices, discounts and product offerings are subject to change without notice.</p>
Terms & Conditions of Sales	<p>Sales by Knoll, Inc. or Knoll North America Corp. ("Seller") of Knoll Product Lines (hereinafter "Products") within the United States and Canada are made only on the terms which are contained in this Selling Policy. Seller hereby gives notice of its objection to any different or additional terms and conditions. This sale is expressly conditional upon Purchaser's assent to the terms and conditions set forth below. Additional terms and conditions may apply to KnollStudio and KnollTextiles orders. These terms and conditions may be modified or supplemented only by a written document signed by an authorized representative of Seller. These terms and conditions supercede any prior and/or contemporaneous agreements or correspondence between Purchaser and Seller. Written quotations expire thirty (30) days from the date of issuance and can be withdrawn by written notice anytime during that period. Where Purchaser and Seller have entered into the Knoll Electronic Terms and Conditions, all orders, acknowledgements, invoices and other business communications placed or transmitted in accordance with the Knoll Electronic Terms and Conditions shall be deemed to be in writing and signed and shall be valid for all purposes as if they were originated and maintained in documentary form.</p>
Ordering Information	<p>All orders must be in writing. The product pattern number(s) contained on Seller's order acknowledgement shall be the final expression of the order.</p>
Order Confirmation	<p>A purchase order is not binding on Seller until Purchaser has received Seller's order confirmation or acknowledgment.</p>
Pricing Policies	<p>List prices are subject to change without notice.</p> <p>List prices shall be those prices in effect on the date of receipt of a complete purchase order unless shipment is requested more than ninety (90) days after order entry in which case prices in effect on the date of shipment apply. List prices include specified freight costs. Unless specified in writing by Seller, no other charges are included in Seller's list prices.</p>
Taxes	<p>All sales, use, excise and other taxes applicable to the sale of the Products shall be paid by Purchaser. If Purchaser claims an exemption from any tax, Purchaser shall submit to Seller the appropriate exemption certificates.</p>
Terms of Payment	<p>Payment for one hundred percent (100%) of the net order amount is due within thirty (30) days of the date of invoice, which is issued upon shipment. In case of any discrepancies, such as shortages, and Seller is notified in writing within ten (10) days of receipt of Product, only that portion may be deducted and the balance paid. For orders greater than \$100,000 net, a one-third (1/3) deposit is due at the time of order placement, with the remainder due within thirty (30) days of the date of invoice.</p> <p>KnollStudio orders less than \$2,000 require payment for one hundred percent (100%) of the net order amount (including any applicable sales tax and charges for inside delivery, special packaging, etc.), due at time of order placement. For KnollStudio orders greater than \$2,000, a one-half (50%) deposit is due at time of order placement with the remainder (including any applicable sales tax and charges for inside delivery, special packaging, etc.) due prior to shipment.</p> <p>If, in the judgment of Seller, Purchaser's financial condition does not justify the terms of the payment, Seller may require full or partial payment in advance.</p> <p>Past due accounts shall be charged one and one-half percent (1.5%) per month, or the highest rate permitted by law, whichever is less, and will be added to the outstanding balance. In the event Purchaser defaults on payment, Purchaser shall be liable for all collection costs, including reasonable attorney's fees and costs.</p>
Changes and Cancellation	<p>Purchase orders may not be changed or cancelled, in whole or in part, without prior written consent of Seller. Changes may effect delivery dates. Expenses incurred because of changes shall be charged to Purchaser. In the event of cancellations, Purchaser will be liable for reasonable cancellation charges established by Seller. Orders for special Product, orders including "COM" (hereinafter defined) material and orders pursuant to expedited delivery programs, may not be canceled.</p>
Freight Prepaid	<p>Freight is prepaid and included in the price of all Products, except KnollTextiles, within the 48 contiguous United States for orders placed with Knoll, Inc. and within Canada, excluding the Yukon, Northwest Territories, Nunavut and Newfoundland for orders placed with Knoll North America Corp. Packing is tested for rigorous motion and transportation but is not guaranteed to protect furniture from conditions over which the Seller has no control. If special packaging is required for any reason, please consult with your sales representative or dealer. Seller shall select the method of shipment and routing. All shipments shall be tailgate deliveries. Freight for all KnollTextiles orders is prepaid and added to the invoice.</p>
Delivery/Freight Charges	<p>Shipments outside the contiguous 48 United States and Canada shall be shipped F.O.B. Origin.</p> <p>For shipments outside the contiguous United States and Canada, Purchaser is responsible for the cost of freight from point of embarkation, including any handling and transportation charges incidental to loading at the point of departure and unloading at the final destination.</p> <p>Conditions beyond the control of Seller, including weather, available facilities and traffic conditions, may affect exact time of delivery. Seller shall not be responsible for specific carrier delivery date or time unless it has made a specific delivery commitment, in writing.</p> <p>Nonstandard methods of shipment and/or additional services are available upon request. Purchaser will be billed for the differential cost of any special services in excess of standard surface carrier freight costs. Premium charges, at Purchaser's request, will be added for airfreight, exclusive use of vehicle and extra, export or special packaging. Accessorial charges will be added for inside delivery, extra labor, reassignment and redelivery.</p> <p>Partial shipments may be made and invoiced by Seller.</p>
Claims	<p>All shipments for all Knoll Products within the contiguous United States and Canada are F.O.B. Origin. Risk of loss passes to Purchaser at time of delivery to carrier. Purchaser shall inspect all Products upon receipt and notify Seller within ten (10) working days after receipt of any damage or defects which are, or should be, apparent from an inspection of the Product and its packaging. Failure of Purchaser to make a claim against carrier or notify Seller during the ten (10) working day period shall constitute acceptance of the Products and waiver of any apparent defects, errors or shortages. Seller will agree to repair or replace Product damaged in shipment if Purchaser has notified Seller of freight damage within ten (10) working days after receipt and assigns its rights against the carrier.</p>
Seller's Security Interest	<p>Until Seller receives the full payment for the Product, Seller shall have a security interest in the Product. Purchaser agrees to perform all acts, including but not limited to the execution and filing of documentation, which may be necessary to perfect and assure the security interest of Seller.</p>
Returns	<p>The return of Products without a written authorization by Seller shall not be accepted. To receive authorization for Product return, please call Customer Service. All Products that are returned pursuant to a valid authorization shall be subject to a twenty-five percent (25%) of list restocking charge. Products not currently offered for sale by Seller (including COM) shall not be authorized for return. All returned Products must be unused, in original condition and in the original Seller packing cartons. No refund or credit shall be given for damaged Products.</p>
Held Orders/Storage	<p>If Purchaser requests that an order be held or delayed, prices and terms and conditions in effect at the time of shipment shall apply. If Purchaser requests a delay after the time when Seller can defer production, Purchaser will be invoiced for the Product, payable in accordance with standard terms, when the order is ready for shipment. Seller may transfer the Product to storage, in which case all expenses incurred in connection with storage, including demurrage, preparation for storage, storage charges and handling shall be payable by Purchaser upon submission of invoices by Seller. Risk of loss to the Product shall pass to the Purchaser upon delivery of the Product into storage.</p>

Selling Policy

Customer's Own Material	A Purchaser who requests a fabric or other surface material not standard to Seller's line of Products ("COM") must submit samples of the requested material to Seller prior to entry of a purchaser order. Seller shall determine if the material is suitable to its manufacturing processes and meets any requirements of Underwriters Laboratories. If the COM is acceptable, Seller will then establish a price for using the COM or the Product in question. For a description of the procedures for submitting samples and testing, contact customer resources or your sales representative. Seller shall have no responsibility for the appearance, condition, performance, durability, colorfastness or any other physical attribute of the COM. Purchaser shall indemnify and hold Seller harmless for any damages, injuries or losses arising out of or related to use of the COM on the Product.
Warranty	<p>Seller warrants to the original Purchaser only that the Products Seller manufactures and sells to Purchaser are free of defects in workmanship and materials, during the applicable warranty period set forth below.</p> <p>Warranty period set forth below for <i>Bulldog, Chadwick, Essentials Work Chairs, Life, Open Up, RPM, Sapper</i> and <i>SoHo</i> seating is for 24-hour, 7 days a week, multi shift use.</p> <p>Should any failure to conform with this limited warranty appear to a Product listed below during the applicable warranty period from the date of shipment, Seller shall, upon prompt written notice, repair or replace, at its option and costs, the affected part or parts.</p> <p><i>Product and Period of Warranty</i></p> <p><i>Lifetime: AutoStrada, Calibre, Crinion Open Table, Currents, Dividends Horizon, Equity, Morrison, Reff</i> laminate, <i>Series 2 Storage</i> and other non-wood components (except cascade edge worksurfaces, operational parts, controls, electrical, <i>Series 2 Veneer Front Storage</i>, special or custom products or other materials specifically called out below, see below)</p> <p><i>10 Years: AutoStrada, Crinion Open Table, Reff</i> wood components, <i>Series 2 Veneer Front Storage, Wood Casegoods (Magnusson, The Graham Collection), Interaction</i> tables (except height adjustment mechanisms for <i>Counterforce</i>, crank-adjustable, and split-top tables and worksurfaces, see below), <i>Reuter</i> overheads, <i>Reuter</i> vertical storage, <i>Bulldog, Chadwick, Essentials Work Chairs, Life, RPM</i> and <i>Sapper</i> seating structural and operational parts, controls, casters, pneumatic cylinders, seat and back mesh (except seating upholstery, finishes and labor, wood casegoods upholstered surfaces, see below)</p> <p><i>5 Years: Operational parts, controls, electrical (except light ballasts and bulbs, see below), cascade edge worksurfaces, special or custom product, wood veneer products, A3, Currents</i> handcrank, <i>Interaction Counterforce, Interaction</i> crank-adjustable, and split-top mechanisms, <i>KnollStudio, KnollExtra</i> adjustable keyboard supports, VDT carousel, monitor platform, equipment storage drawers and all universal storage drawers, <i>Open Up and SoHo</i> seating structural and operational parts, controls, pneumatic cylinders (except seating upholstery, finishes and labor, see below)</p> <p><i>3 Years: Upholstery, finishes and labor to repair the following chairs: Bulldog, Chadwick, Essentials Work Chairs, Life, Open Up, RPM, Sapper</i> and <i>SoHo.</i></p> <p><i>2 Years: All other KnollExtra</i> product</p> <p><i>1 Year: Light ballasts and bulbs, seating upholstered armpads and soft armpads, wood casegoods upholstered surfaces.</i></p> <p>This warranty does not apply to:</p> <ul style="list-style-type: none">• Damage caused by a carrier other than the Seller.• Normal wear and tear or acts or omissions of parties other than Seller (including user modification).• COM or other third party materials applied to Products.• Products not installed by or under the auspices of a certified dealer of Seller.• Dramatic temperature variations or exposure to unusual conditions.• Except as specifically noted above, textiles and upholstery supplied by <i>KnollTextiles</i> (consult current <i>KnollTextiles</i> price list for applicable warranty). <p>Natural variations occurring in wood, marble, and leather shall not be considered defects, and the Seller does not guarantee the colorfastness or matching of the colors, grains or textures, or surface hardness of such materials. The Seller also does not guarantee the colorfastness of fiberglass panel surfaces.</p> <p>THE EXPRESS WARRANTIES CONTAINED HEREIN ARE IN LIEU OF ALL OTHER WARRANTIES, EXPRESS OR IMPLIED, INCLUDING ANY WARRANTIES OF MERCHANTABILITY AND FITNESS FOR PARTICULAR PURPOSE AND ALL OTHER WARRANTIES ARISING FROM COURSE OF DEALING OR USAGE OF TRADE.</p> <p>The remedies provided above are the Purchaser's sole remedies for any failure of Seller to comply with its obligations regarding the workmanship of its Products. Correction of any nonconformity in the manner and for the period of time provided shall constitute complete fulfillment of all liabilities of Seller, with respect to or arising out of the Product furnished hereunder.</p>
Delay/Force Majeure	Seller shall not be liable for failure to perform or for delay in performance due to fire, flood, strike or other labor difficulty, act of God, act of any governmental authority or of the Purchaser, riot, embargo, fuel or energy shortage, wrecks or delay in transportation, inability to obtain necessary labor, materials or manufacturing facilities from usual sources or failure of suppliers to meet their contractual obligations, or due to any cause beyond its reasonable control. If any such event occurs, Seller may extend delivery dates by a period of time necessary to overcome the effect of such delay, allocate available Product or cancel any purchase order.
Compliance with Law	PURCHASER IS SOLELY RESPONSIBLE FOR COMPLIANCE WITH ALL APPLICABLE FEDERAL, STATE AND LOCAL LAWS, ORDINANCES, REGULATIONS, RULES AND STANDARDS RELATING TO THE INSTALLATION, MAINTENANCE, USE AND OPERATION OF THE PRODUCTS.
Patents	<p>Subject to the following provisions, Seller shall, at its own expense, defend or, at its option, settle any claim, suit or proceeding brought against the Purchaser, and/or its vendees, mediate and immediate, so far as based on an allegation that any Product or any part thereof furnished hereunder constitutes a direct or a contributory infringement of any claim of any patent of the United States or Canada. This obligation shall be effective only if Purchaser shall have made all payments then due hereunder and if Seller is notified promptly in writing and given authority, information and assistance for the defense of said claim, suit or proceeding. Seller shall pay all damages and costs awarded in such suit or proceedings so defended.</p> <p>The foregoing indemnity does not apply to the following:</p> <ul style="list-style-type: none">• Products supplied according to a design other than that of Seller, and which is required by the Purchaser.• Combination of the Product with another product not furnished hereunder unless Seller is a contributory infringer.• Any settlements of a suit or proceeding made without Seller's written consent.
Limitations of Liability	<p>SELLER, ITS CONTRACTORS, AUTHORIZED DEALERS AND SUBCONTRACTORS OR SUPPLIERS OF ANY TIER SHALL NOT BE LIABLE TO PURCHASER FOR ANY SPECIAL, INDIRECT, INCIDENTAL OR CONSEQUENTIAL DAMAGES ARISING FROM A BREACH OF THIS AGREEMENT.</p> <p>Purchaser's remedies set forth herein are exclusive and the liability of Seller with respect to the breach of this agreement or any contract entered into between the parties pursuant hereto shall not exceed the price of the Product or part on which such liability is based.</p>

General Ordering Information

The Products

This guide encompasses all standard products for this product group.

Sizes

Dimensions listed in this guide are indicated as:

H = height

W = width

D = depth

Dia. = diameter

Rad. = radius

Pricing

All prices shown are list.

How to Order

Select pattern numbers and quantities required for your complete installation. Product questions can be addressed in the specific sections of this guide or by contacting your sales representative or customer resource representative at 1-800-343-5665.

Next, select options (if required), along with colors and finishes appropriate to each product. Reference the Finishes and Fabrics pages for color designations.

On large installations, an item's "designated area" can be specified to assist in product organization and handling.

To expedite complete / correct entry of your order, be certain all pattern numbers, quantities, colors and area identifications are completely specified. Also, include complete purchase order numbers, bill-to and ship-to addresses, a contact name and specific factory shipping dates required.

Mail all orders to:

Knoll, Inc.

1235 Water Street

P.O. Box 157

East Greenville, PA 18041

Attention: Order Entry

Once your order is entered at Knoll, an acknowledgment will be mailed to you. You will be advised of your scheduled shipping date within five days of the original acknowledgment. If it is necessary to revise your order, please contact your customer resource representative.

Sustainability Statement

Sustainable design is a key component of Knoll's environmental focus. Our commitment to social responsibility and a healthy environment has prompted us to further articulate our longstanding environmental programs and, with encouragement and support from our colleagues in the industry, we have re-energized our focus on such "green" initiatives as life cycle analysis and LEED™ certification. Knoll is proud to have contributed to projects that have received LEED certification from the U.S. Green Building Council.

For the latest information on Knoll products that help our customers achieve LEED certification, log on to knoll.com, click on "About Knoll" and then "Environmental Focus."