

---

# KnollStudio

Price List  
July 2023

# Knoll











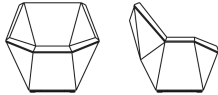



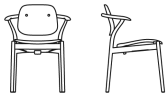
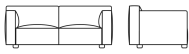

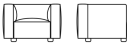







Introduction	Designer Index	3	
	Visual Index	5	
	Using the KnollStudio Price List	19	
	Spinneybeck Leather Grades	20	
	Upholstery Notes	21	
	🔥 California Technical Bulletin 133	22	
	Intertek Clean Air Certification	25	
	KnollStudio Finish Code Chart: Compatibility with Knoll Office Systems	26	
	Materials and Finishes	27	
	Product Maintenance	28	
	KnollStudio Outdoor Care Guidelines	30	
	Placing Your KnollStudio Order	31	
	Side Chairs and Lounge Seating	David Adjaye : The Washington Collection for Knoll™	32
		Ini Archibong : Iquo Cafe Collection	36
Edward Barber & Jay Osgerby : Sofa Collection		40	
Edward Barber & Jay Osgerby : Pilot by Knoll® Lounge Collection		48	
Edward Barber & Jay Osgerby : Piton™ Stools		52	
Harry Bertoia : Side Chair		54	
Harry Bertoia : Two-Tone Side Chair		56	
Harry Bertoia : Barstools		58	
Harry Bertoia : Bertoia Leather-Covered Side Chair and Barstool		66	
Harry Bertoia : Indoor/Outdoor Bertoia Molded Shell Side Chair and Barstool		68	
Harry Bertoia : Bertoia Dolly for stacking chairs and Ganging Mechanism		70	
Harry Bertoia : Diamond™ Lounge Seating		72	
Harry Bertoia : Two-Tone Diamond™ Chair		74	
Harry Bertoia : Child's Diamond™ Lounge Seating		76	
Harry Bertoia : Bird Lounge Chair and Ottoman		78	
Harry Bertoia : Asymmetric Chaise		80	
Harry Bertoia : Bench		82	
Pierre Beucler and Jean-Christophe Poggioli: Contract Lounge Seating		84	
Pierre Beucler and Jean-Christophe Poggioli: Residential Lounge Seating		90	
Cini Boeri : Pillows		102	
Marcel Breuer : Cesca™ Chair		104	
Marcel Breuer : Cesca™ Bar Height Stools		108	
Marcel Breuer : Cesca™ Counter Height Stools		110	
Marcel Breuer : Wassily™ Chair		112	
Marcel Breuer : MB Lounge		114	
Jonathan Crinion : Crinion Chair		116	
Joseph Paul D'Urso : Contract Lounge Seating		118	
Joseph Paul D'Urso : Residential Lounge Seating		122	
Joseph Paul D'Urso : Swivel Lounge Seating		126	
Raul de Armas : de Armas Chair		128	
Raul de Armas : Vertical de Armas Chair		134	
Frank Gehry : Side and Dining Chairs		138	
Frank Gehry : Lounge Seating		140	
Markus Jehs and Jürgen Laub : Jehs+Laub Lounge Collection, pedestal base		142	
Markus Jehs and Jürgen Laub : Jehs+Laub Lounge Collection, wire base		144	
Florence Knoll : Lounge Seating		146	
Florence Knoll : Relaxed Lounge Seating		148	
Florence Knoll : Relaxed Benches and Stool		150	
Florence Knoll : Model 31 and Model 33, Single Upholstery		154	
Florence Knoll : Model 31 and Model 33, Split Upholstery		156	
KnollStudio : Throw Pillows		158	
Marc Krusin : Guest Seating Collection	160		
Maya Lin : Stones	174		
Piero Lissoni : Divina® Lounge Seating	178		
Piero Lissoni : KN™ Collection	184		
Piero Lissoni : Avio™ Sofa Collection	190		





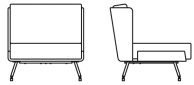
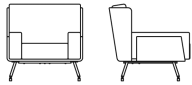
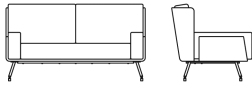
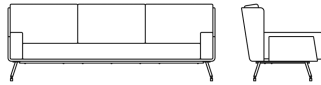
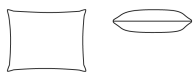

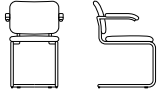

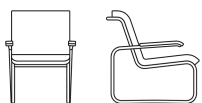
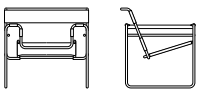
Side Chairs and Lounge Seating (cont'd.)	Ross Lovegrove : Sprite Armless Chair	224
	Ross Lovegrove : Sprite Arm Chair	226
	Marco Maran : Gigi® Arm Chair	228
	Marco Maran : Gigi® Armless Chair	232
	Marco Maran : Gigi® Armless Chair with Sled Base	236
	Marco Maran : Gigi® Barstool and Swivel Chair	240
	Ludwig Mies van der Rohe : Tubular Brno Chair	242
	Ludwig Mies van der Rohe : Flat Bar Brno Chair	244
	Ludwig Mies van der Rohe : Four Seasons Stool	246
	Ludwig Mies van der Rohe : MR Lounge Seating	248
	Ludwig Mies van der Rohe : MR Chair	250
	Ludwig Mies van der Rohe : Barcelona® Lounge Seating	252
	Ludwig Mies van der Rohe : Barcelona® Relaxed Lounge Seating	254
	Ludwig Mies van der Rohe : Krefeld™ Collection	256
	George Nakashima : Straight Chair	262
	Marc Newson : Newson Aluminum Chair	264
	Jonathan Olivares : Aluminum Stacking Chair	266
	Jorge Pensi : Toledo Stacking Chair	268
	Charles Pfister : Petite Lounge Seating	270
	Charles Pfister : Lounge Seating	274
	Charles Pfister : Sofa System	276
	Warren Platner : Seating Collection	280
	Warren Platner : Easy Chair and Ottoman	282
	Charles Pollock : Executive Conference Armless Chairs	284
	Charles Pollock : Executive Conference Arm Chairs	286
	Charles Pollock : Arm Chair	288
	Joe Ricchio : Joe™ Chair	290
	Joe and Linda Ricchio : JR® and Ricchio Chair with Upholstered Seat	292
	Joe and Linda Ricchio : Fully Upholstered Ricchio and JR® Chairs	298
	Jens Risom : Contract Seating	302
	Jens Risom : Residential Seating	304
	Jens Risom : Seating	308
	Jens Risom : Outdoor Seating	312
	Eero Saarinen : Tulip™ Chairs	316
	Eero Saarinen : Executive Arm Chairs	318
	Eero Saarinen : Executive Armless Chairs	322
	Eero Saarinen : Executive Armless Chairs with Plastic Back	326
	Eero Saarinen : Bar and Counter Height Stools	328
	Eero Saarinen : Womb™ Chair, Ottoman and Settee	330
	Tobia Scarpa : Bastiano Collection	338
Richard Schultz : 1966 Collection® Dining Chairs	340	
Richard Schultz : 1966 Collection® Barstools	342	
Richard Schultz : 1966 Collection® Lounge Seating	344	
Richard Schultz : 1966 Collection® Chaise Lounge Chairs	346	
Richard Schultz : Swell® Seating Collection	348	
Richard Schultz : Topiary® Seating Collection	350	
Shelton Mindel : Shelton Mindel Side Chair	352	
Shelton Mindel : SM1 Lounge Collection	354	
Shelton Mindel : SM2 Lounge Collection	356	
Ufficio Tecnico : Spoleto Chair	360	
Vignelli Associates : Handkerchief Armless Chair	362	
Vignelli Associates : Handkerchief Arm Chair	364	
Tables/Executive Office	David Adjaye : The Washington Collection for Knoll™	366
	Franco Albini : Albini Desk	370
	Ini Archibong : Iquo Cafe Collection	372
	Edward Barber & Jay Osgerby : Piton™ Side Table	376
	Edward Barber & Jay Osgerby : Smalto Table	378
	Marcel Breuer : Laccio Tables	380
	Lewis Butler : Butler™ Tables	382
	Joseph Paul D'Urso : Square Work and Low Tables	384
	Joseph Paul D'Urso : Round Work and Low Tables	386

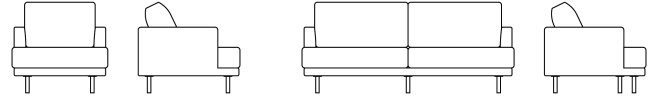
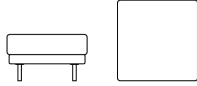
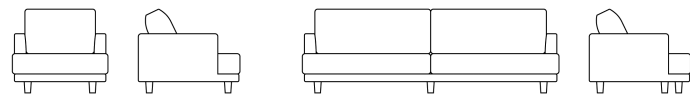

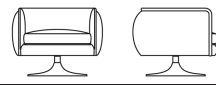
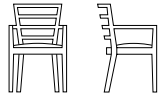

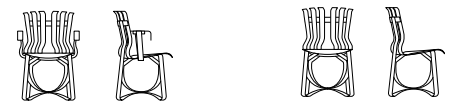
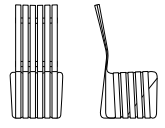

Tables/Executive Office (cont'd.)	Joseph Paul D'Urso : Racetrack Work Tables	390
	Frank Gehry : Face Off Cafe Table	392
	Alexander Girard : Coffee Table	394
	Florence Knoll : Oval Table Desks	396
	Florence Knoll : Round Table Desk	398
	Florence Knoll : Dining Tables and Mini Desk	400
	Florence Knoll : Executive Desk	404
	Florence Knoll : Credenzas	406
	Florence Knoll : AV Depth Credenzas	410
	Florence Knoll : Vertical Storage	412
	Florence Knoll : Coffee Tables	416
	Florence Knoll : Low Coffee Tables	418
	Florence Knoll : End Tables	420
	Florence Knoll : Hairpin™ Stacking Table	422
	Marc Krusin : Occasional Tables	424
	Piero Lissoni : Grasshopper™ Tables	426
	Lucia Mercer : Mercer Table	430
	Ludwig Mies van der Rohe : Barcelona® Table, MR Table	432
	Ludwig Mies van der Rohe : Krefeld™ Side and Coffee Table	434
	Pascal Mourgue : Square and Rectangular Conference Tables	436
	Pascal Mourgue : Round and Racetrack Conference Tables	438
	Pascal Mourgue : Bullet Conference Tables	440
	George Nakashima : Splay-Leg Table and Tray	442
	Isamu Noguchi : Cyclone™ Dining and Side Tables	444
	Jorge Pensi : Pensi Tables	446
	Warren Platner : Dining and Side Tables	450
	Warren Platner : Coffee Tables	454
	Jens Risom : Dining and Side Tables	456
	Jens Risom : Child's Amoeba Table	458
	Jens Risom : Outdoor Tables	460
	Eero Saarinen : Round Dining Tables	462
	Eero Saarinen : Oval Dining Tables	468
	Eero Saarinen : Round End and Coffee Tables	472
	Eero Saarinen : Lounge Tables	476
	Eero Saarinen : Oval End and Coffee Tables	478
	Eero Saarinen : Outdoor Tables	480
	Richard Schultz : Petal® Table Collection	482
	Richard Schultz : 1966 Collection® Dining Tables	484
	Richard Schultz : 1966 Collection® Counter Height Tables	486
	Richard Schultz : 1966 Collection® Bar Height Tables	488
	Richard Schultz : 1966 Collection® End and Coffee Tables	490
	Richard Schultz : 1966 Collection® Serving Cart	494
	Richard Schultz : Topiary® Dining Tables	496
	Shelton Mindel : SM Tables	498
	Daniel Stromborg : Round Tables	500
	Daniel Stromborg : Square Tables	502
	Daniel Stromborg : Rectangular Tables	504
	Vignelli Associates : PaperClip™ Cafe Tables	506
Alpha-Numeric Index		507
Selling Policy		515
General Ordering Information		517

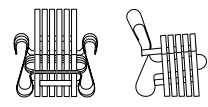
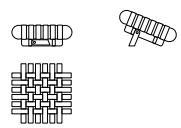
---



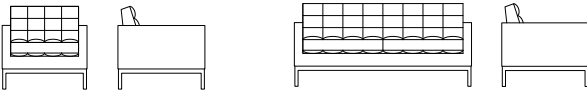
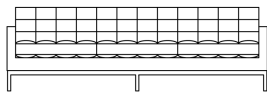

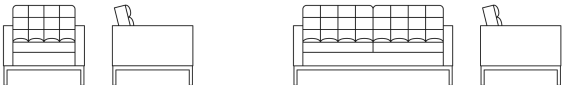
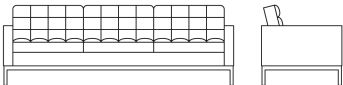
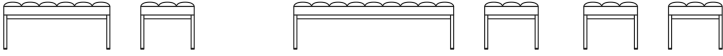
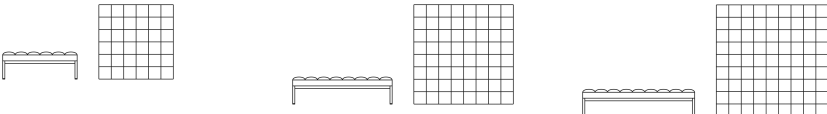





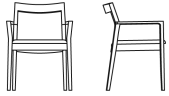

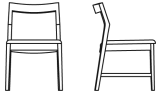
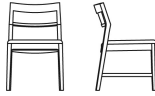
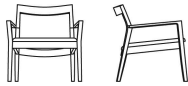
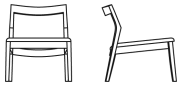
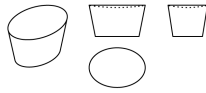

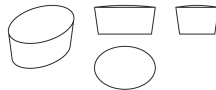
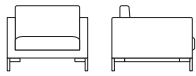
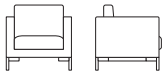
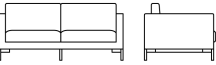
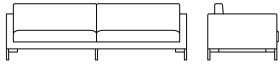



David Adjaye . . . . .	32-35, 366-369
Franco Albini . . . . .	370-371
Ini Archibong . . . . .	36-39, 372-375
Edward Barber & Jay Osgerby . . . . .	40-47
Edward Barber & Jay Osgerby . . . . .	48-53, 376-379
Harry Bertoina . . . . .	54-83
Pierre Beucler & Jean-Christophe Poggioli . . . . .	84-101
Cini Boeri . . . . .	102-103
Marcel Breuer . . . . .	104-115, 380-381
Lewis Butler . . . . .	382-383
Jonathan Crinion . . . . .	116-117
Raul de Armas . . . . .	128-137
Joseph Paul D'Urso . . . . .	118-127, 384-391
Frank Gehry . . . . .	138-141, 392-393
Alexander Girard . . . . .	394-395
Markus Jehs and J rgen Laub . . . . .	142-145
Florence Knoll . . . . .	146-153, 396-423
Florence Knoll, 1954 . . . . .	154-157
Marc Krusin . . . . .	160-173, 424-425
Maya Lin . . . . .	174-177
Piero Lissoni . . . . .	178-223, 426-429
Ross Lovegrove . . . . .	224-227
Marco Maran . . . . .	228-241
Lucia Mercer . . . . .	430-431
Ludwig Mies van der Rohe . . . . .	242-261, 432-435
Pascal Mourgue . . . . .	436-441
George Nakashima . . . . .	262-263, 442-443
Marc Newson . . . . .	264-265
Isamu Noguchi . . . . .	444-445
Jonathan Olivares . . . . .	266-267
Jorge Pensi . . . . .	268-269, 446-449
Charles Pfister . . . . .	270-279
Warren Platner . . . . .	280-283, 450-455
Charles Pollock . . . . .	284-289
Joseph Ricchio . . . . .	290-301
Linda Ricchio . . . . .	292-301
Jens Risom . . . . .	302-315, 456-461
Eero Saarinen . . . . .	316-337, 462-481
Tobia Scarpa . . . . .	338-339
Richard Schultz . . . . .	340-351, 482-497
Peter Shelton & Lee Mindel . . . . .	352-359, 498-499
Daniel Stromborg . . . . .	500-505
Ufficio Tecnico . . . . .	360-361
Vignelli Associates . . . . .	362
Vignelli Associates: David Law, Lella Vignelli & Massimo Vignelli . . . . .	506-507



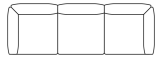
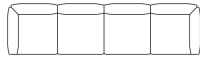

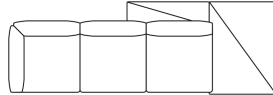





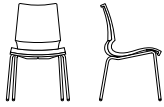

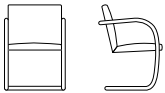
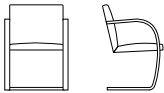
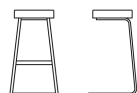
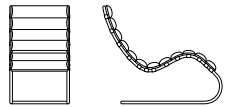
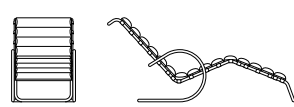
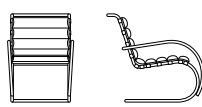
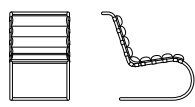

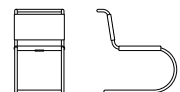
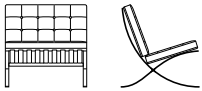
Page	SIDE CHAIRS AND LOUNGE SEATING			
32	ADJAYE	Prism Lounge chair 	Prism Ottoman 	Washington Skeleton 
36	ARCHIBONG	Cafe Chairs stacking armless 	Cafe Chairs stacking arm 	
40	BARBER & OSGERBY	Sofa 	Ottoman 	Arm chair 
		Pillow 	Piton stools 	Pilot High back 
		Pilot Low back 	Pilot Ottoman 	
54	BERTOIA	Side chair 	Barstools 	Stacking chair 
		Child's Diamond chair 	Large Diamond chair 	Bird high back chair 
		Bench 	Asymmetric Lounge 	Ottoman 
84	BEUCLER & POGGIOLI	Small lounge chair 	Lounge chair 	Settee 
				Sofa 
102	BOERI	Large pillow 	Small pillow 	
104	BREUER	Cesca chair 	Cesca Bar and Counter Stools 	
		MB Lounge 	Wassily chair 	



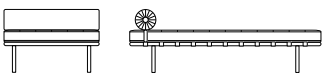

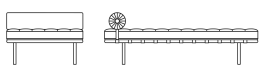

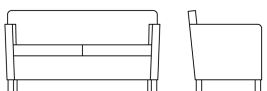
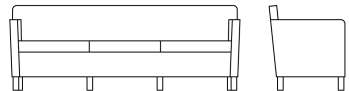
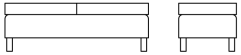



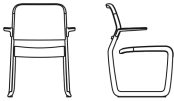
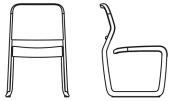



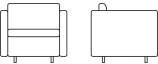
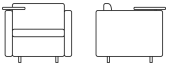
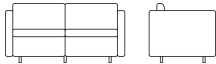
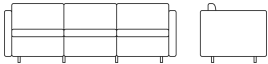

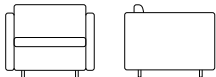
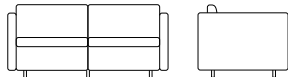
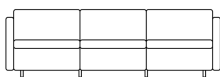
Page		SIDE CHAIR AND LOUNGE SEATING, continued			
116   117	CRINION	Crinion arm chair	Crinion armless chair		
					
118   127	D'URSO	Contract Lounge chair	Small Sofa	Ottoman	
					
		Residential Lounge chair	Sofa	Ottoman	
					
		Swivel Lounge chair			
					
128   135	DE ARMAS	de Armas arm chairs	de Armas armless chairs		
					
		Vertical de Armas arm chairs	Vertical de Armas armless chairs		
					
138   141	GEHRY	Hat Trick arm chair	Hat Trick armless chair	High Sticking chair	Cross Check chair
					
		Power Play chair	Offside ottoman		
					

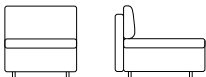

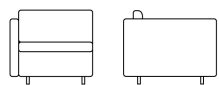
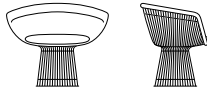

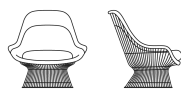
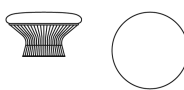

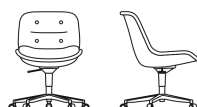

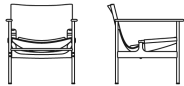

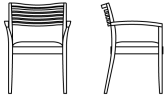
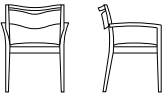
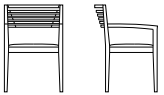
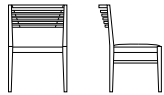

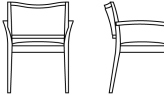
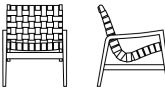

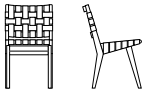

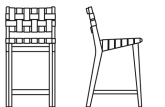
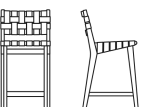

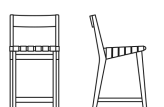

Page		SIDE CHAIR AND LOUNGE SEATING, continued		
144   147	JEHS+LAUB	Lounge chair, pedestal base	Ottoman, pedestal base	
				
		Lounge chair, wire base	Ottoman, wire base	
				
148	KNOLL	Lounge chair	Settee	Sofa
				
		Two seater bench	Three seater bench	
				
		Relaxed Lounge Chair	Relaxed Settee	Relaxed Sofa
				
		Relaxed Two Seat Bench	Relaxed Three Seat Bench	Relaxed Stool
				
		Relaxed Small Bench	Relaxed Medium Bench	Relaxed Large Bench
				
160	KNOLLSTUDIO	Lumbar pillow	Throw pillow	Large throw pillow
				



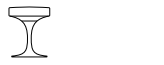





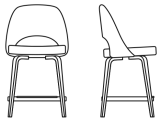
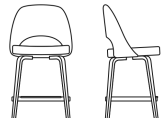



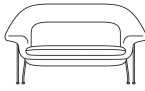







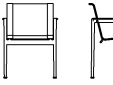

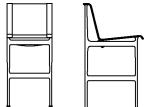
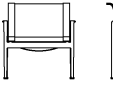
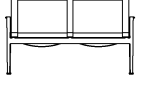

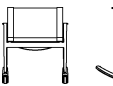
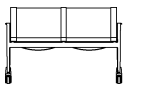

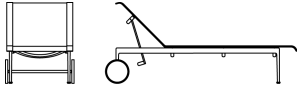







Page		SIDE CHAIR AND LOUNGE SEATING, continued			
162	KRUSIN	<p>Arm chair</p> 	<p>Arm chair with inset</p> 	<p>Armless chair</p> 	<p>Armless chair with inset</p> 
		<p>Arm lounge</p> 	<p>Armless lounge</p> 		
176	LIN	<p>Stones large seat</p> 	<p>Stones small seat</p> 	<p>Stones Coffee table</p> 	
180	LISSONI	<p>Divina Lounge chair</p> 	<p>Petite Lounge chair</p> 	<p>Settee</p> 	<p>Sofa</p> 
		<p>Ottoman</p> 			
186	LISSONI KN COLLECTION	<p>Swivel Large Chair</p> 	<p>Swivel &amp; Reclining High Back Chairs</p> 	<p>Ottoman</p> 	
		<p>KN04 Lounge Chair</p> 	<p>KN05 Settee</p> 		
192	LISSONI AVIO	<p>Two Seat Sofa</p> 	<p>Three Seat Sofa</p> 	<p>Four Seat Sofa</p> 	
		<p>Two Seat Bench</p> 	<p>Three Seat Bench</p> 	<p>Sectional, left hand L table</p> 	
226	LOVEGROVE	<p>Sprite armless chair</p> 	<p>Sprite arm chair</p> 	<p>Sprite Dolly</p> 	

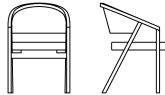
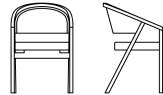

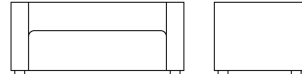

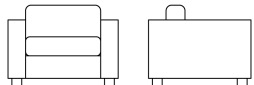
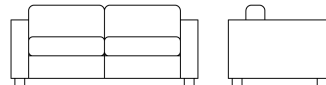
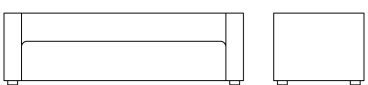









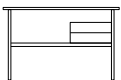



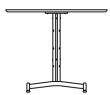
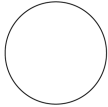

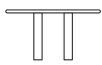





Page		SIDE CHAIRS AND LOUNGE SEATING, continued			
230	MARAN	Gigi arm chair 	Gigi armless chair 	Gigi Barstools 	Gigi Swivel chair 
244	MIES VAN DER ROHE	Tubular Brno chair 	Flat Bar Brno chair 	Four Seasons stool 	
		MR Chaise lounge 	MR adjustable chaise lounge 	MR arm lounge chair 	MR armless lounge chair 
		MR arm chair 	MR armless chair 		
254	MIES VAN DER ROHE	Barcelona chair 	Child's Barcelona chair 	Barcelona stool 	Child's Barcelona stool 
		Barcelona stool with cowhide sling 	Barcelona couch 		
		Barcelona relaxed chair 	Barcelona relaxed stool 	Barcelona Relaxed couch 	
		Krefeld Lounge chair 	Krefeld Settee 	Krefeld Sofa 	
		Krefeld medium and large benches 		Ottoman 	



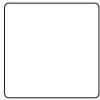

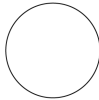
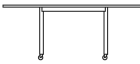

Page	SIDE CHAIRS AND LOUNGE SEATING, continued					
264	NAKASHIMA	Straight chair 				
266	NEWSON	Newson Aluminum Chair with arms 	Newson Aluminum Chair, armless 			
268	OLIVARES	Olivares chair 				
270	PENSI	Toledo chair 	Toledo chair seat cushion 			
272	PFISTER	Petite Lounge chair 	Petite Lounge chair with tablet arm 	Petite Settee 	Petite Sofa 	
		Petite Ottoman 	Lounge chair 	Settee 	Sofa 	
		Ottoman 	Modular Sofa System Center module 	End modules 	Corner module 	
282	PLATNER	Lounge chair 	Arm chair 	Stool 	Easy chair 	Ottoman 
286	POLLOCK	Executive Conference arm chair, 5-star base 	Executive Conference arm chair, 4-star base 	Executive Conference armless chair, 5-star base 	Executive Conference armless chair, 4-star base 	
		Arm Chair 				

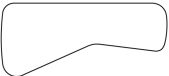
Page		SIDE CHAIRS AND LOUNGE SEATING, continued			
292	RICCHIO	Joe arm chair	JR chair	Ricchio arm chair	Ricchio armless chair
					
		Ricchio Fully upholstered chair JR Fully upholstered chair			
					
306	RISOM	Lounge chairs		Ottoman	
					
		Side chairs		Sitting stool	
					
		Counter Height Stool	Bar Height Stool	Counter Height stool	Bar Height stool
					
		Child's Side chairs		Child's Sitting stool	
					
318	SAARINEN	Tulip arm chair	Tulip armless chair	Stool	
					
320	SAARINEN	Executive arm chair 5-star base	Executive arm chair, 4 star base	Executive armless chair, 5-star base	Executive armless chair, 4-star base
					
		Arm chair	Armless chair	Armless Counter Height Stool	Armless Bar Height Stool
					

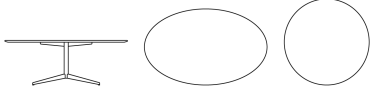
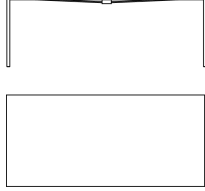
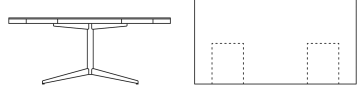

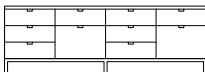
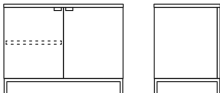
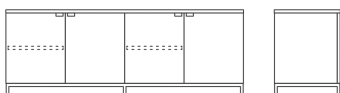
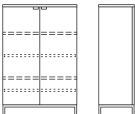

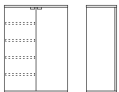



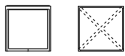
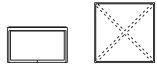
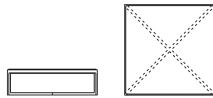
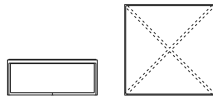
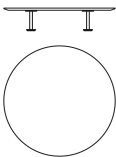
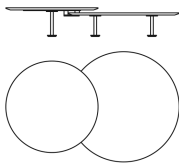
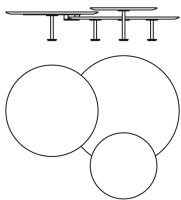
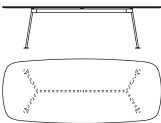
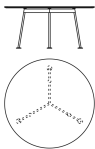

Page		SIDE CHAIRS AND LOUNGE SEATING, continued			
332	SAARINEN	Womb chair 	Ottoman 	Womb Settee 	Medium Womb chair 
					
		Medium Ottoman 	Child's Womb chair 		
342	SCHULTZ	Dining chair with arm 	Dining chair, armless 	Counter height armless barstool 	Bar height armless barstool 
		Lounge chair with arms 	Two seat lounge chair with arms 	Three seat lounge chair with arms 	
		Single rocker 	Double rocker 		
		Contour chaise lounge 	Adjustable chaise lounge 		
		Single seat club chair 	Two seat sofa 	Three seat sofa 	
		Topiary dining chair 	Topiary lounge chair 	Topiary bench 	Topiary small ottoman/end table 

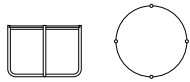
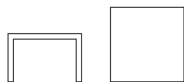

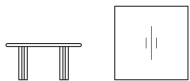
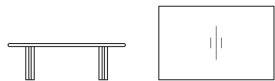

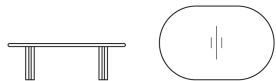

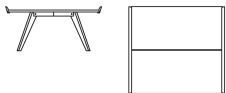



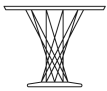
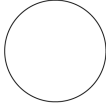







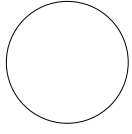
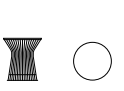
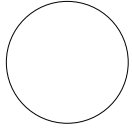

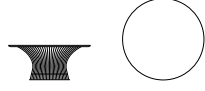









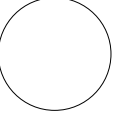

Page		<b>SIDE CHAIRS AND LOUNGE SEATING, continued</b>	
354	SHELTON & MINDEL	SM side chair	SM side chair, fully upholstered
			
		SM1 Lounge chair	SM1 Settee
			
			SM1 Sofa
			
		SM2 Lounge chair	SM2 Settee
			
			SM2 Sofa
			
362	TECHNICO	Spoleto chair	
			
364	VIGNELLI ASSOCIATES	Handkerchief arm chair	Handkerchief armless chair
			

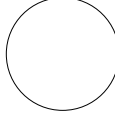

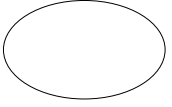



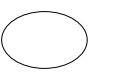

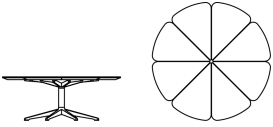
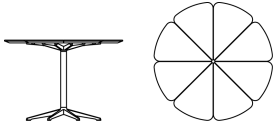
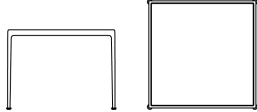
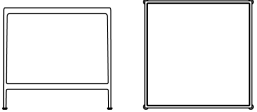
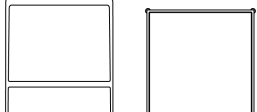
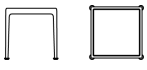

Page	TABLES / EXECUTIVE OFFICE			
368	ADJAYE	Washington Corona  	Prism side tables  	
372	ALBINI	Pedestal desk  		
374	ARCHIBONG	Square bistro table  	Round bistro table  	
378	BARBER & OSGERBY	PITON side tables  	Smalto Tables  	
382	BREUER	Laccio tables  		
384	BUTLER	Coffee tables    		
386	D'URSO	Work and low tables - Square   	Work and low tables - Round   	Work tables - Racetrack  
394	GEHRY	Face Off café tables  		
396	GIRARD	Coffee table  		

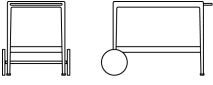
Page	KNOLL	TABLES / EXECUTIVE OFFICE continued		
398	KNOLL	Oval and Round table desks	Dining Table and Mini Desk	Executive desk
				
		Two Position Credenza	Four Position Credenza	
				
		AV Two Position Credenza	AV Four Position Credenza	
				
		Vertical Storage Two Door Credenza	Vertical Storage Two Door, Adjustable Shelf Credenza	
				
		Vertical Storage Two Position Credenza with Divider & Coat Closet	Vertical Storage Two Position Credenza with single width shelves	
				
		Coffee and end tables	Hairpin stacking table	
				

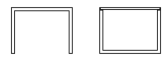

Page		TABLES / EXECUTIVE OFFICE continued			
428	KRUSIN	Square side tables	Square end tables	Square coffee tables	Square coffee tables
					
430	LISSONI	Grasshopper Low Single Round	Grasshopper Low Double Round	Grasshopper Low Triple Round	
					
		Grasshopper High Rectangular	Grasshopper High Round		
					
434	MERCER	Tables			
					
436	MIES VAN DER ROHE	Barcelona table	MR table	Krefeld side table	Krefeld coffee table
					
440	MOURGUE	Pascal square table	Pascal rectangular table	Pascal round table	Pascal racetrack table
					
		Pascal bullet table			
					
446	NAKASHIMA	Splay-leg table	Tray		
					

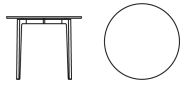
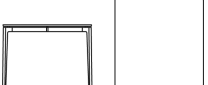
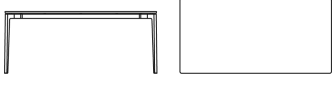
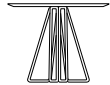
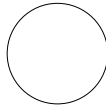
Page	TABLES / EXECUTIVE OFFICE, continued			
448	NOGUCHI	Cyclone dining table	Cyclone side table	
				
450	PENSI	Pensi tables	Pensi high table	
				
				
454	PLATNER	Dining table	Side table	Coffee tables
				
				
460	RISOM	Dining table	Side tables	Amoeba coffee table
				
				
				
				
466	SAARINEN	Dining tables	Side tables	Coffee tables
				
				
				
				
		Outdoor tables		
				
				

Page		TABLES / EXECUTIVE OFFICE, continued			
486	SCHULTZ	Petal end table	Petal coffee table	Petal dining table	
					
		1966 Dining table	1966 Counter Height table	1966 Bar Height table	1966 End table
					
		1966 Coffee table	1966 Serving Cart	Topiary® Dining table	
					
502	SHELTON & MINDEL	SM side table	SM small coffee table	SM large coffee table	SM square coffee table
					
504	STROMBORG	Round table	Square table	Rectangular table	
					
510	VIGNELLI ASSOCIATES	PaperClip tables			
					

**A Price List Overview**

Where do I send my order? How should I maintain my marble table? From textile options to wood polishes, the KnollStudio price list is designed to provide you with everything you need to know in order to understand, specify, and care for furniture in the KnollStudio Collection.

This book is divided into two easy-to-use sections.

- Side Chairs and Lounge Seating
- Tables and Executive Office

For a quick overview of the collection's scope, review the Visual Index on pages 5. If you're looking for pieces by a specific designer, try the Designer Index on page 4.

**Leathers, Textiles, and Finishes**

Pages 20-21 explains the broad selection of Spinneybeck leathers available for KnollStudio furniture.

Additional upholstery notes and Customer's Own Material (COM) information are available on page 21.

For detailed explanations of the many materials used in constructing KnollStudio furniture, consult page 27. A cross-reference of KnollStudio veneer or lumber finishes with standard Knoll Office veneers is provided on page 26. Easy-care maintenance information is also provided on pages 28-29.

**Placing Your KnollStudio Order**

For information about where to send your order and key terms and conditions, see page 31.

The complete Knoll Selling Policy is available on pages 515-516.

General Ordering Information and Knoll's Sustainability Statement is available on page 517

**Product Information On Each Page**

On each page, the following features will assist you:

*Description* provides both the pattern number and a basic description of the product.

*Dimensions* provide the overall space the product will require. Statistics are based on the maximum width, depth, and height of the product.

*Weight* is based on the product itself. It does not include packaging. Weights are rounded to the nearest pound.

Weights of upholstered items do not include weight of textile/leather. To calculate total weight, multiply covering requirements by textile/leather weight, and add to product weight.

*Pattern Number* provides both the product identification number and all additional selections required for ordering. Finish options are enclosed in parentheses. Finish suffix descriptions are found under Finishes on the bottom portion of the page.

*Order Code/Ordering Information* outlines exactly how to specify KnollStudio product and the full scope of finishes and other options. The Order Code provides an example of how one pattern number on the page is specified.

*Construction* provides specific materials and finishes employed, as well as specific construction details.

*Textiles and Leather Grades* list by price group all KnollTextiles and Spinneybeck Leathers approved for each seating piece. This list is derived through careful examination of the textile or leather's distinctive upholstery characteristics and the form and structure of each piece of furniture. KnollTextiles or Spinneybeck leathers that are not listed have been rejected because Knoll cannot ensure their performance on that product. To view the full range of colorways available for each fabric or leather, consult any Knoll or Spinneybeck representative.

**Cal 133 Technical Bulletin**

Many KnollStudio products meet California Technical Bulletin 133. Information for specifying these items is on page 22. Applicable upcharge will be listed on the respective price list page.

**Intertek Clean Air Certification**

Intertek's Clean Air Certification validates the level of volatile organic compound (VOC) emissions from products. VOCs are gases emitted from products and include a variety of chemicals that may affect consumers' health in the short- and long-term. Both Intertek Clean Air GOLD and SILVER certifications ensure the user-health, safety and sustainability of KnollStudio products. A selection of Knoll Office and KnollStudio products are Intertek certified Clean Air, most of which are certified GOLD, which imposes more rigorous standards than certified SILVER.

**Note to Knoll Dealer Sellers:**

The products contained in this price list are also available through the Knoll Essentials program, with limited exceptions. For additional information, please contact your customer service representative or visit Knoll Exchange.

**For More Information**

For more information, contact your KnollStudio representative, a Knoll Space reailer or e-tailer, or telephone Customer Services at 800 343-KNOLL. To find the retailer or showroom nearest you, visit [www.knoll.com](http://www.knoll.com).

For the ultimate in comfort, durability, and prestige, many KnollStudio products can be upholstered in Spinneybeck leathers.

Spinneybeck leathers are made from the top 2% of the world's finest hides, inspected numerous times during production to ensure evenness of grain, surface, color and the absence of scars.

After tanning, all Spinneybeck leathers are drum-dyed, a time-consuming procedure which ensures color penetration throughout the hide. Each hide is then finished in the manner which will best bring out its individual character.

Spinneybeck leathers are all full-grain aniline drum-dyed products imported from Italy.

The following Spinneybeck leathers are approved for application on KnollStudio products. Leathers are grouped into five price categories referred to as "grades." The selection of approved leathers varies by product. Please refer to the pricing page of each product line for more information.

Square footage requirements for Customer's Own Leather (COL) are listed on the left side of the pricing page. Please refer to Upholstery Notes on page 21 and The Knoll Selling Policy on pages 515-516 for further information regarding COL.

For further information call Spinneybeck at 1-800-482-7777.

**Grades****U**

Vicenza  
Volo

**Characteristics**

Heavily finished cowhide, corrected grain, slightly raised grain texture  
Heavily finished cowhide, corrected grain, slightly raised grain texture

**V**

Acqua  
Andes  
Embossed  
Tipped  
España  
Hand Tipped  
Maremma  
Velluto Pelle

Heavy water-repellent finished kip, corrected grain, slightly raised grain texture  
Slightly pronounced grain cowhide with a medium finish, and enhanced grain  
Lightly finished cowhide, full grain, embossed pronounced pebble grain  
Smooth, tight grain cowhide; breathable, protective medium finish, enhanced grain  
Two-toned leather, lightly finished cowhide, pronounced pebble grain texture  
Full grain textured suede with impregnated soil-resistant treatment  
Slightly pronounced grain cowhide with a medium finish, enhanced grain

**W**

Alaska  
Antique  
Derby  
Forte  
Lucente  
Sabrina  
Umbria

Pearlized-iridescent protective finish cowhide, full grain with smooth texture  
Smooth tight grain cowhide, lightly antiqued to produce an elegant patina, enhanced grain  
Combination-tanned cowhide; full grain, medium finish and raised grain texture  
High performance, full grain leather with slightly pronounced grain texture  
Smooth, very tight grain cowhide; subtle sheen; light casein finish  
Smooth, tight and full grain kip with a breathable protective finish  
Lightly finished cowhide, full grain, enhanced raised pebble

**X**

Ducale  
Ducale  
Velour

Embossed shrunken grain cowhide, medium protective finish, full grain  
Full grain-sueded cowhide, embossed shrunken grain, scotch-guarded

**Y**

Cascia  
Cervo  
Copenhagen  
Distressed  
Gemma  
Lucca  
Marissa  
Portofino  
Riva  
Rugata  
Saddle  
Sassolino

Full aniline, smooth tight grain  
Full aniline, pronounced grain texture, soft luxurious hand  
Full aniline, 100% vegetable tanned leather, full grain  
Aniline-dyed, paraffin wax final ironing process with a smooth finish, and full grain  
Metallic foil micro perforate cowhide, full grain with smooth texture, casein finish  
Aniline-dyed, pebble grain sueded leather  
Grain-sueded cowhide, scotch-guarded smooth suede grain  
Full grain, lightly finished cowhide, with a pronounced raised texture  
Slightly pronounced grain texture, water-repellent, full grain  
Full grain, very lightly finished cowhide, with a natural shrunken grain texture  
Full aniline, smooth very tight grain surface takes on a rich patina over time  
Medium finished cowhide, full grain, enhanced pronounced pebble

**Textile and Leather Notes**

All seating in this price list includes the cost of applied fabric or leather. To simplify ordering, the seating is arranged into specific upholstery grades and priced accordingly. Samples and prices of cut textiles are available on request. For a full list of the Spinneybeck leathers available, see page 20.

**Leather***The Natural Qualities of Leather*

Natural leather is unique. Because every animal is different, each hide has its own individual color, texture, and life-marks. In fact, our leathers are painstakingly treated to retain their natural appearance and hand. Range marks are not camouflaged. Colors and texture vary, and will do so more with age as the leather mellows and takes on a rich patina.

*Spinneybeck Leathers*

Spinneybeck offers full-grain Italian leathers.

Spinneybeck features three different tanning processes which preserve the leather. The first is mineral tannage, in which chromium salts are used; the second is vegetable tannage, in which bark tanning is used; and the third is a combination of the first two processes. Each leather is tanned in the manner which will best accentuate its unique characteristics.

Spinneybeck leathers are drum-dyed which tumbles the leather over and over for smooth, even coloring absorbed directly into the leather. This aniline-dyeing process enhances the natural qualities of leather grain. Many competitors use vat-dyeing. This does not dye the leather in an even manner.

If you have further questions on Spinneybeck leathers, contact your Knoll representative or telephone Spinneybeck Customer Service at 1-800 482-7777.

Below are additional details on the three major types of Spinneybeck leathers.

*Naked Leather (Capri, Copenhagen, Distressed, Maremma, Saddle)* Naked leather contains no foreign substances which would affect the superbly soft, mellow hand of this most luxurious of upholstery leathers. Natural markings are

accentuated. Since there are no barriers against spillage or staining, naked leathers should be carefully specified. However, scratches and marks will dissipate in time as the leather develops a beautiful patina.

*Leathers with Protective Finishes:*

*(Acqua, Alaska, Amazon, Andes, Antique, Derby, Ducale, España, Forte, Hand Tipped, Lucente, Montalcino, Portofino, Riva, Sabrina, Velluto Pelle, Volo)*

For high traffic areas, protective finishes allow leather to be not only practical, but easy to maintain.

*Grain Sueded Leathers (Ducale Velour, Marissa)*

Full grain leathers that have been lightly buffed to raise the nap of the surface are referred to as "grain sueded" leathers. This produces the soft hand of sueded leathers. For maximum soil resistance and durability, these leathers have received an impregnated soil resistance treatment during the drum-dye process which permeates the leather, making it repellent to liquid and dirt.

**Textile***Classic Boucle*

Classic Boucle is with spun Boucle yarn that is a blend of wool and nylon that is piece dyed. Color can vary from lot-to-lot and it is important to use the same lot for multiple piece orders. Please notate sales order when items must match. Classic Boucle, Pearl contains natural, un-dyed wool and will have darker hairs woven within the textile.

**Knoll Upholstery Restrictions**

Every Knoll leather and fabric is exhaustively tested on each Knoll upholstered item. This is done in addition to the most extensive program of independent fabric testing in the industry. On furniture, testing ensures precise fit and appearance, without stretch, puddling, telegraphing or other common problems frequently experienced when careful factory pre-qualification is eliminated.

When Knoll suggests that a particular leather or fabric not be used on an object, this does not mean the material is defective in any way; it only implies less than perfect performance with the form and structure of a specific item on furniture.

**Instructions for Ordering Nano-Tex**

The minimum for Nano-Tex on KnollStudio orders is 1-lot \$250 net for up to 70 yards. Nano-Tex orders of 71+ yards is \$3.25 net/yard.

Dealer instructions for ordering Nano-Tex:

- 1) Visit [knolltextiles.com/technical](http://knolltextiles.com/technical) documents and open the Nano-Tex specifications to see if the fabric is approved with the finish.
- 2) If approved, check the seating matrix at [knolltextiles.com](http://knolltextiles.com) to see if the fabric alone is approved on the chair. (If yes, proceed to #3).
- 3) Contact your account manager with the fabric name, treatment required, and name and pattern number of desired chair. They will see if Knoll has tested this fabric with finish/treatment on said chair. In most cases, application testing has not been done and they will contact the appropriate parties to initiate approval and determine leadtime for testing.
- 4) If approved, book order with a suffix of N (for Nano-Tex) after the fabric pattern number.
- 5) The fabric grade will remain the same. Add line item for finish/treatment required and multiply the finish cost by the number of yards required.

**Customer's Own Material (COM) Customer's Own Leather (COL)**

While Knoll is pleased to cooperate with COM/COL selections, an extra charge is required to help offset receiving and handling costs. Such charges are included under the COM/COL title of the price columns in this price list. Prior to order placement, a sample cutting of actual COM/COL must be submitted to Knoll in East Greenville or through your regional Knoll office for preliminary approval of intended item (8" x 8" minimum memo sample if solid; if COM has a repeat, the sample must be large enough to show the repeat).

Even after such preliminary approval, Knoll reserves the right to reject COM/COL, including, if necessary, the item intended for use with COM/COL, if Knoll considers the customer-supplied material inadequate for any reason. When COM/COL is accepted, KnollStudio assumes no responsibility for its appearance, durability, color fastness or any other quality after upholstered on a Knoll product.

Published yardage requirements are based upon Knoll 52" width material unless specified otherwise. Leather requirements are based on whole hides with a minimum of 50 square feet per hide. However, in some cases, the nature or pattern of COM/COL will require additional yardage/square feet and/or additional labor charges. When this is necessary, the customer will be notified at the same time that the preliminary sample is approved.

If your COM/COL is approved, you may send the required amount for the product to:

Knoll, Inc.  
1235 Water St  
East Greenville, PA 18041  
Attn: Customer Resources

COM/COL must be marked with designated approval number and customer's name.

For additional information, see Customer's Own Material (COM) under Selling Policy on pages 515-516.

**Test Objective**

California Technical Bulletin 133 (Cal 133) is a full-scale seating test, not a component test. Testing must be performed on the designated seating unit and textile together. Component data alone cannot be used to certify compliance with the regulation. Under Cal 133 you cannot assume that seating or textiles that have passed individually will pass together.

**Test Procedure**

The seating unit is exposed to a square open flame gas burner for 80 seconds, positioned at the center of the seating unit, two inches from the back and one inch from the seat.

**Scope**

Cal 133 only applies to seating units. The bulletin is designed for high risk public areas:

- Nursing homes
- Health care facilities
- Public auditoriums
- Hotels (more than 10 seating units in one room)
- Motels (more than 10 seating units in one room)
- Jails and prisons

Tables and desks are not covered by the bulletin. Variations may occur in individual states with regards to specific application. In California only, compliance is at the discretion of the fire marshal in any building which is fully sprinklered.

**KnollStudio Approvals**

Tested seating units have been tested in a worst case scenario thus covering other fabrics of lighter weight and same construction. When specifying Cal 133, the seating unit may be constructed with a fire resistant foam and a fire blocker will be laminated to the textile.

**How To Specify**

It is easy to specify Cal 133 on KnollStudio seating. Simply add the suffix “C” to the end of the pattern number prior to the textile selection. Approved textile selections must have the suffix 133 added to the end of the pattern number.

Example: Bertoia side chair, chrome, seat pad in Common Ground/Basalt 420C-C-K-C-K448/12-133

**Testing Additional Product**

If you would like to test a specific product:

Specify chair and textile desired - adding appropriate C and 133 codes as explained.

Testing lead time will be the standard lead time of the chair plus 4 - 6 weeks for testing procedure.

Test cost will be the regular price of the chair plus \$520 for the testing procedures.

All prices below are list.

KnollStudio CAL 133 Approved Products					
Designer	Product	Pattern #	Unupholstered, no upcharge	Knoll Textiles, upcharge	Spinneybeck leather, upcharge
Bertoia	Side Chair, seat cushion	420K	approved	approved, no upcharge	approved, no upcharge
Bertoia	Barstools, Bar Height, seat cushion	427K	approved	approved, no upcharge	approved, no upcharge
Bertoia	Barstools, Counter Height, seat cushion	428K	approved	approved, no upcharge	approved, no upcharge
Bertoia	Diamond Lounge Chair	421K	approved	approved, no upcharge	approved, no upcharge
Bertoia	Diamond Lounge Chair	421F	approved	approved, no upcharge	approved, no upcharge
Bertoia	Child’s Diamond Lounge Chair	421LS-K		approved, no upcharge	approved, no upcharge
Bertoia	Child’s Diamond Lounge Chair	421LS-U		approved, no upcharge	
Bertoia	Large Diamond Chair	422F		approved, no upcharge	
Bertoia	Bird Lounge Chair and Ottoman	423LU, 424YU		approved, no upcharge	
Bertoia	Asymmetric Chaise	429LU, 429F		approved, no upcharge	
Breuer	Cesca Chair	50A, 50C		\$132.00	
Breuer	Wassily Chair	50L	approved		approved
Crinion	Crinion Chair	58A, 58C		\$76.00	
D’Urso	Lounge Chair	2160, 2160R		\$766.00	\$895.00
D’Urso	Lounge Chair, split upholstery	2160S, 2160RS		\$1,164.00	\$1,164.00
D’Urso	Swivel Lounge Chair	2165		\$693.00	
D’Urso	Small Sofa	2161		\$1,366.00	\$1,495.00
D’Urso	Small Sofa, split upholstery	2161S		\$1,797.00	\$1,797.00
D’Urso	Residential Sofa	2162R		\$1,669.00	\$1,797.00
D’Urso	Residential Sofa, split upholstery	2162RS		\$2,097.00	\$2,097.00
D’Urso	Ottoman	2163, 2163R		\$413.00	\$549.00
D’Urso	Ottoman, split upholstery	2163S, 2163RS		\$700.00	\$700.00
de Armas	de Armas Chair Collection	38A, 38AW, 38C, 28CW, 41A, 41AW, 41C, 41CW		\$76.00	\$76.00
de Armas	de Armas Chair Collection	38AW-U, 38CW-U, 41AW-U, 41CW-U		\$135.00	\$135.00

KnollStudio CAL 133 Approved Products (continued)					
Designer	Product	Pattern #	Unupholstered, no upcharge	Knoll Textiles, upcharge	Spinneybeck leather, upcharge
Jehs+Laub	Lounge Chair	JL1-P, JL1-PLt, JL2-P, JL2-PLT, JL1-W, JL1-WLT, JL2-W, JL2-WLT		\$318.00	\$428.00
Jehs+Laub	Ottoman Chair	JL3-P, JL3-PLT, JL3-W, JL3-WLT		\$122.00	
Knoll	Lounge Chair	1205S1		\$736.00	\$867.00
Knoll	Settee	1205S2		\$1,281.00	\$1,514.00
Knoll	Sofa	1205S3		\$1,716.00	\$2,024.00
Knoll	Small Bench	2530Y2C		\$172.00	\$460.00
Knoll	Large Bench	2530Y3C		\$321.00	\$650.00
Lin	Stones, seat pad	83Y-K, 84Y-K		\$76.00	
Lissoni	Divina Petite Lounge Chair	67S		\$497.00	\$932.00
Lissoni	Divina Standard Lounge Chair	67, 67R		\$797.00	\$1,163.00
Lissoni	Divina Settee	68, 68R		\$1,223.00	\$1,841.00
Lissoni	Divina Optional Side Cushion	68C		\$110.00	
Lissoni	Divina Sofa	69, 69R		\$1,835.00	\$2,370.00
Lissoni	Divina Ottoman	73, 73R		\$429.00	\$797.00
Lovegrove	Sprite Arm and Armless Chair	27C, 27A	approved	\$76.00	\$76.00
Mies van der Rohe	Tubular Brno Chair	245AT, 245AB		\$808.00	\$808.00
Mies van der Rohe	Flat Bar Brno Chair	255AS, 255CS		\$808.00	\$808.00
Mies van der Rohe	Four Seasons Stool	257C			\$212.00
Mies van der Rohe	Barcelona Lounge Chair	250LS, 250LC			\$661.00
Mies van der Rohe	Child's Barcelona Chair	250LC-S			\$582.00
Mies van der Rohe	Barcelona Ottoman	251YS, 251YC			\$335.00
Mies van der Rohe	Child's Barcelona Ottoman	251YC-S			\$288.00
Mies van der Rohe	Krefeld Lounge Chair	751		\$704.00	\$1,118.00
Mies van der Rohe	Krefeld Settee	752		\$871.00	\$1,554.00
Mies van der Rohe	Krefeld Sofa	753		\$1,197.00	\$2,010.00
Mies van der Rohe	Krefeld Ottoman	754		\$327.00	\$585.00
Mies van der Rohe	Krefeld Medium Bench	755		\$545.00	\$879.00
Mies van der Rohe	Krefeld Large Bench	756		\$597.00	\$1,187.00
Pensi	Toledo Stacking Chair	29C	approved		
Pfister	Standard Lounge Chair, Petite Lounge Chair	1051C, 1051C-S		\$812.00	\$1,225.00
Pfister	Standard Settee	1052C		\$1,391.00	\$2,123.00
Pfister	Standard Sofa	1053C		\$1,812.00	\$3,006.00
Pfister	Corner Module	1050C-3		\$760.00	\$1,244.00
Pfister	End Module, left panel and right panel	1050C-1, 1050C-2		\$680.00	\$1,063.00
Pfister	Center Module	1050C		\$557.00	\$878.00
Pfister	Standard Ottoman	1059C		\$427.00	\$589.00
Pollock	Executive/Conference Arm and Armless Chairs	12A, 12C		\$141.00	\$141.00
Ricchio	Joe Chair	48A		\$76.00	\$76.00
Ricchio	Ricchio Chair	37A, 37C		\$76.00	\$76.00
Ricchio	JR Chair	44A		\$76.00	\$76.00
Ricchio	Fully Upholstered Ricchio Chair	37A-U, 37C-U, 44A-U		\$214.00	\$214.00
Ricchio	Ricchio Barstool	37CH, 37CM		\$76.00	\$76.00
Risom	Risom Stool, Side and Lounge Chair	666C, 667Y, 666CS, 667YS, 654LA, 654LC		approved, no upcharge	approved, no upcharge
Saarinen	Executive Arm Chairs	71A		\$339.00	\$492.00
Saarinen	Executive Armless Chairs	72C		\$234.00	\$492.00
Saarinen	Womb Settee	73L		\$1,034.00	\$1,921.00
Saarinen	Womb Chair	70L		\$825.00	\$1,524.00
Saarinen	Medium Womb Chair	70LM		\$573.00	\$1,391.00
Saarinen	Womb Ottoman	74Y		\$250.00	\$454.00
Saarinen	Medium Womb Ottoman	74YM		\$195.00	\$397.00
Shelton Mindel	Side Chair	SM8A		\$76.00	\$76.00
Shelton Mindel	Side Chair Fully Upholstered	SM8A-U		\$214.00	\$214.00
Shelton Mindel	SM1 Lounge Chair	SM1-1		\$703.00	\$882.00



KnollStudio CAL 133 Approved Products (continued)					
Designer	Product	Pattern #	Unupholstered, no upcharge	Knoll Textiles, upcharge	Spinneybeck leather, upcharge
Shelton Mindel	SM1 Settee	SM1-2		\$979.00	\$1,259.00
Shelton Mindel	SM1 Sofa	SM1-3		\$1,225.00	\$1,668.00
Shelton Mindel	SM2 Lounge Chair	SM2-1		\$899.00	\$979.00
Shelton Mindel	SM2 Lounge Chair- combination	SM2S-1		\$1,584.00	\$1,584.00
Shelton Mindel	SM2 Settee	SM2-2		\$1,440.00	\$1,526.00
Shelton Mindel	SM2 Settee- combination	SM2S-2		\$2,350.00	\$2,350.00
Shelton Mindel	SM2 Sofa	SM2-3		\$2,116.00	\$2,303.00
Shelton Mindel	SM2 Sofa- combination	SM2S-3		\$3,334.00	\$3,334.00
Vignelli Associates	Handkerchief Arm and Armless Chair	4901K, 4902K	approved	\$76.00	

---

## **Intertek Clean Air Certification**

Intertek's Clean Air Certification validates the level of volatile organic compound (VOC) emissions from products. VOCs are gases emitted from products and include a variety of chemicals that may affect consumers' health in the short- and long-term. Both Intertek Clean Air GOLD and SILVER certifications ensure the user-health, safety and sustainability of Knoll products. A selection of Knoll Office and Studio products are Intertek certified Clean Air, most of which are certified GOLD, which imposes more rigorous standards than certified SILVER.

### **Certified Clean Air GOLD**

- USGBC LEED credits
- California 01350 Special Environmental Requirements (CDPH).
- California Department of General Service (DGS) Indoor Air Quality Specifications for Open Panel Office Furniture
- Compliant to BIFMA e3 standard credit 7.6.2 and 7.6.3.

# KnollStudio Finish Code Chart

## Compatibility with Knoll Office Systems

### Wood Compatibility Matrix

To match KnollStudio wood side chairs with Knoll Office or KnollStudio veneer finishes, please specify the appropriate Special code. Finishes are matched on either maple or beech basewood depending on depth of color.

Please note: this match is complimentary in color only. Perception can be affected by the variation in the grain of the basewood.

Specify:

1. Pattern Number
2. Finish selection
3. Textile selection

Example: **37A-BQV411-K784/74**

**37A**, Ricchio Side Chair

**BQV411**, V2 Natural Veneer - Light Walnut

**K784/74**, Knoll Velvet/Moss

To match Propeller, Pixel, and LSM with Knoll Office or KnollStudio finishes, please submit a request through CPD. Any of the finishes listed below may be used at no additional upcharge.

KNOLL OFFICE VENEER FINISHES			STUDIO WOOD SIDE CHAIR FINISHES	
	CUT	Standard Finish Code	Special Code - Maple	Special Code - Beech
<b>V1 Engineered Techwoods</b>				
Maple *	FC	506B	•	•
Cherry *	FC	509B	•	BQY319
Medium Walnut*	FC	512B	•	B323
Dark Mahogany*	FC	628B	•	BQY326
Medium Teak	QC	513B	•	BQY342
Espresso	QC	514B	•	BQY344
Natural**	QC	637B	Contact CPD	•
Blond Maple (Maple)**	QC	638B	Contact CPD	•
Light Cherry (Cherry)**	QC	639B	•	BQY831
Black Oak	RC	641B	•	BQY851
Light Walnut	QC	644B	•	BQY881
Dove Grey	QC	645B	Contact CPD	•
* = previously Reff Techwoods, ** = previously, Morrison Techgrain. Names and codes in parenthesis ( ) are names prior to 2009.				
<b>V2 Natural Veneers</b>				
Bronzed Cherry	FC	002B	•	B312A
Maple (Light Maple)	FC	006B	•	•
Light Walnut	FC	017B	•	BQV411
Peacock Green Walnut	FC	021B	•	BQV415
Old English Walnut	FC	022B	•	BQV417
<b>V3 Natural Exotic Veneers</b>				
Figured Sycamore	QC	044B	•	•
<b>Propeller Veneer Finishes</b>				
American Cherry	FC	X	•	BQEX
Warm Brown Walnut	FC	J	•	BQEJ
Ebonized Walnut	FC	D	Contact CPD	BE

FC= Flat Cut Veneer, exhibits cathedral pattern

RC= Rift Cut Veneer, Straight Grain

QC = Quarter Cut Veneer, Straight Grain

• = Not possible

**KnollStudio Natural Materials**

Wood, marble, granite, and slate are natural materials that vary. Use material samples and printed sample materials as reference only.

KnollStudio printed and finish samples offer an example of what an “average” natural material may look like, within a range of acceptance carefully delineated by Knoll. Because of the breadth of variations possible with any natural material, Knoll specialists select these materials with stringent criteria, accepting only the top 3 - 5% of what is available.

**Wood***Knoll Natural Veneers*

All natural finishes are selected from the finest hardwoods available around the world. Veneers are flat cut and carefully matched so that cathedral or heart patterns are perfectly balanced. Natural veneers also are cut to allow a generous margin of quarter-grain figuring ensuring invisible splicing.

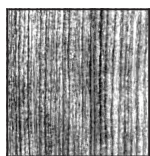

*Quarter Pattern*

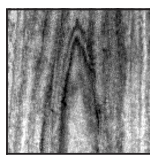

*Cathedral Pattern*

**Finishes**

Most finishes are designed to coordinate with standard Morrison and Reff. For reference, consult the matrix on page 26.

**Marble, Granite and Slate**

Knoll selects the highest quality, structurally sound marble, granite and slate available, through a host of quarries in the United States, Turkey, Spain, Slovenia and Italy. Because each mountain range and quarry have their own signature, every marble piece - even within a single quarry - is unique. Hues, veins, crystals, fossils, clouds, and distinctive marks will vary from piece to piece. This is the extraordinary character of stone as a material. Its high quality and its unique nature give Knoll tables a feel of incredible sculptural beauty. The following list are the marbles, granites, travertines, and slates that KnollStudio offers:

**Coated Marbles***Coated Marbles*

Coated marbles have transparent, high-polish, acrylic coating to prevent use-associated stains. Even with this protection, coated marbles should not be used outdoors. Stains should be wiped immediately. Coating will yellow over time.

*Satin Coated Marble*

Satin coated marbles have transparent satin acrylic coating to prevent use-associated stains. This satin finish gives the stone a natural, honed appearance while providing the same protective qualities as the Coated Marbles. Even with this protection, satin coated marbles should not be used outdoors. Stains should be wiped immediately. Coating will yellow over time.

*Arabescato*

Ivory white with dark grey veining. May contain random green veins.

*Calacatta*

Ivory white. Gold and beige random veins with additional veins varying from cream to green and grey.

*Carrara*

White background with grey veining.

*Espresso Marble*

Light and dark brown with white and beige veining.

*Grey Marble*

Grey with black and white veins. Hues vary in tone and intensity.

*Grigio Marquina*

Dark warm grey with thin black veining and characterized by white linear veins.

*Portoro Marble*

Deep black background with large striking white and silver veining. Some gold veining may be present.

*Rosso Rubino*

Rich red with hues that can vary from violet to green with white and green veins. Hues vary in tone and intensity.

*Verde Alpi*

Green. Black and white veins. Hues vary in tone and intensity.

**Natural Marbles**

Natural marbles have a protective sealer to protect the stone from aging and staining. Sealer has to be renewed periodically (see product maintenance on page 28). Natural marbles are not suitable for outdoor use.

*Carrara*

White background with grey veining.

*Calacatta*

Ivory white. Gold and beige random veins with additional veins varying from cream to green and grey.

**Natural Granites**

Natural granites have a sealer to protect the stone from aging and staining. Sealer has to be renewed periodically (see product maintenance on page 29). Because of its non-porous density, granite does not require protective acrylic coatings.

*Black Andes Granite*

Black with reflective mica crystallines.

**Slate**

Natural cleft slate is available on Vignelli PaperClip Tables, SM Tables, and Saarinen Tables.

In combination with a weather-resistant base, PaperClip tables with slate tops are suitable for outdoor use. Please refer to respective product pages for recommended outdoor finish combinations.

**Cane**

Cane is a natural material that might present slight variations in color and texture. For more detail, visit the Cesca price list pages.

**Man-Made Materials & Finishes***Stainless Steel*

Completely rust-proof, highly durable, and resistant to bending stress.

*Polished Chrome*

Several-step plating process that includes a heavy layer of nickel for added rust protection and a bright mirror finish.

*Satin Chrome*

Chrome plating applied for a soft satinized chrome finish with a higher nickel content.

*Nickel Finish*

A warm, lustrous finish of nickel electroplate. Yellowish in color. Coated with clear lacquer to prevent oxidation.

*Polished Aluminum*

A shiny, polished finish.

*Clear Anodized Aluminum*

A light grey satin finish.

*18K Gold*

Gold frame is plated with 18K gold, and covered with clear lacquer for protection.

*Fused Nylon Rilsan*

A very durable and adhesive fused nylon-dipped finish. Scratch, chip, and chemical resistant. Appropriate for outdoor use.

*Laminate/Color Core Laminate*

An exceptionally durable plastic surface. Highly resistant to most chemicals and extensive wear.

*Cotton Webbing*

100% cotton unfinished webbing.

*Cotton/Nylon Webbing*

60% nylon, 40% cotton mixed yarns with silicone water-based protective coating.

*Sunbrella™ Webbing*

Sunbrella™ Webbing uses reinforced yarns that are UV/fade resistant, water repellent, bleach-cleanable, stain resistant and are designed to flex. 87% Sunbrella Acrylic, 13% Sunbrella Polyester.

*Porcelain*

An oven-baked finish on steel support with high durability.

*Outdoor Powder Coat:*

Durable outdoor powder finish that will provide excellent color and gloss retention with limited exposure to outdoor elements.

*Painted, acid etched glass:*

Clear glass with an acid etched top and painted underside. Polished and beveled edges surround.

*Vetro Bianco:*

Vetro Bianco is an engineered resin free quartz surface. The brilliant white surface is nonporous, stain proof, and extremely durable making it suitable for indoor and outdoor use.

*With proper care, your KnollStudio furniture should last for years to come. To help ensure the longevity of your purchase, below are helpful hints on routine cleaning for your KnollStudio piece. Most basic maintenance can be performed with common household cleaning products.*

#### Textiles

See KnollTextiles website for detailed cleaning and care instructions. Wipe all spills immediately. Brush and vacuum every three to four months. Use a foam upholstery cleaner as directed semi-annually, or more frequently if necessary. Try a hidden area to test for color fastness.

#### Spinneybeck Leathers

Leather is hardy and will adjust to its environment. It mellows gracefully with age. Leather is expected to change; even the oils from our hands help to develop the patina.

Full grain, aniline leather is undemanding. It breathes, has a life of its own, and requires little care. It should not be abused by harsh cleaners, or substances such as wax or mink oils which will clog the pores. A periodic wipe with a damp cloth is a sufficient means of cleaning under normal conditions.

Spinneybeck now offers a leather maintenance kit specifically designed for the 28 quantities offered. The kit includes a cleaner, conditioner and ink-remover and can be ordered by calling 1 800 482-7777. There are three types of kits:

- finished products
- full aniline products
- brush-sueded products

The following guidelines will help you to maintain the beauty of the leather without destroying any of its natural characteristics.

#### Naked Leather

**(Capri, Cervo, Copenhagen, Cordovan, Distressed, Prima, Saddle)**

Naked leathers contain no foreign substances that act as a barrier against spillage or staining. They should be selected with this in mind.

The only recommended cleaning method for naked leather is to wipe the entire surface with a soft woolen cloth and water. Do not spot rub for it will darken only that area. The idea is to even out any abrasions or stains.

With use, naked leather develops a beautiful patina that removes many small scratches and abrasions as body oils moisturize and revitalize the leather. Substantial body oil marks will also dissipate over time, particularly if rubbed down with cool water.

#### Protective Finished Leathers (Acqua, Alaska, Amazon, Andes, Antique, Arizona, Derby, Ducale, España, Forte, Hand Tipped, Portofino, Riva, Sabrina, Salon, Torello, Velluto Pelle, Vicenza, Volo)

For high traffic use, breathable protective finish allows leather not only to be practical but also easy to maintain. It can be cleaned by wiping the entire surface with a soft cloth and a very mild solution of Ivory Flakes and cold water, followed by wiping the entire surface with water alone.

#### Grain Sueded Leather (Ducale Velour, Marissa)

For maximum soil resistance and durability these leathers have received an impregnated soil resistant treatment in the drum which permeates the leather making it repellent to liquid and dirt.

Grain sueded leather can be maintained with moderate care because spillage will bead and roll off. However, spillage should not be allowed to puddle, and should be blotted dry immediately. For normal care, leather should be brushed occasionally, with a sueded cleaning block to help remove general soilage.

If you have further questions about the care and maintenance of Spinneybeck leather, call Spinneybeck Customer Service at 800 482-7777.

#### Cowhide Slings, Belting Leather

For normal cleaning, use a soft cloth dampened with a solution of mild soap or detergent (Ivory Flakes) well dissolved in water. Rub very lightly, never pressing hard. Do not use solvents because dye may run. For scratches, use liquid shoe polish and buff when dry. Any liquids spilled on leather should be mopped up as soon as possible in order to avoid being absorbed by the leather.

#### Cane

Use water and glycerin every three months to keep cane from drying out.

#### Vinyl

Clean frequently with a mild detergent and water. Use leather or plastic cleaners for unusually heavy use. Do not use solvents such as gasoline because plastic surface will gum and deteriorate.

#### Wood

Clean with a commercial brand of liquid furniture polish twice a month. For stubborn dirt or light scratches, rub lightly with very fine steel wool before using furniture polish. To rejuvenate luster, apply a furniture cream as a last step. Do not use water or household solvents: they will destroy the protective finish.

#### Lacquer Finishes on Wood (Florence Knoll credenza)

Frequent cleaning recommended: once per week with heavy use or once per month with light use. Clean with ordinary household soaps or detergents, well dissolved in water. Polish with lemon oil using a very soft cloth. For stubborn dirt or light scratches, uniformly apply Cleanbright Liquid Ebony or Guardsman liquid furniture polish with cheesecloth. Allow ten minutes to dry and wipe with a clean, dry cloth. For nicks, chips, and deep scratches, contact a professional refinisher. Never use abrasives.

#### Teak

Do not apply teak oil if you are using your furniture outdoors. For teak furniture used outdoors, clean with soapy water and allow to dry. Note that teak exposed to the sun will patina to a silvery grey color. For teak furniture used indoors, wipe surface with soft cloth to remove dust. Apply thin layer of teak oil using a paint brush and wipe excess using a soft cloth. Oil can be applied every 3 months to maintain rich color.

#### Wood Frame Chairs

Clean with dry and soft cloth. Rub smoothly with damp, lukewarm cloth. Treat stubborn stains with household soap solution or a solution with dishwashing liquid. Wipe off with clean, dry cloth. Do not use acid or abrasive detergents.

#### Marble with Acrylic Coating

Wash with lukewarm water. Wash more thoroughly with Windex, Fantastik, Ivory Flakes in warm water, or other non-abrasive solutions. Rinse with warm water and dry with a soft cloth.

#### Natural Marbles/Marbles without Acrylic Coating

Cleaning: Wipe off stains and liquid spills immediately with water and soft cloth. Never use steel wool or other abrasives on marble.

Maintenance: The mineral surface of marble is very porous and easily absorbs moisture and fluids causing staining and discoloring. If applied on a yearly basis, impregnators or penetrating sealers protect the interior of the stone, inhibit discoloration and allow the stone to breathe and release water vapor.

To restore a uniform luster, clean surface from any grit or debris, then remove all topical coatings with Stoneguard Stripper. Use Marbalex to rinse surface, then let top dry for twelve hours before applying stone impregnator. Apply SCI Impregnator using a clean and dry applicator brush. After five minutes, wipe off the excess with soft, white terry cloth. If impregnator is absorbed within five minutes apply second coat at least twelve hours later.

Never use steel wool or other abrasives on marble.

**Slate**

Apply a generous amount of soap solution (1:5) to the table top with a hard brush. Wipe off the top with a clean, damp cloth. Repeat as often as required. Apply mineral oil or lemon oil as needed to protect surface and maintain color.

**Granite**

Clean with Windex, Fantastik, or other non-abrasive solutions on a regular basis. Apply a marble wax to improve luster and protect finish. Routine maintenance will prevent the stone from darkening with use from body oils, and will help maintain an evenness of color.

**Vetro Bianco**

Wash surface with lukewarm water. Clean more thoroughly with a non-abrasive solution such as Windex or Fantastik. Rinse with warm water and dry with a soft cloth. Wipe off stains immediately with water and a soft cloth. Never use steel wool or other abrasives on surface.

**Glass/Acrylic Polycarbonate**

Clean with Windex, Fantastik or other non-abrasive cleaning solutions. Wipe dry with a clean cloth.

**Laminate/Melamine**

Scrub with Windex, Fantastik, Mr. Clean, or other household soaps or detergents well dissolved in water, or with a very soft cloth dampened with alcohol or a synthetic thinner. For a dull finish, rub with jeweler's rouge as a polishing agent and finish with paste wax. Never use abrasives. Remove stubborn stains with Soft Scrub.

**Stainless Steel**

Use Windex, Fantastik, or other non-abrasive household cleaners. For small scratches, rub with Comet, Ajax, or other mild abrasives in the direction of the grain. Apply a coat of auto wax to maintain beauty.

**Chrome/Satin Chrome**

Clean with Windex or an automotive chrome cleaner such as Semi-Chrome twice a month. Apply a coat of hard paste wax to protect against moisture.

**Nickel**

Clean with Windex, Fantastik, or other non-abrasive cleaning solutions. If discoloration occurs, rub lightly with a fine steel wool to restore luster. Steel wool Grade #0000 is recommended. Touch-up with a clear lacquer to prevent oxidation.

**Copper (uncoated)**

Polish using a soft cloth and metal polish cream such as BlueMagic®. Do not use harsh abrasive or steel wool.

**Polished Aluminum**

Clean with Windex, Fantastik, or other non-abrasive cleaning solutions. Coat with a hard paste wax semi-annually to maintain luster and prevent discoloration.

**Anodized Aluminum**

Clean with mild soaps, detergents, or other non-abrasive cleaning agents. Apply paste wax or DuPont non-abrasive car polish #7 twice a year to prevent oxidation.

For stubborn stains or discolorations, apply navel jelly aluminum cleaner.

**Urethane Edge**

Clean with household soaps and detergents well dissolved in water. Do not use abrasive cleaning solutions.

**Epoxy**

Clean with Windex, Fantastik, or other ordinary non-abrasive household soaps, detergents, or ammonia at least once a month to prevent yellowing. For scratches and chips, rub with Comet, Ajax, or other mild abrasives. For deeper scratches, contact Knoll Customer Service for touch-up paint. Shine with a high grade auto polish. Never use harsh abrasives or steel wool.

**Rilsan®**

Clean with Windex, Fantastik, or other ordinary non-abrasive household soaps or detergents. For ink stains on white surfaces, use Soft Scrub. For scratches and chips, rub with Comet, Ajax, or other mild abrasives. For deeper scratches, use a good grade automotive acrylic-lacquer touch-up paint. Shine with a high grade auto polish. Never use harsh abrasives or steel wool.

**Porcelain**

Clean with damp cloth using water or Windex. Do not use any abrasive detergent.

**Powder Coat Paint**

Clean with Windex or Endust using a soft cloth. Remove stubborn stains with Soft Scrub.

**Polyester Shell**

Clean with Windex or soap and water. Do not use any abrasive detergent.

**Plastic Seat Shells**

Clean with damp cloth with diluted soap. Wipe dry with clean cloth. Do not use any abrasive or acid detergents.

**Cotton Webbing**

Use damp cloth to clean. Do not use detergent or soap or any abrasive detergent.

**Cotton/Nylon Webbing**

Use damp cloth to wipe off stains.

**Moving Parts**

Lubricate moving parts every six months.

**Swivel Mechanism**

Apply a paste-type grease to swivel mechanism once a year.

**Plastic/Polyethelene**

Clean using a soft rag, either dry or wet. When needed, use mild pH-balanced soap diluted in water. Do not use abrasives sponges, acidic products or solvents containing ammonia.

To remove scuff marks, lightly rub scuff mark with a dry, non-scratch scour pad, like Scotch-Brite.

---

**Knoll outdoor furniture is designed to withstand years of normal use with proper care and maintenance. By following the basic precautions below, you can be sure that your furniture will be enjoyed for many years to come.**

## **Cleaning**

- Do not use a power washer as a method of cleaning as it may abrade the finish.
- Surfaces, painted frames, fabrics, mesh, and teak should be cleaned regularly with mild soap and water to prevent the build-up of dirt, pollen, mildew, and mold. Harsh abrasives should not be used.
- If furniture is used near the ocean or indoor pool area, rinsing, and wiping down your furniture regularly will prevent the formation of salt and chloride residues, which can corrode finishes.
- It is recommended that towels or other coverings are used to protect vinyl strapping and mesh when body oils, sunscreens, suntan lotions are being used, as some of these products may stain. If direct contact occurs clean promptly.

## **Sun Protection**

- No material is fade-proof under years of exposure to the sun's UV rays and elements. To minimize possible fading, keep products covered when not in use and limit exposure to direct sunlight when possible.

## **Extreme Weather**

- Extreme conditions in summer and winter will cause materials to expand and contract. Always cover furniture when not in use, and when possible, bring indoors during the off-season.
- Do not store product upside down as water could accumulate in the frames causing corrosion and potentially damage, in freezing temperatures.

**Use the Following Address:**

If you would like to send an order directly to our order entry departments, please use the following address:

Knoll, Inc.  
P.O. Box 157  
East Greenville, PA 18041  
Attn: Order Entry

Fax: 215 679-1570  
Tel: 800 343-KNOLL

**When Placing Your Order, Include:**

- All information requested on the order form.
- Local taxes for the “delivered to” address.
- For orders \$2,000 or under (including applicable taxes and delivery/installation fees, if any), full payment must be made when order is placed.
- For orders over \$2,000, a deposit equal to one-half of the complete order value is required at order placement. Balance must be settled before shipment.

**Key Points to Remember:**

All accepted orders will be confirmed in writing on the Knoll standard acknowledgement form. A copy of the acknowledgement will be mailed to the customer prior to production.

Freight within the 48 contiguous United States and Canada, excluding the Yukon, Northwest Territories and Newfoundland, is prepaid and included in the price of all orders.

For residential orders, Knoll strongly recommends White Glove delivery service to most locations in the Continental United States and Canada. White Glove service includes inside delivery, unpacking, furniture installation and removing cartons and crates. The fee for this service will be quoted at the point of purchase.

KnollStudio’s limited warranty covers all furniture against manufacturing defects in this price list for a period of five years after delivery to the customer.

All pricing is in U.S. dollars.



**For More Information:**

For complete Knoll Selling Policy and warranty information, please refer to pages 515-516 in the back of this price list.

For additional information on KnollStudio, contact your KnollStudio representative, a Knoll Space retailer or e-tailer, or telephone Customer Services at 800 343-KNOLL. To find the retailer or showroom nearest you, visit [www.knoll.com](http://www.knoll.com).

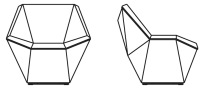
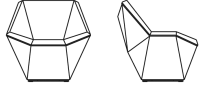

David Adjaye  
*The Washington Collection for Knoll™*  
*Prism™ Lounge Chair and Ottoman*

	description	w	d	h	height, seat	textile fabric yards
<i>Designer(s):</i> David Adjaye, 2014  <i>Award(s):</i> Editors Choice Award, Lounge Furniture Collection, NeoCon June 2015, USA; Metropolis Likes Award, Metropolis Magazine, June 2015, USA	<b>WL21F</b> Lounge Chair, fixed base 	33 1/4"	31 1/2"	31 1/2"	16 1/4"	2
	<b>WL21S</b> Lounge Chair, swivel base 	33 1/4"	31 1/2"	31 1/2"	16 1/4"	2
	<b>WL23</b> Ottoman 	26 3/4"	17"	16 3/4"	15 1/2"	1







pattern no.	A	B	C	D	E	F	G	H	I
<b>WL21F-(-)</b>	\$20,502.	\$20,564.	\$20,634.	\$20,717.	\$20,834.	\$20,900.	\$21,017.	\$21,093.	\$21,326.
<b>WL21S-(-)</b>	21,123.	21,185.	21,255.	21,339.	21,454.	21,522.	21,636.	21,716.	21,948.
<b>WL23-(-)</b>	10,601.	10,630.	10,666.	10,706.	10,765.	10,798.	10,856.	10,897.	11,011.

Order Code	Ordering Information	Construction
<i>Example:</i> <b>WL21S-111G-K1882/9</b> <b>WL21S</b> Lounge, swivel <b>111G</b> Black base <b>K1882/9</b> Melange/Onyx	<i>Base finishes:</i> Black (suffix 111G) White (suffix 118G) Red (suffix 845G)  <i>Maintenance:</i> See pages 28-29.	<i>Base:</i> Constructed of 3/4" Birch plywood panels covered in a plastic color core laminate which maintains color throughout so vibrancy is maintained from edge to edge. Panels are assembled together using poplar wood corner blocks.  <i>Upholstery:</i> Textile upholstered over individual panels of urethane molded foam. All upholstery will feature a black leather welt along the edges where the base and upholstery meet.  <i>Note:</i> Swivel base returns to center.

- Specify:*
1. Pattern number
  2. Base finish selection
  3. Textile selection

Approved KnollTextiles Grades/Fabrics				
<b>A</b> Hourglass Cross Tech Sonnet	<b>C</b> Circa Classic Boucle	<b>G</b> Haze Melange Ultrasuede	<b>I</b> Ravello	Check with your KnollTextiles Representatives for changes or additions.
<b>B</b> Chroma Journey Keaton Knoll Felt Knoll Hopsack Ransom Synth	<b>D</b> Buzz	<b>H</b> Magritte		

David Adjaye  
*The Washington Collection for Knoll™*  
*Skeleton™ Chair*

	description	seat h	w	d	h	weight
<p><i>Designer(s):</i> David Adjaye, 2013</p> <p><i>Award(s):</i> 2014 Design Guild Mark Best of NeoCon Gold Award 2014</p> 	<p><b>WS1CA</b> Skeleton™ painted aluminum chair</p> 	17 1/2"	18"	20 1/4"	32 1/2"	20 lbs.
	<p><b>WS1CA</b> Skeleton™ nickel plated aluminum chair</p> 	17 1/2"	18"	20 1/4"	32 1/2"	20 lbs.
	<p><b>WS1CA</b> Skeleton™ copper plated aluminum chair, natural</p> 	17 1/2"	18"	20 1/4"	32 1/2"	20 lbs.

pattern no.	
<b>WS1CA-( )</b>	\$1,512.
<b>WS1CA-NO</b>	3,055.
<b>WS1CA-NCU</b>	3,054.

Order Code	Ordering Information	Construction
<p><i>Example:</i> <b>WS1CA-001</b></p> <p><b>WS1CA</b> Aluminum chair</p> <p><b>001</b> Black paint finish</p>	<p><i>Aluminum paint finishes:</i>                      Black (suffix 001)                      Grey (suffix 003)                      Green (suffix 007)                      White (suffix WHT)                      Sterling (suffix 906T)</p> <p><i>Aluminum, plated finish:</i>                      Copper, natural (suffix NCU)                      Brushed Nickel (suffix NO)</p> <p><i>Outdoor Use:</i>                      With proper maintenance painted aluminum chairs are appropriate for outdoor environments.</p> <p><i>Maintenance:</i>                      See pages 28-29.</p>	<p><i>Aluminum Chair:</i>                      Constructed from die-cast aluminum, the chair's shell and legs are cast in three parts and connected using mortise and tenon joinery and stainless steel fasteners. Available in ultra-durable powder coat paint, a nickel plated finish, a natural copper plated finish that will patina with age. Features four nylon glides.</p> <p><i>Outdoor Use:</i>                      With proper care, the Washington Skeleton Chair in powder coat paint finishes is appropriate for outdoor environments.</p>
<p><i>Specify:</i></p> <p>1. Pattern number                      2. Paint finish selection</p>		<p><i>Note:</i>                      Copper plated chairs will patina with age.</p> <p>The Washington Skeleton chair is certified Clean Air GOLD.</p>



# Ini Archibong

## Iquo Cafe Collection

### Iquo Armless Chair

Designer(s):  
Ini Archibong, 2022

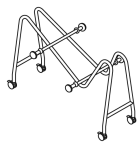

description	type	seat h	w	d	h	textile fabric yds.	leather sq ft	weight
<b>AR1C</b> Armless Chair, unupholstered (stacking)	plastic seat and back	19"	16 1/2"	22"	31"			10 lbs.
								
<b>AR1CK</b> Armless Chair, plastic back, upholstered seat (non-stacking)	upholstered seat	19"	16 1/2"	22"	31"	.6	10	10 lbs.
								
<b>AR1CU</b> Armless Chair, upholstered seat and back (non-stacking)	upholstered seat and back	19"	16 1/2"	22"	31"	1	18	10 lbs.
								
<b>ARDOLLY</b> Iquo Chair Dolly			23 1/2"	44 1/2"	30 1/2"			21 lbs.
								

Order Code	Ordering Information	Construction
<i>Example:</i> <b>AR1CK-BL-BLK-K2074/2</b>	<b>Frame Finish:</b> Black (suffix BL)	<b>Frame:</b> Frames are injection molded glass filled nylon. Bumpers are thermoplastic polyurethane.
<b>AR1CK</b> Armless Chair, plastic back, upholstered seat	<b>Plastic Seat and Back Finish:</b> Black (suffix BLK) Light Grey (suffix LGY) Dark Grey (suffix DGY) Red Orange (suffix ROG) Green (suffix GRN)	<b>Seat and Back:</b> Molded glass filled polypropylene. Stainless steel screws used to attach shells to the frame.
<b>BL</b> Black frame	<b>Upholstery/COM Information:</b> Prices shown include fabric or leather upholstery. Contact your Knoll representative for colors. Only approved KnollTextiles and Spinneybeck leather may be ordered.	<b>Upholstered Seat and Back:</b> Plastic shell with urethane foam for comfort and full wrapped in selected upholstery. Stitching goes around perimeter of seat and back.
<b>BLK</b> Black back	Customer's Own Material is available pending approval. For approval requirements, processing instructions and ordering information please see page 18.	<b>Stacking Chairs:</b> Chairs stack 6 high on the floor and 10 high on the Iquo dolly. Arm and armless chairs can stack together. <i>Note:</i> Upholstered chairs <u>do not</u> stack.
<b>K2074/2</b> Aegean, Lemon	<b>Outdoor Use:</b> With proper care and limited exposure to the elements, chairs specified with plastic seat and back are appropriate for outdoor environments.	<b>Dolly:</b> Black powder coated 14 gauge tubular steel frame, four handles that act as bumpers to cushion the chairs, and four locking casters. Dolly with 10 arm chairs measures 69" high. <b>Not appropriate for outdoor storage.</b>
<b>Specify:</b>	<b>Maintenance:</b> See pages 28-29.	
1. Pattern number	The Iquo Collection is certified Clean Air GOLD.	
2. Frame finish		
3. Back finish		
4. Seat finish or Textile/Leather selection		

pattern no.	unupholstered	grades A	COM B	C	D	E	F	G	H	I	COL U	V	W	X	Y
<b>AR1C-(-)(-)</b>	\$749.	\$0.	\$0.	\$0.	\$0.	\$0.	\$0.	\$0.	\$0.	\$0.	\$0.	\$0.	\$0.	\$0.	\$0.
<b>AR1CK-(-)(-)</b>	0.	1,161.	1,182.	1,204.	1,221.	1,241.	1,266.	1,292.	1,301.	1,360.	1,467.	1,584.	1,735.	1,778.	1,819.
<b>AR1CU-(-)</b>	0.	1,291.	1,328.	1,368.	1,397.	1,437.	1,482.	1,529.	1,543.	1,650.	1,795.	2,006.	2,279.	2,355.	2,430.
<b>ARDOLLY</b>	1,224.	0.	0.	0.	0.	0.	0.	0.	0.	0.	0.	0.	0.	0.	0.

Approved KnollTextiles Grades/Fabrics				Spinneybeck Leather			
<b>A</b> Beacon Bocce Chance Common Ground Cloth Crossroad Delite Facet Hourglass Mariner Monarch Overture Soliloquy Sonnet Trophy	<b>B</b> continued Holbrook Journey Keaton Knoll Felt Knoll Hopsack Little Devil Ludlow Melody Paradigm Prim Radiance Ransom Roam Spree Summit Synth Venue Westwood Yeni	<b>C</b> Axiom © Baxter Cario Charm Circa Classic Boucle Contour Dune Echo Enmesh Empire Stripe Entourage Essence Fibra Greenwich Hudson Kaleidoscope CR Lagos Magnolia Milestone Palisade Panache CR Quark Roundtrip Sahara Sequin CR Smart © Spectator	<b>C</b> continued Swing Tower Grid Wit  <b>D</b> Buzz Eclat Weave Hologram Island Menagerie Origins  <b>E</b> Aegean Cleo Demure Currents Highland Ikat Stripe Juno Kampala Katazome Kimono Kamba Marquee Meroe Midpoint Premier Rebel Shima Tryst Tempest Vatera Whip	<b>F</b> Atelier Biscayne Century Coco Cornaro Glider Jasmine Liberty Mod Plaid Rivington Soon Totem Tweed Frieze  <b>G</b> Alter Ego Arber Aurora Djenne Feeling Plaid Gibson Hampshire Haze Kamani Kinabalu Melange Metalic Gloss Spencer Straie Stripe Ultrasuede Utrillo	<b>H</b> Bavaria Constance Firefly  <b>I</b> Byron Cato Diamond Days Digi Velvet Doily Dynamic Ita Jaipur Knoll Velvet Limani Mepal North Island Olema Piper Rutledge Tudor Vermeer Zimba	<b>U</b> Vicenza Volo  <b>V</b> Acqua Andes Embossed Tipped España Hand Tipped Maremma Velluto Pelle  <b>W</b> Alaska Antique Derby Forte Lucente Sabrina © Fire Retardant Chemicals	<b>X</b> Ducale Ducale Velour  <b>Y</b> Cervo Copenhagen Distressed Lucca Marissa Portofino Riva Saddle Torello

*Check with your KnollTextiles or Spinneybeck Representative for changes or additions.*



# Ini Archibong

## Iquo Cafe Collection

### Iquo Armchair

Designer(s):  
Ini Archibong, 2022

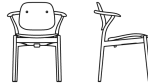
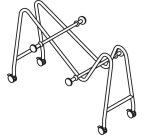

description	type	seat h	w	d	h	textile fabric yds.	leather sq ft	weight
<b>AR1A</b> Arm Chair, unupholstered (stacking)	plastic seat and back	19"	23 1/2"	22 1/2"	31"			10 lbs.
								
<b>AR1AK</b> Arm Chair, plastic back, upholstered seat (non-stacking)	upholstered seat	19"	23 1/2"	22 1/2"	31"	.6	10	10 lbs.
								
<b>AR1AU</b> Arm Chair, upholstered seat and back (non-stacking)	upholstered seat and back	19"	23 1/2"	22 1/2"	31"	1	18	10 lbs.
								
<b>ARDOLLY</b> Iquo Chair Dolly			23 1/2"	44 1/2"	30 1/2"			21 lbs.
								

Order Code	Ordering Information	Construction
<i>Example:</i> <b>AR1AK-BL-BLK-K2074/2</b>	<i>Frame Finish:</i> Black (suffix BL)	<i>Frame:</i> Frames are injection molded glass filled nylon. Bumpers are thermoplastic polyurethane.
<b>AR1AK</b> Arm chair, plastic back, upholstered seat	<i>Plastic Seat and Back Finish:</i> Black (suffix BLK) Light Grey (suffix LGY) Dark Grey (suffix DGY) Red Orange (suffix ROG) Green (suffix GRN)	<i>Seat and Back:</i> Molded glass filled polypropylene. Stainless steel screws used to attach shells to the frame.
<b>BL</b> Black frame	<i>Upholstery/COM Information:</i> Prices shown include fabric or leather upholstery. Contact your Knoll representative for colors. Only approved KnollTextiles and Spinneybeck leather may be ordered.	<i>Upholstered Seat and Back:</i> Plastic shell with urethane foam for comfort and full wrapped in selected upholstery. Stitching goes around perimeter of seat and back.
<b>BLK</b> Black back	Customer's Own Material is available pending approval. For approval requirements, processing instructions and ordering information please see page 18.	<i>Stacking Chairs:</i> Chairs stack 6 high on the floor and 10 high on the Iquo dolly. Arm and armless chairs can stack together. <i>Note:</i> Upholstered chairs <u>do not</u> stack.
<b>K2074/2</b> Aegean, Lemon	<i>Outdoor Use:</i> With proper care and limited exposure to the elements, chairs specified with plastic seat and back are appropriate for outdoor environments.	<i>Dolly:</i> Black powder coated 14 gauge tubular steel frame, four handles that act as bumpers to cushion the chairs, and four locking casters. Dolly with 10 arm chairs measures 69" high. <b>Not appropriate for outdoor storage.</b>
<i>Specify:</i> 1. Pattern number 2. Frame finish 3. Back finish 4. Seat finish or Textile/Leather selection	<i>Maintenance:</i> See pages 28-29.	
	The Iquo Collection is certified Clean Air GOLD.	

pattern no.	unupholstered	grades A	COM B	C	D	E	F	G	H	I	COL U	V	W	X	Y
<b>AR1A-(-)(-)</b>	\$772.	\$0.	\$0.	\$0.	\$0.	\$0.	\$0.	\$0.	\$0.	\$0.	\$0.	\$0.	\$0.	\$0.	\$0.
<b>AR1AK-(-)(-)</b>	0.	1,185.	1,206.	1,228.	1,244.	1,265.	1,291.	1,316.	1,324.	1,384.	1,492.	1,608.	1,758.	1,802.	1,844.
<b>AR1AU-(-)</b>	0.	1,315.	1,353.	1,391.	1,423.	1,461.	1,507.	1,553.	1,569.	1,675.	1,819.	2,030.	2,302.	2,379.	2,454.
<b>ARDOLLY</b>	1,224.	0.	0.	0.	0.	0.	0.	0.	0.	0.	0.	0.	0.	0.	0.

Approved KnollTextiles Grades/Fabrics				Spinneybeck Leather			
<b>A</b> Beacon Bocce Chance Common Ground Cloth Crossroad Delite Facet Hourglass Mariner Monarch Overture Soliloquy Sonnet Trophy	<b>B</b> continued Holbrook Journey Keaton Knoll Felt Knoll Hopsack Little Devil Ludlow Melody Paradigm Prim Radiance Ransom Roam Spree Summit Synth Venue Westwood Yeni	<b>C</b> Axiom © Baxter Cario Charm Circa Classic Boucle Contour Dune Echo Enmesh Empire Stripe Entourage Essence Fibra Greenwich Hudson Kaleidoscope CR Magnolia Milestone Palisade Panache CR Quark Roundtrip Sahara Sequin CR Smart © Spectator	<b>C</b> continued Swing Tower Grid Wit  <b>D</b> Buzz Eclat Weave Hologram Island Menagerie Origins  <b>E</b> Aegean Cleo Currents Demure Highland Ikate Stripe Juno Kampala Katazome Kimono Kamba Marquee Meroe Midpoint Premier Rebel Shima Tryst Tempest Vatera Whip	<b>F</b> Atelier Biscayne Century Coco Cornaro Glider Jasmine Liberty Mod Plaid Rivington Soon Totem Tweed Frieze  <b>G</b> Alter Ego Arber Aurora Djenne Feeling Plaid Gibson Hampshire Haze Kamani Kinabalu Melange Metalic Gloss Spencer Straie Stripe Ultrasuede Utrillo	<b>H</b> Bavaria Constance Firefly  <b>I</b> Byron Cato Diamond Days Digi Velvet Doily Dynamic Ita Jaipur Knoll Velvet Limani Mepal North Island Olema Piper Rutledge Tudor Vermeer Zimba	<b>U</b> Vicenza Volo  <b>V</b> Acqua Andes Embossed Tipped España Hand Tipped Maremma Velluto Pelle  <b>W</b> Alaska Antique Derby Forte Lucente Sabrina © Fire Retardant Chemicals	<b>X</b> Ducale Ducale Velour  <b>Y</b> Cervo Copenhagen Distressed Lucca Marissa Portofino Riva Saddle Torello

*Check with your KnollTextiles or Spinneybeck Representative for changes or additions.*





# Edward Barber & Jay Osgerby

## Sofa Collection

### Lounge Seating

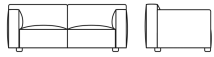
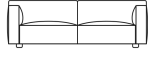
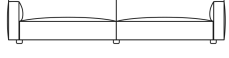
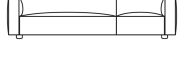
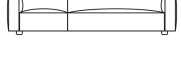
Designer(s):  
Edward Barber and Jay Osgerby,  
2013

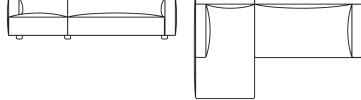

description	seat h	arm h	w	d	h	textile fabric yds.	req. leather sq. ft.
<b>BO2</b> Two Seat Sofa 	15 3/4"	25"	73 1/4"	40 1/4"	28 1/4"	10.7	220
<b>BO3</b> Three Seat Sofa 	15 3/4"	25"	85"	40 1/4"	28 1/4"	13	240
<b>BO4</b> Four Seat Sofa 	15 3/4"	25"	132 1/4"	40 1/4"	28 1/4"	14.9	330
<b>BO5L</b> Asymmetric Sofa, left 	15 3/4"	25"	102 3/4"	40 1/4"	28 1/4"	12.3	270
<b>BO5R</b> Asymmetric Sofa, right 	15 3/4"	25"	102 3/4"	40 1/4"	28 1/4"	12.3	270
<b>BO15L</b> Asymmetric Sofa with Left Chaise 	15 3/4"	25"	102 3/4"	66"	28 1/4"	13.9	310
<b>BO15R</b> Asymmetric Sofa with Right Chaise 	15 3/4"	25"	102 3/4"	66"	28 1/4"	13.9	310
<b>BO6</b> Ottoman, small 			29 1/2"	29 1/2"	15 1/4"	2.1	45

Order Code	Ordering Information	Construction
<i>Example:</i> <b>BO3-C-H800/19</b>	<i>Base/Leg Finish:</i> Chrome (suffix C) Jet Black (suffix 111) Medium Metallic Grey (suffix 612) Red Coral (suffix CRL)	<i>Frame:</i> Hardwood and plywood construction with elastomeric suspension sheet webbing and foam supported sit-through feature at the cushion breaks.
<b>BO3</b>	Barber & Osgerby Three Seat sofa	<i>Stitching:</i> Pinched topstitched seaming.
<b>C</b>	Polished chrome	<i>Legs:</i> Die cast aluminum legs with height adjustable glides.
<b>H800/19</b>	Cato, Fire Red	<i>Note:</i> Four Seat and Asymmetric Sofas come in two sections and are joined by a pin and socket locking mechanism in the joining leg.
	<i>Upholstery/COM information:</i> Prices shown include fabric or leather upholstery. Contact your Knoll representative for colors. Only approved KnollTextiles and Spinneybeck leathers may be ordered.	<i>Upholstery:</i> High density foam construction throughout with gel infused high density memory foam on top seating surface. All textiles must be railroaded - including COMs.
	Customer's Own Material is available pending approval. For approval requirements, processing instructions and ordering information please see page 21.	All textiles must be railroaded - including COMs
	<i>Maintenance:</i> See pages 28-29.	

*Specify:*

1. Pattern number
2. Base finish selection
3. Textile/leather selection

pattern no.	grades	COM								COL				
	A	B	C	D	E	F	G	H	I	U	V	W	X	Y
<b>BO2-(-)(-)</b>	\$11,214.	\$11,556.	\$11,943.	\$12,400.	\$13,034.	\$13,403.	\$14,048.	\$14,475.	\$15,758.	\$21,028.	\$22,405.	\$25,206.	\$25,790.	\$26,470.
<b>BO3-(-)(-)</b>	12,900.	13,318.	13,785.	14,341.	15,111.	15,560.	16,343.	16,865.	18,422.	23,537.	25,039.	28,097.	28,731.	29,474.
<b>BO4-(-)(-)</b>	16,921.	17,401.	17,939.	18,574.	19,457.	19,970.	20,867.	21,466.	23,252.	31,627.	33,694.	37,895.	38,771.	39,789.
<b>BO5L-(-)(-)</b>	14,638.	15,036.	15,475.	16,002.	16,731.	17,156.	17,894.	18,388.	19,866.	26,819.	28,510.	31,949.	32,664.	33,497.
<b>BO5R-(-)(-)</b>	14,638.	15,036.	15,475.	16,002.	16,731.	17,156.	17,894.	18,388.	19,866.	26,819.	28,510.	31,949.	32,664.	33,497.
<b>BO15L-(-)(-)</b>	17,192.	17,640.	18,141.	18,733.	19,555.	20,034.	20,872.	21,431.	23,096.	29,065.	31,008.	34,956.	35,778.	36,734.
<b>BO15R-(-)(-)</b>	17,192.	17,640.	18,141.	18,733.	19,555.	20,034.	20,872.	21,431.	23,096.	29,065.	31,008.	34,956.	35,778.	36,734.
<b>BO6-(-)(-)</b>	3,805.	3,874.	3,947.	4,039.	4,164.	4,236.	4,361.	4,445.	4,697.	5,879.	6,163.	6,735.	6,853.	6,992.

#### Approved KnollTextiles Grades/Fabrics

<b>A</b> Cross Tech * Crossroad Delite Facet Hourglass * Infinite Mariner * Overture Presto * Sonnet Uni-Form *	<b>B</b> continued Little Devil Melody <sup>®</sup> Summit Tinge <sup>®</sup> Topos * Vast * Wild Thing	<b>C</b> Chameleon * Circa * Classic Boucle * Contour Entwine * Groovy Lagos On Point * Patchwork * Plaid On Prestini * Pullman Swing Utmost II * Utopia *	<b>D</b> Buzz Pathway * Plaidtastic Retreat * Vice Versa	<b>E</b> Aegean * Currents Flower Power * Highland * Off The Grid Rebel * Tempest	<b>F</b> Atelier Cornaro * Double Agent <sup>®</sup> * Imprint * Swank	<b>G</b> All Star Alter Ego Aurora * Dapper Fancy Twill Haze Melange * Modern Tweed Texnet Ultrasuede * Vert *	<b>H</b> Chiseled	<b>I</b> Bella * Cato Chic * Hastings * Prince Hairy
--	---	---	---	--	---	---	----------------------	---

#### Spinneybeck Leather

<b>U</b> Vicenza * Volo *	<b>V</b> Acqua * Amalfi Andes * Embossed Tipped * España * Velluto Pelle *	<b>W</b> Antique * Alaska * Forte * Lucente * Sabrina * Umbria *	<b>Y</b> Cascia Riva * Rugata
---------------------------------	--	--	--

\*Approved for the Asymmetric Sofa with Chaise (BO15R, BO15L)

<sup>®</sup> Fire Retardant Chemicals

Check with your KnollTextiles or Spinneybeck Representative for changes or additions.

# Edward Barber & Jay Osgerby

## Sofa Collection

### Lounge Seating

	description	seat h	arm h	w	d	h	textile fabric yds.	req. leather sq. ft.
<i>Designer(s):</i> Edward Barber and Jay Osgerby, 2013	<b>B07</b> Ottoman, medium 			35 1/2"	35 1/2"	15 1/4"	2.5	60





pattern no.	grades <b>A</b>	COM <b>B</b>	<b>C</b>	<b>D</b>	<b>E</b>	<b>F</b>	<b>G</b>	<b>H</b>	<b>I</b>	COL <b>U</b>	<b>V</b>	<b>W</b>	<b>X</b>	<b>Y</b>
<b>B07-(-)(-)</b>	\$4,248.	\$4,332.	\$4,420.	\$4,526.	\$4,675.	\$4,760.	\$4,909.	\$5,012.	\$5,310.	\$7,034.	\$7,314.	\$7,887.	\$8,007.	\$8,149.

Order Code	Ordering Information	Construction
<i>Example:</i> <b>BO3-C-H800/19</b>	<i>Base/Leg Finish:</i> Chrome (suffix C) Jet Black (suffix 111) Medium Metallic Grey (suffix 612) Red Coral (suffix CRL)	<i>Frame:</i> Hardwood and plywood construction with elastomeric suspension sheet webbing and foam supported sit-through feature at the cushion breaks.
<b>BO3</b>	Barber & Osgerby Three Seat sofa	<i>Stitching:</i> Pinched topstitched seaming.
<b>C</b>	Polished chrome	<i>Legs:</i> Die cast aluminum legs with height adjustable glides.
<b>H800/19</b>	Cato, Fire Red	<i>Note:</i> Four Seat and Asymmetric Sofas come in two sections and are joined by a pin and socket locking mechanism in the joining leg.
<i>Specify:</i>	<i>Upholstery/COM information:</i> Prices shown include fabric or leather upholstery. Contact your Knoll representative for colors. Only approved KnollTextiles and Spinneybeck leathers may be ordered.	<i>Upholstery:</i> High density foam construction throughout with gel infused high density memory foam on top seating surface. All textiles must be railroaded - including COMs.
1. Pattern number	Customer's Own Material is available pending approval. For approval requirements, processing instructions and ordering information please see page 21.	All textiles must be railroaded - including COMs
2. Base finish selection	<i>Maintenance:</i> See pages 28-29.	
3. Textile/leather selection		

Approved KnollTextiles Grades/Fabrics				Spinneybeck Leather	
<b>A</b> Cross Tech * Crossroad Delite Facet Hourglass * Infinite Mariner * Overture Presto * Sonnet Uni-Form *	<b>B</b> continued Little Devil Melody <sup>Ⓒ</sup> Summit Tinge <sup>Ⓒ</sup> Topos * Vast * Wild Thing	<b>D</b> Buzz Pathway * Plaidtastic Retreat * Vice Versa	<b>G</b> All Star Alter Ego Aurora * Dapper Fancy Twill Haze Melange * Modern Tweed Texnet Ultrasuede * Vert *	<b>U</b> Vicenza * Volo *	<b>W</b> Antique * Alaska * Forte * Lucente * Sabrina * Umbria *
<b>B</b> Calypso Cozy Cord Day Tripper Diva Dottie Helios Instinct * Keaton Knoll Felt * Knoll Hopsack *	<b>C</b> Chameleon * Circa * Classic Boucle * Contour Entwine * Groovy Lagos On Point * Patchwork * Plaid On Prestini * Pullman Swing Utmost II * Utopia *	<b>E</b> Aegean * Currents Flower Power * Highland * Off The Grid Rebel * Tempest	<b>H</b> Chiseled	<b>V</b> Acqua * Amalfi Andes * Embossed Tipped * España * Velluto Pelle *	<b>Y</b> Cascia Riva * Rugata
		<b>F</b> Atelier Cornaro * Double Agent <sup>Ⓒ</sup> * Imprint * Swank	<b>I</b> Bella * Cato Chic * Hastings * Prince Hairy		

\*Approved for the Asymmetric Sofa with Chaise (BO15R, BO15L)  
<sup>Ⓒ</sup> Fire Retardant Chemicals  
*Check with your KnollTextiles or Spinneybeck Representative for changes or additions.*

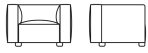
Edward Barber & Jay Osgerby  
Sofa Collection  
Compact Lounge Seating

	description	seat h	arm h	w	d	h	textile fabric yds.	req. leather sq. ft.	weight
<i>Designer(s):</i> Edward Barber and Jay Osgerby, 2013	<b>BOC1</b> Armchair 	15 1/4"	25"	39 1/2"	33 3/4"	25"	5.9	125	
	<b>BOC2</b> Two Seat sofa 	15 1/4"	25"	64 1/2"	33 3/4"	25"	8.7	175	

pattern no.	grades <b>A</b>	COM <b>B</b>	<b>C</b>	<b>D</b>	<b>E</b>	<b>F</b>	<b>G</b>	<b>H</b>	<b>I</b>	COL <b>U</b>	<b>V</b>	<b>W</b>	<b>X</b>	<b>Y</b>
<b>BOC1-(-)( )</b>	\$6,927.	\$7,119.	\$7,331.	\$7,581.	\$7,933.	\$8,135.	\$8,487.	\$8,725.	\$9,435.	\$12,698.	\$13,481.	\$15,073.	\$15,404.	\$15,790.
<b>BOC2-(-)( )</b>	9,750.	10,030.	10,345.	10,716.	11,230.	11,530.	12,054.	12,401.	13,445.	17,972.	19,065.	21,294.	21,761.	22,300.

Order Code	Ordering Information	Construction
<i>Example:</i> <b>BOC2-SGE-K1320/3</b>		
<b>BOC2</b> Barber & Osgerby Two Seat sofa	<i>Base/Leg Finish:</i> Chrome (suffix C) Jet Black (suffix 111) Medium Metallic Grey (suffix 612) Red Coral (suffix CRL)	<i>Frame:</i> Hardwood and plywood construction with elastomeric suspension sheet webbing and foam supported sit-through feature at the cushion breaks.  <i>Upholstery:</i> High density foam construction throughout with gel infused high density memory foam on top seating surface.  <i>Stitching:</i> Pinched topstitched seaming.
<b>SGE</b> Sage		
<b>K1320/3</b> Cornaro, Mist		
<i>Specify:</i> 1. Pattern number 2. Base finish selection 3. Textile/leather selection	<i>Upholstery/COM information:</i> Prices shown include fabric or leather upholstery. Contact your Knoll representative for colors. Only approved KnollTextiles and Spinneybeck leathers may be ordered.  Customer's Own Material is available pending approval. For approval requirements, processing instructions and ordering information please see page 21.  <i>Maintenance:</i> See pages 28-29.	<i>Legs:</i> Die cast aluminum legs with height adjustable glides.

Approved KnollTextiles Grades/Fabrics				Spinneybeck Leather	
<b>A</b> Crossroad Delite Facet Hourglass * Infinite Mariner * Overture Presto * Sonnet Uni-Form *	<b>C</b> Circa * Classic Boucle * Contour Groovy Lagos On Point * Patchwork * Plaid On Pullman Swing Utmost II *	<b>D</b> Buzz Pathway * Plaidtastic  <b>E</b> Aegean * Currents Flower Power * Highland * Off The Grid Rebel * Tempest  <b>F</b> Cornaro * Double Agent  * Imprint * Swank	<b>G</b> All Star Alter Ego Dapper Fancy Twill Haze Melange * Modern Tweed Texnet Ultrasuede * Vert *  <b>H</b> Chiseled  <b>I</b> Bella Cato Chic Hastings * Prince Hairly	<b>U</b> Vicenza * Volo *  <b>V</b> Acqua * Amalfi Andes * Embossed Tipped * España * Velluto Pelle *	<b>W</b> Antique * Alaska * Forte * Lucente * Sabrina * Umbria *  <b>Y</b> Cascia Riva * Rugata
				Check with your KnollTextiles or Spinneybeck Representative for changes or additions. * Approved for the Asymmetric Sofa with Chaise (BO15R, BO15L)  Fire Retardant Chemicals	

Edward Barber & Jay Osgerby  
Sofa Collection  
Pillows

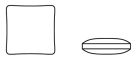
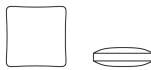
	description	w	d	textile fabric yds.	req. leather sq. ft.
<i>Designer(s):</i> Edward Barber and Jay Osgerby, 2013  	<b>BO8P</b> Pillow, small	19"	19"	1.9	25
		<b>BO9P</b> Pillow, large	23 1/2"	23 1/2"	2.6
					

pattern no.	A	B	C	D	E	F	G	H	I	U	V	W	X	Y
<b>BO8P-( )</b>	\$755.	\$817.	\$884.	\$966.	\$1,079.	\$1,145.	\$1,259.	\$1,336.	\$1,562.	\$1,761.	\$1,918.	\$2,234.	\$2,302.	\$2,379.
<b>BO9P-( )</b>	1,011.	1,095.	1,186.	1,299.	1,450.	1,541.	1,699.	1,800.	2,114.	2,181.	2,366.	2,750.	2,828.	2,922.









Order Code	Ordering Information	Construction
<i>Example:</i> <b>BO8P-K1054/9</b>	<i>Upholstery/COM information:</i> Prices shown include fabric upholstery only. Contact your Knoll representative for colors. Only approved KnollTextiles may be ordered.	<i>Fill:</i> Made from 90% feather and 10% down.  <i>Ticking:</i> 100% cotton.
<b>BO8P</b> Small pillow		
<b>K1054/9</b> Circa/Red	<b>Customer's Own Material is not approved.</b>	

*Specify:*  
1. Pattern number  
2. Textile selection

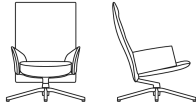
Approved KnollTextiles Grades/Fabrics			Spinneybeck Leather			
<b>A</b> Crossroad Delite Facet Hourglass * Infinite Mariner * Overture Presto * Sonnet Uni-Form *	<b>C</b> Circa Classic Boucle * Contour Groovy Lagos On Point * Patchwork * Plaid On Pullman Swing Utmost II Wow Factor	<b>D</b> Buzz Pathway * Plaidtastic  <b>E</b> Aegean * Currents Flower Power * Highland * Off The Grid Rebel * Tempest  <b>F</b> Cornaro * Double Agent * Imprint * Swank	<b>G</b> All Star Alter Ego Dapper Fancy Twill Haze Melange * Modern Tweed Texnet Ultrasuede * Vert *  <b>H</b> Chiseled  <b>I</b> Bella * Cato Chic * Guise Hastings * Prince Hairly	<b>U</b> Vicenza * Volo *  <b>V</b> Acqua * Amalfi Andes * Embossed Tipped * Espana * Velluto Pelle *	<b>W</b> Antique * Alaska * Forte * Lucente * Sabrina * Umbria *  <b>Y</b> Cascia Riva * Rugata	*Approved for the Asymmetric Sofa with Chaise (BO15R, BO15L)  Ⓔ Fire Retardant Chemicals  <i>Check with your KnollTextiles or Spinneybeck Representative for changes or additions.</i>

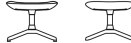

# Edward Barber & Jay Osgerby Pilot by Knoll® Lounge Collection High Back

	description	seat h	arm h	w	d	h	Base Finish	textile fabric yds.	req. leather sq. ft.	weight
<i>Designer(s):</i> Edward Barber and Jay Osgerby, 2014	<b>BO30-AL</b> Pilot by Knoll® High Back Lounge Chair, Loop arm 	16"	20"	27 1/4"	30 3/8"	39 3/8"	Dark Grey, painted	6	61	59 lbs.
		16"	20"	27 1/4"	30 3/8"	39 3/8"	Polished aluminum	6	61	59 lbs.
	<b>BO30-AU</b> Pilot by Knoll® High Back Lounge Chair, Upholstered arm 	16"	21 1/2"	27 1/4"	30 3/8"	39 3/8"	Dark Grey, painted	6	61	59 lbs.
		16"	21 1/2"	27 1/4"	30 3/8"	39 3/8"	Polished aluminum	6	61	59 lbs.
	<b>BO30-C</b> Pilot by Knoll® High Back Lounge Chair, Armless 	16"		23 3/8"	30 3/8"	39 3/8"	Dark Grey, painted	6	61	57 lbs.
		16"		23 3/8"	30 3/8"	39 3/8"	Polished aluminum	6	61	57 lbs.
	<b>BO32</b> Pilot by Knoll® Ottoman 			19 3/4"	20"	15 1/2"	Dark Grey, painted	2	27	15 lbs.
				19 3/4"	20"	15 1/2"	Polished aluminum	2	27	15 lbs.
										

Order Code	Ordering Information
<i>Example:</i> <b>BO30-AL-3-K1523/25</b>	<i>Base finishes:</i> Polished Aluminum (suffix P) Dark Grey paint (suffix 3)
<b>BO30</b>	Pilot by Knoll® High Back Lounge Chair
<b>AL</b>	Loop arms
<b>3</b>	Dark Grey, painted (base and arms)
<b>K1523/25</b>	Hourglass/Iron
<i>Specify:</i>	<i>Two or three split upholstery option:</i> Seat, back and upholstered arms can be specified in different fabrics or leathers. <b>Fabric and leather cannot be mixed.</b> Indicate <b>S</b> followed by the textile or leather for seat, back and arms (if applicable). For any split upholstery, price equals the higher seat or back upholstery grade plus \$148 upcharge. <b>Specification example:</b> Pattern number: BO30-AU-P-S-K-1882/8-K2063/3-K1579/5 High Back Lounge Chair, upholstered arms, polished aluminum base, split upholstery Seat textile: Melange/Flannel (Grade G) Back textile: Tivoli/Dove (Grade F) Arms textile: Tudor/Glacier (grade I) Price = Grade G + \$148 upcharge  <i>Customer's Own Material is available pending approval. For approval requirements, processing instructions and ordering information please see page 21.</i>  <i>Maintenance:</i> See pages 28-29.
	<i>Upholstery/COM information:</i> Prices shown include fabric or leather upholstery. Contact your Knoll representative for colors. Only approved KnollTextiles and Spinneybeck leathers may be ordered.  <i>COM split fabric requirements:</i> Seat: 2.4 yards Back: 2.4 yards Arms: 1.2 yards  <i>COL split leather requirements:</i> Seat: 19 square feet Back: 28 square feet Arms: 14 square feet
	<i>Loop Arm specification:</i> The selected base finish will automatically designate coordinating arm finish: Polished Aluminum base / Chrome loop arms Dark Grey painted base / Black loop arms with Dark Grey brackets  <i>Optional return to rener mechanism:</i> An optional return to center mechanism is available at an upcharge of \$474. The return to center mechanism allows for 360° swivel movement and returns to a center position when not engaged. To specify return to center mechanism, add suffix RC following the parent pattern number. <i>Example:</i> BO30-AL-3-RC-K1523/25.







pattern no.	grades <b>A</b>	COM <b>B</b>	<b>C</b>	<b>D</b>	<b>E</b>	<b>F</b>	<b>G</b>	<b>H</b>	<b>I</b>	COL <b>U</b>	<b>V</b>	<b>W</b>	<b>X</b>	<b>Y</b>
<b>BO30-AL-3(-)</b>	\$5,440.	\$5,557.	\$5,724.	\$5,861.	\$6,055.	\$6,225.	\$6,420.	\$6,566.	\$7,233.	\$8,122.	\$8,515.	\$9,359.	\$9,641.	\$10,138.
<b>BO30-AL-P(-)</b>	5,756.	5,873.	6,040.	6,176.	6,370.	6,541.	6,734.	6,883.	7,549.	8,436.	8,832.	9,672.	9,955.	10,453.
<b>BO30-AU-3(-)</b>	5,908.	6,027.	6,193.	6,328.	6,524.	6,694.	6,888.	7,036.	7,703.	8,718.	9,111.	9,953.	10,237.	10,733.
<b>BO30-AU-P(-)</b>	6,084.	6,204.	6,370.	6,506.	6,698.	6,871.	7,062.	7,210.	7,880.	8,893.	9,290.	10,130.	10,413.	10,911.
<b>BO30-C-3(-)</b>	4,727.	4,843.	5,013.	5,147.	5,342.	5,513.	5,707.	5,853.	6,521.	7,327.	7,722.	8,562.	8,847.	9,342.
<b>BO30-C-P(-)</b>	4,902.	5,022.	5,189.	5,323.	5,519.	5,689.	5,881.	6,031.	6,696.	7,504.	7,899.	8,739.	9,022.	9,521.
<b>BO32-3(-)</b>	2,912.	2,989.	3,057.	3,074.	3,102.	3,194.	3,397.	3,482.	3,684.	3,545.	3,874.	4,112.	4,218.	4,329.
<b>BO32-P(-)</b>	3,018.	3,095.	3,164.	3,178.	3,206.	3,298.	3,504.	3,587.	3,791.	3,651.	3,981.	4,215.	4,324.	4,433.

Construction	Approved KnollTextiles Grades/Fabrics	Spinneybeck Leather
<i>Base:</i> Four star, cantilevered, 360° swivel, die cast aluminum base, available polished or painted in a highly durable powder coat.  <i>Upholstery:</i> Highly resilient polyurethane molded foam, overlaid with knit backed polyester fiber. Top stitched, open parallel double side seaming.  <i>Substructure:</i> Comprised of steel, die cast aluminum and elastic webbing embedded inside polyurethane molded foam.  <i>Arms:</i> <b>Loop Arms:</b> steel rod loop arms and die cast aluminum arm brackets. <b>Upholstered Arms:</b> steel weldment substructure embedded inside highly resilient polyurethane molded foam, overlaid with knit backed polyester fiber.	<b>A</b> Common Ground Cross Tech Crossroad Delite Facet Hourglass Infinite Mariner Overture Presto Sonnet  <b>B</b> Calypso Cozy Cord Day Tripper Diva Dottie Ferry Forza <sup>®</sup> Helios Instinct Journey Keaton Knoll Felt Knoll Hopsack Ludlow Melody <sup>®</sup> Prairie  <b>B</b> cont. Summit Tinge Topos Vast Venue Vinyl <sup>®</sup> Westwood Wild Thing  <b>C</b> Atlas Chameleon Circa Classic Boucle Contour Dune Entwine Groovy Lagos On Point Patchwork Palisade Plaid On Prestini Sahara Sequin CR Swing Utmost II Utopia	<b>U</b> Vicenza Volo  <b>V</b> Acqua Amalfi Andes España Velluto Pelle  <b>W</b> Alaska Antique Forte Sabrina Umbria  <b>Y</b> Cascia Copenhagen Marissa Riva Saddle  <sup>®</sup> Fire Retardant Chemicals  <i>Check with your KnollTextiles or Spinneybeck Representative for changes or additions.</i>
	<b>D</b> Buzz Pathway Plaidtastic Retreat Vice Versa Woodland  <b>E</b> Currents Demure Flower Power Highland Off The Grid Rebel Tempest Whip  <b>F</b> Atelier Century Cornaro Double Agent <sup>®</sup> Homage Imprint Rivington Tweed Frieze Swank	<b>G</b> All Star Aurora Dapper Fancy Twill Haze Melange Texnet Ultrasuede Vert  <b>H</b> Chiseled  <b>I</b> Bella Chic Prince Hairly Tudor

# Edward Barber & Jay Osgerby

## Pilot by Knoll® Lounge Collection

### Low Back

	description	seat h	arm h	w	d	h	Base Finish	textile fabric yds.	req. leather sq. ft.	weight
<i>Designer(s):</i> Edward Barber and Jay Osgerby, 2014	<b>BO31-AL</b> Pilot by Knoll® Low Back Lounge Chair, Loop arm 	16"	20"	27 1/4"	27 1/2"	31 7/8"	Dark Grey, painted	5.5	57	57 lbs.
		16"	20"	27 1/4"	27 1/2"	31 7/8"	Polished aluminum	5.5	57	57 lbs.
	<b>BO31-AU</b> Pilot by Knoll® Low Back Lounge Chair, Upholstered arm 	16"	21 1/2"	27 1/4"	27 1/2"	31 7/8"	Dark Grey, painted	5.5	57	57 lbs.
		16"	21 1/2"	27 1/4"	27 1/2"	31 7/8"	Polished aluminum	5.5	57	57 lbs.
	<b>BO31-C</b> Pilot by Knoll® Low Back Lounge Chair, Armless 	16"		23 3/8"	27 1/2"	31 7/8"	Dark Grey, painted	5.5	55	55lbs.
		16"		23 3/8"	27 1/2"	31 7/8"	Polished aluminum	5.5	55	55lbs.
	<b>BO32</b> Pilot by Knoll® Ottoman 			19 3/4"	20"	15 1/2"	Dark Grey, painted	2	27	15 lbs.
				19 3/4"	20"	15 1/2"	Polished aluminum	2	27	15 lbs.



Order Code	Ordering Information
<i>Example:</i> <b>BO31-AL-3-K1523/25</b>	<i>Base finishes:</i> Polished Aluminum (suffix P) Dark Grey paint (suffix 3)
<b>BO31</b> Pilot by Knoll® Low Back Lounge Chair	
<b>AL</b> Loop arms	<i>Loop Arm finishes:</i> Loop with chrome brackets Black painted loop with dark grey painted brackets
<b>3</b> Dark Grey, painted (base and arms)	<i>Loop Arm specification:</i> The selected base finish will automatically designate coordinating arm finish: Polished Aluminum base / Chrome loop arms Dark Grey painted base / Black loop arms with Dark Grey brackets
<b>K1523/25</b> Hourglass/Iron	<i>Optional return to renter mechanism:</i> An optional return to center mechanism is available at an upcharge of \$474. The return to center mechanism allows for 360° swivel movement and returns to a center position when not engaged. To specify return to center mechanism, add suffix RC following the parent pattern number. <i>Example:</i> BO31-AL-3-RC-K1523/25.
<i>Specify:</i>	<i>Two or three split upholstery option:</i> Seat, back and upholstered arms can be specified in different fabrics or leathers. <u>Fabric and leather cannot be mixed.</u> Indicate <b>S</b> followed by the textile or leather for seat, back and arms (if applicable). For any split upholstery, price equals the higher seat or back upholstery grade plus \$148 upcharge. <u>Specification example:</u> Pattern number: BO31-AU-P-S-K-1882/8-K2063/3-K1579/5 Low Back Lounge Chair, upholstered arms, polished aluminum base, split upholstery Seat textile: Melange/Flannel (Grade G) Back textile: Tivoli/Dove (Grade F) Arms textile: Tudor/Glacier (grade I) Price = Grade G+ \$148 upcharge
	<i>Upholstery/COM information:</i> Prices shown include fabric or leather upholstery. Contact your Knoll representative for colors. Only approved KnollTextiles and Spinneybeck leathers may be ordered.  <i>Customer's Own Material</i> is available pending approval. For approval requirements, processing instructions and ordering information please see page 21.  <i>Maintenance:</i> See pages 28-29.
	<i>COM split fabric requirements:</i> Seat: 2.4 yards Back: 1.9 yards Arms: 1.2 yards  <i>COL split leather requirements:</i> Seat: 19 square feet Back: 22 square feet Arms: 14 square feet

pattern no.	grades <b>A</b>	COM <b>B</b>	<b>C</b>	<b>D</b>	<b>E</b>	<b>F</b>	<b>G</b>	<b>H</b>	<b>I</b>	COL <b>U</b>	<b>V</b>	<b>W</b>	<b>X</b>	<b>Y</b>
<b>BO31-AL-3-(-)</b>	\$5,093.	\$5,201.	\$5,358.	\$5,479.	\$5,658.	\$5,814.	\$5,995.	\$6,127.	\$6,743.	\$7,532.	\$7,886.	\$8,645.	\$8,902.	\$9,346.
<b>BO31-AL-P-(-)</b>	5,409.	5,519.	5,672.	5,797.	5,975.	6,131.	6,308.	6,442.	7,056.	7,846.	8,201.	8,962.	9,216.	9,663.
<b>BO31-AU-3-(-)</b>	5,603.	5,711.	5,866.	5,987.	6,168.	6,324.	6,498.	6,635.	7,249.	8,106.	8,463.	9,223.	9,476.	9,924.
<b>BO31-AU-P-(-)</b>	5,779.	5,887.	6,040.	6,165.	6,344.	6,498.	6,678.	6,813.	7,426.	8,283.	8,638.	9,398.	9,654.	10,100.
<b>BO31-C-3-(-)</b>	4,387.	4,495.	4,649.	4,773.	4,953.	5,107.	5,287.	5,422.	6,034.	6,736.	7,093.	7,851.	8,106.	8,555.
<b>BO31-C-P-(-)</b>	4,565.	4,673.	4,828.	4,952.	5,128.	5,287.	5,463.	5,599.	6,212.	6,914.	7,269.	8,027.	8,283.	8,728.
<b>BO32-3-(-)</b>	2,912.	2,989.	3,057.	3,074.	3,102.	3,194.	3,397.	3,482.	3,684.	3,545.	3,874.	4,112.	4,218.	4,329.
<b>BO32-P-(-)</b>	3,018.	3,095.	3,164.	3,178.	3,206.	3,298.	3,504.	3,587.	3,791.	3,651.	3,981.	4,215.	4,324.	4,433.

Construction	Approved KnollTextiles Grades/Fabrics	Spinneybeck Leather
<i>Base:</i> Four star, cantilevered, 360° swivel, die cast aluminum base, available polished or painted in a highly durable powder coat.	<b>A</b> Common Ground Cross Tech Crossroad Delite Facet Hourglass Infinite Mariner Overture Presto Sonnet	<b>U</b> Vicenza Volo <b>V</b> Acqua Amalfi Andes España Velluto Pelle
<i>Upholstery:</i> Highly resilient polyurethane molded foam, overlaid with knit backed polyester fiber. Top stitched, open parallel double side seaming.	<b>B</b> cont. Summit Tinge Topos Vast Venue Vinyl <sup>Ⓞ</sup> Westwood Wild Thing	<b>W</b> Alaska Antique Forte Sabrina Umbria <b>Y</b> Cascia Copenhagen Marissa Riva Saddle
<i>Substructure:</i> Comprised of steel, die cast aluminum and elastic webbing embedded inside polyurethane molded foam.	<b>C</b> Atlas Chameleon Circa Classic Boucle Contour Dune Entwine Groovy Lagos On Point Patchwork Palisade Plaid On Prestini Sahara Sequin CR Swing Utmost II Utopia	<b>I</b> Bella Chic Prince Hairy Tudor  <sup>Ⓞ</sup> Fire Retardant Chemicals
<i>Arms:</i> <u>Loop Arms:</u> steel rod loop arms and die cast aluminum arm brackets. <u>Upholstered Arms:</u> steel weldment substructure embedded inside highly resilient polyurethane molded foam, overlaid with knit backed polyester fiber.	<b>E</b> Currents Demure Flower Power Highland Off The Grid Rebel Tempest Whip <b>F</b> Atelier Century Cornaro Double Agent <sup>Ⓞ</sup> Homage Imprint Rivington Tweed Frieze Swank	<i>Check with your KnollTextiles or Spinneybeck Representative for changes or additions.</i>

*Designer(s):*  
 Edward Barber and Jay Osgerby,  
 2014

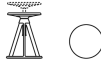

description	w	d	h	seat finish	weight
<b>BO10C</b> stool, indoor fixed height, swivel seat 	14 1/4"	14 1/4"	18"	Aluminum, polished	14 lbs.
	14 1/4"	14 1/4"	18"	Ash	12 lbs.
<b>BO10CO</b> stool, outdoor fixed height, swivel seat 	14 1/4"	14 1/4"	18"	Aluminum, painted (seat matches base)	14 lbs.
	14 1/4"	14 1/4"	18"	Teak	12 lbs.
<b>BO11C</b> stool, indoor adjustable height, swivel seat 	14 1/4"	14 1/4"	18" - 22"	Aluminum, painted (seat matches base)	15 lbs.
	14 1/4"	14 1/4"	18" - 22"	Aluminum, polished	15 lbs.
	14 1/4"	14 1/4"	18" - 22"	Ash	13 lbs.
	14 1/4"	14 1/4"	18" - 22"	Teak	13 lbs.

pattern no.	list
<b>BO10C-AP-( )</b>	\$981.
<b>BO10C-AE-( )</b>	1,383.
<b>BO10CO-( )-( )</b>	837.
<b>BO10CO-K-( )</b>	1,753.
<b>BO11C-( )-( )</b>	904.
<b>BO11C-AP-( )</b>	1,048.
<b>BO11C-AE-( )</b>	1,447.
<b>BO11C-K-( )</b>	1,821.

**Order Code**

<i>Example:</i> <b>BO10C-AP-CRLT</b>	
<b>BO10C</b>	Stool, indoor fixed height, swivel seat
<b>AP</b>	Aluminum, polished
<b>CRLT</b>	Red Coral

*Specify:*

1. Pattern number
2. Seat selection
3. Base selection

**Ordering Information**

*Aluminum seat finishes:*  
 Polished Aluminum (suffix AP)  
 Painted Aluminum Seat \*:  
 Jet Black (Suffix 111T)  
 Med. Metallic Grey, (suffix 612T)  
 Red Coral (suffix CRLT)  
 Sterling (suffix 906T)  
 White (suffix WHTT)

(base must be specified in the same color)

*Wood Seat Finishes:*  
 Ebonized Ash (suffix AE)  
 Teak, natural (suffix K) \*

**\* Outdoor Use:**  
**The painted aluminum and teak seats are approved for outdoor use when used on the fixed height stool only**

**Construction**





*Base paint finishes:*  
 Jet Black (suffix 111T)  
 Medium Metallic Grey (suffix 612T)  
 Red Coral (suffix CRLT)  
 Sterling (suffix 906T)  
 White (suffix WHTT)

*Maintenance:*  
 See pages 28-29.

*Base:*  
 Base is constructed of die-cast aluminum with stainless steel fasteners and finished with a highly durable powder coat paint. Height adjustable

*Aluminum Seats:*  
 Contoured die-cast aluminum seats are attached to the base with stainless steel fasteners. Available in a polished aluminum or painted with a highly durable powder coat paint.

# Harry Bertoia Side Chair

	description	seat h	w	d	h	textile fabric yds.	req. leather sq. ft.	weight
<i>Designer(s):</i> Harry Bertoia, 1952	<b>420CU</b> Side chair, full cover 	17 3/4"	21 3/4"	19 3/4"	28 3/4"	1.8	n/a	14 lbs.
		17 3/4"	21 3/4"	19 3/4"	28 3/4"	1.8	n/a	14 lbs.
		17 3/4"	21 3/4"	19 3/4"	28 3/4"	1.8	n/a	14 lbs.
<i>Award(s):</i> "Designer of the Year" 1955, USA; Certificate of Merit, American Institute of Architects	<b>420F</b> Full cover replacement <b>420C</b> Side chair, back pad and seat cushion 					1.8	n/a	
		17 3/4"	21 3/4"	19 3/4"	28 3/4"	1.5	n/a	14 lbs.
		17 3/4"	21 3/4"	19 3/4"	28 3/4"	1.5	n/a	14 lbs.
	<b>420P</b> Back pad replacement <b>420KP</b> Back pad and seat cushion replacement <b>420C</b> Side chair, seat cushion or unupholstered 					0.7	n/a	
		17 3/4"	21 3/4"	19 3/4"	28 3/4"	0.8	14	14 lbs.
		17 3/4"	21 3/4"	19 3/4"	28 3/4"	0.8	14	14 lbs.
	<b>420K</b> Seat cushion replacement					0.8	14	

Order Code	Ordering Information
<i>Example:</i> <b>420C-C-K-K242/13</b>	<i>Frame finishes:</i> Black (suffix BL) Blue (suffix BU) Green (suffix GE) Polished Chrome (suffix C) 18k Gold Plated (suffix GLD) Orange Red (suffix RD) Satin Chrome (suffix CO) White (suffix W) Yellow (suffix YL)
<b>420C</b> Side chair	<i>Upholstery options:</i> Full cover (suffix U) Seat cushion only (suffix K) Back pad and seat cushion combination (suffix KP)
<b>C</b> Polished Chrome	<i>Upholstery/COM information:</i> Prices shown include fabric or leather upholstery. Contact your Knoll representative for colors. Only approved KnollTextiles and Spinneybeck leathers may be ordered.
<b>K</b> Seat cushion	<i>Outdoor use:</i> With proper care and limited exposure to the elements, the Bertoia Collection is appropriate for outdoor environments. Specify powder coat finish (red, yellow, green, blue, black, white). Consult a Knoll representative for appropriate upholstery options.
<b>K242/13</b> Vinyl, White	For outdoor seat pad, specify O in front of textile selection: Ex. 420C-W-K-O-K24221
<i>Specify:</i> 1. Pattern number 2. Finish selection 3. Upholstery option 4. Cal 133 Fire Code option 5. Textile selection	<i>Note:</i> The Knoll logo is stamped into the base of the chair.  <i>Maintenance:</i> See pages 28-29.
<i>For cushion replacement specify:</i> 1. Pattern number 2. Textile selection	<i>Cal 133 Fire Code #:</i> The Bertoia Chairs with seat cushion attached comply with the California Technical Bulletin 133 standard in all upholstery. Specify suffix -C at end of pattern number and suffix -133 at end of textile selection.

pattern no.	unuph. (remove suffix -K)	grades A	COM B	C	D	E	F	G	H	I	COL U	V	W	X	Y	
<b>420C-( )-U</b>		\$2,261.	\$2,379.	\$2,486.	\$2,621.	\$2,719.	\$2,799.	\$2,918.	\$3,164.	\$3,341.						
<b>420C-CO-U</b>		2,639.	2,760.	2,866.	3,000.	3,101.	3,179.	3,297.	3,540.	3,720.						
<b>420C-GLD-U</b>		4,308.	4,422.	4,525.	4,655.	4,749.	4,826.	4,940.	5,177.	5,346.						
<b>420F-( )</b>		1,006.	1,115.	1,214.	1,331.	1,429.	1,496.	1,604.	1,833.	1,992.						
<b>420C-( )-KP</b>		2,426.	2,486.	2,547.	2,611.	2,665.	2,706.	2,767.	2,894.	3,091.						
<b>420C-CO-KP</b>		2,820.	2,883.	2,942.	3,006.	3,058.	3,099.	3,164.	3,288.	3,486.						
<b>420C-GLD-KP</b>		4,467.	4,525.	4,584.	4,645.	4,696.	4,737.	4,795.	4,916.	5,106.						
<b>420P-( )</b>		672.	697.	720.	750.	772.	786.	817.	872.	912.						
<b>420KP-( )</b>		1,066.	1,121.	1,174.	1,236.	1,283.	1,319.	1,379.	1,494.	1,577.						
<b>420C-( )-K</b>		1,275.	1,597.	1,650.	1,701.	1,761.	1,806.	1,847.	1,902.	2,011.	2,097.	2,411.	2,608.	3,004.	3,087.	3,183.
<b>420C-CO-K</b>		1,665.	1,992.	2,044.	2,095.	2,153.	2,199.	2,241.	2,293.	2,407.	2,487.	2,804.	3,000.	3,397.	3,480.	3,577.
<b>420C-GLD-K</b>		3,360.	3,671.	3,720.	3,770.	3,826.	3,871.	3,911.	3,962.	4,068.	4,150.	4,452.	4,642.	5,022.	5,102.	5,195.
<b>420K-( )</b>		384.	428.	475.	529.	567.	601.	650.	749.	820.	1,100.	1,269.	1,619.	1,688.	1,765.	

Construction	Approved KnollTextiles Grades/Fabrics	Spinneybeck Leather
<i>Base and basket:</i> Welded steel with rods in polished or satin chrome, plated in 18k gold, or highly durable outdoor power coat (red, yellow, green, blue, white, black). The diameter of the base rods are 11mm. The diameter of the edge rods is 4.5 mm and the interlacements measure 4mm. The chair features stainless steel connections and plastic glides.	<b>A</b> Bocce Common Ground * Commuter Cloth * Crossroad * Delite * Facet Hourglass * Infinite Mariner * Overture Presto * Soliloquy Sonnet * Trophy * Uni-Form *  <b>B</b> Abacus Attire * Belize ° Bistro Calypso Chronicle Day Tripper * Diva * Dottie Ferry * Forza ™ Grande Grandview Holbrook Instinct Journey * Keaton * Knoll Felt * Knoll Hopsack * Little Devil * Petal Pusher * ™ Prairie ° Prim	<b>U</b> Vicenza Volo  <b>V</b> Acqua Amalfi Andes Embossed Tipped Hand Tipped Velluto Pelle  <b>W</b> Alaska Antique Derby Forte Lucente Sabrina Umbria  * Approved for fully upholstered versions. ™ Fire Retardant Chemicals ° Approved for outdoor seat pad
<i>Upholstery:</i> Cushion and back pad secured to chair with domed metal lock snaps. Seat cushions and back pads have fabric edges. Full covers are stretched over wire seat basket and attach to seat basket with hooks. Back pad is not available with leather upholstery.	<b>B</b> continued Puff * Ransom * Roam Rush Hour Summit Sutton Synth * Tabloid Topos * Vast Venue * Versa Vibe II Vinyl ™ ° Wild Thing *  <b>C</b> Atlas Axiom ™ Classic Boucle * Durand Earthwork Entourage * Entwine * Lagos Milestone Patchwork Prestini * Pullman * Quark Roundtrip Sinclair ° Smart ™ Spectator Swing * Tight Rope Tower Grid Utopia ° Wit Wow Factor *	<b>X</b> Ducale Ducale Velour  <b>Y</b> Cervo Copenhagen Distressed Gemma Lucca Marissa Portofino Riva Torello  <b>H</b> Bavaria * Catwalk * Stretch Appeal World Piece  <b>I</b> Aswan Bella Byron Cato * Chic * Cummings Doily Dynamic Hastings Ita * Knoll Velvet * North Island * Prince Hair * Rutledge Stripe It ° Tudor Zimba *
	<b>D</b> Buzz Chain Link Hologram Menagerie Retreat Zoom  <b>E</b> Aegean * Flower Power Highland * Ikat Stripe Kimono Marquee Nature Walk Rebel * Sherman * Tempest Tryst  <b>F</b> Atelier * Calais Cotton Velvet Cornaro Double Agent Glider Homage Imprint In Stitches * ™ Liberty Mod Plaid Totem Tweed Frieze	<b>G</b> All Star * Alter Ego * Aurora * Dapper * Duchess Haze * Kamani Looped In * Melange * Modern Tweed * Rivers Straie Stripe Ultrasuede * Utrillo * Vert *  <b>I</b> Aswan Bella Byron Cato * Chic * Cummings Doily Dynamic Hastings Ita * Knoll Velvet * North Island * Prince Hair * Rutledge Stripe It ° Tudor Zimba *

# Harry Bertoia

## Two-Tone Side Chair

	description	seat h	w	d	h	textile fabric yds	req. leather sq. ft	weight
<i>Designer(s):</i> Harry Bertoia, 1952	<b>420CT-U</b> Two-Tone Side chair, full cover	17 3/4"	21 3/4"	19 3/4"	28 3/4"	1.8	n/a	14 lbs.
<i>Award(s):</i> "Designer of the Year" 1955, USA; Certificate of Merit, American Institute of Architects	<b>420CT-KP</b> Two-Tone Side chair, back pad and seat cushion	17 3/4"	21 3/4"	19 3/4"	28 3/4"	1.5	n/a	14 lbs.
	<b>420CT-K</b> Two-Tone Side chair, seat cushion	17 3/4"	21 3/4"	19 3/4"	28 3/4"	0.8	14	14 lbs.
	<b>420F</b> Full cover replacement					1.8	n/a	
	<b>420KP</b> Back pad and seat cushion replacement					1.5	n/a	
	<b>420P</b> Back pad replacement					0.7	n/a	
	<b>420K</b> Seat cushion replacement					0.8	14	



Order Code	Ordering Information
<i>Example:</i> <b>420CT-U-BU-W-K242/13</b>	<i>Frame finishes:</i> Polished Chrome (suffix C) Black (suffix BL) Blue (suffix BU) Orange Red (suffix RD) White (suffix W)
<b>420CT-U</b>	Two-Tone Side chair, fully upholstered
<b>BU</b>	Blue basket
<b>W</b>	White base
<b>K242/13</b>	Vinyl, White
<i>Specify:</i>	<i>Upholstery options:</i> Full cover (suffix U) Seat cushion only (suffix K) Back pad and seat cushion combination (suffix KP)
1. Pattern number	
2. Basket finish selection	
3. Base finish selection	
4. Textile selection	
<i>For cushion replacement specify:</i>	<i>Upholstery/COM information:</i> Prices shown include fabric or leather upholstery. Contact your Knoll representative for colors. Only approved KnollTextiles and Spinneybeck leathers may be ordered.
1. Pattern number	
2. Textile selection	

pattern no.	unuph.	A	B	C	D	E	F	G	H	I	COL U	V	W	X	Y
<b>420CT-U(-)(-)(-)</b>		\$2,261.	\$2,379.	\$2,486.	\$2,621.	\$2,719.	\$2,799.	\$2,918.	\$3,164.	\$3,341.					
<b>420CT-K(-)(-)(-)</b>		2,426.	2,486.	2,547.	2,611.	2,665.	2,706.	2,767.	2,894.	3,091.					
<b>420CT-K(-)(-)(-)</b>		1,275.	1,597.	1,650.	1,701.	1,761.	1,806.	1,847.	1,902.	2,011.	2,097.	2,411.	2,608.	3,004.	3,087.
<b>420F(-)</b>		1,006.	1,115.	1,214.	1,331.	1,429.	1,496.	1,604.	1,833.	1,992.					
<b>420KP(-)</b>		1,066.	1,121.	1,174.	1,236.	1,283.	1,319.	1,379.	1,494.	1,577.					
<b>420P(-)</b>		672.	697.	720.	750.	772.	786.	817.	872.	912.					
<b>420K(-)</b>		384.	428.	475.	529.	567.	601.	650.	749.	820.	1,100.	1,269.	1,619.	1,688.	1,765.

Construction	Approved KnollTextiles Grades/Fabrics	Spinneybeck Leather
<i>Base and basket:</i> Welded steel with rods in polished chrome, or highly durable power coat (red, blue, white, black). The diameter of the base rods are 11mm. The diameter of the edge rods is 4.5 mm and the interlacements measure 4mm. The chair features stainless steel connections and plastic glides.	<b>A</b> Bocce Common Ground * Commuter Cloth * Crossroad * Delite * Facet Hourglass * Infinite Mariner * Overture Presto * Soliloquy Sonnet * Trophy * Uni-Form *	<b>X</b> Ducale Ducale Velour
<i>Upholstery:</i> Cushion and back pad secured to chair with domed metal lock snaps. Seat cushions and back pads have fabric edges. Full covers are stretched over wire seat basket and attach to seat basket with hooks. Back pad is not available with leather upholstery.	<b>B</b> continued Ransom * Roam Rush Hour Summit Sutton Synth * Tabloid Topos * Vast Venue * Versa Vibe II Vinyl <sup>Ⓞ</sup> Wild Thing *	<b>Y</b> Cervo Copenhagen Distressed Gemma Lucca Marissa Portofino Riva Torello
<i>Note:</i> Two-Tone Bertoia Chairs are not appropriate for outdoor use.	<b>C</b> Atlas Axiom <sup>Ⓞ</sup> Classic Boucle * Durand Earthwork Entourage * Entwine * Lagos Milestone Patchwork Prestini * Pullman * Quark Roundtrip Sinclair <sup>Ⓞ</sup> Smart <sup>Ⓞ</sup> Spectator Swing * Tight Rope Tower Grid Utopia <sup>Ⓞ</sup> Wit Wow Factor *	<b>U</b> Vicenza Volo
Screws that attach the base to the basket are are not painted to match the basket finish.	<b>E</b> Aegean * Flower Power Highland * Ikat Stripe Kimono Marquee Nature Walk Rebel * Sherman * Tempest Tryst	<b>V</b> Acqua Amalfi Andes Embossed Tipped Hand Tipped Velluto Pelle
	<b>F</b> Atelier * Calais Cotton Velvet Cornaro Double Agent Glider Homage Imprint In Stitches * <sup>Ⓞ</sup> Liberty Mod Plaid Totem Tweed Frieze	<b>W</b> Alaska Antique Derby Forte Lucente Sabrina Umbria
	<b>G</b> Buzz Chain Link Hologram Menagerie Retreat Zoom	<b>X</b> Ducale Ducale Velour
	<b>H</b> Bavaria * Catwalk * Stretch Appeal World Piece	<b>Y</b> Cervo Copenhagen Distressed Gemma Lucca Marissa Portofino Riva Torello
	<b>I</b> Aswan Bella Byron Cato * Chic * Cummings Doily Dynamic Hastings Ita * Knoll Velvet * North Island * Prince Hair * Rutledge Stripe It <sup>Ⓞ</sup> Tudor Zimba *	<b>U</b> Vicenza Volo
	<b>K</b> Kamoni Looped In * Melange * Modern Tweed * Rivers Straie Stripe Ultrasuede * Utrillo * Vert *	<b>V</b> Acqua Amalfi Andes Embossed Tipped Hand Tipped Velluto Pelle
	<b>L</b> Lagos Milestone Patchwork Prestini * Pullman * Quark Roundtrip Sinclair <sup>Ⓞ</sup> Smart <sup>Ⓞ</sup> Spectator Swing * Tight Rope Tower Grid Utopia <sup>Ⓞ</sup> Wit Wow Factor *	<b>W</b> Alaska Antique Derby Forte Lucente Sabrina Umbria
	<b>M</b> Marquee Nature Walk Rebel * Sherman * Tempest Tryst	<b>X</b> Ducale Ducale Velour
	<b>N</b> Nature Walk Rebel * Sherman * Tempest Tryst	<b>Y</b> Cervo Copenhagen Distressed Gemma Lucca Marissa Portofino Riva Torello
	<b>O</b> Overture Presto * Soliloquy Sonnet * Trophy * Uni-Form *	<b>U</b> Vicenza Volo
	<b>P</b> Presto * Soliloquy Sonnet * Trophy * Uni-Form *	<b>V</b> Acqua Amalfi Andes Embossed Tipped Hand Tipped Velluto Pelle
	<b>Q</b> Quark Roundtrip Sinclair <sup>Ⓞ</sup> Smart <sup>Ⓞ</sup> Spectator Swing * Tight Rope Tower Grid Utopia <sup>Ⓞ</sup> Wit Wow Factor *	<b>W</b> Alaska Antique Derby Forte Lucente Sabrina Umbria
	<b>R</b> Rush Hour Summit Sutton Synth * Tabloid Topos * Vast Venue * Versa Vibe II Vinyl <sup>Ⓞ</sup> Wild Thing *	<b>X</b> Ducale Ducale Velour
	<b>S</b> Sherman * Tempest Tryst	<b>Y</b> Cervo Copenhagen Distressed Gemma Lucca Marissa Portofino Riva Torello
	<b>T</b> Tempest Tryst	<b>U</b> Vicenza Volo
	<b>U</b> Utrillo * Vert *	<b>V</b> Acqua Amalfi Andes Embossed Tipped Hand Tipped Velluto Pelle
	<b>V</b> Vicenza Volo	<b>W</b> Alaska Antique Derby Forte Lucente Sabrina Umbria
	<b>W</b> Wow Factor *	<b>X</b> Ducale Ducale Velour
	<b>X</b> Xanthos	<b>Y</b> Yacht

# Harry Bertoia

## Barstools

### Bar Height Stools

*Designer(s):*  
Harry Bertoia, 1952

*Award(s):*  
“Designer of the Year” 1955,  
USA; Certificate of Merit,  
American Institute of Architects



description	seat h	w	d	h	textile fabric yds.	req. leather sq. ft.	weight
<b>428C-KP</b> Barstool, back pad and seat cushion, bar height	29 1/4"	21 3/4"	22"	43"	1.5	n/a	22 lbs.
	29 1/4"	21 3/4"	22"	43"	1.5	n/a	22 lbs.
	29 1/4"	21 3/4"	22"	43"	1.5	n/a	22 lbs.
<b>428P</b> Back pad replacement					0.7	n/a	
<b>428KP</b> Back pad and seat cushion replacement					1.5	n/a	
<b>428C</b> Barstool, seat cushion or unupholstered, bar height	29 1/4"	21 3/4"	22"	43"	0.8	14	21 lbs.
	29 1/4"	21 3/4"	22"	43"	0.8	14	21 lbs.
	29 1/4"	21 3/4"	22"	43"	0.8	14	21 lbs.
<b>428K</b> Seat cushion replacement					0.8	14	

Order Code	Ordering Information
<i>Example:</i> <b>428C-C-KP-K1021/8</b>	<i>Frame finishes:</i> Black (suffix BL) Polished Chrome (suffix C) Satin Chrome (suffix CO) 18k Gold Plated (suffix GLD) White (suffix W)
<b>428C</b> Barstool, bar height	<i>Upholstery options:</i> Full cover (suffix U) Seat cushion only (suffix K) Back pad and seat cushion combination (suffix KP)
<b>C</b> Polished Chrome	<i>Upholstery/COM information:</i> Prices shown include fabric or leather upholstery. Contact your Knoll representative for colors. Only approved KnollTextiles and Spinneybeck leather may be ordered.
<b>KP</b> Back and seat pad	<i>Outdoor use:</i> With proper care and limited exposure to the elements, the 428 Bertoia Barstool is appropriate for outdoor environments. Specify outdoor powder coat. Consult a Knoll representative for appropriate upholstery options.
<b>K1021/8</b> Ultrasuede, Poppy	For outdoor seat pad, specify O in front of textile selection: Ex. 428C-W-K-O-K24221
	<i>Customer's Own Material</i> is available pending approval. For approval requirements, processing instructions and ordering information, please see page 21.
	<i>Cal 133 Fire Code *</i> : The Bertoia Barstools with seat cushion attached comply with the California Technical Bulletin 133 standard in all upholstery. Specify suffix -C at end of pattern number and suffix -133 at end of textile selection.
	<i>Maintenance:</i> See pages 28-29.
	<i>Note:</i> The Knoll logo is stamped into the base of the barstool.
	The Bertoia Bar Height stool is certified Clean Air GOLD.

pattern no.	unuph. (remove suffix -K)	grades A	COM B	C	D	E	F	G	H	I	COL U	V	W	X	Y	
<b>428C-( )-KP</b>		\$3,418.	\$3,480.	\$3,536.	\$3,601.	\$3,656.	\$3,695.	\$3,759.	\$3,882.	\$3,975.						
<b>428C-CO-KP</b>		4,092.	4,153.	4,212.	4,278.	4,333.	4,369.	4,434.	4,559.	4,647.						
<b>428C-GLD-KP</b>		5,797.	5,858.	5,912.	5,974.	6,025.	6,064.	6,125.	6,242.	6,333.						
<b>428P-( )</b>		672.	697.	720.	750.	772.	786.	817.	872.	912.						
<b>428KP-( )</b>		1,066.	1,121.	1,174.	1,236.	1,283.	1,319.	1,379.	1,494.	1,577.						
<b>428C-( )-K</b>		2,262.	2,539.	2,584.	2,633.	2,683.	2,723.	2,755.	2,800.	2,901.	2,973.	3,246.	3,414.	3,755.	3,825.	3,910.
<b>428C-CO-K</b>		2,939.	3,213.	3,260.	3,305.	3,359.	3,400.	3,430.	3,478.	3,578.	3,647.	3,922.	4,086.	4,429.	4,504.	4,584.
<b>428C-GLD-K</b>		4,686.	4,952.	4,996.	5,043.	5,091.	5,129.	5,159.	5,202.	5,301.	5,370.	5,633.	5,794.	6,122.	6,189.	6,269.
<b>428K-( )</b>		384.	428.	475.	529.	567.	601.	650.	749.	820.	1,100.	1,269.	1,619.	1,688.	1,765.	

Construction	Approved KnollTextiles Grades/Fabrics	Spinneybeck Leather
<i>Base and basket:</i> Welded steel with rods in polished or satin chrome, plated in 18k gold, or highly durable bonded powder coat (white and black). Stainless steel connections. Holes pre-drilled for easy snap-in installation. 1 1/4" wide round articulated glides on barstool. Black plastic glide with metal cover. Barstool base wire diameter measures 14mm, basket edge measures 7mm and interplacements measure 5 mm.	<b>A</b> Bocce Common Ground * Commuter Cloth * Crossroad * Delite * Facet Hourglass * Infinite Mariner * Overture Presto * Soliloquy Sonnet * Trophy * Uni-Form *	<b>U</b> Vicenza Volo <b>V</b> Acqua Amalfi Andes Embossed Tipped Hand Tipped Velluto Pelle <b>W</b> Alaska Antique Derby Forte Lucente Sabrina Umbria
<i>Upholstery:</i> Cushion and back pad secured to chair with domed metal lock snaps. Seat cushions and back pads have fabric edges. Full covers are stretched over wire seat basket and attach to seat basket with hooks. Back pad is not available with leather upholstery.	<b>B</b> continued Puff * Ransom * Roam Rush Hour Summit Sutton Synth * Tabloid Topos * Vast Venue * Versa Vibe II Vinyl (L) ° Wild Thing *	<b>X</b> Ducale Ducale Velour <b>Y</b> Cervo Copenhagen Distressed Gemma Lucca Marissa Portofino Riva Torello
	<b>C</b> Atlas Axiom (L) Classic Boucle * Durand Earthwork Entourage * Entwine * Lagos Milestone Patchwork Prestini * Pullman * Quark Roundtrip Sinclair ° Smart (L) Spectator Swing * Tight Rope Tower Grid Utopia ° Wit Wow Factor *	<b>H</b> Bavaria * Catwalk * Stretch Appeal World Piece <b>I</b> Aswan Bella Byron Cato * Chic * Cummings Doily Dynamic Hastings Ita * Knoll Velvet * North Island * Prince Hair * Rutledge Stripe It ° Tudor Zimba *
	<b>D</b> Buzz Chain Link Hologram Menagerie Retreat Zoom <b>E</b> Aegean * Flower Power Highland * Ikat Stripe Kimono Marquee Nature Walk Rebel * Sherman * Tempest Tryst <b>F</b> Atelier * Calais Cotton Velvet Cornaro Double Agent Glider Homage Imprint In Stitches * (L) Liberty Mod Plaid Totem Tweed Frieze	<b>G</b> All Star * Alter Ego * Aurora * Dapper * Duchess Haze * Kamani Looped In * Melange * Modern Tweed * Rivers Straie Stripe Ultrasuede * Utrillo * Vert * <b>H</b> Bavaria * Catwalk * Stretch Appeal World Piece <b>I</b> Aswan Bella Byron Cato * Chic * Cummings Doily Dynamic Hastings Ita * Knoll Velvet * North Island * Prince Hair * Rutledge Stripe It ° Tudor Zimba *
		<b>X</b> Ducale Ducale Velour <b>Y</b> Cervo Copenhagen Distressed Gemma Lucca Marissa Portofino Riva Torello  * Approved for fully upholstered versions. (L) Fire Retardant Chemicals ° Approved for outdoor seat pads  <i>Check with your KnollTextiles or Spinneybeck Representative for changes or additions.</i>

# Harry Bertoia

## Barstools

### Bar Height Stools

	description	seat h	w	d	h	textile fabric yds.	leather sq. ft.	weight
<i>Designer(s):</i> Harry Bertoia, 1952	<b>428CU</b> Barstool, full cover, bar height	29 1/4"	21 3/4"	22"	43"	1.8	n/a	22 lbs.
		29 1/4"	21 3/4"	22"	43"	1.8	n/a	22 lbs.
		29 1/4"	21 3/4"	22"	43"	1.8	n/a	22 lbs.
<i>Award(s):</i> “Designer of the Year” 1955, USA; Certificate of Merit, American Institute of Architects	<b>428F</b> Full cover replacement					1.8	n/a	



Order Code	Ordering Information
<i>Example:</i> <b>428C-C-KP-K1021/8</b>	<i>Frame finishes:</i> Black (suffix BL) Polished Chrome (suffix C) Satin Chrome (suffix CO) 18k Gold Plated (suffix GLD) White (suffix W)
<b>428C</b> Barstool, bar height	<i>Customer's Own Material</i> is available pending approval. For approval requirements, processing instructions and ordering information, please see page 21.
<b>C</b> Polished Chrome	<i>Cal 133 Fire Code *</i> The Bertoia Barstools with seat cushion attached comply with the California Technical Bulletin 133 standard in all upholstery. Specify suffix -C at end of pattern number and suffix -133 at end of textile selection.
<b>KP</b> Back and seat pad	<i>Maintenance:</i> See pages 28-29.
<b>K1021/8</b> Ultrasuede, Poppy	<i>Note:</i> The Knoll logo is stamped into the base of the barstool.
<i>Specify:</i> 1. Pattern number 2. Finish selection 3. Upholstery option 4. Cal 133 Fire Code option 5. Textile selection	<i>Upholstery options:</i> Full cover (suffix U) Seat cushion only (suffix K) Back pad and seat cushion combination (suffix KP)
<i>For cushion replacement, specify:</i> 1. Pattern number 2. Textile selection	<i>Upholstery/COM information:</i> Prices shown include fabric or leather upholstery. Contact your Knoll representative for colors. Only approved KnollTextiles and Spinneybeck leather may be ordered.
	<i>Outdoor use:</i> With proper care and limited exposure to the elements, the 428 Bertoia Barstool is appropriate for outdoor environments. Specify outdoor powder coat. Consult a Knoll representative for appropriate upholstery options.
	For outdoor seat pad, specify O in front of textile selection: Ex. 428C-W-K-O-K24221

pattern no.	unuph. (remove suffix -K)	grades <b>A</b>	COM <b>B</b>	<b>C</b>	<b>D</b>	<b>E</b>	<b>F</b>	<b>G</b>	<b>H</b>	<b>I</b>	COL <b>U</b>	<b>V</b>	<b>W</b>	<b>X</b>	<b>Y</b>
<b>428C-( )-U</b>		\$3,066.	\$3,169.	\$3,267.	\$3,380.	\$3,464.	\$3,534.	\$3,641.	\$3,846.	\$4,004.					
<b>428C-CO-U</b>		3,714.	3,817.	3,916.	4,024.	4,117.	4,181.	4,286.	4,495.	4,647.					
<b>428C-GLD-U</b>		5,458.	5,558.	5,652.	5,760.	5,843.	5,910.	6,012.	6,208.	6,360.					
<b>428F-( )</b>		1,006.	1,115.	1,214.	1,331.	1,429.	1,496.	1,604.	1,833.	1,992.					

Construction	Approved KnollTextiles Grades/Fabrics	Spinneybeck Leather
<i>Base and basket:</i> Welded steel with rods in polished or satin chrome, plated in 18k gold, or highly durable bonded powder coat (white and black). Stainless steel connections. Holes pre-drilled for easy snap-in installation. 1 1/2" wide round articulated glides on barstool. Black plastic glide with metal cover. Barstool base wire diameter measures 14mm, basket edge measures 7mm and interlacements measure 5 mm.	<b>A</b> Bocce Common Ground * Commuter Cloth * Crossroad * Delite * Hourglass * Infinite Mariner * Overture Presto * Soliloquy Sonnet * Trophy * Uni-Form *	<b>U</b> Vicenza Volo
<i>Upholstery:</i> Cushion and back pad secured to chair with domed metal lock snaps. Seat cushions and back pads have fabric edges. Full covers are stretched over wire seat basket and attach to seat basket with hooks. Back pad is not available with leather upholstery.	<b>B</b> Abacus Attire * Belize ° Bistro Calypso Chronicle Day Tripper * Diva * Dottie Ferry * Forza ™ Grande Grandview Holbrook Instinct Journey * Keaton * Knoll Felt * Knoll Hopsack * Little Devil * Petal Pusher * ™ Prairie ° Prim Puff *	<b>X</b> Ducale Ducale Velour
	<b>C</b> Atlas Axiom ™ Classic Boucle * Durand Earthwork Entourage * Entwine * Lagos Milestone Patchwork Prestini * Pullman * Quark Roundtrip Sinclair ° Smart ™ Spectator Swing * Tight Rope Tower Grid Utopia ° Wit Wow Factor *	<b>V</b> Acqua Amalfi Andes Embossed Tipped Hand Tipped Velluto Pelle
	<b>D</b> Buzz Chain Link Hologram Menagerie Retreat Zoom	<b>W</b> Alaska Antique Derby Forte Lucente Sabrina Umbria
	<b>E</b> Aegean * Flower Power Highland * Ikat Stripe Kimono Marquee Nature Walk Rebel * Sherman * Tempest Tryst	<b>Y</b> Cervo Copenhagen Distressed Gemma Lucca Marissa Portofino Riva Torello
	<b>F</b> Atelier * Calais Cotton Velvet Cornaro Double Agent Glider Homage Imprint In Stitches * ™ Liberty Mod Plaid Totem Tweed Frieze	<b>H</b> Bavaria * Catwalk * Stretch Appeal World Piece
	<b>G</b> All Star * Alter Ego * Aurora * Dapper * Duchess Haze * Kamani Looped In * Melange * Modern Tweed * Rivers Straie Stripe Ultrasuede * Utrillo * Vert *	<b>I</b> Aswan Bella Byron Cato * Chic * Cummings Doily Dynamic Hastings Ita * Knoll Velvet * North Island * Prince Hairy * Rutledge Stripe It ° Tudor Zimba *
		* Approved for fully upholstered versions. ™ Fire Retardant Chemicals ° Approved for outdoor seat pads
		<i>Check with your KnollTextiles or Spinneybeck Representative for changes or additions.</i>

# Harry Bertoia

## Barstools

### Counter Height Stools

	description	seat h	w	d	h	textile fabric yds.	req. leather sq. ft.	weight
<i>Designer(s):</i> Harry Bertoia, 1952	<b>426C</b> Barstool, seat cushion or unupholstered, counter height	25"	21 3/4"	22"	38 1/2"	0.8	14	20 lbs.
		25"	21 3/4"	22"	38 1/2"	0.8	14	20 lbs.
		25"	21 3/4"	22"	38 1/2"	0.8	14	20 lbs.
<i>Award(s):</i> “Designer of the Year” 1955, USA; Certificate of Merit, American Institute of Architects	<b>426C-KP</b> Barstool, back pad and seat cushion, counter height	25"	21 3/4"	22"	38 1/2"	1.5	n/a	20 lbs.
		25"	21 3/4"	22"	38 1/2"	1.5	n/a	20 lbs.
		25"	21 3/4"	22"	38 1/2"	1.5	n/a	20 lbs.
	<b>427K</b> Seat cushion replacement					0.8	14	
	<b>427KP</b> Back pad and seat cushion replacement					1.5	n/a	
	<b>427P</b> Back pad replacement					0.7	n/a	

pattern no.	unuph. (remove suffix -K)	grades <b>A</b>	COM <b>B</b>	<b>C</b>	<b>D</b>	<b>E</b>	<b>F</b>	<b>G</b>	<b>H</b>	<b>I</b>	COL <b>U</b>	<b>V</b>	<b>W</b>	<b>X</b>	<b>Y</b>
<b>426C-( )-K</b>	\$2,262.	\$2,539.	\$2,584.	\$2,633.	\$2,683.	\$2,723.	\$2,755.	\$2,800.	\$2,901.	\$2,973.	\$3,246.	\$3,414.	\$3,755.	\$3,825.	\$3,910.
<b>426C-CO-K</b>	2,939.	3,213.	3,260.	3,305.	3,359.	3,400.	3,430.	3,478.	3,578.	3,647.	3,922.	4,086.	4,429.	4,504.	4,584.
<b>426C-GLD-K</b>	4,686.	4,952.	4,996.	5,043.	5,091.	5,129.	5,159.	5,202.	5,301.	5,370.	5,633.	5,794.	6,122.	6,189.	6,269.

<b>426C-( )-KP</b>	3,418.	3,480.	3,536.	3,601.	3,656.	3,695.	3,759.	3,882.	3,975.						
<b>426C-CO-KP</b>	4,092.	4,153.	4,212.	4,278.	4,333.	4,369.	4,434.	4,559.	4,647.						
<b>426C-GLD-KP</b>	5,797.	5,858.	5,912.	5,974.	6,025.	6,064.	6,125.	6,242.	6,333.						

<b>427K-( )</b>	384.	428.	475.	529.	567.	601.	650.	749.	820.	1,100.	1,269.	1,619.	1,688.	1,765.
<b>427KP-( )</b>	1,066.	1,121.	1,174.	1,236.	1,283.	1,319.	1,379.	1,494.	1,577.					
<b>427P-( )</b>	672.	697.	720.	750.	772.	786.	817.	872.	912.					

Order Code	Ordering Information		
<i>Example:</i> <b>426C-C-U-K1207/2</b>	<i>Frame finishes:</i> Black (suffix BL) Polished Chrome (suffix C) Satin Chrome (suffix CO) 18k Gold Plated (suffix GLD) White (suffix W)	Customer's Own Material is available pending approval for approval requirements, processing instructions and ordering information please see page 21.	<i>Cal 133 Fire Code # :</i> The Bertoia Barstools with seat cushion attached comply with the California Technical Bulletin 133 standard in all upholstery. Specify suffix -C at end of pattern number and suffix -133 at end of textile selection.
<b>426C</b> Barstool, counter height			
<b>C</b> Polished Chrome			
<b>U</b> Fully upholstered			
<b>K1207/2</b> Knoll Felt, Tan			
<i>Specify:</i>	<i>Upholstery options:</i> Full cover (suffix U) Seat cushion only (suffix K) Back pad and seat cushion combination (suffix KP)	<i>Note:</i> <b>In 2021, counter stool seat height has changed from 27.5" to 25" to align with industry standards. Please note the change in pattern number from the original 427C to the new 426C.</b>	<i>Maintenance:</i> See pages 28-29.
1. Pattern number			
2. Finish selection			
3. Upholstery option			
4. Cal 133 Fire Code option			
5. Textile selection			
<i>For cushion replacement, specify:</i>	<i>Upholstery/COM information:</i> Prices shown include fabric or leather upholstery. Contact your Knoll representative for colors. Only approved KnollTextiles and Spinneybeck leathers may be ordered.		<i>Note:</i> The Knoll logo is stamped into the base of the barstool.
1. Pattern number			
2. Textile selection			
	<i>Outdoor use:</i> With proper care and limited exposure to the elements, the 426 Bertoia Barstool is appropriate for outdoor environments. Specify outdoor powder coat. Consult a Knoll representative for appropriate upholstery options.		The Bertoia Counter Height stool is certified Clean Air GOLD.
	For outdoor seat pad, specify O in front of textile selection: Ex. 426C-W-K- <b>O</b> -K24221		

Construction	Approved KnollTextiles Grades/Fabrics	Spinneybeck Leather
<i>Base and basket:</i> Welded steel with rods in polished or satin chrome, plated 18k gold, or highly durable bonded powder coat (white and black). Stainless steel connections. Holes pre-drilled for easy snap-in installation. 1 1/4" wide round articulated glides on barstool. Black plastic glide with metal cover. Barstool base wire diameter measures 14mm, basket edge measures 7mm and interlacements measure 5 mm.	<b>A</b> Bocce Common Ground * Commuter Cloth * Crossroad * Delite * Facet Hourglass * Infinite Mariner * Overture Presto * Soliloquy Sonnet * Trophy * Uni-Form *  <b>B</b> continued Ransom * Roam Rush Hour Summit Sutton Synth * Tabloid Topos * Vast Venue * Versa Vibe II Vinyl <sup>Ⓞ</sup> Wild Thing *  <b>C</b> Atlas Axiom <sup>Ⓞ</sup> Classic Boucle * Durand Earthwork Entourage * Entwine * Lagos Milestone Patchwork Prestini * Pullman * Quark Roundtrip Sinclair <sup>Ⓞ</sup> Smart <sup>Ⓞ</sup> Spectator Swing * Tight Rope Tower Grid Utopia <sup>Ⓞ</sup> Wit Wow Factor *	<b>D</b> Buzz Chain Link Hologram Menagerie Retreat Zoom  <b>E</b> Aegean * Flower Power Highland * Ikat Stripe Kimono Marquee Nature Walk Rebel * Sherman * Tempest Tryst  <b>F</b> Atelier * Calais Cotton Velvet Cornaro Double Agent Glider Homage Imprint In Stitches * <sup>Ⓞ</sup> Liberty Mod Plaid Totem Tweed Frieze  <b>G</b> All Star * Alter Ego * Aurora * Dapper * Duchess Haze * Kamani Looped In * Melange * Modern Tweed * Rivers Straie Stripe Ultrasuede * Utrillo * Vert *  <b>H</b> Bavaria * Catwalk * Stretch Appeal World Piece  <b>I</b> Aswan Bella Byron Cato * Chic * Cummings Doily Dynamic Hastings Ita * Knoll Velvet * North Island * Prince Hair * Rutledge Stripe It <sup>Ⓞ</sup> Tudor Zimba *  <b>U</b> Vicenza Volo  <b>V</b> Acqua Amalfi Andes Embossed Tipped Hand Tipped Velluto Pelle  <b>W</b> Alaska Antique Derby Forte Lucente Sabrina Umbria  <b>X</b> Ducale Ducale Velour  <b>Y</b> Cervo Copenhagen Distressed Gemma Lucca Marissa Portofino Riva Torello
<i>Upholstery:</i> Cushion and back pad secured to chair with domed metal lock snaps. Seat cushions and back pads have fabric edges. Full covers are stretched over wire seat basket and attach to seat basket with hooks. Back pad is not available with leather upholstery.		* Approved for fully upholstered versions. <sup>Ⓞ</sup> Fire Retardant Chemicals <sup>Ⓞ</sup> Approved for outdoor seat pad  <i>Check with your KnollTextiles or Spinneybeck Representative for changes or additions.</i>



# Harry Bertoia

## Barstools

### Counter Height Stools

	description	seat h	w	d	h	textile fabric yds.	leather sq. ft.	weight	
<i>Designer(s):</i> Harry Bertoia, 1952	<b>426CU</b> Barstool, full cover, counter height	25"	21 3/4"	22"	38 1/2"	1.8	n/a	20 lbs.	
		25"	21 3/4"	22"	38 1/2"	1.8	n/a	20 lbs.	
		25"	21 3/4"	22"	38 1/2"	1.8	n/a	20 lbs.	
<i>Award(s):</i> “Designer of the Year” 1955, USA; Certificate of Merit, American Institute of Architects	<b>427F</b> Full cover replacement							1.8	n/a



pattern no.	unuph. (remove suffix -K)	grades <b>A</b>	COM <b>B</b>	<b>C</b>	<b>D</b>	<b>E</b>	<b>F</b>	<b>G</b>	<b>H</b>	<b>I</b>	COL <b>U</b>	<b>V</b>	<b>W</b>	<b>X</b>	<b>Y</b>
<b>426C-( )-U</b>		\$3,066.	\$3,169.	\$3,267.	\$3,380.	\$3,464.	\$3,534.	\$3,641.	\$3,846.	\$4,004.					
<b>426C-CO-U</b>		3,714.	3,817.	3,916.	4,024.	4,117.	4,181.	4,286.	4,495.	4,647.					
<b>426C-GLD-U</b>		5,458.	5,558.	5,652.	5,760.	5,843.	5,910.	6,012.	6,208.	6,360.					
<b>427F-( )</b>		1,006.	1,115.	1,214.	1,331.	1,429.	1,496.	1,604.	1,833.	1,992.					

Order Code	Ordering Information
<i>Example:</i> <b>426C-C-U-K1207/2</b>	<i>Frame finishes:</i>
<b>426C</b> Barstool, counter height	Black (suffix BL)
<b>C</b> Polished Chrome	Polished Chrome (suffix C)
<b>U</b> Fully upholstered	Satin Chrome (suffix CO)
<b>K1207/2</b> Knoll Felt, Tan	18k Gold Plated (suffix GLD)
	White (suffix W)
<i>Specify:</i>	<i>Upholstery options:</i>
1. Pattern number	Full cover (suffix U)
2. Finish selection	Seat cushion only (suffix K)
3. Upholstery option	Back pad and seat cushion combination (suffix KP)
4. Cal 133 Fire Code option	
5. Textile selection	
<i>For cushion replacement, specify:</i>	<i>Upholstery/COM information:</i>
1. Pattern number	Prices shown include fabric or leather upholstery. Contact your Knoll representative for colors. Only approved KnollTextiles and Spinneybeck leathers may be ordered.
2. Textile selection	
	<i>Outdoor use:</i>
	With proper care and limited exposure to the elements, the 426 Bertoia Barstool is appropriate for outdoor environments. Specify outdoor powder coat. Consult a Knoll representative for appropriate upholstery options.
	For outdoor seat pad, specify O in front of textile selection: Ex. 426C-W-K-O-K24221
	<i>Customer's Own Material is available pending approval for approval requirements, processing instructions and ordering information please see page 21.</i>
	<i>Note:</i> <b>In 2021, counter stool seat height has changed from 27.5" to 25" to align with industry standards. Please note the change in pattern number from the original 427C to the new 426C.</b>
	<i>Cal 133 Fire Code * :</i> The Bertoia Barstools with seat cushion attached comply with the California Technical Bulletin 133 standard in all upholstery. Specify suffix -C at end of pattern number and suffix -133 at end of textile selection.
	<i>Maintenance:</i> See pages 28-29.
	<i>Note:</i> The Knoll logo is stamped into the base of the barstool.
	The Bertoia Counter Height stool is certified Clean Air GOLD.



Construction	Approved KnollTextiles Grades/Fabrics	Spinneybeck Leather
<i>Base and basket:</i> Welded steel with rods in polished or satin chrome, plated 18k gold, or highly durable bonded powder coat (white and black). Stainless steel connections. Holes pre-drilled for easy snap-in installation. 1 1/4" wide round articulated glides on barstool. Black plastic glide with metal cover. Barstool base wire diameter measures 14mm, basket edge measures 7mm and interlacements measure 5 mm.	<b>A</b> Bocce Common Ground * Commuter Cloth * Crossroad * Delite * Facet Hourglass * Infinite Mariner * Overture Presto * Soliloquy Sonnet * Trophy * Uni-Form *  <b>B</b> continued Ransom * Roam Rush Hour Summit Sutton Synth * Tabloid Topos * Vast Venue * Versa Vibe II Vinyl <sup>Ⓞ</sup> Wild Thing *  <b>C</b> Atlas Axiom <sup>Ⓞ</sup> Classic Boucle * Durand Earthwork Entourage * Entwine * Lagos Milestone Patchwork Prestini * Pullman * Quark Roundtrip Sinclair <sup>Ⓞ</sup> Smart <sup>Ⓞ</sup> Spectator Swing * Tight Rope Tower Grid Utopia <sup>Ⓞ</sup> Wit Wow Factor *	<b>U</b> Vicenza Volo  <b>V</b> Acqua Amalfi Andes Embossed Tipped Hand Tipped Velluto Pelle  <b>W</b> Alaska Antique Derby Forte Lucente Sabrina Umbria  <b>X</b> Ducale Ducale Velour  <b>Y</b> Cervo Copenhagen Distressed Gemma Lucca Marissa Portofino Riva Torello
<i>Upholstery:</i> Cushion and back pad secured to chair with domed metal lock snaps. Seat cushions and back pads have fabric edges. Full covers are stretched over wire seat basket and attach to seat basket with hooks. Back pad is not available with leather upholstery.	<b>D</b> Buzz Chain Link Hologram Menagerie Retreat Zoom  <b>E</b> Aegean * Flower Power Highland * Ikat Stripe Kimono Marquee Nature Walk Rebel * Sherman * Tempest Tryst  <b>F</b> Atelier * Calais Cotton Velvet Cornaro Double Agent Glider Homage Imprint In Stitches * <sup>Ⓞ</sup> Liberty Mod Plaid Totem Tweed Frieze	<b>G</b> All Star * Alter Ego * Aurora * Dapper * Duchess Haze * Kamani Looped In * Melange * Modern Tweed * Rivers Straie Stripe Ultrasuede * Utrillo * Vert *  <b>H</b> Bavaria * Catwalk * Stretch Appeal World Piece  <b>I</b> Aswan Bella Byron Cato * Chic * Cummings Doily Dynamic Hastings Ita * Knoll Velvet * North Island * Prince Hair * Rutledge Stripe It <sup>Ⓞ</sup> Tudor Zimba *
		* Approved for fully upholstered versions. <sup>Ⓞ</sup> Fire Retardant Chemicals <sup>Ⓞ</sup> Approved for outdoor seat pad  <i>Check with your KnollTextiles or Spinneybeck Representative for changes or additions.</i>

# Harry Bertoia

## Bertoia Leather-Covered Side Chair and Barstool

Designer(s):  
Harry Bertoia, 1960



description	seat h	w	d	h	weight	base finish
<b>420L</b> Leather-Covered Side Chair 	17 3/4"	21 3/4"	19 3/4"	28 3/4"	26 lbs.	Painted
	17 3/4"	21 3/4"	19 3/4"	28 3/4"	26 lbs.	Polished chrome
<b>428L</b> Leather-Covered Barstool, bar height 	29 1/4"	21 3/4"	22"	43"	33 lbs.	Painted
	29 1/4"	21 3/4"	22"	43"	33 lbs.	Polished chrome
<b>426L</b> Leather-Covered Barstool, counter height 	25"	21 3/4"	22"	38 1/2"	33 lbs.	Painted
	25"	21 3/4"	22"	38 1/2"	33 lbs.	Polished chrome







pattern no.	list
<b>420L-( )-(W,BL)</b>	\$2,911.
<b>420L-( )-C</b>	2,938.
<b>428L-( )-(W,BL)</b>	3,418.
<b>428L-( )-C</b>	3,443.
<b>426L-( )-(W,BL)</b>	3,418.
<b>426L-( )-C</b>	3,443.

Order Code	Ordering Information	Construction
<i>Example:</i> <b>420L-NAT-C</b>	<i>Leather finishes:</i> Black (suffix BL) Dark Brown (suffix DB) Natural (suffix NAT)	<i>Base:</i> Welded steel rods in polished chrome or highly durable bonded powder coat (white and black). <i>Side Chairs:</i> diameter of the base rods are 11mm featuring stainless steel connections and plastic glides. <i>Bar and Counter Height Stools:</i> diameter of the base rods are 14mm featuring stainless steel connections and 1 1/4" wide round articulated glides with metal cover.
<b>420L</b> Leather-covered side chair	<i>Base finishes:</i> Polished Chrome (suffix C) Black (suffix BL) White (suffix W)	<i>Basket:</i> Glass fiber reinforced shell. The plastic shells are completely upholstered in Italian leather, with a 1/2" flange and exposed running stitch detail along the outside edge of the shell. The stitching matches the color of the leather.
<b>WH</b> Natural		<b>Note: Bertoia Leather-Covered Chairs and Stools are not appropriate for outdoor use.</b>
<b>C</b> Polished chrome base		

- Specify:
1. Pattern number
  2. Leather finish
  3. Base finish

# Harry Bertoia

## Indoor/Outdoor Bertoia Molded Shell Side Chair and Barstool

	description	seat h	w	d	h	weight	base finish
<b>Designer(s):</b> Harry Bertoia, 1960      	<b>420PL</b> Molded Shell Side chair  	17 3/4"	21 3/4"	19 3/4"	28 3/4"	14 lbs.	Painted, Outdoor
		17 3/4"	21 3/4"	19 3/4"	28 3/4"	14 lbs.	Polished chrome, Indoor
	<b>426PL</b> Molded Shell Barstool, counter height  	25	21 3/4"	22"	38 1/2"	22 lbs.	Painted, Outdoor
		25	21 3/4"	22"	38 1/2"	22 lbs.	Polished chrome, Indoor
	<b>428PL</b> Molded Shell Barstool, bar height  	29 1/4"	21 3/4"	22"	43"	23 lbs.	Painted, Outdoor
		29 1/4"	21 3/4"	22"	43"	23 lbs.	Polished chrome, Indoor
	<b>420PLS</b> Molded Shell Side chair, stacking base  	18 1/4"	22"	21 3/4"	30 1/2"	14 lbs.	Painted, Indoor
		18 1/4"	22"	21 3/4"	30 1/2"	14 lbs.	Polished chrome, Indoor

pattern no.	list
<b>420PL-( )-( BL, W)</b>	\$627.
<b>420PL-(BL, OR, MG, YE)-C</b>	652.
<b>426PL-( )-(BL, W)</b>	1,038.
<b>426PL-(BL, OR, MG, YE)-C</b>	1,062.
<b>428PL-( )-(BL, W)</b>	1,038.
<b>428PL-(BL, OR, MG, YE)-C</b>	1,062.
<b>420PLS-(BL, OR, MG, YE)-(BL, W)</b>	798.
<b>420PLS-(BL, OR, MG, YE)-C</b>	821.

Order Code	Ordering Information	Construction
<b>Example: 420PL-BL-BL</b> <b>420PL</b> Molded Shell side chair <b>BL</b> Black shell <b>BL</b> Blackbase	<b>Molded Shell finishes:</b> Black (suffix BL) Blue (suffix BU) Medium Grey (suffix MG) Orange Red (suffix OR) White (suffix WH) Yellow (suffix YE)  <b>Base finishes:</b> Black (suffix BL) White (suffix W) Polished Chrome (suffix C) *  *Polished Chrome NOT suitable for outdoor use  <b>Note:</b> In 2021, counter stool seat height has changed from 27.5" to 25" to align with industry standards. Please note the change in pattern number from the original 427N to the new 426PL.	<b>Base:</b> Welded steel rods in polished chrome or highly durable bonded powder coat (white and black). <b>Side Chairs:</b> diameter of the base rods are 11mm featuring stainless steel connections and plastic glides. <b>Stacking Side Chairs:</b> diameter of legs are 16mm featuring four rubber bumpers to assure proper stacking. <b>NOT FOR OUTDOOR USE.</b> <b>Bar and Counter Height Stools:</b> diameter of the base rods are 14mm featuring stainless steel connections and 1 1/4" wide round articulated glides with metal cover.  <b>Basket:</b> Polypropylene shell.

- Specify:**
1. Pattern number
  2. Molded Shell finish
  3. Base finish

# Harry Bertoia

## *Bertoia Dolly for stacking chairs and Ganging Mechanism*

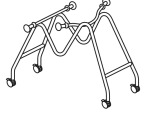
	description	seat h	w	d	h	weight	base finish
<p><i>Designer(s):</i> Harry Bertoia, 1960</p> 	<p><b>420NSDOLLY</b> Dolly for chair</p> 		24 3/4"	45"	28 3/4"		
	<p><b>87GA</b> Ganging mechanism</p>						

pattern no.	list
<b>420NSDOLLY</b>	\$906.
<b>87GA</b>	53.

Order Code	Ordering Information	Construction
<p><i>Example:</i> <b>420N-WH-C</b></p> <p><b>420N</b> Molded Shell side chair</p> <p><b>WH</b> White shell</p> <p><b>C</b> Polished chrome base</p>	<p><i>Molded Shell finishes:</i> White (suffix WH) Blue (suffix BU)</p> <p><i>Note:</i>For Black, Orange Red, Yellow or Medium Grey shells, see Indoor/Outdoor Bertoia Molded Shell Page.</p> <p><i>Base finishes:</i> Polished Chrome (suffix C)</p> <p><b>Note:</b> In 2021, counter stool seat height has changed from 27.5" to 25" to align with industry standards. Please note the change in pattern number from the original 427N to the new 426N.</p>	<p><i>Base:</i> Welded steel rods in polished chrome or highly durable bonded powder coat (white and black).</p> <p><i>Side Chairs:</i> diameter of the base rods are 11mm featuring stainless steel connections and plastic glides.</p> <p><i>Stacking Side Chairs:</i> diameter of legs are 16mm featuring four rubber bumpers to assure proper stacking.</p> <p><i>Bar and Counter Height Stools:</i> diameter of the base rods are 14mm featuring stainless steel connections and 1 1/4" wide round articulated glides with metal cover.</p> <p><i>Basket:</i> Glass fiber reinforced nylon shell.</p>

*Specify:*

1. Pattern number
2. Molded Shell finish
3. Base finish

*Transportation Dolly:*







Black painted steel frame with plastic wheels and locking casters. 12 Bertoia Molded Stacking chairs can be stacked on the dolly. Dollies can stack three high for compact storage. Dolly with 12 chairs will measure 56.25" h, 24.75" w, 45.5" d.

*Stacking bumper:*  
Clear thermoplastic elastomer bumper secured between base and shell.

*Ganging mechanism:*  
The easy-to-detach ganging mechanism links two adjoining frames at the front legs or rear legs. Ganging mechanism consists of black molded polypropylene. Chairs with ganging mechanism can be stacked.



# Harry Bertoia

## Diamond™ Lounge Seating

	description	seat h	w	d	h	textile fabric yds.	req. leather sq. ft.	weight	
<i>Designer(s):</i> Harry Bertoia, 1952	<b>421L</b> Diamond chair, seat cushion with glides 	16 1/2"	33 1/2"	28 1/4"	30"	0.7	14	16 lbs.	
		16 1/2"	33 1/2"	28 1/4"	30"	0.7	14	16 lbs.	
		16 1/2"	33 1/2"	28 1/4"	30"	0.7	14	16 lbs.	
<i>Award(s):</i> “Designer of the Year” 1955, USA; Certificate of Merit, American Institute of Architects	<b>421K</b> Seat cushion replacement 					0.7	14		
		<b>421LU</b> Diamond chair, full cover with glides 	16 1/2"	33 1/2"	28 1/4"	30"	3.0	n/a	16 lbs.
		16 1/2"	33 1/2"	28 1/4"	30"	3.0	n/a	16 lbs.	
	<b>421F</b> Full cover replacement 					3.0	n/a		
		<b>422LU</b> Large diamond chair, full cover with glides 	15 1/4"	45"	31 1/2"	28 1/4"	3.8	n/a	24 lbs.
		15 1/4"	45"	31 1/2"	28 1/4"	3.8	n/a	24 lbs.	
	<b>422F</b> Full cover replacement					3.8	n/a		

pattern no.	grades <b>A</b>	COM <b>B</b>	<b>C</b>	<b>D</b>	<b>E</b>	<b>F</b>	<b>G</b>	<b>H</b>	<b>I</b>	COL <b>U</b>	<b>V</b>	<b>W</b>	<b>X</b>	<b>Y</b>
<b>421L-( )-K</b>	\$2,512.	\$2,570.	\$2,622.	\$2,675.	\$2,719.	\$2,754.	\$2,812.	\$2,916.	\$2,992.	\$3,543.	\$3,753.	\$4,185.	\$4,276.	\$4,381.
<b>421L-GLD-K</b>	4,182.	4,203.	4,228.	4,254.	4,292.	4,318.	4,354.	4,381.	4,459.	6,207.	6,289.	6,457.	6,490.	6,530.
<b>421LCO-K</b>	3,055.	3,110.	3,165.	3,216.	3,261.	3,296.	3,355.	3,457.	3,532.	4,084.	4,298.	4,731.	4,816.	4,924.
<b>421K-( )</b>	635.	684.	731.	780.	820.	853.	897.	993.	1,065.	1,561.	1,756.	2,141.	2,220.	2,316.
<b>421L-( )-U</b>	3,968.	4,199.	4,402.	4,626.	4,811.	4,949.	5,175.	5,612.	5,931.					
<b>421L-GLD-U</b>	5,574.	5,795.	5,989.	6,206.	6,383.	6,515.	6,734.	7,154.	7,461.					
<b>421LCO-U</b>	4,487.	4,715.	4,917.	5,146.	5,333.	5,465.	5,690.	6,131.	6,450.					
<b>421F-( )</b>	1,553.	1,752.	1,934.	2,139.	2,302.	2,420.	2,630.	3,013.	3,298.					
<b>422L-(C,1,2)-U</b>	5,300.	5,541.	5,755.	6,002.	6,194.	6,342.	6,588.	7,051.	7,390.					
<b>422L-GLD-U</b>	10,117.	10,349.	10,555.	10,793.	10,977.	11,120.	11,358.	11,801.	12,128.					
<b>422F-( )</b>	1,608.	1,813.	2,005.	2,217.	2,389.	2,512.	2,723.	3,129.	3,426.					



Order Code	Ordering Information
<i>Example:</i> <b>421L-CO-U-K231/1</b>	<i>Frame finishes (421L,LU):</i> Black (suffix BL) Polished Chrome (suffix C) Satin Chrome (suffix CO) White (suffix W) 18k Gold Plated (suffix GLD)
<b>421L</b> Diamond chair	
<b>CO</b> Satin Chrome	
<b>U</b> Fully upholstered	
<b>K231/1</b> Cuddle Cloth, Neutral	
<i>Specify:</i> 1. Pattern number 2. Finish selection 3. Upholstery option 4. Cal 133 Fire Code Option 5. Textile selection	<i>Frame finishes (421LS):</i> Black (suffix BL) Polished Chrome (suffix C) Satin Chrome (suffix CO) White (suffix W) 18k Gold Plated (suffix GLD)
<i>For cushion replacement, specify:</i> 1. Pattern number 2. Textile selection	<i>Frame finishes (422LU):</i> Black (suffix L) Polished Chrome (suffix C) 18k Gold Plated (suffix GLD) White (suffix W)
	<i>Upholstery options:</i> Full cover (suffix U) Seat cushion only (suffix K)
	Upholstery/COM information: Prices shown include fabric or leather upholstery. Contact your Knoll representative for colors. Only approved KnollTextiles and Spinneybeck leathers may be ordered.
	Customer's Own Material is available pending approval. For approval requirements, processing instructions and ordering information please see page 21.
	<i>Outdoor use:</i> With proper care and limited exposure to the elements, the 421 Bertoia Diamond Chair is appropriate for outdoor environments. Specify powder coat finish. Consult a Knoll representative for appropriate upholstery options.
	Cal 133 Fire Code <b>A</b> : Bertoia 421 chair with seat pad attached complies with the California Technical Bulletin 133 standard in <i>all</i> upholstery. Specify suffix -C at end of pattern number. <i>Maintenance:</i> See pages 28-29.
	<i>Note:</i> The Knoll logo is stamped into the base of the chair.
	The Bertoia Diamond Lounge Seating is certified Clean Air GOLD.
	For outdoor seat pad, specify O in front of textile selection: Ex. 421L-W-K-O-K24221

Construction	Approved KnollTextiles Grades/Fabrics	Spinneybeck Leather
<i>Frame:</i> Welded steel with rods in polished or satin (421L only) chrome finish, powder coat (white and black), or plated in 18k gold. Stainless steel connections. Four plastic glides. On all Diamond chairs, the base wire diameter measures 11mm. The frame edge wire diameter measures 4.5mm, the interlacings measure 4mm in diameter.	<b>A</b> Common Ground Crossroad Delite Facet Hourglass Mariner Presto Sonnet Trophy Uni-Form	<b>U</b> Vicenza * Volo * <b>V</b> Acqua * Amalfi Andes * Embossed Tipped * Hand Tipped * Velluto Pelle * <b>W</b> Alaska * Antique * Derby * Forte *
<i>Upholstery:</i> Cushion secured to chair with lock-snaps. Full covers are stretched over wire frame and attach to seat basket with hooks. Cushions and covers fit all Bertoia Diamond Chairs manufactured since 1952 within a limited range of tolerance.	<b>B</b> continued Knoll Felt Knoll Hopsack Little Devil Prairie * Ransom * Synth Vast * Venue Vinyl  * <b>C</b> Classic Boucle Entourage Entwine Prestini Pullman Quark * Ferry Forza  * Grande * Journey Keaton	<b>W</b> continued Lucente * Sabrina * Umbria * <b>X</b> Ducale * Ducale Velour * <b>Y</b> Cervo * Copenhagen * Distressed * Gemma * Lucca * Marissa * Portofino * Riva * Rugata * Saddle * Torello *
422L is not available with seat pad option.	<b>D</b> Buzz Chain Link * Hologram * Retreat * Zoom *	<b>E</b> Aegean Flower Power * Highland Marquee * Rebel Sherman Tempest <b>F</b> Atelier Calais Cotton Velvet * Cornaro Imprint In Stitches Totem * Tweed Frieze * <b>G</b> All Star Alter Ego Dapper Duchess Haze
	<b>E</b> continued Looped In Melange Modern Tweed Ultrasuede Utrillo * Vert <b>H</b> Bavaria Catwalk * Stretch Appeal <b>I</b> Bella Cato Chic Dynamic Ita Knoll Velvet North Island Prince Hair Stripe It * Zimba	* Available on 421K and 421KS seat cushion only.  Fire Retardant Chemicals ° Approved for outdoor seat pad

Check with your KnollTextiles or Spinneybeck Representative for changes or additions.

# Harry Bertoia

## Two-Tone Diamond™ Chair

	description	seat h	w	d	h	textile fabric yds.	req. leather sq. ft.	weight
<i>Designer(s):</i> Harry Bertoia, 1952	<b>421LT-U</b> Two-Tone Diamond chair, full cover with glides	16 1/2"	33 1/2"	28 3/4"	30"	3.0	n/a	16 lbs.
<i>Award(s):</i> "Designer of the Year" 1955, USA; Certificate of Merit, American Institute of Architects								
	<b>421LT-K</b> Two-Tone Diamond chair, seat cushion with glides	16 1/2"	33 1/2"	28 3/4"	30"	0.7	14	16 lbs.
								
	<b>421F</b> Full cover replacement					3.0	n/a	
	<b>421K</b> Seat cushion replacement					0.7	14	

pattern no.	grades <b>A</b>	COM <b>B</b>	<b>C</b>	<b>D</b>	<b>E</b>	<b>F</b>	<b>G</b>	<b>H</b>	<b>I</b>	COL <b>U</b>	<b>V</b>	<b>W</b>	<b>X</b>	<b>Y</b>
<b>421LT-U-(-)-(-)</b>	\$3,968.	\$4,199.	\$4,402.	\$4,626.	\$4,811.	\$4,949.	\$5,175.	\$5,612.	\$5,931.					

<b>421LT-K-(-)-(-)</b>	2,512.	2,570.	2,622.	2,675.	2,719.	2,754.	2,812.	2,916.	2,992.	3,543.	3,753.	4,185.	4,276.	4,381.
------------------------	--------	--------	--------	--------	--------	--------	--------	--------	--------	--------	--------	--------	--------	--------

<b>421F-(-)</b>	1,553.	1,752.	1,934.	2,139.	2,302.	2,420.	2,630.	3,013.	3,298.					
<b>421K-(-)</b>	635.	684.	731.	780.	820.	853.	897.	993.	1,065.	1,561.	1,756.	2,141.	2,220.	2,316.

Order Code	Ordering Information
<i>Example:</i> <b>421LT-K-RD-BL-H800/19</b>	<i>Frame finishes:</i> Polished Chrome (suffix C) Black (suffix BL) Blue (suffix BU) Orange Red (suffix RD) White (suffix W)
<b>421LT-K</b> Two-Tone Diamond chair, seat pad	<i>Cal 133 Fire Code # :</i> Bertoia 421 chair with seat pad attached complies with the California Technical Bulletin 133 standard in <i>all</i> upholstery. Specify suffix -C at end of pattern number.
<b>RD</b> Orange Red basket	<i>Maintenance:</i> See pages 28-29.
<b>BL</b> Black base	<i>Note:</i> The Knoll logo is stamped into the base of the chair.
<b>H800/19</b> Cato, Fire Red	<i>The Bertoia Diamond Lounge Seating is certified Clean Air GOLD.</i>
	<i>Upholstery options:</i> Full cover (suffix U) Seat cushion only (suffix K)
<i>Specify:</i> 1. Pattern number 2. Basket finish selection 3. Base finish selection 4. Textile selection	<i>Upholstery/COM information:</i> Prices shown include fabric or leather upholstery. Contact your Knoll representative for colors. Only approved KnollTextiles and Spinneybeck leathers may be ordered.
<i>For cushion replacement, specify:</i> 1. Pattern number 2. Textile selection	Customer's Own Material is available pending approval. For approval requirements, processing instructions and ordering information please see page 21.

Construction	Approved KnollTextiles Grades/Fabrics	Spinneybeck Leather
<i>Frame:</i> Welded steel with rods in polished chrome finish and powder coat. Stainless steel connections. Four plastic glides. On all Diamond chairs, the base wire diameter measures 11mm. The frame edge wire diameter measures 4.5mm, the interlacements measure 4mm in diameter.	<b>A</b> Common Ground Crossroad Delite Facet Hourglass Mariner Presto Sonnet Trophy Uni-Form	<b>U</b> Vicenza * Volo * <b>V</b> Acqua * Amalfi Andes * Embossed Tipped * Hand Tipped * Velluto Pelle * <b>W</b> Alaska * Antique * Derby * Forte *
<i>Upholstery:</i> Cushion secured to chair with lock-snaps. Full covers are stretched over wire frame and attach to seat basket with hooks. Cushions and covers fit all Bertoia Diamond Chairs manufactured since 1952 within a limited range of tolerance.	<b>B</b> continued Knoll Felt Knoll Hopsack Little Devil Prairie * <sup>o</sup> Ransom * Synth Vast * Venue Vinyl <sup>Ⓞ</sup> * <sup>o</sup>	<b>W</b> continued Lucente * Sabrina * Umbria * <b>X</b> Ducale * Ducale Velour * <b>Y</b> Cervo * Copenhagen * Distressed * Gemma * Lucca * Marissa * Portofino * Riva * Rugata * [Sa]ddle * Torello *
<i>Note:</i> Two-Tone Bertoia Diamond Chairs are not appropriate for outdoor use.	<b>C</b> Classic Boucle Entourage Entwine Prestini Pullman Quark * Swing Utopia * <sup>o</sup> Wow Factor	<b>I</b> Bella Cato Chic Dynamic Ita Knoll Velvet North Island Prince Hairly Stripe It * <sup>o</sup> Zimba
Screws that attach the base to the basket are not painted to match the basket finish.	<b>D</b> Buzz Chain Link * Hologram * Retreat * Zoom *	<b>E</b> Aegean Flower Power * Highland Marquee * Rebel Sherman Tempest
	<b>F</b> Atelier Calais Cotton Velvet *	<b>G</b> continued Looped In Melange Modern Tweed Ultrasuede Utrillo * Vert
	<b>G</b> All Star Alter Ego Dapper Duchess Haze	<b>H</b> Bavaria Catwalk * Stretch Appeal

\* Available on 421K and 421KS seat cushion only.  
Ⓞ Fire Retardant Chemicals

Check with your KnollTextiles or Spinneybeck Representative for changes or additions.

# Harry Bertoia

## Child's Diamond™ Lounge Seating

	description	seat h	w	d	h	textile fabric yds.	req. leather sq. ft.	weight
<i>Designer(s):</i> Harry Bertoia, 1952	<b>421FS</b> Child's Diamond, full cover replacement					2.5	n/a	
<i>Award(s):</i> "Designer of the Year" 1955, USA; Certificate of Merit, American Institute of Architects	<b>421KS</b> Child's Diamond, seat cushion replacement					0.7	11	
	<b>421LS</b> Child's Diamond chair, full cover with glides	11 3/4"	24 1/2"	22 3/4"	24"	2.5	n/a	10 lbs.
	<b>421LS</b> Child's Diamond chair, seat cushion with glides	11 3/4"	24 1/2"	22 3/4"	24"	0.7	11	9 lbs.



pattern no.	list	A	B	C	D	E	F	G	H	I	U	V	W	X	Y
<b>421FS-(-)</b>		\$956.	\$1,049.	\$1,142.	\$1,242.	\$1,319.	\$1,379.	\$1,480.	\$1,666.	\$1,803.					
<b>421KS-(-)</b>		377.	402.	431.	455.	480.	496.	526.	573.	615.	784.	888.	1,105.	1,151.	1,200.
<b>421LS-C-U</b>		1,906.	1,984.	2,062.	2,145.	2,215.	2,265.	2,351.	2,510.	2,627.					
<b>421LS-C-K</b>		1,468.	1,489.	1,510.	1,533.	1,553.	1,565.	1,593.	1,636.	1,677.	1,809.	1,902.	2,081.	2,121.	2,162.



Order Code	Ordering Information
<i>Example:</i> <b>421L-CO-U-K231/1</b>	<i>Frame finishes (421L,LU):</i> Black (suffix BL) Polished Chrome (suffix C) Satin Chrome (suffix CO) Fully upholstered 18k Gold Plated (suffix GLD)
<b>421L</b> Diamond chair	<i>Upholstery/COM information:</i> Prices shown include fabric or leather upholstery. Contact your Knoll representative for colors. Only approved KnollTextiles and Spinneybeck leathers may be ordered.
<b>CO</b> Satin Chrome	<i>Cal 133 Fire Code ★ :</i> Bertoia 421 chair with seat pad attached complies with the California Technical Bulletin 133 standard in <i>all</i> upholstery. Specify suffix -C at end of pattern number. <i>Maintenance:</i> See pages 28-29.
<b>U</b> Fully upholstered	<i>Note:</i> The Knoll logo is stamped into the base of the chair.
<b>K231/1</b> Cuddle Cloth, Neutral	<i>The Bertoia Diamond Lounge Seating is certified Clean Air GOLD.</i>
<i>Specify:</i> 1. Pattern number 2. Finish selection 3. Upholstery option 4. Cal 133 Fire Code Option 5. Textile selection	<i>Customer's Own Material is available pending approval. For approval requirements, processing instructions and ordering information please see page 21.</i>
<i>For cushion replacement, specify:</i> 1. Pattern number 2. Textile selection	<i>Outdoor use:</i> With proper care and limited exposure to the elements, the 421 Bertoia Diamond Chair is appropriate for outdoor environments. Specify powder coat finish. Consult a Knoll representative for appropriate upholstery options.
	<i>The Child's Diamond Chair is compliant to the Consumer Product Safety Improvement Act of 2008 for Children's Products, 16 C.F.R. 1303, CPSIA Title 1 Section 101 for Total Lead in Substrates and Surface Coatings.</i>
	<i>Frame finishes (421LS):</i> Black (suffix BL) Polished Chrome (suffix C) Satin Chrome (suffix CO) White (suffix W) 18k Gold Plated (suffix GLD)
	<i>Upholstery options:</i> Full cover (suffix U) Seat cushion only (suffix K)

Construction	Approved KnollTextiles Grades/Fabrics	Spinneybeck Leather
<i>Frame:</i> Welded steel with rods in polished or satin (421L only) chrome finish, powder coat (white and black), or plated in 18k gold. Stainless steel connections. Four plastic glides. On all Diamond chairs, the base wire diameter measures 11mm. The frame edge wire diameter measures 4.5mm, the interlacements measure 4mm in diameter.	<b>A</b> Common Ground Crossroad Delite Facet Hourglass Mariner Presto Sonnet Trophy Uni-Form	<b>U</b> Vicenza * Volo * <b>V</b> Acqua * Amalfi Andes * Embossed Tipped * Hand Tipped * Velluto Pelle * <b>W</b> Alaska * Antique * Derby * Forte *
<i>Upholstery:</i> Cushion secured to chair with lock-snaps. Full covers are stretched over wire frame and attach to seat basket with hooks. Cushions and covers fit all Bertoia Diamond Chairs manufactured since 1952 within a limited range of tolerance.	<b>B</b> continued Knoll Felt Knoll Hopsack Little Devil Prairie * Ransom * Synth Vast * Venue Vinyl Ⓢ * <b>C</b> Classic Boucle Entourage Entwine Prestini Pullman Quark * Swing Utopia * Wow Factor	<b>W</b> continued Lucente * Sabrina * Umbria * <b>X</b> Ducale * Ducale Velour * <b>Y</b> Cervo * Copenhagen * Distressed * Gemma * Lucca * Marissa * Portofino * Riva * Rugata * [Sa]ddle * Torello *
422L is not available with seat pad option.	<b>D</b> Buzz Chain Link * Hologram * Retreat * Zoom *	<b>E</b> Aegean Flower Power * Highland Marquee * Rebel Sherman Tempest <b>F</b> Atelier Calais Cotton Velvet * Cornaro Imprint In Stitches Totem * Tweed Frieze * <b>G</b> All Star Alter Ego Dapper Duchess Haze
<i>Child's Diamond Chair:</i> The Child's Diamond Chair is 75% scale of the standard size and is only available with polished chrome frame.	<b>G</b> continued Looped In Melange Modern Tweed Ultrasuede Utrillo * Vert <b>H</b> Bavaria Catwalk * Stretch Appeal <b>I</b> Bella Cato Chic Dynamic Ita Knoll Velvet North Island Prince Hairy Stripe It * Zimba	* Available on 421K and 421KS seat cushion only. Ⓢ Fire Retardant Chemicals

Check with your KnollTextiles or Spinneybeck Representative for changes or additions.

# Harry Bertoia

## Bird Lounge Chair and Ottoman

	description	seat h	w	d	h	textile fabric yds.	req. leather sq. ft.	weight
<i>Designer(s):</i> Harry Bertoia, 1952	<b>423LU</b> Bird high back chair, full cover with glides	14 1/2"	38 1/2"	33"	40 1/4"	3.8	n/a	21 lbs.
<i>Award(s):</i> "Designer of the Year," USA, 1955; Certificate of Merit, American Institute of Architects; Design Center Stuttgart Award, W. Germany, 1962								
	<b>423F</b> Full cover replacement					3.8	n/a	
	<b>424YU</b> Ottoman, full cover with glides	14 1/2"	23 1/2"	17 1/4"	14 1/2"	1.3	n/a	9 lbs.
								
	<b>424F</b> Full cover replacement					1.3	n/a	



pattern no.	grades <b>A</b>	COM <b>B</b>	<b>C</b>	<b>D</b>	<b>E</b>	<b>F</b>	<b>G</b>	<b>H</b>	<b>I</b>
<b>423L-(C,1,2)-U</b>	\$6,342.	\$6,593.	\$6,830.	\$7,094.	\$7,304.	\$7,458.	\$7,718.	\$8,222.	\$8,584.
<b>423F-( )</b>	1,965.	2,193.	2,411.	2,647.	2,839.	2,981.	3,213.	3,677.	4,006.
<b>424Y-(C,1,2)-U</b>	2,068.	2,148.	2,225.	2,318.	2,390.	2,446.	2,526.	2,704.	2,826.
<b>424F-( )</b>	825.	907.	975.	1,050.	1,121.	1,170.	1,246.	1,407.	1,520.

### Order Code

<i>Example:</i>	<b>423L-C-U-K1084/9</b>
<b>423L</b>	Bird high back chair
<b>C</b>	Polished Chrome
<b>U</b>	Full cover
<b>K1084/9</b>	Harrison, Dunbar

### Specify:

1. Pattern number
2. Finish selection
3. Upholstery option
4. Textile selection

### For cushion replacement, specify:

1. Pattern number
2. Textile selection

### Ordering Information

*Frame finishes:*  
Black (suffix 1)  
Polished Chrome (suffix C)  
White (suffix 2)

*Upholstery/COM information:*  
Prices shown include fabric or leather upholstery. Contact your Knoll representative for colors. Only approved KnollTextiles and Spinneybeck leathers may be ordered.

Customer's Own Material is available pending approval. For approval requirements, processing instructions and ordering information please see page 21.

*Cal 133 Fire Code #:*  
The Bird chair and ottoman complies with the California Technical Bulletin 133 standard if upholstered in Cal133 approved KnollTextiles. Specify suffix -C at end of pattern number and suffix -133 at end of textile selection.

*Maintenance:*  
See pages 28-29.

*Note:*  
The Knoll logo is stamped into the base of the chair and bench.

The Bertoia Bird Lounge Seating is certified Clean Air GOLD.

### Construction

*Frame:*  
Welded steel with rods in polished chrome or bonded Rilsan® finish, a very durable and adhesive fused nylon-dipped finish. Scratch, chip, and chemical resistant. Stainless steel connections. Four plastic glides. Frame wire diameter measures 4.5mm. Interlacement wire diameter measures 4mm.

*Upholstery:*  
High back chairs only available with full cover. Full covers are stretched over wire frame and attach to seat basket with hooks. Full cover replacement for High Back Chairs fit all Bertoia High Back Chairs manufactured since 1952 within a limited range of tolerance.

### Approved KnollTextiles Grades/Fabrics

<b>A</b> Common Ground **	<b>C</b> Classic Boucle Entourage Entwine Prestini Pullman Swing * Theory Ⓞ *	<b>F</b> Atelier Cornaro Imprint In Stitches *	<b>H</b> Bavaria Stretch Appeal
<b>B</b> Attire Diva Dottie * Ferry Journey Keaton Knoll Felt Knoll Hopsack Little Devil Ransom * Synth Vast * Venue * Vinyl Ⓞ *°	<b>D</b> Buzz	<b>G</b> All Star Alter Ego Dapper Duchess Fancy Twill ** Haze * Looped In Melange Modern Tweed Ultrasuede * Utrillo * Vert	<b>I</b> Bella Cato Chic Dynamic Ita Knoll Velvet * North Island Prince Harry Zimba



\* Available on seat cushion only.  
\*\* Available on full cover only.  
Ⓞ Fire Retardant Chemicals  
° Approved for outdoor seat pad

Check with your KnollTextiles Representative for changes or additions.



# Harry Bertoia

## Asymmetric Chaise

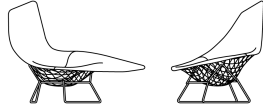
	description	seat h	w	d	h	textile fabric yds.	weight
<i>Designer(s):</i> Harry Bertoia, 1952	<b>429L</b> Asymmetric Chaise, unupholstered, with glides		52"	38 1/2"	40 1/4"		23 lbs.
<i>Award(s):</i> Honorable Mention, Annual Design Awards, ID Magazine 2006							
	<b>429L</b> Asymmetric Chaise, seat pad, with glides		52"	38 1/2"	40 1/4"	2.5	24 lbs.
							
	<b>429K</b> Seat cushion replacement					2.5	
	<b>429L</b> Asymmetric Chaise, fully upholstered, with glides		52"	38 1/2"	40 1/4"	4.5	22 lbs.
							
	<b>429F</b> Full cover replacement					4.5	

pattern no.	grades	COM	C	D	E	F	G	H	I	
<b>429L-( )</b>		\$14,602.								
<b>429L-( )-K</b>		15,679.	15,788.	15,893.	16,008.	16,102.	16,176.	16,291.	16,517.	16,678.
<b>429K-( )</b>		1,148.	1,250.	1,352.	1,461.	1,551.	1,613.	1,727.	1,935.	2,090.
<b>429L-( )-U</b>		16,731.	16,928.	17,122.	17,332.	17,502.	17,628.	17,837.	18,239.	18,530.
<b>429F-( )</b>		2,731.	2,919.	3,099.	3,297.	3,460.	3,578.	3,776.	4,153.	4,428.

### Order Code

<i>Example:</i>	<b>429L-C-U-K1152/8</b>
<b>429L</b>	Asymmetric chaise
<b>C</b>	Polished Chrome
<b>U</b>	Fully upholstered
<b>K1152/8</b>	Stirling, Cobble

### Specify:

1. Pattern number
2. Frame finish
3. Upholstery option
4. Textile selection

### For seat cushion replacement specify:

1. Pattern number
2. Textile selection

### Ordering Information

*Frame finishes:*  
Chrome (suffix C)  
White (suffix 2)

*Upholstery options:*  
Fully upholstered (suffix U)  
Seat cushion only (suffix K)

### Upholstery/COM information:

Prices shown include fabric or leather upholstery. Contact your Knoll representative for colors. Only approved KnollTextiles and Spinneybeck leathers may be ordered.

Customer's Own Material is available pending approval. For approval requirements, processing instructions and ordering information please see page 21.

### Outdoor Use:

With proper care and limited exposure to the elements, the 429 Bertoia Asymmetric chaise is appropriate for outdoor environments. Specify Rilsan® finish. Consult a Knoll representative for appropriate upholstery options.

For outdoor seat pad, specify O in front of textile selection:  
Ex. 429L-2-K-O-K24221

### Cal 133 Fire Code ⚡:

The Asymmetric chaise complies with the California Technical Bulletin 133 standard if upholstered in Cal 133 approved KnollTextiles. Specify suffix -C at end of pattern number and suffix -133 at end of textile selection.

### Maintenance:

See pages 28-29.

### Note:

The Knoll logo is stamped into the base of the Chaise.

The Bertoia Asymmetric Chaise is certified Clean Air GOLD.

### Construction

#### Frame:

Welded steel rods in polished chrome or bonded white Rilsan® finish, a very durable and adhesive fused nylon-dipped finish. Scratch, chip and chemical resistant. Chrome chair features chrome connections. White Rilsan® finish chair features stainless steel connections suitable for outdoor use. Holes are drilled for the glides, and are included with the Chaise.

#### Upholstery:

Seat cushion secured to chair with lock-snaps. Full covers are stretched over wire frame and attach with hooks. Seat cushions and full covers will ship already attached to the chaise. If ordering a full cover replacement, installation must be performed by Knoll Field Services.





### Approved KnollTextiles Grades/Fabrics

<b>A</b> Common Ground * *	<b>C</b> Classic Boucle Entourage Entwine Prestini Pullman Swing * Theory Ⓔ * Wow Factor	<b>F</b> Atelier Cornaro Imprint In Stitches *	<b>H</b> Bavaria Stretch Appeal
<b>B</b> Attire Diva Dottie * Ferry Journey Keaton Knoll Felt Knoll Hopsack Little Devil Ransom * Synth Vast * Venue * Vinyl Ⓔ * °	<b>D</b> Buzz	<b>G</b> All Star Alter Ego Dapper Duchess Fancy Twill * * Haze * Looped In Melange Modern Tweed Ultrasuede * Utrillo * Vert	<b>I</b> Bella Cato Chic Dynamic Ita Knoll Velvet * North Island Prince Ha iry Zimba

\* Available on seat cushion only.  
\* \* Available on full cover only.  
Ⓔ Fire Retardant Chemicals  
° Approved for outdoor seat pad

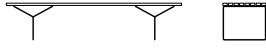
Check with your KnollTextiles Representative for changes or additions.

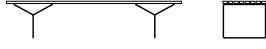
# Harry Bertoia Bench

description	seat h	w	d	h	textile fabric yds.	req.leather sq. ft.	weight	frame
<b>400Y</b> Bench 	15 1/4"	72"	19"	15 1/4"			32 lbs.	Chrome
<b>400K</b> Seat cushion (one of maximum three) 		19"	19"	3"	1.2	15	2 lbs.	
<b>410Y</b> Outdoor Teak Bench 	15 1/4"	72"	19"	15 1/4"			32 lbs.	Paint
<b>410K</b> Outdoor Seat cushion (one of maximum three) 		19"	19"	3"	1.2	15	2 lbs.	

Designer(s):  
Harry Bertoia, 1952



Order Code	Ordering Information	Construction
<i>Example:</i> <b>400Y-CBL</b>	<i>Bench frame/slat finish combinations:</i> Chrome/black (suffix CBL) Chrome/white (suffix CW) Black/teak (suffix BLK) White/teak (suffix WK) Stainless/teak (suffix SK)	<i>Bench platform:</i> Solid wood horizontal slats pre-treated to help prevent sagging or warping. Slats in black or white painted finish and teak. Base wire diameter measures 12mm.
<b>400Y</b> Bench		
<b>C1</b> Chrome frame with black slats	<i>Maintenance:</i> See pages 28-29.	
<i>Example:</i> <b>400K-H800/19</b>	<i>Note:</i> The Knoll logo is stamped into the base of the bench.	
<b>400K</b> Seat cushion		Platform bench cushion available separately: firm foam cushions upholstered with welt detail. Three cushions maximum per bench.
<b>H800/19</b> Cato, Fire Red	<i>Upholstery/COM information:</i> Prices shown include fabric or leather upholstery. Contact your Knoll representative for colors. Only approved KnollTextiles and Spinneybeck leathers may be ordered.	<i>Outdoor use:</i> With proper care and preventative maintenance, benches specified with painted or stainless steel base and teak slats are appropriate for outdoor use.
<i>Example:</i> <b>410K-K1557/8</b>		To specify outdoor bench cushions, use pattern number 410K and appropriate outdoor upholstery.
<b>410K</b> Outdoor Seat Cushion		<i>Outdoor paint:</i> Ultra-durable polyester powder coat paint.
<b>K1557/8</b> Baxter, Hazel	Customer's Own Material is available pending approval. For approval requirements, processing instructions and ordering information please see page 21.	
<i>Specify:</i>		
1. Pattern number		
2. Frame/Slat finish selection		
3. Seat cushion option		
4. Textile selection		
<i>For seat cushion only, specify:</i>		
1. Pattern number		
2. Textile selection		

pattern no.	grades	COM	C	D	E	F	G	H	I	COL	U	V	W	X	Y
<b>400Y-(CBL,CW)</b>	\$5,021.														
<b>400K-()</b>		660.	727.	787.	859.	918.	963.	1,030.	1,167.	1,267.	1,392.	1,562.	1,903.	1,978.	2,054.
<b>410Y-(BLK,WK)</b>	3,708.														
<b>410Y-SK</b>	4,683.														
<b>410K-()</b>		0.	727.	787.	0.	0.	0.	0.	0.	0.	0.	0.	0.	0.	0.

Approved KnollTextiles Grades/Fabrics				Spinneybeck Leather			
<b>A</b> Alignment	<b>B</b> continued Knoll Felt	<b>C</b> continued Fibra	<b>D</b> continued Kabuki	<b>G</b> All Star	<b>H</b> continued Stretch Appeal	<b>U</b> Vicenza	<b>X</b> Ducale
Bocce	Knoll Hopsack	Greenwich	Menagerie	Alter Ego	World Piece	Volo	Ducale Velour
Chance	Little Devil	Groovy	Origins	Arber			
Common Ground	Ludlow	Hudson	Retreat	Aurora	<b>I</b> Aswan	<b>V</b> Acqua	<b>Y</b> Cervo
Commuter Cloth	Melody <sup>Ⓢ</sup>	Kaleidoscope CR	Vice Versa	Color Collage	Byron	Amalfi	Copenhagen
Cross Tech	Paradigm	Kaya CR	Woodland	Dapper	Cato	Andes	Distressed
Crossroad	Petal Pusher <sup>Ⓢ</sup>	Lagos	Zoom	Djenne	Dutchess	Embossed Tipped	Gemma
Delite	Prairie *	Lore CR		Djenné	Fancy Twill	Espana	Lucca
Facet	Prim	Milestone		Djenné	Gibson	Hand Tipped	Marissa
Heavy Metal	Radiance	On Point	<b>E</b> Aegean	Haze	Haze	Maremma	Portofino
Hourglass	Ransom	Palisade	Circle Point	Kamani	Diamond Days	Velluto Pelle	Riva
Infinite	Roam	Panache CR	Cleo	Looped In	Dynamic		Rugata
Mariner	Rush Hour	Patchwork	Demure	Melange	Florescence	<b>W</b> Alaska	Saddle
Monarch	Shadow Play	Plaid On	Flower Power	Modern Tweed	Hastings	Antique	
Overture	Spree	Prestini	Highland	In Step	In Step	Derby	
Prep	Summit	Pullman	Ikat Stripe	Ita	Jaipur	Forte	
Presto	Sutton	Quark	Juno	Ultrasuede	Knoll Velvet	Lucente	
Soliloquy	Synth	Roundtrip	Kampala	Utrillo	Limani	Sabrina	
Sonnet	Tabloid	Sahara	Kimono	Vert	North Island	Umbria	
Trophy	Tinge	Sequin CR	Mamba		Olema		
Uni-Form	Topos	Sinclair *	Marquee	<b>H</b> Bavaria	Piper		
	Vast	Smart <sup>Ⓢ</sup>	Meroe	Catwalk	Prince Hiary		
	Venue	Spectator	Midpoint	Chiseled	Rutledge		
	Versa	Stepping Stones	Nature Walk	Constance	Sandis		
	Vinyl <sup>Ⓢ</sup>	Swing	Plaidtastic	Firefly	Stripe It		
	Westwood	Tilden <sup>Ⓢ</sup>	Rebel		Tudor		
	Wild Thing	Tower Grid	Sherman		Zimba		
		Utmost II	Shima				
		Wit	Tempest				
		Wow Factor	Vatera				
		Zari CR					
		Zen Wave	<b>F</b> Atelier				
	<b>C</b> Axiom <sup>Ⓢ</sup>		Biscayne				
	Baxter *		Century				
	Chameleon		Cornaro				
	Charm		Double Agent <sup>Ⓢ</sup>				
	Circa	<b>D</b> Buzz	Glider				
	Classic Boucle	Code	Homage				
	Dune	Coterie	Imprint				
	Durand	Eclat Weave	In Stitches				
	Earthwork	Hologram	Jasmine				
	Empire Stripe	Island	Liberty				
	Entourage		Mod Plaid				
	Entwine		Rivington				
	Essence		Totem				
			Tweed Frieze				
			Swank				

\*Appropriate for outdoor use. Specify 410K.  
<sup>Ⓢ</sup> Fire Retardant Chemicals

Check with your KnollTextiles or Spinneybeck Representative for changes or additions.

# Pierre Beucler and Jean-Christophe Poggioli Architecture & Associés Contract Lounge Seating

Designer(s):  
Pierre Beucler and  
Jean-Christophe Poggioli, 2012



description	seat h	arm h	w	d	h	type	textile	leather	weight
							fabric yds	sq ft	
<b>AAC4</b> AA Small Lounge chair, low back, std. wing, same upholstery, frame and cushions	16 1/2"	-	27 1/8"	32 3/4"	30 1/8"		4.4	81	-
<b>AAC4</b> AA Small Lounge chair, low back, std. wing, combination upholstery, frame and cushions	-	-	-	-	-	frame uph.	2.4	41	-
						upchg, cushions	2.3	40	-
<b>AAC1</b> AA Lounge chair, low back, std. wing, arm cushions, same upholstery, frame and cushions	16 1/2"	-	31 1/2"	32 3/4"	30 1/8"		6.3	113	-
<b>AAC1</b> AA Lounge chair, low back, std. wing, arm cushions, combination upholstery, frame and cushions	-	-	-	-	-	frame uph.	3.2	50	-
						upchg, cushions	3.5	63	-

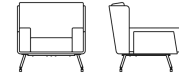

Order Code	Ordering Information	Construction
<i>Example:</i> <b>AAC4-CU-K1479/6-K1406/7</b>	<i>Leg finishes:</i> Chrome (suffix C) Copper (suffix CU)	<i>Frame:</i> Constructed in two formed plywood frames, back and seat, giving the pieces their architectural form. Frames are softened with highly resilient urethane foam wrapping.
<b>AAC4</b> AA Small Lounge Chair	<i>Copper leg upcharge:</i> Copper leg finish is available at an upcharge of \$486 list. Use suffix CU to specify.	<i>Upholstery:</i> Interior loose cushions are available in either residential or contract versions. Contract cushions provide a tailored look for high use areas, while residential cushions convey a relaxed aesthetic. For units with combination upholstery, add list price of surround in appropriate grade with the list price of cushions to obtain total list price for item.
<b>CU</b> Copper legs	<i>Upholstery/COM information:</i> Prices shown includes fabric or leather upholstery. Contact your Knoll representative for colors. Only approved KnollTextiles and Spinneybeck leathers may be ordered.	<i>Cushion fill:</i> "Contract" back and seat cushion are multi-density urethane foam.
<b>K1479/6</b> Surround in Haiku, Storm		<i>Legs:</i> Machined steel legs feature height adjustable feet for leveling.
<b>K1406/7</b> Cushions in Sonnet, Denim	<i>Maintenance:</i> See pages 28-29.	

*Specify:*

1. Pattern number
2. Leg finish
3. Textile selection

*Specify with split upholstery:*

1. Pattern number
2. Leg finish
3. Textile selection, Surround
4. Textile selection, Cushions

pattern no.	grades	COM	C	D	E	F	G	H	I	COL	V	W	X	Y
<b>AAC4-(-)(-)</b>	\$5,641.	\$5,781.	\$5,919.	\$6,069.	\$6,189.	\$6,279.	\$6,428.	\$6,713.	\$6,926.	\$8,467.	\$8,988.	\$10,052.	\$10,274.	\$10,532.
<b>AAC4S-(-)(-)</b>	4,272.	4,348.	4,421.	4,504.	4,571.	4,618.	4,698.	4,853.	4,971.	5,621.	5,883.	6,425.	6,537.	6,668.
<b>AAC4 cushions</b>	1,668.	1,745.	1,815.	1,895.	1,957.	2,005.	2,084.	2,232.	2,343.	2,959.	3,216.	3,741.	3,849.	3,979.
<b>AAC1-(-)(-)</b>	6,194.	6,398.	6,593.	6,809.	6,985.	7,108.	7,323.	7,731.	8,034.	10,017.	10,743.	12,228.	12,535.	12,894.
<b>AAC1S-(-)(-)</b>	4,603.	4,707.	4,806.	4,915.	5,001.	5,067.	5,180.	5,386.	5,538.	6,209.	6,532.	7,189.	7,323.	7,481.
<b>AAC1 cushions</b>	1,903.	2,016.	2,126.	2,246.	2,342.	2,411.	2,532.	2,756.	2,924.	3,919.	4,327.	5,153.	5,325.	5,524.

Approved KnollTextiles Grades/Fabrics						Spinneybeck Leather	
<b>A</b> Chance Common Ground Commuter Cloth Cross Tech Crossroad Delite Facet Hourglass Infinite Mariner Overture Prep * Presto * Sonnet Trophy Uni-Form *	<b>B</b> continued Prairie * Ransom Rush Hour Summit Sutton Synth * Tinge Vast Venue * Westwood * Wild Thing  <b>C</b> Atlas * Chameleon Charm * <sup>†</sup> Circa * Classic Boucle Contour Earthwork Entourage Entwine Groovy Hudson Lagos	<b>C</b> continued Milestone * On Point Palisade Patchwork Panache * Plaid On Prestini Quark * Sahara Sequin CR * Stepping Stones * Swing Tilden <sup>Ⓢ</sup> * Utmost II Utopia  <b>D</b> Buzz Eclat Weave * Menagerie Pathway Plaidtastic Retreat Vice Versa	<b>E</b> Aegean Circle Point * Currents Flower Power Highland Kampala * Off The Grid Rebel Sherman Shima Tempest  <b>F</b> Atelier Calais Cotton Velvet * Cornaro Double Agent <sup>Ⓢ</sup> Homage Imprint Liberty Rivington * Shima Soon Swank	<b>G</b> All Star Alter Ego Aurora Dapper Fancy Twill Haze Kamani * Looped In Melange Modern Tweed * Texnet Ultrasuede Vert  <b>H</b> Chiseled	<b>I</b> Bella Cato Chic Dynamic Hastings Knoll Velvet * <sup>†</sup> Piper * Rutledge Tudor  <b>U</b> Vicenza Volo  <b>V</b> Acqua Andes Embossed Tipped España Velluto Pelle  <b>W</b> Alaska Antique Forte Sabrina Umbria	<b>X</b> Ducale Velour  <b>Y</b> Cascia Cervo Copenhagen Distressed Marissa Riva Rugata Saddle	

\* Not approved on frame  
<sup>†</sup>Indicates fabrics without topstitching  
<sup>Ⓢ</sup> Fire Retardant Chemicals

Check with your KnollTextiles or Spinneybeck Representative for additions or changes.

# Pierre Beucler and Jean-Christophe Poggioli

## Architecture & Associés

### Contract Lounge Seating

Designer(s):  
Pierre Beucler and  
Jean-Christophe Poggioli, 2012



description	seat h	arm h	w	d	h	type	textile	leather	weight
							fabric yds	sq ft	
<b>AAC2</b> AA Settee, low back, std. wing, arm cushions, same upholstery, frame and cushions	16 1/2"	—	58"	32 3/4"	30 1/8"		9.3	170	—
<b>AAC2</b> AA Settee, low back, std. wing, arm cushions, combination upholstery, frame and cushions	—	—	—	—	—	frame uph.	4	70	—
						upchg. cushions	5.3	100	—
<b>AAC3</b> AA Sofa, low back, std. wing, arm cushions, same upholstery, frame and cushions	16 1/2"	—	85 1/4"	32 3/4"	30 1/8"		11.5	225	—
<b>AAC3</b> AA Sofa, low back, std. wing, arm cushions, combination upholstery, frame and cushions	—	—	—	—	—	frame uph.	4.7	90	—
						upchg. cushions	7.2	138	—

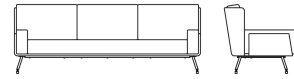
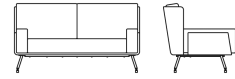

Order Code	Ordering Information	Construction
<i>Example:</i> <b>AAC4-CU-K1479/6-K1406/7</b>	<i>Leg finishes:</i> Chrome (suffix C) Copper (suffix CU)	<i>Frame:</i> Constructed in two formed plywood frames, back and seat, giving the pieces their architectural form. Frames are softened with highly resilient urethane foam wrapping.
<b>AAC4</b> AA Small Lounge Chair	<i>Copper leg upcharge:</i> Copper leg finish is available at an upcharge of \$486 list. Use suffix CU to specify.	<i>Cushion fill:</i> "Contract" back and seat cushion are multi-density urethane foam.
<b>CU</b> Copper legs	<i>Upholstery/COM information:</i> Prices shown includes fabric or leather upholstery. Contact your Knoll representative for colors. Only approved KnollTextiles and Spinneybeck leathers may be ordered.	<i>Legs:</i> Machined steel legs feature height adjustable feet for leveling.
<b>K1479/6</b> Surround in Haiku, Storm	Customer's Own Material is available pending approval. For approval requirements, processing instructions and ordering information please see page 21.	
<b>K1406/7</b> Cushions in Sonnet, Denim	<i>Maintenance:</i> See pages 28-29.	

*Specify:*

1. Pattern number
2. Leg finish
3. Textile selection

*Specify with split upholstery:*

1. Pattern number
2. Leg finish
3. Textile selection, Surround
4. Textile selection, Cushions

pattern no.	grades	COM								COL				
	A	B	C	D	E	F	G	H	I	U	V	W	X	Y
<b>AAC2-(-)(-)</b>	\$8,747.	\$9,045.	\$9,331.	\$9,649.	\$9,909.	\$10,093.	\$10,410.	\$11,012.	\$11,458.	\$14,548.	\$15,643.	\$17,872.	\$18,336.	\$18,876.
<b>AAC2S-(-)(-)</b>	6,423.	6,552.	6,678.	6,811.	6,925.	7,000.	7,137.	7,400.	7,592.	8,701.	9,152.	10,073.	10,263.	10,485.
<b>AAC2 cushions</b>	2,773.	2,944.	3,105.	3,288.	3,433.	3,539.	3,720.	4,063.	4,318.	5,980.	6,627.	7,939.	8,212.	8,530.
<b>AAC3-(-)(-)</b>	11,175.	11,546.	11,901.	12,293.	12,613.	12,843.	13,235.	13,979.	14,530.	18,918.	20,369.	23,320.	23,936.	24,649.
<b>AAC3S-(-)(-)</b>	8,079.	8,230.	8,377.	8,535.	8,666.	8,760.	8,920.	9,224.	9,449.	11,037.	11,617.	12,797.	13,045.	13,330.
<b>AAC3 cushions</b>	3,714.	3,948.	4,172.	4,415.	4,614.	4,759.	5,001.	5,470.	5,814.	8,146.	9,036.	10,845.	11,224.	11,664.

Approved KnollTextiles Grades/Fabrics						Spinneybeck Leather	
<b>A</b> Chance Common Ground Commuter Cloth Cross Tech Crossroad Delite Facet Hourglass Infinite Mariner Overture Prep * Presto * Sonnet Trophy Uni-Form *	<b>B</b> continued Prairie * Ransom Rush Hour Summit Sutton Synth * Tinge Vast Venue * Westwood * Wild Thing	<b>C</b> continued Milestone * On Point Palisade Patchwork Panache * Plaid On Prestini Quark * Sahara Sequin CR * Stepping Stones * Swing Tilden ® * Utmost II Utopia	<b>E</b> Aegean Circle Point * Currents Flower Power Highland Kampala * Off The Grid Rebel Sherman Shima Tempest	<b>G</b> All Star Alter Ego Aurora Dapper Fancy Twill Haze Kamani * Looped In Melange Modern Tweed * Texnet Ultrasuede Vert	<b>I</b> Bella Cato Chic Dynamic Hastings Knoll Velvet * <sup>†</sup> Piper * Rutledge Tudor	<b>U</b> Vicenza Volo	<b>X</b> Ducale Velour
<b>B</b> Argyle * Belize * Calypso Cozy Cord * Day Tripper Diva Dottie Ferry * Helios Instinct Journey Knoll Felt Knoll Hopsack Little Devil Ludlow Melody ®	<b>C</b> Atlas * Chameleon Charm * <sup>†</sup> Circa * Classic Boucle Contour Earthwork Entourage Entwine Groovy Hudson Lagos	<b>D</b> Buzz Eclat Weave * Menagerie Pathway Plaidtastic Retreat Vice Versa	<b>F</b> Atelier Calais Cotton Velvet * Cornaro Double Agent ® Homage Imprint Liberty Rivington * Shima Soon Swank	<b>H</b> Chiseled	<b>V</b> Acqua Andes Embossed Tipped España Velluto Pelle	<b>Y</b> Cascia Cervo Copenhagen Distressed Marissa Riva Rugata Saddle	

\* Not approved on frame  
<sup>†</sup>Indicates fabrics without topstitching  
Knoll Felt/Ivory K1207/1 not approved  
® Fire Retardant Chemicals

Check with your KnollTextiles or Spinneybeck Representative for additions or changes.



# Pierre Beucler and Jean-Christophe Poggioli

## Architecture & Associés

### Contract Lounge Seating

Designer(s):  
Pierre Beucler and  
Jean-Christophe Poggioli, 2012

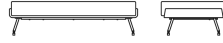

description	seat h	arm h	w	d	h	type	textile fabric yds	leather sq ft	weight
<b>AAC5</b> AA Small Ottoman, same upholstery, frame and cushions 	–	–	27 1/2"	24 1/2"	16"		2.2	40	–
<b>AAC5</b> AA Small Ottoman, combination upholstery, frame and cushions	–	–	–	–	–	frame uph.	1.2	18	–
	–	–	–	–	–	upchg, cushions	1.3	22	–
<b>AAC6</b> AA Medium Ottoman, same upholstery, frame and cushions 	–	–	31 1/8"	29 1/2"	16"		3.3	60	–
<b>AAC6</b> AA Medium Ottoman, combination upholstery, frame and cushions	–	–	–	–	–	frame uph.	1.8	28	–
	–	–	–	–	–	upchg, cushions	2.3	32	–
<b>AAC7</b> AA Large Ottoman, same upholstery, frame and cushions 	–	–	59"	29 1/2"	16 1/2"		4.5	70	–
<b>AAC7</b> AA Large Ottoman, combination upholstery, frame and cushions	–	–	–	–	–	frame uph.	2.2	31	–
	–	–	–	–	–	upchg, cushions	2.7	43	–

pattern no.	grades A	COM B	C	D	E	F	G	H	I	COL U	V	W	X	Y
<b>AAC5-(-)(-)</b>	\$3,305.	\$3,381.	\$3,449.	\$3,520.	\$3,583.	\$3,626.	\$3,701.	\$3,842.	\$3,947.	\$4,741.	\$4,997.	\$5,523.	\$5,636.	\$5,758.
<b>AAC5S-(-)(-)(-)</b>	2,512.	2,552.	2,586.	2,633.	2,664.	2,688.	2,729.	2,809.	2,863.	3,098.	3,213.	3,452.	3,498.	3,557.
<b>AAC5 cushions</b>	998.	1,039.	1,081.	1,123.	1,161.	1,186.	1,230.	1,315.	1,377.	1,699.	1,842.	2,129.	2,192.	2,261.
<b>AAC6-(-)(-)</b>	3,484.	3,588.	3,691.	3,802.	3,893.	3,959.	4,073.	4,283.	4,444.	5,544.	5,931.	6,720.	6,883.	7,074.
<b>AAC6S-(-)(-)(-)</b>	2,616.	2,676.	2,731.	2,793.	2,845.	2,882.	2,942.	3,056.	3,144.	3,509.	3,694.	4,060.	4,136.	4,225.
<b>AAC6 cushions</b>	1,118.	1,192.	1,263.	1,341.	1,404.	1,449.	1,531.	1,682.	1,790.	2,091.	2,296.	2,716.	2,804.	2,906.
<b>AAC7-(-)(-)</b>	5,274.	5,422.	5,560.	5,712.	5,837.	5,928.	6,079.	6,371.	6,588.	7,738.	8,215.	9,185.	9,388.	9,623.
<b>AAC7S-(-)(-)(-)</b>	4,053.	4,123.	4,189.	4,268.	4,329.	4,372.	4,445.	4,589.	4,695.	5,017.	5,217.	5,624.	5,709.	5,806.
<b>AAC7 cushions</b>	1,438.	1,525.	1,607.	1,700.	1,776.	1,831.	1,921.	2,096.	2,226.	2,776.	3,053.	3,617.	3,734.	3,873.

Order Code	Ordering Information	Construction
<i>Example:</i> <b>AAC7-C-K1617/3</b>	<i>Leg finishes:</i> Chrome (suffix C) Copper (suffix CU)	<i>Frame:</i> Constructed in two formed plywood frames, back and seat, giving the pieces their architectural form. Frames are softened with highly resilient urethane foam wrapping.
<b>AAC7</b>	AA Large Ottoman	<i>Cushion fill:</i> "Contract" back and seat cushion are multi-density urethane foam.
<b>C</b>	Chrome legs	<i>Legs:</i> Machined steel legs feature height adjustable feet for leveling.
<b>K1617/3</b>	Dynamic, Radiant	<i>Upholstery:</i> Interior loose cushions are available in either residential or contract versions. Contract cushions provide a tailored look for high use areas, while residential cushions convey a relaxed aesthetic. For units with combination upholstery, add list price of surround in appropriate grade with the list price of cushions to obtain total list price for item.
<i>Specify:</i>	<i>Copper leg upcharge:</i> Copper leg finish is available at an upcharge of \$486 list. Use suffix CU to specify.	
1. Pattern number	<i>Upholstery/COM information:</i> Prices shown includes fabric or leather upholstery. Contact your Knoll representative for colors. Only approved KnollTextiles and Spinneybeck leathers may be ordered.	
2. Leg finish		
3. Textile selection	Customer's Own Material is available pending approval. For approval requirements, processing instructions and ordering information please see page 21.	
<i>Specify with split upholstery:</i>	<i>Maintenance:</i> See pages 28-29.	
1. Pattern number		
2. Leg finish		
3. Textile selection, Surround		
4. Textile selection, Cushions		

Approved KnollTextiles Grades/Fabrics						Spinneybeck Leather	
<b>A</b> Chance Common Ground Commuter Cloth Cross Tech Crossroad Delite Facet Hourglass Infinite Mariner Overture Prep * Presto * Sonnet Trophy Uni-Form *	<b>B</b> continued Prairie * Ransom Rush Hour Summit Sutton Synth * Tinge Vast Venue * Westwood * Wild Thing	<b>C</b> continued Milestone * On Point Palisade Patchwork Panache * Plaid On Prestini Quark * Sahara Sequin CR * Stepping Stones * Swing Tilden <sup>Ⓢ</sup> * Utmost II Utopia	<b>E</b> Aegean Circle Point * Currents Flower Power Highland Kampala * Off The Grid Rebel Sherman Shima Tempest	<b>G</b> All Star Alter Ego Aurora Dapper Fancy Twill Haze Kamani * Looped In Melange Modern Tweed * Texnet Ultrasuede Vert	<b>I</b> Bella Cato Chic Dynamic Hastings Knoll Velvet * <sup>†</sup> Piper * Rutledge Tudor	<b>U</b> Vicenza Volo	<b>X</b> Ducale Velour
<b>B</b> Argyle * Belize * Calypso Cozy Cord * Day Tripper Diva Dottie Ferry * Helios Instinct Journey Knoll Felt Knoll Hopsack Little Devil Ludlow Melody <sup>Ⓢ</sup>	<b>C</b> Atlas * Chameleon Charm * <sup>†</sup> Circa * Classic Boucle Contour Earthwork Entourage Entwine Groovy Hudson Lagos	<b>D</b> Buzz Eclat Weave * Menagerie Pathway Plaidtastic Retreat Vice Versa	<b>F</b> Atelier Calais Cotton Velvet * Cornaro Double Agent <sup>Ⓢ</sup> Homage Imprint Liberty Rivington * Shima Soon Swank	<b>H</b> Chiseled	<b>V</b> Acqua Andes Embossed Tipped España Velluto Pelle	<b>Y</b> Cascia Cervo Copenhagen Distressed Marissa Riva Rugata Saddle	* Not approved on frame <sup>†</sup> Indicates fabrics without topstitching Knoll Felt/Ivory K1207/1 not approved <sup>Ⓢ</sup> Fire Retardant Chemicals

Check with your KnollTextiles or Spinneybeck Representative for additions or changes.



# Pierre Beucler and Jean-Christophe Poggioli

## Architecture & Associés

### Residential Lounge Seating

Designer(s):  
Pierre Beucler and  
Jean-Christophe Poggioli, 2012



description	seat h	arm h	w	d	h	type	textile	leather	weight
							fabric yds	sq ft	
<b>AAR4</b> AA Small Lounge chair, low back, std. wing, same upholstery, frame and cushions	16 1/2"	—	27 1/8"	32 1/4"	30 1/8"		4.5	82	—
						from uph.	2.4	42	—
						upchg, cushions	2.5	40	—
<b>AAR1</b> AA Lounge chair, low back, std. wing, arm cushions, same upholstery, frame and cushions	16 1/2"	—	31 1/2"	32 1/4"	30 1/8"		6.4	118	—
						frame uph.	3.1	50	—
						upchg, cushions	4.7	68	—
<b>AAR1</b> AA Lounge chair, low back, std. wing, arm cushions, combination upholstery, frame and cushions	—	—	—	—	—				—

pattern no.	grades	COM								COL				
	A	B	C	D	E	F	G	H	I	U	V	W	X	Y
<b>AAR4-(-)(-)</b>	\$5,621.	\$5,767.	\$5,906.	\$6,059.	\$6,183.	\$6,275.	\$6,428.	\$6,720.	\$6,932.	\$8,476.	\$9,004.	\$10,081.	\$10,301.	\$10,565.
<b>AAR4S-(-)(-)</b>	4,250.	4,331.	4,404.	4,483.	4,550.	4,597.	4,682.	4,836.	4,951.	5,641.	5,910.	6,461.	6,579.	6,710.
<b>AAR4 cushions</b>	1,685.	1,762.	1,840.	1,926.	1,994.	2,045.	2,129.	2,292.	2,411.	2,949.	3,205.	3,732.	3,841.	3,967.
<b>AAR1-(-)(-)</b>	6,178.	6,385.	6,582.	6,799.	6,979.	7,104.	7,322.	7,738.	8,043.	10,172.	10,932.	12,480.	12,802.	13,177.
<b>AAR1S-(-)(-)</b>	4,576.	4,676.	4,772.	4,878.	4,961.	5,026.	5,129.	5,333.	5,480.	6,189.	6,510.	7,169.	7,305.	7,463.
<b>AAR1 cushions</b>	2,010.	2,162.	2,308.	2,469.	2,602.	2,692.	2,851.	3,156.	3,383.	4,093.	4,531.	5,425.	5,611.	5,828.

Order Code	Ordering Information	Construction
<i>Example:</i> <b>AAR1-CU-CV44-H800/2</b>	<i>Leg finishes:</i> Chrome (suffix C) Copper (suffix CU)	<i>Frame:</i> Constructed in two formed plywood frames, back and seat, giving the pieces their architectural form. Frames are softened with highly resilient urethane foam wrapping.
<b>AAR1</b> AA Lounge Chair		<i>Cushion fill:</i> "Residential" back cushion is 100% polyester fiber and the seat is a multi-density urethane foam.
<b>CU</b> Copper legs		<i>Legs:</i> Machined steel legs feature height adjustable feet for leveling.
<b>CV44</b> Surround in Cervo, Lessinia	<i>Copper leg upcharge:</i> Copper leg finish is available at an upcharge of \$486 list. Use suffix CU to specify.	<i>Upholstery:</i> Interior loose cushions are available in either residential or contract versions. Contract cushions provide a tailored look for high use areas, while residential cushions convey a relaxed aesthetic. For units with combination upholstery, add list price of surround in appropriate grade with the list price of cushions to obtain total list price for item.
<b>H800/2</b> Cushions in Cato, Sand	<i>Upholstery/COM information:</i> Prices shown includes fabric or leather upholstery. Contact your Knoll representative for colors. Only approved KnollTextiles and Spinneybeck leathers may be ordered.	
<i>Specify:</i>	<i>Maintenance:</i> See pages 28-29.	
1. Pattern number		
2. Leg finish		
3. Textile selection		
<i>Specify with split upholstery:</i>		
1. Pattern number		
2. Leg finish		
3. Textile selection, Surround		
4. Textile selection, Cushions		

Approved KnollTextiles Grades/Fabrics						Spinneybeck Leather	
<b>A</b> Chance Common Ground Commuter Cloth Cross Tech Crossroad Delite Facet Hourglass Infinite Mariner Overture Prep * Presto * Sonnet Trophy Uni-Form *	<b>B</b> continued Prairie * Ransom Rush Hour Summit Sutton Synth * Tinge Vast Venue * Westwood * Wild Thing	<b>C</b> continued Milestone * On Point Palisade Patchwork Panache * Plaid On Prestini Sahara Sequin CR * Stepping Stones * Swing Tilden ® * Utmost II Utopia	<b>E</b> Aegean Circle Point * Currents Flower Power Highland Kampala * Off The Grid Rebel Sherman Shima Tempest	<b>G</b> All Star Alter Ego Aurora Dapper Fancy Twill Haze Kamani * Looped In Melange Modern Tweed * Texnet Ultrasuede Vert	<b>I</b> Bella Cato Chic Dynamic Hastings Knoll Velvet * <sup>†</sup> Piper * Rutledge Tudor	<b>U</b> Vicenza Volo	<b>X</b> Ducale Velour
<b>B</b> Argyle * Belize * Calypso Cozy Cord * Day Tripper Diva Dottie Ferry * Helios Instinct Journey Knoll Felt Knoll Hopsack Little Devil Ludlow Melody ®	<b>C</b> Atlas * Chameleon Charm * Contour <sup>†</sup> Circa * Classic Boucle Earthwork Entourage Entwine Groovy Hudson Lagos	<b>D</b> Buzz Eclat Weave * Menagerie Pathway Plaidtastic Retreat Vice Versa	<b>F</b> Atelier Calais Cotton Velvet * Cornaro Double Agent ® Homage Imprint Liberty Rivington * Shima Soon Swank	<b>H</b> Chiseled	<b>V</b> Acqua Andes Embossed Tipped España Velluto Pelle	<b>Y</b> Cascia Cervo Copenhagen Distressed Marissa Riva Rugata Saddle	

\* Not approved on frame  
† Indicates fabrics without topstitching  
Knoll Felt/Ivory K1207/1 not approved  
® Fire Retardant Chemicals

Check with your KnollTextiles or Spinneybeck Representative for additions or changes.

# Pierre Beucler and Jean-Christophe Poggioli

## Architecture & Associés

### Residential Lounge Seating

Designer(s):  
Pierre Beucler and  
Jean-Christophe Poggioli, 2012

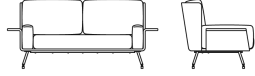
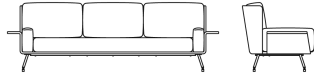

description	seat h	arm h	w	d	h	type	textile	leather	weight
							fabric yds	sq ft	
<b>AAR2</b> AA Settee, low back, std. wing, arms, arm cushions, same upholstery, frame and cushions	16 1/2"	—	69 1/2"	32 3/4"	30 1/8"		9.5	177	—
						frame	4.3	76	—
						upchg, cushions	6.7	101	—
<b>AAR3</b> AA Sofa, low back, std. wing, arms, arm cushions, same upholstery, frame and cushions	16 1/2"	—	97"	32 3/4"	30 1/8"		12.5	231	—
						frame uph.	5.4	93	—
						upchg cushions	8.5	138	—

pattern no.	grades <b>A</b>	COM <b>B</b>	<b>C</b>	<b>D</b>	<b>E</b>	<b>F</b>	<b>G</b>	<b>H</b>	<b>I</b>	COL <b>U</b>	<b>V</b>	<b>W</b>	<b>X</b>	<b>Y</b>
<b>AAR2-(-)(-)</b>	\$8,765.	\$9,072.	\$9,366.	\$9,688.	\$9,950.	\$10,143.	\$10,465.	\$11,081.	\$11,536.	\$14,803.	\$15,948.	\$18,268.	\$18,750.	\$19,314.
<b>AAR2S-(-)(-)(-)</b>	6,453.	6,590.	6,724.	6,871.	6,989.	7,076.	7,222.	7,500.	7,704.	8,922.	9,412.	10,409.	10,618.	10,859.
<b>AAR2 cushions</b>	2,908.	3,126.	3,331.	3,559.	3,744.	3,879.	4,108.	4,542.	4,861.	6,018.	6,673.	7,994.	8,272.	8,591.
<b>AAR3-(-)(-)</b>	11,261.	11,668.	12,051.	12,478.	12,823.	13,074.	13,497.	14,307.	14,907.	19,128.	20,618.	23,651.	24,279.	25,012.
<b>AAR3S-(-)(-)(-)</b>	8,139.	8,313.	8,481.	8,663.	8,814.	8,922.	9,105.	9,455.	9,716.	11,140.	11,738.	12,961.	13,215.	13,511.
<b>AAR3 cushions</b>	3,839.	4,113.	4,374.	4,663.	4,899.	5,071.	5,360.	5,910.	6,314.	8,141.	9,033.	10,842.	11,218.	11,656.

Order Code	Ordering Information	Construction
<i>Example:</i> <b>AAR1-CU-CV44-H800/2</b>	<i>Leg finishes:</i> Chrome (suffix C) Copper (suffix CU)	<i>Frame:</i> Constructed in two formed plywood frames, back and seat, giving the pieces their architectural form. Frames are softened with highly resilient urethane foam wrapping.
<b>AAR1</b> AA Lounge Chair		<i>Cushion fill:</i> "Residential" back cushion is 100% polyester fiber and the seat is a multi-density urethane foam.
<b>CU</b> Copper legs		<i>Legs:</i> Machined steel legs feature height adjustable feet for leveling.
<b>CV44</b> Surround in Cervo, Lessinia	<i>Copper leg upcharge:</i> Copper leg finish is available at an upcharge of \$486 list. Use suffix CU to specify.	<i>Upholstery:</i> Interior loose cushions are available in either residential or contract versions. Contract cushions provide a tailored look for high use areas, while residential cushions convey a relaxed aesthetic. For units with combination upholstery, add list price of surround in appropriate grade with the list price of cushions to obtain total list price for item.
<b>H800/2</b> Cushions in Cato, Sand	<i>Upholstery/COM information:</i> Prices shown includes fabric or leather upholstery. Contact your Knoll representative for colors. Only approved KnollTextiles and Spinneybeck leathers may be ordered.	
	<i>Maintenance:</i> See pages 28-29.	
<i>Specify:</i>		
1. Pattern number		
2. Leg finish		
3. Textile selection		
<i>Specify with split upholstery:</i>		
1. Pattern number		
2. Leg finish		
3. Textile selection, Surround		
4. Textile selection, Cushions		

Approved KnollTextiles Grades/Fabrics						Spinneybeck Leather	
<b>A</b> Chance Common Ground Commuter Cloth Cross Tech Crossroad Delite Facet Hourglass Infinite Mariner Overture Prep * Presto * Sonnet Trophy Uni-Form *	<b>B</b> continued Prairie * Ransom Rush Hour Summit Sutton Synth * Tinge Vast Venue * Westwood * Wild Thing  <b>C</b> Atlas * Chameleon Charm * Contour† Circa * Classic Boucle Earthwork Entourage Entwine Groovy Hudson Lagos	<b>C</b> continued Milestone * On Point Palisade Patchwork Panache * Plaid On Prestini Sahara Sequin CR * Stepping Stones * Swing Tilden Ⓢ * Utmost II Utopia  <b>D</b> Buzz Eclat Weave * Menagerie Pathway Plaidtastic Retreat Vice Versa	<b>E</b> Aegean Circle Point * Currents Flower Power Highland Kampala * Off The Grid Rebel Sherman Shima Tempest  <b>F</b> Atelier Calais Cotton Velvet * Cornaro Double Agent Ⓢ Homage Imprint Liberty Rivington * Shima Soon Swank	<b>G</b> All Star Alter Ego Aurora Dapper Fancy Twill Haze Kamani * Looped In Melange Modern Tweed * Texnet Ultrasuede Vert  <b>H</b> Chiseled	<b>I</b> Bella Cato Chic Dynamic Hastings Knoll Velvet *† Piper * Rutledge Tudor  <b>U</b> Vicenza Volo  <b>V</b> Acqua Andes Embossed Tipped España Velluto Pelle  <b>W</b> Alaska Antique Forte Sabrina Umbria	<b>X</b> Ducale Velour  <b>Y</b> Cascia Cervo Copenhagen Distressed Marissa Riva Rugata Saddle	

\* Not approved on frame  
† Indicates fabrics without topstitching  
Knoll Felt/Ivory K1207/1 not approved  
Ⓢ Fire Retardant Chemicals

Check with your KnollTextiles or Spinneybeck Representative for additions or changes.

# Pierre Beucler and Jean-Christophe Poggioli

## Architecture & Associés

### Residential Lounge Seating

*Designer(s):*  
Pierre Beucler and  
Jean-Christophe Poggioli, 2012



description	seat h	arm h	w	d	h	type	textile fabric yds	leather sq ft	weight
<b>AAR8</b> AA Lounge chair, high back, std. wing, arm cushions, same upholstery, frame and cushions	16 1/2"	—	31 1/2"	36"	36 3/8"		7.3	132	—
<b>AAR8</b> AA Lounge chair, high back, std. wing, arm cushions, combination upholstery, frame and cushions	—	—	—	—	—	frame uph.	3.6	60	—
	—	—	—	—	—	upchg. cushions	4.5	72	—
<b>AAR9</b> AA Settee, high back, std. wing, arms, arm cushions, same upholstery, frame and cushions	16 1/2"	—	69 1/2"	36"	36 3/8"		11.2	203	—
<b>AAR9</b> AA Settee, high back, std. wing, arms, arm cushions, combination upholstery, frame and cushions	—	—	—	—	—	frame uph.	5	89	—
	—	—	—	—	—	upchg. cushions	6.8	114	—

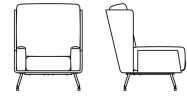

Order Code	Ordering Information	Construction
<i>Example:</i> <b>AAR9-C-PR34-K128/3</b>	<i>Leg finishes:</i> Chrome (suffix C) Copper (suffix CU)	<i>Frame:</i> Constructed in two formed plywood frames, back and seat, giving the pieces their architectural form. Frames are softened with highly resilient urethane foam wrapping.
<b>AAR9</b>	AA Settee, high back	<i>Cushion fill:</i> "Residential" back cushion is 100% polyester fiber and the seat is a multi-density urethane foam.
<b>C</b>	Chrome legs	<i>Legs:</i> Machined steel legs feature height adjustable feet for leveling.
<b>PR34</b>	Surround in Prima, Scarlattì	<i>Upholstery:</i> Interior loose cushions are available in either residential or contract versions. Contract cushions provide a tailored look for high use areas, while residential cushions convey a relaxed aesthetic. For units with combination upholstery, add list price of surround in appropriate grade with the list price of cushions to obtain total list price for item.
<b>K128/3</b>	Cushions in Arno, Obsidian	<i>Upholstery/COM information:</i> Prices shown includes fabric or leather upholstery. Contact your Knoll representative for colors. Only approved KnollTextiles and Spinneybeck leathers may be ordered.
<i>Specify:</i>		<i>Maintenance:</i> See pages 28-29.
1. Pattern number		
2. Leg finish		
3. Textile selection		
<i>Specify with split upholstery:</i>		
1. Pattern number		
2. Leg finish		
3. Textile selection, Surround		
4. Textile selection, Cushions		

pattern no.	grades	COM								COL				
	A	B	C	D	E	F	G	H	I	U	V	W	X	Y
<b>AAR8-(-)(-)</b>	\$6,291.	\$6,530.	\$6,752.	\$7,000.	\$7,205.	\$7,352.	\$7,601.	\$8,073.	\$8,424.	\$10,714.	\$11,568.	\$13,299.	\$13,660.	\$14,078.
<b>AAR8S-(-)(-)</b>	4,644.	4,759.	4,869.	4,992.	5,092.	5,164.	5,288.	5,520.	5,692.	6,579.	6,964.	7,751.	7,914.	8,106.
<b>AAR8 cushions</b>	2,000.	2,146.	2,285.	2,438.	2,565.	2,653.	2,805.	3,098.	3,312.	4,249.	4,714.	5,658.	5,857.	6,083.
<b>AAR9-(-)(-)</b>	9,174.	9,536.	9,883.	10,264.	10,575.	10,799.	11,178.	11,904.	12,440.	16,004.	17,316.	19,976.	20,533.	21,180.
<b>AAR9S-(-)(-)</b>	6,684.	6,845.	6,998.	7,170.	7,308.	7,408.	7,578.	7,904.	8,141.	9,566.	10,139.	11,304.	11,548.	11,831.
<b>AAR9 cushions</b>	2,998.	3,219.	3,428.	3,659.	3,847.	3,984.	4,213.	4,656.	4,983.	6,580.	7,312.	8,809.	9,121.	9,484.

Approved KnollTextiles Grades/Fabrics						Spinneybeck Leather	
<b>A</b> Chance Common Ground Commuter Cloth Cross Tech Crossroad Delite Facet Hourglass Infinite Mariner Overture Prep * Presto * Sonnet Trophy Uni-Form *	<b>B</b> continued Prairie * Ransom Rush Hour Summit Sutton Synth * Tinge Vast Venue * Westwood * Wild Thing  <b>C</b> Atlas * Chameleon Charm * <sup>†</sup> Circa * Classic Boucle Contour Earthwork Entourage Entwine Groovy Hudson Lagos	<b>C</b> continued Milestone * On Point Palisade Patchwork Panache * Plaid On Prestini Sahara Sequin CR * Stepping Stones * Swing Tilden <sup>Ⓞ</sup> * Utmost II Utopia  <b>D</b> Buzz Eclat Weave * Menagerie Pathway Plaidtastic Retreat Vice Versa	<b>E</b> Aegean Circle Point * Currents Flower Power Highland Kampala * Off The Grid Rebel Sherman Shima Tempest  <b>F</b> Atelier Calais Cotton Velvet *  <b>G</b> Cornaro Double Agent <sup>Ⓞ</sup> Homage Imprint Liberty Rivington * Shima Soon Swank	<b>G</b> All Star Alter Ego Aurora Dapper Fancy Twill Haze Kamani * Looped In Melange Modern Tweed * Texnet Ultrasuede Vert  <b>H</b> Chiseled	<b>I</b> Bella Cato Chic Dynamic Hastings Knoll Velvet * <sup>†</sup> Piper * Rutledge Tudor  <b>U</b> Vicenza Volo  <b>V</b> Acqua Andes Embossed Tipped España Velluto Pelle  <b>W</b> Alaska Antique Forte Sabrina Umbria	<b>X</b> Ducale Velour  <b>Y</b> Cascia Cervo Copenhagen Distressed Marissa Riva Rugata Saddle	

\* Not approved on frame  
<sup>†</sup> Indicates fabrics without topstitching  
 Knoll Felt/Ivory K1207/1 not approved  
 Ⓞ Fire Retardant Chemicals

Check with your KnollTextiles or Spinneybeck Representative for additions or changes.



# Pierre Beucler and Jean-Christophe Poggioli

## Architecture & Associés

### Residential Lounge Seating

*Designer(s):*  
Pierre Beucler and  
Jean-Christophe Poggioli, 2012



description	seat h	arm h	w	d	h	type	textile fabric yds	leather sq ft	weight
<b>AAR10</b> AA Sofa, high back, std. wing, arms, arm cushions, same upholstery, frame and cushions	16 1/2"	—	97"	36"	36 3/8"		13.8	243	—
<b>AAR10</b> AA Sofa, high back, std. wing, arms, arm cushions, combination upholstery, frame and cushions	—	—	—	—	—	frame uph.	6.1	110	—
	—	—	—	—	—	upchg, cushions	8.6	157	—
<b>AAR11</b> AA Settee, high back, large wing, arms, same upholstery, frame and cushions	16 1/2"	—	69 1/2"	36"	36 3/8"		10.3	190	—
<b>AAR11</b> AA Settee, high back, large wing, arms, combination upholstery, frame and cushions	—	—	—	—	—	frame uph.	5.5	97	—
	—	—	—	—	—	upchg, cushions	5	93	—

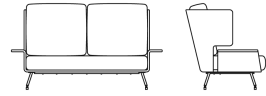

Order Code	Ordering Information	Construction
<i>Example:</i> <b>AAR9-C-PR34-K128/3</b>	<i>Leg finishes:</i> Chrome (suffix C) Copper (suffix CU)	<i>Frame:</i> Constructed in two formed plywood frames, back and seat, giving the pieces their architectural form. Frames are softened with highly resilient urethane foam wrapping.
<b>AAR9</b> AA Settee, high back		<i>Cushion fill:</i> "Residential" back cushion is 100% polyester fiber and the seat is a multi-density urethane foam.
<b>C</b> Chrome legs		<i>Legs:</i> Machined steel legs feature height adjustable feet for leveling.
<b>PR34</b> Surround in Prima, Scarlatti	<i>Copper leg upcharge:</i> Copper leg finish is available at an upcharge of \$486 list. Use suffix CU to specify.	<i>Upholstery:</i> Interior loose cushions are available in either residential or contract versions. Contract cushions provide a tailored look for high use areas, while residential cushions convey a relaxed aesthetic. For units with combination upholstery, add list price of surround in appropriate grade with the list price of cushions to obtain total list price for item.
<b>K128/3</b> Cushions in Arno, Obsidian	<i>Upholstery/COM information:</i> Prices shown includes fabric or leather upholstery. Contact your Knoll representative for colors. Only approved KnollTextiles and Spinneybeck leathers may be ordered.	
<i>Specify:</i>	<i>Maintenance:</i> See pages 28-29.	
1. Pattern number		
2. Leg finish		
3. Textile selection		
<i>Specify with split upholstery:</i>		
1. Pattern number		
2. Leg finish		
3. Textile selection, Surround		
4. Textile selection, Cushions		

pattern no.	grades A	COM B	C	D	E	F	G	H	I	COL U	V	W	X	Y
<b>AAR10-(-)(-)</b>	\$11,719.	\$12,166.	\$12,591.	\$13,058.	\$13,443.	\$13,720.	\$14,189.	\$15,079.	\$15,743.	\$19,898.	\$21,467.	\$24,651.	\$25,317.	\$26,089.
<b>AAR10S-(-)(-)(-)</b>	8,428.	8,626.	8,814.	9,019.	9,191.	9,312.	9,521.	9,917.	10,205.	11,985.	12,697.	14,137.	14,438.	14,788.
<b>AAR10 cushions</b>	3,957.	4,235.	4,499.	4,792.	5,032.	5,201.	5,495.	6,052.	6,463.	8,952.	9,963.	12,022.	12,450.	12,951.
<b>AAR11-(-)(-)</b>	9,906.	10,238.	10,554.	10,904.	11,192.	11,397.	11,746.	12,416.	12,907.	16,346.	17,573.	20,063.	20,580.	21,185.
<b>AAR11S-(-)(-)(-)</b>	7,279.	7,458.	7,629.	7,812.	7,968.	8,077.	8,262.	8,621.	8,885.	10,408.	11,031.	12,304.	12,567.	12,879.
<b>AAR11 cushions</b>	3,094.	3,255.	3,407.	3,580.	3,716.	3,817.	3,987.	4,311.	4,550.	6,074.	6,677.	7,896.	8,149.	8,445.

Approved KnollTextiles Grades/Fabrics						Spinneybeck Leather	
<b>A</b> Chance Common Ground Commuter Cloth Cross Tech Crossroad Delite Facet Hourglass Infinite Mariner Overture Prep * Presto * Sonnet Trophy Uni-Form *	<b>B</b> continued Prairie * Ransom Rush Hour Summit Sutton Synth * Tinge Vast Venue * Westwood * Wild Thing	<b>C</b> continued Milestone * On Point Palisade Patchwork Panache * Plaid On Prestini Sahara Sequin CR * Stepping Stones * Swing Tilden © * Utmost II Utopia	<b>E</b> Aegean Circle Point * Currents Flower Power Highland Kampala * Off The Grid Rebel Sherman Shima Tempest	<b>G</b> All Star Alter Ego Aurora Dapper Fancy Twill Haze Kamani * Looped In Melange Modern Tweed * Texnet Ultrasuede Vert	<b>I</b> Bella Cato Chic Dynamic Hastings Knoll Velvet *† Piper * Rutledge Tudor	<b>U</b> Vicenza Volo	<b>X</b> Ducale Velour
<b>B</b> Argyle * Belize * Calypso Cozy Cord * Day Tripper Diva Dottie Ferry * Helios Instinct Journey Knoll Felt Knoll Hopsack Little Devil Ludlow Melody ©	<b>C</b> Atlas * Chameleon Charm *† Circa * Classic Boucle Contour Earthwork Entourage Entwine Groovy Hudson Lagos	<b>D</b> Buzz Eclat Weave * Menagerie Pathway Plaidtastic Retreat Vice Versa	<b>F</b> Atelier Calais Cotton Velvet * Cornaro Double Agent © Homage Imprint Liberty Rivington * Shima Soon Swank	<b>H</b> Chiseled	<b>V</b> Acqua Andes Embossed Tipped España Velluto Pelle	<b>Y</b> Cascia Cervo Copenhagen Distressed Marissa Riva Rugata Saddle	

\* Not approved on frame  
† Indicates fabrics without topstitching  
Knoll Felt/Ivory K1207/1 not approved  
© Fire Retardant Chemicals

Check with your KnollTextiles or Spinneybeck Representative for additions or changes.

# Pierre Beucler and Jean-Christophe Poggioli

## Architecture & Associés

### Residential Lounge Seating

Designer(s):  
Pierre Beucler and  
Jean-Christophe Poggioli, 2012



description	seat h	arm h	w	d	h	type	leather sq ft	textile fabric yds	weight
<b>AAR12L</b> AA Chaise, high back, large wing, left arm, same upholstery, frame and cushions	16 1/2"	—	35 1/2"	69"	36 3/8"		150	8.3	—
<b>AAR12L</b> AA Chaise, high back, large wing, left arm, combination upholstery, frame and cushions	—	—	—	—	—	frame uph.	86	5.3	—
	—	—	—	—	—	upchg, cushions	64	4.4	—
<b>AAR12R</b> AA Chaise, high back, large wing, right arm, same upholstery, frame and cushions	16 1/2"	—	35 1/2"	69"	36 3/8"		150	8.3	—
<b>AAR12R</b> AA Chaise, high back, large wing, right arm, combination upholstery, frame and cushions	—	—	—	—	—	frame uph.	86	5.3	—
	—	—	—	—	—	upchg, cushions	64	4.4	—

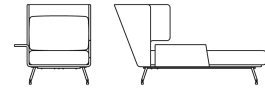

Order Code	Ordering Information	Construction
<i>Example:</i> <b>AAR12L-CU-RA1805-K1021/5</b>	<i>Leg finishes:</i> Chrome (suffix C) Copper (suffix CU)	<i>Frame:</i> Constructed in two formed plywood frames, back and seat, giving the pieces their architectural form. Frames are softened with highly resilient urethane foam wrapping.
<b>AAR12L</b> AA Chaise, left arm	<i>Copper leg upcharge:</i> Copper leg finish is available at an upcharge of \$486 list. Use suffix CU to specify.	<i>Cushion fill:</i> "Residential" back cushion is 100% polyester fiber and the seat is a multi-density urethane foam.
<b>CU</b> Copper legs		<i>Legs:</i> Machined steel legs feature height adjustable feet for leveling.
<b>RA1805</b> Surround in Riva, Labbo		
<b>K1021/5</b> Cushions in Ultrasuede, Aztec		
<i>Specify:</i> 1. Pattern number 2. Leg finish 3. Textile selection	<i>Upholstery/COM information:</i> Prices shown includes fabric or leather upholstery. Contact your Knoll representative for colors. Only approved KnollTextiles and Spinneybeck leathers may be ordered.	<i>Upholstery:</i> Interior loose cushions are available in either residential or contract versions. Contract cushions provide a tailored look for high use areas, while residential cushions convey a relaxed aesthetic. For units with combination upholstery, add list price of surround in appropriate grade with the list price of cushions to obtain total list price for item.
<i>Specify with split upholstery:</i> 1. Pattern number 2. Leg finish 3. Textile selection, Surround 4. Textile selection, Cushions	Customer's Own Material is available pending approval. For approval requirements, processing instructions and ordering information please see page 21.	
	<i>Maintenance:</i> See pages 28-29.	

pattern no.	grades <b>A</b>	COM <b>B</b>	<b>C</b>	<b>D</b>	<b>E</b>	<b>F</b>	<b>G</b>	<b>H</b>	<b>I</b>	COL <b>U</b>	<b>V</b>	<b>W</b>	<b>X</b>	<b>Y</b>
<b>AAR12L-(-)(-)</b>	\$9,521.	\$9,789.	\$10,046.	\$10,329.	\$10,557.	\$10,723.	\$11,006.	\$11,543.	\$11,940.	\$14,684.	\$15,650.	\$17,618.	\$18,026.	\$18,506.

<b>AAR12LS-(-)(-)</b>	7,243.	7,412.	7,578.	7,759.	7,906.	8,011.	8,193.	8,535.	8,787.	9,985.	10,540.	11,671.	11,901.	12,177.
<b>AAR12L cushions</b>	2,860.	3,004.	3,142.	3,292.	3,410.	3,499.	3,648.	3,935.	4,145.	4,835.	5,248.	6,085.	6,261.	6,465.

<b>AAR12R-(-)(-)</b>	9,521.	9,789.	10,046.	10,329.	10,557.	10,723.	11,006.	11,543.	11,940.	14,684.	15,650.	17,618.	18,026.	18,506.
----------------------	--------	--------	---------	---------	---------	---------	---------	---------	---------	---------	---------	---------	---------	---------

<b>AAR12RS-(-)(-)</b>	7,243.	7,412.	7,578.	7,759.	7,906.	8,011.	8,193.	8,535.	8,787.	9,985.	10,540.	11,671.	11,901.	12,177.
<b>AAR12R cushions</b>	2,860.	3,004.	3,142.	3,292.	3,410.	3,499.	3,648.	3,935.	4,145.	4,835.	5,248.	6,085.	6,261.	6,465.

#### Approved KnollTextiles Grades/Fabrics

<b>A</b> Chance Common Ground Commuter Cloth Cross Tech Crossroad Delite Facet Hourglass Infinite Mariner Overture Prep * Presto * Sonnet Trophy Uni-Form *	<b>B</b> continued Prairie * Ransom Rush Hour Summit Sutton Synth * Tinge Vast Venue * Westwood * Wild Thing  <b>C</b> Atlas * Chameleon Charm * <sup>†</sup> Circa * Classic Boucle Contour Earthwork Entourage Entwine Groovy Hudson Lagos	<b>C</b> continued Milestone * On Point Palisade Patchwork Panache * Plaid On Prestini Quark * Sahara Sequin CR * Stepping Stones * Swing Tilden <sup>Ⓞ</sup> * Utmost II Utopia  <b>D</b> Buzz Eclat Weave * Menagerie Pathway Plaidtastic Retreat Vice Versa	<b>E</b> Aegean Circle Point * Currents Flower Power Highland Kampala * Off The Grid Rebel Sherman Shima Tempest  <b>F</b> Atelier Calais Cotton Velvet *  Cornaro Double Agent <sup>Ⓞ</sup> Homage Imprint Liberty Rivington * Shima Soon Swank	<b>G</b> All Star Alter Ego Aurora Dapper Fancy Twill Haze Kamani * Looped In Melange Modern Tweed * Texnet Ultrasuede Vert  <b>H</b> Chiseled	<b>I</b> Bella Cato Chic Dynamic Hastings Knoll Velvet * <sup>†</sup> Piper * Rutledge Tudor	<b>U</b> Vicenza Volo  <b>V</b> Acqua Andes Embossed Tipped España Velluto Pelle  <b>W</b> Alaska Antique Forte Sabrina Umbria	<b>X</b> Ducale Velour  <b>Y</b> Cascia Cervo Copenhagen Distressed Marissa Riva Rugata Saddle
---	--	---	--	--	---	--	---

\* Not approved on frame  
† Indicates fabrics without topstitching  
Knoll Felt/Ivory K1207/1 not approved  
Ⓞ Fire Retardant Chemicals

Check with your KnollTextiles or Spinneybeck Representative for additions or changes.



# Pierre Beucler and Jean-Christophe Poggioli

## Architecture & Associés

### Residential Lounge Seating

Designer(s):  
Pierre Beucler and  
Jean-Christophe Poggioli, 2012



description	seat h	arm h	w	d	h	type	textile fabric yds	leather sq ft	weight
<b>AAR5</b> AA Small Ottoman, same upholstery, frame and cushions 	–	–	27 1/2"	24 1/2"	16"		2.2	40	–
<b>AAR5</b> AA Small Ottoman, combination upholstery, frame and cushions	–	–	–	–	–	frame uph.	1.2	18	–
	–	–	–	–	–	upchg, cushions	1.3	22	–
<b>AAR6</b> AA Medium Ottoman, same upholstery, frame and cushions 	–	–	31 1/8"	29 1/2"	16"		3.3	60	–
<b>AAR6</b> AA Medium Ottoman, combination upholstery, frame and cushions	–	–	–	–	–	frame uph.	1.8	28	–
	–	–	–	–	–	upchg, cushions	2.3	32	–
<b>AAR7</b> AA Large Ottoman, same upholstery, frame and cushions 	–	–	59"	29 1/2"	16 1/2"		4.5	74	–
<b>AAR7</b> AA Large Ottoman, combination upholstery, frame and cushions	–	–	–	–	–	frame uph.	2.2	31	–
	–	–	–	–	–	upchg, cushions	2.7	43	–

pattern no.	grades A	COM B	C	D	E	F	G	H	I	COL U	V	W	X	Y
<b>AAR5-(-)(-)</b>	\$3,305.	\$3,381.	\$3,449.	\$3,520.	\$3,583.	\$3,626.	\$3,701.	\$3,842.	\$3,947.	\$4,741.	\$4,997.	\$5,523.	\$5,636.	\$5,758.
<b>AAR5S-(-)(-)(-)</b>	2,512.	2,552.	2,586.	2,633.	2,664.	2,688.	2,729.	2,809.	2,863.	3,098.	3,213.	3,452.	3,498.	3,557.
<b>AAR5 cushions</b>	998.	1,039.	1,081.	1,123.	1,161.	1,186.	1,230.	1,315.	1,377.	1,699.	1,842.	2,129.	2,192.	2,261.
<b>AAR6-(-)(-)</b>	3,484.	3,588.	3,691.	3,802.	3,893.	3,959.	4,073.	4,283.	4,444.	5,544.	5,931.	6,720.	6,883.	7,074.
<b>AAR6S-(-)(-)(-)</b>	2,616.	2,676.	2,731.	2,793.	2,845.	2,882.	2,942.	3,056.	3,144.	3,509.	3,694.	4,060.	4,136.	4,225.
<b>AAR6 cushions</b>	1,118.	1,192.	1,263.	1,341.	1,404.	1,449.	1,531.	1,682.	1,790.	2,091.	2,296.	2,716.	2,804.	2,906.
<b>AAR7-(-)(-)</b>	5,274.	5,422.	5,560.	5,712.	5,837.	5,928.	6,079.	6,371.	6,588.	7,738.	8,215.	9,185.	9,388.	9,623.
<b>AAR7S-(-)(-)(-)</b>	4,053.	4,123.	4,189.	4,268.	4,329.	4,372.	4,445.	4,589.	4,695.	5,017.	5,217.	5,624.	5,709.	5,806.
<b>AAR7 cushions</b>	1,438.	1,525.	1,607.	1,700.	1,776.	1,831.	1,921.	2,096.	2,226.	2,776.	3,053.	3,617.	3,734.	3,873.

Order Code	Ordering Information	Construction
<i>Example:</i> <b>AAR5-C-SL69</b>	<i>Leg finishes:</i> Chrome (suffix C) Copper (suffix CU)	<i>Frame:</i> Constructed in two formed plywood frames, back and seat, giving the pieces their architectural form. Frames are softened with highly resilient urethane foam wrapping.
<b>AAR5</b>	AA Small Ottoman	
<b>C</b>	Chrome legs	
<b>SL69</b>	Saddle, Seal Bay	
	<i>Copper leg upcharge:</i> Copper leg finish is available at an upcharge of \$486 list. Use suffix CU to specify.	<i>Cushion fill:</i> "Residential" back cushion is 100% polyester fiber and the seat is a multi-density urethane foam.
	<i>Upholstery/COM information:</i> Prices shown includes fabric or leather upholstery. Contact your Knoll representative for colors. Only approved KnollTextiles and Spinneybeck leathers may be ordered.	<i>Legs:</i> Machined steel legs feature height adjustable feet for leveling.
	<i>Maintenance:</i> See pages 28-29.	<i>Upholstery:</i> Interior loose cushions are available in either residential or contract versions. Contract cushions provide a tailored look for high use areas, while residential cushions convey a relaxed aesthetic. For units with combination upholstery, add list price of surround in appropriate grade with the list price of cushions to obtain total list price for item.
<i>Specify:</i>		
1. Pattern number		
2. Leg finish		
3. Textile selection		
<i>Specify with split upholstery:</i>		
1. Pattern number		
2. Leg finish		
3. Textile selection, Surround		
4. Textile selection, Cushions		
	Customer's Own Material is available pending approval. For approval requirements, processing instructions and ordering information please see page 21.	

Approved KnollTextiles Grades/Fabrics						Spinneybeck Leather	
<b>A</b> Chance Common Ground Commuter Cloth Cross Tech Crossroad Delite Facet Hourglass Infinite Mariner Overture Prep * Presto * Sonnet Trophy Uni-Form *	<b>B</b> continued Prairie * Ransom Rush Hour Summit Sutton Synth * Tinge Vast Venue * Westwood * Wild Thing	<b>C</b> continued Milestone * On Point Palisade Patchwork Panache * Plaid On Prestini Quark * Sahara Sequin CR * Stepping Stones * Swing Tilden © * Utmost II Utopia	<b>E</b> Aegean Circle Point * Currents Flower Power Highland Kampala * Off The Grid Rebel Sherman Shima Tempest	<b>G</b> All Star Alter Ego Aurora Dapper Fancy Twill Haze Kamani * Looped In Melange Modern Tweed * Texnet Ultrasuede Vert	<b>I</b> Bella Cato Chic Dynamic Hastings Knoll Velvet * <sup>†</sup> Piper * Rutledge Tudor	<b>U</b> Vicenza Volo	<b>X</b> Ducale Velour
<b>B</b> Argyle * Belize * Calypso Cozy Cord * Day Tripper Diva Dottie Ferry * Helios Instinct Journey Knoll Felt Knoll Hopsack Little Devil Ludlow Melody ©	<b>C</b> Atlas * Chameleon Charm * <sup>†</sup> Circa * Classic Boucle Contour Earthwork Entourage Entwine Groovy Hudson Lagos	<b>D</b> Buzz Eclat Weave * Menagerie Pathway Plaidtastic Retreat Vice Versa	<b>F</b> Atelier Calais Cotton Velvet * Cornaro Double Agent © Homage Imprint Liberty Rivington * Shima Soon Swank	<b>H</b> Chiseled	<b>V</b> Acqua Andes Embossed Tipped España Velluto Pelle	<b>W</b> Alaska Antique Forte Sabrina Umbria	<b>Y</b> Cascia Cervo Copenhagen Distressed Marissa Riva Rugata Saddle



\* Not approved on frame  
† Indicates fabrics without topstitching  
Knoll Felt/Ivory K1207/1 not approved  
© Fire Retardant Chemicals

Check with your KnollTextiles or Spinneybeck Representative for additions or changes.

# Cini Boeri Pillows

Designer(s):  
Cini Boeri, 2008



description	seat h	arm h	w	d	h	textile fabric yds.	req. leather sq. ft.	weight
<b>CBP1</b> Large throw pillow 			31"		24"	2	n/a	
<b>CBP2</b> Small throw pillow 			24"		18"	1.6	n/a	

pattern no.	grades <b>A</b>	COM <b>B</b>	<b>C</b>	<b>D</b>	<b>E</b>	<b>F</b>	<b>G</b>	<b>H</b>	<b>I</b>	COL <b>U</b>	<b>V</b>	<b>W</b>	<b>X</b>	<b>Y</b>
<b>CBP1-( )</b>	\$683.	\$755.	\$825.	\$900.	\$963.	\$1,009.	\$1,085.	\$1,229.	\$1,335.					
<b>CBP2-( )</b>	588.	651.	726.	806.	870.	909.	985.	1,125.	1,233.					

### Order Code

<i>Example:</i>	<b>CBP1-K1152/1</b>
<b>CBP1</b>	Large pillow
<b>K1152/1</b>	Stirling, Gable

### Specify:

1. Pattern number
2. Textile selection

### Ordering Information

*Upholstery/COM information:*  
Contact your Knoll representative for colors. Only approved KnollTextiles and Spinneybeck leathers may be ordered.

**Customer's Own Material in textile applications is limited and no COL leather applications are approved.**  
For approval requirements, processing instructions and ordering information, please see page 21.

*Maintenance:*  
See pages 28-29.

*Note:*  
The Cini Boeri Pillow is certified Clean Air GOLD.

### Construction

*Pillow:*  
Throw pillows for the Cini Boeri Lounge Collection are available in two sizes. Pillows are composed of of recycled polyester. Since pillow is not fitted it is available in fabric only.

### Approved KnollTextiles Grades/Fabrics

<b>A</b> Alignment Beacon Bocce Chance Common Ground Commuter Cloth Cross Tech Crossroad Delite Facet Heavy Metal Hourglass Infinite Mariner Monarch Overture Prep Presto Sonnet Trophy Uni-Form	<b>B</b> Abacus Argyle Belize Bistro Calypso Chronicle Close Knit Cozy Cord Day Tripper Diva Dottie Ferry Gala II Grandview Holbrook Instinct	<b>C</b> continued Journey Keaton Knoll Felt Knoll Hopsack Little Devil Ludlow Melody <sup>Ⓞ</sup> Nonchalant CR Paradigm Prairie Prim Radiance Ransom Roam Rush Hour Spree Summit Sutton Synth Tabloid Tinge Topos Vast Venue Versa Westwood Wild Thing	<b>C</b> continued Durand Earthwork Empire Stripe Entourage Entwine Essence Fibra Greenwich Groovy Hudson Kaleidoscope Lagos Lore CR Milestone On Point Palisade Panache CR Patchwork Plaid On Prestini Pullman Quark Roundtrip Sahara Spectator Stepping Stones Swing Tight Rope Tilden <sup>Ⓞ</sup> Tower Grid	<b>C</b> continued Wow Factor Utmost II Utopia Zari CR	<b>D</b> Buzz Coterie Eclat Weave Hologram Island Kabuki Menagerie Origins Pathway Plaidtastic Retreat Vice Versa Woodland Zoom	<b>E</b> Aegean Circle Point Currents Flower Power Highland Ikat Stripe Kampala Kimono Mamba Marquee Meroe Off The Grid Rebel Sherman Shima Tempest Tryst Whip	<b>F</b> Atelier Biscayne Calais Cotton Velvet Century Cornaro Glider Homage Imprint Liberty Mod Plaid Rivington Soon Swank Totem	<b>G</b> All Star Alter Ego Aurora Dapper Djenne Fancy Twill Gibson Haze Melange Modern Tweed Spencer Texnet Ultrasuede Utrillo Vert	<b>H</b> Chiseled Constance Firefly  <b>I</b> Bella Byron Cato Chic Diamond Days Doily Dynamic Florescence Guise Hastings In Step Jaipur Knoll Velvet Olema Piper Rutledge Sandis Stripe It Tudor Zimba
---	---	--	---	---	---	--	--	---	--

### Spinneybeck Leather

<b>U</b> Vicenza Volo	<b>V</b> Acqua Andes España Embossed Tipped Hand Tipped Velluto Pelle	<b>W</b> Alaska Antique Derby Forte Lucente Sabrina Umbria	<b>X</b> Ducale Ducale Velour	<b>Y</b> Cascia Cervo Copenhagen Distressed Marissa Riva Rugata Saddle
-----------------------------	---	---	-------------------------------------	--

<sup>Ⓞ</sup> Fire Retardant Chemicals

*Check with your KnollTextiles or Spinneybeck Representative for changes or additions.*

# Marcel Breuer Cesca™ Chair

Designer(s):  
Marcel Breuer, 1928

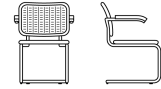
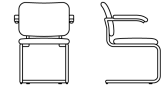

description	seat h	arm h	w	d	h	textile fabric yds.	req. leather sq. ft.	weight	seat and back finish
<b>51A-7</b> Arm chair, fully upholstered seat and back	17 3/4"	27"	23 1/2"	23 1/2"	31 1/2"	1.1	20	17 lbs.	
<b>51A-5</b> Arm chair, machine caned seat and back or upholstered seat and machine caned back	17 3/4"	27"	23 1/2"	23 1/2"	31 1/2"			16 lbs.	upholstered seat and cane back
	17 3/4"	27"	23 1/2"	23 1/2"	31 1/2"			16 lbs.	full cane

### Order Code

<i>Example:</i>	<b>51A-5-S-K2450/3-B</b>
<b>51A-5</b>	Cesca arm chair
<b>S</b>	Split upholstery
<b>K2450/3</b>	Prestini seat upholstery
<b>B</b>	Clear cane frame back
<i>Example:</i>	<b>51A-7-K1207/12-K1207/12</b>
<b>51A-7</b>	Cesca arm chair, fully upholstered
<b>K1207/12</b>	Knoll Felt, Baltic

Note:  
Cesca chairs are part of a collection. Please refer to the Wassily lounge chair and Laccio tables on pages 112 and 380.

### Specify:

1. Pattern number
2. Cal 133 option (add C)
3. Split upholstery option (add S)
4. Textile, leather, or wood frame selection, seat
5. Textile, leather, or wood frame selection, back

### Ordering Information

*Wood frame finish:*  
Clear (suffix B)  
Ebonized (suffix BE)

*Split upholstery option:*  
The seat and back of the Cesca chairs can be specified in split upholstery. Indicate "S" before selected seat upholstery or wood frame finish, followed by selected back upholstery or wood frame finish. If selecting cane back and upholstered seat, always use the cane pattern number. The price equals the price of the higher upholstery grade. **The arms will always match the back finish. Please note it is not possible to have a cane seat and an upholstered back; or to combine two different wood frame finishes.**

*Upholstery/COM information:*  
Prices shown include fabric or leather upholstery. Contact your Knoll representative for colors. Only approved KnollTextiles and Spinneybeck leathers may be ordered.

Customer's Own Material is available pending approval. For approval requirements, processing instructions and ordering information please see page 21.

*COM split fabric requirements:*  
Back and arms upholstery: 0.7 yards  
Seat upholstery: 0.4 yards

*COL split fabric requirements:*  
Back and arms upholstery: 14 square feet  
Seat upholstery: 6 square feet

*Cal 133 Fire Code #:*  
The Cesca chair complies with California Technical Bulletin 133 with select KnollTextiles. Upcharge applies, see page 18.

*Note:*  
The KnollStudio logo and signature of Marcel Breuer are stamped into the base of the chair.

The Cesca Chair is certified Clean Air GOLD.

*Maintenance:*  
See pages 28-29.

### Construction

*Fully upholstered chairs:*  
Urethane foam over molded plywood seat and back. Solid hardwood arms. Arms are upholstered.

*Cane inset chairs:*  
Hardwood beech seat/back frames and arms with natural clear lacquer or matte ebonized finish. Machine caned insets.

*Frame:*  
1" diameter round steel tube with chrome-plated and polished finish.

*Glides:*  
Opaque plastic; snap-in place design. Glides shipped with each chair for optional in-field insertion.

pattern no.	cane	grades A	COM B	C	D	E	F	G	H	I	COL U	V	W	X	Y
<b>51A-7</b>		\$1,482.	\$1,534.	\$1,583.	\$1,593.	\$1,612.	\$1,676.	\$1,818.	\$1,878.	\$2,017.	\$2,037.	\$2,345.	\$2,566.	\$2,667.	\$2,767.
<b>51A-5-S</b>	0.	1,693.	1,713.	1,729.	1,733.	1,739.	1,763.	1,814.	1,835.	1,886.	1,853.	1,945.	2,012.	2,043.	2,073.
<b>51A-5</b>	1,788.	0.	0.	0.	0.	0.	0.	0.	0.	0.	0.	0.	0.	0.	0.

### Approved KnollTextiles Grades/Fabrics

<b>A</b> Alignment Beacon Bocce Chance Common Ground Commuter Cloth Crossroad Delite Hourglass Infinite Mariner Overture Prep Presto Soliloquy Sonnet Trophy Uni-Form	<b>B</b> Abacus Argyle Attire Bistro Boundary Calypso Chronicle Close Knit Day Tripper Diva Dottie Ferry Forza © Gala II Grande Grandview	<b>C</b> Atlas Axiom © Baxter Chameleon Charm Circa Classic Boucle Durand Earthwork Empire Stripe Entwine Entourage Essence Fibra Greenwich Hudson Lagos Magnolia On Point Palisade Patchwork Panache CR Plaid On Prestini Pullman Quark Roundtrip Versa Sequin CR Sinclair Smart © Spectator Stepping Stones Swing	<b>C</b> continued Tight Rope Tilden © Tower Grid Wow Factor Utmost II Utopia Wit Zari CR	<b>D</b> Buzz Code Coterie Eclat Weave Hologram Island Menagerie Origins Plaidtastic Retreat Vice Versa Woodand Zoom	<b>E</b> Aegean Circle Point Cleo Demure Flower Power Highland Ikat Stripe Juno Kampala Mamba Marquee Midpoint Nature Walk Off The Grid Rebel Sherman Shima Tempest Vatera Whip	<b>F</b> Atelier Calais Cotton Velvet Century Biscayne Cornaro Double Agent © Glider Homage In Stitches Jasmine Liberty Mod Plaid Rivington Totem Tweed Frieze	<b>G</b> All Star Alter Ego Aurora Color Collage Dapper Djenne Duchess Fancy Twill Gibson Kamani Looped In Melange Modern Tweed Spencer Straie Stripe Texnet Ultrasuede Utrillo Vert	<b>H</b> Bavaria Catwalk Chiseled Constance Firefly Stretch Appeal Twist Tie World Piece	<b>I</b> Aswan Bella Byron Cato Chic Diamond Days Doily Dynamic Florescence Guise Hastings In Step Ita Knoll Velvet Limani North Island Olema Piper Prince Hairy Rutledge Tudor Zimba	<b>U</b> Vicenza Volo	<b>X</b> Ducale Velour	<b>Y</b> Cervo Copenhagen Distressed Gemma Lucca Marissa Riva
---	---	---	---	---	---	--	---	--	---	-----------------------------	---------------------------	--

### Spinneybeck Leather

<b>U</b> Vicenza Volo	<b>X</b> Ducale Velour
<b>V</b> Acqua Amalfi Andes Embossed Tipped España Velluto Pelle	<b>Y</b> Cervo Copenhagen Distressed Gemma Lucca Marissa Riva
<b>W</b> Alaska Antique Derby Forte Lucente Sabrina Umbria	

© Fire Retardant Chemicals

*Check with your KnollTextiles or Spinneybeck Representative for changes or additions.*

# Marcel Breuer Cesca™ Chair

Designer(s):  
Marcel Breuer, 1928

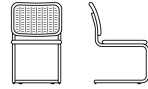
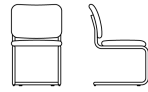

description	seat h	w	d	h	textile fabric yds.	leather sq. ft.	weight	seat and back finish
<b>51C-2</b> Armless chair, fully upholstered seat and back	17 3/4"	18 1/2"	23 1/2"	31 1/2"	1.1	20	14 lbs.	
<b>51C-1</b> Armless chair, machine caned seat and back or upholstered seat and machine caned back	17 3/4"	18 1/2"	23 1/2"	31 1/2"			11 lbs.	upholstered seat and cane back
	17 3/4"	18 1/2"	23 1/2"	31 1/2"			11 lbs.	full cane

### Order Code

<i>Example:</i>	<b>51C-1-S-K2450/3-B</b>
<b>51A-5</b>	Cesca armless chair
<b>S</b>	Split upholstery
<b>K2450/3</b>	Prestini seat upholstery
<b>B</b>	Clear cane frame back

<i>Example:</i>	<b>51C-2-K1207/12-K1207/12</b>
<b>51C-2</b>	Cesca armless chair, fully upholstered
<b>K1207/12</b>	Knoll Felt, Baltic

Note:  
Cesca chairs are part of a collection. Please refer to the Wassily lounge chair and Laccio tables on pages 112 and 380.

### Specify:

1. Pattern number
2. Cal 133 option (add C)
3. Split upholstery option (add S)
4. Textile, leather, or wood frame selection, seat
5. Textile, leather, or wood frame selection, back

### Ordering Information

*Wood frame finish:*  
Clear (suffix B)  
Ebonized (suffix BE)

*Split upholstery option:*  
The seat and back of the Cesca chairs can be specified in split upholstery. Indicate "S" before selected seat upholstery or wood frame finish, followed by selected back upholstery or wood frame finish. If selecting cane back and upholstered seat, always use the cane pattern number. The price equals the price of the higher upholstery grade. **Please note it is not possible to have a cane seat and an upholstered back; or to combine two different wood frame finishes.**

*Upholstery/COM information:*  
Prices shown include fabric or leather upholstery. Contact your Knoll representative for colors. Only approved KnollTextiles and Spinneybeck leathers may be ordered.

Customer's Own Material is available pending approval. For approval requirements, processing instructions and ordering information please see page 21.

*COM split fabric requirements:*  
Back upholstery: 0.4 yards  
Seat upholstery: 0.4 yards

*COL split fabric requirements:*  
Back upholstery: 6 square feet  
Seat upholstery: 6 square feet

*Cal 133 Fire Code #:*  
The Cesca chair complies with California Technical Bulltin 133 with select KnollTextiles. Upcharge applies, see page 18.

*Note:*  
The KnollStudio logo and signature of Marcel Breuer are stamped into the base of the chair.

The Cesca Chair is certified Clean Air GOLD.

*Maintenance:*  
See pages 28-29.

### Construction

*Fully upholstered chairs:*  
Urethane foam over molded plywood seat and back.

*Cane inset chairs:*  
Hardwood beech seat/back frames and arms with natural clear lacquer or matte ebonized finish. Machine caned insets.

*Frame:*  
1" diameter round steel tube with chrome-plated and polished finish.

*Glides:*  
Opaque plastic; snap-in place design. Glides shipped with each chair for optional in-field insertion.

pattern no.	cane	grades A	COM B	C	D	E	F	G	H	I	COL U	V	W	X	Y
<b>51C-2</b>		\$1,074.	\$1,130.	\$1,181.	\$1,190.	\$1,212.	\$1,279.	\$1,429.	\$1,489.	\$1,640.	\$1,661.	\$1,984.	\$2,219.	\$2,326.	\$2,431.
<b>51C-1-S</b>	0.	1,390.	1,412.	1,433.	1,438.	1,445.	1,471.	1,532.	1,557.	1,614.	1,625.	1,751.	1,845.	1,886.	1,928.
<b>51C-1</b>	1,719.	0.	0.	0.	0.	0.	0.	0.	0.	0.	0.	0.	0.	0.	0.

### Approved KnollTextiles Grades/Fabrics

<b>A</b> Alignment Beacon Bocce Chance Common Ground Commuter Cloth Crossroad Delite Hourglass Infinite Mariner Overture Prep Presto Soliloquy Sonnet Trophy Uni-Form	<b>B</b> continued Helios Instinct Journey Keaton Knoll Felt Knoll Hopsack Little Devil Melody Paradigm Petal Pusher Prairie Prim Puff Radiance Ransom Roam Rush Hour Shadow Play Spree Summit Sutton Synth Tabloid Tinge Topos Vast Venue Versa Vibe II Vinyl Wild Thing Yeni	<b>C</b> Atlas Axiom Baxter Chameleon Charm Circa Classic Boucle Durand Earthwork Empire Stripe Entwine Entourage Essence Fibra Greenwich Hudson Lagos Magnolia On Point Palisade Patchwork Panache CR Plaid On Prestini Pullman Quark Roundtrip Sequin CR Sinclair Smart Spectator Stepping Stones Swing	<b>C</b> continued Tight Rope Tilden Tower Grid Wow Factor Utmost II Utopia Wit Zari CR	<b>D</b> Buzz Code Coterie Eclat Weave Hologram Island Menagerie Origins Plaidtastic Retreat Vice Versa Woodand Zoom	<b>E</b> Aegean Circle Point Cleo Demure Flower Power Highland Ikat Stripe Juno Kampala Mamba Marquee Midpoint Nature Walk Off The Grid Rebel Sherman Shima Tempest Vatera Whip	<b>F</b> Atelier Calais Cotton Velvet Century Biscayne Cornaro Double Agent Glider Homage In Stitches Jasmine Liberty Mod Plaid Rivington Totem Tweed Frieze	<b>G</b> All Star Alter Ego Aurora Color Collage Dapper Djenne Duchess Fancy Twill Gibson Kamani Looped In Melange Modern Tweed Spencer Straie Stripe Texnet Ultrasuede Utrillo Vert	<b>H</b> Bavaria Catwalk Chiseled Constance Firefly Stretch Appeal Twist Tie World Piece	<b>I</b> Aswan Bella Byron Cato Chic Diamond Days Doily Dynamic Florescence Guise Hastings In Step Ita Knoll Velvet Limani North Island Olema Piper Prince Hairy Rutledge Tudor Zimba	<b>U</b> Vicenza Volo	<b>X</b> Ducale Velour	<b>Y</b> Cervo Copenhagen Distressed Gemma Lucca Marissa Riva
---	--	--	---	---	---	--	---	--	---	-----------------------------	---------------------------	--

### Spinneybeck Leather

<b>U</b> Vicenza Volo	<b>X</b> Ducale Velour
<b>V</b> Acqua Amalfi Andes Embossed Tipped España Velluto Pelle	<b>Y</b> Cervo Copenhagen Distressed Gemma Lucca Marissa Riva
<b>W</b> Alaska Antique Derby Forte Lucente Sabrina Umbria	

Ⓢ Fire Retardant Chemicals

*Check with your KnollTextiles or Spinneybeck Representative for changes or additions.*

# Marcel Breuer

## Cesca™ Bar Height Stools

Designer(s):  
Marcel Breuer, 1928



description	seat h	w	d	h	textile fabric yds.	leather sq. ft.	weight	seat and back finish
<b>51CH-2</b> Armless bar height stool, fully upholstered seat and back	29	18 1/9	21 2/3	42	1.1	20	25 lbs.	
<b>51CH-1</b> Armless bar height stool, machine caned seat and back or upholstered seat and machine caned back	29	18 1/9	21 2/3	42			20 lbs.	upholstered seat and cane back
	28	18 1/9	21 2/3	42			20 lbs.	full cane

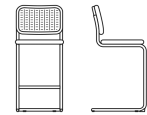
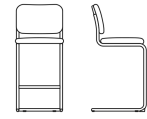

Order Code	Ordering Information	Construction
------------	----------------------	--------------

<i>Example:</i> <b>51CH-1-S-K2450/3-B</b>	<i>Wood frame finish:</i> Clear (suffix B) Ebonized (suffix BE)	<i>COM split upholstery fabric requirements:</i> Back upholstery: 0.4 yards Seat upholstery: 0.4 yards
<b>51CH-1</b> Cesca armless bar height stool		
<b>S</b> Split upholstery	<i>Split upholstery option:</i> The seat and back of the Cesca stools can be specified in split upholstery. Indicate "S" before selected seat upholstery or wood frame finish, followed by selected back upholstery or wood frame finish. If selecting cane back and uphostered seat, always use the cane pattern number. The price equals the price of the higher upholstery grade. <b>Please note it is not possible to have a cane seat and an upholstered back; or to combine two different wood frame finishes.</b>	<i>COL split fabric requirements:</i> Back upholstery: 6 square Seat upholstery: 6 square
<b>K2450/3</b> Prestini Jam seat upholstery		<i>Cal 133 Fire Code #:</i> The Cesca stools comply with California Technical Bulletin 133 with select KnollTextiles. Upcharge applies, see page 18.
<b>B</b> Clear cane frame back		<i>Frame:</i> 1" diameter round steel tube with chrome-plated and polished finish.
<i>Example:</i> <b>51CH-2-K2021/5-K2021/5</b>		<i>Glides:</i> Black plastic anti-tip front glides. Front glides provide stability and prevent the stools from tipping forward. Black matching back glides.
<b>51CH-2</b> Cesca armless bar height stool		
<b>K2405/5</b> Firefly, Glasswing	<i>Upholstery/COM information:</i> Prices shown include fabric or leather upholstery. Contact your Knoll representative for colors. Only approved KnollTextiles and Spinneybeck leathers may be ordered.	<i>Note:</i> The KnollStudio logo and signature of Marcel Breuer are stamped into the base of the chair.
		The Cesca stools are certified Clean Air GOLD.
		<i>Maintenance:</i> See pages 28-29.

Note:  
Cesca bar height stools are part of a collection. Please refer to the Cesca chair, Wassily lounge chair and Laccio tables on pages 112 and 380.

- Specify:
1. Pattern number
  2. Cal 133 option (add C)
  3. Split upholstery option (add S)
  4. Textile, leather, or wood frame selection, seat
  5. Textile, leather, or wood frame selection, back

Customer's Own Material is available pending approval. For approval requirements, processing instructions and ordering information please see page 21.

pattern no.	cane	grades A	COM B	C	D	E	F	G	H	I	COL U	V	W	X	Y
<b>51CH-2</b>		\$1,597.	\$1,670.	\$1,738.	\$1,752.	\$1,781.	\$1,869.	\$2,067.	\$2,147.	\$2,345.	\$2,373.	\$2,802.	\$3,110.	\$3,252.	\$3,392.

<b>51CH-1-S</b>	0.	1,571.	1,592.	1,612.	1,617.	1,626.	1,651.	1,713.	1,735.	1,794.	1,800.	1,932.	2,024.	2,067.	2,108.
-----------------	----	--------	--------	--------	--------	--------	--------	--------	--------	--------	--------	--------	--------	--------	--------

<b>51CH-1</b>	1,897.
---------------	--------

### Approved KnollTextiles Grades/Fabrics

<b>A</b> Alignment Beacon Bocce Chance Common Ground Commuter Cloth Crossroad Delite Hourglass Infinite Mariner Overture Prep Presto Soliloquy Sonnet Trophy Uni-Form	<b>B</b> continued Helios Instinct Journey Keaton Knoll Felt Knoll Hopsack Little Devil Melody Paradigm Petal Pusher Prairie Prim Puff Radiance Ransom Roam Rush Hour Shadow Play Spree Summit Sutton Synth Tabloid Tinge Topos Vast Venue Versa Close Knit Day Tripper Diva Dottie Ferry Forza Gala II Grande Grandview	<b>C</b> Atlas Axiom Baxter Chameleon Charm Circa Classic Boucle Durand Earthwork Empire Stripe Entwine Entourage Essence Fibra Greenwich Hudson Lagos Magnolia On Point Palisade Patchwork Panache CR Plaid On Prestini Pullman Quark Roundtrip Sequin CR Sinclair Smart Spectator Stepping Stones Swing	<b>C</b> continued Tight Rope Tilden Tower Grid Wow Factor Utmost II Utopia Wit Zari CR	<b>D</b> Buzz Code Coterie Eclat Weave Hologram Island Menagerie Origins Plaidtastic Retreat Vice Versa Woodand Zoom	<b>E</b> Aegean Circle Point Cleo Kamani Demure Flower Power Highland Ikat Stripe Juno Kampala Mamba Marquee Midpoint Nature Walk Off The Grid Rebel Sherman Shima Tempest Vatera Whip
--	---	---	---	--	--

### Spinneybeck Leather

<b>U</b> Vicenza Volo	<b>X</b> Ducale Velour
<b>V</b> Acqua Amalfi Andes Embossed Tipped España Velluto Pelle	<b>Y</b> Cervo Copenhagen Distressed Gemma Lucca Marissa Riva
<b>W</b> Alaska Antique Derby Forte Lucente Sabrina Umbria © Fire Retardant Chemicals	

Check with your KnollTextiles or Spinneybeck Representative for changes or additions.

# Marcel Breuer

## Cesca™ Counter Height Stools

Designer(s):  
Marcel Breuer, 1928



description	seat h	w	d	h	textile fabric yds.	leather sq. ft.	weight	seat and back finish
<b>51CM-2</b> Armless counter height stool, fully upholstered seat and back	25	18 1/9	21 2/3	38	1.1	20	24 lbs.	
<b>51CM-1</b> Armless counter height stool, machine caned seat and back or upholstered seat and machine caned back	25	18 1/9	21 2/3	38			19 lbs.	upholstered seat and cane back
	24	18 1/9	21 2/3	38			19 lbs.	full cane

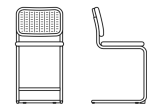
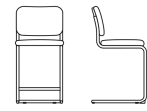

Order Code	Ordering Information	Construction
------------	----------------------	--------------

<i>Example:</i> <b>51CM-1-S-K2450/3-B</b>	<i>Wood frame finish:</i> Clear (suffix B) Ebonized (suffix BE)	<i>COM split upholstery fabric requirements:</i> Back upholstery: 0.4 yards Seat upholstery: 0.4 yards
<b>S</b>	Split upholstery	<i>Fully upholstered stools:</i> Urethane foam over molded plywood seat and back.
<b>K2450/3</b>	Prestini, Jam seat upholstery	<i>Cane inset stools:</i> Hardwood beech seat/back frames in natural clear lacquer or matte ebonized finish. Machine caned insets.
<b>B</b>	Clear cane frame back	<i>Frame:</i> 1" diameter round steel tube with chrome-plated and polished finish.
<i>Example:</i> <b>51CM-2-K2450/5-K2450/5</b>	<i>Split upholstery option:</i> The seat and back of the Cesca stools can be specified in split upholstery. Indicate "S" before selected seat upholstery or wood frame finish, followed by selected back upholstery or wood frame finish. If selecting cane back and uphostered seat, always use the cane pattern number. The price equals the price of the higher upholstery grade. <b>Please note it is not possible to have a cane seat and an upholstered back; or to combine two different wood frame finishes.</b>	<i>Glides:</i> Black plastic anti-tip front glides. Front glides provide stability and prevent the stools from tipping forward. Black matching back glides.
<b>51CM-2</b>	Cesca armless counter height stool	<i>Cal 133 Fire Code #:</i> The Cesca stools comply with California Technical Bulletin 133 with select KnollTextiles. Upcharge applies, see page 18.
<b>K2450/5</b>	Firefly, Glasswing	<i>Note:</i> The KnollStudio logo and signature of Marcel Breuer are stamped into the base of the chair.

*Upholstery/COM information:*  
Prices shown include fabric or leather upholstery. Contact your Knoll representative for colors. Only approved KnollTextiles and Spinneybeck leathers may be ordered.

*Maintenance:*  
See pages 28-29.

The Cesca stools are certified Clean Air GOLD.

Note:  
Cesca counter height stools are part of a collection. Please refer to the Cesca chair, Wassily lounge chair and Laccio tables on pages 112 and 380.

- Specify:
1. Pattern number
  2. Cal 133 option (add C)
  3. Split upholstery option (add S)
  4. Textile, leather, or wood frame selection, seat
  5. Textile, leather, or wood frame selection, back

pattern no.	cane	grades A	COM B	C	D	E	F	G	H	I	COL U	V	W	X	Y
<b>51CM-2</b>		\$1,597.	\$1,670.	\$1,738.	\$1,752.	\$1,781.	\$1,869.	\$2,067.	\$2,147.	\$2,345.	\$2,373.	\$2,802.	\$3,110.	\$3,252.	\$3,392.
<b>51CM-1-S</b>	0.	1,571.	1,592.	1,612.	1,617.	1,626.	1,651.	1,713.	1,735.	1,794.	1,800.	1,932.	2,024.	2,067.	2,108.
<b>51CM-1</b>	1,897.														

Approved KnollTextiles Grades/Fabrics	Spinneybeck Leather
---------------------------------------	---------------------

<b>A</b> Alignment Beacon Bocce Chance Common Ground Commuter Cloth Crossroad Delite Hourglass Infinite Mariner Overture Prep Presto Soliloquy Sonnet Trophy Uni-Form	<b>B</b> continued Helios Instinct Journey Keaton Knoll Felt Knoll Hopsack Little Devil Melody Paradigm Petal Pusher Prairie Prim Puff Radiance Ransom Roam Rush Hour Shadow Play Spree Summit Sutton Synth Tabloid Tinge Topos Vast Venue Versa Close Knit Day Tripper Diva Dottie Ferry Forza Gala II Grande Grandview	<b>C</b> Atlas Axiom Baxter Chameleon Charm Circa Classic Boucle Durand Earthwork Empire Stripe Entwine Entourage Essence Fibra Greenwich Hudson Lagos Magnolia On Point Palisade Patchwork Panache CR Plaid On Prestini Pullman Quark Roundtrip Sequin CR Sinclair Smart Spectator Stepping Stones Swing	<b>C</b> continued Tight Rope Tilden Tower Grid Wow Factor Utmost II Utopia Wit Zari CR	<b>D</b> Buzz Code Coterie Eclat Weave Hologram Island Menagerie Origins Plaidtastic Retreat Vice Versa Woodand Zoom	<b>E</b> Aegean Circle Point Cleo Kamani Demure Flower Power Highland Ikat Stripe Juno Kampala Mamba Marquee Midpoint Nature Walk Off The Grid Rebel Sherman Shima Tempest Vatera Whip	<b>F</b> Atelier Calais Cotton Velvet Century Biscayne Cornaro Double Agent Glider Homage In Stitches Jasmine Liberty Mod Plaid Rivington Totem Tweed Frieze	<b>G</b> All Star Alter Ego Aurora Color Collage Dapper Djenne Duchess Fancy Twill Gibson Cleo Kamani Looped In Melange Modern Tweed Spencer Straie Stripe Texnet Ultrasuede Utrillo Vert	<b>H</b> Bavaria Catwalk Chiseled Constance Firefly Stretch Appeal World Piece	<b>I</b> Aswan Bella Byron Cato Chic Diamond Days Doily Dynamic Florescence Guise Hastings In Step Ita Knoll Velvet Limani North Island Olema Piper Prince Hairy Rutledge Tudor Zimba	<b>U</b> Vicenza Volo	<b>X</b> Ducale Velour	<b>Y</b> Cervo Copenhagen Distressed Gemma Lucca Marissa Riva	<b>V</b> Acqua Amalfi Andes Embossed Tipped España Velluto Pelle	<b>W</b> Alaska Antique Derby Forte Lucente Sabrina Umbria	<b>Ⓞ</b> Fire Retardant Chemicals
---	---	--	---	---	---	--	---	---	---	-----------------------------	---------------------------	--	--	---	-----------------------------------

*Check with your KnollTextiles or Spinneybeck Representative for changes or additions.*



# Marcel Breuer Wassily™ Chair

description	seat h	arm h	w	d	h	weight	frame
<b>50L</b> Wassily chair	16½"	23"	31"	27"	28¾"	25 lbs.	polished chrome
	16½"	23"	31"	27"	28¾"	25 lbs.	18k gold

*Designer(s):*  
Marcel Breuer, 1925

*Award(s):*  
The Museum of Modern Art, New York, USA, 1968; Recognition as "Piece of Art," W. Germany, 1982

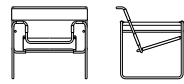

pattern no.	list
<b>50L-( )</b>	\$5,342.
<b>50L-GLD-( )</b>	8,035.

Order Code	Ordering Information
<i>Example:</i> <b>50L-3COLHH</b>	<i>Spinneybeck Belting Leather:</i>
<b>50L</b> Wassily chair	Black (suffix BLBLCK)
<b>3COLHH</b> Haired Hide, Tri-Colored	Brown (suffix BL1923)
	Burnt Orange (suffix BL1907)
	Chocolate (suffix BL1902)
	Cognac (suffix BL1904)
	Cream (suffix BL1919)
	Dark Mustard (suffix BL1903)
	Dark Salmon (suffix BL1906)
	Deep Green (suffix BL1911)
	Deep Purple (suffix BL1913)
	Eggplant (suffix BL1926)
	Fudge (suffix BL1901)
	Gun Metal (suffix BL1917)
	Key Lime (suffix BL1910)
	Khaki (suffix BL1922)
	Lemon Meringue (suffix BL1909)
	Light Grey (suffix BL1916)
	Medium Grey (suffix BL1918)
	Putty (suffix BL1920)
	Simply Red (suffix BL1905)
	Smoke (suffix BL1915)
	Sunshine (suffix BL1908)
	Taupe (suffix BL1921)
	Umber (suffix BL1925)
	Warm Beige (suffix BL1924)
	White (suffix BL1914)
	<i>Cowhide leather colors:</i>
	Black (suffix L80)
	Light Brown (suffix L82)
	White Beige (suffix L84)
	<i>Haired Hide:</i>
	Black (suffix BLCKHH)
	Chestnut (suffix OA12HH)
	Gold (suffix OCP5HH)
	Tan (suffix OCP3HH)
	Tri-Color (suffix 3COLHH)
	<i>Upholstery note:</i>
	<b>No Customer's Own Materials can be used.</b>
	<i>Replacement slings:</i>
	Knoll does not recommend replacement slings. This procedure requires the chair to be disassembled and rebuilt, a complex and time consuming process.

*Note:*  
The Wassily Chair is part of a collection. Please refer to Cesca side chairs and Laccio tables on pages 104 and 330.

*Specify:*

1. Pattern number
2. Sling material and color selection

Construction
<i>Cal 133 Fire Code #:</i>
The Wassily chair complies with California Technical Bulltin 133, see page 18.
<i>Maintenance:</i>
See pages 28-29.
<i>Note:</i>
The KnollStudio logo and signature of Marcel Breuer is stamped into the base of the chair.
The Wassily Chair is certified Clean Air GOLD.
Please ask your Spinneybeck Representative for samples of the belting leather and haired hide.
<i>Frame:</i>
Tubular steel with a polished chrome finish or plated in 18k gold.
<i>Upholstery:</i>
<i>Cowhide Slings:</i>
Thick cowhide leather slings in three colors. Edges dyed to match for Black and Light Brown colors. White Beige will have edges matching Light Brown cowhide color.
<i>Belting Leather:</i>
Highly durable Spinneybeck belting leather in twenty seven colors. Belting leather edges will always match specified color.
<i>Haired Hide:</i>
Spinneybeck haired hide in eight colors. Haired Hide is a natural material, markings are one-of-a-kind and will vary from piece to piece.
<i>Glides:</i>
Four, molded clear plastic glides with twin-pin snap-in construction included with each chair.

# Marcel Breuer

## MB Lounge

	description	w	d	h	textile fabric yds.	req. leather sq. ft.	weight
<i>Designer(s):</i> Marcel Breuer, 1928	<b>50-128</b> Lounge Chair	23 1/2"	32"	30 1/2"	2.25	40	41 lbs

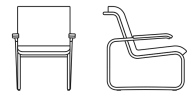

Order Code	Ordering Information	Construction
------------	----------------------	--------------

<i>Example:</i> <b>50-128-K349/4</b>		
<b>50-128</b>	Lounge Chair, chrome	
<b>K349/4</b>	Alignment, Paprika	

*Base finish options:*  
Polished Chrome (suffix C)

*Upholstery/COM information:*  
Prices shown include fabric or leather upholstery. Contact your Knoll representative for colors. Only approved KnollTextiles and Spinneybeck leathers may be ordered.

*Note:*  
Designer signature and KnollStudio logo are stamped into the base of the frame.

*Maintenance:*  
See pages 28-29.

*Frame:*  
Bent tubular steel with a polished chrome finish. Metal horizontal springs provide support for seat and back cushion. Solid wood natural oak arm rests.

*Upholstery:*  
Continuous seat and back upholstered molded foam cushion attached to exposed metal frame with velcro straps. Available in textile or leather.

*Note:*  
Cushion can be removed from frame for easy cleanability.

*Glides:*  
Four, molded clear plastic glides with twin-pin snap-in construction included with each chair.

*Specify:*

1. Pattern number
2. Textile selection

Customer's Own Material is available pending approval. For approval requirements, processing instructions and ordering information please see page 21.

pattern no.	grade <b>A</b>	COM <b>B</b>	<b>C</b>	<b>D</b>	<b>E</b>	<b>F</b>	<b>G</b>	<b>H</b>	<b>I</b>	COL <b>U</b>	<b>V</b>	<b>W</b>	<b>X</b>	<b>Y</b>
<b>50-128-()</b>	\$2,129.	\$2,209.	\$2,297.	\$2,367.	\$2,428.	\$2,525.	\$2,578.	\$2,646.	\$2,875.	\$3,332.	\$3,846.	\$4,509.	\$4,694.	\$4,878.

Approved KnollTextiles Grades/Fabrics	Spinneybeck Leather
---------------------------------------	---------------------

<b>A</b> Alignment Bocce Common Ground Commuter Cloth Crossroad Cross Tech Delite Facet Hourglass Infinite Mariner Roam Prep Soliloquy * Sonnet Uni-Form	<b>B</b> continued Keaton Knoll Felt Knoll Hopsack Little Devil Ludlow Melody <sup>®</sup> Paradigm Prairie Prim Radiance Ransom Roam Rush Hour Spree SummitSutton Tabloid Tinge Topos Vast Versa Westwood Wild Thing	<b>C</b> continued Kaleidoscope CR Lagos Lore CR Milestone On Point Palisade Patchwork Posh Prestini Pullman Quark Roundtrip Sequin CR * Smart <sup>®</sup> Spectator * Swing Tilden <sup>®</sup> Tower Grid Utmost II Utopia Wit Zari CR *	<b>D</b> Buzz Code Coterie Eclat Weave Island Menagerie Origins Pathway Plaidtastic Retreat Vice Versa Woodland	<b>E</b> Aegean Circle Point Cleo Currents Flower Power Highland Ikat Stripe Juno Kampala Kimono Mamba Marquee Meroe Midpoint Nature Walk Off The Grid Premier Rebel Shima Tempest Vatera Vice Versa Whip	<b>F</b> Biscayne Cornaro * Double Agent <sup>®</sup> Glider Imprint In Stitches Liberty Rivington Soon	<b>G</b> All Star Andissa Aurora Color Collage Dapper Duchess Fancy Twill Gibson	<b>G</b> continued Haze Kamani Melange Modern Tweed Spencer Straie Stripe Texnet Ultrasuede Utrillo Vert	<b>H</b> Bavaria Catwalk Constance Firefly Twist Tie World Piece	<b>I</b> Aswan Bella Byron * Cato Cummings * Diamond Days Doily Dynamic Florescence Hastings Ita Jaipur Knoll Velvet North Island Olema Piper Prince Hairy Rutledge Sandis Stripe It Zimba
--	---	---	---	--	--	--	--	--	---

<b>U</b> Vicenza Volo	<b>X</b> Ducale+ Ducale Velour
<b>V</b> Acqua Amalfi Andes España+ Velluto Pelle	<b>Y</b> Cervo Copenhagen Distressed+ Lucca Marissa Portofino+ Riva Rugata Sassolino

<sup>®</sup> Fire Retardant Chemicals



*Check with your KnollTextile or Spinneybeck Representative for any changes or additions.*

# Jonathan Crinion Crinion Chair

*Designer(s):*  
Jonathan Crinion, 1999

*Award(s):*  
FX International Interior Design  
Award, 1999



description	seat h	arm h	w	d	h	textile fabric yds.	req. leather sq. ft.	weight	finish
<b>58A</b> Arm chair, upholstered seat 	17 1/2"	26 1/2"	23 1/4"	19 1/2"	30 3/4"	0.7	13	18 lbs.	beech stains
	17 1/2"	26 1/2"	23 1/4"	19 1/2"	30 3/4"	0.7	13	17 lbs.	maple
<b>58C</b> Armless chair, upholstered seat 	17 1/2"		20 1/2"	19 1/2"	30 3/4"	0.7	13	16 lbs.	beech stains
	17 1/2"		20 1/2"	19 1/2"	30 3/4"	0.7	13	15 lbs.	maple
<b>58A-R</b> Seat pad replacement, for arm chair with upholstered seat 58A						0.7	13		
<b>58C-R</b> Seat pad replacement, for armless chair with upholstered seat 58C						0.7	13		

### Order Code

<i>Example:</i>	<b>58A-BB-K715/3</b>
<b>58A</b>	Crinion arm chair
<b>B323</b>	Medium Walnut
<b>K715/3</b>	Abacus, Gold Coin

### Specify:

1. Pattern number
2. Finish selection
3. Textile selection

### Ordering Information

*Clear Maple finish:*  
Maple (suffix KC)

*Beech frame stains:*  
Beech (suffix B311)  
Bronzed Cherry (suffix B312A)  
Burnt Walnut (suffix B313)  
Deep Red Mahogany (suffix B328)  
Ebonized (suffix BE)  
Light Cherry (suffix B315)  
Light Walnut (suffix B411)  
Medium Cherry (suffix B319)  
Medium Red Mahogany (suffix BR)  
Medium Walnut (suffix B323)  
Natural Beech (suffix BN)  
Warm Brown Walnut (suffix J)

*Upholstery/COM information:*  
Prices shown include fabric or leather upholstery. Contact your Knoll representative for colors. Only approved KnollTextiles and Spinneybeck leathers may be ordered.

Customer's Own Material is available pending approval. For approval requirements, processing instructions and ordering information please see page 21.

*KnollStudio wood finishes:*  
KnollStudio wood finishes complement a large variety of KnollStudio veneer and Knoll Office veneer finishes. To select correct complementary finish, please refer to KnollStudio Wood Finish Matrix on page 26. Complementary finishes are available at no upcharge. If no complementary standard finish is available, please refer to custom finish policy below.

*Cal 133 Fire Code #:*  
Crinion Chairs with upholstered seat comply with the California Technical Bulletin 133 standard if upholstered in Cal 133 approved upholstery. Specify suffix -C at end of pattern number and suffix -133 at end of textile selection. Upcharge applies, see page 18.

*Maintenance:*  
See pages 28-29.

*Note:*  
The Crinion Chair is certified Clean Air GOLD.

### Construction

*Frame:*  
Clear Maple Chair: Select clear maple hardwood frame with maple plywood back panel in clear finish. Dowel, mortise and tenon construction. Arm supported by metal cross dowel.

Beech Chair: Select beech hardwood frame with plywood back panel in clear or stained finishes. Arm supported by metal cross dowel.

*Seat pad:*  
Upholstered, high-density polyurethane foam seat pad on a plywood seat basket with Dymetrol® suspension. Seat pad reaches to the seat frame edge, surrounds arm.

*Seat pad replacement:*  
Seat pad can be replaced in the field.

*Finish:*  
Catalyzed lacquer protective coating. Hand-applied final wax coating.

*High Traffic Areas:*  
When specifying armless chair in high use or high traffic areas, we recommend the use of a stretcher for added strength. Contact CPD or your KnollStudio sales representative for more information.

pattern no.	grades <b>A</b>	COM <b>B</b>	<b>C</b>	<b>D</b>	<b>E</b>	<b>F</b>	<b>G</b>	<b>H</b>	<b>I</b>	COL <b>U</b>	<b>V</b>	<b>W</b>	<b>X</b>	<b>Y</b>
<b>58A-( )</b>	\$2,318.	\$2,362.	\$2,404.	\$2,449.	\$2,485.	\$2,512.	\$2,566.	\$2,646.	\$2,717.	\$2,942.	\$3,103.	\$3,435.	\$3,501.	\$3,583.
<b>58A-(KC)</b>	2,839.	2,884.	2,923.	2,969.	3,007.	3,037.	3,087.	3,166.	3,239.	3,461.	3,626.	3,957.	4,023.	4,102.
<b>58C-( )</b>	1,975.	2,018.	2,062.	2,102.	2,148.	2,170.	2,215.	2,308.	2,373.	2,599.	2,757.	3,089.	3,160.	3,235.
<b>58C-(KC)</b>	2,351.	2,394.	2,437.	2,478.	2,522.	2,544.	2,586.	2,681.	2,748.	2,969.	3,132.	3,461.	3,534.	3,605.
<b>58A-R-( )</b>	387.	432.	467.	510.	548.	567.	616.	699.	761.	970.	1,125.	1,439.	1,506.	1,580.
<b>58C-R-( )</b>	387.	432.	467.	510.	548.	567.	616.	699.	761.	970.	1,125.	1,439.	1,506.	1,580.

### Approved KnollTextiles Grades/Fabrics



<b>A</b> Alignment Beacon Bocce Chance Common Ground Commuter Cloth Crossroad Delite Facet Foil Rap Heavy Metal Hourglass Infinite Mariner Monarch Overture Prep Presto Soliloquy Sonnet Trophy Uni-Form	<b>B</b> continued Forza <sup>Ⓞ</sup> Gala II Grande Grandview Helios Hollbrook Journey Keaton Knoll Hopsack Little Devil Ludlow Melody <sup>Ⓞ</sup> Paradigm Petal Pusher <sup>Ⓞ</sup> Prairie Prim Puff Radiance Ransom Roam Rush Hour Shadow Play Spree Summit Sutton Synth Tabloid Tinge Topos Vast Venue Versa Vinyl <sup>Ⓞ</sup> Westwood Wild Thing	<b>C</b> Atlas Axiom <sup>Ⓞ</sup> Baxter Chameleon Charm Circa Classic Boucle Contour Durand Earthwork Empire Stripe Entourage Entwine Essence Greenwich Groovy Hudson Kaleidoscope CR Lagos Lore CR Magnolia Milestone On Point Palisade Panache CR Patchwork Plaid On Prestini Pullman Quark Roundtrip Sequin CR Sinclair Smart <sup>Ⓞ</sup>	<b>C</b> continued Stepping Stones Spectator Swing Tight Rope Tilden <sup>Ⓞ</sup> Tower Grid Utmost II Utopia Wit Wow Factor Zari CR	<b>D</b> Buzz Code Coterie Hologram Island Kabuki Menagerie Origins Pathway Plaidtastic Retreat Vice Versa Woodland Zoom	<b>E</b> Aegean Circle Point Cleo Currents Flower Power Highland Kampala Ikat Stripe Juno Mamba Marquee Midpoint Nature Walk Off The Grid Sherman Shima Tempest Tryst Vatera Whip	<b>F</b> Atelier Biscayne Calais Cotton Velvet Century Cornaro Double Agent <sup>Ⓞ</sup> Glider Homage Imprint In Stitches Liberty Mod Plaid Rivington Soon Swank Totem Tweed Frieze	<b>G</b> All Star Alter Ego Arber Aurora Color Collage Dapper Djenne Duchess Fancy Twill Gibson Haze Kamani Looped In Melange Modern Tweed Rivers Straie Stripe Texnet Ultrasuede Utrillo Vert	<b>H</b> Bavaria Constance Stretch Appeal Twist Tie World Piece	<b>I</b> Aswan Bella Byron Cato Chic Cummings Diamond Days Doily Dynamic Florescence Guisse Hastings In Step Ita Jaipur Knoll Velvet Limani North Island Olema Piper Prince Hairy Rutledge Stripe It Tudor Zimba	<b>U</b> Vicenza Volo	<b>V</b> Acqua Andes Embossed Tipped España Hand Tipped Velluto Pelle	<b>W</b> Alaska Antique Forte Lucente Sabrina Umbria	<b>X</b> Ducale Ducale Velour	<b>Y</b> Cervo Copenhagen Distressed Gemma Lucca Marissa Portofino Riva
--	---	--	---	--	---	--	---	--	---	-----------------------------	---	--	-------------------------------------	---

### Spinneybeck Leather

<sup>Ⓞ</sup> Fire Retardant Chemicals
---------------------------------------

*Check with your KnollTextiles or Spinneybeck Representative for changes or additions.*





# Joseph Paul D’Urso Contract Lounge Seating

	description	w	d	h	seat h	arm h	type	textile fabric yds.	leather sq ft	weight
<i>Designer(s):</i> Joseph Paul D’Urso, 2008	<b>2160</b> Contract Lounge chair, same upholstery, frame and cushions	34"	36 1/2"	30 1/2"	17 3/8"	22 3/8"		7.6	105	70 lbs.
										
	<b>2160</b> Contract Lounge chair, combination upholstery, frame and cushions	34"	36 1/2"	30 1/2"	17 3/8"		frame uph.	4.6	60	
							upchg, cushions	3.2	50	

pattern no.	grades A	COM B	C	D	E	F	G	H	I	COL U	V	W	X	Y
<b>2160-C-( )</b>	\$5,934.	\$6,203.	\$6,450.	\$6,727.	\$6,951.	\$7,117.	\$7,390.	\$7,919.	\$8,309.	\$10,054.	\$10,782.	\$12,253.	\$12,563.	\$12,919.
<b>2160S-C-( )-( )</b>	4,528.	4,732.	4,923.	5,133.	5,302.	5,432.	5,641.	6,047.	6,340.	7,217.	7,760.	8,871.	9,101.	9,370.
<b>upchg, cushions</b>	1,940.	2,028.	2,110.	2,199.	2,273.	2,328.	2,415.	2,587.	2,717.	3,094.	3,327.	3,802.	3,897.	4,016.

Order Code	Ordering Information	Construction
<i>Example:</i> <b>2160-C-H800/40</b>	<i>Leg finishes:</i> Polished Chrome (suffix C)	<i>Frame:</i> Constructed of plywood with sinuous spring seat suspension and matrix back suspension. Standard lounge chair and small sofa depth is 36"; residential sofa is 40" deep.
<b>2160</b>	D’Urso Contract Lounge Collection, lounge chair	<i>Stitching:</i> Non-directional textiles with railroad application, single needle topstitch for arms, double needle topstitch for seat and back cushions; directional textiles, single needle topstitch for arms, double needle topstitch for seat and back cushions, single blind stitch for vertical seams of seat cushion, a vertical single blind center seam joins inside and outside back panels of the sofa; leather, single needle topstitch for arms, double needle topstitch for seat and back cushions, single blind stitch for vertical seams of seat cushion, a vertical double needle topstitch seam joins inside and outside back panels of sofa. Ottoman; all applications, double needle topstitch for horizontal cushion seams, single blind seam for vertical seams of seat cushion.
<b>C</b>	Polished Chrome legs	
<b>H800/40</b>	Cato, Orange	
<i>Example:</i> <b>2161-C-S-HT1502-K1206/6</b>	<i>Upholstery/COM information:</i> Prices shown includes fabric or leather upholstery. Contact your Knoll representative for colors. Only approved KnollTextiles and Spinneybeck leathers may be ordered.	<i>Upholstery:</i> One seat and back cushion for the Lounge Chair, two seat and back cushions for the Small Sofa, one semi-attached cushion for Ottoman. For units with combination upholstery, add list price of surround in appropriate grade with the list price of cushions to obtain total list price for item.
<b>2161</b>	D’Urso Contract Lounge Collection, small sofa	
<b>C</b>	Polished Chrome legs	
<b>S</b>	Split upholstery	
<b>HT1502</b>	Surround in Hand Tipped, Mesa Verde	
<b>K1206/6</b>	Cushions in Knoll Hopsack, Gold	<i>Legs:</i> 6" steel leg, 1 1/4" diameter, available in polished chrome with black nylon glides.
	<i>Maintenance:</i> See pages 28-29.	

- Specify:*
1. Pattern number
  2. Leg finish
  3. Textile selection
- Specify with split upholstery:*
1. Pattern number
  2. Leg finish
  3. Split upholstery option
  4. Textile selection, Surround
  5. Textile selection, Cushions

Approved KnollTextiles Grades/Fabrics				Spinneybeck Leather																					
<b>A</b>	Alignment Beacon Bocce Common Ground Commuter Cloth Cross Tech Crossroad Delite Facet Hourglass Mariner Monarch Overture Prep Presto Sonnet Trophy Uni-Form	<b>B</b>	continued Little Devil Ludlow Melody  Paradigm Prairie Prim Radianc Ransom Rush Hour Sprée Summit Sutton Synth Tabloid Tinge Topos Vast Venue Versa Vinyl  Westwood Wild Thing	<b>C</b>	continued Empire Stripe Entourage Entwine Essence Fibra Groovy Hudson Kaleidoscope CR Lagos Lore CR Milestone On Point Palisade Panache CR Patchwork Plaid On Prestini Pullman Quark Roundtrip Sahara Sequin CR Spectator Stepping Stones Swing Tilden  Utmost II Utopia Wit Zari CR	<b>D</b>	Buzz Coterie Eclat Weave Hologram Island Kabuki Menagerie Pathway Retreat Vice Versa Woodland Zoom	<b>E</b>	Aegean Circle Point Currents Demure Flower Power Highland Ikat Stripe Kampala Kimono Mamba Marquee Meroc Rebel Sherman Shima Tempest Tryst Whip	<b>F</b>	Atelier Calais Cotton Velvet Cornaro Double Agent  Imprint In Stitches Liberty Mod Plaid Rivington Soon Swank Totem Tweed Frieze	<b>G</b>	All Star Alter Ego Aurora Dapper Djenne Fancy Twill Gibson Haze Looped In Melange Modern Tweed Spencer Shima Ultrasuede Vert	<b>H</b>	Chiseled Constance Firefly Bella Byron Cato Chiseled Diamond Days Doily Dynamic Florescence Guise Hastings In Step Knoll Velvet Piper Prince Hairy Tudor Zimba	<b>U</b>	Vicenza Volo	<b>V</b>	Acqua Amalfi Andes Embossed Tipped España Hand Tipped Velluto Pelle	<b>W</b>	Alaska Antique Derby Forte Lucente Sabrina Umbria	<b>X</b>	Ducale Ducale Velour	<b>Y</b>	Cascia Cervo Copenhagen Distressed Marissa Riva Rugata Saddle
				 Fire Retardant Chemicals * Approved for 2161P only.																					
				<i>Check with your KnollTextiles or Spinneybeck Representative for additions or changes.</i>																					

# Joseph Paul D’Urso Contract Lounge Seating

Designer(s):  
Joseph Paul D’Urso, 2008



description	width	depth	height	seat h, max	arm h, max	type	textile fabric yards	leather sq ft	weight
<b>2161</b> Contract Small Sofa, same upholstery, frame and cushions	74"	36 1/2"	30 1/2"	17 3/8"	22 3/8"		13.5	215	135 lbs.
<b>2161</b> Contract Small Sofa, combination upholstery, frame and cushions	74"	36 1/2"	30 1/2"	17 3/8"	frame uph.	upchg, cushions	6.5	95	
							7	120	
<b>2163</b> Contract Ottoman, same upholstery, frame and cushions	28 1/2"	28 1/2"	16"	16"			3.5	45	29 lbs.
<b>2163</b> Contract Ottoman, combination upholstery, frame and cushions	28 1/2"	28 1/2"	16"	16"	frame uph.	upchg, cushions	1.4	15	
							2.8	30	
<b>2161P</b> Optional side cushion for small sofa	17"	3"	11"				1	n/a	5 lbs.

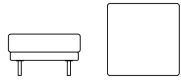
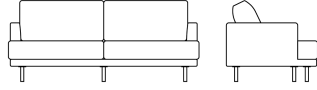

Order Code	Ordering Information	Construction
<i>Example:</i> <b>2160-C-H800/40</b>	<i>Leg finishes:</i> Polished Chrome (suffix C)	<i>Frame:</i> Constructed of plywood with sinuous spring seat suspension and matrix back suspension. Standard lounge chair and small sofa depth is 36"; residential sofa is 40" deep.
<b>2160</b>	D’Urso Contract Lounge Collection, lounge chair	<i>Stitching:</i> Non-directional textiles with railroad application, single needle topstitch for arms, double needle topstitch for seat and back cushions; directional textiles, single needle topstitch for arms, double needle topstitch for seat and back cushions, single blind stitch for vertical seams of seat cushion, a vertical single blind center seam joins inside and outside back panels of the sofa; leather, single needle topstitch for arms, double needle topstitch for seat and back cushions, single blind stitch for vertical seams of seat cushion, a vertical double needle topstitch seam joins inside and outside back panels of sofa. Ottoman; all applications, double needle topstitch for horizontal cushion seams, single blind seam for vertical seams of seat cushion.
<b>C</b>	Polished Chrome legs	
<b>H800/40</b>	Cato, Orange	
<i>Example:</i> <b>2161-C-S-HT1502-K1206/6</b>	<i>Upholstery/COM information:</i> Prices shown includes fabric or leather upholstery. Contact your Knoll representative for colors. Only approved KnollTextiles and Spinneybeck leathers may be ordered.	<i>Upholstery:</i> One seat and back cushion for the Lounge Chair, two seat and back cushions for the Small Sofa, one semi-attached cushion for Ottoman. For units with combination upholstery, add list price of surround in appropriate grade with the list price of cushions to obtain total list price for item.
<b>2161</b>	D’Urso Contract Lounge Collection, small sofa	
<b>C</b>	Polished Chrome legs	
<b>S</b>	Split upholstery	
<b>HT1502</b>	Surround in Hand Tipped, Mesa Verde	
<b>K1206/6</b>	Cushions in Knoll Hopsack, Gold	<i>Legs:</i> 6" steel leg, 1 1/4" diameter, available in polished chrome with black nylon glides.
	<i>Maintenance:</i> See pages 28-29.	

Specify:

1. Pattern number
2. Leg finish
3. Textile selection

Specify with split upholstery:

1. Pattern number
2. Leg finish
3. Split upholstery option
4. Textile selection, Surround
5. Textile selection, Cushions

pattern no.	grade <b>A</b>	COM <b>B</b>	<b>C</b>	<b>D</b>	<b>E</b>	<b>F</b>	<b>G</b>	<b>H</b>	<b>I</b>	COL <b>U</b>	<b>V</b>	<b>W</b>	<b>X</b>	<b>Y</b>
<b>2161-C-( )</b>	\$9,367.	\$9,837.	\$10,283.	\$10,772.	\$11,175.	\$11,466.	\$11,955.	\$12,894.	\$13,585.	\$17,709.	\$19,193.	\$22,216.	\$22,844.	\$23,577.
<b>2161S-C-( )-( )</b>	7,148.	7,505.	7,846.	8,220.	8,529.	8,749.	9,122.	9,838.	10,365.	12,707.	13,773.	15,939.	16,390.	16,916.
<b>upchg, cushions</b>	3,064.	3,216.	3,361.	3,524.	3,654.	3,746.	3,911.	4,214.	4,443.	5,445.	5,904.	6,833.	7,027.	7,251.
<b>2163-C-( )</b>	3,573.	3,720.	3,859.	4,011.	4,136.	4,228.	4,377.	4,671.	4,888.	5,548.	5,861.	6,492.	6,625.	6,780.
<b>2163S-C-( )-( )</b>	2,724.	2,839.	2,944.	3,058.	3,156.	3,226.	3,341.	3,565.	3,729.	3,982.	4,205.	4,659.	4,752.	4,862.
<b>upchg, cushions</b>	1,168.	1,216.	1,262.	1,313.	1,353.	1,383.	1,434.	1,530.	1,596.	1,704.	1,800.	1,998.	2,038.	2,085.
<b>2161P-( )</b>	660.	695.	727.	764.	791.	816.	852.	919.	973.					

Approved KnollTextiles Grades/Fabrics						Spinneybeck Leather			
<b>A</b> Alignment Beacon Bocce Common Ground Commuter Cloth Cross Tech Crossroad Delite Facet Hourglass Mariner Monarch Overture Prep Presto Sonnet Trophy Uni-Form	<b>B</b> continued Little Devil Ludlow Melody <sup>®</sup> Paradigm Prairie Prim Radiance Ransom Rush Hour Spree Summit Sutton Synth Tabloid Tinge Topos Vast Venue Versa Vinyl <sup>®</sup> Westwood Wild Thing	<b>C</b> continued Empire Stripe Entourage Entwine Essence Fibra Groovy Hudson Kaleidoscope CR Lagos Lore CR Milestone On Point Palisade Panache CR Patchwork Plaid On Prestini Pullman Quark Roundtrip Sahara Sequin CR Spectator Stepping Stones Swing Tilden <sup>®</sup> Utmost II Utopia Wit Zari CR	<b>D</b> Buzz Coterie Eclat Weave Hologram Island Kabuki Menagerie Pathway Retreat Vice Versa Woodland Zoom	<b>E</b> Aegean Circle Point Currents Demure Flower Power Highland Ikat Stripe Kampala Kimono Mamba Marquee Merroe Rebel Sherman Shima Tempest Tryst Whip	<b>F</b> Atelier Calais Cotton Velvet Cornaro Double Agent <sup>®</sup> Imprint In Stitches Liberty Mod Plaid Rivington Soon Swank Totem Tweed Frieze	<b>G</b> All Star Alter Ego Aurora Dapper Djenne Fancy Twill Gibson Haze Looped In Melange Modern Tweed Spencer Texnet Ultrasuede Vert	<b>H</b> Chiseled Constance Firefly Bella Byron Cato Chiseled Diamond Days Doily Dynamic Florescence Guise Hastings In Step Knoll Velvet Piper Prince Hairy Tudor Zimba	<b>U</b> Vicenza Volo  <b>V</b> Acqua Amalfi Andes Embossed Tipped España Hand Tipped Velluto Pelle  <b>W</b> Alaska Antique Derby Forte Lucente Sabrina Umbria	<b>X</b> Ducale Ducale Velour  <b>Y</b> Cascia Cervo Copenhagen Distressed Marissa Riva Rugata Saddle
						<sup>®</sup> Fire Retardant Chemicals * Approved for 2161P only.			
						Check with your KnollTextiles or Spinneybeck Representative for additions or changes.			

# Joseph Paul D’Urso Residential Lounge Seating

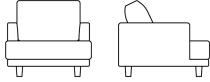
	description	w	d	h	seat h	arm h	type	textile fabric yds.	leather sq ft.	weight
<i>Designer(s):</i> Joseph Paul D’Urso, 2008	<b>2160R</b> Residential Lounge chair, same upholstery, frame and cushions	34"	36 1/2"	28 1/2"	15 3/8"	20 3/8"		7.6	105	67 lbs.
										
	<b>2160R</b> Residential Lounge chair, combination upholstery, frame and cushions	34"	36 1/2"	28 1/2"	15 3/8"		frame uph.	4.6	60	
							upchg, cushions	3.2	50	

pattern no.	grades A	COM B	C	D	E	F	G	H	I	COL U	V	W	X	Y
<b>2160R-(-)(-)</b>	\$5,934.	\$6,203.	\$6,450.	\$6,727.	\$6,951.	\$7,117.	\$7,390.	\$7,919.	\$8,309.	\$10,054.	\$10,782.	\$12,253.	\$12,563.	\$12,919.
<b>2160RS-(-)(-)(-)</b>	4,528.	4,732.	4,923.	5,133.	5,302.	5,432.	5,641.	6,047.	6,340.	7,217.	7,760.	8,871.	9,101.	9,370.
<b>upchg, cushions</b>	1,940.	2,028.	2,110.	2,199.	2,273.	2,328.	2,415.	2,587.	2,717.	3,094.	3,327.	3,802.	3,897.	4,016.

Order Code	Ordering Information	Construction
<i>Example:</i> <b>2160R-OE-K162/25</b>	<i>Leg finishes:</i> Burnt Walnut on Oak (suffix 0313) Clear Oak (suffix OC) Ebonized on Oak (suffix OE) Polished Chrome (suffix C)	<i>Frame:</i> Constructed of plywood with sinuous spring seat suspension and matrix back suspension. Standard lounge chair and sofa depth is 36"; residential sofa is 40" deep.
<b>2160R</b>	D’Urso Residential Lounge Collection, lounge chair	<i>Stitching:</i> Non-directional textiles with railroad application, single needle topstitch for arms, double needle topstitch for seat and back cushions; directional textiles, single needle topstitch for arms, double needle topstitch for seat and back cushions, single blind stitch for vertical seams of seat cushion, a vertical single blind center seam joins inside and outside back panels of the sofa; leather, single needle topstitch for arms, double needle topstitch for seat and back cushions, single blind stitch for vertical seams of seat cushion, a vertical double needle topstitch seam joins inside and outside back panels of sofa. Ottoman; all applications, double needle topstitch for horizontal cushion seams, single blind seam for vertical seams of seat cushion.
<b>OE</b>	Ebonized legs	<i>Upholstery:</i> One seat and back cushion for the Lounge Chair, two seat and back cushions for the Sofa, one semi-attached cushion for Ottoman. For units with combination upholstery, add list price of surround in appropriate grade with the list price of cushions to obtain total list price for item.
<b>K162/25</b>	Classic Boucle, Aegean	<i>Cushions:</i> Seat cushions constructed of highly resilient polyurethane foam and polyester fiber, wrapped in polyester fiber batting. Back cushion constructed with a soft polyurethane foam core and polyester fiber fill. Side cushion constructed of 10/90 down with a down proof ticking.
<i>Example:</i> <b>21623R-0313-S-K1152/8-K1024/3</b>	<i>Upholstery/COM information:</i> Prices shown includes fabric or leather upholstery. Contact your Knoll representative for colors. Only approved KnollTextiles and Spinneybeck leathers may be ordered.	<i>Legs:</i> 4" steel leg, 1 1/4" diameter, available in polished chrome with black nylon glides, or 4" turned solid oak leg available in natural oak, medium walnut on oak and ebonized oak with white nylon glides.
<b>2163R</b>	D’Urso Residential Lounge Collection, ottoman	<i>Leather cushions feature a perforated zipper breather panel.</i>
<b>0313</b>	Burnt Walnut legs	
<b>S</b>	Split upholstery	
<b>K1152/8</b>	Surround in Stirling, Cobble	
<b>K1024/3</b>	Cushions in Coco, Ciel	
<i>Specify:</i>	<i>Maintenance:</i> See pages 28-29.	
1. Pattern number		
2. Leg finish		
3. Textile selection		
<i>Specify with split upholstery:</i>		
1. Pattern number		
2. Leg finish		
3. Split upholstery option		
4. Textile selection, Surround		
5. Textile selection, Cushions		

Approved KnollTextiles Grades/Fabrics					Spinneybeck Leather									
<b>A</b> Alignment Beacon Bocce Common Ground Commuter Cloth Cross Tech Crossroad Delite Facet Hourglass Mariner Monarch Overture Prep Presto Sonnet Trophy Uni-Form	<b>B</b> continued Little Devil Ludlow Melody (E) Paradigm Prairie Prim Radianc Ransom Rush Hour Spree Summit Sutton Synth Tabloid Tinge Topos Vast Venue Versa Vinyl (E) Westwood Wild Thing	<b>C</b> continued Empire Stripe Entourage Entwine Essence Fibra Groovy Hudson Kaleidoscope CR Lagos Lore CR Milestone On Point Palisade Panache CR Patchwork Plaid On Prestini Pullman Quark Roundtrip Sahara Sequin CR Spectator Stepping Stones Swing Tilden (E) Utmost II Utopia Wit Zari CR	<b>D</b> Buzz Coterie Eclat Weave Hologram Island Kabuki Menagerie Pathway Retreat Vice Versa Woodland Zoom	<b>E</b> Aegean Circle Point Currents Demure Flower Power Highland Ikat Stripe Kampala Kimono Mamba Marquee Meroc Rebel Sherman Shima Tempest Tryst Whip	<b>F</b> Atelier Calais Cotton Velvet Cornaro Double Agent (E) Imprint In Stitches Liberty Mod Plaid Rivington Soon Swank Totem Tweed Frieze	<b>G</b> All Star Alter Ego Aurora Dapper Djenne Fancy Twill Gibson Haze Looped In Melange Modern Tweed Spencer Texnet Ultrasuede Vert	<b>H</b> Chiseled Constance Firefly Bella Byron Cato Chiseled Diamond Days Doily Dynamic Florescence Guise Hastings In Step Knoll Velvet Piper Prince Hairy Tudor Zimba	<b>U</b> Vicenza Volo	<b>X</b> Ducale Ducale Velour	<b>V</b> Acqua Amalfi Andes Embossed Tipped España Hand Tipped Velluto Pelle	<b>Y</b> Cascia Cervo Copenhagen Distressed Marissa Riva Rugata Saddle	<b>W</b> Alaska Antique Derby Forte Lucente Sabrina Umbria	<b>Ⓢ</b> Fire Retardant Chemicals * Approved for 2162P only.	<i>Check with your KnollTextiles or Spinneybeck Representative for additions or changes.</i>

# Joseph Paul D’Urso

## Residential Lounge Seating

Designer(s):  
Joseph Paul D’Urso, 2008



description	width	depth	height	seat h, max	arm h, max	type	textile fabric yards	leather sq ft	weight	
<b>2162R</b> Residential Sofa, same upholstery, frame and cushions	90"	40 1/2"	28 1/2"	15 7/8"	20 7/8"		14	250	151 lbs.	
<b>2162R</b> Residential Sofa, combination upholstery, frame and cushions	90"	40 1/2"	28 1/2"	15 7/8"		frame uph.	6.7	110		
							upchg, cushions	7.7	145	
<b>2163R</b> Residential Ottoman, same upholstery, frame and cushions	28 1/2"	28 1/2"	14"	14"			3.5	45	26 lbs.	
<b>2163R</b> Residential Ottoman, combination upholstery, frame and cushions	28 1/2"	28 1/2"	14"	14"		frame uph.	1.4	15		
							upchg, cushions	2.8	30	
<b>2162P</b> Optional side cushion for residential sofa	21"	5"	11"				1	n/a	6 lbs.	

### Order Code

<i>Example:</i> <b>2160R-OE-K162/25</b>
<b>2160R</b> D’Urso Residential Lounge Collection, lounge chair
<b>OE</b> Ebonized legs
<b>K162/25</b> Classic Boucle, Aegean
<i>Example:</i> <b>21623R-0313-S-K1152/8-K1024/3</b>
<b>2163R</b> D’Urso Residential Lounge Collection, ottoman
<b>0313</b> Burnt Walnut legs
<b>S</b> Split upholstery
<b>K1152/8</b> Surround in Stirling, Cobble
<b>K1024/3</b> Cushions in Coco, Ciel

### Specify:

1. Pattern number
2. Leg finish
3. Textile selection

### Specify with split upholstery:

1. Pattern number
2. Leg finish
3. Split upholstery option
4. Textile selection, Surround
5. Textile selection, Cushions

### Ordering Information

**Leg finishes:**  
Burnt Walnut on Oak (suffix 0313)  
Clear Oak (suffix OC)  
Ebonized on Oak (suffix OE)  
Polished Chrome (suffix C)

**Upholstery/COM information:**  
Prices shown includes fabric or leather upholstery. Contact your Knoll representative for colors. Only approved KnollTextiles and Spinneybeck leathers may be ordered.

Customer’s Own Material is available pending approval. For approval requirements, processing instructions and ordering information please see page 21.

**Maintenance:**  
See pages 28-29.

### Construction

**Frame:**  
Constructed of plywood with sinuous spring seat suspension and matrix back suspension. Standard lounge chair and sofa depth is 36"; residential sofa is 40" deep.

**Upholstery:**  
One seat and back cushion for the Lounge Chair, two seat and back cushions for the Sofa, one semi-attached cushion for Ottoman. For units with combination upholstery, add list price of surround in appropriate grade with the list price of cushions to obtain total list price for item.

Railroad upholstery application is standard for all non-directional textiles. Please see ‘Stitching’ for seam details.

**Cushions:**  
Seat cushions constructed of highly resilient polyurethane foam and polyester fiber, wrapped in polyester fiber batting. Back cushion constructed with a soft polyurethane foam core and polyester fiber fill. Side cushion constructed of 10/90 down with a down proof ticking.

Leather cushions feature a perforated zipper breather panel.

**Stitching:**  
Non-directional textiles with railroad application, single needle topstitch for arms, double needle topstitch for seat and back cushions; directional textiles, single needle topstitch for arms, double needle topstitch for seat and back cushions, single blind stitch for vertical seams of seat cushion, a vertical single blind center seam joins inside and outside back panels of the sofa; leather, single needle topstitch for arms, double needle topstitch for seat and back cushions, single blind stitch for vertical seams of seat cushion, a vertical double needle topstitch seam joins inside and outside back panels of sofa. Ottoman; all applications, double needle topstitch for horizontal cushion seams, single blind seam for vertical seams of seat cushion.

**Legs:**  
4" steel leg, 1 1/4" diameter, available in polished chrome with black nylon glides, or 4" turned solid oak leg available in natural oak, medium walnut on oak and ebonized oak with white nylon glides.

pattern no.	grade A	COM B	C	D	E	F	G	H	I	COL U	V	W	X	Y
<b>2162R-(-)(-)</b>	\$11,483.	\$11,985.	\$12,461.	\$12,987.	\$13,412.	\$13,722.	\$14,246.	\$15,246.	\$15,984.	\$21,210.	\$22,937.	\$26,448.	\$27,180.	\$28,032.
<b>2162RS-(-)(-)(-)</b>	8,761.	9,144.	9,507.	9,909.	10,235.	10,473.	10,868.	11,633.	12,196.	15,216.	16,456.	18,975.	19,497.	20,112.
<b>upchg, cushions</b>	3,755.	3,919.	4,076.	4,247.	4,385.	4,486.	4,659.	4,986.	5,229.	6,524.	7,052.	8,135.	8,356.	8,620.
<b>2163R-(-)(-)</b>	3,573.	3,720.	3,859.	4,011.	4,136.	4,228.	4,377.	4,671.	4,888.	5,548.	5,861.	6,492.	6,625.	6,780.
<b>2163RS-(-)(-)(-)</b>	2,724.	2,839.	2,944.	3,058.	3,156.	3,226.	3,341.	3,565.	3,729.	3,982.	4,205.	4,659.	4,752.	4,862.
<b>upchg, cushions</b>	1,168.	1,216.	1,262.	1,313.	1,353.	1,383.	1,434.	1,530.	1,596.	1,704.	1,800.	1,998.	2,038.	2,085.
<b>2162P-(-)</b>	660.	695.	727.	764.	791.	816.	852.	919.	973.					

### Approved KnollTextiles Grades/Fabrics

<b>A</b> Alignment Beacon Bocce Common Ground Commuter Cloth Cross Tech Crossroad Delite Facet Hourglass Mariner Monarch Overture Prep Presto Sonnet Trophy Uni-Form	<b>B</b> continued Little Devil Ludlow Melody (G) Paradigm Prairie Prim Radiance Ransom Rush Hour Spree Summit Sutton Synth Tabloid Tinge Topos Vast Venue Versa Vinyl (G) Westwood Wild Thing	<b>C</b> continued Empire Stripe Entourage Entwine Essence Fibra Groovy Hudson Kaleidoscope CR Lagos Lore CR Milestone On Point Palisade Panache CR Patchwork Plaid On Prestini Pullman Quark Roundtrip Sahara Sequin CR Spectator Stepping Stones Swing Tilden (G) Utmost II Utopia Wit Zari CR	<b>D</b> Buzz Coterie Eclat Weave Hologram Island Kabuki Menagerie Pathway Retreat Vice Versa Woodland Zoom	<b>E</b> Aegean Circle Point Currents Demure Flower Power Highland Ikat Stripe Kampala Kimono Mamba Marquee Meroc Rebel Sherman Shima Tempest Tryst Whip
--	---	---	---	--

### Spinneybeck Leather

<b>U</b> Vicenza Volo	<b>X</b> Ducale Ducale Velour
<b>V</b> Acqua Amalfi Andes Embossed Tipped España Hand Tipped Velluto Pelle	<b>Y</b> Cascia Cervo Copenhagen Distressed Marissa Riva Rugata Saddle
<b>W</b> Alaska Antique Derby Forte Lucente Sabrina Umbria	

(G) Fire Retardant Chemicals  
\* Approved for 2162P only.

Check with your KnollTextiles or Spinneybeck Representative for additions or changes.

# Joseph Paul D’Urso Swivel Lounge Seating

description	seat h,	seat h,	w	d	h, min	h, max	textile	req.	weight
	min	max					fabric	leather	
	yds.	sq. ft.							
2165 Swivel Lounge chair	17"	20"	32"	30"	25 3/4"	28 3/4"	4.25	100	52 lbs.

Designer(s):  
Joseph Paul D’Urso, 2008

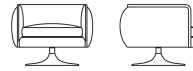

pattern no.	grades	COM	C	D	E	F	G	H	I	U	V	W	X	Y
2165-( )-( )	\$4,341.	\$4,487.	\$4,627.	\$4,785.	\$4,907.	\$4,999.	\$5,156.	\$5,451.	\$5,669.	\$8,192.	\$8,760.	\$9,920.	\$10,161.	\$10,443.

Order Code	Ordering Information	Construction
<i>Example:</i> <b>2165-RC-AP-K1320/4</b>	<i>Frame finish:</i> Polished Aluminum (suffix AP) Textured Black (suffix TB) Warm White (suffix WW)	<i>Frame:</i> Inner frame of solid wood and bent laminate plywood.
<b>2165</b> Joseph Paul D’Urso Swivel lounge	<i>Maintenance:</i> See pages 28-29.	<i>Base:</i> Die cast aluminum base available in polished aluminum or powder coat paint finish.
<b>RC</b> Return to center mechanism	<i>Note:</i> The KnollStudio logo and signature of Joseph Paul D’Urso are located on the underside of chair.	<i>Upholstery:</i> Textile application must be railroaded. Urethane foam with polyester top layer wraps interior frame and a fully upholstered panel surrounds chair.
<b>AP</b> Polished Aluminum	<i>Upholstery/COM information:</i> Prices shown include fabric upholstery. Contact your Knoll representative for colors. Only approved KnollTextiles may be ordered.	<i>Leather upholstery features two vertical double-needle top stitched seams on the outside back of the chair.</i>
<b>K1320/4</b> Cornaro, Tabasco	<b>Customer’s Own Material in textile applications is limited.</b> For approval requirements, processing instructions and ordering information please see page 21.	<i>Cushion:</i> Urethane foam with polyester fiber wrap. Case with a single needle-top stitch detail.
<i>Note:</i> The Joseph Paul D’Urso Swivel lounge chair is part of a collection. Please refer to the Joseph Paul D’Urso Lounge and Table Collections on pages 118, 122, 384, 386 and 390.		
<i>Specify:</i> 1. Pattern number 2. Return to center mechanism, option 3. Frame finish 4. Textile selection		

Control:	Approved KnollTextiles Grades/Fabrics	Spinneybeck Leather
360° Swivel mechanism with pneumatic seat height adjustment, cable operated with a low profile lever, flush mounted on the underside of the chair.	<b>A</b> Facet Mariner Oh La La Sonnet	<b>V</b> Amalfi Andes España
<i>Return to center mechanism:</i> Optional return to center mechanism allows for 360° swivel movement and returns to a center position when not engaged. Available as fixed height only with an 19" seat height and a 27 3/4" overall height.	<b>B</b> Attire Cozy Cord Dottie Knoll Felt Knoll Hopsack Little Devil Melody Puff Topos Vast	<b>Y</b> Marissa Riva
To specify return to center mechanism, add suffix RC following parent pattern number.	<b>C</b> Chameleon Classic Boucle On Point Patchwork Prestini Wow Factor	<b>W</b> Sabrina
	<b>D</b> Buzz Pathway Retreat Vice Versa	<b>Ⓢ</b> Fire Retardant Chemicals
	<b>E</b> Circle Point Currents Flower Power Off The Grid Rebel Tempest	<i>Check with your KnollTextiles Representative for changes or additions.</i>
	<b>F</b> Facet Mariner Oh La La Sonnet	
	<b>G</b> Aurora Dapper Looped In Modern Tweed Rivers Vert	
	<b>H</b> Bavaria Stretch Appeal	
	<b>I</b> Aswan Cato Doily Floressence Guise North Island Stripe It	



# Raul de Armas de Armas Chair

*Designer(s):*  
Raul de Armas, 1991

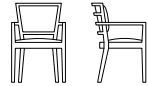
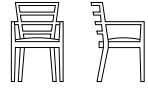

description	seat h	arm h	w	d	h	textile	req.	weight	finish
						fabric yds/ welt	leather sq. ft.		
<b>38A</b> Arm chair, upholstered seat, no welt	17 1/2"	25 1/2"	21 1/4"	22 1/2"	33 1/2"	0.7/1.4	13	17 lbs.	other finishes
<b>38AW</b> Arm chair, upholstered seat, with welt	17 1/2"	25 1/2"	21 1/4"	22 1/2"	33 1/2"	0.7/1.4	13	16 lbs.	maple
<b>38AW-U</b> Arm chair, fully upholstered, with welt	17 1/2"	25 1/2"	21 1/4"	22 1/2"	33 1/2"	1.5	27	18 lbs.	other finishes
	17 1/2"	25 1/2"	21 1/4"	22 1/2"	33 1/2"	1.5	27	17 lbs.	maple

## Order Code

<i>Example:</i>	<b>38A-B319-K787/174</b>
<b>38A</b>	de Armas arm chair, upholstered seat
<b>B319</b>	Medium Cherry
<b>K787/174</b>	Calais Cotton Velvet, Black Plum

## Specify:

1. Pattern number
2. Finish selection
3. Cal 133 Fire Code option
4. Textile selection

## Ordering Information:

*Maple:*  
Clear Maple (suffix KC)

*Beech frame stains:*  
Beech (suffix B311)  
Bronzed Cherry (suffix B312A)  
Burnt Walnut (suffix B313)  
Deep Red Mahogany (suffix B328)  
Ebonized (suffix BE)  
Light Cherry (suffix B315)  
Light Walnut (suffix B411)  
Medium Cherry (suffix B319)  
Medium Red Mahogany (suffix BR)  
Medium Walnut (suffix B323)  
Natural Beech (suffix BN)  
Warm Brown Walnut (suffix J)

## Ordering Information

*Upholstery/COM information:*  
Prices shown include fabric or leather upholstery. Contact your Knoll representative for colors. Only approved KnollTextiles and Spinneybeck leathers may be ordered.

Customer's Own Material is available pending approval. For approval requirements, processing instructions and ordering information please see page 21.

*KnollStudio wood finishes:*  
KnollStudio wood finishes complement a large variety of KnollStudio veneer and Knoll Office veneer finishes. To select correct complementary finish, please refer to KnollStudio Wood Finish Matrix on page 26. Complimentary finishes are available at no upcharge. If no complementary standard finish is available, please refer to custom finish policy below.

*Cal 133 Fire Code # :*  
The de Armas Chairs comply with the California Technical Bulletin 133 standard if upholstered in Cal 133 approved upholstery. Specify suffix -C at end of pattern number and suffix -133 at end of textile selection. Upcharge applies, see page 18.

*Certified Wood:*  
Chairs manufactured using FSC certified hardwoods are available through Custom Product Development. Extended leadtime and upcharge apply.

*Maintenance:*  
See pages 28-29.

*Note:*  
The de Armas Chair is certified Clean Air GOLD.

## Construction

*Frame:*  
Select clear maple hardwood in clear finish or select beech hardwood in stained finish.

*Finish:*  
Catalyzed lacquer protective coating. Hand-applied final wax coating.

*Seat:*  
Highly elastic woven membrane suspension with polyurethane foam insert.

*Upholstery:*  
Inset seat available with optional welt detail. Fully upholstered features inset back with welt detail.

*Glides:*  
Recessed plastic glides.

*High Traffic Areas:*  
When specifying armless chair in high use or high traffic areas, we recommend the use of a stretcher for added strength. Contact CPD or your KnollStudio sales representative for more information.

pattern no.	grades <b>A</b>	COM <b>B</b>	<b>C</b>	<b>D</b>	<b>E</b>	<b>F</b>	<b>G</b>	<b>H</b>	<b>I</b>	COL <b>U</b>	<b>V</b>	<b>W</b>	<b>X</b>	<b>Y</b>
<b>38A-( ) or 38AW-( )</b>	\$1,953.	\$1,990.	\$2,029.	\$2,051.	\$2,078.	\$2,101.	\$2,126.	\$2,189.	\$2,292.	\$2,536.	\$2,679.	\$2,962.	\$3,025.	\$3,093.
<b>38A-KC or 38AW-KC</b>	2,145.	2,181.	2,219.	2,246.	2,267.	2,292.	2,317.	2,377.	2,483.	2,723.	2,870.	3,152.	3,216.	3,285.
<b>38AW-U-( )</b>	2,925.	2,989.	3,046.	3,112.	3,164.	3,202.	3,267.	3,394.	3,486.	3,839.	4,058.	4,509.	4,603.	4,707.
<b>38AW-U-KC</b>	3,206.	3,268.	3,328.	3,396.	3,449.	3,487.	3,550.	3,674.	3,766.	4,120.	4,338.	4,790.	4,887.	4,990.

## Approved KnollTextiles Grades/Fabrics

<b>A</b> Alignment * Beacon * Bocce * Chance * Common Ground * Commuter Cloth * Crossroad Delite * Facet Foil Rap * Heavy Metal * Hourglass Infinite * Mariner * Monarch * Oh La La * Overture * Prep * Presto * Sonnet * Trophy * Uni-Form *	<b>B</b> Abacus * Argyle * Attire Belize Bistro * Boundary * Calypso * Chronicle * Close Knit * Cozy Cord * Day Tripper Dottie * Ferry * Forza * <sup>Ⓞ</sup>	<b>C</b> Axiom * <sup>Ⓞ</sup> Atlas * Baxter * Cairo * Chameleon * Charm * Circa * Classic Boucle * Contour Durand * Earthwork * Empire Stripe Entourage * Entwine * Essence * Fibra * Greenwich * Groovy Hudson * Kaleidoscope CR * Lagos * Lore CR * Magnolia * Milestone * On Point * Palisade * Panache CR * Patchwork * Plaid On * Prestini * Pullman *	<b>C</b> continued Quark * Roundtrip * Sahara * Sequin CR * Sinclair * Smart * <sup>Ⓞ</sup> Spectator * Stepping Stones * Swing * Tight Rope * Tilden * <sup>Ⓞ</sup> Tower Grid * Utmost II Utopia * Wit * Wow Factor Zari CR *	<b>D</b> Buzz Code * Coterie * Eclat Weave * Hologram * Island * Menagerie * Origins * Pathway * Plaidtastic Retreat * Vice Versa * Woodland * Zoom *	<b>E</b> Aegean * Circle Point * Cleo * Currents Demure * Flower Power * Highland * Ikat Stripe * Juno * Kampala * Kimono *	<b>E</b> continued Mamba * Marquee * Meroe * Midpoint Nature Walk Off The Grid * Rebel * Sherman * Shima * Tempest Tryst Vatera * Whip *	<b>F</b> Atelier * Biscayne * Calais Cotton Velvet Century * Cornaro * Dapper Double Agent * <sup>Ⓞ</sup> Fancy Twill Glider * Homage * Imprint * In Stitches * Liberty * Mod Plaid * Rivington * Soon * Swank Totem * Tweed Frieze *	<b>G</b> All Star Alter Ego * Arber * Aurora * Color Collage * Djenne * Duchess Gibson * Haze * Kamani *	<b>G</b> continued Looped In Melange * Modern Tweed * Rivers * Spencer * Straie Stripe * Texnet * Ultrasuede * Utrillo * Vert *	<b>H</b> Bavaria * Catwalk * Chiseled * Constance * Firefly * Stretch Appeal * Twist Tie * World Piece	<b>I</b> Aswan * Bella * Byron * Cato * Chic * Cummings * Diamond Days * Doily * Dynamic * Florescence * Guise Hastings * In Step Ita * Jaipur * Knoll Velvet * Limani * Mepal * North Island * Olema * Piper * Prince Hair Rutledge * Sandis * Stripe It * Tudor * Zimba *	<b>U</b> Vicenza * Volo *	<b>V</b> Acqua * Andes * Embossed Tipped * España * Hand Tipped * Velluto Pelle *	<b>W</b> Alaska * Antique * Derby * Forte * Lucente Sabrina * Umbria *	<b>X</b> Ducale * Ducale Velour *  <b>Y</b> Cervo * Copenhagen * Distressed * Gemma * Lucca * Marissa * Portofino * Riva * Saddle *  * Approved for fully upholstered versions. ** Approved for seat pad with no wetting only. <sup>Ⓞ</sup> Fire Retardant Chemicals
---	---	---	--	---	--	---	---	--	---	--	--	---------------------------------	---	---	---

## Spinneybeck Leather

# Raul de Armas de Armas Chair

description	seat h	arm h	w	d	h	textile	req.	weight	finish
						fabric yds/ welt	leather sq. ft.		
<b>38C</b> Armless chair, upholstered seat, no welt	17 1/2"		21 1/4"	22 1/2"	33 1/2"	0.7/1.4	13	15 lbs.	other finishes
<b>38CW</b> Armless chair, upholstered seat, with welt	17 1/2"		21 1/4"	22 1/2"	33 1/2"	0.7/1.4	13	15 lbs.	maple

Designer(s):  
Raul de Armas, 1991

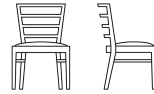

### Order Code

<i>Example:</i>	<b>38A-B319-K787/174</b>
<b>38A</b>	de Armas arm chair, upholstered seat
<b>B319</b>	Medium Cherry
<b>K787/174</b>	Calais Cotton Velvet, Black Plum

### Specify:

1. Pattern number
2. Finish selection
3. Cal 133 Fire Code option
4. Textile selection

### Ordering Information:

*Maple:*  
Clear Maple (suffix KC)

*Beech frame stains:*  
Beech (suffix B311)  
Bronzed Cherry (suffix B312A)  
Burnt Walnut (suffix B313)  
Deep Red Mahogany (suffix B328)  
Ebonized (suffix BE)  
Light Cherry (suffix B315)  
Light Walnut (suffix B411)  
Medium Cherry (suffix B319)  
Medium Red Mahogany (suffix BR)  
Medium Walnut (suffix B323)  
Natural Beech (suffix BN)  
Warm Brown Walnut (suffix J)

### Ordering Information

*Upholstery/COM information:*  
Prices shown include fabric or leather upholstery. Contact your Knoll representative for colors. Only approved KnollTextiles and Spinneybeck leathers may be ordered.

Customer's Own Material is available pending approval. For approval requirements, processing instructions and ordering information please see page 21.

*KnollStudio wood finishes:*  
KnollStudio wood finishes complement a large variety of KnollStudio veneer and Knoll Office veneer finishes. To select correct complementary finish, please refer to KnollStudio Wood Finish Matrix on page 26. Complimentary finishes are available at no upcharge. If no complementary standard finish is available, please refer to custom finish policy below.

*Cal 133 Fire Code # :*  
The de Armas Chairs comply with the California Technical Bulletin 133 standard if upholstered in Cal 133 approved upholstery. Specify suffix -C at end of pattern number and suffix -133 at end of textile selection. Upcharge applies, see page 18.

*Certified Wood:*  
Chairs manufactured using FSC certified hardwoods are available through Custom Product Development. Extended leadtime and upcharge apply.

*Maintenance:*  
See pages 28-29.

*Note:*  
The de Armas Chair is certified Clean Air GOLD.

### Construction

*Frame:*  
Select clear maple hardwood in clear finish or select beech hardwood in stained finish.

*Finish:*  
Catalyzed lacquer protective coating. Hand-applied final wax coating.

*Seat:*  
Highly elastic woven membrane suspension with polyurethane foam insert.

*Upholstery:*  
Inset seat available with optional welt detail. Fully upholstered features inset back with welt detail.

*Glides:*  
Recessed plastic glides.

*High Traffic Areas:*  
When specifying armless chair in high use or high traffic areas, we recommend the use of a stretcher for added strength. Contact CPD or your KnollStudio sales representative for more information.

pattern no.	grades <b>A</b>	COM <b>B</b>	<b>C</b>	<b>D</b>	<b>E</b>	<b>F</b>	<b>G</b>	<b>H</b>	<b>I</b>	COL <b>U</b>	<b>V</b>	<b>W</b>	<b>X</b>	<b>Y</b>
<b>38C-( ) or 38CW-( )</b>	\$1,847.	\$1,885.	\$1,927.	\$1,948.	\$1,975.	\$1,996.	\$2,026.	\$2,081.	\$2,193.	\$2,436.	\$2,578.	\$2,860.	\$2,918.	\$2,989.
<b>38C-KC or 38CW-KC</b>	2,031.	2,069.	2,110.	2,133.	2,157.	2,181.	2,208.	2,265.	2,373.	2,617.	2,760.	3,043.	3,101.	3,171.

### Approved KnollTextiles Grades/Fabrics

<b>A</b> Alignment * Beacon * Bocce * Chance * Common Ground * Commuter Cloth * Crossroad Delite * Facet Foil Rap * Heavy Metal * Hourglass Infinite * Mariner * Monarch * Oh La La * Overture * Prep * Presto * Sonnet * Trophy * Uni-Form *	<b>B</b> Gala II * Grandview * Grande * Helios * Holbrook * Instinct * Journey * Keaton * Knoll Felt * Knoll Hopsack * Little Devil * Ludlow * Lyric * Melody * <sup>Ⓞ</sup> Paradigm * Petal Pusher * <sup>Ⓞ</sup> Prairie * Prim * Puff * Radiance * Ransom * Roam * Rush Hour * Shadow Play Spree * Summit * Sutton * Synth * Tabloid * Topos * Vast * Venue * Versa * Vinyl * <sup>Ⓞ</sup> Westwood * Wild Thing Yeni *	<b>C</b> Axiom * <sup>Ⓞ</sup> Atlas * Baxter * Cairo * Chameleon * Charm * Circa * Classic Boucle * Contour Durand * Earthwork * Empire Stripe Entourage * Entwine * Essence * Fibra * Greenwich * Groovy Hudson * Kaleidoscope CR * Lagos * Lore CR * Magnolia * Milestone * On Point * Palisade * Panache CR * Patchwork * Plaid On * Prestini * Pullman *	<b>C</b> continued Quark * Roundtrip * Sahara * Sequin CR * Sinclair * Smart * <sup>Ⓞ</sup> Spectator * Stepping Stones * Swing * Tight Rope * Tilden * <sup>Ⓞ</sup> Tower Grid * Utmost II Utopia * Wit * Wow Factor Zari CR *	<b>D</b> Buzz Code * Coterie * Eclat Weave * Hologram * Island * Menagerie * Origins * Pathway * Plaidtastic Retreat * Vice Versa * Woodland * Zoom *	<b>E</b> Aegean * Circle Point * Cleo * Currents Demure * Flower Power * Highland * Ikat Stripe * Juno * Kampala * Kimono *	<b>E</b> continued Mamba * Marquee * Meroe * Midpoint Nature Walk Off The Grid * Rebel * Sherman * Shima * Tempest Tryst Vatera * Whip *	<b>F</b> Atelier * Biscayne * Calais Cotton Velvet Century ** Cornaro * Dapper Double Agent * <sup>Ⓞ</sup> Fancy Twill Glider * Homage * Imprint * In Stitches * Liberty * Mod Plaid * Rivington * Soon * Swank Totem * Tweed Frieze *	<b>G</b> All Star Alter Ego * Arber * Aurora * Color Collage ** Djenne * Duchess Gibson * Haze * Kamani *	<b>G</b> continued Looped In Melange * Modern Tweed * Rivers * Spencer * Straie Stripe * Texnet * Ultrasuede * Utrillo * Vert *	<b>H</b> Bavaria ** Catwalk * Chiseled * Constance * Firefly * Stretch Appeal * Twist Tie * World Piece	<b>I</b> Aswan * Bella * Byron * Cato ** Chic * Cummings * Diamond Days * Doily * Dynamic * Florescence * Guise Hastings * In Step Ita * Jaipur * Knoll Velvet * Limani * Mepal * North Island ** Olema * Piper * Prince Hair Rutledge * Sandis * Stripe It * Tudor * Zimba *	<b>U</b> Vicenza * Volo *	<b>V</b> Acqua * Andes * Embossed Tipped * España * Hand Tipped ** Velluto Pelle *	<b>W</b> Alaska * Antique * Derby ** Forte * Lucente Sabrina * Umbria *	<b>X</b> Ducale ** Ducale Velour **	<b>Y</b> Cervo * Copenhagen * Distressed * Gemma * Lucca * Portofino ** Riva * Saddle **
---	--	---	--	---	--	---	--	---	---	---	--	---------------------------------	--	--	---	--

### Spinneybeck Leather

<b>U</b> Vicenza * Volo *	<b>X</b> Ducale ** Ducale Velour **
<b>V</b> Acqua * Andes * Embossed Tipped * España * Hand Tipped ** Velluto Pelle *	<b>Y</b> Cervo * Copenhagen * Distressed * Gemma * Lucca * Portofino ** Riva * Saddle **
<b>W</b> Alaska * Antique * Derby ** Forte * Lucente Sabrina * Umbria *	* Approved for fully upholstered versions. ** Approved for seat pad with no wetting only. <sup>Ⓞ</sup> Fire Retardant Chemicals

*Check with your KnollTextiles or Spinneybeck Representative for changes or additions.*

# Raul de Armas de Armas Chair

description	seat h	arm h	w	d	h	textile	req.	weight	finish
						fabric yds/ welt	leather sq. ft.		
<b>38CW-U</b> Armless chair, fully upholstered, with welt	17 1/2"		21 1/4"	22 1/2"	33 1/2"	1.5	27	16 lbs.	other finishes
	17 1/2"		21 1/4"	22 1/2"	33 1/2"	1.5	27	16 lbs.	maple
<b>38R</b> Seat basket replacement						0.7/1.4	13		

Designer(s):  
Raul de Armas, 1991

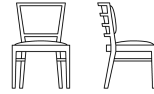

### Order Code

<i>Example:</i>	<b>38A-B319-K787/174</b>
<b>38A</b>	de Armas arm chair, upholstered seat
<b>B319</b>	Medium Cherry
<b>K787/174</b>	Calais Cotton Velvet, Black Plum

### Specify:

1. Pattern number
2. Finish selection
3. Cal 133 Fire Code option
4. Textile selection

### Ordering Information:

*Maple:*  
Clear Maple (suffix KC)

*Beech frame stains:*  
Beech (suffix B311)  
Bronzed Cherry (suffix B312A)  
Burnt Walnut (suffix B313)  
Deep Red Mahogany (suffix B328)  
Ebonized (suffix BE)  
Light Cherry (suffix B315)  
Light Walnut (suffix B411)  
Medium Cherry (suffix B319)  
Medium Red Mahogany (suffix BR)  
Medium Walnut (suffix B323)  
Natural Beech (suffix BN)  
Warm Brown Walnut (suffix J)

### Ordering Information

*Upholstery/COM information:*  
Prices shown include fabric or leather upholstery. Contact your Knoll representative for colors. Only approved KnollTextiles and Spinneybeck leathers may be ordered.

Customer's Own Material is available pending approval. For approval requirements, processing instructions and ordering information please see page 21.

*KnollStudio wood finishes:*  
KnollStudio wood finishes complement a large variety of KnollStudio veneer and Knoll Office veneer finishes. To select correct complementary finish, please refer to KnollStudio Wood Finish Matrix on page 26. Complimentary finishes are available at no upcharge. If no complementary standard finish is available, please refer to custom finish policy below.

*Cal 133 Fire Code # :*  
The de Armas Chairs comply with the California Technical Bulletin 133 standard if upholstered in Cal 133 approved upholstery. Specify suffix -C at end of pattern number and suffix -133 at end of textile selection. Upcharge applies, see page 18.

*Certified Wood:*  
Chairs manufactured using FSC certified hardwoods are available through Custom Product Development. Extended leadtime and upcharge apply.

*Maintenance:*  
See pages 28-29.

*Note:*  
The de Armas Chair is certified Clean Air GOLD.

### Construction

*Frame:*  
Select clear maple hardwood in clear finish or select beech hardwood in stained finish.

*Finish:*  
Catalyzed lacquer protective coating. Hand-applied final wax coating.

*Seat:*  
Highly elastic woven membrane suspension with polyurethane foam insert.

*Upholstery:*  
Inset seat available with optional welt detail. Fully upholstered features inset back with welt detail.

*Glides:*  
Recessed plastic glides.

*High Traffic Areas:*  
When specifying armless chair in high use or high traffic areas, we recommend the use of a stretcher for added strength. Contact CPD or your KnollStudio sales representative for more information.

pattern no.	grades <b>A</b>	COM <b>B</b>	<b>C</b>	<b>D</b>	<b>E</b>	<b>F</b>	<b>G</b>	<b>H</b>	<b>I</b>	COL <b>U</b>	<b>V</b>	<b>W</b>	<b>X</b>	<b>Y</b>
<b>38CW-U-( )</b>	\$2,635.	\$2,692.	\$2,754.	\$2,817.	\$2,873.	\$2,910.	\$2,976.	\$3,097.	\$3,191.	\$3,556.	\$3,774.	\$4,203.	\$4,318.	\$4,425.
<b>38CW-U-KC</b>	2,887.	2,946.	3,006.	3,070.	3,126.	3,162.	3,230.	3,351.	3,443.	3,807.	4,026.	4,457.	4,574.	4,681.
<b>38R-( )</b>	600.	632.	676.	697.	721.	746.	770.	829.	933.	1,182.	1,325.	1,604.	1,667.	1,734.

### Approved KnollTextiles Grades/Fabrics

<b>A</b> Alignment * Beacon * Bocce * Chance * Common Ground * Commuter Cloth * Crossroad Delite * Facet Foil Rap * Heavy Metal * Hourglass Infinite * Mariner * Monarch * Oh La La * Overture * Prep * Presto * Sonnet * Trophy * Uni-Form *	<b>B</b> Abacus * Argyle * Attire Belize Bistro * Boundary * Calypso * Chronicle * Close Knit * Cozy Cord * Day Tripper Dottie * Ferry * Forza * <sup>Ⓞ</sup>	<b>C</b> Axiom * <sup>Ⓞ</sup> Atlas * Baxter * Cairo * Chameleon * Charm * Circa * Classic Boucle * Contour Durand * Earthwork * Empire Stripe Entourage * Entwine * Essence * Fibra * Greenwich * Groovy Hudson * Kaleidoscope CR * Lagos * Lore CR * Magnolia * Milestone * On Point * Palisade * Panache CR * Patchwork * Plaid On * Prestini * Pullman *	<b>C</b> continued Quark * Roundtrip * Sahara * Sequin CR * Sinclair * Smart * <sup>Ⓞ</sup> Spectator * Stepping Stones * Swing * Tight Rope * Tilden * <sup>Ⓞ</sup> Tower Grid * Utmost II Utopia * Wit * Wow Factor Zari CR *	<b>D</b> Buzz Code * Coterie * Eclat Weave * Hologram * Island * Menagerie * Origins * Pathway * Plaidtastic Retreat * Vice Versa * Woodland * Zoom *	<b>E</b> Aegean * Circle Point * Cleo * Currents Demure * Flower Power * Highland * Ikat Stripe * Juno * Kampala * Kimono *	<b>E</b> continued Mamba * Marquee * Meroe * Midpoint Nature Walk Off The Grid * Rebel * Sherman * Shima * Tempest Tryst Vatera * Whip *	<b>F</b> Atelier * Biscayne * Calais Cotton Velvet Century * Cornaro * Dapper Double Agent * <sup>Ⓞ</sup> Fancy Twill Glider * Homage * Imprint * In Stitches * Liberty * Mod Plaid * Rivington * Soon * Swank Totem * Tweed Frieze *	<b>G</b> All Star Alter Ego * Arber * Aurora * Color Collage * Djenne * Duchess Gibson * Haze * Kamani *	<b>G</b> continued Looped In Melange * Modern Tweed * Rivers * Spencer * Straie Stripe * Texnet * Ultrasuede * Utrillo * Vert *	<b>H</b> Bavaria * Catwalk * Chiseled * Constance * Firefly * Stretch Appeal * Twist Tie * World Piece	<b>I</b> Aswan * Bella * Byron * Cato * Chic * Cummings * Diamond Days * Doily * Dynamic * Florescence * Guise Hastings * In Step Ita * Jaipur * Knoll Velvet * Limani * Mepal * North Island * Olema * Piper * Prince Hairy Rutledge * Sandis * Stripe It * Tudor * Zimba *	<b>U</b> Vicenza * Volo *	<b>V</b> Acqua * Andes * Embossed Tipped * España * Hand Tipped * Velluto Pelle *	<b>W</b> Alaska * Antique * Derby * Forte * Lucente Sabrina * Umbria *	<b>X</b> Ducale * Ducale Velour * <b>Y</b> Cervo * Copenhagen * Distressed * Gemma * Lucca * Portofino * Riva * Saddle *  * Approved for fully upholstered versions. ** Approved for seat pad with no wetting only. <sup>Ⓞ</sup> Fire Retardant Chemicals
---	---	---	--	---	--	---	---	--	---	--	---	---------------------------------	---	---	--

### Spinneybeck Leather

# Raul de Armas

## Vertical de Armas Chair

Designer(s):  
Raul de Armas, 2000

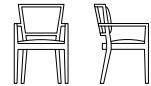
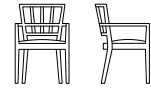

description	seat h	arm h	w	d	h	textile	req.	weight	finish
						fabric	leather		
						yds/ welt	sq. ft.		
<b>41A</b> Arm chair, upholstered seat, no welt	17 1/2"	25 1/2"	21 1/4"	22 1/2"	33 1/2"	0.7/1.4	13	17 lbs.	other finishes
<b>41AW</b> Arm chair, upholstered seat, with welt	17 1/2"	25 1/2"	21 1/4"	22 1/2"	33 1/2"	0.7/1.4	13	16 lbs.	maple
<b>41AW-U</b> Arm chair, fully upholstered, with welt	17 1/2"	25 1/2"	21 1/4"	22 1/2"	33 1/2"	1.5	27	18 lbs.	other finishes
	17 1/2"	25 1/2"	21 1/4"	22 1/2"	33 1/2"	1.5	27	17 lbs.	maple
<b>41R</b> Seat basket replacement						0.7/1.4	13		

### Order Code

<i>Example:</i>	<b>41A-B319-K787/174</b>
<b>41A</b>	de Armas arm chair
<b>B319</b>	Medium Cherry
<b>K2085/1</b>	Crossroad, Pearl

### Specify:

1. Pattern number
2. Finish selection
3. Cal 133 Fire Code option
4. Textile selection

### Ordering Information:

*Maple:*  
Clear Maple (suffix KC)

*Beech frame stains:*  
Beech (suffix B311)  
Bronzed Cherry (suffix B312A)  
Burnt Walnut (suffix B313)  
Deep Red Mahogany (suffix B328)  
Ebonized (suffix BE)  
Light Cherry (suffix B315)  
Light Walnut (suffix B411)  
Medium Cherry (suffix B319)  
Medium Red Mahogany (suffix BR)  
Medium Walnut (suffix B323)  
Natural Beech (suffix BN)  
Warm Brown Walnut (suffix J)

### Ordering Information

*Upholstery/COM information:*  
Prices shown include fabric or leather upholstery. Contact your Knoll representative for colors. Only approved KnollTextiles and Spinneybeck leathers may be ordered.

Customer's Own Material is available pending approval. For approval requirements, processing instructions and ordering information please see page 21.

*KnollStudio wood finishes:*  
KnollStudio wood finishes complement a large variety of KnollStudio veneer and Knoll Office veneer finishes. To select correct complementary finish, please refer to KnollStudio Wood Finish Matrix on page 26. Complementary finishes are available at no upcharge. If no complementary standard finish is available, please refer to custom finish policy below.

*Cal 133 Fire Code # :*  
The de Armas Chairs comply with the California Technical Bulletin 133 standard if upholstered in Cal 133 approved upholstery. Specify suffix -C at end of pattern number and suffix -133 at end of textile selection. Upcharge applies, see page 18.

*Certified Wood:*  
Chairs manufactured using FSC certified hardwoods are available through Custom Product Development. Extended leadtime and upcharge apply.

*Maintenance:*  
See pages 28-29.

*Note:*  
The Vertical de Armas Chair is certified Clean Air GOLD.

### Construction

*Frame:*  
Select clear maple hardwood in clear finish or select beech hardwood in stained finish.

*Finish:*  
Catalyzed lacquer protective coating. Hand-applied final wax coating.

*Seat:*  
Highly elastic woven membrane suspension with polyurethane foam insert.

*Upholstery:*  
Inset seat available with optional welt detail. Fully upholstered features inset back with welt detail.

*Glides:*  
Recessed plastic glides.

*High Traffic Areas:*  
When specifying armless chair in high use or high traffic areas, we recommend the use of a stretcher for added strength. Contact CPD or your KnollStudio sales representative for more information.

pattern no.	grades	COM	C	D	E	F	G	H	I	COL					
	A	B								U	V	W	X	Y	
<b>41A-( ) or 41AW-( )</b>	\$1,953.	\$1,990.	\$2,029.	\$2,051.	\$2,078.	\$2,101.	\$2,126.	\$2,189.	\$2,292.	\$2,536.	\$2,679.	\$2,962.	\$3,025.	\$3,093.	
<b>41A-KC or 41AW-KC</b>	2,145.	2,181.	2,219.	2,246.	2,267.	2,292.	2,317.	2,377.	2,483.	2,723.	2,870.	3,152.	3,216.	3,285.	
<b>41AW-U-( )</b>	2,925.	2,989.	3,046.	3,112.	3,164.	3,202.	3,267.	3,394.	3,486.	3,839.	4,058.	4,509.	4,603.	4,707.	
<b>41AW-U-KC</b>	3,206.	3,268.	3,328.	3,396.	3,449.	3,487.	3,550.	3,674.	3,766.	4,120.	4,338.	4,790.	4,887.	4,990.	
<b>41R-( )</b>	600.	632.	676.	697.	721.	746.	770.	829.	933.	1,182.	1,325.	1,604.	1,667.	1,734.	

### Approved KnollTextiles Grades/Fabrics

<b>A</b> Alignment * Beacon * Bocce * Chance * Common Ground * Commuter Cloth * Crossroad Delite * Facet * Foil Rap * Heavy Metal * Hourglass Infinite * Mariner * Monarch * Oh La La * Overture * Prep * Presto * Sonnet * Trophy * Uni-Form *	<b>B</b> Gala II * Grandview * Grande * Helios * Holbrook * Instinct * Journey * Keaton * Knoll Felt * Knoll Hopsack * Little Devil * Ludlow * Lyric * Melody * <sup>Ⓞ</sup> Paradigm * Petal Pusher * <sup>Ⓞ</sup> Prairie * Prim * Puff * Radiance * Ransom * Roam * Rush Hour * Shadow Play Spree * Summit * Sutton * Synth * Tabloid * Topos * Vast * Venue * Versa * Vinyl * <sup>Ⓞ</sup> Westwood * Wild Thing Yeni *	<b>C</b> Axiom * <sup>Ⓞ</sup> Atlas * Baxter * Cairo * Chameleon * Charm * Circa * Classic Boucle * Contour * Durand * Earthwork * Empire Stripe Entourage * Entwine * Essence * Fibra * Greenwich * Groovy Hudson * Kaleidoscope CR * Lagos * Lore CR * Magnolia * Milestone * On Point * Palisade * Panache CR * Patchwork * Plaid On * Prestini * Pullman *	<b>C</b> continued Quark * Roundtrip * Sahara * Sequin CR * Sinclair * Smart * <sup>Ⓞ</sup> Spectator * Stepping Stones * Swing * Tight Rope * Tilden * <sup>Ⓞ</sup> Tower Grid * Utmost II Utopia * Wit * Wow Factor Zari CR *	<b>D</b> Buzz Code * Coterie * Eclat Weave * Hologram * Island * Menagerie * Origins * Pathway * Plaidtastic Retreat * Vice Versa * Woodland * Zoom *	<b>E</b> Aegean * Circle Point * Cleo * Currents * Demure * Flower Power * Highland * Ikat Stripe * Juno * Kampala * Kimono *	<b>E</b> continued Mamba * Marquee * Meroe * Midpoint Nature Walk Off The Grid * Rebel * Sherman * Shima * Tempest Tryst Vatera * Whip *	<b>F</b> Atelier * Biscayne * Calais Cotton Velvet Century * Cornaro * Dapper Double Agent * <sup>Ⓞ</sup> Fancy Twill Glider * Homage * Imprint * In Stitches * Liberty * Mod Plaid * Rivington * Soon * Swank Totem * Tweed Frieze *	<b>G</b> continued Looped In Melange * Modern Tweed * Rivers * Spencer * Straie Stripe * Texnet * Ultrasuede * Utrillo * Vert *	<b>H</b> Bavaria * Catwalk * Chiseled * Constance * Firefly * Stretch Appeal * Twist Tie * World Piece	<b>I</b> Aswan * Bella * Byron * Cato * Chic * Cummings * Diamond Days * Doily * Dynamic * Guise Floressence * Hastings * In Step Ita * Jaipur * Knoll Velvet * Limani * Mepal * North Island * Olema * Piper * Prince Hair Rutledge * Sandis * Stripe It * Tudor * Zimba *	<b>U</b> Vicenza * Volo	<b>V</b> Acqua * Andes * Embossed Tipped * España * Hand Tipped * Velluto Pelle *	<b>W</b> Alaska * Antique * Derby * Forte * Lucente Sabrina * Umbria *	<b>X</b> Ducale * Ducale Velour *  <b>Y</b> Cervo * Copenhagen * Distressed * Gemma * Lucca * Marissa * Portofino * Riva * Saddle *  * Approved for fully upholstered versions. ** Approved for seat pad with no wetting only. Ⓞ Fire Retardant Chemicals
---	--	---	--	---	--	---	---	---	--	--	-------------------------------	---	---	--

### Spinneybeck Leather

# Raul de Armas

## Vertical de Armas Chair

Designer(s):  
Raul de Armas, 2000

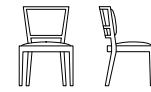
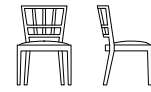

description	seat h	arm h	w	d	h	textile	leather	weight	finish
						fabric yds/ welt	sq. ft.		
<b>41C</b> Armless chair, upholstered seat, no welt	17 1/2"		21 1/4"	22 1/2"	33 1/2"	0.7/1.4	13	15 lbs.	other finishes
<b>41CW</b> Armless chair, upholstered seat, with welt	17 1/2"		21 1/4"	22 1/2"	33 1/2"	0.7/1.4	13	16 lbs.	maple
<b>41CW-U</b> Armless chair, fully upholstered, with welt	17 1/2"		21 1/4"	22 1/2"	33 1/2"	1.5	27	16 lbs.	other finishes
	17 1/2"		21 1/4"	22 1/2"	33 1/2"	1.5	27	17 lbs.	maple
<b>41R</b> Seat basket replacement						0.7/1.4	13		

### Order Code

<i>Example:</i>	<b>41A-B319-K787/174</b>
<b>41A</b>	de Armas arm chair
<b>B319</b>	Medium Cherry
<b>K2085/1</b>	Crossroad, Pearl

### Specify:

1. Pattern number
2. Finish selection
3. Cal 133 Fire Code option
4. Textile selection

### Ordering Information:

*Maple:*  
Clear Maple (suffix KC)

*Beech frame stains:*  
Beech (suffix B311)  
Bronzed Cherry (suffix B312A)  
Burnt Walnut (suffix B313)  
Deep Red Mahogany (suffix B328)  
Ebonized (suffix BE)  
Light Cherry (suffix B315)  
Light Walnut (suffix B411)  
Medium Cherry (suffix B319)  
Medium Red Mahogany (suffix BR)  
Medium Walnut (suffix B323)  
Natural Beech (suffix BN)  
Warm Brown Walnut (suffix J)

### Ordering Information

*Upholstery/COM information:*  
Prices shown include fabric or leather upholstery. Contact your Knoll representative for colors. Only approved KnollTextiles and Spinneybeck leathers may be ordered.

Customer's Own Material is available pending approval. For approval requirements, processing instructions and ordering information please see page 21.

*KnollStudio wood finishes:*  
KnollStudio wood finishes complement a large variety of KnollStudio veneer and Knoll Office veneer finishes. To select correct complementary finish, please refer to KnollStudio Wood Finish Matrix on page 26. Complementary finishes are available at no upcharge. If no complementary standard finish is available, please refer to custom finish policy below.

*Cal 133 Fire Code ▲ :*  
The de Armas Chairs comply with the California Technical Bulletin 133 standard if upholstered in Cal 133 approved upholstery. Specify suffix -C at end of pattern number and suffix -133 at end of textile selection. Upcharge applies, see page 18.

*Certified Wood:*  
Chairs manufactured using FSC certified hardwoods are available through Custom Product Development. Extended leadtime and upcharge apply.

*Maintenance:*  
See pages 28-29.

*Note:*  
The Vertical de Armas Chair is certified Clean Air GOLD.

### Construction

*Frame:*  
Select clear maple hardwood in clear finish or select beech hardwood in stained finish.

*Finish:*  
Catalyzed lacquer protective coating. Hand-applied final wax coating.

*Seat:*  
Highly elastic woven membrane suspension with polyurethane foam insert.

*Upholstery:*  
Inset seat available with optional welt detail. Fully upholstered features inset back with welt detail.

*Glides:*  
Recessed plastic glides.

*High Traffic Areas:*  
When specifying armless chair in high use or high traffic areas, we recommend the use of a stretcher for added strength. Contact CPD or your KnollStudio sales representative for more information.

pattern no	grades	COM	C	D	E	F	G	H	I	COL	V	W	X	Y
	A	B								U				
<b>41C-( ) or 41CW-( )</b>	\$1,847.	\$1,885.	\$1,927.	\$1,948.	\$1,975.	\$1,996.	\$2,026.	\$2,081.	\$2,193.	\$2,436.	\$2,578.	\$2,860.	\$2,918.	\$2,989.
<b>41C-KC or 41CW-KC</b>	2,031.	2,069.	2,110.	2,133.	2,157.	2,181.	2,208.	2,265.	2,373.	2,617.	2,760.	3,043.	3,101.	3,171.
<b>41CW-U-( )</b>	2,635.	2,692.	2,754.	2,817.	2,873.	2,910.	2,976.	3,097.	3,191.	3,556.	3,774.	4,203.	4,318.	4,425.
<b>41CW-U-KC</b>	2,887.	2,946.	3,006.	3,070.	3,126.	3,162.	3,230.	3,351.	3,443.	3,807.	4,026.	4,457.	4,574.	4,681.
<b>41R-( )</b>	600.	632.	676.	697.	721.	746.	770.	829.	933.	1,182.	1,325.	1,604.	1,667.	1,734.

### Approved KnollTextiles Grades/Fabrics



<b>A</b> Alignment * Beacon * Bocce * Chance * Common Ground * Commuter Cloth * Crossroad Delite * Facet * Foil Rap * Heavy Metal * Hourglass Infinite * Mariner * Monarch * Oh La La * Overture * Prep * Presto * Sonnet * Trophy * Uni-Form *	<b>B</b> Gala II * Grandview * Grande * Helios * Holbrook * Instinct * Journey * Keaton * Knoll Felt * Knoll Hopsack * Little Devil * Ludlow * Lyric * Melody * <sup>Ⓔ</sup> Paradigm * Petal Pusher * <sup>Ⓔ</sup> Prairie * Prim * Puff * Radiance * Ransom * Roam * Rush Hour * Shadow Play Spree * Summit * Sutton * Synth * Tabloid * Topos * Vast * Venue * Versa * Vinyl * <sup>Ⓔ</sup> Westwood * Wild Thing Yeni *	<b>C</b> Axiom * <sup>Ⓔ</sup> Atlas * Baxter * Cairo * Chameleon * Charm * Circa * Classic Boucle * Contour * Durand * Earthwork * Empire Stripe Entourage * Entwine * Essence * Fibra * Greenwich * Groovy Hudson * Kaleidoscope CR * Lagos * Lore CR * Magnolia * Milestone * On Point * Palisade * Panache CR * Patchwork * Plaid On * Prestini * Pullman *	<b>C</b> continued Quark * Roundtrip * Sahara * Sequin CR * Sinclair * Smart * <sup>Ⓔ</sup> Spectator * Stepping Stones * Swing * Tight Rope * Tilden * <sup>Ⓔ</sup> Tower Grid * Utmost II Utopia * Wit * Wow Factor Zari CR *	<b>D</b> Buzz Code * Coterie * Eclat Weave * Hologram * Island * Menagerie * Origins * Pathway * Plaidtastic Retreat * Vice Versa * Woodland * Zoom *	<b>E</b> Aegean * Circle Point * Cleo * Currents * * Demure * Flower Power * Highland * Ikat Stripe * Juno * Kampala * Kimono *	<b>E</b> continued Mamba * Marquee * Meroe * Midpoint Nature Walk Off The Grid * Rebel * Sherman * Shima * Tempest Tryst Vatera * Whip *	<b>F</b> Atelier * Biscayne * Calais Cotton Velvet Century * * Cornaro * Dapper Double Agent * <sup>Ⓔ</sup> Fancy Twill Glider * Homage * Imprint * In Stitches * Liberty * Mod Plaid * Rivington * Soon * Swank Totem * Tweed Frieze *	<b>G</b> All Star Alter Ego * Arber * Aurora * Color Collage * * Djenne * Duchess Gibson * Haze * Kamani *	<b>G</b> continued Looped In Melange * Modern Tweed * Rivers * Spencer * Straie Stripe * Texnet * Ultrasuede * Utrillo * Vert * Bavaria * * Catwalk * Chiseled * Constance * Firefly * Stretch Appeal * Twist Tie * World Piece	<b>H</b> Aswan * Bella * Byron * Cato * * Chic * Cummings * Diamond Days * Doily * Dynamic * Florescence * Guise Hastings * In Step Ita * Jaipur * Knoll Velvet * Limani * Mepal * North Island * * Olema * Piper * Prince Hair Rutledge * Sandis * Stripe It * Tudor * Zimba *	<b>U</b> Vicenza *▲ Volo *▲	<b>X</b> Ducale *▲▲ Ducale Velour * *▲	<b>V</b> Acqua *▲ Andes *▲ Embossed Tipped * España *▲ Hand Tipped * * Velluto Pelle *▲	<b>Y</b> Cervo * Copenhagen *▲ Gemma * Lucca * Marissa * *▲ Portofino * * Riva *▲ Saddle * *▲	<b>W</b> Alaska *▲ Antique *▲ Derby * *▲ Forte *▲ Lucente Sabrina *▲ Umbria *
---	--	---	--	---	--	---	---	--	---	--	-----------------------------------	--	---	---	--

### Spinneybeck Leather

\* Approved for fully upholstered versions.  
\*\* Approved for seat pad with no wetting only.  
Ⓔ Fire Retardant Chemicals

*Check with your KnollTextiles or Spinneybeck Representative for changes or additions.*

# Frank Gehry Side and Dining Chairs

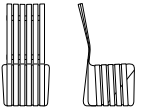
	description	seat h	arm h	w	d	h	textile fabric yds.	req. leather sq. ft.	weight
<i>Designer(s):</i> Frank Gehry, 1990	<b>91A-GC</b> Hat Trick arm chair 	18"	25 7/8"	23 7/8"	22 1/4"	33 1/2"			14 lbs.
		18"	25 7/8"	23 7/8"	22 1/4"	33 1/2"	0.8	15	14 lbs.
<i>Award(s):</i> ASID Award, 1992; ROSCOE Award, 1992; ID Magazine Gold Award, 1992; ICFE Award for Excellence, 1992; IBD Award (Silver), 1992; Premium Imperiale Award (Prince Takamatsu World Culture Award), 1992; Time Magazine, Best Design of 1992	<b>91C-GC</b> Hat Trick armless chair 	18"		20"	22 1/4"	33 1/2"			11 lbs.
		18"		20"	22 1/4"	33 1/2"	0.8	15	11 lbs.
	<b>91K</b> Seat cushion replacement for Hat Trick arm and armless chair						0.8	15	
	<b>92C-GC</b> High Sticking high back chair 	17 7/8"		20 1/8"	23 7/8"	43 7/8"			12 lbs.
		17 7/8"		20 1/8"	23 7/8"	43 7/8"	0.7	14	12 lbs.
	<b>92K</b> Seat cushion replacement						0.7	14	

pattern no.	unuphol.	grades A	COM B	C	D	E	F	G	H	I	COL U	V	W	X	Y
<b>91A-GC</b>	\$5,269.														
<b>91A-GC-K</b>		5,767.	5,797.	5,826.	5,857.	5,881.	5,903.	5,933.	5,995.	6,036.	6,194.	6,311.	6,541.	6,588.	6,645.
<b>91C-GC</b>	4,009.														
<b>91C-GC-K</b>		4,505.	4,537.	4,561.	4,595.	4,623.	4,639.	4,672.	4,734.	4,777.	4,938.	5,049.	5,283.	5,327.	5,384.
<b>91K-( )</b>		597.	626.	652.	684.	713.	728.	762.	823.	870.	1,029.	1,142.	1,369.	1,417.	1,474.
<b>92C-GC</b>	6,889.														
<b>92C-GC-K</b>		7,386.	7,418.	7,445.	7,476.	7,504.	7,518.	7,552.	7,613.	7,658.	7,787.	7,891.	8,104.	8,150.	8,199.
<b>92K-( )</b>		640.	672.	699.	731.	757.	773.	809.	871.	913.	1,039.	1,148.	1,359.	1,403.	1,452.

Order Code	Ordering Information	Construction
<i>Example:</i> <b>91A-GC-K-SA783</b>	<i>Finishes:</i> Clear Maple (suffix GC)	<i>Frame:</i> Constructed of hard white maple veneers in 2" wide, 1/8" thick strips on Hat Trick and High Sticking chair, laminated to 7 to 9-ply thickness with high-bonding urea glue. All wood grains run in same direction for resilience. Thermo-set assembly glue provides structural rigidity without the need for metal connectors, while allowing for ergonomic movement and flexibility. Backs on all chairs flex for added comfort.
<b>91A</b> Hat Trick arm chair	<i>Seat cushion option:</i> To specify seat cushion, add "K" to end of pattern number and then list textile/leather pattern number.	<i>Cushions:</i> 1/2" thick high resiliency foam on Hat Trick. 3/4" thick high resiliency foam on High Sticking. Hat Trick cushion "shower cap" design envelopes entire seat. Square High Sticking cushion snap-locks underneath chair.
<b>GC</b> Clear Maple	<i>Upholstery/COM information:</i> Prices shown include fabric or leather upholstery. Contact your Knoll representative for colors. Only approved KnollTextiles and Spinneybeck leathers may be ordered.	<i>Glides:</i> Clear plastic with matte frost finish.
<b>K</b> Seat cushion	Customer's Own Material is available pending approval. For approval requirements, processing instructions and ordering information please see page 21.	
<b>SA783</b> Sabrina, Carmen		
<i>Example:</i> <b>92K-K1320/4</b>		
<b>92K</b> High sticking seat cushion replacement		
<b>K1320/4</b> Cornaro, Tabasco		
<i>Note:</i> The Gehry chairs are part of a collection. Please refer to Gehry tables on page 392.		
<i>Specify:</i> 1. Pattern number 2. Finish selection 3. Textile selection		
<i>Seat cushion replacement, specify:</i> 1. Pattern number 2. Textile selection		

Approved KnollTextiles Grades/Fabrics						Spinneybeck Leather								
<b>A</b> Alignment Beacon Bocce Chance Common Ground Commuter Cloth Crossroad Delite Facet Hourglass Infinite Mariner Overture Prep Presto Soliloquy Sonnet Trophy Uni-Form	<b>B</b> continued Journey Keaton Knoll Felt Knoll Hopsack Little Devil Ludlow Melody <sup>®</sup> Paradigm Prairie Ransom Roam Rush Hour Shadow Play Spree Sutton Synth Tabloid Topos Venue Versa Vinyl <sup>®</sup> Westwood Wild Thing	<b>C</b> continued Earthwork Empire Stripe Entourage Entwine Essence Fibra Greenwich Hudson Lagos Lore CR Magnolia Milestone Palisade Panache CR Patchwork Prestini Pullman Quark Roundtrip Sequin CR Sinclair Smart <sup>®</sup> Stepping Stones Swing Tilden <sup>®</sup> Tower Grid	<b>C</b> continued Wow Factor Zari CR	<b>D</b> Buzz Code Compass CR Coterie Eclat Weave In Stitches Island Menagerie Origins Plaidtastic Retreat Vice Versa Woodland Zoom	<b>E</b> Aegean Cleo Currents Demure Flower Power Highland Kampala Ikat Stripe Kimono Mamba Marquee Midpoint Nature Walk Rebel Sherman Shima Tempest Vatera	<b>F</b> Atelier Biscayne Calais Cotton Velvet Cornaro Double Agent <sup>®</sup> Glider Homage Imprint In Stitches Liberty Mod Plaid Rivington Totem Tweed Frieze	<b>G</b> All Star Alter Ego Arber Aurora Color Collage Dapper Duchess Fancy Twill Gibson Kamani Looped In Melange Modern Tweed Spencer Straie Stripe Ultrasuede Utrillo Vert	<b>H</b> Bavaria Catwalk Chiseled Firefly Stretch Appeal Twist Tie World Piece	<b>I</b> Aswan Bella Byron Chic Diamond Days Doily Dynamic Florescence Hastings In Step Ita Jaipur Knoll Velvet Limani North Island Olema Piper Prince Hairy Rutledge Sandis Stripe It Tudor Zimba	<b>U</b> Vicenza Volo	<b>V</b> Acqua Amalfi Andes Embossed Tipped España Velluto Pelle	<b>W</b> Alaska Antique Forte Lucente Sabrina Umbria <sup>®</sup> Fire Retardant Chemicals	<b>X</b> Ducale Ducale Velour	<b>Y</b> Cervo Copenhagen Gemma Lucca Marissa Riva

*Check with your KnollTextiles or Spinneybeck Representative for changes or additions.*

# Frank Gehry Lounge Seating

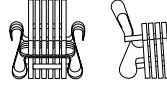
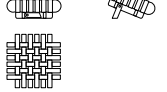
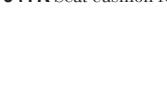
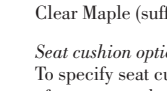
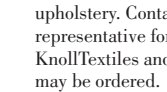
	description	seat h	arm h	w	d	h	textile fabric yds.	req. leather sq. ft.	weight
<i>Designer(s):</i> Frank Gehry, 1990	<b>93A-GC</b> Cross Check arm chair 	18 1/8"	28 3/4"	28 1/2"	24 7/8"	33 3/8"			12 lbs.
		18 1/8"	28 3/4"	28 1/2"	24 7/8"	33 3/8"	0.8	15	12 lbs.
<i>Award(s):</i> ASID Award, 1992; ROSCOE Award, 1992; ID Magazine Gold Award, 1992; ICFE Award for Excellence, 1992; IBD Award (Silver), 1992; Premium Imperiale Award (Prince Takamatsu World Culture Award), 1992; Time Magazine, Best Design of 1992	<b>93K</b> Seat cushion replacement 						0.8	15	
	<b>94L-GC</b> Power Play club chair 	16"	23 1/2"	31 1/8"	30 1/8"	32 7/8"			26 lbs.
		16"	23 1/2"	31 1/8"	30 1/8"	32 7/8"	0.7	14	26 lbs.
	<b>94K</b> Seat cushion replacement 						0.7	14	
	<b>94LY-GC</b> Off Side ottoman 			23 1/8"	23 3/8"	8 1/8"-13 7/8"			6 lbs.
				23 1/8"	23 3/8"	8 1/8"-13 7/8"	0.7	14	6 lbs.
	<b>94YK</b> Seat cushion replacement 						0.7	14	



### Order Code

<i>Example:</i>	<b>93A-GC-K-K124/14</b>
<b>93A</b>	Cross Check arm chair
<b>GC</b>	Clear Maple
<b>K</b>	Seat cushion
<b>K1106/8</b>	Spencer, Apricot
<i>Example:</i>	<b>93K-K1106/8</b>
<b>93K</b>	Cross Check chair seat cushion replacement
<b>K1175/3</b>	Obi, Geta

*Note:*  
The Gehry chairs are part of a collection. Please refer to Gehry tables on page 392.

### Specify:

1. Pattern number
2. Seat cushion option
3. Textile selection

### Seat cushion replacement, specify:

1. Pattern number
2. Textile selection

### Ordering Information

*Finishes:*  
Clear Maple (suffix GC)

*Seat cushion option:*  
To specify seat cushion, add "K" to end of pattern number and then list textile/leather pattern number.

*Upholstery/COM information:*  
Prices shown include fabric or leather upholstery. Contact your Knoll representative for colors. Only approved KnollTextiles and Spinneybeck leathers may be ordered.

Customer's Own Material is available pending approval. For approval requirements, processing instructions and ordering information please see page 18.

*Power Play note:*  
Power Play slats flex individually for added comfort. Recessed screws connect seat and arm.

*Off Side note:*  
Ottoman has one pair of legs that, locked in upright position, create a slanted leg and foot rest (metal fasteners). Legs fold underneath for low foot rest or floor cushion.

*Note:*  
The underside of each piece is embossed with the Knoll logo and Frank Gehry's signature.

*Maintenance:*  
See pages 28-29.

### Construction

*Frame:*  
Constructed of hard white maple veneers in 2" wide, 1/32" thick strips. Laminated to 6 to 9-ply thickness with high-bonding urea glue. All wood grains run in same direction for resilience. Thermoset assembly glue provides structural rigidity minimizing the need for metal connectors, while allowing for ergonomic movement and flexibility. Backs on all chairs flex for added comfort.

To maximize tension compression, no assembly glues are used in woven seat: weaves flex in unison for spring-like comfort.

*Cushions:*  
1" thick high resiliency foam for fish-shaped Cross Check cushion. 3/4" thick high resiliency foam for square Power Play and Off Side cushions. Cushions snap-lock underneath chair.

*Glides:*  
Clear plastic with a matte frost finish.

pattern no.	unuphol.	grades A	COM B	C	D	E	F	G	H	I	COL U	V	W	X	Y
<b>93A-GC</b>	\$8,520.														
<b>93A-GC-K</b>		9,321.	9,394.	9,466.	9,544.	9,605.	9,650.	9,734.	9,878.	9,986.	10,516.	10,801.	11,363.	11,480.	11,617.
<b>93K-( )</b>		936.	1,012.	1,084.	1,163.	1,228.	1,266.	1,348.	1,495.	1,602.	2,133.	2,413.	2,977.	3,099.	3,235.
<b>94L-GC</b>	17,584.														
<b>94L-GC-K</b>		18,329.	18,399.	18,457.	18,529.	18,586.	18,629.	18,700.	18,834.	18,935.	19,495.	19,766.	20,303.	20,415.	20,557.
<b>94K-( )</b>		880.	941.	1,010.	1,081.	1,134.	1,178.	1,247.	1,386.	1,482.	2,049.	2,317.	2,857.	2,969.	3,103.
<b>94LY-GC</b>	5,269.														
<b>94LY-GC-K</b>		5,978.	6,047.	6,106.	6,175.	6,223.	6,263.	6,333.	6,461.	6,559.	7,095.	7,351.	7,867.	7,979.	8,099.
<b>94YK-( )</b>		842.	900.	963.	1,030.	1,084.	1,123.	1,194.	1,325.	1,420.	1,953.	2,209.	2,724.	2,837.	2,962.

### Approved KnollTextiles Grades/Fabrics

<b>A</b> Alignment Beacon Bocce Chance Common Ground Commuter Cloth Crossroad Delite Facet Hourglass Infinite Mariner Overture Prep Presto Soliloquy Sonnet Trophy Uni-Form	<b>B</b> Abacus Argyle Attire Belize Bistro Boundary Calypso Chronicle Close Knit Day Tripper Diva Dottie Ferry Forza Ⓞ Gala II Grande Grandview Helios Hollbrook Instinct	<b>C</b> continued Journey Keaton Knoll Felt Knoll Hopsack Little Devil Ludlow Melody Ⓞ Paradigm Prairie Prim Radiance Ransom Roam Rush Hour Shadow Play Spree Sutton Synth Tabloid Topos Venue Versa Vinyl Ⓞ Westwood Wild Thing	<b>C</b> continued Earthwork Empire Stripe Entourage Entwine Essence Fibra Greenwich Hudson Lagos Lore CR Magnolia Milestone Palisade Panache CR Patchwork Prestini Pullman Quark Roundtrip Sequin CR Sinclair Smart Ⓞ Stepping Stones Swing Tilden Ⓞ Tower Grid	<b>C</b> continued Wow Factor Zari CR	<b>D</b> Buzz Code Compass CR Coterie Eclat Weave Hologram Island Menagerie Origins Plaidtastic Retreat Vice Versa Woodland Zoom	<b>E</b> Aegean Cleo Demure Flower Power Highland Kampala Ikat Stripe Kimono Mamba Marquee Midpoint Nature Walk Rebel Sherman Shima Tempest Vatera	<b>F</b> Atelier Biscayne Calais Cotton Velvet Cornaro Double Agent Ⓞ Glider Homage Imprint In Stitches Liberty Mod Plaid Rivington Totem Tweed Frieze	<b>G</b> All Star Alter Ego Arber Aurora Color Collage Dapper Duchess Fancy Twill Gibson Kamani Looped In Melange Modern Tweed Spencer Straie Stripe Texnet Ultrasuede Utrillo Vert	<b>H</b> Bavaria Catwalk Chiseled Firefly Stretch Appeal Twist Tie World Piece	<b>I</b> Aswan Bella Byron Chic Diamond Days Doily Dynamic Florescence Hastings In Step Ita Jaipur Knoll Velvet Limani North Island Olema Piper Prince Hairy Rutledge Sandis Stripe It Tudor Zimba	<b>U</b> Vicenza Volo	<b>V</b> Acqua Amalfi Andes Embossed Tipped España Velluto Pelle	<b>W</b> Alaska Antique Forte Lucente Sabrina Umbria Ⓞ Fire Retardant Chemicals	<b>X</b> Ducale Ducale Velour	<b>Y</b> Cervo Copenhagen Distressed Gemma Lucca Marissa Riva
--	--	---	---	--	--	---	---	--	---	---	-----------------------------	--	--	-------------------------------------	--

### Spinneybeck Leather



*Check with your KnollTextiles or Spinneybeck Representative for changes or additions.*

# Markus Jehs and Jurgen Laub

## Jehs+Laub Lounge Collection, pedestal base

Designer(s):  
Markus Jehs and Jurgen Laub,  
2008



description	seat h	w	d	h	weight	type	textile fabric yds.	req. leather sq. ft.
<b>JL1-P</b> Jehs+Laub Lounge chair, fixed back, pedestal base	15"	33 1/4"	30 1/2"	38 1/2"	48 lbs.		3.1	50
								
<b>JL1-PLT</b> Jehs+Laub Lounge chair, fixed back, pedestal base, contrast leather welt option	15"	33 1/4"	30 1/2"	38 1/2"	48 lbs.	uphol.	3.1	50
						welt		4
<b>JL3-P</b> Jehs+Laub Ottoman, pedestal base		31"	22 1/2"	17 1/4"	27 lbs.		1.2	20
								
<b>JL3-PLT</b> Jehs+Laub Ottoman, pedestal base, contrast leather welt option		31"	22 1/2"	17 1/4"	27 lbs.	uphol.	1.2	20
						welt		3

pattern no.	grades A	COM B	C	D	E	F	G	H	I	COL U	V	W	X	Y
<b>JL1-P-(-)(-)(-)</b>	\$6,423.	\$6,531.	\$6,631.	\$6,745.	\$6,836.	\$6,900.	\$7,018.	\$7,232.	\$7,389.	\$9,068.	\$9,413.	\$10,117.	\$10,260.	\$10,430.

<b>JL1-PLT-(-)(-)(-)</b>	6,423.	6,531.	6,631.	6,745.	6,836.	6,900.	7,018.	7,232.	7,389.	9,068.	9,413.	10,117.	10,260.	10,430.
<b>JL1-PLT-upchg, welt</b>										1,057.	1,226.	1,560.	1,632.	1,714.

<b>JL3-P-(-)(-)</b>	3,744.	3,788.	3,825.	3,870.	3,908.	3,931.	3,976.	4,059.	4,121.	4,446.	4,584.	4,863.	4,926.	4,992.
---------------------	--------	--------	--------	--------	--------	--------	--------	--------	--------	--------	--------	--------	--------	--------

<b>JL3-PLT-(-)(-)(-)</b>	3,744.	3,788.	3,825.	3,870.	3,908.	3,931.	3,976.	4,059.	4,121.	4,446.	4,584.	4,863.	4,926.	4,992.
<b>JL3-PLT-upchg, welt</b>										856.	1,025.	1,362.	1,434.	1,517.

Order Code	Ordering Information	Construction
<i>Example:</i> <b>JL2-PLT-C-K1080/8-VO939</b>	<i>Base finishes:</i> Polished Aluminum (suffix AP) Textured Black paint (suffix TB)	<i>Maintenance:</i> See pages 28-29.
<b>JL2</b>	Jehs+Laub Lounge chair, articulating back	
<b>PLT</b>	Pedestal base with contrast leather trim	<i>Note:</i> The KnollStudio logo and signature of Markus Jehs and Jurgen Laub are located on the underside of the chair and ottoman.
<b>AP</b>	Polished Aluminum	<i>Base:</i> Pedestal base is available with polished aluminum finish and wire base is available with polished chrome finish, both bases are also available with textured black paint finish.
<b>K1080/8</b>	Rivington, Parchment	<i>Upholstery:</i> Polyurethane foam with polyester-fiber backing. Hidden seam tufting eliminates the need for traditional pulls or buttons. A perimeter welt is standard on both chair and ottoman and is available as a self welt (same material) or as a contrasting leather welt. Please specify pattern number with LT suffix, for contrasting welt, and add appropriate leather upcharge for total list price of the piece. Leather welt option is available on textile and leather upholstery.
<b>VO939</b>	Volo, Talc	The Jehs+Laub Lounge Collection with pedestal base is certified Clean Air GOLD.
<i>Specify:</i>	Customer's Own Material is available pending approval. For approval requirements, processing instructions and ordering information please see page 21.	
1. Pattern number		
2. Return to center mechanism, option		
3. Base finish selection		
4. Textile selection		
5. Contrast leather trim selection, upcharge applies		

Return to center mechanism:	Approved KnollTextiles Grades/Fabrics	Spinneybeck Leather
Optional return to center mechanism allows for 360° swivel movement and returns to a center position when not engaged.	<b>A</b> Common Ground Cross Tech Crossroad Delite Facet Hourglass Infinite Mariner Overture Presto Sonnet Uni-Form	<b>U</b> Vicenza Volo <b>V</b> Acqua Amalfi Andes Embossed Tipped España Maremma Velluto Pelle <b>W</b> Alaska Antique Forte Sabrina Umbria © Fire Retardant Chemicals
To specify return to center mechanism, add suffix RC following the parent pattern number.	<b>B</b> cont. Ransom Summit Synth Tinge Topos Vast Venue Vinyl Wild Thing	<b>X</b> Ducale Velour <b>Y</b> Cascia Cervo Copenhagen Distressed Marissa Riva Rugata Saddle
<i>Glides:</i> Nylon glides, natural.	<b>C</b> Atlas Chameleon Circa Classic Boucle Contour Groovy On Point Palisade Patchwork Prestini Pullman Sahara Sequin CR Swing Utmost II Utopia	<b>H</b> Catwalk Chiseled Stretch Appeal <b>I</b> Bella Chic Hastings Knoll Velvet Prince Hairly Tudor
<i>Control:</i> 360° swivel mechanism.	<b>D</b> Buzz Pathway Retreat Satellite	<b>E</b> Aegean Currents Demure Highland Rebel Tempest Whip
	<b>F</b> Atelier Calais Cotton Velvet Cornaro Double Agent Rivington Soon Swank Tweed Frieze	<b>G</b> All Star Alter Ego Aurora Dapper Fancy Twill Haze Looped In Melange Modern Tweed Texnet Ultrasuede Vert



# Markus Jehs and Jurgen Laub

## Jehs+Laub Lounge Collection, wire base

Designer(s):  
Markus Jehs and Jurgen Laub,  
2008

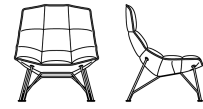

description	seat h	w	d	h	weight	type	textile fabric yds.	req. leather sq. ft.
<b>JL1-W</b> Jehs+Laub Lounge chair, fixed back, wire base	14 1/2"	33 1/4"	30 1/2"	38"	43 lbs.		3.1	50
<b>JL1-WLT</b> Jehs+Laub Lounge chair, fixed back, wire base, contrast leather welt option	14 1/2"	33 1/4"	30 1/2"	38"	43 lbs.	uphol. welt	3.1	50 4
<b>JL3-W</b> Jehs+Laub Ottoman, wire base		31"	22 1/2"	16 3/4"	22 lbs.		1.2	20
<b>JL3-WLT</b> Jehs+Laub Ottoman, wire base, contrast leather welt option		31"	22 1/2"	16 3/4"	22 lbs.	uphol. welt	1.2	20 3

pattern no.	grades A	COM B	C	D	E	F	G	H	I	COL U	V	W	X	Y
<b>JL1-W-(-)(-)</b>	\$6,423.	\$6,531.	\$6,631.	\$6,745.	\$6,836.	\$6,900.	\$7,018.	\$7,232.	\$7,389.	\$9,068.	\$9,413.	\$10,117.	\$10,260.	\$10,430.
<b>JL1-WLT-(-)(-)(-)</b> <b>JL1-WLT-upchg, welt</b>	6,423.	6,531.	6,631.	6,745.	6,836.	6,900.	7,018.	7,232.	7,389.	9,068. 1,057.	9,413. 1,226.	10,117. 1,560.	10,260. 1,632.	10,430. 1,714.
<b>JL3-W-(-)(-)</b>	3,744.	3,788.	3,825.	3,870.	3,908.	3,931.	3,976.	4,059.	4,121.	4,446.	4,584.	4,863.	4,926.	4,992.
<b>JL3-WLT-(-)(-)(-)</b> <b>JL3-WLT-upchg, welt</b>	3,744.	3,788.	3,825.	3,870.	3,908.	3,931.	3,976.	4,059.	4,121.	4,446. 856.	4,584. 1,025.	4,863. 1,362.	4,926. 1,434.	4,992. 1,517.

Order Code	Ordering Information	Construction
<i>Example:</i> <b>JL2-PLT-C-K1080/8-VO939</b>	<i>Base finishes:</i> Polished Aluminum (suffix AP) Textured Black paint (suffix TB)	<i>Shell:</i> Molded and reinforced urethane.
<b>JL2</b> Jehs+Laub Lounge chair, articulating back	<i>Upholstery/COM information:</i> Prices shown include fabric or leather upholstery. Contact your Knoll representative for colors. Only approved KnollTextiles and Spinneybeck leathers may be ordered.	<i>Base:</i> Pedestal base is available with polished aluminum finish and wire base is available with polished chrome finish, both bases are also available with textured black paint finish.
<b>PLT</b> Pedestal base with contrast leather trim	<i>Maintenance:</i> See pages 28-29.	<i>Upholstery:</i> Polyurethane foam with polyester-fiber backing. Hidden seam tufting eliminates the need for traditional pulls or buttons. A perimeter welt is standard on both chair and ottoman and is available as a self welt (same material) or as a contrasting leather welt. Please specify pattern number with LT suffix, for contrasting welt, and add appropriate leather upcharge for total list price of the piece. Leather welt option is available on textile and leather upholstery.
<b>AP</b> Polished Aluminum	<i>Note:</i> The KnollStudio logo and signature of Markus Jehs and Jurgen Laub are located on the underside of the chair and ottoman.	
<b>K1080/8</b> Rivington, Parchment	The Jehs+Laub Lounge Collection with pedestal base is certified Clean Air GOLD.	
<b>VO939</b> Volo, Talc	Customer's Own Material is available pending approval. For approval requirements, processing instructions and ordering information please see page 21.	

- Specify:
1. Pattern number
  2. Return to center mechanism, option
  3. Base finish selection
  4. Textile selection
  5. Contrast leather trim selection, upcharge applies

Return to center mechanism:	Approved KnollTextiles Grades/Fabric	Spinneybeck Leather
Optional return to center mechanism allows for 360° swivel movement and returns to a center position when not engaged.	<b>A</b> Common Ground Cross Tech Crossroad Delite Facet Hourglass Infinite Mariner Overture Presto Sonnet Uni-Form	<b>U</b> Vicenza ▲ Volo ▲ <b>V</b> Acqua ▲ Amalfi Andes ▲ Embossed Tipped España ▲ Maremma ▲ Velluto Pelle ▲
To specify return to center mechanism, add suffix RC following the parent pattern number.	<b>B</b> cont. Ransom Summit Synth Tinge Topos Vast Venue Vinyl © Wild Thing	<b>X</b> Ducale Velour <b>Y</b> Cascia Cervo ▲ Copenhagen ▲ Distressed ▲ Marissa ▲ Riva ▲ Rugata Saddle ▲
<i>Glides:</i> Nylon glides, natural.	<b>C</b> Atlas Chameleon Circa Classic Boucle Contour Groovy On Point Palisade Patchwork Prestini Pullman Sahara Sequin CR Swing Utmost II Utopia	<b>W</b> Alaska ▲ Antique ▲ Forte ▲ Sabrina ▲ Umbria © Fire Retardant Chemicals
<i>Control:</i> 360° swivel mechanism.	<b>D</b> Buzz Pathway Retreat Satellite	<b>H</b> Catwalk Chiseled Stretch Appeal
	<b>E</b> Aegean Currents Demure Highland Rebel Tempest Whip	<b>I</b> Bella Chic Hastings Knoll Velvet Prince Hair Tudor
	<b>F</b> Atelier Calais Cotton Velvet Cornaro Double Agent © Rivington Soon Swank Tweed Frieze	

# Florence Knoll Lounge Seating

Designer(s):  
Florence Knoll

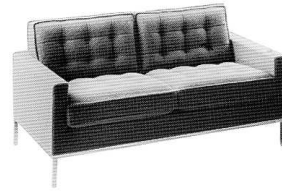

description	seat h	arm h	w	d	h	textile fabric yds.	req. leather sq. ft.	weight
<b>1205S1</b> Lounge chair	17 1/2"	23 1/2"	32 1/4"	32 1/4"	31 1/4"	6.75	97	70 lbs.
	17 1/2"	23 1/2"	32 1/4"	32 1/4"	31 1/4"	6.75	97	70 lbs.

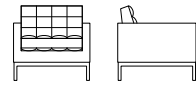

<b>1205S2</b> Settee	17 1/2"	23 1/2"	62 1/2"	32 1/4"	31 1/4"	11.8	145	101 lbs.
	17 1/2"	23 1/2"	62 1/2"	32 1/4"	31 1/4"	11.8	145	101 lbs.

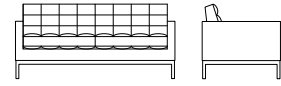

<b>1205S3</b> Sofa	17 1/2"	23 1/2"	90 1/2"	32 1/4"	31 1/4"	15.7	193	166 lbs.
	17 1/2"	23 1/2"	90 1/2"	32 1/4"	31 1/4"	15.7	193	166 lbs.

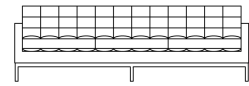

<b>2530Y2C</b> Two Seater Bench			36 1/4"	19 1/2"	16 1/4"	1.6	20	29 lbs.
---------------------------------	--	--	---------	---------	---------	-----	----	---------

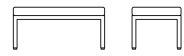

<b>2530Y3C</b> Three Seater Bench			60 1/4"	19 1/2"	16 1/4"	2.5	32	47 lbs.
-----------------------------------	--	--	---------	---------	---------	-----	----	---------



Order Code	Ordering Information	Construction
------------	----------------------	--------------

<i>Example:</i> <b>1205-CO-S3-K349/4</b>	<i>Base finish options:</i>	<i>Note:</i>
<b>1205</b> Florence Knoll Lounge	Polished Chrome (suffix C)	Designer signature and KnollStudio logo are stamped into the base of the frame.
<b>CO</b> Satin Chrome	Satin Chrome (suffix CO) Not available on bench	
<b>S3</b> Sofa		<i>Cal 133 Fire Code #:</i>
<b>K349/4</b> Alignment, Paprika		The Florence Knoll Lounge collection complies with the California Technical Bulletin 133 standard if upholstered in Cal 133 approved upholstery. Specify suffix -C at end of pattern number and suffix -133 at end of textile selection. Upcharge applies, see page 18.

*Note:*  
Florence Knoll lounge seating is part of a collection. Please refer to Florence Knoll executive collection, conference and low tables beginning on page 396.

- Specify:*
1. Pattern number
  2. Base finish selection (chair, settee and sofa only)
  3. Textile selection

*Upholstery/COM information:*  
Prices shown include fabric or leather upholstery. Contact your Knoll representative for colors. Only approved KnollTextiles and Spinneybeck leathers may be ordered.

Customer's Own Material is available pending approval. For approval requirements, processing instructions and ordering information please see page 21.

*Maintenance:*  
See pages 28-29.

*Note:*  
The Florence Knoll Lounge Collection is certified Clean Air GOLD.

*Chair, Settee and Sofa:*  
Inner frame solid wood. Exposed metal frame and legs heavy gauge tubular steel in polished or satin chrome finish.

*Bench:*  
Upholstered seat attached to exposed metal frame. Heavy gauge steel in a polished chrome finish. Seat cushion is permanently attached to frame. Large bench consists of 2 separate 30" cushions. Frame only available in polished chrome.

*Upholstery:*  
Seat consists of solid plywood deck with full foam suspension. Arm, seat and back cushions variable density foam. Seat and back covering is fully welted and tufted. Pieces upholstered in leather have matching buttons, pieces upholstered in fabric do not have buttons.

*Glides:*  
Bench and lounge collection have chrome-plated adjustable glides used for levelling.

pattern no.	grades	COM	C	D	E	F	G	H	I	COL	U	V	W	X	Y
<b>1205-C-S1</b>	\$10,341.	\$10,583.	\$10,808.	\$11,062.	\$11,266.	\$11,414.	\$11,671.	\$12,150.	\$12,504.	\$15,117.	\$16,051.	\$17,950.	\$18,347.	\$18,807.	
<b>1205-CO-S1</b>	10,540.	10,783.	11,010.	11,264.	11,469.	11,615.	11,870.	12,349.	12,707.	15,317.	16,250.	18,150.	18,549.	19,008.	

<b>1205-C-S2</b>	16,523.	16,899.	17,261.	17,651.	17,974.	18,209.	18,606.	19,353.	19,913.	23,527.	24,930.	27,775.	28,363.	29,055.	
<b>1205-CO-S2</b>	16,829.	17,200.	17,564.	17,958.	18,278.	18,512.	18,908.	19,657.	20,216.	23,833.	25,235.	28,078.	28,664.	29,357.	

<b>1205-C-S3</b>	22,858.	23,338.	23,795.	24,288.	24,702.	24,998.	25,498.	26,447.	27,158.	32,390.	34,252.	38,042.	38,825.	39,744.	
<b>1205-CO-S3</b>	23,266.	23,752.	24,201.	24,702.	25,110.	25,405.	25,907.	26,858.	27,568.	32,801.	34,661.	38,451.	39,234.	40,152.	

<b>2530Y2C</b>	5,079.	5,143.	5,200.	5,273.	5,333.	5,373.	5,445.	5,577.	5,675.	5,983.	6,221.	6,702.	6,810.	6,926.	
----------------	--------	--------	--------	--------	--------	--------	--------	--------	--------	--------	--------	--------	--------	--------	--

<b>2530Y3C</b>	8,383.	8,506.	8,621.	8,749.	8,849.	8,921.	9,049.	9,292.	9,462.	9,815.	10,195.	10,972.	11,132.	11,327.	
----------------	--------	--------	--------	--------	--------	--------	--------	--------	--------	--------	---------	---------	---------	---------	--

Approved KnollTextiles Grades/Fabrics	Spinneybeck Leather
---------------------------------------	---------------------

<b>A</b> Alignment Beacon Bocce Chance Common Ground Commuter Cloth Cross Tech Crossroad Delite Facet Hourglass Infinite Mariner Monarch Overture Presto * * Sonnet Trophy Uni-Form	<b>B</b> continued Grande Helios Instinct Journey Keaton Knoll Felt Knoll Hopsack Little Devil Ludlow Melody <sup>®</sup> Prairie Radiance Ransom Spree Summit Synth Tinge Topos Vast Venue Westwood Wild Thing	<b>C</b> Atlas Chameleon Circa Classic Boucle Contour Entourage Greenwich Groovy Lagos Lore CR On Point Palisade Patchwork Prestini Pullman Sahara Sequin CR	<b>C</b> continued Stepping Stones Swing * * Tilden <sup>®</sup> Utmost II Utopia	<b>D</b> Buzz Eclat Weave Hologram Pathway Retreat Woodland Zoom	<b>E</b> Aegean Currents Demure Highland Mamba Rebel Tempest Whip	<b>F</b> Atelier Calais Cotton Velvet Cornaro * * Double Agent <sup>®</sup> Imprint Rivington Soon Swank	<b>G</b> All Star Alter Ego Aurora Dapper Fancy Twill Haze Looped In Melange Modern Tweed Spencer Texnet Ultrasuede Vert	<b>H</b> Chiseled	<b>I</b> Bella Cato Chic Dynamic Florescence Hastings Knoll Velvet Prince Hairy Tudor	<b>U</b> Vicenza Volo	<b>V</b> Acqua Amalfi Andes Embossed Tipped España Velluto Pelle	<b>W</b> Alaska Antique Forte Lucente Sabrina Umbria <sup>®</sup> Fire Retardant Chemicals * Will be produced with matching buttons rather than tufted * *Fabric will be railroaded	<b>Y</b> Cascia Cervo Copenhagen Distressed Marissa Riva Rugata Saddle
---	---	---	--	---	---	---	---	----------------------	--	-----------------------------	--	--	--

*Check with your KnollTextiles or Spinneybeck Representative for changes or additions.*

# Florence Knoll

## Relaxed Lounge Seating

Designer(s):  
Florence Knoll

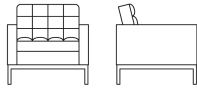
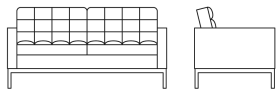
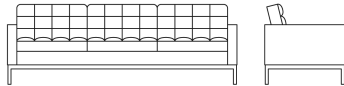

description	seat h	arm h	w	d	h	textile fabric yds.	req. leather sq. ft.	w
<b>1206S1</b> Relaxed Lounge Chair 	18 1/4"	23 1/2"	32 1/4"	32 1/4"	31 1/4"	6.9	125	70
<b>1206S2</b> Relaxed Settee 	18 1/4"	23 1/2"	63"	35"	31 1/4"	10.9	182	125
<b>1206S3</b> Relaxed Sofa 	18 1/4"	23 1/2"	91"	35"	31 1/4"	13.8	240	177

pattern no.	grade <b>A</b>	COM <b>B</b>	<b>C</b>	<b>D</b>	<b>E</b>	<b>F</b>	<b>G</b>	<b>H</b>	<b>I</b>	COL <b>U</b>	<b>V</b>	<b>W</b>	<b>X</b>	<b>Y</b>
<b>1206-C-S1</b>	\$8,534.	\$8,732.	\$8,920.	\$9,130.	\$9,297.	\$9,419.	\$9,632.	\$10,026.	\$10,319.	\$12,474.	\$13,244.	\$14,814.	\$15,140.	\$15,523.
<b>1206-C-S2</b>	13,637.	13,943.	14,244.	14,567.	14,833.	15,028.	15,352.	15,970.	16,431.	19,418.	20,574.	22,919.	23,406.	23,976.
<b>1206-C-S3</b>	18,865.	19,261.	19,637.	20,043.	20,383.	20,630.	21,044.	21,825.	22,412.	26,730.	28,270.	31,394.	32,039.	32,798.

Order Code	Ordering Information	Construction
<i>Example:</i> <b>1206-C-S3-K349/4</b>	<i>Base finish options:</i> Polished Chrome (suffix C)	<i>Chair, Settee and Sofa:</i> Inner frame solid wood. Exposed metal frame and legs heavy gauge tubular steel in polished chrome finish.
<b>1206</b> Florence Knoll Relaxed Lounge	<i>Upholstery/COM information:</i> Prices shown include fabric or leather upholstery. Contact your Knoll representative for colors. Only approved KnollTextiles and Spinneybeck leathers may be ordered.	Sofa has four legs (versus six on the standard version). Relaxed back cushions are attached with a zipper as opposed to sewn.
<b>C</b> Polished Chrome	<i>Maintenance:</i> See pages 28-29.	<i>Upholstery:</i> Seat consists of solid plywood deck with full foam suspension. Arm, seat and back cushions multi-density foam. Seat and back covering is tufted and covered with polyester fiberfill to enhance comfort. Pieces upholstered in leather have matching buttons. Pieces upholstered in fabric do not have buttons. *Due to differing textile thicknesses, dimensions may vary by +/- 1/2".
<b>S3</b> Sofa	Customer's Own Material is available pending approval. For approval requirements, processing instructions and ordering information please see page 21.	<i>Glides:</i> Black nylon non-adjustable glides.
<b>K349/4</b> Alignment, Paprika		

*Note:*  
Florence Knoll lounge seating is part of a collection. Please refer to Florence Knoll executive collection, conference and low tables beginning on page 400.

- Specify:*
1. Pattern number
  2. Base finish selection (chair, settee and sofa only)
  3. Textile selection

Approved KnollTextiles Grades/Fabrics						Spinneybeck Leather								
<b>A</b> Alignment Beacon Bocce Chance Common Ground Commuter Cloth Cross Tech Crossroad Delite Facet Hourglass Infinite Mariner Monarch Overture Presto * * Sonnet Trophy Uni-Form	<b>B</b> continued Grande Helios Instinct Journey Keaton Knoll Felt Knoll Hopsack Little Devil Ludlow Melody <sup>®</sup> Prairie Radiance Ransom Spree Summit Synth Tinge Topos Vast Venue Westwood Wild Thing	<b>C</b> Atlas Chameleon Circa Classic Boucle Contour Entourage Entwine Greenwich Groovy Lagos Lore CR On Point Palisade Patchwork Prestini Synth Sahara Sequin CR	<b>C</b> continued Stepping Stones Swing * * Tilden <sup>®</sup> Utmost II Utopia	<b>D</b> Buzz Eclat Weave Hologram Pathway Retreat Woodland Zoom	<b>E</b> Aegean Currents Demure Highland Mamba Rebel Tempest Whip	<b>F</b> Atelier Calais Cotton Velvet Cornaro * * Double Agent <sup>®</sup> Imprint Rivington Soon Swank	<b>G</b> All Star Alter Ego Aurora Dapper Fancy Twill Haze Looped In Melange Modern Tweed Spencer Texnet Ultrasuede Vert	<b>H</b> Chiseled	<b>I</b> Bella Cato Chic Dynamic Floressence Hastings Knoll Velvet Prince Hairy Tudor	<b>U</b> Vicenza Volo	<b>V</b> Acqua Amalfi Andes Embossed Tipped España Velluto Pelle	<b>W</b> Alaska Antique Forte Lucente Sabrina	<b>Y</b> Cascia Cervo Copenhagen Distressed Marissa Riva Rugata Saddle	<sup>®</sup> Fire Retardant Chemicals



*Check with your KnollTextiles or Spinneybeck Representative for changes or additions.*

# Florence Knoll

## Relaxed Benches and Stool

Designer(s):  
Florence Knoll

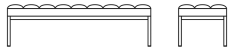

description	w	d	h	textile fabric yds.	req. leather sq. ft.	weight
<b>2530YRC1</b> Relaxed Stool 	19"	19"	16 1/2"	1.3	11	36 lbs
<b>2530YRC2</b> Relaxed Two Seat Bench 	37 1/4"	19"	16 1/2"	1.9	19	52 lbs.
<b>2530YRC3</b> Relaxed Three Seat Bench 	56 3/4"	19"	16 1/2"	2.5	26	62 lbs.

pattern no.	grade <b>A</b>	COM <b>B</b>	<b>C</b>	<b>D</b>	<b>E</b>	<b>F</b>	<b>G</b>	<b>H</b>	<b>I</b>	COL <b>U</b>	<b>V</b>	<b>W</b>	<b>X</b>	<b>Y</b>
<b>2530YRC1</b>	\$2,685.	\$2,719.	\$2,751.	\$2,788.	\$2,820.	\$2,841.	\$2,882.	\$2,949.	\$3,003.	\$3,164.	\$3,292.	\$3,546.	\$3,601.	\$3,662.
<b>2530YRC2</b>	4,148.	4,203.	4,250.	4,310.	4,358.	4,392.	4,450.	4,558.	4,639.	4,890.	5,086.	5,479.	5,564.	5,659.
<b>2530YRC3</b>	6,852.	6,951.	7,047.	7,150.	7,232.	7,292.	7,396.	7,594.	7,734.	8,023.	8,332.	8,968.	9,098.	9,260.

Order Code	Ordering Information	Construction
<i>Example:</i> <b>2530YRC3-C-K349/4</b>	<i>Base finish options:</i> Polished Chrome (suffix C)	<i>Construction:</i> Inner frame solid wood. Exposed metal frame and legs heavy gauge tubular steel in polished chrome finish.
<b>2530YRC3</b> Relaxed Three Seat Bench	<i>Upholstery/COM information:</i> Prices shown include fabric or leather upholstery. Contact your Knoll representative for colors. Only approved KnollTextiles and Spinneybeck leathers may be ordered.	<i>Upholstery:</i> Upholstered seat attached to exposed metal frame. Seat cushion tufted and covered with polyester fiberfill to enhance comfort. No buttons on textile or leather upholstery.
<b>C</b> Polished Chrome base	<i>Maintenance:</i> See pages 28-29.	<i>Note:</i> Seat cushion is permanently attached to frame.
<b>K349/4</b> Alignment, Paprika	Customer's Own Material is available pending approval. For approval requirements, processing instructions and ordering information please see page 21.	<i>Glides:</i> Black nylon non-adjustable glides.

*Note:*  
Florence Knoll lounge seating is part of a collection. Please refer to Florence Knoll executive collection, conference and low tables beginning on page 400.

- Specify:*
1. Pattern number
  2. Base finish selection
  3. Textile selection

Approved KnollTextiles Grades/Fabrics				Spinneybeck Leather			
<b>A</b> Alignment Beacon Bocce Chance Common Ground Commuter Cloth Cross Tech Crossroad Delite Facet Hourglass Infinite Mariner Monarch Overture Presto * * Sonnet Trophy Uni-Form	<b>B</b> continued Grande Helios Instinct Journey Keaton Knoll Felt Knoll Hopsack Little Devil Ludlow Melody <sup>®</sup> Prairie Radiance Ransom Spree Summit Synth Tinge Topos Vast Venue Westwood Wild Thing	<b>C</b> Atlas Chameleon Circa Classic Boucle Contour Entourage Entwine Greenwich Groovy Lagos Lore CR On Point Palisade Patchwork Prestini Pullman Sahara Sequin CR	<b>C</b> continued Stepping Stones Swing * * Tilden <sup>®</sup> Utmost II Utopia <b>D</b> Buzz Eclat Weave Hologram Pathway Retreat Woodland Zoom	<b>E</b> Aegean Currents Demure Highland Mamba Rebel Tempest Whip <b>F</b> Atelier Calais Cotton Velvet Cornaro * * Double Agent <sup>®</sup> Imprint Rivington Soon Swank	<b>G</b> All Star Alter Ego Aurora Dapper Fancy Twill Haze Looped In Melange Modern Tweed Spencer Texnet Ultrasuede Vert <b>H</b> Chiseled <b>I</b> Bella Cato Chic Dynamic Floressence Hastings Knoll Velvet Prince Hairy Tudor	<b>U</b> Vicenza Volo <b>V</b> Acqua Amalfi Andes Embossed Tipped España Velluto Pelle <b>W</b> Alaska Antique Forte Lucente Sabrina  <sup>®</sup> Fire Retardant Chemicals	<b>Y</b> Cascia Cervo Copenhagen Distressed Marissa Riva Rugata Saddle

*Check with your KnollTextiles or Spinneybeck Representative for changes or additions.*

# Florence Knoll

## Relaxed Benches and Stool

Designer(s):  
Florence Knoll

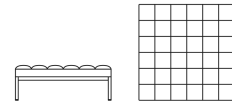

description	w	d	h	textile fabric yds.	req. leather sq. ft.	weight
<b>2530YRC4</b> Relaxed Small Square Bench	37 3/4"	37 3/4"	13 3/4"	2.5	32	73 lbs.
<b>2530YRC5</b> Relaxed Medium Square Bench	50 1/2"	50 1/2"	13 3/4"	3.6	52	84 lbs.
<b>2530YRC6</b> Relaxed Large Square Bench	56 3/4"	56 3/4"	13 3/4"	4	63	91 lbs.

pattern no.	grade <b>A</b>	COM <b>B</b>	<b>C</b>	<b>D</b>	<b>E</b>	<b>F</b>	<b>G</b>	<b>H</b>	<b>I</b>	COL <b>U</b>	<b>V</b>	<b>W</b>	<b>X</b>	<b>Y</b>
<b>2530YRC4</b>	\$5,613.	\$5,685.	\$5,750.	\$5,833.	\$5,897.	\$5,942.	\$6,021.	\$6,166.	\$6,276.	\$6,617.	\$6,880.	\$7,412.	\$7,530.	\$7,658.
<b>2530YRC5</b>	8,062.	8,179.	8,290.	8,412.	8,508.	8,578.	8,702.	8,933.	9,098.	9,438.	9,802.	10,550.	10,704.	10,894.
<b>2530YRC6</b>	8,868.	8,995.	9,119.	9,251.	9,360.	9,437.	9,571.	9,826.	10,008.	10,382.	10,783.	11,606.	11,775.	11,983.

Order Code	Ordering Information	Construction
<i>Example:</i> <b>2530YRC6-C-K349/4</b>	<i>Base finish options:</i> Polished Chrome (suffix C)	<i>Construction:</i> Inner frame solid wood. Exposed metal frame and legs heavy gauge tubular steel in polished chrome finish.
<b>2530YRC6</b> Relaxed Large Square Bench	<i>Upholstery/COM information:</i> Prices shown include fabric or leather upholstery. Contact your Knoll representative for colors. Only approved KnollTextiles and Spinneybeck leathers may be ordered.	<i>Upholstery:</i> Upholstered seat attached to exposed metal frame. Seat cushion tufted and covered with polyester fiberfill to enhance comfort. No buttons on textile or leather upholstery.
<b>C</b> Polished Chrome base	<i>Maintenance:</i> See pages 28-29.	<i>Note:</i> Seat cushion is permanently attached to frame.
<b>K349/4</b> Alignment, Paprika	Customer's Own Material is available pending approval. For approval requirements, processing instructions and ordering information please see page 21.	<i>Glides:</i> Black nylon non-adjustable glides.

*Note:*  
Florence Knoll lounge seating is part of a collection. Please refer to Florence Knoll executive collection, conference and low tables beginning on page 400.

- Specify:*
1. Pattern number
  2. Base finish selection
  3. Textile selection

Approved KnollTextiles Grades/Fabrics				Spinneybeck Leather			
<b>A</b> Alignment Beacon Bocce Chance Common Ground Commuter Cloth Cross Tech Crossroad Delite Facet Hourglass Infinite Mariner Monarch Overture Presto * * Sonnet Trophy Uni-Form	<b>B</b> continued Grande Helios Instinct Journey Keaton Knoll Felt Knoll Hopsack Little Devil Ludlow Melody <sup>®</sup> Prairie Radiance Ransom Spree Summit Synth Tinge Topos Vast Venue Westwood Wild Thing	<b>C</b> Atlas Chameleon Circa Classic Boucle Contour Entourage Entwine Greenwich Groovy Lagos Lore CR On Point Palisade Patchwork Prestini Synth Sahara Sequin CR	<b>C</b> continued Stepping Stones Swing * * Tilden <sup>®</sup> Utmost II Utopia  <b>D</b> Buzz Eclat Weave Hologram Pathway Retreat Woodland Zoom	<b>E</b> Aegean Currents Demure Highland Mamba Rebel Tempest Whip  <b>F</b> Atelier Calais Cotton Velvet Cornaro * * Double Agent <sup>®</sup> Imprint Rivington Soon Swank	<b>G</b> All Star Alter Ego Aurora Dapper Fancy Twill Haze Looped In Melange Modern Tweed Spencer Texnet Ultrasuede Vert  <b>H</b> Chiseled  <b>I</b> Bella Cato Chic Dynamic Floressence Hastings Knoll Velvet Prince Hairy Tudor	<b>U</b> Vicenza Volo  <b>V</b> Acqua Amalfi Andes Embossed Tipped España Velluto Pelle  <b>W</b> Alaska Antique Forte Lucente Sabrina <sup>®</sup> Fire Retardant Chemicals	<b>Y</b> Cascia Cervo Copenhagen Distressed Marissa Riva Rugata Saddle

*Check with your KnollTextiles or Spinneybeck Representative for changes or additions.*

# Florence Knoll

## Model 31 and Model 33, Single Upholstery

model	description	seat h	w	d	h	textile fabric yds.	req. leather sq. ft.	weight
FKM-31 <i>Designer(s): Florence Knoll, 1954</i>	Florence Knoll Model 31 Lounge chair, Single Upholstery	17"	23 1/4"	26 1/4"	29 1/4"	2.5	25	27 lbs.
FKM-33	Florence Knoll Model 33 Sofa, Single Upholstery	17"	70 3/4"	26 1/4"	29 1/4"	5	52	67 lbs.

*textile upholstery, seamless*

*polyurethane, vinyl, and leather upholstery, with seams*

pattern no.	Base Grade	grade A	COM B	C	D	E	F	G	H	I	COL U	V	W	X	Y
<b>FKM-31-NA-S</b>	\$2,460.	\$2,583.	\$2,841.	\$2,983.	\$3,133.	\$3,289.	\$3,454.	\$3,626.	\$3,808.	\$4,265.	\$4,392.	\$4,656.	\$4,889.	\$4,987.	\$5,236.
<b>FKM-33-NA-S</b>	5,030.	5,282.	5,810.	6,100.	6,405.	6,725.	7,062.	7,415.	7,785.	8,720.	8,981.	9,520.	9,996.	10,196.	10,706.

Order Code	Ordering Information
<i>Example:</i> <b>FKM-31-NA-S</b>	<i>To order please specify:</i>
<b>FKM</b> Florence Knoll Models	1. Pattern number
<b>31</b> Model 31 Lounge chair	2. Frame finish
<b>NA</b> Foam and suspension	<i>Frame Finish options:</i>
<b>S</b> Single upholstery	color Suffix upchg
	Black 111S n/c
	Chrome (31) C \$200
	Chrome (33) C \$500
	Please note, the Florence Knoll Model 33 Sofa, when specified with Polyurethanes, Vinyls, and Leathers, will be upholstered with two seams evenly spaced across the width. This is to maintain the structure and consistency in upholstery.
	<i>Upholstery / COM information:</i> Prices shown include fabric or leather upholstery. Contact your Knoll representative for colors. Only approved KnollTextiles and Spinneybeck leathers may be ordered. Customer's Own Material is available pending approval. For approval requirements, processing instructions and ordering information please see page 21.
	<i>Frame:</i> Heavy gauge steel in a powder coated black paint or a polished chrome finish. Seat and back cushions are permanently attached to the frame.
	<i>Upholstery:</i> High resilient cut foam, nylon suspension with steel springs.
	<i>Glides:</i> Lounge chair and sofa are standard with glides that have black or zinc-plated hoods, with white nylon on the bottom. The glides have swivel functionality.
	KnollTextiles Hourglass K1523 is the base grade textile for the Florence Knoll Models 31 and 33.
	Maintenance: See pages 28-29.
	<i>Note:</i> The Florence Knoll Lounge Collection is certified Clean Air GOLD.

Approved KnollTextiles Grades/Fabrics							Spinneybeck Leather						
<b>A</b> Bocce Commuter Cloth Crossroad Delite Facet Infinite Overture Ponder Sonnet	<b>B</b> Attire Brigadoon Boundary Calypso Cameo Day Tripper Diva Dottie	<b>B</b> continued Journey Keaton Knoll Felt Knoll Hopsack Little Devil Prairie Summit Topos Vast Venue Vibe II Wild Thing	<b>C</b> Atlas Cairo Chameleon Circa Color Field Contour Durnad Entwine Greenwich Hudson Lagos Magnolia On Point Plaid On Prestini Pullman Smart Tenmoku Wit Woodland II Wow Facor	<b>D</b> Chain Link Eclat Weave Island Origins Plaidtastic Retreat	<b>E</b> Aegean Circle Point Alter Ego Currents Midpoint Off the grid Rebel Seurat Tempest Vice Versa Whip	<b>F</b> Biscayne Homage Imprint In Stitches It's Complicated Mod Plaid Rivington	<b>G</b> All Star Alter Ego Arrondissement Aurora Color Collage Dapper Djenne Melange Modern Tweed Striae Stripe Texnet Ultrasuede Vert	<b>H</b> Catwalk Firefly World Piece	<b>I</b> Cato Dolly Dynamic In Step Stripe it	<b>U</b> Vicenza Volo	<b>V</b> Acqua Andes Embossed Tipped España Hand Tipped Velluto Pelle	<b>W</b> Alaska Forte Lucente Sabrina	<b>Y</b> Copenhagen Lucca Marissa Portofino Riva Saddle

*Check with your KnollTextiles or Spinneybeck Representative for changes or additions.*

# Florence Knoll

## Model 31 and Model 33, Split Upholstery

model	description	seat h	w	d	h	textile fabric yds.	req. leather sq. ft.	weight
FKM-31 <i>Designer(s): Florence Knoll, 1954</i>	Florence Knoll Model 31 Lounge chair, Split Upholstery	17"	23 1/4"	26 3/4"	29 1/4"	1.25	12.5	27 lbs.
		17"	23 1/4"	26 3/4"	29 1/4"	1.25	12.5	27 lbs.
FKM-33	Florence Knoll Model 33 Sofa, Split Upholstery	17"	70 3/4"	26 3/4"	29 1/4"	2.5	29	67 lbs.
		17"	70 3/4"	26 3/4"	29 1/4"	2.5	29	67 lbs.



textile upholstery, seamless



polyurethane, vinyl, and leather upholstery, with seams



pattern no.	Base Grade	grade A	COM B	C	D	E	F	G	H	I	COL					U	V	W	X	Y
<b>FKM-31-NA-B BACK</b>	\$1,230.	\$1,292.	\$1,421.	\$1,492.	\$1,566.	\$1,645.	\$1,727.	\$1,813.	\$1,904.	\$2,132.	\$2,196.	\$2,328.	\$2,444.	\$2,493.	\$2,618.					
<b>FKM-31-NA-B SEAT</b>	1,230.	1,292.	1,421.	1,492.	1,566.	1,645.	1,727.	1,813.	1,904.	2,132.	2,196.	2,328.	2,444.	2,493.	2,618.					
<b>FKM-33-NA-B BACK</b>	2,515.	2,641.	2,905.	3,050.	3,203.	3,363.	3,531.	3,707.	3,893.	4,360.	4,491.	4,760.	4,998.	5,098.	5,353.					
<b>FKM-33-NA-B SEAT</b>	2,515.	2,641.	2,905.	3,050.	3,203.	3,363.	3,531.	3,707.	3,893.	4,360.	4,491.	4,760.	4,998.	5,098.	5,353.					

Order Code	Ordering Information
<i>Example:</i> <b>FKM-31-NA-B</b>	<i>To order please specify:</i>
<b>FKM</b> Florence Knoll Models	1. Pattern number
<b>31</b> Model 31 Lounge chair	2. Frame finish
<b>NA</b> Foam and suspension	<i>Frame Finish options:</i>
<b>B</b> Split upholstery	color Suffix upchg
	Black 111S n/c
	Chrome (31) C \$200
	Chrome (33) C \$500
	<i>Split Upholstery incurs an upcharge of \$135.</i>
	Please note, the Florence Knoll Model 33 Sofa, when specified with Polyurethanes, Vinyls, and Leathers, will be upholstered with two seams evenly spaced across the width. This is to maintain the structure and consistency in upholstery.
	<i>Upholstery / COM information:</i> Prices shown include fabric or leather upholstery. Contact your Knoll representative for colors. Only approved KnollTextiles and Spinneybeck leathers may be ordered. Customer's Own Material is available pending approval. For approval requirements, processing instructions and ordering information please see page 21.
	<i>Frame:</i> Heavy gauge steel in a powder coated black paint or a polished chrome finish. Seat and back cushions are permanently attached to the frame.
	<i>Upholstery:</i> High resilient cut foam, nylon suspension with steel springs.
	<i>Glides:</i> Lounge chair and sofa are standard with glides that have black or zinc-plated hoods, with white nylon on the bottom. The glides have swivel functionality.
	Maintenance: See pages 28-29.
	<i>Note:</i> The Florence Knoll Lounge Collection is certified Clean Air GOLD.
	KnollTextiles Hourglass K1523 is the base grade textile for the Florence Knoll Models 31 and 33.

Approved KnollTextiles Grades/Fabrics										Spinneybeck Leather		
<b>A</b> Bocce Commuter Cloth Crossroad Delite Facet Infinite Overture Ponder Sonnet	<b>B</b> continued Journey Keaton Knoll Felt Knoll Hopsack Little Devil Prairie Summit Topos Vast Venue Vibe II Wild Thing	<b>C</b> Atlas Cairo Chameleon Circa Color Field Contour Durnad Entwine Greenwich Hudson Lagos Magnolia On Point Plaid On Prestini Pullman Smart Tenmoku Wit Woodland II Wow Facor	<b>D</b> Chain Link Eclat Weave Island Origins Plaidtastic Retreat	<b>E</b> Aegean Circle Point Lagos Currents Midpoint Off the grid Rebel Seurat Tempest Vice Versa Whip	<b>F</b> Biscayne Homage Imprint In Stitches It's Complicated Mod Plaid Rivington	<b>G</b> All Star Alter Ego Arrondissement Aurora Color Collage Dapper Djenne Melange Modern Tweed Striae Stripe Textnet Ultrasuede Vert	<b>H</b> Catwalk Firefly World Piece	<b>I</b> Cato Dolly Dynamic In Step Stripe it	<b>U</b> Vicenza Volo	<b>V</b> Acqua Andes Embossed Tipped España Hand Tipped Velluto Pelle	<b>W</b> Alaska Forte Lucente Sabrina	<b>Y</b> Copenhagen Lucca Marissa Portofino Riva Saddle

*Check with your KnollTextiles or Spinneybeck Representative for changes or additions.*



description	w	d	textile fabric yds.	type
<b>KSP1</b> Lumbar pillow 	20"	10.5"	0.4	same upholstery
<b>KSP1S</b> Lumbar pillow	20"	10.5"	0.4	combination upholstery
<b>KSP2</b> Throw pillow 	16"	16"	0.8	same upholstery
<b>KSP2S</b> Throw pillow	16"	16"	0.8	combination upholstery
<b>KSP3</b> Large throw pillow 	20"	20"	0.7	same upholstery
<b>KSP3S</b> Large throw pillow	20"	20"	0.7	combination upholstery

pattern no.	A	B	C	D	E	F	G	H	I
<b>KSP1-(-)</b>	\$253.	\$263.	\$276.	\$290.	\$297.	\$306.	\$318.	\$346.	\$360.
<b>KSP1S-(-)(-)</b>	278.	291.	303.	314.	326.	333.	347.	369.	388.
<b>KSP2-(-)</b>	317.	330.	345.	352.	364.	371.	387.	409.	428.
<b>KSP2S-(-)(-)</b>	350.	362.	376.	388.	398.	402.	418.	443.	458.
<b>KSP3-(-)</b>	505.	530.	553.	576.	600.	614.	639.	684.	720.
<b>KSP3S-(-)(-)</b>	559.	585.	605.	631.	651.	667.	691.	738.	775.

Order Code	Ordering Information	Construction
<i>Example:</i> <b>KSP1-K1174/6</b>	<i>Upholstery/COM information:</i>	<i>Fill:</i>
<b>KSP1</b> Lumbar pillow, same upholstery	Prices shown include fabric upholstery only. Contact your Knoll representative for colors.	Made from 100% recycled polyester.
<b>K1174/6</b> Kimono, Sakura		<i>Ticking:</i>
<i>Example:</i> <b>KSP3S-K1155/6-K1021/2</b>	<i>Note:</i>	100% cotton.
<b>KSP3S</b> Large throw pillow, combination upholstery	For pillows with combination upholstery, list price is the highest of the two grades.	
<b>K1155/6</b> Jaipur, Ginger		
<b>K1021/2</b> Ultrasuede, Sand		

*Specify:*

1. Pattern number
2. Upholstery selection
3. Upholstery selection for split upholstery

Approved KnollTextiles Grades/Fabrics

<b>A</b> Alignment Beacon Bocce Chance Common Ground Commuter Cloth Cross Tech Crossroad Delite Heavy Metal Hourglass Infinite Mariner Monarch Oh La La Overture Prep Presto Soliloquy Sonnet Trophy Uni-Form	<b>B</b> Abacus Argyle Attire Belize Bistro Boundary Calypso Chronicle Close Knit Cozy Cord Day Tripper Diva Dottie Ferry Gala II Grande Grandview Helios Holbrook	<b>C</b> continued Instinct Journey Keaton Knoll Felt Knoll Hopsack Little Devil Ludlow Melody <sup>Ⓢ</sup> Nonchalant CR Paradigm Prairie Prim Puff Radiance Ransom Roam Rush Hour Shadow Play Spree Summit Sutton Synth Tabloid Tinge Topos Vast Venue Versa Westwood Wild Thing Yeni	<b>D</b> Buzz Code Coterie Eclat Weave Hologram Island Menagerie Origins Pathway Plaidtastic Retreat Vice Versa Woodland Zoom	<b>E</b> Aegean Circle Point Cleo Demure Flower Power Highland Ikat Stripe Juno Kampala Kimono Mamba Marquee Meroe Midpoint Nature Walk Off The Grid Rebel Sherman Shima Tempest Vatera Whip	<b>F</b> Atelier Biscayne Calais Cotton Velvet Cornaro Double Agent <sup>Ⓢ</sup> Glider Homage In Stitches Jasmine Liberty Mod Plaid Rivington Soon Swank Totem	<b>G</b> All Star Alter Ego Arber Aurora Dapper Djenne Duchess Fancy Twill Gibson Haze Kamani Melange Modern Tweed Rivers Spencer Straie Stripe Texnet Ultrasuede Utrillo Vert	<b>H</b> Bavaria Catwalk Chiseled Constance Firefly Stretch Appeal Twist Tie World Piece	<b>I</b> Aswan Bella Cato Chic Diamond Days Doily Dynamic Florescence Hastings In Step Jaipur Knoll Velvet North Island Olema Piper Prince Hairy Rutledge Sandis Stripe It Tudor Zimba	<sup>Ⓢ</sup> Fire Retardant Chemicals  <i>Check with your KnollTextiles Representative for changes or additions.</i>
---	---	---	---	--	---	--	--	---	--



# Marc Krusin

## Guest Seating Collection

### Side Chair with Arms

Designer(s):  
Marc Krusin, 2011

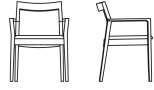

description	seat h	arm h	w	d	h	textile fabric yds.	required leather sq. ft.	weight	finish
<b>MK01A</b> Krusin arm chair, slat back 	18 1/2"	24 1/2"	23 1/2"	21 3/4"	30 1/2"	0.8	14.5	14 lbs.	beech finish
	18 1/2"	24 1/2"	23 1/2"	21 3/4"	30 1/2"	0.8	14.5	14 lbs.	ash or oak finish
	18 1/2"	24 1/2"	23 1/2"	21 3/4"	30 1/2"	0.8	14.5	14 lbs.	walnut finish
<b>MK01R</b> Seat basket replacement for side chair						0.8	14.5		
<b>MK01RCN</b> Woven rush seat basket replacement for side chair									light kraft

#### Order Code

<i>Example:</i>	<b>MK01A-BE-K1207/17</b>
<b>MK01A</b>	Krusin arm chair
<b>BE</b>	Ebonized
<b>K1207/17</b>	Knoll Felt, Pewter

#### Specify:

1. Pattern number
2. Woven rush seat, optional
3. Finish selection
4. Textile selection

#### Ordering Information:

*Ash:*  
White Ash (suffix A101)

*Beech frame stains:*  
Beech (suffix B311)  
Bronzed Cherry (suffix B312A)  
Burnt Walnut (suffix B313)  
Deep Red Mahogany (suffix B328)  
Ebonized (suffix BE)  
Light Cherry (suffix B315)  
Light Walnut (suffix B411)  
Medium Cherry (suffix B319)  
Medium Red Mahogany (suffix BR)  
Medium Walnut (suffix B323)  
Natural Beech (suffix BN)  
Warm Brown Walnut (J)

*Oak:*  
Ebonized Oak (suffix OE)  
Fumed Oak (suffix OF)  
Grey Oak, White Ceruse (suffix OGW)  
Grey Oak, Black Ceruse (suffix OGB)  
Natural Oak (suffix ON)

*Walnut:*  
American Walnut (suffix AW)

*Optional Woven Seat:*  
An optional woven paper rush seat is available at an upcharge, from grade A pricing, of \$350 for side chairs and \$393 for lounge chairs. Place suffix CN between parent pattern number and wood finish suffix.

*Example:* **MK01A-CN-BE**

*Upholstery/COM information:*  
List prices shown include fabric or leather upholstery. Contact your Knoll representative for colors. Only approved KnollTextiles and Spinneybeck leathers may be ordered.

Customer's Own Material is available pending approval. For approval requirements, processing instructions and ordering information please see page 21.

*KnollStudio natural wood finishes:*  
The Krusin Collection of guest seating features a low sheen, urethane finish. This finish, available on Ash, Oak, and Walnut delivers the tactility of natural wood while providing a durable matte finish.

Ash and Oak feature a unique staining process that replicate traditional cerused finishes.

#### Construction

*KnollStudio Beech wood finishes:*  
KnollStudio Beech finishes complement a large variety of KnollStudio veneer and Knoll Office veneer finishes. To select correct complementary finish, please refer to KnollStudio Wood Finish Matrix on page 26. If no complementary finish is available, please refer to custom finish policy below.

*Certified Wood:*  
Chairs manufactured using FSC certified hardwoods are available through Custom Product Development. Extended leadtime and upcharge apply.

*Woven Rush Seats:*  
A woven natural paper rush seat is available on side and lounge chairs. Not available on chairs with inset back upholstery. Paper rush is a natural, uncoated material.

**KnollStudio will not warrant soiled or stained woven seats. A one year warranty will cover woven seats for manufacturer's defects.**

*Seat basket replacements:*  
Upholstered and woven seats sit on chair frame. Screws lock basket in place for easy installation or removal.

*Finish:*  
Beech, Catalyzed lacquer protective coating. Hand applied final wax coating. Ash, Oak, and Walnut, urethane protective coating. Hand applied final wax coating.

*Glides:*  
Chairs feature nylon glides.

pattern no.	woven seat	grades <b>A</b>	COM <b>B</b>	<b>C</b>	<b>D</b>	<b>E</b>	<b>F</b>	<b>G</b>	<b>H</b>	<b>I</b>	COL <b>U</b>	<b>V</b>	<b>W</b>	<b>X</b>	<b>Y</b>
<b>MK01A-( )</b>		\$1,596.	\$1,621.	\$1,650.	\$1,678.	\$1,699.	\$1,717.	\$1,742.	\$1,798.	\$1,839.	\$2,134.	\$2,210.	\$2,410.	\$2,449.	\$2,500.
<b>MK01A-(A101, O_)</b>		1,975.	1,999.	2,026.	2,052.	2,078.	2,092.	2,122.	2,177.	2,215.	2,511.	2,584.	2,785.	2,826.	2,875.
<b>MK01A-(AW)</b>		2,434.	2,455.	2,483.	2,511.	2,536.	2,550.	2,579.	2,635.	2,674.	2,968.	3,044.	3,244.	3,286.	3,331.
<b>MK01R</b>		467.	491.	516.	546.	567.	585.	614.	667.	709.	986.	1,062.	1,262.	1,301.	1,350.
<b>MK01RCN</b>		602.													

#### Approved KnollTextiles Grades/Fabrics

<b>A</b> Alignment Beacon Bocce Chance Common Ground Commuter Cloth Crossroad Delite Facet )Foil Rap Heavy Metal Hourglass Infinite Mariner Monarch Oh La La * Overture Prep Presto Soliloquy Sonnet Trophy Uni-Form	<b>B</b> continued Ferry Forza <sup>®</sup> Gala II Grande Grandview Holbrook Instinct Journey Keaton Knoll Felt Knoll Hopsack Little Devil Ludlow Melody <sup>®</sup> Paradigm Petat Pusher <sup>®</sup> Prairie Prim Puff * Radiance Ransom Roam Rush Hour Shadow Play Spree Summit Sutton Synth Tabloid Tinge Topos Vast Venue Versa Vinyl <sup>®</sup> Westwood Wild Thing	<b>C</b> Atlas Axiom <sup>®</sup> Baxter Cairo Chameleon Charm Circa Classic Boucle Contour * Durand Earthwork Empire Stripe Entourage Entwine Essence Fibra Greenwich Groovy Hudson Kaleidoscope CR Kaya CR Lagos Lore CR Magnolia Milestone On Point Palisade Panache CR Patchwork Plaid On Prestini Pullman Quark Roundtrip Sahara Sequin CR	<b>C</b> continued Sinclair Smart <sup>®</sup> Spectator Stepping Stones Swing Tight Rope Tilden * <sup>®</sup> Tower Grid Utmost II Utopia * Wit Wow Factor Zari CR Zen Wave	<b>D</b> Buzz Code Coterie Eclat Weave Hologram Island Kabuki Menagerie Origins Pathway Plaidtastic Retreat Vice Versa Woodland Zoom	<b>E</b> Aegean Cleo Currents * Flower Power Highland Ikat Stripe Juno Kampala Kimono	<b>E</b> continued Mamba Marquee Midpoint Off The Grid Rebel Sherman Shima Tempest Tryst Vatera Whip *	<b>F</b> Atelier Biscayne Calais Cotton Velvet Century Cornaro Double Agent <sup>®</sup> Glider Homage Imprint In Stitches Liberty Mod Plaid Rivington Soon Swank Totem Tweed Frieze	<b>G</b> continued Modern Tweed Rivers Spencer Straie Stripe Texnet Ultrasuede Utrillo Vert	<b>H</b> Bavaria Catwalk Chiseled Constance Firefly Stretch Appeal Twist Tie World Piece	<b>I</b> Aswan Bella Byron Cato Chic Cummings Diamond Days Doily * Dynamic Floressence Hastings In Step Ita Jaipur Knoll Velvet Limani Mepal North Island Olema Piper Prince Hairly Rutledge Sandis Stripe It Tudor Zimba	<b>U</b> Vicenza Volo	<b>V</b> Acqua Amalfi Andes Embossed Tip España Hand Tipped Maremma Velluto Pelle	<b>X</b> Ducale * Ducale Velour	<b>Y</b> Cervo * Copenhagen Distressed Gemma * Lucca * Marissa Portofino Riva Saddle
---	---	---	---	---	--	---	--	---	--	---	-----------------------------	---	---------------------------------------	---

#### Spinneybeck Leather

<b>U</b> Vicenza Volo	<b>V</b> Acqua Amalfi Andes Embossed Tip España Hand Tipped Maremma Velluto Pelle	<b>X</b> Ducale * Ducale Velour	<b>Y</b> Cervo * Copenhagen Distressed Gemma * Lucca * Marissa Portofino Riva Saddle
<b>W</b> Alaska Antique Derby Forte Lucente Sabrina Umbria * <sup>®</sup> Fire Retardant Chemicals *Not approved for inset blank.			

*Check with your KnollTextiles or Spinneybeck Representative for changes or additions.*

# Marc Krusin

## Guest Seating Collection

### Side Chair with Arms

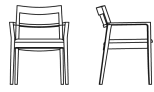

Designer(s):  
Marc Krusin, 2011

description	seat h	arm h	w	d	h	textile fabric yds.	required leather sq. ft.	weight	finish
<b>MK01AU</b> Krusin arm chair, uphol. inset back	18½"	24½"	23½"	21¾"	30½"	1.3	14.5	14 lbs.	beech finish
	18½"	24½"	23½"	21¾"	30½"	1.3	14.5	14 lbs.	ash or oak finish
	18½"	24½"	23½"	21¾"	30½"	1.3	14.5	14 lbs.	walnut finish
<b>MK01R</b> Seat basket replacement for side chair						0.8	14.5		
<b>MK01RCN</b> Woven rush seat basket replacement for side chair									light kraft

#### Order Code

*Example:* **MK01A-BE-S-K1207/17-K1207/4**

<b>MK01A</b>	Krusin arm chair
<b>BE</b>	Ebonized
<b>S</b>	Split upholstery option
<b>K1207/17</b>	seat: Knoll Felt, Pewter
<b>K1207/4</b>	back: Knoll Felt, Green

#### Specify:

1. Pattern number
2. Woven rush seat, optional
3. Finish selection
4. Split upholstery option (add S)
5. Textile selection

#### Ordering Information:

*Ash:*  
White Ash (suffix A101)

*Beech frame stains:*  
Beech (suffix B311)  
Bronzed Cherry (suffix B312A)  
Burnt Walnut (suffix B313)  
Deep Red Mahogany (suffix B328)  
Ebonized (suffix BE)  
Light Cherry (suffix B315)  
Light Walnut (suffix B411)  
Medium Cherry (suffix B319)  
Medium Red Mahogany (suffix BR)  
Medium Walnut (suffix B323)  
Natural Beech (suffix BN)  
Warm Brown Walnut (J)

*Split upholstery option:*  
The seat and back of the Krusin Side Chair can be specified in split upholstery. Indicate S before selected seat upholstery, followed by selected back upholstery. The price equals the price of the higher upholstery grade.

*COM split fabric requirements:*  
Back upholstery: 0.5 yards  
Seat upholstery: 0.8 yards

*COL split leather requirements:*  
Back upholstery: 6 square feet  
Seat upholstery: 14.5 square feet

*Upholstery/COM information:*  
List prices shown include fabric or leather upholstery. Contact your Knoll representative for colors. Only approved KnollTextiles and Spinneybeck leathers may be ordered.

Customer's Own Material is available pending approval. For approval requirements, processing instructions and ordering information please see page 21.

*KnollStudio natural wood finishes:*  
The Krusin Collection of guest seating features a low sheen, urethane finish. This finish, available on Ash, Oak, and Walnut delivers the tactility of natural wood while providing a durable matte finish.

Ash and Oak feature a unique staining process that replicate traditional cereused finishes.

*KnollStudio Beech wood finishes:*  
KnollStudio Beech finishes complement a large variety of KnollStudio veneer and Knoll Office veneer finishes. To select correct complementary finish, please refer to KnollStudio Wood Finish Matrix on page 26. If no complementary finish is available, please refer to custom finish policy below.

*Certified Wood:*  
Chairs manufactured using FSC certified hardwoods are available through Custom Product Development. Extended leadtime and upcharge apply.

*Maintenance:*  
See pages 28-29

*Note:*  
The Krusin Collection chairs are certified Clean Air GOLD in all wood finishes.

*Cal 133 Fire Code #:*  
The Krusin Side Chairs comply with the California Technical Bulletin 133 standard if upholstered in Cal 133 approved upholstery. Specify suffix -C at end of pattern number and suffix -133 at end of textile selection. Upcharge applies, see page 18.

#### Construction

*Frame:*  
Select American and European hard wood frames. Dowel and mortise and tenon construction, steam bent top rail. A bent laminate upholstered inset back is available. The back of inset features horizontal grain direction.

*Upholstered Seat:*  
High density, polyurethane foam used in all upholstered areas. Elastic seat belt suspension.

*Woven Rush Seats:*  
A woven natural paper rush seat is available on side and lounge chairs. Not available on chairs with inset back upholstery. Paper rush is a natural, uncoated material.

**KnollStudio will not warrant soiled or stained woven seats. A one year warranty will cover woven seats for manufacturer's defects.**

*Seat basket replacements:*  
Upholstered and woven seats sit on chair frame. Screws lock basket in place for easy installation or removal.

*Finish:*  
Beech, Catalyzed lacquer protective coating. Hand applied final wax coating. Ash, Oak, and Walnut, urethane protective coating. Hand applied final wax coating.

*Glides:*  
Chairs feature nylon glides.

pattern no.	woven seat	grades <b>A</b>	COM <b>B</b>	<b>C</b>	<b>D</b>	<b>E</b>	<b>F</b>	<b>G</b>	<b>H</b>	<b>I</b>	COL <b>U</b>	<b>V</b>	<b>W</b>	<b>X</b>	<b>Y</b>
<b>MK01AU-( )</b>		\$2,039.	\$2,062.	\$2,090.	\$2,118.	\$2,141.	\$2,157.	\$2,185.	\$2,241.	\$2,281.	\$2,576.	\$2,651.	\$2,850.	\$2,892.	\$2,941.
<b>MK01AU-(A101, O__)</b>		2,414.	2,439.	2,467.	2,497.	2,517.	2,536.	2,565.	2,616.	2,655.	2,953.	3,028.	3,227.	3,267.	3,316.
<b>MK01AU-(AW)</b>		2,874.	2,896.	2,924.	2,953.	2,976.	2,993.	3,020.	3,076.	3,113.	3,408.	3,488.	3,684.	3,727.	3,774.
<b>MK01R</b>		467.	491.	516.	546.	567.	585.	614.	667.	709.	986.	1,062.	1,262.	1,301.	1,350.
<b>MK01RCN</b>		602.													

#### Approved KnollTextiles Grades/Fabrics

<b>A</b> Alignment Beacon Bocce Chance Common Ground Commuter Cloth Crossroad Delite Facet Foil Rap Heavy Metal Hourglass Infinite Mariner Monarch Oh La La * Overture Prep Presto Soliloquy Sonnet Trophy Uni-Form	<b>B</b> continued Ferry Forza <sup>Ⓟ</sup> Gala II Grande Grandview Holbrook Instinct Journey Keaton Knoll Felt Knoll Hopsack Little Devil Ludlow Melody <sup>Ⓟ</sup> Paradigm Petat Pusher <sup>Ⓟ</sup> Prairie Prim Puff * Radiance Ransom Roam Rush Hour Shadow Play Spree Summit Sutton Synth Tabloid Tinge Topos Vast Venue Versa Vinyl <sup>Ⓟ</sup> Westwood Wild Thing	<b>C</b> Atlas Axiom <sup>Ⓟ</sup> Baxter Cairo Chameleon Charm Circa Classic Boucle Contour * Durand Earthwork Empire Stripe Entourage Entwine Essence Fibra Greenwich Groovy Hudson Kaleidoscope CR Kaya CR Lagos Lore CR Magnolia Milestone On Point Palisade Panache CR Patchwork Plaid On Prestini Pullman Quark Roundtrip Sahara Sequin CR	<b>C</b> continued Sinclair Smart <sup>Ⓟ</sup> Spectator Stepping Stones Swing Tight Rope Tilden * <sup>Ⓟ</sup> Tower Grid Utmost II Utopia * Wit Wow Factor Zari CR Zen Wave	<b>D</b> Buzz Code Coterie Eclat Weave Hologram Island Kabuki Menagerie Origins Pathway Plaidtastic Retreat Vice Versa Woodland Zoom	<b>E</b> Aegean Cleo Currents * Flower Power Highland Ikat Stripe Juno Kampala Kimono
---	---	---	---	---	--

#### Spinneybeck Leather

<b>U</b> Vicenza Volo	<b>X</b> Ducale * Ducale Velour
<b>V</b> Acqua Amalfi Andes Embossed Tip España Hand Tipped Maremma Velluto Pelle	<b>Y</b> Cervo * Copenhagen Distressed Gemma * Lucca * Marissa Portofino Riva Saddle
<b>W</b> Alaska Antique Derby Forte Lucente Sabrina Umbria *	<sup>Ⓟ</sup> Fire Retardant Chemicals *Not approved for inset back.
<b>G</b> continued Modern Tweed Rivers Spencer Straie Stripe Texnet Ultrasuede Utrillo Vert	<b>H</b> Bavaria Catwalk Chiseled Constance Firefly Stretch Appeal Twist Tie World Piece
<b>I</b> Aswan Bella Byron Cato Chic Cummings Diamond Days Doily * Dynamic Florescence Hastings In Step Ita Jaipur Knoll Velvet Limani Mepal North Island Olema Piper Prince Hairly Rutledge Sandis Stripe It Tudor Zimba	<b>F</b> Atelier Biscayne Calais Cotton Velvet Century Cornaro Double Agent <sup>Ⓟ</sup> Glider Homage Imprint In Stitches Liberty Mod Plaid Rivington Soon Swank Totem Tweed Frieze

*Check with your KnollTextiles or Spinneybeck Representative for changes or additions.*

Marc Krusin  
 Guest Seating Collection  
 Side Chair with Arms

Designer(s):  
 Marc Krusin, 2011



description	seat h	arm h	w	d	h	textile fabric yds.	required leather sq. ft.	weight	finish
<b>MK03A</b> Krusin arm chair, wood back	18 1/2"	24 1/2"	23 1/2"	21 3/4"	30 1/2"	0.8	14.5	14 lbs.	beech finish
	18 1/2"	24 1/2"	23 1/2"	21 3/4"	30 1/2"	0.8	14.5	14 lbs.	ash or oak finish
	18 1/2"	24 1/2"	23 1/2"	21 3/4"	30 1/2"	0.8	14.5	14 lbs.	walnut finish
<b>MK01R</b> Seat basket replacement for side chair						0.8	14.5		
<b>MK01RCN</b> Woven rush seat basket replacement for side chair									light kraft

Order Code

Example: **MK03A-BE-K2201/1**

<b>MK03A</b>	Krusin arm chair, wood back
<b>BE</b>	Ebonized
<b>K2201/1</b>	Oh La La/Argent

Specify:

1. Pattern number
2. Woven rush seat, optional
3. Finish selection
4. Textile selection

Ordering Information:

Ash:

White Ash (suffix A101)

Beech frame stains:

- Beech (suffix B311)
- Bronzed Cherry (suffix B312A)
- Burnt Walnut (suffix B313)
- Deep Red Mahogany (suffix B328)
- Ebonized (suffix BE)
- Light Cherry (suffix B315)
- Light Walnut (suffix B411)
- Medium Cherry (suffix B319)
- Medium Red Mahogany (suffix BR)
- Medium Walnut (suffix B323)
- Natural Beech (suffix BN)
- Warm Brown Walnut (J)

Oak:

- Ebonized Oak (suffix OE)
- Fumed Oak (suffix OF)
- Grey Oak, White Ceruse (suffix OGW)
- Grey Oak, Black Ceruse (suffix OGB)
- Natural Oak (suffix ON)

Walnut:

American Walnut (suffix AW)

Optional Woven Seat:

An optional woven paper rush seat is available at an upcharge, from grade A pricing, of \$350 for side chairs and \$393 for lounge chairs. Place suffix CN between parent pattern number and wood finish suffix.

Example: **MK03A-CN-BE**

Upholstery/COM information:

List prices shown include fabric or leather upholstery. Contact your Knoll representative for colors. Only approved KnollTextiles and Spinneybeck leathers may be ordered.

Customer's Own Material is available pending approval. For approval requirements, processing instructions and ordering information please see page 21.

KnollStudio natural wood finishes:

The Krusin Collection of guest seating features a low sheen, urethane finish. This finish, available on Ash, Oak, and Walnut delivers the tactility of natural wood while providing a durable matte finish.

Ash and Oak feature a unique staining process that replicate traditional cerused finishes.

Construction

Frame:

Select American and European hard wood frames. Dowel and mortise and tenon construction, steam bent top rail. A bent laminate upholstered inset back is available. The back of inset features horizontal grain direction.

Upholstered Seat:

High density, polyurethane foam used in all upholstered areas. Elastic seat belt suspension.

Woven Rush Seats:

A woven natural paper rush seat is available on side and lounge chairs. Not available on chairs with inset back upholstery. Paper rush is a natural, uncoated material.

**KnollStudio will not warrant soiled or stained woven seats. A one year warranty will cover woven seats for manufacturer's defects.**

Seat basket replacements:

Upholstered and woven seats sit on chair frame. Screws lock basket in place for easy installation or removal.

Finish:

Beech, Catalyzed lacquer protective coating. Hand applied final wax coating. Ash, Oak, and Walnut, urethane protective coating. Hand applied final wax coating.

Glides:

Chairs feature nylon glides.

pattern no.	woven seat	grades <b>A</b>	COM <b>B</b>	<b>C</b>	<b>D</b>	<b>E</b>	<b>F</b>	<b>G</b>	<b>H</b>	<b>I</b>	COL <b>U</b>	<b>V</b>	<b>W</b>	<b>X</b>	<b>Y</b>
<b>MK03A-( )</b>		\$1,799.	\$1,824.	\$1,853.	\$1,883.	\$1,903.	\$1,920.	\$1,946.	\$2,003.	\$2,043.	\$2,338.	\$2,414.	\$2,612.	\$2,653.	\$2,703.
<b>MK03A-(A101, O_)</b>		2,178.	2,201.	2,229.	2,256.	2,282.	2,296.	2,325.	2,380.	2,417.	2,716.	2,788.	2,989.	3,030.	3,078.
<b>MK03A-(AW)</b>		2,636.	2,659.	2,687.	2,716.	2,739.	2,755.	2,783.	2,838.	2,877.	3,171.	3,250.	3,450.	3,489.	3,535.
<b>MK01R</b>		467.	491.	516.	546.	567.	585.	614.	667.	709.	986.	1,062.	1,262.	1,301.	1,350.
<b>MK01RCN</b>		602.													

Approved KnollTextiles Grades/Fabrics

<b>A</b> Alignment Beacon Bocce Chance Common Ground Commuter Cloth Crossroad Delite Facet Foil Rap Heavy Metal Hourglass Infinite Mariner Monarch Oh La La * Overture Prep Presto Soliloquy Sonnet Trophy Uni-Form	<b>B</b> continued Ferry Forza <sup>®</sup> Gala II Grande Grandview Holbrook Instinct Journey Keaton Knoll Felt Knoll Hopsack Little Devil Ludlow Melody <sup>®</sup> Paradigm Petat Pusher <sup>®</sup> Prairie Prim Puff * Radiance Ransom Roam Rush Hour Shadow Play Spree Summit Sutton Synth Tabloid Tinge Topos Vast Venue Versa Vinyl <sup>®</sup> Westwood Wild Thing	<b>C</b> Atlas Axiom <sup>®</sup> Baxter Cairo Chameleon Charm Circa Classic Boucle Contour * Durand Earthwork Empire Stripe Entourage Entwine Essence Fibra Greenwich Groovy Hudson Kaleidoscope CR Kaya CR Lagos Lore CR Magnolia Milestone On Point Palisade Panache CR Patchwork Plaid On Prestini Pullman Quark Roundtrip Sahara Sequin CR	<b>C</b> continued Sinclair Smart <sup>®</sup> Spectator Stepping Stones Swing Tight Rope Tilden * <sup>®</sup> Tower Grid Utmost II Utopia * Wit Wow Factor Zari CR Zen Wave	<b>D</b> Buzz Code Coterie Eclat Weave Hologram Island Kabuki Menagerie Origins Pathway Plaidtastic Retreat Vice Versa Woodland Zoom	<b>E</b> Aegean Cleo Currents * Flower Power Highland Ikat Stripe Juno Kampala Kimono	<b>E</b> continued Mamba Marquee Midpoint Off The Grid Rebel Sherman Shima Tempest Tryst Vatera Whip *	<b>F</b> Atelier Biscayne Calais Cotton Velvet Century Cornaro Double Agent <sup>®</sup> Glider Homage Imprint In Stitches Liberty Mod Plaid Rivington Soon Swank Totem Tweed Frieze	<b>G</b> All Star Alter Ego Arber Aurora Dapper Djenne Duchess Fancy Twill Gibson Haze Kamani Looped In Melange	<b>G</b> continued Modern Tweed Rivers Spencer Straie Stripe Texnet Ultrasede Utrillo Vert <b>H</b> Bavaria Catwalk Chiseled Constance Firefly Stretch Appeal Twist Tie World Piece <b>I</b> Aswan Bella Byron Cato Chic Cummings Diamond Days Doily * Dynamic Floressence Hastings In Step Ita Jaipur Knoll Velvet Limani Mepal North Island Olema Piper Prince Hair Rutledge Sandis Stripe It Tudor Zimba	<b>U</b> Vicenza Volo <b>V</b> Acqua Amalfi Andes Embossed Tip España Hand Tipped Maremma Velluto Pelle <b>W</b> Alaska Antique Derby Forte Lucente Sabrina Umbria * <sup>®</sup> Fire Retardant Chemicals *Not approved for inset back.	<b>X</b> Ducale * Ducale Velour <b>Y</b> Cervo * Copenhagen Distressed Gemma * Lucca * Marissa Portofino Riva Saddle
--	---	---	---	---	--	---	--	--	---	---	--

Spinneybeck Leather

*Check with your KnollTextiles or Spinneybeck Representative for changes or additions.*

# Marc Krusin

## Guest Seating Collection

### Armless Side Chair

*Designer(s):*  
Marc Krusin, 2011



description	seat h	w	d	h	textile fabric yds.	required leather sq. ft.	weight	finish
<b>MK01C</b> Krusin armless chair, slat back	18½"	20¼"	21¾"	30½"	0.8	14.5	12 lbs.	beech finish
	18½"	20¼"	21¾"	30½"	0.8	14.5	12 lbs.	ash or oak finish
	18½"	20¼"	21¾"	30½"	0.8	14.5	12 lbs.	walnut finish
<b>MK01R</b> Seat basket replacement for side chair					0.8	14.5		
<b>MK01RCN</b> Woven rush seat basket replacement for side chair								light kraft

#### Order Code

<i>Example:</i>	<b>MK01A-BE-K1207/17</b>
<b>MK01A</b>	Krusin arm chair
<b>BE</b>	Ebonized
<b>K1207/17</b>	Knoll Felt, Pewter

#### Specify:

1. Pattern number
2. Woven rush seat, optional
3. Finish selection
4. Textile selection

#### Ordering Information:

*Ash:*  
White Ash (suffix A101)

*Beech frame stains:*  
Beech (suffix B311)  
Bronzed Cherry (suffix B312A)  
Burnt Walnut (suffix B313)  
Deep Red Mahogany (suffix B328)  
Ebonized (suffix BE)  
Light Cherry (suffix B315)  
Light Walnut (suffix B411)  
Medium Cherry (suffix B319)  
Medium Red Mahogany (suffix BR)  
Medium Walnut (suffix B323)  
Natural Beech (suffix BN)  
Warm Brown Walnut (J)

*Oak:*  
Ebonized Oak (suffix OE)  
Fumed Oak (suffix OF)  
Grey Oak, White Ceruse (suffix OGW)  
Grey Oak, Black Ceruse (suffix OGB)  
Natural Oak (suffix ON)

*Walnut:*  
American Walnut (suffix AW)

**Optional Woven Seat:**  
An optional woven paper rush seat is available at an upcharge, from grade A pricing, of \$350 for side chairs and \$393 for lounge chairs. Place suffix CN between parent pattern number and wood finish suffix.  
**Example:MK01A-CN-BE**

**Upholstery/COM information:**  
List prices shown include fabric or leather upholstery. Contact your Knoll representative for colors. Only approved KnollTextiles and Spinneybeck leathers may be ordered.  
Customer's Own Material is available pending approval. For approval requirements, processing instructions and ordering information please see page 21.

**KnollStudio natural wood finishes:**  
The Krusin Collection of guest seating features a low sheen, urethane finish. This finish, available on Ash, Oak, and Walnut delivers the tactility of natural wood while providing a durable matte finish.

Ash and Oak feature a unique staining process that replicate traditional cereused finishes.

#### Construction

**KnollStudio Beech wood finishes:**  
KnollStudio Beech finishes complement a large variety of KnollStudio veneer and Knoll Office veneer finishes. To select correct complementary finish, please refer to KnollStudio Wood Finish Matrix on page 26. If no complementary finish is available, please refer to custom finish policy below.

**Certified Wood:**  
Chairs manufactured using FSC certified hardwoods are available through Custom Product Development. Extended leadtime and upcharge apply.

**Maintenance:**  
See pages 28-29

**Cal 133 Fire Code:**  
The Krusin Side Chairs comply with the California Technical Bulletin 133 standard if upholstered in Cal 133 approved upholstery. Specify suffix -C at end of pattern number and suffix -133 at end of textile selection. Upcharge applies, see page 18.

**Seat basket replacements:**  
Upholstered and woven seats sit on chair frame. Screws lock basket in place for easy installation or removal.

**Finish:**  
Beech, Catalyzed lacquer protective coating. Hand applied final wax coating. Ash, Oak, and Walnut, urethane protective coating. Hand applied final wax coating.

**Glides:**  
Chairs feature nylon glides.

**Note:**  
The Krusin Collection chairs are certified Clean Air GOLD in all wood finishes.

**Frame:**  
Select American and European hard wood frames. Dowel and mortise and tenon construction, steam bent top rail. A bent laminate upholstered inset back is available. The back of inset features horizontal grain direction.

**Upholstered Seat:**  
High density, polyurethane foam used in all upholstered areas. Elastic seat belt suspension.

**Woven Rush Seats:**  
A woven natural paper rush seat is available on side and lounge chairs. Not available on chairs with inset back upholstery. Paper rush is a natural, uncoated material.

pattern no.	woven seat	grades <b>A</b>	COM <b>B</b>	<b>C</b>	<b>D</b>	<b>E</b>	<b>F</b>	<b>G</b>	<b>H</b>	<b>I</b>	COL <b>U</b>	<b>V</b>	<b>W</b>	<b>X</b>	<b>Y</b>
<b>MK01C-( )</b>		\$1,459.	\$1,486.	\$1,512.	\$1,540.	\$1,562.	\$1,580.	\$1,607.	\$1,662.	\$1,700.	\$1,975.	\$2,049.	\$2,249.	\$2,288.	\$2,337.
<b>MK01C-(A101, O_)</b>		1,839.	1,860.	1,890.	1,918.	1,940.	1,955.	1,984.	2,042.	2,079.	2,376.	2,451.	2,650.	2,689.	2,739.
<b>MK01C-(AW)</b>		2,294.	2,319.	2,345.	2,376.	2,398.	2,413.	2,442.	2,500.	2,537.	2,833.	2,908.	3,105.	3,147.	3,197.

<b>MK01R</b>	467.	491.	516.	546.	567.	585.	614.	667.	709.	986.	1,062.	1,262.	1,301.	1,350.
--------------	------	------	------	------	------	------	------	------	------	------	--------	--------	--------	--------

<b>MK01RCN</b>	602.
----------------	------

#### Approved KnollTextiles Grades/Fabrics

<b>A</b> Alignment Beacon Bocce Chance Common Ground Commuter Cloth Crossroad Delite Facet Foil Rap Heavy Metal Hourglass Infinite Mariner Monarch Oh La La * Overture Prep Presto Soliloquy Sonnet Trophy Uni-Form	<b>B</b> continued Ferry Forza <sup>®</sup> Gala II Grande Grandview Holbrook Instinct Journey Keaton Knoll Felt Knoll Hopsack Little Devil Ludlow Melody <sup>®</sup> Paradigm Petals Pusher <sup>®</sup> Prairie Prim Puff * Radiance Ransom Roam Rush Hour Shadow Play Spree Summit Sutton Synth Tabloid Tinge Topology Vast Venue Versa Vinyl <sup>®</sup> Westwood Wild Thing	<b>C</b> Atlas Axiom <sup>®</sup> Baxter Cairo Chameleon Charm Circa Classic Boucle Contour * Durand Earthwork Empire Stripe Entourage Entwine Essence Fibra Greenwich Groovy Hudson Kaleidoscope CR Kaya CR Lagos Lore CR Magnolia Milestone On Point Palisade Panache CR Patchwork Plaid On Prestini Pullman Quark Roundtrip Sahara Sequin CR	<b>C</b> continued Sinclair Smart <sup>®</sup> Spectator Stepping Stones Swing Tight Rope Tilden * <sup>®</sup> Tower Grid Utmost II Utopia * Wit Wow Factor Zari CR Zen Wave	<b>D</b> Buzz Code Coterie Eclat Weave Hologram Island Kabuki Menagerie Origins Pathway Plaidtastic Retreat Vice Versa Woodland Zoom	<b>E</b> Aegean Cleo Currents * Flower Power Highland Ikat Stripe Juno Kampala Kimono	<b>E</b> continued Mamba Marquee Midpoint Off The Grid Rebel Sherman Shima Tempest Tryst Vatera Whip *	<b>F</b> Atelier Biscayne Calais Cotton Velvet Century Cornaro Double Agent <sup>®</sup> Glider Homage Imprint In Stitches Liberty Mod Plaid Rivington Soon Swank Totem Tweed Frieze	<b>G</b> continued Modern Tweed Rivers Spencer Straie Stripe Texnet Ultrasuede Utrillo Vert	<b>H</b> Bavaria Catwalk Chiseled Constance Firefly Stretch Appeal Twist Tie World Piece	<b>I</b> Aswan Bella Byron Cato Chic Cummings Diamond Days Doily * Dynamic Florescence Hastings In Step Ita Jaipur Knoll Velvet Limani Mepal North Island Olema Piper Prince Hairly Rutledge Sandis Stripe It Tudor Zimba	<b>U</b> Vicenza Volo	<b>V</b> Acqua Amalfi Andes Embossed Tip España Hand Tipped Maremma Velluto Pelle	<b>X</b> Ducale * Ducale Velour	<b>Y</b> Cervo * Copenhagen Distressed Gemma * Lucca * Marissa Portofino Riva Saddle
--	---	---	---	---	--	---	--	---	--	---	-----------------------------	---	---------------------------------------	---

#### Spinneybeck Leather

<b>W</b> Alaska Antique Derby Forte Lucente Sabrina Umbria * <sup>®</sup> Fire Retardant Chemicals *Not approved for inset blank.
--

*Check with your KnollTextiles or Spinneybeck Representative for changes or additions.*

# Marc Krusin

## Guest Seating Collection

### Armless Side Chair

Designer(s):  
Marc Krusin, 2011

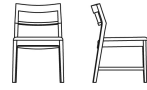

description	seat h	w	d	h	textile fabric yds.	required leather sq. ft.	weight	finish
<b>MK01CU</b> Krusin armless chair, uphol. inset back	18½"	20¼"	21¾"	30½"	1.3	14.5	12 lbs.	beech finish
	18½"	20¼"	21¾"	30½"	1.3	14.5	12 lbs.	ash or oak finish
	18½"	20¼"	21¾"	30½"	1.3	14.5	12 lbs.	walnut finish
<b>MK01R</b> Seat basket replacement for side chair					0.8	14.5		
<b>MK01RCN</b> Woven rush seat basket replacement for side chair								light kraft

#### Order Code

*Example:* **MK01A-BE-S-K1207/17-K1207/4**

<b>MK01A</b>	Krusin arm chair
<b>BE</b>	Ebonized
<b>S</b>	Split upholstery option
<b>K1207/17</b>	seat: Knoll Felt, Pewter
<b>K1207/4</b>	back: Knoll Felt, Green

**Oak:**  
Ebonized Oak (suffix OE)  
Fumed Oak (suffix OF)  
Grey Oak, White Ceruse (suffix OGW)  
Grey Oak, Black Ceruse (suffix OGB)  
Natural Oak (suffix ON)

**Walnut:**  
American Walnut (suffix AW)

**Optional Woven Seat:**  
An optional woven paper rush seat is available at an upcharge, from grade A pricing, of \$350 for side chairs and \$393 for lounge chairs. Place suffix CN between parent pattern number and wood finish suffix.

*Example:* **MK01A-CN-BE**

**Split upholstery option:**  
The seat and back of the Krusin Side Chair can be specified in split upholstery. Indicate S before selected seat upholstery, followed by selected back upholstery. The price equals the price of the higher upholstery grade.

**COM split fabric requirements:**  
Back upholstery: 0.5 yards  
Seat upholstery: 0.8 yards

**COL split leather requirements:**  
Back upholstery: 6 square feet  
Seat upholstery: 14.5 square feet

**Upholstery/COM information:**  
List prices shown include fabric or leather upholstery. Contact your Knoll representative for colors. Only approved KnollTextiles and Spinneybeck leathers may be ordered.

Customer's Own Material is available pending approval. For approval requirements, processing instructions and ordering information please see page 21.

**KnollStudio natural wood finishes:**  
The Krusin Collection of guest seating features a low sheen, urethane finish. This finish, available on Ash, Oak, and Walnut delivers the tactility of natural wood while providing a durable matte finish.

Ash and Oak feature a unique staining process that replicate traditional cereused finishes.

#### Construction

**Frame:**  
Select American and European hard wood frames. Dowel and mortise and tenon construction, steam bent top rail. A bent laminate upholstered inset back is available. The back of inset features horizontal grain direction.

**Upholstered Seat:**  
High density, polyurethane foam used in all upholstered areas. Elastic seat belt suspension.

**Woven Rush Seats:**  
A woven natural paper rush seat is available on side and lounge chairs. Not available on chairs with inset back upholstery. Paper rush is a natural, uncoated material.

**KnollStudio will not warrant soiled or stained woven seats. A one year warranty will cover woven seats for manufacturer's defects.**

**Seat basket replacements:**  
Upholstered and woven seats sit on chair frame. Screws lock basket in place for easy installation or removal.

**Finish:**  
Beech, Catalyzed lacquer protective coating. Hand applied final wax coating. Ash, Oak, and Walnut, urethane protective coating. Hand applied final wax coating.

**Glides:**  
Chairs feature nylon glides.

**Note:**  
The Krusin Collection chairs are certified Clean Air GOLD in all wood finishes.

pattern no.	woven seat	grades A	COM B	C	D	E	F	G	H	I	COL U	V	W	X	Y
<b>MK01CU-( )</b>		\$1,902.	\$1,927.	\$1,953.	\$1,982.	\$2,004.	\$2,018.	\$2,049.	\$2,102.	\$2,143.	\$2,414.	\$2,489.	\$2,689.	\$2,730.	\$2,778.
<b>MK01CU-(A101, O__)</b>		2,281.	2,302.	2,330.	2,360.	2,380.	2,398.	2,426.	2,482.	2,518.	2,816.	2,893.	3,093.	3,132.	3,179.
<b>MK01CU-(AW)</b>		2,737.	2,761.	2,786.	2,816.	2,839.	2,855.	2,885.	2,941.	2,977.	3,275.	3,351.	3,547.	3,588.	3,637.
<b>MK01R</b>		467.	491.	516.	546.	567.	585.	614.	667.	709.	986.	1,062.	1,262.	1,301.	1,350.
<b>MK01RCN</b>		602.													

#### Approved KnollTextiles Grades/Fabrics

<b>A</b> Alignment Beacon Bocce Chance Common Ground Commuter Cloth Crossroad Delite Facet Foil Rap Heavy Metal Hourglass Infinite Mariner Monarch Oh La La * Overture Prep Presto Soliloquy Sonnet Trophy Uni-Form	<b>B</b> continued Ferry Forza Ⓞ Gala II Grande Grandview Hollbrook Instinct Journey Keaton Knoll Felt Knoll Hopsack Little Devil Ludlow Melody Ⓞ Paradigm Petat Pusher Ⓞ Prairie Prim Puff * Radiance Ransom Roam Rush Hour Shadow Play Spree Summit Sutton Synth Tabloid Tinge Topos Vast Venue Versa Vinyl Ⓞ Westwood Wild Thing	<b>C</b> Atlas Axiom Ⓞ Baxter Cairo Chameleon Charm Circa Classic Boucle Contour * Durand Earthwork Empire Stripe Entourage Entwine Essence Fibra Greenwich Groovy Hudson Kaleidoscope CR Kaya CR Lagos Lore CR Magnolia Milestone On Point Palisade Panache CR Patchwork Plaid On Prestini Pullman Quark Roundtrip Sahara Sequin CR	<b>C</b> continued Sinclair Smart Ⓞ Spectator Stepping Stones Swing Tight Rope Tilden * Ⓞ Tower Grid Utmost II Utopia * Wit Wow Factor Zari CR Zen Wave	<b>D</b> Buzz Code Coterie Eclat Weave Hologram Island Kabuki Menagerie Origins Pathway Plaidtastic Retreat Vice Versa Woodland Zoom	<b>E</b> Aegean Cleo Currents * Flower Power Highland Ikat Stripe Juno Kampala Kimono				
<b>E</b> continued Mamba Marquee Midpoint Off The Grid Rebel Sherman Shima Tempest Tryst Vatera Whip *	<b>F</b> Atelier Biscayne Calais Cotton Velvet Century Cornaro Double Agent Ⓞ Glider Homage Imprint In Stitches Liberty Mod Plaid Rivington Soon Swank Totem Tweed Frieze	<b>G</b> continued Modern Tweed Rivers Spencer Straie Stripe Texnet Ultrasuede Utrillo Vert	<b>H</b> Bavaria Catwalk Chiseled Constance Firefly Stretch Appeal Twist Tie World Piece	<b>I</b> Aswan Bella Byron Cato Chic Cummings Diamond Days Doily * Dynamic Florescence Hastings In Step Ita Jaipur Knoll Velvet Limani Mepal North Island Olema Piper Prince Hairly Rutledge Sandis Stripe It Tudor Zimba	<b>U</b> Vicenza Volo	<b>V</b> Acqua Amalfi Andes Embossed Tip España Hand Tipped Maremma Velluto Pelle	<b>W</b> Alaska Antique Derby Forte Lucente Sabrina Umbria *	<b>X</b> Ducale * Ducale Velour	<b>Y</b> Cervo * Copenhagen Distressed Gemma * Lucca * Marissa Portofino Riva Saddle

#### Spinneybeck Leather

<b>U</b> Vicenza Volo	<b>V</b> Acqua Amalfi Andes Embossed Tip España Hand Tipped Maremma Velluto Pelle	<b>W</b> Alaska Antique Derby Forte Lucente Sabrina Umbria *	<b>X</b> Ducale * Ducale Velour	<b>Y</b> Cervo * Copenhagen Distressed Gemma * Lucca * Marissa Portofino Riva Saddle
-----------------------------	---	---	---------------------------------------	---

*Check with your KnollTextiles or Spinneybeck Representative for changes or additions.*

# Marc Krusin

## Guest Seating Collection

### Armless Side Chair

*Designer(s):*  
Marc Krusin, 2011

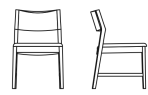

description	seat h	w	d	h	textile	required	weight	finish
					fabric yds.	leather sq. ft.		
<b>MK03C</b> Krusin armless chair, wood back	16"	27"	25 1/4"	26"	0.9	16.5	14 lbs.	beech finish
	18 1/2"	23 1/2"	21 3/4"	30 1/2"	0.8	14.5	14 lbs.	ash or oak finish
	18 1/2"	23 1/2"	21 3/4"	30 1/2"	0.8	14.5	14 lbs.	walnut finish
<b>MK01R</b> Seat basket replacement for side chair					0.8	14.5		
<b>MK01RCN</b> Woven rush seat basket replacement for side chair								light kraft

#### Order Code

<i>Example:</i>	<b>MK03C-BE-K2201/1</b>
<b>MK03C</b>	Krusin armless chair
<b>BE</b>	Ebonized
<b>K2201/1</b>	Oh La La/Argent

#### Specify:

1. Pattern number
2. Woven rush seat, optional
3. Finish selection
4. Textile selection

#### Ordering Information:

*Ash:*  
White Ash (suffix A101)

*Beech frame stains:*  
Beech (suffix B311)  
Bronzed Cherry (suffix B312A)  
Burnt Walnut (suffix B313)  
Deep Red Mahogany (suffix B328)  
Ebonized (suffix BE)  
Light Cherry (suffix B315)  
Light Walnut (suffix B411)  
Medium Cherry (suffix B319)  
Medium Red Mahogany (suffix BR)  
Medium Walnut (suffix B323)  
Natural Beech (suffix BN)  
Warm Brown Walnut (J)

*Oak:*  
Ebonized Oak (suffix OE)  
Fumed Oak (suffix OF)  
Grey Oak, White Ceruse (suffix OGW)  
Grey Oak, Black Ceruse (suffix OGB)  
Natural Oak (suffix ON)

*Walnut:*  
American Walnut (suffix AW)

*Optional Woven Seat:*  
An optional woven paper rush seat is available at an upcharge, from grade A pricing, of \$350 for side chairs and \$393 for lounge chairs. Place suffix CN between parent pattern number and wood finish suffix.  
*Example:* **MK03A-CN-BE**

*Upholstery/COM information:*  
List prices shown include fabric or leather upholstery. Contact your Knoll representative for colors. Only approved KnollTextiles and Spinneybeck leathers may be ordered.  
Customer's Own Material is available pending approval. For approval requirements, processing instructions and ordering information please see page 21.

*KnollStudio natural wood finishes:*  
The Krusin Collection of guest seating features a low sheen, urethane finish. This finish, available on Ash, Oak, and Walnut delivers the tactility of natural wood while providing a durable matte finish.

Ash and Oak feature a unique staining process that replicate traditional cereumed finishes.

#### Construction

*KnollStudio Beech wood finishes:*  
KnollStudio Beech finishes complement a large variety of KnollStudio veneer and Knoll Office veneer finishes. To select correct complementary finish, please refer to KnollStudio Wood Finish Matrix on page 26. If no complementary finish is available, please refer to custom finish policy below.

*Certified Wood:*  
Chairs manufactured using FSC certified hardwoods are available through Custom Product Development. Extended leadtime and upcharge apply.

*Maintenance:*  
See pages 28-29

*Cal 133 Fire Code:*  
The Krusin Side Chairs comply with the California Technical Bulletin 133 standard if upholstered in Cal 133 approved upholstery. Specify suffix -C at end of pattern number and suffix -133 at end of textile selection. Upcharge applies, see page 18.

*Seat basket replacements:*  
Upholstered and woven seats sit on chair frame. Screws lock basket in place for easy installation or removal.

*Finish:*  
Beech, Catalyzed lacquer protective coating. Hand applied final wax coating. Ash, Oak, and Walnut, urethane protective coating. Hand applied final wax coating.

*Glides:*  
Chairs feature nylon glides.

*Note:*  
The Krusin Collection chairs are certified Clean Air GOLD in all wood finishes.

*Frame:*  
Select American and European hard wood frames. Dowel and mortise and tenon construction, steam bent top rail. A bent laminate upholstered inset back is available. The back of inset features horizontal grain direction.

*Upholstered Seat:*  
High density, polyurethane foam used in all upholstered areas. Elastic seat belt suspension.

*Woven Rush Seats:*  
A woven natural paper rush seat is available on side and lounge chairs. Not available on chairs with inset back upholstery. Paper rush is a natural, uncoated material.

pattern no.	woven seat	grades	COM										COL				
		<b>A</b>	<b>B</b>	<b>C</b>	<b>D</b>	<b>E</b>	<b>F</b>	<b>G</b>	<b>H</b>	<b>I</b>	<b>U</b>	<b>V</b>	<b>W</b>	<b>X</b>	<b>Y</b>		
<b>MK03C-( )</b>		\$1,663.	\$1,689.	\$1,717.	\$1,744.	\$1,765.	\$1,786.	\$1,811.	\$1,864.	\$1,904.	\$2,178.	\$2,253.	\$2,452.	\$2,490.	\$2,540.		
<b>MK03C-(A101, O_)</b>		2,043.	2,064.	2,095.	2,122.	2,144.	2,159.	2,189.	2,246.	2,283.	2,579.	2,654.	2,853.	2,893.	2,943.		
<b>MK03C-(AW)</b>		2,500.	2,522.	2,548.	2,579.	2,603.	2,616.	2,645.	2,703.	2,740.	3,037.	3,111.	3,308.	3,352.	3,400.		
<b>MK01R</b>		467.	491.	516.	546.	567.	585.	614.	667.	709.	986.	1,062.	1,262.	1,301.	1,350.		
<b>MK01RCN</b>	602.																

#### Approved KnollTextiles Grades/Fabrics



<b>A</b> Alignment Beacon Bocce Chance Common Ground Commuter Cloth Crossroad Delite Facet Foil Rap Heavy Metal Hourglass Infinite Mariner Monarch Oh La La * Overture Prep Presto Soliloquy Sonnet Trophy Uni-Form	<b>B</b> continued Ferry Forza <sup>®</sup> Gala II Grande Grandview Holbrook Instinct Journey Keaton Knoll Felt Knoll Hopsack Little Devil Ludlow Melody <sup>®</sup> Paradigm Petat Pusher <sup>®</sup> Prairie Prim Puff * Radiance Ransom Roam Rush Hour Shadow Play Spree Summit Sutton Synth Tabloid Tinge Topos Vast Venue Versa Vinyl <sup>®</sup> Westwood Wild Thing	<b>C</b> Atlas Axiom <sup>®</sup> Baxter Cairo Chameleon Charm Circa Classic Boucle Contour * Durand Earthwork Empire Stripe Entourage Entwine Essence Fibra Greenwich Groovy Hudson Kaleidoscope CR Kaya CR Lagos Lore CR Magnolia Milestone On Point Palisade Panache CR Patchwork Plaid On Prestini Pullman Quark Roundtrip Sahara Sequin CR	<b>C</b> continued Sinclair Smart <sup>®</sup> Spectator Stepping Stones Swing Tight Rope Tilden * <sup>®</sup> Tower Grid Utmost II Utopia * Wit Wow Factor Zari CR Zen Wave	<b>D</b> Buzz Code Coterie Eclat Weave Hologram Island Kabuki Menagerie Origins Pathway Plaidtastic Retreat Vice Versa Woodland Zoom	<b>E</b> Aegean Cleo Currents * Flower Power Highland Ikat Stripe Juno Kampala Kimono	<b>E</b> continued Mamba Marquee Midpoint Off The Grid Rebel Sherman Shima Tempest Tryst Vatera Whip *	<b>F</b> Atelier Biscayne Calais Cotton Velvet Century Cornaro Double Agent <sup>®</sup> Glider Homage Imprint In Stitches Liberty Mod Plaid Rivington Soon Swank Totem Tweed Frieze	<b>G</b> continued Modern Tweed Rivers Spencer Straie Stripe Texnet Ultrasuede Utrillo Vert <b>H</b> Bavaria Catwalk Chiseled Constance Firefly Stretch Appeal Twist Tie World Piece	<b>I</b> Aswan Bella Byron Cato Chic Cummings Diamond Days Doily * Dynamic Floressence Hastings In Step Ita Jaipur Knoll Velvet Limani Mepal North Island Olema Piper Prince Hair Rutledge Sandis Stripe It Tudor Zimba	<b>U</b> Vicenza Volo	<b>V</b> Acqua Amalfi Andes Embossed Tip España Hand Tipped Maremma Velluto Pelle	<b>W</b> Alaska Antique Derby Forte Lucente Sabrina Umbria * <sup>®</sup> Fire Retardant Chemicals *Not approved for inset bank.	<b>X</b> Ducale * Ducale Velour	<b>Y</b> Cervo * Copenhagen Distressed Gemma * Lucca * Marissa Portofino Riva Saddle
--	---	---	---	---	--	---	--	---	---	-----------------------------	---	---	---------------------------------------	---

#### Spinneybeck Leather

# Marc Krusin

## Guest Seating Collection

### Lounge Seating

	description	seat h	arm h	w	d	h	textile fabric yds.	required leather sq. ft.	weight	finish
<i>Designer(s):</i> Marc Krusin, 2011	<b>MK02A</b> Krusin Lounge arm chair	16"	21 1/2"	27"	25 3/4"	26"	0.9	16.5	14 lbs.	beech finish
		16"	21 1/2"	27"	25 3/4"	26"	0.9	16.5	14 lbs.	ash or oak finish
		16"	21 1/2"	27"	25 3/4"	26"	0.9	16.5	14 lbs.	walnut finish
	<b>MK02C</b> Krusin Lounge armless chair	16"		23 1/2"	25 3/4"	26"	0.9	16.5	12 lbs.	beech finish
		16"		23 1/2"	25 3/4"	26"	0.9	16.5	12 lbs.	ash or oak finish
		16"		23 1/2"	25 3/4"	26"	0.9	16.5	12 lbs.	walnut finish
	<b>MK02R</b> Seat basket replacement for lounge chair						0.9	16.5		
	<b>MK02RCN</b> Woven rush seat basket replacement for lounge chair									light kraft



#### Order Code

<i>Example:</i>	<b>MK02A-CN-A101</b>
<b>MK02A</b>	Krusin lounge arm chair
<b>CN</b>	Woven rush seat
<b>A101</b>	White Ash

#### Specify:

1. Pattern number
2. Woven rush seat, optional
3. Finish selection
4. Textile selection

#### Ordering Information:

*Ash:*  
White Ash (suffix A101)

*Beech frame stains:*  
Beech (suffix B311)  
Bronzed Cherry (suffix B312A)  
Burnt Walnut (suffix B313)  
Deep Red Mahogany (suffix B328)  
Ebonized (suffix BE)  
Light Cherry (suffix B315)  
Light Walnut (suffix B411)  
Medium Cherry (suffix B319)  
Medium Red Mahogany (suffix BR)  
Medium Walnut (suffix B323)  
Natural Beech (suffix BN)  
Warm Brown Walnut (J)

*Oak:*  
Ebonized Oak (suffix OE)  
Fumed Oak (suffix OF)  
Grey Oak, White Ceruse (suffix OGW)  
Grey Oak, Black Ceruse (suffix OGB)  
Natural Oak (suffix ON)

*Walnut:*  
American Walnut (suffix AW)

#### Optional Woven Seat:

An optional woven paper rush seat is available at an upcharge, from grade A pricing, of \$350 for side chairs and \$393 for lounge chairs. Place suffix CN between parent pattern number and wood finish suffix.

*Example:* **MK02A-CN-A101**

#### Upholstery/COM information:

List prices shown include fabric or leather upholstery. Contact your Knoll representative for colors. Only approved KnollTextiles and Spinneybeck leathers may be ordered.

Customer's Own Material is available pending approval. For approval requirements, processing instructions and ordering information please see page 21.

#### KnollStudio natural wood finishes:

The Krusin Collection of guest seating features a low sheen, urethane finish. This finish, available on Ash, Oak, and Walnut delivers the tactility of natural wood while providing a durable matte finish.

Ash and Oak feature a unique staining process that replicate traditional cereused finishes.

#### KnollStudio Beech wood finishes:

KnollStudio Beech finishes complement a large variety of KnollStudio veneer and Knoll Office veneer finishes. To select correct complementary finish, please refer to KnollStudio Wood Finish Matrix on page 26. If no complementary finish is available, please refer to custom finish policy below.

#### Certified Wood:

Chairs manufactured using FSC certified hardwoods are available through Custom Product Development. Extended leadtime and upcharge apply.

#### Maintenance:

See pages 28-29

#### Note:

The Krusin Collection chairs are certified Clean Air GOLD in all wood finishes.

#### Cal 133 Fire Code:

The Krusin Lounge Chairs comply with the California Technical Bulletin 133 standard if upholstered in Cal 133 approved upholstery. Specify suffix -C at end of pattern number and suffix -133 at end of textile selection. Upcharge applies, see page 18.

#### Construction

##### Frame:

Select American and European hard wood frames. Dowel and mortise and tenon construction, steam bent top rail.

##### Upholstered Seat:

High density, polyurethane foam used in all upholstered areas. Elastic seat belt suspension.

##### Woven Rush Seats:

A woven natural paper rush seat is available on side and lounge chairs. Not available on chairs with inset back upholstery. Paper rush is a natural, uncoated material.

**KnollStudio will not warrant soiled or stained woven seats. A one year warranty will cover woven seats for manufacturer's defects.**

##### Seat basket replacements:

Upholstered and woven seats sit on chair frame. Screws lock basket in place for easy installation or removal.

##### Finish:

Beech, Catalyzed lacquer protective coating. Hand applied final wax coating. Ash, Oak, and Walnut, urethane protective coating. Hand applied final wax coating.

##### Glides:

Chairs feature nylon glides.

pattern no.	woven seat	grades <b>A</b>	COM <b>B</b>	<b>C</b>	<b>D</b>	<b>E</b>	<b>F</b>	<b>G</b>	<b>H</b>	<b>I</b>	COL <b>U</b>	<b>V</b>	<b>W</b>	<b>X</b>	<b>Y</b>
<b>MK02A-( )</b>		\$2,343.	\$2,366.	\$2,398.	\$2,426.	\$2,452.	\$2,474.	\$2,505.	\$2,565.	\$2,609.	\$2,905.	\$2,993.	\$3,216.	\$3,261.	\$3,320.
<b>MK02A-(A101, O_)</b>		2,439.	2,463.	2,491.	2,522.	2,549.	2,568.	2,603.	2,658.	2,705.	3,025.	3,112.	3,335.	3,386.	3,439.
<b>MK02A-(AW)</b>		2,849.	2,874.	2,901.	2,930.	2,959.	2,977.	3,010.	3,067.	3,113.	3,435.	3,523.	3,744.	3,793.	3,848.
<b>MK02C-( )</b>		2,176.	2,198.	2,230.	2,258.	2,284.	2,302.	2,335.	2,395.	2,439.	2,737.	2,822.	3,047.	3,097.	3,151.
<b>MK02C-(A101, O_)</b>		2,271.	2,294.	2,327.	2,355.	2,379.	2,402.	2,434.	2,489.	2,537.	2,857.	2,944.	3,167.	3,216.	3,272.
<b>MK02C-(AW)</b>		2,681.	2,705.	2,736.	2,763.	2,790.	2,811.	2,841.	2,898.	2,945.	3,262.	3,354.	3,578.	3,626.	3,680.
<b>MK02R</b>		577.	602.	629.	659.	680.	697.	726.	780.	818.	1,170.	1,246.	1,446.	1,487.	1,534.
<b>MK02RCN</b>	650.														

#### Approved KnollTextiles Grades/Fabrics

##### A

Alignment  
Beacon  
Bocce  
Chance  
Common Ground  
Commuter Cloth  
Crossroad  
Delite  
Facet  
Foil Rap  
Heavy Metal  
Hourglass  
Infinite  
Mariner  
Monarch  
Oh La La \*  
Overture  
Prep  
Presto  
Soliloquy  
Sonnet  
Trophy  
Uni-Form

##### B

Abacus  
Argyle  
Attire  
Belize  
Bistro  
Boundary  
Calypso  
Chronicle  
Close Knit  
Cozy Cord  
Day Tripper  
Diva  
Dottie

##### B continued

Ferry  
Forza <sup>®</sup>  
Gala II  
Grande  
Grandview  
Holbrook  
Instinct  
Journey  
Keaton  
Knoll Felt  
Knoll Hopsack  
Little Devil  
Ludlow  
Melody <sup>®</sup>  
Paradigm  
Petal Pusher <sup>®</sup>  
Prairie  
Prim  
Puff  
Radiance  
Ransom  
Roam  
Rush Hour  
Shadow Play  
Spree  
Summit  
Sutton  
Synth  
Tabloid  
Tinge  
Topos  
Vast  
Venue  
Versa  
Vinyl <sup>®</sup>  
Westwood  
Wild Thing

##### C

Atlas  
Axiom <sup>®</sup>  
Baxter  
Cairo  
Chameleon  
Charm  
Circa  
Classic Boucle  
Contour  
Durand  
Earthwork  
Empire Stripe  
Entourage  
Entwine  
Essence  
Fibra  
Greenwich  
Groovy  
Hudson  
Kaleidoscope CR  
Kaya CR  
Lagos  
Lore CR  
Magnolia  
Milestone  
On Point  
Palisade  
Panache CR  
Patchwork  
Plaid On  
Prestini  
Pullman  
Quark  
Roundtrip  
Sahara  
Sequin CR

##### C continued

Sinclair  
Smart <sup>®</sup>  
Spectator  
Stepping Stones  
Swing  
Tight Rope  
Tilden \* <sup>®</sup>  
Tower Grid  
Utmost II  
Utopia \*  
Wit  
Wow Factor  
Zari CR  
Zen Wave

##### D

Buzz  
Code  
Coterie  
Eclat Weave  
Hologram  
Island  
Kabuki  
Menagerie  
Origins  
Pathway  
Plaidtastic  
Retreat  
Vice Versa  
Woodland  
Zoom

##### E

Aegean  
Cleo  
Currents  
Flower Power  
Highland  
Ikat Stripe  
Juno  
Kampala  
Kimono

##### E continued

Mamba  
Marquee  
Midpoint  
Off The Grid  
Rebel  
Sherman  
Shima  
Tempest  
Tryst  
Vatera  
Whip \*

##### F

Atelier  
Biscayne  
Calais Cotton  
Velvet  
Century  
Cornaro  
Double Agent <sup>®</sup>  
Glider  
Homage  
Imprint  
In Stitches  
Liberty  
Mod Plaid  
Rivington  
Soon  
Swank  
Totem  
Tweed Frieze

##### G

All Star  
Alter Ego  
Arber  
Aurora  
Dapper  
Djenne  
Duchess  
Fancy Twill  
Gibson  
Haze  
Kamani  
Looped In  
Melange

##### G continued

Modern Tweed  
Rivers  
Spencer  
Straie Stripe  
Texnet  
Ultrasuede  
Utrillo  
Vert

##### I

Aswan  
Bella  
Byron  
Cato  
Chic  
Cummings  
Diamond Days  
Doily  
Dynamic  
Floressence  
Hastings  
In Step  
Ita  
Jaipur  
Knoll Velvet  
Limani  
Mepal  
North Island  
Olema  
Piper  
Prince Hair  
Rutledge  
Sandis  
Stripe It  
Tudor  
Zimba

#### Spinneybeck Leather

##### U

Vicenza  
Volo

##### V

Acqua  
Amalfi  
Andes  
Embossed Tip  
Hand Tipped  
España  
Maremma  
Velluto Pelle

##### W

Alaska  
Antique  
Derby  
Forte  
Lucente  
Sabrina  
Umbria  
<sup>®</sup> Fire Retardant Chemicals

*Check with your KnollTextiles or Spinneybeck Representative for changes or additions.*

##### X

Ducale  
Ducale Velour



##### Y

Cervo  
Copenhagen  
Distressed  
Gemma  
Lucca  
Marissa  
Portofino  
Riva  
Saddle

# Maya Lin

## Stones

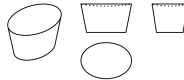
### Seats and Coffee Table

description	w	d	h	material	textile fabric yds.	req. leather sq. ft.	weight
<b>83Y</b> Stones large seat 	27"	19"	15"	molded polyethylene			13 lbs.
	27"	19"	15"	molded polyethylene with weight			22 lbs.
<b>83Y-K</b> Seat cushion for large seat					1.3	30	
<b>84Y</b> Stones small seat 	16"	12"	10"	molded polyethylene			6 lbs.
	16"	12"	10"	molded polyethylene with weight			17 lbs.
<b>84Y-K</b> Seat cushion for small seat					1.0	25	

Designer(s):  
Maya Lin, 1998

Award(s):  
Best of Neocon Silver Award, 1998; Good Design Award, Chicago Athenaeum, 1998; Good Design Award, 2006



#### Order Code

<i>Example:</i>	<b>84YM-W-KHRC-K642/5</b>
<b>84YM</b>	Stones small seat
<b>W</b>	With weight
<b>KHRC</b>	Khaki
<b>K642/5</b>	Mariner, Steel

#### Specify:

1. Pattern number
2. Weight option
3. Finish option;
4. Textile selection

#### Ordering Information:

Molded Polyethylene finish:  
White (suffix WV)

Molded Polyethylene finishes with 100% recycled content:

- Blue (suffix BLRC)
- Chartreuse (CHRC)
- Khaki (suffix KHRC)
- Silver (suffix SPROC)
- Tarmac (suffix TARC)
- Warm Red (suffix WRRRC)

Upholstery/COM information:  
Prices shown include fabric or leather upholstery. Contact your Knoll representative for colors. Only approved KnollTextiles and Spinneybeck leathers may be ordered.

Customer's Own Material is available pending approval. For approval requirements, processing instructions and ordering information please see page 18.

#### Seats and Table:

Stones are available in molded polyethylene in virgin or recycled material. Both versions are fully finished and are enclosed on top, bottom and sides. Seat tops are slightly concave and table top is slightly convex.

#### Note:

The original Maya Lin Coffee Table (85T42) is no longer available and has been replaced by a modified version (85T32). Please note the new dimensions and weight.

#### Outdoor application note:

With proper care and limited exposure to the elements, Stones tables and seats without seat pads are suitable for outdoor use. Polyethylene stones in all colors can be used outdoors. Remove water in the concave seats to avoid permanent stains. White patina may appear on surface. During cool or inclement weather, it is recommended to bring Stones inside.

#### Seat application note:

Do not use as stepping stool.

#### Security Kit:

Security kit hooks onto latch on underside of polyethylene Stone directly into the ground for permanent applications. Due to variations in flooring, kit does not include hardware. Security kit is NOT available on coffee tables.

#### UV Testing:

Maya Lin Stones in polyethylene in all colors have passed UV testing standards including 100 hours under intense UV radiation to test for colorfastness.

#### Cal 133:

For polyethylene Maya Lin Stones in a Cal 133 finish please request through CPD. Please note, specifying the Maya Lin Stone seat pad in a Cal 133 textile does not make the polyethylene Stone Cal 133 approved.

#### Maintenance:

See pages 28-29.

#### Note:

The Maya Lin Seat and Coffee Table are certified Clean Air GOLD.

#### Construction

##### Molded Polyethylene Stones:

Polyethylene stones have integral color with a light texture and a low gloss finish, available in one color.

##### Recycled Molded Polyethylene Stones:

Recycled polyethylene stones are composed of 100% recycled polyethylene in six colors. Black specs will appear randomly on the surface of the stone. Color will vary slightly from stone to stone. Warranty claims for color variations will not be honored.

##### Weighted Polyethylene Stones:

Large and small stones in molded polyethylene can be specified with or without weight. For stones with weight, sand is added at the factory. Weight can be adjusted in the field through access on underside of the stones. There is no option for a sand kit if the Stones are ordered without weight. The coffee table can only be specified without weight.

##### Seat cushions (seats only):

Seat cushions are 2 1/4" thick, solid foam piece with tapered edge and fabric or leather zip-lock cover. Seat cushions are fully upholstered on top and bottom. Seat cushions are not attached to Stone.

pattern no.	unuphol.	grades A	COM B	C	D	E	F	G	H	I	COL U	V	W	X	Y
<b>83YM-( )</b>	\$882.														
<b>83YMW-( )</b>	1,044.														
<b>83Y-K-( )</b>		916.	963.	1,012.	1,060.	1,105.	1,133.	1,186.	1,282.	1,353.	1,880.	2,118.	2,612.	2,713.	2,837.
<b>84YM-( )</b>	607.														
<b>84YMW-( )</b>	700.														
<b>84Y-K-( )</b>		671.	718.	761.	809.	845.	872.	916.	1,012.	1,076.	1,663.	1,887.	2,340.	2,438.	2,544.

#### Approved KnollTextiles Grades/Fabrics

**A** Alignment  
Beacon  
Bocce  
Chance  
Common Ground  
Commuter Cloth  
Cross Tech  
Crossroad  
Delite  
Facet  
Hourglass  
Infinite  
Mariner  
Monarch  
Overture  
Prep  
Presto  
Soliloquy  
Sonnet  
Trophy  
Uni-Form

**B** Abacus  
Argyle  
Attire  
Belize  
Bistro  
Boundary  
Calypso  
Chronicle  
Close Knit  
Cozy Cord  
Day Tripper  
Diva  
Dottie  
Ferry  
Forza <sup>Ⓞ</sup>  
Gala II  
Grande  
Grandview  
Helios  
Holbrook  
Instinct  
Journey  
Keaton

**C** Atlas  
Axiom  
Baxter  
Cairo  
Chameleon  
Charm  
Circa  
Classic Boucle  
Contour  
Dune  
Durand  
Earthwork

**E** continued  
Ludlow  
Knoll Felt  
Knoll Hopsack  
Little Devil  
Melody <sup>Ⓞ</sup>  
Paradigm  
Petal Pusher <sup>Ⓞ</sup>  
Prairie  
Prim  
Puff  
Radiance  
Ransom  
Roam  
Rush Hour  
Shadow Play  
Spree  
Summit  
Sutton  
Synth  
Tabloid  
Tinge  
Topos  
Vast  
Venue  
Versa  
Vinyl <sup>Ⓞ</sup>  
Westwood  
Wild Thing  
Yeni

**D** Buzz  
Code  
Coterie  
Eclat Weave  
Hologram  
Island  
Menagerie  
Origins  
Plaidtastic  
Retreat  
Vice Versa  
Woodland  
Zoom

**F** continued  
Double Agent <sup>Ⓞ</sup>  
Glider  
Homage  
Imprint  
In Stitches  
Jasmine  
Liberty  
Mod Plaid  
Rivington  
Soon  
Swank  
Totem  
Tweed Frieze

**G** continued  
All Star  
Alter Ego  
Arber  
Aurora  
Color Collage  
Dapper  
Djenne  
Duchess  
Fancy Twill  
Gibson  
Haze  
Kamani  
Looped In  
Melange  
Modern Tweed  
Spencer  
Straie Stripe  
Texnet  
Ultrasuede  
Utrillo  
Vert

**H** Bavaria  
Catwalk  
Chiseled  
Constance  
Firefly  
Stretch Appeal  
Twist Tie  
World Piece

**I** Aswan  
Bella  
Byron  
Cato  
Chic  
Diamond Days  
Doily  
Dynamic  
Floressence  
Guise  
Hastings  
In Step  
Ita  
Jaipur  
Knoll Velvet  
Limani  
North Island  
Olema  
Piper  
Prince Hairy  
Rutledge  
Stripe It  
Tudor  
Zimba

#### Spinneybeck Leather

**U** Vicenza  
Volo

**V** Acqua  
Amalfi  
Andes  
Embossed Tipped  
España  
Hand Tipped  
Velluto Pelle

**W** Alaska  
Antique  
Derby  
Forte  
Lucente  
Sabrina  
Umbria  
<sup>Ⓞ</sup> Fire Retardant Chemicals

**X** Ducale  
Ducale Velour

**Y** Cervo  
Copenhagen  
Distressed  
Gemma  
Lucca  
Marissa  
Portofino  
Riva  
Rugata  
Sassolino

Check with your KnollTextiles or Spinneybeck Representative for changes or additions.



# Maya Lin

## Stones

### Seats and Coffee Table

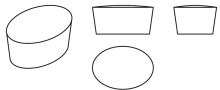
	description	w	d	h	material	textile fabric yds.	req. leather sq. ft.	weight
<i>Designer(s):</i> Maya Lin, 1998	<b>85T32M</b> Stones coffee table	32"	22½"	15"	molded polyethylene			26.5 lbs.
<i>Award(s):</i> Best of Neocon Silver Award, 1998; Good Design Award, Chicago Athenaeum, 1998; Good Design Award, 2006								
	<b>83ANCHOR</b> Stone Security Kit							



#### Order Code

<i>Example:</i>	<b>84YM-W-KHRC-K642/5</b>
<b>84YM</b>	Stones small seat
<b>W</b>	With weight
<b>KHRC</b>	Khaki
<b>K642/5</b>	Mariner, Steel

#### Specify:

1. Pattern number
2. Weight option
3. Finish option;
4. Textile selection

#### Ordering Information:

*Molded Polyethylene finish:*  
White (suffix WV)

*Molded Polyethylene finishes with 100% recycled content:*

- Blue (suffix BLRC)
- Chartreuse (CHRC)
- Khaki (suffix KHRC)
- Silver (suffix SPRC)
- Tarmac (suffix TARC)
- Warm Red (suffix WRRRC)

*Upholstery/COM information:*  
Prices shown include fabric or leather upholstery. Contact your Knoll representative for colors. Only approved KnollTextiles and Spinneybeck leathers may be ordered.

Customer's Own Material is available pending approval. For approval requirements, processing instructions and ordering information please see page 18.

#### Seats and Table:

Stones are available in molded polyethylene in virgin or recycled material. Both versions are fully finished and are enclosed on top, bottom and sides. Seat tops are slightly concave and table top is slightly convex.

#### Note:

The original Maya Lin Coffee Table (85T42) is no longer available and has been replaced by a modified version (85T32). Please note the new dimensions and weight.

#### Outdoor application note:

With proper care and limited exposure to the elements, Stones tables and seats without seat pads are suitable for outdoor use. Polyethylene stones in all colors can be used outdoors. Remove water in the concave seats to avoid permanent stains. White patina may appear on surface. During cool or inclement weather, it is recommended to bring Stones inside.

#### Seat application note:

Do not use as stepping stool.

#### Security Kit:

Security kit hooks onto latch on underside of polyethylene Stone directly into the ground for permanent applications. Due to variations in flooring, kit does not include hardware. Security kit is NOT available on coffee tables.

#### UV Testing:

Maya Lin Stones in polyethylene in all colors have passed UV testing standards including 100 hours under intense UV radiation to test for colorfastness.

#### Cal 133:

For polyethylene Maya Lin Stones in a Cal 133 finish please request through CPD. Please note, specifying the Maya Lin Stone seat pad in a Cal 133 textile does not make the polyethylene Stone Cal 133 approved.

#### Maintenance:

See pages 28-29.

#### Note:

The Maya Lin Seat and Coffee Table are certified Clean Air GOLD.

#### Construction

##### Molded Polyethylene Stones:

Polyethylene stones have integral color with a light texture and a low gloss finish, available in one color.

##### Recycled Molded Polyethylene Stones:

Recycled polyethylene stones are composed of 100% recycled polyethylene in six colors. Black specs will appear randomly on the surface of the stone. Color will vary slightly from stone to stone. Warranty claims for color variations will not be honored.

##### Weighted Polyethylene Stones:

Large and small stones in molded polyethylene can be specified with or without weight. For stones with weight, sand is added at the factory. Weight can be adjusted in the field through access on underside of the stones. There is no option for a sand kit if the Stones are ordered without weight. The coffee table can only be specified without weight.

##### Seat cushions (seats only):

Seat cushions are 2¼" thick, solid foam piece with tapered edge and fabric or leather zip-lock cover. Seat cushions are fully upholstered on top and bottom. Seat cushions are not attached to Stone.

pattern no.	unuphol.	grades	COM							COL					
		<b>A</b>	<b>B</b>	<b>C</b>	<b>D</b>	<b>E</b>	<b>F</b>	<b>G</b>	<b>H</b>	<b>I</b>	<b>U</b>	<b>V</b>	<b>W</b>	<b>X</b>	<b>Y</b>
<b>85T32M-( )</b>	\$1,590.														
<b>83ANCHOR</b>	207.														

#### Approved KnollTextiles Grades/Fabrics

**A**  
Alignment  
Beacon  
Bocce  
Chance  
Common Ground  
Commuter Cloth  
Cross Tech  
Crossroad  
Delite  
Facet  
Hourglass  
Infinite  
Mariner  
Monarch  
Overture  
Prep  
Presto  
Soliloquy  
Sonnet  
Trophy  
Uni-Form

**B**  
Abacus  
Argyle  
Attire  
Belize  
Bistro  
Boundary  
Calypso  
Chronicle  
Close Knit  
Cozy Cord  
Day Tripper  
Diva  
Dottie  
Ferry  
Forza <sup>®</sup>  
Gala II  
Grande  
Grandview  
Helios  
Holbrook  
Instinct  
Journey  
Keaton

**B** continued  
Ludlow  
Knoll Felt  
Knoll Hopsack  
Little Devil  
Melody <sup>®</sup>  
Paradigm  
Petal Pusher <sup>®</sup>  
Prairie  
Prim  
Puff  
Radiance  
Ransom  
Roam  
Rush Hour  
Shadow Play  
Spree  
Summit  
Sutton  
Synth  
Tabloid  
Tinge  
Topos  
Vast  
Venue  
Versa  
Vinyl <sup>®</sup>  
Westwood  
Wild Thing  
Yeni

**C**  
Atlas  
Axiom  
Baxter  
Cairo  
Chameleon  
Charm  
Circa  
Classic Boucle  
Contour  
Dune  
Durand  
Earthwork

**C** continued  
Empire Stripe  
Entourage  
Entwine  
Essence  
Fibra  
Greenwich  
Groovy  
Hudson  
Kaleidoscope CR  
Lagos  
Lore CR  
Magnolia  
Milestone  
Palisade  
Panache CR  
Patchwork  
Plaid On  
Pullman  
Quark  
Roundtrip  
Sahara  
Sequin CR  
Sinclair  
Smart <sup>®</sup>  
Spectator  
Stepping Stones  
Swing  
Tilden <sup>®</sup>  
Tower Grid  
Utmost II  
Utopia  
Wit  
Wow Factor  
Zari CR

**D**  
Buzz  
Code  
Coterie  
Eclat Weave  
Hologram  
Island  
Menagerie  
Origins  
Plaidtastic  
Retreat  
Vice Versa  
Woodland  
Zoom

**F**  
Atelier  
Biscayne  
Calais Cotton  
Velvet  
Century  
Cornaro

**F** continued  
Double Agent <sup>®</sup>  
Glider  
Homage  
Imprint  
In Stitches  
Jasmine  
Liberty  
Mod Plaid  
Rivington  
Soon  
Swank  
Totem  
Tweed Frieze

**G**  
All Star  
Alter Ego  
Arber  
Aurora  
Color Collage  
Dapper  
Djene  
Duchess  
Fancy Twill  
Gibson  
Haze  
Kamani  
Looped In  
Melange  
Modern Tweed  
Spencer  
Straie Stripe  
Texnet  
Ultrasuede  
Utrillo  
Vert

**H**  
Bavaria  
Catwalk  
Chiseled  
Constance  
Firefly  
Stretch Appeal  
Twist Tie  
World Piece

**I**  
Aswan  
Bella  
Byron  
Cato  
Chic  
Diamond Days  
Doily  
Dynamic  
Floressence  
Guise  
Hastings  
In Step  
Ita  
Jaipur  
Knoll Velvet  
Limani  
North Island  
Olema  
Piper  
Prince Hair  
Rutledge  
Stripe It  
Tudor  
Zimba

#### Spinneybeck Leather

**U**  
Vicenza  
Volo

**V**  
Acqua  
Amalfi  
Andes  
Embossed Tipped  
España  
Hand Tipped  
Velluto Pelle

**W**  
Alaska  
Antique  
Derby  
Forte  
Lucente  
Sabrina  
Umbria  
<sup>®</sup> Fire Retardant Chemicals

**X**  
Ducale  
Ducale Velour

**Y**  
Cervo  
Copenhagen  
Gemma  
Lucca  
Marissa  
Portofino  
Riva  
Rugata  
Sassolino

*Check with your KnollTextiles or Spinneybeck Representative for changes or additions.*

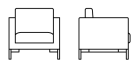
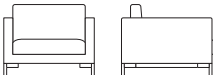
	description	seat h	arm h	w	d	h	foam type	textile fabric yds.	req. leather sq. ft.	weight
<i>Designer(s):</i> Piero Lissoni, 2001	<b>67S</b> Petite lounge chair	16 1/4"	24 1/2"	30 1/2"	31 1/4"	32 1/2"	standard	4.5	72	42 lbs.
										
	<b>67</b> Standard lounge chair	16 1/4"	24 1/4"	37"	35 1/2"	31 1/4"	standard	7.5	108	59 lbs.
		16 1/4"	24 1/4"	37"	35 1/2"	31 1/4"	dual density	7.5	108	59 lbs.

pattern no.	grades	COM								COL					
	A	B	C	D	E	F	G	H	I	U	V	W	X	Y	
<b>67S-()</b>	\$7,133.	\$7,392.	\$7,649.	\$7,921.	\$8,150.	\$8,311.	\$8,590.	\$9,112.	\$9,507.	\$11,518.	\$12,462.	\$14,381.	\$14,780.	\$15,246.	
<b>67-()</b>	8,220.	8,573.	8,907.	9,275.	9,582.	9,797.	10,173.	10,873.	11,396.	13,927.	15,201.	17,782.	18,319.	18,942.	
<b>67R-()</b>	8,630.	8,997.	9,354.	9,741.	10,062.	10,286.	10,679.	11,419.	11,965.	14,622.	15,959.	18,667.	19,235.	19,889.	

Order Code	Ordering Information	Construction
<i>Example:</i> <b>69R-K349/4</b>	<i>Upholstery/COM information:</i>	<i>Cal 133 Fire Code #:</i>
<b>69R</b> Divina sofa, dual density	Prices shown include fabric or leather upholstery. Contact your Knoll representative for colors. Only approved KnollTextiles and Spinneybeck leathers may be ordered.	The Divina Lounge collection complies with the California Technical Bulletin 133 standard if upholstered in Cal 133 approved upholstery. Specify suffix -C at end of pattern number and suffix -133 at end of textile or leather selection. For Cal 133 approval, leather units must be double upholstered: in the F187 fabric barrier and then in leather. Upcharge applies, see page 18.
<b>K349/4</b> Alignment, Paprika	Customer's Own Material is available pending approval. For approval requirements, processing instructions and ordering information please see page 21.	<i>Frame:</i> Inner frame solid wood. Exposed metal frame and legs in heavy gauge tubular steel in polished chrome finish.
<i>Example:</i> <b>68C-K349/4</b>	<i>Optional Side Cushion:</i>	<i>Feet:</i>
<b>68C</b> Divina side cushion	One or two cushions can be specified for the standard lounge chair, settee and sofa. Side cushion is composed of polyurethane with polyester wrap. Since cushion is not fitted, it is available in fabric only.	Chrome-plated feet with polyurethane glides measuring 5.75" high.
<b>K349/4</b> Alignment, Paprika		<i>Standard Cushions:</i> Seat cushion in polyurethane with polyester fiber wrap. Back cushion in polyurethane. Cushions are not reversible.
<i>Specify:</i>		<i>Dual Density Cushions:</i> Back cushion is polyurethane. Seat cushion is dual density foam: a soft foam core with a memory topper. Cushions are not reversible.
1. Pattern number		<i>Upholstery:</i> Double-needled stitching on leather upholstery. Double-needled stitching on thin solid textiles, single-needled stitching on heavily ribbed fabrics and multicolor prints.
2. R for dual density cushions		
3. Textile selection		
<i>Side cushion, specify:</i>		
1. Pattern number		
2. Textile selection		

Approved KnollTextiles Grades/Fabrics	Spinneybeck Leather
<b>A</b> Alignment Beacon Bocce Chance Common Ground Commuter Cloth Cross Tech Crossroad Delite Facet Hourglass Infinite Mariner Monarch Overture Prep Presto Sonnet Trophy Uni-Form	<b>U</b> Vicenza Volo <b>V</b> Acqua Amalfi Andes Embossed Tipped España Hand Tipped Velluto Pelle <b>W</b> Alaska Antique Derby Forte Lucente Sabrina Umbria
<b>B</b> Abacus Argyle Belize Bistro Calypso Chronicle Cozy Cord Day Tripper Diva Dottie Ferry Instinct Gala II	<b>X</b> Ducale Ducale Velour <b>Y</b> Cascia Cervo Copenhagen Distressed Marissa Riva Rugata Saddle
<b>B</b> continued Grandview Helios Holbrook Journey Keaton Knoll Felt Knoll Hopsack Little Devil Ludlow Melody <sup>®</sup> Paradigm Petal Pusher <sup>®</sup> Prairie Prim Radiance Ransom Roam Rush Hour Spree Summit Sutton Synth Tabloid Tinge Topos Vast Venue Versa Vinyl <sup>®</sup> Westwood Wild Thing	<b>G</b> All Star Alter Ego Aurora Dapper Djenne Fancy Twill Haze Looped In Melange Modern Tweed Spencer Texnet Ultrasuede Vert <b>H</b> Chiseled Constance Firefly Hastings Stretch Appeal <b>I</b> Bella Byron Cato Chic Diamond Days Doily Dynamic Guise Florescence In Step Knoll Velvet Olema Piper Prince Hairy Rutledge Sandis Tudor Zimba
<b>C</b> Atlas Axiom <sup>®</sup> Cairo Chameleon Charm Circa Classic Boucle Contour Durand Earthwork Empire Stripe Entourage Entwine Essence Fibra Greenwich Groovy Hudson Kaleidoscope CR Lagos Lore CR Milestone On Point Palisade Panache CR Patchwork Plaid On Prestini Pullman	<b>E</b> Aegean Circle Point Currents Demure Flower Power Highland Ikatt Stripe Kampala Mamba Marquee Meroe Nature Walk Off The Grid Rebel Shima Tempest Tryst Whip <b>F</b> Atelier Biscayne Calais Cotton Velvet Century Cornaro Double Agent <sup>®</sup> Homage Imprint In Stitches Liberty Mod Plaid Rivington Soon Swank Totem
<b>C</b> continued Quark Roundtrip Sabara Sequin CR Stepping Stones Swing Tight Rope Tilden <sup>®</sup> Tower Grid Utmost II Utopia Wit Zari CR	<b>D</b> Buzz Coterie Eclat Weave Hologram Island Kabuki Menagerie Origins Pathway Retreat Vice Versa Woodland Zoom

# Piero Lissoni Divina® Lounge Seating

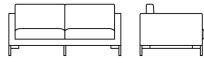
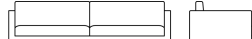
	description	seat h	arm h	w	d	h	foam type	textile fabric yds.	req. leather sq. ft.	weight
<i>Designer(s):</i> Piero Lissoni, 2001	<b>68</b> Settee 	16 1/4"	24 1/4"	66"	35 1/2"	31 1/4"	standard	11.3	163	83 lbs.
		16 1/4"	24 1/4"	66"	35 1/2"	31 1/4"	dual density	11.3	163	83 lbs.
	<b>69</b> Sofa 	16 1/4"	24 1/4"	91"	35 1/2"	31 1/4"	standard	13.3	192	130 lbs.
		16 1/4"	24 1/4"	91"	35 1/2"	31 1/4"	dual density	13.3	192	130 lbs.



pattern no.	grades <b>A</b>	COM <b>B</b>	<b>C</b>	<b>D</b>	<b>E</b>	<b>F</b>	<b>G</b>	<b>H</b>	<b>I</b>	COL <b>U</b>	<b>V</b>	<b>W</b>	<b>X</b>	<b>Y</b>
<b>68- ( )</b>	\$12,459.	\$12,998.	\$13,517.	\$14,087.	\$14,548.	\$14,884.	\$15,460.	\$16,539.	\$17,338.	\$21,257.	\$23,206.	\$27,180.	\$28,006.	\$28,967.
<b>68R- ( )</b>	13,080.	13,649.	14,193.	14,790.	15,275.	15,630.	16,233.	17,369.	18,207.	22,318.	24,368.	28,538.	29,409.	30,417.
<b>69- ( )</b>	14,091.	14,796.	15,466.	16,200.	16,801.	17,235.	17,966.	19,368.	20,406.	26,992.	29,513.	34,628.	35,700.	36,939.
<b>69R- ( )</b>	14,796.	15,535.	16,237.	17,011.	17,640.	18,095.	18,867.	20,334.	21,423.	28,339.	30,984.	36,360.	37,483.	38,788.

Order Code	Ordering Information	Construction
<i>Example:</i> <b>69R-K349/4</b>	<i>Upholstery/COM information:</i> Prices shown include fabric or leather upholstery. Contact your Knoll representative for colors. Only approved KnollTextiles and Spinneybeck leathers may be ordered. Customer's Own Material is available pending approval. For approval requirements, processing instructions and ordering information please see page 21.	<i>Cal 133 Fire Code #:</i> The Divina Lounge collection complies with the California Technical Bulletin 133 standard if upholstered in Cal 133 approved upholstery. Specify suffix -C at end of pattern number and suffix -133 at end of textile or leather selection. For Cal 133 approval, leather units must be double upholstered: in the F187 fabric barrier and then in leather. Upcharge applies, see page 18.
<b>69R</b> Divina sofa, dual density		
<b>K349/4</b> Alignment, Paprika		
<i>Example:</i> <b>68C-K349/4</b>	<i>Optional Side Cushion:</i> One or two cushions can be specified for the standard lounge chair, settee and sofa. Side cushion is composed of polyurethane with polyester wrap. Since cushion is not fitted, it is available in fabric only.	<i>Frame:</i> Inner frame solid wood. Exposed metal frame and legs in heavy gauge tubular steel in polished chrome finish.  <i>Feet:</i> Chrome-plated feet with polyurethane glides measuring 5.75" high.  <i>Standard Cushions:</i> Seat cushion in polyurethane with polyester fiber wrap. Back cushion in polyurethane. Cushions are not reversible.  <i>Dual Density Cushions:</i> Back cushion is polyurethane. Seat cushion is dual density foam: a soft foam core with a memory topper. Cushions are not reversible.  <i>Upholstery:</i> Double-needled stitching on leather upholstery. Double-needled stitching on thin solid textiles, single-needled stitching on heavily ribbed fabrics and multicolor prints.
<b>68C</b> Divina side cushion		
<b>K349/4</b> Alignment, Paprika		
<i>Specify:</i> 1. Pattern number 2. R for dual density cushions 3. Textile selection		
<i>Side cushion, specify:</i> 1. Pattern number 2. Textile selection		
	<i>Maintenance:</i> See pages 28-29.	
	<i>Note:</i> The Divina Lounge Collection is certified Clean Air GOLD.	

Approved KnollTextiles Grades/Fabrics				Spinneybeck Leather										
<b>A</b> Alignment Beacon Bocce Chance Common Ground Commuter Cloth Cross Tech Crossroad Delite Facet Hourglass Infinite Mariner Monarch Overture Prep Presto Sonnet Trophy Uni-Form	<b>B</b> continued Grandview Helios Holbrook Journey Keaton Knoll Felt Knoll Hopsack Little Devil Ludlow Melody <sup>®</sup> Paradigm Petal Pusher <sup>®</sup> Prairie Prim Radiance Ransom Roam Rush Hour Spree Summit Sutton Synth Tabloid Tinge Topos Vast Venue Versa Vinyl <sup>®</sup> Westwood Wild Thing	<b>C</b> Atlas Axiom <sup>®</sup> Cairo Chameleon Charm Circa Classic Boucle Contour Durand Earthwork Empire Stripe Entourage Entwine Essence Fibra Greenwich Groovy Hudson Kaleidoscope CR Lagos Lore CR Milestone On Point Palisade Panache CR Patchwork Plaid On Prestini Pullman	<b>C</b> continued Quark Roundtrip Sahara Sequin CR Stepping Stones Swing Tight Rope Tilden <sup>®</sup> Tower Grid Utmost II Utopia Wit Zari CR	<b>D</b> Buzz Coterie Eclat Weave Hologram Island Kabuki Menagerie Origins Pathway Retreat Vice Versa Woodland Zoom	<b>E</b> Aegean Circle Point Currents Demure Flower Power Highland Ikat Stripe Kampala Mamba Marquee Meroe Nature Walk Off The Grid Rebel Shima Tempest Tryst Whip	<b>F</b> Atelier Biscayne Calais Cotton Velvet Century Cornaro Double Agent <sup>®</sup> Homage Imprint In Stitches Liberty Mod Plaid Rivington Soon Swank Totem	<b>G</b> All Star Alter Ego Aurora Dapper Djenne Fancy Twill Haze Looped In Melange Modern Tweed Spencer Texnet Ultrasuede Vert	<b>H</b> Chiseled Constance Firefly Hastings Stretch Appeal	<b>I</b> Bella Byron Cato Chic Diamond Days Doily Dynamic Guise Florescence In Step Knoll Velvet Olema Piper Prince Hairly Rutledge Sandis Tudor Zimba	<b>U</b> Vicenza Volo	<b>V</b> Acqua Amalfi Andes Embossed Tipped España Hand Tipped Velluto Pelle	<b>W</b> Alaska Antique Derby Forte Lucente Sabrina Umbria	<b>X</b> Ducale Ducale Velour	<b>Y</b> Cascia Cervo Copenhagen Distressed Marissa Riva Rugata Saddle
									<b>®</b> Fire Retardant Chemicals					
														<i>Check with your KnollTextiles or Spinneybeck Representative for changes or additions.</i>

# Piero Lissoni







## Divina® Lounge Seating

	description	seat h	arm h	w	d	h	foam type	textile fabric yds.	req. leather sq. ft.	weight
<i>Designer(s):</i> Piero Lissoni, 2001	<b>68C</b> Optional side cushion for standard chair, settee and sofa			21"	2 1/2"	13 1/4"	standard	1	n/a	5 lbs.
										
	<b>73</b> Ottoman			29 1/2"	29 1/2"	16"	standard	4.1	43	27 lbs.
				29 1/2"	29 1/2"	16"	dual density	4.1	43	27 lbs.

pattern no.	grades <b>A</b>	COM <b>B</b>	<b>C</b>	<b>D</b>	<b>E</b>	<b>F</b>	<b>G</b>	<b>H</b>	<b>I</b>	COL <b>U</b>	<b>V</b>	<b>W</b>	<b>X</b>	<b>Y</b>
<b>68C-( )</b>	\$855.	\$904.	\$951.	\$1,002.	\$1,044.	\$1,078.	\$1,127.	\$1,230.	\$1,299.	\$1,533.	\$1,710.	\$2,075.	\$2,147.	\$2,237.
<b>73-( )</b>	4,256.	4,440.	4,612.	4,802.	4,957.	5,073.	5,265.	5,627.	5,690.	5,902.	6,071.	6,847.	7,009.	7,195.
<b>73R-( )</b>	4,468.	4,660.	4,843.	5,045.	5,202.	5,330.	5,528.	5,910.	5,976.	6,193.	6,377.	7,191.	7,358.	7,558.

Order Code	Ordering Information	Construction
<i>Example:</i> <b>69R-K349/4</b>	<i>Upholstery/COM information:</i> Prices shown include fabric or leather upholstery. Contact your Knoll representative for colors. Only approved KnollTextiles and Spinneybeck leathers may be ordered.	<i>Cal 133 Fire Code #:</i> The Divina Lounge collection complies with the California Technical Bulletin 133 standard if upholstered in Cal 133 approved upholstery. Specify suffix -C at end of pattern number and suffix -133 at end of textile or leather selection. For Cal 133 approval, leather units must be double upholstered: in the F187 fabric barrier and then in leather. Upcharge applies, see page 18.
<b>69R</b> Divina sofa, dual density		<i>Frame:</i> Inner frame solid wood. Exposed metal frame and legs in heavy gauge tubular steel in polished chrome finish.
<b>K349/4</b> Alignment, Paprika		<i>Feet:</i> Chrome-plated feet with polyurethane glides measuring 5.75" high.
<i>Example:</i> <b>68C-K349/4</b>	<i>Customer's Own Material is available pending approval. For approval requirements, processing instructions and ordering information please see page 21.</i>	<i>Standard Cushions:</i> Seat cushion in polyurethane with polyester fiber wrap. Back cushion in polyurethane. Cushions are not reversible.
<b>68C</b> Divina side cushion		<i>Dual Density Cushions:</i> Back cushion is polyurethane. Seat cushion is dual density foam: a soft foam core with a memory topper. Cushions are not reversible.
<b>K349/4</b> Alignment, Paprika	<i>Optional Side Cushion:</i> One or two cushions can be specified for the standard lounge chair, settee and sofa. Side cushion is composed of polyurethane with polyester wrap. Since cushion is not fitted, it is available in fabric only.	<i>Upholstery:</i> Double-needled stitching on leather upholstery. Double-needled stitching on thin solid textiles, single-needled stitching on heavily ribbed fabrics and multicolor prints.
<i>Specify:</i>		
1. Pattern number		
2. R for dual density cushions		
3. Textile selection		
<i>Side cushion, specify:</i>		
1. Pattern number		
2. Textile selection		
	<i>Maintenance:</i> See pages 28-29.	
	<i>Note:</i> The Divina Lounge Collection is certified Clean Air GOLD.	

Approved KnollTextiles Grades/Fabrics	Spinneybeck Leather
<b>A</b> Alignment Beacon Bocce Chance Common Ground Commuter Cloth Cross Tech Crossroad Delite Facet Hourglass Infinite Mariner Monarch Overture Prep Presto Sonnet Trophy Uni-Form	<b>U</b> Vicenza Volo
<b>B</b> continued Grandview Helios Holbrook Journey Keaton Knoll Felt Knoll Hopsack Little Devil Ludlow Melody <sup>®</sup> Paradigm Petal Pusher <sup>®</sup> Prairie Prim Radiance Ransom Roam Rush Hour Spree Summit Sutton Synth Tabloid Tinge Topos Vast Venue Versa Vinyl <sup>®</sup> Westwood Wild Thing	<b>V</b> Acqua Amalfi Andes Embossed Tipped España Hand Tipped Velluto Pelle
<b>C</b> Atlas Axiom <sup>®</sup> Cairo Chameleon Charm Circa Classic Boucle Contour Durand Earthwork Empire Stripe Entourage Entwine Essence Fibra Greenwich Groovy Hudson Kaleidoscope CR Lagos Lore CR Milestone On Point Palisade Panache CR Patchwork Plaid On Prestini Pullman	<b>X</b> Ducale Ducale Velour
<b>C</b> continued Quark Roundtrip Sabara Sequin CR Stepping Stones Swing Tight Rope Tilden <sup>®</sup> Tower Grid Utmost II Utopia Wit Zari CR	<b>Y</b> Cascia Cervo Copenhagen Distressed Marissa Riva Rugata Saddle
<b>E</b> Aegean Circle Point Currents Demure Flower Power Highland Ikatt Stripe Kampala Mamba Marquee Meroe Nature Walk Off The Grid Rebel Shima Tempest Tryst Whip	<b>W</b> Alaska Antique Derby Forte Lucente Sabrina Umbria
<b>G</b> All Star Alter Ego Aurora Dapper Djenne Fancy Twill Haze Looped In Melange Modern Tweed Spencer Texnet Ultrasuede Vert	<b>®</b> Fire Retardant Chemicals
<b>H</b> Chiseled Constance Firefly Hastings Stretch Appeal	<i>Check with your KnollTextiles or Spinneybeck Representative for changes or additions.</i>
<b>F</b> Atelier Biscayne Calais Cotton Velvet Century Cornaro Double Agent <sup>®</sup> Homage Imprint In Stitches Liberty Mod Plaid Rivington Soon Swank Totem	<b>I</b> Bella Byron Cato Chic Diamond Days Doily Dynamic Guisse Florescence In Step Knoll Velvet Olema Piper Prince Hair Rutledge Sandis Tudor Zimba

	description	seat h	w	d	h	textile fabric yds.	req. leather sq. ft.
<p><i>Designer(s):</i> Piero Lissoni, 2018</p>   	<p><b>KN01</b> Swivel Lounge Chair</p> 	15"	41 1/4"	31 1/2"	29 1/2"	3	60
	<p><b>KN02</b> Swivel and Reclining High Back Chair</p> 	15"	37 3/8"	31 1/2"	39 3/8"	4	90
	<p><b>KN03</b> Ottoman</p> 		28 1/4"	23 3/8"	16 1/2"	1	25

pattern no.	grades	COM								COL				
	A	B	C	D	E	F	G	H	I	U	V	W	X	Y
<b>KN01-(AP,CH)-()</b>	\$4,757.	\$4,904.	\$5,038.	\$5,066.	\$5,119.	\$5,298.	\$5,690.	\$5,855.	\$6,250.	\$6,675.	\$7,618.	\$8,292.	\$8,603.	\$8,912.
<b>KN02-(AP,CH)-()</b>	7,195.	7,391.	7,570.	7,607.	7,679.	7,916.	8,439.	8,658.	9,183.	10,010.	11,428.	12,438.	12,903.	13,368.
<b>KN03-(AP,CH)-()</b>	2,143.	2,193.	2,236.	2,247.	2,265.	2,323.	2,454.	2,509.	2,640.	2,978.	3,370.	3,653.	3,781.	3,911.

Order Code	Ordering Information	Construction
<p><i>Example:</i> <b>KN01-AP-H800/44</b></p> <p><b>KN01</b> KN Swivel Lounge Chair</p> <p><b>AP</b> Polished Aluminum</p> <p><b>H800/44</b> Cato, Gray</p>	<p><i>Base finish:</i> Polished Aluminum (suffix AP) Charcoal (suffix CH)</p> <p><i>Upholstery/COM information:</i> Prices shown include fabric or leather upholstery. Contact your Knoll representative for colors. Only approved KnollTextiles and Spinneybeck leathers may be ordered.</p> <p>Customer's Own Material is available pending approval. For approval requirements, processing instructions and ordering information please see page 21.</p> <p><i>Maintenance:</i> See pages 28-29.</p>	<p><i>Frame:</i> Swivel base in polished or coated cast aluminium. Shell is molded reinforced polyurethane foam. All pieces in the collection feature a return to center mechanism, which allows for 360° swivel movement and returns to a center position when not engaged. The base in KN01 and KN02 is equipped with comfort suspension, a feature that enhances comfort and makes getting in and out easy by lowering slightly when sitting down. KN02 also comes with a headrest and integrates a practical manual mechanism built into the armrest that enables the chair to recline and to lock the back in any position. An embroidered circle underneath the right arm allows the user to operate the reclining mechanism.</p> <p><i>Upholstery:</i> Available in a selection of fabrics and leathers. The KN02 model includes a seat cushion padded with down, and an attached lumbar pillow for lower back support.</p>

*Specify:*

1. Pattern number
2. Frame finish selection
3. Textile/leather selection



Approved KnollTextiles Grades/Fabrics			Spinneybeck Leather	
<p><b>A</b> Common Ground Commuter Cloth Crossroad Delite Facet Mariner Sonnet Trophy Uni-Form</p> <p><b>B</b> Attire Diva Ferry Helios Knoll Hopsack * Knoll Felt Little Devil Puff * * Ransom Summit Topos</p> <p><b>C</b> Circa Classic Boucle * Entwine Pullman Swing Utmost II Utopia</p>	<p><b>D</b> Pathway Woodland</p> <p><b>E</b> Aegean Highland Tempest</p> <p><b>F</b> Atelier Rivington</p> <p><b>G</b> Alter Ego Dapper Fancy Twill Haze Melange Modern Tweed Spencer Ultrasuede</p>	<p><b>H</b> Bella Cato Chic Doily * * Dynamic Floressence Limani North Island</p>	<p><b>U</b> Volo</p> <p><b>V</b> Acqua Amalfi Andes España Velluto Pelle</p> <p><b>W</b> Alaska Antique Derby Forte Sabrina</p>	<p><b>X</b> Ducale Velour</p> <p><b>Y</b> Cervo Copenhagen Marissa Lucca Riva</p>

\* Not approved for KN01  
\*\* Not approved for KN04

*Check with your KnollTextiles or Spinneybeck Representative for changes or additions.*

Designer(s):  
Piero Lissoni, 2018



description	seat h	w	d	h	textile fabric yds.	req. leather sq. ft.
<b>KN04T</b> Lounge Chair with tubular legs 	14 1/2"	35"	26 1/4"	27"	3.5	55
	14 1/2"	35"	26 1/4"	27"	3.5	55
<b>KN05T</b> Settee with tubular legs 	14 1/2"	58 3/4"	28"	27"	5	80
	14 1/2"	58 3/4"	28"	27"	5	80

pattern no.	grades <b>A</b>	COM <b>B</b>	<b>C</b>	<b>D</b>	<b>E</b>	<b>F</b>	<b>G</b>	<b>H</b>	<b>I</b>	COL <b>U</b>	<b>V</b>	<b>W</b>	<b>X</b>	<b>Y</b>
<b>KN04T-(C)-( )</b>	\$3,599.	\$3,726.	\$3,864.	\$3,979.	\$4,071.	\$4,224.	\$4,307.	\$4,416.	\$4,778.	\$5,286.	\$5,973.	\$6,861.	\$7,110.	\$7,355.
<b>KN04T-(CH, 1)-( )</b>	3,580.	3,707.	3,845.	3,958.	4,052.	4,204.	4,287.	4,396.	4,759.	5,265.	5,954.	6,842.	7,091.	7,336.
<b>KN05T-(C)-( )</b>	6,260.	6,453.	6,664.	6,836.	6,977.	7,213.	7,338.	7,504.	8,059.	8,748.	9,748.	11,042.	11,402.	11,759.
<b>KN05T-(CH, 1)-( )</b>	5,485.	5,677.	5,889.	6,062.	6,204.	6,438.	6,565.	6,731.	7,284.	7,962.	8,962.	10,256.	10,618.	10,973.

**Order Code**

<i>Example:</i> <b>KN04T-H800/44</b>
<b>KN04T</b> KN Lounge Chair, tubular legs
<b>C</b> Chrome
<b>H800/44</b> Cato, Gray

*Specify:*

1. Pattern number
2. Frame finish selection
3. Textile/leather selection

**Ordering Information**

*Base finish:*  
Chrome (suffix C)  
Charcoal (suffix CH)  
Black (suffix 1)

*Upholstery/COM information:*  
Prices shown include fabric or leather upholstery. Contact your Knoll representative for colors. Only approved KnollTextiles and Spinneybeck leathers may be ordered.

Customer's Own Material is available pending approval. For approval requirements, processing instructions and ordering information please see page 21.

*Maintenance:*  
See pages 28-29.

**Construction**

*Frame:*  
Urethane molded foam glued over welded steel frame with elastic belts.

*Upholstery:*  
Foam over molded, reinforced fiberglass shell. Available in a selection of fabrics and leathers.

*Glides:*  
Non height adjustable glides in matching frame finish. Felt pad glued to underside of glide.

**Approved KnollTextiles Grades/Fabrics**

<b>A</b> Common Ground Commuter Cloth Crossroad Delite Facet Mariner Sonnet Trophy Uni-Form	<b>D</b> Pathway Woodland	<b>H</b> <b>I</b> Bella Cato Chic Doily * * Dynamic Floressence Limani North Island
<b>B</b> Attire Diva Ferry Helios Knoll Hopsack * Knoll Felt Little Devil Puff * * Ransom Summit Topos	<b>F</b> Atelier Rivington	<b>G</b> Alter Ego Dapper Fancy Twill Haze Melange Modern Tweed Spencer Ultrasuede
<b>C</b> Circa Classic Boucle * Contour Entwine Prestini Pullman Swing Utmost II Utopia		

**Spinneybeck Leather**

<b>U</b> Volo	<b>X</b> Ducale Velour
<b>V</b> Acqua Amalfi * Andes España Velluto Pelle	<b>Y</b> Cervo Copenhagen Marissa Lucca Riva
<b>W</b> Alaska Antique Derby Forte Sabrina	

\* Not approved for KN01 and KN05  
\*\* Not approved for KN04

Check with your KnollTextiles or Spinneybeck Representative for changes or additions.

description	seat h	w	d	h	textile fabric yds.	req. leather sq. ft.
<b>KN04W</b> Lounge Chair with wood legs	14 1/2"	35"	26 1/4"	27"	3.5	55

Designer(s):  
Piero Lissoni, 2018



pattern no.	grades <b>A</b>	COM <b>B</b>	<b>C</b>	<b>D</b>	<b>E</b>	<b>F</b>	<b>G</b>	<b>H</b>	<b>I</b>	COL <b>U</b>	<b>V</b>	<b>W</b>	<b>X</b>	<b>Y</b>
<b>KN04W-( )-( )</b>	\$4,323.	\$4,449.	\$4,588.	\$4,702.	\$4,794.	\$4,949.	\$5,032.	\$5,140.	\$5,503.	\$6,010.	\$6,696.	\$7,586.	\$7,835.	\$8,079.

**Order Code      Ordering Information      Construction**

*Example:* **KN04W-VW-H800/44**

<b>KN04W</b>	KN Lounge Chair, wood legs
<b>VW</b>	Walnut on Oak
<b>H800/44</b>	Cato, Gray

**Base finish:**  
Natural Oak (suffix VO)  
Ebonized Oak (suffix VE)  
Walnut on Oak (suffix VW)

**Frame:**  
Urethane molded foam glued over welded steel frame with elastic belts and stained oak legs over metal leg frame.

- Specify:*
1. Pattern number
  2. Frame finish selection
  3. Textile/leather selection

**Upholstery/COM information:**  
Prices shown include fabric or leather upholstery. Contact your Knoll representative for colors. Only approved KnollTextiles and Spinneybeck leathers may be ordered.

**Upholstery:**  
Foam over molded, reinforced fiberglass shell. Available in a selection of fabrics and leathers.

**Glides:**  
Non height adjustable glides. Felt pad glued to underside of glide.

Customer's Own Material is available pending approval. For approval requirements, processing instructions and ordering information please see page 21.

**Maintenance:**  
See pages 28-29.

**Approved KnollTextiles Grades/Fabrics**

<b>A</b> Common Ground Commuter Cloth Crossroad Delite Facet Mariner Sonnet Trophy Uni-Form	<b>D</b> Pathway Woodland	<b>H</b> <b>I</b> Bella Cato Chic Doily * * Dynamic Floressence Limani North Island
<b>B</b> Attire Diva Ferry Helios Knoll Hopsack * Knoll Felt Little Devil Puff * * Ransom Summit Topos	<b>E</b> Aegean Currents Highland Tempest	<b>F</b> Atelier Rivington
<b>C</b> Circa Classic Boucle * Contour Entwine Prestini Pullman Swing Utmost II Utopia	<b>G</b> Alter Ego Dapper Fancy Twill Haze Melange Modern Tweed Spencer Ultrasuede	

**Spinneybeck Leather**





<b>U</b> Volo	<b>X</b> Ducale Velour
<b>V</b> Acqua Amalfi Andes España Velluto Pelle	<b>Y</b> Cervo Copenhagen Marissa Lucca Riva
<b>W</b> Alaska Antique Derby Forte Sabrina	

\* Not approved for KN01  
\*\* Not approved for KN04

Check with your KnollTextiles or Spinneybeck Representative for changes or additions.

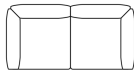
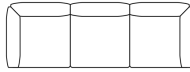
Designer(s):  
Piero Lissoni, 2018



description	w	d	h	weight	textile fabric yds.	req. leather sq. ft.	base
<b>AVC02</b> Two-seat sofa 	67"	33 1/2"	28 1/8"	212 lbs.	10	200	chrome
	67"	33 1/2"	28 1/8"	212 lbs.	10	200	silver or black
<b>AVC03</b> Three-seat sofa 	97 1/4"	33 1/2"	28 1/8"	304 lbs.	13.3	270	chrome
	97 1/4"	33 1/2"	28 1/8"	304 lbs.	13.3	270	silver or black
<b>AVC04</b> Four-seat sofa 	127 3/8"	33 1/2"	28 1/8"	397 lbs.	16.6	340	chrome
	127 3/8"	33 1/2"	28 1/8"	397 lbs.	16.6	340	silver or black
<b>AVCB2</b> Two-seat bench 	61 1/2"	31 1/8"	17 1/8"	159 lbs.	2	100	chrome
	61 1/2"	31 1/8"	17 1/8"	159 lbs.	2	100	silver or black
<b>AVCB3</b> Three-seat bench 	91 1/4"	31 1/8"	17 1/8"	238 lbs.	2	150	chrome
	91 1/4"	31 1/8"	17 1/8"	238 lbs.	2	150	silver or black

Order Code	Ordering Information	Construction
<i>Example:</i> <b>AVC02-S-K2074/2</b>	<i>Base Finish:</i> Silver paint (suffix S) Polished Chrome (suffix C) Black Paint (suffix 1)	<i>Frame:</i> Seats are suspended on a central beam structure made in heavy gauge tubular steel. These beams are interconnected to obtain several configurations and are attached to the legs. Each seat is attached to the metal structure through an individual frame.
<b>AVC02</b> Avio Two-Seat Sofa		
<b>S</b> Silver paint		
<b>K2074/2</b> Aegean, Lemon		
<i>Specify:</i> 1. Pattern number 2. Base finish selection 3. Textile/leather selection	<i>Upholstery/COM Information:</i> Prices shown include fabric or leather upholstery. Contact your Knoll representative for colors. Only approved KnollTextiles and Spinneybeck leather may be ordered.  Customer's Own Material is available pending approval. For approval requirements, processing instructions and ordering information please see page 18.  <i>Maintenance:</i> See pages 28-29.	<i>Upholstery:</i> Seat and back cushions with variable density foam covered with polyester fiberfills to enhance comfort. Slip covers are completely removable.

pattern no.	grades A	COM B	C	D	E	F	G	H	I	COL U	V	W	X	Y
<b>AVC02-C-( )</b>	\$15,839.	\$16,348.	\$16,813.	\$16,908.	\$17,096.	\$17,708.	\$19,075.	\$19,643.	\$21,004.	\$22,582.	\$25,856.	\$28,191.	\$29,266.	\$30,341.
<b>AVC02-(S,1)-( )</b>	15,270.	15,779.	16,244.	16,339.	16,526.	17,139.	18,506.	19,074.	20,436.	22,021.	25,293.	27,631.	28,705.	29,779.
<b>AVC03-C-( )</b>	22,055.	22,730.	23,348.	23,476.	23,724.	24,541.	26,359.	27,114.	28,924.	31,256.	35,675.	38,830.	40,280.	41,731.
<b>AVC03-(S,1)-( )</b>	21,235.	21,910.	22,528.	22,656.	22,906.	23,722.	25,539.	26,295.	28,104.	30,422.	34,840.	37,997.	39,447.	40,897.
<b>AVC04-C-( )</b>	28,260.	29,105.	29,876.	30,035.	30,347.	31,364.	33,632.	34,576.	36,837.	39,916.	45,478.	49,455.	51,279.	53,104.
<b>AVC04-(S,1)-( )</b>	27,199.	28,042.	28,813.	28,973.	29,284.	30,302.	32,572.	33,514.	35,774.	38,838.	44,402.	48,376.	50,201.	52,029.
<b>AVCB2-C-( )</b>	8,030.	8,133.	8,225.	8,245.	8,282.	8,406.	8,680.	8,791.	9,065.	8,893.	9,303.	9,596.	9,730.	9,863.
<b>AVCB2-(S,1)-( )</b>	7,411.	7,513.	7,606.	7,628.	7,664.	7,787.	8,061.	8,172.	8,446.	8,277.	8,686.	8,978.	9,112.	9,247.
<b>AVCB3-C-( )</b>	11,863.	11,963.	12,056.	12,075.	12,111.	12,236.	12,508.	12,623.	12,895.	12,859.	13,268.	13,559.	13,694.	13,829.
<b>AVCB3-(S,1)-( )</b>	11,243.	11,344.	11,438.	11,457.	11,494.	11,617.	11,891.	12,003.	12,277.	12,546.	12,955.	13,247.	13,382.	13,517.

Approved KnollTextiles Grades/Fabrics				Spinneybeck Leather	
<b>A</b> Common Ground Commuter Cloth Crossroad Delite Facet Hourglass Mariner Oh La La Presto Soliloquy Sonnet Trophy Uni-Form	<b>B</b> continued Keaton Knoll Felt Knoll Hopsack Little Devil Prairie Puff Ransom Shadow Play Summit Sutton Synth Venue Westwood	<b>D</b> Buzz Cavalier Pathway Retreat Vice Versa Woodland	<b>E</b> Aegean Circle Point Highland Off The Grid Seurat Tempest	<b>G</b> Alter Ego Dapper Fancy Twill Haze Kingston Looped In Melange Modern Tweed Rivers Spencer Texnet Ultrasuede	<b>H</b> Bella Cato Chic Doily Dynamic Florescence In Step Knoll Velvet Limani North Island Stripe It
<b>B</b> Attire Boundary Diva Ferry Helios Journey	<b>C</b> Circa Classic Boucle Entwine Plaid On Pullman Swing Utmost II Utopia Wow Factor	<b>F</b> Atelier Calais Cotton Velvet Cornaro Rivington Tweed Frieze	<b>I</b> Bella Cato Chic Doily Dynamic Florescence In Step Knoll Velvet Limani North Island Stripe It	<b>U</b> Volo	<b>X</b> Ducale Velour
				<b>V</b> Acqua Amalfi Andes España Velluto Pelle	<b>Y</b> Cervo Copenhagen Lucca Marissa Riva
				<b>W</b> Alaska Antique Forte Sabrina	<b>©</b> Fire Retardant Chemicals
				<i>Check with your KnollTextiles or Spinneybeck Representative for changes or additions.</i>	



Piero Lissoni  
Avio™ Sofa Collection

Designer(s):  
Piero Lissoni, 2018



description	w	d	h	weight	textile fabric yds.	req. leather sq. ft.	base
<b>AVC33</b> Three-seat sofa, righthand ottoman return	97 1/4"	64 1/2"	28 1/8"	384 lbs.	15.5	310	chrome
	97 1/4"	64 1/2"	28 1/8"	384 lbs.	15.5	310	silver or black

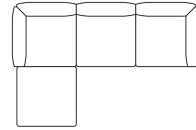

<b>AVC34</b> Three-seat sofa, lefthand ottoman return	97 1/4"	64 1/2"	28 1/8"	384 lbs.	15.5	310	chrome
	97 1/4"	64 1/2"	28 1/8"	384 lbs.	15.5	310	silver or black

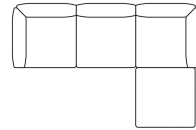

pattern no.	grades A	COM B	C	D	E	F	G	H	I	COL U	V	W	X	Y
<b>AVC33-C-(-)-(-)</b>	\$26,754.	\$27,540.	\$28,260.	\$28,409.	\$28,701.	\$29,651.	\$31,769.	\$32,650.	\$34,763.	\$37,426.	\$42,501.	\$46,124.	\$47,789.	\$49,455.
<b>AVC33-(S,1)-(-)-(-)</b>	25,639.	26,426.	27,146.	27,294.	27,585.	28,536.	30,654.	31,535.	33,644.	36,298.	41,370.	44,994.	46,659.	48,324.

<b>AVC34-C-(-)-(-)</b>	26,754.	27,540.	28,260.	28,409.	28,701.	29,651.	31,769.	32,650.	34,763.	37,426.	42,501.	46,124.	47,789.	49,455.
<b>AVC34-(S,1)-(-)-(-)</b>	25,639.	26,426.	27,146.	27,294.	27,585.	28,536.	30,654.	31,535.	33,644.	36,298.	41,370.	44,994.	46,659.	48,324.

Order Code	Ordering Information	Construction
<i>Example:</i> <b>AVC33-S-K2074/2</b>	<i>Base Finish:</i> Silver paint (suffix S) Polished Chrome (suffix C) Black Paint (suffix 1)	<i>Frame:</i> Seats are suspended on a central beam structure made in heavy gauge tubular steel. These beams are interconnected to obtain several configurations and are attached to the legs. Each seat is attached to the metal structure through an individual frame.
<b>AVC33</b> Avio three-seat sofa, righthand ottoman return	<i>Upholstery/COM Information:</i> Prices shown include fabric or leather upholstery. Contact your Knoll representative for colors. Only approved KnollTextiles and Spinneybeck leather may be ordered.	<i>Upholstery:</i> Seat and back cushions with variable density foam covered with polyester fiberfills to enhance comfort. Slip covers are completely removable.
<b>S</b> Silver paint	Customer's Own Material is available pending approval. For approval requirements, processing instructions and ordering information please see page 18.	
<b>K2074/2</b> Aegean, Lemon	<i>Maintenance:</i> See pages 28-29.	

Specify:

1. Pattern number
2. Base finish selection
3. Textile/leather selection

Approved KnollTextiles Grades/Fabrics				Spinneybeck Leather	
<b>A</b> Common Ground Commuter Cloth Crossroad Delite Facet Hourglass Mariner Oh La La Presto Soliloquy Sonnet Trophy Uni-Form	<b>B</b> continued Keaton Knoll Felt Knoll Hopsack Little Devil Prairie Puff Ransom Shadow Play Summit Sutton Synth Venue Westwood	<b>D</b> Buzz Cavalier Pathway Retreat Vice Versa Woodland	<b>E</b> Aegean Circle Point Highland Off The Grid Seurat Tempest	<b>G</b> Alter Ego Dapper Fancy Twill Haze Kingston Looped In Melange Modern Tweed Rivers Spencer Texnet Ultrasuede	<b>H</b> Bella Cato Chic Doily Dynamic Florescence In Step Knoll Velvet Limani North Island Stripe It
<b>B</b> Attire Boundary Diva Ferry Helios Journey	<b>C</b> Circa Classic Boucle Entwine Plaid On Pullman Swing Utmost II Utopia Wow Factor	<b>F</b> Atelier Calais Cotton Velvet Cornaro Rivington Tweed Frieze	<b>I</b> Bella Cato Chic Doily Dynamic Florescence In Step Knoll Velvet Limani North Island Stripe It	<b>U</b> Volo	<b>X</b> Ducale Velour
				<b>V</b> Acqua Amalfi Andes España Velluto Pelle	<b>Y</b> Cervo Copenhagen Lucca Marissa Riva
				<b>W</b> Alaska Antique Forte Sabrina	
				© Fire Retardant Chemicals	
				<i>Check with your KnollTextiles or Spinneybeck Representative for changes or additions.</i>	

Piero Lissoni  
Avio™ Sofa Collection

Designer(s):  
Piero Lissoni, 2018

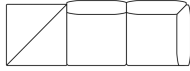
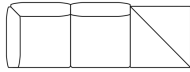

description	w	d	h	weight	textile fabric yds.	req. leather sq. ft.	base	table top finish
<b>AVC35</b> Two-seat sofa, righthand table 	94 7/8"	33 1/2"	28 1/3"	304 lbs.	8.3	170	chrome	Nero Marquina or Carrara
	94 7/8"	33 1/2"	28 1/3"	304 lbs.	8.3	170	chrome	Verdi Alpi
	94 7/8"	33 1/2"	28 1/3"	304 lbs.	8.3	170	silver or black	Nero Marquina or Carrara
	94 7/8"	33 1/2"	28 1/3"	304 lbs.	8.3	170	silver or black	Verdi Alpi
<b>AVC36</b> Two-seat sofa, lefthand table 	94 7/8"	33 1/2"	28 1/3"	304 lbs.	8.3	170	chrome	Nero Marquina or Carrara
	94 7/8"	33 1/2"	28 1/3"	304 lbs.	8.3	170	chrome	Verdi Alpi
	94 7/8"	33 1/2"	28 1/3"	304 lbs.	8.3	170	silver or black	Nero Marquina or Carrara
	94 7/8"	33 1/2"	28 1/3"	304 lbs.	8.3	170	silver or black	Verdi Alpi

pattern no.	grades A	COM B	C	D	E	F	G	H	I	COL U	V	W	X	Y
<b>AVC35-C-(MNS,GCS)-()</b>	\$19,380.	\$19,802.	\$20,187.	\$20,267.	\$20,423.	\$20,931.	\$22,066.	\$22,538.	\$23,668.	\$25,055.	\$27,837.	\$29,825.	\$30,736.	\$31,650.
<b>AVC35-C-MVS-()</b>	20,115.	20,538.	20,923.	21,002.	21,159.	21,668.	22,801.	23,273.	24,405.	25,943.	28,725.	30,712.	31,625.	32,537.
<b>AVC35-(S,1)-(MNS,GCS)-()</b>	18,310.	18,732.	19,118.	19,197.	19,352.	19,862.	20,996.	21,468.	22,598.	24,130.	26,911.	28,900.	29,813.	30,724.
<b>AVC35-(S,1)-MVS-()</b>	19,206.	19,627.	20,013.	20,091.	20,247.	20,758.	21,890.	22,365.	23,493.	25,025.	27,807.	29,794.	30,707.	31,619.
<b>AVC36-C-(MNS,GCS)-()</b>	19,380.	19,802.	20,187.	20,267.	20,423.	20,931.	22,066.	22,538.	23,668.	25,055.	27,837.	29,825.	30,736.	31,650.
<b>AVC36-C-MVS-()</b>	20,115.	20,538.	20,923.	21,002.	21,159.	21,668.	22,801.	23,273.	24,405.	25,943.	28,725.	30,712.	31,625.	32,537.
<b>AVC36-(S,1)-(MNS,GCS)-()</b>	18,310.	18,732.	19,118.	19,197.	19,352.	19,862.	20,996.	21,468.	22,598.	24,130.	26,911.	28,900.	29,813.	30,724.
<b>AVC36-(S,1)-MVS-()</b>	19,206.	19,627.	20,013.	20,091.	20,247.	20,758.	21,890.	22,365.	23,493.	25,025.	27,807.	29,794.	30,707.	31,619.

Order Code	Ordering Information	Construction
<i>Example:</i> <b>AVC36-S-GCS-K2074/2</b>	<i>Base Finish:</i> Silver paint (suffix S) Polished Chrome (suffix C) Black Paint (suffix 1)	<i>Frame:</i> Seats and tables are suspended on a central beam structure made in heavy gauge tubular steel. These beams are interconnected to obtain several configurations and are attached to the legs. Each seat is attached to the metal structure through an individual frame.
<b>AVC37</b> Avio Two-Seat Sofa, lefthand table	<i>Table top finish:</i> Satin Nero Marquina marble (suffix MNS) Satin Verdi Alpi marble (suffix MVS) Satin Carrara marble (suffix GCS)	<i>Upholstery:</i> Seat and back cushions with variable density foam covered with polyester fiberfills to enhance comfort. Slip covers are completely removable.
<b>S</b> Silver paint	<i>Upholstery/COM Information:</i> Prices shown include fabric or leather upholstery. Contact your Knoll representative for colors. Only approved KnollTextiles and Spinneybeck leather may be ordered.	
<b>GCS</b> Satin Carrara marble	Customer's Own Material is available pending approval. For approval requirements, processing instructions and ordering information please see page 21.	
<b>K2074/2</b> Aegean, Lemon	<i>Maintenance:</i> See pages 28-29.	

- Specify:
1. Pattern number
  2. Base finish selection
  3. Table top finish selection
  4. Textile/leather selection

Approved KnollTextiles Grades/Fabrics				Spinneybeck Leather	
<b>A</b> Common Ground Commuter Cloth Crossroad Delite Facet Hourglass Mariner Oh La La Presto Soliloquy Sonnet Trophy Uni-Form	<b>B</b> continued Keaton Knoll Felt Knoll Hopsack Little Devil Prairie Puff Ransom Shadow Play Summit Sutton Synth Venue Westwood	<b>D</b> Buzz Cavalier Pathway Retreat Vice Versa Woodland	<b>G</b> Alter Ego Dapper Fancy Twill Haze Kingston Looped In Melange Modern Tweed Rivers Spencer Texnet Ultrasuede	<b>U</b> Volo	<b>X</b> Ducale Velour
<b>B</b> Attire Boundary Diva Ferry Helios Journey	<b>C</b> Circa Classic Boucle Entwine Plaid On Pullman Swing Utmost II Utopia Wow Factor	<b>E</b> Aegean Circle Point Highland Off The Grid Seurat Tempest	<b>H</b>	<b>V</b> Acqua Amalfi Andes España Velluto Pelle	<b>Y</b> Cervo Copenhagen Lucca Marissa Riva
		<b>F</b> Atelier Calais Cotton Velvet Cornaro Rivington Tweed Frieze	<b>I</b> Bella Cato Chic Doily Dynamic Florescence In Step Knoll Velvet Limani North Island Stripe It	<b>W</b> Alaska Antique Forte Sabrina	
				<b>©</b> Fire Retardant Chemicals	

Check with your KnollTextiles or Spinneybeck Representative for changes or additions.

# Piero Lissoni

## Avio™ Sofa Collection

Designer(s):  
Piero Lissoni, 2018

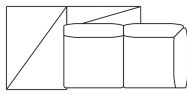
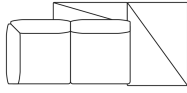

description	w	d	h	weight	textile fabric yds.	req. leather sq. ft.	base	table top finish
<b>AVC37</b> Two-seat sofa, righthand L-shaped table 	94 7/8"	43 1/3"	28 1/3"	419 lbs.	8.3	170	chrome	Nero Marquina or Carrara
	94 7/8"	43 1/3"	28 1/3"	419 lbs.	8.3	170	chrome	Verdi Alpi
	94 7/8"	43 1/3"	28 1/3"	419 lbs.	8.3	170	silver or black	Nero Marquina or Carrara
	94 7/8"	43 1/3"	28 1/3"	419 lbs.	8.3	170	silver or black	Verdi Alpi
<b>AVC38</b> Two-seat sofa, lefthand L-shaped table 	94 7/8"	43 1/3"	28 1/3"	419 lbs.	8.3	170	chrome	Nero Marquina or Carrara
	94 7/8"	43 1/3"	28 1/3"	419 lbs.	8.3	170	chrome	Verdi Alpi
	94 7/8"	43 1/3"	28 1/3"	419 lbs.	8.3	170	silver or black	Nero Marquina or Carrara
	94 7/8"	43 1/3"	28 1/3"	419 lbs.	8.3	170	silver or black	Verdi Alpi

Order Code	Ordering Information	Construction
<i>Example:</i> <b>AVC37-S-GCS-K2074/2</b>	<i>Base Finish:</i> Silver paint (suffix S) Polished Chrome (suffix C) Black Paint (suffix 1)	<i>Frame:</i> Seats and tables are suspended on a central beam structure made in heavy gauge tubular steel. These beams are interconnected to obtain several configurations and are attached to the legs. Each seat is attached to the metal structure through an individual frame.
<b>AVC37</b> Avio Two-Seat Sofa, righthand L-shaped table	<i>Table top finish:</i> Satin Nero Marquina marble (suffix MNS) Satin Verdi Alpi marble (suffix MVS) Satin Carrara marble (suffix GCS)	<i>Upholstery:</i> Seat and back cushions with variable density foam covered with polyester fiberfills to enhance comfort. Slip covers are completely removable.
<b>S</b> Silver paint		
<b>GCS</b> Satin Carrara marble		
<b>K2074/2</b> Aegean, Lemon		
<i>Specify:</i> 1. Pattern number 2. Base finish selection 3. Table top finish selection 4. Textile/leather selection	<i>Upholstery/COM Information:</i> Prices shown include fabric or leather upholstery. Contact your Knoll representative for colors. Only approved KnollTextiles and Spinneybeck leather may be ordered.  Customer's Own Material is available pending approval. For approval requirements, processing instructions and ordering information please see page 21.  <i>Maintenance:</i> See pages 28-29.	

pattern no.	grades <b>A</b>	COM <b>B</b>	<b>C</b>	<b>D</b>	<b>E</b>	<b>F</b>	<b>G</b>	<b>H</b>	<b>I</b>	COL <b>U</b>	<b>V</b>	<b>W</b>	<b>X</b>	<b>Y</b>
<b>AVC37-C-(MNS,GCS)-()</b>	\$27,185.	\$27,607.	\$27,993.	\$28,073.	\$28,227.	\$28,737.	\$29,872.	\$30,344.	\$31,473.	\$33,012.	\$35,794.	\$37,782.	\$38,695.	\$39,609.
<b>AVC37-C-MVS-()</b>	28,969.	29,390.	29,776.	29,855.	30,010.	30,519.	31,655.	32,125.	33,256.	34,794.	37,576.	39,565.	40,477.	41,391.
<b>AVC37-(S,1)-(MNS,GCS)-()</b>	25,382.	25,802.	26,186.	26,268.	26,423.	26,931.	28,065.	28,537.	29,668.	31,200.	33,981.	35,969.	36,880.	37,794.
<b>AVC37-(S,1)-MVS-()</b>	27,163.	27,585.	27,969.	28,051.	28,206.	28,715.	29,848.	30,321.	31,450.	32,982.	35,763.	37,751.	38,664.	39,577.
<b>AVC38-C-(MNS,GCS)-()</b>	27,185.	27,607.	27,993.	28,073.	28,227.	28,737.	29,872.	30,344.	31,473.	33,012.	35,794.	37,782.	38,695.	39,609.
<b>AVC38-C-MVS-()</b>	28,969.	29,390.	29,776.	29,855.	30,010.	30,519.	31,655.	32,125.	33,256.	34,794.	37,576.	39,565.	40,477.	41,391.
<b>AVC38-(S,1)-(MNS,GCS)-()</b>	25,382.	25,802.	26,186.	26,268.	26,423.	26,931.	28,065.	28,537.	29,668.	31,200.	33,981.	35,969.	36,880.	37,794.
<b>AVC38-(S,1)-MVS-()</b>	27,163.	27,585.	27,969.	28,051.	28,206.	28,715.	29,848.	30,321.	31,450.	32,982.	35,763.	37,751.	38,664.	39,577.

Approved KnollTextiles Grades/Fabrics				Spinneybeck Leather	
<b>A</b> Common Ground Commuter Cloth Crossroad Delite Facet Hourglass Mariner Oh La La Presto Soliloquy Sonnet Trophy Uni-Form	<b>B</b> continued Keaton Knoll Felt Knoll Hopsack Little Devil Prairie Puff Ransom Shadow Play Summit Sutton Synth Venue Westwood	<b>D</b> Buzz Cavalier Pathway Retreat Vice Versa Woodland	<b>E</b> Aegean Circle Point Highland Off The Grid Seurat Tempest	<b>G</b> Alter Ego Dapper Fancy Twill Haze Kingston Looped In Melange Modern Tweed Rivers Spencer Texnet Ultrasuede	<b>H</b> Bella Cato Chic Doily Dynamic Florescence In Step Knoll Velvet Limani North Island Stripe It
<b>B</b> Attire Boundary Diva Ferry Helios Journey	<b>C</b> Circa Classic Boucle Entwine Plaid On Pullman Swing Utmost II Utopia Wow Factor	<b>F</b> Atelier Calais Cotton Velvet Cornaro Rivington Tweed Frieze	<b>I</b> Bella Cato Chic Doily Dynamic Florescence In Step Knoll Velvet Limani North Island Stripe It	<b>U</b> Volo	<b>X</b> Ducale Velour
				<b>V</b> Acqua Amalfi Andes España Velluto Pelle	<b>Y</b> Cervo Copenhagen Lucca Marissa Riva
				<b>W</b> Alaska Antique Forte Sabrina	
				© Fire Retardant Chemicals	
				<i>Check with your KnollTextiles or Spinneybeck Representative for changes or additions.</i>	

Piero Lissoni  
Avio™ Sofa Collection

Designer(s):  
Piero Lissoni, 2018

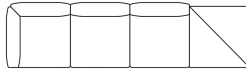

description	w	d	h	weight	textile fabric yds.	req. leather sq. ft.	base	table top finish
<b>AVC43</b> Three-seat sofa, righthand table 	126"	33 1/2"	28 1/3"	397 lbs.	11.6	240	chrome	Nero Marquina or Carrara
	126"	33 1/2"	28 1/3"	397 lbs.	11.6	240	chrome	Verdi Alpi
	126"	33 1/2"	28 1/3"	397 lbs.	11.6	240	silver or black	Nero Marquina or Carrara
<b>AVC44</b> Three-seat sofa, lefthand table 	126"	33 1/2"	28 1/3"	397 lbs.	11.6	240	chrome	Nero Marquina or Carrara
	126"	33 1/2"	28 1/3"	397 lbs.	11.6	240	chrome	Verdi Alpi
	126"	33 1/2"	28 1/3"	397 lbs.	11.6	240	silver or black	Nero Marquina or Carrara
	126"	33 1/2"	28 1/3"	397 lbs.	11.6	240	silver or black	Verdi Alpi

pattern no.	grades A	COM B	C	D	E	F	G	H	I	COL U	V	W	X	Y
<b>AVC43-C-(MNS,GCS)-()</b>	\$25,437.	\$26,025.	\$26,564.	\$26,675.	\$26,893.	\$27,605.	\$29,189.	\$29,848.	\$31,426.	\$33,713.	\$37,641.	\$40,447.	\$41,736.	\$43,025.
<b>AVC43-C-MVS-()</b>	26,330.	26,921.	27,459.	27,570.	27,788.	28,500.	30,085.	30,744.	32,323.	34,609.	38,537.	41,342.	42,632.	43,918.
<b>AVC43-(S,1)-(MNS,GCS)-()</b>	24,284.	24,871.	25,411.	25,521.	25,739.	26,452.	28,037.	28,696.	30,276.	32,539.	36,466.	39,271.	40,560.	41,849.
<b>AVC43-(S,1)-MVS-()</b>	25,171.	25,759.	26,299.	26,410.	26,627.	27,339.	28,924.	29,584.	31,164.	33,434.	37,361.	40,167.	41,456.	42,744.
<b>AVC44-C-(MNS,GCS)-()</b>	25,437.	26,025.	26,564.	26,675.	26,893.	27,605.	29,189.	29,848.	31,426.	33,713.	37,641.	40,447.	41,736.	43,025.
<b>AVC44-C-MVS-()</b>	26,330.	26,921.	27,459.	27,570.	27,788.	28,500.	30,085.	30,744.	32,323.	34,609.	38,537.	41,342.	42,632.	43,918.
<b>AVC44-(S,1)-(MNS,GCS)-()</b>	24,284.	24,871.	25,411.	25,521.	25,739.	26,452.	28,037.	28,696.	30,276.	32,539.	36,466.	39,271.	40,560.	41,849.
<b>AVC44-(S,1)-MVS-()</b>	25,171.	25,759.	26,299.	26,410.	26,627.	27,339.	28,924.	29,584.	31,164.	33,434.	37,361.	40,167.	41,456.	42,744.

Order Code	Ordering Information	Construction
<i>Example:</i> <b>AVC43-S-GCS-K2074/2</b>	<i>Base Finish:</i> Silver paint (suffix S) Polished Chrome (suffix C) Black Paint (suffix 1)	<i>Frame:</i> Seats and tables are suspended on a central beam structure made in heavy gauge tubular steel. These beams are interconnected to obtain several configurations and are attached to the legs. Each seat is attached to the metal structure through an individual frame.
<b>AVC43</b> Avio Three-seat sofa, righthand table		
<b>S</b> Silver paint		
<b>GCS</b> Satin Carrara marble	<i>Table top finish:</i> Satin Nero Marquina marble (suffix MNS) Satin Verdi Alpi marble (suffix MVS) Satin Carrara marble (suffix GCS)	<i>Upholstery:</i> Seat and back cushions with variable density foam covered with polyester fiberfills to enhance comfort. Slip covers are completely removable.
<b>K2074/2</b> Aegean, Lemon		
<i>Specify:</i>	<i>Upholstery/COM Information:</i> Prices shown include fabric or leather upholstery. Contact your Knoll representative for colors. Only approved KnollTextiles and Spinneybeck leather may be ordered.	
1. Pattern number	Customer's Own Material is available pending approval. For approval requirements, processing instructions and ordering information please see page 21.	
2. Base finish selection		
3. Table top finish selection		
4. Textile/leather selection	<i>Maintenance:</i> See pages 28-29.	

Approved KnollTextiles Grades/Fabrics				Spinneybeck Leather	
<b>A</b> Common Ground Commuter Cloth Crossroad Delite Facet Hourglass Mariner Oh La La Presto Soliloquy Sonnnet Trophy Uni-Form	<b>B</b> continued Keaton Knoll Felt Knoll Hopsack Little Devil Prairie Puff Ransom Shadow Play Summit Sutton Synth Venue Westwood	<b>D</b> Buzz Cavalier Pathway Retreat Vice Versa Woodland	<b>E</b> Aegean Circle Point Highland Off The Grid Seurat Tempest	<b>G</b> Alter Ego Dapper Fancy Twill Haze Kingston Looped In Melange Modern Tweed Rivers Spencer Texnet Ultrasuede	<b>H</b> Bella Cato Chic Doily Dynamic Floressence In Step Knoll Velvet Limani North Island Stripe It
<b>B</b> Attire Boundary Diva Ferry Helios Journey	<b>C</b> Circa Classic Boucle Entwine Plaid On Pullman Swing Utmost II Utopia Wow Factor	<b>F</b> Atelier Calais Cotton Velvet Cornaro Rivington Tweed Frieze	<b>I</b> Bella Cato Chic Doily Dynamic Floressence In Step Knoll Velvet Limani North Island Stripe It	<b>U</b> Volo	<b>X</b> Ducale Velour
				<b>V</b> Acqua Amalfi Andes España Velluto Pelle	<b>Y</b> Cervo Copenhagen Lucca Marissa Riva
				<b>W</b> Alaska Antique Forte Sabrina Ⓢ Fire Retardant Chemicals	

Check with your KnollTextiles or Spinneybeck Representative for changes or additions.

Piero Lissoni  
Avio™ Sofa Collection

Designer(s):  
Piero Lissoni, 2018

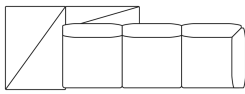
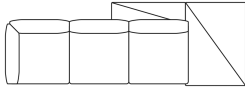

description	w	d	h	weight	textile fabric yds.	req. leather sq. ft.	base	table top finish
<b>AVC45</b> Three-seat sofa, righthand L-shaped table 	126"	43 1/3"	28 1/3"	511 lbs.	11.6	240	chrome	Nero Marquina or Carrara
	126"	43 1/3"	28 1/3"	511 lbs.	11.6	240	chrome	Verdi Alpi
	126"	43 1/3"	28 1/3"	511 lbs.	11.6	240	silver or black	Nero Marquina or Carrara
<b>AVC46</b> Three-seat sofa, lefthand L-shaped table 	126"	43 1/3"	28 1/3"	511 lbs.	11.6	240	chrome	Nero Marquina or Carrara
	126"	43 1/3"	28 1/3"	511 lbs.	11.6	240	chrome	Verdi Alpi
	126"	43 1/3"	28 1/3"	511 lbs.	11.6	240	silver or black	Nero Marquina or Carrara
	126"	43 1/3"	28 1/3"	511 lbs.	11.6	240	silver or black	Verdi Alpi

Order Code	Ordering Information	Construction
<i>Example:</i> <b>AVC45-S-GCS-K2074/2</b>	<i>Base Finish:</i> Silver paint (suffix S) Polished Chrome (suffix C) Black Paint (suffix 1)	<i>Frame:</i> Seats and tables are suspended on a central beam structure made in heavy gauge tubular steel. These beams are interconnected to obtain several configurations and are attached to the legs. Each seat is attached to the metal structure through an individual frame.
<b>AVC45</b> Avio Three-seat sofa, righthand L-shaped table		
<b>S</b> Silver paint	<i>Table top finish:</i> Satin Nero Marquina marble (suffix MNS) Satin Verdi Alpi marble (suffix MVS) Satin Carrara marble (suffix GCS)	<i>Upholstery:</i> Seat and back cushions with variable density foam covered with polyester fiberfills to enhance comfort. Slip covers are completely removable.
<b>GCS</b> Satin Carrara marble		
<b>K2074/2</b> Aegean, Lemon		
<i>Specify:</i> 1. Pattern number 2. Base finish selection 3. Table top finish selection 4. Textile/leather selection	<i>Upholstery/COM Information:</i> Prices shown include fabric or leather upholstery. Contact your Knoll representative for colors. Only approved KnollTextiles and Spinneybeck leather may be ordered.  Customer's Own Material is available pending approval. For approval requirements, processing instructions and ordering information please see page 21.  <i>Maintenance:</i> See pages 28-29.	

pattern no.	grades <b>A</b>	COM <b>B</b>	<b>C</b>	<b>D</b>	<b>E</b>	<b>F</b>	<b>G</b>	<b>H</b>	<b>I</b>	COL <b>U</b>	<b>V</b>	<b>W</b>	<b>X</b>	<b>Y</b>
<b>AVC45-C-(MNS,GCS)-()</b>	\$33,401.	\$33,989.	\$34,528.	\$34,641.	\$34,859.	\$35,569.	\$37,154.	\$37,814.	\$39,393.	\$41,680.	\$45,606.	\$48,411.	\$49,701.	\$50,991.
<b>AVC45-C-MVS-()</b>	35,185.	35,772.	36,311.	36,422.	36,639.	37,351.	38,937.	39,597.	41,175.	43,462.	47,390.	50,193.	51,483.	52,773.
<b>AVC45-(S,1)-(MNS,GCS)-()</b>	31,352.	31,942.	32,482.	32,592.	32,809.	33,522.	35,106.	35,765.	37,345.	39,609.	43,537.	46,341.	47,631.	48,919.
<b>AVC45-(S,1)-MVS-()</b>	33,136.	33,724.	34,263.	34,375.	34,592.	35,305.	36,888.	37,547.	39,127.	41,392.	45,319.	48,124.	49,413.	50,701.
<b>AVC46-C-(MNS,GCS)-()</b>	33,401.	33,989.	34,528.	34,641.	34,859.	35,569.	37,154.	37,814.	39,393.	41,680.	45,606.	48,411.	49,701.	50,991.
<b>AVC46-C-MVS-()</b>	35,185.	35,772.	36,311.	36,422.	36,639.	37,351.	38,937.	39,597.	41,175.	43,462.	47,390.	50,193.	51,483.	52,773.
<b>AVC46-(S,1)-(MNS,GCS)-()</b>	31,352.	31,942.	32,482.	32,592.	32,809.	33,522.	35,106.	35,765.	37,345.	39,609.	43,537.	46,341.	47,631.	48,919.
<b>AVC46-(S,1)-MVS-()</b>	33,136.	33,724.	34,263.	34,375.	34,592.	35,305.	36,888.	37,547.	39,127.	41,392.	45,319.	48,124.	49,413.	50,701.

Approved KnollTextiles Grades/Fabrics				Spinneybeck Leather	
<b>A</b> Common Ground Commuter Cloth Crossroad Delite Facet Hourglass Mariner Oh La La Presto Soliloquy Sonnet Trophy Uni-Form	<b>B</b> continued Keaton Knoll Felt Knoll Hopsack Little Devil Prairie Puff Ransom Shadow Play Summit Sutton Synth Venue Westwood	<b>D</b> Buzz Cavalier Pathway Retreat Vice Versa Woodland	<b>G</b> Alter Ego Dapper Fancy Twill Haze Kingston Looped In Melange Modern Tweed Rivers Spencer Texnet Ultrasuede	<b>U</b> Volo	<b>X</b> Ducale Velour
<b>B</b> Attire Boundary Diva Ferry Helios Journey	<b>C</b> Circa Classic Boucle Entwine Plaid On Pullman Swing Utmost II Utopia Wow Factor	<b>E</b> Aegean Circle Point Highland Off The Grid Seurat Tempest	<b>H</b>  <b>I</b> Bella Cato Chic Doily Dynamic Florescence In Step Knoll Velvet Limani North Island Stripe It	<b>V</b> Acqua Amalfi Andes España Velluto Pelle	<b>Y</b> Cervo Copenhagen Lucca Marissa Riva
		<b>F</b> Atelier Calais Cotton Velvet Cornaro Rivington Tweed Frieze	<b>W</b> Alaska Antique Fortie Sabrina	<i>Check with your KnollTextiles or Spinneybeck Representative for changes or additions.</i>	

Piero Lissoni  
Avio™ Sofa Collection

Designer(s):  
Piero Lissoni, 2018



description	w	d	h	weight	textile fabric yds.	req. leather sq. ft.	base	table top finish
<b>AVC65</b> Five-seat sofa, righthand L-shaped end table	138 1/8"	94 7/8"	28 1/8"	710 lbs.	19.9	410	chrome	Nero Marquina or Carrara
	138 1/8"	94 7/8"	28 1/8"	710 lbs.	19.9	410	chrome	Verdi Alpi
	138 1/8"	94 7/8"	28 1/8"	710 lbs.	19.9	410	silver or black	Nero Marquina or Carrara
	138 1/8"	94 7/8"	28 1/8"	710 lbs.	19.9	410	silver or black	Verdi Alpi

description	w	d	h	weight	textile fabric yds.	req. leather sq. ft.	base	table top finish
<b>AVC66</b> Five-seat sofa, lefthand L-shaped end table	138 1/8"	94 7/8"	28 1/8"	710 lbs.	19.9	410	chrome	Nero Marquina or Carrara
	138 1/8"	94 7/8"	28 1/8"	710 lbs.	19.9	410	chrome	Verdi Alpi
	138 1/8"	94 7/8"	28 1/8"	710 lbs.	19.9	410	silver or black	Nero Marquina or Carrara
	138 1/8"	94 7/8"	28 1/8"	710 lbs.	19.9	410	silver or black	Verdi Alpi

Order Code	Ordering Information	Construction
<i>Example:</i> <b>AVC65-S-GCS-K2074/2</b>	<i>Base Finish:</i> Silver paint (suffix S) Polished Chrome (suffix C) Black Paint (suffix 1)	<i>Frame:</i> Seats and tables are suspended on a central beam structure made in heavy gauge tubular steel. These beams are interconnected to obtain several configurations and are attached to the legs. Each seat is attached to the metal structure through an individual frame.
<b>AVC65</b> Avio Five-seat sofa, righthand L-shaped end table	<i>Table top finish:</i> Satin Nero Marquina marble (suffix MNS) Satin Verdi Alpi marble (suffix MVS) Satin Carrara marble (suffix GCS)	<i>Upholstery:</i> Seat and back cushions with variable density foam covered with polyester fiberfills to enhance comfort. Slip covers are completely removable.
<b>S</b> Silver paint	<i>Upholstery/COM Information:</i> Prices shown include fabric or leather upholstery. Contact your Knoll representative for colors. Only approved KnollTextiles and Spinneybeck leather may be ordered.	
<b>GCS</b> Satin Carrara marble	Customer's Own Material is available pending approval. For approval requirements, processing instructions and ordering information please see page 21.	
<b>K2074/2</b> Aegean, Lemon	<i>Maintenance:</i> See pages 28-29.	
<i>Specify:</i> 1. Pattern number 2. Base finish selection 3. Table top finish selection 4. Textile/leather selection		

pattern no.	grades <b>A</b>	COM <b>B</b>	<b>C</b>	<b>D</b>	<b>E</b>	<b>F</b>	<b>G</b>	<b>H</b>	<b>I</b>	COL <b>U</b>	<b>V</b>	<b>W</b>	<b>X</b>	<b>Y</b>
<b>AVC65-C-(MNS,GCS)-()</b>	\$47,531.	\$48,542.	\$49,468.	\$49,658.	\$50,031.	\$51,253.	\$53,971.	\$55,102.	\$57,812.	\$61,638.	\$68,347.	\$73,139.	\$75,340.	\$77,544.
<b>AVC65-C-MVS-()</b>	49,313.	50,324.	51,251.	51,440.	51,814.	53,035.	55,753.	56,883.	59,594.	63,420.	70,128.	74,920.	77,123.	79,324.
<b>AVC65-(S,1)-(MNS,GCS)-()</b>	44,952.	45,963.	46,887.	47,079.	47,452.	48,673.	51,392.	52,523.	55,232.	59,027.	65,736.	70,529.	72,730.	74,932.
<b>AVC65-(S,1)-MVS-()</b>	46,735.	47,745.	48,670.	48,863.	49,234.	50,456.	53,174.	54,306.	57,015.	60,809.	67,519.	72,312.	74,514.	76,714.
<b>AVC66-C-(MNS,GCS)-()</b>	47,531.	48,542.	49,468.	49,658.	50,031.	51,253.	53,971.	55,102.	57,812.	61,638.	68,347.	73,139.	75,340.	77,544.
<b>AVC66-C-MVS-()</b>	49,313.	50,324.	51,251.	51,440.	51,814.	53,035.	55,753.	56,883.	59,594.	63,420.	70,128.	74,920.	77,123.	79,324.
<b>AVC66-(S,1)-(MNS,GCS)-()</b>	44,952.	45,963.	46,887.	47,079.	47,452.	48,673.	51,392.	52,523.	55,232.	59,027.	65,736.	70,529.	72,730.	74,932.
<b>AVC66-(S,1)-MVS-()</b>	46,735.	47,745.	48,670.	48,863.	49,234.	50,456.	53,174.	54,306.	57,015.	60,809.	67,519.	72,312.	74,514.	76,714.

Approved KnollTextiles Grades/Fabrics				Spinneybeck Leather	
<b>A</b> Common Ground Commuter Cloth Crossroad Delite Facet Hourglass Mariner Oh La La Presto Soliloquy Sonnnet Trophy Uni-Form	<b>B</b> continued Keaton Knoll Felt Knoll Hopsack Little Devil Prairie Puff Ransom Shadow Play Summit Sutton Synth Venue Westwood	<b>D</b> Buzz Cavalier Pathway Retreat Vice Versa Woodland	<b>E</b> Aegean Circle Point Highland Off The Grid Seurat Tempest	<b>G</b> Alter Ego Dapper Fancy Twill Haze Kingston Looped In Melange Modern Tweed Rivers Spencer Texnet Ultrasuede	<b>H</b> Bella Cato Chic Doily Dynamic Floressence In Step Knoll Velvet Limani North Island Stripe It
<b>B</b> Attire Boundary Diva Ferry Helios Journey	<b>C</b> Circa Classic Boucle Entwine Plaid On Pullman Swing Utmost II Utopia Wow Factor	<b>F</b> Atelier Calais Cotton Velvet Cornaro Rivington Tweed Frieze	<b>I</b> Bella Cato Chic Doily Dynamic Floressence In Step Knoll Velvet Limani North Island Stripe It	<b>U</b> Volo	<b>X</b> Ducale Velour
				<b>V</b> Acqua Amalfi Andes España Velluto Pelle	<b>Y</b> Cervo Copenhagen Lucca Marissa Riva
				<b>W</b> Alaska Antique Forte Sabrina Ⓢ Fire Retardant Chemicals	

Check with your KnollTextiles or Spinneybeck Representative for changes or additions.

# Piero Lissoni

## Avio™ Sofa Collection

Designer(s):  
Piero Lissoni, 2018



description	w	d	h	weight	textile fabric yds.	req. leather sq. ft.	base	table top finish
<b>AVC61</b> Five-seat sofa, righthand corner table	127 3/8"	97 1/4"	28 1/3"	595 lbs.	19.9	410	chrome	Nero Marquina or Carrara
	127 3/8"	97 1/4"	28 1/3"	595 lbs.	19.9	410	chrome	Verdi Alpi
	127 3/8"	97 1/4"	28 1/3"	595 lbs.	19.9	410	silver or black	Nero Marquina or Carrara
	127 3/8"	97 1/4"	28 1/3"	595 lbs.	19.9	410	silver or black	Verdi Alpi

<b>AVC62</b> Five-seat sofa, lefthand corner table	127 3/8"	97 1/4"	28 1/3"	595 lbs.	19.9	410	chrome	Nero Marquina or Carrara
	127 3/8"	97 1/4"	28 1/3"	595 lbs.	19.9	410	chrome	Verdi Alpi
	127 3/8"	97 1/4"	28 1/3"	595 lbs.	19.9	410	silver or black	Nero Marquina or Carrara
	127 3/8"	97 1/4"	28 1/3"	595 lbs.	19.9	410	silver or black	Verdi Alpi

Order Code	Ordering Information	Construction
<i>Example:</i> <b>AVC61-S-GCS-K2074/2</b>	<i>Base Finish:</i> Silver paint (suffix S) Polished Chrome (suffix C) Black Paint (suffix 1)	<i>Frame:</i> Seats and tables are suspended on a central beam structure made in heavy gauge tubular steel. These beams are interconnected to obtain several configurations and are attached to the legs. Each seat is attached to the metal structure through an individual frame.
<b>AVC61</b> Avio Five-seat sofa, righthand corner table	<i>Table top finish:</i> Satin Nero Marquina marble (suffix MNS) Satin Verdi Alpi marble (suffix MVS) Satin Carrara marble (suffix GCS)	<i>Upholstery:</i> Seat and back cushions with variable density foam covered with polyester fiberfills to enhance comfort. Slip covers are completely removable.
<b>S</b> Silver paint		
<b>GCS</b> Satin Carrara marble		
<b>K2074/2</b> Aegean, Lemon		
<i>Specify:</i> 1. Pattern number 2. Base finish selection 3. Table top finish selection 4. Textile/leather selection	<i>Upholstery/COM Information:</i> Prices shown include fabric or leather upholstery. Contact your Knoll representative for colors. Only approved KnollTextiles and Spinneybeck leather may be ordered.  Customer's Own Material is available pending approval. For approval requirements, processing instructions and ordering information please see page 21.  <i>Maintenance:</i> See pages 28-29.	

pattern no.	grades <b>A</b>	COM <b>B</b>	<b>C</b>	<b>D</b>	<b>E</b>	<b>F</b>	<b>G</b>	<b>H</b>	<b>I</b>	COL <b>U</b>	<b>V</b>	<b>W</b>	<b>X</b>	<b>Y</b>
<b>AVC61-C-(MNS,GCS)-()</b>	\$39,574.	\$40,585.	\$41,510.	\$41,702.	\$42,074.	\$43,295.	\$46,014.	\$47,144.	\$49,854.	\$53,680.	\$60,389.	\$65,182.	\$67,383.	\$69,583.
<b>AVC61-C-MVS-()</b>	40,461.	41,472.	42,396.	42,588.	42,961.	44,183.	46,901.	48,032.	50,741.	54,567.	61,275.	66,068.	68,272.	70,472.
<b>AVC61-(S,1)-(MNS,GCS)-()</b>	37,883.	38,892.	39,819.	40,008.	40,382.	41,604.	44,321.	45,452.	48,163.	51,958.	58,667.	63,459.	65,660.	67,863.
<b>AVC61-(S,1)-MVS-()</b>	38,778.	39,787.	40,713.	40,903.	41,276.	42,499.	45,217.	46,348.	49,057.	52,846.	59,554.	64,346.	66,548.	68,750.

<b>AVC62-C-(MNS,GCS)-()</b>	39,574.	40,585.	41,510.	41,702.	42,074.	43,295.	46,014.	47,144.	49,854.	53,680.	60,389.	65,182.	67,383.	69,583.
<b>AVC62-C-MVS-()</b>	40,461.	41,472.	42,396.	42,588.	42,961.	44,183.	46,901.	48,032.	50,741.	54,567.	61,275.	66,068.	68,272.	70,472.
<b>AVC62-(S,1)-(MNS,GCS)-()</b>	37,883.	38,892.	39,819.	40,008.	40,382.	41,604.	44,321.	45,452.	48,163.	51,958.	58,667.	63,459.	65,660.	67,863.
<b>AVC62-(S,1)-MVS-()</b>	38,778.	39,787.	40,713.	40,903.	41,276.	42,499.	45,217.	46,348.	49,057.	52,846.	59,554.	64,346.	66,548.	68,750.

Approved KnollTextiles Grades/Fabrics				Spinneybeck Leather	
<b>A</b> Common Ground Commuter Cloth Crossroad Delite Facet Hourglass Mariner Oh La La Presto Soliloquy Sonnet Trophy Uni-Form	<b>B</b> continued Keaton Knoll Felt Knoll Hopsack Little Devil Prairie Puff Ransom Shadow Play Summit Sutton Synth Venue Westwood	<b>D</b> Buzz Cavalier Pathway Retreat Vice Versa Woodland	<b>G</b> Alter Ego Dapper Fancy Twill Haze Kingston Looped In Melange Modern Tweed Rivers Spencer Texnet Ultrasuede	<b>U</b> Volo	<b>X</b> Ducale Velour
<b>B</b> Attire Boundary Diva Ferry Helios Journey	<b>C</b> Circa Classic Boucle Entwine Plaid On Pullman Swing Utmost II Utopia Wow Factor	<b>E</b> Aegean Circle Point Highland Off The Grid Seurat Tempest	<b>H</b>	<b>V</b> Acqua Amalfi Andes España Velluto Pelle	<b>Y</b> Cervo Copenhagen Lucca Marissa Riva
		<b>F</b> Atelier Calais Cotton Velvet Cornaro Rivington Tweed Frieze	<b>I</b> Bella Cato Chic Doily Dynamic Florescence In Step Knoll Velvet Limani North Island Stripe It	<b>W</b> Alaska Antique Forte Sabrina	
				<b>©</b> Fire Retardant Chemicals	

Check with your KnollTextiles or Spinneybeck Representative for changes or additions.

Piero Lissoni  
Avio™ Sofa Collection

Designer(s):  
Piero Lissoni, 2018



description	w	d	h	weight	textile fabric yds.	req. leather sq. ft.	base	table top finish
<b>AVC73</b> Five-seat sofa, righthand L-shaped end table and ottoman	136 3/8"	127 1/8"	28 1/8"	802 lbs.	20.4	420	chrome	Nero Marquina or Carrara
	136 3/8"	127 1/8"	28 1/8"	802 lbs.	20.4	420	chrome	Verdi Alpi
	136 3/8"	127 1/8"	28 1/8"	802 lbs.	20.4	420	silver or black	Nero Marquina or Carrara
	136 3/8"	127 1/8"	28 1/8"	802 lbs.	20.4	420	silver or black	Verdi Alpi

description	w	d	h	weight	textile fabric yds.	req. leather sq. ft.	base	table top finish
<b>AVC74</b> Five-seat sofa, lefthand L-shaped end table and ottoman	136 3/8"	127 1/8"	28 1/8"	802 lbs.	20.4	420	chrome	Nero Marquina or Carrara
	136 3/8"	127 1/8"	28 1/8"	802 lbs.	20.4	420	chrome	Verdi Alpi
	136 3/8"	127 1/8"	28 1/8"	802 lbs.	20.4	420	silver or black	Nero Marquina or Carrara
	136 3/8"	127 1/8"	28 1/8"	802 lbs.	20.4	420	silver or black	Verdi Alpi

Order Code	Ordering Information	Construction
<i>Example:</i> <b>AVC73-S-GCS-K2074/2</b>	<i>Base Finish:</i> Silver paint (suffix S) Polished Chrome (suffix C) Black Paint (suffix 1)	<i>Frame:</i> Seats and tables are suspended on a central beam structure made in heavy gauge tubular steel. These beams are interconnected to obtain several configurations and are attached to the legs. Each seat is attached to the metal structure through an individual frame.
<b>AVC73</b> Avio Five-seat sofa, righthand L-shaped end table and ottoman	<i>Table top finish:</i> Satin Nero Marquina marble (suffix MNS) Satin Verdi Alpi marble (suffix MVS) Satin Carrara marble (suffix GCS)	<i>Upholstery:</i> Seat and back cushions with variable density foam covered with polyester fiberfills to enhance comfort. Slip covers are completely removable.
<b>S</b> Silver paint	<i>Upholstery/COM Information:</i> Prices shown include fabric or leather upholstery. Contact your Knoll representative for colors. Only approved KnollTextiles and Spinneybeck leather may be ordered.	
<b>GCS</b> Satin Carrara marble	Customer's Own Material is available pending approval. For approval requirements, processing instructions and ordering information please see page 21.	
<b>K2074/2</b> Aegean, Lemon	<i>Maintenance:</i> See pages 28-29.	

Specify:

1. Pattern number
2. Base finish selection
3. Table top finish selection
4. Textile/leather selection

pattern no.	grades <b>A</b>	COM <b>B</b>	<b>C</b>	<b>D</b>	<b>E</b>	<b>F</b>	<b>G</b>	<b>H</b>	<b>I</b>	COL <b>U</b>	<b>V</b>	<b>W</b>	<b>X</b>	<b>Y</b>
<b>AVC73-C-(MNS,GCS)-()</b>	\$50,523.	\$51,559.	\$52,508.	\$52,702.	\$53,085.	\$54,336.	\$57,124.	\$58,283.	\$61,060.	\$65,184.	\$72,058.	\$76,966.	\$79,222.	\$81,479.
<b>AVC73-C-MVS-()</b>	52,307.	53,342.	54,290.	54,485.	54,868.	56,119.	58,907.	60,066.	62,844.	66,967.	73,841.	78,750.	81,005.	83,260.
<b>AVC73-(S,1)-(MNS,GCS)-()</b>	47,685.	48,721.	49,671.	49,865.	50,248.	51,500.	54,287.	55,447.	58,224.	62,302.	69,174.	74,083.	76,340.	78,595.
<b>AVC73-(S,1)-MVS-()</b>	49,469.	50,504.	51,451.	51,649.	52,031.	53,283.	56,069.	57,229.	60,007.	64,086.	70,958.	75,867.	78,123.	80,378.

<b>AVC74-C-(MNS,GCS)-()</b>	50,523.	51,559.	52,508.	52,702.	53,085.	54,336.	57,124.	58,283.	61,060.	65,184.	72,058.	76,966.	79,222.	81,479.
<b>AVC74-C-MVS-()</b>	52,307.	53,342.	54,290.	54,485.	54,868.	56,119.	58,907.	60,066.	62,844.	66,967.	73,841.	78,750.	81,005.	83,260.
<b>AVC74-(S,1)-(MNS,GCS)-()</b>	47,685.	48,721.	49,671.	49,865.	50,248.	51,500.	54,287.	55,447.	58,224.	62,302.	69,174.	74,083.	76,340.	78,595.
<b>AVC74-(S,1)-MVS-()</b>	49,469.	50,504.	51,451.	51,649.	52,031.	53,283.	56,069.	57,229.	60,007.	64,086.	70,958.	75,867.	78,123.	80,378.

Approved KnollTextiles Grades/Fabrics

<b>A</b> Common Ground Commuter Cloth Crossroad Delite Facet Hourglass Mariner Oh La La Presto Soliloquy Sonnet Trophy Uni-Form	<b>B</b> continued Keaton Knoll Felt Knoll Hopsack Little Devil Prairie Puff Ransom Shadow Play Summit Sutton Synth Venue Westwood	<b>D</b> Buzz Cavalier Pathway Retreat Vice Versa Woodland	<b>E</b> Aegean Circle Point Highland Off The Grid Seurat Tempest	<b>F</b> Atelier Calais Cotton Velvet Cornaro Rivington Tweed Frieze	<b>G</b> Alter Ego Dapper Fancy Twill Haze Kingston Looped In Melange Modern Tweed Rivers Spencer Texnet Ultrasuede	<b>H</b>	<b>I</b> Bella Cato Chic Doily Dynamic Florescence In Step Knoll Velvet Limani North Island Stripe It
--	---	--	---	--	---	----------	--

Spinneybeck Leather

<b>U</b> Volo	<b>X</b> Ducale Velour
<b>V</b> Acqua Amalfi Andes España Velluto Pelle	<b>Y</b> Cervo Copenhagen Lucca Marissa Riva
<b>W</b> Alaska Antique Forte Sabrina	
© Fire Retardant Chemicals	

Check with your KnollTextiles or Spinneybeck Representative for changes or additions.



Piero Lissoni  
Avio™ Sofa Collection

Designer(s):  
Piero Lissoni, 2018

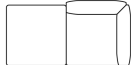

description	w	d	h	weight	textile fabric yds.	req. leather sq. ft.	base
<b>AVC1L</b> Chaise Lounge, left extension 	64 1/2"	33 1/2"	28 1/8"	185 lbs.	7.2	140	chrome
	64 1/2"	33 1/2"	28 1/8"	185 lbs.	7.2	140	silver or black
<b>AVC1R</b> Chaise Lounge, right extension 	64 1/2"	33 1/2"	28 1/8"	185 lbs.	7.2	140	chrome
	64 1/2"	33 1/2"	28 1/8"	185 lbs.	7.2	140	silver or black

pattern no.	grades <b>A</b>	COM <b>B</b>	<b>C</b>	<b>D</b>	<b>E</b>	<b>F</b>	<b>G</b>	<b>H</b>	<b>I</b>	COL <b>U</b>	<b>V</b>	<b>W</b>	<b>X</b>	<b>Y</b>
<b>AVC1L-C-( )</b>	\$12,624.	\$12,989.	\$13,322.	\$13,392.	\$13,528.	\$13,969.	\$14,953.	\$15,362.	\$16,343.	\$17,470.	\$19,760.	\$21,399.	\$22,150.	\$22,901.
<b>AVC1L-(S,1)-( )</b>	12,038.	12,405.	12,739.	12,808.	12,944.	13,385.	14,369.	14,778.	15,758.	16,886.	19,178.	20,813.	21,564.	22,317.
<b>AVC1R-C-( )</b>	12,624.	12,989.	13,322.	13,392.	13,528.	13,969.	14,953.	15,362.	16,343.	17,470.	19,760.	21,399.	22,150.	22,901.
<b>AVC1R-(S,1)-( )</b>	12,038.	12,405.	12,739.	12,808.	12,944.	13,385.	14,369.	14,778.	15,758.	16,886.	19,178.	20,813.	21,564.	22,317.

Order Code	Ordering Information	Construction
<i>Example:</i> <b>AVC73-S-GCS-K2074/2</b>	<i>Base Finish:</i> Silver paint (suffix S) Polished Chrome (suffix C) Black Paint (suffix 1)	<i>Frame:</i> Seats are suspended on a central beam structure made in heavy gauge tubular steel. These beams are interconnected to obtain several configurations and are attached to the legs. Each seat is attached to the metal structure through an individual frame.
<b>AVC73</b> Avio Five-seat sofa, righthand L-shaped end table and ottoman	<i>Table top finish:</i> Satin Nero Marquina marble (suffix MNS) Satin Verdi Alpi marble (suffix MVS) Satin Carrara marble (suffix GCS)	<i>Upholstery:</i> Seat and back cushions with variable density foam covered with polyester fiberfills to enhance comfort. Slip covers are completely removable.
<b>S</b> Silver paint		
<b>GCS</b> Satin Carrara marble		
<b>K2074/2</b> Aegean, Lemon		
<i>Specify:</i> 1. Pattern number 2. Base finish selection 3. Table top finish selection 4. Textile/leather selection	<i>Upholstery/COM Information:</i> Prices shown include fabric or leather upholstery. Contact your Knoll representative for colors. Only approved KnollTextiles and Spinneybeck leather may be ordered.  Customer's Own Material is available pending approval. For approval requirements, processing instructions and ordering information please see page 21.  <i>Maintenance:</i> See pages 28-29.	

Approved KnollTextiles Grades/Fabrics				Spinneybeck Leather	
<b>A</b> Common Ground Commuter Cloth Crossroad Delite Facet Hourglass Mariner Oh La La Presto Soliloquy Sonnet Trophy Uni-Form	<b>B</b> continued Keaton Knoll Felt Knoll Hopsack Little Devil Prairie Puff Ransom Shadow Play Summit Sutton Synth Venue Westwood	<b>D</b> Buzz Cavalier Pathway Retreat Vice Versa Woodland	<b>E</b> Aegean Circle Point Highland Off The Grid Seurat Tempest	<b>G</b> Alter Ego Dapper Fancy Twill Haze Kingston Looped In Melange Modern Tweed Rivers Spencer Texnet Ultrasuede	<b>H</b> Bella Cato Chic Doily Dynamic Floressence In Step Knoll Velvet Limani North Island Stripe It
<b>B</b> Attire Boundary Diva Ferry Helios Journey	<b>C</b> Circa Classic Boucle Entwine Plaid On Pullman Swing Utmost II Utopia Wow Factor	<b>F</b> Atelier Calais Cotton Velvet Cornaro Rivington Tweed Frieze	<b>I</b> Bella Cato Chic Doily Dynamic Floressence In Step Knoll Velvet Limani North Island Stripe It	<b>U</b> Volo	<b>X</b> Ducale Velour
				<b>V</b> Acqua Amalfi Andes España Velluto Pelle	<b>Y</b> Cervo Copenhagen Lucca Marissa Riva
				<b>W</b> Alaska Antique Forte Sabrina Ⓢ Fire Retardant Chemicals	

Check with your KnollTextiles or Spinneybeck Representative for changes or additions.

# Piero Lissoni

## Avio™ Sofa Collection

Designer(s):  
Piero Lissoni, 2018

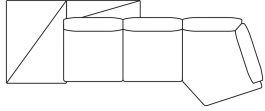
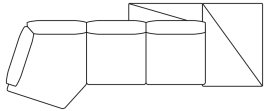

description	w	d	h	weight	textile fabric yds.	req. leather sq. ft.	base	table top finish
<b>AVC75</b> Three-seat sofa, lefthand asymmetric seat, L-shaped table 	133 7/8"	55 1/8"	28 1/8"	522 lbs.	11.85	250	chrome	Nero Marquina or Carrara
	133 7/8"	55 1/8"	28 1/8"	522 lbs.	11.85	250	chrome	Verdi Alpi
	133 7/8"	55 1/8"	28 1/8"	522 lbs.	11.85	250	silver or black	Nero Marquina or Carrara
<b>AVC76</b> Three-seat sofa, righthand asymmetric seat, L-shaped table 	133 7/8"	55 1/8"	28 1/8"	522 lbs.	11.85	250	chrome	Nero Marquina or Carrara
	133 7/8"	55 1/8"	28 1/8"	522 lbs.	11.85	250	chrome	Verdi Alpi
	133 7/8"	55 1/8"	28 1/8"	522 lbs.	11.85	250	silver or black	Nero Marquina or Carrara
	133 7/8"	55 1/8"	28 1/8"	522 lbs.	11.85	250	silver or black	Verdi Alpi

Order Code	Ordering Information	Construction
<i>Example:</i> <b>AVC75-S-GCS-K2074/2</b>	<i>Base Finish:</i> Silver paint (suffix S) Polished Chrome (suffix C) Black Paint (suffix 1)	<i>Frame:</i> Seats are suspended on a central beam structure made in heavy gauge tubular steel. These beams are interconnected to obtain several configurations and are attached to the legs. Each seat is attached to the metal structure through an individual frame.
<b>AVC75</b> Avio Three-seat sofa, lefthand asymmetric seat, L-shaped table	<i>Table top finish:</i> Satin Nero Marquina marble (suffix MNS) Satin Verdi Alpi marble (suffix MVS) Satin Carrara marble (suffix GCS)	<i>Upholstery:</i> Seat and back cushions with variable density foam covered with polyester fiberfills to enhance comfort. Slip covers are completely removable.
<b>S</b> Silver paint		
<b>GCS</b> Satin Carrara marble		
<b>K2074/2</b> Aegean, Lemon		
<i>Specify:</i> 1. Pattern number 2. Base finish selection 3. Table top finish selection 4. Textile/leather selection	<i>Upholstery/COM Information:</i> Prices shown include fabric or leather upholstery. Contact your Knoll representative for colors. Only approved KnollTextiles and Spinneybeck leather may be ordered.  Customer's Own Material is available pending approval. For approval requirements, processing instructions and ordering information please see page 21.  <i>Maintenance:</i> See pages 28-29.	

pattern no.	grades	COM								COL					
	A	B	C	D	E	F	G	H	I	U	V	W	X	Y	
<b>AVC75-C-(MNS,GCS)-()</b>	\$35,789.	\$36,387.	\$36,940.	\$37,056.	\$37,276.	\$38,004.	\$39,621.	\$40,296.	\$41,909.	\$44,672.	\$48,765.	\$51,687.	\$53,029.	\$54,371.	
<b>AVC75-C-MVS-()</b>	37,570.	38,171.	38,723.	38,837.	39,058.	39,786.	41,405.	42,080.	43,692.	46,455.	50,546.	53,468.	54,812.	56,154.	
<b>AVC75-(S,1)-(MNS,GCS)-()</b>	33,043.	33,643.	34,194.	34,308.	34,529.	35,258.	36,876.	37,549.	39,163.	41,911.	46,004.	48,925.	50,268.	51,610.	
<b>AVC75-(S,1)-MVS-()</b>	34,826.	35,427.	35,976.	36,091.	36,312.	37,039.	38,660.	39,331.	40,946.	43,695.	47,784.	50,708.	52,050.	53,393.	
<b>AVC76-C-(MNS,GCS)-()</b>	35,789.	36,387.	36,940.	37,056.	37,276.	38,004.	39,621.	40,296.	41,909.	44,672.	48,765.	51,687.	53,029.	54,371.	
<b>AVC76-C-MVS-()</b>	37,570.	38,171.	38,723.	38,837.	39,058.	39,786.	41,405.	42,080.	43,692.	46,455.	50,546.	53,468.	54,812.	56,154.	
<b>AVC76-(S,1)-(MNS,GCS)-()</b>	33,043.	33,643.	34,194.	34,308.	34,529.	35,258.	36,876.	37,549.	39,163.	41,911.	46,004.	48,925.	50,268.	51,610.	
<b>AVC76-(S,1)-MVS-()</b>	34,826.	35,427.	35,976.	36,091.	36,312.	37,039.	38,660.	39,331.	40,946.	43,695.	47,784.	50,708.	52,050.	53,393.	

Approved KnollTextiles Grades/Fabrics				Spinneybeck Leather	
<b>A</b> Common Ground Commuter Cloth Crossroad Delite Facet Hourglass Mariner Oh La La Presto Soliloquy Sonnnet Trophy Uni-Form	<b>B</b> continued Keaton Knoll Felt Knoll Hopsack Little Devil Prairie Puff Ransom Shadow Play Summit Sutton Synth Venue Westwood	<b>D</b> Buzz Cavalier Pathway Retreat Vice Versa Woodland	<b>E</b> Aegean Circle Point Highland Off The Grid Seurat Tempest	<b>G</b> Alter Ego Dapper Fancy Twill Haze Kingston Looped In Melange Modern Tweed Rivers Spencer Texnet Ultrasuede	<b>H</b> Bella Cato Chic Doily Dynamic Florescence In Step Knoll Velvet Limani North Island Stripe It
<b>B</b> Attire Boundary Diva Ferry Helios Journey	<b>C</b> Circa Classic Boucle Entwine Plaid On Pullman Swing Utmost II Utopia Wow Factor	<b>F</b> Atelier Calais Cotton Velvet Cornaro Rivington Tweed Frieze	<b>I</b> Bella Cato Chic Doily Dynamic Florescence In Step Knoll Velvet Limani North Island Stripe It	<b>U</b> Volo	<b>X</b> Ducale Velour
				<b>V</b> Acqua Amalfi Andes España Velluto Pelle	<b>Y</b> Cervo Copenhagen Lucca Marissa Riva
				<b>W</b> Alaska Antique Forte Sabrina	
					© Fire Retardant Chemicals
					<i>Check with your KnollTextiles or Spinneybeck Representative for changes or additions.</i>

# Piero Lissoni

## Avio™ Sofa Collection

Designer(s):  
Piero Lissoni, 2018

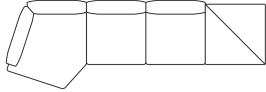
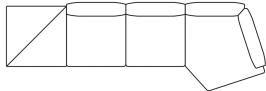

description	w	d	h	weight	textile fabric yds.	req. leather sq. ft.	base	table top finish
<b>AVC88</b> Three-seat sofa, righthand seat, lefthand table 	133 7/8"	45 7/8"	28 1/8"	408 lbs.	11.85	250	chrome	Nero Marquina or Carrara
	133 7/8"	45 7/8"	28 1/8"	408 lbs.	11.85	250	chrome	Verdi Alpi
	133 7/8"	45 7/8"	28 1/8"	408 lbs.	11.85	250	silver or black	Nero Marquina or Carrara
	133 7/8"	45 7/8"	28 1/8"	408 lbs.	11.85	250	silver or black	Verdi Alpi
<b>AVC89</b> Three-seat sofa, lefthand seat, righthand table 	133 7/8"	45 7/8"	28 1/8"	408 lbs.	11.85	250	chrome	Nero Marquina or Carrara
	133 7/8"	45 7/8"	28 1/8"	408 lbs.	11.85	250	chrome	Verdi Alpi
	133 7/8"	45 7/8"	28 1/8"	408 lbs.	11.85	250	silver or black	Nero Marquina or Carrara
	133 7/8"	45 7/8"	28 1/8"	408 lbs.	11.85	250	silver or black	Verdi Alpi

Order Code	Ordering Information	Construction
<i>Example:</i> <b>AVC75-S-GCS-K2074/2</b>	<i>Base Finish:</i> Silver paint (suffix S) Polished Chrome (suffix C) Black Paint (suffix 1)	<i>Frame:</i> Seats and tables are suspended on a central beam structure made in heavy gauge tubular steel. These beams are interconnected to obtain several configurations and are attached to the legs. Each seat is attached to the metal structure through an individual frame.
<b>AVC75</b>	Avio Three-seat sofa, lefthand asymmetric seat, L-shaped table	<i>Upholstery:</i> Seat and back cushions with variable density foam covered with polyester fiberfills to enhance comfort. Slip covers are completely removable.
<b>S</b>	Silver paint	
<b>GCS</b>	Satin Carrara marble	
<b>K2074/2</b>	Aegean, Lemon	
<i>Specify:</i>	<i>Table top finish:</i> Satin Nero Marquina marble (suffix MNS) Satin Verdi Alpi marble (suffix MVS) Satin Carrara marble (suffix GCS)	
1. Pattern number	<i>Upholstery/COM Information:</i> Prices shown include fabric or leather upholstery. Contact your Knoll representative for colors. Only approved KnollTextiles and Spinneybeck leather may be ordered.	
2. Base finish selection	Customer's Own Material is available pending approval. For approval requirements, processing instructions and ordering information please see page 21.	
3. Table top finish selection		
4. Textile/leather selection	<i>Maintenance:</i> See pages 28-29.	

pattern no.	grades <b>A</b>	COM <b>B</b>	<b>C</b>	<b>D</b>	<b>E</b>	<b>F</b>	<b>G</b>	<b>H</b>	<b>I</b>	COL <b>U</b>	<b>V</b>	<b>W</b>	<b>X</b>	<b>Y</b>
<b>AVC88-C-(MNS,GCS)-()</b>	\$27,823.	\$28,425.	\$28,975.	\$29,088.	\$29,312.	\$30,037.	\$31,659.	\$32,330.	\$33,944.	\$36,709.	\$40,800.	\$43,720.	\$45,065.	\$46,406.
<b>AVC88-C-MVS-()</b>	28,718.	29,320.	29,872.	29,983.	30,205.	30,934.	32,553.	33,225.	34,839.	37,603.	41,695.	44,616.	45,959.	47,300.
<b>AVC88-(S,1)-(MNS,GCS)-()</b>	25,973.	26,574.	27,124.	27,238.	27,460.	28,187.	29,807.	30,480.	32,094.	34,842.	38,932.	41,855.	43,197.	44,540.
<b>AVC88-(S,1)-MVS-()</b>	26,860.	27,461.	28,010.	28,127.	28,348.	29,075.	30,694.	31,366.	32,981.	35,739.	39,828.	42,749.	44,094.	45,436.
<b>AVC89-C-(MNS,GCS)-()</b>	27,823.	28,425.	28,975.	29,088.	29,312.	30,037.	31,659.	32,330.	33,944.	36,709.	40,800.	43,720.	45,065.	46,406.
<b>AVC89-C-MVS-()</b>	28,718.	29,320.	29,872.	29,983.	30,205.	30,934.	32,553.	33,225.	34,839.	37,603.	41,695.	44,616.	45,959.	47,300.
<b>AVC89-(S,1)-(MNS,GCS)-()</b>	25,973.	26,574.	27,124.	27,238.	27,460.	28,187.	29,807.	30,480.	32,094.	34,842.	38,932.	41,855.	43,197.	44,540.
<b>AVC89-(S,1)-MVS-()</b>	26,860.	27,461.	28,010.	28,127.	28,348.	29,075.	30,694.	31,366.	32,981.	35,739.	39,828.	42,749.	44,094.	45,436.

Approved KnollTextiles Grades/Fabrics				Spinneybeck Leather	
<b>A</b> Common Ground Commuter Cloth Crossroad Delite Facet Hourglass Mariner Oh La La Presto Soliloquy Sonnnet Trophy Uni-Form	<b>B</b> continued Keaton Knoll Felt Knoll Hopsack Little Devil Prairie Puff Ransom Shadow Play Summit Sutton Synth Venue Westwood	<b>D</b> Buzz Cavalier Pathway Retreat Vice Versa Woodland	<b>E</b> Aegean Circle Point Highland Off The Grid Seurat Tempest	<b>G</b> Alter Ego Dapper Fancy Twill Haze Kingston Looped In Melange Modern Tweed Rivers Spencer Texnet Ultrasuede	<b>H</b> Bella Cato Chic Doily Dynamic Florescence In Step Knoll Velvet Limani North Island Stripe It
<b>B</b> Attire Boundary Diva Ferry Helios Journey	<b>C</b> Circa Classic Boucle Entwine Plaid On Pullman Swing Utmost II Utopia Wow Factor	<b>F</b> Atelier Calais Cotton Velvet Cornaro Rivington Tweed Frieze	<b>I</b> Bella Cato Chic Doily Dynamic Florescence In Step Knoll Velvet Limani North Island Stripe It	<b>U</b> Volo	<b>X</b> Ducale Velour
				<b>V</b> Acqua Amalfi Andes España Velluto Pelle	<b>Y</b> Cervo Copenhagen Lucca Marissa Riva
				<b>W</b> Alaska Antique Forte Sabrina	
				© Fire Retardant Chemicals	
				Check with your KnollTextiles or Spinneybeck Representative for changes or additions.	

# Piero Lissoni

## Avio™ Sofa Collection

Designer(s):  
Piero Lissoni, 2018



description	w	d	h	weight	textile fabric yds.	req. leather sq. ft.	base	table top finish
<b>AVC81</b> Four-seat sofa, righthand L-shaped table, asymmetric seat	123 3/8"	115 3/4"	28 1/2"	628 lbs.	17.1	355	chrome	Nero Marquina or Carrara
	123 3/8"	115 3/4"	28 1/2"	628 lbs.	17.1	355	chrome	Verdi Alpi
	123 3/8"	115 3/4"	28 1/2"	628 lbs.	17.1	355	silver or black	Nero Marquina or Carrara
	123 3/8"	115 3/4"	28 1/2"	628 lbs.	17.1	355	silver or black	Verdi Alpi

<b>AVC82</b> Four-seat sofa, lefthand L-shaped table, asymmetric seat	123 3/8"	115 3/4"	28 1/2"	628 lbs.	17.1	355	chrome	Nero Marquina or Carrara
	123 3/8"	115 3/4"	28 1/2"	628 lbs.	17.1	355	chrome	Verdi Alpi
	123 3/8"	115 3/4"	28 1/2"	628 lbs.	17.1	355	silver or black	Nero Marquina or Carrara
	123 3/8"	115 3/4"	28 1/2"	628 lbs.	17.1	355	silver or black	Verdi Alpi

Order Code	Ordering Information	Construction
<i>Example:</i> <b>AVC81-S-GCS-K2074/2</b>	<i>Base Finish:</i> Silver paint (suffix S) Polished Chrome (suffix C) Black Paint (suffix 1)	<i>Frame:</i> Seats are suspended on a central beam structure made in heavy gauge tubular steel. These beams are interconnected to obtain several configurations and are attached to the legs. Each seat is attached to the metal structure through an individual frame.
<b>AVC81</b> Avio four-seat sofa, righthand L-shaped table, asymmetric seat	<i>Table top finish:</i> Satin Nero Marquina marble (suffix MNS) Satin Verdi Alpi marble (suffix MVS) Satin Carrara marble (suffix GCS)	<i>Upholstery:</i> Seat and back cushions with variable density foam covered with polyester fiberfills to enhance comfort. Slip covers are completely removable.
<b>S</b> Silver paint	<i>Upholstery/COM Information:</i> Prices shown include fabric or leather upholstery. Contact your Knoll representative for colors. Only approved KnollTextiles and Spinneybeck leather may be ordered.	
<b>GCS</b> Satin Carrara marble	Customer's Own Material is available pending approval. For approval requirements, processing instructions and ordering information please see page 21.	
<b>K2074/2</b> Aegean, Lemon	<i>Maintenance:</i> See pages 28-29.	
<i>Specify:</i>		
1. Pattern number		
2. Base finish selection		
3. Table top finish selection		
4. Textile/leather selection		

pattern no.	grades <b>A</b>	COM <b>B</b>	<b>C</b>	<b>D</b>	<b>E</b>	<b>F</b>	<b>G</b>	<b>H</b>	<b>I</b>	COL <b>U</b>	<b>V</b>	<b>W</b>	<b>X</b>	<b>Y</b>
<b>AVC81-C-(MNS,GCS)-()</b>	\$44,012.	\$44,881.	\$45,675.	\$45,838.	\$46,160.	\$47,210.	\$49,545.	\$50,518.	\$52,846.	\$56,429.	\$62,239.	\$66,389.	\$68,293.	\$70,200.
<b>AVC81-C-MVS-()</b>	45,796.	46,663.	47,458.	47,622.	47,941.	48,992.	51,327.	52,298.	54,628.	58,211.	64,022.	68,171.	70,076.	71,983.
<b>AVC81-(S,1)-(MNS,GCS)-()</b>	40,986.	41,854.	42,649.	42,812.	43,133.	44,183.	46,518.	47,489.	49,819.	53,388.	59,198.	63,346.	65,251.	67,159.
<b>AVC81-(S,1)-MVS-()</b>	42,769.	43,637.	44,432.	44,594.	44,917.	45,966.	48,301.	49,273.	51,602.	55,169.	60,981.	65,129.	67,034.	68,942.

<b>AVC82-C-(MNS,GCS)-()</b>	44,012.	44,881.	45,675.	45,838.	46,160.	47,210.	49,545.	50,518.	52,846.	56,429.	62,239.	66,389.	68,293.	70,200.
<b>AVC82-C-MVS-()</b>	45,796.	46,663.	47,458.	47,622.	47,941.	48,992.	51,327.	52,298.	54,628.	58,211.	64,022.	68,171.	70,076.	71,983.
<b>AVC82-(S,1)-(MNS,GCS)-()</b>	40,986.	41,854.	42,649.	42,812.	43,133.	44,183.	46,518.	47,489.	49,819.	53,388.	59,198.	63,346.	65,251.	67,159.
<b>AVC82-(S,1)-MVS-()</b>	42,769.	43,637.	44,432.	44,594.	44,917.	45,966.	48,301.	49,273.	51,602.	55,169.	60,981.	65,129.	67,034.	68,942.

Approved KnollTextiles Grades/Fabrics				Spinneybeck Leather	
<b>A</b> Common Ground Commuter Cloth Crossroad Delite Facet Hourglass Mariner Oh La La Presto Soliloquy Sonnnet Trophy Uni-Form	<b>B</b> continued Keaton Knoll Felt Knoll Hopsack Little Devil Prairie Puff Ransom Shadow Play Summit Sutton Synth Venue Westwood	<b>D</b> Buzz Cavalier Pathway Retreat Vice Versa Woodland	<b>E</b> Aegean Circle Point Highland Off The Grid Seurat Tempest	<b>G</b> Alter Ego Dapper Fancy Twill Haze Kingston Looped In Melange Modern Tweed Rivers Spencer Texnet Ultrasuede	<b>H</b> Alaska Antique Forte Sabrina
<b>B</b> Attire Boundary Diva Ferry Helios Journey	<b>C</b> Circa Classic Boucle Entwine Plaid On Pullman Swing Utmost II Utopia Wow Factor	<b>F</b> Atelier Calais Cotton Velvet Cornaro Rivington Tweed Frieze	<b>I</b> Bella Cato Chic Doily Dynamic Florescence In Step Knoll Velvet Limani North Island Stripe It	<b>U</b> Volo	<b>X</b> Ducale Velour
				<b>V</b> Acqua Amalfi Andes España Velluto Pelle	<b>Y</b> Cervo Copenhagen Lucca Marissa Riva
				<b>W</b> Alaska Antique Forte Sabrina	
					© Fire Retardant Chemicals
					<i>Check with your KnollTextiles or Spinneybeck Representative for changes or additions.</i>

Piero Lissoni  
Avio™ Sofa Collection

Designer(s):  
Piero Lissoni, 2018

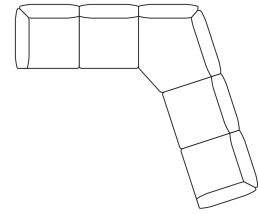

description	w	d	h	weight	textile fabric yds.	req. leather sq. ft.	base	table top finish
<b>AVC87</b> Five-seat sofa, asymmetric center seat	126"	106 3/4"	28 1/2"	514 lbs.	22.1	455	chrome	n/a
	126"	106 3/4"	28 1/2"	514 lbs.	22.1	455	silver or black	n/a

pattern no.	grades <b>A</b>	COM <b>B</b>	<b>C</b>	<b>D</b>	<b>E</b>	<b>F</b>	<b>G</b>	<b>H</b>	<b>I</b>	COL <b>U</b>	<b>V</b>	<b>W</b>	<b>X</b>	<b>Y</b>
<b>AVC87-C-()</b>	\$38,881.	\$40,003.	\$41,028.	\$41,242.	\$41,656.	\$43,012.	\$46,032.	\$47,287.	\$50,298.	\$54,672.	\$62,118.	\$67,436.	\$69,880.	\$72,323.
<b>AVC87-(S,1)-()</b>	36,840.	37,963.	38,990.	39,201.	39,616.	40,971.	43,991.	45,248.	48,254.	52,609.	60,054.	65,374.	67,818.	70,260.

Order Code	Ordering Information	Construction
<i>Example:</i> <b>AVC87-S-GCS-K2074/2</b>	<i>Base Finish:</i> Silver paint (suffix S) Polished Chrome (suffix C) Black Paint (suffix 1)	<i>Frame:</i> Seats are suspended on a central beam structure made in heavy gauge tubular steel. These beams are interconnected to obtain several configurations and are attached to the legs. Each seat is attached to the metal structure through an individual frame.
<b>AVC87</b> Avio five-seat sofa, asymmetric center seat		
<b>S</b> Silver paint		
<b>GCS</b> Satin Carrara marble	<i>Table top finish:</i> Satin Nero Marquina marble (suffix MNS) Satin Verdi Alpi marble (suffix MVS) Satin Carrara marble (suffix GCS)	<i>Upholstery:</i> Seat and back cushions with variable density foam covered with polyester fiberfills to enhance comfort. Slip covers are completely removable.
<b>K2074/2</b> Aegean, Lemon		
<i>Specify:</i>	<i>Upholstery/COM Information:</i> Prices shown include fabric or leather upholstery. Contact your Knoll representative for colors. Only approved KnollTextiles and Spinneybeck leather may be ordered.	
1. Pattern number	Customer's Own Material is available pending approval. For approval requirements, processing instructions and ordering information please see page 21.	
2. Base finish selection		
3. Table top finish selection		
4. Textile/leather selection	<i>Maintenance:</i> See pages 28-29.	

Approved KnollTextiles Grades/Fabrics				Spinneybeck Leather	
<b>A</b> Common Ground Commuter Cloth Crossroad Delite Facet Hourglass Mariner Oh La La Presto Soliloquy Sonnet Trophy Uni-Form	<b>B</b> continued Keaton Knoll Felt Knoll Hopsack Little Devil Prairie Puff Ransom Shadow Play Summit Sutton Synth Venue Westwood	<b>D</b> Buzz Cavalier Pathway Retreat Vice Versa Woodland	<b>G</b> Alter Ego Dapper Fancy Twill Haze Kingston Looped In Melange Modern Tweed Rivers Spencer Texnet Ultrasuede	<b>U</b> Volo	<b>X</b> Ducale Velour
<b>B</b> Attire Boundary Diva Ferry Helios Journey	<b>C</b> Circa Classic Boucle Entwine Plaid On Pullman Swing Utmost II Utopia Wow Factor	<b>E</b> Aegean Circle Point Highland Off The Grid Seurat Tempest	<b>H</b>	<b>V</b> Acqua Amalfi Andes España Velluto Pelle	<b>Y</b> Cervo Copenhagen Lucca Marissa Riva
		<b>F</b> Atelier Calais Cotton Velvet Cornaro Rivington Tweed Frieze	<b>I</b> Bella Cato Chic Doily Dynamic Florescence In Step Knoll Velvet Limani North Island Stripe It	<b>W</b> Alaska Antique Forte Sabrina	
				© Fire Retardant Chemicals	
				<i>Check with your KnollTextiles or Spinneybeck Representative for changes or additions.</i>	

# Piero Lissoni Avio™ Sofa Collection

Designer(s):  
Piero Lissoni, 2018

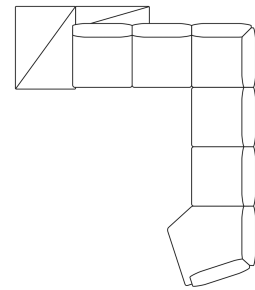

description	w	d	h	weight	textile fabric yds.	req. leather sq. ft.	base	table top finish
<b>AVC90</b> Six-seat sofa, righthand L-shaped table, asymmetric seat	146 1/2"	124 1/2"	28 1/2"	814 lbs.	23.7	495	chrome	Nero Marquina or Carrara
	146 1/2"	124 1/2"	28 1/2"	814 lbs.	23.7	495	chrome	Verdi Alpi
	146 1/2"	124 1/2"	28 1/2"	814 lbs.	23.7	495	silver or black	Nero Marquina or Carrara
	146 1/2"	124 1/2"	28 1/2"	814 lbs.	23.7	495	silver or black	Verdi Alpi

**AVC91** Six-seat sofa, lefthand L-shaped table, asymmetric seat

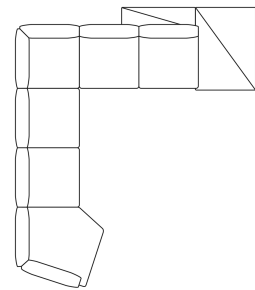

	146 1/2"	124 1/2"	28 1/2"	814 lbs.	23.7	495	chrome	Nero Marquina or Carrara
	146 1/2"	124 1/2"	28 1/2"	814 lbs.	23.7	495	chrome	Verdi Alpi
	146 1/2"	124 1/2"	28 1/2"	814 lbs.	23.7	495	silver or black	Nero Marquina or Carrara
	146 1/2"	124 1/2"	28 1/2"	814 lbs.	23.7	495	silver or black	Verdi Alpi

Order Code	Ordering Information	Construction
------------	----------------------	--------------

<i>Example:</i> <b>AVC90-S-GCS-K2074/2</b>	<i>Base Finish:</i> Silver paint (suffix S) Polished Chrome (suffix C) Black Paint (suffix 1)	<i>Frame:</i> Seats and tables are suspended on a central beam structure made in heavy gauge tubular steel. These beams are interconnected to obtain several configurations and are attached to the legs. Each seat is attached to the metal structure through an individual frame.
<b>AVC90</b> Avio six-seat sofa, righthand L-shaped table		
<b>S</b> Silver paint		
<b>GCS</b> Satin Carrara marble		

*Table top finish:*  
Satin Nero Marquina marble (suffix MNS)  
Satin Verdi Alpi marble (suffix MVS)  
Satin Carrara marble (suffix GCS)

*Specify:*

1. Pattern number
2. Base finish selection
3. Table top finish selection
4. Textile/leather selection

*Upholstery/COM Information:*  
Prices shown include fabric or leather upholstery. Contact your Knoll representative for colors. Only approved KnollTextiles and Spinneybeck leather may be ordered.

Customer's Own Material is available pending approval. For approval requirements, processing instructions and ordering information please see page 21.

*Maintenance:*  
See pages 28-29.

pattern no.	grades <b>A</b>	COM <b>B</b>	<b>C</b>	<b>D</b>	<b>E</b>	<b>F</b>	<b>G</b>	<b>H</b>	<b>I</b>	COL <b>U</b>	<b>V</b>	<b>W</b>	<b>X</b>	<b>Y</b>
<b>AVC90-C-(MNS,GCS)-()</b>	\$56,436.	\$57,637.	\$58,741.	\$58,967.	\$59,412.	\$60,865.	\$64,103.	\$65,449.	\$68,677.	\$72,488.	\$80,589.	\$86,374.	\$89,033.	\$91,691.
<b>AVC90-C-MVS-()</b>	58,218.	59,420.	60,523.	60,750.	61,194.	62,648.	65,886.	67,233.	70,460.	74,271.	82,371.	88,157.	90,815.	93,473.
<b>AVC90-(S,1)-(MNS,GCS)-()</b>	52,922.	54,126.	55,228.	55,454.	55,899.	57,354.	60,590.	61,937.	65,165.	70,205.	78,305.	84,091.	86,749.	89,408.
<b>AVC90-(S,1)-MVS-()</b>	54,706.	55,908.	57,010.	57,237.	57,682.	59,137.	62,373.	63,720.	66,948.	71,988.	80,087.	85,874.	88,532.	91,190.

<b>AVC91-C-(MNS,GCS)-()</b>	56,436.	57,637.	58,741.	58,967.	59,412.	60,865.	64,103.	65,449.	68,677.	72,488.	80,589.	86,374.	89,033.	91,691.
<b>AVC91-C-MVS-()</b>	58,218.	59,420.	60,523.	60,750.	61,194.	62,648.	65,886.	67,233.	70,460.	74,271.	82,371.	88,157.	90,815.	93,473.
<b>AVC91-(S,1)-(MNS,GCS)-()</b>	52,922.	54,126.	55,228.	55,454.	55,899.	57,354.	60,590.	61,937.	65,165.	70,205.	78,305.	84,091.	86,749.	89,408.
<b>AVC91-(S,1)-MVS-()</b>	54,706.	55,908.	57,010.	57,237.	57,682.	59,137.	62,373.	63,720.	66,948.	71,988.	80,087.	85,874.	88,532.	91,190.

Approved KnollTextiles Grades/Fabrics	Spinneybeck Leather
---------------------------------------	---------------------

<b>A</b> Common Ground Commuter Cloth Crossroad Delite Facet Hourglass Mariner Oh La La Presto Soliloquy Sonnet Trophy Uni-Form	<b>B</b> continued Keaton Knoll Felt Knoll Hopsack Little Devil Prairie Puff Ransom Shadow Play Summit Sutton Synth Venue Westwood	<b>D</b> Buzz Cavalier Pathway Retreat Vice Versa Woodland	<b>E</b> Aegean Circle Point Highland Off The Grid Seurat Tempest	<b>F</b> Atelier Calais Cotton Velvet Cornaro Rivington Tweed Frieze	<b>G</b> Alter Ego Dapper Fancy Twill Haze Kingston Looped In Melange Modern Tweed Rivers Spencer Texnet Ultrasuede	<b>H</b>	<b>I</b> Bella Cato Chic Doily Dynamic Florescence In Step Knoll Velvet Limani North Island Stripe It	<b>U</b> Volo	<b>X</b> Ducale Velour	<b>V</b> Acqua Amalfi Andes España Velluto Pelle	<b>Y</b> Cervo Copenhagen Lucca Marissa Riva	<b>W</b> Alaska Antique Forte Sabrina	<b>©</b> Fire Retardant Chemicals
--	---	--	---	--	---	----------	--	------------------	---------------------------	---	---	---	-----------------------------------

*Check with your KnollTextiles or Spinneybeck Representative for changes or additions.*

Piero Lissoni  
Avio™ Sofa Collection

Designer(s):  
Piero Lissoni, 2018



description	w	d	h	weight	textile fabric yds.	req. leather sq. ft.	base
<b>AVC93</b> Five-seat L-Shaped sofa	97 1/4"	97 1/4"	28 1/2"	489 lbs.	21.4	475	chrome
	97 1/4"	97 1/4"	28 1/2"	489 lbs.	21.4	475	silver or black

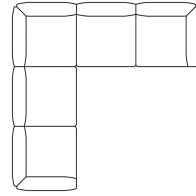

<b>AVC94</b> Six-seat L-shaped sofa, left hand	127 3/8"	97 1/4"	28 1/2"	581 lbs.	24.6	550	chrome
	127 3/8"	97 1/4"	28 1/2"	581 lbs.	24.6	550	silver or black

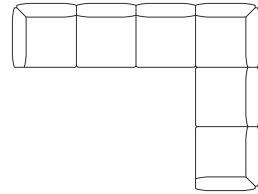

<b>AVC95</b> Six-seat L-shaped sofa, right hand	127 3/8"	97 1/4"	28 1/2"	581 lbs.	24.6	550	chrome
	127 3/8"	97 1/4"	28 1/2"	581 lbs.	24.6	550	silver or black

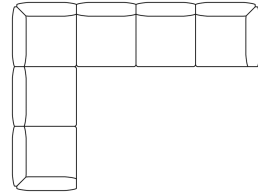

Order Code	Ordering Information	Construction
<i>Example:</i> <b>AVC93-S-K2074/2</b>	<i>Base Finish:</i> Silver paint (suffix S) Polished Chrome (suffix C) Black Paint (suffix 1)	<i>Frame:</i> Seats are suspended on a central beam structure made in heavy gauge tubular steel. These beams are interconnected to obtain several configurations and are attached to the legs. Each seat is attached to the metal structure through an individual frame.
<b>AVC93</b> Avio Five-Seat L-Shaped Sofa		
<b>S</b> Silver paint		
<b>K2074/2</b> Aegean, Lemon	<i>Upholstery/COM Information:</i> Prices shown include fabric or leather upholstery. Contact your Knoll representative for colors. Only approved KnollTextiles and Spinneybeck leather may be ordered.  Customer's Own Material is available pending approval. For approval requirements, processing instructions and ordering information please see page 18.	<i>Upholstery:</i> Seat and back cushions with variable density foam covered with polyester fiberfills to enhance comfort. Slip covers are completely removable.
	<i>Maintenance:</i> See pages 28-29.	

Specify:

1. Pattern number
2. Base finish selection
3. Textile/leather selection

pattern no.	grades <b>A</b>	COM <b>B</b>	<b>C</b>	<b>D</b>	<b>E</b>	<b>F</b>	<b>G</b>	<b>H</b>	<b>I</b>	COL <b>U</b>	<b>V</b>	<b>W</b>	<b>X</b>	<b>Y</b>
<b>AVC93-C-( )</b>	\$35,322.	\$36,165.	\$37,096.	\$37,776.	\$38,664.	\$39,710.	\$40,770.	\$41,135.	\$43,559.	\$51,072.	\$57,035.	\$64,741.	\$66,898.	\$69,022.
<b>AVC93-(S,1)-( )</b>	34,028.	34,874.	35,805.	36,484.	37,371.	38,416.	39,477.	39,840.	42,267.	49,721.	55,686.	63,390.	65,547.	67,671.

<b>AVC94-C-( )</b>	41,921.	42,892.	43,963.	44,744.	45,763.	46,966.	48,187.	48,602.	51,393.	60,309.	67,215.	76,137.	78,632.	81,094.
<b>AVC94-(S,1)-( )</b>	40,396.	41,367.	42,438.	43,218.	44,239.	45,439.	46,660.	47,078.	49,866.	58,706.	65,610.	74,533.	77,028.	79,491.

<b>AVC95-C-( )</b>	41,921.	42,892.	43,963.	44,744.	45,763.	46,966.	48,187.	48,602.	51,393.	60,309.	67,215.	76,137.	78,632.	81,094.
<b>AVC95-(S,1)-( )</b>	40,396.	41,367.	42,438.	43,218.	44,239.	45,439.	46,660.	47,078.	49,866.	58,706.	65,610.	74,533.	77,028.	79,491.

Approved KnollTextiles Grades/Fabrics				Spinneybeck Leather	
<b>A</b> Common Ground Commuter Cloth Crossroad Delite Facet Hourglass Mariner Oh La La Presto Soliloquy Sonnnet Trophy Uni-Form	<b>B</b> continued Keaton Knoll Felt Knoll Hopsack Little Devil Prairie Puff Ransom Shadow Play Summit Sutton Synth Venue Westwood	<b>D</b> Buzz Cavalier Pathway Retreat Vice Versa Woodland	<b>E</b> Aegean Circle Point Highland Off The Grid Seurat Tempest	<b>G</b> Alter Ego Dapper Fancy Twill Haze Kingston Looped In Melange Modern Tweed Rivers Spencer Texnet Ultrasuede	<b>H</b> Bella Cato Chic Doily Dynamic Floressence In Step Knoll Velvet Limani North Island Stripe It
<b>B</b> Attire Boundary Diva Ferry Helios Journey	<b>C</b> Circa Classic Boucle Entwine Plaid On Pullman Swing Utmost II Utopia Wow Factor	<b>F</b> Atelier Calais Cotton Velvet Cornaro Rivington Tweed Frieze	<b>I</b> Bella Cato Chic Doily Dynamic Floressence In Step Knoll Velvet Limani North Island Stripe It	<b>U</b> Volo	<b>X</b> Ducale Velour
				<b>V</b> Acqua Amalfi Andes España Velluto Pelle	<b>Y</b> Cervo Copenhagen Lucca Marissa Riva
				<b>W</b> Alaska Antique Forte Sabrina Ⓢ Fire Retardant Chemicals	

Check with your KnollTextiles or Spinneybeck Representative for changes or additions.

# Piero Lissoni

## Avio™ Sofa Collection

Designer(s):  
Piero Lissoni, 2018

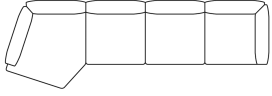
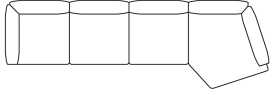
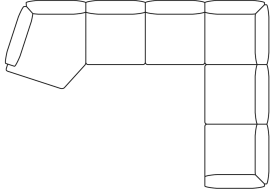
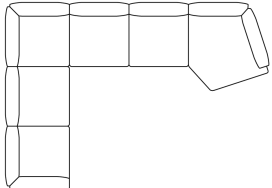

description	w	d	h	weight	textile fabric yds.	req. leather sq. ft.	base
<b>AVC96</b> Four-seat sofa, right hand asymmetric seat 	133 1/2"	45 7/8"	28 1/8"	407 lbs.	17	375	chrome
	133 1/2"	45 7/8"	28 1/8"	407 lbs.	17	375	silver or black
<b>AVC97</b> Four-seat sofa, left hand asymmetric seat 	133 1/2"	45 7/8"	28 1/8"	407 lbs.	17	375	chrome
	133 1/2"	45 7/8"	28 1/8"	407 lbs.	17	375	silver or black
<b>AVC98</b> Six-seat L-shaped sofa, right hand asymmetric seat 	133 1/2"	97 1/4"	28 1/8"	605 lbs.	25.15	550	chrome
	133 1/2"	97 1/4"	28 1/8"	605 lbs.	25.15	550	silver or black
<b>AVC99</b> Six-seat L-shaped sofa, left hand asymmetric seat 	133 1/2"	97 1/4"	28 1/8"	605 lbs.	25.15	550	chrome
	133 1/2"	97 1/4"	28 1/8"	605 lbs.	25.15	550	silver or black

Order Code	Ordering Information	Construction
<i>Example:</i> <b>AVC96-S-K2074/2</b>	<i>Base Finish:</i> Silver paint (suffix S) Polished Chrome (suffix C) Black Paint (suffix 1)	<i>Frame:</i> Seats are suspended on a central beam structure made in heavy gauge tubular steel. These beams are interconnected to obtain several configurations and are attached to the legs. Each seat is attached to the metal structure through an individual frame.
<b>AVC96</b> Avio Four-Seat Sofa, Right Hand Asymmetric Seat	<i>Upholstery/COM Information:</i> Prices shown include fabric or leather upholstery. Contact your Knoll representative for colors. Only approved KnollTextiles and Spinneybeck leather may be ordered.	<i>Upholstery:</i> Seat and back cushions with variable density foam covered with polyester fiberfills to enhance comfort. Slip covers are completely removable.
<b>S</b> Silver paint	Customer's Own Material is available pending approval. For approval requirements, processing instructions and ordering information please see page 18.	
<b>K2074/2</b> Aegean, Lemon	<i>Maintenance:</i> See pages 28-29.	
<i>Specify:</i> 1. Pattern number 2. Base finish selection 3. Textile/leather selection		

pattern no.	grades <b>A</b>	COM <b>B</b>	<b>C</b>	<b>D</b>	<b>E</b>	<b>F</b>	<b>G</b>	<b>H</b>	<b>I</b>	COL <b>U</b>	<b>V</b>	<b>W</b>	<b>X</b>	<b>Y</b>
<b>AVC96-C-()</b>	\$30,174.	\$30,844.	\$31,583.	\$32,123.	\$32,828.	\$33,658.	\$34,502.	\$34,790.	\$36,717.	\$42,751.	\$47,461.	\$53,542.	\$55,243.	\$56,922.
<b>AVC96-(S,1)-()</b>	29,075.	29,745.	30,486.	31,025.	31,731.	32,560.	33,403.	33,692.	35,619.	41,608.	46,315.	52,398.	54,101.	55,779.
<b>AVC97-C-()</b>	30,174.	30,844.	31,583.	32,123.	32,828.	33,658.	34,502.	34,790.	36,717.	42,751.	47,461.	53,542.	55,243.	56,922.
<b>AVC97-(S,1)-()</b>	29,075.	29,745.	30,486.	31,025.	31,731.	32,560.	33,403.	33,692.	35,619.	41,608.	46,315.	52,398.	54,101.	55,779.
<b>AVC98-C-()</b>	43,767.	44,759.	45,852.	46,653.	47,695.	48,924.	50,171.	50,596.	53,448.	62,175.	69,081.	78,002.	80,497.	82,960.
<b>AVC98-(S,1)-()</b>	42,164.	43,156.	44,250.	45,049.	46,092.	47,320.	48,567.	48,995.	51,846.	60,492.	67,400.	76,322.	78,816.	81,279.
<b>AVC99-C-()</b>	43,767.	44,759.	45,852.	46,653.	47,695.	48,924.	50,171.	50,596.	53,448.	62,175.	69,081.	78,002.	80,497.	82,960.
<b>AVC99-(S,1)-()</b>	42,164.	43,156.	44,250.	45,049.	46,092.	47,320.	48,567.	48,995.	51,846.	60,492.	67,400.	76,322.	78,816.	81,279.

Approved KnollTextiles Grades/Fabrics				Spinneybeck Leather	
<b>A</b> Common Ground Commuter Cloth Crossroad Delite Facet Hourglass Mariner Oh La La Presto Soliloquy Sonnnet Trophy Uni-Form	<b>B</b> continued Keaton Knoll Felt Knoll Hopsack Little Devil Prairie Puff Ransom Shadow Play Summit Sutton Synth Venue Westwood	<b>D</b> Buzz Cavalier Pathway Retreat Vice Versa Woodland	<b>G</b> Alter Ego Dapper Fancy Twill Haze Kingston Looped In Melange Modern Tweed Rivers Spencer Texnet Ultrasuede	<b>U</b> Volo	<b>X</b> Ducale Velour
<b>B</b> Attire Boundary Diva Ferry Helios Journey	<b>C</b> Circa Classic Boucle Entwine Plaid On Pullman Swing Utmost II Utopia Wow Factor	<b>E</b> Aegean Circle Point Highland Off The Grid Seurat Tempest	<b>H</b>	<b>V</b> Acqua Amalfi Andes España Velluto Pelle	<b>Y</b> Cervo Copenhagen Lucca Marissa Riva
		<b>F</b> Atelier Calais Cotton Velvet Cornaro Rivington Tweed Frieze	<b>I</b> Bella Cato Chic Doily Dynamic Floressence In Step Knoll Velvet Limani North Island Stripe It	<b>W</b> Alaska Antique Forte Sabrina Ⓢ Fire Retardant Chemicals	

Check with your KnollTextiles or Spinneybeck Representative for changes or additions.



# Ross Lovegrove

## Sprite Armless Chair

Designer(s):  
Ross Lovegrove, 2004



description	face/back	seat h	w	d	h	textile fabric yds.	leather sq ft.	weight
<b>27C</b> Same finish, face and back	maple/maple	17"	18 1/4"	22"	32"	0.5	10	10 lbs.
	paint A/paint A	17"	18 1/4"	22"	32"	0.5	10	10 lbs.
	veneer/veneer	17"	18 1/4"	22"	32"	0.5	10	10 lbs.
<b>27C</b> Combination face and back	maple/paint or paint/maple	17"	18 1/4"	22"	32"	0.5	10	10 lbs.
	paint A/paint B or paint B/Paint A	17"	18 1/4"	22"	32"	0.5	10	10 lbs.
	veneer/paint or paint/veneer	17"	18 1/4"	22"	32"	0.5	10	10 lbs.
Sprite Dolly			14.5"	31"	26.5"			10 lbs.
<b>27CGA</b> Sprite Ganging Mechanism, Armless								
<b>TR</b> Sprite Tablet Arm			9 1/4"	13"				

### Order Code

Example: **27CTR-KC-BL-C-K(VP-BLK)**

<b>27C</b>	Armless chair
<b>TR</b>	Tablet Arm (\$394 list upcharge)
<b>KC</b>	Rotary Maple face
<b>BL</b>	Black painted back
<b>C</b>	Chrome legs
<b>K</b>	Seat cushion
<b>VP-BLK</b>	Velluto Pelle, Black

### Specify:

1. Pattern number
2. Optional tablet arm (\$394 list upcharge)
3. Finish selection, face
4. Finish selection, back
5. Leg finish (chrome only)
6. Seat cushion option
7. Textile selection

### Ordering Information:

Maple finish:  
Rotary Maple (suffix KC)

### Exotic Alpi and Veneer finishes:

- Beech (suffix BN)
- Cherry (suffix CY)
- Walnut (suffix WA)
- Zebra (suffix ZE)
- Macasser Ebony (suffix ME)
- Black and White Woodgrain (suffix WB)

### Construction

**Shell:**  
Molded plywood shell made of six layers of maple and three layers of adhesive.

**Alpi Veneers:**  
Reconstituted veneers made of both plantation poplar and Obece/Ayous, a bland African wood from well-managed sources with a long term forestry management plan.

**Leg finish:**  
Chrome (suffix C)

**Maintenance:**  
See pages 28-29.

**Cal 133 Fire Code ▲:**  
The Sprite chair complies with the Cal 133 standard if unupholstered or if upholstered in Cal 133 approved upholstery. Specify suffix -C at end of pattern number and suffix -133 at end of textile selection. Upcharge applies, see page 22.

**Note:**  
The Sprite Chair is certified Clean Air GOLD.

**Base:**  
3/8" tubular steel with mirror chrome finish. Shell connected to the seat with four screws. Four rubber bumpers assure proper stacking.

**Upholstery:**  
Seat pad, upholstered in fabric or leather with urethane foam. Water based glue used for upholstery. Seat pad is attached to chair by four screws.

**Stacking:**  
Armless Sprite chairs without seatpad can stack 8-10 high, with seatpad, 4-6.

**Transportation Dolly:**  
Chrome plated steel frame with rubber wheels, 10-12 Sprite armless chairs can stack on a dolly. Dolly with 10 armless chairs measures: 53" h x 40" w x 22" d

**Ganging Mechanism:**  
Armless mechanism measures 7.4". Device is constructed of a low durometer thermoplastic elastomer with a neodymium magnet. When not in use, the mechanism is easily stored (magnetized) to the underside of the chair.

**Tablet Arm:**  
Tablet is right-handed with a fixed, chrome-plated arm. Integral to the frame, the tablet is black laminate with a 1/2" beveled birch edge. Tablet is factory installed and cannot be retrofitted in the field. For left handed version, please contact CPD. Sprite tablet arm passes BIFMA standards. Sprite chairs with tablet arm stack 4 high.

pattern no.	unuphol. (remove suffix -k)	grades	COM	C	D	E	F	G	H	I	COL	V	W	X	Y
<b>27C-(KC)-(KC)-C-K</b>	\$874.	\$1,091.	\$1,117.	\$1,134.	\$1,161.	\$1,180.	\$1,196.	\$1,220.	\$1,266.	\$1,299.	\$1,446.	\$1,536.	\$1,722.	\$1,762.	\$1,806.
<b>27C-(-)(-)-C-K</b>	1,048.	1,268.	1,292.	1,315.	1,336.	1,357.	1,372.	1,395.	1,444.	1,475.	1,623.	1,710.	1,897.	1,939.	1,983.
<b>27C-(-)(-)-C-K</b>	1,467.	1,686.	1,705.	1,729.	1,753.	1,768.	1,790.	1,808.	1,858.	1,890.	2,038.	2,127.	2,316.	2,355.	2,402.
<b>27C-(-)(-)-C-K</b>	1,091.	1,314.	1,335.	1,357.	1,379.	1,400.	1,414.	1,439.	1,487.	1,519.	1,665.	1,756.	1,941.	1,982.	2,028.
<b>27C-(-)(-)-C-K</b>	1,170.	1,391.	1,414.	1,438.	1,461.	1,481.	1,496.	1,520.	1,565.	1,597.	1,750.	1,837.	2,024.	2,062.	2,108.
<b>27C-(-)(-)-C-K</b>	1,533.	1,753.	1,772.	1,797.	1,821.	1,840.	1,855.	1,881.	1,927.	1,957.	2,103.	2,196.	2,380.	2,420.	2,467.
<b>27DOLLY</b>	962.														
<b>27CGA</b>	38.														
<b>TR</b>	678.														

### Approved KnollTextiles Grades/Fabrics

<b>A</b> Alignment Bocce Common Ground Commuter Cloth Crossroad Delite Facet Foil Rap Heavy Metal Hourglass Mariner Monarch Overture Prep Presto Sonnet Uni-Form	<b>B</b> Abacus Argyle Belize Bistro Boundary Calypso Chronicle Close Knit Cozy Cord Digital Tape Diva Ferry Forza Grande Grandview Helios Holbrook	<b>C</b> continued Cairo Charm Circa Classic Boucle Contour Durand Earthwork Empire Stripe Essence Fibra Greenwich Hudson Lagos Lore CR Milestone Palisade Plaid On Posh Summit Sutton Tabloid Tinge Vast Versa Vinyl Westwood Yeni	<b>C</b> continued Wit Zari CR	<b>D</b> Coterie Eclat Weave Hologram Island Menagerie Origins Pathway Vice Versa Woodland Zoom	<b>E</b> Aegean Circle Point Cleo Currents Demure Flower Power Highland Ikat Stripe Juno Kampala Kimono Mamba Marquee Meroe Midpoint Nature Walk Off The Grid Sherman Shima Vatera Whip	<b>F</b> Atelier Biscayne Calais Cotton Velvet Century Homage * In Stitches Liberty Mod Plaid Rivington Soon Totem Tweed Frieze	<b>G</b> Alter Ego Andissa Aurora * Djenne Duchess Gibson Haze Kamani Melange Modern Tweed Rivers * Spencer Straie Stripe Texnet Ultrasuede Vert	<b>H</b> Bavaria Catwalk Constance Firefly Stretch Appeal	<b>I</b> Aswan Byron Cato Diamond Days Doily Dynamic Guisse Hastings Ita Jaipur Knoll Velvet Limani North Island Olema Piper Prince Hair Rutledge Sandis Zimba	<b>U</b> Vicenza Volo	<b>V</b> Acqua Amalfi Andes Embossed Tipped España Hand Tipped Maremma Velluto Pelle	<b>W</b> Alaska Amazon Antique Derby Forte Lucente Sabrina	<b>X</b> Ducale Ducale Velour	<b>Y</b> Cascia Cervo Copenhagen Distressed Marissa Portofino Riva Saddle
---	--	--	--------------------------------------	---	--	--	--	--	---	-----------------------------	--	---	-------------------------------------	---

### Spinneybeck Leather

<b>U</b> Vicenza Volo	<b>V</b> Acqua Amalfi Andes Embossed Tipped España Hand Tipped Maremma Velluto Pelle	<b>W</b> Alaska Amazon Antique Derby Forte Lucente Sabrina	<b>X</b> Ducale Ducale Velour	<b>Y</b> Cascia Cervo Copenhagen Distressed Marissa Portofino Riva Saddle
-----------------------------	--	---	-------------------------------------	---



© Fire Retardant Chemicals

Check with your KnollTextiles or Spinneybeck Representative for changes or additions.

# Ross Lovegrove Sprite Arm Chair

Designer(s):  
Ross Lovegrove, 2004



description	face/back/arm	arm h	seat h	w	d	h	textile fabric yds.	leather sq ft.	weight
<b>27A</b> Same finish, face and back 	maple/maple/urethane arms	25 1/2"	17"	29"	22"	32"	0.5	10	13 lbs.
	paint A/paint A/urethane arms	25 1/2"	17"	29"	22"	32"	0.5	10	13 lbs.
	veneer/veneer/urethane arms	25 1/2"	17"	29"	22"	32"	0.5	10	13 lbs.
<b>27A</b> Combination, face and back 	maple/paint or paint/maple urethane arms	25 1/2"	17"	29"	22"	32"	0.5	10	13 lbs.
	paint A/paint B or paint B/paint A urethane arms	25 1/2"	17"	29"	22"	32"	0.5	10	13 lbs.
	veneer/paint or paint/veneer urethane arms	25 1/2"	17"	29"	22"	32"	0.5	10	13 lbs.
Sprite Dolly 				14.5"	31"	26.5"			10 lbs.
<b>27AGA</b> Sprite Ganging Mechanism, Arm									

### Order Code

Example:	<b>27C-KC-BL-C-BP-K(VP-BLK)</b>
<b>27C</b>	Armless chair
<b>KC</b>	Rotary Maple face
<b>BL</b>	Black painted back
<b>C</b>	Chrome legs
<b>BP</b>	Urethane arms
<b>K</b>	Seat cushion
<b>VP-BLK</b>	Velluto Pelle, Black

### Specify:

- Pattern number
- Finish selection, face
- Finish selection, back
- Leg finish (chrome only)
- Arm finish
- Seat cushion option
- Textile selection

### Ordering Information:

Maple finish:  
Rotary Maple (suffix KC)

### Exotic Alpi and Veneer finishes:

- Beech (suffix BN)
- Cherry (suffix CY)
- Walnut (suffix WA)
- Zebra (suffix ZE)
- Macasser Ebony (suffix ME)
- Black and White Woodgrain (suffix WB)

### Construction

**Shell:**  
Molded plywood shell made of six layers of maple and three layers of adhesive.

**Paint:**  
Smooth highly durable paint.

**Edge finish:**  
On chairs painted one color, edge will be painted. For chairs in two-tone combination or with veneer option, edge will be natural maple. For chairs in Exotic Alpi veneer finish, edges are natural maple. For high use applications, maple or veneer options are recommended.

**Base:**  
3/8" tubular steel with mirror chrome finish. Shell connected to the seat with four screws. Four rubber bumpers assure proper stacking.

**Note:**  
The Sprite Chair is certified Clean Air GOLD.

**Upholstery:**  
Seat pad, upholstered in fabric or leather with urethane foam. Water based glue used for upholstery. Seat pad is attached to chair by four screws.

**Armpads:**  
Black self skinning polyurethane pads (available on painted or maple/veneer chairs).

**Stacking:**  
Arm Sprite chairs with or without seatpad can stack 4-6 high.

**Transportation Dolly:**  
Chrome-plated steel frame with rubber wheels. 4-6 Sprite arm chairs stack on a dolly. Dolly with 10 armless chairs measures: 53" h x 40" w x 29" d

**Ganging Mechanism**  
Arm mechanism measures 10". Device is constructed of a low durometer thermoplastic elastomer with a neodymium magnet. When not in use, the mechanism is easily stored (magnetized) to the underside of the chair.

pattern no.	unuphol. (remove suffix -k)	grades A	COM B	C	D	E	F	G	H	I	COL U	V	W	X	Y
<b>27A-(KC)-(KC)-C-(BP)-K</b>	\$1,189.	\$1,412.	\$1,438.	\$1,458.	\$1,487.	\$1,507.	\$1,520.	\$1,548.	\$1,595.	\$1,632.	\$1,782.	\$1,880.	\$2,071.	\$2,113.	\$2,157.
<b>27A-( )-( )-C-(BP)-K</b>	1,282.	1,510.	1,534.	1,557.	1,586.	1,602.	1,617.	1,644.	1,693.	1,727.	1,881.	1,975.	2,163.	2,209.	2,253.
<b>27A-( )-( )-C-(BP)-K</b>	1,704.	1,934.	1,956.	1,979.	2,004.	2,028.	2,039.	2,069.	2,114.	2,148.	2,302.	2,398.	2,586.	2,634.	2,678.
<b>27A-(KC)-( )-C-(BP)-K</b>	1,330.	1,559.	1,586.	1,602.	1,633.	1,652.	1,665.	1,694.	1,740.	1,772.	1,928.	2,024.	2,215.	2,260.	2,304.
<b>27A-( )-( )-C-(BP)-K</b>	1,407.	1,636.	1,659.	1,682.	1,705.	1,729.	1,740.	1,767.	1,813.	1,849.	2,003.	2,098.	2,290.	2,331.	2,378.
<b>27A-( )-( )-C-(BP)-K</b>	1,778.	2,005.	2,031.	2,050.	2,079.	2,099.	2,113.	2,143.	2,192.	2,221.	2,375.	2,471.	2,663.	2,706.	2,751.
<b>27DOLLY</b>	962.														
<b>27AGA</b>	38.														

### Approved KnollTextiles Grades/Fabrics

<b>A</b> Alignment Bocce Common Ground Commuter Cloth Crossoad Delite Facet Foil Rap Heavy Metal Hourglass Mariner Monarch Overture Prep Presto Sonnet Uni-Form	<b>B</b> continued Journey Keaton Knoll Felt Knoll Hopsack Little Devil Ludlow Melody (TM) Paradigm Petal Pusher (TM) Prairie Prim Puff Radiance Ransom Roam Rush Hour Spree Summit Sutton Tabloid Tinge Vast Versa Vinyl (TM) Westwood Yeni	<b>C</b> continued Cairo Charm Circa Classic Boucle Contour Durand Earthwork Empire Stripe Essence Fibra Greenwich Hudson Kaleidoscope CR Lagos Lore CR Milestone Palisade Plaid On Posh Prestini Pullman Quark Roundtrip Sinclair Smart (TM) Spectator Stepping Stones Tight Rope Tilden (TM) Tower Grid	<b>C</b> continued Wit Zari CR	<b>D</b> continued Coterie Eclat Weave Hologram Island Menagerie Origins Pathway Vice Versa Woodland Zoom	<b>E</b> continued Aegean Circle Point Cleo Currents Demure Flower Power Gibson Haze Kamani Limani North Island Olema Piper Prince Hairly Rutledge Sandis Zimba	<b>F</b> continued Atelier Biscayne Calais Cotton Velvet Century Glider Homage * In Stitches Liberty Mod Plaid Rivington Soon Totem Tweed Frieze	<b>G</b> continued Alter Ego Andissa Aurora * Djenne Duchess Hastings Ita Jaipur Knoll Velvet Limani North Island Olema Piper Prince Hairly Rutledge Sandis Zimba	<b>H</b> continued Bavaria Catwalk Constance Firefly Stretch Appeal	<b>I</b> continued Aswan Byron Cato Diamond Days Doily Dynamic Guisse Hastings Ita Jaipur Knoll Velvet Limani North Island Olema Piper Prince Hairly Rutledge Sandis Zimba	<b>U</b> continued Vicenza Volo	<b>V</b> continued Acqua Amalfi Andes Embossed Tipped España Hand Tipped Maremma Velluto Pelle	<b>W</b> continued Alaska Amazon Antique Derby Forte Lucente	<b>X</b> continued Ducale Ducale Velour	<b>Y</b> continued Cervo Copenhagen Distressed Lucca Marissa Portofino Riva Saddle
---	--	---	--------------------------------------	---	--	--	--	--	---	---------------------------------------	--	--	---	--

### Spinneybeck Leather

<b>U</b> continued Vicenza Volo	<b>V</b> continued Acqua Amalfi Andes Embossed Tipped España Hand Tipped Maremma Velluto Pelle	<b>W</b> continued Alaska Amazon Antique Derby Forte Lucente
---------------------------------------	--	--



(TM) Fire Retardant Chemicals

Check with your KnollTextiles or Spinneybeck Representative for changes or additions.

# Marco Maran Gigi® Arm Chair

Designer(s):  
Marco Maran, 2000



description	seat h	arm h	w	d	h	textile	
						fabric yds.	weight
<b>87A</b> Arm chair, stacking 	18"	26½"	19¾"	20"	34¼"		14 lbs.
<b>87A-K-N</b> Arm chair with seat pad, non-stacking 	18"	26½"	19¾"	20"	34¼"	0.7	15 lbs.

pattern no.	unuphol.	A	COM B	C	D	E	F	G	H	I
<b>87A-( )</b>	\$993.									
<b>87A-K-N-( )-( )</b>		1,388.	1,410.	1,435.	1,457.	1,480.	1,494.	1,519.	1,565.	1,599.

**Order Code**

<i>Example:</i> <b>87A-014</b>
<b>87A</b> Gigi arm stacking chair
<b>014</b> Black shell

*Specify:*

1. Pattern number
2. Shell finish
3. Textile selection

**Ordering Information**

*Shell finishes:*  
Black (suffix 014)  
Graphite (suffix 003)  
Mango (suffix 006)  
Navy (suffix 012)  
Red (suffix 007)  
Seafoam (suffix 010)  
White (suffix 001)

*Upholstery/Com information:*  
Prices shown include fabric or leather upholstery. Contact your Knoll representative for colors. Only approved KnollTextiles and Spinneybeck leathers may be ordered.

Customer's Own Material is available pending approval. For approval requirements, processing instructions and ordering information, please see page 21.

*Maintenance:*  
See pages 28-29.

*Stacking feature:*  
Gigi armless unupholstered chairs stack 4 high on floor.  
Gigi armless chairs with seat pad and bumper stack 4 high on floor.  
Gigi armless chairs with seat pad and stacking bumper stack 8-10 high on a dolly.  
Gigi arm chair with seat pad and stacking bumper stack 4 high on floor and dolly.  
Gigi arm chair stacks 4 high on floor and dolly.  
Gigi chairs with seatpad without bumper (87CK-N, 87AK-N) do not stack.

*Note:*  
The Gigi Chair is certified Clean Air GOLD.

**Construction**

*Description:*  
Coloured polypropylene shell on a chrome-plated base. Arm chairs have black polypropylene molded arm pads. Chair back flexes for comfort. Gigi chairs are easily cleaned in food areas and work with a booster seat.

*Seat Pad:*  
Seat pad is permanently attached to the seat with bolts in the factory. Seat pad is not retrofittable in the field. Constructed of ABS with high resilient foam.

*Stacking bumper:*  
Black flexible urethane stacking pad secured between base and shell.

*Transportation Dolly:*  
Chrome plated steel frame with rubber wheels. 10 Gigi armless chairs can be stacked on the dolly. Dollies can stack three high for compact storage. Dolly with 10 chairs will measure 56.3" h, 19.75" w, 41" d. Dolly does not lock.

**Approved KnollTextiles Grades/Fabrics**

*Tablet Arm:*  
The tablet attaches to the chair frame underneath the seat. It is aligned with the front leg and has a flip up mechanism. Tablet is black melamine. Steel support with chrome finish. Tablet arm can be used with armless chair only. Gigi with tablet can be stacked 4 high on the floor and on the dolly.

*Note:*  
Tablet arm option is not offered with stacking bumper.

*Ganging Mechanism:*  
The easy-to-detach ganging mechanism links two adjoining frames at the front legs or rear legs. Ganging mechanism consists of black molded polypropylene. Chairs with ganging mechanism can be stacked. Tablet arm ships separate from the chair and can be retrofitted in the field. Arm chairs can not be ganged with armless chairs.

<b>A</b> Alignment Bocce Chance Common Ground Commuter Cloth Cross Tech Crossroad Delite Facet Foil Rap Heavy Metal Hourglass Infinite Mariner Monarch Overture Prep Presto Soliloquy Sonnet Uni-Form	<b>B</b> Abacus Argyle Attire Belize Bistro Block Party <sup>Ⓞ</sup> Calypso Chronicle Close Knit Cozy Cord Day Tripper Diva Dottie Ferry Gala II Grande Grandview Helios Holbrook	<b>B</b> continued Instinct Journey Keaton Knoll Felt Knoll Hopsack Little Devil Ludlow Melody <sup>Ⓞ</sup> Paradigm Petal Pusher <sup>Ⓞ</sup> Prairie Prim Puff Radiance Ransom Roam Rush Hour Shadow Play Spree Summit Sutton Tabloid Tinge Vast Venue Versa Westwood Wild Thing Yeni	<b>C</b> continued Contour Dune Durand Earthwork Entourage Entwine Essence Fibra Greenwich Groovy Hudson Kaleidoscope CR Kaya CR Lagos Lore CR Milestone On Point Palisade Patchwork Panache CR Plaid On Prestini Pullman Quark Roundtrip Sequin CR Smart <sup>Ⓞ</sup> Spectator Stepping Stones Swing Tight Rope Tilden <sup>Ⓞ</sup> Tower Grid	<b>C</b> continued Utmost II Utopia Wit Wow Factor Zari CR	<b>D</b> Buzz Code Coterie Eclat Weave Hologram Island Menagerie Origins Pathway Plaidtastic Retreat Vice Versa Woodland Zoom	<b>E</b> Aegean Circle Point Cleo Currents Denure Flower Power Highland Ikat Stripe Juno Kampala Kimono Mamba Marquee Meroe Midpoint Nature Walk Off The Grid Rebel Sherman Tempest Tryst Vatera Whip	<b>F</b> Atelier Calais Cotton Velvet Century Biscayne Cornaro Double Agent <sup>Ⓞ</sup> Glider Homage Imprint In Stitches Liberty Mod Plaid Rivington Soon Swank Totem Tweed Frieze	<b>G</b> All Star Alter Ego Andissa Aurora Color Collage Dapper Djenne Duchess Fancy Twill Gibson Haze Kamani Looped In Melange Modern Tweed Rivers Straie Stripe Texnet Ultrasuede Vert	<b>H</b> Bavaria Catwalk Constance Firefly Stretch Appeal Twist Tie World Piece	<b>I</b> Aswan Bella Byron Cato Chic Cummings Diamond Days Doily Dynamic Florescence Guise In Step Ita Jaipur Mepal North Island Olema Piper Prince Hairly Rutledge Sandis Stripe It Zimba
--	---	--	---	---	---	--	--	--	--	---

<sup>Ⓞ</sup> Fire Retardant Chemicals  
*Check with your KnollTextiles representative for changes or additions.*

Marco Maran  
Gigi® Arm Chair

Designer(s):  
Marco Maran, 2000



description	seat h	arm h	w	d	h	textile fabric yds.	weight
<b>87A-K-S</b> Arm chair with seat pad, stacking	18"	26½"	19¾"	20"	34¼"	0.7	16 lbs.
<b>87Dolly</b> Dolly for 10 Gigi chairs			19.2"	31"	26½"		11 lbs.
<b>87Tablet</b> Folding tablet arm, right for armless chair				9¼"	12"		
<b>87GA</b> Ganging mechanism							



Order Code

Example:	<b>87A-014</b>
<b>87A</b>	Gigi arm stacking chair
<b>014</b>	Black shell

Specify:

1. Pattern number
2. Shell finish
3. Textile selection

Ordering Information

**Shell finishes:**  
Black (suffix 014)  
Graphite (suffix 003)  
Mango (suffix 006)  
Navy (suffix 012)  
Red (suffix 007)  
Seafoam (suffix 010)  
White (suffix 001)

**Upholstery/Com information:**  
Prices shown include fabric or leather upholstery. Contact your Knoll representative for colors. Only approved KnollTextiles and Spinneybeck leathers may be ordered.

Customer's Own Material is available pending approval. For approval requirements, processing instructions and ordering information, please see page 21.

**Maintenance:**  
See pages 28-29.

**Stacking feature:**  
Gigi armless unupholstered chairs stack 4 high on floor.  
Gigi armless chairs with seat pad and bumper stack 4 high on floor.  
Gigi armless chairs with seat pad and stacking bumper stack 8-10 high on a dolly.  
Gigi arm chair with seat pad and stacking bumper stack 4 high on floor and dolly.  
Gigi arm chair stacks 4 high on floor and dolly.  
Gigi chairs with seatpad without bumper (87CK-N, 87AK-N) do not stack.

**Note:**  
The Gigi Chair is certified Clean Air GOLD.

Construction

**Description:**  
Coloured polypropylene shell on a chrome-plated base. Arm chairs have black polypropylene molded arm pads. Chair back flexes for comfort. Gigi chairs are easily cleaned in food areas and work with a booster seat.

**Seat Pad:**  
Seat pad is permanently attached to the seat with bolts in the factory. Seat pad is not retrofittable in the field. Constructed of ABS with high resilient foam.

**Stacking bumper:**  
Black flexible urethane stacking pad secured between base and shell.

**Transportation Dolly:**  
Chrome plated steel frame with rubber wheels. 10 Gigi armless chairs can be stacked on the dolly. Dollies can stack three high for compact storage. Dolly with 10 chairs will measure 56.3" h, 19.75" w, 41" d. Dolly does not lock.

pattern no.	unuphol.	A	COM B	C	D	E	F	G	H	I
<b>87A-K-S(-)(-)</b>		\$1,529.	\$1,553.	\$1,574.	\$1,599.	\$1,621.	\$1,636.	\$1,662.	\$1,709.	\$1,745.
<b>87Dolly</b>	1,050.									
<b>87TABLET</b>	431.									
<b>87GA</b>	53.									

Approved KnollTextiles Grades/Fabrics

Tablet Arm:

The tablet attaches to the chair frame underneath the seat. It is aligned with the front leg and has a flip up mechanism. Tablet is black melamine. Steel support with chrome finish. Tablet arm can be used with armless chair only. Gigi with tablet can be stacked 4 high on the floor and on the dolly.

Note:

Tablet arm option is not offered with stacking bumper.

Ganging Mechanism:

The easy-to-detach ganging mechanism links two adjoining frames at the front legs or rear legs. Ganging mechanism consists of black molded polypropylene. Chairs with ganging mechanism can be stacked. Tablet arm ships separate from the chair and can be retrofitted in the field. Arm chairs can not be ganged with armless chairs.



<b>A</b> Alignment Bocce Chance Common Ground Commuter Cloth Cross Tech Crossroad Delite Facet Foil Rap Heavy Metal Hourglass Infinite Mariner Monarch Overture Prep Presto Soliloquy Sonnet Uni-Form	<b>B</b> continued Instinct Journey Keaton Knoll Felt Knoll Hopsack Little Devil Ludlow Melody <sup>Ⓞ</sup> Paradigm Petat Pusher <sup>Ⓞ</sup> Prairie Prim Puff Radiance Ransom Roam Rush Hour Shadow Play Spree Summit Sutton Tabloid Tinge Vast Venue Versa Westwood Wild Thing Yeni	<b>C</b> continued Contour Dune Durand Earthwork Entourage Entwine Essence Fibra Greenwich Groovy Hudson Kaleidoscope CR Kaya CR Lagos Lore CR Milestone On Point Palisade Patchwork Panache CR Plaid On Prestini Pullman Quark Roundtrip Sequin CR Smart <sup>Ⓞ</sup> Spectator Stepping Stones Swing Tight Rope Tilden <sup>Ⓞ</sup> Tower Grid	<b>C</b> continued Utmost II Utopia Wit Wow Factor Zari CR <b>D</b> Buzz Code Coterie Eclat Weave Hologram Island Menagerie Origins Pathway Plaidtastic Retreat Vice Versa Woodland Zoom <b>E</b> Aegean Circle Point Cleo Currents Denure Flower Power Highland Ikat Stripe Juno Kampala Kimono Mamba Marquee Meroe Midpoint Nature Walk Off The Grid Rebel Sherman Tempest Tryst Vatera Whip	<b>F</b> Atelier Calais Cotton Velvet Century Biscayne Cornaro Double Agent <sup>Ⓞ</sup> Glider Homage Imprint In Stitches Liberty Mod Plaid Rivington Soon Swank Totem Tweed Frieze <b>G</b> All Star Alter Ego Andissa Aurora Color Collage Dapper Djenne Duchess Fancy Twill Gibson Haze Kamani Looped In Melange Modern Tweed Rivers Straie Stripe Texnet Ultrasuede Vert  <sup>Ⓞ</sup> Fire Retardant Chemicals	<b>H</b> Bavaria Catwalk Constance Firefly Stretch Appeal Twist Tie World Piece <b>I</b> Aswan Bella Byron Cato Chic Cummings Diamond Days Doily Dynamic Florescence Guise In Step Ita Jaipur Mepal North Island Olema Piper Prince Hairly Rutledge Sandis Stripe It Zimba
---	--	---	--	---	---

Check with your KnollTextiles representative for changes or additions.

# Marco Maran Gigi® Armless Chair

Designer(s):  
Marco Maran, 2000



description	seat h	w	d	h	textile fabric	
					yds.	weight
<b>87C</b> Armless chair, stacking	18"	19 3/4"	20"	34 1/4"		11 lbs.
						
<b>87C-K-N</b> Armless chair with seat pad, non-stacking	18"	19 3/4"	20"	34 1/4"	0.7	12 lbs.
						

pattern no.	unuphol.	A	COM B	C	D	E	F	G	H	I
<b>87C-( )</b>	\$631.									
<b>87C-K-N-( )-( )</b>		1,026.	1,049.	1,073.	1,098.	1,119.	1,133.	1,161.	1,207.	1,245.

### Order Code

<i>Example:</i>	<b>87C-K-S-010-K1207/1</b>
<b>87C-K-S</b>	Gigi armless stacking chair with seat pad
<b>010</b>	Seafoam shell
<b>K1207/1</b>	Knoll Felt, Ivory

### Specify:

1. Pattern number
2. Shell finish
3. Textile finish

### Ordering Information

*Shell finishes:*  
Black (suffix 014)  
Graphite (suffix 003)  
Mango (suffix 006)  
Navy (suffix 012)  
Red (suffix 007)  
Seafoam (suffix 010)  
White (suffix 001)

*Upholstery/Com information:*  
Prices shown include fabric or leather upholstery. Contact your Knoll representative for colors. Only approved KnollTextiles and Spinneybeck leathers may be ordered.

Customer's Own Material is available pending approval. For approval requirements, processing instructions and ordering information, please see page 21.

### Maintenance:

See pages 28-29.

*Stacking feature:*  
Gigi armless unupholstered chairs stack 4 high on floor.  
Gigi armless chairs with seat pad and bumper stack 4 high on floor.  
Gigi armless chairs with seat pad and stacking bumper stack 8-10 high on a dolly.

Gigi arm chair with seat pad and stacking bumper stack 4 high on floor and dolly.  
Gigi arm chair stacks 4 high on floor and dolly.  
Gigi chairs with seatpad without bumper (87CK-N, 87AK-N) do not stack.

*Note:*  
The Gigi Chair is certified Clean Air GOLD.

### Construction

*Description:*  
Coloured polypropylene shell on a chrome-plated base. Arm chairs have black polypropylene molded arm pads. Chair back flexes for comfort. Gigi chairs are easily cleaned in food areas and work with a booster seat.

*Seat Pad:*  
Seat pad is permanently attached to the seat with bolts in the factory. Seat pad is not retrofittable in the field. Constructed of ABS with high resilient foam.

*Stacking bumper:*  
Black flexible urethane stacking pad secured between base and shell.

*Transportation Dolly:*  
Chrome plated steel frame with rubber wheels. 10 Gigi chairs can be stacked on the dolly. Dollies can stack three high for compact storage. Dolly with 10 chairs will measure 56.3" h, 19.75" w, 41" d. Dolly does not lock.

### Approved KnollTextiles Grades/Fabrics

#### Tablet Arm:

The tablet attaches to the chair frame underneath the seat. It is aligned with the front leg and has a flip up mechanism. Tablet is black melamine. Steel support with chrome finish. Tablet arm can be used with armless chair only. Gigi with tablet can be stacked 4 high on the floor and on the dolly.

#### Note:

Tablet arm option is not offered with stacking bumper.

#### Ganging Mechanism:



The easy-to-detach ganging mechanism links two adjoining frames at the front legs or rear legs. Ganging mechanism consists of black molded polypropylene. Chairs with ganging mechanism can be stacked. Tablet arm ships separate from the chair and can be retrofitted in the field. Arm chairs can not be ganged with armless chairs.

<b>A</b> Alignment Bocce Chance Common Ground Commuter Cloth Cross Tech Crossroad Delite Facet Foil Rap Heavy Metal Hourglass Infinite Mariner Monarch Overture Prep Presto Soliloquy Sonnet Uni-Form	<b>B</b> Abacus Argyle Attire Belize Bistro Block Party <sup>Ⓞ</sup> Calypso Chronicle Close Knit Cozy Cord Day Tripper Diva Dottie Ferry Gala II Grande Grandview Helios Holbrook	<b>B</b> continued Instinct Journey Keaton Knoll Felt Knoll Hopsack Little Devil Ludlow Melody <sup>Ⓞ</sup> Paradigm Petal Pusher <sup>Ⓞ</sup> Prairie Prim Puff Radiance Ransom Roam Rush Hour Shadow Play Spree Summit Sutton Tabloid Tinge Vast Venue Versa Westwood Wild Thing Yeni	<b>C</b> Atlas Axiom <sup>Ⓞ</sup> Baxter Cairo Chameleon Charm Circa Classic Boucle	<b>C</b> continued Contour Dune Durand Earthwork Entourage Entwine Essence Fibra Greenwich Groovy Hudson Kaleidoscope CR Kaya CR Lagos Lore CR Milestone On Point Palisade Patchwork Panache CR Plaid On Prestini Pullman Quark Roundtrip Sequin CR Smart <sup>Ⓞ</sup> Spectator Stepping Stones Swing Tight Rope Tilden <sup>Ⓞ</sup> Tower Grid	<b>C</b> continued Utmost II Utopia Wit Wow Factor Zari CR	<b>D</b> Buzz Code Coterie Eclat Weave Hologram Island Menagerie Origins Pathway Plaidtastic Retreat Vice Versa Woodland Zoom	<b>E</b> Aegean Circle Point Cleo Currents Denure Flower Power Highland Ikat Stripe Juno Kampala Kimono Mamba Marquee Meroe Midpoint Nature Walk Off The Grid Rebel Sherman Tempest Tryst Vatera Whip	<b>F</b> Atelier Calais Cotton Velvet Century Biscayne Cornaro Double Agent <sup>Ⓞ</sup> Glider Homage Imprint In Stitches Liberty Mod Plaid Rivington Soon Swank Totem Tweed Frieze	<b>G</b> All Star Alter Ego Andissa Aurora Color Collage Dapper Djenne Duchess Fancy Twill Gibson Haze Kamani Looped In Melange Modern Tweed Rivers Straie Stripe Texnet Ultrasuede Vert	<b>H</b> Bavaria Catwalk Constance Firefly Stretch Appeal Twist Tie World Piece	<b>I</b> Aswan Bella Byron Cato Chic Cummings Diamond Days Doily Dynamic Florescence Guise In Step Ita Jaipur Mepal North Island Olema Piper Prince Hairly Rutledge Sandis Stripe It Zimba
--	---	--	---	---	---	---	--	--	--	--	---

<sup>Ⓞ</sup> Fire Retardant Chemicals

Check with your KnollTextiles representative for changes or additions.

# Marco Maran Gigi® Armless Chair

	description	seat h	w	d	h	textile fabric yds.	weight
<i>Designer(s):</i> Marco Maran, 2000	<b>87C-K-S</b> Armless chair with seat pad, stacking	18"	19 3/4"	20"	34 1/4"	0.7	13 lbs.
							
	<b>87Dolly</b> Dolly for 10 Gigi chairs		19.2"	31"	26 1/2"		11 lbs.
							
	<b>87Tablet</b> Folding tablet arm, right for armless chair			9 1/4"	12"		
	<b>87GA</b> Ganging mechanism						

Order Code	Ordering Information	Construction
------------	----------------------	--------------

<i>Example:</i> <b>87C-K-S-010-K1207/1</b>	<i>Shell finishes:</i> Black (suffix 014) Graphite (suffix 003) Mango (suffix 006) Navy (suffix 012) Red (suffix 007) Seafoam (suffix 010) White (suffix 001)	<i>Maintenance:</i> See pages 28-29.	<i>Description:</i> Coloured polypropylene shell on a chrome-plated base. Arm chairs have black polypropylene molded arm pads. Chair back flexes for comfort. Gigi chairs are easily cleaned in food areas and work with a booster seat.
<b>87C-K-S</b> Gigi armless stacking chair with seat pad	<i>Stacking feature:</i> Gigi armless unupholstered chairs stack 4 high on floor. Gigi armless chairs with seat pad and bumper stack 4 high on floor. Gigi armless chairs with seat pad and stacking bumper stack 8-10 high on a dolly. Gigi arm chair with seat pad and stacking bumper stack 4 high on floor and dolly. Gigi arm chair stacks 4 high on floor and dolly.	<i>Seat Pad:</i> Seat pad is permanently attached to the seat with bolts in the factory. Seat pad is not retrofittable in the field. Constructed of ABS with high resilient foam.	<i>Seat Pad:</i> Seat pad is permanently attached to the seat with bolts in the factory. Seat pad is not retrofittable in the field. Constructed of ABS with high resilient foam.
<b>010</b> Seafoam shell	<i>Upholstery/Com information:</i> Prices shown include fabric or leather upholstery. Contact your Knoll representative for colors. Only approved KnollTextiles and Spinneybeck leathers may be ordered.	<i>Stacking bumper:</i> Black flexible urethane stacking pad secured between base and shell.	<i>Stacking bumper:</i> Black flexible urethane stacking pad secured between base and shell.
<b>K1207/1</b> Knoll Felt, Ivory	Customer's Own Material is available pending approval. For approval requirements, processing instructions and ordering information, please see page 21.	<i>Transportation Dolly:</i> Chrome plated steel frame with rubber wheels. 10 Gigi chairs can be stacked on the dolly. Dollies can stack three high for compact storage. Dolly with 10 chairs will measure 56.3" h, 19.75" w, 41" d. Dolly does not lock.	<i>Transportation Dolly:</i> Chrome plated steel frame with rubber wheels. 10 Gigi chairs can be stacked on the dolly. Dollies can stack three high for compact storage. Dolly with 10 chairs will measure 56.3" h, 19.75" w, 41" d. Dolly does not lock.
<i>Specify:</i> 1. Pattern number 2. Shell finish 3. Textile finish	<i>Note:</i> The Gigi Chair is certified Clean Air GOLD.		

pattern no.	unuphol.	A	COM B	C	D	E	F	G	H	I
<b>87C-K-S(-)(-)</b>		\$1,167.	\$1,193.	\$1,215.	\$1,242.	\$1,262.	\$1,278.	\$1,302.	\$1,352.	\$1,388.
<b>87Dolly</b>	1,050.									
<b>87TABLET</b>	431.									
<b>87GA</b>	53.									

### Approved KnollTextiles Grades/Fabrics

<i>Tablet Arm:</i> The tablet attaches to the chair frame underneath the seat. It is aligned with the front leg and has a flip up mechanism. Tablet is black melamine. Steel support with chrome finish. Tablet arm can be used with armless chair only. Gigi with tablet can be stacked 4 high on the floor and on the dolly.	<b>A</b> Alignment Bocce Chance Common Ground Commuter Cloth Cross Tech Crossroad Delite Facet Foil Rap Heavy Metal Hourglass Infinite Mariner Monarch Overture Prep Presto Soliloquy Sonnet Uni-Form	<b>B</b> continued Instinct Journey Keaton Knoll Felt Knoll Hopsack Little Devil Ludlow Melody (Ⓞ) Paradigm Petat Pusher (Ⓞ) Prairie Prim Puff Radiance Ransom Roam Rush Hour Shadow Play Spree Summit Sutton Tabloid Tinge Vast Venue Versa Westwood Wild Thing Yeni	<b>C</b> continued Contour Dune Durand Earthwork Entourage Entwine Essence Fibra Greenwich Groovy Hudson Kaleidoscope CR Kaya CR Lagos Lore CR Milestone On Point Palisade Patchwork Panache CR Plaid On Prestini Pullman Quark Roundtrip Sequin CR Smart (Ⓞ) Spectator Stepping Stones Swing Tight Rope Tilden (Ⓞ) Tower Grid	<b>C</b> continued Utmost II Utopia Wit Wow Factor Zari CR  <b>D</b> Buzz Code Coterie Eclat Weave Hologram Island Menagerie Origins Pathway Plaidtastic Retreat Vice Versa Woodland Zoom  <b>E</b> Aegean Circle Point Cleo Currents Denure Flower Power Highland Ikat Stripe Juno Kampala Kimono Mamba Marquee Meroe Midpoint Nature Walk Off The Grid Rebel Sherman Tempest Tryst Vatera Whip	<b>F</b> Atelier Calais Cotton Velvet Century Biscayne Cornaro Double Agent (Ⓞ) Glider Homage Imprint In Stitches Liberty Mod Plaid Rivington Soon Swank Totem Tweed Frieze  <b>G</b> All Star Alter Ego Andissa Aurora Color Collage Dapper Djenne Duchess Flower Power Gibson Haze Kamani Looped In Melange Modern Tweed Rivers Straie Stripe Texnet Ultrasuede Vert  Ⓞ Fire Retardant Chemicals	<b>H</b> Bavaria Catwalk Constance Firefly Stretch Appeal Twist Tie World Piece  <b>I</b> Aswan Bella Byron Cato Chic Cummings Diamond Days Doily Dynamic Florescence Guise In Step Ita Jaipur Mepal North Island Olema Piper Prince Hair Rutledge Sandis Stripe It Zimba
---	--	--	---	--	--	---

Check with your KnollTextiles representative for changes or additions.

# Marco Maran

## Gigi® Armless Chair with Sled Base

Designer(s):  
Marco Maran, 2000



description	seat h	w	d	h	textile fabric	
					yds.	weight
<b>87CSB</b> Armless chair with sled base, stacking	18"	21 3/8"	21"	34 1/4"	0.7	14 lbs.
<b>87CSB-K-N</b> Armless chair with sled base, seat pad upholstery, non-stacking	18"	21 3/8"	21"	34 1/4"	0.7	14 lbs.



### Order Code

<i>Example:</i>	<b>87CSB-K-N-010-K1621/21</b>
<b>87CSB-K-N</b>	Gigi armless chair with sled base, non-stacking with seat pad
<b>010</b>	Seafoam shell
<b>K1621/21</b>	Classic Boucle, Smoke

### Specify:

1. Pattern number
2. Shell finish
3. Textile selection

### Ordering Information

*Shell finishes:*  
Black (suffix 014)  
Graphite (suffix 003)  
Mango (suffix 006)  
Navy (suffix 012)  
Red (suffix 007)  
Seafoam (suffix 010)  
White (suffix 001)

*Upholstery/COM information:*  
Prices shown include fabric or leather upholstery. Contact your Knoll representative for colors. Only approved KnollTextiles and Spinneybeck leathers may be ordered.

Customer's Own Material is available pending approval. For approval requirements, processing instructions and ordering information, please see page 21.

*Maintenance:*  
See pages 28-28.

*Stacking feature:*  
Gigi with sled base, armless, unupholstered stack 4 high on floor.  
Gigi with sled base, armless, unupholstered stack 8-10 high on dolly.  
Gigi with sled base, armless, seat pad upholstery with stacking bumper stack 4 high on floor.  
Gigi with sled base, armless, seat pad upholstery with stacking bumper stack 8-10 high on dolly.

### Construction

*Description:*  
Coloured polypropylene shell on a chrome-plated base. Arm chairs have black polypropylene molded arm pads. Chair back flexes for comfort. Gigi chairs are easily cleaned in food areas and work with a booster seat.

*Seat Pad:*  
Seat pad is permanently attached to the seat with bolts in the factory. Seat pad is not retrofittable in the field. Constructed of ABS with high resilient foam.

*Stacking bumper:*  
Black flexible urethane stacking pad secured between base and shell.

*Transportation Dolly:*  
Chrome plated steel frame with rubber wheels. 10 Gigi chairs can be stacked on the dolly. Dollies can stack three high for compact storage. Dolly with 10 chairs will measure 56.3" h, 19.75" w, 41" d. Dolly does not lock.

pattern no.	unuphol.	COM									
		A	B	C	D	E	F	G	H	I	
<b>87CSB-( )</b>	\$872.										
<b>87CSB-K-N-( )-( )</b>		1,263.	1,287.	1,313.	1,336.	1,357.	1,372.	1,399.	1,446.	1,483.	



### Approved KnollTextiles Grades/Fabrics

<b>A</b> Alignment Bocce Chance Common Ground Commuter Cloth Cross Tech Crossroad Delite Facet Foil Rap Heavy Metal Hourglass Infinite Mariner Monarch Overture Prep Presto Soliloquy Sonnet Uni-Form	<b>B</b> continued Instinct Journey Keaton Knoll Felt Knoll Hopsack Little Devil Ludlow Melody <sup>Ⓞ</sup> Paradigm Petal Pusher <sup>Ⓞ</sup> Prairie Prim Puff Radiance Ransom Roam Rush Hour Shadow Play Spree Summit Sutton Tabloid Tinge Vast Venue Versa Westwood Wild Thing Yeni	<b>C</b> continued Contour Dune Durand Earthwork Entourage Entwine Essence Fibra Greenwich Groovy Hudson Kaleidoscope CR Kaya CR Lagos Lore CR Milestone On Point Palisade Patchwork Panache CR Plaid On Prestini Pullman Quark Roundtrip Sequin CR Smart <sup>Ⓞ</sup> Spectator Stepping Stones Swing Tight Rope Tilden <sup>Ⓞ</sup> Tower Grid	<b>C</b> continued Utmost II Utopia Wit Wow Factor Zari CR  <b>D</b> Buzz Code Coterie Eclat Weave Hologram Island Menagerie Origins Pathway Plaidtastic Retreat Vice Versa Woodland Zoom	<b>F</b> Atelier Calais Cotton Velvet Century Biscayne Cornaro Double Agent <sup>Ⓞ</sup> Glider Homage Imprint In Stitches Liberty Mod Plaid Rivington Soon Swank Totem Tweed Frieze	<b>G</b> All Star Alter Ego Andissa Aurora Color Collage Dapper Djenne Duchess Flower Power Highland Ikat Stripe Juno Kampala Kimono Mamba Marquee Meroe Midpoint Nature Walk Off The Grid Rebel Sherman Tempest Tryst Vatera Whip	<b>H</b> Bavaria Catwalk Constance Firefly Stretch Appeal Twist Tie World Piece  <b>I</b> Aswan Bella Byron Cato Chic Cummings Diamond Days Doily Dynamic Florescence Guise In Step Ita Jaipur Mepal North Island Olema Piper Prince Hair Rutledge Sandis Stripe It Zimba
--	--	---	--	--	--	---

<sup>Ⓞ</sup> Fire Retardant Chemicals

*Check with your KnollTextiles representative for changes or additions.*

# Marco Maran Gigi® Armless Chair with Sled Base

	description	height, seat	width	depth	height	textile fabric yds.	weight
<i>Designer(s):</i> Marco Maran, 2000	<b>87CSB-K-S</b> Armless chair with sled base, seat pad upholstery, stacking	18"	21 3/8"	21"	34 1/4"	0.7	14 lbs.
							
	<b>87Dolly</b> Dolly for 10 Gigi chairs		19.2"	31"	26 1/2"		11 lbs.
							

pattern no.	unuphol.	A	COM B	C	D	E	F	G	H	I
<b>87CSB-K-S-( )-( )</b>		\$1,405.	\$1,433.	\$1,450.	\$1,480.	\$1,498.	\$1,513.	\$1,540.	\$1,591.	\$1,627.
<b>87Dolly</b>	1,050.									

**Order Code**

**Ordering Information**

*Example:* **87CSB-K-N-010-K1621/21**

<b>87CSB-K-N</b>	Gigi armless chair with sled base, non-stacking with seat pad
<b>010</b>	Seafoam shell
<b>K1621/21</b>	Classic Boucle, Smoke

*Shell finishes:*  
Black (suffix 014)  
Graphite (suffix 003)  
Mango (suffix 006)  
Navy (suffix 012)  
Red (suffix 007)  
Seafoam (suffix 010)  
White (suffix 001)

*Stacking feature:*  
Gigi with sled base, armless, unupholstered stack 4 high on floor.  
Gigi with sled base, armless, unupholstered stack 8-10 high on dolly.  
Gigi with sled base, armless, seat pad upholstery with stacking bumper stack 4 high on floor.  
Gigi with sled base, armless, seat pad upholstery with stacking bumper stack 8-10 high on dolly.

*Upholstery/COM information:*  
Prices shown include fabric or leather upholstery. Contact your Knoll representative for colors. Only approved KnollTextiles and Spinneybeck leathers may be ordered.

*Maintenance:*  
See pages 28-28.

*Stacking feature:*  
Gigi with sled base, armless, unupholstered stack 8-10 high on dolly.  
Gigi with sled base, armless, seat pad upholstery with stacking bumper stack 4 high on floor.  
Gigi with sled base, armless, seat pad upholstery with stacking bumper stack 8-10 high on dolly.

**Construction**

*Description:*  
Coloured polypropylene shell on a chrome-plated base. Arm chairs have black polypropylene molded arm pads. Chair back flexes for comfort. Gigi chairs are easily cleaned in food areas and work with a booster seat.

*Seat Pad:*  
Seat pad is permanently attached to the seat with bolts in the factory. Seat pad is not retrofittable in the field. Constructed of ABS with high resilient foam.

*Stacking bumper:*  
Black flexible urethane stacking pad secured between base and shell.

*Transportation Dolly:*  
Chrome plated steel frame with rubber wheels. 10 Gigi chairs can be stacked on the dolly. Dollies can stack three high for compact storage. Dolly with 10 chairs will measure 56.3" h, 19.75" w, 41" d. Dolly does not lock.

Customer's Own Material is available pending approval. For approval requirements, processing instructions and ordering information, please see page 21.

*Specify:*

1. Pattern number
2. Shell finish
3. Textile selection





**Approved KnollTextiles Grades/Fabrics**

<b>A</b> Alignment Bocce Chance Common Ground Commuter Cloth Cross Tech Crossroad Delite Facet Foil Rap Heavy Metal Hourglass Infinite Mariner Monarch Overture Prep Presto Soliloquy Sonnet Uni-Form	<b>B</b> continued Instinct Journey Keaton Knoll Felt Knoll Hopsack Little Devil Ludlow Melody Ⓞ Paradigm Petat Pusher Ⓞ Prairie Prim Puff Radiance Ransom Roam Rush Hour Shadow Play Spree Summit Sutton Tabloid Tinge Vast Venue Versa Westwood Wild Thing Yeni	<b>C</b> continued Contour Dune Durand Earthwork Entourage Entwine Essence Fibra Greenwich Groovy Hudson Kaleidoscope CR Kaya CR Lagos Lore CR Milestone On Point Palisade Patchwork Panache CR Plaid On Prestini Pullman Quark Roundtrip Sequin CR Smart Ⓞ Spectator Stepping Stones Swing Tight Rope Tilden Ⓞ Tower Grid	<b>C</b> continued Utmost II Utopia Wit Wow Factor Zari CR  <b>D</b> Buzz Code Coterie Eclat Weave Hologram Island Menagerie Origins Pathway Plaidtastic Retreat Vice Versa Woodland Zoom	<b>F</b> Atelier Calais Cotton Velvet Century Biscayne Cornaro Double Agent Ⓞ Glider Homage Imprint In Stitches Liberty Mod Plaid Rivington Soon Swank Totem Tweed Frieze	<b>H</b> Bavaria Catwalk Constance Firefly Stretch Appeal Twist Tie World Piece  <b>I</b> Aswan Bella Byron Cato Chic Cummings Diamond Days Doily Dynamic Florescence Guise In Step Ita Jaipur Mepal North Island Olema Piper Prince Hairly Rutledge Sandis Stripe It Zimba
			<b>E</b> Aegean Circle Point Cleo Currents Demure Flower Power Highland Ikat Stripe Juno Kampala Kimono Mamba Marquee Meroe Midpoint Nature Walk Off The Grid Rebel Sherman Tempest Tryst Vatera Whip	<b>G</b> All Star Alter Ego Andissa Aurora Color Collage Dapper Djenne Duchess Fancy Twill Gibson Haze Kamani Looped In Melange Modern Tweed Rivers Straie Stripe Texnet Ultrasuede Vert	<b>G</b> Fire Retardant Chemicals

*Check with your KnollTextiles representative for changes or additions.*



Marco Maran  
Gigi® Barstool and Swivel Chair

	description	seat h, min	seat h, max	arm h, min	arm h, max	w	d	h, min	h, max	weight
<p><i>Designer(s):</i> Marco Maran, 2002</p> 	<b>87CS</b> Gigi armless swivel chair 	17 1/4"	22 1/2"			22 9/10"	25"	33 1/2"	38 1/4"	17 lbs.
	<b>87AS</b> Gigi arm swivel chair 	17 1/4"	22 1/2"	24 1/4"	29 1/4"	22 9/10"	25"	33 1/2"	38 1/4"	21 lbs.
	<b>87CM</b> Gigi barstool, counter-height 		24"			19 3/4"	20"		40 1/2"	14 lbs.
	<b>87CH</b> Gigi barstool, bar-height 		29 1/2"			19 3/4"	20"		46"	15 lbs.

pattern no.	
<b>87CS-()</b>	\$1,710.
<b>87AS-()</b>	1,984.
<b>87CM-()</b>	1,212.
<b>87CH-()</b>	1,212.

**Order Code**

Example:	<b>87AS-006</b>
<b>87AS</b>	Gigi arm swivel chair
<b>006</b>	Mango shell

*Specify:*

1. Pattern number
2. Shell finish

**Ordering Information**

*Shell Finishes:*  
 Black (suffix 014)  
 Graphite (suffix 003)  
 Mango (suffix 006)  
 Navy (suffix 012)  
 Red (suffix 007)  
 Seafoam (suffix 010)  
 White (suffix 001)

*Maintenance:*  
 See pages 28-29.

*Note:*  
 The Gigi Stool and Swivel Chair are certified Clean Air GOLD.

**Construction**

*Description:*  
 Coloured polypropylene and 15% fiberglass shell on a chrome-plated base. Arm chairs have black polypropylene molded arm pads. Chair back flexes for comfort. Gigi chairs are easily cleaned in food service areas.

*Swivel:*  
 Swivel mechanism with pneumatic seat height adjustment T-section polished aluminum base, with hard black casters. Colored polypropylene shell on a chrome-plated base. Armchairs have black polypropylene molded arm pads.

# Ludwig Mies van der Rohe Tubular Brno Chair

description	frame	seat					arm h	textile fabric yds.	req. leather sq. ft.	weight
		h	h	w	d	h				
<b>245A</b> Brno Tugendhat arm chair - tubular frame, with thin seat and back	polished chrome	17 1/4"	25 1/4"	22 1/4"	22 1/2"	31 1/2"	1.7	28	23 lbs.	
	stainless steel	17 1/4"	25 1/4"	22 1/4"	22 1/2"	31 1/2"	1.7	28	24 lbs.	
<b>245AT</b> Brno Classic arm chair - tubular frame, with thick seat and back	polished chrome	17 1/4"	25 1/4"	22 1/4"	22 1/2"	31 1/2"	1.7	28	23 lbs.	
	stainless steel	17 1/4"	25 1/4"	22 1/4"	22 1/2"	31 1/2"	1.7	28	24 lbs.	

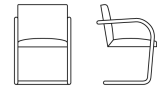
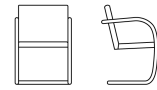

*Designer(s):*  
Ludwig Mies van der Rohe, 1930  
Design from the Mies van der Rohe Archive of The Museum of Modern Art

*Award(s):*  
The Museum of Modern Art, New York, USA, 1977



**G** Glides (add -G to end of pattern number)

**P** Perforated leather option (add P to end of pattern number and suffix -PERF to leather selection)

30

## Order Code      Ordering Information      Construction

*Example:* **245A-S-P-VO906-PERF**

<b>245A</b>	Tubular arm chair, thin seat
<b>S</b>	Stainless Steel
<b>P</b>	Perforated leather
<b>VO906-PERF</b>	Volo, Navy, perforated

*Finishes:*  
Polished Chrome (suffix C)  
Stainless Steel (suffix S)

*Upholstery/COM information:*  
Prices shown include fabric or leather upholstery. Contact your Knoll representative for colors. Only approved KnollTextiles and Spinneybeck leathers may be ordered.

Customer's Own Material is available pending approval. For approval requirements, processing instructions and ordering information please see page 21.

*Perforated leather option:*  
The Tubular Brno Chairs are available in perforated leather upholstery. Specify suffix -P at end of pattern number and suffix -PERF at end of leather selection. 30 sq. ft. of leather required.

*Cal 133 Fire Code # :*  
The Tubular Brno Chairs comply with the California Technical Bulletin 133 standard if upholstered in Cal 133 approved upholstery. Specify suffix -C at end of pattern number and suffix -133 at end of textile selection. Upcharge applies, see page 22.

*Frame:*  
**Stainless steel:**  
Tubular pre-stressed, pre-buffed 14 gauge stainless steel. Clean, seamless joints and hidden drilled or countersunk holes (as opposed to punched) render the chair free of deformation.

**Polished chrome:**  
11 gauge steel. The mirror chrome-plating process includes lengthy nickel and silicone coatings for rust protection and increased durability. All chairs are polished to a mirror finish. Clean, seamless joints and hidden drilled or countersunk holes (as opposed to punched) render the chair free of deformation.

*Maintenance:*  
See pages 28-29.

*Note:*  
The KnollStudio logo and signature of Ludwig Mies van der Rohe are stamped into the frame of the chair under the arm.

The Tubular Brno Chair is certified Clean Air GOLD.

*Upholstery:*  
Inner hardwood frame cushioned with variable density foam. Dymetrol seat suspension enhances comfort level. Replacement seat and backs are not available on Brno chairs. Tubular Brno with thin seat (245A, 245AS) has no welt detail. Tubular Brno with thick seat (245AT, 245AB) has welt detail on underside of seat.

*Optional glides:*  
Six clear plastic glides in specially drilled holes.

*Note:*  
The Tubular and Flat Bar Brno chairs are part of a collection. Please refer to Mies side chairs and lounge seating beginning on page 242 and tables, beginning on page 432.

- Specify:*
1. Pattern number
  2. Glide option
  3. Cal 133 Fire Code option
  4. Perforated leather option
  5. Textile selection

pattern no.	grades <b>A</b>	COM <b>B</b>	<b>C</b>	<b>D</b>	<b>E</b>	<b>F</b>	<b>G</b>	<b>H</b>	<b>I</b>	COL						<b>V</b>	<b>W</b>	<b>X</b>	<b>Y</b>
<b>245A-C</b>	\$3,143.	\$3,239.	\$3,331.	\$3,401.	\$3,463.	\$3,524.	\$3,586.	\$3,743.	\$4,024.	\$4,349.	\$4,667.	\$5,296.	\$5,448.	\$5,586.					
<b>245A-S</b>	4,066.	4,164.	4,256.	4,323.	4,386.	4,444.	4,509.	4,667.	4,947.	5,270.	5,587.	6,217.	6,371.	6,505.					

<b>245AT-C</b>	3,598.	3,693.	3,788.	3,860.	3,918.	3,979.	4,040.	4,199.	4,479.	4,802.	5,117.	5,749.	5,905.	6,036.			
<b>245AT-S</b>	4,502.	4,595.	4,690.	4,762.	4,825.	4,884.	4,942.	5,098.	5,384.	5,708.	6,020.	6,653.	6,810.	6,944.			

<b>G</b>	43.
<b>P</b>	1,275.

## Approved KnollTextiles Grades/Fabrics      Spinneybeck Leather

<b>A</b> Alignment Beacon Bocce Chance Common Ground Commuter Cloth Cross Tech Crossroad Delite Facet Foil Rap Heavy Metal Hourglass Infinite Mariner Monarch Oh La La Overture Prep Presto Soliloquy Sonnet Trophy Uni-Form	<b>B</b> continued Gala II Grande Grandview Helios Hollbrook Instinct Journey Keaton Knoll Felt Knoll Hopsack Little Devil Ludlow Melody <sup>®</sup> Paradigm Petat Pusher <sup>®</sup> Prairie Prim Puff Radiance Ransom Roam Rush Hour Shadow Play Spree Summit Sutton Synth Tabloid Tinge Topos Vast Venue Versa Vinyl <sup>®</sup> Westwood Wild Thing Yeni	<b>C</b> Atlas Axiom <sup>®</sup> Baxter Cairo Chameleon Charm Circa Classic Boucle Dune Durand Earthwork Empire Stripe Entourage Entwine Essence Fibra Greenwich Groovy Hudson Kaleidoscope CR Lagos Lore CR Magnolia Milestone On Point Palisade Panache CR Patchwork Plaid On Prestini Pullman Quark Roundtrip Sahara Sequin CR Sinclair Smart <sup>®</sup> Spectator Stepping Stones Swing Tight Rope	<b>C</b> continued Tilden <sup>®</sup> Tower Grid Utmost II Utopia Wit Wow Factor Zari CR	<b>D</b> Buzz Code Coterie Eclat Weave Hologram Island Menagerie Origins Pathway Plaitastic Retreat Vice Versa Woodland Zoom	<b>E</b> Aegean Circle Point Cleo Demure Flower Power Highland Ikast Stripe Juno Kampala Kimono Mamba Marquee Meroe Midpoint Nature Walk Off The Grid Rebel Sherman Shima Tempest Tryst Vatera Whip	<b>F</b> Atelier Biscayne Calais Cotton Velvet Century Cornaro Double Agent <sup>®</sup> Glider Homage Imprint In Stitches Jasmine Liberty Mod Plaid Rivington Soon Swank Totem Tweed Frieze	<b>G</b> continued Straie Stripe Texnet Ultrasuede Utrillo Vert	<b>H</b> Bavaria Catwalk Chiseled Constance Firefly Stretch Appeal Twist Tie World Piece	<b>I</b> Aswan Bella Byron Cato Chic Cummings Diamond Days Doily Dynamic Florescence Guise Hastings In Step Ita Jaipur Knoll Velvet Limani Mepal North Island Olema Piper Prince Hair Rutledge Sandis Stripe It Tudor Zimba	<b>U</b> Vicenza Volo	<b>V</b> Acqua Amalfi Andes Embossed Tipped España Hand Tipped Maremma Velluto Pelle	<b>W</b> Alaska Antique Derby Forte Lucente Sabrina Umbria	<b>X</b> Ducale Ducale Velour	<b>Y</b> Cervo Copenhagen Distressed Gemma Lucca Marissa Portofino Riva Saddle
--	--	--	--	--	--	---	--	--	--	-----------------------------	--	---	-------------------------------------	---

<sup>®</sup> Fire Retardants Chemicals

*Check with your KnollTextiles or Spinneybeck Representative for changes or additions.*

# Ludwig Mies van der Rohe Flat Bar Brno Chair

	description	frame	seat h	arm h	w	d	h	textile fabric yds.	req. leather sq. ft.	weight
<i>Designer(s):</i> Ludwig Mies van der Rohe, 1930	<b>255A</b> Brno arm chair, flat bar frame, with armpads	polished chrome	17 1/2"	25 3/4"	22 3/4"	22 1/2"	31 1/2"	1.7	28	37 lbs.
		stainless steel	17 1/2"	25 3/4"	22 3/4"	22 1/2"	31 1/2"	1.7	28	38 lbs.
<i>Award(s):</i> The Museum of Modern Art, New York, USA, 1977	<b>255C</b> Brno arm chair, flat bar frame, without armpads	antiqued bronze, satin	17 1/2"	25 3/4"	22 3/4"	22 1/2"	31 1/2"	1.7	28	38 lbs.
		polished chrome	17 1/2"	25 3/4"	22 3/4"	22 1/2"	31 1/2"	1.7	28	38 lbs.
		stainless steel	17 1/2"	25 3/4"	22 3/4"	22 1/2"	31 1/2"	1.7	28	38 lbs.
	<b>P</b> Perforated leather option (add P to end of pattern number and suffix -PERF to leather selection)									30
	<b>G</b> Glides (add -G to end of pattern number)									

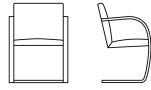
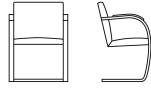

Order Code	Ordering Information	Construction
------------	----------------------	--------------

<i>Example:</i> <b>245A-S-P-VO906-PERF</b>		
<b>245A</b>	Tubular arm chair, thin seat	
<b>S</b>	Stainless Steel	
<b>P</b>	Perforated leather	
<b>VO906-PERF</b>	Volo, Navy, perforated	

*Finishes:*  
Polished Chrome (suffix C)  
Stainless Steel (suffix S)  
Antiqued Bronze, Satin (suffix BAS)

*Upholstery/COM information:*  
Prices shown include fabric or leather upholstery. Contact your Knoll representative for colors. Only approved KnollTextiles and Spinneybeck leathers may be ordered.

*Perforated leather option:*  
The Tubular Brno Chairs are available in perforated leather upholstery. Specify suffix -P at end of pattern number and suffix -PERF at end of leather selection. 30 sq. ft. of leather required.

*Cal 133 Fire Code ⚡ :*  
The Tubular Brno Chairs comply with the California Technical Bulletin 133 standard if upholstered in Cal 133 approved upholstery. Specify suffix -C at end of pattern number and suffix -133 at end of textile selection. Upcharge applies, see page 22.

*Frame:*  
*Stainless steel:*  
Stainless steel frame is 304 bar stock stainless steel. Frame is hand-ground and hand-buffed to mirror finish. No visible connections between seat and frame. Seat and back constructed of durable hardwood.

*Plated finishes:*  
Two plating finishes available:  
Plated chrome with mirror finish (available on 255A and 255C) or antiqued bronze with satin finish (available on 255C only).

*Upholstery:*  
Inner hardwood frame cushioned with variable density foam. Dymetrol seat suspension enhances comfort level. Replacement seat and backs are not available on Brno chairs. Flat Bar Brno Chair with and without armpads have welt detail on underside of seat and outside of back. Optional armpads have welt around perimeter.

*Optional glides:*  
Six clear plastic glides in specially drilled holes.

*Maintenance:*  
See pages 28-29.

*Note:*  
The KnollStudio logo and signature of Ludwig Mies van der Rohe are stamped into the frame of the chair under the arm.

The Tubular Bar Brno Chair is certified Clean Air GOLD.

*Woven leather option:*  
The Tubular Brno Chairs can be upholstered in woven leather as a COL. 30 sq. ft. of woven leather required. Specify suffix -W after pattern number.

*Note:*  
The Tubular and Flat Bar Brno chairs are part of a collection. Please refer to Mies side chairs and lounge seating beginning on page 242 and tables, beginning on page 432.

- Specify:*
1. Pattern number
  2. Glide option
  3. Cal 133 Fire Code option
  4. Perforated leather option
  5. Textile selection

pattern no.	grades	COM	C	D	E	F	G	H	I	COL	V	W	X	Y
<b>255A-C</b>	\$4,479.	\$4,583.	\$4,681.	\$4,751.	\$4,812.	\$4,869.	\$4,937.	\$5,095.	\$5,388.	\$5,713.	\$6,031.	\$6,680.	\$6,835.	\$6,977.
<b>255A-S</b>	6,702.	6,809.	6,902.	6,979.	7,038.	7,097.	7,159.	7,319.	7,612.	7,941.	8,259.	8,907.	9,062.	9,199.

<b>255C-BAS</b>	8,209.	8,294.	8,377.	8,393.	8,425.	8,531.	8,768.	8,868.	9,104.	9,258.	9,725.	10,057.	10,211.	10,365.
<b>255C-C</b>	4,040.	4,136.	4,229.	4,303.	4,369.	4,422.	4,482.	4,639.	4,928.	5,251.	5,563.	6,194.	6,350.	6,485.
<b>255C-S</b>	6,233.	6,330.	6,423.	6,495.	6,563.	6,619.	6,678.	6,833.	7,121.	7,445.	7,756.	8,391.	8,545.	8,676.

<b>P</b>	1,275.
<b>G</b>	43.

Approved KnollTextiles Grades/Fabrics	Spinneybeck Leather
---------------------------------------	---------------------

<b>A</b> Alignment Beacon Bocce Chance Common Ground Commuter Cloth Cross Tech Crossroad Delite Facet Foil Rap Heavy Metal Hourglass Infinite Mariner Monarch Oh La La Overture Prep Presto Soliloquy Sonnet Trophy Uni-Form	<b>B</b> continued Gala II Grande Grandview Helios Holbrook Instinct Journey Keaton Knoll Felt Knoll Hopsack Little Devil Ludlow Melody <sup>Ⓞ</sup> Paradigm Petal Pusher <sup>Ⓞ</sup> Prairie Prim Puff Radiance Ransom Roam Rush Hour Shadow Play Spree Summit Sutton Synth Tabloid Tinge Topos Vast Venue Versa Vinyl <sup>Ⓞ</sup> Westwood Wild Thing Yeni	<b>C</b> Atlas Axiom <sup>Ⓞ</sup> Baxter Cairo Chameleon Charm Circa Classic Boucle Dune Durand Earthwork Empire Stripe Entourage Entwine Essence Fibra Greenwich Groovy Hudson Kaleidoscope CR Lagos Lore CR Magnolia Milestone On Point Palisade Panache CR Patchwork Plaid On Prestini Pullman Quark Roundtrip Sahara Sequin CR Sinclair Smart <sup>Ⓞ</sup> Spectator Stepping Stones Swing Tight Rope	<b>C</b> continued Tilden <sup>Ⓞ</sup> Tower Grid Utmost II Utopia Wit Wow Factor Zari CR	<b>D</b> Buzz Code Coterie Eclat Weave Hologram Island Menagerie Origins Pathway Plaitastic Retreat Vice Versa Woodland Zoom	<b>E</b> Aegean Circle Point Cleo Demure Flower Power Highland Ikat Stripe Juno Kampala Kimono Mamba Marquee Meroe Midpoint Nature Walk Off The Grid Rebel Sherman Shima Tempest Tryst Vatera Whip	<b>F</b> Atelier Biscayne Calais Cotton Velvet Century Cornaro Double Agent <sup>Ⓞ</sup> Glider Homage Imprint In Stitches Jasmine Liberty Mod Plaid Rivington Soon Swank Totem Tweed Frieze	<b>G</b> continued Straie Stripe Texnet Ultrasuede Utrillo Vert <b>H</b> Bavaria Catwalk Chiseled Constance Firefly Stretch Appeal Twist Tie World Piece <b>I</b> Aswan Bella Byron Cato Chic Cumings Diamond Days Doily Dynamic Florescence Guise Hastings In Step Ita Jaipur Knoll Velvet Limani Mepal North Island Olema Piper Prince Hairy Rutledge Sandis Stripe It Tudor Zimba	<b>U</b> Vicenza Volo <b>V</b> Acqua Amalfi Andes Embossed Tipped España Hand Tipped * Maremma * Velluto Pelle <b>W</b> Alaska Antique Derby Forte Lucente * Sabrina Umbria	<b>X</b> Ducale Ducale Velour <b>Y</b> Cervo Copenhagen Distressed Gemma Lucca * Marissa Portofino * Riva Saddle *
--	--	--	--	--	---	---	--	--	--

\*Not approved on 255A arm chairs.  
<sup>Ⓞ</sup> Fire Retardants Chemicals

Check with your KnollTextiles or Spinneybeck Representative for changes or additions.

# Ludwig Mies van der Rohe

## Four Seasons Stool

Designer(s):  
Ludwig Mies van der Rohe, 1958

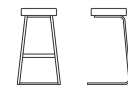

description	w	d	seat h	textile fabric yds.	req. leather sq. ft.	weight	frame
<b>257C</b> Four Seasons Stool	17"	17"	30"	0.8	15	24 lbs.	polished chrome
	17"	17"	30"	0.8	15	24 lbs.	antiqued bronze, satin

### Order Code

Example: <b>257C-DV116</b>
<b>257C</b> Four Seasons Stool
<b>DV116</b> Ducale Velour, Lava

### Specify:

1. Pattern number
2. Textile selection

### Ordering Information

#### Upholstery/COM information:

Prices shown include fabric or leather upholstery. Contact your Knoll representative for colors. Only approved KnollTextiles and Spinneybeck leathers may be ordered.

Customer's Own Material is available pending approval. For approval requirements, processing instructions and ordering information please see page 21.

#### Maintenance:

See pages 28-29.

#### Note:

The KnollStudio logo and signature of Ludwig Mies van der Rohe are stamped into the base of the stool.

#### Cal 133 Fire Code:

The Four Seasons Stools comply with the California Technical Bulletin 133 standard if upholstered in Cal 133 approved upholstery. Specify suffix -C at end of pattern number and suffix -133 at end of textile selection. Upcharge applies, see page 22.

The Four Season Stool is certified Clean Air GOLD.

### Construction

#### Frame:

Bent steel frame with chrome plating or Antiqued Bronze plating in satin finish.

#### Upholstery:

Seat upholstered in leather or fabric over foam cushion reinforced with a plywood form.

#### Stitching:

Stitching detail is found on the rear left hand corner of the stool.

pattern no.	grades	COM	C	D	E	F	G	H	I	COL	V	W	X	Y
<b>257C-C-()</b>	\$4,596.	\$4,626.	\$4,656.	\$4,687.	\$4,711.	\$4,732.	\$4,762.	\$4,829.	\$4,868.	\$5,035.	\$5,152.	\$5,384.	\$5,434.	\$5,491.
<b>257C-BAS-()</b>	6,867.	6,907.	6,944.	6,951.	6,966.	7,014.	7,121.	7,167.	7,274.	7,302.	7,542.	7,714.	7,794.	7,872.

### Approved KnollTextiles Grades/Fabrics

<b>A</b> Alignment Beacon Bocce Chance Common Ground Commuter Cloth Cross Tech Crossroad Delite Facet Heavy Metal Hourglass Infinite Mariner Monarch Overture Prep Presto Soliloquy Sonnet Trophy Uni-Form	<b>B</b> continued Dottie Ferry Forza Gala II Grande Grandview Helios Holbrook Instinct Journey Keaton Knoll Felt Knoll Hopsack Little Devil Ludlow Melody Paradigm Petal Pusher Prairie Prim Puff Radiance Ransom Roam Rush Hour Shadow Play Spree Summit Sutton Synth Tabloid Tinge Topos Vast Venue Versa Vinyl Westwood Wild Thing Yeni	<b>C</b> Axiom Baxter Cairo Chameleon Charm Circa Classic Boucle Dune Durand Earthwork Empire Stripe Entourage Entwine Essence Fibra Greenwich Groovy Hudson Kaleidoscope CR Lagos Lore CR Magnolia Puff Milestone Palisade Panache CR Patchwork Plaid On Prestini Pullman Quark Roundtrip Sahara Sequin CR Sinclair Smart Spectator	<b>C</b> continued Stepping Stones Swing Tight Rope Tilden Tower Grid Utmost II Utopia Wit Wow Factor Zari CR	<b>D</b> Buzz Code Coterie Eclat Weave Hologram Island Menagerie Origins Pathway Plaidtastic Retreat Vice Versa Woodland Zoom	<b>E</b> Aegean Cleo Demure Flower Power Highland Ikat Stripe Kampala Kimono Mamba Marquee Meroe Midpoint Nature Walk Off The Grid Rebel Sherman Tempest Vatera Whip	<b>F</b> Atelier Calais Cotton Velvet Century Biscayne Cornaro Double Agent Glider Imprint In Stitches Jasmine Liberty Mod Plaid Rivington Soon Swank Totem Tweed Frieze	<b>G</b> All Star Alter Ego Andissa Arber Dapper Djenne Duchess Fancy Twill Gibson Haze Kamani Looped In Melange Modern Tweed Spencer Straie Stripe Texnet Ultrasuede Utrillo Vert	<b>H</b> Bavaria Catwalk Chiseled Constance Firefly Stretch Appeal World Piece	<b>I</b> Aswan Byron Cato Cummings Diamond Days Doily Dynamic Florescence Guise In Step Ita Hastings Jaipur Knoll Velvet Limani Mepal North Island Olema Piper Prince Hairy Rutledge Stripe It Tudor Zimba	<b>U</b> Vicenza Volo	<b>V</b> Acqua Amalfi Andes Embossed Tipped España Hand Tipped Velluto Pelle	<b>W</b> Alaska Antique Derby Forte Lucente Sabrina Umbria	<b>X</b> Ducale Ducale Velour	<b>Y</b> Cervo Copenhagen Distressed Gemma Lucca Marissa Portofino Riva Saddle
--	---	---	---	---	---	--	--	---	--	-----------------------------	---	---	-------------------------------------	---

### Spinneybeck Leather

<b>U</b> Vicenza Volo	<b>X</b> Ducale Ducale Velour
<b>V</b> Acqua Amalfi Andes Embossed Tipped España Hand Tipped Velluto Pelle	<b>Y</b> Cervo Copenhagen Distressed Gemma Lucca Marissa Portofino Riva Saddle
<b>W</b> Alaska Antique Derby Forte Lucente Sabrina Umbria	<b>Fire Retardants Chemicals</b>

Check with your KnollTextiles or Spinneybeck Representative for changes or additions.

# Ludwig Mies van der Rohe

## MR Lounge Seating

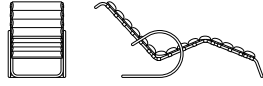
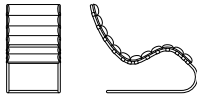
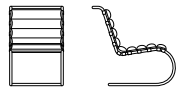
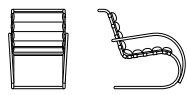
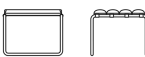
	description	frame	seat h	arm h	w	d	h	req. leather sq. ft.	weight	
<p><i>Designer(s):</i> Mies van der Rohe, 1929 Design from the Mies van der Rohe Archive of The Museum of Modern Art</p> <p><i>Award(s):</i> The Museum of Modern Art, New York, USA; Design Center Stuttgart Award, W. Germany, 1978</p> 	<p><b>242LC</b> MR adjustable chaise lounge</p> 	Sandwiched straps		19 1/2"	26 3/4" - 35 1/2"	70 1/2"	31 3/4"	133	43 lbs.	
	<p><b>241LC</b> MR chaise lounge</p> 	Sandwiched straps			24 1/2"	47 1/4"	37 1/2"	106	39 lbs.	
	<p><b>247LC</b> MR armless lounge chair</p> 	Sandwiched straps		17 3/4"		23 3/4"	34 3/4"	34 3/4"	75	24 lbs.
	<p><b>248LC</b> MR lounge chair with arms</p> 	Sandwiched straps		17 3/4"	23"	25 3/4"	34 3/4"	34 3/4"	75	32 lbs.
	<p><b>243LC</b> MR Stool</p> 	Sandwiched straps				23 3/4"	22 1/2"	18"		12 lbs.

pattern no.	U	V	W	X	Y
<b>242LC-()</b>	\$11,487.	\$12,279.	\$13,303.	\$13,590.	\$13,872.
<b>241LC-()</b>	9,475.	10,147.	11,012.	11,254.	11,493.
<b>247LC-()</b>	7,010.	7,498.	8,127.	8,304.	8,478.
<b>248LC-()</b>	7,782.	8,269.	8,900.	9,075.	9,249.
<b>243LC-()</b>	3,829.	4,135.	4,529.	4,639.	4,748.

Order Code	Ordering Information	Construction
<p><i>Example:</i> <b>241LC-VP03</b></p> <p><b>241LC</b> Chaise lounge</p> <p><b>VP03</b> Velluto Pelle, Espresso</p>	<p><i>Upholstery note:</i> Prices shown include leather upholstery and strap selection. <b>No Customer's Own Material can be used.</b></p> <p><i>Note:</i> The MR Lounge Seating is certified Clean Air GOLD.</p>	<p><i>Frame:</i> Seamless tubular steel with a polished chrome finish. Glides are included.</p> <p><i>Upholstery straps:</i> Upholstery straps are sandwiched to belting thickness on both front and back, with sides stained to match. 241LC contains 12 belting support straps; 242LC contains 15 straps; 247LC and 248LC contain 9 straps each; 243LC contains 4 straps.</p> <p><i>Upholstery:</i> Leather is crafted in a series of quilted and seamed cushion sections. Cushions are attached via leather strips which wrap around the belting support straps and are secured with snap buttons.</p>

Note:  
The Mies lounge chairs are part of a collection. Please refer to Mies side chairs and lounge seating beginning on page 242, and tables, beginning on page 432.



- Specify:*
1. Pattern number
  2. Strap selection
  3. Textile selection

Spinneybeck Leather	
<p><b>U</b> Vicenza Volo</p>	<p><b>X</b> Ducale Ducale Velours</p>
<p><b>V</b> Acqua Amalfi Andes Embossed Tipped España Hand Tipped Velluto Pelle</p>	<p><b>Y</b> Capri Cascia Cervo Copenhagen Distressed Lucca Marissa Portofino Riva Rugata Saddle Sassolino</p>
<p><b>W</b> Alaska Amazon Antique Derby Forte Lucente Sabrina Umbria</p>	

*Check with your Spinneybeck Representative for changes or additions.*

# Ludwig Mies van der Rohe

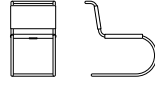
## MR Chair

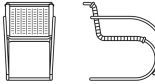
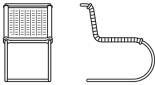



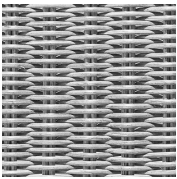

	description	seat h	arm h	w	d	h	weight
<i>Designer(s):</i> Ludwig Mies van der Rohe, 1927	<b>256CC</b> MR cowhide armless side chair, chrome frame	18"		19 1/4"	27 1/4"	31"	17 lbs.
<i>Award(s):</i> The Museum of Modern Art, New York, USA, 1977; Design Center Stuttgart Award, W.Germany, 1978							
	<b>256AC-RN</b> MR Rattan side chair with arms, chrome frame	18"	27"	21"	32 1/2"	31"	24 lbs.
							
	<b>256CC-RN</b> MR Rattan armless side chair, chrome frame	18"		19 1/4"	27 1/4"	31"	17 lbs.
							
	<b>256CKIT</b> Replacement sling kit with laces for armless chair						
	<b>256LACE</b> Replacement leather laces for arm/armless chair						

pattern no.	
<b>256CC-L ( )</b>	\$2,614.
<b>256AC-RN</b>	4,247.
<b>256CC-RN</b>	3,191.
<b>256CKIT-L ( )</b>	1,540.
<b>256LACE-L ( )</b>	118.

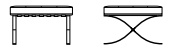
Order Code	Ordering Information
<i>Example:</i> <b>256AC-RN</b>	<i>Cowhide Selection:</i> Black (suffix L80) Light Brown (suffix L82) White Beige (suffix L84)
<b>256AC-RN</b> MR rattan side chair with arms, chrome frame	<i>Note:</i> The KnollStudio logo and signature of Ludwig Mies van der Rohe is stamped into the base of the MR chair.
<i>Note:</i> The MR chairs are part of a collection. Please refer to Mies side chairs and lounge seating beginning on page 242 and tables, beginning on page 432.	<i>Upholstery/COM information:</i> Prices shown include leather upholstery. <b>No Customer's Own Material is available.</b>
<i>Specify:</i> 1. Pattern number 2. Cowhide selection	<i>Maintenance:</i> See pages 28-29.

Construction	
<i>MR CHAIR</i> <i>Frame:</i> Polished chrome frame with woven Rattan.	<i>Woven Rattan detail:</i> 
<i>Woven Rattan:</i> Natural cane handwoven onto polished chrome frame and protected by a clear lacquer finish.	
<i>Rattan Maintenance:</i> Use water and glycerin every three months to keep cane from drying out.	
<i>Glides:</i> Four molded clear plastic glides with twin-pin snap-in construction included with all MR chairs.	

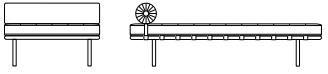
# Ludwig Mies van der Rohe Barcelona® Lounge Seating

	description	frame	straps	seat h	bolster h	w	d	h	req. leather sq. ft.	weight
<i>Designer(s):</i> Mies van der Rohe, 1929	<b>250L</b> Barcelona chair	chrome		17"	29½"	30"	30¼"	50	47 lbs.	
										
<i>Award(s):</i> The Museum of Modern Art, New York, USA, 1977	<b>251Y</b> Barcelona stool	chrome		14¼"	22½"	24"	14¾"	25	28 lbs.	
		stainless		14¼"	22½"	24"	14¾"	25	31 lbs.	
	<b>251YC-L80</b> Barcelona stool with cowhide sling	chrome		12¼"	21½"	23"	12¼"	n/a	26 lbs.	
										
	<b>250LC-S</b> Child's Barcelona chair	chrome		14"	24"	24"	25"	32	41 lbs.	
										
	<b>251YC-S</b> Child's Barcelona stool	chrome		12"	19"	18"	12"	15	25 lbs.	
										
	<b>258L</b> Barcelona couch	stainless	black	15½"	25"	39"	78"	25"	110	84 lbs.
		stainless	colors	15½"	25"	39"	78"	25"	110	84 lbs.
	<b>250LS</b> Barcelona chair	stainless		17"	29½"	30"	30¼"	50	53 lbs.	
										

**Order Code**

<i>Example:</i>	<b>250LS-DV116</b>
<b>250LS</b>	Barcelona chair
<b>DV116</b>	Ducale Velour, Lava

*Note:*  
Barcelona lounge seating and couch are part of a collection. Please refer to Mies side chairs and lounge seating beginning on page 242 and tables, beginning on page 432.

*Specify:*

1. Pattern number
2. Cal 133 Fire Code option (chair and stool only)
3. Leather selection

**Ordering Information**

*Upholstery note:*  
Prices shown include leather upholstery and strap selection. **No Customer's Own Material can be used.**

*Cal 133 Fire Code* ▲ :  
The Barcelona Lounge Chair and Stool comply with the California Technical Bulletin 133 standard if upholstered in Cal 133 approved upholstery. Specify suffix -C after pattern number. Upcharge applies, see page 22.

*Maintenance:*  
See pages 28-29.

*Note:*  
The KnollStudio logo and signature of Ludwig Mies van der Rohe is stamped on each piece.

The Barcelona Lounge Seating Collection is Clean Air GOLD.

The Child's Barcelona chair and stool are compliant to the Consumer Product Safety Improvement Act of 2008 for Children's Products, 16 C.F.R. 1303, CPSIA Title 1 Section 101 for Total Lead in Substrates and Surface Coatings.

**Construction**

*BARCELONA CHAIR AND STOOL*  
*Stainless Steel Frame:*  
Premium grade 304 bar stock stainless steel. Single piece construction ensures long-term durability. Frame is shaped, welded and hand-buffed to mirror finish. Upholstery straps attached with solid stainless steel screws.

*Chrome Frame:*  
Hand-ground and hand-buffed to a mirror finish. Upholstery attaches with aluminum rivets.

*Upholstery straps:*  
Cowhide belting straps. Side and all sides are dyed to match specified upholstery color. Chair contains 17 belting support straps; stool 7. Child's Chair contains 13 belting support straps; stool 7.

pattern no.	cowhide	U	V	W	X	Y
<b>250LC</b>		\$11,962.	\$14,727.	\$15,672.	\$15,862.	\$16,093.
<b>251YC</b>		5,656.	6,950.	7,423.	7,518.	7,632.
<b>251YS</b>		10,571.	10,850.	11,414.	11,550.	11,673.
<b>251YC-L80</b>	3,877.					
<b>250LC-S</b>		10,152.	12,504.	13,305.	13,471.	13,666.
<b>251YC-S</b>		4,800.	5,903.	6,300.	6,386.	6,483.
<b>258LS-(HO1)</b>		20,903.	21,708.	23,342.	23,680.	24,077.
<b>258LS-(-)</b>		22,518.	23,688.	26,070.	26,560.	27,136.
<b>250LS</b>		18,268.	18,897.	20,027.	20,225.	20,533.

*Upholstery:*  
Chair has 40 individual panels for the chair and 16 for the stool; Child's Chair has 40 individual panels for the chair and 16 for the stool. Individual panels are cut, hand-welted, and hand-tufted with leather and buttons produced from a single cowhide. Cushions are premium quality, highly resilient urethane foam with down-like dacron polyester fiberfill.

*Child's Barcelona Chair and Stool:*  
The Child's Barcelona Chair and Stool is 80% scale of standard size.

*BARCELONA STOOL WITH COWHIDE SLING:*  
Thick cowhide sling in black with nylon laces on a chrome frame.

*BARCELONA COUCH*  
*Platform:*  
Hardwood frame is Sapele Mahogany from Africa. Wood has oak-like strength and is characterized by a dark or reddish-brown color. Frame is finished with a protective clear lacquer finish. 11 thick cowhide leather straps over rubber webbing.

*Legs:*  
Tubular steel in polished stainless steel finish.

*Bolster:*  
Bolster in matching leather is secured to cushion platform with straps complete with lock snaps.

*Upholstery straps:*  
Cowhide belting straps with front, back, and side edges all stained to match specified upholstery color. For black straps, specify option (HO1). For matching straps in all other colors, specify leather upholstery selection and straps will be produced to match. Couch contains 11 belting support straps over rubber webbing.

*Upholstery:*  
72 individual panels are cut, hand-welted and hand-tufted with leather and buttons produced from a single cowhide. Cushions are premium quality, fire retardant, high resilient urethane foam with down-like dacron polyester fiberfill.



**Spinneybeck Leather**

<b>U</b> Vicenza Volo	<b>X</b> Ducale Ducale Velours
<b>V</b> Acqua Amalfi Andes Embossed Tipped * España Hand Tipped * Maremma Velluto Pelle	<b>Y</b> Cervo * Copenhagen Distressed Lucca Marissa Portofino * Riva Rugata Saddle
<b>W</b> Alaska Amazon Antique Derby Forte Lucente * Sabrina	

\* Not approved for Cal133 upholstery on 258LS.

*Check with your KnollTextiles or Spinneybeck Representative for changes or additions.*

# Ludwig Mies van der Rohe Barcelona® Relaxed Lounge Seating

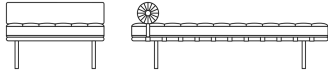
description	frame	straps	seat h	bolster			req. leather sq. ft.	weight
				h	w	d		
<i>Designer(s):</i> Mies van der Rohe, 1929  <i>Award(s):</i> The Museum of Modern Art, New York, USA, 1977	<b>250LR</b> Barcelona relaxed chair	chrome	17"	29 1/2"	30"	30 1/4"	50	47 lbs.
		stainless	17"	29 1/2"	30"	30 1/4"	50	53 lbs.
	<b>251YR</b> Barcelona relaxed stool	chrome	14 3/4"	22 1/2"	24"	14 3/4"	25	28 lbs.
		stainless steel	14 3/4"	22 1/2"	24"	14 3/4"	25	31 lbs.
	<b>258LR-S</b> Barcelona relaxed couch	stainless	black	15 1/3"	25"	39"	78"	84 lbs.
		stainless	colors	15 1/3"	25"	39"	78"	84 lbs.

pattern no.	U	V	W	X	Y
<b>250LR-C</b>	\$12,653.	\$15,577.	\$16,576.	\$16,778.	\$17,021.
<b>250LR-S</b>	19,322.	19,988.	21,182.	21,391.	21,717.
<b>251YR-C</b>	5,983.	7,351.	7,851.	7,953.	8,071.
<b>251YR-S</b>	11,181.	11,476.	12,073.	12,217.	12,346.
<b>258LR-S-HO1</b>	22,106.	22,960.	24,688.	25,046.	25,465.
<b>258LR-S- ( )</b>	23,818.	25,056.	27,575.	28,093.	28,701.

**Order Code**

<i>Example:</i>	<b>250LR-S-DV116</b>
<b>250LRS</b>	Barcelona Relaxed Chair, stainless
<b>DV116</b>	Ducale Velour, Lava

*Note:*  
Barcelona Relaxed seating and couch are part of a collection. Please refer to Mies side chairs and lounge seating beginning on page 242 and tables, beginning on page 432.

*Specify:*

1. Pattern number
2. Cal 133 Fire Code option (chair and stool only)
3. Leather selection

**Ordering Information**

*Upholstery note:*  
Prices shown include leather upholstery and strap selection. **No Customer's Own Material can be used.**

*Cal 133 Fire Code:*  
The Barcelona Relaxed Lounge Chair and Stool comply with the California Technical Bulletin 133 standard if upholstered in Cal 133 approved upholstery. Specify suffix -C after pattern number. Upcharge applies, see page 22.

*Maintenance:*  
See pages 28-29.

*Note:*  
The KnollStudio logo and signature of Ludwig Mies van der Rohe is stamped on each piece.

The Barcelona Relaxed Lounge Seating Collection is certified Clean Air GOLD.

**Construction**

*BARCELONA RELAXED CHAIR AND STOOL*  
*Stainless Steel Frame:*  
Premium grade 304 bar stock stainless steel. Single piece construction ensures long-term durability. Frame is shaped, welded and hand-buffed to mirror finish. Upholstery straps attached with solid stainless steel screws.

*Chrome Frame:*  
Hand-ground and hand-buffed to a mirror finish. Upholstery attaches with aluminum rivets.

*Upholstery straps:*  
Cowhide belting straps. Side and all sides are dyed to match specified upholstery color. Chair contains 17 belting support straps; stool contains 7.

*Upholstery:*  
Chair has 40 individual panels, the stool has 16. Individual panels are cut, hand-welted, and hand-tufted with leather and buttons produced from a single cowhide. Cushions are a soft density, fire retardant urethane foam blanketed with a non-woven fabric topper and an additional Dacron later for a softer feel. The relaxed cushions offer a more supple and relaxed exterior appearance.

*BARCELONA RELAXED COUCH*  
*Platform:*  
Hardwood frame is Sapele Mahogany from Africa. Wood has oak-like strength and is characterized by a dark or reddish-brown color. Frame is finished with a protective clear lacquer finish. 11 thick cowhide leather straps over rubber webbing.

*Legs:*  
Tubular steel in polished stainless steel finish.

*Bolster:*  
Bolster in matching leather is secured to cushion platform with straps complete with lock snaps.

*Upholstery straps:*  
Cowhide belting straps with front, back, and side edges all stained to match specified upholstery color. For black straps, specify option (HO1). For matching straps in all other colors, specify leather upholstery selection and straps will be produced to match. Couch contains 11 belting support straps over rubber webbing.

*Upholstery:*  
72 individual panels are cut, hand-welted and hand-tufted with leather and buttons produced from a single cowhide. Cushions are a soft density, fire retardant urethane foam blanketed with a non-woven fabric topper and an additional Dacron layer for a softer feel. The relaxed cushions offer a more supple and relaxed exterior appearance.

**Spinneybeck Leather**

<b>U</b> Vicenza Volo	<b>X</b> Ducale Ducale Velours
<b>V</b> Acqua Amalfi Andes Embossed Tipped * España Hand Tipped * Maremma Velluto Pelle	<b>Y</b> Cervo * Copenhagen Distressed Lucca Marissa Portofino * Riva Rugata Saddle
<b>W</b> Alaska Amazon Antique Derby Forte Lucente * Sabrina * Not approved for Cal133 upholstery on 258LR-S.	

*Check with your KnollTextiles or Spinneybeck Representative for changes or additions.*



# Ludwig Mies van der Rohe Krefeld™ Collection

*Designer(s):*  
Ludwig Mies van der Rohe, 1930  
Design from the Mies van der  
Rohe Archive of The Museum of  
Modern Art

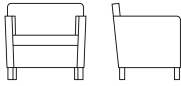
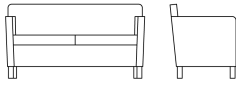

description	seat h	arm h	w	d	h	type	textile fabric yds.	req. leather sq. ft.	weight
<b>751</b> Lounge chair	17 1/4"	25"	32"	27"	30"		6.5	80	59 lbs.
									
Lounge chair in textile with leather welt option						uphol.	6.5		
						welt		21	
<b>752</b> Settee	17 1/4"	25"	57"	27"	30"		8	120	93 lbs.
									
Settee in textile with leather welt option						uphol.	8		
						welt		25	

pattern no.	grades <b>A</b>	COM <b>B</b>	<b>C</b>	<b>D</b>	<b>E</b>	<b>F</b>	<b>G</b>	<b>H</b>	<b>I</b>	COL <b>U</b>	<b>V</b>	<b>W</b>	<b>X</b>	<b>Y</b>
<b>751-(-)(-)</b>	\$5,038.	\$5,445.	\$5,828.	\$6,253.	\$6,595.	\$6,848.	\$7,271.	\$8,084.	\$8,907.	\$10,019.	\$10,757.	\$12,275.	\$12,585.	\$12,953.
<b>751LT-(-)(-)(-)</b>	5,038.	5,445.	5,828.	6,253.	6,595.	6,848.	7,271.	8,084.	8,907.					
<b>751LT-upchg, welt</b>										1,414.	1,593.	1,951.	2,028.	2,114.
<b>752-(-)(-)</b>	7,935.	8,352.	8,756.	9,198.	9,558.	9,823.	10,267.	11,113.	11,734.	15,701.	16,678.	18,663.	19,074.	19,554.
<b>752LT-(-)(-)(-)</b>	7,935.	8,352.	8,756.	9,198.	9,558.	9,823.	10,267.	11,113.	11,734.					
<b>752LT-upchg, welt</b>										1,674.	1,883.	2,315.	2,404.	2,505.

**Order Code**

<i>Example:</i>	<b>751-AWE-DV112</b>
<b>751</b>	Krefeld lounge chair
<b>AWE</b>	Wenge legs
<b>DV112</b>	Ducale Velour, Brandy
<i>Example:</i>	<b>752-AWA-K1026/3-VO904</b>
<b>752</b>	Krefeld settee
<b>AWA</b>	Light Walnut legs
<b>K1026/3</b>	Cross Stitch, Windsor
<b>VO904</b>	Volo, Stallion welt

Krefeld lounge seating is part of a collection. Please refer to Mies side chairs and lounge seating beginning on page 242 and tables, beginning on page 432.

*Specify:*

1. Pattern number
2. Leg finish
3. Textile selection

*Leather Welt selection, specify:*

1. Pattern number
2. Leg finish
3. Textile selection
4. Leather Welt Selection (upcharge applies)

**Ordering Information**

*Leg finishes:*  
Clear Oak (suffix AOC)  
Deep Red Mahogany (suffix AF)  
Light Walnut (suffix AWA)  
Medium Cherry (suffix AM)  
Wenge (suffix AWE)

*Leather Welt Option:*  
The Krefeld collection may be specified with an optional leather welt option. Welt contours all edges, including cushions. Please specify pattern number with LT suffix and add appropriate leather upcharge for total list price of the piece. Leather welt option is available on textile upholstery only.

*Cal 133 Fire Code:*  
The Krefeld Lounge Collection complies with the California Technical Bulletin 133 standard if upholstered in Cal 133 approved upholstery. Specify suffix -C after pattern number. Upcharge applies, see page 22.

*Maintenance:*

See pages 28-29.

*Note:*

The Krefeld Collection is certified Clean Air GOLD.

**Construction**

*Frame:*  
Inner frame in engineered hardwood and plywood. Legs are removable, and are attached to metal plate attached to frame. Coil spring suspension for enhanced comfort. Dynamic suspension in the back for added flexibility and support. Legs are ash hardwood stained (in wenge, medium cherry, deep red mahogany, walnut and clear oak).

*Upholstery:*  
High-density foam cushions with dacron top layer. Benches and ottoman feature dual density foam for added softness and support. Side panel upholstery is tailored to fit, seat and back cushions are more loose.

*Inside dimensions:*  
751 Lounge Chair:  
d: 21"  
w: 26" \*

752 Settee:  
d: 21"  
w: 51" \*

753 Sofa:  
d: 21"  
w: 76" \*

*\*Width measured at the inside of the front of the arms. The chair tapers back, resulting in less width at the back of the chair than the front.*

**Approved KnollTextiles Grades/Fabrics**

<b>A</b> Alignment Beacon Bocce Chance Common Ground Commuter Cloth Cross Tech Crossroad Delite Facet Hourglass Infinite Mariner Monarch Overture Prep Sonnet Trophy Uni-Form	<b>B</b> continued Grandview Helios Holbrook Instinct Journey Keaton Knoll Felt Knoll Hopsack # Little Devil Ludlow Melody <sup>®</sup> Paradigm Petral Pusher <sup>®</sup> Prairie Prim Radiance Ransom Roam Rush Hour Spree Summit Sutton Synth Tabloid Tinge Topos Vast Venue Versa Vinyl <sup>®</sup> Wild Thing	<b>C</b> Atlas Axiom <sup>®</sup> Cairo Chameleon Charm Circa Classic Boucle Contour Durand Earthwork Empire Stripe Entourage Entwine Essence Fibra Greenwich Groovy Hudson Lagos Lore CR Milestone On Point Palisade Panache CR Patchwork Prestini Pullman Quark Roundtrip	<b>C</b> continued Sequin CR Stepping Stones Swing Tight Rope Tilden <sup>®</sup> Tower Grid Utmost II Utopia Wit Zari CR	<b>D</b> Buzz Code Coterie Eclat Weave Hologram Island Kabuki Menagerie Origins Pathway Retreat Woodland Zoom
--	---	--	---	--

**Spinneybeck Leather**

<b>U</b> Vicenza Volo	<b>V</b> Acqua Amalfi Andes Embossed Tipped España Hand Tipped Velluto Pelle	<b>W</b> Alaska Antique Forte Lucente Sabrina # Umbria	<b>Y</b> Cascia Cervo Copenhagen Distressed Marissa Riva Rugata Saddle
<b>H</b> Constance Firefly Stretch Appeal	<b>I</b> Aswan Bella Byron Cato Chic Diamond Days Doily Dynamic Florescence Hastings Knoll Velvet Olema Piper Prince Hairy Rutledge Sandis Tudor Zimba	<b>®</b> Fire Retardants Chemicals	<i>Check with your KnollTextiles or Spinneybeck Representative for changes or additions.</i>

# Ludwig Mies van der Rohe Krefeld™ Collection

*Designer(s):*  
Ludwig Mies van der Rohe, 1930  
Design from the Mies van der Rohe Archive of The Museum of Modern Art



description	seat h	arm h	w	d	h	type	textile fabric yds.	req. leather sq. ft.	weight	
<b>753 Sofa</b>	17 1/4"	25"	82"	27"	30"		11	160	122 lbs.	
Sofa in textile with leather welt option							uphol.	11		
							welt		34	
<b>754 Ottoman</b>	17 1/4"		26"	20 1/2"	17 1/4"		3	50	17 lbs.	
Ottoman in textile with leather welt option							uphol.	3		
							welt		15	

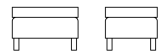
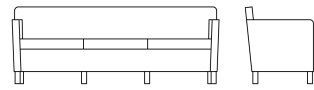

### Order Code

<i>Example:</i>	<b>751-AWE-DV112</b>
<b>751</b>	Krefeld lounge chair
<b>AWE</b>	Wenge legs
<b>DV112</b>	Ducale Velour, Brandy
<i>Example:</i>	<b>752-AWA-K1026/3-VO904</b>
<b>752</b>	Krefeld settee
<b>AWA</b>	Light Walnut legs
<b>K1026/3</b>	Cross Stitch, Windsor
<b>VO904</b>	Volo, Stallion welt

Krefeld lounge seating is part of a collection. Please refer to Mies side chairs and lounge seating beginning on page 242 and tables, beginning on page 432.

### Specify:

1. Pattern number
2. Leg finish
3. Textile selection

### Leather Welt selection, specify:

1. Pattern number
2. Leg finish
3. Textile selection
4. Leather Welt Selection (upcharge applies)

### Ordering Information

*Leg finishes:*  
Clear Oak (suffix AOC)  
Deep Red Mahogany (suffix AF)  
Light Walnut (suffix AWA)  
Medium Cherry (suffix AM)  
Wenge (suffix AWE)

*Leather Welt Option:*  
The Krefeld collection may be specified with an optional leather welt option. Welt contours all edges, including cushions. Please specify pattern number with LT suffix and add appropriate leather upcharge for total list price of the piece. Leather welt option is available on textile upholstery only.

*Cal 133 Fire Code #:*  
The Krefeld Lounge Collection complies with the California Technical Bulletin 133 standard if upholstered in Cal 133 approved upholstery. Specify suffix -C after pattern number. Upcharge applies, see page 22.

### Maintenance:

See pages 28-29.

### Note:

The Krefeld Collection is certified Clean Air GOLD.

### Construction

*Frame:*  
Inner frame in engineered hardwood and plywood. Legs are removable, and are attached to metal plate attached to frame. Coil spring suspension for enhanced comfort. Dynamic suspension in the back for added flexibility and support. Legs are ash hardwood stained (in wenge, medium cherry, deep red mahogany, walnut and clear oak).

*Upholstery:*  
High-density foam cushions with dacron top layer. Benches and ottoman feature dual density foam for added softness and support. Side panel upholstery is tailored to fit, seat and back cushions are more loose.

*Inside dimensions:*  
751 Lounge Chair:  
d: 21"  
w: 26" \*

752 Settee:  
d: 21"  
w: 51" \*

753 Sofa:  
d: 21"  
w: 76" \*

*\*Width measured at the inside of the front of the arms. The chair tapers back, resulting in less width at the back of the chair than the front.*

pattern no.	grades	COM								COL				
	A	B	C	D	E	F	G	H	I	U	V	W	X	Y
<b>753-(-)(-)</b>	\$10,334.	\$10,816.	\$11,274.	\$11,786.	\$12,206.	\$12,504.	\$13,015.	\$13,984.	\$14,698.	\$19,976.	\$21,160.	\$23,580.	\$24,083.	\$24,671.

<b>753LT-(-)(-)(-)</b>	10,334.	10,816.	11,274.	11,786.	12,206.	12,504.	13,015.	13,984.	14,698.					
<b>753LT-upchg, welt</b>										2,274.	2,565.	3,144.	3,262.	3,403.
<b>754-(-)(-)</b>	2,956.	3,077.	3,197.	3,326.	3,432.	3,508.	3,638.	3,885.	4,069.	5,441.	5,719.	6,290.	6,412.	6,549.

<b>754LT-(-)(-)(-)</b>	2,956.	3,077.	3,197.	3,326.	3,432.	3,508.	3,638.	3,885.	4,069.					
<b>754LT-upchg, welt</b>										1,005.	1,131.	1,388.	1,441.	1,503.

### Approved KnollTextiles Grades/Fabrics

<b>A</b> Alignment Beacon Bocce Chance Common Ground Commuter Cloth Cross Tech Crossroad Delite Facet Hourglass Infinite Mariner Monarch Overture Prep Sonnet Trophy Uni-Form	<b>B</b> continued Grandview Helios Holbrook Instinct Journey Keaton Knoll Felt Knoll Hopsack # Little Devil Ludlow Melody © Paradigm Petal Pusher © Prairie Prim Radiance Ransom Roam Rush Hour Spree Summit Sutton Synth Tabloid Tinge Topos Vast Venue Versa Vinyl © Wild Thing	<b>C</b> Atlas Axiom © Cairo Chameleon Charm Circa Classic Boucle Contour Durand Earthwork Empire Stripe Entourage Entwine Essence Fibra Greenwich Groovy Hudson Lagos Lore CR Milestone On Point Palisade Panache CR Patchwork Prestini Pullman Quark Roundtrip	<b>C</b> continued Sequin CR Stepping Stones Swing Tight Rope Tilden © Tower Grid Utmost II Utopia Wit Zari CR	<b>D</b> Buzz Code Coterie Eclat Weave Hologram Island Kabuki Menagerie Origins Pathway Retreat Woodland Zoom
--	---	---	--	--

### Spinneybeck Leather

<b>U</b> Vicenza Volo	<b>V</b> Acqua Amalfi Andes Embossed Tipped España Hand Tipped Velluto Pelle	<b>W</b> Alaska Antique Forte Lucente Sabrina # Umbria	<b>Y</b> Cascia Cervo Copenhagen Distressed Marissa Riva Rugata Saddle
<b>H</b> Constance Firefly Stretch Appeal	<b>I</b> Aswan Bella Byron Cato Chic Diamond Days Doily Dynamic Florescence Hastings Knoll Velvet Olema Piper Prince Hairy Rutledge Sandis Tudor Zimba	<b>©</b> Fire Retardants Chemicals	<i>Check with your KnollTextiles or Spinneybeck Representative for changes or additions.</i>

# Ludwig Mies van der Rohe

## Krefeld™ Collection

*Designer(s):*  
Ludwig Mies van der Rohe, 1930  
Design from the Mies van der Rohe Archive of The Museum of Modern Art

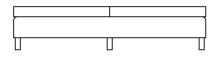

description	seat h	arm h	w	d	h	type	textile fabric yds.	req. leather sq. ft.	weight
<b>755</b> Medium Bench 	17 1/4"		51"	20 1/2"	17 1/4"		5	64	21 lbs.
Medium Bench in textile with leather welt option						uphol.	5		
						welt		20	
<b>756</b> Large Bench 	17 1/4"		76"	20 1/2"	17 1/4"		5.5	80	45 lbs.
Large Bench in textile with leather welt option						uphol.	5.5		
						welt		20	

### Order Code

<i>Example:</i>	<b>751-AWE-DV112</b>
<b>751</b>	Krefeld lounge chair
<b>AWE</b>	Wenge legs
<b>DV112</b>	Ducale Velour, Brandy
<i>Example:</i>	<b>752-AWA-K1026/3-VO904</b>
<b>752</b>	Krefeld settee
<b>AWA</b>	Light Walnut legs
<b>K1026/3</b>	Cross Stitch, Windsor
<b>VO904</b>	Volo, Stallion welt

Krefeld lounge seating is part of a collection. Please refer to Mies side chairs and lounge seating beginning on page 242 and tables, beginning on page 432.

### Specify:

1. Pattern number
2. Leg finish
3. Textile selection

### Leather Welt selection, specify:

1. Pattern number
2. Leg finish
3. Textile selection
4. Leather Welt Selection (upcharge applies)

### Ordering Information

#### Leg finishes:

Clear Oak (suffix AOC)  
Deep Red Mahogany (suffix AF)  
Light Walnut (suffix AWA)  
Medium Cherry (suffix AM)  
Wenge (suffix AWE)

#### Leather Welt Option:

The Krefeld collection may be specified with an optional leather welt option. Welt contours all edges, including cushions. Please specify pattern number with LT suffix and add appropriate leather upcharge for total list price of the piece. Leather welt option is available on textile upholstery only.

#### Cal 133 Fire Code #:

The Krefeld Lounge Collection complies with the California Technical Bulletin 133 standard if upholstered in Cal 133 approved upholstery. Specify suffix -C after pattern number. Upcharge applies, see page 22.

#### Maintenance:

See pages 28-29.

#### Note:

The Krefeld Collection is certified Clean Air GOLD.

### Construction

#### Frame:

Inner frame in engineered hardwood and plywood. Legs are removable, and are attached to metal plate attached to frame. Coil spring suspension for enhanced comfort. Dynamic suspension in the back for added flexibility and support. Legs are ash hardwood stained (in wenge, medium cherry, deep red mahogany, walnut and clear oak).

#### Upholstery:

High-density foam cushions with dacron top layer. Benches and ottoman feature dual density foam for added softness and support. Side panel upholstery is tailored to fit, seat and back cushions are more loose.

#### Inside dimensions:

751 Lounge Chair:  
d: 21"  
w: 26" \*

752 Settee:  
d: 21"  
w: 51" \*

753 Sofa:  
d: 21"  
w: 76" \*

\*Width measured at the inside of the front of the arms. The chair tapers back, resulting in less width at the back of the chair than the front.

pattern no.	grades A	COM B	C	D	E	F	G	H	I	COL U	V	W	X	Y
<b>755-(-)(-)</b>	\$4,099.	\$4,311.	\$4,523.	\$4,753.	\$4,938.	\$5,079.	\$5,301.	\$5,742.	\$6,062.	\$6,504.	\$7,053.	\$8,174.	\$8,409.	\$8,677.
<b>755LT-(-)(-)(-)</b>	4,099.	4,311.	4,523.	4,753.	4,938.	5,079.	5,301.	5,742.	6,062.					
<b>755LT-upchg, welt</b>										1,341.	1,513.	1,869.	1,943.	2,029.
<b>756-(-)(-)</b>	4,756.	5,046.	5,326.	5,628.	5,881.	6,062.	6,364.	6,950.	7,379.	8,476.	9,251.	10,824.	11,145.	11,529.
<b>756LT-(-)(-)(-)</b>	4,756.	5,046.	5,326.	5,628.	5,881.	6,062.	6,364.	6,950.	7,379.					
<b>756LT-upchg, welt</b>										1,384.	1,557.	1,908.	1,984.	2,072.

### Approved KnollTextiles Grades/Fabrics

**A**  
Alignment  
Beacon  
Bocce  
Chance  
Common Ground  
Commuter Cloth  
Cross Tech  
Crossroad  
Delite  
Facet  
Hourglass  
Infinite  
Mariner  
Monarch  
Overture  
Prep  
Sonnet  
Trophy  
Uni-Form

**B**  
Abacus  
Argyle  
Belize  
Bistro  
Calypso  
Chronicle  
Cozy Cord  
Day Tripper  
Diva  
Dottie  
Ferry  
Gala II  
Grande

**B** continued  
Grandview  
Helios  
Holbrook  
Instinct  
Journey  
Keaton  
Knoll Felt  
Knoll Hopsack #  
Little Devil  
Ludlow  
Melody Ⓢ  
Paradigm  
Petat Pusher Ⓢ  
Prairie  
Prim  
Radiance  
Ransom  
Roam  
Rush Hour  
Spree  
Summit  
Sutton  
Synth  
Tabloid  
Tinge  
Topos  
Vast  
Venue  
Versa  
Vinyl Ⓢ  
Wild Thing

**C**  
Atlas  
Axiom Ⓢ  
Cairo  
Chameleon  
Charm  
Circa  
Classic Boucle  
Contour  
Durand  
Earthwork  
Empire Stripe  
Entourage  
Entwine  
Essence  
Fibra  
Greenwich  
Groovy  
Hudson  
Lagos  
Lore CR  
Milestone  
On Point  
Palisade  
Panache CR  
Patchwork  
Prestini  
Pullman  
Quark  
Roundtrip

**C** continued  
Sequin CR  
Stepping Stones  
Swing  
Tight Rope  
Tilden Ⓢ  
Tower Grid  
Utmost II  
Utopia  
Wit  
Zari CR  
**D**  
Buzz  
Code  
Coterie  
Eclat Weave  
Hologram  
Island  
Kabuki  
Menagerie  
Origins  
Pathway  
Retreat  
Woodland  
Zoom

**E**  
Aegean  
Currents  
Demure  
Flower Power  
Highland  
Ikat Stripe  
Kampala  
Kimono  
Mamba  
Marquee  
Meroe  
Nature Walk  
Rebel  
Sherman  
Shima  
Tempest  
Tryst  
Whip  
**F**  
Atelier  
Biscayne  
Calais Cotton  
Velvet  
Cornaro  
Double Agent Ⓢ  
Glider  
Imprint  
In Stitches  
Liberty  
Mod Plaid  
Rivington  
Soon  
Totem

**G**  
All Star  
Alter Ego  
Aurora  
Dapper  
Djenne  
Haze  
Looped In  
Melange  
Modern Tweed  
Texnet  
Ultrasuede  
Vert  
**H**  
Constance  
Firefly  
Stretch Appeal  
**I**  
Aswan  
Bella  
Byron  
Cato  
Chic  
Diamond Days  
Doily  
Dynamic  
Florescence  
Hastings  
Knoll Velvet  
Olema  
Piper  
Prince Hairy  
Rutledge  
Sandis  
Tudor  
Zimba

### Spinneybeck Leather

**U**  
Vicenza  
Volo  
**V**  
Acqua  
Amalfi  
Andes  
Embossed Tipped  
España  
Hand Tipped  
Velluto Pelle  
**W**  
Alaska  
Antique  
Forte  
Lucente  
Sabrina #  
Umbria

Ⓢ Fire Retardants Chemicals

Check with your KnollTextiles or Spinneybeck Representative for changes or additions.

George Nakashima  
Straight Chair



	description	seat h	w	d	h	weight
<i>Designer(s):</i> George Nakashima, 1946	<b>N19</b> Straight Chair	17 1/4"	22 1/2"	17 1/2"	30"	11 lbs.



pattern no.	
<b>N19-AW</b>	\$1,677.

Order Code	Ordering Information	Construction
<i>Example:</i> <b>N19-AW</b>	<i>Finishes:</i> American Walnut (suffix AW)	<i>Frame:</i> Constructed from solid American Walnut, turned American Walnut legs and stretchers, and contrasting Hickory spindles, clear low-sheen finish and nylon glides.
<b>N19</b> Straight Chair	<i>Maintenance:</i> See pages 28-29.	<i>Note:</i> <b>American Walnut exhibits a high degree of natural color characteristics, ranging from chocolate, grey and purplish-browns to deep honey. Color variation will soften and become more uniform over time.</b>
<b>AW</b> American Walnut	<i>Note:</i> The Straight Chair is certified Clean Air GOLD.	
<i>Note:</i> The Straight chair is part of a collection. Please refer to the Splay-Leg table on page 442.	<i>Note:</i> Each chair features George Nakashima's signature under the seat.	
<i>Specify:</i> 1. Pattern number 2. Finish		

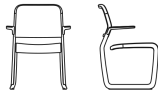
Marc Newson  
Newson Aluminum Chair

	description	seat h	arm h	w	d	h	weight
<i>Designer(s):</i> Marc Newson, 2018	<b>MN01A</b> Newson Aluminum Chair with arms 	18"	24 3/4"	25 7/8"	23 3/4"	33"	20 lbs.
		18"	24 3/4"	25 7/8"	23 3/4"	33"	20 lbs.
	<b>MN01C</b> Newson Aluminum Chair, armless 	18"		22 1/2"	23 3/4"	33"	18 lbs.
		18"		22 1/2"	23 3/4"	33"	18 lbs.



pattern no.	list
<b>MN01A-(BL)-(-)(-)</b>	\$2,383.
<b>MN01A-(MS, WW)-(-)(-)</b>	2,650.
<b>MN01C-(BL)-(-)(-)</b>	2,194.
<b>MN01C-(MS, WW)-(-)(-)</b>	2,421.

Order Code	Ordering Information	Construction
<i>Example:</i> <b>MN01C-WW-MG-M2</b>	<i>Frame paint finishes:</i> Metallic Silver paint (suffix MS) Black paint (suffix BL) Warm White paint (suffix WW)	<i>Frame:</i> Powder coated die cast aluminum with nylon glides.
<b>MN01C</b> Newson Aluminum Chair, armless	<i>Back insert finishes:</i> Black (suffix BL) Medium Grey (suffix MG)	<i>Back insert:</i> Fiberglass reinforced nylon in medium grey or black finish.
<b>WW</b> Warm White frame paint	<i>Mesh finishes:</i> Black (suffix M1) Warm White (suffix M2) Medium Grey (suffix M3) Blue (suffix M4) Orange (suffix M5) Yellow (suffix M6)	<b>Glides and arm pads (when applicable) will match back insert finish selection.</b>
<b>MG</b> Medium Grey back insert	<i>Maintenance:</i> See pages 28-29.	<i>Arm pad content:</i> Self-skinning urethane in medium grey or black finish.
<b>M2</b> Warm White mesh		<i>Mesh:</i> The mesh seats and backs are knitted using two components: polyester yarn, which adds color and a soft hand, along with thermoplastic elastomer which provides the structural element.

- Specify:*
1. Pattern number
  2. Frame paint finish
  3. Back insert finish
  4. Mesh finish

The Newson Aluminum Chair is certified Clean Air GOLD.

*Cal 117-2013:*  
The Newson Aluminum Chair passes the California Technical Bulletin 117-2013 requirements (June 2013 version).

*Stacking:*  
Newson Aluminum Chairs stack up to four high.

# Jonathan Olivares

## Aluminum Stacking Chair



	description	seat h	w	d	h	weight
<i>Designer(s):</i> Jonathan Olivares, 2012	<b>OAC1</b> Olivares Chair	17 1/2"	22 1/3"	21 7/8"	31 1/2"	15 lbs.



pattern no.	list
<b>OAC1-( )</b>	\$1,304.

Order Code	Ordering Information	Construction
<i>Example:</i> <b>OAC1-WHT</b>	<i>Paint finishes:</i>	<i>Shell:</i>
<b>OAC1</b> Olivares chair	White (suffix WHT)	Constructed from die-cast aluminum with integrated leg tenons. A long low-profile nylon stacking bumper distributes the chair's weight over a wide area providing a more stable stacking condition. The designer's signature and KnollStudio logo are located under the seat.
<b>WHT</b> White paint finish	Grey (suffix GRY)	
	Yellow (suffix YEL)	
	Lime Green (suffix LGR)	
	Orange (suffix ORG)	
	Plum (suffix PLM)	
	Sky Blue (suffix SBL)	
	Blue (suffix BLU)	
	Dark Charcoal (CHR)	
<i>Specify:</i>	<i>Maintenance:</i>	<i>Legs:</i>
1. Pattern number	See pages 28-29.	Aluminum extruded legs are secured to the chair's shell using epoxy and stainless steel fasteners.
2. Paint finish selection		
		<i>Paint:</i>
		Ultra-durable polyester powder coat paint.
		<i>Glides:</i>
		1/4" flat nylon glides.
		<i>Stacking:</i>
		Chairs stack six on the floor.
		<i>Outdoor use:</i>
		With proper preventative maintenance, the Olivares chair is appropriate for outdoor environments.

# Jorge Pensi Toledo Stacking Chair

	description	seat h	arm h	w	d	h	textile fabric yds.	req. leather sq. ft.	weight
<i>Designer(s):</i> Jorge Pensi, 1988	<b>29C</b> Toledo Chair 	17 1/4"	27 1/4"	21 1/8"	21 1/4"	29 7/8"			15 lbs.
<i>Award(s):</i> First Place, Sidi Selection, Valencia, Spain, 1988; "Delta Plate" of ADI FAD, 1988; Design Center Stuttgart Award, W. Germany, 1990	<b>29K</b> Toledo Chair, seat cushion replacement 						0.6	7	



Order Code	Ordering Information	Construction
<i>Example:</i> <b>29C-29K-K161/1</b>		
<b>29C</b> Toledo chair	<i>Note:</i> The Toledo Chair is available in the United States only.	<i>Seat, back, arms:</i> Polished cast aluminum, thermo-treated.
<b>29K</b> Seat cushion option	<i>Upholstery/COM information:</i> Prices shown include fabric or leather upholstery. Contact your Knoll representative for colors. Only approved KnollTextiles and Spinneybeck leathers may be ordered.	<i>Legs:</i> Anodized, polished tubular aluminum. The Toledo chair is 100% recyclable.
<b>K161/1</b> Classic Boucle, Pearl	<i>Maintenance:</i> See pages 28-29.	<i>Stacking feature:</i> Chairs can be stacked up to 4 high for compact storage.
<i>Note:</i> Toledo Chairs are part of a collection. Please refer to Pensi Tables on pages 446.	<i>Note:</i> Toledo Chairs are stamped under the seat with the name of the designer and the manufacturer, AMAT 3.	<i>Outdoor use:</i> With proper preventative maintenance, the Toledo Chair is appropriate for outdoor environments. Aluminum will not reflect extreme outdoor temperatures.
<i>Specify:</i> 1. Pattern number 2. Seat pad option 3. Textile selection	Customer's Own Material is available pending approval. For approval requirements, processing instructions and ordering information please see page 21.	<i>Optional seat pad:</i> Regardless of the textile, the seat pad is not approved for outdoor use.
	The Toledo Stacking Chair is certified Clean Air GOLD.	Toledo Stacking Chair is manufactured in Spain by Amat-3.

pattern no.		grades <b>A</b>	COM <b>B</b>	<b>C</b>	<b>D</b>	<b>E</b>	<b>F</b>	<b>G</b>	<b>H</b>	<b>I</b>	COL <b>U</b>	<b>V</b>	<b>W</b>	<b>X</b>	<b>Y</b>
<b>29C</b>	\$2,732.														
<b>29K</b>		387.	421.	450.	486.	513.	532.	567.	635.	686.	678.	756.	909.	940.	977.

Approved KnollTextiles Grades/Fabric					Spinneybeck Leathers				
<b>A</b>	<b>B</b>	<b>C</b>	<b>C</b>	<b>F</b>	<b>H</b>	<b>I</b>	<b>U</b>	<b>V</b>	<b>Y</b>
Alignment Analogy Beacon Bocce Chance Common Ground Commuter Cloth Facet Foil Rap Heavy Metal Hourglass Infinite Mariner Monarch Oh La La Prep Presto Soliloquy Sonnet Stacks Trophy	<b>B</b> continued Ferry Forza Framework Gala II Grande Grandview Instinct Journey Keaton Knoll Felt Knoll Hopsack Lyric Night Life Nonchalant CR Paradigm Pop Prairie Prim Puff Ransom Roam Rush Hour Shadow Play Soiree Spotlight Spree Sutton Synth Topos Vast Venue Versa Vinyl Wild Thing Zephyr	<b>C</b> Atlas Autobahn Axiom Baxter Biota Charm Circa Classic Boucle Contour Durand Earthwork Empire Stripe Entourage Fibra Fox Trot CR Greenwich Groovy Highline CR Hudson Kaleidoscope CR Lore CR Milestone On Point Panache CR Patchwork Plaid On Pony Up Posh Prestini Quark Regard CR Roundtrip Sequin CR Sahara Sandpiper Sinclair	<b>C</b> continued Smart Spectator Stepping Stones Swing Tight Rope Tilden Tower Grid Utmost II Vibe Wow Factor Zari CR	<b>F</b> Biscayne Cornaro Double Agent Glider Homage Imprint Jubilee Kinship Rivington Swank Totem Tweed Frieze	<b>H</b> Bavaria Chiseled Constance Gezelle Haiku Twist Tie World Piece	<b>I</b> Bella Byron Canaan Cato Chic Cummings Diamond Days Doily Dynamic Fiori Galloway Gates Gramercy Hastings In Step Ita Jaipur Knoll Velvet Mepal North Island Olema Piper Prince Hair Rutledge Sandis Stirling Tudor Walker Worth Zimba	<b>U</b> Vicenza Volo	<b>V</b> Acqua Amalfi Andes Embossed Tipped España Hand Tipped Maremma Velluto Pelle	<b>Y</b> Cervo Copenhagen Distressed Gemma Lucca Marissa Portofino Riva
							<b>W</b> Alaska Antique Arizona Derby Forte Lucente Sabrina Umbria	<b>X</b> Ducale Fire Retardants Chemicals	

Check with your KnollTextiles or Spinneybeck Representative for changes or additions.

# Charles Pfister Petite Lounge Seating

Designer(s):  
Charles Pfister, 1971

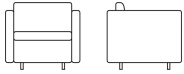
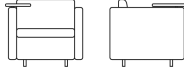

description	seat h	arm h	w	d	h	textile fabric yds.	req. leather sq. ft.	weight
<b>1051C-S</b> Petite lounge chair	16"	24"	29 1/2"	29 1/2"	26"	6.5	117	39 lbs.
								
<b>1051C-ST-( )</b> Petite Pfister lounge chair with optional tablet arm	16"	24"	29 1/2"	29 1/2"	26"	6.5	117	41 lbs.
								

Order Code	Ordering Information	Construction
<i>Example:</i> <b>1051C-ST-R-H-K109/15</b>	<i>Tablet arm option (suffix ST), lounge chair only:</i>	<i>Frame:</i>
<b>1051C</b> Petite Pfister lounge chair	Left handed (suffix L)	Constructed in sections with a combination plywood/hardwood seat and back.
<b>ST</b> Tablet arm option	Right handed (suffix R)	
<b>R</b> Right handed tablet arm		<i>Upholstery:</i>
<b>H</b> Caster option	<i>Caster option (suffix H), lounge chair only:</i>	Petite Pfister lounge seat and back cushion are fully upholstered. Double-needled top stitching on leather upholstery and on thin solid textiles. Single-needled top stitching on heavily ribbed fabrics and multicolor prints. No sag spring deck covered in black cotton textile.
<b>K109/15</b> Haze, Persimmon	To specify four casters add -H to end of pattern number before upholstery selection.	<i>Swivel tablet:</i>
	<i>Upholstery/COM information:</i>	Machined aluminum, post and socket mechanism with black phenolic rectangular tablet; swivels 360°. Tablet dimensions are 10" x 14".
	Prices shown include fabric or leather upholstery. Contact your Knoll representative for colors. Only approved KnollTextiles and Spinneybeck leathers may be ordered.	<i>Seat height:</i>
	Customer's Own Material is available pending approval. Non-railroad COM fabrics will require additional yardage. For approval requirements, processing instructions and ordering information please see page 21.	Seat height is measured from the floor to the crown of the seat cushion. Height could vary up to 1/2" depending on leather or textile specified.
	<i>Cal 133 Fire Code:</i>	
	Petite Pfister lounge seating complies with the California Technical Bulletin 133 standard if upholstered in Cal 133 approved upholstery. Specify suffix -C at end of pattern number and suffix -133 at end of textile selection. Upcharge applies, see page 22.	
	<i>Note:</i>	
	The Petite Pfister Lounge Seating Collection is certified Clean Air GOLD.	

*Specify:*

1. Pattern number
2. Cal 133 Fire Code option
3. Tablet option (lounge chair only), right or left
4. Caster option (lounge chair only)
5. Textile selection

pattern no.	grades <b>A</b>	COM <b>B</b>	<b>C</b>	<b>D</b>	<b>E</b>	<b>F</b>	<b>G</b>	<b>H</b>	<b>I</b>	COL <b>U</b>	<b>V</b>	<b>W</b>	<b>X</b>	<b>Y</b>
<b>1051C-S</b>	\$3,877.	\$4,240.	\$4,589.	\$4,970.	\$5,285.	\$5,505.	\$5,882.	\$6,615.	\$7,356.	\$9,259.	\$10,564.	\$13,333.	\$13,765.	\$14,402.
<b>1051C-ST-( )</b>	4,897.	5,259.	5,611.	5,986.	6,300.	6,527.	6,900.	7,633.	8,378.	10,281.	11,581.	14,353.	14,782.	15,423.

**Approved KnollTextiles Grades/Fabrics**

<b>A</b> Alignment Beacon Bocce Chance Common Ground Commuter Cloth Cross Tech Crossroad Delite Facet Hourglass Infinite Mariner Monarch Oh La La Overture Prep Soliloquy Sonnet Trophy Uni-Form	<b>B</b> continued Grandview Helios Holbrook Instinct Journey Keaton Knoll Felt Knoll Hopsack Little Devil Ludlow Melody <sup>®</sup> Paradigm Petal Pusher <sup>®</sup> Prairie Prim Puff Radiance Ransom Roam Rush Hour Shadow Play Spree Summit Sutton Synth Tabloid Tinge Topos Vast Venue Versa Vinyl <sup>®</sup> Westwood Yeni	<b>C</b> Atlas Axiom <sup>®</sup> Baxter Cairo Chameleon Charm Circa Classic Boucle Contour Dune Durand Earthwork Empire Stripe Entourage Entwine Essence Fibra Greenwich Groovy Hudson Kaleidoscope CR Lagos Lore CR Magnolia Milestone On Point Palisade Panache CR Patchwork Plaid On Prestini Pullman Quark Roundtrip Sahara Sequin CR Sinclair Smart <sup>®</sup> Spectator Sherman Shima Stepping Stones Swing	<b>C</b> continued Tempest Tilden <sup>®</sup> Tower Grid Tryst Utmost II Utopia Vatera WhipTight Rope Wit Wow Factor Zari CR	<b>D</b> Buzz Code Coterie Eclat Weave Island Menagerie Origins Pathway Plaidtastic Vice Versa Woodland Zoom	<b>E</b> Aegean Circle Point Cleo Currents Demure Flower Power Highland Ikat Stripe Juno Kampala Kimono Mamba Marquee Meroe Midpoint Nature Walk Off The Grid Rebel
---	---	---	--	--	---

**Spinneybeck Leather**

<b>U</b> Vicenza Volo	<b>V</b> Acqua Amalfi Andes Embossed Tipped España Hand Tipped Maremma Velluto Pelle	<b>W</b> Alaska Antique Derby Forte Lucente Sabrina Umbria	<b>X</b> Ducale Ducale Velour	<b>Y</b> Cascia Cervo Copenhagen Distressed Lucca Marissa Portofino Riva Rugata Saddle Sassolino
<sup>®</sup> Fire Retardants Chemicals				
<i>Check with your KnollTextiles or Spinneybeck Representative for changes or additions.</i>				





# Charles Pfister

## Petite Lounge Seating

Designer(s):  
Charles Pfister, 1971

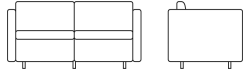

description	height, seat	height, arm	width	depth	height	textile fabric yards	leather sq ft	weight
<b>1052C-S</b> Petite settee 	16"	24"	53"	29 1/2"	26"	10.8	194	64 lbs.
<b>1053C-S</b> Petite sofa 	16"	24"	76 1/2"	29 1/2"	26"	15.0	270	88 lbs.
<b>1059C-S</b> Petite ottoman 			22"	22"	16"	3.8	69	18 lbs.
<b>H</b> Optional casters for Petite lounge chair								

Order Code	Ordering Information	Construction
<i>Example:</i> <b>1051C-ST-R-H-K109/15</b>	<i>Tablet arm option (suffix ST), lounge chair only:</i>	<i>Frame:</i>
<b>1051C</b> Petite Pfister lounge chair	Left handed (suffix L)	Constructed in sections with a combination plywood/hardwood seat and back.
<b>ST</b> Tablet arm option	Right handed (suffix R)	
<b>R</b> Right handed tablet arm		<i>Upholstery:</i>
<b>H</b> Caster option		Petite Pfister lounge seat and back cushion are fully upholstered.
<b>K109/15</b> Haze, Persimmon	<i>Caster option (suffix H), lounge chair only:</i>	Double-needled top stitching on leather upholstery and on thin solid textiles.
	To specify four casters add -H to end of pattern number before upholstery selection.	Single-needled top stitching on heavily ribbed fabrics and multicolor prints. No sag spring deck covered in black cotton textile.
	<i>Upholstery/COM information:</i>	<i>Swivel tablet:</i>
	Prices shown include fabric or leather upholstery. Contact your Knoll representative for colors. Only approved KnollTextiles and Spinneybeck leathers may be ordered.	Machined aluminum, post and socket mechanism with black phenolic rectangular tablet; swivels 360°. Tablet dimensions are 10" x 14".
	<i>Cal 133 Fire Code:</i>	<i>Seat height:</i>
	Petite Pfister lounge seating complies with the California Technical Bulletin 133 standard if upholstered in Cal 133 approved upholstery. Specify suffix -C at end of pattern number and suffix -133 at end of textile selection. Upcharge applies, see page 22.	Seat height is measured from the floor to the crown of the seat cushion. Height could vary up to 1/2" depending on leather or textile specified.
	<i>Note:</i>	
	The Petite Pfister Lounge Seating Collection is certified Clean Air GOLD.	

*Specify:*

1. Pattern number
2. Cal 133 Fire Code option
3. Tablet option (lounge chair only), right or left
4. Caster option (lounge chair only)
5. Textile selection

pattern no.	grade <b>A</b>	COM <b>B</b>	<b>C</b>	<b>D</b>	<b>E</b>	<b>F</b>	<b>G</b>	<b>H</b>	<b>I</b>	COL <b>U</b>	<b>V</b>	<b>W</b>	<b>X</b>	<b>Y</b>
<b>1052C-S</b>	\$6,810.	\$7,407.	\$7,985.	\$8,609.	\$9,125.	\$9,498.	\$10,129.	\$11,329.	\$12,558.	\$15,773.	\$17,931.	\$22,527.	\$23,241.	\$24,303.
<b>1053C-S</b>	9,516.	10,354.	11,152.	12,031.	12,750.	13,271.	14,149.	15,822.	17,541.	22,065.	25,064.	31,458.	32,450.	33,932.
<b>1059C-S</b>	2,861.	3,065.	3,252.	3,457.	3,624.	3,744.	3,954.	4,341.	4,742.	6,048.	6,770.	8,305.	8,547.	8,905.
<b>H</b>														

Approved KnollTextiles Grades/Fabrics

<b>A</b> Alignment Beacon Bocce Chance Common Ground Commuter Cloth Cross Tech Crossroad Facet Hourglass Infinite Mariner Monarch Oh La La Overture Prep Soliloquy Sonnet Trophy Uni-Form	<b>B</b> continued Grandview Helios Holbrook Instinct Journey Keaton Knoll Felt Knoll Hopsack Little Devil Ludlow Melody <sup>®</sup> Paradigm Petal Pusher <sup>®</sup> Prairie Prim Puff Radiance Ransom Roam Rush Hour Shadow Play Spree Summit Sutton Synth Tabloid Tinge Topos Vast Venue Versa Vinyl <sup>®</sup> Westwood Yeni	<b>C</b> Atlas Axiom <sup>®</sup> Baxter Cairo Chameleon Charm Circa Classic Boucle Contour Dune Durand Earthwork Empire Stripe Entourage Entwine Essence Fibra Greenwich Groovy Hudson Kaleidoscope CR Lagos Lore CR Magnolia Milestone On Point Palisade Panache CR Patchwork Plaid On Prestini Pullman Quark Roundtrip Sahara Sequin CR Sinclair Smart <sup>®</sup> Spectator Sherman Shima Stepping Stones Swing	<b>C</b> continued Tempest Tilden <sup>®</sup> Tower Grid Tryst Utmost II Utopia Vatera WhipTight Rope Wit Wow Factor Zari CR	<b>D</b> Buzz Code Coterie Eclat Weave Island Menagerie Origins Pathway Plaidtastic Vice Versa Woodland Zoom	<b>E</b> Aegean Circle Point Cleo Currents Demure Flower Power Highland Ikat Stripe Juno Kampala Kimono Mamba Marquee Meroe Midpoint Nature Walk Off The Grid Rebel	<b>F</b> Atelier Biscayne Calais Cotton Velvet Century Cornaro Double Agent <sup>®</sup> Glider Homage Imprint In Stitches Jasmine Liberty Mod Plaid Rivington Soon Totem	<b>G</b> All Star Alter Ego Andissa Arber Aurora Color Collage Dapper Djenne Duchess Gibson Fancy Twill Haze Kamani Looped In Melange Modern Tweed Rivers Spencer Straie Stripe Texnet Ultrasuede Utrillo Vert	<b>H</b> Bavaria Catwalk Constance Firefly Stretch Appeal Twist Tie World Piece	<b>I</b> Aswan Bella Byron Cato Chic Cummings Diamond Days Doily Dynamic Florescence Guise Hastings In Step Ita Jaipur Knoll Velvet Limani Mepal North Island Olema Piper Prince Hair Rutledge Sandis Stripe It Tudor Zimba	<b>U</b> Vicenza Volo	<b>V</b> Acqua Amalfi Andes Embossed Tipped España Hand Tipped Maremma Velluto Pelle	<b>W</b> Alaska Antique Derby Forte Lucente Sabrina Umbria	<b>X</b> Ducale Ducale Velour	<b>Y</b> Cascia Cervo Copenhagen Distressed Lucca Marissa Portofino Riva Rugata Saddle Sassolino
---	---	---	--	--	---	--	---	--	--	-----------------------------	--	---	-------------------------------------	---

Spinneybeck Leather



<sup>®</sup> Fire Retardants Chemicals

Check with your KnollTextiles or Spinneybeck Representative for changes or additions.

# Charles Pfister Lounge Seating

Designer(s):  
Charles Pfister, 1971

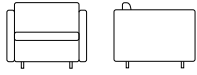
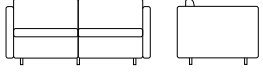

description	seat h	arm h	w	d	h	textile fabric yds.	req. leather sq. ft.	weight
<b>1051C</b> Standard lounge chair	16"	24"	33 1/2"	33"	26"	7.2	130	44 lbs.
								
<b>1052C</b> Standard settee	16"	24"	60 1/2"	33"	26"	12.4	224	73 lbs.
								
<b>1053C</b> Standard sofa	16"	24"	87"	33"	26"	17.6	318	101 lbs.
								
<b>1059C</b> Standard ottoman			27 1/4"	27 1/4"	16"	3.8	69	20 lbs.
								

Order Code	Ordering Information	Construction
------------	----------------------	--------------

<i>Example:</i> <b>1053C-MABLK</b>		
<b>1053C</b>	Pfister sofa	
<b>MABLK</b>	Marissa, Black	

- Specify:
1. Pattern number
  2. Cal 133 Fire Code option
  3. Textile selection

**Upholstery/COM information:**  
Prices shown include fabric or leather upholstery. Contact your Knoll representative for colors. Only approved KnollTextiles and Spinneybeck leathers may be ordered.

Customer's Own Material is available pending approval. Non-railroad COM fabrics will require additional yardage. For approval requirements, processing instructions and ordering information please see page 21.

**Cal 133 Fire Code #:**  
Pfister lounge seating complies with the California Technical Bulletin 133 standard if upholstered in Cal 133 approved upholstery. Specify suffix -C at end of pattern number and suffix -133 at end of textile selection. Upcharge applies, see page 22.

**Maintenance:**  
To fluff standard Pfister cushions, turn cushion upside down occasionally. See also pages 28-29.

**Note:**  
The Pfister Lounge Seating Collection is certified Clean Air GOLD.

**Frame:**  
Constructed in sections with a combination plywood/hardwood seat and back.

**Upholstery:**  
Pfister lounge seat and back cushion are fully upholstered. Double-needled top stitching on leather upholstery and on thin solid textiles. Single-needled top stitching on heavily ribbed fabrics and multicolor prints. No sag spring deck covered in black cotton textile.

**Seat height:**  
Seat height is measured from the floor to the crown of the seat cushion. Height could vary up to 1/2" depending on leather or textile specified.

**Glides:**  
Nylon, adjustable.

**Cushion fill:**  
Polyester wrap: foam core with polyester fiber wrap for tight, tailored aesthetic.



pattern no.	grades <b>A</b>	COM <b>B</b>	<b>C</b>	<b>D</b>	<b>E</b>	<b>F</b>	<b>G</b>	<b>H</b>	<b>I</b>	COL <b>U</b>	<b>V</b>	<b>W</b>	<b>X</b>	<b>Y</b>
<b>1051C</b>	\$4,859.	\$5,248.	\$5,620.	\$6,027.	\$6,359.	\$6,601.	\$7,006.	\$7,789.	\$8,590.	\$10,736.	\$12,143.	\$15,117.	\$15,582.	\$16,276.
<b>1052C</b>	8,590.	9,262.	9,898.	10,602.	11,181.	11,590.	12,299.	13,640.	15,013.	18,735.	21,151.	26,287.	27,085.	28,273.
<b>1053C</b>	12,037.	12,991.	13,896.	14,896.	15,714.	16,299.	17,302.	19,206.	21,157.	26,510.	29,936.	37,225.	38,354.	40,049.
<b>1059C</b>	3,614.	3,825.	4,021.	4,236.	4,410.	4,539.	4,757.	5,164.	5,583.	6,981.	7,721.	9,298.	9,548.	9,914.

Approved KnollTextiles Grades/Fabrics	Spinneybeck Leather
---------------------------------------	---------------------

<b>A</b> Alignment Beacon Bocce Chance Common Ground Commuter Cloth Cross Tech Crossroad Delite Facet Hourglass Infinite Mariner Monarch Oh La La Overture Prep Soliloquy Sonnet Trophy Uni-Form	<b>B</b> continued Grandview Helios Holbrook Instinct Journey Keaton Knoll Felt Knoll Hopsack Little Devil Ludlow Melody <sup>®</sup> Paradigm Petal Pusher <sup>®</sup> Prairie Prim Puff Radiance Ransom Roam Rush Hour Shadow Play Spree Summit Sutton Synth Tabloid Tinge Topos Vast Venue Versa Vinyl <sup>®</sup> Westwood Yeni	<b>C</b> Atlas Axiom <sup>®</sup> Baxter Cairo Chameleon Charm Circa Classic Boucle Contour Dune Durand Earthwork Empire Stripe Entourage Entwine Essence Fibra Greenwich Groovy Hudson Kaleidoscope CR Lagos Lore CR Magnolia Milestone On Point Palisade Panache CR Patchwork Plaid On Pullman Quark Roundtrip Sahara Sequin CR Sinclair Smart <sup>®</sup> Spectator Stepping Stones Swing	<b>C</b> continued Tight Rope Tilden <sup>®</sup> Tower Grid Utmost II Utopia Wit Wow Factor Zari CR  <b>D</b> Buzz Code Coterie Eclat Weave Hologram Island Menagerie Retreat Vice Versa Woodland Zoom  <b>E</b> Aegean Circle Point Cleo Currents Demure Flower Power Highland Ikat Stripe Juno Kampala Kimono Mamba Marquee Meroe Midpoint Nature Walk Off The Grid Rebel Sherman Shima Tempest Tryst Vatera Whip	<b>F</b> Atelier Biscayne Calais Cotton Velvet Century Cornaro Double Agent <sup>®</sup> Glider Homage Imprint In Stitches Jasmine Liberty Mod Plaid Rivington Soon Totem  <b>G</b> All Star Alter Ego Andissa Arber Aurora Color Collage Dapper Djenne Duchess Gibson Fancy Twill Haze Kamani Looped In Melange Modern Tweed Rivers Spencer Straie Stripe Texnet Ultrasuede Utrillo Vert	<b>H</b> Bavaria Catwalk Constance Firefly Stretch Appeal Twist Tie World Piece  <b>I</b> Aswan Bella Byron Cato Chic Cummings Diamond Days Doily Dynamic Florescence Guise Hastings In Step Ita Jaipur Knoll Velvet Limani Mepal North Island Olema Piper Prince Hairy Rutledge Sandis Stripe It Tudor Zimba	<b>U</b> Vicenza Volo  <b>V</b> Acqua Amalfi Andes Embossed Tipped España Hand Tipped Maremma Velluto Pelle  <b>W</b> Alaska Antique Derby Forté Lucente Sabrina Umbria	<b>X</b> Ducale Ducale Velour  <b>Y</b> Cascia Cervo Copenhagen Distressed Lucca Marissa Portofino Riva Rugata Saddle Sassolino
---	---	---	---	---	---	--	--

<sup>®</sup> Fire Retardants Chemicals  
  
Check with your KnollTextiles or Spinneybeck Representative for changes or additions.

# Charles Pfister Sofa System

	description	seat h	arm h	w	d	h	textile fabric yds.	req. leather sq. ft.	weight
<i>Designer(s):</i> Charles Pfister, 1971	<b>1050C</b> Center module	16"		27 1/4"	33"	26"	5.2	94	28 lbs.
									
	<b>1050C-1</b> End module, arm panel on right side of user	16"	24"	30 1/8"	33"	26"	6.2	112	36 lbs.
									

pattern no.	grades	COM	C	D	E	F	G	H	I	COL	U	V	W	X	Y
<b>1050C</b>	\$3,705.	\$3,987.	\$4,249.	\$4,549.	\$4,791.	\$4,964.	\$5,260.	\$5,828.	\$6,401.	\$8,141.	\$9,153.	\$11,210.	\$11,645.	\$12,146.	
<b>1050C-1</b>	4,596.	4,936.	5,254.	5,612.	5,895.	6,106.	6,455.	7,129.	7,811.	9,953.	11,163.	13,615.	14,125.	14,723.	

Order Code	Ordering Information	Construction
<i>Example:</i> <b>1050C-3-K349/1</b>	<i>Upholstery/COM information:</i> Prices shown include fabric or leather upholstery. Contact your Knoll representative for colors. Only approved KnollTextiles and Spinneybeck leathers may be ordered. <u>Note:</u> Non-railroad COM fabrics will require additional yardage.	<i>Cal 133 Fire Code ▲ :</i> The Pfister Collection complies with the California Technical Bulletin 133 standard if upholstered in Cal 133 approved upholstery. Specify polyester fiber wrap and suffix -C at end of pattern number and suffix -133 at end of textile selection. Upcharge applies, see page 18.
<b>1050C-3</b> Pfister corner module	Customer's Own Material is available pending approval. For approval requirements, processing instructions and ordering information please see page 21.	<i>Frame:</i> Constructed in sections with a combination plywood/hardwood seat and back.
<b>K349/1</b> Alignment, Sand		
<i>Specify:</i> 1. Pattern number 2. Cal 133 Fire Code option 3. Textile selection	<i>Seat height:</i> Seat height is measured from the floor to the crown of the seat cushion. Height could vary up to 1/2" depending on leather or textile specified.	<i>Upholstery:</i> Pfister sofa system cushions are fully upholstered. Coverings are upholstered on both sides in fabric or leather. Double-needled top stitching on leather upholstery and thin solid textiles. Single-needled top stitching on heavily ribbed fabrics and multicolor prints. No sag spring deck covered in black cotton textile.
	<i>Maintenance:</i> To fluff cushions, turn cushion upside down occasionally. See also pages 28-29.	<i>Cushion fill:</i> Polyester wrap: foam core with polyester fiber wrap for tight, tailored aesthetic.
	<i>Note:</i> Modules shipped with unupholstered sides unless specified. For upholstered sides, contact your Knoll representative for pricing. All modules shipped knocked-down (KD), assembly required.	<i>Glides:</i> Nylon, adjustable.
	<i>Note:</i> The Pfister Sofa System is certified Clean Air GOLD.	

Approved KnollTextiles Grades/Fabrics						Spinneybeck Leather	
<b>A</b> Alignment Beacon Bocce Chance Common Ground Commuter Cloth Cross Tech Crossroad Delite Facet Hourglass Infinite Mariner Monarch Oh La La Overture Prep Soliloquy Sonnet Trophy Uni-Form	<b>B</b> continued Grandview Helios Holbrook Instinct Journey Keaton Knoll Felt Knoll Hopsack Little Devil Ludlow Melody <sup>Ⓞ</sup> Paradigm Petal Pusher <sup>Ⓞ</sup> Prairie Prim Puff Radiance Ransom Roam Rush Hour Shadow Play Spree Summit Sutton Synth Tabloid Tinge Topos Vast Venue Versa Vinyl <sup>Ⓞ</sup> Westwood Yeni	<b>C</b> Atlas Axiom <sup>Ⓞ</sup> Baxter Cairo Chameleon Charm Circa Classic Boucle Contour Dune Durand Earthwork Empire Stripe Entourage Entwine Essence Fibra Greenwich Groovy Hudson Kaleidoscope CR Lagos Lore CR Magnolia Milestone On Point Palisade Panache CR Patchwork Plaid On Pullman Quark Roundtrip Sahara Sequin CR Sinclair Smart <sup>Ⓞ</sup> Spectator Stepping Stones Swing	<b>C</b> continued Tight Rope Tilden <sup>Ⓞ</sup> Tower Grid Utmost II Utopia Wit Wow Factor Zari CR  <b>D</b> Buzz Code Coterie Eclat Weave Hologram Island Menagerie Retreat Vice Versa Woodland Zoom  <b>E</b> Aegean Circle Point Cleo Currents Demure Flower Power Highland Ikat Stripe Juno Kampala Kimono Mamba Marquee Meroe Midpoint Nature Walk Off The Grid Rebel Sherman Shima Tempest Tryst Vatera Whip	<b>F</b> Atelier Biscayne Calais Cotton Velvet Century Cornaro Double Agent <sup>Ⓞ</sup> Glider Homage Imprint In Stitches Jasmine Liberty Mod Plaid Rivington Soon Totem  <b>G</b> All Star Alter Ego Andissa Arber Aurora Color Collage Dapper Djenne Duchess Gibson Fancy Twill Haze Kamani Looped In Melange Modern Tweed Rivers Spencer Straie Stripe Texnet Ultrasuede Utrillo Vert	<b>H</b> Bavaria Catwalk Constance Firefly Stretch Appeal Twist Tie World Piece  <b>I</b> Aswan Bella Byron Cato Chic Cummings Diamond Days Doily Dynamic Florescence Guise Hastings In Step Ita Jaipur Knoll Velvet Limani Mepal North Island Olema Piper Prince Hairy Rutledge Sandis Stripe It Tudor Zimba	<b>U</b> Vicenza Volo  <b>V</b> Acqua Amalfi Andes Embossed Tipped España Hand Tipped Maremma Velluto Pelle  <b>W</b> Alaska Antique Derby Forte Lucente Sabrina Umbria	<b>X</b> Ducale Ducale Velour  <b>Y</b> Cascia Cervo Copenhagen Lucca Marissa Portofino Riva Rugata Saddle Sassolino
						<sup>Ⓞ</sup> Fire Retardants Chemicals	
						<i>Check with your KnollTextiles or Spinneybeck Representative for changes or additions.</i>	

# Charles Pfister Sofa System

Designer(s):  
Charles Pfister, 1971



description	seat h	arm h	w	d	h	textile fabric yds.	req. leather sq. ft.	weight
<b>1050C-2</b> End module, arm panel on left side of user	16"	24"	30 1/2"	33"	26"	6.2	112	36 lbs.
<b>1050C-3</b> Corner module	16"	24"	33"	33"	26"	7.0	126	41 lbs.

pattern no.	grades <b>A</b>	COM <b>B</b>	<b>C</b>	<b>D</b>	<b>E</b>	<b>F</b>	<b>G</b>	<b>H</b>	<b>I</b>	COL <b>U</b>	<b>V</b>	<b>W</b>	<b>X</b>	<b>Y</b>
<b>1050C-2</b>	\$4,596.	\$4,936.	\$5,254.	\$5,612.	\$5,895.	\$6,106.	\$6,455.	\$7,129.	\$7,811.	\$9,953.	\$11,163.	\$13,615.	\$14,125.	\$14,723.
<b>1050C-3</b>	5,674.	6,057.	6,413.	6,816.	7,138.	7,374.	7,771.	8,529.	9,302.	11,828.	13,181.	15,944.	16,521.	17,190.

Order Code	Ordering Information	Construction
<i>Example:</i> <b>1050C-3-K349/1</b>	<i>Upholstery/COM information:</i> Prices shown include fabric or leather upholstery. Contact your Knoll representative for colors. Only approved KnollTextiles and Spinneybeck leathers may be ordered. <u>Note:</u> Non-railroad COM fabrics will require additional yardage.	<i>Frame:</i> Constructed in sections with a combination plywood/hardwood seat and back.
<b>1050C-3</b> Pfister corner module	<i>Cal 133 Fire Code ▲ :</i> The Pfister Collection complies with the California Technical Bulletin 133standard if upholstered in Cal 133 approved upholstery. Specify polyester fiber wrap and suffix -C at end of pattern number and suffix -133 at end of textile selection. Upcharge applies, see page 18.	<i>Upholstery:</i> Pfister sofa system cushions are fully upholstered. Coverings are upholstered on both sides in fabric or leather. Double-needled top stitching on leather upholstery and thin solid textiles. Single-needled top stitching on heavily ribbed fabrics and multicolor prints. No sag spring deck covered in black cotton textile.
<b>K349/1</b> Alignment, Sand	<i>Seat height:</i> Seat height is measured from the floor to the crown of the seat cushion. Height could vary up to 1/2" depending on leather or textile specified.	<i>Cushion fill:</i> Polyester wrap: foam core with polyester fiber wrap for tight, tailored aesthetic.
<i>Specify:</i> 1. Pattern number 2. Cal 133 Fire Code option 3. Textile selection	<i>Maintenance:</i> To fluff cushions, turn cushion upside down occasionally. See also pages 28-29.	<i>Glides:</i> Nylon, adjustable.
	<i>Note:</i> Customer's Own Material is available pending approval. For approval requirements, processing instructions and ordering information please see page 21.	
	<i>Note:</i> Modules shipped with unupholstered sides unless specified. For upholstered sides, contact your Knoll representative for pricing. All modules shipped knocked-down (KD), assembly required.	
	<i>Note:</i> The Pfister Sofa System is certified Clean Air GOLD.	



Approved KnollTextiles Grades/Fabrics						Spinneybeck Leather								
<b>A</b> Alignment Beacon Bocce Chance Common Ground Commuter Cloth Cross Tech Crossroad Delite Facet Hourglass Infinite Mariner Monarch Oh La La Overture Prep Soliloquy Sonnet Trophy Uni-Form	<b>B</b> continued Grandview Helios Holbrook Instinct Journey Keaton Knoll Felt Knoll Hopsack Little Devil Ludlow Melody <sup>®</sup> Paradigm Petal Pusher <sup>®</sup> Prairie Prim Puff Radiance Ransom Roam Rush Hour Shadow Play Spree Summit Sutton Synth Tabloid Tinge Topos Vast Venue Versa Vinyl <sup>®</sup> Westwood Yeni	<b>C</b> Atlas Axiom <sup>®</sup> Baxter Cairo Chameleon Charm Circa Classic Boucle Contour Dune Durand Earthwork Empire Stripe Entourage Entwine Essence Fibra Greenwich Groovy Hudson Kaleidoscope CR Lagos Lore CR Magnolia Milestone On Point Palisade Panache CR Patchwork Plaid On Pullman Quark Roundtrip Sahara Sequin CR Sinclair Smart <sup>®</sup> Spectator Stepping Stones Swing	<b>C</b> continued Tight Rope Tilden <sup>®</sup> Tower Grid Utmost II Utopia Wit Wow Factor Zari CR	<b>D</b> Buzz Code Coterie Eclat Weave Hologram Island Menagerie Retreat Vice Versa Woodland Zoom	<b>E</b> Aegean Circle Point Cleo Currents Demure Flower Power Highland Ikat Stripe Juno Kampala Kimono Mamba Marquee Meroe Midpoint Nature Walk Off The Grid Rebel Sherman Shima Tempest Tryst Vatera Whip	<b>F</b> Atelier Biscayne Calais Cotton Velvet Century Cornaro Double Agent <sup>®</sup> Glider Homage Imprint In Stitches Jasmine Liberty Mod Plaid Rivington Soon Totem	<b>G</b> All Star Alter Ego Andissa Arber Aurora Color Collage Dapper Djenne Duchess Gibson Fancy Twill Haze Kamani Looped In Melange Modern Tweed Rivers Spencer Straie Stripe Texnet Ultrasuede Utrillo Vert	<b>H</b> Bavaria Catwalk Constance Firefly Stretch Appeal Twist Tie World Piece	<b>I</b> Aswan Bella Byron Cato Chic Cummings Diamond Days Doily Dynamic Florescence Guise Hastings In Step Ita Jaipur Knoll Velvet Limani Mepal North Island Olema Piper Prince Hairy Rutledge Sandis Stripe It Tudor Zimba	<b>U</b> Vicenza Volo	<b>V</b> Acqua Amalfi Andes Embossed Tipped España Hand Tipped Maremma Velluto Pelle	<b>W</b> Alaska Antique Derby Forte Lucente Sabrina Umbria	<b>X</b> Ducale Ducale Velour	<b>Y</b> Cascia Cervo Copenhagen Lucca Morissina Portofino Riva Rugata Saddle Sassolino
						<sup>®</sup> Fire Retardants Chemicals								
						<i>Check with your KnollTextiles or Spinneybeck Representative for changes or additions.</i>								

# Warren Platner Seating Collection

*Designer(s):*  
Warren Platner, 1962

*Award(s):*  
1966 American Institute of  
Architects International Award

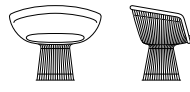
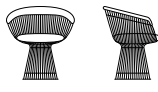

description	seat h	w	d	h	frame	textile fabric yds.	req. leather sq ft	weight
<b>1715L</b> Lounge chair 	18 1/2"	36 1/2"	25 1/2"	30 1/4"	nickel	4.0	n/a	37 lbs.
	18 1/2"	36 1/2"	25 1/2"	30 1/4"	gold	4.0	n/a	37 lbs.
	18 1/2"	36 1/2"	25 1/2"	30 1/4"	bronze	4.0	n/a	37 lbs.
<b>1725A</b> Arm chair 	19"	26 1/2"	22"	28 3/4"	nickel	1.8	35	21 lbs.
	19"	26 1/2"	22"	28 3/4"	gold	1.8	35	21 lbs.
	19"	26 1/2"	22"	28 3/4"	bronze	1.8	35	21 lbs.
<b>1719Y</b> Stool 	22 3/4"	15 1/4"		22 3/4"	nickel	1.1	20	12 lbs.
	22 3/4"	15 1/4"		22 3/4"	gold	1.1	20	12 lbs.
	22 3/4"	15 1/4"		22 3/4"	bronze	1.1	20	12 lbs.

pattern no.	grades <b>A</b>	COM <b>B</b>	<b>C</b>	<b>D</b>	<b>E</b>	<b>F</b>	<b>G</b>	<b>H</b>	<b>I</b>	COL <b>U</b>	<b>V</b>	<b>W</b>	<b>X</b>	<b>Y</b>
<b>1715L-N(-)</b>	\$11,681.	\$11,852.	\$12,020.	\$12,201.	\$12,348.	\$12,455.	\$12,639.	\$12,987.	\$13,241.					
<b>1715L-GLD(-)</b>	15,576.	15,704.	15,843.	16,007.	16,236.	16,372.	16,606.	16,764.	17,227.					
<b>1715L-BRM(-)</b>	12,342.	12,513.	12,683.	12,860.	13,012.	13,118.	13,299.	13,648.	13,899.					
<b>1725A-N(-)</b>	6,702.	6,783.	6,855.	6,939.	7,006.	7,056.	7,136.	7,294.	7,408.	7,871.	8,173.	8,785.	8,912.	9,064.
<b>1725A-GLD(-)</b>	9,775.	9,830.	9,893.	9,969.	10,075.	10,132.	10,238.	10,309.	10,517.	15,045.	15,257.	15,691.	15,780.	15,887.
<b>1725A-BRM(-)</b>	7,239.	7,314.	7,390.	7,474.	7,542.	7,593.	7,668.	7,829.	7,943.	8,411.	8,708.	9,323.	9,452.	9,598.
<b>1719Y-N(-)</b>	3,785.	3,828.	3,875.	3,925.	3,964.	3,995.	4,046.	4,141.	4,212.	4,444.	4,614.	4,966.	5,041.	5,126.
<b>1719Y-GLD(-)</b>	5,671.	5,707.	5,743.	5,790.	5,852.	5,888.	5,954.	5,998.	6,123.	8,665.	8,785.	9,033.	9,085.	9,144.
<b>1719Y-BRM(-)</b>	3,949.	3,997.	4,042.	4,092.	4,135.	4,165.	4,214.	4,308.	4,381.	4,612.	4,782.	5,134.	5,205.	5,294.

### Order Code

<i>Example:</i>	<b>1725A-N-H800/2</b>
<b>1725A</b>	Platner Arm Chair
<b>N</b>	Nickel Frame
<b>H800/2</b>	Cato, Sand

*Note:*  
Platner lounge seating is part of a collection. Please refer to Platner Easy Chair and Ottoman on page 282 and Platner Tables on page 450.

### Specify:

1. Pattern number
2. Frame finish
3. Textile selection

### Ordering Information

*Frame:*  
Polished Nickel (suffix N)  
18k Gold Plated (suffix GLD)  
Metallic Bronze (suffix BRM)

*Upholstery/COM information:*  
Prices shown include fabric upholstery. Contact your Knoll representative for colors. Only approved KnollTextiles and Spinneybeck leather may be ordered.

Customer's Own Material is available pending approval. For approval requirements, processing instructions and ordering information please see page 21.

**Cal 133 Fire Code ★:**  
The Platner Seating Collection complies with the California Technical Bulletin 133 standard if upholstered in Cal 133 approved upholstery. Specify suffix -C at end of pattern number and suffix -133 at end of textile selection. Upcharge applies, see page 22.

*Maintenance:*  
See pages 28-29.

*Note:*  
The Platner Easy Chair and Ottoman are certified Clean Air GOLD.

### Construction

*Frame:*  
Forms created by vertical steel wire rods welded to circular horizontal and edge-framing rods. Finish in bright nickel with clear lacquer protection, painted bronze metallic, or plated in 18k gold.

*Base:*  
Clear plastic extrusion ring for smooth bottom surface.

*Upholstery:*  
Molded fiberglass shell with molded latex foam cushion. Cushions with latex core and zipper cover and zipper cover attach to seat with Velcro.

### Approved KnollTextiles Grades/Fabrics

<b>A</b> Beacon Bocce Chance Common Ground Commuter Cloth Crossroad Delite Facet Hourglass Mariner Monarch Overture Soliloquy Sonnet Trophy	<b>B</b> continued Ludlow Melody <sup>Ⓒ</sup> Paradigm Prim Puff Radiance Ransom Roam Shadow Play ** Spree Summit Synth Topos Venue Yeni	<b>C</b> continued Greenwich Hudson Kaleidoscope CR Lagos Magnolia Milestone Palisade Panache CR Plaid On Prestini Quark Roundtrip Sahara Sequin CR Smart <sup>Ⓒ</sup> Spectator Swing Tower Grid Wit	<b>E</b> Aegean Circle Point Cleo Demure Flower Power Highland Ikat Stripe Kampala Katazome Marquee Meroe Midpoint Rebel Shima Tryst Vatera Whip	<b>G</b> Alter Ego Arber Aurora Djenne Feeling Plaid Gibson Hampshire Haze Kamani Kinabalu Melange Spencer Straie Stripe Ultrasuede Utrillo Vert	<b>I</b> Byron Cato Diamond Days Digi Velvet Doily Dynamic Guise Ita Jaipur Knoll Velvet Limani Mepal North Island Olema Piper Rutledge Tudor Vermeer Zimba	<b>H</b> Bavaria Constance Firefly	<b>F</b> Atelier Biscayne Century Coco Cornaro Glider Homage Jasmine Liberty Mod Plaid Rivington Soon ** Totem Tweed Frieze
<b>B</b> Abacus Argyle Belize Bistro Boundary Calypso Cameo Chronicle Close Knit Diva Ferry Gala II Grande Grandview Holbrook Instinct Journey Keaton Knoll Felt Knoll Hopsack Little Devil	<b>C</b> Axiom <sup>Ⓒ</sup> Baxter Cairo Charm Circa Classic Boucle Dune Earthwork Echo Enmesh Entourage Essence Fibra	<b>D</b> Buzz Coterie Eclat Weave Hologram Island Menagerie Origins Pathway					

### Spinneybeck Leather

<b>U</b> Vicenza Volo	<b>V</b> Acqua Amalfi ** Andes Embossed Tipped España Hand Tipped Maremma Velluto Pelle	<b>W</b> Alaska Antique Derby Forte Lucente Sabrina	<b>X</b> Ducale Ducale Velour	<b>Y</b> Cervo Copenhagen Distressed Lucca Marissa Portofino Riva Saddle Sassolino
-----------------------------	---	---	-------------------------------------	---

\*Approved for 1719Y stool only  
\*\*Not approved for 1715L lounge chair  
Ⓒ Fire Retardants Chemicals

Check with your KnollTextiles or Spinneybeck Representative for changes or additions.

# Warren Platner Easy Chair and Ottoman

Designer(s):  
Warren Platner, 1962

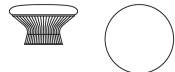

description	seat h	w	d	h	frame	textile	
						fabric yds.	weight
<b>1705L</b> Easy Chair 	18 3/4"	39 3/8"	37"	38 3/4"	nickel	7.0	n/a
	18 3/4"	39 3/8"	37"	38 3/4"	gold plated	7.0	n/a
	18 3/4"	39 3/8"	37"	38 3/4"	metallic bronze	7.0	n/a
<b>1709Y</b> Ottoman 	-	26 3/4"	26 3/4"	16 7/8"	nickel	2.75	n/a
	-	26 3/4"	26 3/4"	16 7/8"	gold plated	2.75	n/a
	-	26 3/4"	26 3/4"	16 7/8"	metallic bronze	2.75	n/a

pattern no.	grades									
	A	B	C	D	E	F	G	H	I	
<b>1705L-N</b>	\$18,276.	\$18,512.	\$18,735.	\$18,985.	\$19,185.	\$19,334.	\$19,582.	\$20,053.	\$20,400.	
<b>1705L-GLD</b>	25,261.	25,629.	25,965.	26,037.	26,171.	26,616.	27,607.	28,018.	29,006.	
<b>1705L-BRM</b>	18,468.	18,841.	19,186.	19,258.	19,395.	19,849.	20,861.	21,281.	22,289.	
<b>1709Y-N</b>	5,010.	5,103.	5,191.	5,291.	5,367.	5,427.	5,523.	5,709.	5,847.	
<b>1709Y-GLD</b>	6,695.	6,833.	6,957.	6,985.	7,034.	7,199.	7,568.	7,722.	8,089.	
<b>1709Y-BRM</b>	5,250.	5,386.	5,512.	5,538.	5,589.	5,754.	6,123.	6,275.	6,643.	

### Order Code

<i>Example:</i>	<b>1705L-N-H800/2</b>
<b>1705L</b>	Platner Easy chair
<b>N</b>	Nickel frame
<b>H800/2</b>	Cato, Sand

*Note:*  
Platner Easy Chair and Ottoman is part of a collection. Please refer to Platner Seating Collection on page 280 and Platner tables on page 450.

### Specify:

1. Pattern number
2. Frame finish
3. Textile selection

### Ordering Information

*Frame:*  
Polished Nickel (suffix N)  
18k Gold Plated (suffix GLD)  
Metallic Bronze (suffix BRM)

*Upholstery/COM information:*  
Prices shown include fabric upholstery. Contact your Knoll representative for colors. Only approved KnollTextiles may be ordered. All textiles will be cut railroad.

Customer's Own Material is available pending approval. For approval requirements, processing instructions and ordering information please see page 21.

*Cal 133 Fire Code #:*  
The Easy Chair and Ottoman comply with the California Technical Bulletin 133 standard if upholstered in Cal 133 approved upholstery. Specify suffix -C at end of pattern number and suffix -133 at end of textile selection. Upcharge applies, see page 22.

### Maintenance:

See pages 28-29.

*Note:*  
The Platner Easy Chair and Ottoman are certified Clean Air GOLD.

### Construction

*Construction:*  
Hand bent vertical steel wire rods welded to circular horizontal and edge-framing rods. Finish in bright nickel with a clear lacquer protection, a painted metallic bronze, or plated in 18k gold. Clear plastic extrusion ring for a smooth bottom surface. Molded fiberglass shell with highly resilient molded urethane foam cushions. Seat and ottoman cushion utilize the same highly resilient molded urethane foam cushion.



### Approved KnollTextiles Grades/Fabrics

<b>A</b> Bocce Common Ground Commuter Cloth Cross Tech * Delite Facet Infinite Monarch Oh La La * Sonnet Trophy Uni-Form	<b>B</b> continued Little Devil Ludlow Melody <sup>Ⓢ</sup> Paradigm Petal Pusher <sup>Ⓢ</sup> Prim Puff Radiance Ransom Roam Shadow Play * Spree Summit Topos Wild Thing Yeni	<b>C</b> continued Groovy Hudson Milestone On Point * Patchwork Plaid On Prestini Pullman Quark Roundtrip Smart <sup>Ⓢ</sup> Swing Tight Rope Tower Grid Utmost II * Wit Wow Factor	<b>E</b> continued Flower Power Highland Ikat Stripe Juno Kampala Kimono Mamba Marquee Meroe Off The Grid Rebel Shima Tempest Whip	<b>G</b> All Star Alter Ego Aurora Color Collage * Dapper Djenne * Duchess Fancy Twill * Gibson Haze Kamani Looped In Melange Modern Tweed Spencer Straie Stripe Ultrasuede Utrillo Vert	<b>H</b> Bavaria Catwalk Constance Firefly Twist Tie * World Piece	<b>I</b> Bella Cato Chic Diamond Days Doily Dynamic Floressence * Guise Hastings In Step * Jaipur Knoll Velvet Limani North Island Olema Piper Prince Hair Rutledge Stripe It * Zimba
<b>B</b> Abacus Argyle Attire Belize Boundary Chronicle Cozy Cord Day Tripper Diva Dottie Ferry Grande Grandview Holbrook Instinct Journey Keaton Knoll Felt Knoll Hopsack	<b>C</b> Chameleon * Charm Circa Classic Boucle Dune Earthwork Entwine Essence Fibra Greenwich	<b>D</b> Buzz Code * Eclat Weave Hologram Menagerie Origins Pathway Plaidtastic Retreat * Vice Versa *	<b>F</b> Atelier Biscayne Double Agent * <sup>Ⓢ</sup> Glider Homage Imprint In Stitches Liberty Mod Plaid Rivington			
		<b>E</b> Aegean Circle Point Cleo Demure				

\*Approved for 1709Y Ottoman only  
<sup>Ⓢ</sup> Fire Retardants Chemicals

# Charles Pollock

## Executive Conference Armless Chairs

	description	seat h	arm h	w	d	h	textile fabric yds.	req. leather sq. ft.	weight	type
<i>Designer(s):</i> Charles Pollock, 1963	<b>12C-4S</b> Armless chair, swivel/tilt, pneumatic height, seat height adjustment, 4-Star Base 	18 1/2" - 21 1/4"		23 1/2"	28 1/4"	31 1/2" - 34 1/4"	1.1	20	44 lbs.	Black Painted
		18 1/2" - 21 1/4"		23 1/2"	28 1/4"	31 1/2" - 34 1/4"	1.1	20	44 lbs.	Polished Aluminum
	<b>12C-5S</b> Armless chair, swivel/tilt, pneumatic height, seat height adjustment, 5-Star Base 	18 1/2" - 21 1/4"		23 1/2"	28 1/4"	31 1/2" - 34 1/4"	1.1	20	44 lbs.	Black Painted
		18 1/2" - 21 1/4"		23 1/2"	28 1/4"	31 1/2" - 34 1/4"	1.1	20	44 lbs.	Polished Aluminum
	<b>1250COVER</b> Replacement cover						1.1	20		
	<b>1250BUTTON</b> Replacement buttons (specify upholstery)									

Order Code	Ordering Information	Construction
<i>Example:</i> <b>12C-5S-H-1-AM3030</b>	<i>Base/Frame finishes:</i> Polished Aluminum (suffix A) Black (suffix 1)	<i>Outer shell:</i> Integrally colored, black textured polypropylene.
<b>12C-5S</b>	Pollock armless chair, 5-star base	<i>Casters:</i> Black 2" twin wheel hard casters for use on carpeted floors. Housing components in polished chrome or black chrome finish. Optional soft casters for use on wood and other resilient flooring.
<b>H</b>	Hard wheel casters	<i>Frame:</i> Extruded aluminum with polished or black anodized finish. Steel support plate spans the width of the seat cushion.
<b>1</b>	Black base	<i>Glides:</i> Aluminum glide in chrome or black painted finish with felt disc.
<b>AM3030</b>	Amazon, Bossa Nova	<i>Controls:</i> 360° swivel; tilt and pneumatic seat height adjustment.
	<i>Note:</i> Base and frame finish will match.	<i>Replacement buttons:</i> Set of 6 buttons for one chair.
	<i>Upholstery/COM information:</i> Prices shown include fabric or leather upholstery. Contact your Knoll representative for colors. Only approved KnollTextiles and Spinneybeck leathers may be ordered.	<i>Replacement cover:</i> Must be installed by an upholsterer.
	<i>Customer's Own Material</i> is available pending approval. For approval requirements, processing instructions and ordering information please see page 21.	
	<i>Maintenance:</i> See pages 28-29.	
	<i>Cal 133 Fire Code:</i> The Pollock Chair complies with the California Technical Bulletin 133 standard if upholstered in Cal 133 approved upholstery. Specify suffix -C at end of pattern number and suffix -133 at end of textile selection. Upcharge applies, see page 22.	
	<i>Note:</i> The Pollock Executive Conference Arm and Armless Chair are Clean Air GOLD.	

- Specify:*
1. Pattern number
  2. Casters
  3. Base finish
  4. Cal 133 Fire Code option
  5. Textile selection



pattern no.	grades	COM	C	D	E	F	G	H	I	COL	V	W	X	Y
<b>12C-4S-G-1(-)</b>	\$3,272.	\$3,335.	\$3,401.	\$3,441.	\$3,484.	\$3,523.	\$3,561.	\$3,662.	\$3,842.	\$4,017.	\$4,229.	\$4,720.	\$4,811.	\$4,856.
<b>12C-4S-G-A(-)</b>	3,332.	3,397.	3,461.	3,502.	3,545.	3,583.	3,620.	3,723.	3,903.	4,077.	4,290.	4,780.	4,872.	4,916.
<b>12C-5S-(H,R)-1(-)</b>	3,755.	3,819.	3,883.	3,925.	3,967.	4,006.	4,043.	4,145.	4,325.	4,499.	4,712.	5,202.	5,294.	5,339.
<b>12C-5S-(H,R)-A(-)</b>	3,816.	3,879.	3,944.	3,985.	4,027.	4,066.	4,102.	4,205.	4,386.	4,559.	4,773.	5,263.	5,355.	5,399.
<b>1250COVER</b>	624.	684.	742.	781.	820.	849.	885.	980.	1,149.	1,295.	1,495.	1,940.	2,020.	2,066.
<b>1250BUTTON-(-)</b>	75.	75.	75.	75.	75.	75.	75.	75.	75.	112.	112.	112.	112.	112.

Approved KnollTextiles Grades/Fabrics				Spinneybeck Leather			
<b>A</b> Beacon Bocce Chance Common Ground Commuter Cloth Crossroad Delite Facet Hourglass Infinite Mariner Monarch Overture Prep Presto Soliloquy Sonnet Trophy Uni-Form	<b>B</b> continued Instinct Journey Keaton Knoll Felt Knoll Hopsack Little Devil Ludlow Melody Paradigm Petal Pusher Prairie Prim Radiance Ransom Roam Rush Hour Shadow Play Spree Sutton Synth Tabloid Tinge Topos Vast Venue Versa Westwood Wild Thing	<b>C</b> Axiom Baxter Cairo Chameleon Charm Circa Classic Boucle Durand Earthwork Empire Stripe Entourage Entwine Essence Fibra Greenwich Groovy Hudson Lagos Lore CR Magnolia Milestone Palisade Panache CR Patchwork Plaid On Prestini Pullman Quark Roundtrip Sequin CR Sinclair Smart Spectator Stepping Stones Swing Tight Rope Tower Grid Tilden	<b>C</b> continued Wit Wow Factor Zari CR <b>D</b> Buzz Code Coterie Eclat Weave Hologram Island Menagerie Origins Plaidtastic Retreat Vice Versa Woodland Zoom <b>E</b> Aegean Circle Point Cleo Demure Flower Power Highland Ikat Stripe Juno Kampala Kimono Mamba Marquee Meroe Midpoint Off The Grid Nature Walk Rebel Sherman Tempest Vatera	<b>F</b> Atelier Biscayne Century Cornaro Double Agent Glider Homage Imprint In Stitches Liberty Mod Plaid Rivington Swank Totem Tweed Frieze <b>G</b> All Star Alter Ego Arber Color Collage Dapper Djenne Duchess Fancy Twill Gibson Kamani Looped In Melange Modern Tweed Spencer Straie Stripe Texnet Ultrasuede Utrillo Vert	<b>H</b> Bavaria Catwalk Chiseled Constance Firefly Stretch Appeal Twist Tie World Piece <b>I</b> Aswan Bella Byron Chic Diamond Days Doily Dynamic Florescence In Step Ita Jaipur Knoll Velvet Limani North Island Olema Piper Prince Hair Rutledge Stripe It Tudor Zimba	<b>U</b> Vicenza Volo <b>V</b> Acqua Amalfi Andes Embossed Tipped España Hand Tipped Velluto Pelle <b>W</b> Alaska Antique Derby Forte Lucente Sabrina Umbria Fire Retardants Chemicals	<b>X</b> Ducale Ducale Velour <b>Y</b> Cervo Copenhagen Distressed Gemma Lucca Marissa Portofino Riva

*Check with your KnollTextiles or Spinneybeck Representative for changes or additions.*

# Charles Pollock

## Executive Conference Arm Chairs

	description	height, seat	height, arm	width	depth	h	textile fabric yds.	req. leather sq. ft.	weight	type
<i>Designer(s):</i> Charles Pollock, 1963	<b>12A-4S</b> Arm chair, swivel/tilt, pneumatic height, seat height adjustment, 4-Star Base 	18 1/2" - 21 1/4"	24 1/2" - 27 1/4"	26 1/4"	28 1/4"	31 1/2" - 34 1/4"	1.1	20	44 lbs.	Black Painted
		18 1/2" - 21 1/4"	24 1/2" - 27 1/4"	26 1/4"	28 1/4"	31 1/2" - 34 1/4"	1.1	20	44 lbs.	Polished Aluminum
	<b>12A-5S</b> Arm chair, swivel/tilt, pneumatic height, seat height adjustment, 5-Star Base 	18 1/2" - 21 1/4"	24 1/2" - 27 1/4"	26 1/4"	28 1/4"	31 1/2" - 34 1/4"	1.1	20	44 lbs.	Black Painted
		18 1/2" - 21 1/4"	24 1/2" - 27 1/4"	26 1/4"	28 1/4"	31 1/2" - 34 1/4"	1.1	20	44 lbs.	Polished Aluminum
	<b>1250COVER</b> Replacement cover						1.1	20		
	<b>1250BUTTON</b> Replacement buttons (specify upholstery)									

Order Code	Ordering Information	Construction
<i>Example:</i> <b>12A-5S-H-1-AM3030</b>	<i>Base/Frame finishes:</i> Polished Aluminum (suffix A) Black (suffix 1)	<i>Outer shell:</i> Integrally colored, black textured polypropylene.
<b>12A-5S</b>	Pollock arm chair, 5-star base	<i>Casters:</i> Black 2" twin wheel hard casters for use on carpeted floors. Housing components in polished chrome or black chrome finish. Optional soft casters for use on wood and other resilient flooring.
<b>H</b>	Hard wheel casters	<i>Frame:</i> Extruded aluminum with polished or black anodized finish. Steel support plate spans the width of the seat cushion.
<b>1</b>	Black base	<i>Glides:</i> Aluminum glide in chrome or black painted finish with felt disc.
<b>AM3030</b>	Amazon, Bossa Nova	<i>Controls:</i> 360° swivel; tilt and pneumatic seat height adjustment.
	<i>Note:</i> Base and frame finish will match.	<i>Replacement buttons:</i> Set of 6 buttons for one chair.
	<i>Upholstery/COM information:</i> Prices shown include fabric or leather upholstery. Contact your Knoll representative for colors. Only approved KnollTextiles and Spinneybeck leathers may be ordered.	<i>Replacement cover:</i> Must be installed by an upholsterer.
	Customer's Own Material is available pending approval. For approval requirements, processing instructions and ordering information please see page 21.	
	<i>Maintenance:</i> See pages 28-29.	
	<i>Cal 133 Fire Code:</i> The Pollock Chair complies with the California Technical Bulletin 133 standard if upholstered in Cal 133 approved upholstery. Specify suffix -C at end of pattern number and suffix -133 at end of textile selection. Upcharge applies, see page 22.	
	<i>Note:</i> The Pollock Executive Conference Arm and Armless Chair are Clean Air GOLD.	

- Specify:*
1. Pattern number
  2. Casters
  3. Base finish
  4. Cal 133 Fire Code option
  5. Textile selection



pattern no.	grades	COM	C	D	E	F	G	H	I	COL	V	W	X	Y
<b>12A-4S-G-1-()</b>	\$3,610.	\$3,679.	\$3,739.	\$3,792.	\$3,834.	\$3,872.	\$3,914.	\$4,017.	\$4,208.	\$4,384.	\$4,607.	\$5,116.	\$5,205.	\$5,260.
<b>12A-4S-G-A-()</b>	3,671.	3,739.	3,801.	3,854.	3,893.	3,932.	3,974.	4,077.	4,268.	4,443.	4,668.	5,177.	5,265.	5,320.
<b>12A-5S-(H,R)-1-()</b>	4,093.	4,163.	4,223.	4,276.	4,317.	4,354.	4,396.	4,499.	4,690.	4,866.	5,090.	5,599.	5,688.	5,743.
<b>12A-5S-(H,R)-A-()</b>	4,153.	4,223.	4,283.	4,336.	4,376.	4,415.	4,457.	4,559.	4,751.	4,926.	5,151.	5,659.	5,748.	5,803.
<b>1250COVER</b>	624.	684.	742.	781.	820.	849.	885.	980.	1,149.	1,295.	1,495.	1,940.	2,020.	2,066.
<b>1250BUTTON-()</b>	75.	75.	75.	75.	75.	75.	75.	75.	75.	112.	112.	112.	112.	112.

Approved KnollTextiles Grades/Fabrics				Spinneybeck Leather			
<b>A</b> Beacon Bocce Chance Common Ground Commuter Cloth Crossroad Delite Facet Hourglass Infinite Mariner Monarch Overture Prep Presto Soliloquy Sonnet Trophy Uni-Form	<b>B</b> continued Instinct Journey Keaton Knoll Felt Knoll Hopsack Little Devil Ludlow Melody Paradigm Petal Pusher Prairie Prim Radiance Ransom Roam Rush Hour Shadow Play Spree Sutton Synth Tabloid Tinge Topos Vast Venue Versa Westwood Wild Thing	<b>C</b> Axiom Baxter Cairo Chameleon Charm Circa Classic Boucle Durand Earthwork Empire Stripe Entourage Entwine Essence Fibra Greenwich Groovy Hudson Lagos Lore CR Magnolia Milestone Palisade Panache CR Patchwork Plaid On Prestini Pullman Quark Roundtrip Sequin CR Sinclair Smart Spectator Stepping Stones Swing Tight Rope Tower Grid Tilden	<b>C</b> continued Wit Wow Factor Zari CR  <b>D</b> Buzz Code Coterie Eclat Weave Hologram Island Menagerie Origins Plaidtastic Retreat Vice Versa Woodland Zoom  <b>E</b> Aegean Circle Point Cleopatra Demure Flower Power Highland Ikat Stripe Juno Kampala Kimono Mamba Marquee Meroc Midpoint Off The Grid Nature Walk Rebel Sherman Tempest Vatera	<b>F</b> Atelier Biscayne Century Cornaro Double Agent Glider Homage Imprint In Stitches Liberty Mod Plaid Rivington Swank Totem Tweed Frieze  <b>G</b> All Star Alter Ego Arber Color Collage Dapper Djenne Duchess Fancy Twill Gibson Kamani Looped In Melange Modern Tweed Spencer Straie Stripe Texnet Ultrasuede Utrillo Vert	<b>H</b> Bavaria Catwalk Chiseled Constance Firefly Stretch Appeal Twist Tie World Piece  <b>I</b> Aswan Bella Byron Chic Diamond Days Doily Dynamic Florescence In Step Ita Jaipur Knoll Velvet Limani North Island Olema Piper Prince Hair Rutledge Stripe It Tudor Zimba	<b>U</b> Vicenza Volo  <b>V</b> Acqua Amalfi Andes Embossed Tipped España Hand Tipped Velluto Pelle  <b>W</b> Alaska Antique Derby Forte Lucente Sabrina Umbria Fire Retardants Chemicals	<b>X</b> Ducale Ducale Velour  <b>Y</b> Cervo Copenhagen Gemma Lucca Marissa Portofino Riva

*Check with your KnollTextiles or Spinneybeck Representative for changes or additions.*



Charles Pollock  
Arm Chair

	description	seat h	arm h	w	d	h	weight
<i>Designer(s):</i> Charles Pollock, 1960	<b>657</b> Arm Chair	16 1/4"	22 3/4"	25"	26"	27 3/4"	32 lbs.
							

pattern no.	
<b>657-(BL_) - (PT_, HT_)</b>	\$5,244.

**Order Code**

<i>Example:</i> <b>657-BL-PT</b>
<b>657</b> arm chair
<b>BL</b> belting leather
<b>PT</b> Portofino

*Specify:*

1. Pattern number
2. Belting leather selection
3. Cushion upholstery selection

**Ordering Information**

*Frame finishes:*  
Chrome/black

*Sling upholstery:*  
Spinneybeck Belting Leather (suffix BL\_)

*Seat pad:*  
Spinneybeck Portofino (suffix PT\_)  
Spinneybeck Hand Tipped (suffix HT\_)

*Upholstery note:*  
**No Customer's Own Materials can be used.**

*Replacement slings:*  
Knoll does not recommend replacement slings. This procedure requires the chair to be disassembled and rebuilt, a complex and time consuming process.

*Maintenance:*  
See pages 28-29.

Please ask your Spinneybeck Representative for samples of the belting leather.

**Construction**

*Frame:*  
Tubular steel legs, polished chrome finish. Cast aluminum arms and stretchers, black painted finish. Stamped steel glides.

*Upholstery:*  
Belting leather sling. Cushion is urethane foam upholstered in Portofino or Hand Tipped leather.

# Joe Ricchio Joe™ Chair

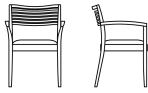

description	seat h	arm h	w	d	h	textile fabric yds.	req. leather sq. ft.	weight	finish
<b>48A</b> Joe arm chair	19"	26"	24"	22"	32"	0.8	14.5	16 lbs.	other stains
	19"	26"	24"	22"	32"	0.8	14.5	16 lbs.	maple, ebonized
<b>48R</b> Seat basket replacement for 48A						0.8	13		

### Order Code

<i>Example:</i>	48A-BN-K224/1
<b>48A</b>	Joe arm chair
<b>BN</b>	Natural Beech
<b>K1320/1</b>	Cornaro, Castor

### Specify:

1. Pattern number
2. Finish
3. Cal 133 fire code option
4. Textile selection

### Ordering Information

**Maple:**  
Clear Maple (suffix KC)

**Beech frame stains:**  
Beech (suffix B311)  
Bronzed Cherry (suffix B312A)  
Burnt Walnut (suffix B313)  
Deep Red Mahogany (suffix B328)  
Ebonized (suffix BE)  
Light Cherry (suffix B315)  
Light Walnut (suffix B411)  
Medium Cherry (suffix B319)  
Medium Red Mahogany (suffix BR)  
Medium Walnut (suffix B323)  
Natural Beech (suffix BN)  
Warm Brown Walnut (suffix J)

**Upholstery/COM information:**  
Prices shown include fabric or leather upholstery. Contact your Knoll representative for colors. Only approved KnollTextiles and Spinneybeck leathers may be ordered.

Customer's Own Material is available pending approval. For approval requirements, processing instructions and ordering information please see page 21.

**KnollStudio wood finishes:**  
KnollStudio wood finishes complement a large variety of KnollStudio veneer and Knoll Office veneer finishes. To select correct complementary finish, please refer to KnollStudio Wood Finish Matrix on page 26. If no complementary standard finish is available, please refer to custom finish policy below.

**Cal 133 Fire Code #:**  
The Joe Chair complies with the California Technical Bulletin 133 standard if upholstered in Cal 133 approved upholstery. Specify suffix -C at end of pattern number and suffix -133 at end of textile selection. Upcharge applies, see page 22.

**Certified Wood:**  
Chairs manufactured using FSC certified hardwoods are available through Custom Product Development. Extended leadtime and upcharge apply.

**Maintenance:**  
See pages 28-29.

**Note:**  
The Joe Chair is certified Clean Air GOLD.

### Construction

**Frame:**  
Select maple hardwood in clear or beech hardwood in stained finish.

**Upholstered seat:**  
Elastic seat belt suspension, high resilient foam. Seat basket is 1.25" thick.

pattern no.	grades A	COM B	C	D	E	F	G	H	I	COL U	V	W	X	Y
<b>48A-( )</b>	\$1,610.	\$1,651.	\$1,687.	\$1,726.	\$1,757.	\$1,777.	\$1,813.	\$1,893.	\$1,946.	\$2,132.	\$2,265.	\$2,542.	\$2,599.	\$2,663.
<b>48A-(KC, BE)</b>	1,858.	1,894.	1,932.	1,970.	2,001.	2,020.	2,060.	2,140.	2,194.	2,375.	2,510.	2,786.	2,845.	2,908.
<b>48R-( )</b>	327.	366.	401.	444.	475.	497.	544.	611.	676.	871.	1,009.	1,296.	1,356.	1,424.



### Approved KnollTextiles Grades/Fabrics

<b>A</b> Alignment Beacon Bocce Chance Common Ground Commuter Cloth Crossroad Delite Facet Foil Rap Heavy Metal Hourglass Infinite Mariner Monarch Oh La La Overture Prep Presto Soliloquy Sonnet Trophy Uni-Form	<b>B</b> continued Forza <sup>®</sup> Gala II Grande Grandview Helios Holbrook Instinct Journey Keaton Knoll Felt Knoll Hopsack Little Devil Ludlow Melody <sup>®</sup> Paradigm Petal Pusher <sup>®</sup> Prairie Prim Puff Radiance Ransom Roam Rush Hour Shadow Play Spree Summit Sutton Synth Tabloid Tinge Topos Venue Versa Vinyl <sup>®</sup> Wild thing Yeni	<b>C</b> Atlas Axiom <sup>®</sup> Baxter Cairo Chameleon Charm Circa Classic Boucle Contour Dune Durand Earthwork Empire Stripe Entourage Entwine Essence Fibra Greenwich Groovy Hudson Kaleidoscope CR Kaya CR Lagos Lore CR Magnolia Milestone On Point Palisade Panache CR Patchwork Plaid On Prestini Pullman Quark	<b>C</b> continued Roundtrip Sabara Sequin CR Sinclair Smart <sup>®</sup> Stepping Stones Spectator Swing Tight Rope Tilden <sup>®</sup> Tower Grid Utmost II Wit Wow Factor Zari CR Zen Wave	<b>D</b> Buzz Code Coterie Eclat Weave Hologram Island Kabuki Menagerie Origins Pathway Plaidtastic Retreat Vice Versa Woodland Zoom
<b>E</b> Aegean Circle Point Currents Demure Flower Power Highland Ikat Stripe Juno Kampala Kimono Mamba Marquee Meroe Midpoint Nature Walk Off The Grid Rebel Sherman Shima Tempest Tryst Vatera Whip	<b>F</b> Atelier Biscayne Calais Cotton Velvet Century Cornaro Double Agent <sup>®</sup> Glider Imprint In Stitches Liberty Mod Plaid Rivington Soon Swank Totem Tweed Frieze	<b>G</b> continued Color Collage Dapper Djenne Duchess Fancy Twill Gibson Haze Kamani Looped in Melange Modern Tweed Straie Stripe Texnet Ultrasuede Utrillo Vert	<b>H</b> Bavaria Catwalk Chiseled Constance Firefly Stretch Appeal Twist Tie World Piece	<b>I</b> Aswan Bella Byron Cato Chic Cummings Diamond Days Doily Dynamic Florescence Guise Hastings In Step Jaipur Knoll Velvet Limani Mepal North Island Olema Piper Prince Hair Rutledge Sandis Stripe It Tudor Zimba
<b>U</b> Vicenza Volo	<b>V</b> Acqua Amalfi Andes Embossed Tipped España Hand Tipped Maremma Velluto Pelle	<b>W</b> Alaska Antique Derby Forte Lucente Sabrina Umbria <sup>®</sup> Fire Retardants Chemicals	<b>X</b> Ducale Ducale Velour	<b>Y</b> Cervo Copenhagen Distressed Gemma Lucca Marissa Portofino Riva Saddle

### Spinneybeck Leather

*Check with your KnollTextiles or Spinneybeck Representative for changes or additions.*

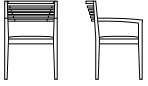
# Joe and Linda Ricchio JR® and Ricchio Chair with Upholstered Seat

	description	seat h	arm h	w	d	h	textile fabric yds.	req. leather sq. ft.	weight	finish		
<i>Designer(s):</i> Joseph and Linda Ricchio, 1990	37A Arm chair 	18"	25 1/4"	21 1/4"	23 1/2"	32 1/4"	0.7	13	17 lbs.	maple, ebonized		
		18"	25 1/4"	21 1/4"	23 1/2"	32 1/4"	0.7	13	17 lbs.	other finishes		
<i>Award(s):</i> Roscoe, 1991	 	<b>T</b> Thick seat option (add -T to end of pattern number)										
		<b>37R-T</b> Thick seat basket replacement for 37A and 37C							0.7	13		
		<b>37R</b> Seat basket replacement for 37A and 37C							0.7	13		

pattern no.	grades <b>A</b>	COM <b>B</b>	<b>C</b>	<b>D</b>	<b>E</b>	<b>F</b>	<b>G</b>	<b>H</b>	<b>I</b>	COL <b>U</b>	<b>V</b>	<b>W</b>	<b>X</b>	<b>Y</b>	list
<b>37A-(KC, BE)</b>	\$1,840.	\$1,880.	\$1,907.	\$1,948.	\$1,984.	\$2,004.	\$2,045.	\$2,121.	\$2,176.	\$2,411.	\$2,554.	\$2,833.	\$2,890.	\$2,959.	
<b>37A-()</b>	1,751.	1,789.	1,813.	1,858.	1,893.	1,915.	1,951.	2,031.	2,084.	2,319.	2,463.	2,743.	2,799.	2,865.	
<b>T-upcharge</b>															34.
<b>37R-T-()</b>	383.	423.	455.	489.	525.	549.	588.	665.	718.	953.	1,096.	1,376.	1,435.	1,502.	
<b>37R-()</b>	349.	389.	421.	455.	491.	515.	554.	631.	684.	919.	1,062.	1,342.	1,401.	1,468.	

## Order Code      Ordering Information      Construction

*Example:* **37A-T-BN-K1320/4**

<b>37A</b>	Arm chair
<b>T</b>	Thick seat
<b>BN</b>	Natural Beech
<b>K1320/4</b>	Comaro, Tabasco

*Specify:*

1. Pattern number
2. Thick seat option (Ricchio chair only)
3. Finish selection
4. Cal 133 Fire Code option
5. Textile selection

*Maple:*  
Clear Maple (suffix KC)

*Beech frame stains:*  
Beech (suffix B311)  
Bronzed Cherry (suffix B312A)  
Burnt Walnut (suffix B313)  
Deep Red Mahogany (suffix B328)  
Ebonized (suffix BE)  
Light Cherry (suffix B315)  
Light Walnut (suffix B411)  
Medium Cherry (suffix B319)  
Medium Red Mahogany (suffix BR)  
Medium Walnut (suffix B323)  
Natural Beech (suffix BN)  
Warm Brown Walnut (suffix J)

*Upholstery/COM information:*  
Prices shown include fabric or leather upholstery. Contact your Knoll representative for colors. Only approved KnollTextiles and Spinneybeck leathers may be ordered.

Customer's Own Material is available pending approval. For approval requirements, processing instructions and ordering information please see page 21.

*KnollStudio wood finishes:*  
KnollStudio wood finishes complement a large variety of KnollStudio veneer and Knoll Office veneer finishes. To select correct complementary finish, please refer to KnollStudio Wood Finish Matrix on page 26. If no complementary standard finish is available, please refer to custom finish policy below.

*Cal 133 Fire Code #:*  
The JR and Ricchio Chairs comply with the California Technical Bulletin 133 standard if upholstered in Cal 133 approved upholstery. Specify suffix -C at end of pattern number and suffix -133 at end of textile selection. Upcharge applies, see page 22.

*Certified Wood:*  
Chairs manufactured using FSC certified hardwoods are available through Custom Product Development. Extended leadtime and upcharge apply.

*Maintenance:*  
See pages 28-29.

*Note:*  
The JR and Ricchio Chair are certified Clean Air GOLD.

JR Chair (44A) does not stack.

*Frame:*  
Select clear maple hardwood in clear or beech hardwood in stained finish. Dowel and mortise and tenon construction.

*Upholstered seat:*  
Injection-molded copolymer plastic seat pan screws into corner blocks of chair frame. Standard seat basket is 1" thick. Thick seat basket option is 2" (Ricchio chair only). Note upcharge above.

*Upholstered Seat:*  
High density, polyurethane foam used in all upholstered areas. Elastic seat belt suspension.

*Seat Basket Replacement:*  
Upholstered seat sits on chair frame. Screws lock basket in place for easy installation or removal. For seat basket replacements for JR chairs ordered prior to February 2007, specify pattern numbers 37R-S. Pricing for 44R will apply.

*Finish:*  
Catalyzed lacquer protective coating. Hand-applied final wax coating.

*Glides:*  
Recessed plastic glides.

## Approved KnollTextiles Grades/Fabrics      Spinneybeck Leather

<b>A</b> Alignment Beacon Bocce Chance Common Ground Commuter Cloth Cross Tech Crossroad Delite Facet Foil Rap Heavy Metal Hourglass Infinite Mariner Monarch Oh La La Overture Prep Presto Soliloquy Sonnet Trophy Uni-Form	<b>B</b> continued Forza <sup>®</sup> Gala II Grand Grandview Helios Holbrook Instinct Journey Keaton Knoll Felt Knoll Hopsack Little Devil Ludlow Melody <sup>®</sup> Paradigm Petal Pusher <sup>®</sup> Prairie Prim Puff Radiance Ransom Roam Rush Hour Shadow Play Spree Summit Sutton Synth Tabloid Tinge Topos Venue Versa Vinyl <sup>®</sup> Wild Thing Yeni	<b>C</b> Atlas Axiom <sup>®</sup> Baxter Cairo Chameleon Charm Circa Classic Boucle Contour Dune Durand Earthwork Empire Stripe Entourage Entwine Essence Fable CR Fibra Greenwich Groovy Hudson Kaleidoscope CR Kaya CR Kora CR Lagos Lore CR Magnolia Milestone On Point Palisade Panache CR Patchwork Plaid On Prestini Pullman Quark	<b>C</b> continued Roundtrip Sahara Sequin CR Sinclair Smart <sup>®</sup> Stepping Stones Spectator Spot On Swing Tight Rope Tilden <sup>®</sup> Tower Grid Utmost II Utopia Wit Wow Factor Zari CR Zen Wave	<b>E</b> continued Juno Kampala Kimono Mamba Marquee Meroe Midpoint Nature Walk Off The Grid Rebel Sherman Shima Tempest Tryst Vatera Whip	<b>G</b> continued Haze Kamani Looped In Melange Modern Tweed Straie Stripe Texnet Ultrasuede Utrillo Vert	<b>H</b> Bavaria Catwalk Chiseled Constance Firefly Stretch Appeal Twist Tie World Piece	<b>I</b> Aswan Bella Byron Cato Chic Cummings Diamond Days Doily Dynamic Floressence Guise Hastings In Step Jaipur Knoll Velvet Limani Mepal North Island Olema Piper Prince Hair Rutledge Sandis Stripe It Tudor Zimba	<b>U</b> Vicenza Volo	<b>V</b> Acqua Amalfi Andes Embossed Tipped España Hand Tipped Maremma Velluto Pelle	<b>X</b> Ducale Ducale Velour	<b>Y</b> Cervo Copenhagen Distressed Gemma Lucca Marissa Portofino Riva Saddle	<b>W</b> Alaska Antique Derby Forte Lucente Sabrina Umbria	<sup>®</sup> Fire Retardants Chemicals
--	---	--	--	--	--	--	---	-----------------------------	--	-------------------------------------	---	---	--

*Check with your KnollTextiles or Spinneybeck Representative for changes or additions.*

# Joe and Linda Ricchio

## JR® and Ricchio Chair with Upholstered Seat

	description	height, seat	height, arm	width	depth	height	textile fabric yards	leather sq ft	weight	finish
<i>Designer(s):</i> Joseph and Linda Ricchio, 1990	<b>37R-T</b> Thick seat basket replacement for 37A and 37C						0.7	13		
<i>Award(s):</i> Roscoe, 1991	<b>37R</b> Seat basket replacement for 37A and 37C						0.7	13		
	<b>T</b> Thick seat option (add -T to end of pattern number)									
	37C Armless chair	18"		21 1/4"	23 1/2"	32 1/4"	0.7	13	15 lbs.	maple, ebonized
		18"		21 1/4"	23 1/2"	32 1/4"	0.7	13	15 lbs.	other finishes



Order Code	Ordering Information	Construction
------------	----------------------	--------------

<i>Example:</i> <b>37A-T-BN-K1320/4</b>		
<b>37A</b>	Arm chair	
<b>T</b>	Thick seat	
<b>BN</b>	Natural Beech	
<b>K1320/4</b>	Comaro, Tabasco	

*Upholstery/COM information:*  
Prices shown include fabric or leather upholstery. Contact your Knoll representative for colors. Only approved KnollTextiles and Spinneybeck leathers may be ordered.

Customer's Own Material is available pending approval. For approval requirements, processing instructions and ordering information please see page 21.

*KnollStudio wood finishes:*  
KnollStudio wood finishes complement a large variety of KnollStudio veneer and Knoll Office veneer finishes. To select correct complementary finish, please refer to KnollStudio Wood Finish Matrix on page 26. If no complementary standard finish is available, please refer to custom finish policy below.

*Cal 133 Fire Code #:*  
The JR and Ricchio Chairs comply with the California Technical Bulletin 133 standard if upholstered in Cal 133 approved upholstery. Specify suffix -C at end of pattern number and suffix -133 at end of textile selection. Upcharge applies, see page 22.

*Certified Wood:*  
Chairs manufactured using FSC certified hardwoods are available through Custom Product Development. Extended leadtime and upcharge apply.

*Maintenance:*  
See pages 28-29.

*Note:*  
The JR and Ricchio Chair are certified Clean Air GOLD.

JR Chair (44A) does not stack.

*Frame:*  
Select clear maple hardwood in clear or beech hardwood in stained finish. Dowel and mortise and tenon construction.

*Upholstered seat:*  
Injection-molded copolymer plastic seat pan screws into corner blocks of chair frame. Standard seat basket is 1" thick. Thick seat basket option is 2" (Ricchio chair only). Note upcharge above.

*Upholstered Seat:*  
High density, polyurethane foam used in all upholstered areas. Elastic seat belt suspension.

*Seat Basket Replacement:*  
Upholstered seat sits on chair frame. Screws lock basket in place for easy installation or removal. For seat basket replacements for JR chairs ordered prior to February 2007, specify pattern numbers 37R-S. Pricing for 44R will apply.

*Finish:*  
Catalyzed lacquer protective coating. Hand-applied final wax coating.

*Glides:*  
Recessed plastic glides.



pattern number	grades A	COM B	C	D	E	F	G	H	I	COL U	V	W	X	Y	list
<b>37R-T(-)</b>	\$383.	\$423.	\$455.	\$489.	\$525.	\$549.	\$588.	\$665.	\$718.	\$953.	\$1,096.	\$1,376.	\$1,435.	\$1,502.	
<b>37R(-)</b>	349.	389.	421.	455.	491.	515.	554.	631.	684.	919.	1,062.	1,342.	1,401.	1,468.	
<b>T-upcharge</b>															34.
<b>37C-(KC, BE)</b>	1,727.	1,765.	1,798.	1,839.	1,873.	1,891.	1,934.	2,008.	2,063.	2,300.	2,440.	2,718.	2,778.	2,847.	
<b>37C(-)</b>	1,642.	1,686.	1,714.	1,754.	1,790.	1,806.	1,848.	1,927.	1,980.	2,215.	2,357.	2,636.	2,692.	2,761.	

Approved KnollTextiles Grades/Fabrics	Spinneybeck Leather
---------------------------------------	---------------------

<b>A</b> Alignment Beacon Bocce Chance Common Ground Commuter Cloth Cross Tech Crossroad Delite Facet Foil Rap Heavy Metal Hourglass Infinite Mariner Monarch Oh La La Overture Prep Presto Soliloquy Sonnet Trophy Uni-Form	<b>B</b> continued Forza (®) Gala II Grande Grandview Helios Holbrook Instinct Journey Keaton Knoll Felt Knoll Hopsack Little Devil Ludlow Melody (®) Paradigm Petal Pusher (®) Prairie Prim Puff Radiance Ransom Roam Rush Hour Shadow Play Spree Summit Sutton Synth Tabloid Tinge Topos Venue Versa Vinyl (®) Wild Thing Yeni	<b>C</b> Atlas Axiom (®) Baxter Cairo Chameleon Charm Circa Classic Boucle Contour Dune Durand Earthwork Empire Stripe Entourage Entwine Fable CR Fibra Greenwich Groovy Hudson Kaleidoscope CR Kaya CR Kora CR Lagos Lore CR Magnolia Milestone On Point Palisade Panache CR Patchwork Plaid On Prestini Pullman Quark	<b>C</b> continued Roundtrip Sahara Sequin CR Sinclair Smart (®) Stepping Stones Spectator Spot On Swing Tight Rope Tilden (®) Tower Grid Utmost II Utopia Wit Wow Factor Zari CR Zen Wave	<b>D</b> Buzz Code Coterie Eclat Weave Hologram Island Kabuki Menagerie Origins Pathway Plaidtastic Retreat Vice Versa Woodland Zoom	<b>E</b> Aegean Circle Point Currents Demure Flower Power Highland Ikat Stripe					
<b>E</b> continued Juno Kampala Kimono Mamba Marquee Meroe Midpoint Nature Walk Off The Grid Rebel Sherman Shima Tempest Tryst Vatera Whip	<b>F</b> Atelier Biscayne Calais Cotton Velvet Century Cornaro Double Agent (®) Clider Imprint In Stitches Liberty Mod Plaid Rivington Soon Swank Totem Tweed Frieze	<b>G</b> continued Haze Kamani Looped In Melange Modern Tweed Straie Stripe Texnet Ultr suede Utrillo Vert	<b>H</b> Bavaria Catwalk Chiseled Constance Firefly Stretch Appeal Twist Tie World Piece	<b>I</b> Aswan Bella Byron Cato Chic Cummings Diamond Days Doily Dynamic Floressence Guise Hastings In Step Jaipur Knoll Velvet Limani Mepal North Island Olema Piper Prince Hair Rutledge Sandis Stripe It Tudor Zimba	<b>U</b> Vicenza Volo	<b>X</b> Ducale Ducale Velour	<b>V</b> Acqua Amalfi Andes Embossed Tipped España Hand Tipped Maremma Velluto Pelle	<b>Y</b> Cervo Copenhagen Distressed Gemma Lucca Marissa Portofino Riva Saddle	<b>W</b> Alaska Antique Derby Forte Lucente Sabrina Umbria	(®) Fire Retardants Chemicals

*Check with your KnollTextiles or Spinneybeck Representative for changes or additions.*

# Joe and Linda Ricchio JR® and Ricchio Chair with Upholstered Seat

	description	seat h	arm h	w	d	h	textile fabric, yds.	weight	finish	req. leather sq. ft
<i>Designer(s):</i> Joseph and Linda Ricchio, 1990	<b>44A</b> JR Arm chair, non-stacking 	19"	25 3/4"	23 1/2"	21 5/8"	32 1/8"	0.7	14 lbs.	maple, ebonized	13
		19"	25 3/4"	23 1/2"	21 5/8"	32 1/8"	0.7	14 lbs.	other finishes	13
<i>Award(s):</i> Roscoe, 1991	<b>44R</b> Seat basket replacement for 44A and 44A-U 						0.8			14.5

### Order Code

<i>Example:</i>	<b>37A-T-BN-K1320/4</b>
<b>37A</b>	Arm chair
<b>T</b>	Thick seat
<b>BN</b>	Natural Beech
<b>K1320/4</b>	Comaro, Tabasco

### Specify:

1. Pattern number
2. Thick seat option (Ricchio chair only)
3. Finish selection
4. Cal 133 Fire Code option
5. Textile selection

### Maple:

Clear Maple (suffix KC)

### Beech frame stains:

- Beech (suffix B311)
- Bronzed Cherry (suffix B312A)
- Burnt Walnut (suffix B313)
- Deep Red Mahogany (suffix B328)
- Ebonized (suffix BE)
- Light Cherry (suffix B315)
- Light Walnut (suffix B411)
- Medium Cherry (suffix B319)
- Medium Red Mahogany (suffix BR)
- Medium Walnut (suffix B323)
- Natural Beech (suffix BN)
- Warm Brown Walnut (suffix J)

### Ordering Information

#### Upholstery/COM information:

Prices shown include fabric or leather upholstery. Contact your Knoll representative for colors. Only approved KnollTextiles and Spinneybeck leathers may be ordered.

Customer's Own Material is available pending approval. For approval requirements, processing instructions and ordering information please see page 21.

#### KnollStudio wood finishes:

KnollStudio wood finishes complement a large variety of KnollStudio veneer and Knoll Office veneer finishes. To select correct complementary finish, please refer to KnollStudio Wood Finish Matrix on page 26. If no complementary standard finish is available, please refer to custom finish policy below.

#### Cal 133 Fire Code #:

The JR and Ricchio Chairs comply with the California Technical Bulletin 133 standard if upholstered in Cal 133 approved upholstery. Specify suffix -C at end of pattern number and suffix -133 at end of textile selection. Upcharge applies, see page 22.

#### Certified Wood:

Chairs manufactured using FSC certified hardwoods are available through Custom Product Development. Extended leadtime and upcharge apply.

#### Maintenance:

See pages 28-29.

#### Note:

The JR and Ricchio Chair are certified Clean Air GOLD.

JR Chair (44A) does not stack.

### Construction

#### Frame:

Select clear maple hardwood in clear or beech hardwood in stained finish. Dowel and mortise and tenon construction.

#### Upholstered seat:

Injection-molded copolymer plastic seat pan screws into corner blocks of chair frame. Standard seat basket is 1" thick. Thick seat basket option is 2" (Ricchio chair only). Note upcharge above.

#### Upholstered Seat:

High density, polyurethane foam used in all upholstered areas. Elastic seat belt suspension.

#### Seat Basket Replacement:

Upholstered seat sits on chair frame. Screws lock basket in place for easy installation or removal. For seat basket replacements for JR chairs ordered prior to February 2007, specify pattern numbers 37R-S. Pricing for 44R will apply.

#### Finish:

Catalyzed lacquer protective coating. Hand-applied final wax coating.

#### Glides:

Recessed plastic glides.

pattern no.	grades A	COM B	C	D	E	F	G	H	I	COL U	V	W	X	Y
<b>44A-(KC, BE)</b>	\$1,821.	\$1,862.	\$1,893.	\$1,934.	\$1,971.	\$1,990.	\$2,035.	\$2,111.	\$2,162.	\$2,364.	\$2,502.	\$2,790.	\$2,848.	\$2,916.
<b>44A-( )</b>	1,727.	1,767.	1,799.	1,840.	1,880.	1,894.	1,940.	2,017.	2,072.	2,273.	2,409.	2,695.	2,755.	2,822.
<b>44R-( )</b>	327.	366.	401.	444.	475.	497.	544.	611.	676.	871.	1,009.	1,296.	1,356.	1,424.

### Approved KnollTextiles Grades/Fabrics

<b>A</b> Alignment Beacon Bocce Chance Common Ground Commuter Cloth Cross Tech Crossroad Delite Facet Foil Rap Heavy Metal Hourglass Infinite Mariner Monarch Oh La La Overture Prep Presto Soliloquy Sonnet Trophy Uni-Form	<b>B</b> continued Forza ® Gala II Grande Grandview Helios Holbrook Instinct Journey Keaton Knoll Felt Knoll Hopsack Little Devil Ludlow Melody ® Paradigm Petal Pusher ® Prairie Prim Puff Radiance Ransom Roam Rush Hour Shadow Play Spree Summit Sutton Synth Tabloid Tinge Topos Venue Versa Vinyl ® Wild Thing Yeni	<b>C</b> Atlas Axiom ® Baxter Cairo Chameleon Charm Circa Classic Boucle Contour Dune Durand Earthwork Empire Stripe Entourage Entwine Fable CR Fibra Greenwich Groovy Hudson Kaleidoscope CR Kaya CR Kora CR Lagos Lore CR Magnolia Milestone On Point Palisade Panache CR Patchwork Plaid On Prestini Pullman Quark	<b>C</b> continued Roundtrip Sahara Sequin CR Sinclair Smart ® Stepping Stones Spectator Spot On Swing Tight Rope Tilden ® Tower Grid Utmost II Utopia Wit Wow Factor Zari CR Zen Wave	<b>D</b> Buzz Code Coterie Eclat Weave Hologram Island Kabuki Menagerie Origins Pathway Plaidtastic Retreat Vice Versa Woodland Zoom	<b>E</b> Aegean Circle Point Currents Demure Flower Power Highland Ikat Stripe	<b>E</b> continued Juno Kampala Kimono Mamba Marquee Meroe Midpoint Nature Walk Off The Grid Rebel Sherman Shima Tempest Tryst Vatera Whip	<b>F</b> Atelier Biscayne Calais Cotton Velvet Century Cornaro Double Agent ® Clider Imprint In Stitches Liberty Mod Plaid Rivington Soon Swank Totem Tweed Frieze	<b>G</b> continued Haze Kamani Looped In Melange Modern Tweed Straie Stripe Texnet Ultrasuede Utrillo Vert	<b>H</b> Bavaria Catwalk Chiseled Constance Firefly Stretch Appeal Twist Tie World Piece	<b>I</b> Aswan Bella Byron Cato Chic Cummings Diamond Days Doily Dynamic Floressence Guise Hastings In Step Jaipur Knoll Velvet Limani Mepal North Island Olema Piper Prince Hair Rutledge Sandis Stripe It Tudor Zimba	<b>U</b> Vicenza Volo	<b>V</b> Acqua Amalfi Andes Embossed Tipped España Hand Tipped Maremma Velluto Pelle	<b>W</b> Alaska Antique Derby Forte Lucente Sabrina Umbria	<b>X</b> Ducale Ducale Velour	<b>Y</b> Cervo Copenhagen Gemma Lucca Marissa Portofino Riva Saddle
--	---	--	--	---	---	--	---	--	--	---	-----------------------------	--	---	-------------------------------------	---

### Spinneybeck Leather

® Fire Retardants Chemicals

Check with your KnollTextiles or Spinneybeck Representative for changes or additions.

# Joe and Linda Ricchio

## Fully Upholstered Ricchio and JR® Chairs

**Designer(s):**  
Joseph and Linda Ricchio, 1994

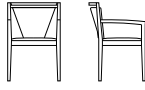
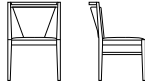

description	seat h	arm h	w	d	h	textile fabric yds.	req. leather sq. ft.	weight	finish
<b>37A-U</b> Ricchio arm chair, uphol. seat and back 	18 1/2"	26"	21 3/8"	23 3/4"	32 1/4"	1	19	21 lbs.	maple, ebonized
	18 1/2"	26"	21 3/8"	23 3/4"	32 1/4"	1	19	21 lbs.	other finishes
<b>37C-U</b> Ricchio armless chair, uphol. seat and back 	18 1/2"		21 3/8"	23 3/4"	32 1/4"	1	19	19 lbs.	maple, ebonized
	18 1/2"		21 3/8"	23 3/4"	32 1/4"	1	19	19 lbs.	other finishes

Order Code	Ordering Information	Construction
------------	----------------------	--------------

<i>Example:</i> <b>37A-U-B319-K1084/2</b>	<i>Upholstery/COM information:</i> Prices shown include fabric or leather upholstery. Contact your Knoll representative for colors. Only approved KnollTextiles and Spinneybeck leathers may be ordered.	<i>Cal 133 Fire Code #:</i> The Fully Upholstered Ricchio Chairs comply with the California Technical Bulletin 133 standard if upholstered in Cal 133 approved upholstery. Specify suffix -C at end of pattern number and suffix -133 at end of textile selection. Upcharge applies, see page 22.
<b>37A</b> Ricchio arm chair, upholstered seat and back	<i>Customer's Own Material</i> is available pending approval. For approval requirements, processing instructions and ordering information please see page 21.	<i>Frame:</i> Select clear maple hardwood in clear or beech hardwood in stained finish.
<b>U</b> Upholstered seat and back		
<b>B319</b> Medium Cherry		
<b>K1084/2</b> Harrison, Campbell		

*Specify:*

1. Pattern number
2. Finish selection
3. Cal 133 Fire Code option
4. Textile selection

*Maple:*

Clear Maple (suffix KC)

*Beech frame stains:*

- Beech (suffix B311)
- Bronzed Cherry (suffix B312A)
- Burnt Walnut (suffix B313)
- Deep Red Mahogany (suffix B328)
- Ebonized (suffix BE)
- Light Cherry (suffix B315)
- Light Walnut (suffix B411)
- Medium Cherry (suffix B319)
- Medium Red Mahogany (suffix BR)
- Medium Walnut (suffix B323)
- Natural Beech (suffix BN)
- Warm Brown Walnut (suffix J)

pattern no.	grades <b>A</b>	COM <b>B</b>	<b>C</b>	<b>D</b>	<b>E</b>	<b>F</b>	<b>G</b>	<b>H</b>	<b>I</b>	COL <b>U</b>	<b>V</b>	<b>W</b>	<b>X</b>	<b>Y</b>
<b>37A-U-(KC, BE)</b>	\$2,457.	\$2,510.	\$2,565.	\$2,615.	\$2,664.	\$2,696.	\$2,755.	\$2,857.	\$2,939.	\$3,456.	\$3,665.	\$4,069.	\$4,155.	\$4,256.
<b>37A-U-()</b>	2,331.	2,389.	2,439.	2,490.	2,542.	2,574.	2,634.	2,736.	2,816.	3,335.	3,540.	3,947.	4,035.	4,133.
<b>37C-U-(KC, BE)</b>	2,345.	2,402.	2,445.	2,503.	2,550.	2,582.	2,640.	2,748.	2,822.	3,347.	3,547.	3,957.	4,044.	4,139.
<b>37C-U-()</b>	2,229.	2,282.	2,328.	2,386.	2,436.	2,467.	2,525.	2,633.	2,706.	3,230.	3,432.	3,840.	3,926.	4,024.

**Approved KnollTextiles Grades/Fabrics**

<b>A</b> Alignment Beacon Bocce Chance Common Ground Commuter Cloth Cross Tech Crossroad Delite Facet Foil Rap Heavy Metal Hourglass Infinite Mariner Monarch Oh La La Overture Prep Presto Soliloquy Sonnet Trophy Uni-Form	<b>B</b> continued Forza ② Gala II Grande Grandview Helios Holbrook Instinct Journey Keaton Knoll Felt Knoll Hopsack Little Devil Ludlow Melody ② Paradigm Petal Pusher ② Prairie Prim Puff Radiance Ransom Roam Rush Hour Shadow Play Spree Summit Sutton Synth Tabloid Tinge Topos Venue Versa Vinyl ② Wild Thing Yeni	<b>C</b> Atlas Axiom ② Baxter Cairo Chameleon Charm Circa Classic Boucle Dune Durand Earthwork Empire Stripe Entourage Entwine Essence Fable CR Fibra Greenwich Groovy Hudson Kaleidoscope CR Kaya CR Kora CR Lagos Lore CR Magnolia Milestone On Point Palisade Panache CR Patchwork Plaid On Prestini Pullman Quark	<b>C</b> continued Roundtrip Sahara Sequin CR Sinclair Smart ② Stepping Stones Spectator Spot On Swing Tight Rope Tilden ② Tower Grid Utmost II Utopia Wit Wow Factor Zari CR Zen Wave	<b>D</b> Buzz Code Coterie Eclat Weave Hologram Island Kabuki Menagerie Origins Pathway Plaidtastic Retreat Vice Versa Woodland Zoom	<b>E</b> Aegean Circle Point Demure Flower Power Highland Ikat Stripe
--	--	--	--	---	---

**Spinneybeck Leather**

<b>E</b> continued Juno Kampala Kimono Mamba Marquee Meroe Midpoint Nature Walk Off The Grid Rebel Sherman Shima Tempest Tryst Vatera Whip	<b>F</b> Atelier Biscayne Calais Cotton Velvet Century Cornaro Double Agent ② Glider Imprint In Stitches Liberty Mod Plaid Rivington Soon Swank Totem Tweed Frieze	<b>G</b> continued Haze Kamani Looped In Melange Modern Tweed Straie Stripe Texnet Ultrasuede Utrillo Vert	<b>H</b> Bavaria Catwalk Chiseled Constance Firefly Stretch Appeal Twist Tie World Piece	<b>I</b> Aswan Bella Byron Cato Chic Cummings Diamond Days Dynamic Floressence Hastings In Step Jaipur Knoll Velvet Limani Mepal North Island Olema Piper Prince Hairly Rutledge Sandis Stripe It Tudor Zimba	<b>U</b> Vicenza Volo	<b>V</b> Acqua Amalfi Andes Embossed Tipped España Velluto Pelle	<b>W</b> continued Forte Lucente Sabrina	<b>X</b> Ducale Velour	<b>Y</b> Cervo Copenhagen Distressed Gemma Marissa Riva
--	---	--	--	---	-----------------------------	--	---	---------------------------	---

② Fire Retardants Chemicals

*Check with KnollTextiles or Spinneybeck Representative for changes or additions.*

# Joe and Linda Ricchio

## Fully Upholstered Ricchio and JR® Chairs

*Designer(s):*  
Joseph and Linda Ricchio, 1994

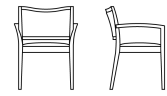

description	height, seat	height, arm	w	d	h	textile fabric yds.	reg. leather sq. ft.	weight	finish
	19"	26"	24"	22"	32"	1	18	15 lbs.	other finishes

pattern no.	grade	A	B	C	D	E	F	G	H	I	COL U	V	W	X	Y
44AU-(KC, BE)	\$2,386.	\$2,426.	\$2,467.	\$2,511.	\$2,547.	\$2,573.	\$2,617.	\$2,704.	\$2,762.	\$2,960.	\$3,110.	\$3,418.	\$3,480.	\$3,557.	
44AU-()	2,151.	2,194.	2,232.	2,278.	2,315.	2,337.	2,380.	2,467.	2,528.	2,722.	2,876.	3,183.	3,243.	3,320.	

Order Code	Ordering Information	Construction
------------	----------------------	--------------

<i>Example:</i> <b>37A-U-B319-K1084/2</b>		
<b>37A</b>	Ricchio arm chair, upholstered seat and back	
<b>U</b>	Upholstered seat and back	
<b>B319</b>	Medium Cherry	
<b>K1084/2</b>	Harrison, Campbell	

*Upholstery/COM information:*  
Prices shown include fabric or leather upholstery. Contact your Knoll representative for colors. Only approved KnollTextiles and Spinneybeck leathers may be ordered.

Customer's Own Material is available pending approval. For approval requirements, processing instructions and ordering information please see page 21.

*KnollStudio wood finishes:*  
KnollStudio wood finishes complement a large variety of KnollStudio veneer and Knoll Office veneer finishes. To select correct complementary finish, please refer to KnollStudio Wood Finish Matrix on page 26. If no complementary standard finish is available, please refer to custom finish policy below.

*Cal 133 Fire Code #:*  
The Fully Upholstered Ricchio Chairs comply with the California Technical Bulletin 133 standard if upholstered in Cal 133 approved upholstery. Specify suffix -C at end of pattern number and suffix -133 at end of textile selection. Upcharge applies, see page 22.

*Certified Wood:*  
Chairs manufactured using FSC certified hardwoods are available through Custom Product Development. Extended leadtime and upcharge apply.

*Maintenance:*  
See pages 28-29

*Note:*  
The Fully Upholstered Ricchio and JR Chairs are certified Clean Air GOLD.

*Frame:*  
Select clear maple hardwood in clear or beech hardwood in stained finish.

*Fully upholstered chairs:*  
Plywood core back panel bolted to frame for added strength. Optional arm panels have plywood core bolted to frame. Injection-molded plastic seat pan. High density, polyurethane foam used in all upholstered areas. JR fully upholstered chair does not stack.

*Finish:*  
Catalyzed lacquer protective coating. Hand-applied final wax coating.

*Glides:*  
Recessed plastic glides.

*Specify:*

1. Pattern number
2. Finish selection
3. Cal 133 Fire Code option
4. Textile selection

*Maple:*

Clear Maple (suffix KC)

*Beech frame stains:*

- Beech (suffix B311)
- Bronzed Cherry (suffix B312A)
- Burnt Walnut (suffix B313)
- Deep Red Mahogany (suffix B328)
- Ebonized (suffix BE)
- Light Cherry (suffix B315)
- Light Walnut (suffix B411)
- Medium Cherry (suffix B319)
- Medium Red Mahogany (suffix BR)
- Medium Walnut (suffix B323)
- Natural Beech (suffix BN)
- Warm Brown Walnut (suffix J)

Approved KnollTextiles Grades/Fabrics	Spinneybeck Leather
---------------------------------------	---------------------

<b>A</b> Alignment Beacon Bocce Chance Common Ground Commuter Cloth Cross Tech Crossroad Delite Facet Foil Rap Heavy Metal Hourglass Infinite Mariner Monarch Oh La La Overture Prep Presto Soliloquy Sonnet Trophy Uni-Form	<b>B</b> continued Forza © Gala II Grande Grandview Helios Holbrook Instinct Journey Keaton Knoll Felt Knoll Hopsack Little Devil Ludlow Melody © Paradigm Petal Pusher © Prairie Prim Puff Radiance Ransom Roam Rush Hour Shadow Play Spree Summit Sutton Synth Tabloid Tinge Topos Venue Versa Vinyl © Wild Thing Yeni	<b>C</b> Atlas Axiom © Baxter Cairo Chameleon Charm Circa Classic Boucle Dune Durand Earthwork Empire Stripe Entourage Entwine Essence Fable CR Fibra Greenwich Groovy Hudson Kaleidoscope CR Kaya CR Kora CR Lagos Lore CR Magnolia Milestone On Point Palisade Panache CR Patchwork Plaid On Prestini Pullman Quark	<b>C</b> continued Roundtrip Sahara Sequin CR Sinclair Smart © Stepping Stones Spectator Spot On Swing Tight Rope Tilden © Tower Grid Utmost II Utopia Wit Wow Factor Zari CR Zen Wave	<b>D</b> Buzz Code Coterie Eclat Weave Hologram Island Kabuki Menagerie Origins Pathway Plaidtastic Retreat Vice Versa Woodland Zoom	<b>E</b> Aegean Circle Point Demure Flower Power Highland Ikat Stripe	<b>E</b> continued Juno Kampala Kimono Mamba Marquee Meroe Midpoint Nature Walk Off The Grid Rebel Sherman Shima Tempest Tryst Vatera Whip	<b>F</b> Atelier Biscayne Calais Cotton Velvet Century Cornaro Double Agent © Glider Imprint In Stitches Liberty Mod Plaid Rivington Soon Swank Totem Tweed Frieze	<b>G</b> continued Haze Kamani Looped In Melange Modern Tweed Straie Stripe Texnet Ultrasuede Utrillo Vert	<b>H</b> Bavaria Catwalk Chiseled Constance Firefly Stretch Appeal Twist Tie World Piece	<b>I</b> Aswan Bella Byron Cato Chic Cummings Diamond Days Dynamic Floressence Hastings In Step Jaipur Knoll Velvet Limani Mepal North Island Olema Piper Prince Hairly Rutledge Sandis Stripe It Tudor Zimba	<b>U</b> Vicenza Volo	<b>V</b> Acqua Amalfi Andes Embossed Tipped España Velluto Pelle	<b>W</b> Alaska Antique	<b>W</b> continued Forte Lucente Sabrina	<b>X</b> Ducale Velour	<b>Y</b> Cervo Copenhagen Dressed Gemma Marissa Riva
--	--	--	--	---	---	--	---	--	--	---	-----------------------------	--	-------------------------------	---	---------------------------	--

© Fire Retardants Chemicals

Check with KnollTextiles or Spinneybeck Representative for changes or additions.





# Jens Risom

## Contract Seating

### Side Chairs and Lounge

Designer(s):  
Jens Risom, 1943



description	seat h	w	d	h	reuphol. kit ydg.	weight
<b>666CC-WB</b> Contract side chair with webbed seat and back	17 3/4"	17 1/4"	18"	30 3/8"		see below
						
<b>666C-WB-KIT</b> Re-upholstery kit for side chair with webbed back					14.0	
<b>666CC</b> Contract side chair with webbed seat	17 3/4"	17 1/4"	18"	30 3/8"		see below
						
<b>666C-KIT</b> Re-upholstery kit for side chair with wood back					9.0	
<b>654LCC</b> Contract armless lounge chair	16"	20"	27 1/2"	30 1/4"		see below
						
<b>654LA</b> Arm lounge chair	16"	23 3/4"	27 3/4"	30 1/4"		see below
						
<b>654L-KIT</b> Re-upholstery kit for arm and armless lounge chair					25	

pattern no.	maple, ebonized	walnut	teak	webbing kit
<b>666CC-WB-(-)(-)</b>	\$1,703.	\$2,126.	\$1,984.	
<b>666C-WB-KIT-(-)</b>				164.
<b>666CC-(-)(-)</b>	1,570.	2,038.	n/a	
<b>666C-KIT-(-)</b>				132.
<b>654LCC-(-)(-)</b>	2,354.	2,472.	2,434.	
<b>654LA-(-)(-)</b>	2,690.	2,824.	n/a	
<b>654L-KIT-(-)</b>				221.

#### Order Code

<i>Example:</i>	<b>654LCC-KC-RD</b>
<b>654LCC</b>	Risom Contract armless lounge chair
<b>KC</b>	Clear maple
<b>RD</b>	Red cotton webbing

Note:  
The Risom lounge chairs are part of a collection. Please refer to the Risom side chairs on page 0 and tables on page 456.

#### Specify:

1. Pattern number
2. Frame finish
3. Webbing color selection

#### Ordering Information

*Frame finishes:*  
Clear maple (suffix KC)  
Ebonized maple (suffix KE)  
Light walnut (suffix LWT)  
Teak (suffix K)

*Cotton webbing colors:*  
Aubergine (suffix AU)  
Black (suffix BL)  
Dark grey (suffix DG)  
Flax (suffix FL)  
Forest green (suffix FG)  
Khaki (suffix KH)  
Maize (suffix MZ)  
Navy (suffix NA)  
Red (suffix RD)  
Steel blue (suffix SB)

*Cotton/nylon webbing colors:*  
Blueberry (suffix BU)  
Eucalyptus (suffix EU)  
Licorice (suffix LC)  
Nutmeg (suffix NM)  
Squash (suffix SH)  
Tomato (suffix TO)

*Sunbrella® webbing colors:*  
Antique Beige (suffix AB)  
Carbon (suffix CB)  
Charcoal (suffix CH)  
Fern (suffix FR)  
Navy (suffix NV)  
Ochre (suffix OC)

#### Re-upholstery kit:

Webbing straps in one length to re-upholster existing chairs. Must be reupholstered by a professional upholsterer.

#### Note:

The Risom Contract chairs are certified Clean Air GOLD.

#### Maintenance:

See pages 28-29.

#### Note:

**Risom Contract Seating features solid wood stretchers underneath the seats for reinforced durability in high traffic environments. Wood stretchers match wood frame finish selection.**

#### Construction

##### Frame:

Select maple or walnut hardwood with clear finish. Ebonized finish is stained maple hardwood. Mortise and tenon construction. Seat basket of arm lounge chair attaches to frame with invisible screws. Teak frame is solid teak lumber with an oiled finish.

##### Finish:

Lacquer finish on walnut and maple frames. Oiled finish on teak frame.

##### Risom Stretcher detail:

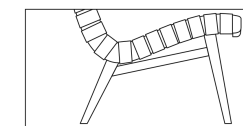

##### Upholstery:

Cotton webbing is 100% natural cotton. Nylon webbing straps are 100% nylon. Cotton and Nylon webbing are CAL133 approved.

Sunbrella® Strap is made with reinforced Sunbrella yarns that are designed to stretch, UV/fade resistant, water repellent, bleach cleanable and stain resistant.

##### Weight:



Side chair with webbed seat and back in Maple or Ebonized finishes weighs 13 lbs. Maple finish weighs 12 lbs. Teak finish weighs 10 lbs. Side chair with webbed seat in Maple or Ebonized finishes weighs 13 lbs. Maple finish weighs 12 lbs. Armless lounge chair in Maple and Ebonized finishes weighs 16 lbs. Walnut finish weighs 14 lbs. Teak finish weighs 13 lbs.



Jens Risom  
Residential Seating  
Side Chairs and Stool

Designer(s):  
Jens Risom, 1943

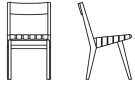

description	seat h	w	d	h	reuphol. kit ydg.	weight
<b>666C-KIT</b> Re-upholstery kit for side chair with wood back					9.0	
<b>666C-WB-KIT</b> Re-upholstery kit for side chair with webbed back					14.0	
<b>666C-WB</b> Side chair with webbed seat and back	17 1/4"	17 1/4"	18"	30 3/8"		see below
						
<b>666C</b> Side chair with webbed seat	17 1/4"	17 1/4"	18"	30 3/8"		see below
						
<b>667Y-KIT</b> Re-upholstery kit for stool					7.0	
<b>667Y</b> Sitting stool	17 1/8"	16 1/2"	15 1/8"	17 1/8"		see below
						

pattern no.	maple, ebonized	walnut	teak	webbing kit
<b>666C-KIT- ( )</b>				\$132.
<b>666C-WB-KIT- ( )</b>				164.
<b>666C-WB- ( )-( )</b>	1,481.	1,848.	1,984.	
<b>666C- ( )-( )</b>	1,365.	1,772.	n/a	
<b>667Y-KIT- ( )</b>				112.
<b>667Y- ( )-( )</b>	881.	921.	n/a	

Order Code

Ordering Information

<i>Example:</i> <b>666C-WB-KC-RD</b>
<b>666C-WB</b> Risom side chair with webbed seat and back
<b>KC</b> Clear maple
<b>RD</b> Red cotton webbing

*Frame finishes:*  
Clear maple (suffix KC)  
Ebonized maple (suffix KE)  
Light walnut (suffix LWT)  
Teak (suffix K)

*Cotton webbing colors:*  
Aubergine (suffix AU)  
Black (suffix BL)  
Dark grey (suffix DG)  
Flax (suffix FL)  
Forest green (suffix FG)  
Khaki (suffix KH)  
Maize (suffix MZ)  
Navy (suffix NA)  
Red (suffix RD)  
Steel blue (suffix SB)

Cotton/nylon webbing colors:  
Blueberry (suffix BU)  
Eucalyptus (suffix EU)  
Licorice (suffix LC)  
Nutmeg (suffix NM)  
Squash (suffix SH)  
Tomato (suffix TO)

*Sunbrella® webbing colors:*  
Antique Beige (suffix AB)  
Carbon (suffix CB)  
Charcoal (suffix CH)  
Fern (suffix FR)  
Navy (suffix NV)  
Ochre (suffix OC)

**\*Teak frames with cotton or nylon webbing are for indoor use only.**

Re-upholstery kit:  
Webbing straps in one length to re-upholster existing chairs. Must be reupholstered by a professional upholsterer.

*Note:*  
The Risom side chairs are certified Clean Air GOLD.

*Maintenance:*  
See pages 28-29.

*Note:*  
The Risom lounge chairs are part of a collection. Please refer to the Risom side chairs on page 0 and tables on page 456.

*Specify:*  
1. Pattern number  
2. Frame finish  
3. Webbing color selection

Construction

*Frame:*  
Select maple or walnut hardwood with clear finish. Ebonized finish is stained maple hardwood. Mortise and tenon construction. Teak frame is solid teak lumber with an oiled finish.

*Note:*  
Teak frames include teak stretchers underneath the seat.

*Finish:*  
Lacquer finish on walnut and maple frames. Oiled finish on teak frame.

*Upholstery:*  
Cotton webbing is 100% natural cotton. Nylon webbing straps are 100% nylon. Cotton and Nylon webbing are CAL133 approved.



Sunbrella® Strap is made with reinforced Sunbrella yarns that are designed to stretch, UV/fade resistant, water repellent, bleach cleanable and stain resistant.

*Weight:*  
Side Chair with webbed seat and back in Maple or Ebonized finishes weighs 12 lbs. Walnut finish weighs 11 lbs. Teak finish weighs 10 lbs. Side Chair with webbed seat in Maple or Ebonized finishes weighs 12lbs. Walnut finish weighs 11lbs. Sitting stool in Maple or Ebonized finishes weighs 7 lbs. Walnut finish weighs 7 lbs.

Jens Risom  
Residential Seating  
Lounge Chairs

Designer(s):  
Jens Risom, 1943



description	seat h	arm h	w	d	h	reuphol. kit ydg.	weight
<b>654LA</b> Arm lounge chair 	16"	22"	23 3/4"	27 1/4"	30 1/4"		see below
<b>654LC</b> Armless lounge chair 	16"		20"	27 1/2"	30 1/4"		see below
<b>654L-KIT</b> Re-upholstery kit for arm and armless lounge chair						25	
<b>655LO</b> Ottoman 			19"	17 1/4"	16"		see below
<b>655LO-KIT</b> Re-upholstery kit for ottoman						11	

pattern no.	maple, ebonized	walnut	teak	webbing kit
<b>654LA-(-)(-)</b>	\$2,690.	\$2,824.	n/a	
<b>654LC-(-)(-)</b>	2,048.	2,148.	2,434.	
<b>654L-KIT-(-)</b>				221.
<b>655LO-(-)(-)</b>	1,157.	1,432.	1,272.	
<b>655LO-KIT-(-)</b>				148.

Order Code

Example:	<b>654LC-KC-RD</b>
<b>654LC</b>	Risom armless lounge chair
<b>KC</b>	Clear maple
<b>RD</b>	Red cotton webbing

Note:  
The Risom lounge chairs are part of a collection. Please refer to the Risom side chairs on page 0 and tables on page 456.

- Specify:
1. Pattern number
  2. Frame finish
  3. Webbing color selection

Ordering Information

**Frame finishes:**  
Clear maple (suffix KC)  
Ebonized maple (suffix KE)  
Light walnut (suffix LWT)  
Teak (suffix K)

**Cotton webbing colors:**  
Aubergine (suffix AU)  
Black (suffix BL)  
Dark grey (suffix DG)  
Flax (suffix FL)  
Forest green (suffix FG)  
Khaki (suffix KH)  
Maize (suffix MZ)  
Navy (suffix NA)  
Red (suffix RD)  
Steel blue (suffix SB)

**Cotton/nylon webbing colors:**  
Blueberry (suffix BU)  
Eucalyptus (suffix EU)  
Licorice (suffix LC)  
Nutmeg (suffix NM)  
Squash (suffix SH)  
Tomato (suffix TO)

**Sunbrella® webbing colors:**  
Antique Beige (suffix AB)  
Carbon (suffix CB)  
Charcoal (suffix CH)  
Fern (suffix FR)  
Navy (suffix NV)  
Ochre (suffix OC)

**\*Teak frames with cotton or nylon webbing are for indoor use only.**

**Re-upholstery kit:**  
Webbing straps in one length to re-upholster existing chairs. Must be reupholstered by a professional upholsterer.

**Note:**  
The Risom Lounge chairs are certified Clean Air GOLD.

**Maintenance:**  
See pages 28-29.

Construction

**Frame:**  
Select maple or walnut hardwood with clear finish. Ebonized finish is stained maple hardwood. Mortise and tenon construction. Seat basket of arm lounge chair attaches to arm frame with invisible screws. Teak frame is solid teak lumber with an oiled finish.

**Note:**  
Teak frames include teak stretchers underneath the seat.

**Finish:**  
Lacquer finish on walnut and maple frames. Oiled finish on teak frame.

**Upholstery:**  
Cotton webbing is 100% natural cotton. Nylon webbing straps are 100% nylon. Cotton and Nylon webbing are CAL133 approved.

Sunbrella® Strap is made with reinforced Sunbrella yarns that are designed to stretch, UV/fade resistant, water repellent, bleach cleanable and stain resistant.

**Weight:**  
Arm lounge chair in Maple or Ebonized finishes weighs 20 lbs. Walnut finish weighs 17 lbs. Armless lounge chair in Maple and Ebonized finishes weighs 14 lbs. Walnut finish weighs 12 lbs. Teak finish weighs 13 lbs.

# Jens Risom

## Seating

### Bar and Counter Height Stools

Designer(s):  
Jens Risom, 1943

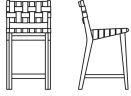
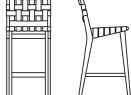
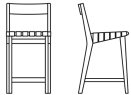
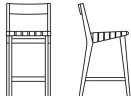

description	height, seat	width	depth	height	Reuphol. Kit ydg.	weight
<b>666CM-WB</b> Counter height stool with webbed seat and back	24"	17 1/4"	19 3/4"	35"		16
						
<b>666CH-WB</b> Bar height stool with webbed seat and back	28"	17 1/4"	20 3/8"	39"		18
						
<b>666C-WB-KIT</b> Re-upholstery kit for stool with webbed back					14.0	
<b>666CM</b> Counter height stool with webbed seat and wood back	24"	17 1/4"	19 3/4"	35"		16
						
<b>666CH</b> Bar height stool with webbed seat and wood back	28"	17 1/4"	20 3/8"	39"		18
						
<b>666C-KIT</b> Re-upholstery kit for stool with wood back					9.0	

pattern number	maple, ebonized	walnut	teak	list
<b>666CM-WB-(-)(-)</b>	\$2,241.	\$2,594.	\$2,724.	
<b>666CH-WB-(-)(-)</b>	2,241.	2,594.	2,724.	
<b>666C-WB-KIT-(-)</b>				164.
<b>666CM-(-)(-)</b>	2,128.	2,520.	2,615.	
<b>666CH-(-)(-)</b>	2,128.	2,520.	2,615.	
<b>666C-KIT-(-)</b>				132.

#### Order Code      Ordering Information

<i>Example:</i> <b>666CM-WB-KC-AP-FG</b>	<i>Frame finishes:</i> Clear maple (suffix KC) Ebonized maple (suffix KE) Light walnut (suffix LWT) Teak (suffix K)	<i>Cotton/nylon webbing colors:</i> Blueberry (suffix BU) Eucalyptus (suffix EU) Licorice (suffix LC) Nutmeg (suffix NM) Squash (suffix SH) Tomato (suffix TO)	<i>Re-upholstery kit:</i> Webbing straps in one length to re-upholster existing stools. Must be reupholstered by a professional upholsterer.
<b>666CM-WB</b> Risom counter height stool with webbed seat and back			
<b>KC</b> Clear Maple			
<b>AP</b> Polished Aluminum			
<b>FG</b> Forest Green			
	<i>Foot Cap Finishes:</i> Polished Aluminum (suffix AP) Black Paint (BL)	<i>Sunbrella® webbing colors:</i> Antique Beige (suffix AB) Aubergine (suffix AU) Black (suffix BL) Charcoal (suffix CH) Fern (suffix FR) Navy (suffix NV) Ochre (suffix OC)	<i>Note:</i> The Risom side stools are certified Clean Air GOLD.
	<i>Cotton webbing colors:</i> Aubergine (suffix AU) Black (suffix BL) Dark grey (suffix DG) Flax (suffix FL) Forest green (suffix FG) Khaki (suffix KH) Maize (suffix MZ) Navy (suffix NA) Red (suffix RD) Steel blue (suffix SB)	<b>*Teak frames with cotton or nylon webbing are for indoor use only.</b>	<i>Maintenance:</i> See pages 28-29.

- Specify:
1. Pattern number
  2. Frame finish
  3. Foot cap selection
  4. Webbing selection



#### Construction

<i>Frame:</i> Select maple or walnut hardwood with clear finish. Ebonized finish is stained maple hardwood. Mortise and tenon construction. Teak frame is solid teak lumber with an oiled finish.	<i>Upholstery:</i> Cotton webbing is 100% natural cotton. Nylon webbing straps are 100% nylon. Cotton and Nylon webbing are CAL133 approved.
<i>Note:</i> Teak frames include teak stretchers underneath the seat.	Sunbrella® Strap is made with reinforced Sunbrella yarns that are designed to stretch, UV/fade resistant, water repellent, bleach cleanable and stain resistant.
<i>Finish:</i> Lacquer finish on walnut and maple frames. Oiled finish on teak frame.	<i>Footcap:</i> Die cast aluminum cap.

Jens Risom  
Seating  
Child's Side Chairs and Stool

Designer(s):  
Jens Risom, 1943



description	seat h	w	d	h	reuphol. kit ydg.	weight
<b>666CS</b> Child's Risom chair, webbed seat only 	13 1/4"	13 1/8"	15 3/8"	23"		6 lbs.
<b>666CS-KIT</b> Re-upholstery kit for Child's side chair with webbed seat					7.0	
<b>666CS-WB</b> Child's Risom chair with webbed seat and back 	13 1/4"	13 1/8"	15 3/8"	23"		6 lbs.
<b>666CS-WB-KIT</b> Re-upholstery kit for Child's side chair with webbed seat and back					9.0	
<b>667YS</b> Child's sitting stool 	13 1/2"	12 3/8"	11 1/2"	13 1/2"		6 lbs.
<b>667YS-KIT</b> Re-upholstery kit for Child's Sitting stool					5.5	



pattern no.	honey beech	webbing kit
<b>666CS-HB-( )</b>	\$499.	
<b>666CS-KIT-( )</b>		95.
<b>666CS-WB-HB-( )</b>	556.	
<b>666CS-WB-KIT-( )</b>		138.
<b>667YS-HB-( )</b>	363.	
<b>667YS-KIT-( )</b>		85.

Order Code	Ordering Information	Construction
<i>Example:</i> <b>666CS-WB-HB-OR</b>	<i>Frame finishes:</i> Honey Beech (suffix HB)	<i>Frame:</i> Select European Beech hardwood with a toned natural finish. Mortise and tenon construction.
<b>666CS-WB</b> Child's Risom side chair with webbed seat and back	<i>Child's nylon webbing colors:</i> Blue (suffix BC) Green (suffix GC) Orange (suffix OC) Red (suffix RC)	<i>Finish:</i> Toned catalyzed lacquer finish
<b>HB</b> Honey Beech	<i>Re-upholstery kit:</i> Webbing straps in one length to re-upholster existing chairs. Must be reupholstered by a professional upholsterer.	<i>Child's Risom Chairs:</i> Child's Risom Chairs are 75% scale of standard Risom chair. Child's size chairs are only available in Honey Beech (HB) finish and approved nylon webbing.
<b>OR</b> Orange nylon webbing	<i>Maintenance:</i> See pages 28-29.	<i>Upholstery:</i> Nylon webbing is CAL133 approved.
Note: The Child's Risom side chairs are part of a collection. Please refer to the Child's Risom Amoeba table on page 458.		<i>Note:</i> The Child's Risom chair and stool are compliant to the Consumer Product Safety Improvement Act of 2008 for Children's Products, 16 C.F.R. 1303, CPSIA Title 1 Section 101 for Total Lead in Substrates and Surface Coatings.
Specify: 1. Pattern number 2. Frame finish 3. Webbing color selection		

Jens Risom  
*Outdoor Seating*  
*Side Chairs, Lounge and Ottoman*

Designer(s):  
 Jens Risom, 1943



description	seat h	arm h	w	d	h	reuphol. kit ydg.	weight
<b>666C-WB</b> Side chair with webbed seat and back	17 3/4"		17 1/4"	18"	30 3/8"		10 lbs.
							
<b>666C-WB-KIT</b> Re-upholstery kit for side chair with webbed back						14.0	
<b>654LC</b> Armless lounge chair	16"		20"	27 1/2"	30 3/4"		13 lbs.
							
<b>654L-KIT</b> Re-upholstery kit for arm and armless lounge chair						25	
<b>655LO</b> Ottoman			19"	17 3/4"	16"		8 lbs.
							
<b>655LO-KIT</b> Re-upholstery kit for ottoman						11	

pattern no.	teak	webbing kit
<b>666C-WB-K-( )</b>	\$1,984.	
<b>666C-WB-KIT-( )</b>		164.
<b>654LC-K-( )</b>	2,434.	
<b>654L-KIT-( )</b>		221.
<b>655LO-K-( )</b>	1,272.	
<b>655LO-KIT-( )</b>		148.

Order Code	Ordering Information
<i>Example:</i> <b>654LC-K-AB</b>	<i>Frame finishes:</i> Teak (suffix K)
<b>654LC</b> Risom lounge chair, armless	<i>Sunbrella® webbing colors:</i> Antique Beige (suffix AB) Carbon (suffix CB) Charcoal (suffix CH) Fern (suffix FR) Navy (suffix NV) Ochre (suffix OC)
<b>K</b> Teak	<i>Re-upholstery kit:</i> Webbing straps in one length to re-upholster existing chairs. Must be reupholstered by a professional upholsterer.
<b>AB</b> Sunbrella® Antique Beige	<i>Note:</i> The Risom Lounge chairs are certified Clean Air GOLD.
<i>Note:</i> The Risom lounge chairs are part of a collection. Please refer to the Risom side chairs on page 0 and tables on page 456.	<i>Maintenance:</i> See pages 28-29.
<i>Specify:</i> 1. Pattern number 2. Frame finish 3. Webbing color selection	

Construction
<i>Teak Frame:</i> Solid teak lumber with an oiled finish. Stainless steel staples.
<i>Note:</i> Teak will patina over time if left outdoors and will turn a silvery grey color.
<i>Upholstery:</i> Sunbrella® Strap is made with reinforced Sunbrella yarns that are designed to stretch, UV/fade resistant, water repellent, bleach cleanable and stain resistant. Straps are attached to the frame using stainless steel staples.

Jens Risom  
Outdoor Seating  
Bar and Counter Height Stools

Designer(s):  
Jens Risom, 1943

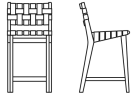
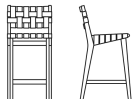
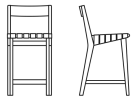
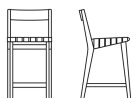

description	seat h	arm h	w	d	h	reuphol. kit ydg.	weight
<b>666C-WB-KIT</b> Re-upholstery kit for side chair with webbed back						14.0	
<b>666CM-WB</b> Counter height stool with webbed seat and back	24"		17 1/4"	19 3/4"	35"		16
							
<b>666CH-WB</b> Bar height stool with webbed seat and back	28"		17 1/4"	20 3/8"	39"		18
							
<b>666CM</b> Counter height stool with webbed seat and wood back	24"		17 1/4"	19 3/4"	35"		16
							
<b>666CH</b> Bar height stool with webbed seat and wood back	28"		17 1/4"	20 3/8"	39"		18
							
<b>666C-KIT</b> Re-upholstery kit for stool with wood back						9.0	

Order Code

Example: **666CM-WB-K-AP-NV**

<b>666CM-WB</b>	Risom counter height stool with webbed seat and back
<b>K</b>	Teak
<b>AP</b>	Polished Aluminum
<b>NV</b>	Navy

Specify:

1. Pattern number
2. Frame finish
3. Foot cap selection
4. Webbing selection

Ordering Information

**Frame finishes:**  
Teak (suffix K)

**Foot Cap Finishes:**  
Polished Aluminum (suffix AP)  
Black Paint (BL)

**Sunbrella® webbing colors:**  
Antique Beige (suffix AB)  
Carbon (suffix CB)  
Charcoal (suffix CH)  
Fern (suffix FR)  
Navy (suffix NV)  
Ochre (suffix OC)

**Re-upholstery kit:**  
Webbing straps in one length to re-upholster existing chairs. Must be reupholstered by a professional upholsterer.

**Note:**  
The Risom Lounge chairs are certified Clean Air GOLD.

**Maintenance:**  
See pages 28-29.

pattern no.	teak	list
<b>666C-WB-KIT-(-)</b>		\$164.
<b>666CM-WB-(-)(-)</b>	2,724.	
<b>666CH-WB-(-)(-)</b>	2,724.	
<b>666CM-(-)(-)</b>	2,615.	
<b>666CH-(-)(-)</b>	2,615.	
<b>666C-KIT-(-)</b>		132.

Construction

**Teak Frame:**  
Mortise and tenon construction. Teak frame is solid teak lumber with an oiled finish. Stainless steel staples.

**Note:**  
Teak frames include teak stretchers underneath the seat.



**Finish:**  
Lacquer finish on walnut and maple frames. Oiled finish on teak frame.

**Note:**  
Teak will patina over time if left outdoors and will turn a silvery grey color.

**Upholstery:**  
Sunbrella® Strap is made with reinforced Sunbrella® yarns that are designed to stretch, UV/fade resistant, water repellent, bleach cleanable and stain resistant. Straps are attached to the frame using stainless steel staples.

**Footcap:**  
Die cast aluminum cap with outdoor grade coating.

# Eero Saarinen Tulip™ Chairs

description	upholstery	dimensions						textile	req.	weight
		seat h	arm h	w	d	h	fabric yds.	leather sq. ft.		
<b>150A</b> Tulip arm chair 	inner shell	18"	25 1/8"	26"	23 1/4"	32"	2.3	n/a	24 lbs.	
	seat cushion	18"	25 1/8"	26"	23 1/4"	32"	0.8	14	18 lbs.	
<b>150AX-(1,2)U</b>	inner shell	18"	25 1/8"	26"	23 1/4"	32"	2.3	n/a	23 lbs.	
	seat cushion	18"	25 1/8"	26"	23 1/4"	32"	0.8	14	18 lbs.	
<b>150K</b> Upholstered cushion replacement, arm chair	seat cushion						0.8	14		
<b>151C</b> Tulip armless chair 	inner shell	18 1/2"	20"	21 1/4"	32"	1.7	n/a	20 lbs.		
	seat cushion	18 1/2"	20"	21 1/4"	32"	0.8	14	17 lbs.		
	inner shell	18 1/2"	20"	21 1/4"	32"	1.7	n/a	19 lbs.		
	seat cushion	18 1/2"	20"	21 1/4"	32"	0.8	14	16 lbs.		
<b>151K</b> Upholstered cushion replacement, armless chair	seat cushion						0.8	14		
<b>153Y</b> Stool 		16 1/2"	15 1/2"	18"		0.8	14	10 lbs.		

*Designer(s):*  
Eero Saarinen, 1957

*Award(s):*  
The Museum of Modern Art, New York, USA, 1969; Federal Award for Industrial Design, W. Germany, 1969; Design Center Stuttgart Award, W. Germany, 1962



## Order Code

<i>Example:</i>	<b>150AX-2-U-K2074/6</b>
<b>150AX</b>	Tulip arm chair, fixed position
<b>2</b>	White
<b>U</b>	Upholstered inner shell and seat cushion
<b>K2074/6</b>	Aegean, Sunshine

*Note:*  
The Saarinen chairs are part of a collection. Please refer to Saarinen lounge seating, executive chairs and tables on pages 318 and 462.

## Specify:

1. Pattern number
2. Swivel or fixed position
3. Finish selection
4. Upholstery option (except stool)
5. Textile selection

## Ordering Information

*Swivel or fixed position:*  
Swivel action (suffix S)  
Fixed position (suffix X)

*Base and shell finishes:*  
Black (suffix 1)  
White (suffix 2)

*Upholstery options:*  
Upholstered seat cushion only (suffix K)  
Upholstered inner shell and seat cushion (suffix U)

*Upholstery/COM information:*  
Prices shown include fabric or leather upholstery. Contact your Knoll representative for colors. Only approved KnollTextiles and Spinneybeck leathers may be ordered.

Customer's Own Material is available pending approval. For approval requirements, processing instructions and ordering information please see page 21.

*Maintenance:*  
See pages 28-29.

*Note:*  
The signature of Eero Saarinen and the KnollStudio logo are located on the underside of the base.

The Tulip Chair is certified Clean Air GOLD.

## Construction

*Base:*  
Cast aluminum. Rilsan® finish for black and white chairs, platinum chairs consist of a high-resilient polyurethane enamel wet coat with a clear satin finish.

*Shell:*  
Molded fiberglass reinforced plastic bonded finish.

*Upholstery:*  
Upholstered or unupholstered inner shell, with removable foam cushion (zippered cover and Velcro fastening).

*Cal 133 Fire Code ♣:*  
The 513Y Saarinen Stool complies with the California Technical Bulletin 133 standard if upholstered in Cal 133 approved upholstery. Specify suffix -C at end of pattern number and suffix -133 at end of textile selection. Upcharge applies, see page 22.

pattern no.	grades	COM	C	D	E	F	G	H	I	COL	V	W	X	Y
<b>150AS-(1,2)U</b>	\$6,546.	\$6,653.	\$6,754.	\$6,874.	\$6,963.	\$7,032.	\$7,146.	\$7,359.	\$7,518.					
<b>150AS-(1,2,PL)K</b>	3,903.	3,935.	3,963.	3,997.	4,026.	4,044.	4,080.	4,141.	4,187.	4,323.	4,439.	4,664.	4,710.	4,763.
<b>150AX-(1,2)U</b>	6,113.	6,223.	6,326.	6,440.	6,533.	6,600.	6,714.	6,931.	7,094.					
<b>150AX-(1,2,PL)K</b>	3,679.	3,708.	3,741.	3,776.	3,801.	3,818.	3,856.	3,918.	3,963.	4,101.	4,212.	4,440.	4,483.	4,542.
<b>150K</b>	772.	807.	834.	868.	888.	909.	940.	1,000.	1,044.	1,275.	1,378.	1,593.	1,636.	1,688.
<b>151CS-(1,2)U</b>	5,520.	5,603.	5,675.	5,760.	5,830.	5,879.	5,963.	6,123.	6,240.					
<b>151CS-(1,2,PL)K</b>	3,363.	3,397.	3,428.	3,460.	3,489.	3,508.	3,540.	3,604.	3,651.	3,846.	3,959.	4,185.	4,232.	4,286.
<b>151CX-(1,2)U</b>	5,330.	5,408.	5,489.	5,573.	5,640.	5,687.	5,774.	5,934.	6,053.					
<b>151CX-(1,2,PL)K</b>	3,042.	3,076.	3,103.	3,138.	3,165.	3,184.	3,219.	3,284.	3,328.	3,668.	3,781.	4,007.	4,056.	4,109.
<b>151K</b>	772.	807.	834.	868.	888.	909.	940.	1,000.	1,044.	1,275.	1,378.	1,593.	1,636.	1,688.
<b>153YS-(1, 2, PL)</b>	1,989.	2,017.	2,047.	2,079.	2,102.	2,121.	2,153.	2,215.	2,260.	2,389.	2,489.	2,706.	2,751.	2,802.

## Approved KnollTextiles Grades/Fabrics

<b>A</b> Alignment * Beacon Bocce * Common Ground * Commuter Cloth * Cross Tech Crossroad * Delite * Facet Hourglass * Infinite * Mariner * Monarch Overture * Prep Presto (n/a on stool) Soliloquy * Sonnet * Trophy * Uni-Form	<b>B</b> continued Keaton * Knoll Felt * Knoll Hopsack * Little Devil * Ludlow * Melody <sup>®</sup> Paradigm * Petal Pusher * <sup>®</sup> Pop * Prairie * Prim * Puff * Radiance * Ransom * Roam * Rush Hour * Shadow Play * Spree * Summit Sutton * Synth * Tabloid * Tinge * Topos * Vast Venue * Versa * Vinyl <sup>®</sup> Wild Thing * Yeni *	<b>C</b> Atlas * Axiom * <sup>®</sup> Baxter * Cairo * Chameleon Charm * Circa * Classic Boucle * Dune * Durand * Earthwork * Empire Stripe Entourage * Entwine * Essence * Fibra * Greenwich * Groovy Hudson Lagos * Lore CR Magnolia Milestone * On Point * Panache CR * Patchwork * Plaidtastic * Retreat Vice Versa * Woodland * Zoom	<b>C</b> continued Sinclair * Smart * <sup>®</sup> Spectator * Stepping Stones Swing * Tight Rope * Tilden * <sup>®</sup> Tower Grid * Utmost II * Utopia * Wit * Wow Factor * Zari CR *	<b>D</b> Buzz Code Coterie * Eclat Weave * Hologram Island * Kabuki Menagerie * Origins * Pathway * Plaidtastic * Retreat Vice Versa * Woodland * Zoom	<b>E</b> Aegean * Circle Point Cleo * Demure * Highland * Ikat Stripe * Juno *	<b>E</b> continued Kampala * Mamba * Marquee * Meroe * Midpoint * Nature Walk Off The Grid Premier * <sup>^</sup> Rebel * Sherman * Tempest Vatera Whip *	<b>F</b> Atelier * Biscayne * Calais Cotton Velvet Century * Cornaro * Double Agent * <sup>®</sup> Glider * Imprint * In Stitches * Liberty * Mod Plaid * Rivington * Soon Totem * Tweed Frieze *	<b>G</b> All Star * Alter Ego Arber * Aurora * Color Collage * Dapper * Djenne Duchess * Fancy Twill * Gibson *	<b>G</b> continued Haze * Kamani Looped In * Melange * Modern Tweed Rivers * Spencer * Texnet * Ultrasuede * Utrillo * Vert	<b>H</b> Bavaria * Catwalk Constance * Firefly * Stretch Appeal * Twist Tie * World Piece *	<b>I</b> Aswan * Bella * Bryon * Cato * Chic * Diamond Days * Doily * Dynamic * Florescence * In Step * Ita * Jaipur * Knoll Velvet * Limani * North Island * Olema Piper * Prince Hair Rutledge * Sandis * Stripe It * Tudor * Zimba *	<b>U</b> Vicenza Volo	<b>V</b> Acqua Amalfi Andes Embossed Tipped España Hand Tipped Velluto Pelle	<b>W</b> Alaska Antique Forte Lucente Sabrina Umbria	<b>X</b> Ducale Ducale Velour	<b>Y</b> Cervo Copenhagen Distressed Gemma Lucca Marissa Portofino Riva
---	--	--	---	---	---	--	---	---	--	--	--	-----------------------------	---	--	-------------------------------------	---

## Spinneybeck Leather

* Approved for fully upholstered versions. <sup>®</sup> Fire Retardants Chemicals <sup>^</sup> Not approved on 153Y Stool
<i>Check with your KnollTextiles or Spinneybeck Representative for changes or additions.</i>

# Eero Saarinen Executive Arm Chairs

Designer(s):  
Eero Saarinen, 1950



description	seat h,		w	d	h, min		h, max	textile fabric yds.	req. leather sq. ft.	weight	type
	min	max									
<b>71A-5S</b> Executive arm chair with pneumatic seat height adjustment, 5-Star Base	18 1/4"	21"	26"	24 3/4"	32 3/4"	35 1/2"	2.9	47	34 lbs.	Black painted	
	18 1/4"	21"	26"	24 3/4"	32 3/4"	35 1/2"	2.9	47	34 lbs.	Polished Aluminum	
<b>71A-4S</b> Executive arm chair with pneumatic seat height adjustment, 4-Star Base	18 3/8"	21 3/8"	26"	24 3/4"	33 1/8"	35 1/8"	2.9	47	34 lbs.	Black painted	
	18 3/8"	21 3/8"	26"	24 3/4"	33 1/8"	35 1/8"	2.9	47	34 lbs.	Polished Aluminum	
Executive arm chair with wood legs and glides, contrast leather welt option								6.25		welt	

### Order Code

<i>Example:</i>	<b>71A-5S-R-A-ES8080</b>
<b>71A-5S</b>	Arm Chair, 5-star base
<b>R</b>	Soft wheel casters
<b>A</b>	Aluminum base
<b>ES8080</b>	Espana, Serpentina

Note:  
The Saarinen executive chairs are part of a collection. Please refer to Saarinen side chairs, lounge chairs and tables on beginning on pages 316 and 462.

### Specify:

1. Pattern number
2. Caster type
3. Base finish
4. Cal 133 fire code option
5. Textile selection

### Ordering Information

**Base Finishes:**  
Black (1)  
Polished Aluminum (suffix A)

**Caster option:**  
Hard Casters (suffix H)  
Soft Casters (suffix R)

**Split upholstery option:**  
The seat and back of the Saarinen Executive Chair can be specified in split upholstery. Indicate S before selected seat upholstery, followed by selected back upholstery. The price equals the price of the higher upholstery grade.

**COM split fabric requirements:**  
Back upholstery: 2.25 yards  
Seat upholstery: 1.25 yards

**COL split leather requirements:**  
Back upholstery: 40 square feet  
Seat upholstery: 23 square feet

**Upholstery/COM information:**  
Prices shown include fabric or leather upholstery. Contact your Knoll representative for colors. Only approved KnollTextiles and Spinneybeck leathers may be ordered.

Customer's Own Material is available pending approval. For approval requirements, processing instructions and ordering information please see page 21.

**Cal 133 Fire Code #:**  
The Saarinen Executive Chairs comply with the California Technical Bulletin 133 standard if upholstered in Cal 133 approved upholstery. Specify suffix -C at end of pattern number and suffix -133 at end of textile selection. Upcharge applies, see page 22.

**Maintenance:**  
See pages 28-29.

**Note:**  
The Saarinen Executive Arm Chair is certified Clean Air GOLD.

### Construction

**Frame:**  
Molded reinforced polyurethane shell. Contoured plywood seat form.

**Upholstery:**  
Urethane foam cushion. Welt detail along arm, back and top of seat is available as a self welt (same material) or as a contrasting leather welt. Please specify pattern number with LT suffix, for contrasting welt, and add appropriate leather upcharge for total list price of the piece. Leather welt option is available on both textile and leather upholstery.  
**71A-4S-H-A-LT-H800/12-ES8080**

**Swivel base:**  
Five-star and Four-star steel base in polished aluminum or painted black finish which includes the height adjustment bar. Polished aluminum base features a silver painted finish on the bottom portion of the star base.

**Controls:**  
360° swivel; tilt and pneumatic seat height adjustment.

### Approved KnollTextiles Grades/Fabrics

**Casters:**  
Black 2" twin wheel hard casters for use on carpeted floors. Housing components in polished chrome or black chrome finish. Optional soft casters for use on wood and other resilient flooring.

**Glides:**  
Aluminum glide in chrome or black painted finish with felt disc.

<b>A</b> Beacon Common Ground # Commuter Cloth # Crossroad Delite Facet Hourglass Mariner Presto Sonnet Uni-Form Trophy	<b>B</b> continued Shadow Play Sutton Synth Tinge Topos Venue Vinyl Ⓞ Wild Thing	<b>C</b> Axiom Classic Boucle Durand Entourage Entwine Essence Lagos Prestini Quark Sequin CR Sinclair Smart Stepping Stones Swing Tilden Wow Factor	<b>D</b> Buzz Hologram Vice Versa Woodland Zoom	<b>E</b> Aegean Highland Kampala Mamba Sherman Tempest	<b>F</b> Atelier Biscayne Century Cornaro Homage Imprint In Stitches Liberty Rivington Tweed Frieze	<b>G</b> All Star Alter Ego Brugge
---	--	--	--	--	---	---

### Spinneybeck Leather

<b>U</b> Vicenza Volo	<b>V</b> Acqua Amalfi Andes Embossed Tipped España Velluto Pelle	<b>X</b> Ducale Ducale Velour	<b>Y</b> Cervo Copenhagen Distressed Marissa Riva
-----------------------------	--	-------------------------------------	--

Ⓞ Fire Retardants Chemicals

*Check with your KnollTextiles or Spinneybeck Representative for changes or additions.*

pattern no.	upcharge	COL													
		<b>A</b>	<b>B</b>	<b>C</b>	<b>D</b>	<b>E</b>	<b>F</b>	<b>G</b>	<b>H</b>	<b>I</b>	<b>U</b>	<b>V</b>	<b>W</b>	<b>X</b>	<b>Y</b>
<b>71A-5S-(H,R)-1-()</b>		\$4,100.	\$4,210.	\$4,315.	\$4,432.	\$4,529.	\$4,597.	\$4,716.	\$4,937.	\$5,104.	\$6,433.	\$6,797.	\$7,530.	\$7,681.	\$7,857.
<b>71A-5S-(H,R)-A-()</b>		4,164.	4,273.	4,377.	4,495.	4,591.	4,660.	4,779.	4,998.	5,166.	6,495.	6,860.	7,592.	7,744.	7,919.
<b>71A-4S-G-1-()</b>		3,599.	3,708.	3,812.	3,931.	4,026.	4,094.	4,214.	4,433.	4,602.	5,930.	6,295.	7,027.	7,180.	7,354.
<b>71A-4S-G-A-()</b>		3,661.	3,770.	3,875.	3,993.	4,089.	4,157.	4,277.	4,497.	4,664.	5,995.	6,359.	7,090.	7,242.	7,415.
<b>71A-upchg, welt</b>											317.	362.	450.	468.	491.



# Eero Saarinen Executive Arm Chairs



description	seat h,		w	d	h,		textile fabric yds.	req. leather sq. ft.	weight	type
	min	max			min	max				
<b>71A</b> Executive arm chair with tubular legs and glides	18"	26"	24 3/4"	31 1/2"	2.9	47	19 lbs.			
	18"	26"	24 3/4"	31 1/2"	2.9	47	19 lbs.			
<b>71A-W</b> Executive arm chair with wood legs and glides	18"	26"	24 3/4"	31 1/2"	2.9	47	18 lbs.			
Executive arm chair with wood legs and glides, contrast leather welt option							6.25		welt	

Designer(s):  
Eero Saarinen, 1950

pattern no.	grades <b>A</b>	COM <b>B</b>	<b>C</b>	<b>D</b>	<b>E</b>	<b>F</b>	<b>G</b>	<b>H</b>	<b>I</b>	COL <b>U</b>	<b>V</b>	<b>W</b>	<b>X</b>	<b>Y</b>
<b>71A-(BL,C)-()</b>	\$3,070.	\$3,179.	\$3,293.	\$3,404.	\$3,502.	\$3,570.	\$3,690.	\$3,911.	\$4,076.	\$5,403.	\$5,762.	\$6,492.	\$6,645.	\$6,823.
<b>71A-GLD-()</b>	3,824.	3,933.	4,045.	4,157.	4,256.	4,323.	4,443.	4,663.	4,829.	6,157.	6,516.	7,245.	7,399.	7,577.
<b>71A-W-()-()</b>	3,597.	3,710.	3,818.	3,942.	4,041.	4,112.	4,233.	4,461.	4,631.	5,956.	6,334.	7,090.	7,244.	7,431.

<b>71A-upchg, welt</b>										317.	362.	450.	468.	491.
------------------------	--	--	--	--	--	--	--	--	--	------	------	------	------	------

## Order Code

<i>Example:</i>	<b>71A-C-H800/19</b>
<b>71A</b>	Open back arm chair
<b>C</b>	Chrome legs
<b>H800/19</b>	Cato/Red

Note:  
The Saarinen executive chairs are part of a collection. Please refer to Saarinen side chairs, lounge chairs and tables on beginning on pages 316 and 462.

## Specify:

1. Pattern number
2. Base finish
3. Cal 133 fire code option
4. Split upholstery option (add S)
5. Textile selection

## Ordering Information

**Wood Leg Finishes:**  
Ebonized Walnut (suffix D)  
Light Oak (suffix LO)  
Light Walnut (suffix LWA)  
Reff Dark Cherry (suffix V314)

**Tubular Leg Finishes:**  
Black (BL)  
Polished Chrome (suffix C)  
Gold (suffix GLD)

**Split upholstery option:**  
The seat and back of the Saarinen Executive Chair can be specified in split upholstery. Indicate S before selected seat upholstery, followed by selected back upholstery. The price equals the price of the higher upholstery grade.

**COM split fabric requirements:**  
Back upholstery: 2.25 yards  
Seat upholstery: 1.25 yards

**COL split leather requirements:**  
Back upholstery: 40 square feet  
Seat upholstery: 23 square feet

**Upholstery/COM information:**  
Prices shown include fabric or leather upholstery. Contact your Knoll representative for colors. Only approved KnollTextiles and Spinneybeck leathers may be ordered.

Customer's Own Material is available pending approval. For approval requirements, processing instructions and ordering information please see page 21.

**Cal 133 Fire Code #:**  
The Saarinen Executive Chairs comply with the California Technical Bulletin 133 standard if upholstered in Cal 133 approved upholstery. Specify suffix -C at end of pattern number and suffix -133 at end of textile selection. Upcharge applies, see page 22.

**Maintenance:**  
See pages 28-29.

**Note:**  
The Saarinen Executive Arm Chair is certified Clean Air GOLD.

## Construction

**Frame:**  
Molded reinforced polyurethane shell. Contoured plywood seat form.

**Upholstery:**  
Urethane foam cushion. Welt detail along arm, back and top of seat is available as a self welt (same material) or as a contrasting leather welt. Please specify pattern number with LT suffix, for contrasting welt, and add appropriate leather upcharge for total list price of the piece. Leather welt option is available on both textile and leather upholstery.

**Steel leg base:**  
Four legs in seamless tubular steel with polished chrome, 18k plated gold, or matte black powder coat.

## Approved KnollTextiles Grades/Fabrics

<b>A</b>	Beacon Common Ground # Commuter Cloth # Crossroad Delite Facet Hourglass Mariner Presto Sonnet Uni-Form Trophy	<b>B</b>	continued Shadow Play Sutton Synth Tinge Topos Venue Vinyl Ⓞ Wild Thing	<b>C</b>	Axiom Ⓞ Classic Boucle Durand Entourage Entwine Essence Lagos Prestini Quark Sequin CR Sinclair Smart Ⓞ Stepping Stones Swing Tilden Ⓞ Wow Factor	<b>D</b>	Buzz Hologram Vice Versa Woodland Zoom	<b>E</b>	Aegean Highland Kampala Mamba Sherman Tempest	<b>F</b>	Atelier Biscayne Century Cornaro Homage Imprint In Stitches Liberty Rivington Tweed Frieze	<b>G</b>	All Star Alter Ego Brugge
----------	---	----------	---	----------	--	----------	--	----------	--	----------	---	----------	---------------------------------

## Spinneybeck Leather

<b>U</b>	Vicenza Volo	<b>X</b>	Ducale Ducale Velour
<b>V</b>	Acqua Amalfi Andes Embossed Tipped España Velluto Pelle	<b>Y</b>	Cervo Copenhagen Distressed Marissa Riva
<b>W</b>	Alaska Antique Forte Sabrina		

Ⓞ Fire Retardants Chemicals

Check with your KnollTextiles or Spinneybeck Representative for changes or additions.

# Eero Saarinen

## Executive Armless Chairs

Designer(s):  
Eero Saarinen, 1946



**72C-5S** Executive armless chair with pneumatic seat height adjustment, 5-Star Base

description	seat h,		w	d	h,		textile fabric yds.	req. leather sq. ft.	weight
	min	max			min	max			
<b>72C-5S</b> Executive armless chair with pneumatic seat height adjustment, 5-Star Base	16 3/4"	19 1/2"	22 1/2"	24"	31 1/4"	34"	2.0	35	29 lbs.
	16 3/4"	19 1/2"	22 1/2"	24"	31 1/4"	34"	2.0	35	29 lbs.



**72C-4S** Executive armless chair with pneumatic seat height adjustment, 4-Star Base

<b>72C-4S</b> Executive armless chair with pneumatic seat height adjustment, 4-Star Base	17"	19 3/4"	22 1/2"	24"	31 1/2"	34 1/4"	2.0	35	29 lbs.
	17"	19 3/4"	22 1/2"	24"	31 1/2"	34 1/4"	2.0	35	29 lbs.

### Order Code

<i>Example:</i>	<b>72C-5S-H-1-CD70-AL5008</b>
<b>72C-5S</b>	Armless Chair, 4-star base
<b>H</b>	Hard wheel casters
<b>1</b>	black base
<b>CD70</b>	seat: Cordovan, Rembrandt Brown
<b>AL5008</b>	back: Alaska, Caribou

Note:  
The Saarinen executive chairs are part of a collection. Please refer to Saarinen side chairs, lounge chairs and tables on beginning on pages 316 and 462.

### Specify:

1. Pattern number
2. Caster type
3. Base finish
4. Cal 133 fire code option
5. Split upholstery option (add S)
6. Textile selection, seat
7. Textile selection, back

### Ordering Information

*Base Finishes:*  
Black (1)  
Polished Aluminum (suffix A)

*Caster option:*  
Hard Casters (suffix H)  
Soft Casters (suffix R)

*Split upholstery option:*  
The seat and back of the Saarinen Executive Chair can be specified in split upholstery. Indicate S before selected seat upholstery, followed by selected back upholstery. The price equals the price of the higher upholstery grade.

*COM split fabric requirements:*  
Back upholstery: 1.5 yards  
Seat upholstery: .75 yards

*COL split leather requirements:*  
Back upholstery: 27 square feet  
Seat upholstery: 13.5 square feet

*Upholstery/COM information:*  
Prices shown include fabric or leather upholstery. Contact your Knoll representative for colors. Only approved KnollTextiles and Spinneybeck leathers may be ordered. Customer's Own Material is available pending approval. For approval requirements, processing instructions and ordering information please see page 21.

### Cal 133 Fire Code #:

The Saarinen Executive Chairs comply with the California Technical Bulletin 133 standard if upholstered in Cal 133 approved upholstery. Specify suffix -C at end of pattern number and suffix -133 at end of textile selection. Upcharge applies, see page 22.

*Maintenance:*  
See pages 28-29.

*Note:*  
The Saarinen Executive Armless Chair is certified Clean Air GOLD.

### Construction:

*Frame:*  
Molded reinforced polyurethane shell.  
Contoured plywood seat form.

### Upholstery:

Urethane foam cushion.

### Swivel base:

Five-star and Four-star steel base in polished aluminum or painted black finish which includes the height adjustment bar. Polished aluminum base features a silver painted finish on the bottom portion of the star base.

*Controls:*  
360° swivel; tilt and pneumatic seat height adjustment.

*Casters:*  
Black 2" twin wheel hard casters for use on carpeted floors. Housing components in polished chrome or black chrome finish. Optional soft casters for use on wood and other resilient flooring.

*Glides:*  
Aluminum glide in chrome or black painted finish with felt disc.

pattern no.	upcharge	COL													
		grades A	COM B	C	D	E	F	G	H	I	U	V	W	X	Y
<b>72C-5S-(H,R)-1-( )</b>		\$2,918.	\$2,996.	\$3,068.	\$3,150.	\$3,212.	\$3,261.	\$3,342.	\$3,497.	\$3,608.	\$4,324.	\$4,594.	\$5,137.	\$5,251.	\$5,382.
<b>72C-5S-(H,R)-A-( )</b>		2,980.	3,058.	3,130.	3,213.	3,273.	3,324.	3,404.	3,560.	3,671.	4,387.	4,656.	5,199.	5,314.	5,445.
<b>72C-4S-G-1-( )</b>		2,415.	2,494.	2,566.	2,647.	2,708.	2,760.	2,839.	2,994.	3,106.	3,822.	4,091.	4,634.	4,749.	4,880.
<b>72C-4S-G-A-( )</b>		2,490.	2,557.	2,630.	2,710.	2,772.	2,822.	2,902.	3,056.	3,169.	3,884.	4,153.	4,697.	4,812.	4,942.

### Approved KnollTextiles Grades/Fabrics

<b>A</b> Beacon Bocce Chance Common Ground Commuter Cloth Cross Tech Crossroad Delite Facet Hourglass Infinite Mariner Overture Prep Presto Soliloquy Sonnet Uni-Form Trophy	<b>B</b> continued Helios Holbrook Instinct Journey Keaton Knoll Felt Knoll Hopsack Little Devil Ludlow Paradigm Petal Pusher Prairie Prim Puff Ransom Radiance Roam Rush Hour Shadow Play Soiree Spree Sutton Synth Tabloid Tinge Topos Venue Versa Vinyl Wild Thing	<b>C</b> Axiom Baxter Charm Circa Classic Boucle Durand Earthwork Empire Stripe Entourage Entwine Essence Greenwich Hudson Kaleidoscope CR Lagos Lore CR Magnolia Milestone Panache CR Patchwork Plaid On Prestini Synth Rountrip Sequin CR Sinclair Smart Spectator	<b>C</b> continued Stepping Stones Swing Tilden Tower Grid Wow Factor Zari CR  <b>D</b> Buzz Code Coterie Eclat Weave Hologram Island Menagerie Origins Retreat Vice Versa Woodland Zoom  <b>E</b> Aegean Cleo Demure Flower Power Highland Juno Kampala Mamba Marquee Nature Walk Rebel Sherman Tempest Vatera	<b>F</b> Atelier Biscayne Century Cornaro Double Agent Glider Homage Imprint In Stitches Liberty Mod Plaid Rivington Soon Totem Tweed Frieze  <b>G</b> All Star Alter Ego Arber Color Collage Dapper Djenne Duchess Fancy Twill Gibson Kamani Looped In Melange Modern Tweed Spencer Straie Stripe Ultrasuede Utrillo Vert	<b>H</b> Bavaria Catwalk Constance Stretch Appeal Twist Tie World Piece  <b>I</b> Aswan Bella Cato Chic Diamond Days Doily Dynamic Florescence Hastings In Step Ita Jaipur Knoll Velvet North Island Olema Piper Prince Hair Rutledge Stripe It Tudor Zimba	<b>U</b> Vicenza Volo  <b>V</b> Acqua Amalfi Andes Embossed Tipped España Velluto Pelle  <b>W</b> Alaska Antique Forte Sabrina Umbria	<b>X</b> Ducale Ducale Velour  <b>Y</b> Cervo Copenhagen Distressed Gemma Lucca Marissa Portofino Riva
---	---	--	---	---	--	--	--

### Spinneybeck Leather

<b>U</b> Vicenza Volo	<b>X</b> Ducale Ducale Velour
<b>V</b> Acqua Amalfi Andes Embossed Tipped España Velluto Pelle	<b>Y</b> Cervo Copenhagen Distressed Gemma Lucca Marissa Portofino Riva
<b>W</b> Alaska Antique Forte Sabrina Umbria	

Ⓢ Fire Retardants Chemicals

Check with your KnollTextiles or Spinneybeck Representative for changes or additions.

# Eero Saarinen

## Executive Armless Chairs

*Designer(s):*  
Eero Saarinen, 1946



description	seat h	width	d	height	textile fabric yds.	req. leather sq. ft.	weight
<b>72C</b> Executive armless chair with tubular legs and glides	18 7/8"	22 1/2"	20 1/2"	31 1/2"	2.0	35	14 lbs.
	18 7/8"	22 1/2"	20 1/2"	31 1/2"	2.0	35	14 lbs.
<b>72C-W</b> Executive armless chair with wood legs and glides	18 7/8"	22 1/2"	20 1/2"	31 1/2"	2.0	35	13 lbs.

pattern no.	grades <b>A</b>	COM <b>B</b>	<b>C</b>	<b>D</b>	<b>E</b>	<b>F</b>	<b>G</b>	<b>H</b>	<b>I</b>	COL <b>U</b>	<b>V</b>	<b>W</b>	<b>X</b>	<b>Y</b>
<b>72C-(BL,C)-()</b>	\$2,060.	\$2,135.	\$2,208.	\$2,288.	\$2,353.	\$2,404.	\$2,483.	\$2,638.	\$2,751.	\$3,423.	\$3,691.	\$4,235.	\$4,346.	\$4,480.
<b>72C-GLD-()</b>	2,813.	2,888.	2,961.	3,041.	3,106.	3,159.	3,235.	3,390.	3,505.	4,175.	4,444.	4,988.	5,099.	5,234.
<b>72C-W-()-()</b>	2,627.	2,704.	2,780.	2,863.	2,929.	2,980.	3,065.	3,224.	3,342.	4,021.	4,299.	4,861.	4,981.	5,117.

Order Code	Ordering Information
<i>Example:</i> <b>72C-W-D-K2201/4</b>	<i>Split upholstery option:</i>
<b>72C</b> Open back chair, armless	The seat and back of the Saarinen Executive Chair can be specified in split upholstery. Indicate S before selected seat upholstery, followed by selected back upholstery. The price equals the price of the higher upholstery grade.
<b>W</b> Wood legs	
<b>D</b> Ebonized Walnut leg finish	
<b>K2201/4</b> Oh La La, Sage	

*Note:*  
The Saarinen executive chairs are part of a collection. Please refer to Saarinen side chairs, lounge chairs and tables on beginning on pages 316 and 462.

- Specify:*
1. Pattern number
  2. Leg base option
  3. Cal 133 fire code option
  4. Split upholstery option (add S)
  5. Textile selection, seat
  6. Textile selection, back

*Wood Leg Finishes:*  
Ebonized Walnut (suffix D)  
Light Oak (suffix LO)  
Light Walnut (suffix LWA)  
Reff Dark Cherry (suffix V314)

*Tubular Leg Finishes:*  
Black (suffix BL)  
Polished Chrome (suffix C)  
Gold (suffix GLD)

*COM split fabric requirements:*  
Back upholstery: 1.5 yards  
Seat upholstery: .75 yards

*COL split leather requirements:*  
Back upholstery: 27 square feet  
Seat upholstery: 13.5 square feet

*Upholstery/COM information:*  
Prices shown include fabric or leather upholstery. Contact your Knoll representative for colors. Only approved KnollTextiles and Spinneybeck leathers may be ordered. Customer's Own Material is available pending approval. For approval requirements, processing instructions and ordering information please see page 21.

*Cal 133 Fire Code #:*  
The Saarinen Executive Chairs comply with the California Technical Bulletin 133 standard if upholstered in Cal 133 approved upholstery. Specify suffix -C at end of pattern number and suffix -133 at end of textile selection. Upcharge applies, see page 22.

*Maintenance:*  
See pages 28-29.

*Note:*  
The Saarinen Executive Armless Chair is certified Clean Air GOLD.

### Construction

*Frame:*  
Molded reinforced polyurethane shell. Contoured plywood seat form.

*Upholstery:*  
Urethane foam cushion.

*Steel Leg base:*  
Four legs in seamless tubular steel with polished chrome, 18k plated gold, or matte black powder coat.

*Wood leg base:*  
Steam bent laminated ply oak with a clear or stained finish. Finish is complementary match to Saarinen, Florence Knoll and Platner low tables

*Glides:*  
Molded nylon disk in stamped steel shroud.

### Approved KnollTextiles Grades/Fabrics

<b>A</b> Beacon Bocce Chance Common Ground Commuter Cloth Cross Tech Crossroad Facet Hourglass Infinite Mariner Overture Prep Presto Soliloquy Sonnet Uni-Form Trophy	<b>B</b> continued Helios Holbrook Instinct Journey Keaton Knoll Felt Knoll Hopsack Little Devil Ludlow Paradigm Petal Pusher Prairie Prim Puff Ransom Radiance Roam Rush Hour Shadow Play Soiree Spree Sutton Synth Tabloid Tinge Topos Venue Versa Vinyl Wild Thing	<b>C</b> Axiom Baxter Charm Circa Classic Boucle Durand Earthwork Empire Stripe Entourage Entwine Essence Greenwich Hudson Kaleidoscope CR Lagos Lore CR Magnolia Milestone Panache CR Patchwork Plaid On Prestini Quark Rountrip Sequin CR Sinclair Smart Spectator	<b>C</b> continued Stepping Stones Swing Tilden Tower Grid Wow Factor Zari CR  <b>D</b> Buzz Code Coterie Eclat Weave Hologram Island Menagerie Origins Retreat Vice Versa Woodland Zoom  <b>E</b> Aegean Cleo Demure Flower Power Highland Juno Kampala Mamba Marquee Nature Walk Rebel Sherman Tempest Vatera	<b>F</b> Atelier Biscayne Century Cornaro Double Agent Glider Homage Imprint In Stitches Liberty Mod Plaid Rivington Soon Totem Tweed Frieze  <b>G</b> All Star Alter Ego Arber Color Collage Dapper Djenne Duchess Fancy Twill Gibson Kamani Looped In Melange Modern Tweed Spencer Straie Stripe Ultrasuede Utrillo Vert	<b>H</b> Bavaria Catwalk Constance Stretch Appeal Twist Tie World Piece  <b>I</b> Aswan Bella Cato Chic Diamond Days Doily Dynamic Florescence Hastings In Step Ita Jaipur Knoll Velvet North Island Olema Piper Prince Hairy Rutledge Stripe It Tudor Zimba	<b>U</b> Vicenza Volo  <b>V</b> Acqua Amalfi Andes Embossed Tipped España Velluto Pelle  <b>W</b> Alaska Antique Forte Sabrina Umbria  Ⓞ Fire Retardants Chemicals	<b>X</b> Ducale Ducale Velour  <b>Y</b> Cervo Copenhagen Distressed Gemma Lucca Marissa Portofino Riva
---	---	--	---	---	---	---	--

*Check with your KnollTextiles or Spinneybeck Representative for changes or additions.*

# Eero Saarinen

## Executive Armless Chairs with Plastic Back



	description	seat h	width	d	height	textile fabric yds.	req. leather sq. ft.	weight
<i>Designer(s):</i> Eero Saarinen, 1946	<b>72CP</b> Executive armless chair with plastic back, tubular legs and glides	18 3/4"	22"	20 1/2"	31 1/2"	1.3	12	16 lbs.
	<b>72CP-W</b> Executive armless chair with plastic back, wood legs	18 3/4"	22 1/2"	20 1/2"	31 1/2"	1.3	12	16 lbs.

pattern no.	grades <b>A</b>	COM <b>B</b>	<b>C</b>	<b>D</b>	<b>E</b>	<b>F</b>	<b>G</b>	<b>H</b>	<b>I</b>	COL <b>U</b>	<b>V</b>	<b>W</b>	<b>X</b>	<b>Y</b>
<b>72CP-(BL,C)-(-)</b>	\$1,433.	\$1,482.	\$1,531.	\$1,581.	\$1,626.	\$1,653.	\$1,709.	\$1,808.	\$1,883.	\$1,773.	\$1,866.	\$2,051.	\$2,091.	\$2,136.
<b>72CP-W-(-)-(-)</b>	2,085.	2,136.	2,184.	2,234.	2,279.	2,305.	2,361.	2,461.	2,537.	2,426.	2,518.	2,704.	2,744.	2,788.

### Order Code

<i>Example:</i>	<b>72CP-W-SLT-D-K2201/4</b>
<b>72CP</b>	Open back chair, armless
<b>W</b>	Wood leg
<b>SLT</b>	Salt plastic back
<b>D</b>	Ebonized Walnut leg finish
<b>K2201/4</b>	Oh La La, Sage

**Note:**  
The Saarinen executive chairs are part of a collection. Please refer to Saarinen side chairs, lounge chairs and tables on beginning on pages 316 and 462.

### Specify:

1. Pattern number
2. Plastic back selection
3. Leg finish
4. Cal 133 (optional)
5. Textile selection

### Ordering Information

**Wood Leg Finishes:**  
Ebonized Walnut (suffix D)  
Light Oak (suffix LO)  
Light Walnut (suffix LWA)  
Reff Dark Cherry (suffix V314)

**Tubular Leg Finishes:**  
Black (suffix BL)  
Polished Chrome (suffix C)

**Plastic Back Finishes:**  
Anise (ANS)  
Cumin (suffix CMN)  
Nutmeg (suffix NMG)  
Paprika (suffix PRK)  
Pepper (PPR)  
Poppy (PPY)  
Salt (suffix SLT)  
Turmeric (suffix TMC)

**Upholstery/COM information:**  
Prices shown include fabric or leather upholstery. Contact your Knoll representative for colors. Only approved KnollTextiles and Spinneybeck leathers may be ordered. Customer's Own Material is available pending approval. For approval requirements, processing instructions and ordering information please see page 21.

**Cal 133 Fire Code #:**  
The Saarinen Executive Chairs comply with the California Technical Bulletin 133 standard if upholstered in Cal 133 approved upholstery. Specify suffix -C at end of pattern number and suffix -133 at end of textile selection. Upcharge applies, see page 22. Approval does not apply to chairs with plastic backs.

**Maintenance:**  
See pages 28-29.

**Note:**  
The Saarinen Executive Armless Chair is certified Clean Air GOLD.

### Construction

**Plastic Back:**  
Molded polypropylene shell with slight texture. Note that the seat of the plastic back version is slightly wider than the fully upholstered version.

**Upholstery:**  
Urethane foam cushion.

**Steel Leg base:**  
Four legs in seamless tubular steel with polished chrome, 18k plated gold, or matte black powder coat.

**Wood leg base:**  
Steam bent laminated ply oak with a clear or stained finish. Finish is complementary match to Saarinen, Florence Knoll and Platner low tables

**Glides:**  
Molded nylon disk in stamped steel shroud.

### Approved KnollTextiles Grades/Fabrics

<b>A</b> Beacon Bocce Chance Common Ground Commuter Cloth Cross Tech Crossroad Delite Facet Hourglass Infinite Mariner Overture Prep Presto Soliloquy Sonnet Uni-Form Trophy	<b>B</b> continued Helios Holbrook Instinct Journey Keaton Knoll Felt Knoll Hopsack Little Devil Ludlow Paradigm Petal Pusher Prairie Prim Puff Ransom Radiance Roam Rush Hour Shadow Play Soiree Spree Sutton Synth Tabloid Tinge Topos Venue Versa Vinyl Wild Thing	<b>C</b> Axiom Baxter Chameleon Charm Circa Classic Boucle Durand Earthwork Empire Stripe Entourage Entwine Essence Greenwich Hudson Kaleidoscope CR Lagos Lore CR Magnolia Milestone Panache CR Patchwork Plaid On Prestini Quark Rountrip Sequin CR Sinclair Smart Spectator	<b>C</b> continued Stepping Stones Swing Tilden Tower Grid Wow Factor Zari CR  <b>D</b> Buzz Code Coterie Eclat Weave Hologram Island Menagerie Origins Retreat Vice Versa Woodland Zoom  <b>E</b> Aegean Cleo Demure Flower Power Highland Juno Kampala Mamba Marquee Nature Walk Rebel Sherman Tempest Vatera	<b>F</b> Atelier Biscayne Century Cornaro Double Agent Glider Homage Imprint In Stitches Liberty Mod Plaid Rivington Soon Totem Tweed Frieze  <b>G</b> All Star Alter Ego Arber Color Collage Dapper Djenne Duchess Fancy Twill Gibson Kamani Looped In Melange Modern Tweed Spencer Straie Stripe Ultrasuede Utrillo Vert	<b>H</b> Bavaria Catwalk Constance Stretch Appeal Twist Tie World Piece  Aswan Bella Cato Chic Diamond Days Doily Dynamic Florescence Hastings In Step Ita Jaipur Knoll Velvet North Island Olema Piper Prince Hairy Rutledge Stripe It Tudor Zimba	<b>U</b> Vicenza Volo  <b>V</b> Acqua Amalfi Andes Embossed Tipped España Velluto Pelle  <b>W</b> Alaska Antique Forte Sabrina Umbria	<b>X</b> Ducale Ducale Velour  <b>Y</b> Cervo Copenhagen Distressed Gemma Lucca Marissa Portofino Riva  <b>Ⓞ</b> Fire Retardants Chemicals
---	---	---	---	---	---	--	--

*Check with your KnollTextiles or Spinneybeck Representative for changes or additions.*

# Eero Saarinen

## Bar and Counter Height Stools

Designer(s):  
Eero Saarinen, 1946

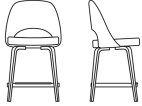
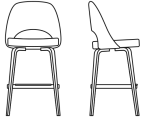

description	seat h	width	d	height	textile fabric yds.	req. leather sq. ft.	weight
<b>72CM-W</b> Executive armless counter height stool with wood legs and glides	25	22 1/2	19 1/2	40	2.0	35	17 lbs.
							
<b>72CH-W</b> Executive armless bar height stool with wood legs and glides	30	22 1/2	19 1/2	45	2.0	35	18 lbs.
							

pattern no.	grades	COM									COL				
	A	B	C	D	E	F	G	H	I	U	V	W	X	Y	
<b>72CM-W(-)(-)(-)</b>	\$3,379.	\$3,457.	\$3,533.	\$3,617.	\$3,682.	\$3,733.	\$3,818.	\$3,979.	\$4,094.	\$4,775.	\$5,053.	\$5,614.	\$5,734.	\$5,870.	
<b>72CH-W(-)(-)(-)</b>	3,379.	3,457.	3,533.	3,617.	3,682.	3,733.	3,818.	3,979.	4,094.	4,775.	5,053.	5,614.	5,734.	5,870.	

### Order Code

<i>Example:</i>	<b>72CM-W-D-AP-K2051/1</b>
<b>72CM</b>	Counter height stool
<b>W</b>	Wood legs
<b>D</b>	Ebonized Walnut leg finish
<b>AP</b>	Polished Aluminum foot cap
<b>K2051/1</b>	Divi, Moon

Note:  
The Saarinen Executive Stools are part of a collection. Please refer to Saarinen side chairs, lounge chairs and tables on pages 316 and 462.

### Specify:

1. Pattern number
2. Leg base option
3. Foot cap finish
4. Cal 133 fire code option
5. Split upholstery option (add S)
6. Textile selection, seat
7. Textile selection, back

### Ordering Information

**Wood Leg Finishes:**  
Ebonized Walnut (suffix D)  
Light Oak (suffix LO)  
Light Walnut (suffix LWA)  
Pearwood (suffix P)  
Reff Dark Cherry (suffix V314)

**Foot Cap Finishes:**  
Polished Aluminum (suffix AP)  
Black Paint (BL)

**Split upholstery option:**  
The seat and back of the Saarinen Executive Stools can be specified in split upholstery. Indicate S before selected seat upholstery, followed by selected back upholstery. The price equals the price of the higher upholstery grade.

**COM split fabric requirements:**  
Back upholstery: 1.5 yards  
Seat upholstery: .75 yards

**COL split leather requirements:**  
Back upholstery: 27 square feet  
Seat upholstery: 13.5 square feet

### Construction

**Frame:**  
Molded reinforced polyurethane shell. Contoured plywood seat form.

**Upholstery:**  
Urethane foam cushion. **Note that the cushion on the Executive bar and counter stools with wood legs is 2 1/8" thick.** The cushion on the Saarinen Executive arm chair with wood legs is 4 1/8" thick. The cushion on the Saarinen Executive armless chair with wood legs is 3 1/8" thick.

**Wood leg base:**  
Solid steam bent oak with clear or stained finish. Finish is complementary match to Saarinen, Florence Knoll and Platner low tables.

**Foot cap:**  
Die cast aluminum cap.

**Glides:**  
Molded nylon disk in stamped steel shroud.



### Approved KnollTextiles Grades/Fabrics

<b>A</b> Beacon Bocce Chance Common Ground Commuter Cloth Cross Tech Crossroad Facet Hourglass Infinite Mariner Overture Prep Presto Soliloquy Sonnet Uni-Form Trophy	<b>B</b> continued Helios Holbrook Instinct Journey Keaton Knoll Felt Knoll Hopsack Little Devil Ludlow Paradigm Petal Pusher Prairie Prim Puff Ransom Radiance Roam Rush Hour Shadow Play Soiree Spree Sutton Synth Tabloid Tinge Topos Venue Versa Vinyl Wild Thing	<b>C</b> Axiom Baxter Charm Circa Classic Boucle Durand Earthwork Empire Stripe Entourage Entwine Essence Greenwich Hudson Kaleidoscope CR Lagos Lore CR Magnolia Milestone Panache CR Patchwork Plaid On Prestini Quark Rountrip Sequin CR Sinclair Smart Spectator	<b>C</b> continued Stepping Stones Swing Tilden Tower Grid Wow Factor Zari CR	<b>D</b> Buzz Code Coterie Eclat Weave Hologram Island Menagerie Origins Retreat Vice Versa Woodland Zoom	<b>E</b> Aegean Cleo Demure Flower Power Highland Juno Kampala Mamba Marquee Nature Walk Rebel Sherman Tempest Vatera	<b>F</b> Atelier Biscayne Century Cornaro Double Agent Glider Homage Imprint In Stitches Liberty Mod Plaid Rivington Soon Totem Tweed Frieze	<b>G</b> All Star Alter Ego Arber Color Collage Dapper Djenne Duchess Fancy Twill Gibson Kamani Looped In Melange Modern Tweed Spencer Straie Stripe Ultrasuede Utrillo Vert	<b>H</b> Bavaria Catwalk Constance Stretch Appeal Twist Tie World Piece	<b>I</b> Aswan Bella Cato Chic Diamond Days Doily Dynamic Florescence Hastings In Step Ita Jaipur Knoll Velvet North Island Olema Piper Prince Hairy Rutledge Stripe It Tudor Zimba	<b>U</b> Vicenza Volo	<b>V</b> Acqua Amalfi Andes Embossed Tipped España Velluto Pelle	<b>W</b> Alaska Antique Forte Sabrina Umbria	<b>X</b> Ducale Ducale Velour	<b>Y</b> Cervo Copenhagen Distressed Gemma Lucca Marissa Portofino Riva
---	---	--	---	---	---	---	--	---	--	-----------------------------	--	---	-------------------------------------	---

Check with your KnollTextiles or Spinneybeck Representative for changes or additions.

# Eero Saarinen

## Womb™ Chair, Ottoman and Settee

	description	seat h	arm h	w	d	h	textile fabric yds.	req. leather sq. ft.	weight
<i>Designer(s):</i> Eero Saarinen, 1948	<b>70L</b> Womb chair	16"	20½"	40"	34"	35½"	7.2	165	36 lbs.
		16"	20½"	40"	34"	35½"	7.2	165	36 lbs.
	<b>74Y</b> Ottoman			25½"	20"	16"	2.1	55	13 lbs.
				25½"	20"	16"	2.1	55	13 lbs.

**Order Code** **Ordering Information**

<i>Example:</i> <b>70LM-BL-K530/4</b>	<i>Base finishes:</i> Black (suffix BL) Polished Chrome (suffix C) 18k Gold Plated (suffix GLD)	<i>Split upholstery option:</i> The surround and cushions of the Womb chair and ottoman and Womb settee may be specified with split upholstery. Indicate S before selected surround upholstery, followed by selected cushion upholstery. Price equals the higher upholstery grade.	<i>COL split leather requirements:</i> 75% Womb chair body: 90 square ft 75% Womb chair seat/back: 23 square ft 85% Womb chair body: 96 square ft 85% Womb chair seat/back: 25 square ft 85% Ottoman body: 48 square ft 85% Ottoman cushion: 25 square ft 100% Womb chair body: 110 square ft 100% Womb chair seat/back: 40 square ft
---------------------------------------	--	---	---

Note:  
The Womb chair and ottoman and Womb Settee are part of a collection. Please refer to Saarinen side and executive chairs and tables on pages 316 and 462.

- Specify:*
1. Pattern number/size
  2. Base finish selection
  3. Cal 133 option
  4. Split upholstery option (add S)
  5. Textile selection

*Upholstery/COM information:*  
Prices shown include fabric or leather upholstery. Contact your Knoll representative for colors. Only approved KnollTextiles and Spinneybeck leathers may be ordered.

Customer's Own Material is available pending approval. For approval requirements, processing instructions and ordering information please see page 21.

*COM split fabric requirements:*  
75% Womb chair body: 3.5 yards  
75% Womb chair seat/back: 1.25 yards  
85% Womb chair body: 3.75 yards  
85% Womb chair seat/back: 1.25 yards  
85% Ottoman body: 1 yard  
85% Ottoman cushion: .75 yards  
100% Womb chair body: 5.50 yards  
100% Womb chair seat/back: 2 yards  
100% Ottoman body: 1 yard  
100% Ottoman cushion: 1.25 yards  
100% Womb settee body: 9 yards  
100% Womb settee seat/back: 2.6 yards

*Maintenance:*  
See pages 28-29.

*Cal 133 Fire Code #:*  
The Womb Chair, Ottoman, and Settee comply with the California Technical Bulletin 133 standard if upholstered in Cal 133 approved upholstery. Specify suffix -C at end of pattern number and suffix -133 at end of textile selection. Upcharge applies, see page 22.

*Note:*  
The Saarinen Womb chair and ottoman and Womb settee are certified Clean Air GOLD.

pattern no.	grades A	COM B	C	D	E	F	G	H	I	COL U	V	W	X	Y
<b>70L-(BL,C)-()</b>	\$7,747.	\$8,136.	\$8,530.	\$8,820.	\$9,068.	\$9,296.	\$9,545.	\$10,176.	\$11,332.	\$12,918.	\$14,227.	\$17,584.	\$18,167.	\$18,525.
<b>70L-GLD-()</b>	9,253.	9,642.	10,036.	10,326.	10,574.	10,804.	11,052.	11,683.	12,839.	14,426.	15,732.	19,090.	19,675.	20,031.
<b>74Y-(BL,C)-()</b>	2,284.	2,380.	2,485.	2,560.	2,627.	2,688.	2,754.	2,913.	3,206.	3,490.	3,826.	4,698.	4,851.	4,942.
<b>74Y-GLD-()</b>	3,790.	3,887.	3,991.	4,067.	4,132.	4,193.	4,261.	4,421.	4,712.	4,996.	5,334.	6,205.	6,359.	6,448.

**Construction** **Approved KnollTextiles Grades/Fabrics** **Spinneybeck Leather**

<i>Base:</i> Steel wire with a polished chrome or 18k plated gold finish, or matte black powder-coat.	<b>A</b> Alignment Bocce Common Ground Commuter Cloth Cross Tech Crossroad Delite Facet Hourglass Infinite Mariner Overture Prep Soliloquy * Sonnet Uni-Form	<b>B</b> continued Sutton Tabloid Tinge Vast Versa Westwood Wild Thing	<b>C</b> Atlas Cairo Chameleon Charm Circa Classic Boucle Contour Durand Earthwork Empire Stripe * Entourage * Entwine Essence Fibra Greenwich Hudson Kaleidoscope CR Lagos Lore CR Milestone On Point Palisade Patchwork Plaid On Posh Prestini Pullman Quark Roundtrip Sequin CR * Smart Ⓞ Spectator * Swing Tilden Ⓞ Tower Grid Utmost II Wit Wow Factor Zari CR *	<b>D</b> Buzz Code Coterie Eclat Weave Island Menagerie Origins Pathway Plaidtastic Retreat Vice Versa Woodland	<b>E</b> Aegean Circle Point Cleo Currents Flower Power Highland Ikat Stripe Juno Kampala Kimono Mamba Marquee Meroe Midpoint Nature Walk Off The Grid Rebel Shima Tempest Vatera Whip	<b>F</b> Atelier Biscayne Cornaro * Double Agent Ⓞ Glider Homage Imprint In Stitches Liberty Mod Plaid Rivington Soon	<b>G</b> All Star Andissa Aurora Color Collage Djenne Duchess Fancy Twill Gibson Haze Kamani Looped In Melange Modern Tweed Rivers Spencer Straie Stripe Texnet Ultrasuede Utrillo Vert	<b>H</b> Bavaria Catwalk Constance Firefly Twist Tie	<b>I</b> Aswan Bella Byron * Cato Cummings * Diamond Days Doily Dynamic Florescence Guise Hastings In Step Ita Jaipur Knoll Velvet Limani North Island Olema Piper Prince Hair Rutledge Sandis Stripe It Zimba	<b>U</b> Vicenza Volo	<b>V</b> Acqua Amalfi Andes Embossed Tipped España+ Velluto Pelle	<b>W</b> Alaska Antique Derby Forte Lucente Sabrina Umbria	<b>X</b> Ducale+ Ducale Velour	<b>Y</b> Cervo Copenhagen Distressed+ Lucca Marissa Portofino+ Riva Rugata Sassolino
--	---	---	--	--	--	--	--	--	---	--------------------------	--	--	-----------------------------------	--

**Note:** All KnollTextiles and COM fabrics are railroaded on the Womb chair.

\* Approved for chair and ottoman cushion upholstery only.  
+ Not approved for small and medium Womb chairs and ottomans.  
Ⓞ Fire Retardants Chemicals

*Check with your KnollTextile or Spinneybeck Representative for any changes or additions.*

# Eero Saarinen

## Womb™ Chair, Ottoman and Settee

description	height, seat	height, arm	w	d	h	textile fabric yards	req. leather sq. ft.	weight
<b>73L</b> Womb Settee	16"	20½"	62¼"	34"	35½"	11.4	385	-

Designer(s):  
Eero Saarinen, 1948

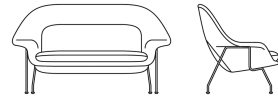

### Order Code      Ordering Information

*Example:* **70LM-BL-K530/4**

<b>70LM</b>	Medium womb chair
<b>BL</b>	Black base
<b>K530/4</b>	Lyonese Velvet, Cognac

Note:  
The Womb chair and ottoman and Womb Settee are part of a collection. Please refer to Saarinen side and executive chairs and tables on pages 316 and 462.

- Specify:
1. Pattern number/size
  2. Base finish selection
  3. Cal 133 option
  4. Split upholstery option (add S)
  5. Textile selection

**Base finishes:**  
Black (suffix BL)  
Polished Chrome (suffix C)

**Upholstery/COM information:**  
Prices shown include fabric or leather upholstery. Contact your Knoll representative for colors. Only approved KnollTextiles and Spinneybeck leathers may be ordered.

Customer's Own Material is available pending approval. For approval requirements, processing instructions and ordering information please see page 21.

**Split upholstery option:**  
The surround and cushions of the Womb chair and ottoman and Womb settee may be specified with split upholstery. Indicate S before selected surround upholstery, followed by selected cushion upholstery. Price equals the higher upholstery grade.

**COM split fabric requirements:**  
75% Womb chair body: 3.5 yards  
75% Womb chair seat/back: 1.25 yards  
85% Womb chair body: 3.75 yards  
85% Womb chair seat/back: 1.25 yards  
85% Ottoman body: 1 yard  
85% Ottoman cushion: .75 yards  
100% Womb chair body: 5.50 yards  
100% Womb chair seat/back: 2 yards  
100% Ottoman body: 1 yard  
100% Ottoman cushion: 1.25 yards  
100% Womb settee body: 9 yards  
100% Womb settee seat/back: 2.6 yards

**COL split leather requirements:**  
75% Womb chair body: 90 square ft  
75% Womb chair seat/back: 23 square ft  
85% Womb chair body: 96 square ft  
85% Womb chair seat/back: 25 square ft  
85% Ottoman body: 48 square ft  
85% Ottoman cushion: 25 square ft  
100% Womb chair body: 110 square ft  
100% Womb chair seat/back: 40 square ft  
100% Ottoman body: 27.5 square ft  
100% Ottoman cushion: 27.5 square ft  
100% Womb settee body: 275 square ft  
100% Womb settee seat/back: 110 square ft

**Maintenance:**  
See pages 28-29.

**Cal 133 Fire Code #:**  
The Womb Chair, Ottoman, and Settee comply with the California Technical Bulletin 133 standard if upholstered in Cal 133 approved upholstery. Specify suffix -C at end of pattern number and suffix -133 at end of textile selection. Upcharge applies, see page 22.

**Note:**  
The Saarinen Womb chair and ottoman and Womb settee are certified Clean Air GOLD.

pattern no.	grades	COM	C	D	E	F	G	H	I	COL	V	W	X	Y
<b>73L-(BL,C)-()</b>	\$12,035.	\$12,638.	\$13,249.	\$13,702.	\$14,084.	\$14,439.	\$14,829.	\$15,808.	\$17,602.	\$20,065.	\$22,100.	\$27,315.	\$28,218.	\$28,775.

### Construction      Approved KnollTextiles Grades/Fabrics      Spinneybeck Leather

**Base:**  
Steel wire with a polished chrome or matte black powder-coat.

**Frame and upholstery:**  
Foam over molded, reinforced fiberglass shell on chair. Foam cushion over molded plywood platform on ottoman. Separate seat, back, and ottoman cushions constructed of polyester fiber with foam core.

**Glides:**  
Stainless steel and nylon articulating glides.

**Medium and Child's Womb Chairs:**  
Medium Womb chair and ottoman are 85% scale of standard Womb chair. Child's Womb chair is 75% scale of standard chair. Child's chair does not have accompanying ottoman.

- A** Alignment
- Bocce
- Common Ground
- Commuter Cloth
- Cross Tech
- Crossroad
- Delite
- Facet
- Hourglass
- Infinite
- Mariner
- Overture
- Prep
- Soliloquy \*
- Sonnet
- Uni-Form

- B** Abacus
- Argyle
- Attire
- Belize
- Bistro
- Block Party ®
- Calypso
- Chronicle
- Cozy Cord
- Day Tripper
- Diva
- Dottie
- Ferry
- Grande
- Grandview
- Helios
- Holbrook
- Instinct
- Journey
- Keaton
- Knoll Felt
- Knoll Hopsack
- Little Devil
- Ludlow
- Melody ®
- Paradigm
- Prairie
- Prim
- Puff
- Radiance
- Ransom
- Roam
- Rush Hour
- Shadow Play
- Spree
- Summit

- C** Atlas
- Cairo
- Chameleon
- Charm
- Circa
- Classic Boucle
- Contour
- Durand
- Earthwork
- Empire Stripe \*
- Entourage \*
- Entwine
- Essence
- Fibra
- Greenwich
- Hudson
- Kaleidoscope CR
- Lagos
- Lore CR
- Milestone
- On Point
- Palisade
- Patchwork
- Plaid On
- Posh
- Prestini
- Pullman
- Quark
- Roundtrip
- Sequin CR \*
- Smart ®
- Spectator \*
- Swing
- Tilden ®
- Tower Grid
- Utmost II
- Wit
- Wow Factor
- Zari CR \*

- D** Buzz
- Code
- Coterie
- Eclat Weave
- Island
- Menagerie
- Origins
- Pathway
- Plaidtastic
- Retreat
- Vice Versa
- Woodland

- E** Aegean
- Circle Point
- Cleo
- Currents
- Flower Power
- Highland
- Ikat Stripe
- Juno
- Kampala
- Kimono
- Mamba
- Marquee
- Meroe
- Midpoint
- Nature Walk
- Off The Grid
- Rebel
- Shima
- Tempest
- Vatera
- Whip

- G** All Star
- Andissa
- Aurora
- Color Collage
- Djenne
- Duchess
- Fancy Twill
- Gibson
- Haze
- Kamani
- Looped In
- Melange
- Modern Tweed
- Rivers
- Spencer
- Straie Stripe
- Texnet
- Ultrasuede
- Utrillo
- Vert

- H** Bavaria
- Catwalk
- Constance
- Firefly
- Twist Tie

- I** Aswan
- Bella
- Byron \*
- Cato
- Cummings \*
- Diamond Days
- Doily
- Dynamic
- Florescence
- Guise
- Hastings
- In Step
- Ita
- Jaipur
- Knoll Velvet
- Limani
- North Island
- Olema
- Piper
- Prince Hairly
- Rutledge
- Sandis
- Stripe It
- Zimba

**Note:** All KnollTextiles and COM fabrics are railroaded on the Womb chair.

\* Approved for chair and ottoman cushion upholstery only.  
+ Not approved for small and medium Womb chairs and ottomans.  
® Fire Retardants Chemicals

Check with your KnollTextile or Spinneybeck Representative for any changes or additions.

# Eero Saarinen

## Womb™ Chair, Ottoman and Settee

	description	seat h	arm h	w	d	h	textile fabric yds.	req. leather sq. ft.	weight
<i>Designer(s):</i>	<b>70LM</b> Medium Womb chair	15"	18"	35"	31"	31 1/4"	5	96	31 lbs.
Eero Saarinen, 1948	<b>74YM</b> Medium ottoman			21"	17 1/2"	14 1/4"	1.7	48	11 lbs.



### Order Code      Ordering Information

<i>Example:</i> <b>70LM-BL-K530/4</b>	<i>Base finishes:</i> Black (suffix BL) Polished Chrome (suffix C)	<i>Split upholstery option:</i> The surround and cushions of the Womb chair and ottoman and Womb settee may be specified with split upholstery. Indicate S before selected surround upholstery, followed by selected cushion upholstery. Price equals the higher upholstery grade.	<i>COL split leather requirements:</i> 75% Womb chair body: 90 square ft 75% Womb chair seat/back: 23 square ft 85% Womb chair body: 96 square ft 85% Womb chair seat/back: 25 square ft 85% Ottoman body: 48 square ft 85% Ottoman cushion: 25 square ft 100% Womb chair body: 110 square ft 100% Womb chair seat/back: 40 square ft 100% Ottoman body: 27.5 square ft 100% Ottoman cushion: 27.5 square ft 100% Womb settee body: 275 square ft 100% Womb settee seat/back: 110 square ft
<b>70LM</b> Medium womb chair			
<b>BL</b> Black base			
<b>K530/4</b> Lyonese Velvet, Cognac			
<i>Note:</i> The Womb chair and ottoman and Womb Settee are part of a collection. Please refer to Saarinen side and executive chairs and tables on pages 316 and 462.	<i>Upholstery/COM information:</i> Prices shown include fabric or leather representative for colors. Only approved KnollTextiles and Spinneybeck leathers may be ordered.	<i>COM split fabric requirements:</i> 75% Womb chair body: 3.5 yards 75% Womb chair seat/back: 1.25 yards 85% Womb chair body: 3.75 yards 85% Womb chair seat/back: 1.25 yards 85% Ottoman body: 1 yard 85% Ottoman cushion: .75 yards 100% Womb chair body: 5.50 yards 100% Womb chair seat/back: 2 yards 100% Ottoman body: 1 yard 100% Ottoman cushion: 1.25 yards 100% Womb settee body: 9 yards 100% Womb settee seat/back: 2.6 yards	<i>Maintenance:</i> See pages 28-29.
<i>Specify:</i> 1. Pattern number/size 2. Base finish selection 3. Cal 133 option 4. Split upholstery option (add S) 5. Textile selection	<i>Customer's Own Material</i> is available pending approval. For approval requirements, processing instructions and ordering information please see page 21.	<i>Cal 133 Fire Code #:</i> The Womb Chair, Ottoman, and Settee comply with the California Technical Bulletin 133 standard if upholstered in Cal 133 approved upholstery. Specify suffix -C at end of pattern number and suffix -133 at end of textile selection. Upcharge applies, see page 22.	<i>Note:</i> The Saarinen Womb chair and ottoman and Womb settee are certified Clean Air GOLD.

pattern no.	grades	COM	C	D	E	F	G	H	I	COL	U	V	W	X	Y
<b>70LM-(BL,C)-()</b>	\$7,308.	\$7,673.	\$8,045.	\$8,321.	\$8,550.	\$8,768.	\$9,005.	\$9,597.	\$10,690.	\$12,185.	\$13,422.	\$16,589.	\$17,136.	\$17,477.	
<b>74YM-(BL,C)-()</b>	2,155.	2,248.	2,349.	2,413.	2,478.	2,536.	2,597.	2,748.	3,026.	3,294.	3,609.	4,432.	4,576.	4,662.	

### Construction      Approved KnollTextiles Grades/Fabrics      Spinneybeck Leather

<i>Base:</i> Steel wire with a polished chrome or matte black powder-coat.	<b>A</b> Alignment Bocce Common Ground Commuter Cloth Cross Tech Crossroad Delite Facet Hourglass Infinite Mariner Overture Prep Soliloquy * Sonnet Uni-Form	<b>B</b> continued Sutton Tabloid Tinge Vast Versa Westwood Wild Thing	<b>D</b> Buzz Code Coterie Eclat Weave Island Menagerie Origins Pathway Plaidtastic Retreat Vice Versa Woodland	<b>G</b> All Star Andissa Aurora Color Collage Djenne Duchess Fancy Twill Gibson Haze Kamani Looped In Melange Modern Tweed Rivers Spencer Straie Stripe Texnet Ultrasuede Utrillo Vert	<b>U</b> Vicenza Volo	<b>X</b> Ducale+ Ducale Velour
<i>Frame and upholstery:</i> Foam over molded, reinforced fiberglass shell on chair. Foam cushion over molded plywood platform on ottoman. Separate seat, back, and ottoman cushions constructed of polyester fiber with foam core.	<b>C</b> Atlas Cairo Chameleon Charm Circa Classic Boucle Contour Durand Earthwork Empire Stripe * Entourage * Entwine Essence Fibra Greenwich Hudson Kaleidoscope CR Lagos Lore CR Milestone On Point Palisade Patchwork Plaid On Posh Prestini Pullman Quark Roundtrip Sequin CR * Smart <sup>®</sup> Spectator * Swing Tilden <sup>®</sup> Tower Grid Utmost II Wit Wow Factor Zari CR *	<b>E</b> Aegean Circle Point Cleo Currents Flower Power Highland Ikat Stripe Juno Kampala Kimono Mamba Marquee Meroe Midpoint Nature Walk Off The Grid Rebel Shima Tempest Vatera Whip	<b>E</b> Aegean Circle Point Cleo Currents Flower Power Highland Ikat Stripe Juno Kampala Kimono Mamba Marquee Meroe Midpoint Nature Walk Off The Grid Rebel Shima Tempest Vatera Whip	<b>H</b> Bavaria Catwalk Constance Firefly Twist Tie	<b>V</b> Acqua Amalfi Andes Embossed Tipped España+ Velluto Pelle	<b>Y</b> Cervo Copenhagen Distressed+ Lucca Marissa Portofino+ Riva Rugata Sassolino
<i>Glides:</i> Stainless steel and nylon articulating glides.	<b>B</b> Abacus Argyle Attire Belize Bistro Block Party <sup>®</sup> Calypso Chronicle Cozy Cord Day Tripper Diva Dottie Ferry Grande Grandview Helios Holbrook Instinct Journey Keaton Knoll Felt Knoll Hopsack Little Devil Ludlow Melody <sup>®</sup> Paradigm Prairie Prim Puff Radiance Ransom Roam Rush Hour Shadow Play Spree Summit	<b>F</b> Atelier Biscayne Cornaro * Double Agent <sup>®</sup> Glider Homage Imprint In Stitches Liberty Mod Plaid Rivington Soon	<b>I</b> Aswan Bella Byron * Cato Cummings * Diamond Days Doily Dynamic Florescence Guise Hastings In Step Ita Jaipur Knoll Velvet Limani North Island Olema Piper Prince Hair Rutledge Sandis Stripe It Zimba	<b>W</b> Alaska Antique Derby Forte Lucente Sabrina Umbria	<b>Note:</b> All KnollTextiles and COM fabrics are railroaded on the Womb chair.	<b>Note:</b> All KnollTextiles and COM fabrics are railroaded on the Womb chair.  * Approved for chair and ottoman cushion upholstery only. + Not approved for small and medium Womb chairs and ottomans. <sup>®</sup> Fire Retardants Chemicals
					<i>Check with your KnollTextile or Spinneybeck Representative for any changes or additions.</i>	



# Eero Saarinen Womb™ Chair, Ottoman and Settee

description	seat h	arm h	w	d	h	textile fabric yds.	req. leather sq. ft.	weight
<b>70LS</b> Child's Womb chair	14 1/2"	17"	31"	28"	27 1/4"	5	90	27 lbs.

Designer(s):  
Eero Saarinen, 1948



## Order Code      Ordering Information

*Example:* **70LM-BL-K530/4**

<b>70LM</b>	Medium womb chair
<b>BL</b>	Black base
<b>K530/4</b>	Lyonese Velvet, Cognac

Note:  
The Womb chair and ottoman and Womb Settee are part of a collection. Please refer to Saarinen side and executive chairs and tables on pages 316 and 462.

*Specify:*

1. Pattern number/size
2. Base finish selection
3. Cal 133 option
4. Split upholstery option (add S)
5. Textile selection

**Base finishes:**  
Black (suffix BL)  
Polished Chrome (suffix C)

**Upholstery/COM information:**  
Prices shown include fabric or leather upholstery. Contact your Knoll representative for colors. Only approved KnollTextiles and Spinneybeck leathers may be ordered.

Customer's Own Material is available pending approval. For approval requirements, processing instructions and ordering information please see page 21.

**Split upholstery option:**  
The surround and cushions of the Womb chair and ottoman and Womb settee may be specified with split upholstery. Indicate S before selected surround upholstery, followed by selected cushion upholstery. Price equals the higher upholstery grade.

**COM split fabric requirements:**  
75% Womb chair body: 3.5 yards  
75% Womb chair seat/back: 1.25 yards  
85% Womb chair body: 3.75 yards  
85% Womb chair seat/back: 1.25 yards  
85% Ottoman body: 1 yard  
85% Ottoman cushion: .75 yards  
100% Womb chair body: 5.50 yards  
100% Womb chair seat/back: 2 yards  
100% Ottoman body: 1 yard  
100% Ottoman cushion: 1.25 yards  
100% Womb settee body: 9 yards  
100% Womb settee seat/back: 2.6 yards

**COL split leather requirements:**  
75% Womb chair body: 90 square ft  
75% Womb chair seat/back: 23 square ft  
85% Womb chair body: 96 square ft  
85% Womb chair seat/back: 25 square ft  
85% Ottoman body: 48 square ft  
85% Ottoman cushion: 25 square ft  
100% Womb chair body: 110 square ft  
100% Womb chair seat/back: 40 square ft  
100% Ottoman body: 27.5 square ft  
100% Ottoman cushion: 27.5 square ft  
100% Womb settee body: 275 square ft  
100% Womb settee seat/back: 110 square ft

**Maintenance:**  
See pages 28-29.

**Cal 133 Fire Code #:**  
The Womb Chair, Ottoman, and Settee comply with the California Technical Bulletin 133 standard if upholstered in Cal 133 approved upholstery. Specify suffix -C at end of pattern number and suffix -133 at end of textile selection. Upcharge applies, see page 22.

**Note:**  
The Saarinen Womb chair and ottoman and Womb settee are certified Clean Air GOLD.

pattern no.	grades A	COM B	C	D	E	F	G	H	I	COL U	V	W	X	Y
<b>70LS-(BL,C)-( )</b>	\$6,579.	\$6,906.	\$7,240.	\$7,487.	\$7,700.	\$7,895.	\$8,106.	\$8,637.	\$9,622.	\$10,968.	\$12,080.	\$14,930.	\$15,423.	\$15,727.

## Construction      Approved KnollTextiles Grades/Fabrics      Spinneybeck Leather

**Base:**  
Steel wire with a polished chrome or matte black powder-coat.

**Frame and upholstery:**  
Foam over molded, reinforced fiberglass shell on chair. Foam cushion over molded plywood platform on ottoman. Separate seat, back, and ottoman cushions constructed of polyester fiber with foam core.

**Glides:**  
Stainless steel and nylon articulating glides.

**Medium and Child's Womb Chairs:**  
Medium Womb chair and ottoman are 85% scale of standard Womb chair. Child's Womb chair is 75% scale of standard chair. Child's chair does not have accompanying ottoman.





<b>A</b> Alignment Bocce Common Ground Commuter Cloth Cross Tech Crossroad Delite Facet Hourglass Infinite Mariner Overture Prep Soliloquy * Sonnet Uni-Form	<b>B</b> continued Sutton Tabloid Tinge Vast Versa Westwood Wild Thing	<b>C</b> Atlas Cairo Chameleon Charm Circa Classic Boucle Contour Durand Earthwork Empire Stripe * Entourage * Entwine Essence Fibra Greenwich Hudson Kaleidoscope CR Lagos Lore CR Milestone On Point Palisade Patchwork Plaid On Posh Prestini Pullman Quark Roundtrip Sequin CR * Smart <sup>®</sup> Spectator * Swing Tilden <sup>®</sup> Tower Grid Utmost II Wit Wow Factor Zari CR *	<b>D</b> Buzz Code Coterie Eclat Weave Island Menagerie Origins Pathway Plaidtastic Retreat Vice Versa Woodland	<b>E</b> Aegean Circle Point Cleo Currents Flower Power Highland Ikat Stripe Juno Kampala Kimono Mamba Marquee Meroe Midpoint Nature Walk Off The Grid Rebel Shima Tempest Vatera Whip	<b>F</b> Atelier Biscayne Cornaro * Double Agent <sup>®</sup> Glider Homage Imprint In Stitches Liberty Mod Plaid Rivington Soon	<b>G</b> All Star Andissa Aurora Color Collage Djenne Duchess Fancy Twill Gibson Haze Kamani Looped In Melange Modern Tweed Rivers Spencer Straie Stripe Texnet Ultrasuede Utrillo Vert	<b>H</b> Bavaria Catwalk Constance Firefly Twist Tie	<b>I</b> Aswan Bella Byron * Cato Cummings * Diamond Days Doily Dynamic Florescence Guise Hastings In Step Ita Jaipur Knoll Velvet Limani North Island Olema Piper Prince Hairy Rutledge Sandis Stripe It Zimba	<b>U</b> Vicenza Volo	<b>V</b> Acqua Amalfi Andes Embossed Tipped España+ Velluto Pelle	<b>W</b> Alaska Antique Derby Forte Lucente Sabrina Umbria	<b>X</b> Ducale+ Ducale Velour	<b>Y</b> Cervo Copenhagen Distressed+ Lucca Marissa Portofino+ Riva Rugata Sassolino
---	---	--	---	---	--	---	---	---	-----------------------------	---	---	--------------------------------------	---

**Note:** All KnollTextiles and COM fabrics are railroaded on the Womb chair.

\* Approved for chair and ottoman cushion upholstery only.  
+ Not approved for small and medium Womb chairs and ottomans.  
<sup>®</sup> Fire Retardants Chemicals

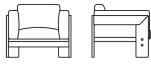
Check with your KnollTextile or Spinneybeck Representative for any changes or additions.

Tobia Scarpa  
Bastiano Collection

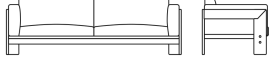

	description	height, seat	height, arm	width	depth	height	textile fabric yards	leather sq ft	weight
<i>Designer(s):</i> Tobia Scarpa, 1962	<b>53-145P</b> Petite lounge chair	16 1/2"	23"	33 1/2"	30 1/2"	27 1/2"	5.5	165	90 lbs.
									
	<b>53-146P</b> Petite settee	18"	23 1/2"	55 1/2"	30 1/2"	27 1/2"	6.5	220	135 lbs.
									
	<b>53-147</b> Sofa	18 1/4"	25 1/2"	86 1/2"	34 1/2"	30"	8	220	155 lbs.
									

Order Code	Ordering Information	Construction
<i>Example:</i> <b>53-145P-AE-K2074/8</b>	<i>Frame Finish:</i> Ebonized Ash (suffix AE)	<i>Frame:</i> Solid ash wood frame, stained to achieve an ebonized finish. The seat support frame is wood with coated steel straps.
<b>53-145P</b> Bastiano Petite Lounge Chair	<i>Upholstery/COM information:</i> Prices shown include fabric or leather upholstery. Contact your Knoll representative for colors. Only approved KnollTextiles and Spinneybeck leathers may be ordered.	<i>Upholstery:</i> Seat, back and arm cushions have a variable foam core with polyester fiber wrap. All cushions have zippers. Arm and seat cushions have a strap attached to a recessed hidden hook in the wood structure to ensure the cushions remain in an upright position.
<b>AE</b> Ebonized Ash	Customer's Own Material is available pending approval. For approval requirements, processing instructions and ordering information please see page 21.	
<b>K2074/8</b> Aegean, Path	<i>Maintenance:</i> See pages 28-29.	
<i>Specify:</i>		
1. Pattern number		
2. Frame finish selection		
3. Textile/leather selection		

pattern no.	grades	COM								COL				
	A	B	C	D	E	F	G	H	I	U	V	W	X	Y
<b>53-145P</b>	\$9,917.	\$10,180.	\$10,421.	\$10,470.	\$10,569.	\$10,886.	\$11,595.	\$11,890.	\$12,595.	\$14,765.	\$17,313.	\$19,132.	\$19,967.	\$20,802.
<b>53-146P</b>	10,100.	10,412.	10,697.	10,756.	10,868.	11,247.	12,084.	12,432.	13,266.	16,630.	20,025.	22,449.	23,564.	24,679.
<b>53-147</b>	11,890.	12,274.	12,624.	12,697.	12,837.	13,301.	14,332.	14,760.	15,788.	18,304.	21,699.	24,127.	25,240.	26,355.

Approved KnollTextiles Grades/Fabrics				Spinneybeck Leather			
<b>A</b> Alignment Beacon Bocce Chance Common Ground Commuter Cloth Crossroad Delite Facet Hourglass Infinite Mariner Monarch Oh La La Overture Prep Soliloquy Sonnet Trophy Uni-Form	<b>B</b> continued Grandview Helios Holbrook Instinct Journey Keaton Knoll Hopsack Little Devil Lyric Ludlow Melody <sup>®</sup> Night Life Petal Pusher <sup>®</sup> Prairie <sup>®</sup> Prim Puff Radiance Ransom Roam Rush Hour Soiree Spree Stripmania Summit Sutton Synth Tabloid Tinge <sup>®</sup> Vast Venue Versa Vibe II Vinyl <sup>®</sup> Westwood Yeni	<b>C</b> Atlas Axiom <sup>®</sup> Baxter Cairo Charm Circa Classic Boucle Color Field Contour Dune Durand Earthwork Empire Stripe Essence Fibra Greenwich Groovy Hudson Kaya CR Lagos Lore CR Magnolia Milestone On Point Palisade Panache CR Patchwork Plaid On Prestini Pullman Quark Sahara Sequin CR Sinclair Smart <sup>®</sup>	<b>C</b> continued Swing Tight Rope Tilden <sup>®</sup> Tower Grid Wit Zen Wave  <b>D</b> Chain Link Code Coterie Eclat Weave Hologram Ikat Stripe Island Kabuki Menagerie Origins Pathway Plaidtastic Theory <sup>®</sup> Woodland Zoom  <b>E</b> Aegean Circle Point Cleo Currents Demure Flower Power Highland Juno Kimono Mamba Marquee Meroe Midpoint Nature Walk Off The Grid Premier Rebel Sherman Shima Tryst Vatera Whip	<b>F</b> Atelier Biscayne Calais Cotton Velvet Glider Homage In Stitches It's Complicated <sup>®</sup> Jasmine Liberty Mod Plaid Rivington Sideline Soon Totem  <b>G</b> All Star Alter Ego Andissa Arabella Arber Arrondissement Aurora Duchess Gibson Haze Kamani Kingston Looped In Melange Modern Tweed Rivers Sablon Spencer Straie Stripe Ultrasuede Utrillo Vert	<b>H</b> Bavaria Catwalk Constance Firefly Gezelle Stretch Appeal Twist Tie World Piece  <b>I</b> Aswan Byron Cato Cummings Diamond Days Doily Dynamic Guise Hastings Ita Jaipur Knoll Velvet Limani Mepal North Island Olema Piper Prince Hairy Rutledge Sandis Tudor Zimba	<b>U</b> Vicenza Volo  <b>V</b> Acqua Amalfi Andes Embossed Tipped España Hand Tipped Maremma Velluto Pelle  <b>W</b> Alaska Amazon Antique Derby Forte Lucente Sabrina Umbria	<b>X</b> Ducale Ducale Velour  <b>Y</b> Cascia Cervo Copenhagen Distressed Lucca Marissa Portofino Riva Rugata Saddle Sassolino
<p><sup>®</sup> Fire Retardants Chemicals</p> <p>Check with your KnollTextiles or Spinneybeck Representative for changes or additions.</p>							

Richard Schultz  
1966 Collection® Dining Chairs

	description	seat h	arm h	w	d	h	textile fabric yds.	weight
<i>Designer(s):</i> Richard Schultz, 1966    	<b>1966-45H</b> Dining chair with arms	18"	25"	23"	24 1/4"	31"		22 lbs.
	<b>1966-45HCOV</b> Dining chair with arms cover	—	—	—	—	—		—
	<b>1966-46H</b> Dining chair, armless	18"		19"	24 1/4"	31"		20 lbs.
	<b>1966-46HCOV</b> Dining chair, armless, cover							
	<b>1966-45P</b> Chair pad for 1966-45H, 46H, 46C, 46B						1.25	



pattern no.		COM	
<b>1966-45H-( )-( )</b>			\$2,707.
<b>1966-45HCOV</b>			455.
<b>1966-46H-( )-( )</b>			2,707.
<b>1966-46HCOV</b>			455.
<b>1966-45P</b>		776.	816.

Order Code	Ordering Information
<i>Example:</i> <b>1966-45H-B-W-W</b>	<i>Strap finishes:</i>
<b>1966-45H</b> Dining chair with arms	White (suffix W)
<b>B</b> Brown straps	Brown (suffix B)
<b>W</b> White mesh	Grey (suffix G)
<b>W</b> White frame	Onyx (suffix O)
	Sand (suffix S)
	Bronze (suffix Z)
	<i>Mesh finishes:</i>
	White (suffix W)
	Grey Tone (suffix T)
	Onyx (suffix O)
	Aluminum (suffix A)
	Bronze (suffix Z)
	Chestnut (suffix N)
	<i>Frame finishes:</i>
	Blue (suffix BLU)
	Chestnut (suffix N)
	Dark Bronze (suffix 14)
	Green (suffix 007)
	Light Bronze (suffix 13)
	Lime Green (suffix LGR)
	Onyx (suffix O)
	Orange (suffix ORG)
	Plum (suffix PLM)
	Sky Blue (suffix 3)
	Warm Wood (suffix 12)
	Weatherable Silver (suffix S)
	White (suffix W)
	Yellow (suffix YEL)
	<i>Maintenance:</i>
	See pages 28-29.
	<i>Outdoor Care Guidelines</i>
	See page 30.
	<i>Upholstery/COM information:</i>
	Prices shown include fabric upholstery only. Contact your Knoll representative for colors.
	Customer's Own Material is available pending approval. For approval requirements, processing instructions and ordering information, please see page 21

- Specify:*
1. Pattern number
  2. Strap color
  3. Mesh color
  4. Frame color

Construction	Approved KnollTextiles Grades/Fabrics
<i>Frame:</i> Frame is aluminum castings and extrusions welded and glued together using a two-part epoxy. Finished in highly durable weather resistant polyester powder coat paint.	<b>B</b> Belize Prairie Vinyl
<i>Seat:</i> Woven vinyl coated polyester mesh is sewn to pure vinyl straps using Teflon thread to form the seat and back. Stainless steel supports provides shape and is attached to the frame with stainless steel connectors.	<b>C</b> Baxter Noble Sinclair
<i>Glides:</i> Clear butyrate plastic.	<i>Check with your KnollTextiles Representative for changes or additions.</i>

Richard Schultz  
1966 Collection® Barstools

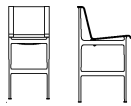
	description	seat h	w	d	h	textile fabric yds.	weight
<p><i>Designer(s):</i> Richard Schultz, 1966</p> 	<b>1966-46C</b> Counter height armless barstool	26"	19"	24 1/4"	39 1/4"		24 lbs.
							
	<b>1966-46CCOV</b> Counter height armless barstool cover						
	<b>1966-46B</b> Bar height armless barstool	31"	19"	24 1/4"	44 1/4"		24 lbs.
							
	<b>1966-46BCOV</b> Bar height armless barstool cover						
	<b>1966-45P</b> Chair pad for 1966-45H, 46H, 46C, 46B					1.25	

pattern no.		COM	
<b>1966-46C-( )-( )</b>	\$3,049.	<b>B</b>	<b>C</b>
<b>1966-46CCOV</b>	581.		
<b>1966-46B-( )-( )</b>	3,394.		
<b>1966-46BCOV</b>	635.		
<b>1966-45P</b>	776.		816.



Order Code	Ordering Information
<i>Example:</i> <b>1966-46B-O-O-O</b>	
<b>1966-46B</b> Bar height barstool	<i>Strap finishes:</i> White (suffix W) Brown (suffix B) Grey (suffix G) Onyx (suffix O) Sand (suffix S) Bronze (suffix Z)
<b>O</b> Onyx strap	<i>Frame finishes:</i> Blue (suffix BLU) Chestnut (suffix N) Dark Bronze (suffix 14) Green (suffix 007) Light Bronze (suffix 13) Lime Green (suffix LGR) Onyx (suffix O) Orange (suffix ORG) Plum (suffix PLM) Sky Blue (suffix 3) Warm Wood (suffix 12) Weatherable Silver (suffix S) White (suffix W) Yellow (suffix YEL)
<b>O</b> Onyx mesh	<i>Maintenance:</i> See pages 28-29.
<b>O</b> Onyx frame	<i>Outdoor Care Guidelines</i> See page 30.
	<i>Upholstery/COM information:</i> Prices shown include fabric upholstery only. Contact your Knoll representative for colors.
	Customer's Own Material is available pending approval. For approval requirements, processing instructions and ordering information, please see page 21
<i>Specify:</i> 1. Pattern number 2. Strap color 3. Mesh color 4. Frame color	<i>Mesh finishes:</i> White (suffix W) Grey Tone (suffix T) Onyx (suffix O) Aluminum (suffix A) Bronze (suffix Z) Chestnut (suffix N)

Construction	Approved KnollTextiles Grades/Fabrics
<i>Frame:</i> Frame is aluminum castings and extrusions welded and glued together using a two-part epoxy. Finished in highly durable weather resistant polyester powder coat paint.	<b>B</b> Belize Prairie Vinyl
<i>Seat:</i> Woven vinyl coated polyester mesh is sewn to pure vinyl straps using Teflon thread to form the seat and back. Stainless steel supports provides shape and is attached to the frame with stainless steel connectors.	<b>C</b> Baxter Noble Sinclair
<i>Glides:</i> Clear butyrate plastic.	<i>Check with your KnollTextiles Representative for changes or additions.</i>

Richard Schultz  
1966 Collection® Lounge Seating

Designer(s):  
Richard Schultz, 1966

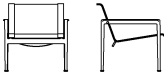
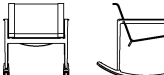
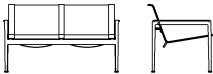
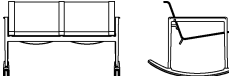
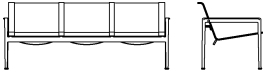

description	seat h	arm h	w	d	h	textile fabric yds.	weight
<b>1966-25</b> Lounge chair with arms 	14"	20 1/2"	26"	28 1/4"	26"		24 lbs.
<b>1966-25COV</b> Lounge chair with arms, cover							
<b>1966-25R</b> Single Rocker 	14"	20 1/2"	26"	35"	29"		30 lbs.
<b>1966-25RCOV</b> Single Rocker, cover							
<b>1966-255</b> Two seat lounge chair with arms 	14"	20 1/2"	46"	28 1/4"	26"		28 lbs.
<b>1966-255COV</b> Two seat lounge chair with arms, cover							
<b>1966-255R</b> Double Rocker 	14"	20 1/2"	46"	35"	29"		34 lbs.
<b>1966-255RCOV</b> Double Rocker, cover							
<b>1966-355</b> Three seat lounge chair with arms 	14"	20 1/2"	66"	28 1/4"	26"		32 lbs.
<b>1966-355COV</b> Three seat lounge chair with arms, cover							
<b>1966-250</b> ottoman 			23"	27"	14"		12 lbs.
<b>1966-250COV</b> ottoman cover							
<b>1966-25P</b> Chair pad for 1966-25, 25R, 255, 255R, 355						1.5	
<b>1966-250P</b> Ottoman pad for 1966-250						1.25	

Order Code

Example:	<b>1966-25-G-T-S</b>
<b>1966-25</b>	Lounge chair with arms
<b>G</b>	Grey strap
<b>T</b>	Grey Tone mesh
<b>S</b>	Weatherable Silver frame

Specify:  
1. Pattern number  
2. Strap color  
3. Mesh color  
4. Frame color

Ordering Information

*Strap finishes:*  
White (suffix W)  
Brown (suffix B)  
Grey (suffix G)  
Onyx (suffix O)  
Sand (suffix S)  
Bronze (suffix Z)

*Mesh finishes:*  
White (suffix W)  
Grey Tone (suffix T)  
Onyx (suffix O)  
Aluminum (suffix A)  
Bronze (suffix Z)  
Chestnut (suffix N)

*Frame finishes:*  
Blue (suffix BLU)  
Chestnut (suffix N)  
Dark Bronze (suffix 14)  
Green (suffix 007)  
Light Bronze (suffix 13)  
Lime Green (suffix LGR)  
Onyx (suffix O)  
Orange (suffix ORG)  
Plum (suffix PLM)  
Sky Blue (suffix 3)  
Warm Wood (suffix 12)  
Weatherable Silver (suffix S)  
White (suffix W)  
Yellow (suffix YEL)

*Maintenance:*  
See pages 28-29.

*Outdoor Care Guidelines*  
See page 30.

*Upholstery/COM information:*  
Prices shown include fabric upholstery only. Contact your Knoll representative for colors.

Customer's Own Material is available pending approval. For approval requirements, processing instructions and ordering information, please see page 21

pattern no.	COM	
<b>1966-25-( )-( )</b>		\$2,962.
<b>1966-25COV</b>		536.
<b>1966-25R-( )-( )</b>		3,750.
<b>1966-25RCOV</b>		632.
<b>1966-255-( )-( )</b>		4,052.
<b>1966-255COV</b>		951.
<b>1966-255R-( )-( )</b>		4,878.
<b>1966-255RCOV</b>		1,129.
<b>1966-355-( )-( )</b>		5,345.
<b>1966-355COV</b>		1,309.
<b>1966-250-( )-( )</b>		2,618.
<b>1966-250COV</b>		695.
<b>1966-25P</b>	671.	715.
<b>1966-250P</b>	622.	661.

Construction

*Frame:*  
Frame is aluminum castings and extrusions welded and glued together using a two-part epoxy. Finished in highly durable weather resistant polyester powder coat paint.

*Seat:*  
Woven vinyl coated polyester mesh is sewn to pure vinyl straps using Teflon thread to form the seat and back. Stainless steel supports provides shape and is attached to the frame with stainless steel connectors.



*Glides:*  
Clear butyrate plastic.

Approved KnollTextiles Grades/Fabrics

- B** Belize  
Prairie  
Vinyl
- C** Baxter  
Noble  
Sinclair

*Check with your KnollTextiles Representative for changes or additions.*

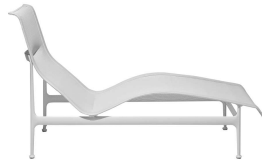
Richard Schultz  
1966 Collection® Chaise Lounge Chairs

	description	seat h	w	d	h	textile fabric yds.	weight
<i>Designer(s):</i> Richard Schultz, 1966    	<b>1966-41</b> Contour chaise lounge	13"	24½"	58"	33¾"		32 lbs.
	<b>1966-41COV</b> Contour chaise lounge cover						
	<b>1966-42</b> Adjustable chaise lounge	14¾"	25½"	76"	36"		37 lbs.
	<b>1966-42COV</b> Adjustable chaise lounge cover						
	<b>1966-41P</b> 1966 Contour chaise pad					2.5	
	<b>1966-42P</b> 1966 Adjustable chaise pad					2.5	

pattern no.	COM	
<b>1966-41-( )-( )</b>		\$4,628.
<b>1966-41COV</b>		1,338.
<b>1966-42-( )-( )</b>		6,157.
<b>1966-42COV</b>		1,158.
<b>1966-41P</b>	1,241.	1,316.
<b>1966-42P</b>	970.	1,048.

Order Code	Ordering Information
<i>Example:</i> <b>1966-41-W-W-W</b>	
<b>1966-41</b> Contour chaise lounge	<i>Strap finishes:</i> White (suffix W) Brown (suffix B) Grey (suffix G) Onyx (suffix O) Sand (suffix S) Bronze (suffix Z)
<b>W</b> White strap	<i>Frame finishes:</i> Blue (suffix BLU) Chestnut (suffix N) Dark Bronze (suffix 14) Green (suffix 007) Light Bronze (suffix 13) Lime Green (suffix LGR) Onyx (suffix O) Orange (suffix ORG) Plum (suffix PLM) Sky Blue (suffix 3) Warm Wood (suffix 12) Weatherable Silver (suffix S) White (suffix W) Yellow (suffix YEL)
<b>W</b> White mesh	<i>Maintenance:</i> See pages 28-29.
<b>W</b> White frame	<i>Outdoor Care Guidelines:</i> See page 30.
	<i>Upholstery/COM information:</i> Prices shown include fabric upholstery only. Contact your Knoll representative for colors.
<i>Specify:</i> 1. Pattern number 2. Strap color 3. Mesh color 4. Frame color	Customer's Own Material is available pending approval. For approval requirements, processing instructions and ordering information, please see page 21

Construction	Approved KnollTextiles Grades/Fabrics
<i>Frame:</i> Frame is aluminum castings and extrusions welded and glued together using a two-part epoxy. Finished in highly durable weather resistant polyester powder coat paint.	<b>B</b> Belize Prairie Vinyl
<i>Seat:</i> Woven vinyl coated polyester mesh is sewn to pure vinyl straps using Teflon thread to form the seat and back. Stainless steel supports provides shape and is attached to the frame with stainless steel connectors.	<b>C</b> Baxter Noble Sinclair
<i>Glides:</i> Clear butyrate plastic.	<i>Check with your KnollTextiles Representative for changes or additions.</i>

	description	seat h	w	d	h	textile fabric yds.	weight
<p><i>Designer(s):</i> Richard Schultz, 2007</p> 	<b>SWELL-31</b> Single seat club chair	16 1/2"	30"	31 1/2"	28"		22 lbs.
	<b>SWELL-31COV</b> Single seat club chair cover						
	<b>SWELL-32</b> Two seat sofa	16 1/2"	58 1/2"	31 1/2"	28"		42 lbs.
	<b>SWELL-32COV</b> Two seat sofa cover						
	<b>SWELL-33</b> Three seat sofa	16 1/2"	87"	31 1/2"	28"		63 lbs.
	<b>SWELL-33COV</b> Three seat sofa cover						
	<b>SWELL-20P</b> 20" square pillow for SWELL-31, 32, 33					0.75	
	<b>SWELL-31P</b> Seat pad for SWELL-31, 32, 33					2.75	





pattern no.		COM	
<b>SWELL-31-(-)-(-)</b>	\$4,276.		
<b>SWELL-31COV</b>		655.	
<b>SWELL-32-(-)-(-)</b>		6,744.	
<b>SWELL-32COV</b>		1,095.	
<b>SWELL-33-(-)-(-)</b>		8,587.	
<b>SWELL-33COV</b>		1,377.	
<b>SWELL-20P</b>		342.	364.
<b>SWELL-31P</b>		1,331.	1,416.

Order Code	Ordering Information
<i>Example:</i> <b>SWELL-33-B-W-W</b>	
<b>SWELL-33</b> Three seat sofa	<i>Strap finishes:</i> White (suffix W) Brown (suffix B) Grey (suffix G) Onyx (suffix O) Sand (suffix S) Bronze (suffix Z)
<b>B</b> Brown strap	<i>Frame finishes:</i> Blue (suffix BLU) Chestnut (suffix N) Dark Bronze (suffix 14) Green (suffix 007) Light Bronze (suffix 13) Lime Green (suffix LGR) Onyx (suffix O) Orange (suffix ORG) Plum (suffix PLM) Sky Blue (suffix 3) Warm Wood (suffix 12) Weatherable Silver (suffix S) White (suffix W) Yellow (suffix YEL)
<b>W</b> White mesh	<i>Maintenance:</i> See pages 28-29.
<b>W</b> White frame	<i>Outdoor Care Guidelines:</i> See page 30.
	<i>Upholstery/COM information:</i> Prices shown include fabric upholstery only. Contact your Knoll representative for colors.
	Customer's Own Material is available pending approval. For approval requirements, processing instructions and ordering information, please see page 21
<i>Specify:</i> 1. Pattern number 2. Strap color 3. Mesh color 4. Frame color	<i>Mesh finishes:</i> White (suffix W) Grey Tone (suffix T) Onyx (suffix O) Aluminum (suffix A) Bronze (suffix Z) Chestnut (suffix N)

Construction	Approved KnollTextiles Grades/Fabrics
<i>Frame:</i> Frame is aluminum castings and extrusions welded and glued together using a two-part epoxy. Finished in highly durable weather resistant polyester powder coat paint.	<b>B</b> Belize Prairie Vinyl
<i>Seat:</i> Woven vinyl coated polyester mesh is sewn to pure vinyl straps using Teflon thread to form the seat and back. Stainless steel supports provides shape and is attached to the frame with stainless steel connectors.	<b>C</b> Baxter Noble Sinclair
<i>Glides:</i> Clear butyrate plastic.	<i>Check with your KnollTextiles Representative for changes or additions.</i>

Designer(s):  
 Richard Schultz, 1996



description	seat h	arm h	w	d	h	textile fabric yds.	weight
<b>TOP-45</b> Topiary dining chair	18"	25"	26 1/2"	24"	34"		38 lbs.
							
<b>TDCP</b> Chair pad for Topiary dining chair TOP-45						1.0	
<b>TOP-45COV</b> Topiary dining chair cover							
<b>TOP-25</b> Topiary lounge chair	16"	21 1/2"	32"	32"	30 1/2"		45 lbs.
							
<b>TLCP</b> Chair pad for Topiary lounge chair TOP-25						1.0	
<b>TOP-25COV</b> Topiary lounge chair cover							
<b>TOP-455</b> Topiary bench	18"	25"	55"	26"	34 1/2"		84 lbs.
							
<b>TBP</b> Chair pad for Topiary bench TOP-455						2.0	
<b>TOP-455COV</b> Topiary bench cover							
<b>TOP-250</b> Topiary small ottoman/end table			20 3/4"	22"	15"		23 lbs.
							
<b>TSOP</b> Seat pad for Topiary ottoman TOP-250						1.0	
<b>TOP-250COV</b> Topiary small ottoman/end table cover							

**Order Code**

Example:	<b>TOP-455-1</b>
<b>TOP-455</b>	Bench
<b>1</b>	Forest Green finish

Specify:

1. Pattern number
2. Finish color

**Ordering Information**

<b>Finishes:</b>	Sky Blue (suffix 3)
Blue (suffix BLU)	Terra Cotta (suffix 5)
Chestnut (suffix N)	Warm Wood (suffix 12)
Choice White (suffix 6)	Weatherable Silver (suffix S)
Daffodil Yellow (suffix 2)	White (suffix W)
Dark Bronze (suffix 14)	Yellow (suffix YEL)
Forest Green (suffix 1)	
Green (suffix 007)	
Light Bronze (suffix 13)	
Lime Green (suffix LGR)	
Onyx (suffix 0)	
Orange (suffix ORG)	
Plum (suffix PLM)	

**Maintenance:**  
 See pages 28-29.

**Upholstery/COM information:**  
 Prices shown include fabric upholstery only. Contact your Knoll representative for colors.

Customer's Own Material is available pending approval. For approval requirements, processing instructions and ordering information, please see page 21

pattern no.		COM	
<b>TOP-45- ( )</b>	\$2,665.	<b>B</b>	<b>C</b>
<b>TDCP</b>		471.	502.
<b>TOP-45COV</b>	588.		
<b>TOP-25- ( )</b>	3,443.		
<b>TLCP</b>		648.	679.
<b>TOP-25COV</b>	628.		
<b>TOP-455- ( )</b>	5,104.		
<b>TBP</b>		981.	1,044.
<b>TOP-455COV</b>	1,134.		
<b>TOP-250- ( )</b>	2,267.		
<b>TSOP</b>		622.	652.
<b>TOP-250COV</b>	516.		

**Construction**

**Topiary frame:**  
 3/16" aluminum sheet stamped and formed. Stainless steel connectors and finished in highly durable weather resistant polyester powder coat paint. Clear butyrate plastic glides.

**Approved KnollTextiles Grades/Fabrics**

- B** Belize  
 Prairie  
 Vinyl
- C** Baxter  
 Noble  
 Sinclair

Check with your KnollTextiles Representative for changes or additions.





# Shelton Mindel

## Shelton Mindel Side Chair

*Designer(s):*  
Peter Shelton and Lee Mindel,  
2006

*Award(s):*  
Good Design Award, 2006

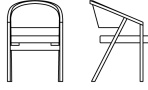

description	seat h	arm h	w	d	h	textile fabric yds.	leather sq. ft.	weight	finish
<b>SM8A</b> Arm chair 	18"	23 1/2"	22"	23 1/2"	32"	1	18	19 lbs.	Other finishes
	18"	23 1/2"	22"	23 1/2"	32"	1	18	24 lbs.	Golden Oak, Maple
	18"	23 1/2"	22"	23 1/2"	32"	1	18	22 lbs.	Light Walnut
<b>SM8A-U</b> Arm chair, fully uph. 	18"	23 1/2"	22"	23 1/2"	32"	1.5	27	20 lbs.	Other finishes
	18"	23 1/2"	22"	23 1/2"	32"	1.5	27	25 lbs.	Golden Oak, Maple
	18"	23 1/2"	22"	23 1/2"	32"	1.5	27	23 lbs.	Light Walnut
<b>SM8R</b> seat basket replacement for SM8A and SM8A-U						1	18		

Order Code	Ordering Information	Construction
<i>Example:</i> <b>SM8A-B312-K162/20</b>	<i>Oak with light lacquer finish:</i> Golden Oak (suffix GO)	<i>KnollStudio wood finishes:</i> KnollStudio wood finishes complement a large variety of KnollStudio veneer and Knoll Office veneer finishes. To select correct complementary finish, please refer to KnollStudio Wood Finish Matrix on page 26. If no complementary standard finish is available, please refer to custom finish policy below.
<b>SM8A</b>	Shelton Mindel side chair, seat upholstery only	<i>Frame:</i> Available in Beech, Walnut and Oak hardwood with mortise and tenon construction.
<b>B312</b>	Bronzed Cherry	<i>Upholstered Seat:</i> 1 1/4" thick seat filled with high density polyurethane foam, with elastic webbing suspension in a cross weave. Seat frame is constructed of 1" plywood.
<b>K162/20</b>	Classic Boucle, Neutral	<i>Fully Upholstered:</i> Inside back upholstery is inset in frame. * indicates approved textiles and leathers.
	<i>Maple:</i> Clear Maple (suffix KC)	<i>Finish:</i> Satin catalyzed lacquer finish. Oak and Walnut versions have lower sheen.
	<i>Beech frame stains:</i> Bronzed Cherry (suffix B312A) Burnt Walnut (suffix B313) Ebonized (suffix BE) Light Cherry (suffix B315) Light Walnut (suffix B411) Medium Cherry (suffix B319) Medium Red Mahogany (suffix BR) Medium Walnut (suffix B323) Natural Beech (suffix BN) Peacock Green Walnut (suffix B415) Smoked Walnut (suffix B418)	<i>Cal 133 Fire Code:</i> The Shelton Mindel Side Chairs comply with the California Technical Bulletin 133 standard if upholstered in Cal 133 approved upholstery. Specify suffix -C at end of pattern number and suffix -133 at end of textile selection. Upcharge applies, see page 22.
	<i>Upholstery/COM information:</i> Prices shown include fabric or leather upholstery. Contact your Knoll representative for colors. Only approved KnollTextiles and Spinneybeck leathers may be ordered.	<i>Maintenance:</i> See pages 28-29.
	Customer's Own Material is available pending approval. For approval requirements, processing instructions and ordering information please see page 21.	<i>Note:</i> The Shelton Mindel Side Chair is certified Clean Air GOLD.
		<i>Certified Wood:</i> Chairs manufactured using FSC certified hardwoods are available through Custom Product Development. Extended leadtime and upcharge apply.

pattern no.	grades	COM								COM				
	A	B	C	D	E	F	G	H	I	U	V	W	X	Y
<b>SM8A-( )</b>	\$2,351.	\$2,390.	\$2,430.	\$2,475.	\$2,509.	\$2,535.	\$2,578.	\$2,658.	\$2,718.	\$2,915.	\$3,064.	\$3,361.	\$3,426.	\$3,499.
<b>SM8A-(GO,KC)</b>	2,820.	2,861.	2,901.	2,945.	2,979.	3,006.	3,047.	3,132.	3,194.	3,387.	3,535.	3,838.	3,896.	3,972.
<b>SM8A-(LWT)</b>	3,213.	3,256.	3,296.	3,339.	3,377.	3,399.	3,440.	3,526.	3,586.	3,781.	3,927.	4,229.	4,287.	4,367.
<b>SM8A-U-( )</b>	2,829.	2,890.	2,950.	3,015.	3,066.	3,104.	3,171.	3,296.	3,386.	3,679.	3,896.	4,349.	4,444.	4,552.
<b>SM8A-U-(GO,KC)</b>	3,213.	3,275.	3,331.	3,399.	3,452.	3,490.	3,557.	3,680.	3,768.	4,063.	4,281.	4,735.	4,830.	4,938.
<b>SM8A-U-(LWT)</b>	3,641.	3,701.	3,756.	3,824.	3,877.	3,916.	3,982.	4,108.	4,199.	4,486.	4,706.	5,158.	5,253.	5,362.
<b>SM8R-( )</b>	635.	672.	708.	742.	773.	795.	835.	908.	958.	1,445.	1,577.	1,839.	1,891.	1,956.

Approved KnollTextiles Grades/Fabrics						Spinneybeck Leather	
<b>A</b> Alignment Beacon * Bocce * Chance * Common Ground Commuter Cloth * Cross Tech Crossroad Delite * Facet Hourglass * Infinite * Mariner * Monarch Overture * Prep * Presto * Soliloquy * Sonnet * Trophy * Uni-Form *	<b>B</b> continued Knoll Felt * Knoll Hopsack * Little Devil Ludlow * Melody <sup>Ⓞ</sup> Commuter Cloth * Prairie * Prim * Puff Radiance * Ransom * Roam * Rush Hour * Shadow Play Spree * Summit * Sutton * Soliloquy * Sonnet * Trophy * Uni-Form *	<b>C</b> continued Hudson * Kaleidoscope CR Lagos * Lore CR * Magnolia * Milestone * On Point Palisade * Panache CR Patchwork * Plaid On Prestini * Pullman * Quark * Roundtrip * Sahara Sequin CR Sinclair * Smart * Spectator * Stepping Stones Swing * Tight Rope * Tilden Tower Grid * Utmost II * Utopia * Wit * Wow Factor *	<b>D</b> continued Menagerie * Origins * Plaidtastic * Retreat * Vice Versa * Woodland * Zoom  <b>E</b> Aegean * Circle Point Cleo * Demure Flower Power Highland * Ikat Stripe * Juno * Kampala * Kimono Mamba Marquee * Meroe Midpoint * Nature Walk * Rebel * Sherman * Vatera *	<b>F</b> continued Soon * Swank * Totem * Tweed Frieze  <b>G</b> All Star * Alter Ego Arber * Aurora * Color Collage Dapper * Duchess Fancy Twill * Haze Kamani * Looped In * Melange * Modern Tweed * Rivers * Spencer Straie Stripe * Ultrasuede * Utrillo Vert *	<b>I</b> Aswan * Bella * Byron * Cato * Chic * Cummings * Diamond Days Doily Dynamic * Floressence * Guise Hastings * Ita * Jaipur Knoll Velvet * Limani North Island * Olema * Piper * Prince Hairy * Rutledge * Sandis Stripe It * Tudor * Zimba *	<b>U</b> Vicenza * Volo *  <b>V</b> Acqua * Andes * Embossed Tipped * España * Maremma Velluto Pelle *  <b>W</b> Alaska * Amazon * Antique * Forte * Lucente Sabrina * Umbria	<b>X</b> Ducale * Ducale Velour *  <b>Y</b> Cervo * Copenhagen * Distressed * Gemma Lucca Marissa * Riva *
						*Approved for fully upholstered versions. <sup>Ⓞ</sup> Fire Retardants Chemicals	
						Check with your KnollTextiles or Spinneybeck Representative for changes or additions.	

# Shelton Mindel

## SM1 Lounge Collection

Designer(s):  
Peter Shelton and Lee Mindel,  
2006



description	seat h	arm h	w	d	h	textile fabric yds.	leather sq. ft.	weight
<b>SM1-1</b> SM1 Lounge chair	15 1/2"	25 1/2"	39"	32 1/4"	25 1/2"	6.5	80	83 lbs.
<b>SM1-2</b> SM1 Settee	15 1/2"	25 1/2"	61 1/2"	32 1/4"	25 1/2"	9.0	120	96 lbs.
<b>SM1-3</b> SM1 Sofa	15 1/2"	25 1/2"	85 1/2"	32 1/4"	25 1/2"	11.3	148	116 lbs.

Order Code	Ordering Information	Construction
------------	----------------------	--------------

<i>Example:</i> <b>SM1-1-AOC-K349/1</b>	<i>Leg finishes:</i> Clear Oak (suffix AOC) Ebonized (suffix AE) Polished Stainless Steel (suffix S)	<i>Frame:</i> Constructed in multi ply plywood with sinuous spring seat suspension and elastic webbing back suspension.
<b>SM1-1</b> SM1 Lounge Chair		
<b>AOC</b> Clear Oak legs		
<b>K349/1</b> Alignment, Sand		

*Upholstery/COM information:*  
Prices shown include fabric or leather upholstery. Contact your Knoll representative for colors. Only approved KnollTextiles and Spinneybeck leathers may be ordered.

*Upholstery:*  
Seat and back cushions are continuous on all models.

*Cushion fill:*  
Arm, seat and back cushions in variable density foam with Dacron wrap.

*Stitching:*  
Double-needled topstitching on leather upholstery. Double-needled topstitching on thin solid textiles, single-blind stitching on heavily ribbed fabrics and multicolor prints.

*Legs:*  
Round legs in Ash hardwood stained in Clear Oak, Ebonized or Polished Stainless Steel finish.

Customer's Own Material is available pending approval. For approval requirements, processing instructions and ordering information please see page 21.

*Cal 133 Fire Code #:*  
The SM1 Lounge Collection complies with the California Technical Bulletin 133 standard if upholstered in Cal 133 approved upholstery. Specify suffix -C at end of pattern number and suffix -133 at end of textile selection. Upcharge applies, see page 22.

*Maintenance:*  
See pages 28-29.

The SM1 lounge collection is part of a collection. Please refer to the Shelton Mindel side chair on page 352, SM2 lounge collection on page 356 and the SM table collection on page 498.

*Specify:*

1. Pattern number
2. Leg finish
3. Textile selection

pattern no.	grades	COM	C	D	E	F	G	H	I	COL	V	W	X	Y
<b>SM1-1-(-)(-)</b>	\$6,044.	\$6,310.	\$6,564.	\$6,845.	\$7,076.	\$7,243.	\$7,525.	\$8,061.	\$8,453.	\$9,686.	\$10,509.	\$12,180.	\$12,530.	\$12,933.

<b>SM1-2-(-)(-)</b>	9,022.	9,394.	9,749.	10,139.	10,455.	10,686.	11,073.	11,821.	12,365.	14,373.	15,608.	18,120.	18,638.	19,245.
---------------------	--------	--------	--------	---------	---------	---------	---------	---------	---------	---------	---------	---------	---------	---------

<b>SM1-3-(-)(-)</b>	10,657.	11,122.	11,570.	12,057.	12,456.	12,746.	13,236.	14,167.	14,855.	17,197.	18,718.	21,813.	22,453.	23,205.
---------------------	---------	---------	---------	---------	---------	---------	---------	---------	---------	---------	---------	---------	---------	---------

### Approved KnollTextiles Grades/Fabrics

<b>A</b> Alignment Beacon Bocce Chance Common Ground Commuter Cloth Cross Tech Crossroad Delite Facet Heavy Metal Hourglass Infinite Mariner Monarch Oh La La Overture Prep Presto Sonnet Trophy Uni-Form	<b>B</b> Argyle Belize Bistro Calypso Chronicle Day Tripper Diva Dottie Ferry Gala II Helios Holbrook Instinct Journey Keaton Knoll Felt Knoll Hopsack Little Devil Ludlow Melody Paradigm Petal Pusher Prairie	<b>C</b> continued Prim Radiance Ransom Roam Rush Hour Spree Summit Sutton Synth Tabloid Tinge Vast Venue Versa Vinyl Westwood Wild Thing	<b>D</b> Coterie Eclat Weave * Island Kabuki Menagerie Origins Pathway Retreat Vice Versa Woodland	<b>E</b> continued Roundtrip Sahara Sequin CR Swing Tight Rope Tilden Tower Grid Utmost II Utopia Wit	<b>F</b> Atelier Biscayne Calais Cotton Velvet Century Cornaro Double Agent Imprint In Stitches Liberty Mod Plaid Rivington Soon Swank Totem Tweed Frieze *	<b>G</b> All Star Aurora Dapper Djenne Fancy Twill Haze * Looped In Melange Modern Tweed Spencer Ultrasuede Vert	<b>H</b> Chiseled Constance Firefly	<b>I</b> Bella Cato Chic Diamond Days Doily Dynamic Floressence Guise Hastings Knoll Velvet * Olema Piper Prince Hairy Rutledge Sandis Tudor Zimba	<b>U</b> Vicenza Volo	<b>V</b> Acqua Andes Embossed Tipped España Velluto Pelle	<b>W</b> Alaska Amazon Antique Derby Forte Lucente Sabrina Umbria	<b>X</b> Ducale Ducale Velour	<b>Y</b> Cascia Cervo Copenhagen Distressed Marissa Riva Rugata Saddle
---	--	---	--	--	---	--	--	---	-----------------------------	--	---	-------------------------------------	--

### Spinneybeck Leather

<b>U</b> Vicenza Volo	<b>V</b> Acqua Andes Embossed Tipped España Velluto Pelle	<b>W</b> Alaska Amazon Antique Derby Forte Lucente Sabrina Umbria	<b>X</b> Ducale Ducale Velour	<b>Y</b> Cascia Cervo Copenhagen Distressed Marissa Riva Rugata Saddle
-----------------------------	--	---	-------------------------------------	--

\* Indicates fabrics without topstitching.  
Ⓢ Fire Retardants Chemicals

Check with your KnollTextiles or Spinneybeck Representative for additions or changes.

# Shelton Mindel

## SM2 Lounge Collection

Designer(s):  
Peter Shelton and Lee Mindel,  
2006



description	seat h	arm h	w	d	h	type	textile	leather	weight
							fabric yds.	sq ft	
<b>SM2-1</b> SM2 Lounge chair, same upholstery, frame and cushions	18 3/4"	24"	39 3/8"	35 1/4"	30 1/2"		8.3	124	56 lbs.
<b>SM2-1</b> SM2 Lounge chair, combination upholstery, frame and cushions	18 3/4"		39 3/8"	35 1/4"	30 1/2"	frame uph.	5	76	
						upchg. cushions	4.25	56	

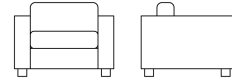

Order Code	Ordering Information	Construction
<i>Example:</i> <b>SM2-2-S-K349/1</b>	<i>Leg finishes:</i> Clear Oak (suffix AOC) Ebonized (suffix AE) Polished Stainless Steel (suffix S)	<i>Frame:</i> Constructed in 3/8" multi ply plywood with sinuous spring seat suspension and matrix back suspension.
<b>SM2-2</b> SM2 Lounge Collection, settee		<i>Cushion fill:</i> Arm, seat and back cushions in variable density foams with Dacron wrap. The seat and back cushions are filled with memory foam.
<b>S</b> Stainless Steel legs		<i>Stitching:</i> Double needle top stitching on arms and back. Single needle top stitching on seat and back cushions in textile, double needle stitching for leather.
<b>K349/1</b> Alignment, Sand	<i>Upholstery/ COM information:</i> Prices shown includes fabric or leather upholstery. Contact your Knoll representative for colors. Only approved KnollTextiles and Spinneybeck leathers may be ordered.	<i>Legs:</i> Round legs in Ash substrate with a Clear Oak, Ebonized or Polished Stainless Steel finish.
<i>Example:</i> <b>SM2S-2-AE-VOBLK-K349/1</b>	<i>Customer's Own Material</i> is available pending approval. For approval requirements, processing instructions and ordering information please see page 21.	
<b>SM2-2</b> SM2 Lounge Collection, settee		
<b>AE</b> Ebonized legs		
<b>VOBLK</b> Surround in Volo, Black		
<b>K349/1</b> Cushions in Alignment, Sand		

The SM2 lounge collection is part of a collection. Please refer to the Shelton Mindel side chair on page 352, SM1 lounge collection on page 354 and SM table collection on page 498.

*Specify:*

1. Pattern number
2. Leg finish
3. Textile selection

*Specify with split upholstery:*

1. Pattern number
2. Leg finish
3. Textile selection, Surround
4. Textile selection, Cushions

*Cal 133 Fire Code #:*

The SM2 Lounge Collection complies with the California Technical Bulletin 133 standard if upholstered in Cal 133 approved upholstery. Specify suffix -C at end of pattern number and suffix -133 at end of textile selection. Upcharge applies, see page 22.

*Maintenance:*

See pages 28-29.

pattern no.	grades	COM	C	D	E	F	G	H	I	COL	V	W	X	Y
<b>SM2-1-(-)(-)</b>	\$7,788.	\$8,133.	\$8,453.	\$8,819.	\$9,109.	\$9,323.	\$9,683.	\$10,368.	\$10,871.	\$13,271.	\$14,541.	\$17,160.	\$17,680.	\$18,301.
<b>SM2S-1-(-)(-)(-)</b>	6,235.	6,485.	6,716.	6,980.	7,189.	7,342.	7,602.	8,098.	8,467.	9,160.	9,943.	11,530.	11,864.	12,247.
<b>upchg, cushions</b>	2,293.	2,470.	2,636.	2,820.	2,968.	3,080.	3,261.	3,614.	3,874.	4,464.	5,038.	6,213.	6,456.	6,737.

Approved KnollTextiles Grades/Fabrics						Spinneybeck Leather	
<b>A</b> Alignment Beacon Bocce Chance Common Ground Commuter Cloth Cross Tech Crossroad Delite Facet Heavy Metal Hourglass Infinite Mariner Monarch Overture Prep Presto Sonnet Trophy Uni-Form	<b>B</b> continued Knoll Hopsack Little Devil Ludlow Melody <sup>Ⓞ</sup> Paradigm Petal Pusher <sup>Ⓞ</sup> Prairie Prim Radiance Ransom Roam Rush Hour Spree Summit Sutton Synth Tabloid Tinge Venue Vast Versa Vinyl <sup>Ⓞ</sup> Westwood	<b>C</b> continued Entourage Entwine Essence Fibra Greenwich Hudson Kaleidoscope CR Lagos Milestone On Point Palisade Panache CR * Patchwork Plaid On Prestini Pullman Roundtrip Sahara Sequin CR Stepping Stones Swing Tight Rope Tilden <sup>Ⓞ</sup> Tower Grid Utmost II Utopia Wit Zari CR	<b>D</b> continued Menagerie Origins Pathway Retreat Vice Versa Woodland  <b>E</b> Aegean Circle Point Demure Flower Power Highland Kampala Ikat Stripe Mamba Marquee Meroe Nature Walk Rebel Shima Meroe Tryst Whip	<b>F</b> continued Soon Totem Tweed Frieze *  <b>G</b> Aurora Dapper Djenne Fancy Twill Haze * Looped In Melange Modern Tweed Spencer Ultrasuede Vert	<b>H</b> Chiseled Constance Firefly  <b>I</b> Bella Cato * Chic Diamond Days Doily Dynamic Floressence Guisse Hastings Knoll Velvet * Olema Piper Rutledge Sandis Tudor Zimba	<b>U</b> Vicenza Volo  <b>V</b> Acqua Andes Embossed Tipped España Velluto Pelle  <b>W</b> Alaska Amazon Antique Derby Forte Lucente Sabrina Umbria	<b>X</b> Ducale Ducale Velour  <b>Y</b> Cascia Cervo Copenhagen Distressed Marissa Riva Rugata Saddle

\* Indicates fabrics without topstitching.  
<sup>Ⓞ</sup> Fire Retardants Chemicals

Check with your KnollTextiles or Spinneybeck Representative for additions or changes.

# Shelton Mindel SM2 Lounge Collection

Designer(s):  
Peter Shelton and Lee Mindel,  
2006



description	seat h	arm h	w	d	height	type	textile fabric yds.	leather sq ft	weight
<b>SM2-2</b> SM2 Settee, same upholstery, frame and cushions	18 1/4"	24"	60 1/2"	35 1/4"	30 1/2"		13.25	168	77 lbs.
<b>SM2-2</b> SM2 Settee, combination upholstery, frame and cushions	18 1/4"	24"	60 1/2"	35 1/4"	30 1/2"	frame uph.	7.5	104	
						upchg, cushions	7.5	80	
<b>SM2-3</b> SM2 Sofa, same upholstery, frame and cushions	18 1/4"	24"	93 1/2"	35 1/4"	30 1/2"		19.5	208	108 lbs.
<b>SM2-3</b> SM2 Sofa, combination upholstery, frame and cushions	18 1/4"	24"	93 1/2"	35 1/4"	30 1/2"	frame uph.	9.5	128	
						upchg, cushions	11.25	104	

Order Code	Ordering Information	Construction
<i>Example:</i> <b>SM2-2-S-K349/1</b>	<i>Leg finishes:</i> Clear Oak (suffix AOC) Ebonyed (suffix AE) Polished Stainless Steel (suffix S)	<i>Frame:</i> Constructed in 3/8" multi ply plywood with sinuous spring seat suspension and matrix back suspension.
<b>S</b>	Stainless Steel legs	
<b>K349/1</b>	Alignment, Sand	
<i>Example:</i> <b>SM2S-2-AE-VOBLK-K349/1</b>	<i>Upholstery/ COM information:</i> Prices shown includes fabric or leather upholstery. Contact your Knoll representative for colors. Only approved KnollTextiles and Spinneybeck leathers may be ordered.	<i>Cushion fill:</i> Arm, seat and back cushions in variable density foams with Dacron wrap. The seat and back cushions are filled with memory foam.
<b>SM2-2</b>	SM2 Lounge Collection, settee	
<b>AE</b>	Ebonized legs	
<b>VOBLK</b>	Surround in Volo, Black	
<b>K349/1</b>	Cushions in Alignment, Sand	
	Customer's Own Material is available pending approval. For approval requirements, processing instructions and ordering information please see page 21.	<i>Stitching:</i> Double needle top stitching on arms and back. Single needle top stitching on seat and back cushions in textile, double needle stitching for leather.
	<i>Cal 133 Fire Code #:</i> The SM2 Lounge Collection complies with the California Technical Bulletin 133 standard if upholstered in Cal 133 approved upholstery. Specify suffix -C at end of pattern number and suffix -133 at end of textile selection. Upcharge applies, see page 22.	<i>Legs:</i> Round legs in Ash substrate with a Clear Oak, Ebonyed or Polished Stainless Steel finish.

Specify with split upholstery:

1. Pattern number
2. Leg finish
3. Textile selection, Surround
4. Textile selection, Cushions

pattern no.	grade	COM	C	D	E	F	G	H	I	COL	V	W	X	Y
<b>SM2-2-(-)(-)</b>	\$11,664.	\$12,209.	\$12,731.	\$13,304.	\$13,773.	\$14,110.	\$14,688.	\$15,778.	\$16,585.	\$18,864.	\$20,591.	\$24,104.	\$24,834.	\$25,683.
<b>SM2S-2-(-)(-)(-)</b>	9,147.	9,476.	9,791.	10,140.	10,421.	10,627.	10,972.	11,635.	12,122.	13,170.	14,239.	16,415.	16,864.	17,394.
<b>upchg, cushionsS</b>	3,425.	3,732.	4,026.	4,350.	4,616.	4,807.	5,134.	5,753.	6,213.	6,413.	7,233.	8,907.	9,257.	9,661.
<b>SM2-3-(-)(-)</b>	15,091.	15,896.	16,665.	17,508.	18,197.	18,698.	19,545.	21,153.	22,341.	23,827.	25,965.	30,313.	31,219.	32,271.
<b>SM2S-3-(-)(-)(-)</b>	11,804.	12,280.	12,733.	13,230.	13,639.	13,932.	14,432.	15,380.	16,082.	16,629.	17,947.	20,620.	21,178.	21,824.
<b>upchg, cushionsSO</b>	4,497.	4,959.	5,403.	5,895.	6,289.	6,579.	7,061.	7,992.	8,681.	8,269.	9,340.	11,513.	11,965.	12,493.

Approved KnollTextiles Grades/Fabrics						Spinneybeck Leather	
<b>A</b> Alignment Beacon Bocce Chance Common Ground Commuter Cloth Cross Tech Crossroad Delite Facet Heavy Metal Hourglass Infinite Mariner Monarch Overture Prep Presto Sonnet Trophy Uni-Form	<b>B</b> continued Knoll Hopsack Little Devil Ludlow Melody <sup>Ⓞ</sup> Paradigm Petal Pusher <sup>Ⓞ</sup> Prairie Prim Radiance Ransom Roam Rush Hour Spree Summit Sutton Synth Tabloid Tinge Venue Vast Versa Vinyl <sup>Ⓞ</sup> Westwood	<b>C</b> continued Entourage Entwine Essence Fibra Greenwich Hudson Kaleidoscope CR Lagos Milestone On Point Palisade Panache CR * Patchwork Plaid On Prestini Pullman Roundtrip Sahara Sequin CR Stepping Stones Swing Tight Rope Tilden <sup>Ⓞ</sup> Tower Grid Utmost II Utopia Wit Zari CR	<b>D</b> continued Menagerie Origins Pathway Retreat Vice Versa Woodland  <b>E</b> Aegean Circle Point Demure Flower Power Highland Kampala Ikat Stripe Mamba Marquee Meroe Nature Walk Rebel Shima Meroe Tryst Whip	<b>F</b> continued Soon Totem Tweed Frieze *  <b>G</b> Aurora Dapper Djenne Fancy Twill Haze * Looped In Melange Modern Tweed Spencer Ultrasuede Vert	<b>H</b> Chiseled Constance Firefly  <b>I</b> Bella Cato * Chic Diamond Days Doily Dynamic Florescence Guisse Hastings Knoll Velvet * Olema Piper Rutledge Sandis Tudor Zimba	<b>U</b> Vicenza Volo  <b>V</b> Acqua Andes Embossed Tipped España Velluto Pelle  <b>W</b> Alaska Amazon Antique Derby Forte Lucente Sabrina Umbria	<b>X</b> Ducale Ducale Velour  <b>Y</b> Cascia Cervo Copenhagen Distressed Marissa Riva Rugata Saddle
						* Indicates fabrics without topstitching. Ⓞ Fire Retardants Chemicals	
						<i>Check with your KnollTextiles or Spinneybeck Representative for additions or changes.</i>	

# Ufficio Tecnico Spoleto Chair

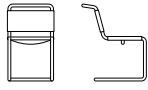

	description	seat h	w	d	h	weight
<i>Designer(s):</i> Ufficio Tecnico, 1971	<b>50CS</b> Spoleto armless chair	18"	18½"	23½"	32"	17 lbs.
						
	<b>50KIT</b> Replacement sling kit with nylon laces, cowhide					
	<b>50KIT</b> Replacement sling kit with nylon laces, belting leather					
	<b>50LACE</b> Replacement nylon laces for cowhide, belting leather and hair hide slings					

pattern no.	
<b>50CS-( )</b>	\$2,851.
<b>50KIT-L ( )</b>	1,283.
<b>50KIT-(BL, HH) ( )</b>	1,283.
<b>50LACE-(L, BL, HH)-( )</b>	123.

Order Code	Ordering Information
<i>Example:</i> <b>50CS-BL1901</b>	<i>Spinneybeck Belting Leather:</i>
<b>50CS</b> Spoleto armless chair	Black (suffix BLBLCK)
<b>BL1901</b> Belting leather, Fudge	Chocolate (suffix BL1902)
	Cognac (suffix BL1904)
	Dark Mustard (suffix BL1903)
	Dark Salmon (suffix BL1906)
	Deep Blue (suffix BL1912)
	Deep Green (suffix BL1911)
	Deep Purple (suffix BL1913)
	Fudge (suffix BL1901)
	Key Lime (suffix BL1910)
	Lemon Meringue (suffix BL1909)
	Simply Red (suffix BL1905)
	Sunshine (suffix BL1908)
	Sweet Potato (suffix BL1907)
	White (suffix BL1914)
	<i>Cowhide selection:</i>
	Black (suffix L80)
	Light Brown (suffix L82)
	White Beige (suffix L84)
<i>Specify:</i>	<i>Haired Hide:</i>
1. Pattern number	Black (BLCKHH)
2. Sling material and color selection	Chestnut (suffix OA12HH)
	Gold (suffix OCP5HH)
	Tan (suffix OCP3HH)
	Tri-Color (3COLHH)
	<i>Upholstery/COM information:</i>
	Prices shown include leather upholstery.
	<b>Customer's Own Material is not available.</b>
	<i>Maintenance:</i>
	See pages 28-29.
	<i>Note:</i>
	Please ask your Spinneybeck Representative for samples of the belting leather and haired hide.

Construction	
<i>Frame:</i>	<i>Laces:</i>
Seamless tubular steel in polished chrome finish.	Nylon laces are dyed to match specified leather. Haired hide and belting leather option will have nylon laces.
<i>Upholstery:</i>	<i>Glides:</i>
<i>Cowhide Slings:</i>	Four molded clear plastic glides with twin-pin snap-in construction included with all Spoleto chairs.
Thick cowhide leather slings in three colors. Edges dyed to match for Black and Light Brown colors. White Beige will have edges matching Light Brown cowhide color.	<i>Replacement Slings:</i>
<i>Belting Leather:</i>	Slings can be replaced in the field by field services or a furniture repair specialist. Kit includes back and seat replacement slings with nylon laces. Slings should be fitted by field services or by a professional upholsterer.
Highly durable Spinneybeck belting leather in fifteen colors. Belting leather edges will always match specified color.	
<i>Haired Hide:</i>	
Spinneybeck haired hide in eight colors. Haired Hide is a natural material, markings are one-of-a-kind and will vary from piece to piece.	

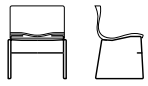
Vignelli Associates  
Handkerchief Armless Chair

	description	seat h	w	d	h	textile fabric yds.	weight
<i>Designer(s):</i> Vignelli Designs, 1983	<b>4901</b> Armless chair, unupholstered shell	18"	23"	22 1/2"	29"		21 lbs.
							
	<b>4901K-N</b> Armless chair, seat pad, non-stacking	18"	23"	22 1/2"	29"	0.7	23 lbs.
							
	<b>4901K-S</b> Armless chair, seat pad, stacking	18"	23"	22 1/2"	29"	0.7	23 lbs.
	<b>49100D</b> Stacking dolly		24 3/8"	26"	12"		10 lbs.
	<b>G</b> Optional glides						

Order Code	Ordering Information	Construction
<i>Example:</i> <b>4901-W-C</b>	<i>Shell colors:</i> Black (suffix B) Grey (suffix G) Midnight (MD) Red (suffix R) White (suffix W)	Customer's Own Material is available pending approval. For approval requirements, processing instructions and ordering information please see page 21.
<b>4901</b>	Handkerchief unupholstered armless chair	<i>Shell:</i> Compression-molded. Highly durable fiberglass reinforced polyester; with urethane paint finish.
<b>W</b>	White shell	<i>Seat pad:</i> High-resilience polyurethane cushion bonded to a semi-rigid thermoformed support.
<b>C</b>	Polished chrome frame	<i>Base:</i> 7/16" steel wire finished in brightly polished chrome.
	<i>Base finishes:</i> Polished Chrome (suffix C)	<i>Optional glides:</i> Nylon. (Add -G to end of pattern number)
	<i>Upholstery/COM information:</i> Prices shown include fabric upholstery. Contact your Knoll representative for colors. Only approved KnollTextiles and Spinneybeck leathers may be ordered.	<i>Stacking bumper:</i> Black flexible urethane stacking pad secured between base and shell.
	<i>Cal 133 Fire Code #:</i> The Handkerchief Chair complies with the California Technical Bulletin 133 standard if upholstered in Cal 133 approved upholstery. Specify suffix -C at end of pattern number and suffix -133 at end of textile selection. Upcharge applies, see page 22.	
	<i>Maintenance:</i> See pages 28-29.	
	<i>Note:</i> The Handkerchief Armless Chair is certified Clean Air GOLD.	

Note:  
The Vignelli Handkerchief side chairs are part of a collection. Please refer to Vignelli PaperClip Tables on page 506.

Specify:  
1. Pattern number  
2. Shell color selection  
3. Base finish selection  
4. Glide option  
5. Cal 133 Fire Code option for seat pad  
6. Textile selection for seat pad

pattern no.	upchg	grades <b>A</b>	COM <b>B</b>	<b>C</b>	<b>D</b>	<b>E</b>	<b>F</b>	<b>G</b>	<b>H</b>	<b>I</b>
<b>4901-(-)-C</b>	\$1,117.									
<b>4901K-N(-)-C(-)</b>		1,621.	1,652.	1,688.	1,722.	1,753.	1,777.	1,809.	1,882.	1,934.
<b>4901K-S(-)-C(-)</b>		1,682.	1,714.	1,750.	1,782.	1,809.	1,834.	1,871.	1,939.	1,991.
<b>49100D</b>	2,382.									
<b>G</b>	41.									

Approved KnollTextiles Grades/Fabrics					
<i>Stacking features:</i> 4901 and 4901K-S chairs stack 15-20 high. Chairs without stacking bumper (4901K-N) do not stack.	<b>A</b> Alignment Beacon Bocce Chance Common Ground Commuter Cloth Cross Tech Crossroad Delite Facet Hourglass Infinite Monarch Oh La La Overture Prep Soliloquy Sonnet Trophy Uni-Form	<b>B</b> continued Ludlow Melody <sup>Ⓞ</sup> Paradigm Petal Pusher <sup>Ⓞ</sup> Prairie Prim Radiance Ransom Roam Rush Hour Shadow Play Spree Summit Sutton Synth Tabloid Tinge Topos Venue Versa Westwood Wild Thing	<b>C</b> continued Kaleidoscope CR Kaya CR Lagos Lore CR Magnolia Milestone On Point Palisade Patchwork Plaid On Prestini Pullman Regard CR Roundtrip Sinclair Smart <sup>Ⓞ</sup> Spectator Stepping Stones Tight Rope Tilden <sup>Ⓞ</sup> Tower Grid Utmost II Utopia Wit Wow Factor	<b>D</b> Buzz Code Coterie Eclat Weave Island Kabuki Menagerie Origins Pathway Plaidtastic Retreat Vice Versa Woodland	<b>E</b> Aegean Circle Point Cleo Currents Demure Flower Power Highland Ikat Stripe Juno Kampala Kimono Marquee Meroe Midpoint Nature Walk Off The Grid Rebel Sherman Tempest Tryst Vatera Whip
	<b>B</b> Argyle Attire Belize Bistro Calypso Chronicle Close Knit Cozy Cord Day Tripper Diva Dottie Ferry Gala II Grandview Helios Holbrook Instinct Journey Knoll Felt Knoll Hopsack Little Devil	<b>C</b> Atlas Axiom <sup>Ⓞ</sup> Baxter Cairo Chameleon Circa Classic Boucle Contour Dune Durand Entourage Entwine Essence Fibra Greenwich Hudson	<b>D</b> Code Coterie Eclat Weave Island Kabuki Menagerie Origins Pathway Plaidtastic Retreat Vice Versa Woodland	<b>E</b> Atelier Biscayne Century Cornaro Double Agent <sup>Ⓞ</sup> Floressence Glider Homage Imprint In Stitches Liberty Mod Plaid Rivington Sandis Soon Stripe It Swank Tweed Frieze	<b>F</b> Fire Retardants Chemicals
	<b>G</b> All Star Alter Ego Andissa Arber Dapper Djenne Duchess Fancy Twill Gibson Kamani Looped In Melange Modern Tweed Straie Stripe Texnet Ultrasuede Utrillo Vert	<b>H</b> Bavaria Catwalk Constance Firefly Stretch Appeal Twist Tie	<b>I</b> Aswan Bella Byron Cato Cummings Diamond Days Doily Dynamic Guise In Step Ita Jaipur Mepal Olema Piper Sandis Tudor Zimba		<i>Check with your KnollTextiles representative for changes or additions.</i>

# Vignelli Associates

## Handkerchief Arm Chair

Designer(s):  
Vignelli Designs, 1983



description	seat h	arm h	w	d	h	textile fabric yds.	weight
<b>4902</b> Arm chair, unupholstered shell	18"	26"	26"	22 1/2"	29"		24 lbs.
<b>4902K-N</b> Arm chair, seat pad, non-stacking	18"	26"	26"	22 1/2"	29"	0.7	26 lbs.
<b>4902K-S</b> Arm chair, seat pad, stacking	18"	26"	26"	22 1/2"	29"	0.7	26 lbs.
<b>49100D</b> Stacking dolly			24 3/8"	26"	12"		10 lbs.
<b>G</b> Glides (add -G to end of pattern number)							

Order Code	Ordering Information	Construction
<i>Example:</i> <b>4902-MD-C</b>	<i>Shell colors:</i> Black (suffix B) Grey (suffix G) Midnight (MD) Red (suffix R) White (suffix W)	Customer's Own Material is available pending approval. For approval requirements, processing instructions and ordering information please see page 21.
<b>4902</b>	Handkerchief unupholstered arm chair	<i>Shell:</i> Compression-molded. Highly durable fiberglass reinforced polyester; with urethane paint finish.
<b>MD</b>	Midnight shell	<i>Seat pad:</i> High-resilience polyurethane cushion bonded to a semi-rigid thermoformed support.
<b>C</b>	Chrome frame	<i>Base:</i> 7/16" steel wire finished in brightly polished chrome.
	<i>Base finishes:</i> Polished Chrome (suffix C)	<i>Optional glides:</i> Nylon. (Add -G to end of pattern number)
	<i>Upholstery/COM information:</i> Prices shown include fabric upholstery. Contact your Knoll representative for colors. Only approved KnollTextiles and Spinneybeck leathers may be ordered.	<i>Stacking bumper:</i> Black flexible urethane stacking pad secured between base and shell.
	<i>Cal 133 Fire Code #:</i> The Handkerchief Chair complies with the California Technical Bulletin 133 standard if upholstered in Cal 133 approved upholstery. Specify suffix -C at end of pattern number and suffix -133 at end of textile selection. Upcharge applies, see page 22.	
	<i>Maintenance:</i> See pages 28-29.	
	<i>Note:</i> The Handkerchief Arm Chair is certified Clean Air GOLD.	

Note:  
The Vignelli Handkerchief side chairs are part of a collection. Please refer to Vignelli PaperClip Tables on page 506.

- Specify:
1. Pattern number
  2. Shell color selection
  3. Base finish selection
  4. Glide option
  5. Cal 133 Fire Code option for seat pad
  6. Textile selection for seat pad

pattern no.	upchg	grades <b>A</b>	COM <b>B</b>	<b>C</b>	<b>D</b>	<b>E</b>	<b>F</b>	<b>G</b>	<b>H</b>	<b>I</b>
<b>4902-(-)C</b>	\$1,390.									
<b>4902K-N-(-)C-(-)</b>		1,831.	1,862.	1,894.	1,933.	1,962.	1,984.	1,998.	2,090.	2,141.
<b>4902K-S-(-)C-(-)</b>		1,885.	1,920.	1,951.	1,990.	2,018.	2,042.	2,078.	2,145.	2,197.
<b>49100D</b>	2,382.									
<b>G [4902]</b>	41.									

Approved KnollTextiles Grades/Fabrics										
<i>Stacking features:</i> 4902 and 4902K-S chairs stack 15-20 high. Chairs without stacking bumper (4902K-N) do not stack.	<b>A</b> Alignment Beacon Bocce Chance Common Ground Commuter Cloth Cross Tech Crossroad Delite Facet Hourglass Infinite Monarch Oh La La Overture Prep Soliloquy Sonnet Trophy Uni-Form	<b>B</b> continued Ludlow Melody <sup>Ⓞ</sup> Paradigm Petal Pusher <sup>Ⓞ</sup> Prairie Prim Radiance Ransom Roam Rush Hour Shadow Play Spree Summit Sutton Synth Tabloid Tinge Topos Venue Versa Westwood Wild Thing	<b>C</b> continued Kaleidoscope CR Kaya CR Lagos Lore CR Magnolia Milestone On Point Palisade Patchwork Plaid On Prestini Pullman Regard CR Roundtrip Sinclair Smart <sup>Ⓞ</sup> Spectator Stepping Stones Tight Rope Tilden <sup>Ⓞ</sup> Tower Grid Utmost II Utopia Wit Wow Factor	<b>D</b> Buzz Code Coterie Eclat Weave Island Kabuki Menagerie Origins Pathway Plaidtastic Retreat Vice Versa Woodland	<b>E</b> Aegean Circle Point Cleo Currents Demure Flower Power Highland Ikat Stripe Juno Kampala Kimono Marquee Meroe Midpoint Nature Walk Off The Grid Rebel Sherman Tempest Tryst Vatera Whip	<b>F</b> Atelier Biscayne Century Cornaro Double Agent <sup>Ⓞ</sup> Florescence Glider Homage Imprint In Stitches Liberty Mod Plaid Rivington Sandis Soon Stripe It Swank Tweed Frieze	<b>G</b> All Star Alter Ego Andissa Arber Dapper Djenne Duchess Fancy Twill Gibson Kamani Looped In Melange Modern Tweed Straie Stripe Texnet Ultrasuede Utrillo Vert	<b>H</b> Bavaria Catwalk Constance Firefly Stretch Appeal Twist Tie	<b>I</b> Aswan Bella Byron Cato Cummings Diamond Days Doily Dynamic Guise In Step Ita Jaipur Mepal Olema Piper Sandis Tudor Zimba	<sup>Ⓞ</sup> Fire Retardants Chemicals

Check with your KnollTextiles representative for changes or additions.

David Adjaye  
*The Washington Collection for Knoll™*  
 Corona™ Coffee Table

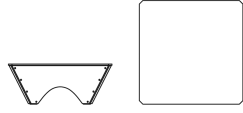
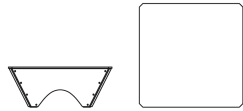
	description	w	d	h	base	weight
Designer(s): David Adjaye, 2013 	<b>WC2T</b> Washington Corona™ aluminum coffee table, black painted 	40 3/4"	40 3/4"	15 3/4"	Aluminum	170 lbs.
	<b>WC3T</b> Washington Corona™ aluminum coffee table, white painted 	40 3/4"	40 3/4"	15 3/4"	Aluminum	170 lbs.

pattern no	clear glass
<b>WC2T</b>	\$13,110.
<b>WC3T</b>	13,110.

Order Code	Ordering Information	Construction
Example: <b>WC2T</b> <b>WC2T</b> Aluminum coffee table, black painted	Glass finish: Starphire Clear glass  Maintenance: See pages 28-29.	Clear glass top: Top is 1/2" thick optically Starphire clear glass with a jewel-polished, chamfered edge.  Aluminum base: Constructed from four die-cast aluminum panels, connected by aluminum connector plates and stainless steel hardware. The interior and exterior of the panels are finished in a smooth gloss black or white powder coat paint. Tables specified in black will have black painted metal connectors. Tables specified in white will have non-painted stainless steel metal connectors.

Specify:  
 1. Pattern number



David Adjaye  
*The Washington Collection for Knoll™*  
*Prism™ Side Table*

	description	w	d	h
<i>Designer(s):</i> David Adjaye, 2014	<b>WL25T</b> Side table	17"	14½"	18"

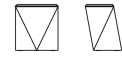

*Award(s):*  
 Editors Choice Award, Lounge Furniture Collection, NeoCon June 2015, USA; MetropolisLikes Award, Metropolis Magazine, June 2015, USA



pattern no	MA, MAS, GG, GGS, MN, MNS	MC, MCS	MV, MVS
<b>WL25T-( )-( )</b>	\$10,622.	\$11,021.	\$11,201.

Order Code	Ordering Information	Construction
<i>Example:</i> <b>WL25T-118G-MCS</b>	<i>Base finishes:</i> Black (suffix 111G) White (suffix 118G) Red (suffix 845G)	<i>Base:</i> Constructed of ¾" Baltic Birch plywood panels covered in a plastic color core laminate which maintains color throughout so vibrancy is maintained from edge to edge. Panels are assembled together using poplar wood corner blocks.
<b>WL25T</b> Side table	<i>Polished Coated marble top finishes:</i> Arabescato: white-grey (suffix MA) Calacatta: white-grey/beige (suffix MC) Grey Marble: light grey (suffix GG) Nero Marquina: black (suffix MN) Verdi Alpi: green (suffix MV)	
<b>118G</b> White base	<i>Satin Coated marble top finishes:</i> Arabescato: white-grey (suffix MAS) Calacatta: white-grey/beige (suffix MCS) Grey Marble: light grey (suffix GGS) Nero Marquina: black (suffix MNS) Verdi Alpi: green (suffix MVS)	
<b>MCS</b> Satin Calacatta	<i>Maintenance:</i> See pages 28-29.	

- Specify:*
1. Pattern number
  2. Base finish selection
  3. Marble selection

Franco Albini  
Albini Desk

description	w	d	h	weight
<b>80D</b> Pedestal desk	48"	26"	27 1/2"	95 lbs.

Designer(s):  
Franco Albini, 1938



pattern no.	
<b>80D-(E, L2)</b>	\$8,642.

Order Code

Example: <b>80D-E</b>
<b>80D</b> Albini desk
<b>E</b> Ebonized Oak pedestal

Specify:

1. Pattern number
2. Pedestal finish

Ordering Information

Albini pedestal finishes:  
Ebonized Oak (suffix E)  
White Lacquer (suffix L2)

Maintenance:  
See pages 28-29.

Construction

Base:  
Frame and legs in square steel tube with chrome finish.

Top:  
1/2" clear tempered glass.

Pedestal:  
2 drawer "floating" wood pedestal. Rear open shelf for magazines or small books.

Pedestal dimensions:  
16 1/2" w x 26" d x 8 1/4" h

Drawer dimensions:  
14 1/8" w x 14 1/8" d x 2 1/2" h

Rear shelf dimensions:  
15 1/2" w x 8 1/2" d x 7" h

Drawer mounts only on the right side.

Ini Archibong  
Iquo Cafe Collection  
Iquo Cafe Tables

Designer(s):  
Ini Archibong, 2022



description	w	d	h	weight	top
<b>ARD3030</b> Square bistro table, dining height 	30"	30"	28 3/4"	26 lbs.	laminata
	30"	30"	28 3/4"	29 lbs.	resin
	30"	30"	28 3/4"	79 lbs.	vetro bianco

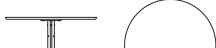

description	w	d	h	weight	top
<b>ARD36D</b> Round bistro table, dining height 	36"	36"	28 3/4"	27 lbs.	laminata
	36"	36"	28 3/4"	31 lbs.	resin
	36"	36"	28 3/4"	88 lbs.	vetro bianco

pattern no.	Polished Aluminum / Painted Onyx
<b>ARD3030-( )-(LBL, LWH, LLG)</b>	\$2,635.
<b>ARD3030-( )-(RBL, RWH, RLG)</b>	2,268.
<b>ARD3030-( )-(VB)</b>	4,887.

<b>ARD36D-( )-(LBL, LWH, LLG)</b>	3,140.
<b>ARD36D-( )-(RBL, RWH, RLG)</b>	2,703.
<b>ARD36D-( )-(VB)</b>	5,177.

Order Code

<i>Example:</i>	<b>ARD3030-A-RBL-NG</b>
<b>ARD3030</b>	30"x30" Square Table
<b>A</b>	Polished Aluminum
<b>RBL</b>	Black resin
<b>NG</b>	No cutout

Specify:

1. Pattern number
2. Base finish option
3. Top finish selection
4. Cutout option

Ordering Information

*Base finishes:*  
Polished Aluminum (suffix A)  
Onyx (suffix O)

*Resin top finishes:*  
Black (suffix RBL)  
White (suffix RWH)  
Light Grey (suffix RLG)

*Laminate top finishes:*  
Black (suffix LBL)  
White (suffix LWH)  
Light Grey (suffix LLG)

*Engineered Stone:*  
Vetro Bianco: White (suffix VB)

*Outdoor Use:*  
With proper care and limited exposure to the elements, tables specified with Resin or Vetro Bianco top on Onyx painted base are appropriate for outdoor environments. Electrified tables are not suitable for outdoor use.

*Maintenance:*  
See pages 28-29.

The Iquo Collection is certified Clean Air GOLD.

Construction

*Base:*  
4 extruded aluminum rods comprise the table's column and are connected with stainless steel screws and interior spacers. Columns screwed onto aluminum extruded 4 star base. Base is offered in polished aluminum finish or Onyx powder coat.

*Tops:*  
Resin tops are resin impregnated paper with black edge. Laminate tops are matte fingerprint free laminate on birch plywood and painted edge to match. All tops have miter edge detail. Tops have 6 inserts and are attached to base with stainless steel screws.

*Glides:*  
Adjustable steel glides with nonmarring nylon bottom. Cover in stainless steel or black painted finish to match base finish.

Electrical

Iquo Café Tables can be specified with electrical options to receive electrical modules, ARE1 and ARE2.

*Cutout options:(\$39 for two cutouts)*  
No cutout (suffix NG)  
Two cutouts (suffix S2)



Specify suffix code S2 at the end of the table pattern number.

**Example: ARD3030A-RBL-S2**

*Note:*  
Tables specified with suffix S2 for electrical cutouts will include two cutouts. **2 electrical modules will need to be ordered separately.**

Tables specified with electrical cutouts will include 4 plastic vertical wire management clips to neatly run cords down to the floor.

Ini Archibong  
*Iquo Cafe Collection*  
*Iquo Cafe Tables Electrical*

	description	type	power cord
<i>Designer(s):</i> Ini Archibong, 2022	<b>ARE1</b> Single power module 	1 Power	72" Cordset
	<b>ARE2</b> Dual USB module 	2 USB	72" Cordset

pattern no.	
<b>ARE1-( )</b>	\$88.
<b>ARE2-( )</b>	205.

Order Code	Ordering Infomation	Construction
<i>Example:</i> <b>ARE1-W</b> <b>W</b> White finish	<i>Case and Receptable Finishes:</i> Black case with Black receptacles (suffix B) White case with White receptacles (suffix W)	<i>Description:</i> Electrical modules are molded plastic in black or white finish.  USB: 2 Amps
<i>Specify:</i> 1. Pattern number 2. Case finish		

Edward Barber & Jay Osgerby  
*Piton™ Side Table*

description	w	d	h	top finish	weight
<b>BO21T</b> side table	16 1/4"	16 1/4"	21 1/4"	Ash	16 lbs.
	16 1/4"	16 1/4"	21 1/4"	Teak	16 lbs.

*Designer(s):*  
 Edward Barber and Jay Osgerby,  
 2014

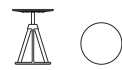

pattern no.	list
<b>BO21T-AE-( )</b>	\$1,447.
<b>BO21T-K-( )</b>	1,821.

**Order Code**

<i>Example:</i>	<b>BO21T-K-WHTT</b>
<b>BO21T</b>	Side Table
<b>K</b>	Teak
<b>WHTT</b>	White

*Specify:*

1. Pattern number
2. Top selection
3. Base selection

**Ordering Information**

*Wood Top Finishes:*  
 Ebonized Ash (suffix AE)  
 Teak, natural (suffix K)

*Base Paint Finishes:*  
 Jet Black (suffix 111T)  
 Medium Metallic Grey (suffix 612T)  
 Red Coral (suffix CRLT)  
 Sterling (suffix 906T)  
 White (suffix WHTT)

*Maintenance:*  
 See pages 28-29.

**Construction**

*Base:*  
 Base is constructed of die-cast aluminum with stainless steel fasteners and finished with a highly durable powder coat in a variety of colors.

*Wood Tops:*  
 Knife edge wood tops are available in ebonized ash or an oiled teak.

Edward Barber & Jay Osgerby  
*Smalto Table*

	description	w	d	h	weight
<i>Designer(s):</i> Edward Barber and Jay Osgerby, 2019	<b>BOH-TR137</b> Round Table	54"	54"	28 3/4"	TBD lbs.

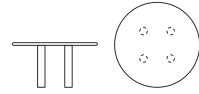

pattern no.	list
<b>BOH-TR137-( )</b>	\$10,644.

Order Code	Ordering Information	Construction
<i>Example:</i> <b>BOH-TR137-SL05</b> <b>BOH-TR137</b> Round Dining Table <b>SL05</b> Black	<i>Base Paint Finishes:</i> Blue (suffix SL01) Grey Green (suffix SL03) Grey (suffix SL04) Black (suffix SL05) White (suffix SL06)  <i>Maintenance:</i> See pages 28-29.	<i>Top:</i> Steel top with scratch resistant porcelain enamel finishing. Honeycomb core to enhance resistance and to eliminate noise.  <i>Legs:</i> Steel tubular legs in the same finish as the top with adjustable polished glide and aluminum polished rim.

- Specify:*
1. Pattern number
  2. Top and base selection

Marcel Breuer  
Laccio Tables

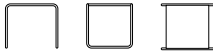
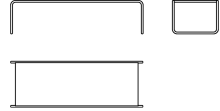
	description	w	d	h	weight
<i>Designer(s):</i> Marcel Breuer, 1924  	<b>50T1</b> Laccio side table 	21 3/4"	19"	17 3/4"	13 lbs.
	<b>50T2</b> Laccio coffee table 	53 1/2"	19"	13 1/2"	29 lbs.

pattern no.	
<b>50T1-( )</b>	\$1,265.
<b>50T2-( )</b>	1,791.

Order Code	Ordering Information	Construction
<i>Example:</i> <b>50T1-F1</b>	<i>Top finishes:</i>	<i>Top:</i>
<b>50T1</b> Laccio side table	Black (suffix F1)	Satin finish, smooth plastic laminate.
<b>F1</b> Black Laminate	Red (suffix F3)	
	White (suffix F2)	<i>Base:</i>
		Frame and legs seamless tubular steel in polished chrome finish.
	<i>Maintenance:</i>	
	See pages 28-29.	
	<i>Note:</i>	
	The KnollStudio logo and signature of Marcel Breuer is stamped into the base of the table.	

Note:  
Laccio tables are part of a collection.  
Please refer to the Cesca and Wassily chairs on pages 104 and 112.

*Specify:*

1. Pattern number
2. Top finish selection

# Lewis Butler Butler™ Tables

*Designer(s):*  
Lewis Butler, 1953



description	w	d	h	weight	base
<b>357</b> Butler rectangular coffee table	54"	24"	16"	44 lbs.	ebonized beech
	54"	24"	16"	44 lbs.	natural oak

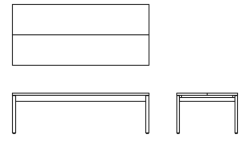

description	w	d	h	weight	base
<b>358</b> Butler coffee table	38"	34"	16"	45 lbs.	ebonized beech
	38"	34"	16"	45 lbs.	natural oak

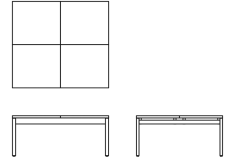

pattern no.	laminate top
<b>357-BE-</b> ( )-( )	\$2,383.
<b>357-ON-</b> ( )-( )	2,554.

<b>358-BE-</b> ( )-( )	2,476.
<b>358-ON-</b> ( )-( )	2,647.

Order Code	Ordering Information	Construction
<i>Example:</i> <b>358-ON-111B-118B</b>	<i>Base finishes:</i> Ebonized Beech (suffix BE) Natural Oak (suffix ON)	<i>Top:</i> Tops are constructed of particle board with white and/or black high gloss laminate finish.
<b>358</b>		
<b>ON</b>		
<b>111B</b>	<i>Top finish 1:</i> Black (suffix 111B) White (suffix 118B)	<i>Base:</i> Base is offered in natural oak on oak, or ebonized finish on beech. Mortise and tenon joinery.
<b>118B</b>		
<i>Specify:</i>	<i>Top finish 2:</i> Black (suffix 111B) White (suffix 118B)	
1. Pattern number		
2. Base finish option		
3. Top finish 1		
4. Top finish 2		
	<i>Maintenance:</i> See pages 28-29.	





# Joseph Paul D’Urso

## Square Work and Low Tables

*Designer(s):*  
Joseph Paul D’Urso, 1980

*Award(s):*  
Design Center Stuttgart Award, W. Germany, 1983; Federal Award for Industrial Design, W. Germany, 1983



description	width between legs	w	d	h, work tables	h, low tables	weight	top
<b>GL</b> Glides							
<b>C</b> Casters							
<b>CX</b> Locking casters							
<b>6348</b> Square table 	22 1/2"	48"	48"	27 1/2"	15 1/4"	197 lbs.	coated marble
	22 1/2"	48"	48"	27 1/2"	15 1/4"	130 lbs.	laminated
	22 1/2"	48"	48"	27 1/2"	15 1/4"	128 lbs.	natural veneer
	22 1/2"	48"	48"	27 1/2"	15 1/4"	197 lbs.	natural marble
<b>6354</b> Square table 	25 3/8"	54"	54"	27 1/2"	15 1/4"	241 lbs.	natural marble
	25 1/8"	54"	54"	27 1/2"	15 1/4"	241 lbs.	coated marble
	25 1/8"	54"	54"	27 1/2"	15 1/4"	281 lbs.	granite
	25 1/8"	54"	54"	27 1/2"	15 1/4"	145 lbs.	laminated
	25 1/8"	54"	54"	27 1/2"	15 1/4"	141 lbs.	natural veneer
<b>6360</b> Square table 	25 1/8"	60"	60"	27 1/2"	15 1/4"	288 lbs.	natural marble
	25 1/8"	60"	60"	27 1/2"	15 1/4"	288 lbs.	coated marble
	25 1/8"	60"	60"	27 1/2"	15 1/4"	338 lbs.	granite
	25 1/8"	60"	60"	27 1/2"	15 1/4"	183 lbs.	laminated
	25 1/8"	60"	60"	27 1/2"	15 1/4"	179 lbs.	natural veneer

### Order Code

<i>Example:</i> <b>6354L-C-111-C</b>	
<b>6354</b>	54" square table
<b>L</b>	Low height
<b>C</b>	Casters
<b>111</b>	Jet Black laminate
<b>C</b>	Polished Chrome

### Specify:

1. Pattern number
2. Specify L for low height tables
3. Glides/casters selection
4. Top finish selection
5. Leg finish selection

### Ordering Information

*Laminated top finishes:*  
Bright White (suffix 118)  
Jet Black (suffix 111)

*Natural veneer top finishes:*  
American Cherry (suffix X)  
Maple (suffix K)

*Natural marble top finishes:*  
Carrara: white-grey (suffix NGC)

*Coated marble top finishes:*  
Carrara: white-grey (suffix GC)

*Granite top finishes:*  
Black Andes: black (suffix GA)

*Leg finishes:*  
Jet Black (suffix 111)  
Medium Metallic Grey (suffix 612)  
Polished Chrome (suffix C)  
Red (suffix RD)

*Glides/ casters:*  
Castors (suffix C)  
Glides, standard option (suffix GL)  
Locking casters (suffix CX)

*Low Tables:*  
**D’Urso tables are available in two heights: standard and low. For low tables, add an L after the parent pattern number. Example: 6348L for low height option.**

*Maintenance:*  
See pages 28-29.

*Note:*  
D’urso Tables are certified Clean Air GOLD.

Weight information above is based on work height tables. For weight information on low height tables, please contact your KnollStudio representative.

### pattern no.

pattern no.	upcharge	base painted	base chrome
<b>GL</b>	n/c		
<b>C</b>	908.		
<b>CX</b>	1,034.		
<b>6348-(-)(GC)-(-)</b>		10,226.	10,856.
<b>6348-(-)(-)(-)</b>		3,755.	4,386.
<b>6348-(-)(-)(-)</b>		6,328.	6,955.
<b>6348-(-)(NGC)-(-)</b>		8,813.	9,441.
<b>6354-(-)(NGC)-(-)</b>		10,341.	10,968.
<b>6354-(-)(GC)-(-)</b>		12,123.	12,752.
<b>6354-(-)(GA)-(-)</b>		13,877.	14,501.
<b>6354-(-)(-)(-)</b>		3,896.	4,526.
<b>6354-(-)(-)(-)</b>		6,542.	7,174.
<b>6360-(-)(NGC)-(-)</b>		11,965.	12,595.
<b>6360-(-)(GC)-(-)</b>		14,153.	14,780.
<b>6360-(-)(GA)-(-)</b>		15,598.	16,227.
<b>6360-(-)(-)(-)</b>		4,246.	4,874.
<b>6360-(-)(-)(-)</b>		7,552.	8,182.

### Construction

*Top:*  
Laminated and veneer or stone surface. Laminated and veneer tops are 3-ply construction with medium density fiberboard core and plastic laminated backer (laminated tops) or paper backer (wood veneer tops). Laminated and veneer tops have a black vinyl bullnose edge. Wood tops are longitudinal veneered. 1/4" thick stone tops have an integral, hand-crafted bullnose edge.

*Edge detail:*  
Laminated/wood tops:

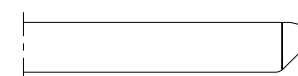

Stone tops:

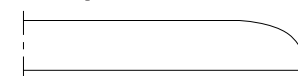

*Base:*  
Racetrack-shaped steel legs with painted or polished chrome finish.

*Glides:*  
Black nylon.

*Castors:*  
3" single, black hard-rubber wheel. Polished chrome wheel housings with black or medium metallic grey legs. Black housings with polished chrome and red leg. Locking castor housings always polished chrome. Tables with castors are at the same height as tables with glides.

Wood tables with castors are weighted with steel plates to ensure stability. Plates are painted and secured under table top.

Please note: Castors cannot be retrofitted to tables with glides.



# Joseph Paul D'Urso

## Round Work and Low Tables

**Designer(s):**  
Joseph Paul D'Urso, 1980

**Award(s):**  
Design Center Stuttgart Award, W. Germany, 1983; Federal Award for Industrial Design, W. Germany, 1983



description	width		h, work tables	h, low tables	weight	top
	between legs	w				
<b>C</b> Casters						
<b>GL</b> Glides						
<b>CX</b> Locking casters						
<b>6242</b> Round table 	20 7/8"	42"	27 1/2"	15 1/4"	110 lbs.	laminata
	20 7/8"	42"	27 1/2"	15 1/4"	109 lbs.	natural veneer
	20 7/8"	42"	27 1/2"	15 1/4"	132 lbs.	natural marble
	20 7/8"	42"	27 1/2"	15 1/4"	132 lbs.	coated marble
<b>6248</b> Round table 	22 1/2"	48"	27 1/2"	15 1/4"	120 lbs.	laminata
	22 1/2"	48"	27 1/2"	15 1/4"	118 lbs.	natural veneer
	22 1/2"	48"	27 1/2"	15 1/4"	162 lbs.	natural marble
	22 1/2"	48"	27 1/2"	15 1/4"	162 lbs.	coated marble
<b>6254</b> Round table 	25 1/8"	54"	27 1/2"	15 1/4"	197 lbs.	coated marble
	25 1/8"	54"	27 1/2"	15 1/4"	229 lbs.	granite
	25 1/8"	54"	27 1/2"	15 1/4"	156 lbs.	laminata
	25 1/8"	54"	27 1/2"	15 1/4"	153 lbs.	natural veneer
	25 1/8"	54"	27 1/2"	15 1/4"	197 lbs.	natural marble

pattern no.	upcharge	base painted	base chrome
<b>C</b>	\$908.		
<b>GL</b>	n/c		
<b>CX</b>	1,034.		
<b>6242-(-)(-)(-)</b>		3,552.	4,177.
<b>6242-(-)(-)(-)</b>		6,183.	6,810.
<b>6242-(-)(NGC-)(-)</b>		6,413.	7,039.
<b>6242-(-)(GC-)(-)</b>		7,268.	7,895.
<b>6248-(-)(-)(-)</b>		3,755.	4,386.
<b>6248-(-)(-)(-)</b>		6,328.	6,955.
<b>6248-(-)(NGC-)(-)</b>		7,552.	8,180.
<b>6248-(-)(GC-)(-)</b>		8,670.	9,295.
<b>6254-(-)(GC-)(-)</b>		10,264.	10,894.
<b>6254-(-)(GA-)(-)</b>		14,176.	14,803.
<b>6254-(-)(-)(-)</b>		3,896.	4,526.
<b>6254-(-)(-)(-)</b>		6,542.	7,174.
<b>6254-(-)(NGC-)(-)</b>		8,852.	9,479.

### Order Code

<i>Example:</i> <b>6248-C-NGC-C</b>	
<b>6248</b>	48" diameter round table
<b>C</b>	Casters
<b>NGC</b>	Carrara Marble
<b>C</b>	Polished Chrome

### Specify:

1. Pattern number
2. Specify L for low height tables
3. Glides/casters selection
4. Top finish selection
5. Leg finish selection

### Ordering Information

**Laminata top finishes:**  
Bright White (suffix 118)  
Jet Black (suffix 111)

**Natural veneer top finishes:**  
American Cherry (suffix X)  
Maple (suffix K)

**Natural marble top finishes:**  
Carrara: white-grey (suffix NGC)

**Coated marble top finishes:**  
Carrara: white-grey (suffix GC)

**Granite top finishes**  
Black Andes: black (suffix GA)

**Leg finishes:**  
Jet Black (suffix 111)  
Medium Metallic Grey (suffix 612)  
Polished Chrome (suffix C)  
Red (suffix RD)

**Glides/casters:**  
Casters (suffix C)  
Glides, standard option (suffix GL)  
Locking casters (suffix CX)

**Low Tables:**  
D'Urso tables are available in two heights: standard and low. For low tables, add an L after the parent pattern number. Example: 6348L for low height option.

**Maintenance:**  
See pages 28-29.

**Note:**  
D'Urso Tables are certified Clean Air GOLD.

Weight information above is based on work height tables. For weight information on low height tables, please contact your KnollStudio representative.

### Construction

**Top:**  
Laminata and veneer or stone surface. Laminata and veneer tops are 3-ply construction with medium density fiberboard core and plastic laminata backer (laminata tops) or paper backer (wood veneer tops). Laminata and veneer tops have a black vinyl bullnose edge. 3/4" thick stone tops have an integral, hand-crafted bullnose edge.

**Edge detail:**  
Laminata/wood tops



Stone tops:



**Base:**  
Racetrack-shaped steel legs with painted or polished chrome finish.

**Glides:**  
Black nylon.

**Casters:**  
3" single, black hard-rubber wheel. Polished chrome wheel housings with black or medium metallic grey legs. Black housings with polished chrome and red leg. Locking caster housings always polished chrome.

Wood tables with casters are weighted with steel plates to ensure stability. Plates are painted and secured under table top.

Please note: Casters cannot be retrofitted to tables with glides.

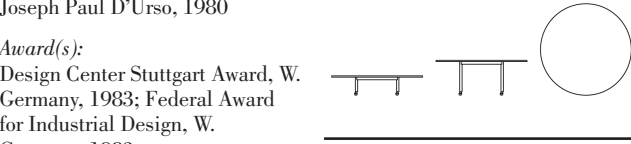
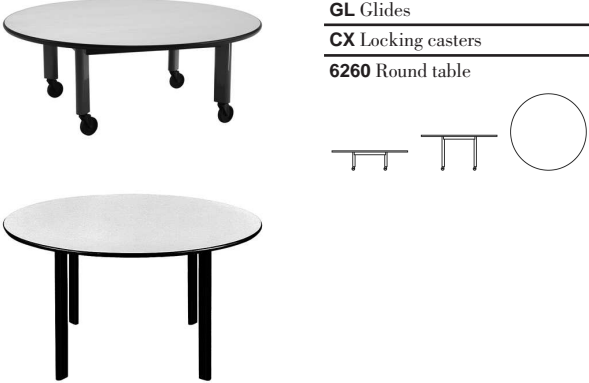

# Joseph Paul D'Urso

## Round Work and Low Tables

	description	width		h, work tables	h, low tables	weight	top
		between legs	w				
<p><i>Designer(s):</i> Joseph Paul D'Urso, 1980</p> <p><i>Award(s):</i> Design Center Stuttgart Award, W. Germany, 1983; Federal Award for Industrial Design, W. Germany, 1983</p> 	<b>6272</b> Round table	31"	72"	27 1/2"	15 1/4"	255 lbs.	Natural veneer
<b>C</b> Casters							
<b>GL</b> Glides							
<b>CX</b> Locking casters							
	<b>6260</b> Round table	25 7/8"	60"	27 1/2"	15 1/4"	164 lbs.	natural veneer
		25 7/8"	60"	27 1/2"	15 1/4"	167 lbs.	laminated
		25 7/8"	60"	27 1/2"	15 1/4"	235 lbs.	coated marble
		25 7/8"	60"	27 1/2"	15 1/4"	235 lbs.	natural marble
		25 7/8"	60"	27 1/2"	15 1/4"	274 lbs.	granite

pattern no.	upcharge	base, painted	base, chrome
<b>6272-( )-( )-( )</b>		\$8,987.	\$9,707.
<b>C</b>			
	908.		
<b>GL</b>			
	n/c		
<b>CX</b>			
	1,034.		
<b>6260-( )-( )-( )</b>		7,552.	8,182.
<b>6260-( )-( )-( )</b>		4,246.	4,874.
<b>6260-( )-(GC)-( )</b>		11,811.	12,438.
<b>6260-( )-(NGC)-( )</b>		10,093.	10,721.
<b>6260-( )-(GA)-( )</b>		15,527.	16,158.

Order Code	Order Information
<i>Example:</i> <b>6248-C-NGC-C</b>	<i>Laminate top finishes:</i> Bright White (suffix 118) Jet Black (suffix 111)
<b>6248</b> 48" diameter round table	<i>Leg finishes:</i> Jet Black (suffix 111) Medium Metallic Grey (suffix 612) Polished Chrome (suffix C) Red (suffix RD)
<b>C</b> Casters	<i>Maintenance:</i> See pages 28-29.
<b>NGC</b> Carrara Marble	<i>Note:</i> D'Urso Tables are certified Clean Air GOLD.
<b>C</b> Polished Chrome	<i>Weight information above is based on work height tables. For weight information on low height tables, please contact your KnollStudio representative.</i>
<i>Specify:</i> 1. Pattern number 2. Specify L for low height tables 3. Glides/casters selection 4. Top finish selection 5. Leg finish selection	<i>Glides/casters:</i> Casters (suffix C) Glides, standard option (suffix GL) Locking casters (suffix CX)
	<i>Low Tables:</i> D'Urso tables are available in two heights: standard and low. For low tables, add an L after the parent pattern number. Example: 6348L for low height option.
	<i>Natural veneer top finishes:</i> American Cherry (suffix X) Maple (suffix K)
	<i>Natural marble top finishes:</i> Carrara: white-grey (suffix NGC)
	<i>Coated marble top finishes:</i> Carrara: white-grey (suffix GC)
	<i>Granite top finishes:</i> Black Andes: black (suffix GA)

Construction	
<p><i>Top:</i> Laminate and veneer or stone surface. Laminate and veneer tops are 3-ply construction with medium density fiberboard core and plastic laminate backer (laminate tops) or paper backer (wood veneer tops). Laminate and veneer tops have a black vinyl bullnose edge. 3/4" thick stone tops have an integral, hand-crafted bullnose edge.</p> 	<p><i>Base:</i> Racetrack-shaped steel legs with painted or polished chrome finish.</p> <p><i>Glides:</i> Black nylon.</p> <p><i>Casters:</i> 3" single, black hard-rubber wheel. Polished chrome wheel housings with black or medium metallic grey legs. Black housings with polished chrome and red leg. Locking caster housings always polished chrome.</p> <p>Wood tables with casters are weighted with steel plates to ensure stability. Plates are painted and secured under table top.</p> <p>Please note: Casters cannot be retrofitted to tables with glides.</p>
<p><i>Edge detail:</i> Laminate/wood tops</p>  <p>Stone tops:</p>	

# Joseph Paul D’Urso

## Racetrack Work Tables

*Designer(s):*  
Joseph Paul D’Urso, 1980

*Award(s):*  
Design Center Stuttgart Award, W. Germany, 1983; Federal Award for Industrial Design, W. Germany, 1983

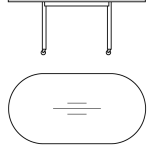

description	w between legs	d between legs	w	d	h	weight	top
<b>GL</b> Glides							
<b>C</b> Casters							
<b>CX</b> Locking casters							
<b>6472</b> Racetrack table 	32 3/4"	20 3/8"	72"	36"	27 1/2"	200 lbs.	coated marble
	32 3/4"	20 3/8"	72"	36"	27 1/2"	232 lbs.	granite
	32 3/4"	20 3/8"	72"	36"	27 1/2"	144 lbs.	laminated
	32 3/4"	20 3/8"	72"	36"	27 1/2"	141 lbs.	natural veneer
	32 3/4"	20 3/8"	72"	36"	27 1/2"	200 lbs.	natural marble

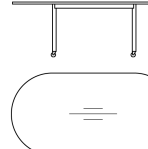
<b>6484</b> Racetrack table 	38 3/4"	20 3/8"	84"	42"	27 1/2"	294 lbs.	natural marble
	38 3/4"	20 3/8"	84"	42"	27 1/2"	294 lbs.	coated marble
	38 3/4"	20 3/8"	84"	42"	27 1/2"	338 lbs.	granite
	38 3/4"	20 3/8"	84"	42"	27 1/2"	162 lbs.	laminated
	38 3/4"	20 3/8"	84"	42"	27 1/2"	159 lbs.	natural veneer

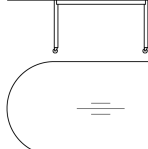
<b>6496</b> Racetrack table 	44 3/4"	22 1/2"	96"	48"	27 1/2"	377 lbs.	natural marble
	44 3/4"	22 1/2"	96"	48"	27 1/2"	377 lbs.	coated marble
	44 3/4"	22 1/2"	96"	48"	27 1/2"	434 lbs.	granite
	44 3/4"	22 1/2"	96"	48"	27 1/2"	177 lbs.	laminated
	44 3/4"	22 1/2"	96"	48"	27 1/2"	173 lbs.	natural veneer

**Order Code**

<i>Example:</i>	<b>6472-GL-GA-C</b>
<b>6472</b>	72" x 36" racetrack table
<b>GL</b>	Glides
<b>GA</b>	Granite
<b>C</b>	Polished Chrome

*Specify:*

1. Pattern number
2. Specify L for low height tables
3. Glides/casters selection
4. Top finish selection
5. Leg finish selection

**Ordering Information**

*Laminated top finishes:*  
Bright White (suffix 118)  
Jet Black (suffix 111)

*Natural veneer top finishes:*  
American Cherry (suffix X)  
Maple (suffix K)

*Natural marble top finishes:*  
Carrara: white-grey (suffix NGC)

*Coated marble top finishes:*  
Carrara: white-grey (suffix GC)

*Granite top finish:*  
Black Andes: black (suffix GA)

*Leg finishes:*  
Jet Black (suffix 111)  
Medium Metallic Grey (suffix 612)  
Polished Chrome (suffix C)  
Red (suffix RD)

*Glides/casters:*

Casters (suffix C)  
Glides, standard option (suffix GL)  
Locking casters (suffix CX)

Casters not available on stone racetrack tables.

pattern no.	upcharge	base painted	base chrome
<b>GL</b>	n/c		
<b>C</b>	908.		
<b>CX</b>	1,034.		
<b>6472-( )-(GC)-( )</b>		11,198.	11,826.
<b>6472-( )-GA-( )</b>		15,596.	16,221.
<b>6472-( )-( )-( )</b>		4,802.	5,430.
<b>6472-( )-( )-( )</b>		7,717.	8,344.
<b>6472-( )-(NGC)-( )</b>		9,622.	10,245.

<b>6484-( )-(NGC)-( )</b>		12,963.	13,589.
<b>6484-( )-(GC)-( )</b>		15,063.	15,691.
<b>6484-( )-GA-( )</b>		18,020.	18,649.
<b>6484-( )-( )-( )</b>		5,153.	5,779.
<b>6484-( )-( )-( )</b>		8,622.	9,249.

<b>6496-( )-(NGC)-( )</b>		16,260.	16,883.
<b>6496-( )-(GC)-( )</b>		19,108.	19,732.
<b>6496-( )-GA-( )</b>		21,668.	22,293.
<b>6496-( )-( )-( )</b>		5,294.	5,915.
<b>6496-( )-( )-( )</b>		9,440.	10,067.

**Construction**

*Maintenance:*  
See pages 28-29.

*Note:*  
D’Urso are certified Clean Air GOLD.

Weight information above is based on work height tables. For weight information on low height tables, please contact your KnollStudio representative.

*Top:*  
Laminated, Techgrain® and veneer or stone surface. Laminated, Techgrain® and veneer tops are 3-ply construction with medium density fiberboard core and plastic laminated backer (laminated tops) or paper backer (wood veneer tops). Laminated, Techgrain® and veneer tops have a black vinyl bullnose edge. Wood tops are longitudinal veneered. 3/4" thick stone tops have an integral, hand-crafted bullnose edge.

*Edge detail:*  
Laminated/Techgrain/wood tops:



Stone tops:



*Base:*  
Racetrack-shaped steel legs with painted or polished chrome finish.

*Glides:*  
Black nylon.

*Casters:*  
3" single, black hard-rubber wheel. Polished chrome wheel housings with black or medium metallic grey legs. Black housings with polished chrome and red leg. Locking caster housings always polished chrome. Not available on stone racetrack tables.

Wood tables with casters are weighted with steel plates to ensure stability. Plates are painted and secured under table top.

Please note: Casters cannot be retrofitted to tables with glides.

# Frank Gehry Face Off Cafe Table

Designer(s):  
Frank Gehry, 1990

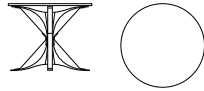
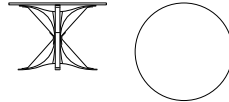

description	w	d	h	weight	top	base
<b>95T-36</b> Face Off 36" café table 	36"		28 3/4"	10 lbs.	glass	clear maple
	36"		28 3/4"	10 lbs.	white laminate	clear maple
<b>95T-40</b> Face Off 40" café table 	40"		28 3/4"	10 lbs.	glass	clear maple
	40"		28 3/4"	10 lbs.	white laminate	clear maple

pattern no.	
<b>95T-36-G2-GC</b>	\$6,503.
<b>95T-36-W-GC</b>	7,708.
<b>95T-40-G2-GC</b>	7,823.
<b>95T-40-W-GC</b>	9,022.

### Order Code

<i>Example:</i>	<b>95T-36-G2-GC</b>
<b>95T-36</b>	36" Face Off table
<b>G2</b>	Clear Glass
<b>GC</b>	Clear Maple

*Note:*  
The Gehry tables are part of a collection. Please refer to Gehry side chairs and lounge seating starting on page 138.

### Specify:

1. Pattern number
2. Top finish selection

### Ordering Information

*Glass top finish:*  
Clear Glass (suffix G2)

*Laminate top finish :*  
White (suffix W)

*Maple Base finish:*  
Clear (suffix GC)

*Shipping note:*  
Tops ship separately.

### Construction

*Signature:*  
The underside of each piece in the Gehry Collection is embossed with Frank Gehry's signature and the Knoll logo.

*Maintenance:*  
See pages 28-29.

*Face Off Cafe Table tops:*  
1/2" thick tempered clear glass with polished edge; 3/8" thick textured laminate top with clear solid edgeband. Four bolts attach table top to base.

*Face Off Cafe Table base:*  
Constructed of hard white maple veneers in 2" wide, 1/8" thick strips. Laminated to 7-ply thickness with high-bonding urea glue. All wood grains run in the same direction for resilience. State-of-the-art thermoset assembly glue provides structural rigidity without the need for metal connectors. Solid maple center column prevents cracking. Arched base design allows ample leg room.

*Glides:*  
Clear plastic with a matte frost finish.

Alexander Girard  
Coffee Table



	description	w	d	h	weight
<i>Designer(s):</i> Alexander Girard, 1948 	<b>108</b> Coffee Table	59"	26"	16"	23 lbs.
		59"	26"	16"	23 lbs.

pattern no.	
<b>108-(LWA, D)-111</b>	\$2,184.
<b>108-KC-111</b>	2,792.

Order Code	Ordering Information	Construction
<i>Example:</i> <b>108-LWA-111</b>	<i>Top Finishes:</i> Ebonized Walnut (suffix D) Light Walnut (suffix LWA) Maple (suffix K)	<i>Top:</i> Top is 3/4" baltic birch core with either plain slice bookmatch maple, cherry or ebonized veneer. Top has a 45° beveled edge.
<b>108</b> Coffee Table		
<b>LWA</b> Light Walnut		
<b>111</b> Jet Black	<i>Leg Finish:</i> Jet Black (suffix 111)	<i>Legs:</i> Cold-roll steel tubes with metal weldment in black powder coat.
<i>Specify:</i>		<i>Maintenance:</i> See pages 28-29.
1. Pattern number		
2. Top finish delection		
3. Leg finish selection		

# Florence Knoll

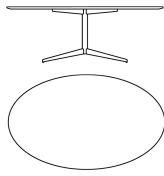
## Oval Table Desks

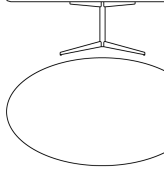
	description	w	d	h	weight	top
<p><i>Designer(s):</i> Florence Knoll, 1961</p> <p><i>Award(s):</i> Design Center Stuttgart Award, 1969-70</p> 	<p><b>2480D</b> Oval table desk</p> 	78"	47 7/8"	27 1/2"	313 lbs.	natural marble
		78"	47 7/8"	28"	185 lbs.	white laminate
		78"	47 7/8"	27 1/2"	313 lbs.	coated marble
		78"	47 7/8"	28"	174 lbs.	natural oak
		78"	47 7/8"	27 1/2"	313 lbs.	coated marble
		78"	47 7/8"	28"	174 lbs.	mahogany
		78"	47 7/8"	28"	174 lbs.	ebonized oak
		78"	47 7/8"	27 1/2"	313 lbs.	coated marble
		78"	47 7/8"	27 1/2"	313 lbs.	coated marble
		78"	47 7/8"	27 1/2"	313 lbs.	coated marble
		78"	47 7/8"	27 1/2"	313 lbs.	coated marble
		78"	47 7/8"	27 1/2"	313 lbs.	coated marble
		78"	47 7/8"	27 1/2"	313 lbs.	coated marble
		78"	47 7/8"	27 1/2"	313 lbs.	coated marble
	<p><b>2481D</b> Oval table desk</p> 	96"	54"	27 1/2"	402 lbs.	natural marble
		96"	54"	27 1/2"	402 lbs.	coated marble
		96"	54"	28"	223 lbs.	white laminate
		96"	54"	27 1/2"	402 lbs.	coated marble
		96"	54"	28"	207 lbs.	natural oak
		96"	54"	28"	207 lbs.	mahogany
		96"	54"	28"	207 lbs.	ebonized oak
		96"	54"	27 1/2"	402 lbs.	coated marble
		96"	54"	27 1/2"	402 lbs.	coated marble
		96"	54"	27 1/2"	402 lbs.	coated marble
		96"	54"	27 1/2"	402 lbs.	coated marble
		96"	54"	27 1/2"	402 lbs.	coated marble
		96"	54"	27 1/2"	402 lbs.	coated marble
		96"	54"	27 1/2"	402 lbs.	coated marble

pattern no.	polished chrome base (C)	satin chrome base (CO)
<b>2480D-( )-(NGC)</b>	\$13,218.	\$13,798.
<b>2480D-( )-F2</b>	13,496.	14,080.
<b>2480D-( )-(MG, MGS)</b>	14,244.	14,808.
<b>2480D-( )-O</b>	14,973.	15,552.
<b>2480D-( )-(GC, GCS)</b>	15,177.	15,758.
<b>2480D-( )-(M7, M9)</b>	15,641.	16,217.
<b>2480D-( )-E</b>	16,296.	16,878.
<b>2480D-( )-(MN, MNS, MA, MAS, GG, GGS)</b>	17,575.	18,151.
<b>2480D-( )-(ME, MES)</b>	17,729.	18,291.
<b>2480D-( )-(MC, MCS)</b>	18,629.	19,208.
<b>2480D-( )-(MV, MVS)</b>	22,856.	23,436.
<b>2481D-( )-(NGC)</b>	16,019.	16,594.
<b>2481D-( )-(MG, MGS)</b>	18,118.	18,676.
<b>2481D-( )-F2</b>	18,629.	19,206.
<b>2481D-( )-(GC, GCS)</b>	18,746.	19,326.
<b>2481D-( )-O</b>	20,409.	20,984.
<b>2481D-( )-(M7, M9)</b>	21,068.	21,644.
<b>2481D-( )-E</b>	21,731.	22,309.
<b>2481D-( )-(ME, MES)</b>	23,439.	23,999.
<b>2481D-( )-(MN, MNS, MA, MAS, GG, GGS)</b>	24,205.	24,783.
<b>2481D-( )-(MC, MCS)</b>	25,657.	26,232.
<b>2481D-( )-(MV, MVS)</b>	31,386.	31,964.

Order Code	Ordering Information
<i>Example:</i> <b>2480T-C-NGC</b>	<i>Base finishes:</i> Polished Chrome (suffix C) Satin Chrome (suffix CO)
<b>2480T</b> Florence Knoll Oval Table Desk	<i>Laminate top finish:</i> White Laminate (suffix F2)
<b>C</b> Polished Chrome	<i>Veneer top finishes:</i> Ebonized Oak (suffix E) Natural Oak (suffix O) Medium Brown Mahogany (suffix M7) Medium Red Mahogany (suffix M9)
<b>NGC</b> Carrara Marble	<i>Polished Coated marble top finishes:</i> Arabescato: white-grey (suffix MA) Calacatta: white-grey/beige (suffix MC) Carrara: white-grey (suffix GC) Espresso: dark brown (suffix ME) Grey Marble: light grey (suffix GG) Grigio Marquina: warm grey (suffix MG) Nero Marquina: black (suffix MN) Verdi Alpi: green (suffix MV)
	<i>Satin Coated marble top finishes:</i> Arabescato: white-grey (suffix MAS) Calacatta: white-grey/beige (suffix MCS) Carrara: white-grey (suffix GCS) Espresso: dark brown (suffix MES) Grey Marble: light grey (suffix GGS) Grigio Marquina: warm grey (suffix MGS) Nero Marquina: black (suffix MNS) Verde Alpi: green (suffix MVS)
	<i>Natural marble top finishes:</i> Calacatta: white-grey/beige (suffix NC) Carrara: white-grey (suffix NCC)
	<i>Maintenance:</i> See pages 28-29.
	<i>Note:</i> KnollStudio logo and signature of Florence Knoll are stamped into the base.
	The Florence Knoll Coffee and End Tables are certified Clean Air GOLD.

*Note:*  
Florence Knoll table desks are part of collection. Please refer to Florence Knoll Lounge seating on page 146 and credenzas, conference and low tables on the following pages.

- Specify:*
1. Pattern number
  2. Base finish option
  3. Top finish selection

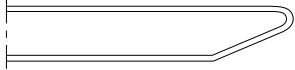
Construction	
<p><i>Base:</i> Frame and legs heavy gauge welded steel. Post and four-star legs in polished chrome finish. Optional satin chrome finish.</p> <p><i>Base footprint dimensions:</i> Base dimensions for the 2480D and 2481D are 42 7/8" w x 27 7/8" w x 28 7/8" d.</p> <p><i>Top:</i> Satin finish smooth laminate, wood veneer, or marble with beveled-edge. Laminate tops are 1 1/4" thick and veneer tops are 1 7/16" thick. Marble coated with transparent acrylic to help eliminate use-associated stains.</p> <p><i>Glides:</i> Adjustable steel glides with a chrome finish.</p>	<p><i>Laminate edge detail:</i></p>  <p><i>Marble edge detail:</i></p> 

# Florence Knoll Round Table Desk

	description	w	d	h	weight	top
<p><i>Designer(s):</i> Florence Knoll, 1961</p> <p><i>Award(s):</i> Design Center Stuttgart Award, 1969-70</p> 	<b>2482T</b> Round table desk	54"		28"	142 lbs.	white laminate
		54"		27 1/2"	241 lbs.	natural marble
	54"		27 1/2"	241 lbs.	241 lbs.	coated marble
	54"		27 1/2"	241 lbs.	241 lbs.	coated marble
	54"		27 1/2"	241 lbs.	241 lbs.	coated marble
	54"		28"	134 lbs.	134 lbs.	natural oak
	54"		28"	134 lbs.	134 lbs.	mahogany
	54"		28"	134 lbs.	134 lbs.	ebonized oak
	54"		27 1/2"	241 lbs.	241 lbs.	coated marble
	54"		27 1/2"	241 lbs.	241 lbs.	coated marble
	54"		27 1/2"	241 lbs.	241 lbs.	coated marble

pattern no.	polished chrome base (C)	satin chrome base (CO)
<b>2482T-( )-F2</b>	\$10,755.	\$11,418.
<b>2482T-( )-(NGC)</b>	11,713.	12,372.
<b>2482T-( )-(MG, MGS)</b>	12,325.	12,964.
<b>2482T-( )-(GC, GCS)</b>	13,112.	13,774.
<b>2482-( )-(ME, MES)</b>	14,399.	15,040.
<b>2482T-( )-O</b>	14,694.	15,359.
<b>2482T-( )-(M7, M9)</b>	15,320.	15,984.
<b>2482T-( )-E</b>	15,950.	16,614.
<b>2482T-( )-(MN, MNS, MA, MAS, GG, GGS)</b>	17,468.	18,128.
<b>2482T-( )-(MC, MCS)</b>	18,340.	19,001.
<b>2482T-( )-(MV, MVS)</b>	22,735.	23,396.

Order Code	Ordering Information
<i>Example:</i> <b>2482T-C-NGC</b>	<i>Base finishes:</i> Polished Chrome (suffix C) Satin Chrome (suffix CO)
<b>2482T</b> Florence Knoll Round Table Desk	<i>Laminate top finish:</i> White Laminate (suffix F2)
<b>C</b> Polished Chrome	<i>Veneer top finishes:</i> Ebonized Oak (suffix E) Natural Oak (suffix O) Medium Brown Mahogany (suffix M7) Medium Red Mahogany (suffix M9)
<b>NGC</b> Carrara Marble	<i>Polished Coated marble top finishes:</i> Arabescato: white-grey (suffix MA) Calacatta: white-grey/beige (suffix MC) Carrara: white-grey (suffix GC) Espresso: dark brown (suffix ME) Grey Marble: light grey (suffix GG) Grigio Marquina: warm grey (suffix MG) Nero Marquina: black (suffix MN) Verdi Alpi: green (suffix MV)
	<i>Satin Coated marble top finishes:</i> Arabescato: white-grey (suffix MAS) Calacatta: white-grey/beige (suffix MCS) Carrara: white-grey (suffix GCS) Espresso: dark brown (suffix MES) Grey Marble: light grey (suffix GGS) Grigio Marquina: warm grey (suffix MGS) Nero Marquina: black (suffix MNS) Verde Alpi: green (suffix MVS)
	<i>Natural marble top finishes:</i> Calacatta: white-grey/beige (suffix NC) Carrara: white-grey (suffix NGC)
<i>Note:</i> Florence Knoll table desks are part of collection. Please refer to Florence Knoll Lounge seating on page 146 and credenzas, conference and low tables on the following pages. <i>Specify:</i> 1. Pattern number 2. Base finish option 3. Top finish selection	<i>Maintenance:</i> See pages 28-29.  <i>Note:</i> KnollStudio logo and signature of Florence Knoll are stamped into the base.  The Florence Knoll Coffee and End Tables are certified Clean Air GOLD.

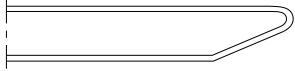
Construction
<p><i>Base:</i> Frame and legs heavy gauge welded steel. Post and four-star legs in polished chrome finish. Optional satin chrome finish.</p> <p><i>Tops:</i> Satin finish smooth laminate, wood veneer, or marble with beveled-edge. Laminate tops are 1 1/4" thick and veneer tops are 1 7/16" thick. Marble coated with transparent acrylic to help eliminate use-associated stains.</p> <p><i>Glides:</i> Adjustable steel glides with a chrome finish.</p>
<p><i>Base footprint dimensions:</i> Base dimensions for the 2480D and 2481D are 42 7/8" w x 27 7/16" w x 28 7/8" d.</p> <p><i>Note:</i> Marbles with Coating will yellow over time.</p>
<p><i>Laminate edge detail:</i></p>  <p><i>Marble edge detail:</i></p> 



# Florence Knoll

## Dining Tables and Mini Desk

Designer(s):  
Florence Knoll

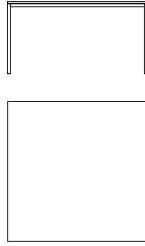
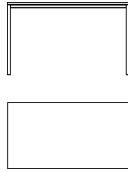
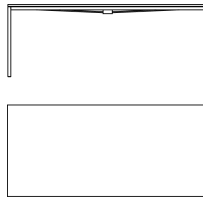

description	w	d	h	weight	top
<b>2520T</b> Square Table 	55 1/8"	55 1/8"	28 3/8"	243 lbs.	Coated marble
	55 1/8"	55 1/8"	28 3/8"	243 lbs.	Coated marble
	55 1/8"	55 1/8"	28 3/8"	243 lbs.	Coated marble
	55 1/8"	55 1/8"	28 3/8"	243 lbs.	Coated marble
<b>2521T</b> Mini Desk 	48"	26"	28 3/8"	99 lbs.	Coated marble
	48"	26"	28 3/8"	99 lbs.	Clear glass
	48"	26"	28 3/8"	99 lbs.	Coated marble
	48"	26"	28 3/8"	99 lbs.	Coated marble
	48"	26"	28 3/8"	99 lbs.	Coated marble
<b>2523T</b> Rectangular Table 	78 1/4"	35 1/2"	28 3/8"	221 lbs.	Coated marble
	78 1/4"	35 1/2"	28 3/8"	221 lbs.	Coated marble
	78 1/4"	35 1/2"	28 3/8"	221 lbs.	Coated marble
	78 1/4"	35 1/2"	28 3/8"	221 lbs.	Coated marble

pattern no.	polished chrome (suffix C)
<b>2520T-C-(MG, MGS)</b>	\$14,514.
<b>2520T-C-(GC, GCS)</b>	15,579.
<b>2520T-C-(MA, MAS)</b>	16,915.
<b>2520T-C-(MC, MCS)</b>	22,243.
<b>2521T-C-(MC, MCS)</b>	10,881.
<b>2521T-C-G2</b>	4,000.
<b>2521T-C-(MG, MGS)</b>	7,703.
<b>2521T-C-(GC, GCS)</b>	8,146.
<b>2521T-C-(MA, MAS)</b>	8,682.
<b>2523T-C-(MG, MGS)</b>	18,073.
<b>2523T-C-(GC, GCS)</b>	19,057.
<b>2523T-C-(MA, MAS)</b>	20,254.
<b>2523T-C-(MC, MCS)</b>	25,148.

### Order Code

<i>Example:</i> <b>2523T-C-MGS</b>	Florence Knoll Rectangular Dining Table
<b>C</b>	Polished Chrome
<b>MGS</b>	Grigio Marquina, Satin

### Specify:

1. Pattern number
2. Base finish option
3. Top finish selection

### Ordering Information

*Base finishes:*  
Polished Chrome (suffix C)

*Glass top finishes:*  
Clear Glass (suffix G2) \*

*Polished Coated marble top finishes:*  
Arabescato: white-grey (suffix MA)  
Calacatta: white-grey/beige (suffix MC)  
Carrara: white-grey (suffix GC)  
Grigio Marquina: warm grey (suffix MG)

*Satin Coated marble top finishes:*  
Arabescato: white-grey (suffix MAS)  
Calacatta: white-grey/beige (suffix MCS)  
Carrara: white-grey (suffix GCS)  
Grigio Marquina: warm grey (suffix MGS)

\*available on 2521T only

*Maintenance:*  
See pages 28-29.

*Note:*  
The KnollStudio logo and signature of Florence Knoll are stamped into the base of the table.

### Construction

*Top:*  
Thick polished plate glass or coated marble with transparent acrylic coating in polished or satin finish to help eliminate use-associated stains. Marble tops arrive with a 1/8" thick black high density particle board spacer glued underneath the perimeter and rests on the table frame with double sided adhesive.

*Note:*  
Marbles with a coating will yellow over time giving the marble a warmer tone.

*Base:*  
Legs are made of solid steel bars and connected to horizontal steel tube rails using steel connectors.

*Substructure:*  
Larger tables, 2523T and 2524T, include an added cross bar between the rails and feature a tension rod substructure to help support the weight of the marble top. Four steel rods connected to the top corners of the table base converge into a chrome box attached to the cross bar. This hidden structure prevents any deflection of the marble.

*Tension rod substructure for 2523T and 2524T:*

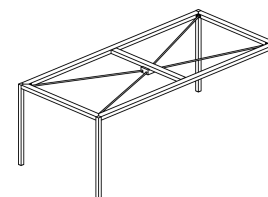

*Tension rod and chrome box detail (view from underside of table):*

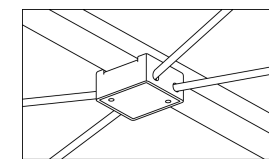

# Florence Knoll

## Dining Tables and Mini Desk

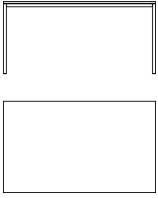
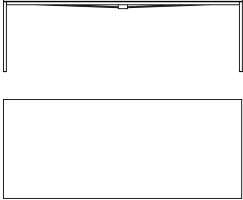
	description	w	d	h	weight	top
<b>Designer(s):</b> Florence Knoll  	<b>2522T Rectangular Table</b>  	60"	36"	28 <sup>3</sup> / <sub>8</sub> "	165 lbs.	Coated marble
		60"	36"	28 <sup>3</sup> / <sub>8</sub> "	165 lbs.	Coated marble
		60"	36"	28 <sup>3</sup> / <sub>8</sub> "	165 lbs.	Coated marble
		60"	36"	28 <sup>3</sup> / <sub>8</sub> "	165 lbs.	Coated marble
	<b>2524T Rectangular Table</b>  	94 <sup>1</sup> / <sub>2</sub> "	39 <sup>3</sup> / <sub>8</sub> "	28 <sup>3</sup> / <sub>8</sub> "	298 lbs.	Coated marble
		94 <sup>1</sup> / <sub>2</sub> "	39 <sup>3</sup> / <sub>8</sub> "	28 <sup>3</sup> / <sub>8</sub> "	298 lbs.	Coated marble
		94 <sup>1</sup> / <sub>2</sub> "	39 <sup>3</sup> / <sub>8</sub> "	28 <sup>3</sup> / <sub>8</sub> "	298 lbs.	Coated marble
		94 <sup>1</sup> / <sub>2</sub> "	39 <sup>3</sup> / <sub>8</sub> "	28 <sup>3</sup> / <sub>8</sub> "	298 lbs.	Coated marble

pattern no.	polished chrome (suffix C)
<b>2522T-C-(MG, MGS)</b>	\$15,086.
<b>2522T-C-(GC, GCS)</b>	15,869.
<b>2522T-C-(MA, MAS)</b>	16,789.
<b>2522T-C-(MC, MCS)</b>	20,554.
<hr/>	
<b>2524T-C-(MG, MGS)</b>	21,374.
<b>2524T-C-(GC, GCS)</b>	22,690.
<b>2524T-C-(MA, MAS)</b>	24,286.
<b>2524T-C-(MC, MCS)</b>	30,844.

Order Code	Ordering Information	Construction
<b>Example: 2523T-C-MGS</b> <b>2523T</b> Florence Knoll Rectangular Dining Table <b>C</b> Polished Chrome <b>MGS</b> Grigio Marquina, Satin	<b>Base finishes:</b> Polished Chrome (suffix C)  <b>Glass top finishes:</b> Clear Glass (suffix G2) *  <b>Polished Coated marble top finishes:</b> Arabescato: white-grey (suffix MA) Calacatta: white-grey/beige (suffix MC) Carrara: white-grey (suffix GC) Grigio Marquina: warm grey (suffix MG)  <b>Satin Coated marble top finishes:</b> Arabescato: white-grey (suffix MAS) Calacatta: white-grey/beige (suffix MCS) Carrara: white-grey (suffix GCS) Grigio Marquina: warm grey (suffix MGS)  *available on 2521T only	<b>Maintenance:</b> See pages 28-29.  <b>Note:</b> The KnollStudio logo and signature of Florence Knoll are stamped into the base of the table.  <b>Top:</b> Thick polished plate glass or coated marble with transparent acrylic coating in polished or satin finish to help eliminate use-associated stains. Marble tops arrive with a 1/8" thick black high density particle board spacer glued underneath the perimeter and rests on the table frame with double sided adhesive.  <b>Note:</b> Marbles with a coating will yellow over time giving the marble a warmer tone.  <b>Base:</b> Legs are made of solid steel bars and connected to horizontal steel tube rails using steel connectors.

- Specify:**
1. Pattern number
  2. Base finish option
  3. Top finish selection

**Substructure:**  
 Larger tables, 2523T and 2524T, include an added cross bar between the rails and feature a tension rod substructure to help support the weight of the marble top. Four steel rods connected to the top corners of the table base converge into a chrome box attached to the cross bar. This hidden structure prevents any deflection of the marble.

Tension rod substructure for 2523T and 2524T:

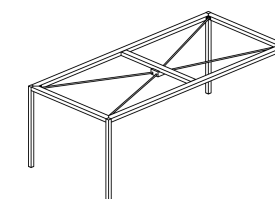

Tension rod and chrome box detail (view from underside of table):

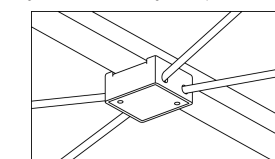

# Florence Knoll *Executive Desk*

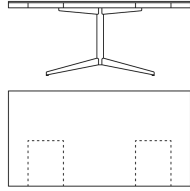
	description	w	d	h	weight	top
<i>Designer(s):</i> Florence Knoll 	<b>2485D</b> Rectangular desk with two pencil drawers 	72"	37 1/4"	29 1/4"	–	Mahogany/Oak/ Walnut
		72"	37 1/4"	29 1/4"	–	Rosewood

pattern no.	polished chrome base (C)	satin chrome base (CO)
<b>2485D-(C, CO)-( )</b>	\$15,470.	\$16,353.
<b>2485D-(C, CO)-(RO)</b>	22,285.	23,170.

## Order Code

<i>Example:</i>	<b>2485D-C-LWA</b>
<b>2523T</b>	Florence Knoll rectangular desk
<b>C</b>	Polished Chrome
<b>LWA</b>	Light Walnut

## Specify:

1. Pattern number
2. Base finish option
3. Top finish selection

## Ordering Information

*Base finishes:*  
 Polished Chrome (suffix C)  
 Satin Chrome (suffix CO)

*Veneer top finishes:*  
 Medium Brown Mahogany (suffix M7)  
 Ebonized Oak (suffix E)  
 Natural Oak (suffix O)  
 Light Walnut (suffix LWA)  
 Rosewood (suffix RO)

*Maintenance:*  
 See pages 28-29.

*Note:*  
 The KnollStudio logo and signature of Florence Knoll are stamped into the base of the table.

## Construction

*Base:*  
 Frame and legs heavy gauge welded steel. Post and four-star legs in polished chrome finish.

*Top:*  
 Top and side are constructed of solid MDF core with veneer faces.

*Drawers:*  
 Two pencil drawers are constructed of solid maple lumber. Fronts are solid lumber with veneer face and edge. Pencil tray is solid lumber. Drawers on ball bearing metal slides.

*Base footprint dimensions:*  
 Base dimensions for the 2485D is 42 1/8" w x 27 1/8" d.

*Glides:*  
 Adjustable steel glides with a chrome finish.

# Florence Knoll

## Credenzas

### Two Position Credenzas

*Designer(s):*  
Florence Knoll, 1961



description	w	d	h	body
<b>2541M</b> Six box drawers (each with one removable partition)	37 1/2"	18"	25 1/2"	natural oak
	37 1/2"	18"	25 1/2"	mahogany
	37 1/2"	18"	25 1/2"	ebonized oak
<b>2542M</b> Four box drawers (each with one removable partition), one full extension file drawer with two metal bars for hanging files	37 1/2"	18"	25 1/2"	natural oak
	37 1/2"	18"	25 1/2"	mahogany
	37 1/2"	18"	25 1/2"	ebonized oak
<b>2545M</b> Two storage cabinets with two adjustable shelves for use in one or both cabinets	37 1/2"	18"	25 1/2"	ebonized oak
	37 1/2"	18"	25 1/2"	natural oak
	37 1/2"	18"	25 1/2"	mahogany
	37 1/2"	18"	25 1/2"	white lacquer
<b>2546M</b> Two box drawers (each with one removable partition), two full extension file drawers with two metal bars for hanging files	37 1/2"	18"	25 1/2"	natural oak
	37 1/2"	18"	25 1/2"	mahogany
	37 1/2"	18"	25 1/2"	ebonized oak

pattern no.	(MN, MNS, MA MAS, MC, MCS MV, MVS GG, GGS)		(Gc, GCS)	(NGC)	(MN, MNS, MA, MAS, MC, MCS MV, MVS, GG, GGS)		(GC, GCS)	(NGC)
	wood top/ polished base	marble top/ polished base	marble top/ polished base	marble top/ polished base	wood top/ satin base	marble top/ satin base	marble top/ satin base	marble top/ satin base
<b>2541M-( )-O-( )-( )</b>	\$14,663.	\$15,947.	\$15,947.	\$15,608.	\$14,875.	\$16,158.	\$16,158.	\$15,820.
<b>2541M-( )-(M7, M9)-( )-( )</b>	15,556.	16,878.	16,878.	16,522.	15,762.	17,085.	17,085.	16,732.
<b>2541M-( )-E-( )-( )</b>	16,503.	17,622.	17,622.	17,260.	16,715.	17,832.	17,832.	17,469.
<b>2542M-( )-O-( )-( )</b>	14,148.	15,387.	15,387.	15,046.	14,353.	15,596.	15,596.	15,254.
<b>2542M-( )-(M7, M9)-( )-( )</b>	14,828.	16,130.	16,130.	15,776.	15,036.	16,334.	16,334.	15,983.
<b>2542M-( )-E-( )-( )</b>	15,607.	16,878.	16,878.	16,513.	15,813.	17,081.	17,081.	16,718.
<b>2545M-( )-E-( )-( )</b>	10,730.	11,864.	11,864.	11,541.	10,942.	12,074.	12,074.	11,747.
<b>2545M-( )-O-( )-( )</b>	9,299.	10,377.	10,377.	10,088.	9,509.	10,586.	10,586.	10,297.
<b>2545M-( )-(M7, M9)-( )-( )</b>	9,990.	11,125.	11,125.	10,818.	10,200.	11,336.	11,336.	11,028.
<b>2545M-( )-2-( )-( )</b>	n/a	12,605.	12,605.	12,179.	n/a	12,817.	12,817.	12,390.
<b>2546M-( )-O-( )-( )</b>	13,884.	15,111.	15,111.	14,761.	14,091.	15,451.	15,451.	15,103.
<b>2546M-( )-(M7, M9)-( )-( )</b>	14,478.	15,761.	15,761.	15,399.	14,682.	16,101.	16,101.	15,742.
<b>2546M-( )-E-( )-( )</b>	15,165.	16,503.	16,503.	16,132.	15,369.	16,846.	16,846.	16,476.

Order Code	Ordering Information
<i>Example:</i> <b>2545M-C-M9-M9</b>	<i>Specify:</i>
<b>2545M</b> Florence Knoll credenza, two position	1. Pattern number
<b>C</b> Polished Chrome	2. Base finish option
<b>M9</b> Medium Red Mahogany body	3. Body veneer selection
<b>M9</b> Medium Red Mahogany top	4. Top marble or wood selection
<b>2545x</b> Optional central locking system	5. Optional central locking system (upcharge \$465)
	<i>Base finishes:</i> Polished Chrome (suffix C) Satin Chrome (suffix CO)

Florence Knoll credenzas are part of a collection. Please refer to Florence Knoll lounge seating on page 146 and table desks, conference and low tables on beginning on page 396.

*Body and top veneers/lacquer:*  
Ebonized Oak (suffix E)  
Medium Brown Mahogany (suffix M7)  
Medium Red Mahogany (suffix M9)  
Natural Oak (suffix O)  
White Lacquer (on 2545M only: suffix 2)

*Polished Coated marble top finishes:*  
Arabescato: white-grey (suffix MA)  
Calacatta: white-grey/beige (suffix MC)  
Carrara: white-grey (suffix GC)  
Grey Marble: light grey (suffix GG)  
Nero Marquina: black (suffix MN)  
Verde Alpi: green (suffix MV)

*Satin Coated marble top finishes:*  
Arabescato: white-grey (suffix MAS)  
Calacatta: white-grey/beige (suffix MCS)  
Carrara: white-grey (suffix GCS)  
Grey Marble: light grey (suffix GGS)  
Nero Marquina: black (suffix MNS)  
Verde Alpi: green (suffix MVS)

*Natural marble top finishes:*  
Carrara: white-grey (suffix NGC)

*Central locking:*  
Optional central locking secures drawers and doors instantly with one single key lock located in credenza top (left front side). Add proper lock suffix to item number at an additional cost of \$465. See chart for ordering information.

Credenza pattern no.	Locking system pattern no.
2541M	2541X
2542M	2542X
2545M	2545X
2546M	2546X

*Note:*  
KnollStudio logo and Florence Knoll's signature are stamped on each piece.

For weight information, please contact your KnollStudio representative.

*Maintenance:*  
See pages 28-29.

Construction			
<i>Base:</i> Welded square steel tube in polished chrome finish. Optional satin chrome finish. Adjustable glides.	<i>Top :</i> 3/4" thick marble coated with transparent acrylic to help eliminate use-associated stains. Squared edge detail. 1/4" wood top matching body available. Wood tops finished with transparent polyurethane coat.	<i>Front:</i> Drawer and door fronts in same wood veneers or lacquer finish as body. All have polished aluminum pulls, top flush mounted storage doors with magnetic closures. Location A storage hinges open from left. Location B storage hinges open from right. Other hinging available as special. Pull out drawers with smooth-glide extension slides. Drawer and storage have matching veneer inside.	<i>Shelves:</i> There are 2 adjustable shelves included on the 2545M credenza. If specifying in white lacquer or with locking mechanism, 4 shelves will be included.
<i>Body:</i> Wood veneer sides and matching back panel in oak or mahogany. Oak and mahogany finished with transparent polyurethane coat. Only 2545M storage cabinet available in white lacquer.	<i>Note:</i> Marbles with a coating will yellow over time.		

# Florence Knoll

## Credenzas

### Four Position Credenzas

Designer(s):  
Florence Knoll, 1961



description	w	d	h	body
<b>2543M</b> Eight box drawers (each with one removable partition), two full-extension file drawers with two metal bars each for hanging files	74 3/4"	18"	25 1/2"	natural oak
	74 3/4"	18"	25 1/2"	mahogany
	74 3/4"	18"	25 1/2"	ebonized oak
<b>2544M</b> Four storage cabinets with four adjustable shelves for use in two or more of the cabinets	74 3/4"	18"	25 1/2"	natural oak
	74 3/4"	18"	25 1/2"	mahogany
	74 3/4"	18"	25 1/2"	ebonized oak
	74 3/4"	18"	25 1/2"	white lacquer
<b>2547M</b> Four box drawers (each with one removable partition), one full-extension file drawer with two metal bars for hanging files. Two storage cabinets with two adjustable shelves for use in one or both cabinets	74 3/4"	18"	25 1/2"	natural oak
	74 3/4"	18"	25 1/2"	mahogany
	74 3/4"	18"	25 1/2"	ebonized oak
<b>2548M</b> Four box drawers (each with one removable partition), one full-extension file drawer with two metal bars, two storage cabinets with two adjustable shelves for use in one or both cabinets	74 3/4"	18"	25 1/2"	natural oak
	74 3/4"	18"	25 1/2"	mahogany
	74 3/4"	18"	25 1/2"	ebonized oak
<b>2549M</b> Four box drawers (each with one removable partition), four full-extension file drawers with two metal bars each for hanging files	74 3/4"	18"	25 1/2"	natural oak
	74 3/4"	18"	25 1/2"	mahogany
	74 3/4"	18"	25 1/2"	ebonized oak

#### Order Code

<i>Example:</i>	<b>2543M-CO-P-MN</b>
<b>2543M</b>	Florence Knoll credenza, four position
<b>CO</b>	Satin Chrome
<b>E</b>	Ebonized oak body
<b>MN</b>	Nero Marquina top
<b>2543x</b>	Optional locking system

Florence Knoll credenzas are part of a collection. Please refer to Florence Knoll lounge seating on page 146 and table desks, conference and low tables beginning on page 396.

#### Ordering Information

- Specify:*
1. Pattern number
  2. Base finish option
  3. Body veneer selection
  4. Top marble or wood selection
  5. Optional central locking system (upcharge \$932)
- Base finishes:*  
Polished Chrome (suffix C)  
Satin Chrome (suffix CO)
- Body and top veneers/lacquer:*  
Ebonized Oak (suffix E)  
Medium Brown Mahogany (suffix M7)  
Medium Red Mahogany (suffix M9)  
Natural Oak (suffix O)  
White Lacquer (on 2544M only: suffix 2)
- Polished Coated marble top finishes:*  
Arabescato: white-grey (suffix MA)  
Calacatta: white-grey/beige (suffix MC)  
Carrara: white-grey (suffix GC)

- Grey Marble: light grey (suffix GG)  
Nero Marquina: black (suffix MN)  
Verde Alpi: green (suffix MV)
- Satin Coated marble top finishes:*  
Arabescato: white-grey (suffix MAS)  
Calacatta: white-grey/beige (suffix MCS)  
Carrara: white-grey (suffix GCS)  
Grey Marble: light grey (suffix GGS)  
Nero Marquina: black (suffix MNS)  
Verde Alpi: green (suffix MVS)
- Natural marble top finishes:*  
Carrara: white-grey (suffix NGC)

*Central locking:*  
Optional central locking secures drawers and doors instantly with one single key lock located in credenza top (left front side). Add proper lock suffix to item number at an additional cost of \$932. See chart below for ordering information.

Credenza pattern no.	Central locking system pattern no.
2453M	2543X
2544M	2544X
2547M	2547X
2548M	2548X
2549M	2549X

*Note:*  
KnollStudio logo and Florence Knoll's signature are stamped on each piece.

For weight information, please contact your KnollStudio representative.

*Maintenance:*  
See pages 28-29.

pattern no.	wood top/ polished base	(MN, MNS, MA, MAS, MC, MCS MV, MVS, GG, GGS) marble top/ polished base	(GC, GCS) marble top/ polished base	(NGC) marble top/ polished base	wood top/ satin base	(MN, MNS, MA, MAS, MC, MCS MV, MVS, GG, GGS) marble top/ satin base	(GC, GCS) marble top/ satin base	(NGC) marble top/ satin base
<b>2543M-( )-O-( )-( )</b>	\$28,202.	\$30,796.	\$30,796.	\$30,095.	\$28,542.	\$31,140.	\$31,140.	\$30,441.
<b>2543M-( )-(M7,M9)-( )-( )</b>	29,965.	32,468.	32,468.	31,733.	30,304.	32,812.	32,812.	32,078.
<b>2543M-( )-E-( )-( )</b>	31,521.	34,142.	34,142.	33,377.	31,861.	34,483.	34,483.	33,720.
<b>2544M-( )-O-( )-( )</b>	18,396.	20,591.	20,591.	19,990.	18,739.	20,936.	20,936.	20,336.
<b>2544M-( )-(M7,M9)-( )-( )</b>	19,585.	21,705.	21,705.	21,077.	19,932.	22,053.	22,053.	21,422.
<b>2544M-( )-E-( )-( )</b>	20,607.	22,819.	22,819.	22,173.	20,947.	23,163.	23,163.	22,521.
<b>2544M-( )-2-( )-( )</b>	n/a	25,106.	25,106.	24,201.	n/a	25,450.	25,450.	24,548.
<b>2547M-( )-O-( )-( )</b>	23,300.	25,713.	25,713.	25,058.	23,639.	26,056.	26,056.	25,399.
<b>2547M-( )-(M7,M9)-( )-( )</b>	24,684.	27,015.	27,015.	26,335.	25,028.	27,358.	27,358.	26,678.
<b>2547M-( )-E-( )-( )</b>	25,895.	28,308.	28,308.	27,602.	26,235.	28,649.	28,649.	27,942.
<b>2548M-( )-O-( )-( )</b>	23,300.	25,713.	25,713.	25,058.	23,639.	26,056.	26,056.	25,399.
<b>2548M-( )-(M7,M9)-( )-( )</b>	24,684.	27,015.	27,015.	26,335.	25,028.	27,358.	27,358.	26,678.
<b>2548M-( )-E-( )-( )</b>	25,895.	28,308.	28,308.	27,602.	26,235.	28,649.	28,649.	27,942.
<b>2549M-( )-O-( )-( )</b>	27,158.	29,680.	29,680.	28,967.	27,502.	30,023.	30,023.	29,315.
<b>2549M-( )-(M7,M9)-( )-( )</b>	28,925.	31,348.	31,348.	30,611.	29,271.	31,695.	31,695.	30,954.
<b>2549M-( )-E-( )-( )</b>	30,480.	33,019.	33,019.	32,226.	30,822.	33,366.	33,366.	32,572.

#### Construction

*Base:*  
Welded square steel tube in polished chrome finish. Optional satin chrome finish. Adjustable glides.

*Body:*  
Wood veneer sides and matching back panel in oak or mahogany. Oak and mahogany finished with transparent polyurethane coat. Only 2544M storage cabinet available in white lacquer.

*Top:*  
3/4" thick marble coated with transparent acrylic to help eliminate use-associated stains. Squared edge detail. 3/4" wood top matching body available. Wood tops finished with transparent polyurethane coat.

*Note:*  
Marbles with a coating will yellow over time.

*Front:*  
Drawer and door fronts in same wood veneers or lacquer finish as body. All have polished aluminum pulls, top flush mounted storage doors with magnetic closures. Location A storage hinges open from left. Location B storage hinges open from right. Other hinges open from right. Other hinging available as special. Pull out drawers with smooth-glide extension slides. Drawer and storage have matching veneer inside.

*Shelves:*  
There are 2 adjustable shelves included on the 2548M credenza. If specifying in white lacquer or with locking mechanism, 4 shelves will be included.

There are 4 adjustable shelves included on the 2544M credenza. If specifying in white lacquer or with locking mechanism, 8 shelves will be included.

# Florence Knoll

## AV Depth Credenzas

### Two and Four Position

Designer(s):  
Florence Knoll, 1961

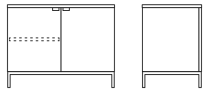
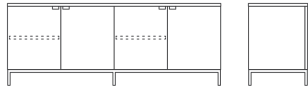

description	w	d	h	body
<b>2545AV</b> 2-door, AV compatible interior 	42 1/4"	23.5"	30 1/2"	ebonized oak
	42 1/4"	23.5"	30 1/2"	medium brown or medium red mahogany
	42 1/4"	23.5"	30 1/2"	natural oak
	42 1/4"	23.5"	30 1/2"	white lacquer
<b>2544AV</b> 4-door, AV compatible interior 	83 3/4"	23.5"	30 1/2"	ebonized oak
	83 3/4"	23.5"	30 1/2"	medium brown or medium red mahogany
	83 3/4"	23.5"	30 1/2"	natural oak
	83 3/4"	23.5"	30 1/2"	white lacquer

pattern no.	wood top/ polished base	(MN, MNS, MA, MAS,MC,MCS, MV, MVS, GG, GGS)	(GC, GCS) marble top/ polished base	(NGC) marble top/ polished base	wood top/ satin base	(MN, MNS, MA, MAS,MC,MCS, MV, MVS, GG, GGS)	(GC, GCS) marble top/ satin base	(NGC) marble top/ polished base
	<b>2545AV-( )-E-( )</b>	\$11,070.	\$12,159.	\$12,159.	\$11,851.	\$11,271.	\$12,361.	\$12,361.
<b>2545AV-( )-(M7,M9)-( )</b>	10,358.	11,452.	11,452.	11,156.	10,559.	11,651.	11,651.	11,358.
<b>2545AV-( )-O-( )</b>	9,695.	10,731.	10,731.	10,453.	9,896.	10,932.	10,932.	10,653.
<b>2545AV-( )-2-( )</b>	n/a	12,873.	12,873.	12,464.	n/a	13,074.	13,074.	12,664.
<b>2544AV-( )-E-( )</b>	20,566.	22,695.	22,695.	22,075.	20,900.	23,029.	23,029.	22,407.
<b>2544AV-( )-(M7,M9)-( )</b>	19,585.	21,622.	21,622.	21,020.	19,919.	21,956.	21,956.	21,352.
<b>2544AV-( )-O-( )</b>	18,441.	20,553.	20,553.	19,974.	18,772.	20,885.	20,885.	20,306.
<b>2544AV-( )-2-( )</b>	n/a	24,893.	24,893.	24,022.	n/a	25,226.	25,226.	24,357.

#### Order Code

<i>Example:</i>	<b>2545AV-C-M9-M9</b>
<b>2545AV</b>	Florence Knoll 2-door AV compatible credenza
<b>C</b>	Polished Chrome
<b>M9</b>	Medium Red Mahogany body
<b>M9</b>	Medium Red Mahogany top

#### Ordering Information

*Specify:*

1. Pattern number
2. Base finish option
3. Body veneer selection
4. Top marble or wood selection
5. Optional locking system (upcharge \$290 or \$579)

*Base finishes:*  
Polished Chrome (suffix C)  
Satin Chrome (suffix CO)

*Body and top veneers/lacquer:*  
Ebonized Oak (suffix E)  
Medium Brown Mahogany (suffix M7)  
Medium Red Mahogany (suffix M9)  
Natural Oak (suffix O)  
White Lacquer (on 2545M only: suffix 2)

*Polished Coated marble top finishes:*  
Arabescato: white-grey (suffix MA)  
Calacatta: white-grey/beige (suffix MC)  
Carrara: white-grey (suffix GC)  
Grey Marble: light grey (suffix GG)  
Nero Marquina: black (suffix MN)  
Verde Alpi: green (suffix MV)

*Satin Coated marble top finishes:*  
Arabescato: white-grey (suffix MAS)  
Calacatta: white-grey/beige (suffix MCS)  
Carrara: white-grey (suffix GCS)  
Grey Marble: light grey (suffix GGS)  
Nero Marquina: black (suffix MNS)  
Verde Alpi: green (suffix MVS)

*Natural marble top finishes:*  
Carrara: white-grey (suffix NGC)

*Wood top finishes:*  
Ebonized Oak (suffix E)  
Medium Brown Mahogany (suffix M7)  
Medium Red Mahogany (suffix M9)  
Natural Oak (suffix O)

*Locking:*  
Optional locking feature secures doors instantly with key lock located on credenza door. Add proper lock suffix to item number at an additional cost of \$290 for the two-position credenza, and \$579 for the four-position credenza. See chart for ordering information.

Credenza pattern no.	Locking system pattern no.
2545AV	2545AVX
2544AV	2544AVX

*Note:*  
KnollStudio logo and Florence Knoll's signature are stamped on each piece.

For weight information, please contact your KnollStudio representative.

*Maintenance:*  
See pages 28-29.

#### Construction

*Base:*  
Welded square steel tube in polished chrome finish. Optional satin chrome finish. Adjustable glides.

*Body:*  
Wood veneer sides and matching back panel in oak, pearwood, or mahogany. Oak and mahogany finished with transparent polyurethane coat.

*Top:*  
3/4" thick marble coated with transparent acrylic to help eliminate use-associated stains. Squared edge detail. 3/4" wood top matching body available. Wood tops finished with transparent polyurethane coat.

*Interior Dimensions:*  
Each interior position of the AV credenzas measures 20" wide, 24" high, and 21 3/4" deep.

Ventilation cutouts measure 11.5" x 15.25" on the back of each position. There is also a covered ventilation hole on the bottom measuring 3.875" in diameter.

*Front:*  
Door fronts in same wood veneers or lacquer finish as body. All have polished aluminum pulls, top flush mounted storage doors with magnetic closures. Other hinging available as special. Storage has matching veneer inside.

# Florence Knoll

## Vertical Storage

### Two Position

Designer(s):  
Florence Knoll, 1961



description	w	d	h	body
<b>2550V</b> 2-door, double-width shelves	37 1/2"	18"	57"	ebonized oak
	37 1/2"	18"	57"	medium brown or medium red mahogany
	37 1/2"	18"	57"	natural oak
	37 1/2"	18"	57"	white lacquer

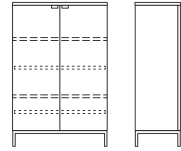

description	w	d	h	body
<b>2551V</b> 2-door, center divider, adjustable shelves	37 1/2"	18"	57"	ebonized oak
	37 1/2"	18"	57"	medium brown or medium red mahogany
	37 1/2"	18"	57"	natural oak
	37 1/2"	18"	57"	white lacquer

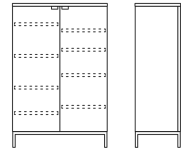

pattern no.	wood top/ polished base	(MN,MNS,MA, MAS,MC,MCS, MV,MVS, GG,GGS) marble top/ polished base	(GC, GCS) marble top/ polished base	(NGC) marble top/ polished base	wood top/ satin base	(MN,MNS,MA, MAS,MC,MCS, MV,MVS, GG,GGS) marble top/ satin base	(GC, GCS) marble top/ satin base	(NGC) marble top satin base
	<b>2550V-(-)E-(-)</b>	\$11,574.	\$12,661.	\$12,661.	\$12,352.	\$11,774.	\$12,863.	\$12,863.
<b>2550V-(-)(M7,M9)-(-)</b>	10,861.	11,953.	11,953.	11,658.	11,061.	12,154.	12,154.	11,859.
<b>2550V-(-)O-(-)</b>	10,199.	11,234.	11,234.	10,956.	10,399.	11,434.	11,434.	11,156.
<b>2550V-(-)2-(-)</b>	n/a	13,375.	13,375.	12,966.	n/a	13,577.	13,577.	13,168.

<b>2551V-(-)E-(-)</b>	11,574.	12,661.	12,661.	12,352.	11,774.	12,863.	12,863.	12,553.
<b>2551V-(-)(M7,M9)-(-)</b>	10,861.	11,953.	11,953.	11,658.	11,061.	12,154.	12,154.	11,859.
<b>2551V-(-)O-(-)</b>	10,199.	11,234.	11,234.	10,956.	10,399.	11,434.	11,434.	11,156.
<b>2551V-(-)2-(-)</b>	n/a	13,375.	13,375.	12,966.	n/a	13,577.	13,577.	13,168.

Order Code	Ordering Information
<i>Example:</i> <b>2550V-C-M9-M9</b>	<i>Specify:</i>
<b>2550V</b> Florence Knoll 2-door credenza, double width shelves	<ol style="list-style-type: none"> <li>1. Pattern number</li> <li>2. Base finish option</li> <li>3. Body veneer selection</li> <li>4. Top marble or wood selection</li> <li>5. Optional locking system (upcharge \$290)</li> </ol>
<b>C</b> Polished Chrome	<i>Polished Coated marble top finishes:</i> Arabescato: white-grey (suffix MA) Calacatta: white-grey/beige (suffix MC) Carrara: white-grey (suffix GC) Grey Marble: light grey (suffix GG) Nero Marquina: black (suffix MN) Verde Alpi: green (suffix MV)
<b>M9</b> Medium Red Mahogany body	<i>Satin Coated marble top finishes:</i> Arabescato: white-grey (suffix MAS) Calacatta: white-grey/beige (suffix MCS) Carrara: white-grey (suffix GCS) Grey Marble: light grey (suffix GGS) Nero Marquina: black (suffix MNS) Verde Alpi: green (suffix MVS)
<b>M9</b> Medium Red Mahogany top	<i>Natural marble top finishes:</i> Carrara: white-grey (suffix NGC)
	<i>Wood top finishes:</i> Ebonized Oak (suffix E) Medium Brown Mahogany (suffix M7) Medium Red Mahogany (suffix M9) Natural Oak (suffix O)
	<i>Locking:</i> Optional locking feature secures doors instantly with key lock located on credenza door. Add proper lock suffix to item number at an additional cost of \$290. See chart for ordering information.
	<i>Credenza pattern no.</i> <i>Locking system pattern no.</i>
	2550V      2550VX 2551V      2551VX 2552VL      2552VLX 2552VR      2552VRX
	<i>Note:</i> KnollStudio logo and Florence Knoll's signature are stamped on each piece.
	For weight information, please contact your KnollStudio representative.
	<i>Maintenance:</i> See pages 28-29.

Florence Knoll vertical storage is part of a collection. Please refer to Florence Knoll lounge seating on page 146 and table desks, conference and low tables on beginning on page 396.

Construction
<i>Base:</i> Welded square steel tube in polished chrome finish. Optional satin chrome finish. Adjustable glides.
<i>Top :</i> 3/4" thick marble coated with transparent acrylic to help eliminate use-associated stains. Squared edge detail. 3/8" wood top matching body available. Wood tops finished with transparent polyurethane coat.
<i>Front:</i> Door fronts in same wood veneers or lacquer finish as body. All have polished aluminum pulls, top flush mounted storage doors with magnetic closures. Other hinging available as special. Storage has matching veneer inside.
<i>Body:</i> Wood veneer sides and matching back panel in oak, or mahogany. Oak and mahogany finished with transparent polyurethane coat.

# Florence Knoll

## Vertical Storage

### Two Position, Center Divider and Coat Closet

Designer(s):  
Florence Knoll, 1961



description	w	d	h	body
<b>2552VL</b> 2-door, center divider, left coat closet and right single width shelves	37 1/2"	18"	57"	black or white lacquer
	37 1/2"	18"	57"	ebonized oak
	37 1/2"	18"	57"	medium brown or medium red mahogany
	37 1/2"	18"	57"	natural oak

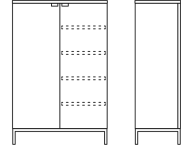

description	w	d	h	body
<b>2552VR</b> 2-door, center divider, right coat closet and left single width shelves	37 1/2"	18"	57"	black or white lacquer
	37 1/2"	18"	57"	ebonized oak
	37 1/2"	18"	57"	medium brown or medium red mahogany
	37 1/2"	18"	57"	natural oak

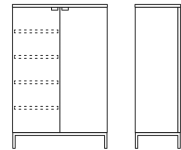

pattern no.	(MN, MNS, MA, MAS, MC, MCS, MV, MVS, GG, GGS)		(GC, GCS)	(NGC)	(MN, MNS, MA, MAS, MC, MCS, MV, MVS, GG, GGS)		(GC, GCS)	(NGC)
	wood top/ polished base	marble top/ polished base	marble top/ polished base	marble top/ polished base	wood top/ satin base	marble top/ satin base	marble top/ satin base	marble top/ satin base
<b>2552VL-( )-(1,2)-( )</b>	n/a	\$13,375.	\$13,375.	\$12,966.	n/a	\$13,577.	\$13,577.	\$13,168.
<b>2552VL-( )-E-( )</b>	11,574.	12,661.	12,661.	12,352.	11,774.	12,863.	12,863.	12,553.
<b>2552VL-( )-(M7,M9)-( )</b>	10,861.	11,953.	11,953.	11,658.	11,061.	12,154.	12,154.	11,859.
<b>2552VL-( )-O-( )</b>	10,199.	11,234.	11,234.	10,956.	10,399.	11,434.	11,434.	11,156.

<b>2552VR-( )-(1,2)-( )</b>	n/a	13,375.	13,375.	12,966.	n/a	13,577.	13,577.	13,168.
<b>2552VR-( )-E-( )</b>	11,574.	12,661.	12,661.	12,352.	11,774.	12,863.	12,863.	12,553.
<b>2552VR-( )-(M7,M9)-( )</b>	10,861.	11,953.	11,953.	11,658.	11,061.	12,154.	12,154.	11,859.
<b>2552VR-( )-O-( )</b>	10,199.	11,234.	11,234.	10,956.	10,399.	11,434.	11,434.	11,156.

#### Order Code

<i>Example:</i>	<b>2550V-C-M9-M9</b>
<b>2550V</b>	Florence Knoll 2-door credenza, double width shelves
<b>C</b>	Polished Chrome
<b>M9</b>	Medium Red Mahogany body
<b>M9</b>	Medium Red Mahogany top

Florence Knoll vertical storage is part of a collection. Please refer to Florence Knoll lounge seating on page 146 and table desks, conference and low tables on beginning on page 396.

#### Ordering Information

- Specify:*
1. Pattern number
  2. Base finish option
  3. Body veneer selection
  4. Top marble or wood selection
  5. Optional central locking system (upcharge \$290)
- Base finishes:*  
Polished Chrome (suffix C)  
Satin Chrome (suffix CO)
- Body and top veneers/lacquer:*  
Ebonized Oak (suffix E)  
Medium Brown Mahogany (suffix M7)  
Medium Red Mahogany (suffix M9)  
Natural Oak (suffix O)  
White Lacquer (on 2545M only: suffix 2)

*Polished Coated marble top finishes:*  
Arabescato: white-grey (suffix MA)  
Calacatta: white-grey/beige (suffix MC)  
Carrara: white-grey (suffix GC)  
Grey Marble: light grey (suffix GG)  
Nero Marquina: black (suffix MN)  
Verde Alpi: green (suffix MV)

*Satin Coated marble top finishes:*  
Arabescato: white-grey (suffix MAS)  
Calacatta: white-grey/beige (suffix MCS)  
Carrara: white-grey (suffix GCS)  
Grey Marble: light grey (suffix GGS)  
Nero Marquina: black (suffix MNS)  
Verde Alpi: green (suffix MVS)

*Natural marble top finishes:*  
Carrara: white-grey (suffix NGC)

*Wood top finishes:*  
Ebonized Oak (suffix E)  
Medium Brown Mahogany (suffix M7)  
Medium Red Mahogany (suffix M9)  
Natural Oak (suffix O)

*Locking:*  
Optional locking feature secures doors instantly with key lock located on credenza door. Add proper lock suffix to item number at an additional cost of \$290. See chart for ordering information.

Credenza pattern no.	Locking system pattern no.
2550V	2550VX
2551V	2551VX
2552VL	2552VLX
2552VR	2552VRX

*Note:*  
KnollStudio logo and Florence Knoll's signature are stamped on each piece.

For weight information, please contact your KnollStudio representative.

*Maintenance:*  
See pages 28-29.

#### Construction

*Base:*  
Welded square steel tube in polished chrome finish. Optional satin chrome finish. Adjustable glides.

*Body:*  
Wood veneer sides and matching back panel in oak or mahogany. Oak and mahogany finished with transparent polyurethane coat.

*Top :*  
3/4" thick marble coated with transparent acrylic to help eliminate use-associated stains. Squared edge detail. 3/8" wood top matching body available. Wood tops finished with transparent polyurethane coat.

*Front:*  
Door fronts in same wood veneers or lacquer finish as body. All have polished aluminum pulls, top flush mounted storage doors with magnetic closures. Other hinging available as special. Storage has matching veneer inside.



# Florence Knoll Coffee Tables

Designer(s):  
Florence Knoll

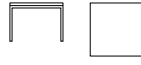
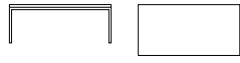

description	w	d	h	weight	top	
<b>2510T</b> Square coffee table 	23 1/2"	23 1/2"	17"	50 lbs.	clear glass	
	23 1/2"	23 1/2"	17"	50 lbs.	white or black glass	
	23 1/2"	23 1/2"	17"	65 lbs.	natural marble	
	23 1/2"	23 1/2"	17"	65 lbs.	coated marble	
	23 1/2"	23 1/2"	17"	33 lbs.	veneer	
	23 1/2"	23 1/2"	17"	65 lbs.	coated marble	
	23 1/2"	23 1/2"	17"	65 lbs.	coated marble	
	23 1/2"	23 1/2"	17"	65 lbs.	coated marble	
	23 1/2"	23 1/2"	17"	65 lbs.	coated marble	
	23 1/2"	23 1/2"	17"	67 lbs.	granite	
	23 1/2"	23 1/2"	17"	65 lbs.	natural marble	
	<b>2511T</b> Rectangular coffee table 	45"	22 1/2"	17"	76 lbs.	clear glass
		45"	22 1/2"	17"	104 lbs.	natural marble
45"		22 1/2"	17"	104 lbs.	coated marble	
45"		22 1/2"	17"	45 lbs.	veneer	
45"		22 1/2"	17"	104 lbs.	coated marble	
45"		22 1/2"	17"	104 lbs.	coated marble	
45"		22 1/2"	17"	104 lbs.	coated marble	
45"		22 1/2"	17"	104 lbs.	coated marble	
45"		22 1/2"	17"	104 lbs.	coated marble	
45"		22 1/2"	17"	106 lbs.	granite	
45"		22 1/2"	17"	104 lbs.	natural marble	

pattern no.	polished chrome (suffix C)	satin chrome (suffix CO)
<b>2510T(-)G2</b>	\$1,565.	\$1,687.
<b>2510T(-)C1, C2</b>	2,153.	2,273.
<b>2510T(-)(-)(NGC)</b>	2,731.	2,849.
<b>2510T(-)(-)(MN, MNS, MA, MAS, GG, GGS)</b>	2,874.	2,993.
<b>2510T(-)(-)(LO, LWA, D, V314)</b>	2,985.	3,103.
<b>2510T(-)(-)(GC, GCS)</b>	3,011.	3,130.
<b>2510(-)(-)(MG, MGS)</b>	3,099.	3,216.
<b>2510T(-)(-)(MC, MCS)</b>	3,279.	3,397.
<b>2510(-)(-)(ME, MES)</b>	3,359.	3,474.
<b>2510T(-)(-)(MV, MVS)</b>	3,805.	3,924.
<b>2510T(-)(-)(GA)</b>	4,898.	5,017.
<b>2510T(-)(-)(NC)</b>	5,311.	5,433.
<b>2511T(-)G2</b>	2,163.	2,337.
<b>2511T(-)(-)(NGC)</b>	3,642.	3,812.
<b>2511T(-)(-)(MN, MNS, MA, MAS, GG, GGS)</b>	3,932.	4,102.
<b>2511T(-)(-)(LO, LWA, D, V314)</b>	3,962.	4,135.
<b>2511T(-)(-)(GC, GCS)</b>	4,121.	4,294.
<b>2511T(-)(-)(MC, MCS)</b>	4,487.	4,660.
<b>2511T(-)(-)(MG, MGS)</b>	4,756.	4,920.
<b>2511T(-)(-)(MV, MVS)</b>	5,301.	5,471.
<b>2511(-)(-)(ME, MES)</b>	5,734.	5,900.
<b>2511T(-)(-)(GA)</b>	6,559.	6,732.
<b>2511T(-)(-)(NC)</b>	7,549.	7,721.

Order Code	Ordering Information
<i>Example:</i> <b>2510T-C-G2</b>	<i>Base finishes:</i> Polished Chrome (suffix C) Satin Chrome (suffix CO)
<b>2510T</b>	Florence Knoll square coffee table
<b>C</b>	Polished Chrome
<b>G2</b>	Clear glass
<i>Note:</i> Florence Knoll coffee tables are part of a collection. Please refer to Florence Knoll lounge seating on page 146 and desks and credenzas beginning on page 396.	<i>Glass top finishes:</i> Black Glass (suffix C1) Clear Glass (suffix G2) White Glass (suffix C2)
<i>Specify:</i> 1. Pattern number 2. Base finish option 3. Top selection	<i>Veneer finishes:</i> Ebonized Walnut (suffix D) Light Oak (suffix LO) Light Walnut (suffix LWA) Reff Dark Cherry (suffix V314)
	<i>Polished Coated marble top finishes:</i> Arabescato: white-grey (suffix MA) Calacatta: white-grey/beige (suffix MC) Carrara: white-grey (suffix GC) Espresso: dark brown (suffix ME) Grey Marble: light grey (suffix GG) Grigio Marquina: warm grey (suffix MG) Nero Marquina: black (suffix MN) Verdi Alpi: green (suffix MV)
	<i>Granite top finish:</i> Black Andes: black (suffix GA)
	<i>Note:</i> Wood finishes on Florence Knoll low tables differ from those on the table desk and credenzas.
	<i>Base:</i> Polished chrome-plated or satin chrome-plated steel.
	<i>Maintenance:</i> See pages 28-29.
	<i>Note:</i> KnollStudio logo and signature of Florence Knoll are stamped into the base.
	The Florence Knoll Coffee and End Tables are certified Clean Air GOLD.
	<i>Satin Coated marble top finishes:</i> Arabescato: white-grey (suffix MAS) Calacatta: white-grey/beige (suffix MCS) Carrara: white-grey (suffix GCS) Espresso: dark brown (suffix MES) Grey Marble: light grey (suffix GGS) Grigio Marquina: warm grey (suffix MGS) Nero Marquina: black (suffix MNS) Verde Alpi: green (suffix MVS)
	<i>Natural marble top finishes:</i> Calacatta: white-grey/beige (suffix NC) Carrara: white-grey (suffix NGC)

Construction
<i>Top:</i> 5/8" thick polished plate glass or coated marble with transparent acrylic to help eliminate use-associated stains. 3/4" thick natural marble and granite top with protective sealer.
<i>Note:</i> Marbles with a coating will yellow over time.
<i>Wood Top:</i> Tops are constructed of veneered medium density fiberboard with a cathedral grain pattern in various toned or stained finishes for light oak, light walnut, and reff dark cherry. Ebonized walnut features a black stain on walnut substrate. Tops are 3/4" thick. Base and Top ship separately. Top is attached to base with wood screws that are enclosed in hardware packet.

# Florence Knoll

## Low Coffee Tables

Designer(s):  
Florence Knoll

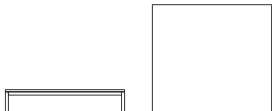

description	w	d	h	weight	top
<b>2512L</b> Low coffee table 	47 1/4"	47 1/4"	13 3/4"	135 lbs.	clear glass
	47 1/4"	47 1/4"	13 3/4"	205 lbs.	coated marble
	47 1/4"	47 1/4"	13 3/4"	205 lbs.	coated marble
	47 1/4"	47 1/4"	13 3/4"	205 lbs.	coated marble
	47 1/4"	47 1/4"	13 3/4"	205 lbs.	coated marble

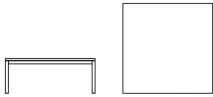
description	w	d	h	weight	top
<b>2517L</b> Low coffee table 	35 1/2"	35 1/2"	13 3/4"	84 lbs.	clear glass
	35 1/2"	35 1/2"	13 3/4"	124 lbs.	coated marble
	35 1/2"	35 1/2"	13 3/4"	124 lbs.	coated marble
	35 1/2"	35 1/2"	13 3/4"	124 lbs.	coated marble
	35 1/2"	35 1/2"	13 3/4"	124 lbs.	coated marble

pattern no.	polished chrome (suffix C)
<b>2512L-( )-G2</b>	\$2,929.
<b>2512L-( )-(MG, MGS)</b>	9,885.
<b>2512L-( )-(GC, GCS)</b>	11,053.
<b>2512L-( )-(MA, MAS)</b>	11,635.
<b>2512L-( )-(MC, MCS)</b>	15,486.

<b>2517L-( )-G2</b>	2,030.
<b>2517L-( )-(GC, GCS)</b>	5,855.
<b>2517L-( )-(MG, MGS)</b>	6,104.
<b>2517L-( )-(MC, MCS)</b>	6,781.
<b>2517L-( )-(MA, MAS)</b>	6,843.

Order Code	Ordering Information	Construction
<i>Example:</i> <b>2517L-C-G2</b>	<i>Base finishes:</i> Polished Chrome (suffix C)	<i>Base:</i> Polished chrome.
<b>2517L</b> Florence Knoll Low square coffee table	<i>Polished Coated marble top finishes:</i> Arabescato: white-grey (suffix MA) Calacatta: white-grey/beige (suffix MC) Carrara:white-grey (suffix GC) Grigio Marquina: warm grey (suffix MG)	<i>Maintenance:</i> See pages 28-29.
<b>C</b> Polished Chrome	<i>Satin Coated marble top finishes:</i> Arabescato: white-grey (suffix MAS) Calacatta: white-grey/beige (suffix MCS) Carrara: white-grey (suffix GCS) Grigio Marquina: warm grey (suffix MCS)	<i>Note:</i> KnollStudio logo and signature of Florence Knoll are stamped into the base.
<b>G2</b> Clear glass		<i>Note:</i> The Florence Knoll Coffee and End Tables are certified Clean Air GOLD.

*Note:*  
Florence Knoll coffee tables are part of a collection. Please refer to Florence Knoll lounge seating on page 146 and desks and credenzas beginning on page 396.

*Specify:*

1. Pattern number
2. Base finish option
3. Top selection

# Florence Knoll End Tables



Designer(s):  
Florence Knoll

description	w	d	h	weight	top	
<b>2515T</b> Square end table 	29 1/2"	29 1/2"	19"	71 lbs.	clear glass	
	29 1/2"	29 1/2"	19"	95 lbs.	natural marble	
	29 1/2"	29 1/2"	19"	95 lbs.	coated marble	
	29 1/2"	29 1/2"	19"	95 lbs.	coated marble	
	29 1/2"	29 1/2"	19"	44 lbs.	veneer	
	29 1/2"	29 1/2"	19"	95 lbs.	coated marble	
	29 1/2"	29 1/2"	19"	95 lbs.	coated marble	
	29 1/2"	29 1/2"	19"	95 lbs.	coated marble	
	29 1/2"	29 1/2"	19"	95 lbs.	coated marble	
	29 1/2"	29 1/2"	19"	96 lbs.	granite	
	29 1/2"	29 1/2"	19"	95 lbs.	natural marble	
	<b>2517T</b> Square end table 	35 1/2"	35 1/2"	19"	93 lbs.	clear glass
		35 1/2"	35 1/2"	19"	128 lbs.	natural marble
35 1/2"		35 1/2"	19"	53 lbs.	veneer	
35 1/2"		35 1/2"	19"	128 lbs.	coated marble	
35 1/2"		35 1/2"	19"	128 lbs.	coated marble	
35 1/2"		35 1/2"	19"	128 lbs.	coated marble	
35 1/2"		35 1/2"	19"	128 lbs.	coated marble	
35 1/2"		35 1/2"	19"	128 lbs.	coated marble	
35 1/2"		35 1/2"	19"	128 lbs.	coated marble	
35 1/2"		35 1/2"	19"	131 lbs.	granite	
35 1/2"		35 1/2"	19"	128 lbs.	natural marble	

pattern no.	polished chrome (suffix C)	satin chrome (suffix CO)
<b>2515T( )-G2</b>	\$2,090.	\$2,211.
<b>2515T( )-(NGC)</b>	3,216.	3,341.
<b>2515T( )-(MN, MNS, MA, MAS, GG, GGS)</b>	3,439.	3,565.
<b>2515T( )-(GC, GCS)</b>	3,604.	3,731.
<b>2515T( )-(LO, LWA, D, V314)</b>	4,092.	4,215.
<b>2515T( )-(MG, MGS)</b>	4,204.	4,327.
<b>2515T( )-(MC, MCS)</b>	4,715.	4,840.
<b>2515T( )-(MV, MVS)</b>	4,782.	4,903.
<b>2515( )-(ME, MES)</b>	5,026.	5,150.
<b>2515T( )-(GA)</b>	6,275.	6,397.
<b>2515T( )-(NC)</b>	7,000.	7,113.
<b>2517T( )-G2</b>	2,430.	2,602.
<b>2517T( )-(NGC)</b>	4,182.	4,354.
<b>2517T( )-(LO, LWA, D, V314)</b>	4,265.	4,434.
<b>2517T( )-(MN, MNS, MA, MAS, GG, GGS)</b>	4,584.	4,753.
<b>2517T( )-(GC, GCS)</b>	4,802.	4,974.
<b>2517T( )-(MG, MGS)</b>	5,519.	5,682.
<b>2517T( )-(MV, MVS)</b>	5,986.	6,157.
<b>2517T( )-(MC, MCS)</b>	6,277.	6,450.
<b>2517T( )-(ME, MES)</b>	6,558.	6,720.
<b>2517T( )-(GA)</b>	7,476.	7,649.
<b>2517T( )-(NC)</b>	8,525.	8,693.

Order Code	Ordering Information
<i>Example:</i> <b>2517T-CO-GS</b>	<i>Base finishes:</i>
<b>2517T</b> Florence Knoll square end table	Polished Chrome (suffix C) Satin Chrome (suffix CO)
<b>CO</b> Satin Chrome	<i>Glass top finishes:</i>
<b>GS</b> Cedar Stone	Clear Glass (suffix G2)
<i>Note:</i> Florence Knoll end tables are part of a collection. Please refer to Florence Knoll lounge seating on page 146 and desks and credenzas beginning on page 396.	<i>Veneer finishes:</i> Ebonized Walnut (suffix D) Light Oak (suffix LO) Light Walnut (suffix LWA) Reff Dark Cherry (suffix V314)
<i>Specify:</i> 1. Pattern number 2. Base finish option 3. Top selection	<i>Polished Coated marble top finishes:</i> Arabescato: white-grey (suffix MA) Calacatta: white-grey/beige (suffix MC) Carrara: white-grey (suffix GC) Espresso: dark brown (suffix ME) Grey Marble: light grey (suffix GG) Grigio Marquina: warm grey (suffix MG) Nero Marquina: black (suffix MN) Verdi Alpi: green (suffix MV)
	<i>Satin Coated marble top finishes:</i> Arabescato: white-grey (suffix MAS) Calacatta: white-grey/beige (suffix MCS) Carrara: white-grey (suffix GCS) Espresso: dark brown (suffix MES) Grey Marble: light grey (suffix GGS) Grigio Marquina: warm grey (suffix MGS) Nero Marquina: black (suffix MNS) Verde Alpi: green (suffix MVS)
	<i>Natural marble top finishes:</i> Calacatta: white-grey/beige (suffix NC) Carrara: white-grey (suffix NGC)
	<i>Granite top finish:</i> Black Andes: black (suffix GA)
	<i>Note:</i> Wood finishes on Florence Knoll low tables differ from those on the table desk and credenzas.
	<i>Base:</i> Polished chrome-plated or satin chrome-plated steel.
	<i>Maintenance:</i> See pages 28-29.
	<i>Note:</i> KnollStudio logo and signature of Florence Knoll are stamped into the base.
	The Florence Knoll Coffee and End Tables are certified Clean Air GOLD.

Construction
<i>Top:</i> 3/8" thick polished plate glass or coated marble with transparent acrylic to help eliminate use-associated stains. 3/4" thick natural marble and granite top with protective sealer.
<i>Note:</i> Marbles with a coating will yellow over time.
<i>Wood Top:</i> Tops are constructed of veneered medium density fiberboard with a cathedral grain pattern in various toned or stained finishes for light oak, light walnut, and reff dark cherry. Ebonized walnut features a black stain on walnut substrate. Tops are 3/4" thick. Tops contain threaded inserts and attach to base with screws.

# Florence Knoll

## Hairpin™ Stacking Table

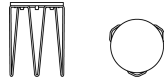
	description	w	d	h	base	weight
<i>Designer(s):</i> Florence Knoll, 1947	<b>75</b> Hairpin stacking table 	13"	13"	18½"	Paint	7 lbs
		13"	13"	18½"	Chrome	7 lbs

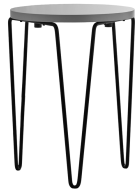





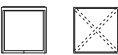

pattern no.	colored laminate	woodgrain laminate
<b>75-(-)( )</b>	\$414.	\$457.
<b>75-(-)(C)</b>	457.	498.

Order Code	Ordering Information	Construction
<i>Example:</i> <b>75-F1-W</b>	<i>Colored Laminate Finishes:</i>	<i>Base:</i>
<b>75</b> Hairpin stacking table	Black (suffix F1)	Base is constructed of bent cold rolled steel rods and powder coated paint finish or chrome plated. Stainless steel screws attach base to the table top.
<b>F1</b> Black laminate	White (suffix F2)	
<b>W</b> White base	<i>Woodgrain Laminate Finishes:</i>	<i>Laminate Top:</i>
	Grey Ash (suffix 142)	MDF top is sandwiched between laminate layer with ABS edge. Woodgrain laminate tops will feature a matching woodgrain ABS edge. Three nylon bumpers underneath the top prevent scratches when tables are stacked.
	Light Ash (suffix 139)	
	Zebra (suffix 145)	<i>Note:</i>
<i>Specify:</i>	<i>Base Finishes:</i>	Tables stack up to 5 high.
1. Pattern number	Chrome (suffix C)	
2. Top selection	Black (suffix BL)	
3. Base selection	White (suffix W)	
	Blue (suffix BU)	
	Orange Red (suffix RD)	
	Yellow (suffix YL)	
	Green (suffix GE)	
	<i>Maintenance:</i>	The Florence Knoll Hairpin Stacking Table is certified Clean Air GOLD.
	See pages 28-29.	

Designer(s):  
Marc Krusin, 2012

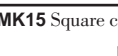

description	w	d	h	base
<b>MK11</b> Square side table 	18"	18"	18"	Ash, Beech & Oak
	18"	18"	18"	Walnut
<b>MK12</b> Square side table 	18"	18"	22"	Ash, Beech & Oak
	18"	18"	22"	Walnut
<b>MK13</b> Square end table 	24"	24"	14"	Ash, Beech & Oak
	24"	24"	14"	Walnut
<b>MK14</b> Square coffee table 	36"	36"	10"	Ash, Beech & Oak
	36"	36"	10"	Walnut
<b>MK15</b> Square coffee table 	36"	36"	14"	Ash, Beech & Oak
	36"	36"	14"	Walnut
<b>MK16</b> Rectangular coffee table 	40"	24"	14"	Ash, Beech & Oak
	40"	24"	14"	Walnut

pattern no	glass& laminate tops	veneer top	leather	GE, GES	MA, MAS, ME, MES, MG, MGS	MC, MCS	engineered stone (VB)
<b>MK11-(-)(-)</b>	\$1,596.	\$2,402.	\$2,705.	\$2,939.	\$3,081.	\$3,395.	\$2,841.
<b>MK11-(-)-AW</b>	1,791.	2,719.	2,945.	3,178.	3,324.	3,629.	3,091.
<b>MK12-(-)(-)</b>	1,610.	2,414.	2,719.	2,953.	3,098.	3,408.	2,874.
<b>MK12-(-)-AW</b>	1,811.	2,754.	2,961.	3,208.	3,355.	3,666.	3,130.
<b>MK13-(-)(-)</b>	1,968.	2,576.	3,081.	3,618.	3,804.	4,334.	3,877.
<b>MK13-(-)-AW</b>	2,286.	2,994.	3,486.	4,019.	4,205.	4,735.	4,277.
<b>MK14-(-)(-)</b>	2,674.	2,994.	4,708.	5,302.	6,010.	6,893.	6,899.
<b>MK14-(-)-AW</b>	2,939.	3,401.	5,048.	5,642.	6,346.	7,239.	7,245.
<b>MK15-(-)(-)</b>	2,674.	2,994.	4,708.	5,302.	6,010.	6,893.	6,899.
<b>MK15-(-)-AW</b>	2,939.	3,401.	5,048.	5,642.	6,346.	7,239.	7,245.
<b>MK16-(-)(-)</b>	2,855.	3,696.	5,032.	5,772.	6,929.	8,156.	5,294.
<b>MK16-(-)-AW</b>	2,969.	3,818.	5,154.	5,919.	7,076.	8,301.	5,433.

**Order Code**

<i>Example:</i>	<b>MK13-G2-A101</b>
<b>MK13</b>	Square End Table
<b>G2</b>	Clear Glass
<b>A101</b>	White ash base

*Note:*  
When specifying veneer tops, the base finish matches top. Contrasting top and base finish is not a standard option

*Specify:*

1. Pattern number
2. Top Finish
3. Base Finish

**Ordering Information**

**Base Finishes:**

*Ash:*  
White Ash, suffix A101

*Oak:*  
Natural Oak (suffix ON)  
Ebonized Oak (suffix OE)  
Fumed Oak (suffix OF)

*Walnut:*  
American Walnut (suffix AW)

*Beech:*  
Beech (suffix B311)  
Bronzed Cherry (suffix B12A)  
Burnt Walnut (suffix B313)  
Deep Red Mahogany (suffix B328)  
Ebonized (suffix BE)  
Light Cherry (suffix B315)  
Light Walnut (suffix B411)  
Medium Cherry (suffix B319)  
Medium Red Mahogany (suffix BR)  
Medium Walnut (suffix B323)  
Natural Beech (suffix BN)

**Top Finishes:**

*Laminate:*  
Bright White (suffix 118)

*Glass:*  
Clear Glass (suffix G2)

*Ash:*  
White Ash (suffix A101)

*Oak:*  
Natural Oak (suffix ON)  
Ebonized Oak (suffix OE)  
Fumed Oak (suffix OF)

*Walnut:*  
American Walnut (suffix AW)

*Veneer:*

*Beech:*  
Beech (suffix B311)  
Bronzed Cherry (suffix B312A)  
Burnt Walnut (suffix B313)  
Deep Red Mahogany (suffix B328)  
Ebonized (suffix BE)  
Light Cherry (suffix B315)  
Medium Cherry (suffix B319)  
Medium Red Mahogany (suffix BR)  
Medium Walnut (suffix B323)  
Natural Beech (suffix BN)

**Construction**

*Leather:*

*Spinneybeck Riva:*  
Anata Beccorosso (suffix RA1808)  
Aquila de Mare (suffix RA1813)  
Beccaccia de Mare (suffix RA1815)  
Black (suffix RABLK)  
Cavaliere d'Italia (suffix RA1804)  
Paggiarolo (suffix RA1809)  
Spatola (suffix RA1806)  
\*CFA waived for this product line

*Coated Marble (polished, satin):*  
Arabescato (suffix MA, MAS)  
Calacatta (suffix MC, MCS)  
Espresso Marble (suffix ME, MES)  
Grigio Marquina (suffix MG, MGS)

*Engineered Stone:*  
Vetro Bianco (VB)

*Frame:*

Select American and European hard wood frames. Dowel and mortise and tenon construction.

*Marble and Glass Tops:*  
Inset 1/4" thick coated marbles in polished or satin acrylic coating and clear tempered glass with radius corners. Tops rest within the frame.

*Veneer and Laminate Tops:*  
Constructed with MDF core with solid lumber edges. Laminate has painted filled edge. Face and back are veneer or laminate Inset tops have threaded inserts to attach to frame.

*Leather Tops:*  
Constructed with MDF core wrapped in select Riva leather in various colors.

*Finish:*

Beech, Catalyzed lacquer protective coating. Hand applied final wax coating. Ash, Oak, and Walnut with low sheen urethane protective coating. Hand applied final wax coating. Conversion varnish top coat.

*Glides:*  
Felt glides included with all bases for use on hard floor surfaces.

Piero Lissoni  
Grasshopper™ Tables  
Low Table Sets

Designer(s):  
Piero Lissoni, 2018



description	w	h	base weight	base	additional top
<b>LL10</b> Low Single Round Table	39 1/2"	8"	13 lbs.	Chrome	
	39 1/2"	8"	13 lbs.	Painted Black	

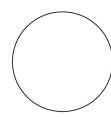

description	w	h	base weight	base	additional top
<b>LLS8</b> Low Double Round Table	39 1/2"	8"	46 lbs.	Chrome	Top A
	39 1/2"	8"	46 lbs.	Painted Black	Top A
	32 3/4"	10"			Top B

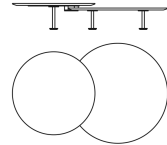

description	w	h	base weight	base	additional top
<b>LLS7</b> Low Triple Round Table	39 1/2"	8"	82 lbs.	Chrome	Top A
	39 1/2"	8"	82 lbs.	Painted Black	Top A
	32 3/4"	10"			Top B
	23 3/4"	11 3/4"			Top C

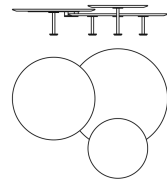

pattern no.	laminate top	black glass top	(MV,MVS) marble top	(MN,MNS) marble top	(GC,GCS) marble top	(MR,MRS) marble top	(MA,MAS) marble top	(MC,MCS) marble top
<b>LL10-C</b>	\$3,237.	\$3,895.	\$6,219.	\$7,081.	\$6,973.	\$7,186.	\$7,833.	\$9,341.
<b>LL10-BM</b>	2,579.	3,237.	5,562.	6,422.	6,314.	6,528.	7,175.	8,683.

<b>LLS8-C- ( )</b>	3,874.	4,532.	6,855.	7,716.	7,609.	7,822.	8,471.	9,979.
<b>LLS8-BM- ( )</b>	3,067.	3,726.	6,051.	6,909.	6,804.	7,017.	7,663.	9,171.
<b>LLS8 Top B</b>	1,561.	1,837.	3,715.	4,298.	4,235.	4,385.	4,830.	5,859.

<b>LLS7-C- ( )</b>	5,264.	5,923.	8,247.	9,107.	9,000.	9,213.	9,860.	11,369.
<b>LLS7-BM- ( )</b>	4,066.	4,722.	7,048.	7,907.	7,802.	8,013.	8,663.	10,167.
<b>LLS7 Top B</b>	1,561.	1,837.	3,715.	4,298.	4,235.	4,385.	4,830.	5,859.
<b>LLS7 Top C</b>	1,094.	1,316.	2,176.	2,474.	2,440.	2,515.	2,750.	3,292.

Order Code

<i>Example:</i>	<b>LLS8-C-MA-MN</b>
<b>LLS8</b>	Low Round Table, Double
<b>C</b>	Chrome base
<b>MA</b>	Arabescato
<b>MN</b>	Nero Marquina

Specify:

1. Pattern number
2. Base finish option
3. Large top A finish selection
4. Medium top B finish selection (if applicable)
5. Small top C finish selection (if applicable)

Ordering Information

*Base finishes:*  
Chrome (suffix C)  
Painted Black (suffix BM)

*Laminate and glass top finishes:*  
White Laminate (suffix F2)  
Black Glass (suffix C1)

*Polished Coated marble top finishes:*  
Arabescato: white-grey (suffix MA)  
Calacatta: white-grey/beige (suffix MC)  
Carrara: white-grey (suffix GC)  
Nero Marquina: black (suffix MN)  
Rosso Rubino: rich red (suffix MR)  
Verde Alpi: green (suffix MV)

*Satin Coated marble top finishes:*  
Arabescato: white-grey (suffix MAS)  
Calacatta: white-grey/beige (suffix MCS)  
Carrara: white-grey (suffix GCS)  
Nero Marquina: black (suffix MNS)  
Rosso Rubino: rich red (suffix MRS)  
Verde Alpi: green (suffix MVS)

*Note:* LLS8 and LLS7 include multiple tabletops that can be specified in different finishes. The final list price for LLS8 should include the price for Top A in specified finish plus Top B in specified finish. The final list price for LLS7 should include the price for Top A in specified finish, plus Top B in specified finish, plus Top C in specified finish.

*Maintenance:*  
See pages 28-29.

Construction

*Base:*  
Polished chrome-plated or powder coated high performance alloy steel.

*Top:*  
Bevel-edge satin smooth laminate or marble. Rounded edge back silk-screen painted frosted tempered extra clear glass.

*Note:*  
The tables are fixed when they are in a set of two. The 23 3/4" table can be moved 90° if it is part of a set of three. The individual tables in LLS8 and LLS7 configurations are not freestanding.

*Overall Widths:*  
LLS8: 59.8" W  
LLS7: 75.25" W

Piero Lissoni  
Grasshopper™ Tables  
High Tables

Designer(s):  
Piero Lissoni, 2018



description	w	d	h	base weight	base
<b>LH27</b> High Rectangular Table	106"	43"	28"	57 lbs.	Chrome
	106"	43"	28"	57 lbs	Painted Black

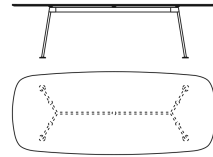

<b>LH24</b> High Rectangular Table	94 1/2"	39 1/2"	28"	53 lbs	Chrome
	94 1/2"	39 1/2"	28"	53 lbs.	Painted Black

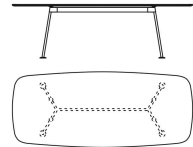

<b>LH20</b> High Rectangular Table	79"	35 1/2"	28"	51 lbs.	Chrome
	79"	35 1/2"	28"	51 lbs.	Painted Black

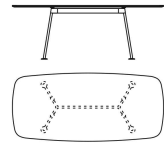

<b>LH15</b> High Round Table	60"		28"	40 lbs.	Chrome
	60"		28"	40 lbs.	Painted Black

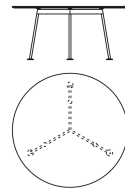

<b>LH13</b> High Round Table	54"		28"	38 lbs.	Chrome
	54"		28"	38 lbs.	Painted Black

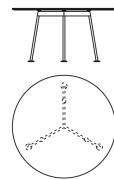

pattern no.	clear glass top	sanded glass top	(MV,MVS) marble top	(MN,MNS) marble top	(GC, GCS) marble top	(MR,MRS) marble top	(MA,MAS) marble top	(MC,MCS) marble top
<b>LH27-C</b>	\$13,627.	\$14,731.	\$21,281.	\$23,838.	\$23,520.	\$24,158.	\$26,078.	\$30,537.
<b>LH27-BM</b>	11,621.	12,726.	19,275.	21,833.	21,514.	22,151.	24,072.	28,529.

<b>LH24-C</b>	12,248.	13,151.	18,756.	20,824.	20,569.	21,078.	22,629.	26,238.
<b>LH24-BM</b>	10,274.	11,176.	16,780.	18,852.	18,595.	19,107.	20,654.	24,264.

<b>LH20-C</b>	11,209.	11,888.	16,642.	18,180.	17,991.	18,371.	19,540.	22,246.
<b>LH20-BM</b>	9,234.	9,913.	14,669.	16,208.	16,016.	16,399.	17,566.	20,273.

<b>LH15-C</b>	10,127.	10,944.	15,220.	17,237.	16,983.	17,481.	18,999.	22,511.
<b>LH15-BM</b>	8,917.	9,733.	14,011.	16,027.	15,773.	16,271.	17,790.	21,304.

<b>LH13-C</b>	9,403.	10,094.	13,459.	15,072.	14,870.	15,273.	16,484.	19,307.
<b>LH13-BM</b>	8,216.	8,906.	12,270.	13,882.	13,681.	14,085.	15,295.	18,118.

Order Code

Example:	<b>LH27-C-MVS</b>
<b>LH27</b>	High Rectangular Table
<b>C</b>	Chrome base
<b>MVS</b>	Verdi Alpi, Satin

Specify:

1. Pattern number
2. Base finish option
3. Top glass or marble selection

Ordering Information

Base finishes:  
Chrome (suffix C)  
Painted Black (suffix BM)

Glass top finishes:  
Clear Glass (suffix G2)  
Sanded Glass (suffix GS)

Polished Coated marble top finishes:  
Arabescato: white-grey (suffix MA)  
Calacatta: white-grey/beige (suffix MC)  
Carrara: white-grey (suffix GC)  
Nero Marquina: black (suffix MN)  
Rosso Rubino: rich red (suffix MR)  
Verde Alpi: green (suffix MV)

Construction

Base:  
Polished chrome-plated or powder coated high performance alloy steel.

Top:  
Bevel-edge marble. Transparent or back frosted extra clear tempered glass.

Maintenance:  
See pages 28-29.

Satin Coated marble top finishes:  
Arabescato: white-grey (suffix MAS)  
Calacatta: white-grey/beige (suffix MCS)  
Carrara: white-grey (suffix GCS)  
Nero Marquina: black (suffix MNS)  
Rosso Rubino: rich red (suffix MRS)  
Verde Alpi: green (suffix MVS)

Lucia Mercer  
Mercer Table

	description	w	d	h	weight
<i>Designer(s):</i> Lucia Mercer, 1982	<b>701T</b> Mercer Table 	21 3/8"	13 1/2"	15"	243 lbs
		21 7/8"	13 1/2"	15"	243 lbs
		21 1/8"	13 1/2"	15"	243 lbs

*Award(s):*  
IBD Award, USA, 1983



pattern no.	list
<b>701T-MC</b>	\$10,222.
<b>701T-MV</b>	10,319.
<b>701T-MN</b>	7,738.

Order Code	Ordering Information	Construction
<i>Example:</i> <b>701T</b>	<i>Natural marble finishes:</i> Nero Marquina: black (suffix MN) Calacatta: white-grey/beige (suffix MC) Verde Alpi: green (suffix MV)	The Mercer Table is solid natural (uncoated) marble.  <i>Note:</i> Top surface dimensions are 14.5" w x 13.5" d
<b>701T</b> Mercer Table		
<b>MN</b> Nero Marquina		



*Specify:*  
1. Pattern number  
2. Top selection

*Maintenance:*  
See pages 28-29.



# Ludwig Mies van der Rohe

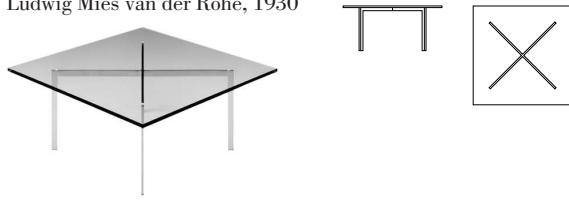
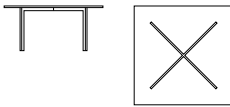

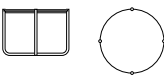

## Barcelona® Table, MR Table

	description	w	d	h	weight	top	base
<p><i>Designer(s):</i> Ludwig Mies van der Rohe, 1930</p> 	<p><b>252</b> Barcelona table</p> 	40"	40"	17"	134 lbs.	Clear glass	Stainless steel
		40"	40"	18.5"	140 lbs.	Clear glass	Polished chrome
		40"	40"	17"	134 lbs.	Starphire glass	Stainless steel
		40"	40"	18.5"	140 lbs.	Starphire glass	Polished chrome
	<p><b>259TS</b> MR table</p> 	28.5"		20.8"	37 lbs.	Clear glass	Stainless steel

pattern no.	
<b>252</b>	\$6,293.
<b>252C</b>	3,790.
<b>252-SFG</b>	7,032.
<b>252C-SFG</b>	4,740.
<b>259TS-G</b>	2,992.

Order Code	Ordering Information	Construction
<p><i>Example:</i> <b>252C-SFG</b></p> <p><b>252</b> Barcelona table</p> <p><b>C</b> Polished Chrome</p> <p><b>SFG</b> Starphire Glass</p>	<p><i>Shipping:</i> Top and base of MR Tables ship in separate packages.</p> <p><i>Maintenance:</i> See pages 28-29.</p> <p><i>Note:</i> The KnollStudio logo and signature of Ludwig Mies van der Rohe is stamped into the base of the MR and Barcelona tables.</p> <p>The Barcelona Table and MR Table are certified Clean Air GOLD.</p>	<p><b>BARCELONA TABLE</b> <i>Clear Glass Top:</i> 3/4" thick top with a 1/8" wide beveled edge. Top and edges have a slight green tint.</p> <p><i>Starphire™ Glass Top:</i> Starphire glass is more clear and luminous than regular glass. The low iron content gives glass a crystal quality. 1/8" bevel edge has an exceptionally clear character.</p> <p><i>Stainless Steel Base:</i> Premium grade 202 bar stock stainless steel. Single piece construction ensures long-term durability. Frame hand-ground and hand-buffed to mirror finish.</p> <p><i>Polished Chrome Base:</i> Hand-ground and hand-buffed to a mirror finish. Single piece construction.</p> <p><i>Bumpers:</i> Polished Chrome table has black bumpers. Stainless steel table has white bumpers.</p>
<p><i>Note:</i> The Mies Barcelona and MR tables are part of a collection. Please refer to Mies side chairs and lounge seating beginning on page 242.</p> <p><i>Specify:</i></p> <ol style="list-style-type: none"> <li>1. Pattern number</li> <li>2. Base finish option</li> <li>3. Top selection</li> </ol>		<p><b>MR TABLE</b> <i>Top:</i> 1/2" thick clear polished plate glass.</p> <p><i>Base:</i> Frame and legs are tubular and rectangular stainless steel welded together. Seamless construction buffed to a mirror finish.</p>

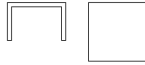
# Ludwig Mies van der Rohe Krefeld™ Side and Coffee Table

	description	w	d	h	weight
<p><i>Designer(s):</i> Ludwig Mies van der Rohe, 1930 Design from the Mies van der Rohe Archive of The Museum of Modern Art</p>  	<p><b>759</b> Square Table</p> 	27 1/2"	27 1/2"	17 3/4"	35 lbs.
	<p><b>760</b> Rectangular Coffee Table</p> 	54"	27 1/2"	17 3/4"	63 lbs.

pattern number	clear oak	stained finishes
<b>759-()</b>	\$3,496.	\$3,599.
<b>760-()</b>	7,479.	7,701.

**Order Code**

<i>Example:</i>	<b>759-OWE</b>
<b>759</b>	Krefeld square coffee table
<b>OWE</b>	Wenge

*Note:*  
The Mies Krefeld tables are part of a collection. Please refer to Mies side chairs and lounge seating beginning on page 242.

*Specify:*  
1. Pattern number  
2. Finish selection

**Ordering Information**

*Table finishes:*  
Wenge (OWE)  
Medium Cherry (OM)  
Deep Red Mahogany (OF)  
Light Walnut (OWA)  
Clear Oak (OC)

*Maintenance:*  
See pages 27-28.



**Construction**

*Base and Top:*  
Oak with stained or clear oak finish.  
Open pore finish. Black plastic glides.  
Seamless connection between top and base.

# Pascal Mourgue

## Square and Rectangular Conference Tables

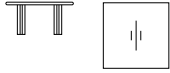
### PVC-T edge

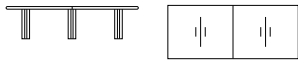
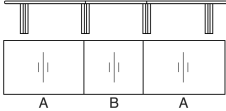
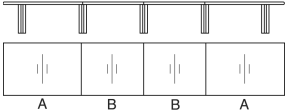

description	seating			w	d	h	weight	top
	capacity *	section	legs					
<b>47TS15</b> square table 	8	1	4	60 1/4"	60 1/4"	28 3/4"	309 lbs.	Coated marble
	8	1	4	60 1/4"	60 1/4"	28 3/4"	309 lbs.	Natural marble
	8	1	4	60 1/4"	60 1/4"	28 3/4"	178 lbs.	Laminate
	8	1	4	60 1/4"	60 1/4"	28 3/4"	166 lbs.	Veneer
<b>47TS20</b> rectangular table 	8	1	4	80"	48 1/2"	28 3/4"	328 lbs.	Coated marble
	8	1	4	80"	48 1/2"	28 3/4"	328 lbs.	Natural marble
	8	1	4	80"	48 1/2"	28 3/4"	187 lbs.	Laminate
	8	1	4	80"	48 1/2"	28 3/4"	175 lbs.	Veneer
<b>47TS31</b> rectangular table 	10	2	6	120"	48 1/2"	28 3/4"	262 lbs.	Veneer
	10	2	6	120"	48 1/2"	28 3/4"	279 lbs.	Laminate
<b>47TS48</b> rectangular table 	16	3	8	204"	48 1/2"	28 3/4"	450 lbs.	Laminate
	16	3	8	204"	48 1/2"	28 3/4"	425 lbs.	Veneer
<b>47TS64</b> rectangular table 	22	4	10	268"	48 1/2"	28 3/4"	586 lbs.	Laminate
	22	4	10	268"	48 1/2"	28 3/4"	554 lbs.	Veneer

\* Based on 26" wide arm chairs

Order Code	Ordering Information		
<i>Example:</i> <b>47TS31-1-V315</b>	<i>Leg finishes:</i>	<i>Veneer/bullnose finishes:</i>	<i>Certified Wood:</i>
<b>47TS31</b> Pascal rectangular table	Matte Black Epoxy (suffix 1)	American Cherry (suffix X)	Tables manufactured using FSC certified hardwoods and veneers and/or LEED compliant recyclable components are available through Custom Product Development. Extended leadtime and upcharge apply.
<b>1</b> Black Epoxy	Polished Aluminum (suffix AP)	Ebonized Walnut (suffix D)	
<b>V315</b> Light Cherry Veneer	<i>Laminate finishes:</i>	Light Cherry (suffix V315)	
<i>Example:</i> <b>47TSV15-AP-119-V315</b>	Bright White (suffix 118)	Maple (suffix K)	
<b>47TSV15</b> Pascal square table, with veneer edge	Folkstone Grey (suffix 114)	Medium Red Mahogany (suffix Z)	
<b>AP</b> Polished Aluminum	Fog (suffix 128)	Natural Beech (suffix B)	
<b>119</b> Pumice	Jet Black (suffix 111)	Warm Brown Walnut (suffix J)	
<b>V315</b> Light Cherry Veneer	Light Grey (suffix L)	<i>Polished Coated marble finishes:</i>	<i>Maintenance:</i>
	Pumice (suffix 119)	Carrara: white-grey (suffix GC)	See pages 28-29.
	Slate (suffix SL)	<i>Natural marble finishes:</i>	<i>Note:</i>
	Soft Grey (suffix 117)	Carrara: white-grey (suffix NGC)	Acrylic marble coating will yellow over time.
		<i>Veneer edge:</i>	
		For veneer edge, add 'V' after 4th digit. For example, for a 48 1/2" square table with veneer edge, specify 47TSV12.	The Pascal Table with Laminate top and PVC edge is certified Clean Air GOLD.

- Specify:
1. Pattern number
  2. Leg finish selection
  3. Top finish selection
  4. Wood bullnose finish selection (for laminate tops only)

pattern no.	pvc edge	veneer edge (add V after 4th digit)	marble top
<b>47TS15-(1, AP)-(GC)</b>			\$18,770.
<b>47TS15-(1, AP)-(NGC)</b>			15,760.
<b>47TS15-(1, AP)-(-)(-)</b>	6,434.	7,505.	
<b>47TS15-(1, AP)-(-)</b>	7,233.	8,838.	
<b>47TS20-(1, AP)-(GC)</b>			18,967.
<b>47TS20-(1, AP)-(NGC)</b>			15,957.
<b>47TS20-(1, AP)-(-)(-)</b>	6,434.	7,233.	
<b>47TS20-(1, AP)-(-)</b>	7,505.	8,838.	
<b>47TS31-(1, AP)-(-)</b>			12,058.
<b>47TS31-(1, AP)-(-)(-)</b>			9,912.
<b>47TS48-(1, AP)-(-)(-)</b>			17,602.
<b>47TS48-(1, AP)-(-)</b>			20,898.
			23,042.
<b>47TS64-(1, AP)-(-)(-)</b>			20,244.
<b>47TS64-(1, AP)-(-)</b>			25,480.
			28,666.
			32,151.

Construction			
<p><i>Combining tables:</i> If individual tables are purchased with the intent of placing them contiguously, they should be quoted for flitch or book match. When desired specifically for combination, note that information on the order so that bullnose edges and legs at each table junction are removable. Leveling strip slides into slots at edges. Legs connect into inserts that span tops. Bullnose edges store for future retrieval and separation.</p> <p><i>Standard size tables:</i> For additional standard size tables please consult your KnollStudio representative, dealer or Customer Service associate.</p> <p><i>Special width tables:</i> For standard depth tables (42 1/4", 48 1/2", and 60 1/4"), you may determine list pricing on any special width between two standard sizes simply by identifying the next higher standard width tables, and add 5% to the standard list price.</p>	<p>For example, if requesting an 80" w x 42 1/4" d table, you would identify the next wider table (84" w x 42 1/4" d) and add 5% to the list price of that standard size. Consult a KnollStudio representative for special Order Code.</p> <p><i>Special sizes and finishes:</i> For all other sizes and for special finishes, consult your KnollStudio representative, dealer, or Customer Services for information.</p> <p><i>Legs:</i> Extruded aluminum leg in black epoxy or polished aluminum finish. Multiple sectioned tables have two legs bridging each section, plus two legs at each end.</p> <p><i>Marble top:</i> 13/16" thick marble coated with transparent acrylic to help eliminate use-associated stains.</p>	<p><i>Laminate and wood tops:</i> Tops are 1 1/8" thick. Wood tops are cross-veneered. Tops available with black semi-gloss extruded PVC-T mold bullnose edge or stained solid wood bullnose edge. For PVC-T bullnose, short ends of rectangular table have a wood bullnose with a black semi-gloss paint to match the PVC-T edges.</p> <p><i>Glides:</i> Adjustable nylon, black epoxy finish.</p> <p><i>Shipping:</i> Top and base shipped in separate pieces; assembly required.</p>	<p><i>To assemble:</i> Legs connect into predrilled inserts using mounting hardware (included).</p>  <p><i>Bullnose edge detail:</i></p> 

# Pascal Mourgue







## Round and Racetrack Conference Tables

### PVC-T edge

**Designer(s):**  
Pascal Mourgue, 1985

**Award(s):**  
The Roscoe Commendation, USA  
1985; IBD Product Design Award,  
1985; Corporate Design and  
Reality Product Design Award,  
1986

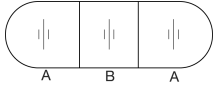

description	seating		legs	w	d	h	weight	top
	capacity *	section						
<b>47TR15</b> round table 	7	1	4	60 1/4"		28 3/4"	250 lbs.	Coated marble
	7	1	4	60 1/4"		28 3/4"	250 lbs.	Natural marble
	7	1	4	60 1/4"		28 3/4"	147 lbs.	Laminate
	7	1	4	60 1/4"		28 3/4"	138 lbs.	Veneer
<b>47TR24</b> racetrack table 	8	1	4	97"	48 1/2"	28 3/4"	605 lbs.	Coated marble
	8	1	4	97"	48 1/2"	28 3/4"	605 lbs.	Natural marble
	8	1	4	97"	48 1/2"	28 3/4"	315 lbs.	Laminate
	8	1	4	97"	48 1/2"	28 3/4"	313 lbs.	Veneer
<b>47TR26</b> racetrack table 	8	2	6	108"	48 1/2"	28 3/4"	377 lbs.	Veneer
	8	2	6	108"	48 1/2"	28 3/4"	380 lbs.	Laminate
<b>47TR30</b> racetrack table 	10	2	6	120"	48 1/2"	28 3/4"	280 lbs.	Laminate
	10	2	6	120"	48 1/2"	28 3/4"	262 lbs.	Veneer
<b>47TR50</b> racetrack table 	16	3	8	192"	60 1/4"	28 3/4"	510 lbs.	Laminate
	16	3	8	192"	60 1/4"	28 3/4"	485 lbs.	Veneer
<b>47TR72</b> racetrack table 	6	1	4	84"	42 1/4"	28 3/4"	177 lbs.	Laminate
	6	1	4	84"	42 1/4"	28 3/4"	165 lbs.	Veneer

\* Based on 26" wide arm chairs

Order Code	Ordering Information		
<i>Example:</i> <b>47TR26-1-K</b>	<i>Specify:</i>	<i>Veneer/bullnose finishes:</i>	<i>Certified Wood:</i>
<b>47TR26</b> Pascal racetrack table	1. Pattern number	American Cherry (suffix X)	Tables manufactured using FSC certified
<b>1</b> Black Epoxy	2. Leg finish selection	Ebonized Walnut (suffix D)	hardwoods and veneers and/or LEED
<b>K</b> Maple Veneer	3. Top finish selection	Light Cherry (suffix V315)	compliant recyclable components are
<i>Example:</i> <b>47TRV15-AP-J</b>	4. Wood bullnose finish selection (for laminate tops only)	Maple (suffix K)	available through Custom Product
<b>47TRV15</b> Pascal round table, with veneer edge	<i>Leg finishes:</i>	Medium Red Mahogany (suffix Z)	Development. Extended leadtime and
<b>AP</b> Polished Aluminum	Matte Black Epoxy (suffix 1)	Natural Beech (suffix B)	upcharge apply.
<b>J</b> Warm Brown Walnut Veneer	Polished Aluminum (suffix AP)	Warm Brown Walnut (suffix J)	<i>Maintenance:</i>
	<i>Laminate finishes:</i>	<i>Polished Coated marble finishes:</i>	See pages 28-29.
	Bright White (suffix 118)	Carrara: white-grey (suffix GC)	<i>Note:</i>
	Fog (suffix 128)	<i>Natural marble finishes:</i>	Acrylic marble coating will yellow over
	Folkstone Grey (suffix 114)	Carrara: white-grey (suffix NGC)	time.
	Jet Black (suffix 111)	<i>Veneer edge:</i>	The Pascal Table with Laminate top and
	Light Grey (suffix L)	For veneer edge, add 'V' after 4th digit.	PVC edge is certified Clean Air GOLD.
	Pumice (suffix 119)	For example, for a 48 1/2" round table,	
	Soft Grey (suffix 117)	specify 47TRV12.	
	Slate (suffix SL)		

pattern no.	pvc edge	veneer edge (add V after 4th digit)	marble top
<b>47TR15-(1, AP)-(GC)</b>			\$15,069.
<b>47TR15-(1, AP)-(NGC)</b>			12,783.
<b>47TR15-(1, AP)-(-)(-)</b>	6,698.	8,838.	
<b>47TR15-(1, AP)-(-)</b>	7,505.	10,448.	
<b>47TR24-(1, AP)-(GC)</b>			22,469.
<b>47TR24-(1, AP)-(NGC)</b>			18,746.
<b>47TR24-(1, AP)-(-)(-)</b>	7,772.	10,448.	
<b>47TR24-(1, AP)-(-)</b>	9,107.	12,328.	
<b>47TR26-(1, AP)-(-)</b>			11,150.
<b>47TR26-(1, AP)-(-)(-)</b>	9,388.	12,617.	
<b>47TR30-(1, AP)-(-)(-)</b>			11,150.
<b>47TR30-(1, AP)-(-)</b>	14,675.	18,193.	
<b>47TR50-(1, AP)-(-)(-)</b>			17,145.
<b>47TR50-(1, AP)-(-)</b>	27,875.	34,623.	
<b>47TR72-(1, AP)-(-)(-)</b>			6,967.
<b>47TR72-(1, AP)-(-)</b>	8,039.	11,253.	

#### Construction

**Standard size tables:**  
For additional standard size tables please consult your KnollStudio representative, dealer or Customer Service associate.

**Special width tables:**  
For standard depth tables (42 1/4", 48 1/2", and 60 1/4"), you may determine list pricing on any special width between two standard sizes simply by identifying the next higher standard width tables, and add 5% to the standard list price.

For example, if requesting an 80" w x 42 1/4" d table, you would identify the next wider table (84" w x 42 1/4" d) and add 5% to the list price of that standard size. Consult a KnollStudio representative for special Order Code.

**Special sizes and finishes:**  
For all other sizes and for special finishes, consult your KnollStudio representative, dealer, or Customer Services for information.

**Legs:**  
Extruded aluminum leg in black epoxy or polished aluminum finish. Multiple sectioned tables have two legs bridging each section, plus two legs at each end.

**Laminate and wood tops:**  
Tops are 1 1/8" thick. Wood tops are cross-veneered. Tops available with black semi-gloss extruded PVC-T mold bullnose edge or stained solid wood bullnose edge. Bullnose edges on ends of racetrack tables are single, continuous arcs of wood.

**Marble top:**  
13/16" thick marble coated with transparent acrylic to help eliminate use-associated stains.

**Glides:**  
Adjustable nylon, black epoxy finish.

**Shipping:**  
Top and base shipped in separate pieces; assembly required.

**To assemble:**  
Legs connect into predrilled inserts using mounting hardware (included).



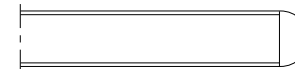

**Bullnose edge detail:**



# Pascal Mourgue

## Bullet Conference Tables

### PVC-T edge

description	seating capacity *		legs	w	d	h	weight	top
	section							
<b>47TR22</b> bullet table 	8	1	4	87 3/4"	48 1/2"	28 3/4"	356 lbs.	Coated marble
	8	1	4	87 3/4"	48 1/2"	28 3/4"	356 lbs.	Natural marble
	8	1	4	87 3/4"	48 1/2"	28 3/4"	201 lbs.	Laminate
	8	1	4	87 3/4"	48 1/2"	28 3/4"	188 lbs.	Veneer
<b>47TR19</b> bullet table 	7	1	4	76"	60 1/4"	28 3/4"	353 lbs.	Coated marble
	7	1	4	76"	60 1/4"	28 3/4"	353 lbs.	Natural marble
	7	1	4	76"	60 1/4"	28 3/4"	200 lbs.	Laminate
	7	1	4	76"	60 1/4"	28 3/4"	187 lbs.	Veneer
								

*Designer(s):*  
Pascal Mourgue, 1985

*Award(s):*  
The Roscoe Commendation, USA  
1985; IBD Product Design Award,  
1985; Corporate Design and  
Reality Product Design Award,  
1986

pattern no.	pvc edge	veneer edge (add V after 4th digit)	marble top
<b>47TR22-(1, AP)-(GC)</b>			\$19,645.
<b>47TR22-(1, AP)-(NGC)</b>			16,494.
<b>47TR22-(1, AP)-(-)(-)</b>	7,337.	9,912.	
<b>47TR22-(1, AP)-(-)</b>	8,039.	11,253.	
<b>47TR19-(1, AP)-(GC)</b>			20,838.
<b>47TR19-(1, AP)-(NGC)</b>			17,446.
<b>47TR19-(1, AP)-(-)(-)</b>	7,337.	9,912.	
<b>47TR19-(1, AP)-(-)</b>	8,039.	11,253.	



\* Based on 26" wide arm chairs

Order Code	Ordering Information
<i>Example:</i> <b>47TR19-AP-111</b>	<i>Specify:</i>
<b>47TR19</b> Pascal bullet table	1. Pattern number
<b>AP</b> Polished Aluminum	2. Leg finish selection
<b>111</b> Jet Black Laminate	3. Top finish selection
	4. Wood bullnose finish selection (for laminate tops only)
<i>Example:</i> <b>47TRV22-1-111-B</b>	<i>Leg finishes:</i>
<b>47TRV22</b> Pascal bullet table, with veneer edge	Matte Black Epoxy (suffix I)
<b>1</b> Black Epoxy	Polished Aluminum (suffix AP)
<b>111</b> Jet Black Laminate	
<b>B</b> Natural Beech Veneer	<i>Laminate finishes:</i>
	Bright White (suffix 118)
	Fog (suffix 128)
	Jet Black (suffix 111)
	Light Grey (suffix L)
	Pumice (suffix 119)
	Slate (suffix SL)
	<i>Laminate finishes, continued:</i>
	Folkstone Grey (suffix 114)
	Soft Grey (suffix 117)
	<i>Veneer/bullnose finishes:</i>
	American Cherry (suffix X)
	Ebonized Walnut (suffix D)
	Light Cherry (suffix V315)
	Maple (suffix K)
	Medium Red Mahogany (suffix Z)
	Natural Beech (suffix B)
	Warm Brown Walnut (suffix J)
	<i>Polished Coated marble finishes:</i>
	Carrara: white-grey (suffix GC)
	<i>Natural marble finishes:</i>
	Carrara: white-grey (suffix NGC)
	<i>Veneer edge:</i>
	For veneer edge, add 'V' after 4th digit.
	For example, for a 204" x 60 1/4" rectangular table with veneer edge, specify 47TSV52.

Construction
<i>Certified Wood:</i> Tables manufactured using FSC certified hardwoods and veneers and/or LEED compliant recyclable components are available through Custom Product Development. Extended leadtime and upcharge apply.
<i>Standard size tables:</i> For additional standard size tables please consult your KnollStudio representative, dealer or Customer Service associate.
<i>Special width tables:</i> For standard depth tables (42 3/4", 48 1/2", and 60 1/4"), you may determine list pricing on any special width between two standard sizes simply by identifying the next higher standard width tables, and add 5% to the standard list price.
<i>For example,</i> if requesting an 80" w x 42 3/4" d table, you would identify the next wider table (84" w x 42 3/4" d) and add 5% to the list price of that standard size. Consult a KnollStudio representative for special Order Code.
<i>Special sizes and finishes:</i> For all other sizes and for special finishes, consult your KnollStudio representative, dealer, or Customer Services for information.
<i>Legs:</i> Extruded aluminum leg in black epoxy or polished aluminum finish. Multiple sectioned tables have two legs bridging each section, plus two legs at each end.
<i>Laminate and wood tops:</i> Tops are 1 1/8" thick. Wood tops are cross-veneered. Tops available with black semi-gloss extruded PVC-T mold bullnose edge or stained solid wood bullnose edge. Bullnose edges on ends of racetrack tables are single, continuous arcs of wood.
<i>Marble top:</i> 1 1/16" thick marble coated with transparent acrylic to help eliminate use-associated stains.
<i>Glides:</i> Adjustable nylon, black epoxy finish.
<i>Shipping:</i> Top and base shipped in separate pieces; assembly required.
<i>To assemble:</i> Legs connect into predrilled inserts using mounting hardware (included).
<i>Note:</i> Acrylic marble coating will yellow over time.
The Pascal Table with Laminate top and PVC edge is certified Clean Air GOLD.

# George Nakashima

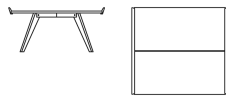
## Splay-Leg Table and Tray

	description	w	d	h	weight
 <p><i>Designer(s):</i> George Nakashima, 1946</p>	<b>N10</b> Splay-Leg Table 	37 1/4"	34 1/4"	17 1/2"	33 lbs.
	<b>N20</b> Tray 	21 3/8"	16"	1 1/4"	5 lbs.

pattern no.	
<b>N10-( )-AW</b>	\$3,956.
<b>N20-DF-( )</b>	858.

Order Code	Ordering Information	Construction
<i>Specify:</i> <b>N10-HK-AW</b>	<i>Finishes, table only:</i>	<i>TABLE:</i>
<b>N10</b> Splay-Leg Table	American Walnut (suffix AW)	<i>Top:</i>
<b>HK</b> Hickory	Hickory (suffix HK)	Tops are veneered with reverse slip-matched cathedral pattern, matching solid wood edge in clear low-sheen finish.
<b>AW</b> American Walnut	<i>Finishes, tray only:</i>	<i>TRAY:</i>
<i>Specify:</i> <b>N20-DF-BS</b>	Brazilian Santos (suffix BS)	<i>Top:</i>
<b>N20</b> Tray	Douglas Fir (suffix DF)	Tops are constructed of solid Douglas Fir lumber that is quarter-cut and finished in a clear low-sheen finish.
<b>DF</b> Douglas Fir	Wenge (suffix WG)	<i>Edge detail:</i>
<b>BS</b> Brazilian Santos	<i>Maintenance:</i>	Available in two finishes: solid Brazilian Santos; solid Wenge. Edge details are joined to top with mortise and tenon joints.
	See pages 28-28.	

*Note:*  
The Splay-Leg Table and Tray are part of a collection. Please refer to the Straight chair on page 262.

*Note:*  
Each table and tray features George Nakashima's signature under the table top.

- For Splay-Leg Table, specify:*
1. Pattern number
  2. Primary finish
  3. Edge detail finish

The Splay-Leg Table is certified Clean Air GOLD.

- For Splay-Leg Tray, specify:*
1. Pattern number
  2. Tray finish
  3. Edge detail finish

Isamu Noguchi  
Cyclone™ Dining and Side Tables

Designer(s):  
Isamu Noguchi, 1954

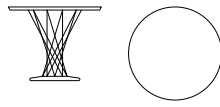
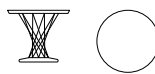

description	w	d	h	weight	top	base
<b>311</b> Cyclone Dining table 	36"		28"	89 lbs.	Black laminate	Cast iron black
	36"		28"	89 lbs.	White laminate	Cast iron black
	36"		28"	89 lbs.	Veneer	Cast iron black
	36"		28"	89 lbs.	Rosewood	Cast iron black
<b>312</b> Cyclone Dining table 	42"		28"	97 lbs.	Black laminate	Cast iron black
	42"		28"	97 lbs.	White laminate	Cast iron black
	42"		28"	97 lbs.	Veneer	Cast iron black
	42"		28"	97 lbs.	Rosewood	Cast iron black
<b>87</b> Side table 	24"		20"	31 lbs.	Black laminate	Cast iron black
	24"		20"	31 lbs.	White laminate	Cast iron black
	24"		20"	31 lbs.	Veneer	Cast iron black
	24"		20"	31 lbs.	Rosewood	Cast iron black

pattern no.	list
<b>311-F1</b>	\$4,480.
<b>311-F2</b>	4,480.
<b>311-(D, LO, LWA)</b>	4,843.
<b>311-RO</b>	5,069.
<b>312-F1</b>	4,920.
<b>312-F2</b>	4,920.
<b>312-(D, LO, LWA)</b>	5,359.
<b>312-RO</b>	5,680.
<b>87-F1</b>	2,956.
<b>87-F2</b>	2,956.
<b>87-(D, LO, LWA)</b>	3,285.
<b>87-RO</b>	3,387.

Order Code

<i>Example:</i>	<b>312-F2</b>
<b>312</b>	Cyclone dining table
<b>F2</b>	White Laminate top

Specify:

1. Pattern number
2. Top finish selection

Ordering Information

*Laminate top finish:*  
Black (F1)  
White (F2)

*Wood Veneer Top Finishes:*  
Ebonized Walnut (D)  
Light Oak (LO)  
Light Walnut (LWA)  
Rosewood (RO)

*Note:*  
Each table features a signature plate under the table top with the KnollStudio logo and Isamu Noguchi's signature.

*Maintenance:*  
See pages 28-29.

*Note:*  
The Cyclone Table is certified Clean Air GOLD.





Construction

*Noguchi table top:*  
Top is laminate or wood veneer with a natural birch edge. Top is 0.8" thick.

*Noguchi table base:*  
Cast iron, black textured powder-coat.

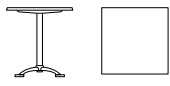
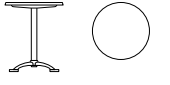
*Noguchi table column:*  
Steel wire column, chrome plated finish.

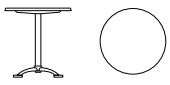
Jorge Pensi  
*Pensi Tables*  
*Small Cafe and Bar Height Tables*

	description	top	w	d	h	weight
<i>Designer(s):</i> Jorge Pensi, 1988	<b>29TS-27</b> Square café table 	Disks, wrapped edge	27 1/2"	27 1/2"	28 1/4"	35 lbs.
		Metallic Trespa, natural black edge	27 1/2"	27 1/2"	28 1/4"	32 lbs.
<i>Award(s):</i> First Place, Sidi Selection, Valencia, Spain, 1988; "Delta Plate" of ADI FAD, 1988; Design Center Stuttgart Award, W. Germany, 1990	<b>29TR-23</b> Round café table 	Disks, wrapped edgeband	23 3/8"		28 1/4"	25 lbs.
		Metallic Trespa, natural black edge	23 3/8"		28 1/4"	23 lbs.
	<b>29TR-27</b> Round café table 	Disks, wrapped edge	27 1/2"		28 1/4"	31 lbs.
		Metallic Trespa, natural black edge	27 1/2"		28 1/4"	27 lbs.
	<b>29TR-H-23</b> Bar-height café table 	Disks, wrapped edge	23 3/8"		43 1/5"	26 lbs.
		Metallic Trespa, natural black edge	23 3/8"		43 1/5"	24 lbs.

pattern no.	
<b>29TS-27-DE</b>	\$2,321.
<b>29TS-27-LM</b>	3,824.
<b>29TR-23-DE</b>	2,108.
<b>29TR-23-LM</b>	2,941.
<b>29TR-27-DE</b>	2,321.
<b>29TR-27-LM</b>	3,824.
<b>29TR-H-23-DE</b>	2,586.
<b>29TR-H-23-LM</b>	3,494.

Order Code	Ordering Information	Construction
<i>Example:</i> <b>29TS-27-DE</b>	<i>Table top finishes:</i> Disks, wrapped edge * (suffix DE) Metallic Trespa (suffix LM)	<i>Top:</i> Two stainless steel finishes: acid-etched pattern of concentric circles; sanded pattern of scalloped, compact disk-like, 1 1/4" wide circles; both with wrapped edge. One metallic Trespa option with a natural black phenolic edge. The Trespa metallic (LM) top finish is UV resistant, does not reflect heat, easy to clean and made of recyclable materials. The Trespa metallic (LM) top finish is ideal for outdoor use.
<b>29TS</b> Pensi table, square top	<i>Maintenance:</i> See pages 28-29.	
<b>27</b> 27" wide and deep	<i>Note:</i> The Pensi Table is certified Clean Air GOLD .	
<b>DE</b> Disks, wrapped edge	*Disks pattern does not appear on edge.	
<i>Note:</i> Pensi Tables are part of a collection. Please refer to Toledo chairs on page 268.	<i>Note:</i> The Pensi Tables are available in the United States only.	
<i>Specify:</i> 1. Pattern number 2. Table size 3. Top finish selection		

*Base:*  
Anodized and polished cast aluminum with 4 1/8" pad-like feet. Four-star base on cafe tables. Five-star base on bistro and dining tables. The central column is a polished and anodized aluminum round tube. Internal weight for additional stability. Black silicone non-scuffing glides.

*Outdoor use:*  
With proper preventative maintenance, the Toledo Table is appropriate for outdoor environments.

Square tables, Disks, wrapped edge (DE)

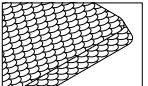

Round tables, Disks, wrapped edge (DE)

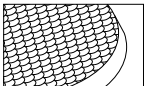

Round tables, Metallic Trespa top, phenolic black edge (LM)





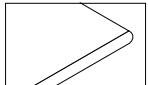

Square tables, Metallic Trespa top, phenolic black edge (LM)



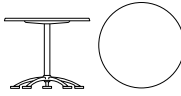
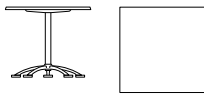

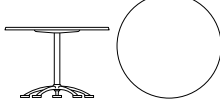
Jorge Pensi  
Pensi Tables  
Large Bistro Tables

	description	top	w	d	h	weight
<i>Designer(s):</i> Jorge Pensi, 1988	<b>29TR-35</b> Round bistro table 	Disks, wrapped edge	35 7/8"		29 1/2"	50 lbs.
		Metallic Trespa, natural black edge	35 7/8"		29 1/2"	46 lbs.
<i>Award(s):</i> First Place, Sidi Selection, Valencia, Spain, 1988; "Delta Plate" of ADI FAD, 1988; Design Center Stuttgart Award, W. Germany, 1990	<b>29TS-35</b> Square bistro table 	Disks, wrapped edge	35 7/8"	35 7/8"	29 1/2"	58 lbs.
		Metallic Trespa, natural black edge	35 7/8"	35 7/8"	29 1/2"	54 lbs.
	<b>29TR-43</b> Round dining table 	Metallic Trespa, natural black edge	43 1/4"		29 1/2"	57 lbs.
		Disks, wrapped edge	43 1/4"		29 1/2"	65 lbs.
						

pattern no.	
<b>29TR-35-DE</b>	\$5,398.
<b>29TR-35-LM</b>	6,443.
<b>29TS-35-DE</b>	5,398.
<b>29TS-35-LM</b>	6,443.
<b>29TR-43-LM</b>	11,228.
<b>29TR-43-DE</b>	6,600.

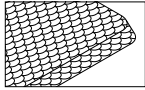
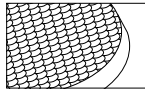
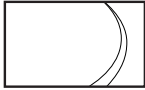
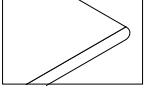

Order Code	Ordering Information	Construction
<i>Example:</i> <b>29TS-35-DE</b>	<i>Table top finishes:</i> Disks, wrapped edge * (suffix DE) Metallic Trespa (suffix LM)	<i>Top:</i> Two stainless steel finishes: acid-etched pattern of concentric circles; sanded pattern of scalloped, compact disk-like, 1 1/4" wide circles; both with wrapped edge. One metallic Trespa option with a natural black phenolic edge. The Trespa metallic (LM) top finish is UV resistant, does not reflect heat, easy to clean and made of recyclable materials. The Trespa metallic (LM) top finish is ideal for outdoor use.
<b>29TS</b> Pensi table	<i>Maintenance:</i> See pages 28-29.	
<b>35</b> 35" wide and deep	<i>Note:</i> The Pensi Table is certified Clean Air GOLD.	
<b>DE</b> Disks, wrapped edge	*Disks pattern does not appear on edge.	
<i>Note:</i> Pensi Tables are part of a collection. Please refer to Toledo chairs on page 268.	<i>Note:</i> The Pensi Tables are available in the United States only.	
<i>Specify:</i> 1. Pattern number 2. Table size 3. Top finish selection		

<i>Base:</i> Anodized and polished cast aluminum with 4 7/8" pad-like feet. Four-star base on cafe tables. Five-star base on bistro and dining tables. The central column is a polished and anodized aluminum round tube. Internal weight for additional stability. Black silicone non-scuffing glides.	<i>Base:</i> Anodized and polished cast aluminum with 4 7/8" pad-like feet. Four-star base on cafe tables. Five-star base on bistro and dining tables. The central column is a polished and anodized aluminum round tube. Internal weight for additional stability. Black silicone non-scuffing glides.	<i>Base:</i> Anodized and polished cast aluminum with 4 7/8" pad-like feet. Four-star base on cafe tables. Five-star base on bistro and dining tables. The central column is a polished and anodized aluminum round tube. Internal weight for additional stability. Black silicone non-scuffing glides.
Square tables, Disks, wrapped edge (DE) 	Round tables, Disks, wrapped edge (DE) 	Round tables, Metallic Trespa top, phenolic black edge (LM) 
	Square tables, Metallic Trespa top, phenolic black edge (LM) 	

# Warren Platner Dining and Side Tables

Designer(s):  
Warren Platner, 1962

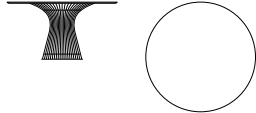
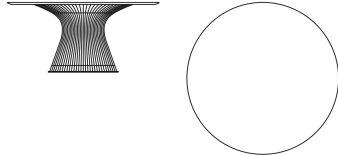
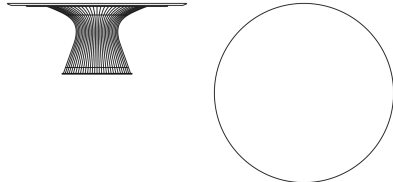

description	base w	w	h	weight	top
<b>3716T</b> Dining table 	20 3/4"	53 3/4"	27"	152 lbs.	Clear glass
	20 3/4"	53 3/4"	27"	152 lbs.	Bronze glass
	20 3/4"	53 3/4"	27"	254 lbs.	Natural marble
	20 3/4"	53 3/4"	27"	254 lbs.	Coated marble
	20 3/4"	53 3/4"	27"	254 lbs.	Coated marble
	20 3/4"	53 3/4"	27"	267 lbs.	Granite
	20 3/4"	53 3/4"	27"	227 lbs.	Veneer
	20 3/4"	53 3/4"	27"	254 lbs.	Coated marble
	20 3/4"	53 3/4"	27"	254 lbs.	Natural marble
	<b>3715T</b> Dining table 	27 3/4"	60"	27"	236 lbs.
<b>3718T</b> Dining table 	27 3/4"	70"	27"	295 lbs.	Clear glass
<b>3710T</b> Side table 	13"	15 3/4"	18"	14 lbs.	Clear glass
	13"	15 3/4"	18"	14 lbs.	Bronze glass
	13"	15 3/4"	18"	22 lbs.	Natural marble
	13"	15 3/4"	18"	22 lbs.	Coated marble
	13"	15 3/4"	18"	22 lbs.	Coated marble
	13"	15 3/4"	18"	22 lbs.	Coated marble
	13"	15 3/4"	18"	22 lbs.	Coated marble
	13"	15 3/4"	18"	15 lbs.	Veneer

pattern no.	polished nickel	metallic bronze	gold plated
<b>3716T-( )-G2</b>	\$7,870.	\$8,343.	\$12,226.
<b>3716T-( )-BRG</b>	8,262.	8,759.	12,839.
<b>3716T-( )-(NGC)</b>	11,548.	13,376.	17,941.
<b>3716T-( )-(GC, GCS)</b>	12,950.	14,779.	20,115.
<b>3716T-( )-(MN, MNS, MA, MAS, GG, GGS)</b>	13,995.	14,835.	21,741.
<b>3716T-( )-(MC, MCS)</b>	14,578.	15,454.	22,644.
<b>3716T-( )-(GA)</b>	15,585.	17,417.	24,212.
<b>3716T-( )-(LO, LWA, D, V314)</b>	16,638.	17,638.	25,847.
<b>3716T-( )-(MV, MVS)</b>	18,771.	19,893.	29,157.
<b>3716T-( )-(NC)</b>	20,258.	21,473.	31,466.
<b>3715T-( )-G2</b>	10,298.	10,974.	n/a
<b>3718T-( )-G2</b>	11,318.	11,992.	n/a
<b>3710T-( )-G2</b>	1,832.	2,447.	3,200.
<b>3710T-( )-BRG</b>	1,921.	2,571.	3,358.
<b>3710T-( )-(NGC)</b>	2,484.	3,143.	3,860.
<b>3710T-( )-(GC, GCS)</b>	2,682.	3,341.	4,167.
<b>3710T-( )-(MN, MNS, MA, MAS, GG, GGS)</b>	3,004.	3,186.	4,667.
<b>3710T-( )-(MV, MVS)</b>	3,043.	3,226.	4,730.
<b>3710T-( )-(MC, MCS)</b>	3,153.	3,347.	4,899.
<b>3710T-( )-(LO, LWA, D, V314)</b>	4,179.	4,428.	6,493.

**Order Code**

<i>Example:</i>	<b>3710T-N-BRG</b>
<b>3710T</b>	Platner side table
<b>N</b>	Nickel
<b>BRG</b>	Bronze Glass

*Note:*  
Platner dining and side tables are part of a collection. Please refer to Platner lounge seating on page 230 and Platner coffee tables on page 454.

- Specify:*
1. Pattern number
  2. Base finish option
  3. Top option

**Ordering Information**

*Frame:*  
Polished Nickel (suffix N)  
Metallic Bronze (suffix BRM)  
18k Gold Plated (suffix GLD)

*Glass top finishes:*  
Clear Glass (suffix G2)  
Bronze Glass (suffix BRG)

*Veneer finishes:*  
Ebonized Walnut (suffix D)  
Light Oak (suffix LO)  
Light Walnut (suffix LWA)  
Reff Dark Cherry (suffix V314)

*Polished Coated marble top finishes:*  
Arabescato: white-grey (suffix MA)  
Carrara: white-grey (suffix GC)  
Calacatta: white-grey/beige (suffix MC)  
Grey Marble: light grey (suffix GG)  
Nero Marquina: black (suffix MN)  
Verde Alpi: green (suffix MV)

*Satin Coated marble top finishes:*  
Arabescato: white-grey (suffix MAS)  
Calacatta: white-grey/beige (suffix MCS)  
Carrara: white-grey (suffix GCS)  
Grey Marble: light grey (suffix GGS)  
Nero Marquina: black (suffix MNS)  
Verde Alpi: green (suffix MVS)

*Natural marble top finishes:*  
Calacatta: white-grey/beige (suffix NC)  
Carrara: white-grey (suffix NGC)

*Granite top finish:*  
Black Andes: black (suffix GA)

**Construction**

*Maintenance:*  
See pages 28-29.

*Note:*  
Marbles with a coating will yellow over time.

The Platner Tables are certified Clean Air GOLD.

*Frame:*  
Vertical steel wire rods welded to circular horizontal and edge-framing rods. Finish in bright nickel with a clear lacquer protection, a painted metallic bronze, or plated in 18k gold.

*Base:*  
Clear plastic extrusion ring for smooth bottom surface.

*Glass top:*  
3/8" thick tempered glass for coffee and dining tables.  
1/4" thick tempered glass for side tables.

*Edge detail for glass:*

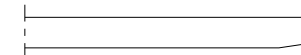

*Marble Top:*  
All marble tops feature a bevel edge. 3/4" thick coated marble tops have transparent acrylic coating to help eliminate use-associated stains. 3/4" thick natural marble tops and granite tops have protective sealer. Larger tops have subtop that fits into base opening to ensure stability.

*Marble edge detail:*

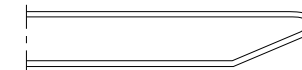

*Wood Top:*  
Tops are constructed of veneered medium density fiberboard with a cathedral grain pattern in various toned or stained finishes for light oak, light walnut, and reff dark cherry. Ebonized walnut features a black stain on walnut substrate. All tops are 1/16" thick. Edges are 1/4" solid wood to match face veneer. Wood tops are weighted with plates to ensure stability.

# Warren Platner

## Dining and Side Tables



*Designer(s):*  
Warren Platner, 1962

description	base w	w	h	weight	top
<b>3710T</b> Side table	13"	15 3/4"	18"	25 lbs.	Granite
	13"	15 3/4"	18"	22 lbs.	Natural marble

pattern no.	polished nickel	metallic bronze	gold plated
<b>3710T-( )-(GA)</b>	\$5,090.	\$5,748.	\$7,906.
<b>3710T-( )-(NC)</b>	5,692.	6,350.	8,842.

Order Code	Ordering Information
<i>Example:</i> <b>3710T-N-BRG</b>	
<b>3710T</b>	Platner side table
<b>N</b>	Nickel
<b>BRG</b>	Bronze Glass



*Note:*  
Platner dining and side tables are part of a collection. Please refer to Platner lounge seating on page 280 and Platner coffee tables on page 454.

- Specify:*
1. Pattern number
  2. Base finish option
  3. Top option

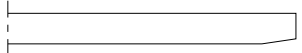
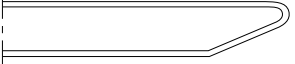
Ordering Information	Polished Coated marble top finishes:	Natural marble top finishes:
<i>Frame:</i> Polished Nickel (suffix N) Metallic Bronze (suffix BRM) 18k Gold Plated (suffix GLD)	Arabescato: white-grey (suffix MA) Carrara: white-grey (suffix GC) Calacatta: white-grey/beige (suffix MC) Grey Marble: light grey (suffix GG) Nero Marquina: black (suffix MN) Verde Alpi: green (suffix MV)	Calacatta: white-grey/beige (suffix NC) Carrara: white-grey (suffix NGC)
<i>Glass top finishes:</i> Clear Glass (suffix G2) Bronze Glass (suffix BRG)	<i>Granite top finish:</i> Black Andes: black (suffix GA)	
<i>Veneer finishes:</i> Ebony Walnut (suffix D) Light Oak (suffix LO) Light Walnut (suffix LWA) Reff Dark Cherry (suffix V314)	<i>Satin Coated marble top finishes:</i> Arabescato: white-grey (suffix MAS) Calacatta: white-grey/beige (suffix MCS) Carrara: white-grey (suffix GCS) Grey Marble: light grey (suffix GGS) Nero Marquina: black (suffix MNS) Verde Alpi: green (suffix MVS)	

Construction
<i>Maintenance:</i> See pages 28-29.
<i>Note:</i> Marbles with a coating will yellow over time.
The Platner Tables are certified Clean Air GOLD.
<i>Frame:</i> Vertical steel wire rods welded to circular horizontal and edge-framing rods. Finish in bright nickel with a clear lacquer protection, a painted metallic bronze, or plated in 18k gold.
<i>Base:</i> Clear plastic extrusion ring for smooth bottom surface.
<i>Glass top:</i> 3/8" thick tempered glass for coffee and dining tables. 1/4" thick tempered glass for side tables.
<i>Edge detail for glass:</i> 
<i>Marble Top:</i> All marble tops feature a bevel edge. 3/4" thick coated marble tops have transparent acrylic coating to help eliminate use-associated stains. 3/4" thick natural marble tops and granite tops have protective sealer. Larger tops have subtop that fits into base opening to ensure stability.
<i>Marble edge detail:</i> 
<i>Wood Top:</i> Tops are constructed of veneered medium density fiberboard with a cathedral grain pattern in various toned or stained finishes for light oak, light walnut, and reff dark cherry. Ebonyized walnut features a black stain on walnut substrate. All tops are 1/16" thick. Edges are 3/4" solid wood to match face veneer. Wood tops are weighted with plates to ensure stability.

# Warren Platner Coffee Tables

	description	base w	w	h	weight	top	
<b>Designer(s):</b> Warren Platner, 1962 	<b>3712T</b> Coffee table 	18 1/2"	36"	15 1/4"	107 lbs.	Coated marble	
		18 1/2"	36"	15 1/4"	107 lbs.	Coated marble	
		18 1/2"	36"	15 1/4"	107 lbs.	Granite	
		18 1/2"	36"	15 1/4"	107 lbs.	Coated marble	
		18 1/2"	36"	15 1/4"	107 lbs.	Natural marble	
		18 1/2"	36"	15 1/4"	96 lbs.	Natural veneer	
		18 1/2"	36"	15 1/4"	58 lbs.	Clear glass	
		18 1/2"	36"	15 1/4"	58 lbs.	Bronze glass	
		18 1/2"	36"	15 1/4"	107 lbs.	Natural marble	
		18 1/2"	36"	15 1/4"	107 lbs.	Coated marble	
		<b>3714T</b> Coffee table 	18 1/2"	42 1/4"	15 1/4"	139 lbs.	Natural marble
			18 1/2"	42 1/4"	15 1/4"	139 lbs.	Coated marble
			18 1/2"	42 1/4"	15 1/4"	139 lbs.	Coated marble
			18 1/2"	42 1/4"	15 1/4"	139 lbs.	Coated marble
			18 1/2"	42 1/4"	15 1/4"	139 lbs.	Granite
18 1/2"	42 1/4"		15 1/4"	139 lbs.	Coated marble		
18 1/2"	42 1/4"		15 1/4"	139 lbs.	Natural marble		
18 1/2"	42 1/4"		15 1/4"	108 lbs.	Veneer		
18 1/2"	42 1/4"		15 1/4"	71 lbs.	Clear glass		
18 1/2"	42 1/4"		15 1/4"	71 lbs.	Bronze glass		

pattern no.	polished nickel	metallic bronze	gold plated
<b>3712T-( )-(MN, MNS, MA, MAS, GG, GGS)</b>	\$6,516.	\$6,905.	\$10,120.
<b>3712T-( )-(MC, MCS)</b>	6,840.	7,253.	10,623.
<b>3712T-( )-(GA)</b>	8,062.	8,921.	12,526.
<b>3712T-( )-(MV, MVS)</b>	8,720.	9,244.	13,546.
<b>3712T-( )-(NC)</b>	9,598.	10,457.	14,909.
<b>3712T-( )-(LO, LWA, D, V314)</b>	10,130.	10,737.	15,737.
<b>3712T-( )-G2</b>	3,354.	3,556.	5,209.
<b>3712T-( )-BRG</b>	3,520.	3,731.	5,466.
<b>3712T-( )-(NGC)</b>	5,544.	6,402.	8,615.
<b>3712T-( )-(GC, GCS)</b>	6,242.	7,101.	9,698.
<b>3714T-( )-(NGC)</b>	6,748.	7,606.	10,482.
<b>3714T-( )-(GC, GCS)</b>	7,649.	8,502.	11,882.
<b>3714T-( )-(MN, MNS, MA, MAS, GG, GGS)</b>	7,917.	8,391.	12,297.
<b>3714T-( )-(MC, MCS)</b>	9,105.	9,653.	14,144.
<b>3714T-( )-(GA)</b>	9,900.	10,668.	15,383.
<b>3714T-( )-(MV, MVS)</b>	11,227.	11,894.	17,438.
<b>3714T-( )-(NC)</b>	11,927.	12,786.	18,528.
<b>3714T-( )-(LO, LWA, D, V314)</b>	13,253.	14,049.	20,591.
<b>3714T-( )-G2</b>	4,394.	4,659.	6,825.
<b>3714T-( )-BRG</b>	4,613.	4,894.	7,169.

Order Code	Ordering Information
<i>Example:</i> <b>3712T-BRM-MA</b>	<i>Frame:</i>
<b>3712T</b> Platner coffee table	Polished Nickel (suffix N)
<b>BRM</b> Metallic Bronze	Metalllic Bronze (suffix BRM)
<b>MA</b> Arabescato Marble	18k Gold Plated (suffix GLD)
	<i>Glass top finishes:</i>
	Clear Glass (suffix G2)
	Bronze Glass (suffix BRG)
	<i>Veneer finishes:</i>
	Ebonized Walnut (suffix D)
	Light Oak (suffix LO)
	Light Walnut (suffix LWA)
	Reff Dark Cherry (suffix V314)
	<i>Polished Coated marble top finishes:</i>
	Arabescato: white-grey (suffix MA)
	Carrara: white-grey (suffix GC)
	Calacatta: white-grey/beige (suffix MC)
	Grey Marble: light grey (suffix GG)
	Nero Marquina: black (suffix MN)
	Verde Alpi: green (suffix MV)
	<i>Natural marble top finishes:</i>
	Calacatta: white-grey/beige (suffix NC)
	Carrara: white-grey (suffix NGC)
	<i>Granite top finish:</i>
	Black Andes: black (suffix GA)
	<i>Satin Coated marble top finishes:</i>
	Arabescato: white-grey (suffix MAS)
	Calacatta: white-grey/beige (suffix MCS)
	Carrara: white-grey (suffix GCS)
	Grey Marble: light grey (suffix GGS)
	Nero Marquina: black (suffix MNS)
	Verde Alpi: green (suffix MVS)

*Note:*  
Platner coffee table are part of a collection. Please refer to Platner lounge seating on page 280 and Platner dining and side tables on page 450.

- Specify:*
1. Pattern number
  2. Base finish option
  3. Top option

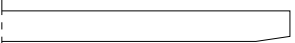
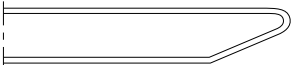



Construction
<i>Maintenance:</i> See pages 28-29.
<i>Note:</i> Marbles with a coating will yellow over time.
The Platner Tables are certified Clean Air GOLD.
<i>Frame:</i> Vertical steel wire rods welded to circular horizontal and edge-framing rods. Finish in bright nickel with a clear lacquer protection, a painted metallic bronze, or plated in 18k gold.
<i>Base:</i> Clear plastic extrusion ring for smooth bottom surface.
<i>Glass top:</i> 3/8" thick tempered glass for coffee and dining tables. 1/4" thick tempered glass for side tables.
<i>Edge detail for glass:</i> 
<i>Marble Top:</i> All marble tops feature a bevel edge. 1/4" thick coated marble tops have transparent acrylic coating to help eliminate use-associated stains. 3/4" thick natural marble tops and granite tops have protective sealer. Larger tops have subtop that fits into base opening to ensure stability.
<i>Marble edge detail:</i> 
<i>Wood Top:</i> Tops are constructed of veneered medium density fiberboard with a cathedral grain pattern in various toned or stained finishes for light oak, light walnut, and reff dark cherry. Ebonized walnut features a black stain on walnut substrate. All tops are 1 1/16" thick. Edges are 1/4" solid wood to match face veneer. Wood tops are weighted with plates to ensure stability.

# Jens Risom

## Dining and Side Tables

Designer(s):  
Jens Risom, 1943



description	w	d	h	weight	base	top
<b>642TR</b> Round dining table 	42"	42"	23"	40 lbs.	Clear Maple	Clear Maple
	42"	42"	23"	40 lbs.	Ebonized Maple	Ebonized Walnut
	42"	42"	23"	40 lbs.	Light Walnut	Light Walnut
<b>614TS</b> Square side table 	14"	14"	18"	7 lbs.	Clear Maple	Clear Maple
	14"	14"	18"	7 lbs.	Ebonized Maple	Ebonized Walnut
	14"	14"	18"	7 lbs.	Light Walnut	Light Walnut
	14"	14"	18"	8 lbs.	Teak	Teak
<b>618TR</b> Round side table 	18"	18"	20"	9 lbs.	Clear Maple	Clear Maple
	18"	18"	20"	9 lbs.	Ebonized Maple	Ebonized Walnut
	18"	18"	20"	9 lbs.	Light Walnut	Light Walnut
	18"	18"	20"	10 lbs.	Teak	Teak
<b>643TA</b> Amoeba shaped coffee table 	42"	32"	16"	22 lbs.	Clear Maple	Clear Maple
	42"	32"	16"	22 lbs.	Ebonized Maple	Ebonized Walnut
	42"	32"	16"	22 lbs.	Light Walnut	Light Walnut

pattern no.	list
<b>642TR-KC-KC</b>	\$2,633.
<b>642TR-KE-D</b>	2,738.
<b>642TR-LWT-LWT</b>	2,874.
<b>614TS-KC-KC</b>	1,226.
<b>614TS-KE-D</b>	1,269.
<b>614TS-LWT-LWT</b>	1,336.
<b>614TS-K-K</b>	1,588.
<b>618TR-KC-KC</b>	1,311.
<b>618TR-KE-D</b>	1,361.
<b>618TR-LWT-LWT</b>	1,432.
<b>618TR-K-K</b>	1,724.
<b>643TA-KC-KC</b>	2,248.
<b>643TA-KE-D</b>	2,341.
<b>643TA-LWT-LWT</b>	2,455.

### Order Code

<i>Example:</i> <b>642TR-KE-BL</b>
<b>642TR</b> Round dining table
<b>KE</b> Ebonized Maple
<b>D</b> Ebonized Walnut

*Note:*  
The Risom Tables are part of a Collection. Please refer to Risom chairs on page 0 and lounge chairs on page 0.

*Specify:*

1. Pattern number
2. Base finish selection
3. Top finish selection

### Ordering Information

*Base finishes:*  
Clear Maple (suffix KC)  
Ebonized Maple (suffix KE)  
Light Walnut (suffix LWT)  
Teak (suffix K)

*Top finishes:*  
Clear Maple (suffix KC)  
Ebonized Walnut (suffix D)  
Light Walnut (suffix LWT)  
Teak (suffix K)

### Construction

*Shipping information:*  
Dining table and Amoeba table shipped knocked down with top and legs in one box. Simple field assembly required. Side tables and coffee tables shipped fully assembled.

*Maintenance:*  
See pages 28-29.



*Note:*  
The Risom dining, side and amoeba tables are certified Clean Air GOLD.

*Legs and aprons:*  
Solid maple or walnut hardwood. Mortise and tenon joints.

*Top:*  
Tops are veneer with cathedral pattern with poplar cross bands and backing. Core and edge is solid hardwood lumber in clear finish.

*Finish:*  
Clear lacquer or ebonized finish.

Jens Risom  
*Child's Amoeba Table*

	description	w	d	h	weight	base	top
<p><i>Designer(s):</i>            Jens Risom, 1943</p> 	<p><b>643TAS</b> Child's Amoeba shaped coffee table</p> 	42"	32"	20"	32 lbs.	Honey Beech	Honey laminate

pattern no.	
<b>643TAS-HB-HL</b>	\$1,027.

Order Code	Ordering Information
<i>Example:</i> <b>643TAS-HB-HL</b>	<i>Base finish:</i> Honey Beech (suffix HB)
<b>643TAS</b>	<i>Top finish:</i> Honey laminate (suffix HL)
<b>HB</b>	Honey Beech
<b>HL</b>	Honey laminate

*Note:*  
 The Child's Risom Amoeba table is part of a Collection. Please refer to the Child's Risom side chairs on page 0.

- Specify:*
1. Pattern number
  2. Base finish selection
  3. Top finish selection



Construction
<p><i>Shipping information:</i>            Child's Risom Amoeba table is shipped knocked down with top and legs in one box. Simple field assembly required.</p> <p><i>Maintenance:</i>            See pages 28-29.</p> <p><i>Note:</i>            The Child's Risom Amoeba table is compliant to the Consumer Product Safety Improvement Act of 2008 for Children's Products, 16 C.F.R. 1303, CPSIA Title 1 Section 101 for Total Lead in Substrates and Surface Coatings.</p>

*Legs and aprons:*  
 Select European Beech hardwood with a toned natural finish. Mortise and tenon construction.

*Top:*  
 3/4" thick wood grain laminate top is 3-ply construction with medium density fiberboard core and plastic laminate backer. Honey laminate features a Beech grain pattern.

*Finish:*  
 Toned catalyzed lacquer finish.

Jens Risom  
Outdoor Tables

	description	w	d	h	weight	base	top
<i>Designer(s):</i> Jens Risom, 1943 	<b>614TS</b> Square side table 	14"	14"	18"	8 lbs.	Teak	Teak
	<b>618TR</b> Round side table 	18"	18"	20"	10 lbs.	Teak	Teak

pattern no.	list
<b>614TS-K-K</b>	\$1,588.
<b>618TR-K-K</b>	1,724.

Order Code	Ordering Information	Construction
<i>Example:</i> <b>618TR-K-K</b>	<i>Base finishes:</i> Teak (suffix K)	<i>Shipping information:</i> Side tables are shipped fully assembled.
<b>618TR</b> Round side table	<i>Top finishes:</i> Teak (suffix K)	<i>Legs and aprons:</i> Solid teak lumber with oiled finish. Mortise and tenon joints.
<b>K</b> Teak		<i>Top:</i> Solid teak lumber with oiled finish.
<b>K</b> Teak		<i>Note:</i> Teak will patina over time if left outdoors and will turn a silvery grey color.
	<i>Note:</i> The Outdoor Risom Tables are part of a Collection. Please refer to Outdoor Risom Seating on page 312 .	<i>Maintenance:</i> Teak oil can be applied with a paint brush every three months to maintain rich color.
	<i>Note:</i> The Risom side tables are certified Clean Air GOLD.	
<i>Specify:</i>		
1. Pattern number		
2. Base finish selection		
3. Top finish selection		

# Eero Saarinen Round Dining Tables

Designer(s):  
Eero Saarinen, 1957



description	w	d	h	weight	top
<b>172TR</b> Small round table, dining height 	35 1/4"		28 1/4"	47 lbs.	Laminate
	35 1/4"		28 1/4"	95 lbs.	Natural marble
	35 1/4"		28 1/4"	95 lbs.	Coated marble
	35 1/4"		28 1/4"	95 lbs.	Coated marble
	35 1/4"		28 1/4"	95 lbs.	Vetro Bianco
	35 1/4"		28 1/4"	95 lbs.	Coated marble
	35 1/4"		28 1/4"	95 lbs.	Coated marble
	35 1/4"		28 1/2"	95 lbs.	Coated marble
	35 1/4"		28 1/4"	51 lbs.	Veneer
	35 1/4"		28 1/4"	51 lbs.	Veneer
	35 1/4"		28 1/4"	103 lbs.	Granite
	35 1/4"		28 1/4"	95 lbs.	Natural marble
	35 1/4"		28 1/4"	95 lbs.	Coated marble
	35 1/4"		28 1/4"	95 lbs.	Slate, natural
<b>173TR</b> Medium round table, dining height 	42 1/4"		28 1/4"	58 lbs.	Laminate
	42 1/4"		28 1/4"	125 lbs.	Natural marble
	42 1/4"		28 1/4"	125 lbs.	Coated marble
	42 1/4"		28 1/4"	125 lbs.	Vetro Bianco
	42 1/4"		28 1/4"	125 lbs.	Coated marble
	42 1/4"		28 1/4"	125 lbs.	Coated marble
	42 1/4"		28 1/4"	63 lbs.	Veneer
	42 1/4"		28 1/4"	125 lbs.	Coated marble
	42 1/4"		28 1/4"	63 lbs.	Veneer
	42 1/4"		28 1/4"	125 lbs.	Coated marble
	42 1/4"		28 1/4"	136 lbs.	Granite
	42 1/4"		28 1/4"	125 lbs.	Coated marble
	42 1/4"		28 1/4"	125 lbs.	Slate, natural
	42 1/4"		28 1/4"	125 lbs.	Natural marble

pattern no.	
<b>172TR-(F2, MF1)-(1, 2, 3)</b>	\$4,265.
<b>172TR-(NGC)-(1, 2, 3)</b>	5,356.
<b>172TR-(MG, MGS)-(1, 2, 3)</b>	5,798.
<b>172TR-(GC, GCS)-(1, 2, 3)</b>	6,058.
<b>172TR-(VB)-(1, 2, 3)</b>	6,203.
<b>172TR-(MN, MNS, MA, MAS, GG, GGS)-(1, 2, 3)</b>	6,508.
<b>172TR-(ME, MES, MP, MPS)-(1, 2, 3)</b>	6,921.
<b>172TR-(MC, MCS)-(1, 2, 3)</b>	7,130.
<b>172TR-(LO, LWA, D, V314)-(1, 2, 3)</b>	7,210.
<b>172TR-(RO)-(1, 2, 3)</b>	7,339.
<b>172TR-(GA)-(1, 2, 3)</b>	7,996.
<b>172TR-(NC)-(1, 2, 3)</b>	9,535.
<b>172TR-(MV, MVS)-(1, 2, 3)</b>	9,544.
<b>172TR-(SN)-(1, 2, 3)</b>	9,968.
<b>173TR-(F2, MF1)-(1, 2, 3)</b>	4,549.
<b>173TR-(NGC)-(1, 2, 3)</b>	6,559.
<b>173TR-(MG, MGS)-(1, 2, 3)</b>	7,322.
<b>173TR-(VB)-(1, 2, 3)</b>	7,359.
<b>173TR-(GC, GCS)-(1, 2, 3)</b>	7,458.
<b>173TR-(MN, MNS, MA, MAS, GG, GGS)-(1, 2, 3)</b>	7,594.
<b>173TR-(RO)-(1, 2, 3)</b>	8,037.
<b>173TR-(MC, MCS)-(1, 2, 3)</b>	8,321.
<b>173TR-(LO, LWA, D, V314)-(1, 2, 3)</b>	8,675.
<b>173TR-(ME, MES, MP, MPS)-(1, 2, 3)</b>	8,791.
<b>173TR-(GA)-(1, 2, 3)</b>	9,744.
<b>173TR-(MV, MVS)-(1, 2, 3)</b>	10,228.
<b>173TR-(SN)-(1, 2, 3)</b>	10,660.
<b>173TR-(NC)-(1, 2, 3)</b>	11,864.

## Order Code

<i>Example:</i>	<b>176TR-MN-1</b>
<b>176TR</b>	Saarinen dining table
<b>MN</b>	Nero Marquina Marble
<b>1</b>	Black

*Note:*  
Saarinen tables are part of a collection. Please refer to Saarinen side chairs, lounge seating, and executive chairs on beginning on page 316.

### Specify:

1. Pattern number
2. Top selection
3. Base finish selection

## Ordering Information

### Base finishes:

- Black (suffix 1)
- White (suffix 2)
- Grey (suffix 3)

### Laminate top finish:

- White (suffix F2)
- Black (suffix MF1)

### Veneer finishes:

- Ebonized Walnut (suffix D)
- Light Oak (suffix LO)
- Light Walnut (suffix LWA)
- Reff Dark Cherry (suffix V314)
- Rosewood (suffix RO)

### Polished Coated marble top finishes:

- Arabescato: white-grey (suffix MA)
- Calacatta: white-grey/beige (suffix MC)
- Carrara: white-grey (suffix GC)
- Espresso: dark brown (suffix ME)
- Grey Marble: light grey (suffix GG)
- Grigio Marquina: warm grey (suffix MG)
- Nero Marquina: black (suffix MN)
- Verde Alpi: green (suffix MV) \*
- Portoro: black/silver (suffix MP)

### Satin Coated marble top finishes:

- Arabescato: white-grey (suffix MAS)
- Calacatta: white-grey/beige (suffix MCS)
- Carrara: white-grey (suffix GCS)
- Espresso: dark brown (suffix MES)
- Grey Marble: light grey (suffix GGS)
- Grigio Marquina: warm grey (suffix MGS)
- Nero Marquina: black (suffix MNS)
- Verde Alpi: green (suffix MVS) \*
- Portoro: black/silver (suffix MPS)

### Natural marble top finishes:

- Calacatta: white-grey/beige (suffix NC)
- Carrara: white-grey (suffix NGC)

### Granite top finish:

- Black Andes: black (suffix GA)

### Engineered Stone:

- Vetro Bianco: white (suffix VB)

### Slate top finish:

- Slate, natural (suffix SN)

### \* Note:

Verdi Alpi may not be specified for 165TR.

## Construction

### Maintenance:

See pages 28-29.

### Note:

Top and base shipped in separate packages. The Knoll logo is stamped into the base of the Saarinen tables. Tops have nameplate with designer's signature.

**Not suitable for outdoor use.**

Marbles with a coating will yellow over time.

Saarinen Dining Tables are certified Clean Air GOLD.

### Base:

Heavy molded cast aluminum, strap-polished. Black and white bases are coated in a tough, abrasion-resistant Rilsan® finish. Grey bases consist of a highly resilient polyurethane enamel wet coat with a clear satin finish.

### Base Measurements:

172TR, 173TR, 176TR: 20" diameter  
164TR, 165TR: 25.984" diameter

### Marble and Laminate Tops:

Bevel-edged satin smooth laminate or marble. 1/4" thick coated marble tops have transparent acrylic coating to help eliminate use-associated stains. 3/4" thick natural marble tops and granite tops have protective sealer. Laminate tops are 1.06" thick.

### Laminate edge detail:

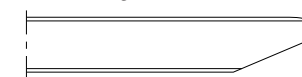

### Marble edge detail:

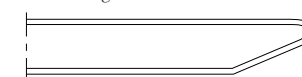

### Wood Top:

Tops are constructed of veneered medium density fiberboard with a cathedral grain pattern in various clear or toned stains. All tops are 1 1/16" thick with the exception of 164TR and 165TR which are 1 1/4" thick. Edges are 1/4" solid wood to match face veneer.

### Engineered Stone:

Polished, bright white surface is nonporous and more compact than most granites. Comprised of 93% fused quartz. It does not yellow or stain and is scratch resistant. Suitable for outdoors.

### Slate:

Beveled edge, 3/4" thick natural cleft slate.

### Note:

Vetro Bianco (VBO) top for outdoor use is only available on 162TR, 164TR, 169TR, 172TR, 173TR, 174TO tables. 162TR, 164TR, 172TR, 173TR, and 174TO use a phenolic subtop with exposed black edges and white laminate faces. Stainless steel hardware will be used for all connections.



# Eero Saarinen Round Dining Tables

Designer(s):  
Eero Saarinen, 1957

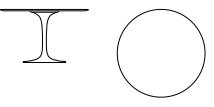
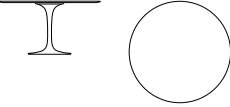

description	w	d	h	weight	top
<b>176TR</b> Medium round table, dining height 	47 1/4"		28 3/4"	76 lbs.	Laminate
	47 1/4"		28 3/4"	153 lbs.	Natural marble
	47 1/4"		28 3/4"	153 lbs.	Coated marble
	47 1/4"		28 3/4"	153 lbs.	Coated marble
	47 1/4"		28 3/4"	153 lbs.	Vetro Bianco
	47 1/4"		28 3/4"	153 lbs.	Coated marble
	47 1/4"		28 3/4"	74 lbs.	Veneer
	47 1/4"		28 3/4"	153 lbs.	Coated marble
	47 1/4"		28 3/4"	74 lbs.	Veneer
	47 1/4"		28 3/4"	153 lbs.	Coated marble
	47 1/4"		28 3/4"	153 lbs.	Slate, natural
	47 1/4"		28 3/4"	166 lbs.	Granite
	47 1/4"		28 3/4"	153 lbs.	Natural marble
	<b>164TR</b> Large round table, dining height 	54"		28 3/4"	102 lbs.
54"			28 3/4"	203 lbs.	Natural marble
54"			28 3/4"	203 lbs.	Vetro Bianco
54"			28 3/4"	203 lbs.	Coated marble
54"			28 3/4"	203 lbs.	Coated marble
54"			28 3/4"	203 lbs.	Coated marble
54"			28 3/4"	103 lbs.	Veneer
54"			28 3/4"	203 lbs.	Coated marble
54"			28 3/4"	103 lbs.	Veneer
54"			28 3/4"	203 lbs.	Coated marble
54"			28 3/4"	218 lbs.	Granite
54"			28 3/4"	203 lbs.	Coated marble
54"			28 3/4"	203 lbs.	Natural marble

pattern no.	
<b>176TR-(F2, MF1)-(1, 2, 3)</b>	\$4,885.
<b>176TR-(NGC)-(1, 2, 3)</b>	6,974.
<b>176TR-(GC, GCS)-(1, 2, 3)</b>	8,010.
<b>176TR-(MN, MNS, MA, MAS, GG, GGS)-(1, 2, 3)</b>	8,155.
<b>176TR-(VB)-(1, 2, 3)</b>	8,404.
<b>176TR-(MG, MGS)-(1, 2, 3)</b>	8,469.
<b>176TR-(RO)-(1, 2, 3)</b>	8,522.
<b>176TR-(MC, MCS)-(1, 2, 3)</b>	8,936.
<b>176TR-(LO, LWA, D, V314)-(1, 2, 3)</b>	9,707.
<b>176TR-(ME, MES, MP, MPS)-(1, 2, 3)</b>	10,330.
<b>176TR-(MV, MVS)-(1, 2, 3)</b>	10,908.
<b>176TR-(SN)-(1, 2, 3)</b>	11,007.
<b>176TR-(GA)-(1, 2, 3)</b>	11,141.
<b>176TR-(NC)-(1, 2, 3)</b>	13,953.
<b>164TR-(F2, MF1)-(1, 2, 3)</b>	6,498.
<b>164TR-(NGC)-(1, 2, 3)</b>	9,331.
<b>164TR-(VB)-(1, 2, 3)</b>	10,598.
<b>164TR-(GC, GCS)-(1, 2, 3)</b>	10,736.
<b>164TR-(MN, MNS, MA, MAS, GG, GGS)-(1, 2, 3)</b>	10,963.
<b>164TR-(MG, MGS)-(1, 2, 3)</b>	11,142.
<b>164TR-(RO)-(1, 2, 3)</b>	11,894.
<b>164TR-(MC, MCS)-(1, 2, 3)</b>	12,016.
<b>164TR-(LO, LWA, D, V314)-(1, 2, 3)</b>	12,157.
<b>164TR-(ME, MES, MP, MPS)-(1, 2, 3)</b>	13,220.
<b>164TR-(GA)-(1, 2, 3)</b>	13,497.
<b>164TR-(MV, MVS)-(1, 2, 3)</b>	14,731.
<b>164TR-(NC)-(1, 2, 3)</b>	18,078.

Order Code	Ordering Information
<i>Example:</i> <b>176TR-MN-1</b>	<i>Base finishes:</i>
<b>176TR</b> Saarinen dining table	Black (suffix 1)
<b>MN</b> Nero Marquina Marble	White (suffix 2)
<b>1</b> Black	Grey (suffix 3)
	<i>Laminate top finish:</i>
	White (suffix F2)
	Black (suffix MF1)
	<i>Veneer finishes:</i>
	Ebonized Walnut (suffix D)
	Light Oak (suffix LO)
	Light Walnut (suffix LWA)
	Reff Dark Cherry (suffix V314)
	Rosewood (suffix RO)
	<i>Polished Coated marble top finishes:</i>
	Arabescato: white-grey (suffix MA)
	Calacatta: white-grey/beige (suffix MC)
	Carrara: white-grey (suffix GC)
	Espresso: dark brown (suffix ME)
	Grey Marble: light grey (suffix GG)
	Grigio Marquina: warm grey (suffix MG)
	Nero Marquina: black (suffix MN)
	Verde Alpi: green (suffix MV) *
	Portoro: black/silver (suffix MP)
	<i>Satin Coated marble top finishes:</i>
	Arabescato: white-grey (suffix MAS)
	Calacatta: white-grey/beige (suffix MCS)
	Carrara: white-grey (suffix GCS)
	Espresso: dark brown (suffix MES)
	Grey Marble: light grey (suffix GGS)
	Grigio Marquina: warm grey (suffix MGS)
	Nero Marquina: black (suffix MNS)
	Verde Alpi: green (suffix MVS) *
	Portoro: black/silver (suffix MPS)
	<i>Natural marble top finishes:</i>
	Calacatta: white-grey/beige (suffix NC)
	Carrara: white-grey (suffix NGC)
	<i>Granite top finish:</i>
	Black Andes: black (suffix GA)
	<i>Engineered Stone:</i>
	Vetro Bianco: white (suffix VB)
	<i>Slate top finish:</i>
	Slate, natural (suffix SN)
	<i>* Note:</i>
	Verdi Alpi may not be specified for 165TR.

*Note:*  
Saarinen tables are part of a collection. Please refer to Saarinen side chairs, lounge seating, and executive chairs on beginning on page 316.

- Specify:*
1. Pattern number
  2. Top selection
  3. Base finish selection

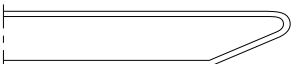
Construction
<i>Maintenance:</i> See pages 28-29.
<i>Note:</i> Top and base shipped in separate packages. The Knoll logo is stamped into the base of the Saarinen tables. Tops have nameplate with designer's signature. <b>Not suitable for outdoor use.</b>
Marbles with a coating will yellow over time.
Saarinen Dining Tables are certified Clean Air GOLD.
<i>Base:</i> Heavy molded cast aluminum, strap-polished. Black and white bases are coated in a tough, abrasion-resistant Rilsan® finish. Grey bases consist of a highly resilient polyurethane enamel wet coat with a clear satin finish.
<i>Base Measurements:</i> 172TR, 173TR, 176TR: 20" diameter 164TR, 165TR: 25.984" diameter
<i>Marble and Laminate Tops:</i> Bevel-edged satin smooth laminate or marble. 3/4" thick coated marble tops have transparent acrylic coating to help eliminate use-associated stains. 3/4" thick natural marble tops and granite tops have protective sealer. Laminate tops are 1.06" thick.
<i>Laminate edge detail:</i> 
<i>Marble edge detail:</i> 
<i>Wood Top:</i> Tops are constructed of veneered medium density fiberboard with a cathedral grain pattern in various clear or toned stains. All tops are 1 1/16" thick with the exception of 164TR and 165TR which are 1 1/4" thick. Edges are 1/4" solid wood to match face veneer.
<i>Engineered Stone:</i> Polished, bright white surface is nonporous and more compact than most granites. Comprised of 93% fused quartz. It does not yellow or stain and is scratch resistant. Suitable for outdoors.
<i>Slate:</i> Beveled edge, 3/4" thick natural cleft slate.
<i>Note:</i> Vetro Bianco (VBO) top for outdoor use is only available on 162TR, 164TR, 169TR, 172TR, 173TR, 174TO tables. 162TR, 164TR, 172TR, 173TR, and 174TO use a phenolic subtop with exposed black edges and white laminate faces. Stainless steel hardware will be used for all connections.

# Eero Saarinen Round Dining Tables

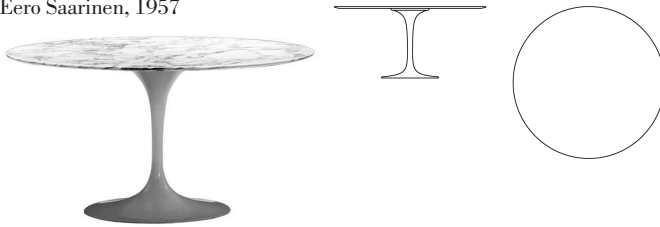
	description	w	d	h	weight	top
<p><i>Designer(s):</i> Eero Saarinen, 1957</p> 	<b>165TR</b> Large round table, dining height	60"		28 3/4"	115 lbs.	Laminate
		60"		28 3/4"	244 lbs.	Natural marble
		60"		28 3/4"	244 lbs.	Coated marble
		60"		28 3/4"	121 lbs.	Veneer
		60"		28 3/4"	121 lbs.	Veneer
		60"		28 3/4"	244 lbs.	Coated marble
		60"		28 3/4"	244 lbs.	Vetro Bianco
		60"		28 3/4"	244 lbs.	Coated marble
		60"		28 3/4"	263 lbs.	Granite
		60"		28 3/4"	244 lbs.	Coated marble
		60"		28 3/4"	244 lbs.	Coated marble
		60"		28 3/4"	244 lbs.	Coated marble
		60"		28 3/4"	244 lbs.	Natural marble

pattern no.	
<b>165TR-(F2, MF1)-(1, 2, 3)</b>	\$10,149.
<b>165TR-(NGC)-(1, 2, 3)</b>	10,698.
<b>165TR-(GC, GCS)-(1, 2, 3)</b>	12,429.
<b>165TR-(RO)-(1, 2, 3)</b>	12,667.
<b>165TR-(LO, LWA, D, V314)-(1, 2, 3)</b>	13,219.
<b>165TR-(MG, MGS)-(1, 2, 3)</b>	13,349.
<b>165TR-(VB)-(1, 2, 3)</b>	13,774.
<b>165TR-(ME, MES, MP, MPS)-(1, 2, 3)</b>	16,138.
<b>165TR-(GA)-(1, 2, 3)</b>	16,203.
<b>165TR-(MN, MNS, MA, MAS, GG, GGS)-(1, 2, 3)</b>	16,867.
<b>165TR-(MC, MCS)-(1, 2, 3)</b>	18,470.
<b>165TR-(NC)-(1, 2, 3)</b>	21,698.

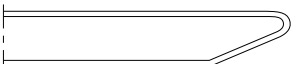

Order Code	Ordering Information
<i>Example:</i> <b>176TR-MN-1</b>	<i>Base finishes:</i>
<b>176TR</b> Saarinen dining table	Black (suffix 1)
<b>MN</b> Nero Marquina Marble	White (suffix 2)
<b>1</b> Black	Grey (suffix 3)
<i>Note:</i> Saarinen tables are part of a collection. Please refer to Saarinen side chairs, lounge seating, and executive chairs on beginning on page 316.	<i>Laminate top finish:</i> White (suffix F2) Black (suffix MF1)
<i>Specify:</i> 1. Pattern number 2. Top selection 3. Base finish selection	<i>Veneer finishes:</i> Ebonized Walnut (suffix D) Light Oak (suffix LO) Light Walnut (suffix LWA) Reff Dark Cherry (suffix V314) Rosewood (suffix RO)
	<i>Polished Coated marble top finishes:</i> Arabescato: white-grey (suffix MA) Calacatta: white-grey/beige (suffix MC) Carrara: white-grey (suffix GC) Espresso: dark brown (suffix ME) Grey Marble: light grey (suffix GG) Grigio Marquina: warm grey (suffix MG) Nero Marquina: black (suffix MN) Verde Alpi: green (suffix MV) * Portoro: black/silver (suffix MP)
	<i>Satin Coated marble top finishes:</i> Arabescato: white-grey (suffix MAS) Calacatta: white-grey/beige (suffix MCS) Carrara: white-grey (suffix GCS) Espresso: dark brown (suffix MES) Grey Marble: light grey (suffix GGS) Grigio Marquina: warm grey (suffix MGS) Nero Marquina: black (suffix MNS) Verde Alpi: green (suffix MVS) * Portoro: black/silver (suffix MPS)
	<i>Natural marble top finishes:</i> Calacatta: white-grey/beige (suffix NC) Carrara: white-grey (suffix NGC)
	<i>Granite top finish:</i> Black Andes: black (suffix GA)
	<i>Engineered Stone:</i> Vetro Bianco: white (suffix VB)
	<i>Slate top finish:</i> Slate, natural (suffix SN)
	<i>* Note:</i> Verdi Alpi may not be specified for 165TR.

Maintenance:	Construction
See pages 28-29.	<i>Base:</i> Heavy molded cast aluminum, strap-polished. Black and white bases are coated in a tough, abrasion-resistant Rilsan® finish. Grey bases consist of a highly resilient polyurethane enamel wet coat with a clear satin finish.
<i>Note:</i> Top and base shipped in separate packages. The Knoll logo is stamped into the base of the Saarinen tables. Tops have nameplate with designer's signature. <b>Not suitable for outdoor use.</b>	<i>Marble and Laminate Tops:</i> Bevel-edged satin smooth laminate or marble. 3/4" thick coated marble tops have transparent acrylic coating to help eliminate use-associated stains. 3/4" thick natural marble tops and granite tops have protective sealer. Laminate tops are 1.06" thick.
Marbles with a coating will yellow over time.	<i>Marble edge detail:</i> 
Saarinen Dining Tables are certified Clean Air GOLD.	<i>Marble edge detail:</i> 
	<i>Wood Top:</i> Tops are constructed of veneered medium density fiberboard with a cathedral grain pattern in various clear or toned stains. All tops are 1 1/16" thick with the exception of 164TR and 165TR which are 1 1/4" thick. Edges are 1/4" solid wood to match face veneer.
	<i>Engineered Stone:</i> Polished, bright white surface is nonporous and more compact than most granites. Comprised of 93% fused quartz. It does not yellow or stain and is scratch resistant. Suitable for outdoors.
	<i>Slate:</i> Beveled edge, 3/4" thick natural cleft slate.
	<i>Note:</i> Vetro Bianco (VBO) top for outdoor use is only available on 162TR, 164TR, 169TR, 172TR, 173TR, 174TO tables. 162TR, 164TR, 172TR, 173TR, and 174TO use a phenolic subtop with exposed black edges and white laminate faces. Stainless steel hardware will be used for all connections.

# Eero Saarinen Oval Dining Tables

Designer(s):  
Eero Saarinen, 1957



description	w	d	h	weight	top
<b>178TO</b> Medium oval table, dining height 	72"	42"	28 1/4"	209 lbs.	Natural marble
	72"	42"	28 1/4"	106 lbs.	Laminate
	72"	42"	28 1/4"	209 lbs.	Coated marble
	72"	47"	28 1/4"	209 lbs.	Coated marble
	72"	42"	28 1/4"	209 lbs.	Vetro Bianco
	72"	42"	28 1/4"	106 lbs.	Veneer
	72"	42"	28 1/4"	209 lbs.	Coated marble
	72"	42"	28 1/4"	106 lbs.	Veneer
	72"	42"	28 1/4"	209 lbs.	Granite
	72"	42"	28 1/4"	209 lbs.	Coated marble
	72"	42"	28 1/4"	209 lbs.	Slate, natural
	72"	42"	28 1/4"	209 lbs.	Coated marble
	72"	42"	28 1/4"	209 lbs.	Natural marble
	72"	42"	28 1/4"	209 lbs.	Coated marble
<b>174TO</b> Medium oval table, dining height 	78"	47 1/4"	28 1/4"	131 lbs.	Laminate
	78"	47 1/4"	28 1/4"	259 lbs.	Natural marble
	78"	47 1/4"	28 1/4"	259 lbs.	Coated marble
	78"	47 1/4"	28 1/4"	259 lbs.	Coated marble
	78"	47 1/4"	28 1/4"	131 lbs.	Veneer
	78"	47 1/4"	28 1/4"	259 lbs.	Vetro Bianco
	78"	47 1/4"	28 1/4"	131 lbs.	Veneer
	78"	47 1/4"	28 1/4"	259 lbs.	Coated marble
	78"	47 1/4"	28 1/4"	259 lbs.	Coated marble
	78"	47 1/4"	28 1/4"	229 lbs.	Granite
	78"	47 1/4"	28 1/4"	259 lbs.	Slate, natural
	78"	47 1/4"	28 1/4"	259 lbs.	Coated marble
	78"	47 1/4"	28 1/4"	259 lbs.	Natural marble
	78"	47 1/4"	28 1/4"	259 lbs.	Coated marble

pattern no.	
<b>178TO-(NGC)-(1, 2, 3)</b>	\$10,546.
<b>178TO-(F2, MF1)-(1, 2, 3)</b>	10,700.
<b>178TO-(GC, GCS)-(1, 2, 3)</b>	12,154.
<b>178TO-(MG, MGS)-(1, 2, 3)</b>	12,423.
<b>178TO-(VB)-(1, 2, 3)</b>	13,542.
<b>178TO-(RO)-(1, 2, 3)</b>	13,748.
<b>178TO-(ME, MES, MP, MPS)-(1, 2, 3)</b>	15,294.
<b>178TO-(LO, LWA, D, V314)-(1, 2, 3)</b>	15,998.
<b>178TO-(GA)-(1, 2, 3)</b>	16,136.
<b>178TO-(MN, MNS, MA, MAS, GG, GGS)-(1, 2, 3)</b>	16,453.
<b>178TO-(SN)-(1, 2, 3)</b>	16,648.
<b>178TO-(MC, MCS)-(1, 2, 3)</b>	18,015.
<b>178TO-(NC)-(1, 2, 3)</b>	20,220.
<b>178TO-(MV, MVS)-(1, 2, 3)</b>	24,160.
<b>174TO-(F2, MF1)-(1, 2, 3)</b>	11,195.
<b>174TO-(NGC)-(1, 2, 3)</b>	11,432.
<b>174TO-(GC, GCS)-(1, 2, 3)</b>	13,391.
<b>174TO-(MG, MGS)-(1, 2, 3)</b>	13,714.
<b>174TO-(RO)-(1, 2, 3)</b>	14,246.
<b>174TO-(VB)-(1, 2, 3)</b>	14,979.
<b>174TO-(LO, LWA, D, V314)-(1, 2, 3)</b>	16,625.
<b>174TO-(ME, MES, MP, MPS)-(1, 2, 3)</b>	17,197.
<b>174TO-(MN, MNS, MA, MAS, GG, GGS)-(1, 2, 3)</b>	17,310.
<b>174TO-(GA)-(1, 2, 3)</b>	17,338.
<b>174TO-(SN)-(1, 2, 3)</b>	17,720.
<b>174TO-(MC, MCS)-(1, 2, 3)</b>	18,954.
<b>174TO-(NC)-(1, 2, 3)</b>	22,360.
<b>174TO-(MV, MVS)-(1, 2, 3)</b>	25,424.

Order Code	Ordering Information
<i>Example:</i> <b>174TO-MA-PL</b>	<i>Base finishes:</i>
<b>174TO</b> Saarinen dining table	Black (suffix 1)
<b>MA</b> Arabescato Marble	White (suffix 2)
<b>2</b> White base	Grey (suffix 3)
	<i>Laminate top finish:</i>
	White (suffix F2)
	Black (suffix MF1)
	<i>Veneer finishes:</i>
	Ebonized Walnut (suffix D)
	Light Oak (suffix LO)
	Light Walnut (suffix LWA)
	Reff Dark Cherry (suffix V314)
	Rosewood (suffix RO)
	<i>Polished Coated marble top finishes:</i>
	Arabescato: white-grey (suffix MA)
	Calacatta: white-grey/beige (suffix MC)
	Carrara: white-grey (suffix GC)
	Espresso: dark brown (suffix ME)
	Grey Marble: light grey (suffix GG)
	Grigio Marquina: warm grey (suffix MG)
	Nero Marquina: black (suffix MN)
	Verde Alpi: green (suffix MV)
	Portoro: black/silver (suffix MP)
	<i>Satin Coated marble top finishes:</i>
	Arabescato: white-grey (suffix MAS)
	Calacatta: white-grey/beige (suffix MCS)
	Carrara: white-grey (suffix GCS)
	Espresso: dark brown (suffix MES)
	Grey Marble: light grey (suffix GGS)
	Grigio Marquina: warm grey (suffix MGS)
	Nero Marquina: black (suffix MNS)
	Verde Alpi: green (suffix MVS)
	Portoro: black/silver (suffix MPS)
	<i>Natural marble top finishes:</i>
	Calacatta: white-grey/beige (suffix NC)
	Carrara: white-grey (suffix NGC)
	<i>Granite top finish:</i>
	Black Andes: black (suffix GA)
	<i>Engineered Stone:</i>
	Vetro Bianco: white (suffix VB)
	<i>Slate top finish:</i>
	Slate, natural (suffix SN)

*Note:*  
Saarinen tables are part of a collection. Please refer to Saarinen side chairs, lounge seating, and executive chairs on beginning on page 316.

- Specify:*
1. Pattern number
  2. Top selection
  3. Base finish selection

### Construction

*Maintenance:*  
See pages 28-29.

*Note:*  
Top and base shipped in separate packages. The Knoll logo is stamped into the base of the Saarinen tables. Tops have nameplate with designer's signature.  
**Not suitable for outdoor use.**

Marbles with a coating will yellow over time.

Saarinen Dining Tables are certified Clean Air GOLD.

*Base:*  
Heavy molded cast aluminum, strap-polished. Black and white bases are coated in a tough, abrasion-resistant Rilsan® finish. Platinum bases consist of a highly resilient polyurethane enamel wet coat with a clear satin finish.

*Base Measurements:*  
178TO, 174TO, 179TO, 175TO: width is 31.3" and depth is 23"

*Marble and Laminate Tops:*  
Bevel-edged satin smooth laminate or marble. 3/4" thick coated marble tops have transparent acrylic coating to help eliminate use-associated stains. 3/4" thick natural marble tops and granite tops have protective sealer. Laminate tops are 1.06" thick.

*Laminate edge detail:*

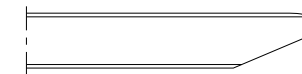

*Marble edge detail:*

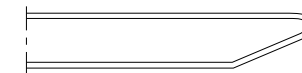

*Engineered Stone:*  
Polished, bright white surface is nonporous and more compact than most granites. Comprised of 93% fused quartz. It does not yellow or stain and is scratch resistant.

*Slate:*  
Beveled edge, 3/4" thick natural cleft slate.

*Note:*  
Vetro Bianco (VBO) top for outdoor use is only available on 162TR, 164TR, 169TR, 172TR, 173TR, 174TO tables. 162TR, 164TR, 172TR, 173TR, and 174TO use a phenolic subtop with exposed black edged and white laminate faces. Stainless steel hardware will be used for all connections.

*Veneer Tops:*  
Tops are constructed of veneered medium density fiberboard with a cathedral grain pattern in various clear or toned stains. Oval dining tops are 1 1/4" thick. Edges are 1/4" solid wood to match face veneer.

# Eero Saarinen

## Oval Dining Tables

	description	w	d	h	weight	top		
<i>Designer(s):</i> Eero Saarinen, 1957	<b>179TO</b> Medium oval table, dining height	84"	47"	28 1/4"	138 lbs.	Laminate		
		84"	47"	28 1/4"	273 lbs.	Natural marble		
		84"	47"	28 1/4"	273 lbs.	Coated marble		
		84"	47"	28 1/4"	138 lbs.	Veneer		
		84"	47"	28 1/4"	273 lbs.	Coated marble		
		84"	47"	28 1/4"	273 lbs.	Vetro Bianco		
		84"	47"	28 1/4"	138 lbs.	Veneer		
		84"	47"	28 1/4"	273 lbs.	Coated marble		
		84"	47"	28 1/4"	273 lbs.	Granite		
		84"	47"	28 1/4"	273 lbs.	Slate, natural		
		84"	47"	28 1/4"	273 lbs.	Coated marble		
		84"	47"	28 1/4"	273 lbs.	Coated marble		
		84"	47"	28 1/4"	273 lbs.	Natural marble		
		84"	47"	28 1/4"	273 lbs.	Coated marble		
			<b>175TO</b> Large oval table, dining height	96"	54"	28 1/4"	169 lbs.	Laminate
				96"	54"	28 1/4"	348 lbs.	Natural marble
96"	54"			28 1/4"	168 lbs.	Veneer		
96"	54"			28 1/4"	348 lbs.	Coated marble		
96"	54"			28 1/4"	348 lbs.	Coated marble		
96"	54"			28 1/4"	168 lbs.	Veneer		
96"	54"			28 1/4"	348 lbs.	Vetro Bianco		
96"	54"			28 1/4"	348 lbs.	Coated marble		
96"	54"			28 1/4"	374 lbs.	Granite		
96"	54"			28 1/4"	348 lbs.	Coated marble		
96"	54"			28 1/4"	348 lbs.	Coated marble		
96"	54"			28 1/4"	348 lbs.	Natural marble		
96"	54"			28 1/4"	348 lbs.	Coated marble		

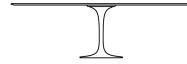

pattern no.	
<b>179TO-(F2, MF1)-(1, 2, 3)</b>	\$11,684.
<b>179TO-(NGC)-(1, 2, 3)</b>	12,322.
<b>179TO-(GC, GCS)-(1, 2, 3)</b>	14,628.
<b>179TO-(RO)-(1, 2, 3)</b>	14,747.
<b>179TO-(MG, MGS)-(1, 2, 3)</b>	15,003.
<b>179TO-(VB)-(1, 2, 3)</b>	16,415.
<b>179TO-(LO, LWA, D, V314)-(1, 2, 3)</b>	17,252.
<b>179TO-(MN, MNS, MA, MAS, GG, GGS)-(1, 2, 3)</b>	18,167.
<b>179TO-(GA)-(1, 2, 3)</b>	18,543.
<b>179TO-(SN)-(1, 2, 3)</b>	18,789.
<b>179TO-(ME, MES, MP, MPS)-(1, 2, 3)</b>	19,101.
<b>179TO-(MC, MCS)-(1, 2, 3)</b>	19,892.
<b>179TO-(NC)-(1, 2, 3)</b>	24,502.
<b>179TO-(MV, MVS)-(1, 2, 3)</b>	26,688.
<b>175TO-(F2, MF1)-(1, 2, 3)</b>	12,671.
<b>175TO-(NGC)-(1, 2, 3)</b>	14,373.
<b>175TO-(RO)-(1, 2, 3)</b>	15,746.
<b>175TO-(GC, GCS)-(1, 2, 3)</b>	17,100.
<b>175TO-(MG, MGS)-(1, 2, 3)</b>	17,585.
<b>175TO-(LO, LWA, D, V314)-(1, 2, 3)</b>	18,509.
<b>175TO-(VB)-(1, 2, 3)</b>	19,285.
<b>175TO-(MN, MNS, MA, MAS, GG, GGS)-(1, 2, 3)</b>	19,882.
<b>175TO-(GA)-(1, 2, 3)</b>	20,945.
<b>175TO-(MC, MCS)-(1, 2, 3)</b>	21,768.
<b>175TO-(ME, MES, MP, MPS)-(1, 2, 3)</b>	22,909.
<b>175TO-(NC)-(1, 2, 3)</b>	28,729.
<b>175TO-(MV, MVS)-(1, 2, 3)</b>	29,216.



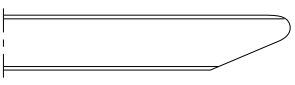
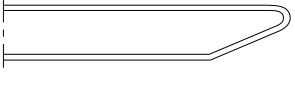

Order Code	Ordering Information
<i>Example:</i> <b>174TO-MA-PL</b>	<i>Base finishes:</i>
<b>174TO</b> Saarinen dining table	Black (suffix 1)
<b>MA</b> Arabescato Marble	White (suffix 2)
<b>2</b> White base	Grey (suffix 3)
	<i>Laminate top finish:</i>
	White (suffix F2)
	Black (suffix MF1)
	<i>Veneer finishes:</i>
	Ebonized Walnut (suffix D)
	Light Oak (suffix LO)
	Light Walnut (suffix LWA)
	Reff Dark Cherry (suffix V314)
	Rosewood (suffix RO)
	<i>Polished Coated marble top finishes:</i>
	Arabescato: white-grey (suffix MA)
	Calacatta: white-grey/beige (suffix MC)
	Carrara: white-grey (suffix GC)
	Espresso: dark brown (suffix ME)
	Grey Marble: light grey (suffix GG)
	Grigio Marquina: warm grey (suffix MG)
	Nero Marquina: black (suffix MN)
	Verde Alpi: green (suffix MV)
	Portoro: black/silver (suffix MP)
	<i>Satin Coated marble top finishes:</i>
	Arabescato: white-grey (suffix MAS)
	Calacatta: white-grey/beige (suffix MCS)
	Carrara: white-grey (suffix GCS)
	Espresso: dark brown (suffix MES)
	Grey Marble: light grey (suffix GGS)
	Grigio Marquina: warm grey (suffix MGS)
	Nero Marquina: black (suffix MNS)
	Verde Alpi: green (suffix MVS)
	Portoro: black/silver (suffix MPS)
	<i>Natural marble top finishes:</i>
	Calacatta: white-grey/beige (suffix NC)
	Carrara: white-grey (suffix NGC)
	<i>Granite top finish:</i>
	Black Andes: black (suffix GA)
	<i>Engineered Stone:</i>
	Vetro Bianco: white (suffix VB)
	<i>Slate top finish:</i>
	Slate, natural (suffix SN)

*Note:*  
Saarinen tables are part of a collection. Please refer to Saarinen side chairs, lounge seating, and executive chairs on beginning on page 316.

- Specify:*
1. Pattern number
  2. Top selection
  3. Base finish selection

Maintenance:	Construction
See pages 28-29.	<i>Base:</i> Heavy molded cast aluminum, strap-polished. Black and white bases are coated in a tough, abrasion-resistant Rilsan® finish. Platinum bases consist of a highly resilient polyurethane enamel wet coat with a clear satin finish.
<i>Note:</i> Top and base shipped in separate packages. The Knoll logo is stamped into the base of the Saarinen tables. Tops have nameplate with designer's signature. <b>Not suitable for outdoor use.</b>	<i>Marble and Laminate Tops:</i> Bevel-edged satin smooth laminate or marble. 3/4" thick coated marble tops have transparent acrylic coating to help eliminate use-associated stains. 3/4" thick natural marble tops and granite tops have protective sealer. Laminate tops are 1.06" thick.
Marbles with a coating will yellow over time.	<i>Engineered Stone:</i> Polished, bright white surface is nonporous and more compact than most granites. Comprised of 93% fused quartz. It does not yellow or stain and is scratch resistant.
Saarinen Dining Tables are certified Clean Air GOLD.	<i>Slate:</i> Beveled edge, 3/4" thick natural cleft slate.
	<i>Note:</i> Vetro Bianco (VBO) top for outdoor use is only available on 162TR, 164TR, 169TR, 172TR, 173TR, 174TO tables. 162TR, 164TR, 172TR, 173TR, and 174TO use a phenolic subtop with exposed black edged and white laminate faces. Stainless steel hardware will be used for all connections.
	<i>Laminate edge detail:</i> 
	<i>Marble edge detail:</i> 
	<i>Veneer Tops:</i> Tops are constructed of veneered medium density fiberboard with a cathedral grain pattern in various clear or toned stains. Oval dining tops are 1 1/4" thick. Edges are 1/4" solid wood to match face veneer.

# Eero Saarinen Round End and Coffee Tables

	description	w	d	h	weight	top
<p><i>Designer(s):</i> Eero Saarinen, 1957</p> 	<p><b>160TR</b> Small round side table, intermediate height</p> 	16 1/4"		20"	12 lbs.	Laminate
		16 1/4"		20"	21 lbs.	Natural marble
		16 1/4"		20"	21 lbs.	Coated marble
		16 1/4"		20"	21 lbs.	Coated marble
		16 1/4"		20"	21 lbs.	Coated marble
		16 1/4"		20"	21 lbs.	Coated marble
		16 1/4"		20"	21 lbs.	Coated marble
		16 1/4"		20"	21 lbs.	Coated marble
		16 1/4"		20"	21 lbs.	Vetro Bianco
		16 1/4"		20"	25 lbs.	Granite
		16 1/4"		20"	21 lbs.	Natural marble
		16 1/4"		20"	14 lbs.	Veneer
		16 1/4"		20"	21 lbs.	Slate, natural
		16 1/4"		20"	14 lbs.	Veneer
			<p><b>163TR</b> Small round side table, intermediate height</p> 	20"		20"
20"				20"	30 lbs.	Natural marble
20"				20"	30 lbs.	Coated marble
20"				20"	30 lbs.	Coated marble
20"				20"	30 lbs.	Coated marble
20"				20"	30 lbs.	Coated marble
20"				20"	30 lbs.	Coated marble
20"				20"	30 lbs.	Vetro Bianco
20"				20"	30 lbs.	Coated marble
20"				20"	30 lbs.	Coated marble
20"				20"	17 lbs.	Veneer
20"				20"	33 lbs.	Granite
20"				20"	30 lbs.	Natural marble
20"				20"	17 lbs.	Veneer
20"				20"	30 lbs.	Slate, natural

pattern no.	
<b>160TR-(F2, MF1)-(1, 2, 3)</b>	\$1,315.
<b>160TR-(NGC)-(1, 2, 3)</b>	1,584.
<b>160TR-(GC, GCS)-(1, 2, 3)</b>	1,734.
<b>160TR-(MN, MNS, MA, MAS, GG, GGS)-(1, 2, 3)</b>	1,822.
<b>160TR-(MC, MCS)-(1, 2, 3)</b>	1,908.
<b>160TR-(MG, MGS)-(1, 2, 3)</b>	2,143.
<b>160TR-(ME, MES, MP, MPS)-(1, 2, 3)</b>	2,208.
<b>160TR-(MV, MVS)-(1, 2, 3)</b>	2,274.
<b>160TR-(VB)-(1, 2, 3)</b>	2,305.
<b>160TR-(GA)-(1, 2, 3)</b>	3,011.
<b>160TR-(NC)-(1, 2, 3)</b>	3,062.
<b>160TR-(LO, LWA, D, V314)-(1, 2, 3)</b>	3,099.
<b>160TR-(SN)-(1, 2, 3)</b>	4,179.
<b>160TR-(RO)-(1, 2, 3)</b>	4,210.
<b>163TR-(F2, MF1)-(1, 2, 3)</b>	1,547.
<b>163TR-(NGC)-(1, 2, 3)</b>	1,727.
<b>163TR-(GC, GCS)-(1, 2, 3)</b>	1,943.
<b>163TR-(MN, MNS, MA, MAS, GG, GGS)-(1, 2, 3)</b>	2,097.
<b>163TR-(MC, MCS)-(1, 2, 3)</b>	2,199.
<b>163TR-(MG, MGS)-(1, 2, 3)</b>	2,552.
<b>163TR-(VB)-(1, 2, 3)</b>	2,602.
<b>163TR-(ME, MES, MP, MPS)-(1, 2, 3)</b>	2,834.
<b>163TR-(MV, MVS)-(1, 2, 3)</b>	2,984.
<b>163TR-(LO, LWA, D, V314)-(1, 2, 3)</b>	3,296.
<b>163TR-(GA)-(1, 2, 3)</b>	3,566.
<b>163TR-(NC)-(1, 2, 3)</b>	3,618.
<b>163TR-(RO)-(1, 2, 3)</b>	4,356.
<b>163TR-(SN)-(1, 2, 3)</b>	4,471.

Order Code	Ordering Information
<i>Example:</i> <b>160TR-MV-2</b>	
<b>161TO</b> Saarinen side table	<i>Base finishes:</i> Black (suffix 1) White (suffix 2) Grey (suffix 3)
<b>MV</b> Verdi Alpi Marble	<i>Laminate top finish:</i> White (suffix F2) Black (suffix MF1)
<b>2</b> White	<i>Veneer Finishes:</i> Ebonized Walnut (suffix D) Light Oak (suffix LO) Light Walnut (suffix LWA) Reff Dark Cherry (suffix V314) Rosewood (suffix RO)
	<i>Polished Coated marble top finishes:</i> Arabescato: white-grey (suffix MA) Calacatta: white-grey/beige (suffix MC) Carrara: white-grey (suffix GC) Espresso: dark brown (suffix ME) Grey Marble: light grey (suffix GG) Grigio Marquina: warm grey (suffix MG) Nero Marquina: black (suffix MN) Verde Alpi: green (suffix MV) Portoro: black/silver (suffix MP)
	<i>Natural marble top finishes:</i> Calacatta: white-grey/beige (suffix NC) Carrara: white-grey (suffix NGC)
	<i>Granite top finish:</i> Black Andes: black (suffix GA)
	<i>Engineered Stone:</i> Vetro Bianco: white (suffix VB)
	<i>Slate top finish:</i> Slate, natural (suffix SN)
	<i>Satin Coated marble top finishes:</i> Arabescato: white-grey (suffix MAS) Calacatta: white-grey/beige (suffix MCS) Carrara: white-grey (suffix GCS) Espresso: dark brown (suffix MES) Grey Marble: light grey (suffix GGS) Grigio Marquina: warm grey (suffix MGS) Nero Marquina: black (suffix MNS) Verde Alpi: green (suffix MVS) Portoro: black/silver (suffix MPS)

*Note:*  
Saarinen tables are part of a collection. Please refer to Saarinen side chairs, lounge seating and executive chairs on pages 316.

*Specify:*



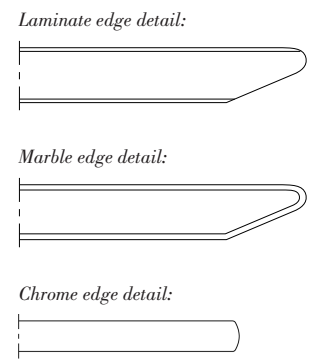

1. Pattern number
2. Top selection
3. Base finish selection

Maintenance:	Construction
See pages 28-29.	<i>Base:</i> Heavy molded cast aluminum, strap-polished. Black and white bases are coated in a tough, abrasion-resistant Rilsan® finish. Platinum bases consist of a highly resilient polyurethane enamel wet coat with a clear satin finish.
<i>Note:</i> Top and base shipped in separate packages. The Knoll logo is stamped into the base of the Saarinen tables. Tops have a nameplate with the designers signature.	<i>Base Diameters:</i> 160TR, 163TR: 10.7" 162TR: 17" 169TR: 13.5"
<b>Not suitable for outdoor use.</b>	<i>Laminate and Marble Tops:</i> Bevel-edged satin smooth laminate or marble. 3/4" thick coated marble tops have transparent acrylic coating to help eliminate use-associated stains. 3/4" thick natural marble tops and granite tops have protective sealer. Laminate tops are 1.06" thick.
Marbles with a coating will yellow over time.	<i>Engineered Stone:</i> Polished, bright white surface is nonporous and more compact than most granites. Comprised of 93% fused quartz. It does not yellow or stain and is scratch resistant. Suitable for outdoors.
Saarinen Round End and Coffee Tables are certified Clean Air GOLD.	<i>Slate:</i> Beveled edge, 3/4" thick natural cleft slate.
	<i>Note:</i> Vetro Bianco (VBO) top for outdoor use is only available on 162TR, 164TR, 169TR, 172TR, 173TR, 174TO tables. 162TR, 164TR, 172TR, 173TR, and 174TO use a phenolic subtop with exposed black edges and white laminate faces. Stainless steel hardware will be used for all connections.
	<i>Veneer Tops:</i> Tops are constructed of veneered medium density fiberboard with a cathedral grain pattern in various clear or toned or stains. All tops are 1 1/8" thick.



# Eero Saarinen

## Round End and Coffee Tables

	description	w	d	h	weight	top		
<p><i>Designer(s):</i> Eero Saarinen, 1957</p> 	<p><b>169TR</b> Small round side table, low height</p> 	20"		13 3/4"	14 lbs.	Laminate		
		20"		13 3/4"	29 lbs.	Natural marble		
		20"		13 3/4"	29 lbs.	Coated marble		
		20"		13 3/4"	29 lbs.	Coated marble		
		20"		13 3/4"	29 lbs.	Coated marble		
		20"		13 3/4"	29 lbs.	Coated marble		
		20"		13 3/4"	29 lbs.	Coated marble		
		20"		13 3/4"	29 lbs.	Coated marble		
		20"		13 3/4"	29 lbs.	Coated marble		
		20"		13 3/4"	16 lbs.	Veneer		
		20"		13 3/4"	32 lbs.	Granite		
		20"		13 3/4"	29 lbs.	Natural marble		
		20"		13 3/4"	16 lbs.	Veneer		
		20"		13 3/4"	29 lbs.	Slate, natural		
			<p><b>162TR</b> Medium round coffee table, low level</p> 	35 1/4"		15 1/4"	40 lbs.	Laminate
				35 1/4"		15 1/4"	88 lbs.	Natural marble
				35 1/4"		15 1/4"	88 lbs.	Coated marble
				35 1/4"		15 1/4"	88 lbs.	Coated marble
35 1/4"				15 1/4"	43 lbs.	Veneer		
35 1/4"				15 1/4"	88 lbs.	Vetro Bianco		
35 1/4"				15 1/4"	43 lbs.	Veneer		
35 1/4"				15 1/4"	88 lbs.	Coated marble		
35 1/4"				15 1/4"	88 lbs.	Coated marble		
35 1/4"				15 1/4"	88 lbs.	Coated marble		
35 1/4"				15 1/4"	96 lbs.	Granite		
35 1/4"				15 1/4"	88 lbs.	Coated marble		
35 1/4"				15 1/4"	88 lbs.	Natural marble		
35 1/4"				15 1/4"	88 lbs.	Slate, natural		

pattern no.	
<b>169TR-(F2, MF1)-(1, 2, 3)</b>	\$1,420.
<b>169TR-(NGC)-(1, 2, 3)</b>	1,686.
<b>169TR-(GC, GCS)-(1, 2, 3)</b>	1,886.
<b>169TR-(MN, MNS, MA, MAS, GG, GGS)-(1, 2, 3)</b>	2,038.
<b>169TR-(MC, MCS)-(1, 2, 3)</b>	2,141.
<b>169TR-(MV, MVS)-(1, 2, 3)</b>	2,706.
<b>169TR-(MG, MGS)-(1, 2, 3)</b>	2,713.
<b>169TR-(ME, MES, MP, MPS)-(1, 2, 3)</b>	2,995.
<b>169TR-(LO, LWA, D, V314)-(1, 2, 3)</b>	3,450.
<b>169TR-(GA)-(1, 2, 3)</b>	3,496.
<b>169TR-(NC)-(1, 2, 3)</b>	3,546.
<b>169TR-(RO)-(1, 2, 3)</b>	4,461.
<b>169TR-(SN)-(1, 2, 3)</b>	4,609.
<b>162TR-(F2, MF1)-(1, 2, 3)</b>	3,570.
<b>162TR-(NGC)-(1, 2, 3)</b>	4,053.
<b>162TR-(GC, GCS)-(1, 2, 3)</b>	4,753.
<b>162TR-(MG, MGS)-(1, 2, 3)</b>	5,250.
<b>162TR-(LO, LWA, D, V314)-(1, 2, 3)</b>	5,255.
<b>162TR-(VB)-(1, 2, 3)</b>	5,589.
<b>162TR-(RO)-(1, 2, 3)</b>	5,954.
<b>162TR-(MN, MNS, MA, MAS, GG, GGS)-(1, 2, 3)</b>	5,997.
<b>162TR-(MC, MCS)-(1, 2, 3)</b>	6,293.
<b>162TR-(ME, MES, MP, MPS)-(1, 2, 3)</b>	6,375.
<b>162TR-(GA)-(1, 2, 3)</b>	7,022.
<b>162TR-(MV, MVS)-(1, 2, 3)</b>	8,158.
<b>162TR-(NC)-(1, 2, 3)</b>	8,555.
<b>162TR-(SN)-(1, 2, 3)</b>	9,404.

Order Code	Ordering Information
<i>Example:</i> <b>160TR-MV-2</b>	
<b>161TO</b> Saarinen side table	<i>Base finishes:</i> Black (suffix 1) White (suffix 2) Grey (suffix 3)
<b>MV</b> Verdi Alpi Marble	<i>Laminate top finish:</i> White (suffix F2) Black (suffix MF1)
<b>2</b> White	<i>Veneer Finishes:</i> Ebonyed Walnut (suffix D) Light Oak (suffix LO) Light Walnut (suffix LWA) Reff Dark Cherry (suffix V314) Rosewood (suffix RO)
	<i>Polished Coated marble top finishes:</i> Arabescato: white-grey (suffix MA) Calacatta: white-grey/beige (suffix MC) Carrara: white-grey (suffix GC) Espresso: dark brown (suffix ME) Grey Marble: light grey (suffix GG) Grigio Marquina: warm grey (suffix MG) Nero Marquina: black (suffix MN) Verde Alpi: green (suffix MV) Portoro: black/silver (suffix MP)
	<i>Natural marble top finishes:</i> Calacatta: white-grey/beige (suffix NC) Carrara: white-grey (suffix NGC)
	<i>Granite top finish:</i> Black Andes: black (suffix GA)
	<i>Engineered Stone:</i> Vetro Bianco: white (suffix VB)
	<i>Slate top finish:</i> Slate, natural (suffix SN)
	<i>Satin Coated marble top finishes:</i> Arabescato: white-grey (suffix MAS) Calacatta: white-grey/beige (suffix MCS) Carrara: white-grey (suffix GCS) Espresso: dark brown (suffix MES) Grey Marble: light grey (suffix GGS) Grigio Marquina: warm grey (suffix MGS) Nero Marquina: black (suffix MNS) Verde Alpi: green (suffix MVS) Portoro: black/silver (suffix MPS)

*Note:*  
Saarinen tables are part of a collection. Please refer to Saarinen side chairs, lounge seating and executive chairs on pages 316.

- Specify:*
1. Pattern number
  2. Top selection
  3. Base finish selection

### Construction

*Maintenance:*  
See pages 28-29.

*Note:*  
Top and base shipped in separate packages. The Knoll logo is stamped into the base of the Saarinen tables. Tops have a nameplate with the designers signature.

**Not suitable for outdoor use.**

Marbles with a coating will yellow over time.

Saarinen Round End and Coffee Tables are certified Clean Air GOLD.

*Base:*  
Heavy molded cast aluminum, strap-polished. Black and white bases are coated in a tough, abrasion-resistant Rilsan® finish. Platinum bases consist of a highly resilient polyurethane enamel wet coat with a clear satin finish.

*Base Diameters:*  
160TR, 163TR: 10.7"  
162TR: 17"  
169TR: 13.5"

*Laminate and Marble Tops:*  
Bevel-edged satin smooth laminate or marble. 3/4" thick coated marble tops have transparent acrylic coating to help eliminate use-associated stains. 3/4" thick natural marble tops and granite tops have protective sealer. Laminate tops are 1.06" thick.

*Laminate edge detail:*

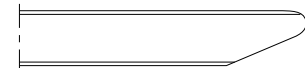

*Marble edge detail:*

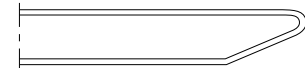

*Chrome edge detail:*





*Engineered Stone:*  
Polished, bright white surface is nonporous and more compact than most granites. Comprised of 93% fused quartz. It does not yellow or stain and is scratch resistant. Suitable for outdoors.

*Slate:*  
Beveled edge, 3/4" thick natural cleft slate.

*Note:*  
Vetro Bianco (VBO) top for outdoor use is only available on 162TR, 164TR, 169TR, 172TR, 173TR, 174TO tables. 162TR, 164TR, 172TR, 173TR, and 174TO use a phenolic subtop with exposed black edges and white laminate faces. Stainless steel hardware will be used for all connections.

*Veneer Tops:*  
Tops are constructed of veneered medium density fiberboard with a cathedral grain pattern in various clear or toned or stains. All tops are 1 1/8" thick.

# Eero Saarinen Lounge Tables

	description	w	d	h	weight	top
<p><i>Designer(s):</i> Eero Saarinen, 1957</p> 	<b>166TR</b> Small round table, lounge height	35 7/8"		26"	47 lbs.	Laminate
		35 7/8"		26"	95 lbs.	Natural marble
		35 7/8"		26"	95 lbs.	Coated marble
		35 7/8"		26"	95 lbs.	Coated marble
		35 7/8"		26"	95 lbs.	Vetro Bianco
		35 7/8"		26"	95 lbs.	Coated marble
		35 7/8"		26"	95 lbs.	Coated marble
		35 7/8"		26"	95 lbs.	Coated marble
		35 7/8"		26"	51 lbs.	Veneer
		35 7/8"		26"	51 lbs.	Veneer
		35 7/8"		26"	103 lbs.	Granite
		35 7/8"		26"	95 lbs.	Natural marble
		35 7/8"		26"	95 lbs.	Coated marble
		35 7/8"		26"	95 lbs.	Slate, natural
			<b>167TR</b> Medium round table, lounge height	42 1/4"		26"
42 1/4"				26"	125 lbs.	Natural marble
42 1/4"				26"	125 lbs.	Coated marble
42 1/4"				26"	125 lbs.	Vetro Bianco
42 1/4"				26"	125 lbs.	Coated marble
42 1/4"				26"	125 lbs.	Coated marble
42 1/4"				26"	125 lbs.	Coated marble
42 1/4"				26"	63 lbs.	Veneer
42 1/4"				26"	125 lbs.	Coated marble
42 1/4"				26"	63 lbs.	Veneer
42 1/4"				26"	125 lbs.	Coated marble
42 1/4"				26"	136 lbs.	Granite
42 1/4"				26"	125 lbs.	Coated marble
42 1/4"				26"	125 lbs.	Slate, natural
42 1/4"				26"	125 lbs.	Natural marble

pattern no.	list
<b>166TR-(F2, MF1)-(1, 2, 3)</b>	\$4,265.
<b>166TR-(NGC)-(1, 2, 3)</b>	5,356.
<b>166TR-(MG, MGS)-(1, 2, 3)</b>	5,798.
<b>166TR-(GC, GCS)-(1, 2, 3)</b>	6,058.
<b>166TR-(VB)-(1, 2, 3)</b>	6,203.
<b>166TR-(MN, MNS, MA, MAS, GG, GGS)-(1, 2, 3)</b>	6,508.
<b>166TR-(ME, MES, MP, MPS)-(1, 2, 3)</b>	6,921.
<b>166TR-(MC, MCS)-(1, 2, 3)</b>	7,130.
<b>166TR-(LO, LWA, D, V314)-(1, 2, 3)</b>	7,210.
<b>166TR-(RO)-(1, 2, 3)</b>	7,339.
<b>166TR-(GA)-(1, 2, 3)</b>	7,996.
<b>166TR-(NC)-(1, 2, 3)</b>	9,535.
<b>166TR-(MV, MVS)-(1, 2, 3)</b>	9,544.
<b>166TR-(SN)-(1, 2, 3)</b>	9,968.
<b>167TR-(F2, MF1)-(1, 2, 3)</b>	4,549.
<b>167TR-(NGC)-(1, 2, 3)</b>	6,559.
<b>167TR-(MG, MGS)-(1, 2, 3)</b>	7,322.
<b>167TR-(VB)-(1, 2, 3)</b>	7,359.
<b>167TR-(GC, GCS)-(1, 2, 3)</b>	7,458.
<b>167TR-(MN, MNS, MA, MAS, GG, GGS)-(1, 2, 3)</b>	7,594.
<b>167TR-(RO)-(1, 2, 3)</b>	8,037.
<b>167TR-(MC, MCS)-(1, 2, 3)</b>	8,321.
<b>167TR-(LO, LWA, D, V314)-(1, 2, 3)</b>	8,675.
<b>167TR-(ME, MES, MP, MPS)-(1, 2, 3)</b>	8,791.
<b>167TR-(GA)-(1, 2, 3)</b>	9,744.
<b>167TR-(MV, MVS)-(1, 2, 3)</b>	10,228.
<b>167TR-(SN)-(1, 2, 3)</b>	10,660.
<b>167TR-(NC)-(1, 2, 3)</b>	11,864.

Order Code	Ordering Information
<i>Example:</i> <b>166TR-MV-2</b>	
<b>166TR</b> Saarinen Lounge table	<i>Base finishes:</i> Black (suffix 1) White (suffix 2) Grey (suffix 3)
<b>MV</b> Verdi Alpi Marble	<i>Laminate top finish:</i> White (suffix F2) Black (suffix MF1)
<b>2</b> White	<i>Veneer Finishes:</i> Ebonized Walnut (suffix D) Light Oak (suffix LO) Light Walnut (suffix LWA) Reff Dark Cherry (suffix V314) Rosewood (suffix RO)
	<i>Polished Coated marble top finishes:</i> Arabescato: white-grey (suffix MA) Calacatta: white-grey/beige (suffix MC) Carrara: white-grey (suffix GC) Espresso: dark brown (suffix ME) Grey Marble: light grey (suffix GG) Grigio Marquina: warm grey (suffix MG) Nero Marquina: black (suffix MN) Verde Alpi: green (suffix MV) Portoro: black/silver (suffix MP)
	<i>Natural marble top finishes:</i> Calacatta: white-grey/beige (suffix NC) Carrara: white-grey (suffix NGC)
	<i>Granite top finish:</i> Black Andes: black (suffix GA)
	<i>Engineered Stone:</i> Vetro Bianco: white (suffix VB)
	<i>Slate top finish:</i> Slate, natural (suffix SN)
	<i>Satin Coated marble top finishes:</i> Arabescato: white-grey (suffix MAS) Calacatta: white-grey/beige (suffix MCS) Carrara: white-grey (suffix GCS) Espresso: dark brown (suffix MES) Grey Marble: light grey (suffix GGS) Grigio Marquina: warm grey (suffix MGS) Nero Marquina: black (suffix MNS) Verde Alpi: green (suffix MVS) Portoro: black/silver (suffix MPS)

*Note:*  
Saarinen tables are part of a collection. Please refer to Saarinen side chairs, lounge seating and executive chairs on pages 316.

- Specify:*
1. Pattern number
  2. Top selection
  3. Base finish selection

### Construction

*Maintenance:*  
See pages 28-29.

*Note:*  
Top and base shipped in separate packages. The Knoll logo is stamped into the base of the Saarinen tables. Tops have a nameplate with the designers signature.

**Not suitable for outdoor use.**

Marbles with a coating will yellow over time.

Saarinen Round End and Coffee Tables are certified Clean Air GOLD.

*Base:*  
Heavy molded cast aluminum, strap-polished. Black and white bases are coated in a tough, abrasion-resistant Rilsan® finish. Platinum bases consist of a highly resilient polyurethane enamel wet coat with a clear satin finish.

*Base Diameters:*  
160TR, 163TR: 10.7"  
162TR: 17"  
169TR: 13.5"

*Laminate and Marble Tops:*  
Bevel-edged satin smooth laminate or marble. 3/4" thick coated marble tops have transparent acrylic coating to help eliminate use-associated stains. 3/4" thick natural marble tops and granite tops have protective sealer. Laminate tops are 1.06" thick.

*Laminate edge detail:*

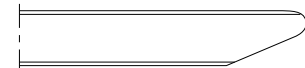

*Marble edge detail:*

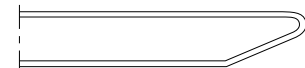

*Chrome edge detail:*

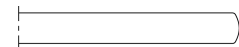

*Engineered Stone:*  
Polished, bright white surface is nonporous and more compact than most granites. Comprised of 93% fused quartz. It does not yellow or stain and is scratch resistant. Suitable for outdoors.

*Slate:*  
Beveled edge, 3/4" thick natural cleft slate.

*Note:*  
Vetro Bianco (VBO) top for outdoor use is only available on 162TR, 164TR, 169TR, 172TR, 173TR, 174TO tables. 162TR, 164TR, 172TR, 173TR, and 174TO use a phenolic subtop with exposed black edges and white laminate faces. Stainless steel hardware will be used for all connections.

*Veneer Tops:*  
Tops are constructed of veneered medium density fiberboard with a cathedral grain pattern in various clear or toned or stains. All tops are 1 1/8" thick.

# Eero Saarinen

## Oval End and Coffee Tables

Designer(s):  
Eero Saarinen, 1957



description	w	d	h	weight	top
<b>161TO</b> Oval side table, intermediate height 	22 1/2"	15"	20"	15 lbs.	Laminate
	22 1/2"	15"	20"	28 lbs.	Natural marble
	22 1/2"	15"	20"	28 lbs.	Coated marble
	22 1/2"	15"	20"	28 lbs.	Coated marble
	22 1/2"	15"	20"	28 lbs.	Coated marble
	22 1/2"	15"	20"	28 lbs.	Coated marble
	22 1/2"	15"	20"	28 lbs.	Coated marble
	22 1/2"	15"	20"	28 lbs.	Vetro Bianco
	22 1/2"	15"	20"	28 lbs.	Coated marble
	22 1/2"	15"	20"	16 lbs.	Veneer
	22 1/2"	15"	20"	29 lbs.	Granite
	22 1/2"	15"	20"	28 lbs.	Natural marble
	22 1/2"	15"	20"	16 lbs.	Veneer
	22 1/2"	15"	20"	28 lbs.	Slate, natural
<b>162TO</b> Oval coffee table, low level 	42 1/4"	27 1/2"	15 1/4"	37 lbs.	Laminate
	42 1/4"	27 1/2"	15 1/4"	80 lbs.	Natural marble
	42 1/4"	27 1/2"	15 1/4"	80 lbs.	Coated marble
	42 1/4"	27 1/2"	15 1/4"	80 lbs.	Coated marble
	42 1/4"	27 1/2"	15 1/4"	40 lbs.	Veneer
	42 1/4"	27 1/2"	15 1/4"	80 lbs.	Vetro Bianco
	42 1/4"	27 1/2"	15 1/4"	80 lbs.	Coated marble
	42 1/4"	27 1/2"	15 1/4"	80 lbs.	Coated marble
	42 1/4"	27 1/2"	15 1/4"	40 lbs.	Veneer
	42 1/4"	27 1/2"	15 1/4"	80 lbs.	Coated marble
	42 1/4"	27 1/2"	15 1/4"	86 lbs.	Granite
	42 1/4"	27 1/2"	15 1/4"	80 lbs.	Coated marble
	42 1/4"	27 1/2"	15 1/4"	80 lbs.	Slate, natural
	42 1/4"	27 1/2"	15 1/4"	80 lbs.	Natural marble

pattern no.	
<b>161TO-(F2, MF1)-(1, 2, 3)</b>	\$1,589.
<b>161TO-(NGC)-(1, 2, 3)</b>	1,593.
<b>161TO-(GC, GCS)-(1, 2, 3)</b>	1,745.
<b>161TO-(MN, MNS, MA, MAS, GG, GGS)-(1, 2, 3)</b>	1,796.
<b>161TO-(MC, MCS)-(1, 2, 3)</b>	1,885.
<b>161TO-(MV, MVS)-(1, 2, 3)</b>	2,134.
<b>161TO-(MG, MGS)-(1, 2, 3)</b>	2,346.
<b>161TO-(VB)-(1, 2, 3)</b>	2,418.
<b>161TO-(ME, MES, MP, MPS)-(1, 2, 3)</b>	2,574.
<b>161TO-(LO, LWA, D, V314)-(1, 2, 3)</b>	3,443.
<b>161TO-(GA)-(1, 2, 3)</b>	3,473.
<b>161TO-(NC)-(1, 2, 3)</b>	3,552.
<b>161TO-(RO)-(1, 2, 3)</b>	4,278.
<b>161TO-(SN)-(1, 2, 3)</b>	4,861.
<b>162TO-(F2, MF1)-(1, 2, 3)</b>	3,586.
<b>162TO-(NGC)-(1, 2, 3)</b>	4,530.
<b>162TO-(GC, GCS)-(1, 2, 3)</b>	5,146.
<b>162TO-(MG, MGS)-(1, 2, 3)</b>	5,238.
<b>162TO-(LO, LWA, D, V314)-(1, 2, 3)</b>	5,255.
<b>162TO-(VB)-(1, 2, 3)</b>	5,325.
<b>162TO-(MN, MNS, MA, MAS, GG, GGS)-(1, 2, 3)</b>	5,407.
<b>162TO-(MC, MCS)-(1, 2, 3)</b>	5,677.
<b>162TO-(RO)-(1, 2, 3)</b>	5,811.
<b>162TO-(ME, MES, MP, MPS)-(1, 2, 3)</b>	6,243.
<b>162TO-(GA)-(1, 2, 3)</b>	7,155.
<b>162TO-(MV, MVS)-(1, 2, 3)</b>	7,390.
<b>162TO-(SN)-(1, 2, 3)</b>	7,592.
<b>162TO-(NC)-(1, 2, 3)</b>	8,910.

Order Code	Ordering Information
<i>Example:</i> <b>161TO-NGC-2</b>	<i>Base finishes:</i>
<b>161TO</b> Saarinen side table	Black (suffix 1)
<b>NGC</b> Carrara Marble	White (suffix 2)
<b>2</b> White	Grey (suffix 3)
	<i>Laminate top finish:</i>
	White (suffix F2)
	Black (suffix MF1)
	<i>Veneer Finishes:</i>
	Ebonized Walnut (suffix D)
	Light Oak (suffix LO)
	Light Walnut (suffix LWA)
	Reff Dark Cherry (suffix V314)
	Rosewood (suffix RO)
	<i>Polished Coated marble top finishes:</i>
	Arabescato: white-grey (suffix MA)
	Calacatta: white-grey/beige (suffix MC)
	Carrara: white-grey (suffix GC)
	Espresso: dark brown (suffix ME)
	Grey Marble: light grey (suffix GG)
	Grigio Marquina: warm grey (suffix MG)
	Nero Marquina: black (suffix MN)
	Verde Alpi: green (suffix MV)
	Portoro: black/silver (suffix MP)
	<i>Satin Coated marble top finishes:</i>
	Arabescato: white-grey (suffix MAS)
	Calacatta: white-grey/beige (suffix MCS)
	Carrara: white-grey (suffix GCS)
	Espresso: dark brown (suffix MES)
	Grey Marble: light grey (suffix GGS)
	Grigio Marquina: warm grey (suffix MGS)
	Nero Marquina: black (suffix MNS)
	Verde Alpi: green (suffix MVS)
	Portoro: black/silver (suffix MPS)
	<i>Natural marble top finishes:</i>
	Calacatta: white-grey/beige (suffix NC)
	Carrara: white-grey (suffix NGC)
	<i>Granite top finish:</i>
	Black Andes: black (suffix GA)
	<i>Engineered Stone:</i>
	Vetro Bianco: white (suffix VB)
	<i>Slate top finish:</i>
	Slate, natural (suffix SN)

*Note:*  
Saarinen tables are part of a collection. Please refer to Saarinen side chairs, lounge seating and executive chairs on pages 316.

- Specify:*
1. Pattern number
  2. Top selection
  3. Base finish selection

### Construction

*Maintenance:*  
See pages 28-29.

*Note:*  
Top and base shipped in separate packages. The Knoll logo is stamped into the base of the Saarinen tables. Tops have a nameplate with the designers signature.  
**Not suitable for outdoor use.**

Marbles with a coating will yellow over time.

Saarinen Oval End and Coffee Tables are certified Clean Air GOLD.

*Base:*

Heavy molded cast aluminum, strap-polished. Black and white bases are coated in a tough, abrasion-resistant Rilsan® finish. Platinum bases consist of a highly resilient polyurethane enamel wet coat with a clear satin finish.

*Base Diameters:*

161TO: 10.7"  
162TO: 17"

*Laminate and Marble Tops:*

Bevel-edged satin smooth laminate or marble. 3/4" thick coated marble tops have transparent acrylic coating to help eliminate use-associated stains. 1/4" thick natural marble tops and granite tops have protective sealer. Laminate tops are 1.06" thick.

*Laminate edge detail:*

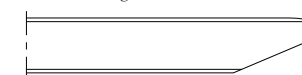

*Marble edge detail:*



*Chrome edge detail:*

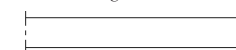

*Veneer Tops:*

Tops are constructed of veneered medium density fiberboard with a cathedral grain pattern in various clear or toned or stains. All tops are 1 1/16" thick.

*Slate:*

Beveled edge, 3/4" thick natural cleft slate.

*Note:*

Vetro Bianco (VBO) top for outdoor use is only available on 162TR, 164TR, 169TR, 172TR, 173TR, 174TO tables. 162TR, 164TR, 172TR, 173TR, and 174TO use a phenolic subtop with exposed black edges and white laminate faces. Stainless steel hardware will be used for all connections.



# Eero Saarinen Outdoor Tables

Designer(s):  
Eero Saarinen, 1957



description	w	d	h	weight	top
<b>169TR</b> Small round side table, low height 	20"		13 3/4"	29 lbs.	Vetro Bianco
	20"		13 3/4"	29 lbs.	Slate, natural
<b>162TR</b> Medium round coffee table, low level 	35 3/4"		15 1/4"	88 lbs.	Vetro Bianco
	35 3/4"		15 1/4"	88 lbs.	Slate, natural
<b>172TR</b> Small round table, dining height 	35 3/4"		28 1/4"	95 lbs.	Vetro Bianco
	35 3/4"		28 1/4"	95 lbs.	Slate, natural
<b>173TR</b> Medium round table, dining height 	42 1/4"		28 1/4"	125 lbs.	Vetro Bianco
	42 1/4"		28 1/4"	125 lbs.	Slate, natural
<b>164TR</b> Large round table, dining height 	54"		28 1/4"	203 lbs.	Vetro Bianco
<b>174TO</b> Medium oval table, dining height 	78"	47 1/4"	28 1/4"	259 lbs.	Vetro Bianco
	78"	47 1/4"	28 1/4"	259 lbs.	Slate, natural

pattern no.	list
<b>169TR-(VBO)-(1, 2)</b>	\$2,829.
<b>169TR-(SNO)-(1, 2)</b>	4,672.
<b>162TR-(VBO)-(1, 2)</b>	5,878.
<b>162TR-(SNO)-(1, 2)</b>	9,644.
<b>172TR-(VBO)-(1, 2)</b>	6,421.
<b>172TR-(SNO)-(1, 2)</b>	10,228.
<b>173TR-(VBO)-(1, 2)</b>	7,730.
<b>173TR-(SNO)-(1, 2)</b>	10,927.
<b>164TR-VBO-(1, 2)</b>	10,887.
<b>174TO-(VBO)-(1, 2)</b>	16,111.
<b>174TO-(SNO)-(1, 2)</b>	18,729.

Order Code	Ordering Information	Construction
<i>Example:</i> <b>173TR-VBO-2</b>	<i>Base finishes:</i> White (suffix 2) Black (suffix 1)	<i>Base:</i> Heavy molded cast aluminum, strap-polished. White bases are coated in a tough, abrasion-resistant Rilsan® finish.
<b>173TR</b> Saarinen dining table	<i>Engineered Stone:</i> Vetro Bianco (suffix VBO)	<i>Edge detail:</i> 
<b>VBO</b> Vetro Bianco	<i>Slate top finish:</i> Slate, natural (suffix SNO)	<i>Engineered Stone:</i> Polished, bright white surface is nonporous and more compact than most granites. Comprised of 93% fused quartz. It does not yellow or stain and is scratch resistant. Exposed black phenolic sub-top edge with white laminate faces. Suitable for outdoors.
<b>2</b> White	<i>Maintenance:</i> See pages 28-29.	<i>Slate:</i> Beveled edge, 3/4" thick natural cleft slate. Black phenolic sub-top with black laminate faces. Suitable for outdoor use.
<i>Note:</i> Saarinen tables are part of a collection. Please refer to Saarinen side chairs, lounge seating, and executive chairs on beginning on page 316.	<i>Note:</i> Top and base shipped in separate packages. The Knoll logo is stamped into the base of the Saarinen tables. Tops have nameplate with designer's signature.	
<i>Specify:</i> 1. Pattern number 2. Top selection 3. Base finish selection		

Richard Schultz  
Petal® Table Collection

Designer(s):  
Richard Schultz, 1960

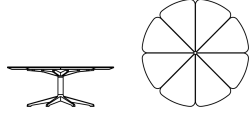
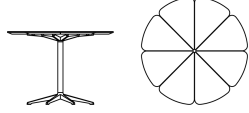

description	w	d	h	weight	top
<b>P320</b> Petal end table 	16"		19"	5 lbs.	White HPDE
	16"		19"	5 lbs.	Teak
<b>P320COV</b> Petal end table cover	–		–	–	–
<b>P321</b> Petal coffee table 	42"		15"	60 lbs.	White HPDE
	42"		15"	60 lbs.	Teak
<b>P321COV</b> Petal coffee table cover	–		–	–	–
<b>P322</b> Petal dining table 	42"		28"	62 lbs.	White HPDE
	42"		28"	62 lbs.	Teak
<b>P322COV</b> Petal dining table cover	–		–	–	–

pattern no.	
<b>P320-W-( )</b>	\$1,953.
<b>P320-K-( )</b>	2,141.
<b>P320COV</b>	563.
<b>P321-W-( )</b>	4,673.
<b>P321-K-( )</b>	4,842.
<b>P321COV</b>	845.
<b>P322-W-( )</b>	4,842.
<b>P322-K-( )</b>	5,012.
<b>P322COV</b>	885.

Order Code

Example:	<b>P320-K-W</b>
<b>P320</b>	Petal side table
<b>K</b>	Teak top
<b>W</b>	White

Specify:

1. Pattern number
2. Top selection
3. Base finish selection

Ordering Information

**Base finishes:**  
 Blue (suffix BLU)  
 Chestnut (suffix N)  
 Dark Bronze (suffix 14)  
 Green (suffix 007)  
 Light Bronze (suffix 13)  
 Lime Green (suffix LGR)  
 Onyx (suffix O)  
 Orange (suffix ORG)  
 Plum (suffix PLM)  
 Sky Blue (suffix 3)  
 Warm Wood (suffix 12)  
 Weatherable Silver (suffix S)  
 White (suffix W)  
 Yellow (suffix YEL)

Construction

**Wood top finishes:**  
 Teak (suffix K)

**High Density Polyurethane top finishes:**  
 White HPDE (suffix W)

**Maintenance:**  
 See pages 28-29.

**Base:**  
 Top spider and base are powder coated cast aluminum. Stem is powder coated stainless steel.

**Wood top:**  
 Vertical grain teak with natural finish.

**HPDE top:**  
 Machined high density polyurethane.



**Note:**  
 Teak tops will patina over time if left outdoors and will turn a silvery grey color.

**Glides:**  
 Molded nylon glides are included on P321 and P322 models only.

Richard Schultz  
1966 Collection® Dining Tables

Designer(s):  
Richard Schultz, 1966

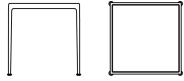
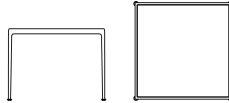
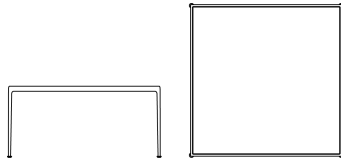
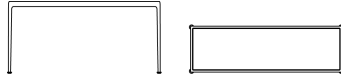
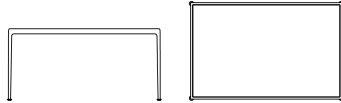

description	w	d	h	weight	top
<b>1966-24H</b> 1966 Dining Table 	28"	28"	28"	39 lbs.	Glass
	28"	28"	28"	36 lbs.	Porcelain
	28"	28"	28"	38 lbs.	Teak
	28"	28"	28"	37 lbs.	Fiberglass
<b>1966-24HCOV</b> 1966 Dining Table cover	-	-	-	-	-
<b>1966-26H</b> 1966 Dining Table 	38"	38"	28"	63 lbs.	Glass
	38"	38"	28"	50 lbs.	Porcelain
	38"	38"	28"	50 lbs.	Teak
	38"	38"	28"	49 lbs.	Fiberglass
<b>1966-26HCOV</b> 1966 Dining Table cover	-	-	-	-	-
<b>1966-60H</b> 1966 Dining Table 	60"	60"	28"	143 lbs.	Glass
	60"	60"	28"	131 lbs.	Porcelain
	60"	60"	28"	120 lbs.	Teak
	60"	60"	28"	106 lbs.	Fiberglass
<b>1966-60HCOV</b> 1966 Dining Table cover	-	-	-	-	-
<b>1966-20H</b> 1966 Dining Table 	60"	18"	28"	50 lbs.	Glass
	60"	18"	28"	61 lbs.	Porcelain
	60"	18"	28"	53 lbs.	Teak
	60"	18"	28"	47 lbs.	Fiberglass
<b>1966-20HCOV</b> 1966 Dining Table cover	-	-	-	-	-
<b>1966-28H</b> 1966 Dining Table 	60"	38"	28"	91 lbs.	Glass
	60"	38"	28"	93 lbs.	Porcelain
	60"	38"	28"	77 lbs.	Teak
	60"	38"	28"	71 lbs.	Fiberglass
<b>1966-28HCOV</b> 1966 Dining Table cover	-	-	-	-	-
<b>1966-90H</b> 1966 Dining Table 	90"	38"	28"	137 lbs.	Glass
	90"	38"	28"	TBD lbs.	Porcelain
	90"	38"	28"	115 lbs.	Teak
	90"	38"	28"	110 lbs.	Fiberglass
<b>1966-90HCOV</b> 1966 Dining Table cover	-	-	-	-	-

pattern no.	
<b>1966-24H-G-(-)(-)</b>	\$3,040.
<b>1966-24H-P-(-)(-)</b>	3,928.
<b>1966-24H-K-(-)</b>	4,091.
<b>1966-24H-F-(-)(-)</b>	4,251.
<b>1966-24HCOV</b>	856.
<b>1966-26H-G-(-)(-)</b>	4,011.
<b>1966-26H-P-(-)(-)</b>	4,780.
<b>1966-26H-K-(-)</b>	5,469.
<b>1966-26H-F-(-)(-)</b>	5,873.
<b>1966-26HCOV</b>	1,018.
<b>1966-60H-G-(-)(-)</b>	7,049.
<b>1966-60H-P-(-)(-)</b>	8,262.
<b>1966-60H-K-(-)</b>	9,196.
<b>1966-60H-F-(-)(-)</b>	9,803.
<b>1966-60HCOV</b>	1,276.
<b>1966-20H-G-(-)(-)</b>	3,420.
<b>1966-20H-P-(-)(-)</b>	4,310.
<b>1966-20H-K-(-)</b>	4,475.
<b>1966-20H-F-(-)(-)</b>	4,635.
<b>1966-20HCOV</b>	991.
<b>1966-28H-G-(-)(-)</b>	4,618.
<b>1966-28H-P-(-)(-)</b>	5,672.
<b>1966-28H-K-(-)</b>	6,726.
<b>1966-28H-F-(-)(-)</b>	7,049.
<b>1966-28HCOV</b>	1,158.
<b>1966-90H-G-(-)(-)</b>	6,563.
<b>1966-90H-P-(-)(-)</b>	8,025.
<b>1966-90H-K-(-)</b>	8,711.
<b>1966-90H-F-(-)(-)</b>	9,317.
<b>1966-90HCOV</b>	1,503.

Order Code

Ordering Information

Example: **1966-24H-P-W-W**  
**1966-24H** 28" x 28" dining table  
**P** Porcelain top  
**W** White top  
**W** White frame

**Base finishes:**  
 Blue (suffix BLU)  
 Chestnut (suffix N)  
 Dark Bronze (suffix 14)  
 Green (suffix 007)  
 Light Bronze (suffix 13)  
 Lime Green (suffix LGR)  
 Onyx (suffix O)  
 Orange (suffix ORG)  
 Plum (suffix PLM)  
 Sky Blue (suffix 3)  
 Warm Wood (suffix 12)  
 Weatherable Silver (suffix S)  
 White (suffix W)  
 Yellow (suffix YEL)

**Porcelain top finishes:**  
 White (suffix W)  
 Brown (suffix B)  
 Marine Blue (suffix M)  
 Warm Wood (suffix 12)  
 Light Bronze (suffix 13)  
 Dark Bronze (suffix 14)  
 Warm Bronze (suffix 16)

**Fiberglass top finishes:**  
 White (suffix W)

**Glass top finishes:**  
 Clear glass (suffix C)  
 Etched glass (suffix E)

Specify:

1. Pattern number
2. Top material
3. Top finish selection
4. Base finish selection

Construction

**Wood top finishes:**  
 Teak (suffix K)

**Maintenance:**  
 See pages 28-29.

**Frame:**  
 Frame is aluminum castings and extrusions welded together. Finished in highly durable weather resistant polyester powder coat paint. Y-shaped stainless steel connectors attach tops on corners.

**Glass Top:**  
 3/8" beveled glass top available in clear or acid etched.

**Porcelain Top:**  
 .08" thick steel plate with a porcelain enamel layer comprised of glass particles, baked to melt into a .002" smooth surface. Honey comb subtup comprised of metal or particle wood board provides additional support.

**Teak:**  
 1" natural teak.

**Fiberglass Top:**  
 1" thick fiberglass available in white finish.

**Note:**  
 Teak tops will patina over time if left outdoors and will turn a silvery grey color.

**Glides:**  
 Clear butyrate plastic.

Richard Schultz  
1966 Collection® Counter Height Tables

Designer(s):  
Richard Schultz, 1966

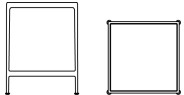
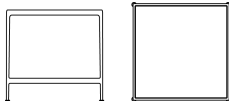
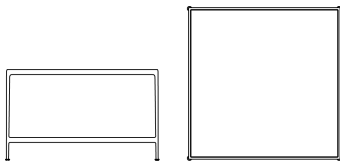
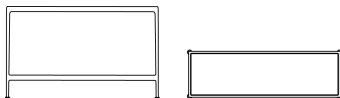
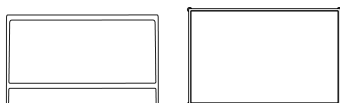

description	w	d	h	weight	top
<b>1966-24C</b> 1966 Counter Height Table 	28"	28"	36"	47 lbs.	Glass
	28"	28"	36"	41 lbs.	Porcelain
	28"	28"	36"	44 lbs.	Teak
	28"	28"	36"	36 lbs.	Fiberglass
<b>1966-24CCOV</b> 1966 Counter Height Table cover	-	-	-	-	-
<b>1966-26C</b> 1966 Counter Height Table 	38"	38"	36"	71 lbs.	Glass
	38"	38"	36"	55 lbs.	Porcelain
	38"	38"	36"	56 lbs.	Teak
	38"	38"	36"	47 lbs.	Fiberglass
<b>1966-26CCOV</b> 1966 Counter Height Table cover	-	-	-	-	-
<b>1966-60C</b> 1966 Counter Height Table 	60"	60"	36"	151 lbs.	Glass
	60"	60"	36"	141 lbs.	Porcelain
	60"	60"	36"	129 lbs.	Teak
	60"	60"	36"	106 lbs.	Fiberglass
<b>1966-60CCOV</b> 1966 Counter Height Table cover	-	-	-	-	-
<b>1966-20C</b> 1966 Counter Height Table 	60"	18"	36"	58 lbs.	Glass
	60"	18"	36"	69 lbs.	Porcelain
	60"	18"	36"	61 lbs.	Teak
	60"	18"	36"	45 lbs.	Fiberglass
<b>1966-20CCOV</b> 1966 Counter Height Table cover	-	-	-	-	-
<b>1966-28C</b> 1966 Counter Height Table 	60"	38"	36"	100 lbs.	Glass
	60"	38"	36"	102 lbs.	Porcelain
	60"	38"	36"	86 lbs.	Teak
	60"	38"	36"	66 lbs.	Fiberglass
<b>1966-28CCOV</b> 1966 Counter Height Table cover	-	-	-	-	-

pattern no.	
<b>1966-24C-G-(-)(-)</b>	\$3,728.
<b>1966-24C-P-(-)(-)</b>	4,618.
<b>1966-24C-K-(-)</b>	4,780.
<b>1966-24C-F-(-)(-)</b>	4,942.
<b>1966-24CCOV</b>	991.
<b>1966-26C-G-(-)(-)</b>	4,698.
<b>1966-26C-P-(-)(-)</b>	5,469.
<b>1966-26C-K-(-)</b>	6,157.
<b>1966-26C-F-(-)(-)</b>	6,563.
<b>1966-26CCOV</b>	1,156.
<b>1966-60C-G-(-)(-)</b>	8,262.
<b>1966-60C-P-(-)(-)</b>	9,479.
<b>1966-60C-K-(-)</b>	10,410.
<b>1966-60C-F-(-)(-)</b>	11,019.
<b>1966-60CCOV</b>	1,452.
<b>1966-20C-G-(-)(-)</b>	4,109.
<b>1966-20C-P-(-)(-)</b>	4,997.
<b>1966-20C-K-(-)</b>	5,158.
<b>1966-20C-F-(-)(-)</b>	5,323.
<b>1966-20CCOV</b>	1,129.
<b>1966-28C-G-(-)(-)</b>	5,509.
<b>1966-28C-P-(-)(-)</b>	6,563.
<b>1966-28C-K-(-)</b>	7,614.
<b>1966-28C-F-(-)(-)</b>	7,940.
<b>1966-28CCOV</b>	1,293.

Order Code

Ordering Information

<i>Example:</i> <b>1966-26C-K-O</b>
<b>1966-26C</b> 38" x 38" counter height table
<b>K</b> Teak top
<b>O</b> Onyx frame

*Base finishes:*  
Blue (suffix BLU)  
Chestnut (suffix N)  
Dark Bronze (suffix 14)  
Green (suffix 007)  
Light Bronze (suffix 13)  
Lime Green (suffix LGR)  
Onyx (suffix O)  
Orange (suffix ORG)  
Plum (suffix PLM)  
Sky Blue (suffix 3)  
Warm Wood (suffix 12)  
Weatherable Silver (suffix S)  
White (suffix W)  
Yellow (suffix YEL)

*Porcelain top finishes:*  
White (suffix W)  
Brown (suffix B)  
Marine Blue (suffix M)  
Warm Wood (suffix 12)  
Light Bronze (suffix 13)  
Dark Bronze (suffix 14)  
Warm Bronze (suffix 16)

*Fiberglass top finishes:*  
White (suffix W)  
  
*Glass top finishes:*  
Clear glass (suffix C)  
Etched glass (suffix E)

Specify:

1. Pattern number
2. Top material
3. Top finish selection
4. Base finish selection

Construction

*Wood top finishes:*  
Teak (suffix K)

*Maintenance:*  
See pages 28-29.

*Frame:*  
Frame is aluminum castings and extrusions welded together. Finished in highly durable weather resistant polyester powder coat paint. Y-shaped stainless steel connectors attach tops on corners.

*Glass Top:*  
3/8" beveled glass top available in clear or acid etched.

*Porcelain Top:*  
.08" thick steel plate with a porcelain enamel layer comprised of glass particles, baked to melt into a .002" smooth surface. Honey comb subtop comprised of metal or particle wood board provides additional support.

*Teak:*  
1" natural teak.

*Fiberglass Top:*  
1" thick fiberglass available in white finish.



*Note:*  
Teak tops will patina over time if left outdoors and will turn a silvery grey color.

*Glides:*  
Clear butyrate plastic.

Richard Schultz  
1966 Collection® Bar Height Tables

Designer(s):  
Richard Schultz, 1966

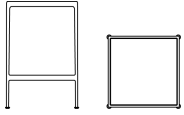
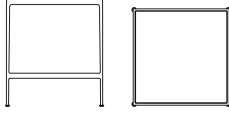
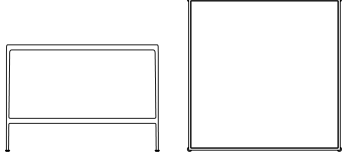

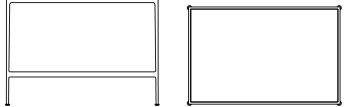
description	w	d	h	weight	top
<b>1966-24B</b> 1966 Bar Height Table 	28"	28"	42"	49 lbs.	Glass
	28"	28"	42"	44 lbs.	Porcelain
	28"	28"	42"	47 lbs.	Teak
	28"	28"	42"	39 lbs.	Fiberglass
<b>1966-24BCOV</b> 1966 Bar Height Table cover	–	–	–	–	–
<b>1966-26B</b> 1966 Bar Height Table 	38"	38"	42"	73 lbs.	Glass
	38"	38"	42"	58 lbs.	Porcelain
	38"	38"	42"	59 lbs.	Teak
	38"	38"	42"	50 lbs.	Fiberglass
<b>1966-26BCOV</b> 1966 Bar Height Table cover	–	–	–	–	–
<b>1966-60B</b> 1966 Bar Height Table 	60"	60"	42"	153 lbs.	Glass
	60"	60"	42"	145 lbs.	Porcelain
	60"	60"	42"	133 lbs.	Teak
	60"	60"	42"	110 lbs.	Fiberglass
<b>1966-60BCOV</b> 1966 Bar Height Table cover	–	–	–	–	–
<b>1966-20B</b> 1966 Bar Height Table 	60"	18"	42"	60 lbs.	Glass
	60"	18"	42"	71 lbs.	Porcelain
	60"	18"	42"	63 lbs.	Teak
	60"	18"	42"	48 lbs.	Fiberglass
<b>1966-20BCOV</b> 1966 Bar Height Table cover	–	–	–	–	–
<b>1966-28B</b> 1966 Bar Height Table 	60"	38"	42"	103 lbs.	Glass
	60"	38"	42"	105 lbs.	Porcelain
	60"	38"	42"	89 lbs.	Teak
	60"	38"	42"	70 lbs.	Fiberglass
<b>1966-28BCOV</b> 1966 Bar Height Table cover	–	–	–	–	–

pattern no.	
<b>1966-24B-G-(-)(-)</b>	\$3,889.
<b>1966-24B-P-(-)(-)</b>	4,780.
<b>1966-24B-K-(-)</b>	4,942.
<b>1966-24B-F-(-)(-)</b>	5,104.
<b>1966-24BCOV</b>	1,093.
<b>1966-26B-G-(-)(-)</b>	4,861.
<b>1966-26B-P-(-)(-)</b>	5,629.
<b>1966-26B-K-(-)</b>	6,321.
<b>1966-26B-F-(-)(-)</b>	6,726.
<b>1966-26BCOV</b>	1,282.
<b>1966-60B-G-(-)(-)</b>	8,426.
<b>1966-60B-P-(-)(-)</b>	9,641.
<b>1966-60B-K-(-)</b>	10,572.
<b>1966-60B-F-(-)(-)</b>	11,180.
<b>1966-60BCOV</b>	1,604.
<b>1966-20B-G-(-)(-)</b>	4,272.
<b>1966-20B-P-(-)(-)</b>	5,158.
<b>1966-20B-K-(-)</b>	5,323.
<b>1966-20B-F-(-)(-)</b>	5,485.
<b>1966-20BCOV</b>	1,264.
<b>1966-28B-G-(-)(-)</b>	5,672.
<b>1966-28B-P-(-)(-)</b>	6,726.
<b>1966-28B-K-(-)</b>	7,776.
<b>1966-28B-F-(-)(-)</b>	8,101.
<b>1966-28BCOV</b>	1,437.

Order Code

<i>Example:</i>	<b>1966-20B-F-W-6</b>
<b>1966-20B</b>	60" x 18" bar height table
<b>F</b>	Fiberglass top
<b>W</b>	White top
<b>6</b>	Choice White frame

Specify:

1. Pattern number
2. Top material
3. Top finish selection
4. Base finish selection

Ordering Information

<i>Base finishes:</i> Blue (suffix BLU) Chestnut (suffix N) Dark Bronze (suffix 14) Green (suffix 007) Light Bronze (suffix 13) Lime Green (suffix LGR) Onyx (suffix O) Orange (suffix ORG) Plum (suffix PLM) Sky Blue (suffix 3) Warm Wood (suffix 12) Weatherable Silver (suffix S) White (suffix W) Yellow (suffix YEL)	<i>Porcelain top finishes:</i> White (suffix W) Brown (suffix B) Marine Blue (suffix M) Warm Wood (suffix 12) Light Bronze (suffix 13) Dark Bronze (suffix 14) Warm Bronze (suffix 16)	<i>Fiberglass top finishes:</i> White (suffix W)  <i>Glass top finishes:</i> Clear glass (suffix C) Etched glass (suffix E)
--	---	--



Construction

<i>Wood top finishes:</i> Teak (suffix K)  <i>Maintenance:</i> See pages 28-29.	<i>Frame:</i> Frame is aluminum castings and extrusions welded together. Finished in highly durable weather resistant polyester powder coat paint. Y-shaped stainless steel connectors attach tops on corners.  <i>Glass Top:</i> 3/8" beveled glass top available in clear or acid etched.  <i>Porcelain Top:</i> .08" thick steel plate with a porcelain enamel layer comprised of glass particles, baked to melt into a .002" smooth surface. Honey comb subtop comprised of metal or particle wood board provides additional support.	<i>Teak:</i> 1" natural teak.  <i>Fiberglass Top:</i> 1" thick fiberglass available in white finish.  <i>Note:</i> Teak tops will patina over time if left outdoors and will turn a silvery grey color.  <i>Glides:</i> Clear butyrate plastic.
---	--	---

Richard Schultz  
1966 Collection® End and Coffee Tables

Designer(s):  
Richard Schultz, 1966

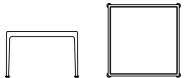
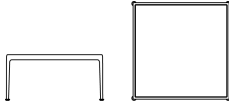
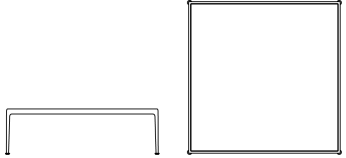
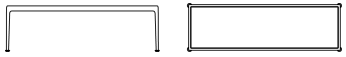

description	w	d	h	weight	top
<b>1966-18L</b> 1966 End Table 	18"	18"	15"	17 lbs.	Glass
	18"	18"	15"	16 lbs.	Porcelain
	18"	18"	15"	24 lbs.	Teak
	18"	18"	15"	17 lbs.	Fiberglass
<b>1966-18LCOV</b> 1966 End Table cover	—	—	—	—	—
<b>1966-19L</b> 1966 Coffee Table 	32"	20"	15"	28 lbs.	Glass
	32"	20"	15"	23 lbs.	Porcelain
	32"	20"	15"	27 lbs.	Teak
	32"	20"	15"	24 lbs.	Fiberglass
<b>1966-19LCOV</b> 1966 Coffee Table cover	—	—	—	—	—
<b>1966-24L</b> 1966 Coffee Table 	28"	28"	15"	34 lbs.	Glass
	28"	28"	15"	30 lbs.	Porcelain
	28"	28"	15"	28 lbs.	Teak
	28"	28"	15"	31 lbs.	Fiberglass
<b>1966-24LCOV</b> 1966 Coffee Table cover	—	—	—	—	—
<b>1966-26L</b> 1966 Coffee Table 	38"	38"	15"	57 lbs.	Glass
	38"	38"	15"	44 lbs.	Porcelain
	38"	38"	15"	44 lbs.	Teak
	38"	38"	15"	43 lbs.	Fiberglass
<b>1966-26LCOV</b> 1966 Coffee Table cover	—	—	—	—	—
<b>1966-60L</b> 1966 Coffee Table 	60"	60"	15"	138 lbs.	Glass
	60"	60"	15"	127 lbs.	Porcelain
	60"	60"	15"	108 lbs.	Teak
	60"	60"	15"	100 lbs.	Fiberglass
<b>1966-60LCOV</b> 1966 Coffee Table cover	—	—	—	—	—
<b>1966-20L</b> 1966 Coffee Table 	60"	18"	15"	44 lbs.	Glass
	60"	18"	15"	55 lbs.	Porcelain
	60"	18"	15"	47 lbs.	Teak
	60"	18"	15"	40 lbs.	Fiberglass
<b>1966-20LCOV</b> 1966 Coffee Table cover	—	—	—	—	—

pattern no.	
<b>1966-18L-G-(-)(-)</b>	\$2,390.
<b>1966-18L-P-(-)(-)</b>	2,722.
<b>1966-18L-K-(-)</b>	2,813.
<b>1966-18L-F-(-)(-)</b>	2,893.
<b>1966-18LCOV</b>	385.
<b>1966-19L-G-(-)(-)</b>	2,796.
<b>1966-19L-P-(-)(-)</b>	3,160.
<b>1966-19L-K-(-)</b>	3,338.
<b>1966-19L-F-(-)(-)</b>	3,499.
<b>1966-19LCOV</b>	625.
<b>1966-24L-G-(-)(-)</b>	2,755.
<b>1966-24L-P-(-)(-)</b>	3,645.
<b>1966-24L-K-(-)</b>	3,809.
<b>1966-24L-F-(-)(-)</b>	3,972.
<b>1966-24LCOV</b>	856.
<b>1966-26L-G-(-)(-)</b>	3,645.
<b>1966-26L-P-(-)(-)</b>	4,415.
<b>1966-26L-K-(-)</b>	5,104.
<b>1966-26L-F-(-)(-)</b>	5,509.
<b>1966-26LCOV</b>	872.
<b>1966-60L-G-(-)(-)</b>	6,563.
<b>1966-60L-P-(-)(-)</b>	7,776.
<b>1966-60L-K-(-)</b>	8,711.
<b>1966-60L-F-(-)(-)</b>	9,317.
<b>1966-60LCOV</b>	1,174.
<b>1966-20L-G-(-)(-)</b>	3,216.
<b>1966-20L-P-(-)(-)</b>	4,109.
<b>1966-20L-K-(-)</b>	4,272.
<b>1966-20L-F-(-)(-)</b>	4,432.
<b>1966-20LCOV</b>	891.

Order Code

Example:	<b>1966-18L-G-E-S</b>
<b>1966-18L</b>	18" x 18" end table
<b>G</b>	Glass top
<b>E</b>	Etched glass top
<b>S</b>	Weatherable Silver frame

Ordering Information

<b>Base finishes:</b> Blue (suffix BLU) Chestnut (suffix N) Dark Bronze (suffix 14) Green (suffix 007) Light Bronze (suffix 13) Lime Green (suffix LGR) Onyx (suffix O) Orange (suffix ORG) Plum (suffix PLM) Sky Blue (suffix 3) Warm Wood (suffix 12) Weatherable Silver (suffix S) White (suffix W) Yellow (suffix YEL)	<b>Porcelain top finishes:</b> White (suffix W) Brown (suffix B) Marine Blue (suffix M) Warm Wood (suffix 12) Light Bronze (suffix 13) Dark Bronze (suffix 14) Warm Bronze (suffix 16)	<b>Fiberglass top finishes:</b> White (suffix W)  <b>Glass top finishes:</b> Clear glass (suffix C) Etched glass (suffix E)
--	---	--





Specify:

1. Pattern number
2. Top material
3. Top finish selection
4. Base finish selection

Construction

<b>Wood top finishes:</b> Teak (suffix K)	<b>Frame:</b> Frame is aluminum castings and extrusions welded together. Finished in highly durable weather resistant polyester powder coat paint. Y-shaped stainless steel connectors attach tops on corners.	<b>Teak:</b> 1" natural teak.
<b>Maintenance:</b> See pages 28-29.	<b>Glass Top:</b> 3/8" beveled glass top available in clear or acid etched.	<b>Fiberglass Top:</b> 1" thick fiberglass available in white finish.
	<b>Porcelain Top:</b> .08" thick steel plate with a porcelain enamel layer comprised of glass particles, baked to melt into a .002" smooth surface. Honey comb subtop comprised of metal or particle wood board provides additional support.	<b>Note:</b> Teak tops will patina over time if left outdoors and will turn a silvery grey color.
		<b>Glides:</b> Clear butyrate plastic.

Richard Schultz  
1966 Collection® End and Coffee Tables

	description	w	d	h	weight	top
<i>Designer(s):</i> Richard Schultz, 1966    	<b>1966-28L</b> 1966 Coffee Table   	60"	38"	15"	85 lbs.	Glass
		60"	38"	15"	87 lbs.	Porcelain
		60"	38"	15"	71 lbs.	Teak
		60"	38"	15"	65 lbs.	Fiberglass
	<b>1966-28LCOV</b> 1966 Coffee Table cover	–	–	–	–	–
	<b>1966-90L</b> 1966 Coffee Table  	90"	38"	15"	132 lbs.	Glass
		90"	38"	15"	TBD lbs.	Porcelain
		90"	38"	15"	105 lbs.	Teak
		90"	38"	15"	100 lbs.	Fiberglass
	<b>1966-90LCOV</b> 1966 Coffee Table cover	–	–	–	–	–

pattern no.	
<b>1966-28L-G-(-)(-)</b>	\$4,133.
<b>1966-28L-P-(-)(-)</b>	5,187.
<b>1966-28L-K-(-)</b>	6,239.
<b>1966-28L-F-(-)(-)</b>	6,563.
<b>1966-28LCOV</b>	1,123.
<b>1966-90L-G-(-)(-)</b>	6,157.
<b>1966-90L-P-(-)(-)</b>	7,407.
<b>1966-90L-K-(-)</b>	8,303.
<b>1966-90L-F-(-)(-)</b>	8,910.
<b>1966-90LCOV</b>	1,426.

Order Code

<i>Example:</i>	<b>1966-18L-G-E-S</b>
<b>1966-18L</b>	18" x 18" end table
<b>G</b>	Glass top
<b>E</b>	Etched glass top
<b>S</b>	Weatherable Silver frame

Specify:

1. Pattern number
2. Top material
3. Top finish selection
4. Base finish selection

Ordering Information

Base finishes:

Blue (suffix BLU)  
Chestnut (suffix N)  
Dark Bronze (suffix 14)  
Green (suffix 007)  
Light Bronze (suffix 13)  
Lime Green (suffix LGR)  
Onyx (suffix O)  
Orange (suffix ORG)  
Plum (suffix PLM)  
Sky Blue (suffix 3)  
Warm Wood (suffix 12)  
Weatherable Silver (suffix S)  
White (suffix W)  
Yellow (suffix YEL)

Porcelain top finishes:

White (suffix W)  
Brown (suffix B)  
Marine Blue (suffix M)  
Warm Wood (suffix 12)  
Light Bronze (suffix 13)  
Dark Bronze (suffix 14)  
Warm Bronze (suffix 16)

Fiberglass top finishes:

White (suffix W)  
  
*Glass top finishes:*  
Clear glass (suffix C)  
Etched glass (suffix E)

Construction

Wood top finishes:

Teak (suffix K)

Maintenance:

See pages 28-29.

Frame:

Frame is aluminum castings and extrusions welded together. Finished in highly durable weather resistant polyester powder coat paint. Y-shaped stainless steel connectors attach tops on corners.

Glass Top:

3/8" beveled glass top available in clear or acid etched.

Porcelain Top:

.08" thick steel plate with a porcelain enamel layer comprised of glass particles, baked to melt into a .002" smooth surface. Honey comb subtop comprised of metal or particle wood board provides additional support.

Teak:

1" natural teak.

Fiberglass Top:

1" thick fiberglass available in white finish.

Note:

Teak tops will patina over time if left outdoors and will turn a silvery grey color.

Glides:

Clear butyrate plastic.

Richard Schultz  
1966 Collection® Serving Cart

Designer(s):  
Richard Schultz, 1966

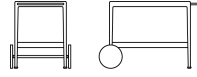

description	w	d	h	weight	top
<b>1966-55</b> Serving cart 	23 1/2"	39"	26 1/4"	55 lbs.	Porcelain
	23 1/2"	39"	26 1/4"	61 lbs.	Teak
	23 1/2"	39"	26 1/4"	61 lbs.	Fiberglass
<b>1966-55COV</b> Serving cart cover					

pattern no.	
<b>1966-55-P-(-)(-)</b>	\$6,098.
<b>1966-55-K-(-)</b>	7,342.
<b>1966-55-F-(-)(-)</b>	7,645.
<b>1966-55COV</b>	1,018.

Order Code

Ordering Information

<i>Example:</i> <b>1966-55-P-M-W</b>
<b>1966-55</b> Serving Cart
<b>P</b> Porcelain top
<b>M</b> Marine Blue top
<b>W</b> White frame

*Base finishes:*  
Blue (suffix BLU)  
Chestnut (suffix N)  
Dark Bronze (suffix 14)  
Green (suffix 007)  
Light Bronze (suffix 13)  
Lime Green (suffix LGR)  
Onyx (suffix O)  
Orange (suffix ORG)  
Plum (suffix PLM)  
Sky Blue (suffix 3)  
Warm Wood (suffix 12)  
Weatherable Silver (suffix S)  
White (suffix W)  
Yellow (suffix YEL)

*Porcelain top finishes:*  
White (suffix W)  
Brown (suffix B)  
Marine Blue (suffix M)  
Warm Wood (suffix 12)  
Light Bronze (suffix 13)  
Dark Bronze (suffix 14)  
Warm Bronze (suffix 16)

*Fiberglass top finishes:*  
White (suffix W)

*Specify:*  
1. Pattern number  
2. Top material  
3. Top finish selection  
4. Base finish selection

Construction

*Wood top finishes:*  
Teak (suffix K)

*Maintenance:*  
See pages 28-29.

*Frame:*  
Frame is aluminum castings and extrusions welded together. Finished in highly durable weather resistant polyester powder coat paint. Y-shaped stainless steel connectors attach tops on corners. Wheels are cast aluminum with rubber tires and a differential axle.

*Porcelain Top:*  
.08" thick steel plate with a porcelain enamel layer comprised of glass particles, baked to melt into a .002" smooth surface. Honey comb subtop comprised of metal or particle wood board provides additional support.

*Teak:*  
1" natural teak.

*Fiberglass Top:*  
1" thick fiberglass available in white finish.

*Note:*  
Teak tops will patina over time if left outdoors and will turn a silvery grey color.





*Glides:*  
Clear butyrate plastic.



Richard Schultz  
*Topiary® Dining Tables*

Designer(s):  
 Richard Schultz, 1996



description	w	d	h	weight	top
<b>TOP-28</b> Topiary dining table base only	24"	24"	28"	45 lbs.	–
					
<b>TH</b> Umbrella support, powder coated, accepts 1 1/4" diameter umbrella shaft					
<b>TI</b> Umbrella weight				13 lbs.	
<b>TG-30</b> Glass top	30"	30"		30 lbs.	tempered glass
					
<b>TG-42</b> Glass top	42"	42"		66 lbs.	tempered glass
					
<b>TG-56</b> Glass top	56"	56"		105 lbs.	tempered glass
					

pattern no.	
<b>TOP-28-( )</b>	\$4,036.
<b>TH-( )</b>	1,013.
<b>TI</b>	430.
<b>TG-30</b>	1,054.
<b>TG-42</b>	1,621.
<b>TG-56</b>	2,749.

**Order Code**

Example:	<b>TOP-28-1</b>
<b>TOP-28</b>	Dining table base
<b>1</b>	Forest Green base

Specify:

1. Pattern number
2. Base finish selection

**Ordering Information**

*Finishes:*  
 Blue (suffix BLU)  
 Chestnut (suffix N)  
 Choice White (suffix 6)  
 Daffodil Yellow (suffix 2)  
 Dark Bronze (suffix 14)  
 Forest Green (suffix 1)  
 Green (suffix 007)  
 Light Bronze (suffix 13)  
 Lime Green (suffix LGR)  
 Onyx (suffix O)  
 Orange (suffix ORG)  
 Plum (suffix PLM)  
 Sky Blue (suffix 3)  
 Terra Cotta (suffix 5)  
 Warm Wood (suffix 12)  
 Weatherable Silver (suffix S)  
 White (suffix W)  
 Yellow (suffix YEL)

**Construction**

*Topiary frame:*  
 3/16" aluminum sheet stamped and formed. Stainless steel connectors and finished in highly durable weather resistant polyester powder coat paint.





*Glass Top:*  
 3/8" beveled clear glass top.

# Shelton Mindel

## SM Tables

*Designer(s):*  
Peter Shelton and Lee Mindel,  
2006



description	w	d	h
<b>SM9</b> Shelton Mindel side table 	24"	24"	18"
<b>SM91</b> Shelton Mindel small coffee table 	42"	24"	14"
<b>SM92</b> Shelton Mindel large coffee table 	48"	30"	14"
<b>SM93</b> Shelton Mindel square coffee table 	40"	40"	14"

pattern no.	white/ clear glass	white/ painted glass	white/ slate	stainless/ clear glass	stainless/ painted glass	stainless/ slate
<b>SM9-(-)(-)</b>	\$5,154.	\$5,593.	\$9,189.	\$5,681.	\$6,120.	\$9,712.
<b>SM91-(-)(-)</b>	5,186.	5,955.	10,682.	5,899.	6,673.	11,395.
<b>SM92-(-)(-)</b>	5,762.	6,720.	12,080.	6,261.	7,222.	12,580.
<b>SM93-(-)(-)</b>	9,412.	10,557.	13,549.	10,330.	11,588.	14,469.

### Order Code

<i>Example:</i> <b>SM93-2-S2</b>	
<b>SM93</b>	Shelton Mindel square coffee table
<b>2</b>	White
<b>S2</b>	Painted White Starphire

*Note:*  
The SM tables are part of a collection. Please refer to SM side chair on page 352 and SM1 and SM2 lounge collection on pages 354 and 356.

### Ordering Information

*Specify:*

1. Pattern number
2. Base option
3. Top option

*Shipping:*

Top and base of SM tables will ship in separate packages.

*Glass top finishes:*

Clear glass (suffix G2)  
Painted White Starphire (suffix S2)

*Slate top finish:*

Natural black (suffix SN)

*Base finishes:*

White (suffix 2)  
Stainless Steel (suffix S)

*Maintenance:*

See pages 27-28.

*Note:*

The SM Table Collection is certified Clean Air GOLD.

For weight information, please contact your KnollStudio representative.

### Construction

*Frame:*





Constructed of seamless stainless steel, frame has continuous appearance. White bases are coated in a tough, abrasion-resistant Rilsan® finish. Polished bases are stainless steel, hand buffed to a mirror finish. Tops rest on four transparent silicon spacers.

*Top:*

Three top options: 3/8" thick clear glass with a 1/8" wide bevel, top and edges have a slight green tint; 3/4" thick Starphire™ glass with a bevel edge, underside of glass is painted white; 3/8" thick natural cleft slate with beveled edge.

*Glides:*

Glides are included with the table base.

	description	w	d	h
<i>Designer(s):</i> Daniel Stromborg, 2012	<b>DS02</b> Round table	32"	32"	29"
<i>Award(s):</i> Best of NeoCon Silver Award 2012				
	<b>DS04</b> Round table	36"	36"	29"
				
	<b>DS06</b> Round table	42"	42"	29"
				

pattern no.	laminate	glass (G2)	GCO	engineered stone (VB)
<b>DS02-(-)(-)(-)</b>	\$2,169.	\$2,691.	\$4,133.	\$4,393.
<b>DS04-(-)(-)(-)</b>	2,395.	3,115.	4,622.	4,928.
<b>DS06-(-)(-)(-)</b>	2,776.	3,838.	6,004.	6,323.

Order Code	Ordering Information	Construction
<i>Example:</i> <b>DS02-118-WHT-YEL</b>	<i>Leg paint finishes:</i> White (suffix WHT) Dark Charcoal (suffix CHR)	<i>Top Finishes:</i>  <i>Laminate, outdoor:</i> Bright White (suffix O118)
<b>DS02</b> 32" Round table		<i>Frame:</i> Frames are constructed from extruded aluminum rails, which are connected using die-cast aluminum 'X' and 'Y' shaped castings. Structural steel legs join the table's extruded aluminum rails through a blind assembly, seamlessly tying the leg to the cope detailed rail. Stainless steel hardware and fasteners are used throughout the table's construction.
<b>118</b> Bright White laminate top	<i>Rail paint finishes:</i> White (suffix WHT) Grey (suffix GRY) Dark Charcoal (suffix CHR) Yellow (suffix YEL) Lime Green (suffix LGR) Orange (suffix ORG) Plum (suffix PLM) Sky Blue (suffix SBL) Blue (suffix BLU)	<i>Glass:</i> Clear Glass (suffix G2)
<b>WHT</b> White leg finish		<i>Natural Marble:</i> Carrara, honed (suffix GCO)
<b>YEL</b> Yellow rail finish		<i>Engineered Stone:</i> Vetro Bianco (suffix VB)
<i>Specify:</i> 1. Pattern number 2. Top finish 3. Leg finish 4. Rail finish		<i>Note:</i> Glass top tables are not suitable for outdoor use. All other top options are suitable for outdoor use.
		<i>Maintenance:</i> See pages 28-29.
		All painted parts are finished in ultra-durable outdoor polyester powder coat finish. Steel legs are pre-treated with a zinc-rich epoxy primer that provides a robust base of protection from the elements.
		Tops are elevated off the table's base using cast aluminum (glass) or nylon spacers (laminate, marble, or engineered stone). All tops are secured to the base using threaded metal inserts and fasteners. For glass tops, the plated brushed aluminum spacer acts as a glass bolt and is attached to the glass using an ultra-strong adhesive.

*Outdoor Laminate:*  
White laminate faces with black phenolic core. Core is constructed of FSC certified craft paper and phenolic resin.



*Glass:*  
1/2" thick clear tempered glass.

*Marble:*  
Honed natural Cararra marble.

*Note:*  
Marble is treated to resist stains with a topical sealer, which requires maintenance. Natural marbles will develop a rich patina when used outdoors. Natural finished marbles will contain open fissures and pin-holes, which is considered a natural desirable trait.

*Engineered Stone:*  
Polished, bright white surface is nonporous and more compact than most granites. Comprised of 93% fused quartz. It does not yellow or stain and is scratch resistant. Suitable for outdoors.

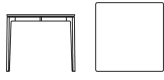
*Glides:*  
Non-marking indoor/outdoor grey nylon glide protects the table and the floor. An adjustable height indoor glide kit is also included.

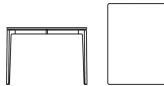
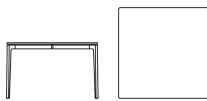
	description	w	d	h
<i>Designer(s):</i> Daniel Stromborg, 2012	<b>DS08</b> Square table	36"	36"	29"
<i>Award(s):</i> Best of NeoCon Silver Award 2012				
	<b>DS10</b> Square table	42"	42"	29"
				
	<b>DS12</b> Square table	48"	48"	29"
				

pattern no.	laminate	G2	GCO	engineered stone (VB)
<b>DS08-(-)(-)(-)</b>	\$2,451.	\$3,046.	\$4,696.	\$4,937.
<b>DS10-(-)(-)(-)</b>	2,848.	3,559.	5,260.	5,626.
<b>DS12-(-)(-)(-)</b>	3,294.	4,367.	5,894.	6,286.

Order Code	Ordering Information	Construction
<i>Example:</i> <b>DS08-NGC-CHR-PLM</b>	<i>Leg paint finishes:</i> White (suffix WHT) Dark Charcoal (suffix CHR)	<i>Top Finishes:</i>  <i>Laminate, outdoor:</i> Bright White (suffix O118)
<b>DS08</b> 36" square table		<i>Frame:</i> Frames are constructed from extruded aluminum rails, which are connected using die-cast aluminum 'X' and 'Y' shaped castings. Structural steel legs join the table's extruded aluminum rails through a blind assembly, seamlessly tying the leg to the cope detailed rail. Stainless steel hardware and fasteners are used throughout the table's construction.
<b>NGC</b> Cararra marble top	<i>Rail paint finishes:</i> White (suffix WHT) Grey (suffix GRY) Dark Charcoal (suffix CHR) Yellow (suffix YEL) Lime Green (suffix LGR) Orange (suffix ORG) Plum (suffix PLM) Sky Blue (suffix SBL) Blue (suffix BLU)	<i>Glass:</i> Clear Glass (suffix G2)
<b>CHR</b> Dark Charcoal leg finish		<i>Natural Marble:</i> Carrara, honed (suffix GCO)
<b>PLM</b> Plum rail finish		<i>Engineered Stone:</i> Vetro Bianco (suffix VB)
<i>Specify:</i> 1. Pattern number 2. Top finish 3. Leg finish 4. Rail finish	<i>Note:</i> Glass top tables are not suitable for outdoor use. All other top options are suitable for outdoor use.	<i>Note:</i> All painted parts are finished in ultra-durable outdoor polyester powder coat finish. Steel legs are pre-treated with a zinc-rich epoxy primer that provides a robust base of protection from the elements.
	<i>Maintenance:</i> See pages 28-29.	<i>Tops are elevated off the table's base using cast aluminum (glass) or nylon spacers (laminate, marble, or engineered stone). All tops are secured to the base using threaded metal inserts and fasteners. For glass tops, the plated brushed aluminum spacer acts as a glass bolt and is attached to the glass using an ultra-strong adhesive.</i>

*Outdoor Laminate:*  
White laminate faces with black phenolic core. Core is constructed of FSC certified craft paper and phenolic resin.

*Glass:*  
1/2" thick clear tempered glass.

*Marble:*  
Honed natural Cararra marble.



*Note:*  
Marble is treated to resist stains with a topical sealer, which requires maintenance. Natural marbles will develop a rich patina when used outdoors. Natural finished marbles will contain open fissures and pin-holes, which is considered a natural desirable trait.

*Engineered Stone:*  
Polished, bright white surface is nonporous and more compact than most granites. Comprised of 93% fused quartz. It does not yellow or stain and is scratch resistant. Suitable for outdoors.

*Glides:*  
Non-marking indoor/outdoor grey nylon glide protects the table and the floor. An adjustable height indoor glide kit is also included.

# Daniel Stromborg

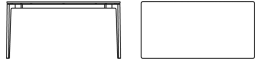
## Rectangular Tables

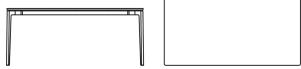
	description	w	d	h
<i>Designer(s):</i> Daniel Stromborg, 2012	<b>DS14</b> Rectangular table	60"	30"	29"
<i>Award(s):</i> Best of NeoCon Silver Award 2012				
	<b>DS16</b> Rectangular table	72"	36"	29"
				

pattern no.	laminate	G2	GCO	engineered stone (VB)
<b>DS14-(-)(-)(-)</b>	\$2,957.	\$3,888.	\$5,432.	\$5,766.
<b>DS16-(-)(-)(-)</b>	3,602.	4,916.	6,485.	6,829.

Order Code	Ordering Information	Construction
<i>Example:</i> <b>DS14-G2-WHT-BLU</b>	<i>Leg paint finishes:</i> White (suffix WHT) Dark Charcoal (suffix CHR)	<i>Top Finishes:</i>  <i>Laminate, outdoor:</i> Bright White (suffix O118)
<b>DS14</b> 60" x 30" rectangular table	<i>Rail paint finishes:</i> White (suffix WHT) Grey (suffix GRY) Dark Charcoal (suffix CHR) Yellow (suffix YEL) Lime Green (suffix LGR) Orange (suffix ORG) Plum (suffix PLM) Sky Blue (suffix SBL) Blue (suffix BLU)	<i>Glass:</i> Clear Glass (suffix G2)
<b>G2</b> Clear glass top		<i>Natural Marble:</i> Carrara, honed (suffix GCO)
<b>WHT</b> White leg finish		<i>Engineered Stone:</i> Vetro Bianco (suffix VB)
<b>BLU</b> Blue rail finish		<i>Note:</i> Glass top tables are not suitable for outdoor use. All other top options are suitable for outdoor use.
<i>Specify:</i> 1. Pattern number 2. Top finish 3. Leg finish 4. Rail finish		<i>Maintenance:</i> See pages 28-29.
		<i>Frame:</i> Frames are constructed from extruded aluminum rails, which are connected using die-cast aluminum 'X' and 'Y' shaped castings. Structural steel legs join the table's extruded aluminum rails through a blind assembly, seamlessly tying the leg to the cope detailed rail. Stainless steel hardware and fasteners are used throughout the table's construction.
		All painted parts are finished in ultra-durable outdoor polyester powder coat finish. Steel legs are pre-treated with a zinc-rich epoxy primer that provides a robust base of protection from the elements.
		Tops are elevated off the table's base using cast aluminum (glass) or nylon spacers (laminate, marble, or engineered stone). All tops are secured to the base using threaded metal inserts and fasteners. For glass tops, the plated brushed aluminum spacer acts as a glass bolt and is attached to the glass using an ultra-strong adhesive.

*Outdoor Laminate:*  
White laminate faces with black phenolic core. Core is constructed of FSC certified craft paper and phenolic resin.





*Glass:*  
1/2" thick clear tempered glass.

*Marble:*  
Honed natural Carrara marble.

*Note:*  
Marble is treated to resist stains with a topical sealer, which requires maintenance. Natural marbles will develop a rich patina when used outdoors. Natural finished marbles will contain open fissures and pin-holes, which is considered a natural desirable trait.

*Engineered Stone:*  
Polished, bright white surface is nonporous and more compact than most granites. Comprised of 93% fused quartz. It does not yellow or stain and is scratch resistant. Suitable for outdoors.

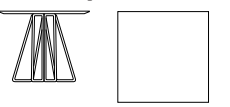
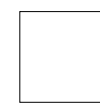
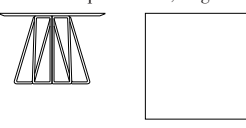
*Glides:*  
Non-marking indoor/outdoor grey nylon glide protects the table and the floor. An adjustable height indoor glide kit is also included.

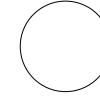
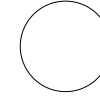
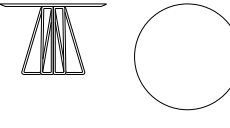
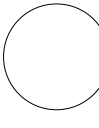
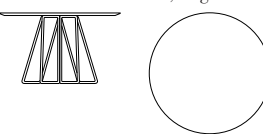
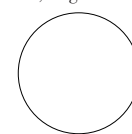
	description	w	d	h	weight	top		
<i>Designer(s):</i> Vignelli Design, 1994				<b>49TS-30</b> Square table, small				
				30"	30"	28 1/8"	37 lbs.	Laminate
				30"	30"	28 1/8"	51 lbs.	Clear glass
		30"	30"	28 1/8"	72 lbs.	Slate		
				<b>49TS-36</b> Square table, medium				
				36"	36"	28 1/8"	105 lbs.	Slate
				36"	36"	28 1/8"	55 lbs.	Laminate
		36"	36"	28 1/8"	75 lbs.	Clear glass		
				<b>49TS-42</b> Square table, large				
				42"	42"	28 1/8"	103 lbs.	Clear glass
				42"	42"	28 1/8"	144 lbs.	Slate
		42"	42"	28 1/8"	75 lbs.	Laminate		
				<b>49TR-36</b> Round table, small				
				36"		28 1/8"	41 lbs.	Laminate
				36"		28 1/8"	57 lbs.	Clear glass
		36"		28 1/8"	80 lbs.	Slate		
				<b>49TR-42</b> Round table, medium				
				42"		28 1/8"	112 lbs.	Slate
				42"		28 1/8"	58 lbs.	Laminate
		42"		28 1/8"	80 lbs.	Clear glass		
				<b>49TR-48</b> Round table, large				
				48"		28 1/8"	106 lbs.	Clear glass
				48"		28 1/8"	147 lbs.	Slate
		48"		28 1/8"	76 lbs.	Laminate		

pattern no.	Painted/ black base	Pol. chrome base
<b>49TS-30-(-)(-)(-)</b>	\$2,887.	\$3,206.
<b>49TS-30-G2-(-)</b>	3,206.	3,529.
<b>49TS-30-SN-(-)</b>	7,385.	7,704.
<b>49TS-36-SN-(-)</b>	8,767.	9,247.
<b>49TS-36-(-)(-)(-)</b>	3,206.	3,689.
<b>49TS-36-G2-(-)</b>	3,856.	4,335.
<b>49TS-42-G2-(-)</b>	4,495.	5,143.
<b>49TS-42-SN-(-)</b>	10,806.	11,455.
<b>49TS-42-(-)(-)(-)</b>	3,528.	4,175.
<b>49TR-36-(-)(-)(-)</b>	2,887.	3,206.
<b>49TR-36-G2-(-)</b>	4,175.	4,497.
<b>49TR-36-SN-(-)</b>	9,013.	9,331.
<b>49TR-42-SN-(-)</b>	11,293.	11,773.
<b>49TR-42-(-)(-)(-)</b>	3,206.	3,689.
<b>49TR-42-G2-(-)</b>	4,659.	5,139.
<b>49TR-48-G2-(-)</b>	5,300.	5,947.
<b>49TR-48-SN-(-)</b>	12,927.	13,572.
<b>49TR-48-(-)(-)(-)</b>	3,528.	4,175.

**Order Code**

<i>Example:</i>	<b>49TS-30-SN-1</b>
<b>49TS-30</b>	PaperClip table, square, 30"
<b>SN</b>	Natural Black slate
<b>1</b>	Black

**Ordering Information**

*Laminate top finishes:*  
Bright White (suffix 118)  
Light Grey (suffix L)  
Fog (suffix 128)  
Jet Black (suffix 111)

*Urethane edge finishes:*  
Light Grey (suffix LG)  
Medium Grey (suffix MG)  
Black (suffix BL)

*Glass top finishes:*  
Clear (suffix G2)

*Slate top finish:*  
Natural Black (suffix SN)

*Outdoor Powder Coat Finish:*  
Black (suffix 1)

*Chrome base finish:*  
Polished Chrome (suffix C)

*Maintenance:*  
See pages 28-29.

*Note:*  
The PaperClip Table is certified Clean Air GOLD.

The Vignelli PaperClip Tables are part of a collection. Please refer to Vignelli Handkerchief Chairs on page 362.

*Specify:*

1. Pattern number
2. Top finish selection
3. Urethane edge detail (laminate tops only)
4. Leg finish selection

**Construction**

*Top:*  
Three top options: 1" thick laminate top with molded urethane beveled edge; 1/2" thick clear tempered glass with polished pencil edge; and 3/4" thick natural cleft slate with beveled edge.

*Base:*  
7/16" diameter cold rolled steel rod with fused polyester, outdoor powder coat and chrome-plated finishes.

*Glides:*  
Plastic.

*Outdoor use:*  
With proper preventative maintenance and limited exposure to the elements, the PaperClip cafe table is appropriate for outdoor environments. Specify outdoor powder coat black (suffix 1) base finish and clear glass (suffix G2) or slate (suffix SN) tops.

*Shipping:*  
All tables shipped knocked-down. Base and top assembly required.

*Laminate/slate edge detail:*

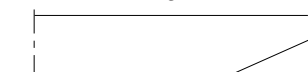

*Glass edge detail:*

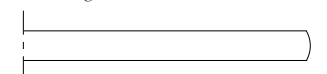

<i>pattern no.</i>	<i>page</i>	<i>pattern no.</i>	<i>page</i>	<i>pattern no.</i>	<i>page</i>	<i>pattern no.</i>	<i>page</i>
1050C	276	1719Y-BRM	280	1966-24L-K	490	1966-42P	346
1050C-1	276	1719Y-GLD	280	1966-24L-P	490	1966-45H	340
1050C-2	278	1719Y-N	280	1966-25	344	1966-45HCOV	340
1050C-3	278	1725A-BRM	280	1966-250	344	1966-45P	340, 342
1051C	274	1725A-GLD	280	1966-250COV	344	1966-46B	342
1051C-S	270	1725A-N	280	1966-250P	344	1966-46BCOV	342
1051C-ST	270	172TR	462, 480	1966-255	344	1966-46C	342
1052C	274	173TR	462, 480	1966-255COV	344	1966-46CCOV	342
1052C-S	272	174TO	468, 480	1966-255R	344	1966-46H	340
1053C	274	175TO	470	1966-255RCOV	344	1966-46HCOV	340
1053C-S	272	176TR	464	1966-25COV	344	1966-55COV	494
1059C	274	178TO	468	1966-25P	344	1966-55-F	494
1059C-S	272	179TO	470	1966-25R	344	1966-55-K	494
108	394	1966-18LCOV	490	1966-25RCOV	344	1966-55-P	494
108-KC-111	394	1966-18L-F	490	1966-26BCOV	488	1966-60BCOV	488
1205-CO-S1	146	1966-18L-G	490	1966-26B-F	488	1966-60B-F	488
1205-CO-S2	146	1966-18L-K	490	1966-26B-G	488	1966-60B-G	488
1205-CO-S3	146	1966-18L-P	490	1966-26B-K	488	1966-60B-K	488
1205-C-S1	146	1966-19LCOV	490	1966-26B-P	488	1966-60B-P	488
1205-C-S2	146	1966-19L-F	490	1966-26CCOV	486	1966-60CCOV	486
1205-C-S3	146	1966-19L-G	490	1966-26C-F	486	1966-60C-F	486
1206-C-S1	148	1966-19L-K	490	1966-26C-G	486	1966-60C-G	486
1206-C-S2	148	1966-19L-P	490	1966-26C-K	486	1966-60C-K	486
1206-C-S3	148	1966-20BCOV	488	1966-26C-P	486	1966-60C-P	486
1250BUTTON	284, 286	1966-20B-F	488	1966-26HCOV	484	1966-60HCOV	484
1250COVER	284, 286	1966-20B-G	488	1966-26H-F	484	1966-60H-F	484
12A-4S-G-1	286	1966-20B-K	488	1966-26H-G	484	1966-60H-G	484
12A-4S-G-A	286	1966-20B-P	488	1966-26H-K	484	1966-60H-K	484
12A-5S	286	1966-20CCOV	486	1966-26H-P	484	1966-60H-P	484
12C-4S-G-1	284	1966-20C-F	486	1966-26LCOV	490	1966-60LCOV	490
12C-4S-G-A	284	1966-20C-G	486	1966-26L-F	490	1966-60L-F	490
12C-5S	284	1966-20C-K	486	1966-26L-G	490	1966-60L-G	490
150AS	316	1966-20C-P	486	1966-26L-K	490	1966-60L-K	490
150AX	316	1966-20HCOV	484	1966-26L-P	490	1966-60L-P	490
150K	316	1966-20H-F	484	1966-28BCOV	488	1966-90HCOV	484
151CS	316	1966-20H-G	484	1966-28B-F	488	1966-90H-F	484
151CX	316	1966-20H-K	484	1966-28B-G	488	1966-90H-G	484
151K	316	1966-20H-P	484	1966-28B-K	488	1966-90H-K	484
153YS	316	1966-20LCOV	490	1966-28B-P	488	1966-90H-P	484
160TR	472	1966-20L-F	490	1966-28CCOV	486	1966-90LCOV	492
161TO	478	1966-20L-G	490	1966-28C-F	486	1966-90L-F	492
162TO	478	1966-20L-K	490	1966-28C-G	486	1966-90L-G	492
162TR	474, 480	1966-20L-P	490	1966-28C-K	486	1966-90L-K	492
163TR	472	1966-24BCOV	488	1966-28C-P	486	1966-90L-P	492
164TR	464	1966-24B-F	488	1966-28HCOV	484	2160-C	118
164TR-VB	464	1966-24B-G	488	1966-28H-F	484	2160R	122
164TR-VBO	480	1966-24B-K	488	1966-28H-G	484	2160RS	122
165TR	466	1966-24B-P	488	1966-28H-K	484	2160S-C	118
165TR-VB	466	1966-24CCOV	486	1966-28H-P	484	2161-C	120
166TR	476	1966-24C-F	486	1966-28LCOV	492	2161P	120
167TR	476	1966-24C-G	486	1966-28L-F	492	2161S-C	120
169TR	474, 480	1966-24C-K	486	1966-28L-G	492	2162P	124
1705L-BRM	282	1966-24C-P	486	1966-28L-K	492	2162R	124
1705L-GLD	282	1966-24HCOV	484	1966-28L-P	492	2162RS	124
1705L-N	282	1966-24H-F	484	1966-355	344	2163-C	120
1709Y-BRM	282	1966-24H-G	484	1966-355COV	344	2163R	124
1709Y-GLD	282	1966-24H-K	484	1966-41	346	2163RS	124
1709Y-N	282	1966-24H-P	484	1966-41COV	346	2163S-C	120
1715L-BRM	280	1966-24LCOV	490	1966-41P	346	2165	126
1715L-GLD	280	1966-24L-F	490	1966-42	346	241LC	248
1715L-N	280	1966-24L-G	490	1966-42COV	346	242LC	248

<i>pattern no.</i>	<i>page</i>	<i>pattern no.</i>	<i>page</i>	<i>pattern no.</i>	<i>page</i>	<i>pattern no.</i>	<i>page</i>
243LC	248	2550V	412	38A	128	426C-CO-K	62
245A-C	242	2551V	412	38A-KC or		426C-CO-KP	62
245A-S	242	2552VL	414	38AW-KC	128	426C-CO-U	64
245AT-C	242	2552VR	414	38AW-U	128	426C-GLD-K	62
245AT-S	242	255A-C	244	38AW-U-KC	128	426C-GLD-KP	62
247LC	248	255A-S	244	38C	130	426C-GLD-U	64
2480D	396	255C-BAS	244	38C-KC or		426L	66
2481D	396	255C-C	244	38CW-KC	130	426PL	68
2482	398	255C-S	244	38CW-U	132	427F	64
2482T	398	256AC-RN	250	38CW-U-KC	132	427K	62
2485D	404	256CC-L	250	38R	132	427KP	62
248LC	248	256CC-RN	250	400K	82	427P	62
250LC	252	256CKIT-L	250	400Y	82	428C	58, 60
250LC-S	252	256LACE-L	250	410K	82	428C-CO-K	58
250LR-C	254	257C-BAS	246	410Y	82	428C-CO-KP	58
250LR-S	254	257C-C	246	410Y-SK	82	428C-CO-U	60
250LS	252	258LR-S	254	41A	134	428C-GLD-K	58
2510T	416	258LR-S-HO1	254	41A-KC or		428C-GLD-KP	58
2510()	416	258LS	252	41AW-KC	134	428C-GLD-U	60
2510T()	416	259TS-G	432	41AW-U	134	428F	60
2511T	416	27A	226	41AW-U-KC	134	428K	58
2511()	416	27AGA	226	41C	136	428KP	58
2511T()	416	27C	224	41C-KC or		428L	66
2512L	418	27CGA	224	41CW-KC	136	428P	58
2515T	420	27DOLLY	224, 226	41CW-U	136	428PL	68
2515()	420	29C	268	41CW-U-KC	136	429F	80
2515T()	420	29K	268	41R	134, 136	429K	80
2517L	418	29TR-23-DE	446	420C	54	429L	80
2517T	420	29TR-23-LM	446	420C-CO-K	54	44A	296
2517T()	420	29TR-27-DE	446	420C-CO-KP	54	44AU	300
251YC	252	29TR-27-LM	446	420C-CO-U	54	44R	296
251YC-L80	252	29TR-35-DE	448	420C-GLD-K	54	47TR15	438
251YC-S	252	29TR-35-LM	448	420C-GLD-KP	54	47TR19	440
251YR-C	254	29TR-43-DE	448	420C-GLD-U	54	47TR22	440
251YR-S	254	29TR-43-LM	448	420CT-K	56	47TR24	438
251YS	252	29TR-H-23-DE	446	420CT-KP	56	47TR26	438
252	432	29TR-H-23-LM	446	420CT-U	56	47TR30	438
2520T-C	400	29TS-27-DE	446	420F	54, 56	47TR30	438
2521T-C	400	29TS-27-LM	446	420K	54, 56	47TR50	438
2521T-C-G2	400	29TS-35-DE	448	420KP	54, 56	47TR72	438
2522T-C	402	29TS-35-LM	448	420L	66	47TS15	436
2523T-C	400	311	444	420NSDOLLY	70	47TS20	436
2524T-C	402	311-F1	444	420P	54, 56	47TS31	436
252C	432	311-F2	444	420PL	68	47TS48	436
252C-SFG	432	311-RO	444	420PLS	68	47TS64	436
252-SFG	432	312	444	421F	72, 74	48A	290
2530Y2C	146	312-F1	444	421FS	76	48R	290
2530Y3C	146	312-F2	444	421K	72, 74	4901	362
2530YRC1	150	312-RO	444	421KS	76	4901K-N	362
2530YRC2	150	357-BE	382	421L	72	4901K-S	362
2530YRC3	150	357-ON	382	421LCO-K	72	4902	364
2530YRC4	152	358-BE	382	421LCO-U	72	4902K-N	364
2530YRC5	152	358-ON	382	421L-GLD-K	72	4902K-S	364
2530YRC6	152	3710T	450, 452	421L-GLD-U	72	49100D	362, 364
2541M	406	3712T	454	421LS-C-K	76	49TR-36	506
2542M	406	3714T	454	421LS-C-U	76	49TR-36-G2	506
2543M	408	3715T	450	421LT-K	74	49TR-36-SN	506
2544AV	410	3716T	450	421LT-U	74	49TR-42	506
2544M	408	3718T	450	422F	72	49TR-42-G2	506
2545AV	410	37A	292	422L	72	49TR-42-SN	506
2545M	406	37A-U	298	422L-GLD-U	72	49TR-48	506
2546M	406	37C	294	423F	78	49TR-48-G2	506
2547M	408	37C-U	298	423L	78	49TR-48-SN	506
2548M	408	37R	292, 294	424F	78	49TS-30	506
2549M	408	37R-T	292, 294	424Y	78	49TS-30-G2	506
				426C	62, 64	49TS-30-SN	506



<i>pattern no.</i>	<i>page</i>	<i>pattern no.</i>	<i>page</i>	<i>pattern no.</i>	<i>page</i>	<i>pattern no.</i>	<i>page</i>
49TS-36	506	655LO	306	752	256	95T-40-G2-GC	392
49TS-36-G2	506	655LO-K	312	752LT	256	95T-40-W-GC	392
49TS-36-SN	506	655LO-KIT	306, 312	752LT-upchg, welt	256	AAC1	84
49TS-42	506	657	288	753	258	AAC1 cushions	84
49TS-42-G2	506	666C	304	753LT	258	AAC1S	84
49TS-42-SN	506	666CC	302	753LT-upchg, welt	258	AAC2	86
50-128	114	666CC-WB	302	754	258	AAC2 cushions	86
50CS	360	666CH	308, 314	754LT	258	AAC2S	86
50KIT	360	666CH-WB	308, 314	754LT-upchg, welt	258	AAC3	86
50KIT-L	360	666C-KIT	302, 304, 308, 314	755	260	AAC3 cushions	86
50L	112	666CM	308, 314	755LT	260	AAC3S	86
50LACE	360	666CM-WB	308, 314	755LT-upchg, welt	260	AAC4	84
50L-GLD	112	666CS-HB	310	756	260	AAC4 cushions	84
50T1	380	666CS-KIT	310	756LT	260	AAC4S	84
50T2	380	666CS-WB-HB	310	756LT-upchg, welt	260	AAC5	88
51A-5	104	666CS-WB-KIT	310	759	434	AAC5 cushions	88
51A-5-S	104	666C-WB	304	760	434	AAC5S	88
51A-7	104	666C-WB-K	312	80D	370	AAC6	88
51C-1	106	666C-WB-KIT	302, 304, 308, 312, 314	83ANCHOR	176	AAC6 cushions	88
51C-1-S	106	667Y	304	83Y-K	174	AAC6S	88
51C-2	106	667Y-KIT	304	83YM	174	AAC7	88
51CH-1	108	667YS-HB	310	83YMW	174	AAC7 cushions	88
51CH-1-S	108	667YS-KIT	310	84Y-K	174	AAC7S	88
51CH-2	108	67	178	84YM	174	AAR1	90
51CM-1	110	67R	178	84YMW	174	AAR1 cushions	90
51CM-1-S	110	67S	178	85T32M	176	AAR10	96
51CM-2	110	68	180	87	444	AAR10 cushions	96
53-145P	338	68C	182	87A	228	AAR10S	96
53-146P	338	68R	180	87A-K-N	228	AAR11	96
53-147	338	69	180	87A-K-S	230	AAR11 cushions	96
58A	116	69R	180	87AS	240	AAR11S	96
58A-R	116	701T-MC	430	87C	232	AAR12L	98
58C	116	701T-MN	430	87CH	240	AAR12L cushions	98
58C-R	116	701T-MV	430	87C-K-N	232	AAR12LS	98
614TS-KC-KC	456	70L	330	87C-K-S	234	AAR12R	98
614TS-KE-D	456	70L-GLD	330	87CM	240	AAR12R cushions	98
614TS-K-K	456, 460	70LM	334	87CS	240	AAR12RS	98
614TS-LWT-LWT	456	70LS	336	87CSB	236	AAR1S	90
618TR-KC-KC	456	71A	320	87CSB-K-N	236	AAR2	92
618TR-KE-D	456	71A-4S-G-1	318	87CSB-K-S	238	AAR2 cushions	92
618TR-K-K	456, 460	71A-4S-G-A	318	87Dolly	230, 234, 238	AAR2S	92
618TR-LWT-LWT	456	71A-5S	318	87-F1	444	AAR3	92
6242	386	71A-GLD	320	87-F2	444	AAR3 cushions	92
6248	386	71A-upchg, welt	318, 320	87GA	70, 230, 234	AAR3S	92
6254	386	71A-W	320	87-RO	444	AAR4	90
6260	388	72C	324	87TABLET	230, 234	AAR4 cushions	90
6272	388	72C-4S-G-1	322	91A-GC	138	AAR4S	90
6348	384	72C-4S-G-A	322	91A-GC-K	138	AAR5	100
6354	384	72C-5S	322	91C-GC	138	AAR5 cushions	100
6360	384	72C-GLD	324	91C-GC-K	138	AAR5S	100
642TR-KC-KC	456	72CH-W	328	91K	138	AAR6	100
642TR-KE-D	456	72CM-W	328	92C-GC	138	AAR6 cushions	100
642TR-LWT-LWT	456	72CP	326	92C-GC-K	138	AAR6S	100
643TA-KC-KC	456	72CP-W	326	92K	138	AAR7	100
643TA-KE-D	456	72C-W	324	93A-GC	140	AAR7 cushions	100
643TA-LWT-LWT	456	73	182	93A-GC-K	140	AAR7S	100
643TAS-HB-HL	458	73L	332	93K	140	AAR8	94
6472	390	73R	182	94K	140	AAR8 cushions	94
6484	390	74Y	330	94L-GC	140	AAR8S	94
6496	390	74Y-GLD	330	94L-GC-K	140	AAR9	94
654LA	302, 306	74YM	334	94LY-GC	140	AAR9 cushions	94
654LC	306	75	422	94LY-GC-K	140	AAR9S	94
654LCC	302	751	256	94YK	140	AR1A	38
654LC-K	312	751LT	256	95T-36-G2-GC	392	AR1AK	38
654L-KIT	302, 306, 312	751LT-upchg, welt	256	95T-36-W-GC	392	AR1AU	38

<i>pattern no.</i>	<i>page</i>	<i>pattern no.</i>	<i>page</i>	<i>pattern no.</i>	<i>page</i>	<i>pattern no.</i>	<i>page</i>
AR1C	36	AVC75-C	210	BO31-AU-3	50	LH15-C	428
AR1CK	36	AVC75-C-MVS	210	BO31-AU-P	50	LH20-BM	428
AR1CU	36	AVC76	210	BO31-C-3	50	LH20-C	428
ARD3030	372	AVC76-C	210	BO31-C-P	50	LH24-BM	428
ARD36D	372	AVC76-C-MVS	210	BO32-3	48, 50	LH24-C	428
ARDOLLY	36, 38	AVC81	214	BO32-P	48, 50	LH27-BM	428
ARE1	374	AVC81-C	214	BO4	40	LH27-C	428
ARE2	374	AVC81-C-MVS	214	BO5L	40	LL10-BM	426
AVC02	190	AVC82	214	BO5R	40	LL10-C	426
AVC02-C	190	AVC82-C	214	BO6	40	LLS7 Top B	426
AVC03	190	AVC82-C-MVS	214	BO7	42	LLS7 Top C	426
AVC03-C	190	AVC87	216	BO8P	46	LLS7-BM	426
AVC04	190	AVC87-C	216	BO9P	46	LLS7-C	426
AVC04-C	190	AVC88	212	BOC1	44	LLS8 Top B	426
AVCIL	208	AVC88-C	212	BOC2	44	LLS8-BM	426
AVCIL-C	208	AVC88-C-MVS	212	BOH-TR137	378	LLS8-C	426
AVC1R	208	AVC89	212	C	384, 386, 388, 390	MK01A	160
AVC1R-C	208	AVC89-C	212	CBP1	102	MK01AU	162
AVC33	192	AVC89-C-MVS	212	CBP2	102	MK01C	166
AVC33-C	192	AVC90	218	CX	384, 386, 388, 390	MK01CU	168
AVC34	192	AVC90-C	218	DS02	500	MK01R	160, 162, 164, 166, 168, 170
AVC34-C	192	AVC90-C-MVS	218	DS04	500	MK01RCN	160, 162, 164, 166, 168, 170
AVC35	194	AVC91	218	DS06	500	MK02A	172
AVC35-C	194	AVC91-C	218	DS08	502	MK02C	172
AVC35-C-MVS	194	AVC91-C-MVS	218	DS10	502	MK02R	172
AVC36	194	AVC93	220	DS12	502	MK02RCN	172
AVC36-C	194	AVC93-C	220	DS14	504	MK03A	164
AVC36-C-MVS	194	AVC94	220	DS16	504	MK03C	170
AVC37	196	AVC94-C	220	FKM-31-NA-B BACK	156	MK11	424
AVC37-C	196	AVC95	220	FKM-31-NA-B SEAT	156	MK12	424
AVC37-C-MVS	196	AVC95-C	220	FKM-31-NA-S	154	MK13	424
AVC38	196	AVC96	222	FKM-33-NA-B BACK	156	MK14	424
AVC38-C	196	AVC96-C	222	FKM-33-NA-B SEAT	156	MK15	424
AVC38-C-MVS	196	AVC97	222	FKM-33-NA-S	154	MK16	424
AVC43	198	AVC97-C	222	G	242, 244, 362	MN01A	264
AVC43-C	198	AVC98	222	G [4902]	364	MN01C	264
AVC43-C-MVS	198	AVC98-C	222	GL	384, 386, 388, 390	N10	442
AVC44	198	AVC99	222	H	272	N19-AW	262
AVC44-C	198	AVC99-C	222	JL1-P	142	N20-DF	442
AVC44-C-MVS	198	AVCB2	190	JL1-PLT	142	OAC1	266
AVC45	200	AVCB2-C	190	JL1-PLT-upchg, welt	142	P	242, 244
AVC45-C	200	AVCB3	190	JL1-W	144	P320COV	482
AVC45-C-MVS	200	AVCB3-C	190	JL1-WLT	144	P320-K	482
AVC46	200	BO10C-AE	52	JL1-WLT-upchg, welt	144	P320-W	482
AVC46-C	200	BO10C-AP	52	JL3-P	142	P321COV	482
AVC46-C-MVS	200	BO10CO	52	JL3-PLT	142	P321-K	482
AVC61	204	BO10CO-K	52	JL3-PLT-upchg, welt	142	P321-W	482
AVC61-C	204	BO11C	52	JL3-W	144	P322COV	482
AVC61-C-MVS	204	BO11C-AE	52	JL3-WLT	144	P322-K	482
AVC62	204	BO11C-AP	52	JL3-WLT-upchg, welt	144	P322-W	482
AVC62-C	204	BO11C-K	52	KN01	184	SM1-1	354
AVC62-C-MVS	204	BO15L	40	KN02	184	SM1-2	354
AVC65	202	BO15R	40	KN03	184	SM1-3	354
AVC65-C	202	BO2	40	KN04T	186	SM2-1	356
AVC65-C-MVS	202	BO21T-AE	376	KN04W	188	SM2-2	358
AVC66	202	BO21T-K	376	KN05T	186	SM2-3	358
AVC66-C	202	BO3	40	KSP1	158	SM2S-1	356
AVC66-C-MVS	202	BO30-AL-3	48	KSP1S	158	SM2S-2	358
AVC73	206	BO30-AL-P	48	KSP2	158	SM2S-3	358
AVC73-C	206	BO30-AU-3	48	KSP2S	158	SM8A	352
AVC73-C-MVS	206	BO30-AU-P	48	KSP3	158	SM8A-U	352
AVC74	206	BO30-C-3	48	KSP3S	158	SM8R	352
AVC74-C	206	BO30-C-P	48	LH13-BM	428	SM9	498
AVC74-C-MVS	206	BO31-AL-3	50	LH13-C	428	SM91	498
AVC75	210	BO31-AL-P	50	LH15-BM	428	SM92	498

<i>pattern no.</i>	<i>page</i>
SM93	498
SWELL-20P	348
SWELL-31	348
SWELL-31COV	348
SWELL-31P	348
SWELL-32	348
SWELL-32COV	348
SWELL-33	348
SWELL-33COV	348
TBP	350
TDCP	350
TG-30	496
TG-42	496
TG-56	496
TH	496
TI	496
TLCP	350
TOP-25	350
TOP-250	350
TOP-250COV	350
TOP-25COV	350
TOP-28	496
TOP-45	350
TOP-455	350
TOP-455COV	350
TOP-45COV	350
TR	224
TSOP	350
T-upcharge	292, 294
upchg, cushions	118, 120, 122, 124, 356
upchg, cushionsS	358
upchg, cushionsSO	358
WC2T	366
WC3T	366
WL21F	32
WL21S	32
WL23	32
WL25T	368
WS1CA	34
WS1CA-NCU	34
WS1CA-NO	34

# Selling Policy

This Selling Policy supersedes all previous selling policies and is inclusive of Knoll, KnollStudio and Muuto. Prices, discounts and product offerings are subject to change without notice.

<b>Terms &amp; Conditions of Sales</b>	Sales by Knoll, Inc. or Knoll North America Corp. ("Seller") of Knoll Product Lines (hereinafter "Products") within the United States and Canada are made only on the terms which are contained in this Selling Policy. Seller hereby gives notice of its objection to any different or additional terms and conditions. This sale is expressly conditional upon Purchaser's assent to the terms and conditions set forth below. Additional terms and conditions may apply to KnollStudio and KnollTextiles orders. These terms and conditions may be modified or supplemented only by a written document signed by an authorized representative of Seller. These terms and conditions supersede any prior and/or contemporaneous agreements or correspondence between Purchaser and Seller. Written quotations expire thirty (30) days from the date of issuance and can be withdrawn by written notice anytime during that period. Where Purchaser and Seller have entered into the Knoll Electronic Terms and Conditions, all orders, acknowledgements, invoices and other business communications placed or transmitted in accordance with the Knoll Electronic Terms and Conditions shall be deemed to be in writing and signed and shall be valid for all purposes as if they were originated and maintained in documentary form.
<b>Ordering Information</b>	All orders must be in writing. The product pattern number(s) contained on Seller's order acknowledgement shall be the final expression of the order.
<b>Order Confirmation</b>	A purchase order is not binding on Seller until Purchaser has received Seller's order confirmation or acknowledgment.
<b>Pricing Policies</b>	List prices are subject to change without notice. List prices shall be those prices in effect on the date of receipt of a complete purchase order unless shipment is requested more than ninety (90) days after order entry in which case prices in effect on the date of shipment apply. List prices include specified freight costs. Unless specified in writing by Seller, no other charges are included in Seller's list prices.
<b>Taxes</b>	All sales, use, excise and other taxes applicable to the sale of the Products shall be paid by Purchaser. If Purchaser claims an exemption from any tax, Purchaser shall submit to Seller the appropriate exemption certificates.
<b>Terms of Payment</b>	Payment for one hundred percent (100%) of the net order amount (including any applicable shipping and handling fee) is due within thirty (30) days of the date of invoice, which is generally issued upon shipment. In case of any discrepancies, such as shortages, and Seller is notified in writing within ten (10) days of receipt of Product, only that portion may be deducted and the balance paid. For orders greater than \$100,000 net, a fifty percent (50%) deposit is due at the time of order placement, with the remainder due within thirty (30) days of the date of invoice. KnollStudio orders less than \$2,000 require payment for one hundred percent (100%) of the net order amount (including any applicable sales tax and charges for inside delivery, special packaging, etc.), due at time of order placement. For KnollStudio orders greater than \$2,000, a one-half (50%) deposit is due at time of order placement with the remainder (including any applicable sales tax and charges for inside delivery, special packaging, etc.) due prior to shipment. If, in the judgment of Seller, Purchaser's financial condition does not justify the terms of the payment, Seller may require full or partial payment in advance. Past due accounts shall be charged one and one-half percent (1.5%) per month, or the highest rate permitted by law, whichever is less, and will be added to the outstanding balance. In the event Purchaser defaults on payment, Purchaser shall be liable for all collection costs, including reasonable attorney's fees and costs.
<b>Changes and Cancellation</b>	Standard purchase orders may not be changed or cancelled, in whole or in part, without prior written consent of Seller. Changes may effect delivery dates. Expenses incurred because of changes shall be charged to Purchaser. In the event of cancellations, Purchaser will be liable for reasonable cancellation charges established by Seller. Orders for special Product, orders including "COM" (hereinafter defined) material and orders pursuant to expedited delivery programs, may not be canceled. QuickShip orders may not be changed or canceled without Knoll's authorization. In the event of Muuto order changes, 25% payment of original net order amount is required for changes incurring the week the order was entered. 100% payment of original net order amount is required for changes incurring the week the order is scheduled to ship. If Muuto is ordered on QuickShip, the QuickShip policy supersedes.
<b>Freight Prepaid</b>	For standard orders, freight is prepaid and included in the price of all Knoll Office and KnollStudio Products, except KnollTextiles and Muuto, within the 48 contiguous United States for orders placed with Knoll, Inc. and within Canada, excluding the Yukon, Northwest Territories, Nunavut and Newfoundland for orders placed with Knoll North America Corp. Packing is tested for rigorous motion and transportation but is not guaranteed to protect furniture from all conditions. If special packaging is required for any reason, please consult with your sales representative or dealer. Seller shall select the method of shipment and routing. Freight for all KnollTextiles orders is prepaid and added to the invoice. Freight for all Muuto orders must be specified at time of order placement and added to the PO.
<b>Delivery/Freight Charges</b>	Shipments outside the contiguous 48 United States and Canada shall be shipped F.O.B. Origin. For shipments outside the contiguous United States and Canada, Purchaser is responsible for the cost of freight from point of embarkation, including any handling and transportation charges incidental to loading at the point of departure and unloading at the final destination. Conditions beyond the control of Seller, including weather, available facilities and traffic conditions, may affect exact time of delivery. Seller shall not be responsible for specific carrier delivery date or time unless it has made a specific delivery commitment, in writing. Nonstandard methods of shipment and/or additional services are available upon request. Orders for QuickShip product shipping direct parcel or White Glove are subject to additional shipping and handling charges and must be paid by Purchaser. Purchaser will be billed for the differential cost of any special services in excess of standard surface carrier freight costs. Premium charges, at Purchaser's request, will be added for airfreight, exclusive use of vehicle and extra, export or special packaging. Accessorial charges will be added for inside delivery, extra labor, reassignment and redelivery. Partial shipments may be made and invoiced by Seller.
<b>Claims</b>	All shipments for Knoll Products within the contiguous United States and Canada are F.O.B. Origin. All risk of loss passes to Purchaser at time of delivery to carrier. Purchaser shall inspect all Products upon receipt and notify Seller within ten (10) working days after receipt of any damage or defects which are, or should be, apparent from an inspection of the Product and its packaging. Failure of Purchaser to notify Seller during the ten (10) working day period shall constitute acceptance of the Products and waiver of any apparent defects, errors or shortages. For all claims relating to Product damaged in transit or for any other claims relating to or arising out of the transportation of the Product, Purchaser must seek recovery from the carrier and Seller has no liability to Purchaser for such claims. Seller may, upon request, assist Purchaser with filing of such claims with the carrier, but Seller will not be liable for any of these transportation related claims.

# Selling Policy

---

<b>Seller's Security Interest</b>	Until Seller receives the full payment for the Product, Seller shall have a security interest in the Product. Purchaser agrees to perform all acts, including but not limited to the execution and filing of documentation, which may be necessary to perfect and assure the security interest of Seller.
<b>Returns</b>	The return of Products without a written authorization by Seller shall not be accepted. To receive authorization for Product return, please call Customer Service. All Products that are returned pursuant to a valid authorization shall be subject to a twenty-five percent (25%) of list restocking charge. Products not currently offered for sale by Seller (including COM) shall not be authorized for return. All returned Products must be unused, in original condition and in the original Seller packing cartons. No refund or credit shall be given for damaged Products.
<b>Held Orders/Storage</b>	If Purchaser requests that an order be held or delayed, prices and terms and conditions in effect at the time of shipment shall apply. If Purchaser requests a delay after the time when Seller can defer production, Purchaser will be invoiced for the Product, payable in accordance with standard terms, when the order is ready for shipment. Seller may transfer the Product to storage, in which case all expenses incurred in connection with storage, including demurrage, preparation for storage, storage charges and handling shall be payable by Purchaser upon submission of invoices by Seller. Risk of loss to the Product shall pass to the Purchaser upon delivery of the Product into storage.
<b>Customer's Own Material</b>	A Purchaser who requests a fabric or other surface material not standard to Seller's line of Products ("COM") must submit samples of the requested material to Seller prior to entry of a purchaser order. Seller shall determine if the material is suitable to its manufacturing processes and meets any requirements of Underwriters Laboratories. If the COM is acceptable, Seller will then establish a price for using the COM or the Product in question. For a description of the procedures for submitting samples and testing, contact customer resources or your sales representative. Seller shall have no responsibility for the appearance, condition, performance, durability, colorfastness or any other physical attribute of the COM. Purchaser shall indemnify and hold Seller harmless for any damages, injuries or losses arising out of or related to use of the COM on the Product.
<b>Delay/Force Majeure</b>	Seller shall not be liable for failure to perform or for delay in performance due to fire, flood, strike or other labor difficulty, act of God, act of war or terrorism, act of any governmental authority or of the Purchaser, riot, embargo, fuel or energy shortage, wrecks or delay in transportation, inability to obtain necessary labor, materials or manufacturing facilities from usual sources or failure of suppliers to meet their contractual obligations, or due to any cause beyond its reasonable control. If any such event occurs, Seller may extend delivery dates by a period of time necessary to overcome the effect of such delay, allocate available Product or cancel any purchase order.
<b>Compliance with Law</b>	<b>PURCHASER IS SOLELY RESPONSIBLE FOR COMPLIANCE WITH ALL APPLICABLE FEDERAL, STATE AND LOCAL LAWS, ORDINANCES, REGULATIONS, RULES AND STANDARDS RELATING TO THE INSTALLATION, MAINTENANCE, USE AND OPERATION OF THE PRODUCTS.</b>
<b>Patents</b>	Subject to the following provisions, Seller shall, at its own expense, defend or, at its option, settle any claim, suit or proceeding brought against the Purchaser, and/or its vendees, mediate and immediate, so far as based on an allegation that any Product or any part thereof furnished hereunder constitutes a direct or a contributory infringement of any claim of any patent of the United States or Canada. This obligation shall be effective only if Purchaser shall have made all payments then due hereunder and if Seller is notified promptly in writing and given authority, information and assistance for the defense of said claim, suit or proceeding. Seller shall pay all damages and costs awarded in such suit or proceedings so defended.  The foregoing indemnity does not apply to the following: <ul style="list-style-type: none"><li>• Products supplied according to a design other than that of Seller, and which is required by the Purchaser.</li><li>• Combination of the Product with another product not furnished hereunder unless Seller is a contributory infringer.</li><li>• Any settlements of a suit or proceeding made without Seller's written consent.</li></ul>
<b>Limitations of Liability</b>	<b>SELLER, ITS CONTRACTORS, AUTHORIZED DEALERS AND SUBCONTRACTORS OR SUPPLIERS OF ANY TIER SHALL NOT BE LIABLE TO PURCHASER FOR ANY SPECIAL, INDIRECT, INCIDENTAL OR CONSEQUENTIAL DAMAGES ARISING FROM A BREACH OF THIS AGREEMENT.</b>  Purchaser's remedies set forth herein are exclusive and the liability of Seller with respect to the breach of this agreement or any contract entered into between the parties pursuant hereto shall not exceed the price of the Product or part on which such liability is based.
<b>Warranty</b>	please visit warranty website link <a href="https://www.knoll.com/help/warranty">https://www.knoll.com/help/warranty</a> for up-to-date information.

# General Ordering Information

---

## **The Products**

This guide encompasses all standard products for this product group.

## **Sizes**

Dimensions listed in this guide are indicated as:

H = height

W = width

D = depth

Dia. = diameter

Rad. = radius

## **Pricing**

All prices shown are list.

## **How to Order**

Select pattern numbers and quantities required for your complete installation. Product questions can be addressed in the specific sections of this guide or by contacting your sales representative or customer resource representative at 1-800-343-5665.

Next, select options (if required), along with colors and finishes appropriate to each product. Reference the Finishes and Fabrics pages for color designations.

On large installations, an item's "designated area" can be specified to assist in product organization and handling.

To expedite complete / correct entry of your order, be certain all pattern numbers, quantities, colors and area identifications are completely specified. Also, include complete purchase order numbers, bill-to and ship-to addresses, a contact name and specific factory shipping dates required.

## **Mail all orders to:**

Knoll, Inc.

1235 Water Street

P.O. Box 157

East Greenville, PA 18041

Attention: Order Entry

Once your order is entered at Knoll, an acknowledgment will be mailed to you. You will be advised of your scheduled shipping date within five days of the original acknowledgment. If it is necessary to revise your order, please contact your customer resource representative.

## Sustainability Statement

---

Sustainable design is a key component of Knoll's environmental focus. Our commitment to social responsibility and a healthy environment has prompted us to further articulate our longstanding environmental programs and, with encouragement and support from our colleagues in the industry, we have re-energized our focus on such "green" initiatives as life cycle analysis and LEED™ certification. Knoll is proud to have contributed to projects that have received LEED certification from the U.S. Green Building Council.

For the latest information on Knoll products that help our customers achieve LEED certification, log on to [knoll.com](http://knoll.com), click on "About Knoll" and then "Environmental Focus."