

Introduction	Introduction to Upstart	2
	Upstart Planning Examples	3
Upstart	Upstart Tables	5
	Upstart Privacy Screens	10
	Upstart Storage	11
Alpha-Numeric Index		13
Selling Policy		14
KnollKey Lock Program		16
General Ordering Information		17

Knoll Upstart is a collection of tables, screens, storage and services distribution components for computer-intensive, active and open work environments.

Upstart plans as single-surface, L- or U-shape workstations, or freestanding worktables and storage in combination with other systems furniture. Tables are available on casters or glides and are adjustable in height.

Complementary products include Currents workshelves, which clamp on to Upstart tables, mobile screens, linkable screens and service wall, monitor supports and desktop accessories. Consult the Currents and KnollExtra price lists for product details and pricing.

Primary and Secondary Worksurfaces

Y-shape table

Primary worksurface for basic workstation. Surface depth increases to accommodate computer at left or right, with curved or flat end.

M-shape table

Primary worksurface for computer-intensive workstation. Surface depth increases at both sides to support two computers, with curved or flat ends.

Extended Corner Table

Primary computer support and adjacent work area that plans in combination with nominal 24" deep worktables or storage.

Corner table, 120°

Primary computer support worksurface, in combination with Currents linkable screens and new V and Y-connectors.

Rectangular table

Primary, secondary or conference support worktables. Small rectangle can be bracketed to another table.

Conference Worksurfaces

Wiper table

Primary or conference support worktable in combination with systems furniture.

Oval

Conference support worktable.

Round, Half Round, Tripod

Conference support over, under or next to Upstart worktables.

Upstart Accessories

Flat Bracket

Bracket joins 2-legged table to other Upstart table at same height.

Cable Tray

Cable tray adds on to worksurface stiffener to control cable bundles and power strips (where permitted by code).

Pencil Drawer

Pencil drawer attaches to the underside of a worksurface at any location.

Screens

Upstart screens mount to the back edge of tables to provide seated visual privacy at a horizon of 39 or 48 inches. Screens are available in translucent or marker surface, and may be combined with magnet rail.

Storage

Storage includes the Upstart cart, for suspended filing and personal storage, and the Upstart tower, which houses binders as well as suspended files and personal storage.

Basic stand-alone Y desk

- the core Upstart application
- 30" x 72" nominal shown; conference depth is approximately 36"

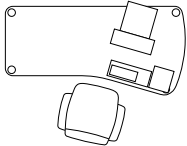

Oval table with Y desk

- 36" x 66" oval table
- 30" x 72" Y return

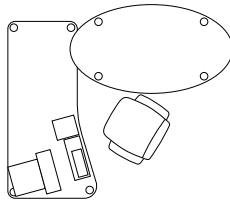

Curved wiper with Y desk

- wiper 66" W
- 30" x 72" Y return

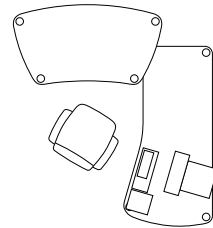

Y desk with 42" round table

- conference table

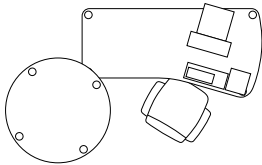

Rectangular table with bracketed return surface

- 72" x 76" approximate footprint
- optional work shelf

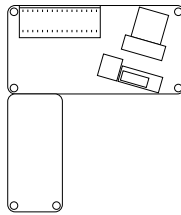

Y and M back-to-back, with 42" conference tables

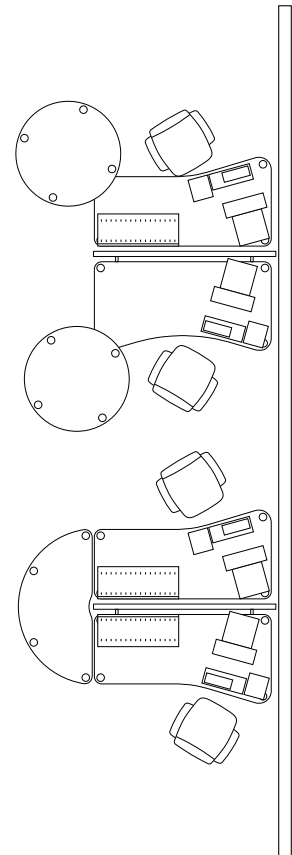

Y desk with tripod table

- 30" x 72" Y desk, work shelf, and mobile pedestal

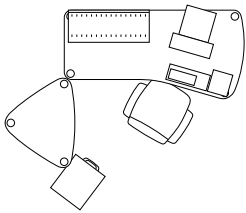

Dual-monitor M desk workstation

- 72" x 100" approximate footprint
- optional work shelf
- flat ends allow placement along wall

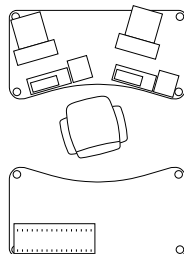

Dual-monitor M desk with tripod table

- 30" x 72" nominal M desk

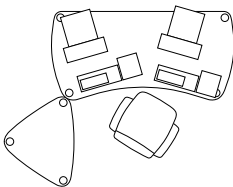

Y desks back-to-back, with half-round shared table

- please note 1.75" setback from the back edge of each top to module line, same as Currents desks.

Y desk with Upstart storage

- 72" x 96" footprint
- 72" table with screen
- cart and tower

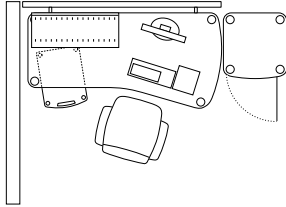

Extended corner desk and tower

- 72" x 72" footprint
- 48" and 72" screens
- cart and tower

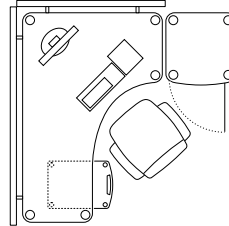

Extended corner desk and adjacent worktable

- 72" x 96" footprint
- 72" x 48" corner and 48" straight desks
- cart and privacy screen

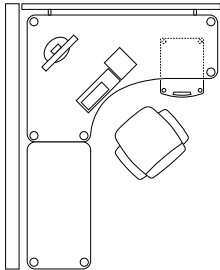

Upstart 120° planning

- group of three 120° corners
- 48" shared privacy screens
- carts

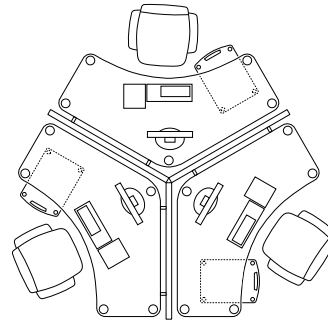

U-shape plannable desks

- 96" x 96" footprint
- two 48" x 72" extended corners
- cart and tower
- 72" privacy screen

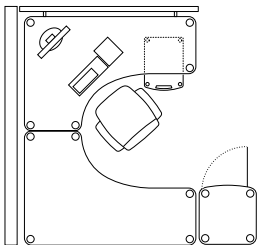

Upstart work group

- 120° corners and shared worktable 48 x 24"
- carts and towers
- 48" privacy screens

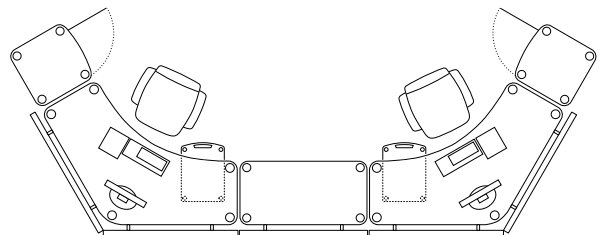

Upstart Tables
primary worksurfaces
table desks

type	application	w	d	h	pattern no.	list price
Y-shape table desk, curved end (left hand shown)	left	72"	28-36"	25-30"	AUP Y72DCL4 () () ()	\$757.
	right	72"	28-36"	25-30"	AUP Y72DCR4 () () ()	757.



M-shape table desk, curved ends		72"	30-36"	25-30"	AUP M72DC4 () () ()	757.
---------------------------------	--	-----	--------	--------	-------------------------------	------

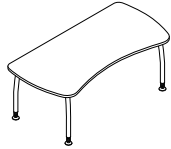

Y-shape table desk, flat ends	left	72"	28-36"	25-30"	AUP Y72DFL4 () () ()	757.
	right	72"	28-36"	25-30"	AUP Y72DFR4 () () ()	757.

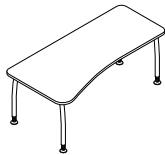

M-shape table desk, flat ends		72"	30-36"	25-30"	AUP M72DF4 () () ()	757.
-------------------------------	--	-----	--------	--------	-------------------------------	------

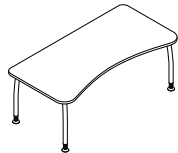

Order Code	Specification Information	Application Notes
Example: AUP Y72DCL4B 53G	Specify:	<i>Leg finishes, paint</i>
A Currents	<i>Top finish, plastic laminates</i>	3 Silver
UP Upstart	B Snow	2 Metallic flint
Y Table shape	L Light grey	U Light metallic grey
72 Width	E Fiber	J Medium metallic grey
D Depth	F Pumice	V Dark metallic grey
C Curved end	V Winter grey	H Metallic beige
L Left hand	S Slate	W Light metallic tan
4 Leg quantity	U Folkstone grey	E Soft grey
B Top finish	D Sand	<i>Casters/glides</i>
5 Edge finish	M42 Soft grey	C Casters
3 Base finish	CM Clear Maple	G Glides
G Glides	PA Pearwood	
	WM Warm Cherry	
	<i>Edge finishes, T-mold</i>	
	O Translucent orange	
	5 Trim grey	
	P Translucent blue	
	W Frosty white	
	N Black	
	L Light grey (available with matching laminate only)	
	F Pumice (available with matching laminate only)	
	D Sand	
	M42 Soft grey	
		Upstart Y and M shape tables combine computer support and adjacent work area in a basic table desk.
		Curved end tops facilitate conferencing in open planning. Flat ends plan close to system panels, Overall width is the same for curved and flat end tops.
		Upstart tops have plastic laminate surface with continuous T-mold edge.
		Upstart tables have four legs with 5" adjustable leveler glides or 4" adjustable casters. Adjustment range is 25-30" for glides and 27-31" for casters.
		Adjustment range enables Upstart tables to overlap or slide under adjacent tables and worksurfaces.

Upstart Tables
primary worksurfaces
corner table desks

type	w	d	h	pattern no.	list price
Extended corner table desk, 90° extended left	72"	48"	25-30"	AUP C7248S5 () () ()	\$865.

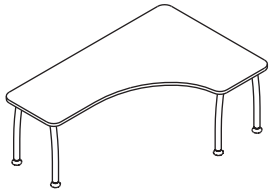

Extended corner table desk, 90° extended right	48"	72"	25-30"	AUP C4872S5 () () ()	865.
--	-----	-----	--------	--------------------------------	------

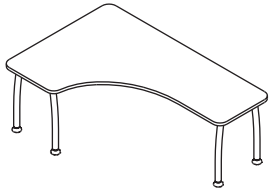

Corner table desk, 120°	48", 48"	22"	25-30"	AUP V48S5 () () ()	811.
-------------------------	----------	-----	--------	------------------------------	------

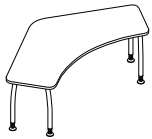

Order Code	Specification Information	Application Notes
Example: AUP C7248S5EOVC	Specify:	
A Currents	<i>Top finish, plastic laminates</i>	
UP Upstart	B Snow	<i>Leg finishes, paint</i>
C Table shape	L Light grey	3 Silver
72 Width, extended left	E Fiber	2 Metallic flint
48 Width	G Medium grey	U Light metallic grey
S Depth	F Pumice	J Medium metallic grey
4 Leg quantity	V Winter grey	V Dark metallic grey
E Top finish	S Slate	H Metallic beige
O Edge finish	U Folkstone grey	W Light metallic tan
V Base finish	D Sand	E Soft grey
C Casters	M42 Soft grey	<i>Casters/glides</i>
	CM Clear Maple	C Casters
	PA Pearwood	G Glides
	WM Warm Cherry	
	<i>Edge finishes, T-mold</i>	
	O Translucent orange	Upstart extended corner and corner shape tables combine computer support and adjacent work area in a basic table desk.
	5 Trim grey	Upstart tops have plastic laminate surface with continuous T-mold edge.
	P Translucent blue	Upstart tables have four or five legs with 5" adjustable leveler glides or 4" adjustable casters. Adjustment range is 25-30" for glides and 27-31" for casters.
	W Frosty white	Adjustment range enables Upstart tables to overlap or slide under adjacent worksurfaces.
	N Black	Extended corner table desks and 120° corner table desk are 22" deep on each side edge. Each back edge of 120° corner desk corresponds to 48" wide Currents linkable screens connected at a 120° angle.
	L Light grey (available with matching laminate only)	
	F Pumice (available with matching laminate only)	
	D Sand	
	M42 Soft grey	

Upstart Tables

secondary worksurfaces

Upstart

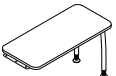



type	w	d	h	pattern no.	list price
 Rectangular table desk, four legs	48"	22"	25-30"	AUP S48S4 () () ()	\$487.
	48"	28"	25-30"	AUP S48D4 () () ()	541.
	60"	28"	25-30"	AUP S60D4 () () ()	595.
	72"	28"	25-30"	AUP S72D4 () () ()	622.
	72"	36"	25-30"	AUP S72E4 () () ()	649.
 Rectangular return, two legs	48"	22"	25-30"	AUP S48S2 () () G	379.

Order Code	Specification Information	Application Notes
Example: AUP S72E4 CMOV	Specify:	<i>Leg finishes, paint</i>
A Currents	<i>Top finish, plastic laminates</i>	3 Silver
UP Upstart	B Snow	2 Metallic flint
S Table shape	L Light grey	U Light metallic grey
72 Width	E Fiber	J Medium metallic grey
E Depth	F Pumice	V Dark metallic grey
4 Leg quantity	V Winter grey	H Metallic beige
CM Top finish	S Slate	W Light metallic tan
O Edge finish	U Folkstone grey	E Soft grey
V Base finish	D Sand	<i>Casters/glides</i>
C Casters	M42 Soft grey	C Casters
	CM Clear Maple	G Glides
	PA Pearwood	
	WM Warm Cherry	
	<i>Edge finishes, T-mold</i>	
	O Translucent orange	Upstart tops have plastic laminate surface with continuous T-mold edge.
	5 Trim grey	Upstart tables have four or five legs with 5" adjustable leveler glides or 4" adjustable casters. Adjustment range is 25-30" for glides and 27-31" for casters.
	P Translucent blue	Adjustment range enables Upstart tables to overlap or slide under adjacent worksurfaces.
	W Frosty white	Rectangular return with two legs includes flat bracket for attachment to primary worksurface at right angle.
	N Black	
	L Light grey (available with matching laminate only)	
	F Pumice (available with matching laminate only)	
	D Sand	
	M42 Soft grey	

Upstart Tables

conference worksurfaces

Upstart

type	w	d	h	pattern no.	list price
Wiper table desk 	61"	32½"	25-30"	AUP W60D4 () () ()	\$595.
Oval table desk, four legs 	66"	36"	25-30"	AUP O664 () () ()	757.
Round table desk, four legs 	42"		25-30"	AUP R424 () () ()	563.
Half round table desk, four legs 	62"	30"	25-30"	AUP D624 () () ()	595.
Tripod table, three legs 	36"	36"	25-30"	AUP T363 () () ()	487.

Order Code	Specification Information	Application Notes
Example: AUP O664B53G	Specify:	<i>Edge finishes, T-mold (cont.)</i>
A Currents	<i>Top finish, plastic laminates</i>	L Light grey (available with matching laminate only)
UP Upstart	B Snow	F Pumice (available with matching laminate only)
O Table shape	L Light grey	D Sand
66 Size	E Fiber	M42 Soft grey
4 Leg quantity	F Pumice	<i>Leg finishes, paint</i>
B Top finish	V Winter grey	3 Silver
5 Edge finish	S Slate	2 Metallic flint
3 Base finish	U Folkstone grey	U Light metallic grey
G Glides	D Sand	J Medium metallic grey
	M42 Soft grey	V Dark metallic grey
	CM Clear Maple	H Metallic beige
	PA Pearwood	W Light metallic tan
	WM Warm Cherry	E Soft grey
	<i>Edge finishes, T-mold</i>	<i>Casters/glides</i>
	O Translucent orange	C Casters
	5 Trim grey	G Glides
	P Translucent blue	
	W Frosty white	
	N Black	



Upstart conference table desks are designed to support conference work in combination with other worktables or systems furniture.

Upstart tops have plastic laminate surface with continuous T-mold edge.

Upstart tables have four legs with 5" adjustable leveler glides or 4" adjustable casters. Adjustment range is 25-30" for glides and 27-31" for casters.

Tops adjust in height to permit conference tops to overlap or roll under adjacent tables.

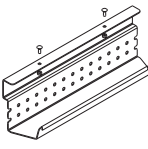
Half round corresponds to back-to-back Y-shape tables or 30" deep straight tables.

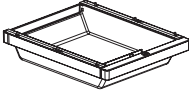
type	w	d	h	pattern no.	list price
Flat bracket 	3 1/2"	14"		AB1 F24	\$27.
Cable tray 	20"	2"	6"	AR1 CB	92.
Carpet grips (set of 10) 				MM2-CG	15.
Non skid grips (set of 10) 				AA1-NSK	27.
Pencil drawer 	12"	15 1/8"	3"	AUP PDU	98.

Order Code	Specification Information	Application Notes
Example: AA1-NSK		
A Currents	Flat bracket and cable tray are black, painted steel.	Flat bracket attaches return worksurface to primary worksurface at right angle.
A1 Accessory	Pencil drawer is integral color, light grey.	Cable tray attaches beneath stiffener under table surface to accommodate transformers or a bundle of cable.
NSK Non skid grips		Carpet grips snap into underside of Upstart leveling glides for traction on carpeted floors. Non-skid grips snap into leveling glides for traction on hard-surface floors. Pencil drawer attaches to the underside of a worksurface at any location.

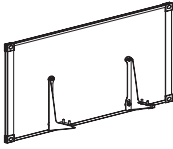
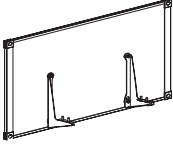
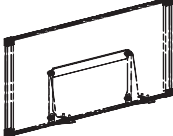
type	application	w	d	h	pattern no.	list price	
	Polycarbonate screen, back of table	36"	3/4"	24"	AUP B3624RC ()	\$314.	
		48"	3/4"	24"	AUP B4824RC ()	357.	
		60"	3/4"	24"	AUP B6024RC ()	411.	
		72"	3/4"	24"	AUP B7224RC ()	449.	
	Marker surface screen, back of table	36"	3/4"	24"	AUP B3624M ()	314.	
		48"	3/4"	24"	AUP B4824M ()	357.	
		60"	3/4"	24"	AUP B6024M ()	411.	
		72"	3/4"	24"	AUP B7224M ()	449.	
	Magnet rail	36" screen	18"	1/4"	2"	AUP MR36 ()	36.
		48" screen	30"	1/4"	2"	AUP MR48 ()	42.
		60" screen	36"	1/4"	2"	AUP MR60 ()	46.
		72" screen	48"	1/4"	2"	AUP MR72 ()	49.

Order Code	
Example:	AUP B7224RC3
A	Currents
UP	Upstart
B	Back of worksurface
72	Width
24	Height
RC	Polycarbonate
3	Silver paint

Specification Information	
Specify:	
<i>Surface type:</i>	
RC	Ribbed polycarbonate
M	Marker Surface
<i>Painted finishes for screen frame, brackets and magnet rail:</i>	
3	Silver
2	Metallic flint
U	Light Metallic grey
J	Medium metallic grey
V	Dark metallic grey
H	Metallic beige
W	Light metallic tan
E	Soft grey

Application Notes
Upstart screens mount on the back of Upstart tables to provide partial enclosure above and below worksurface height.
Screens have a translucent, ribbed polycarbonate or marker surface core. Perimeter frame is painted steel with trim grey molded corner blocks.
Screens include brackets that mount to matching holes under Upstart tables of the same width. Bracket holes are also provided for mounting two 36" wide screens on a 72" wide Upstart table.
Screen mounts in two positions, creating enclosure to a height of 39" or 48" when the table top is adjusted to 28".
Screens may be shared between desks in back to back configurations.
Magnet rails span between screen mounting brackets to hang paper documents.
Magnet rails correspond in width to privacy screens.

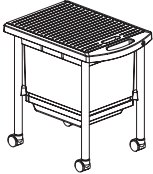
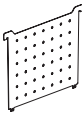
type	application	w	d	h	pattern no.	list price
	locking	16 1/4"	22 1/2"	23"	AUP C L ()	\$433.
	non locking	16 1/4"	22 1/2"	23"	AUP C ()	400.
	locking	16 1/4"	22 1/2"	23"	AUP C DL ()	476.
	non locking	16 1/4"	22 1/2"	23"	AUP C D ()	443.
Vertical divider					AUP VP3	71.
						

Order Code	Specification Information	Application Notes
Example: AUP CDL U		
A Currents	Cart includes integral color file tub and top frame, with translucent polycarbonate receding top. Legs are natural anodized aluminum with non-locking casters. Personal drawer is integral color light grey with a concealed slide lock inside the tub. Divider is light grey, perforated painted steel. <i>Integral color finish for file tub and top frame:</i> U Light grey G1 Glider grey	Upstart cart combines filing and personal storage in an accessible, mobile unit designed to roll under Upstart tables. The cart is not intended to be a mobile seat. Cart includes letter width/legal depth file tub with translucent, receding top. File carts with drawer include 3" high personal storage drawer under files. File cart may be specified with lock.
UP Upstart		
C Cart		
D Drawer		
L Lock		
U Light grey		

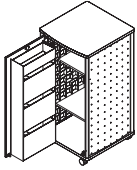
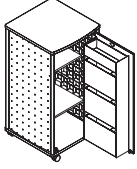
type	application	description	w	d	h	pattern no.	P1	P3	P1/V2	P3/V2	P1/V3	P3/V3	
 <p>Tower, left opening door</p>	active door, 1 file tub, 4 CD tubs	casters	24"	25"	48"	AUP T48E LCT ()()	\$1,568.	\$1,785.	\$1,731.	\$1,839.	\$1,893.	\$2,001.	
		glides	24"	25"	48"	AUP T48E LGT ()()	1,676.	1,893.	1,839.	1,947.	2,001.	2,109.	
	active door, 3 file tubs, 1 CD tub	casters	24"	25"	48"	AUP T48A LCT ()()	1,568.	1,785.	1,731.	1,839.	1,893.	2,001.	
		glides	24"	25"	48"	AUP T48A LGT ()()	1,676.	1,893.	1,839.	1,947.	2,001.	2,109.	
	 <p>Tower, right opening door</p>	active door, 1 file tub, 4 CD tubs	casters	24"	25"	48"	AUP T48E RCT ()()	1,568.	1,785.	1,731.	1,839.	1,893.	2,001.
			glides	24"	25"	48"	AUP T48E RGT ()()	1,676.	1,893.	1,839.	1,947.	2,001.	2,109.
active door, 3 file tubs, 1 CD tub		casters	24"	25"	48"	AUP T48A RCT ()()	1,568.	1,785.	1,731.	1,839.	1,893.	2,001.	
		glides	24"	25"	48"	AUP T48A RGT ()()	1,676.	1,893.	1,839.	1,947.	2,001.	2,109.	
Shelf Insert				20 1/2"	14 1/2"	3/4"	AUPTS						92.

Order Code

Example:	AUP T48A LCT 3 K
A	Currents
UP	Upstart
T	Tower
48	Height
A	Door configuration
L	Left
C	Casters
T	Side panels
3	Top and base finish
K	door finish

Specification Information

Specify:

Door configuration:

A Active door, 3 files, 1 CD
E Active door, 1 file, 4 CD

Specify:

L Left hinge
R Right hinge

C Casters
G Glides

P1 Paint finish for top, base and door:

N2 Flint
NU Light Grey
NJ Medium Grey
NV Dark Grey
NW Light Tan
NH Beige

Paint Group 3:

3	Silver
B	White

Veneer group 2 for door only:

M	Maple Techgrain®
R	Cherry Techgrain®
C	Medium Red Mahogany Techgrain®
P	American Cherry Techgrain®

Veneer group 3 for door only:

K	Maple
X	American cherry
Z	Medium red mahogany

Application Notes

Upstart tower provides shelf, file, CD and personal storage in a compact, luminous enclosure.

Towers include painted finish top and bottom, two shelves, molded translucent side and back panels, clear satin anodized aluminum posts, and hinged door with lock. Doors may be specified with painted or veneer finish.

Side panels support adjustable shelves on a 3" grid.

Active door includes tilting bins for 5" deep, letter or legal files and CDs or personal items.

Upstart towers are designed for rapid assembly on site.

<i>pattern no.</i>	<i>page</i>
AA1-NSK	9
AB1 F24	9
AR1 CB	9
AUP B3624M	10
AUP B3624RC	10
AUP B4824M	10
AUP B4824RC	10
AUP B6024M	10
AUP B6024RC	10
AUP B7224M	10
AUP B7224RC	10
AUP C	11
AUP C D	11
AUP C DL	11
AUP C L	11
AUP C4872S5	6
AUP C7248S5	6
AUP D624	8
AUP M72DC4	5
AUP M72DF4	5
AUP MR36	10
AUP MR48	10
AUP MR60	10
AUP MR72	10
AUP O664	8
AUP PDU	9
AUP R424	8
AUP S48D4	7
AUP S48S2	7
AUP S48S4	7
AUP S60D4	7
AUP S72D4	7
AUP S72E4	7
AUP T363	8
AUP T48A LCT	12
AUP T48A LGT	12
AUP T48A RCT	12
AUP T48A RCT	12
AUP T48E LCT	12
AUP T48E LGT	12
AUP T48E RCT	12
AUP T48E RCT	12
AUP V48S5	6
AUP VP3	11
AUP W60D4	8
AUP Y72DCL4	5
AUP Y72DCR4	5
AUP Y72DFL4	5
AUP Y72DFR4	5
AUPTS	12
MM2-CG	9

Selling Policy

	<p>This Selling Policy supercedes all previous selling policies. Prices, discounts and product offerings are subject to change without notice.</p>
Terms & Conditions of Sales	<p>Sales by Knoll, Inc. or Knoll North America Corp. ("Seller") of Knoll Product Lines (hereinafter "Products") within the United States and Canada are made only on the terms which are contained in this Selling Policy. Seller hereby gives notice of its objection to any different or additional terms and conditions. This sale is expressly conditional upon Purchaser's assent to the terms and conditions set forth below. Additional terms and conditions may apply to KnollStudio and KnollTextiles orders. These terms and conditions may be modified or supplemented only by a written document signed by an authorized representative of Seller. These terms and conditions supercede any prior and/or contemporaneous agreements or correspondence between Purchaser and Seller. Written quotations expire thirty (30) days from the date of issuance and can be withdrawn by written notice anytime during that period. Where Purchaser and Seller have entered into the Knoll Electronic Terms and Conditions, all orders, acknowledgements, invoices and other business communications placed or transmitted in accordance with the Knoll Electronic Terms and Conditions shall be deemed to be in writing and signed and shall be valid for all purposes as if they were originated and maintained in documentary form.</p>
Ordering Information	<p>All orders must be in writing. The product pattern number(s) contained on Seller's order acknowledgement shall be the final expression of the order.</p>
Order Confirmation	<p>A purchase order is not binding on Seller until Purchaser has received Seller's order confirmation or acknowledgment.</p>
Pricing Policies	<p>List prices are subject to change without notice.</p> <p>List prices shall be those prices in effect on the date of receipt of a complete purchase order unless shipment is requested more than one hundred twenty (120) days after order entry in which case prices in effect on the date of shipment apply. List prices include specified freight costs. Unless specified in writing by Seller, no other charges are included in Seller's list prices.</p>
Taxes	<p>All sales, use, excise and other taxes applicable to the sale of the Products shall be paid by Purchaser. If Purchaser claims an exemption from any tax, Purchaser shall submit to Seller the appropriate exemption certificates.</p>
Terms of Payment	<p>Payment for one hundred percent (100%) of the net order amount is due within thirty (30) days of the date of invoice, which is issued upon shipment. In case of any discrepancies, such as shortages, and Seller is notified in writing within ten (10) days of receipt of Product, only that portion may be deducted and the balance paid. For orders greater than \$100,000 net, a one-third (1/3) deposit is due at the time of order placement, with the remainder due within thirty (30) days of the date of invoice.</p> <p>KnollStudio orders less than \$2,000 require payment for one hundred percent (100%) of the net order amount (including any applicable sales tax and charges for inside delivery, special packaging, etc.), due at time of order placement. For KnollStudio orders greater than \$2,000, a one-half (50%) deposit is due at time of order placement with the remainder (including any applicable sales tax and charges for inside delivery, special packaging, etc.) due prior to shipment.</p> <p>If, in the judgment of Seller, Purchaser's financial condition does not justify the terms of the payment, Seller may require full or partial payment in advance.</p> <p>Past due accounts shall be charged one and one-half percent (1.5%) per month, or the highest rate permitted by law, whichever is less, and will be added to the outstanding balance. In the event Purchaser defaults on payment, Purchaser shall be liable for all collection costs, including reasonable attorney's fees and costs.</p>
Changes and Cancellation	<p>Purchase orders may not be changed or cancelled, in whole or in part, without prior written consent of Seller. Changes may effect delivery dates. Expenses incurred because of changes shall be charged to Purchaser. In the event of cancellations, Purchaser will be liable for reasonable cancellation charges established by Seller. Orders for special Product, orders including "COM" (hereinafter defined) material and orders pursuant to expedited delivery programs, may not be canceled.</p>
Freight Prepaid	<p>Freight is prepaid and included in the price of all Products, except KnollTextiles, within the 48 contiguous United States and Canada, excluding the Yukon, Northwest Territories, Nunavut and Newfoundland. Packing is tested for rigorous motion and transportation but is not guaranteed to protect furniture from conditions over which the Seller has no control. If special packaging is required for any reason, please consult with your sales representative or dealer. Seller shall select the method of shipment and routing. All shipments shall be tailgate deliveries. Freight for all KnollTextiles orders is prepaid and added to the invoice.</p>
Delivery/Freight Charges	<p>Shipments outside the contiguous 48 United States and Canada shall be shipped F.O.B. Origin.</p> <p>For shipments outside the contiguous United States and Canada, Purchaser is responsible for the cost of freight from point of embarkation, including any handling and transportation charges incidental to loading at the point of departure and unloading at the final destination.</p> <p>Conditions beyond the control of Seller, including weather, available facilities and traffic conditions, may affect exact time of delivery. Seller shall not be responsible for specific carrier delivery date or time unless it has made a specific delivery commitment, in writing.</p> <p>Nonstandard methods of shipment and/or additional services are available upon request. Purchaser will be billed for the differential cost of any special services in excess of standard surface carrier freight costs. Premium charges, at Purchaser's request, will be added for airfreight, exclusive use of vehicle and extra, export or special packaging. Accessorial charges will be added for inside delivery, extra labor, reconsignment and redelivery.</p> <p>Partial shipments may be made and invoiced by Seller.</p>
Claims	<p>All shipments for all Knoll Products within the contiguous United States and Canada are F.O.B. Origin. Risk of loss passes to Purchaser at time of delivery to carrier. Purchaser shall inspect all Products upon receipt and notify Seller within ten (10) working days after receipt of any damage or defects which are, or should be, apparent from an inspection of the Product and its packaging. Failure of Purchaser to make a claim against carrier or notify Seller during the ten (10) working day period shall constitute acceptance of the Products and waiver of any apparent defects, errors or shortages. Seller will agree to repair or replace Product damaged in shipment if Purchaser has notified Seller of freight damage within ten (10) working days after receipt and assigns its rights against the carrier.</p>
Seller's Security Interest	<p>Until Seller receives the full payment for the Product, Seller shall have a security interest in the Product. Purchaser agrees to perform all acts, including but not limited to the execution and filing of documentation, which may be necessary to perfect and assure the security interest of Seller.</p>
Returns	<p>The return of Products without a written authorization by Seller shall not be accepted. To receive authorization for Product return, please call Customer Service. All Products that are returned pursuant to a valid authorization shall be subject to a twenty-five percent (25%) of list restocking charge. Products not currently offered for sale by Seller (including COM) shall not be authorized for return. All returned Products must be unused, in original condition and in the original Seller packing cartons. No refund or credit shall be given for damaged Products.</p>
Held Orders/Storage	<p>If Purchaser requests that an order be held or delayed, prices and terms and conditions in effect at the time of shipment shall apply. If Purchaser requests a delay after the time when Seller can defer production, Purchaser will be invoiced for the Product, payable in accordance with standard terms, when the order is ready for shipment. Seller may transfer the Product to storage, in which case all expenses incurred in connection with storage, including demurrage, preparation for storage, storage charges and handling shall be payable by Purchaser upon submission of invoices by Seller. Risk of loss to the Product shall pass to the Purchaser upon delivery of the Product into storage.</p>

Selling Policy

Customer's Own Material	A Purchaser who requests a fabric or other surface material not standard to Seller's line of Products ("COM") must submit samples of the requested material to Seller prior to entry of a purchaser order. Seller shall determine if the material is suitable to its manufacturing processes and meets any requirements of Underwriters Laboratories. If the COM is acceptable, Seller will then establish a price for using the COM or the Product in question. For a description of the procedures for submitting samples and testing, contact customer resources or your sales representative. Seller shall have no responsibility for the appearance, condition, performance, durability, colorfastness or any other physical attribute of the COM. Purchaser shall indemnify and hold Seller harmless for any damages, injuries or losses arising out of or related to use of the COM on the Product.
Warranty	<p>Seller warrants to the original Purchaser only that the Products Seller manufactures and sells to Purchaser are free of defects in workmanship and materials, during the applicable warranty period set forth below.</p> <p>Should any failure to conform with this limited warranty appear to a Product listed below during the applicable warranty period from the date of shipment, Seller shall, upon prompt written notice, repair or replace, at its option and costs, the affected part or parts.</p> <p><i>Product and Period of Warranty</i></p> <p><i>Lifetime: AutoStrada, Calibre, Crinion Open Table, Currents, Dividends, Equity, Morrison, Reff</i> laminate and other non-wood components (except operational parts, controls, electrical, special or custom products, see below)</p> <p><i>10 Years: AutoStrada, Crinion Open Table and Reff</i> wood components, wood casegoods (<i>Crinion, Magnusson, Reference</i>), <i>Interaction</i> tables (except height adjustment mechanisms for <i>Counterforce</i>, crank-adjustable, and split-top tables and worksurfaces, see below), <i>Reuter</i> overheads, <i>Reuter</i> vertical storage, <i>Life, Sapper, RPM, Bulldog</i> and <i>Parachute</i> seating structural and operational parts, controls, casters, pneumatic cylinders (except seating upholstery, finishes and labor, see below)</p> <p><i>5 Years:</i> Operational parts, controls, electrical (except light ballasts and bulbs, see below), special or custom product, wood veneer products, <i>A3, Currents</i> handcrank, <i>Interaction Counterforce, Interaction</i> crank-adjustable, and split-top mechanisms, <i>KnollStudio, KnollExtra</i> adjustable keyboard supports, VDT carousel, monitor platform, equipment storage drawers and all universal storage drawers, <i>Open Up, Visor</i> and <i>SoHo</i> seating structural and operational parts, controls, pneumatic cylinders (except seating upholstery, finishes and labor, see below)</p> <p><i>3 Years:</i> Upholstery, finishes and labor to repair the following chairs: <i>Life, Sapper, RPM, Bulldog, Parachute, Open Up</i> and <i>SoHo</i>.</p> <p><i>2 Years:</i> All other <i>KnollExtra</i> product</p> <p><i>1 Year:</i> Light ballasts and bulbs and <i>Equity</i> fiberglass panels, seating upholstered armpads and soft armpads, <i>Visor</i> finishes and labor to repair.</p> <p>This warranty does not apply to:</p> <ul style="list-style-type: none">• Damage caused by a carrier other than the Seller.• Normal wear and tear or acts or omissions of parties other than Seller (including user modification).• COM or other third party materials applied to Products.• Products not installed by or under the auspices of a certified dealer of Seller.• Dramatic temperature variations or exposure to unusual conditions.• Except as specifically noted above, textiles and upholstery supplied by <i>KnollTextiles</i> (consult current <i>KnollTextiles</i> price list for applicable warranty). <p>Natural variations occurring in wood, marble, and leather shall not be considered defects, and the Seller does not guarantee the colorfastness or matching of the colors, grains or textures, or surface hardness of such materials. The Seller also does not guarantee the colorfastness of fiberglass panel surfaces. THE EXPRESS WARRANTIES CONTAINED HEREIN ARE IN LIEU OF ALL OTHER WARRANTIES, EXPRESS OR IMPLIED, INCLUDING ANY WARRANTIES OF MERCHANTABILITY AND FITNESS FOR PARTICULAR PURPOSE AND ALL OTHER WARRANTIES ARISING FROM COURSE OF DEALING OR USAGE OF TRADE.</p> <p>The remedies provided above are the Purchaser's sole remedies for any failure of Seller to comply with its obligations regarding the workmanship of its Products. Correction of any nonconformity in the manner and for the period of time provided shall constitute complete fulfillment of all liabilities of Seller, with respect to or arising out of the Product furnished hereunder.</p>
Delay/Force Majeure	Seller shall not be liable for failure to perform or for delay in performance due to fire, flood, strike or other labor difficulty, act of God, act of any governmental authority or of the Purchaser, riot, embargo, fuel or energy shortage, wrecks or delay in transportation, inability to obtain necessary labor, materials or manufacturing facilities from usual sources or failure of suppliers to meet their contractual obligations, or due to any cause beyond its reasonable control. If any such event occurs, Seller may extend delivery dates by a period of time necessary to overcome the effect of such delay, allocate available Product or cancel any purchase order.
Compliance with Law	PURCHASER IS SOLELY RESPONSIBLE FOR COMPLIANCE WITH ALL APPLICABLE FEDERAL, STATE AND LOCAL LAWS, ORDINANCES, REGULATIONS, RULES AND STANDARDS RELATING TO THE INSTALLATION, MAINTENANCE, USE AND OPERATION OF THE PRODUCTS.
Patents	<p>Subject to the following provisions, Seller shall, at its own expense, defend or, at its option, settle any claim, suit or proceeding brought against the Purchaser, and/or its vendees, mediate and immediate, so far as based on an allegation that any Product or any part thereof furnished hereunder constitutes a direct or a contributory infringement of any claim of any patent of the United States or Canada. This obligation shall be effective only if Purchaser shall have made all payments then due hereunder and if Seller is notified promptly in writing and given authority, information and assistance for the defense of said claim, suit or proceeding. Seller shall pay all damages and costs awarded in such suit or proceedings so defended.</p> <p>The foregoing indemnity does not apply to the following:</p> <ul style="list-style-type: none">• Products supplied according to a design other than that of Seller, and which is required by the Purchaser.• Combination of the Product with another product not furnished hereunder unless Seller is a contributory infringer.• Any settlements of a suit or proceeding made without Seller's written consent.
Limitations of Liability	SELLER, ITS CONTRACTORS, AUTHORIZED DEALERS AND SUBCONTRACTORS OR SUPPLIERS OF ANY TIER SHALL NOT BE LIABLE TO PURCHASER FOR ANY SPECIAL, INDIRECT, INCIDENTAL OR CONSEQUENTIAL DAMAGES ARISING FROM A BREACH OF THIS AGREEMENT. <p>Purchaser's remedies set forth herein are exclusive and the liability of Seller with respect to the breach of this agreement or any contract entered into between the parties pursuant hereto shall not exceed the price of the Product or part on which such liability is based.</p>

KnollKey Lock Program

KnollKey Lock Program General Information

Following is the KnollKey lock policy, applicable to all products.

Key-alike

For the convenience of the user, furniture may be keyed alike at no charge. Write "Key-alike" in the description of your purchase order for any pedestal, overhead, file or other item you wish to have keyed alike.

Using the key-alike instructions, order cores and keys as line items on your purchase order. Do NOT submit a key-alike form. The Knoll East Greenville Lock Center will select key numbers from the standard range of K 001 - K 250. Key numbers will not be repeated unless over 250 sets are ordered. Lock cores keyed-alike will ship separately from the product, ready for field installation.

There is no charge for key-alike orders if placed with the furniture order.

IF THE KEY-ALIKE ORDER IS NOT PLACED AT LEAST TWO WEEKS PRIOR TO THE FURNITURE SHIP DATE, A \$50 HANDLING CHARGE AND AIR FREIGHT CHARGES WILL APPLY.

If product is ordered and shipped random-keyed, additional lock cores for key-alike are billable.

Random-Keying

To specify product keyed-random, write "key-random" in the product description. Random-keyed product is shipped with the lock core factory installed. A shrouded key is included. Random means no effort has been made to match key numbers, or to make them different.

Keys

A Knoll shrouded key is shipped with every lock core. 250 Key numbers are available. For numbers above 250, contact Custom Product Development. Additional keys and key blanks are available. See service parts for more information.

Master Keying

Knoll locks can be controlled by means of a master key. There is no additional per-lock charge for master keying. A letter of approval from the client must accompany orders for master keys.

Installing Lock Cores

Lock cores can be installed or removed in the field by using a change key. Cores must be in the unlocked position to be removed. See service parts for change key pattern number and pricing.

Lock Distribution

All orders for key-alike lock cores/keys are packaged and shipped from the East Greenville Lock Center, regardless of where the pedestals, overhead, or other units are produced. KnollNow and random keyed product will have cores factory-installed.

How to Specify Key-Alike

Following is an example of how to specify key-alike for a cluster of 10 workstations.

Step 1 - Using the project floorplan, count the number of locks in each workstation.

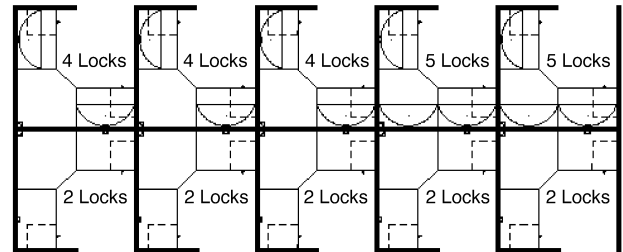

Step 2 - Count the number of workstations with the same quantity of locks. Group together the workstations with a like number of locks.

5 workstations with 2 locks per station
3 workstations with 4 locks per station
2 workstations with 5 locks per station

Step 3 - For the first group (5 sets of 2 locks), enter the number of workstations in the quantity column.

Qty	Pattern #	Description	Unit List	Ext. List
5				

Step 4 - Then enter the pattern number "KSPEC_ _" and add a suffix for the number of locks for that group (i.e., for 2 locks per station, add the suffix "2"). Up to 30 lock cores are available in a set (i.e., KSPEC 30).

Qty	Pattern #	Description	Unit List	Ext. List
5	KSPEC 2	Set of 2 cores/keys	N / C	N / C

Step 5 - Repeat for other groups.

Qty	Pattern #	Description	Unit List	Ext. List
5	KSPEC 2	Set of 2 cores/keys	N / C	N / C
3	KSPEC 4	Set of 4 cores/keys	N / C	N / C
2	KSPEC 5	Set of 5 cores/keys	N / C	N / C

Your Key instructions are complete.

Knoll will select key numbers for each set from 250 available numbers. Additional key numbers are available through Custom Product Development. **For additions to existing installations, specify desired key numbers in the description.**

Service Parts

Pattern #	Description	List Price
KKEY_ _ _	Shrouded Key Specify key number desired	\$5
KBLANK	Shrouded Key Blank	\$5
KSPECB_ _ _	Retrofit Universal Core/Key Specify key number desired	\$18
KCHANGE	Change Key	\$5
KMASTER*	Master Key	\$5

*Note: A letter of approval on company letterhead from the client must accompany all orders for master keys.

General Ordering Information

The Products

This guide encompasses all standard products for this product group.

Sizes

Dimensions listed in this guide are indicated as:

H = height

W = width

D = depth

Dia. = diameter

Rad. = radius

Pricing

All prices shown are list.

How to Order

Select pattern numbers and quantities required for your complete installation. Product questions can be addressed in the specific sections of this guide or by contacting your sales representative or customer resource representative at 1-800-343-5665.

Next, select options (if required), along with colors and finishes appropriate to each product. Reference the Finishes and Fabrics pages for color designations.

On large installations, an item's "designated area" can be specified to assist in product organization and handling.

To expedite complete / correct entry of your order, be certain all pattern numbers, quantities, colors and area identifications are completely specified. Also, include complete purchase order numbers, bill-to and ship-to addresses, a contact name and specific factory shipping dates required.

Mail all orders to:

Knoll, Inc.

1235 Water Street

P.O. Box 157

East Greenville, PA 18041

Attention: Order Entry

Once your order is entered at Knoll, an acknowledgment will be mailed to you. You will be advised of your scheduled shipping date within five days of the original acknowledgment. If it is necessary to revise your order, please contact your customer resource representative.

Sustainability Statement

Sustainable design is a key component of Knoll's environmental focus. Our commitment to social responsibility and a healthy environment has prompted us to further articulate our longstanding environmental programs and, with encouragement and support from our colleagues in the industry, we have re-energized our focus on such "green" initiatives as life cycle analysis and LEED™ certification. Knoll is proud to have contributed to projects that have received LEED certification from the U.S. Green Building Council.

For the latest information on Knoll products that help our customers achieve LEED certification, log on to knoll.com, click on "About Knoll" and then "Environmental Focus."