Standard Specials

Price List
July 2023

Knoll

Dividends Horizon System	Dividends Color Program Finishes	3
	Dividends Legacy Finishes	4
	Dividends Worksurfaces	5
	Dividends Table Supports	8
	Dividends Accessories	9
	Dividends Electrical	10
Reff System	Reff Finishes	16
	Reff Worksurfaces	18
	Reff support components	22
	Cushions for Reff Pedestals	23
Currents System	Worksurface anti-bow strap	24
Alpha-Numeric Index		25
Selling Policy		27
General Ordering Information		29

All dimensions in this price list are nominal and follow standard size convention of its respective product line.

Refer to standard product catalogs for available finishes.

Order Code	Color Name	Old Order Code	Paint Grade	Paint Finishes	Laminate Finishes	2mm Edgeband Finishes	Cascade Worksurface Finishes	Techwood Finishes	Plastic Trim Finishes
Paints and Laminates									
149	Barnwood				•	•			
611T*	Beige Mist Metallic		P2	•					
120T	Black Brown		P1	•					
118T*	Bright White	LH	P1	•	•	•	•		
112T*	Brown		P1	•					
123	Brushed Grey				•				
122	Brushed Sand				•				
143	Classic Oak				•	•			
113T*	Dark Grey	Y3	P1	•		•			•
128	Fog	G			•	•			
114T*	Folkstone Grey		P1	•	•	•	•		
144	Graphite Pear				•	•			
142	Grey Ash				•	•			
111T*	Jet Black	27	P1	•	•	•			
139	Light Ash				•	•			
124	Medium Cherry				•	•	•		
115	Medium Grey				•	•			
115T*	Medium Grey	Y2	P1	•					•
612T*	Medium Metallic Grey	J	P2	•					
121	Micro Grey				•				
129	Micro Sand				•				
126	Natural Cherry				•	•	•		
125	Natural Maple				•	•	•		
119	Pumice	LB, F			•	•	•		
116T*	Sandstone		P1	•					
613	Silver	3	P3	•					
147	Silverwood				•	•			
148	Smokewood				•	•			
117T*	Soft Grey	E, M42	P1	•	•	•	•		•
127	Walnut				•	•	•		
140	Warm Ash				•	•			
141	Whitened Ash				•	•			
145	Zebra				•	•			

* T suffix is for paint finish only

Most products introduced after 2004 are not available in Legacy finishes. See individual pricing pages for availability.

Specify Legacy finishes to match existing product only. Legacy finishes are not available for new customers.

Trim Finishes

- Panel top caps
- Panel post trim
- Pedestal drawer top caps
- Overhead drawer top caps
- Pedestal drawer pulls

Y1 Pewter

Paint Finishes

- Panel base raceway covers
- Panel tiled insert supports
- Solid Steel panel inserts
- Perforated steel panel inserts
- Embossed steel panel inserts
- Overhead storage components
- Pedestals
- Desk components
- Metal panel topcaps and trim

P1 Finishes

Y1 Pewter

P2 Finishes

- H Beige Metallic
- W Light Tan Metallic

All other Knoll paint finishes and custom finishes (Series 2 components only)

Laminates

Worksurfaces

An upcharge applies where specifying Legacy laminates. Add an amount equal to 10% of the solid PVC edgeband list price to the price of any product specified with a Legacy laminate.

- MC Caramel Maple
- CM Clear Maple
- M1 Light Grey
- PA Pearwood
- SD Sand
- B Snow
- WM Warm Cherry
- MR6 Winter Grey Matrix

Note: Laminates and other finishes may vary in color due to different dye lots. Slight variations are to be expected.

Worksurface Edges

2mm edgeband

- MC Caramel Maple
- Y3 Dark Grey
- Y2 Medium Grey
- MT Metal
- Y1 Pewter
- SD Sand
- B Snow
- WM Warm Cherry

Order Code	Color Name	Old Order Code	Paint Grade	Paint Finishes	Laminate Finishes	2mm Edgeband Finishes	Cascade Worksurface Finishes	Techwood Finishes	Plastic Trim Finishes	DS1 Storage Plastic Finishes
Techwoods										
641	Black Oak							•		
638	Blond Maple (formerly known as maple techgrain)							•		
509	Cherry							•		
628	Dark Mahogany							•		
514	Espresso							•		
639	Light Cherry (formerly known as cherry techgrain)							•		
506	Maple							•		
513	Medium Teak							•		
512	Medium Walnut							•		
637	Natural							•		
644	Light Walnut							•		
645	Dove Grey							•		

	Gloss Level	Fill Level
A	Low Gloss	Closed Pore
B	Medium Gloss	Closed Pore
C	High Gloss	Closed Pore
D	Low Gloss	Open Pore
E	Medium Gloss	Open Pore
F	High Gloss	Open Pore

Edge Options for Veneers	
WOOD	Complimentary Wood
SYN	Complimentary Synthetic
WPLY	Wood Ply Edge*
SPLY	Synthetic Ply Edge*

For more detailed information on Veneer finishes, please refer to the Wood Finish Matrix on the Knoll.com

Dividends Worksurfaces
Rectangular 36" Deep
Rectangular 36" Deep + Post

Standard Specials Systems

description	w	d	thickness	pattern no.	laminates w/ ABS edge	laminates w/ woodgrain edge	laminates w/ metal edge	techwood w/ techwood edge
36" Deep Rectangular, No Grommet	30"	36"	1 1/4"	D1R3036NQ	\$938.	\$1,031.	\$1,126.	\$1,218.
	36"	36"	1 1/4"	D1R3636NQ	981.	1,075.	1,175.	1,273.
	42"	36"	1 1/4"	D1R4236NQ	987.	1,082.	1,180.	1,281.
	48"	36"	1 1/4"	D1R4836NQ	993.	1,097.	1,195.	1,296.
	54"	36"	1 1/4"	D1R5436NQ	1,007.	1,110.	1,211.	1,372.
	102"	36"	1 1/4"	D1R10236NQ	1,748.	1,922.	2,096.	2,273.
	108"	36"	1 1/4"	D1R10836NQ	1,852.	2,037.	2,225.	2,408.
	114"	36"	1 1/4"	D1R11436NQ	1,956.	2,155.	2,349.	2,546.
	120"	36"	1 1/4"	D1R12036NQ	2,065.	2,268.	2,472.	2,685.

Dividends Horizon System

Ordering Information

Worksurfaces

1. Pattern Number
2. Laminate Finish
3. Edge Band Finish

Order Code

Worksurfaces

Example: **D1R 3036N Q, 114, 114**

D1R Pattern Number
3036N Q

114 Folkstone Grey
Laminate

114 Folkstone Grey Edge
Band

Included with:

Worksurfaces

Options

Worksurfaces

- Center-Located Edge Grommet
To specify, replace the "N" suffix from the pattern number with "G".
Add \$19.
- Woodgrain edge
- Metal edge

Dividends Worksurfaces

Curvilinear Corner

"L" Shape - Mixed Depths

description	1	2	3	4	t	pattern no.	laminate w/ ABS edge	laminate w/ woodgrain edge	laminate w/ metal edge	techwood w/ techwood edge
Curvilinear Corner "L" Shape Worksurface 24" Deep Return Left and 30" Deep Return Right	36"	48"	24"	30"	1/4"	D1L3648SDNQ	\$1,162.	\$1,277.	\$1,399.	\$2,092.
	36"	54"	24"	30"	1/4"	D1L3654SDNQ	1,295.	1,422.	1,552.	2,327.
	42"	42"	24"	30"	1/4"	D1L4242SDNQ	1,174.	1,293.	1,409.	2,114.
	42"	48"	24"	30"	1/4"	D1L4248SDNQ	1,189.	1,303.	1,423.	2,136.
	42"	66"	24"	30"	1/4"	D1L4266SDNQ	1,423.	1,566.	1,712.	2,565.
	42"	72"	24"	30"	1/4"	D1L4272SDNQ	1,494.	1,643.	1,792.	2,691.
	48"	78"	24"	30"	1/4"	D1L4878SDNQ	1,599.	1,759.	1,915.	2,877.
	48"	84"	24"	30"	1/4"	D1L4884SDNQ	1,702.	1,872.	2,041.	3,064.
	54"	36"	24"	30"	1/4"	D1L5436SDNQ	1,295.	1,422.	1,552.	2,327.
	66"	42"	24"	30"	1/4"	D1L6642SDNQ	1,423.	1,566.	1,712.	2,565.
	72"	42"	24"	30"	1/4"	D1L7242SDNQ	1,494.	1,643.	1,792.	2,691.
	78"	48"	24"	30"	1/4"	D1L7848SDNQ	1,599.	1,759.	1,915.	2,877.
	84"	48"	24"	30"	1/4"	D1L8448SDNQ	1,702.	1,872.	2,041.	3,064.
	96"	48"	24"	30"	1/4"	D1L9648SDNQ	1,911.	2,104.	2,294.	3,444.
Curvilinear Corner "L" Shape Worksurface 30" Deep Return Left and 24" Deep Return Right	36"	48"	30"	24"	1/4"	D1L3648DSNQ	1,162.	1,277.	1,399.	2,092.
	42"	42"	30"	24"	1/4"	D1L4242DSNQ	1,174.	1,293.	1,409.	2,114.
	42"	48"	30"	24"	1/4"	D1L4248DSNQ	1,189.	1,303.	1,423.	2,136.
	42"	66"	30"	24"	1/4"	D1L4266DSNQ	1,423.	1,566.	1,712.	2,565.
	42"	72"	30"	24"	1/4"	D1L4272DSNQ	1,494.	1,643.	1,792.	2,691.
	48"	78"	30"	24"	1/4"	D1L4878DSNQ	1,599.	1,759.	1,915.	2,877.
	48"	84"	30"	24"	1/4"	D1L4884DSNQ	1,702.	1,872.	2,041.	3,064.
	48"	96"	30"	24"	1/4"	D1L4896DSNQ	1,911.	2,104.	2,294.	3,444.
	54"	36"	30"	24"	1/4"	D1L5436DSNQ	1,295.	1,422.	1,552.	2,327.
	66"	42"	30"	24"	1/4"	D1L6642DSNQ	1,423.	1,566.	1,712.	2,565.
	72"	42"	30"	24"	1/4"	D1L7242DSNQ	1,494.	1,643.	1,792.	2,691.
	84"	48"	30"	24"	1/4"	D1L8448DSNQ	1,702.	1,872.	2,041.	3,064.
	96"	48"	30"	24"	1/4"	D1L9648DSNQ	1,911.	2,104.	2,294.	3,444.

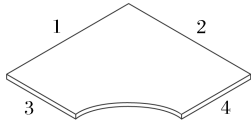
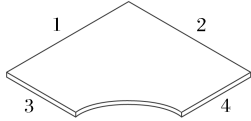

Ordering Information

Worksurfaces

1. Pattern Number
2. Laminate Finish
3. Edge Band Finish

Note:

"S" = 24"D

"D" = 30"D

Order Code

Worksurfaces

Example: **D1L4242SDNQ,114,114**

D1L4242 Pattern Number

114 Folkstone Grey
Laminate

114 Folkstone Grey Edge
Band

Included with:

Worksurfaces

- Worksurfaces
- Panel-to-worksurface bracket

Options

Worksurfaces

- 2 Center-Located Edge Grommets. To specify, replace the "N" suffix from the pattern number with "G".
Add \$30.
- Woodgrain edge
- Metal edge

Dividends Worksurfaces

Dividends Style File tops

description	w	d	pattern no.	laminate w/ ABS edge	laminate w/ woodgain edge	laminate w/ metal edge
	66"	18"	CE6618Q	\$549.	\$604.	\$657.
	78"	18"	CE7818Q	612.	676.	736.
	96"	18"	CE9618Q	791.	870.	950.
	114"	18"	CE11418Q	894.	983.	1,072.

Note: File tops are designed for use with Calibre Lateral Files with Calibre Fronts.
For Series 2 fronts contact CPD.

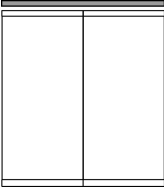
description	w	d	pattern no.	laminate w/ ABS edge	laminate w/ woodgain edge	laminate w/ metal edge
	48"	36"	CE4836Q	634.	698.	759.
	54"	36"	CE5436Q	725.	797.	870.
	66"	36"	CE6636Q	822.	902.	984.
	78"	36"	CE7836Q	915.	1,005.	1,095.
	96"	36"	CE9636Q	1,113.	1,227.	1,337.
	102"	36"	CE10236Q	1,179.	1,299.	1,417.
	114"	36"	CE11436Q	1,281.	1,411.	1,540.
	120"	36"	CE12036Q	1,384.	1,521.	1,661.

Note: File tops are designed for use with Calibre Lateral Files with Calibre Fronts.
For Series 2 Fronts contact CPD.

Order Code

30X18 Dividends Style File Tops
(Calibre Files)

Example: **CE3018**

CE	Dividend Edge
30	30" Wide
18	18" Deep

Specification Information

CE prefixed lateral file tops are designed to be attached to standard 18" deep (nominal) Calibre lateral files and cabinets. Please note that Calibre bookcases are 15" deep nominal and will not accept a Calibre lateral file laminate tops.

Calibre desking surfaces are not designed to serve as lateral file worksurface tops.

Application Notes

Designed for use with standard 18" deep nominal Calibre lateral files and cabinets only.

Actual dimensions are listed in inches

Dividends Table Supports

Double Y Leg Base

Standard Specials Systems

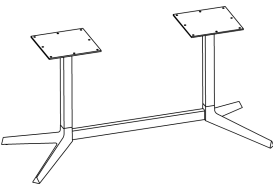
description	type	pattern no.	P1/P2/P3
 <p>Y-Base, Double with stretcher</p>	For use with 60" Wide x 24" or 30" Deep	DT1BYD602430Q	\$1,678.
	For use with 60" Wide x 36" Deep	DT1BYD6036Q	1,685.
	For use with 66" Wide x 24" or 30" Deep	DT1BYD662430Q	1,692.
	For use with 66" Wide x 36" Deep	DT1BYD6636Q	1,701.
	For use with 72" Wide x 24" or 30" Deep	DT1BYD722430Q	1,712.
	For use with 72" Wide x 36" Deep	DT1BYD7236Q	1,719.
	For use with 72" Wide x 42" Deep	DT1BYD7242Q	1,719.
	For use with 78" Wide x 24" or 30" Deep	DT1BYD782430Q	1,729.
	For use with 78" Wide x 36" Deep	DT1BYD7836Q	1,738.
	For use with 78" Wide x 42" Deep	DT1BYD7842Q	1,738.
	For use with 84" Wide x 24" or 30" Deep	DT1BYD842430Q	1,744.
	For use with 84" Wide x 36" Deep	DT1BYD8436Q	1,754.
	For use with 84" Wide x 42" Deep	DT1BYD8442Q	1,754.
	For use with 90" Wide x 24" or 30" Deep	DT1BYD902430Q	1,761.
	For use with 90" Wide x 36" Deep	DT1BYD9036Q	1,771.
	For use with 90" Wide x 42" Deep	DT1BYD9042Q	1,771.
	For use with 96" Wide x 24" or 30" Deep	DT1BYD962430Q	1,781.
	For use with 96" Wide x 36" Deep	DT1BYD9636Q	1,791.
	For use with 96" Wide x 42" Deep	DT1BYD9642Q	1,791.

Ordering Information

Table Supports:

1. Pattern number
2. Paint Finish

Order Code

Double Y Leg Base:

Example: **DT1BYD,114**

DT1 Dividends Horizon
Table

B Base

YD Double Y

114 Paint Finish

Included with:

Note: Table supports are only available in Knoll core finishes.

description	w	d	h	pattern no.	list	P1	P2	P3
Coat hook, 4 per pkg. For Flat top cap				DP5CHQ	\$401.			
Wall mounted bracket with cover For 14" h panel mounted sliding door overheads	30"		14"	DS3WMC1430Q		322.	352.	378.
	33"		14"	DS3WMC1433Q		328.	356.	384.
	36"		14"	DS3WMC1436Q		328.	356.	384.
	42"		14"	DS3WMC1442Q		332.	362.	392.
	48"		14"	DS3WMC1448Q		344.	377.	406.
Wall mounted bracket with cover For 21" h panel mounted sliding door overheads	30"		21"	DS3WMC2130Q		400.	436.	473.
	33"		21"	DS3WMC2133Q		408.	445.	481.
	36"		21"	DS3WMC2136Q		408.	445.	481.
	42"		21"	DS3WMC2142Q		442.	481.	517.
	48"		21"	DS3WMC2148Q		465.	504.	548.
Aluminum shelf with panel brackets	18"	8"	1"	DS1AS18Q()()	750.			
	24"	8"	1"	DS1AS24Q()()	793.			
	30"	8"	1"	DS1AS30Q()()	843.			
	36"	8"	1"	DS1AS36Q()()	893.			
	42"	8"	1"	DS1AS42Q()()	939.			
	48"	8"	1"	DS1AS48Q()()	981.			
	54"	8"	1"	DS1AS54Q()()	1,026.			
	60"	8"	1"	DS1AS60Q()()	1,069.			
	66"	8"	1"	DS1AS66Q()()	1,114.			
	72"	8"	1"	DS1AS72Q()()	1,156.			



Ordering Information

Coat hook

1. Pattern Number
2. Paint Finish

Wall mounted bracket with cover

1. Pattern Number
2. Paint Finish

Aluminum shelf

1. Bracket finish
any standard paint finish
2. Shelf finish
Anodized Aluminum or any standard paint finish except Silver (613)

Application Notes

Wall mounted bracket with cover

For 60" wide overhead, use (2x) 30" brackets
For 66" wide overhead, use (2x) 33" brackets
For 72" wide overhead, use (2x) 36" brackets

Cover is required for aesthetics purpose

Aluminum display shelf

Aluminum display shelves provide an additional level of storage between the worksurface and standard overhead storage.

Aluminum display shelves include brackets for support from vertical panel connector tracks.

Shelves may be mounted on any combination of vertical panels of the same total width.

Shelves may extend 12" past the mounting bracket on either side.

Dividends Horizon Electrical Specifications

Wiring Diagram

8-wire / 3-circuit (2+1)

INDEPENDENT
 NEUTRAL

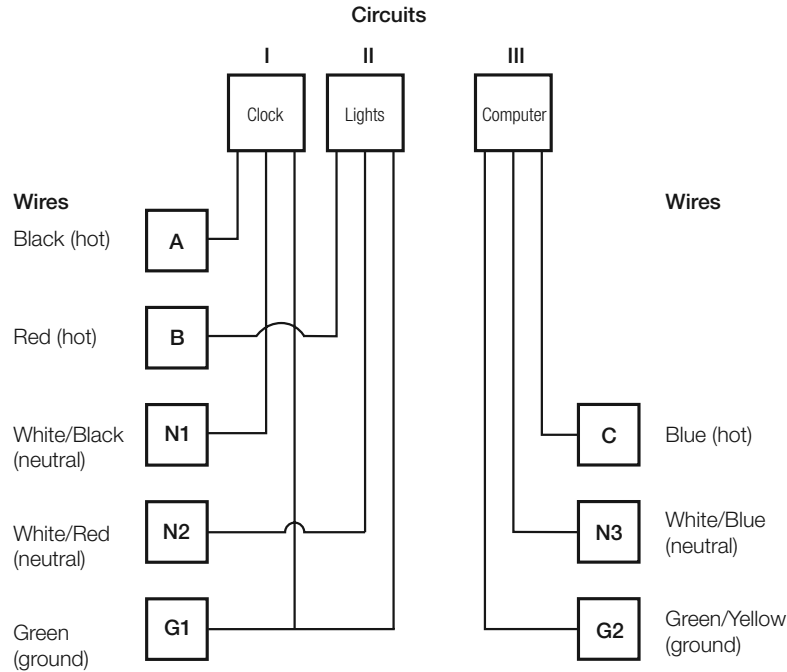

Wiring Diagram

10-wire / 4-circuit (2+2)

INDEPENDENT
 NEUTRAL

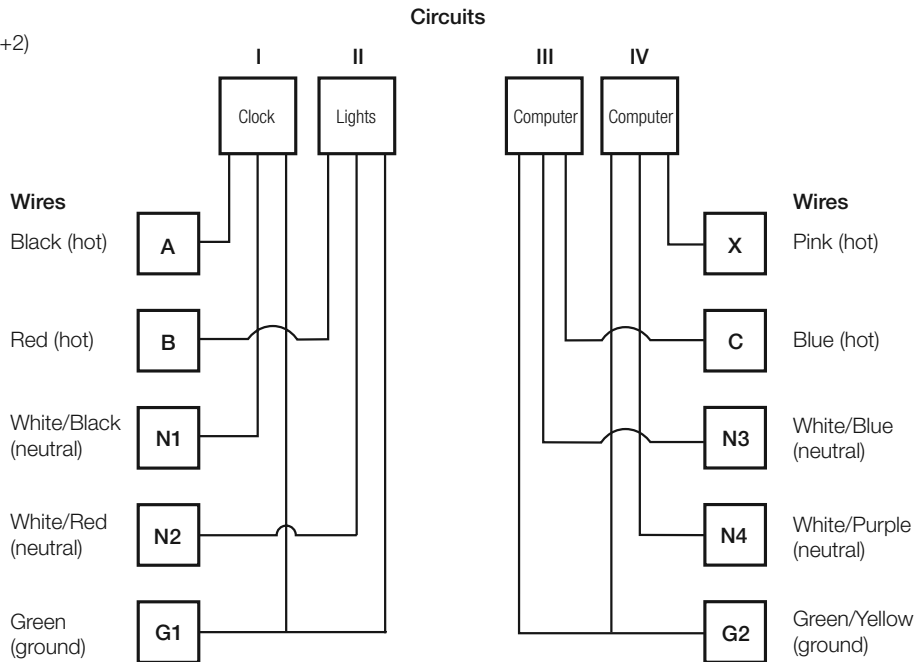







Please note that electrical components (i.e. power module, power jumpers and receptacles) from the 8 and 10-wire electrical systems with independent neutrals **cannot** be used with the 8-wire (3+1 and 2+2) and 10-wire (3+3) electrical systems that have shared neutrals.

Base Raceway

Power Modules, Connectors and Jumpers

8-wire (2+1)

description	type	pattern no.	list
Power Module - Double sided for raceway on both sides 	24"W Panel	DE0EPM24Q	\$183.
	30"W Panel	DE0EPM30Q	197.
	36"W Panel	DE0EPM36Q	204.
	42"W Panel	DE0EPM42Q	220.
	48"W Panel	DE0EPM48Q	232.
Power Module - Single sided for raceway on one side 	24"W Panel	DE0EPMS24Q	183.
	30"W Panel	DE0EPMS30Q	197.
	36"W Panel	DE0EPMS36Q	204.
	42"W Panel	DE0EPMS42Q	220.
	48"W Panel	DE0EPMS48Q	232.
Power Connector (power module-to-power module) 	12" no post	DE0EPCNPQ	122.
	15" with post	DE0EPCWPQ	125.
Power Jumper 	18" W Panel	DE0EPJ18NPQ	140.
	24" W Panel	DE0EPJ24NPQ	159.
	30" W Panel	DE0EPJ30NPQ	166.
	36" W Panel	DE0EPJ36NPQ	170.
	42" W Panel	DE0EPJ42NPQ	178.
	48" W Panel	DE0EPJ48NPQ	193.
Power Jumper (with post) 	18" W Panel + Post	DE0EPJ18WPQ	153.
	24" W Panel + Post	DE0EPJ24WPQ	160.
	30" W Panel + Post	DE0EPJ30WPQ	167.
	36" W Panel + Post	DE0EPJ36WPQ	175.
	42" W Panel + Post	DE0EPJ42WPQ	183.
	48" W Panel + Post	DE0EPJ48WPQ	197.
Multiple Panel Power Jumper (with or without post) 	54"W Panel Run	DE0EPJ54WPQ	207.
	60"W Panel Run	DE0EPJ60WPQ	215.
	66"W Panel Run	DE0EPJ66WPQ	222.
	72"W Panel Run	DE0EPJ72WPQ	229.
	78"W Panel Run	DE0EPJ78WPQ	238.
	84"W Panel Run	DE0EPJ84WPQ	246.

Ordering Information

Order Code

Included with:

Options

Power Jumper

1. Pattern Number

Power Jumper

Example: DE0EPJ18NPQ

DE0E Pattern Number

PJ42NPQ

Power Jumper

Note: Double-sided power module will not fit in a panel base raceway with tile to the floor on one side.

Dividends Electrical
Base Raceway
Power Modules, Connectors and Jumpers
8-wire (2+1)

Standard Specials Systems

description	type	pattern no.	list
Multiple Panel Power Jumper (with or without post)	96"W Panel Run	DE0EPJ96WPQ	\$262.



Ordering Information

Power Jumper
 1. Pattern Number

Order Code

Power Jumper
Example: **DE0EPJ18NPQ**
DE0E Pattern Number
PJ42NPQ





Included with:

Power Jumper
Note: Double-sided power module will not fit in a panel base raceway with tile to the floor on one side.

Options

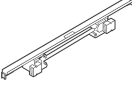
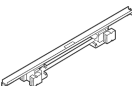
Beltway

Power Modules, Power Connectors and Power Jumpers

description	type	pattern no.	list
Beltway Power Module 1-Side 	30"	DE0EBPM301Q	\$256.
	36"	DE0EBPM361Q	271.
	42"	DE0EBPM421Q	284.
	48"	DE0EBPM481Q	295.
Beltway Power Module 2-Side 	30"	DE0EBPM302Q	256.
	36"	DE0EBPM362Q	271.
	42"	DE0EBPM422Q	284.
	48"	DE0EBPM482Q	295.
Beltway Power Connector 	17" no post	DES0EBPCNPQ	128.
	20" with post	DES0EBPCWPQ	130.
Beltway Power Jumper (no post) 	18"	DES0EBPJ18NPQ	158.
	24"	DES0EBPJ24NPQ	164.
	30"	DES0EBPJ30NPQ	169.
	36"	DES0EBPJ36NPQ	177.
	42"	DES0EBPJ42NPQ	190.
	48"	DES0EBPJ48NPQ	195.
Beltway Power Jumper (with post) 	18"	DES0EBPJ18WPQ	159.
	24"	DES0EBPJ24WPQ	166.
	30"	DES0EBPJ30WPQ	173.
	36"	DES0EBPJ36WPQ	182.
	42"	DES0EBPJ42WPQ	195.
	48"	DES0EBPJ48WPQ	209.
Multiple Panel Power Jumper (with or without post) 	54"	DES0EBPJ54WPQ	209.
	60"	DES0EBPJ60WPQ	220.
	66"	DES0EBPJ66WPQ	228.
	72"	DES0EBPJ72WPQ	237.
	78"	DES0EBPJ78WPQ	245.
	84"	DES0EBPJ84WPQ	259.
	96"	DES0EBPJ96WPQ	279.

Ordering Information

Order Code

Included with:

Options

Beltway Power Jumper

1. Pattern Number

Beltway Power Jumper



Example: **DES0EBPJ18NPQ**

DES0EBP Pattern Number
J18NPQ

Beltway Power Jumper

Beltway

Power Modules, Power Connectors and Power Jumpers

description	type	pattern no.	list
90° Beltway Power Jumper 	30" beltway panel	DE0EPJ120WPQ	\$338.
	36" beltway panel	DE0EPJ126WPQ	347.
	42" beltway panel	DE0EPJ138WPQ	364.
	48" beltway panel	DE0EPJ144WPQ	375.
Vertical Power Jumper (within same panel) 		DE0EVPJQ	290.
Vertical Power Jumper (from adjacent panel) 	30" beltway panel	DE0EPJ48WPQ	197.
	36" beltway panel	DE0EPJ54WPQ	207.
	42" beltway panel	DE0EPJ60WPQ	215.

Ordering Information

Order Code

Included with:

Options

Beltway Power Jumper

Beltway Power Jumper

Beltway Power Jumper



1. Pattern Number

Example: **DES0EBPJ18NPQ**

DES0EBP Pattern Number
J18NPQ

Infeeds

Base Power and Raceway-to-Ceiling Infeeds

description	length	pattern no.	list
Base Power Infeed (specify left or right) 	56"	DE0EBI56(L/R)Q	\$332.
Base Power Infeed (reversible) 	56"	DE0ERBI56Q	402.
Raceway-to-Ceiling Infeed 	144"	DE0ECI144Q	484.

Dividends Horizon System

Ordering Information	Order Code	Included with:	Options
Base Power Infeed (L/R) 1. Pattern Number	Base Power Infeed (L/R) <i>Example:</i> DE18 BI56(L) DE18 Pattern Number (left BI56(L) entry)	Base Power Infeed (L/R)	Base Power Infeed Base Power infeed (L/R): To Specify direction of entry, add either and "L" or "R" suffix to the pattern number.

Wood Finishes

New codes begin with a three digit numeric sequence, followed by a letter suffix. Each letter suffix (A-F) represents a different combination of pore fill options and gloss levels.

Code	<i>V1 TECHWOOD</i>	Code	<i>V2 PREMIUM TECHWOOD</i>	Code	<i>V3 PREMIUM VENEER</i>
638	Blond Maple	647	White Pine	039	Pippy Oak *
628	Dark Mahogany	640	Ebony	044	Figured Sycamore
639	Light Cherry	642	Grigio		
641	Black Oak				
506	Maple		<i>V2 NATURAL VENEER</i>		
509	Cherry	020	Natural Oak		
512	Medium Walnut	038	Rustic Walnut *		
513	Medium Teak	017	Light Walnut		
514	Espresso	002	Bronze Cherry		
637	Natural	006	Maple		
644	Light Walnut	021	Peacock Green Walnut		
645	Dove Grey	022	Old English Walnut		
		037	Birch		

	Gloss Level	Fill Level
A	Low Gloss	Closed Pore
B	MediumGloss	Closed Pore
C	High Gloss	Closed Pore
D	Low Gloss	Open Pore
E	Medium Gloss	Open Pore
F	High Gloss	Open Pore

Edge Options for Veneers

WOOD	Complementary Wood
SYN	Complementary Synthetic
WPLY	Wood Ply Edge *
SPLY	Synthetic Ply Edge *

* Ply Edge available on Birch (037) worksurfaces.

***Note:**

- Synthetic Edge option is available on worksurfaces, only.
- Finishes with * are available on worksurfaces only.

For more detailed information on Veneer finishes, please refer to the Wood Finish Matrix on the Knoll.com

Laminate Finishes

Core Laminate

Surface / Edge

111	Jet Black**
114	Folkstone Grey**
115	Medium Grey**
117	Soft Grey**
118	Bright White**
119	Pumice**
121	Micro Grey *
122	Brushed Sand *
123	Brushed Grey *
128	Fog **
129	Micro Sand *

*121, 122, 123, 129 Not available with matching edge option, and only available on worksurfaces.

**Melamine finish.

Products manufactured in Melamine are available in High Pressure Laminate at a 15% upcharge. Contact customfinish@knoll.com for information on how to specify.

LW Marker Board - Available for panels, Task panels and sliding display boards.

Note: All core Laminate worksurfaces are available with matching and non matching edges.

ie; A worksurface in 118, can have 139 edge finish.

Note: Pedestals and Cabinets with metal interior, when specified in "Wood Grain Laminate" or "Veneer", the shelves are painted black.

Wood Grain Laminates

Surface / Edge

124	Medium Cherry * *
125	Natural Maple * *
126	Natural Cherry * *
127	Walnut * *
139	Light Ash * *
140	Warm Ash**
141	Whitened Ash**
142	Grey Ash**
143	Classic Oak**
144	Graphite Pear**
145	Zebra

Textured Wood Grain

Laminate Surface / Edge

147	Silverwood**
148	Smokewood**
149	Barnwood**

Wood Grain Laminates are NOT available on the following components:

- Storage with J Pull option
- Administrative and Reception products
- 1 1/4" thick Worksurfaces with optional edge
- Panel post covers, post caps, top trims, end trims and screen doors
- 147, 148 and 149 available on build to spec components and 1 1/4" thick worksurfaces. Not available on pre-configured components or 1 1/2" thick worksurfaces.

Additional Edge Options for Laminate worksurfaces (only):

WPLY	Ply Edge - Wood (V1 Pricing)
SPLY	Ply Edge - Synthetic (L Pricing)

Note: neither vertical nor horizontal grain alignment is offered on casegood drawer fronts or doors when a woodgrain laminate finish is chosen.

Important Note:

Laminate wood grain direction depends on the width of the product.

For any vertical surface, ie; modesty panels, overheads and hutches, **up to 60"** wide, the laminate wood grain direction will be **vertical**. For any vertical surface **greater than 60"** wide, the laminate wood grain direction is **horizontal**.

Impact Resistant Laminate

Core & Wood Grain Laminates

Surface / Edge

911	Jet Black
914	Folkstone Grey
917	Soft Grey
918	Bright White
919	Pumice
924	Medium Cherry
925	Natural Maple
926	Natural Cherry
927	Walnut
928	Fog

Note: The Rules of Wood Grain Laminates, applies to the Impact Resistant Laminates. 25% Upcharge applies to the laminate pricing for the Impact Resistant Laminates.

up to 60" (vertical)



60" greater (horizontal)

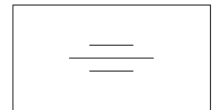

Reff Worksurfaces

1 1/4" thick straight rectilinear

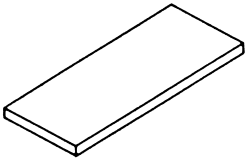
description	d	w	pattern no.	L	M/V1	V2	V3
Straight rectilinear work top 	20"	16"	QRSA161-N-()*	\$597.	\$639.	\$732.	\$993.
		102"	QRSA1021-()()	1,167.	1,240.	1,427.	1,926.
		108"	QRSA1081-()()	1,269.	1,340.	1,540.	2,079.
		114"	QRSA1141-()()	1,372.	1,437.	1,654.	2,234.
		120"	QRSA1201-()()	1,472.	1,536.	1,766.	2,388.
	24"	16"	QRSA162-N-()*	626.	672.	770.	1,041.
		102"	QRSA1022-()()	1,293.	1,375.	1,579.	2,132.
		108"	QRSA1082-()()	1,392.	1,475.	1,693.	2,284.
		114"	QRSA1142-()()	1,492.	1,569.	1,805.	2,438.
		120"	QRSA1202-()()	1,592.	1,667.	1,921.	2,590.
	30"	16"	QRSA163-N-()*	684.	730.	841.	1,133.
		102"	QRSA1023-()()	1,375.	1,462.	1,680.	2,266.
		108"	QRSA1083-()()	1,475.	1,562.	1,796.	2,421.
		114"	QRSA1143-()()	1,576.	1,659.	1,909.	2,575.
		120"	QRSA1203-()()	1,673.	1,759.	2,022.	2,728.
	36"	48"	QRSA484-()()	1,150.	1,230.	1,411.	1,909.
		54"	QRSA544-()()	1,188.	1,271.	1,464.	1,976.
		78"	QRSA784-()()	1,372.	1,461.	1,679.	2,264.
		84"	QRSA844-()()	1,472.	1,560.	1,794.	2,419.
		90"	QRSA904-()()	1,575.	1,657.	1,905.	2,574.
96"		QRSA964-()()	1,672.	1,757.	2,021.	2,724.	
102"		QRSA1024-()()	1,773.	1,856.	2,132.	2,879.	
108"		QRSA1084-()()	1,873.	1,952.	2,244.	3,030.	
114"		QRSA1144-()()	1,975.	2,052.	2,358.	3,186.	
120"		QRSA1204-()()	2,074.	2,151.	2,473.	3,338.	

* For creating freestanding pedestal using standard Reff pedestal. Counterweights must be ordered separately.

Order Code	Specification Information	Application Notes
Example: QRSA903	<i>To order please specify pattern number including:</i>	Products on this page are shipped without hardware which must be ordered separately from the support components section.
QR Reff Standard Special		
S Straight top	<i>1. Grommet options:</i>	Worksurface stiffeners recommended to provide additional support for open spans greater than 54" w.
A 1 1/4" thick	CF = Classic grommet in Flush location	
90 90" wide	PF = Profiles grommet in Flush location	
3 30" deep	N = No Grommet	
CF Grommet Option		
111 Jet Black (grommet)	<i>2. Grommet finishes:</i>	These worksurfaces are predrilled with pilot holes for use with wood screws.
114 Folkstone grey	Painted or Plated	
	<i>3. Finish:</i>	Classic type grommet sits even with top of the worksurface. Profiles type grommets have a 1/16" thick flange which rests above the worksurface.
	Laminate or Wood	Note: When specifying "plated" Classic grommet - The cap is plated and the sleeve comes in black only. Note: Recessed grommet location is note recommended for 20" and 24" deep tops.

Reff Worksurfaces
for calibre file
1 1/4" thick

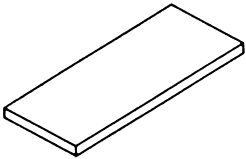
description	d	w	pattern no.	lam.	M/V1	V2	V3
File top, 1 1/4" thick 	18"	30"	QRSAC3018-()()	\$656.	\$702.	\$806.	\$1,092.
		36"	QRSAC3618-()()	692.	744.	850.	1,152.
		42"	QRSAC4218-()()	718.	773.	891.	1,205.
		48"	QRSAC4818-()()	755.	803.	921.	1,245.
		54"	QRSAC5418-()()	783.	835.	958.	1,296.
		60"	QRSAC6018-()()	849.	905.	1,039.	1,401.
		66"	QRSAC6618-()()	867.	930.	1,071.	1,446.
		72"	QRSAC7218-()()	918.	982.	1,125.	1,524.
		78"	QRSAC7818-()()	936.	992.	1,141.	1,536.
		84"	QRSAC8418-()()	984.	1,063.	1,220.	1,644.
		90"	QRSAC9018-()()	1,030.	1,101.	1,267.	1,710.
		96"	QRSAC9618-()()	1,070.	1,143.	1,311.	1,771.
		102"	QRSAC10218-()()	1,167.	1,240.	1,427.	1,926.
		108"	QRSAC10818-()()	1,269.	1,340.	1,540.	2,079.
	36"	36"	QRSAC3636-()()	1,070.	1,143.	1,311.	1,771.
		42"	QRSAC4236-()()	1,108.	1,185.	1,361.	1,841.
		54"	QRSAC5436-()()	1,150.	1,230.	1,411.	1,909.
		60"	QRSAC6036-()()	1,188.	1,271.	1,464.	1,976.
		66"	QRSAC6636-()()	1,230.	1,316.	1,515.	2,040.
		72"	QRSAC7236-()()	1,269.	1,358.	1,566.	2,114.
		78"	QRSAC7836-()()	1,372.	1,461.	1,679.	2,264.
		84"	QRSAC8436-()()	1,472.	1,560.	1,794.	2,419.
	90"	QRSAC9036-()()	1,575.	1,657.	1,905.	2,574.	

Order Code

Example: QRSAC3018	
QR	Reff Standard Special
S	Straight top
A	1 1/4" thick
C	For calibre file
30	30" wide
18	18" deep
114	Folkstone grey top
114	Edgeband finish

Specification Information

To order please specify pattern number including:

1. Top thickness
2. Top finish
3. Edgeband finish

1. Thickness options:
A = 1 1/4"
B = 1 3/4"

Application Notes

1 3/4" thick laminate option is double post formed front and back, all others are edgebanded.

Products on this page are exact width and depth and have no grommet or drilling.

Mixed finish 1 3/4" tops are not post-formed.

Reff Worksurfaces
for Calibre Front Lateral Files C2F and end panel
1 1/4" thick

Standard Specials Systems

description	d	w	pattern no.	L	M/V1	V2	V3
File top, 1 1/4" thick for Calibre front lateral file + one 18" deep end panel no grommet	18"	31"	QRSAEC3118()	\$691.	\$742.	\$849.	\$1,151.
	18"	37"	QRSAEC3718()	718.	773.	890.	1,201.
	18"	43"	QRSAEC4318()	755.	804.	924.	1,248.
	18"	61"	QRSAEC6118()	865.	933.	1,072.	1,449.
	18"	67"	QRSAEC6718()	916.	984.	1,123.	1,520.
	18"	73"	QRSAEC7318()	927.	992.	1,142.	1,541.
	18"	79"	QRSAEC7918()	985.	1,063.	1,215.	1,639.
	18"	85"	QRSAEC8518()	1,031.	1,100.	1,264.	1,710.
	18"	91"	QRSAEC9118()	1,070.	1,142.	1,309.	1,768.
	18"	97"	QRSAEC9718()	1,163.	1,243.	1,428.	1,926.
	18"	103"	QRSAEC10318()	1,257.	1,341.	1,541.	2,083.
	18"	109"	QRSAEC10918()	1,350.	1,442.	1,659.	2,239.
File top, 1 1/4" thick for Calibre front lateral file back to back + one 36" deep end panel no grommet	36"	31"	QRSAEC3136()	1,022.	1,096.	1,258.	1,702.
	36"	37"	QRSAEC3736()	1,065.	1,142.	1,309.	1,769.
	36"	43"	QRSAEC4336()	1,150.	1,230.	1,411.	1,909.
	36"	61"	QRSAEC6136()	1,230.	1,315.	1,519.	2,048.
	36"	67"	QRSAEC6736()	1,270.	1,362.	1,567.	2,115.
	36"	73"	QRSAEC7336()	1,372.	1,461.	1,679.	2,264.
	36"	76"	QRSAEC7936()	1,472.	1,560.	1,794.	2,419.
	36"	85"	QRSAEC8536()	1,575.	1,657.	1,905.	2,574.
	36"	91"	QRSAEC9136()	1,672.	1,757.	2,021.	2,724.
	36"	97"	QRSAEC9736()	1,773.	1,856.	2,132.	2,879.
	36"	103"	QRSAEC10336()	1,873.	1,952.	2,244.	3,030.
	36"	109"	QRSAEC10936()	1,975.	2,052.	2,358.	3,186.

Order Code	Specification Information	Application Notes
Example: QRSAEC3118	<i>To order please specify pattern number including:</i>	To build an enclosure, end panel(s) + top, for Calibre Front C2F lateral files.
QRSA Reff rectangular 1 1/4" thick top	1. Top finish	
EC For Calibre front file + end panel	2. Edge finish	Not to be used with modesty panel.
31 Width	Product on this page will accept woodgrain laminate where laminate is currently an option.	No grommet.
18 Depth		
506B Maple top finish		
Edge finish		

Reff Worksurfaces
for Calibre Front Lateral Files C2F and end panels
1 1/4" thick

description	d	w	pattern no.	L	V1	V2	V3
File top, 1 1/4" thick for Calibre front lateral file + two 18" deep end panel no grommet	18"	32"	QRSAEC3218()	\$691.	\$742.	\$849.	\$1,151.
	18"	38"	QRSAEC3818()	718.	773.	890.	1,201.
	18"	44"	QRSAEC4418()	755.	804.	924.	1,248.
	18"	62"	QRSAEC6218()	865.	933.	1,072.	1,449.
	18"	68"	QRSAEC6818()	916.	984.	1,123.	1,520.
	18"	74"	QRSAEC7418()	927.	992.	1,142.	1,541.
	18"	80"	QRSAEC8018()	985.	1,063.	1,215.	1,639.
	18"	86"	QRSAEC8618()	1,031.	1,100.	1,264.	1,710.
	18"	92"	QRSAEC9218()	1,070.	1,142.	1,309.	1,768.
	18"	98"	QRSAEC9818()	1,163.	1,243.	1,428.	1,926.
	18"	104"	QRSAEC10418()	1,257.	1,341.	1,541.	2,083.
18"	110"	QRSAEC11018()	1,350.	1,442.	1,659.	2,239.	
File top, 1 1/4" thick for Calibre front lateral file back to back + two 36" deep end panels no grommet	36"	32"	QRSAEC3236()	1,022.	1,096.	1,258.	1,702.
	36"	38"	QRSAEC3836()	1,065.	1,142.	1,309.	1,769.
	36"	44"	QRSAEC4436()	1,150.	1,230.	1,411.	1,909.
	36"	62"	QRSAEC6236()	1,230.	1,315.	1,519.	2,048.
	36"	68"	QRSAEC6836()	1,270.	1,362.	1,567.	2,115.
	36"	74"	QRSAEC7436()	1,372.	1,461.	1,679.	2,264.
	36"	80"	QRSAEC8036()	1,472.	1,560.	1,794.	2,419.
	36"	86"	QRSAEC8636()	1,575.	1,657.	1,905.	2,574.
	36"	92"	QRSAEC9236()	1,672.	1,757.	2,021.	2,724.
	36"	98"	QRSAEC9836()	1,773.	1,856.	2,132.	2,879.
	36"	104"	QRSAEC10436()	1,873.	1,952.	2,244.	3,030.
36"	110"	QRSAEC11036()	1,975.	2,052.	2,358.	3,186.	

Order Code	Specification Information	Application Notes
Example: QRSAEC3218	<i>To order please specify pattern number including:</i>	To build an enclosure, end panel(s) + top, for Calibre Front C2F lateral files.
QRSA	Reff rectangular 1 1/4" thick top	
EC	For Calibre front file + end panel	Not to be used with modesty panel.
32	Width	
18	Depth	No grommet.
506B	Maple top finish	
	Edge finish	

Reff support components
end panel for Calibre Front C2F Lateral Files

Standard Specials Systems

description	w	d	h	pattern no.	L	V1	V2	V3
End panel, for end of a Calibre Front lateral file	18"	1"	27"	QREC2718 () ()	\$426.	\$734.	\$830.	\$1,119.
1 1/16" actual thickness	18"	1"	39"	QREC3918 () ()	544.	936.	1,056.	1,426.
	18"	1"	58.5"	QREC5818 () ()	737.	1,268.	1,644.	1,910.
	18"	1"	63"	QREC6318 () ()	776.	1,336.	1,510.	2,035.
	36"	1"	27"	QREC2736 () ()	511.	882.	993.	1,341.
	36"	1"	39"	QREC3936 () ()	648.	1,118.	1,259.	1,705.
	36"	1"	58.5"	QREC5836 () ()	883.	1,520.	1,714.	2,312.
	36"	1"	63"	QREC6336 () ()	935.	1,607.	1,811.	2,448.

Order Code

Example: QREC2718
QR Reff Standard Special
E End panel
C For Calibre front file
27 Height
18 Depth
506B Maple finish

Specification Information

To order please specify pattern number including:

- Finish*

Product on this page will accept woodgrain laminate where laminate is currently an option.

Application Notes

To build an enclosure, end panel(s) + top, for Calibre Front C2F lateral files.

Include levellers and disc attachment hardwards.

Not to be used with modesty panel.

description	type	width	depth	thickness	pattern no.	A	B	C	D	F	G	H	I
Cushion for Reff mobile pedestal (16" w x 19" d)	For J-pull	16"	17 ⁷ / ₈ "	1"	QAS1R11618	\$512.	\$549.	\$613.	\$666.	\$743.	\$823.	\$908.	\$1,002.
	For non J-pull	16"	19"	1"	QAS106808	512.	549.	613.	666.	743.	823.	908.	1,002.



Cushion for Reff mobile pedestal (16" w x 23" d)	For J-pull	16"	21 ⁷ / ₈ "	1"	QAS1R11622	658.	725.	783.	862.	932.	1,003.	1,103.	1,214.
	For non J-pull	16"	23"	1"	QAS11J803	658.	725.	783.	862.	932.	1,003.	1,103.	1,214.

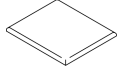

Order Code	Specification Information	Application Notes
Example: QAS1R11618	Specify fabric on purchase order.	Pedestal cushions are for use on Reff mobile pedestals.
R Reff Profiles	Discount as Currents products.	No CAL 133 on special cushions.
11 Thickness		
16 16" wide		
18 18" deep		

description	w	pattern no.	list
Worksurface anti-bow strap	42"	QC81474LAWM142	\$258.
	46"	QC81474LAWM146	264.
	50"	QC81474LAWM150	272.
	54"	QC81474LAWM154	279.
	58"	QC81474LAWM158	286.
	62"	QC81474LAWM162	291.
	66"	QC81474LAWM166	304.
	70"	QC81474LAWM170	313.
	74"	QC81474LAWM174	331.
	78"	QC81474LAWM178	334.
	82"	QC81474LAWM182	344.
	86"	QC81474LAWM186	348.
	90"	QC81474LAWM190	352.
	94"	QC81474LAWM194	362.
	98"	QC81474LAWM198	385.

Order Code

Specification Information

Application Notes

No finish selection

See Field Service for installation instructions.

<i>pattern no.</i>	<i>page</i>	<i>pattern no.</i>	<i>page</i>	<i>pattern no.</i>	<i>page</i>	<i>pattern no.</i>	<i>page</i>
CE10236Q	7	DE0EPJ126WPQ	14	DS1AS48Q	9	QRSA1021	18
CE11418Q	7	DE0EPJ138WPQ	14	DS1AS54Q	9	QRSA1022	18
CE11436Q	7	DE0EPJ144WPQ	14	DS1AS60Q	9	QRSA1023	18
CE12036Q	7	DE0EPJ18NPQ	11	DS1AS66Q	9	QRSA1024	18
CE4836Q	7	DE0EPJ18WPQ	11	DS1AS72Q	9	QRSA1081	18
CE5436Q	7	DE0EPJ24NPQ	11	DS3WMC1430Q	9	QRSA1082	18
CE6618Q	7	DE0EPJ24WPQ	11	DS3WMC1433Q	9	QRSA1083	18
CE6636Q	7	DE0EPJ30NPQ	11	DS3WMC1436Q	9	QRSA1084	18
CE7818Q	7	DE0EPJ30WPQ	11	DS3WMC1442Q	9	QRSA1141	18
CE7836Q	7	DE0EPJ36NPQ	11	DS3WMC1448Q	9	QRSA1142	18
CE9618Q	7	DE0EPJ36WPQ	11	DS3WMC2130Q	9	QRSA1143	18
CE9636Q	7	DE0EPJ42NPQ	11	DS3WMC2133Q	9	QRSA1144	18
D1L3648DSNQ	6	DE0EPJ42WPQ	11	DS3WMC2136Q	9	QRSA1201	18
D1L3648SDNQ	6	DE0EPJ48NPQ	11	DS3WMC2142Q	9	QRSA1202	18
D1L3654SDNQ	6	DE0EPJ48WPQ	11, 14	DS3WMC2148Q	9	QRSA1203	18
D1L4242DSNQ	6	DE0EPJ54WPQ	11, 14	DT1BYD602430Q	8	QRSA1204	18
D1L4242SDNQ	6	DE0EPJ60WPQ	11, 14	DT1BYD6036Q	8	QRSA161-N	18
D1L4248DSNQ	6	DE0EPJ66WPQ	11	DT1BYD662430Q	8	QRSA162-N	18
D1L4248SDNQ	6	DE0EPJ72WPQ	11	DT1BYD6636Q	8	QRSA163-N	18
D1L4266DSNQ	6	DE0EPJ78WPQ	11	DT1BYD722430Q	8	QRSA484	18
D1L4266SDNQ	6	DE0EPJ84WPQ	11	DT1BYD7236Q	8	QRSA544	18
D1L4272DSNQ	6	DE0EPJ96WPQ	12	DT1BYD7242Q	8	QRSA784	18
D1L4272SDNQ	6	DE0EPM24Q	11	DT1BYD782430Q	8	QRSA844	18
D1L4878DSNQ	6	DE0EPM30Q	11	DT1BYD7836Q	8	QRSA904	18
D1L4878SDNQ	6	DE0EPM36Q	11	DT1BYD7842Q	8	QRSA964	18
D1L4884DSNQ	6	DE0EPM42Q	11	DT1BYD842430Q	8	QRSAC10218	19
D1L4884SDNQ	6	DE0EPM48Q	11	DT1BYD8436Q	8	QRSAC10818	19
D1L4896DSNQ	6	DE0EPM54Q	11	DT1BYD8442Q	8	QRSAC3018	19
D1L5436DSNQ	6	DE0EPM60Q	11	DT1BYD902430Q	8	QRSAC3618	19
D1L5436SDNQ	6	DE0EPM66Q	11	DT1BYD9036Q	8	QRSAC3636	19
D1L6642DSNQ	6	DE0EPM72Q	11	DT1BYD9042Q	8	QRSAC4218	19
D1L6642SDNQ	6	DE0EPM78Q	11	DT1BYD962430Q	8	QRSAC4236	19
D1L7242DSNQ	6	DE0ERBI56Q	15	DT1BYD9636Q	8	QRSAC4818	19
D1L7242SDNQ	6	DE0EVFJQ	14	DT1BYD9642Q	8	QRSAC5418	19
D1L7848DSNQ	6	DES0EBPCNPQ	13	QAS106808	23	QRSAC5436	19
D1L8448DSNQ	6	DES0EBPCWPQ	13	QAS11J803	23	QRSAC6018	19
D1L8448SDNQ	6	DES0EBPJ18NPQ	13	QAS1R11618	23	QRSAC6036	19
D1L9648DSNQ	6	DES0EBPJ18WPQ	13	QAS1R11622	23	QRSAC6618	19
D1L9648SDNQ	6	DES0EBPJ24NPQ	13	QC81474LAWM142	24	QRSAC6636	19
D1R10236NQ	5	DES0EBPJ24WPQ	13	QC81474LAWM146	24	QRSAC7218	19
D1R10836NQ	5	DES0EBPJ30NPQ	13	QC81474LAWM150	24	QRSAC7236	19
D1R11436NQ	5	DES0EBPJ30WPQ	13	QC81474LAWM154	24	QRSAC7818	19
D1R12036NQ	5	DES0EBPJ36NPQ	13	QC81474LAWM158	24	QRSAC7836	19
D1R3036NQ	5	DES0EBPJ36WPQ	13	QC81474LAWM162	24	QRSAC8418	19
D1R3636NQ	5	DES0EBPJ42NPQ	13	QC81474LAWM166	24	QRSAC8436	19
D1R4236NQ	5	DES0EBPJ42WPQ	13	QC81474LAWM170	24	QRSAC9018	19
D1R4836NQ	5	DES0EBPJ48NPQ	13	QC81474LAWM174	24	QRSAC9036	19
D1R5436NQ	5	DES0EBPJ48WPQ	13	QC81474LAWM178	24	QRSAC9618	19
DE0EBI56(L/R)Q	15	DES0EBPJ54WPQ	13	QC81474LAWM182	24	QRSAEC10318	20
DE0EBPM301Q	13	DES0EBPJ60WPQ	13	QC81474LAWM186	24	QRSAEC10336	20
DE0EBPM302Q	13	DES0EBPJ66WPQ	13	QC81474LAWM190	24	QRSAEC10418	21
DE0EBPM361Q	13	DES0EBPJ72WPQ	13	QC81474LAWM194	24	QRSAEC10436	21
DE0EBPM362Q	13	DES0EBPJ78WPQ	13	QC81474LAWM198	24	QRSAEC10918	20
DE0EBPM421Q	13	DES0EBPJ84WPQ	13	QREC2718	22	QRSAEC10936	20
DE0EBPM422Q	13	DES0EBPJ96WPQ	13	QREC2736	22	QRSAEC11018	21
DE0EBPM481Q	13	DP5CHQ	9	QREC3918	22	QRSAEC11036	21
DE0EBPM482Q	13	DS1AS18Q	9	QREC3936	22	QRSAEC3118	20
DE0ECI144Q	15	DS1AS24Q	9	QREC5818	22	QRSAEC3136	20
DE0EPCNPQ	11	DS1AS30Q	9	QREC5836	22	QRSAEC3218	21
DE0EPCWPQ	11	DS1AS36Q	9	QREC6318	22	QRSAEC3236	21
DE0EPJ120WPQ	14	DS1AS42Q	9	QREC6336	22	QRSAEC3718	20

<i>pattern no.</i>	<i>page</i>
QRSAEC3736	20
QRSAEC3818	21
QRSAEC3836	21
QRSAEC4318	20
QRSAEC4336	20
QRSAEC4418	21
QRSAEC4436	21
QRSAEC6118	20
QRSAEC6136	20
QRSAEC6218	21
QRSAEC6236	21
QRSAEC6718	20
QRSAEC6736	20
QRSAEC6818	21
QRSAEC6836	21
QRSAEC7318	20
QRSAEC7336	20
QRSAEC7418	21
QRSAEC7436	21
QRSAEC7918	20
QRSAEC7936	20
QRSAEC8018	21
QRSAEC8036	21
QRSAEC8518	20
QRSAEC8536	20
QRSAEC8618	21
QRSAEC8636	21
QRSAEC9118	20
QRSAEC9136	20
QRSAEC9218	21
QRSAEC9236	21
QRSAEC9718	20
QRSAEC9736	20
QRSAEC9818	21
QRSAEC9836	21

Selling Policy

This Selling Policy supersedes all previous selling policies and is inclusive of Knoll, KnollStudio and Muuto. Prices, discounts and product offerings are subject to change without notice.

Terms & Conditions of Sales	Sales by Knoll, Inc. or Knoll North America Corp. ("Seller") of Knoll Product Lines (hereinafter "Products") within the United States and Canada are made only on the terms which are contained in this Selling Policy. Seller hereby gives notice of its objection to any different or additional terms and conditions. This sale is expressly conditional upon Purchaser's assent to the terms and conditions set forth below. Additional terms and conditions may apply to KnollStudio and KnollTextiles orders. These terms and conditions may be modified or supplemented only by a written document signed by an authorized representative of Seller. These terms and conditions supersede any prior and/or contemporaneous agreements or correspondence between Purchaser and Seller. Written quotations expire thirty (30) days from the date of issuance and can be withdrawn by written notice anytime during that period. Where Purchaser and Seller have entered into the Knoll Electronic Terms and Conditions, all orders, acknowledgements, invoices and other business communications placed or transmitted in accordance with the Knoll Electronic Terms and Conditions shall be deemed to be in writing and signed and shall be valid for all purposes as if they were originated and maintained in documentary form.
Ordering Information	All orders must be in writing. The product pattern number(s) contained on Seller's order acknowledgement shall be the final expression of the order.
Order Confirmation	A purchase order is not binding on Seller until Purchaser has received Seller's order confirmation or acknowledgment.
Pricing Policies	List prices are subject to change without notice. List prices shall be those prices in effect on the date of receipt of a complete purchase order unless shipment is requested more than ninety (90) days after order entry in which case prices in effect on the date of shipment apply. List prices include specified freight costs. Unless specified in writing by Seller, no other charges are included in Seller's list prices.
Taxes	All sales, use, excise and other taxes applicable to the sale of the Products shall be paid by Purchaser. If Purchaser claims an exemption from any tax, Purchaser shall submit to Seller the appropriate exemption certificates.
Terms of Payment	Payment for one hundred percent (100%) of the net order amount (including any applicable shipping and handling fee) is due within thirty (30) days of the date of invoice, which is generally issued upon shipment. In case of any discrepancies, such as shortages, and Seller is notified in writing within ten (10) days of receipt of Product, only that portion may be deducted and the balance paid. For orders greater than \$100,000 net, a fifty percent (50%) deposit is due at the time of order placement, with the remainder due within thirty (30) days of the date of invoice. KnollStudio orders less than \$2,000 require payment for one hundred percent (100%) of the net order amount (including any applicable sales tax and charges for inside delivery, special packaging, etc.), due at time of order placement. For KnollStudio orders greater than \$2,000, a one-half (50%) deposit is due at time of order placement with the remainder (including any applicable sales tax and charges for inside delivery, special packaging, etc.) due prior to shipment. If, in the judgment of Seller, Purchaser's financial condition does not justify the terms of the payment, Seller may require full or partial payment in advance. Past due accounts shall be charged one and one-half percent (1.5%) per month, or the highest rate permitted by law, whichever is less, and will be added to the outstanding balance. In the event Purchaser defaults on payment, Purchaser shall be liable for all collection costs, including reasonable attorney's fees and costs.
Changes and Cancellation	Standard purchase orders may not be changed or cancelled, in whole or in part, without prior written consent of Seller. Changes may effect delivery dates. Expenses incurred because of changes shall be charged to Purchaser. In the event of cancellations, Purchaser will be liable for reasonable cancellation charges established by Seller. Orders for special Product, orders including "COM" (hereinafter defined) material and orders pursuant to expedited delivery programs, may not be canceled. QuickShip orders may not be changed or canceled without Knoll's authorization. In the event of Muuto order changes, 25% payment of original net order amount is required for changes incurring the week the order was entered. 100% payment of original net order amount is required for changes incurring the week the order is scheduled to ship. If Muuto is ordered on QuickShip, the QuickShip policy supersedes.
Freight Prepaid	For standard orders, freight is prepaid and included in the price of all Knoll Office and KnollStudio Products, except KnollTextiles and Muuto, within the 48 contiguous United States for orders placed with Knoll, Inc. and within Canada, excluding the Yukon, Northwest Territories, Nunavut and Newfoundland for orders placed with Knoll North America Corp. Packing is tested for rigorous motion and transportation but is not guaranteed to protect furniture from all conditions. If special packaging is required for any reason, please consult with your sales representative or dealer. Seller shall select the method of shipment and routing. Freight for all KnollTextiles orders is prepaid and added to the invoice. Freight for all Muuto orders must be specified at time of order placement and added to the PO.
Delivery/Freight Charges	Shipments outside the contiguous 48 United States and Canada shall be shipped F.O.B. Origin. For shipments outside the contiguous United States and Canada, Purchaser is responsible for the cost of freight from point of embarkation, including any handling and transportation charges incidental to loading at the point of departure and unloading at the final destination. Conditions beyond the control of Seller, including weather, available facilities and traffic conditions, may affect exact time of delivery. Seller shall not be responsible for specific carrier delivery date or time unless it has made a specific delivery commitment, in writing. Nonstandard methods of shipment and/or additional services are available upon request. Orders for QuickShip product shipping direct parcel or White Glove are subject to additional shipping and handling charges and must be paid by Purchaser. Purchaser will be billed for the differential cost of any special services in excess of standard surface carrier freight costs. Premium charges, at Purchaser's request, will be added for airfreight, exclusive use of vehicle and extra, export or special packaging. Accessorial charges will be added for inside delivery, extra labor, reassignment and redelivery. Partial shipments may be made and invoiced by Seller.
Claims	All shipments for Knoll Products within the contiguous United States and Canada are F.O.B. Origin. All risk of loss passes to Purchaser at time of delivery to carrier. Purchaser shall inspect all Products upon receipt and notify Seller within ten (10) working days after receipt of any damage or defects which are, or should be, apparent from an inspection of the Product and its packaging. Failure of Purchaser to notify Seller during the ten (10) working day period shall constitute acceptance of the Products and waiver of any apparent defects, errors or shortages. For all claims relating to Product damaged in transit or for any other claims relating to or arising out of the transportation of the Product, Purchaser must seek recovery from the carrier and Seller has no liability to Purchaser for such claims. Seller may, upon request, assist Purchaser with filing of such claims with the carrier, but Seller will not be liable for any of these transportation related claims.

Selling Policy

Seller's Security Interest	Until Seller receives the full payment for the Product, Seller shall have a security interest in the Product. Purchaser agrees to perform all acts, including but not limited to the execution and filing of documentation, which may be necessary to perfect and assure the security interest of Seller.
Returns	The return of Products without a written authorization by Seller shall not be accepted. To receive authorization for Product return, please call Customer Service. All Products that are returned pursuant to a valid authorization shall be subject to a twenty-five percent (25%) of list restocking charge. Products not currently offered for sale by Seller (including COM) shall not be authorized for return. All returned Products must be unused, in original condition and in the original Seller packing cartons. No refund or credit shall be given for damaged Products.
Held Orders/Storage	If Purchaser requests that an order be held or delayed, prices and terms and conditions in effect at the time of shipment shall apply. If Purchaser requests a delay after the time when Seller can defer production, Purchaser will be invoiced for the Product, payable in accordance with standard terms, when the order is ready for shipment. Seller may transfer the Product to storage, in which case all expenses incurred in connection with storage, including demurrage, preparation for storage, storage charges and handling shall be payable by Purchaser upon submission of invoices by Seller. Risk of loss to the Product shall pass to the Purchaser upon delivery of the Product into storage.
Customer's Own Material	A Purchaser who requests a fabric or other surface material not standard to Seller's line of Products ("COM") must submit samples of the requested material to Seller prior to entry of a purchaser order. Seller shall determine if the material is suitable to its manufacturing processes and meets any requirements of Underwriters Laboratories. If the COM is acceptable, Seller will then establish a price for using the COM or the Product in question. For a description of the procedures for submitting samples and testing, contact customer resources or your sales representative. Seller shall have no responsibility for the appearance, condition, performance, durability, colorfastness or any other physical attribute of the COM. Purchaser shall indemnify and hold Seller harmless for any damages, injuries or losses arising out of or related to use of the COM on the Product.
Delay/Force Majeure	Seller shall not be liable for failure to perform or for delay in performance due to fire, flood, strike or other labor difficulty, act of God, act of war or terrorism, act of any governmental authority or of the Purchaser, riot, embargo, fuel or energy shortage, wrecks or delay in transportation, inability to obtain necessary labor, materials or manufacturing facilities from usual sources or failure of suppliers to meet their contractual obligations, or due to any cause beyond its reasonable control. If any such event occurs, Seller may extend delivery dates by a period of time necessary to overcome the effect of such delay, allocate available Product or cancel any purchase order.
Compliance with Law	PURCHASER IS SOLELY RESPONSIBLE FOR COMPLIANCE WITH ALL APPLICABLE FEDERAL, STATE AND LOCAL LAWS, ORDINANCES, REGULATIONS, RULES AND STANDARDS RELATING TO THE INSTALLATION, MAINTENANCE, USE AND OPERATION OF THE PRODUCTS.
Patents	Subject to the following provisions, Seller shall, at its own expense, defend or, at its option, settle any claim, suit or proceeding brought against the Purchaser, and/or its vendees, mediate and immediate, so far as based on an allegation that any Product or any part thereof furnished hereunder constitutes a direct or a contributory infringement of any claim of any patent of the United States or Canada. This obligation shall be effective only if Purchaser shall have made all payments then due hereunder and if Seller is notified promptly in writing and given authority, information and assistance for the defense of said claim, suit or proceeding. Seller shall pay all damages and costs awarded in such suit or proceedings so defended. The foregoing indemnity does not apply to the following: <ul style="list-style-type: none">• Products supplied according to a design other than that of Seller, and which is required by the Purchaser.• Combination of the Product with another product not furnished hereunder unless Seller is a contributory infringer.• Any settlements of a suit or proceeding made without Seller's written consent.
Limitations of Liability	SELLER, ITS CONTRACTORS, AUTHORIZED DEALERS AND SUBCONTRACTORS OR SUPPLIERS OF ANY TIER SHALL NOT BE LIABLE TO PURCHASER FOR ANY SPECIAL, INDIRECT, INCIDENTAL OR CONSEQUENTIAL DAMAGES ARISING FROM A BREACH OF THIS AGREEMENT. Purchaser's remedies set forth herein are exclusive and the liability of Seller with respect to the breach of this agreement or any contract entered into between the parties pursuant hereto shall not exceed the price of the Product or part on which such liability is based.
Warranty	please visit warranty website link https://www.knoll.com/help/warranty for up-to-date information.

General Ordering Information

The Products

This guide encompasses all standard products for this product group.

Sizes

Dimensions listed in this guide are indicated as:

H = height

W = width

D = depth

Dia. = diameter

Rad. = radius

Pricing

All prices shown are list.

How to Order

Select pattern numbers and quantities required for your complete installation. Product questions can be addressed in the specific sections of this guide or by contacting your sales representative or customer resource representative at 1-800-343-5665.

Next, select options (if required), along with colors and finishes appropriate to each product. Reference the Finishes and Fabrics pages for color designations.

On large installations, an item's "designated area" can be specified to assist in product organization and handling.

To expedite complete / correct entry of your order, be certain all pattern numbers, quantities, colors and area identifications are completely specified. Also, include complete purchase order numbers, bill-to and ship-to addresses, a contact name and specific factory shipping dates required.

Mail all orders to:

Knoll, Inc.

1235 Water Street

P.O. Box 157

East Greenville, PA 18041

Attention: Order Entry

Once your order is entered at Knoll, an acknowledgment will be mailed to you. You will be advised of your scheduled shipping date within five days of the original acknowledgment. If it is necessary to revise your order, please contact your customer resource representative.

Sustainability Statement

Sustainable design is a key component of Knoll's environmental focus. Our commitment to social responsibility and a healthy environment has prompted us to further articulate our longstanding environmental programs and, with encouragement and support from our colleagues in the industry, we have re-energized our focus on such "green" initiatives as life cycle analysis and LEED™ certification. Knoll is proud to have contributed to projects that have received LEED certification from the U.S. Green Building Council.

For the latest information on Knoll products that help our customers achieve LEED certification, log on to knoll.com, click on "About Knoll" and then "Environmental Focus."