

STANDARD SPECIALS OFFICE SEATING

Price List
September 2012



Knoll

Introduction	Knoll and Sustainable Design	2
	GREENGUARD Indoor Air Quality Certified®	3
	Placing Your Knoll Office Seating Order	4
	Visual Index	5
	Office Seating Control Index	7
	KnollTextiles Fabric Application	8
	Customer's Own Material Seating Process Overview	9
	Spinneybeck Leather Application	18
Generation by Knoll®	Generation by Knoll® : work chair	22
	Generation by Knoll® Dimensions, Features and Operating Instructions	24
	Generation by Knoll® Technical Information	26
ReGeneration by Knoll®	ReGeneration by Knoll® : Flex Back Net Chair	28
	ReGeneration by Knoll® : fully upholstered work chair	30
	ReGeneration by Knoll® Dimensions, Features and Operating Instructions	32
	ReGeneration by Knoll® Technical Information	34
Chadwick™	Chadwick™ : tilt stop control	36
	Chadwick™ : basic control	38
	Chadwick™ Construction Information	40
	Chadwick™ Dimensions and Operating Instructions	42
RPM®	RPM® : basic control	44
	RPM® : advanced control	46
	RPM® : CGSB compliant basic control	48
	RPM® : CGSB compliant advanced control	50
	RPM® Dimensions and Operating Instructions	52
	RPM® Control Index	54
Essentials Work Chairs™	EWC Pro™ : upholstered mid-back task chair	56
	EWC Pro™ : upholstered mid-back conference chair	60
	EWC Pro™ Task Dimensions and Operation Instructions	64
	EWC Pro™ Conference Dimensions and Operating Instructions	66
	EWC Tech™ : suspension back task chair	68
	EWC Tech™ : suspension back conference chair	72
	EWC Tech™ Task Dimensions and Operating Instructions	76
	EWC Tech™ Conference Dimensions and Operating Instructions	78
	EWC Sport™ : upholstered mid-back task chair	80
	EWC Sport™ : upholstered mid-back conference chair	84
	EWC Sport™ Task Dimensions and Operating Instructions	88
	EWC Sport™ Conference Dimensions and Operating Instructions	90
Moment™	side chair	92
	Moment™ Technical and Environmental Information	94
Alpha-Numeric Index		95
Selling Policy		97
General Ordering Information		99

Knoll and Sustainable Design

Each year Knoll sets key initiatives in our journey to sustainability. We are members of a global consortium on energy, have adopted a scientific, metrics-based approach to sustainable product design, and maintain a leadership position in establishing universal, verifiable, sustainability standards for our industry.

Knoll promotes independent third-party certification because it provides the most impartial and trustworthy foundation for industry-wide environmental compliance. Certification by established and respected third parties ensures that all manufacturers are held to the same high standards and that customers can trust a company's declaration about the environmental benefits of its products. Knoll third-party partners include: the International Standards Organization (ISO); Forest Stewardship Council (FSC®); Rainforest Alliance; GREENGUARD® Environmental Institute; and The Business and Institutional Furniture Manufacturer's Association (BIFMA) level® certification from Scientific Certification Systems (SCS).

In addition, Knoll is aligned with the U.S. Green Building Council and can help companies, healthcare organizations and educational institutions achieve Leadership in Energy and Environmental Design (LEED®) workplace certification.

Global Climate Change

- Knoll is a sponsor of the Clinton Global Initiative, which brings together a community of global leaders to devise and implement solutions to some of the world's most pressing challenges, including environmental change.
- Knoll has a comprehensive Energy Management Program to increase energy efficiency in products and processes.

Life Cycle Assessment (LCA) Tool

- Life Cycle Assessment is a science-based measurement of a product's environmental impacts throughout its life cycle, from raw materials sourcing through manufacture, shipping, use and re-use or end-of-life. LCA enables cradle-to-cradle implementation of sustainable practices.
- Knoll has partnered with The Green Standard.org to develop an affordable, universal ISO-compliant computer-based LCA tool that can be used by the entire contract furniture industry and is partnering on the development of an Environmental Product Declaration System (EPDs) for Knoll products. EPDs are verified documents containing LCA results and additional environmental performance information about a product.

Setting Industry Standards

- Knoll partners with MTS (The Institute for Market Transformation to Sustainability) to develop the SMaRT® Consensus Sustainable Products Standards, a set of consensus-based sustainable product standards based on the LEED® model, for all building products, fabric, apparel, flooring and carpet. MTS, the developer of SMaRT®, is an accredited American National Standards Institute (ANSI) standard developer.
- Knoll also partners with BIFMA (Business and Institutional Furniture Manufacturers Association) to promote level® sustainability standards for the contract furniture industry.
- Knoll has established FSC® (Forest Stewardship Council) certified wood as the standard for general office open plan office systems, casegoods and tables.
- Knoll has launched Full Circle, a resource recovery program developed with ANEW, to help customers extend the life cycle of surplus furniture, fixtures and equipment (FF&E) in an economically, socially and environmentally responsible manner.
- Our goal is to encourage all manufacturers in the contract furniture industry and related industries to adopt standards that will lead to sustainable products and practices.

For more information about Knoll and sustainable design, visit knoll.com/environment.

All Knoll Office Seating is GREENGUARD Indoor Air Quality® certified and GREENGUARD for Children & SchoolsSM certified.

All KnollExtra® products are GREENGUARD Indoor Air Quality® certified.

Visit GREENGUARD.org for more information and to find printable certificates for Knoll Office Seating that can be used for verification and LEED® submission.

GREENGUARD provides the only guide to certified low-emitting interior products and building materials. Its goal is to help building owners and managers, architects, interior designers and product specifiers build and furnish healthier offices, hospitals, schools and homes by providing a register of tested and certified low-emitting products and materials.

GREENGUARD certification is recognized by the U.S. Green Building Council's LEED® Program. Air Quality Science, an independent indoor air quality laboratory, tests products submitted for certification using stringent environmental chamber testing protocols and current indoor air quality standard. Certification is administered by the GREENGUARD Environmental Institute (GEI), an industry-independent, non-profit organization.

GREENGUARD for Children & SchoolsSM certification complies with the State of California's Department of Health Services Standard Practice (CA Section 01350) for testing chemical emissions from building products used in schools, offices and other sensitive environments. Certified products can contribute to achieving credits in the CHPS Best Practices Manual for K-12 schools, the LEED® Green Building Rating System, Green Guide for Healthcare™, NAHB Green Building Guidelines, Green Globes, Regreen and numerous other local authorities' green building codes.

Knoll Office Seating and KnollExtra® products can contribute to achieving LEED® credits. GREENGUARD-tested and certified office furniture is required for Credit 4.5 in the LEED-CI Indoor Environmental Quality section.

GREENGUARD Certification Program

- Internationally recognized for evaluating product emissions and certifying building materials, furnishings, finishes and cleaning products and processes that meet stringent indoor air quality criteria defined by GEL.
- Products undergo rigorous, third-party testing to determine their impact on indoor air pollution with requirements for ongoing testing and verification.
- Certification confirms a manufacturer's environmental responsibility, and signifies their environmental achievements through independent, third-party testing and verification.
- GREENGUARD Certified products are recommended by leading sustainable building programs, including:
 - U.S Green Building Council's (USGBC) LEED Rating System,
 - National Association of Home Builders (NAHB) Green Building Guidelines,
 - Green Guide for Health Care (GGHC),
 - Collaborative for High Performance Schools (CHPS) Best Practices Manual,
 - New York City Department of Design and Construction Sustainable Design Specifications, among others.

Use the Following Addresses

If you would like to send a standard lead time order to our order entry department, please use the following address:

For North American orders:
Knoll, Inc.
1235 Water Street
East Greenville, PA 18041
Attn: Order Entry

Fax: 215 679-1788
Tel: 800 343-KNOLL

All accepted orders will be confirmed in writing on the Knoll standard order confirmation form.

For More Information

For complete Knoll Selling Policy and warranty information, please refer to page 97 of this price list.

For additional information on Knoll Office Seating, contact your Knoll representative, a Knoll dealer, or telephone Customer Services at 800 343-KNOLL.

Generation by Knoll®

Dark finish, plastic base p. 22



Dark finish, aluminum base, p. 22



Light finish, plastic base, p. 22



Light finish, aluminum base, p. 22



ReGeneration by Knoll®

Flex Back Net, p. 28



Fully upholstered, p.30



Chadwick™

Task, p. 36



RPM®

Basic control, p. 44



Advanced control, p. 46



Essentials Work Chairs™

EWC Pro™ mid-back task, p. 56



EWC Pro™ mid-back conference, p.60



EWC Tech™ task, p. 68



EWC Tech™ conference, p. 72



EWC Sport™ task, p. 80



EWC Sport™ conference, p. 84



Moment™

Side, p. 92



control	illustration	description	application
Weight-Compensated Control with Synchronized Recline		360° swivel; uses body weight in seat as counterbalance for recline resistance, the chair is perfectly adjusted by sitting in it — no adjustment necessary; promotes movement and balance; preference control accommodates a wider range of users.	Generation by Knoll work chairs
Synchronized Tilt Control		360° swivel; back and seat recline in one synchronized movement to support the user's back throughout the recline. As back reclines, the seat drops down slightly, relieving pressure points.	RPM task chairs (basic and advanced controls) Chadwick task chairs (tilt stop and basic controls) Essentials Work Chairs task and conference versions
Swivel Tilt Control		360° swivel; seat and back tilt at the same ratio at a pivot point under the middle of the seat.	Essential Work Chairs task and conference versions

Fabric Application

The application of the KnollTextiles collection to Knoll Office Seating provides the broadest and most exciting selection of standard fabrics in the contract furniture industry.

Developed in collaboration with leading designers, KnollTextiles upholstery harmonizes pattern, color and texture in the Modernist tradition. Choose from a wide selection of fabrics that are appropriate for corporate, hospitality, and healthcare use, ranging from natural fibers such as wool and cotton, to high performance options like Crypton® fabrics. Visit KnollTextiles.com to search the online database.

Fabrics are grouped into categories referred to as “grades.” The selection of approved fabrics varies by product.

Always check with KnollTextiles for textile changes or new applications on seating.

Visit KnollTextiles.com and click on “Textile Matrices” to find the link to the most up-to-date Seating Approval Matrix.

Performance Upholstery Fabrics

KnollTextiles offers a wide selection of high durability and high performance fabric options. For excellent stain resistance, choose from upholstery products with a Nano-Text™ finish. For a complete moisture barrier, so that nothing penetrates the fabric into the cushion, you can select from among Crypton® stain, moisture, odor and bacteria resistant fabrics. In addition, there are bleach-cleanable upholstery products, such as vinyl and solution-dyed nylon. Visit KnollTextiles.com and click on “Upholstery” or “Technical Documents” for details.

Nano-Text™ and Teflon®: Both Nano-Text and Teflon provide additional performance - spill and stain protection - and come stocked on a number of fabrics. These finishes can also be applied to dozens of KnollTextiles fabrics for an upcharge and additional lead time. For moisture barrier, we also offer Crypton and Gore and Nano-Text with DuraBlock.

Crypton®: KnollTextiles stocks over a dozen patterns with Crypton. It has a moisture barrier plus stain, odor and bacteria resistance, to protect the fabric and the cushion.

Nano-Text® with DuraBlock™:

Nano-Text with DuraBlock provides a durable moisture barrier with a soil and stain resistant topical treatment. Even under high pressure, no liquid can travel through the treatment into the cushion. This finish option is stocked on some products and can be added to many existing KnollTextiles upholstery fabrics for an additional upcharge and lead time.

Environmental Options

KnollTextiles offers dozens of upholstery patterns with recycled content or natural fiber. Included in the line is a selection of 100% recycled upholstery fabrics that have no added backing or finish, and are also recyclable at the end of their use. Visit KnollTextiles.com and click on “Environmental Fabrics” for details.

California Technical Bulletin 133 (Cal 133)

Cal 133 is a flammability test procedure for seating furniture for use in public occupancies. Testing must be performed on the designated seating unit and textile together. Component data alone cannot be used to certify compliance with the regulation. Under Cal 133, one cannot assume that seating or textiles that have passed individually will pass together.

Cal 133 (cont.)

Many Knoll Office Seating products can be specified to comply with Cal 133. Applicable upcharge and specification rules are listed on the respective price list page. Chadwick is Cal 133 approved standard. Please refer to the textile matrix for pre-approved Cal 133 upholstery options for the following chairs:

- Sapper
- Open Up (side chair only)
- Life
- RPM
- Essentials Work Chairs

If any other KnollTextiles fabric or COM is desired, Knoll will test the compliance of the specified fabric on the specified chair. The cost of the test will be the price of the chair in the specified fabric plus \$520. The additional fee is to cover the cost of the test. Please see the respective price list page for yardage requirements. The process time for test results is 4-8 weeks. Contact your Knoll customer service representative at 800 343-KNOLL for further test processing instructions.

	Soil & Stain Resistance		Moisture Barrier Plus Soil & Stain Resistance	
	Teflon®	Nano-Text®	Crypton®	Nano-Text® with DuraBlock™
Soil and Stain Resistant Topical Treatment	Yes (Topical)	Yes (Immersion)	Yes	Yes
Water Repellant Finish	No	Yes	Yes	Yes
Moisture Resistant Backing/Barrier	No	No	Yes *	Yes
Breathable	Yes	Yes	Yes	Yes
Microbial Resistant	No	Yes	Yes	Yes
Fabrics Stocked with Finish	Some	Some	Yes	No
Minimum Yardage on Non-Stocked Fabrics	5	5	n/a	5

*Please Note: The moisture resistant backing/barrier on Crypton fabrics is compromised in the Cal 133 lamination process and is therefore not covered under warranty when specified as Cal 133.

Knoll is pleased to cooperate with Customer's Own Material (COM) or Customer's Own Leather (COL) selections after they have been approved by Knoll.

Please refer to the table below for COM process overview. See price list pages for specific chair information. For additional information see Customer's Own Material section in the Selling Policy.

Seating	Pre-Approval				Application Testing		
	Color Specific Testing?	Send to CSR/PM:	Process Time	Application Test Required?	Requires:	Yardage Required for Test	Process Time
Generation by Knoll	No	COM Seating Form & Memo Sample	2-3 days	No*			
RPM	No	COM Seating Form & Memo Sample	2-3 days	Yes	25 chair minimum order OR PO for \$300	1.5	2-3 weeks
Moment	No	COM Seating Form & Memo Sample	2-3 days	No*			
Essentials Work Chairs	No	COM Seating Form & Memo Sample	2-3 days	No*	25 chair minimum order OR PO for \$100	1	2-3 weeks

*Guideline only – subject to the discretion of the production floor.

Cal 133 COM Process Overview

If COM is desired, the fire barrier must be attached when fabric arrives at Knoll. Intek F187 fire barrier is recommended. Knoll will test the compliance of the specified fabric on the specified chair. The cost of the test will include the price of the chair and COM fabric plus \$520. The fee is to cover the cost of the test. Please see respective price list page for yardage requirement. The process time for test results is 4-8 weeks. Contact your Knoll Customer Service Representative at 800-343-KNOLL (5665) for further test processing instructions.

Textile Name	Grade	Direction	Part #	EWC Pro & EWC Tech Task	EWC Sport	Generation by Knoll
Abacus	B	NR	K715	■ ♣	■ ♣	■ ♣
Alignment	A	NR	K349	■ ♣	■ ♣	■ ♣
Analogy	A	NR	K614	■ **	■	○
Arno	H	NR*	K128	■	■	○
Atelier	F	NR	K1607	■	■	■
Atlas	C	NR*	K1236	■ **	○	■
Axiom	C	NR	K1650	■	○	○
Backdrop	B	NR*	W302	■ **	○	○
Bank Shot	B	NR*	K134	○	○	○
Baxter	C	NR	K1557	■	■	■
Belize	B	NR	K1165	■	■	■
Betwixt	B	NR	K1074	■ **	■	■ ♣
Biota	C	NR	K1297	■ **	■	■ ♣
Bocce	A	NR	K1255	■	■	■ ♣
Calais Cotton Velvet	F	NR	K787	○	○	○
Cameo	B	NR	K1443	■	■	■
Cat's Cradle	A	NR	K1290	■ **	■	■ ♣
Cato	I	RR	KH800	○	○	○
Cavalier	D	NR	K217	■ **	■	■
Century	F	NR	K1051	■ **	■	■
Chance	A	NR	K1552	■	■	■
Charm	C	NR	K1049	■ **	■	■
Chroma	B	NR	K345	■ ** ♣	■ ♣	■
Chronicle	B	NR	K1525	■ ♣	■ ♣	■ ♣
Circa	C	NR	K1054	■ **	■	■
Classic Boucle	B	NR*	K162	■	■	■
Close Knit	B	NR	K201	■	■	■
Coco	F	NR	K1024	■	■	■
Common Ground	A	NR*	K448	■ ** ♣	■ ♣	■ ♣
Compass CR	D	NR	HC1183	■ **	■	■
Cornaro	F	NR	K1320	■	■	■
Coterie	D	NR	K1564	○	○	○
Cricket	C	NR	HC1279	■ **	■	○
Cross Stitch	E	NR	K1026	■	■	■
Cuddle Cloth	F	NR*	K231	■	■	■
Dahlia CR	C	NR	HC1660	■	■	■
Decade	C	NR	K1053	■ **	■	■
Dovetail	B	NR	K1150	■ ** ♣	■ ♣	■ ♣
Dristi	A	NR*	K872	■	■	■
Dynamic	I	NR	K1617	■	■	■
Earthwork	C	NR	K1238	■	■	■ ♣
Echo	C	NR	K1019	■	■	■
Eclat Weave	D	NR	K1104	■ **	■	■
Empire Stripe	C	NR	K1025	■ **	○	○
Enmesh	C	NR	K1092	■ ♣	■ ♣	■ ♣
Entourage	C	NR	K1389	■ ** ♣	■ ♣	■
EWC Sport	A	ND	K1196	■ **	■ ♣	○
Fable CR	C	RR	HC1122	■ **	■	■

■ = Available ○ = Not Available ♣ = Cal 133 Pre-approved ^ = Cal 133 Pre-approved on EWC Tech Task ** = Not available with upholstered outer back
 Updated as of August 2012

Textile Name	Moment	ReGeneration by Knoll Seat	ReGeneration by Knoll Inner Back	RPM Task
Abacus	■ ♣	■ ♣	■ ♣	■ ♣
Alignment	■ *** ♣	■ ♣	■ ♣	■ ♣
Analogy	○	○	○	■
Arno	■ *** ♣	○	○	■ ♣
Atelier	■	■	■	■
Atlas	■	○	○	■
Axiom	■	○	○	■
Backdrop	○	○	○	○
Bank Shot	■ ♣	○	○	○
Baxter	■	■	■	■
Belize	■	■	■	■
Betwixt	○	■ ♣	■ ♣	■
Biota	■	■ ♣	■ ♣	■
Bocce	■	■ ♣	■ ♣	■
Calais Cotton Velvet	○	○	○	○
Cameo	■	■	■	■
Cat's Cradle	■	■ ♣	■ ♣	■
Cato	○	○	○	■
Cavalier	■ ♣	■	■	■ ♣
Century	■	■	■	■
Chance	■	■	■	■
Charm	■ ♣	■	■	■
Chroma	■ ♣	■	■	■ ♣
Chronicle	■ ♣	■ ♣	■ ♣	■
Circa	■	■	■	■
Classic Boucle	■	■	■	■ ♣
Close Knit	■	■	■	■
Coco	○	■	■	■
Common Ground	■ ♣	■	■	■ ♣
Compass CR	■	■	○	■
Cornaro	■	■	■	■
Coterie	○	○	○	○
Cricket	■	○	○	○
Cross Stitch	■ ♣	■	■	■ ♣
Cuddle Cloth	■	■	■	■
Dahlia CR	■ ♣	■	■	■
Decade	■	■	■	■
Dovetail	■ ♣	■ ♣	■ ♣	○
Dristi	○	■	■	■
Dynamic	■ ♣	■	■	■
Earthwork	■ ♣	■ ♣	■ ♣	■
Echo	■ ♣	■	■	■
Eclat Weave	■	■	■	■
Empire Stripe	■	○	○	○
Enmesh	■ ♣	■ ♣	■ ♣	■
Entourage	■ ♣	■	■	■ ♣
EWC Sport	○	○	○	○
Fable CR	■	■	■	■

■=Available ○ =Not Available ♣=Cal 133 Pre-approved ^=Cal 133 Pre-approved on EWC Tech Task **=Not available with upholstered outer back
 Updated as of August 2012

Textile Name	Grade	Direction	Part #	EWC Pro & EWC Tech Task	EWC Sport	Generation by Knoll
Fast Forward	B	NR*	W301	■ **	■	■
Ferry	B	NR*	K1697	■	■	■
Fibra	C	NR	K1105	■ **	■	■
Field Day	B	NR*	K124	■ ♣	■ ♣	■ ♣
Foil Rap	A	NR	W535	○	○	○
Forza	B	NR*	K584	○	○	○
Fox Trot CR	C	NR	HC777	■	■	■
Framework	B	NR	K1447	■ ♣	■ ♣	■
Gala II	B	NR	K1520	■ ** ♣	■ ♣	■ ♣
Gibson	G	NR	K1086	■ **	■	■
Grande	B	NR*	K180	■ **	■	■
Grandview	B	NR	K1463	■	■	■
Groove Line	F	NR	K488	■	■	■
Haiku	H	NR	K1479	■	■	■
Harrison	D	NR	K1084	■ **	■	■
Haze	G	NR	K109	■	■	■
Heavy Metal	A	NR	W539	○	○	○
Highline CR	C	NR	HC1064	■ **	■	■
Hive	B	NR	K1694	○	○	○
Hologram	D	NR	K500	■ ** ♣	■ ♣	■
Hourglass	A	NR	K1523	■	■	■
Hula Hoop	C	NR	K753	■ **	■	■
Icon	F	NR	K1028	■	■	■
In The Loop	D	NR	K490	■	■	○
Intrigue	F	NR	K1551	■	■	■
Jubilee	F	NR	K1445	■ **	■ **	○
Kaleidoscope CR	C	NR	HC1186	○	○	■
Katazome	E	NR	K1459	■ **	■	■
Kimono	E	NR	K1174	■ **	■	■
Kinship	F	NR	K1465	■	■	■
Knoll Felt	B	NR	K1207	■	■	■
Knoll Hopsack	B	NR	K1206	■	■	■
Knoll Velvet	I	RR	K784	○	○	○
Kora CR	C	NR	HC1010	■ **	■	■
Legend CR	C	NR	HC1124	○	○	○
Lore CR	C	NR	HC1123	■ ** ^	■	■
Lyonese Velvet	H	NR*	K530	■	○	○
Lyric	B	NR	K698	■	■	■
Mamba	E	NR	K549	■	■	■
Mariner	A	NR*	K642	■ **	■ **	■
Marquee	E	NR	K1608	■	■	■
Masquerade	D	NR	K806	■	■	■
Menagerie	D	NR	K1322	■	■	■
Metro	C	NR	K1018	■ **	○	■
Mini Stitch	B	RR	K1130	■ ** ♣	■ ♣	■ ♣
Mod Plaid	F	NR	K1630	■	■	■
Monarch	A	NR	K1149	■ ♣	■ ♣	■ ♣
Moto CR	C	NR	HC1002	■ ♣	■ ♣	■

■ =Available ○ =Not Available ♣ =Cal 133 Pre-approved ^ =Cal 133 Pre-approved on EWC Tech Task ** =Not available with upholstered outer back
 Updated as of August 2012

Textile Name	Moment	ReGeneration by Knoll Seat	ReGeneration by Knoll Inner Back	RPM Task
Fast Forward	○	○	○	○
Ferry	■	■	■	■
Fibra	■ ♣	■	■	■
Field Day	■ ♣	■ ♣	■ ♣	■ ♣
Foil Rap	○	○	○	○
Forza	○	○	○	○
Fox Trot CR	■	■	■	■
Framework	■ ♣	■	■	■ ♣
Gala II	■ ♣	■	■	■ ♣
Gibson	■ ♣	■	■	■
Grande	■	■	■	■
Grandview	■	■	■	■
Groove Line	■	■	■	■
Haiku	■	■	■	■
Harrison	■ ♣	■	■	■
Haze	■	■	■	■
Heavy Metal	○	○	○	○
Highline CR	■	■	■	■
Hive	○	○	○	○
Hologram	■	■	■	■
Hourglass	■	■	■	■
Hula Hoop	■	■	■	■
Icon	■ ♣	■	■	■
In The Loop	○	○	○	■
Intrigue	■	■	■	■
Jubilee	■	■	■	■
Kaleidoscope CR	○	■	■	○
Katazome	■ ♣	■	■	■
Kimono	■ ♣	■	■	■
Kinship	■ ♣	■	■	■ ♣
Knoll Felt	■ ♣	■	■	■ ♣
Knoll Hopsack	■ ♣	■	■	■ ♣
Knoll Velvet	○	○	○	○
Kora CR	■	■	■	■
Legend CR	○	○	○	○
Lore CR	■	■	■	■
Lyonese Velvet	○	○	○	■
Lyric	■	■	■	■
Mamba	■	■	■	■
Mariner	■ ♣	■	■	■
Marquee	■ ♣	■	■	■
Masquerade	■	■	■	■
Menagerie	■	■	■	■
Metro	■ ** ♣	○	○	■
Mini Stitch	■ ♣	■ ♣	■ ♣	■ ♣
Mod Plaid	■	■	■	■
Monarch	■ ♣	■ ♣	■ ♣	■ ♣
Moto CR	■	■	■	■

■=Available ○ =Not Available ♣=Cal 133 Pre-approved ^=Cal 133 Pre-approved on EWC Tech Task **=Not available with upholstered outer back
 Updated as of August 2012

Textile Name	Grade	Direction	Part #	EWC Pro & EWC Tech Task	EWC Sport	Generation by Knoll
Night Life	B	NR	K181	■	○	■
Nobel	C	NR	K1556	■	■	■
Nonchalant CR	B	NR	HC198	○	○	■
Obi	D	NR	K1175	■	■	■
Panache CR	C	NR	HC1047	■**	■	■
Paradigm	B	NR	K1101	■	■	■
Parasol	C	NR	HC1257	■**	■	○
Pogo	B	NR	K1100	■** ♣	■ ♣	○
Pony Up	C	RR	K1323	■	■	■ ♣
Pop	B	NR*	K782	■**	■	○
Posh	C	NR	K1163	○	○	○
Prep	A	NR	K1076	■**	■	■ ♣
Presto	A	NR	K1000	■ ♣	■ ♣	■ ♣
Prompt	C	NR	K1505	○	○	■
Quark	C	NR	K781	■	■	■
Ransom	B	NR	K1298	■	■	■ ♣
Rattan	G	NR*	K138	■**	■	■
Regard CR	C	NR	HC1063	○	○	■
Ricochet	B	NR*	K498	■ ♣	■ ♣	■ ♣
Rio	C	NR	K1164	■**	■	■
Rivington	F	NR	K1080	■	■	■
Roam	B	NR	K1657	■	■	■
Roundtrip	C	NR	K1430	■** ♣	■ ♣	■
Sahara	C	NR	HC1269	■	■	○
Sandpiper	C	NR	HC1258	○	■	■
Satellite	D	NR*	K503	■	■	■
Sequin CR	C	NR	HC1009	■	■	■
Serendipity	G	NR	K1528	■	■	■
Shima	E	NR	K1468	○	○	○
Sinclair	C	NR	K1555	■	■	■
Smart	C	NR	K1268	■	■	■
Soiree	B	NR	K1616	■ ♣	■ ♣	■ ♣
Soliloquy	A	NR	K1458	■**	■	■
Sonnet	A	NR	K1460	■ ♣	■ ♣	■ ♣
Spark	B	NR	K1075	■	■	■ ♣
Spectator	C	NR	K1391	■** ♣	■ ♣	■
Spencer	G	NR	K1106	■**	○	■
Spot On	C	NR	K1324	■	■	■
Spotlight	B	NR	K772	■	■	■
Spree	B	NR	K1600	■ ♣	■ ♣	■ ♣
Stacks	A	NR	K528	■	■	■ ♣
Star Struck	C	NR	K1048	■**	■	■
Stepping Stones	C	RR	K346	■**	■	■
Swing	C	NR	K479	■	■	■
Theory	D	NR	K1656	○	○	○
Topography	F	NR	K1052	■	■	■
Totem	F	NR	K1561	■	■	○
Transition	C	NR	K816	■** ♣	■ ♣	■ ♣

■=Available ○ =Not Available ♣=Cal 133 Pre-approved ^=Cal 133 Pre-approved on EWC Tech Task **=Not available with upholstered outer back
 Updated as of August 2012

Textile Name	Moment	ReGeneration by Knoll Seat	ReGeneration by Knoll Inner Back	RPM Task
Night Life	■	■	■	■
Nobel	■	■	■	■
Nonchalant CR	○	○	○	■
Obi	■ ♣	■	■	■
Panache CR	■	■	■	■
Paradigm	■ ♣	■	■	■
Parasol	■	○	○	○
Pogo	■ ♣	○	○	○
Pony Up	■	■ ♣	■ ♣	■
Pop	○	○	○	■
Posh	○	○	○	○
Prep	■ ♣	■ ♣	■ ♣	○
Presto	■ ♣	■ ♣	■ ♣	■ ♣
Prompt	■	○	○	○
Quark	■	■	■	■
Ransom	■	■ ♣	■ ♣	■
Rattan	■	■	■	■
Regard CR	■	■	○	○
Ricochet	■ ♣	■ ♣	■ ♣	■
Rio	■	■	■	■
Rivington	■	■	■	■
Roam	■	■	■	■
Roundtrip	■ ♣	■	■	■ ♣
Sahara	■	○	○	■
Sandpiper	■	■	■	■
Satellite	■ ♣	■	■	■
Sequin CR	■	■	■	■
Serendipity	■	■	■	■
Shima	○	○	○	○
Sinclair	■	■	■	■
Smart	■	○	○	○
Soiree	■ ♣	■ ♣	■ ♣	■ ♣
Soliloquy	■	■	■	■
Sonnet	■ ♣	■ ♣	■ ♣	■
Spark	■ ♣	■ ♣	■ ♣	■ ♣
Spectator	■ ♣	■	■	■ ♣
Spencer	○	■	■	○
Spot On	■	■	■	■
Spotlight	■	■	■	■
Spree	■ ♣	■ ♣	■ ♣	■ ♣
Stacks	■	■ ♣	■ ♣	■
Star Struck	■ ♣	■	■	■
Stepping Stones	■	■	■	■
Swing	■	■	■	■
Theory	○	○	○	○
Topography	■	■	■	■
Totem	■	○	○	○
Transition	■ ♣	■ ♣	■ ♣	■ ♣

■=Available ○ =Not Available ♣=Cal 133 Pre-approved ^=Cal 133 Pre-approved on EWC Tech Task **=Not available with upholstered outer back
 Updated as of August 2012

Textile Name	Grade	Direction	Part #	EWC Pro & EWC Tech Task	EWC Sport	Generation by Knoll
Treble CR	C	NR	HC1062	■	■	■
Tryst	E	NR	K1522	■	○	■
Tweed Frieze	F	NR	K754	○	○	○
Ultrasuede	G	NR	K1021	■ ** ▲	■ ▲	■ ▲
Una	F	NR	K451	■ **	■	■
Utmost	B	NR	K1325	■ **	○	○
Venue	B	NR	K1558	■	■	■
Vibe	C	NR*	K1029	○	○	○
Vinyl	B	ND	K242	■ **	○	○
Whip	E	NR	K1386	■	■	■
Wide Angle	B	NR	K244	■ ▲	■ ▲	■ ▲
Zari CR	C	NR	HC1008	■ **	■	■
Zephyr	B	NR	K724	■ **	■	■
Zipline	B	NR	K1448	■ ** ▲	■ ▲	■
Zoom	D	NR	K1131	■ ** ▲	○	■

■=Available ○ =Not Available ▲=Cal 133 Pre-approved ^=Cal 133 Pre-approved on EWC Tech Task **=Not available with upholstered outer back
 Updated as of August 2012

Textile Name	Moment	ReGeneration by Knoll Seat	ReGeneration by Knoll Inner Back	RPM Task
Treble CR	■	■	■	■
Tryst	○	○	○	■
Tweed Frieze	○	○	○	○
Ultrasuede	■ ♣	■ ♣	■ ♣	○
Una	○	■	■	■
Utmost	■	○	○	■
Venue	■	■	■	■
Vibe	■	○	○	■
Vinyl	○	○	○	■
Whip	■ ♣	■	■	■
Wide Angle	○	■ ♣	■ ♣	■
Zari CR	■	■	○	■
Zephyr	■	■	■	■
Zipline	■ ♣	■	■	■ ♣
Zoom	■ *** ♣	■	■	○

For the ultimate in comfort, durability, and prestige, many Knoll Office Seating products can be upholstered in Spinneybeck leathers.

Spinneybeck leathers are made from the top 2% of the world's finest hides, inspected numerous times during production.

After tanning, all Spinneybeck leathers are drum-dyed, a time-consuming procedure which ensures color penetration throughout the hide. Then each hide is finished in the manner which will best bring out its individual character.

Spinneybeck leathers are all full-grain aniline drum-dyed products imported from Italy.

The following Spinneybeck leathers are approved for application on Knoll Office Seating products. Leathers are grouped into five price categories referred to as "grades." The selection of approved leathers varies by product. Please refer to the pricing page for each product line for more information.

Square footage requirements for Customer's Own Leather (COL) are listed on each chair's pricing page. Please refer to COM Seating Process Overview for further information regarding COL.

For further information, call Spinneybeck at 1 800 482-7777.

Grades

T

Vicenza

Characteristics

Finished cowhide, corrected grain that is slightly raised.

U

Verona

Volo

Finished cowhide, corrected grain and raised texture.

Finished cowhide, corrected grain, slightly raised grain texture.

V

Acqua

Andes

Embossed

Tipped

España

Hand Tipped

Maremma

Velluto Pelle

Water-repellent finished cowhide, corrected grain, slightly raised grain texture.

Slightly pronounced grain, finished cowhide and enhanced grain.

Corrected grain, aniline dyed, two-tone, heavily finished leathers breathable protective finish.

Smooth, tight grain cowhide; breathable, protective finish, enhanced grain.

Two-toned leather, lightly finished cowhide, pronounced pebble grain texture.

Full grain textured suede with impregnated soil-resistant treatment.

Slightly pronounced grain, finished cowhide and enhanced grain.

W

Alaska

Amazon

Antique

Arizona

Derby

Forte

Lucente

Sabrina

Pearlized-iridescent protective finish cowhide, full grain with smooth texture.

Mid-weight, full grain cowhide; colors of the Amazonian jungle, raised grain texture.

Smooth tight grain cowhide, lightly antiqued to produce an elegant patina, enhanced grain .

Full grain, lightly finished kip; ironed for tight, smooth texture, glove-like hand.

Combination-tanned cowhide; full grain, lightly finished and raised grain texture.

High performance, full grain leather with slightly pronounced grain texture.

Smooth, very tight grain cowhide; subtle sheen; light casein finish.

Smooth, tight and full grain cowhide with a breathable protective finish.

X

Ducale

Ducale Velour

Embossed shrunken grain cowhide with protective finish, full grain.

Full grain-sueded cowhide, embossed shrunken grain, scotch-guarded.

Y

Capri

Cervo

Copenhagen

Cordovan

Distressed

Marissa

Portofino

Prima

Riva

Saddle

Salon

Chrome-free, light protective finish, full grain cowhide.

Full aniline, cowhide, pronounced grain texture, extremely soft and supple hand.

Full aniline, 100% vegetable tanned leather, full grain.

Aniline-dyed cowhide, light waxy finish, supple hand, full grain.

Aniline-dyed, paraffin wax final ironing process with a smooth finish, and full grain.

Grain-sueded cowhide, smooth suede grain with soil resistant treatment.

Full grain, lightly finished cowhide with a pronounced raised texture.

Full aniline, special oils provide a very elegant and supple hand.

Slightly pronounced grain texture, water-repellent, full grain.

Full aniline, smooth very tight grain surface takes on a rich patina over time.

Full aniline cowhide, ironing process provides a lustrous sheen of traditional leathers.

Leather Name	Grade	Part #	EWC Pro & EWC Tech	EWC Sport	Generation by Knoll	Moment	ReGeneration by Knoll Seat	ReGeneration by Knoll Inner Back	RPM Task
Acqua	V	AU	■ ♣	■ ♣	■ ♣	■ ♣	■	■	■
Alaska	W	AL	■ ♣	■ ♣	■ ♣	■ ♣	■	■	■
Amazon	W	AM	○	○	■	■ ♣	■	■	○
Andes	V	AD	■ ♣	■ ♣	■ ♣	■ ♣	■	■	■
Antique	W	AQ	■ ♣	■ ♣	■ ♣	■ ♣	■	■	■
Arizona	W	AR	■	■ ♣	■ ♣	■ ♣	■	■	■
Capri	Y	CP	○	○	■	■ ♣	■	■	■
Cervo	Y	CV	■	■	■	■	■	■	■
Copenhagen	Y	CO	■**	■	■	■ ♣	■	■	■
Cordovan	Y	CD	○	○	■ ♣	■ ♣	■	■	■
Derby	W	DE	○	○	■	■ ♣	■	■	■
Distressed	Y	DT	■**	■	■	■ ♣	■	■	■
Ducale	X	DL	○	○	■	○	■	■	○
Ducale Velours	X	DV	○	○	■	○	■	■	○
Embossed Tipped	V	ET	○	○	■ ♣	■ ♣	■	■	○
España	V	ES	■ ♣	■ ♣	■ ♣	■ ♣	■	■	■
Forte	W	FE	■ ♣	■ ♣	○	■ ♣	○	○	○
Hand Tipped	V	HT	○	○	■	■ ♣	■	■	○
Lucente	W	LU	○	○	○	○	○	○	○
Maremma	V	MM	○	○	■	■ ♣	■	■	○
Marissa	Y	MA	■ ♣	■ ♣	■ ♣	■ ♣	■	■	○
Portofino	Y	PT	○	○	○	■ ♣	○	○	○
Prima	Y	PR	■ ♣	○	■ ♣	■ ♣	■	■	○
Riva	Y	RA	■	■ ♣	■ ♣	■ ♣	■	■	○
Sabrina	W	SA	■ ♣	■ ♣	■ ♣	■ ♣	■	■	■
Saddle	Y	SL	○	○	○	○	○	○	○
Salon	Y	SN	○	○	■	■ ♣	■	■	○
Velluto Pelle	V	VP	■ ♣	■ ♣	■ ♣	■ ♣	■	■	■
Verona	U	VR	■	■ ♣	■	■ ♣	■	■	■
Vicenza	T	VZ	■	■ ♣	■ ♣	■ ♣	■	■	■
Volo	U	VO	■ ♣	■ ♣	■ ♣	■ ♣	■	■	■

Any of our leather grades may be perforated with any of the patterns shown below to create a crisp, contemporary look.

Perforated Leather is a specialty product, available only on a custom order basis. Please use pattern numbers below. Perforated Leather is available in half hides only. Not recommended on outside back applications (e.g. Bulldog)

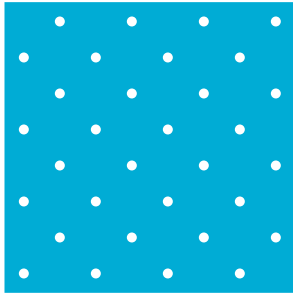

Pattern #330
.052 in. diameter
diagonal pattern
12 holes per square inch

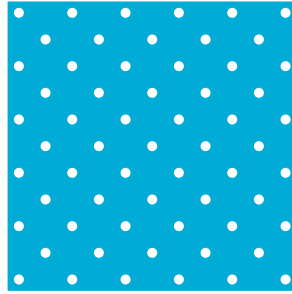

Pattern #457
.052 in. diameter
diagonal pattern
21 holes per square inch

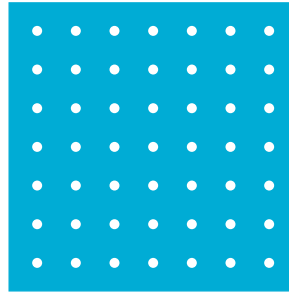

Pattern #1875
.052 in. diameter
straight pattern
25 holes per square inch

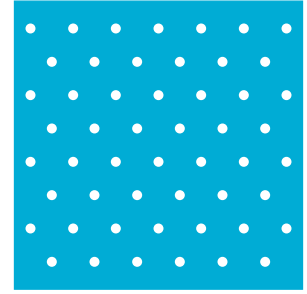

Pattern #560
.052 in. diameter
staggered pattern
22 holes per square inch

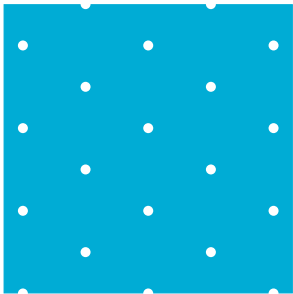

Pattern #280 *
.052 in. diameter
staggered pattern
7 holes per square inch

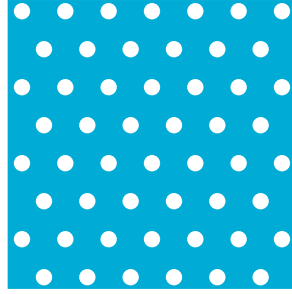

Pattern #560-85
.085 in. diameter
staggered pattern
20 holes per square inch

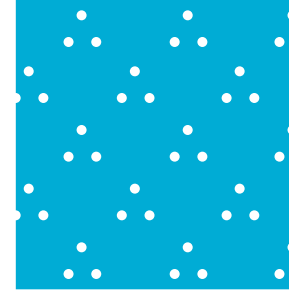

Pattern Multiple Diamond
.052 in. diameter
tri-star pattern
18 holes per square inch

Need Graphic

Pattern #825
.050 in. diameter
diagonal pattern
75 holes per square inch





Waiting on Graphic

Pattern #419 Mini Perf
.052 in. diameter
straight pattern
70 holes per square inch

* Not available on Parachute, Soho, Bulldog One-piece, RPM

This page intentionally left blank

Generation by Knoll® work chair

model	description	pattern no.
<p><i>Designer(s):</i> Formway Design, 2009</p> <p><i>Award(s):</i> NeoCon Gold, Best of NeoCon, Task Chair - Seating, June 2009, USA Best of Year Award, <i>Interior Design</i>, Seating: Contract/Task, December 2009, USA GOOD DESIGN Award, Chicago Athenaeum, 2009, USA Product of the Year: Workplace Seating, FX International Interior Design Awards, November 2010, UK Middle East Office, Exhibition Gold Award, 2010</p> 	armless 	plastic base, standard cylinder, no optional lumbar, hard casters 11-1-NA-2-S-X-HC-ASMQ
	fixed arms 	plastic base, standard cylinder, no optional lumbar, hard casters 11-1-FA-2-S-X-HC-ASMQ
	height adjustable arms 	plastic base, standard cylinder, no optional lumbar, hard casters 11-1-HA-2-S-X-HC-ASMQ
	high performance arms 	plastic base, standard cylinder, no optional lumbar, hard casters 11-1-HP-2-S-X-HC-ASMQ

list price	base grade	grades	COM	C	D	E	F	G	H	I	T	U	V	W	X	Y
\$1,091.		A	B													
\$1,143.																
\$1,164.																
\$1,179.																
\$1,196.																
\$1,216.																
\$1,227.																
\$1,248.																
\$1,284.																
\$1,316.																
\$1,337.																
\$1,379.																
\$1,469.																
\$1,584.																
\$1,636.																
\$1,684.																
1,301.	1,353.	1,374.	1,389.	1,406.	1,426.	1,437.	1,458.	1,494.	1,526.	1,547.	1,589.	1,679.	1,794.	1,846.	1,894.	
1,301.	1,353.	1,374.	1,389.	1,406.	1,426.	1,437.	1,458.	1,494.	1,526.	1,547.	1,589.	1,679.	1,794.	1,846.	1,894.	
1,406.	1,458.	1,479.	1,494.	1,511.	1,531.	1,542.	1,563.	1,599.	1,631.	1,653.	1,694.	1,784.	1,899.	1,951.	1,999.	

Order Code	Ordering Information	Options
<i>Example:</i> 11-1-HP-2-S-X-HC-ASMQ-DK-01-USF-GENU01	<i>Specify:</i>	<i>Lumbar Option:</i>
11 Generation by Knoll	1. Pattern number	For height adjustable lumbar, replace X in pattern with L
1 Work chair	2. Finish color	
HP High performance arms	3. Flex Back Net color	<i>Code: Description:</i>
2 Plastic base	4. Seat foam	L \$82 height adjustable lumbar support
S Standard cylinder	5. Seat textile	
X No optional lumbar		<i>Casters and Glides:</i>
HC Hard casters for soft floors		Replace HC in pattern with one of the following:
ASMQ Fully assembled	<i>Options</i>	
DK Dark finish	<i>Polished Aluminum Base:</i>	
01 Storm Flex Back Net color	Replace 2 in pattern with 4	<i>Code: Upchg: Description:</i>
USF Ultra seat foam	<i>Code: Upchg: Description:</i>	SC \$41 soft casters for hard floors
GENU01 Generation Fabric, Storm	4 \$87 polished aluminum base	GL n/c glides (reduce chair height by 0.25")
	<i>Cylinder Height Options:</i>	<i>Glide detail</i>
<i>Example for Cal 133:</i>	For height ranges see Generation Dimensions page. Replace S in pattern with one of the following:	
11-1-HP-2-S-X-HC-ASMQ-DK-01-USF-C-GENU01-133		
	<i>Code: Description:</i>	<i>Seat Foam Options:</i>
	L low cylinder	Select one of the following:
	H high cylinder	<i>Code: Description:</i>
		TSF thin seat foam
		USF ultra seat foam

Generation Fabric - Base Grade	Textile Options
Generation Fabric prefix GENT for thin seat foam or GENU for ultra seat foam, followed by two digit color code. Select one of the following:	<i>Knoll Textiles fabrics and Spinneybeck leathers:</i> Please refer to the textile matrices at the beginning of the price list for approved fabrics and leathers.
<i>Code: Description:</i>	<i>Customer's Own Material/Leather:</i> See Customer's Own Material Seating Process Overview at the beginning of the price list
01 Storm	
03 Pebble	
04 Desert	
05 Lemongrass	
06 Espresso	
07 Firecracker	
08 Bluemarine	
09 Onyx	
10 Olive	
	COM/COL Textile Requirements (for both thin and ultra seat foam):
	COM fabric .75 yards
	COL leather 11 sq. ft.
	<i>Cal 133:</i> See textile matrices at the beginning of the price list for additional Cal 133 pre-approved textiles. Onyx finish only approved for Cal 133. Generation Fabric is Cal 133 approved but it must be specified as described below and the upcharge does apply. ♣ = Cal 133 pre-approved
	To specify, insert C before seat textile selection and 133 after it.
	<i>Code: Upchg: Description:</i> C()133 \$ 102 Cal 133 compliant

Seat*	BIFMA G1-2002 Ergonomic Guidelines	Generation by Knoll Ergonomic Dimensions	
		Thin Seat Foam	Ultra Seat Foam
Seat Height	15" - 19.9" minimum range (one or combination of chairs)	15" - 19.5" (low cylinder) 16.5" - 21.75" (standard cylinder) 17.75" - 23.25" (high cylinder)	15.75" - 20.25" (low cylinder) 17.25" - 22.5" (standard cylinder) 18.5" - 24" (high cylinder)
Seat Depth (Adjustable)	Include 16.9" or less in range	15" - 18" (with arms) 15" - 17.5" (armless)	15.75" - 18.75" (with arms) 15.75" - 18.25" (armless)
Seat Width	18" minimum	21"	
Seat Pan Angle (Fixed)	In range of 0° - 4° rearward	2.85° rearward at rest	

Back*		
Backrest Height	12.2" minimum	24.125"
Backrest Width	14.2" minimum	19.375" at top of lumbar area
Lumbar Support (Fixed)	In range of 5.9" - 9.8"	9.25"
Lumbar Support (Adjustable)	Include part of 5.9" - 9.8" range	8.125" - 11.375" (optional lumbar)
Angle Between Seat and Back	≥90°, include 10° movement in 90° - 115° range	96° - 111°
Tilt Range of Back	10° minimum	15°

Arms*			
Armrest Height from Seat (Fixed)	between 7.9" - 9.8"	10" (fixed)	9.5" (fixed)
Armrest Height from Seat (Adjustable)	6.9" - 10.8" minimum range (single or multiple sets of arms)	6.625" - 11.125" (height adjustable) 6.625" - 11.125" (high performance)	6.125" - 10.625" (height adjustable) 6.125" - 10.625" (high performance)
Inside Distance Between Armrests (Fixed)	18" minimum	21.5" (fixed and height adjustable)	
Inside Distance Between Armrests (Adjustable)	Include 18" in range	17.5" - 19.5" (high performance)	

* All measurements taken with BIFMA Chair Measuring Device using the Universal Measurement Procedure which has a measurement uncertainty of ±5%

Generation by Knoll Chair Measurements**

A. Overall Height	39.25" - 44.5" (glides reduce height by 0.25")
B. Overall Width	21" armless 28.5" with arms
C. Overall Depth	26" excluding base
D. Arm Height from Floor	26.625" - 32" (fixed arms) 22.75" - 32.5" (height adjustable and high performance arms)
E. Base Diameter	26.75"
Weight	37 lbs. (plastic base, high performance arms) 39 lbs. (aluminum base, high performance arms)

**Standard cylinder

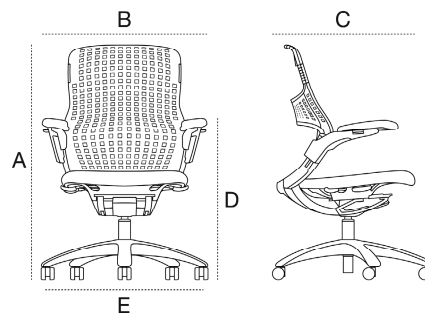

Generation by Knoll Performance Information

Synchronized recline ratio seat:back is 1°:4.4°
Arm pads measure 9.6" long x 4.3" wide
High performance arm pads adjust 2" in width (1" per arm), 1.5" in depth and pivot 45°
Flex Top folds up to 90° rearward

Compliancy: ANSI/BIFMA X5.1 : 2011 (U.S. structural standard)
 BIFMA G1 : 2011 (U.S. ergonomic guidelines)
 ANSI/HFES 100-2007 (U.S. ergonomic standard)
 California T.B. 117 (U.S. flammability standard for foam)
 California T.B. 133 with approved FR textile and Dark finish with fire-retardant additive (U.S. flammability standard for full chair)
 EN 1335-1 : 2000 (European ergonomic standard)
 AS/NZS 4438 : 1997 Level 6 (Australia, New Zealand structural and dimensional standard)
 The Generation by Knoll work chair has been tested and is approved for use by individuals weighing up to 300 pounds

Generation by Knoll® Features and Operating Instructions

No Adjustment Necessary

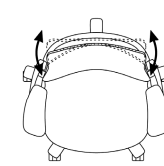

Flex Back

Sit back and the Flex Back supports you and responds to your multidimensional movements.



Flex Top

Simply rest your arms comfortably over the top of the Flex Back.

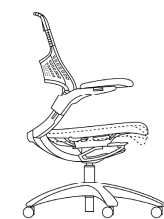

Flex Seat

Sit in any position—forward or sideways—and the Flex Seat supports you with 270° of seat edge flex.

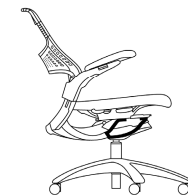

Dynamic Suspension control

The synchronized recline counterbalances your body weight for a smooth and effortless ride. Four independent flexors act as suspension devices that respond to your multidirectional movements—forward, backward and side-to-side.

Intuitive Adjustments (Standard)

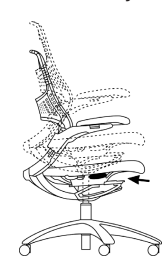

Seat height

Lift the right front lever. Sit down to lower the seat or remove your weight to raise it. Release the lever to lock.

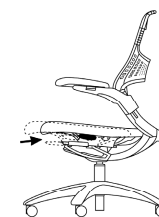

Seat depth

While seated, lift the left lever and slide the seat to the desired position. Release the lever to lock.

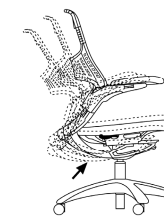

Tilt preference selector

Select the degree of recline movement for your preference and your task. Sit fully upright. Rotate the back right lever until it clicks into one of three positions—all the way back for the most movement, in the middle for less, or all the way forward for greater upright support.

Performance Options

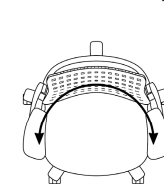

Arm options

Cantilevered arm supports provide seated clearance for your legs and feature Continuous Lumbar, so your back is supported when side sitting.

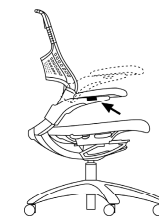

Height adjustable arm

To adjust the height, lift the lever on the arm and lift the arm to disengage. Slide the arm to the desired position and release the lever to lock.

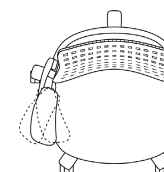

High performance arm

To adjust the height, lift the lever on the arm and lift the arm to disengage. Slide the arm to the desired position and release the lever to lock. Free float arm pads move easily in width and depth, and pivot.

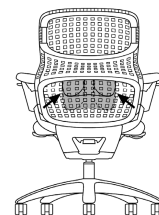

Height adjustable lumbar

Grasp both sides of the lumbar support and slide it to the desired position.

CONSTRUCTION INFORMATION

Flex Back

Integrally colored, high performance elastomer and glass reinforced polyester structure

Fixed, height adjustable and high performance arms

Burnished cast aluminum and integrally colored, glass reinforced nylon supports with integrally colored, self skinning polyurethane arm pads

Flex Seat

High-resiliency molded urethane foam with textile cover and integrally colored, glass reinforced, impact modified nylon structure

Controls

A. Dynamic Suspension control

A solid state construction of integrally colored, high performance elastomer, glass reinforced polyester and cast zinc

B. Tilt preference selector

Integrally colored nylon and acetal; integrally colored, glass reinforced acetal

C. Seat depth adjustment mechanism
Steel plate with integrally colored polypropylene parts

Pneumatic cylinder

Steel

Base

Burnished cast aluminum or integrally colored, glass reinforced nylon; five star design

Hard casters and glides

Integrally colored nylon

Soft casters

Integrally colored nylon over molded with thermoplastic polyurethane

Height adjustable lumbar

Integrally colored, glass reinforced polycarbonate

CLEANING INSTRUCTIONS

Hard surfaces and Flex Back Net

General cleaning

Frequent vacuuming or light brushing to remove dust and grime is recommended. Spot clean with a mild upholstery shampoo or the foam from a mild detergent. When using a cleaning product, follow instructions carefully and clean only in a well-ventilated room. Avoid any product that contains carbon tetrachloride or other toxic materials. With any method, pretest a small area before proceeding. When an overall soiled conditioned has been reached, use a professional furniture cleaning service or call Knoll Field Service at 800-445-5045 with questions.

Healthcare cleaning

Generation's hard surfaces and Flex Back Net successfully passed third-party testing for the following five cleaning agents commonly used in healthcare facilities:

- Clorox Germicidal Liquid Bleach diluted 1:5 ratio to tap water (pH 3.7)
- Clorox Cleanup undiluted 100% solution (pH 9.7)
- Wex-Cide 128 Concentrate Phenolic Germicide by Wexford Labs diluted 1 ounce to 1 gallon tap water (pH 3.7)
- Formula 880 Quaternary Germicide by Grand Technologies diluted 1/2 ounce to 1 gallon tap water (pH 8.1)
- Hydroxi Pro Concentrate 128 by Core Products diluted 1:8 ratio to tap water (pH 7.2)

In addition to the testing detailed above, Knoll has conducted internal testing of Virox 5 RTU cleaning solution on Generation structural parts with no adverse effects.

Generation Fabric

Cleaning code W-S: water or solvent based cleaning agent; can be cleaned with low environmental impact cleaning fluids, including CS-37 certified products. See KnollTextiles Price List for further details on cleaning codes.

ENVIRONMENTAL

SMaRT® Sustainable Platinum certified

SMaRT® Consensus Sustainable Product Standard is a comprehensive, transparent sustainable product standard that measures a product's environmental, economic and social benefits over its life cycle and throughout its global supply chain, from raw materials extraction through use, reclamation or re-use. Generation can contribute to achieving a LEED® Innovation in Design credit for its SMaRT® certification.

BIFMA level® 3 certified

BIFMA has established level® as a common framework against which to evaluate the environmental and social responsibility of a variety of products. level® is part of BIFMA's ongoing development of voluntary product and industry standards that support safe, healthy and sustainable workplaces. To achieve level® certification, Knoll partners with Scientific Certification Systems (SCS), known for its integrity and scientific rigor.

GREENGUARD certified

Generation is GREENGUARD Indoor Air Quality Certified® and GREENGUARD Children & Schools™ certified and can contribute to achieving LEED® credits.

Warranty:

Generation by Knoll is warranted for 12 years, 24-hour, 7 days a week, multi shift use including the Flex Back Net, structural and operational parts, controls, casters, and pneumatic cylinders; 12 years parts and labor to repair; 3 years upholstery, finishes and labor to repair. See Knoll Selling Policy for further details, conditions and exclusions.



This page intentionally left blank.

ReGeneration by Knoll®

Flex Back Net Chair

Designer(s):
Formway Design, 2012



model	description	pattern no.
armless 	high performance elastomer suspension back, recline resistance feature, sliding seat, plastic base, standard cylinder, no optional lumbar, hard casters	44-1-NA-2-S-X-HC-ASMQ
height adjustable 	high performance elastomer suspension back, recline resistance feature, sliding seat, plastic base, standard cylinder, no optional lumbar, hard casters	44-1-HA-2-S-X-HC-ASMQ
high performance 	high performance elastomer suspension back, recline resistance feature, sliding seat, plastic base, standard cylinder, no optional lumbar, hard casters	44-1-HP-2-S-X-HC-ASMQ

list price base grade	grades COM	A	B	C	D	E	F	G	H	I	T	COL U	V	W	X	Y
\$840.	\$855.	\$860.	\$875.	\$895.	\$900.	\$925.	\$940.	\$970.	\$1,015.	\$1,035.	\$1,055.	\$1,140.	\$1,225.	\$1,255.	\$1,290.	
1,040.	1,055.	1,060.	1,075.	1,095.	1,100.	1,125.	1,140.	1,170.	1,215.	1,235.	1,255.	1,340.	1,425.	1,455.	1,490.	
1,140.	1,155.	1,160.	1,175.	1,195.	1,200.	1,225.	1,240.	1,270.	1,315.	1,335.	1,355.	1,440.	1,525.	1,555.	1,590.	

Order Code	Ordering Information	Options
<i>Example:</i> 44-1-HP-2-S-X-HC-ASMQ-DK-09-USF-RU01	<i>Specify:</i> 1. Pattern number 2. Finish color 3. Flex Back Net color 4. Seat foam 5. Seat textile	<i>Lumbar Option:</i> For optional lumbar, replace X in pattern with L <i>Note:</i> To order a lumbar separately, use pattern number 44LUMBAR. The list price is \$50.
44 ReGeneration by Knoll		<i>Flex Back Net Colors:</i> Select one of the following back colors: <i>Code: Description:</i> 03 Pebble (medium grey) 06 Espresso (brown) 09 Onyx (black) 10 Olive (dark green)
1 Flex Back Net model		<i>Seat Foam Options:</i> Select one of the following: <i>Code: Description:</i> TSF thin seat foam USF ultra seat foam (default)
HP High performance arms		<i>Casters and Glides:</i> Replace HC in pattern with one of the following: <i>Code: Upchg: Description:</i> SC \$40 soft casters for hard floors GL n/c glides
2 Plastic base		<i>Finish Color:</i> <i>Code: Description:</i> DK Dark finish
S Standard cylinder		
X No optional lumbar		
HC Hard casters for soft floors		
ASMQ Fully assembled	<i>Polished Aluminum Base:</i> Replace 2 in pattern with 4 <i>Code: Upchg: Description:</i> 4 \$70 polished aluminum base	
DK Dark finish		
09 Onyx Flex Back Net color		
USF Ultra seat foam		
RU01 Generation Fabric, Storm		
<i>Example for Cal 133:</i> 44-1-HP-4-S-X-HC-ASMQ-DK-01-USF-C-K448/12-133	<i>Cylinder Height Options:</i> For height ranges see ReGeneration Dimensions page. Replace S in pattern with one of the following: <i>Code: Description:</i> L low cylinder H high cylinder	

Generation Fabric - Base Grade	Textile Options
Generation Fabric prefix RT for thin seat foam or RU for ultra seat foam, followed by two digit color code. Select one of the following: <i>Code: Description:</i> 01 Storm 03 Pebble 04 Desert 05 Lemongrass 06 Espresso 07 Firecracker 08 Bluemarine 09 Onyx 10 Olive	<i>Knoll Textiles fabrics and Spinneybeck leathers:</i> Please refer to the textile matrices at the beginning of the price list for approved fabrics and leathers. <i>Customer's Own Material/Leather:</i> See Customer's Own Material Seating Process Overview at the beginning of the price list COM/COL Textile Requirements For both thin and ultra seat foam: COM seat = .7 yards COL seat = 11 square feet
	<i>Cal 133:</i> See textile matrices at the beginning of the price list for pre-approved Cal 133 textiles. ‡ = Cal 133 pre-approved To specify, insert C before seat textile selection and 133 after it <i>Code: Upchg: Description:</i> C()133 \$50 Cal 133 compliant

ReGeneration by Knoll®
fully upholstered work chair

	model	description	pattern no.
<p>Designer(s): Formway Design, 2012</p> 	armless	full upholstery over a high performance elastomer suspension back, recline resistance feature, sliding seat, plastic base, standard cylinder, hard casters	44-2-NA-2-S-X-HC-ASMQ
	height adjustable	full upholstery over a high performance elastomer suspension back, recline resistance feature, sliding seat, plastic base, standard cylinder, hard casters	44-2-HA-2-S-X-HC-ASMQ
	high performance	full upholstery over a high performance elastomer suspension back, recline resistance feature, sliding seat, plastic base, standard cylinder, hard casters	44-2-HP-2-S-X-HC-ASMQ

list price base grade	grades COM	A	B	C	D	E	F	G	H	I	T	COL U	V	W	X	Y
\$990.	\$1,020.	\$1,050.	\$1,080.	\$1,100.	\$1,110.	\$1,160.	\$1,190.	\$1,250.	\$1,340.	\$1,350.	\$1,380.	\$1,400.	\$1,470.	\$1,510.	\$1,565.	
1,190.	1,220.	1,250.	1,280.	1,300.	1,310.	1,360.	1,390.	1,450.	1,540.	1,550.	1,580.	1,600.	1,670.	1,710.	1,765.	
1,290.	1,320.	1,350.	1,380.	1,400.	1,410.	1,460.	1,490.	1,550.	1,640.	1,650.	1,680.	1,700.	1,770.	1,810.	1,865.	

Order Code	Ordering Information	Options	Generation Fabric - Base Grade
<i>Example:</i> 44-2-HP-2-S-X-HC-ASMQ-DK-USF-RU09-RB09-ROB09	<i>Specify:</i> 1. Pattern number 2. Finish color 3. Seat foam 4. Seat textile 5. Inner back textile 6. Outer back Generation Fabric color	<i>Casters and Glides:</i> Replace HC in pattern with one of the following: <i>Code: Upchg: Description:</i> SC \$40 soft casters for hard floors GL n/c glides <i>Finish Color:</i> <i>Code: Description:</i> DK Dark finish <i>Seat Foam Options:</i> Select one of the following: <i>Code: Description:</i> TSF thin seat foam USF ultra seat foam (default)	Generation Fabric prefix RT for thin seat foam or RU for ultra seat foam, RB for inner back textile, and ROB for outer back textile, followed by two digit color code. Select one of the following: <i>Code: Description:</i> 01 Storm 03 Pebble 04 Desert 05 Lemongrass 06 Espresso 07 Firecracker 08 Bluemarine 09 Onyx 10 Olive
44	ReGeneration by Knoll		
2	Fully upholstered back		
HP	High performance arms		
2	Plastic base		
S	Standard cylinder		
X	No optional lumbar		
HC	Hard casters for soft floors		
ASMQ	Fully assembled		
DK	Dark finish		
USF	Ultra seat foam		
RU09	Seat textile in Generation Fabric, Storm	<i>Polished Aluminum Base:</i> Replace 2 in pattern with 4 <i>Code: Upchg: Description:</i> 4 \$70 polished aluminum base <i>Cylinder Height Options:</i> For height ranges see Generation Dimensions page. Replace S in pattern with one of the following: <i>Code: Description:</i> L low cylinder H high cylinder	
RB09	Inner back textile in Generation Fabric, Storm		
ROB09	Outer back in Generation Fabric, Storm		
<i>Example for Cal 133:</i> 44-2-HP-2-S-X-HC-ASMQ-DK-USF-C-RU09/133-RB09/133-ROB09			

Textile Options
<p><i>KnollTextiles fabrics and Spinneybeck leathers:</i> Please refer to the textile matrices at the beginning of the price list for approved fabrics and leathers for the seat and inner back.</p> <p>Note: ReGeneration outer back can only be upholstered with Generation Fabric.</p>
<p><i>Customer's Own Material/Leather:</i> See Customer's Own Material Seating Process Overview at the beginning of the price list</p> <p>COM/COL Textile Requirements</p> <p>COM seat (TSF and USF) = .7 yards COM inner back = 1.2 yards COL seat (TSF and USF) = 11 square feet COL inner back = 14 square feet</p>
<p><i>Cal 133:</i> See textile matrices at the beginning of the price list for pre-approved Cal 133 textiles. ♣ = Cal 133 pre-approved</p> <p>To specify, insert C before textile selections and 133 after the seat and inner back textile codes.</p> <p><i>Code: Upchg: Description:</i> C()133 \$100 Cal 133 compliant</p>

	ANSI/HFES 100-2007 Ergonomic Standard (bold = shall)	ReGeneration by Knoll Ergonomic Dimensions	
		Thin Seat Foam	Ultra Seat Foam
Seat*			
Seat Height	4.5" range minimum, within 15" - 22"	15" - 19.7" (low cylinder) 16.4" - 21.6" (standard cylinder) 18" - 23.2" (high cylinder) 22" - 30.8" (high task)	15" - 19.7" (low cylinder) 16.4" - 21.6" (standard cylinder) 18" - 23.2" (high cylinder) 22" - 30.8" (high task)
Seat Depth (Adjustable)	Include 16.9" or less in range	16" - 18"	16" - 18"
Seat Width	17.7" minimum	19.7"	19.7"
Seat Pan Angle (Fixed)	n/a	2° rearward at rest	3° rearward at rest
Seat Pan Angle (Adjustable)	Minimum range of 4°, including 3° rearward	2° - 6° rearward during recline	3° - 7° rearward during recline
Back*			
		Flex Back Net	Fully upholstered
Backrest Height	17.7" minimum	23.1"	23.1"
Backrest Width	14.2" minimum	19.9"	19.9"
Lumbar Support (Fixed)	In range of 5.9" - 9.8"	8.5"	8.5"
Lumbar Support (Adjustable)	Include 5.9" - 9.8" in range	8.9"	n/a
Angle between Seat and Back	≥90°, include 15° movement in 90° - 120° range	95° (work and high task chairs)	96° (work and high task chairs)
Tilt Range of Back	15° minimum	15° (work chair) 4° (high task chair)	15° (work chair) 4° (high task chairs)
Arms*			
		Thin Seat Foam	Ultra Seat Foam
Armrest Height from Seat (Adjustable)	6.7" - 10.6" minimum range	6.8" - 10.8" height adjustable arms 6.6" - 10.8" high performance arms	6.7" - 10.7" height adjustable arms 6.5" - 10.7" high performance arms
Inside Distance between Armrests (Fixed)	18.1" minimum	19.7" height adjustable arms	19.7" height adjustable arms
Inside Distance between Armrests (Adjustable)	Adjustable by user	16" - 20" high performance arms	16" - 20" high performance arms

* All measurements taken with the BIFMA Chair Measuring Device using the Universal Measurement Procedure which has a measurement uncertainty of ± 5%

ReGeneration by Knoll Chair Measurements**

A. Overall Height	38.1" - 43.3" with standard cylinder 43.5" - 52.3" with high task cylinder (add 0.4" for aluminum base)
B. Overall Width	26" armless 28.5" with high performance arms 29" with high performance arms
C. Overall Depth	24.6" excluding base
D. Arm Height from Floor	22.9" - 32.1" (work chair, height adjustable arms) 22.5" - 31.9" (work chair, high performance arms) 28.3" - 40.9" (high task chair, height adjustable arms) 27.9" - 40.7" (high task chair, high performance arms) (add 0.4" for aluminum base)
E. Base Diameter	26"
Weight	27 lbs. (height adjustable arms) 28 lbs. (high performance arms) (aluminum base adds 2 lbs., upholstered back option adds 3 lbs., high task chair adds 4.8 lbs.)

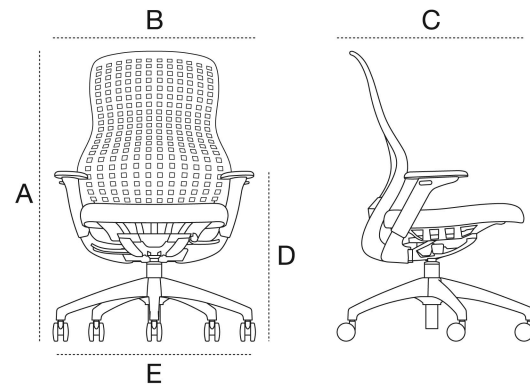

** Flex Back Net, standard cylinder, plastic base

ReGeneration by Knoll Performance Information

Synchronized recline ratio seat: back is 1° : 6°

High performance arm pads measure 8.2" long x 3.8" wide

Height adjustable arm pads measure 6.25" long x 3.4" wide

High performance arm pads adjust 4" in width (2" per arm), 1.75" in depth and pivot 30.5° (20° inward, 10.5° outward)

Compliancy: ANSI/BIFMA X5.1 : 2011 (U.S. structural standard)
ANSI/HFES 100-2007 (U.S. ergonomic standard)
BIFMA G1 : 2002 (U.S. ergonomic guidelines)
California T.B. 117 (U.S. flammability standard for foam)
California T.B. 133 with approved FR textile (U.S. flammability standard for full chair)
The ReGeneration by Knoll work chair has been tested and is approved for use by individuals weighing up to 300 pounds.

ReGeneration by Knoll® Features and Operating Instructions

No Adjustment Necessary

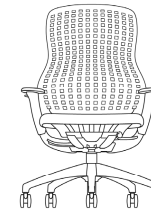

Flex Back Net

Sit back and the Flex Back Net cradles your back, providing integral lumbar support. Optional fully upholstered back provides the additional comfort of foam and fabric over the Flex Back Net.

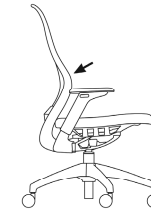

Slim profile back

The contoured frame provides continuous support, following the curves of your shoulders, back and lumbar.

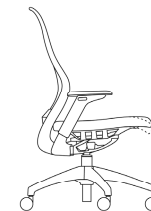

Flex Seat

Sit in any position—forward, sideways or perched—and the Flex Seat supports you with 270° of seat edge flex.

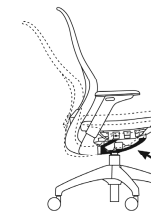

Dynamic Suspension control

The synchronized recline counterbalances your body weight for a smooth and effortless ride. Four independent flexors act as suspension devices that respond to your multidirectional movements—forward, backward and side-to-side.

Intuitive Adjustments (Standard)

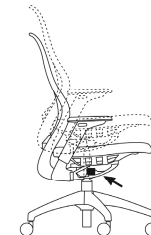

Seat height

Lift the right lever. Sit down to lower the seat or remove your weight to raise it. Release the lever to lock.

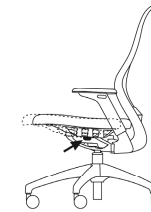

Seat depth

To adjust the seat depth while sitting on the chair, lift the left lever and slide the seat to the desired location. Release the lever to lock.

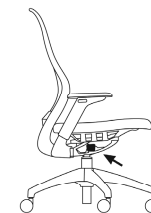

Recline resistance

Sit fully upright. Push the right lever backward for the full range of recline, or pull it forward for upright support.

Performance Options

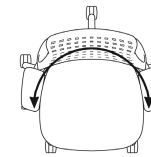

Arm options

Set-back arm supports provide clearance for your legs and feature Continuous Lumbar, so your back is supported when side sitting.

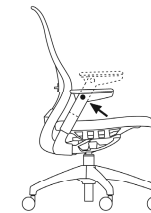

Height adjustable arm

To adjust the height, push the button on the arm. Slide the arm to the desired position and release the button to lock.

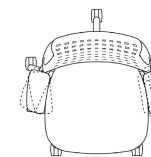

High performance arm

To adjust the height, lift the lever on the arm. Slide the arm to the desired position and release the lever to lock. Free float arm pads easily move in width and depth and pivot.

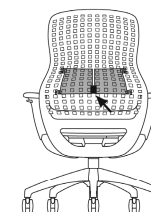

Adjustable lumbar

(Flex Back Net model only)
Grasp the lever at the center of the outer back and slide it to the desired position.

CONSTRUCTION INFORMATION

Slim profile back support

Integrally colored, rapidly-renewable, high performance elastomer with postconsumer recycled content polyester structure; optional biobased urethane foam upholstery with glass reinforced nylon and ABS substrates and sewn textile cover

Adjustable arm supports

Integrally colored, glass reinforced, post consumer recycled content polyester structure

Arm pads

Integrally colored, self skinning polyurethane

Flex Seat

High-resiliency molded biobased foam with sewn textile cover and integrally colored, glass reinforced, impact modified nylon seat structure

Controls

A. Dynamic Suspension control
A solid state construction of integrally colored, high performance elastomer, glass reinforced and cast aluminum

B. Adjustment levers. Integrally colored, glass reinforced nylon

C. Seat depth adjustment plate
Integrally colored, glass reinforced, nylon

Pneumatic cylinder

Steel

Base

Integrally colored, glass reinforced nylon with cast zinc insert or polished, cast aluminum; five star design

Hard casters

Integrally colored nylon and steel

Soft casters

Integrally colored nylon over molded with polyurethane, and steel

Glides

Integrally colored nylon

Optional adjustable lumbar

Frosted clear polyester blend

Footring

Steel footring, aluminum die cast spokes and rubber fit ring

Generation Fabric

100% polyester; 100,000+ double rubs, Wyzenbeek method; Oeko-Tex certified for human safety; Greenguard Indoor Air Quality Certified®

CLEANING INSTRUCTIONS

Hard surfaces and Flex Back Net

General cleaning

Frequent vacuuming or light brushing to remove dust and grime is recommended. Spot clean with a mild upholstery shampoo or the foam from a mild detergent. When using a cleaning product, follow instructions carefully and clean only in a well-ventilated room. Avoid any product that contains carbon tetrachloride or other toxic materials. With any method, pretest a small area before proceeding. When an overall soiled conditioned has been reached, use a professional furniture cleaning service or call Knoll Field Service at 800-445-5045 with questions.

Healthcare cleaning

ReGeneration’s hard surfaces and Flex Back Net successfully passed third-party testing for the following five cleaning agents commonly used in healthcare facilities:

- Clorox Germicidal Liquid Bleach diluted 1:5 ratio to tap water (pH 3.7)
- Clorox Cleanup undiluted 100% solution (pH 9.7)
- Wexside 128 Concentrate Phenolic Germicide by Wexford Labs diluted 1 ounce to 1 gallon tap water (pH 3.7)
- Formula 880 Quaternary Germicide by Grand Technologies diluted 1/2 ounce to 1 gallon tap water (pH 8.1)
- Hydroxi Pro Concentrate 128 by Core Products diluted 1:8 ratio to tap water (pH 7.2)

In addition to the testing detailed above, Knoll has conducted internal testing of Virox 5 RTU cleaning solution on ReGeneration structural parts with no adverse effects.

Generation Fabric

Fabric with cleaning codes W or W-S are designed to be cleaned with low environmental impact cleaning fluids, including GS-37 certified products. See KnollTextiles Price List for further details on cleaning codes.

ENVIRONMENTAL

SMaRT® Sustainable Platinum certified

SMaRT® Consensus Sustainable Product Standard is a comprehensive, transparent sustainable product standard that measures a product’s environmental, economic and social benefits over its life cycle and throughout its global supply chain, from raw materials extraction through use, reclamation or re-use. ReGeneration can contribute to achieving a LEED® Innovation in Design credit for its SMaRT® certification.

BIFMA level® 3 certified BIFMA has established level® as a common framework against which to evaluate the environmental and social responsibility of a variety of products. level® is part of BIFMA’s ongoing development of voluntary product and industry standards that support safe, healthy and sustainable workplaces. To achieve level® certification, Knoll partners with Scientific Certification Systems (SCS), known for its integrity and scientific rigor.

GREENGUARD certified

ReGeneration is GREENGUARD Indoor Air Quality Certified® and GREENGUARD Children & SchoolsSM certified and can contribute to achieving LEED® credits.

Oeko-Tex certified

Generation Fabric is certified by the international third party Oeko-Tex for human safety

WARRANTY

ReGeneration by Knoll is warranted for 24-hour, 7 days a week, multi shift use: 12 years parts and labor to repair; 3 years seating upholstery, textiles and leathers, and finishes. See Knoll Selling Policy for further details, conditions and exclusions.

This page intentionally left blank.

Chadwick™
tilt stop control
fully assembled

	arm	description	pattern no.	list
<p>Designer(s): Don Chadwick, 2005</p> 	Armless	Tilt stop control Note: Arms cannot be added later.	33-NA-1-BK-T-S-X-HC-ASMQ #	\$977.
	Fixed arms	Tilt stop control	33-FA-1-BK-T-S-X-HC-ASMQ #	1,050.
	Height and width adjustable arms	Tilt stop control. Note: A tall adjustable arm option is available. See below for details.	33-AA-1-BK-T-S-X-HC-ASMQ #	1,149.

For Chadwick Fabric selections and pricing, see facing page.

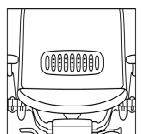
Order Code	Ordering Information	Options
<i>Example:</i> 33-AA-1-BK-T-S-X-HC-05-ASMQ	<i>Specify:</i> 1. Pattern number 2. Fabric color	<i>Arm Option:</i> For Tall Adjustable Arm, replace AA with TA in the pattern number. The tall arm is 3/4" higher than the standard adjustable arm. No upcharge for this option.
33	Chadwick Chair	
AA	Adjustable Arms	
1	Task Chair	<i>Cylinder Height Options:</i> For height ranges see Chadwick Dimensions and Operating Instructions. Replace S in pattern with one of the following options: <i>Code: Upchg: Description:</i> L n/c low cylinder H n/c high cylinder
BK	Black Frame	
T	Tilt Stop Control	<i>Lumbar Option:</i> For lumbar, replace X with L in the pattern number. Add \$100 to list price Note: To order a lumbar separately, use pattern number 33LUMBAR. The list price is \$100.
S	Standard Cylinder	
X	No Lumbar	Lumbar detail 
HC	Hard Black Caster	
05	Black Chadwick Fabric	
ASMQ	Fully assembled	

Chadwick Fabric

Caster Option:

For soft casters, replace HC with SC in the pattern number, and add \$42 to the list price

Glides:

For glides, replace HC with GL in the pattern number. No upcharge for this option.

Glide detail



Black Monofilament:

Code:	Desc:	Upcharge:
01	Beige	n/c
02	Brown	n/c
03	Silver	n/c
04	Green	n/c
05	Black	n/c
06	Red	n/c
07	Blue	n/c

Cal 133:

Chadwick is Cal 133 approved standard. No options or upcharge required.

Chadwick™
basic control
fully assembled

	arm	description	pattern no.	list
<p><i>Designer(s):</i> Don Chadwick, 2005</p> 	Armless	Basic control Note: Arms cannot be added later.	33-NA-1-BK-B-S-X-HC-ASMQ #	\$920.
	Fixed arms	Basic control	33-FA-1-BK-B-S-X-HC-ASMQ #	994.
	Height and width adjustable arms	Basic control. Note: A tall adjustable arm option is available. See below for details.	33-AA-1-BK-B-S-X-HC-ASMQ #	1,092.

For Chadwick Fabric selections and pricing, see facing page.

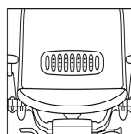
Order Code	Ordering Information	Options
<i>Example:</i> 33-AA-1-BK-B-S-X-HC-05-ASMQ	<i>Specify:</i> 1. Pattern number 2. Fabric color	<i>Arm Option:</i> For Tall Adjustable Arm, replace AA with TA in the pattern number. The tall arm is 3/4" higher than the standard adjustable arm. No upcharge for this option.
33 Chadwick Chair		<i>Cylinder Height Options:</i> For height ranges see Chadwick Dimensions and Operating Instructions. Replace S in pattern with one of the following options: <i>Code: Upchg: Description:</i> L n/c low cylinder H n/c high cylinder
AA Adjustable Arms	<i>Finish color:</i> Black	<i>Lumbar Option:</i> For lumbar, replace X with L in the pattern number. Add \$100 to list price
1 Task Chair		Note: To order a lumbar separately, use pattern number 33LUMBAR. The list price is \$100.
BK Black Frame		Lumbar detail 
B Basic Control		
S Standard Cylinder		
X No Lumbar		
HC Hard Black Caster		
05 Black Chadwick Fabric		
ASMQ Fully assembled		

Chadwick Fabric		
<i>Caster Option:</i> For soft casters, replace HC with SC in the pattern number, and add \$42 to the list price	Black Monofilament:	
<i>Glides:</i> For glides, replace HC with GL in the pattern number. No upcharge for this option.	Code:	Desc: Upcharge:
	01	Beige n/c
	02	Brown n/c
	03	Silver n/c
	04	Green n/c
	05	Black n/c
	06	Red n/c
	07	Blue n/c
	<i>Cal 133:</i> Chadwick is Cal 133 approved standard. No options or upcharge required.	



Standard Features	Benefits
Active Suspension™ Technology includes: 1. Responsive synchronized control and tilt tension	The synchronized control and tilt tension allow the user's torso to open up, promoting healthy circulation and creating a ride that is characterized by a cradled feeling that keeps the user's back in contact with the chair.
2. Resilient, breathable seat and back suspension fabric	Chadwick Fabric provides inherent, energizing support all day long, conforming to the user's shape and minimizing pressure points. The open weave provides aeration.
Forward Tilt: Mechanism automatically includes forward tilt movement	Chadwick offers automatic support for forward seated positions without requiring any additional adjustments.
Variable Seat Depth: Seat depth automatically expands while reclining in the chair	Fits a multitude of users comfortably, no additional adjustments required.
Generous Lumbar Curvature	Chadwick's ample lumbar curvature and conforming back suspension fabric eliminate the need for an additional lumbar mechanism or attachment.
Flexing Arm Pads on Fixed and Adjustable Arms	Suspended design and shape allows the arm pads to flex for additional softness to alleviate pressure points on the wrists.
2 Simple Adjustments: Tension and Seat Height	With so much responsive movement built in, Chadwick only needs two adjustments. They are obvious and simple to operate.

Optional Features	Benefits
Tilt Stop Control	Limits the recline in the upright position to 5 degrees.
Adjustable Arms or Tall Adjustable Arms: both include width adjustment	One finger, ratchet adjustment quickly and easily adjusts. Width adjustment can be accomplished with 3/32" Allen wrench.
Optional Lumbar	Magnetic for easy installation, the lumbar provides a maximum range of adjustability.

To view fabrics online, refer to the Knoll Surface Library at knoll.com (go to the menu bar and click on "Resources" and click on "Surface Finish Library").

Care:
Frequent vacuuming or light brushing to remove dust and grime is recommended. Spot clean, with a mild upholstery shampoo or the foam from a mild detergent. When using a cleaning product, follow instructions carefully and clean only in a well-ventilated room. Avoid any product that contains carbon tetrachloride or other toxic materials. With any method, pretest a small area before proceeding. Use a professional furniture cleaning service when an overall soiled conditioned has been reached.

Chadwick Fabric cleaning code is **W** or **W-S**, meaning water-based cleaning agents and foam or mild, water-free solvents may be used and it can be cleaned with low environmental impact cleaning fluids, including GS-37 certified products. See KnollTextiles.com for further details on cleaning codes.

Healthcare Cleaning Agents:
Chadwick successfully passed third-party testing for the following five cleaning agents commonly used in healthcare facilities:

- Clorox Germicidal Liquid Bleach diluted 1:5 ratio to tap water (pH 3.7)
- Clorox Cleanup undiluted 100% solution (pH 9.7)
- Wex-Cide 128 Concentrate Phenolic Germicide by Wexford Labs diluted 1 ounce to 1 gallon tap water (pH 3.7)
- Formula 880 Quarternary Germicide by Grand Technologies diluted 1/2 ounce to 1 gallon tap water (pH 8.1)
- Hydroxi Pro concentrate 128 by Core Products diluted 1:8 ratio to tap water (pH 7.2)

In addition, Knoll has conducted internal testing of Virox 5 RTU cleaning solution on Chadwick with no adverse effects.

Environmental:
SMaRT® Sustainable Gold certified.
SMaRT® Consensus Sustainable Product Standard is a comprehensive, transparent, sustainable product standard that measures a product's environmental, economic and social benefits over its life and throughout its global supply chain, from raw materials through reclamation or re-use. Chadwick can contribute to achieving a LEED® Innovation in Design Credit.

Cal 133 approved.

GREENGUARD® certified.
Chadwick is GREENGUARD Indoor Air Quality® and GREENGUARD for Children & Schools™ certified and can contribute to achieving LEED® credits.

Construction:
Back Frame
Integrally-colored glass filled nylon

Chadwick Fabric
Polyester monofilament warp with multifilament fill fibers

Chadwick Fabric exceeds 100,000 double rubs Wyzenbeck Method.

Seat Frame
Integrally-colored glass filled nylon

Chadwick Fabric
Polyester monofilament warp with multifilament fill fibers

Soft Edge
Polyurethane foam

Arms
Fixed/Adjustable Arm Pads
Self skinning urethane armpad with flexible spring steel insert

Fixed/Adjustable Arm Supports
Integrally-colored glass filled nylon

Base & Casters
Base
Integrally-colored glass filled nylon

Casters and Glides
Integrally-colored nylon

Soft Casters
Integrally-colored urethane covered nylon

Cylinder
Gas-activated steel seat height mechanism with steel tube (contains nitrogen)

Control
Control housing-aluminum casting and ABS top cover
Component parts-steel, rubber and engineered plastics

Optional Lumbar
Neodymium magnets, polypropylene carrier, TPE pad and back frame

	BIFMA G1-2002 Ergonomic Guidelines	Chadwick Ergonomic Dimensions	
Seat*			
Seat Height	15" - 19.9" minimum range (one or combination of chairs)	Chadwick 15" - 19.1" (low cylinder) 15.9" - 20" (standard cylinder) 16.9" - 21.6" (high cylinder)	Chadwick High Task 23.25" - 30.75"
Seat Depth (Adjustable)	Include 16.9" or less in range	16.9" - 19.4" (range includes reclined position)	16.9" - 19.4" (range includes reclined position)
Seat Width	18" minimum	19.6"	19.6"
Seat Pan Angle (Adjustable)	Include part of 0° - +4° range	-5° - +7° (range includes forward and reclined positions)	-5° - +7° (range includes forward and reclined positions)
Back*			
Backrest Height	12.2" minimum	22.8"	22.8"
Backrest Width	14.2" minimum	18.5"	18.5"
Lumbar Support (Fixed)	In range of 5.9" - 9.8"	7"	7"
Lumbar Support (Adjustable)	Include part of 5.9" - 9.8" range	Exceeds 5.9" - 9.9" (optional lumbar)	Exceeds 5.9" - 9.9" (optional lumbar)
Angle Between Seat and Back	≥90°, include 10° movement in 90° - 115° range	94° - 120°	94° - 120°
Tilt Range of Back	10° minimum	26°	26°
Arms*			
Armrest Height (Fixed)	In range of 7.9" - 9.8"	8.5" (fixed arm)	8.5" (fixed arm)
Armrest Height (Adjustable)	6.9" - 10.8" minimum range (single or multiple sets of arms)	6.9" - 9.4" (adjustable) 8.3" - 10.8" (tall adjustable)	6.9" - 9.4" (adjustable) 8.3" - 10.8" (tall adjustable)
Inside Distance Between Armrests (Fixed)	18" minimum	19.5" (fixed)	19.5" (fixed)
Inside Distance Between Armrests (Adjustable)	Include 18" in range	18.5" - 20.5" (adjustable and tall adjustable)	18.5" - 20.5" (adjustable and tall adjustable)

* All measurements taken with BIFMA Chair Measuring Device using the Universal Measurement Procedure which has a measurement uncertainty of ± 5%

Chadwick Chair Measurements

	Chadwick**	Chadwick High Task
A. Overall Height	37.5" - 42"	44.5" - 52"
B. Overall Width	26.5"	26.5"
C. Overall Depth	25.5"	25.5"
D. Arm Height from Floor	25.5" - 30" (fixed arm) 24" - 31" (adjustable) 24.75" - 31.75" (tall adjustable)	32.5" - 40" (fixed arm) 31" - 41" (adjustable) 31.75" - 41.75" (tall adjustable)
E. Base Diameter	26.5"	26.5"
Weight	37 lbs. (with arms)	41 lbs. (with arms)

**Standard cylinder

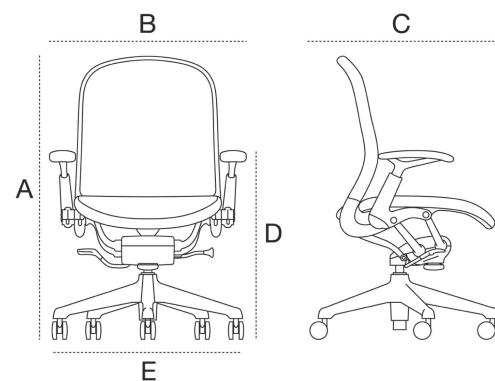

Chadwick - Additional Information

- Synchronized recline ratio seat : back is 1° : 1.2°
- Adjustable and tall adjustable arms adjust 2" in armpad width (1" per side) with 5/32" Allen wrench
- Optional lumbar measures 11.25" x 4.4"
- Chadwick High Task footring measures 19.875" in diameter
- Chadwick High Task footring adjusts 5" in height by a single lever mechanism with 11 locking positions in 1/2" increments
- Compliance: ANSI/BIFMA X5.1 : 2011 (U.S. structural standard), ANSI/HFES 100-2007 (U.S. ergonomic standard), BIFMA G1 : 2002 (U.S. ergonomic guidelines), California T.B. 117 (U.S. flammability standard for foam), California T.B. 133 (U.S. flammability standard for full chair)
- The Chadwick chair line has been tested and is approved for use by individuals weighing up to 300 pounds.

Chadwick™ Operating Instructions

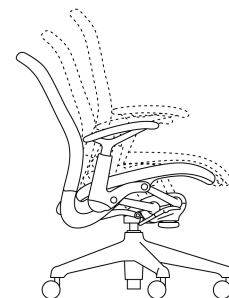

Synchronized Recline with Tilt Tension
Chadwick has a synchronized recline that allows the torso to open up while reclining. To customize the tension of the recline, adjust the tension knob. To decrease the tension, turn the tension knob clockwise (while seated in the chair), and turn it counterclockwise to increase the tension. The underside of the knob also indicates the instructions with arrows.

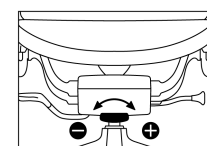

Front View

Seat Height Adjustment

To raise the seat height, remove your weight from the chair while lifting the lever on the right side of the chair. To lower the seat height, lift the lever while sitting in the chair.

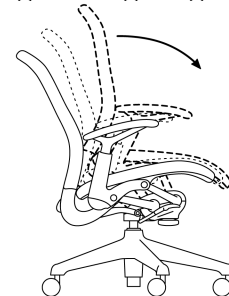
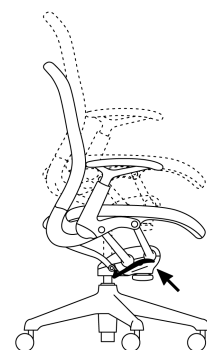

Forward Tilt

Chadwick has a built-in forward tilt that automatically follows and supports the user in the forward posture for typing. No adjustment is required.

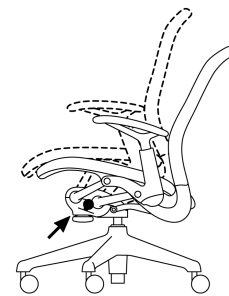

Tilt Stop (Option)

The tilt stop is an upright tilt limiter. When specified, it is the lever on the left side of the chair. If your chair does not have a lever on the left side of the chair, it does not have this feature. The in-and-out lever design operates with an audible click, whereby "out" is engaged, "in" is not engaged.

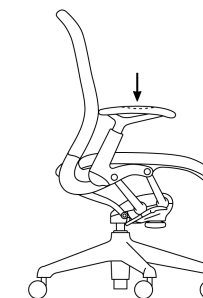

Spring Loaded Arms

Both fixed and adjustable armpads have a spring suspension, which provides the user with armpad softness and flexibility.

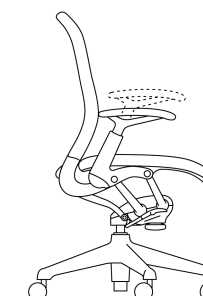

Adjustable Arm Height (Option)

The arm height is adjusted by lifting the armpads upward. No lever is required. Simply move the arms up in five, 1/2" increments for a total of 2 1/2". To lower the arms, lift them to the highest point and at the highest point pull up firmly; and they will return to the lowest point. The arm height adjustment is easy to maneuver with one hand.

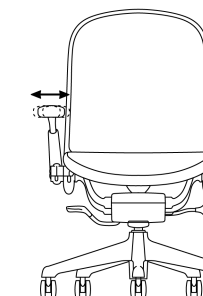

Adjustable Arm Width (Option)

The armpads have a width adjustment of 1/2" inward or 1/2" outward for 1" in total adjustability on each side. A 5/32" Allen wrench is required to adjust the armpad width.

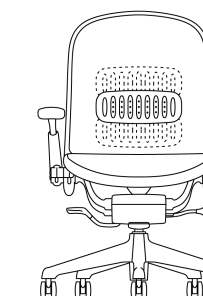

Adjustable Lumbar (Option)

Chadwick has an adjustable lumbar support, if needed. It is secured to the chair with magnets for easy installation and a maximum range of adjustability.

Separate both halves of the lumbar support and place them in the desired position on your chair. Secure the support by putting both halves together around the back suspension fabric of the chair.



Adjust the lumbar by sliding the lumbar pad up and down the back of the chair.

Note: Contains magnets. Consult the Knoll lumbar support hangtag for more information.

RPM®
basic control
fully assembled

Designer(s):
 Carl Magnusson, 2000



arm	description	pattern no.
High performance arm 	Basic control Basic control: synchronized tilt, 4" back height, forward tilt, tilt lock (5 position), side-position tension knob, pneumatic seat height, 360° swivel, instructions attached to side of control	8P4-2-A5GH-ASMQ
Armless 	Basic control Basic control: synchronized tilt, 4" back height, forward tilt, tilt lock (5 position), side-position tension knob, pneumatic seat height, 360° swivel, instructions attached to side of control	8C4-2-A5GH-ASMQ

RPM grade	grades A	COM B	C	D	E	F	G	H	I	T	COL U	V	W	Y
\$1,169.	\$1,323.	\$1,378.	\$1,440.	\$1,471.	\$1,512.	\$1,558.	\$1,627.	\$1,713.	\$1,757.	\$2,088.	\$2,193.	\$2,319.	\$3,107.	\$3,264.
1,036.	1,193.	1,247.	1,310.	1,340.	1,378.	1,425.	1,493.	1,581.	1,627.	1,953.	2,059.	2,184.	2,971.	3,131.

Order Code	Ordering Information	Options
<i>Example:</i> 8A4-2-A5GH-ASMQ	<i>Specify:</i>	<i>Cylinder Height Options:</i>
8A4 RPM task, fixed arms	1. Pattern number	For height ranges see RPM Dimensions and Operating Instructions. Replace 5 in pattern with one of the following options:
2 Black finish and black levers	2. Upholstery selection	
A5G Basic control	<i>Finish color:</i>	<i>Code: Upchg: Description:</i>
H Hard caster for carpet	Black	L n/c low cylinder
ASMQ Fully assembled.		H n/c high cylinder
RAD 27 RPM upholstery Radial Black/Smoke		<i>Caster and Glide Options:</i>
		Substitute H in pattern with one of the following:
		<i>Code: Upchg: Description:</i>
		R \$53 Soft casters for hard surfaces
		G n/c Glides

RPM Grade Upholsteries	
<i>Radial</i>	
RAD7	Midnight/Huckleberry
RAD8	Black/Batik
RAD9	Black/Crimson
RAD10	Claret/Jute
RAD22	Spice/Jute
RAD23	Cappuccino/Pebble Beige
RAD25	Basil/Xanadu
RAD27	Black/Smoke
RAD28	Smoke/Black
RAD29	Smoke/Pebble Beige
<i>Speedway</i>	
SP2	Smoke
SP3	Steel Blue
SP5	Midnight
SP6	Crimson
SP7	Black
SP10	Basil
SP33	Wine
SP36	Chocolate



Ordering Samples/Viewing online:
 To view RPM upholstery colors refer to the Surface Finish Library on knoll.com. Physical samples are the best representation of color. To order samples, contact a Knoll sales representative or Knoll dealer.

Textile Options		
KnollTextiles Fabrics and Spinneybeck Leathers		
Please refer to the textile matrices at the beginning of the price list for approved fabrics and leathers.		
COM/COL Textile Requirement		
	fabric yds.	leather sq. ft.
chair	1.4	25
<i>Cal 133:</i> ‡ = Cal 133 upholstery available. See textile matrices at the beginning of the price list for pre-approved Cal 133 textiles.		
To specify, add C after pattern number and 133 after upholstery code.		
<i>Code:</i> C()133	<i>Upchg:</i> \$139	<i>Description:</i> Cal 133 textile

RPM®
advanced control
fully assembled

Designer(s):
Carl Magnusson, 2000



arm	description	pattern no.
High performance arm	Advanced control (sliding seat pan)	8P4-2-A5KH-ASMQ
	Advanced control: synchronized tilt, 4" back height, sliding seat adjustment, forward tilt, tilt lock (5 position side-position tension knob, pneumatic seat height, 360° swivel, instructions attached to side of control	
Armless	Advanced control (sliding seat pan)	8C4-2-A5KH-ASMQ
	Advanced control: synchronized tilt, 4" back height, sliding seat adjustment, forward tilt, tilt lock (5 position side-position tension knob, pneumatic seat height, 360° swivel, instructions attached to side of control	

RPM grade	grade	COM	C	D	E	F	G	H	I	T	COL	V	W	Y
\$1,211.	\$1,359.	\$1,411.	\$1,470.	\$1,499.	\$1,538.	\$1,581.	\$1,646.	\$1,728.	\$1,774.	\$2,105.	\$2,209.	\$2,336.	\$3,123.	\$3,281.
1,084.	1,232.	1,286.	1,344.	1,373.	1,411.	1,454.	1,522.	1,603.	1,646.	1,975.	2,075.	2,201.	2,987.	3,147.



Order Code	Ordering Information	Options
<i>Example:</i> 8A4-2-A5KH-ASMQ	<i>Specify:</i>	<i>Cylinder Height Options:</i>
8A4 RPM task, fixed arms	1. Pattern number	For height ranges see RPM Dimensions and Operating Instructions. Replace 5 in pattern with one of the following options:
2 Black finish and black levers	2. Upholstery selection	
A5K Advanced control with sliding seat	<i>Finish color:</i>	<i>Code: Upchg: Description:</i>
H Hard caster for carpet	Black	L n/c low cylinder
ASMQ Fully assembled		H n/c high cylinder
RAD 27 RPM upholstery Radial Black/Smoke		<i>Caster and Glide Options:</i>
		Substitute H in pattern with one of the following:
		<i>Code: Upchg: Description:</i>
		R \$53 Soft casters for hard surfaces
		G n/c Glides

RPM Grade Upholsteries	
<i>Radial</i>	Ordering Samples/Viewing online: To view RPM upholstery colors refer to the Surface Finish Library on knoll.com. Physical samples are the best representation of color. To order samples, contact a Knoll sales representative or Knoll dealer.
RAD7	Midnight/Huckleberry
RAD8	Black/Batik
RAD9	Black/Crimson
RAD10	Claret/Jute
RAD22	Spice/Jute
RAD23	Cappuccino/Pebble Beige
RAD25	Basil/Xanadu
RAD27	Black/Smoke
RAD28	Smoke/Black
RAD29	Smoke/Pebble Beige
<i>Speedway</i>	
SP2	Smoke
SP3	Steel Blue
SP5	Midnight
SP6	Crimson
SP7	Black
SP10	Basil
SP33	Wine
SP36	Chocolate

Textile Options		
KnollTextiles Fabrics and Spinneybeck Leathers		
Please refer to the textile matrices at the beginning of the price list for approved fabrics and leathers.		
COM/COL Requirement		
	fabric	leather
	yds.	sq. ft.
chair	1.4	25
<i>Cal 133:</i>		
♣ = Cal 133 upholstery available. See textile matrices at the beginning of the price list for pre-approved Cal 133 textiles.		
To specify, add C after pattern number and 133 after upholstery code.		
<i>Code:</i>	<i>Upchg:</i>	<i>Description:</i>
C()133	\$139	Cal 133 textile

Designer(s):
Carl Magnusson, 2000



arm	description	pattern no.
High performance arm 	Basic control, CGSB compliant Basic control: synchronized tilt, 4" back height, forward tilt, tilt lock (5 position), side-position tension knob, pneumatic seat height, 360° swivel, instructions attached to side of control	8P4-2-A5GH-CGSBQ
Armless 	Basic control, CGSB compliant Basic control: synchronized tilt, 4" back height, forward tilt, tilt lock (5 position), side-position tension knob, pneumatic seat height, 360° swivel, instructions attached to side of control	8C4-2-A5GH-CGSBQ

RPM grade	grades A	COM B	C	D	E	F	G	H	I	T	COL U	V	W	Y
\$1,173.	\$1,327.	\$1,382.	\$1,444.	\$1,475.	\$1,516.	\$1,562.	\$1,631.	\$1,717.	\$1,761.	\$2,092.	\$2,197.	\$2,323.	\$3,111.	\$3,268.
1,040.	1,197.	1,251.	1,314.	1,344.	1,382.	1,429.	1,497.	1,585.	1,631.	1,957.	2,063.	2,188.	2,975.	3,135.



Order Code	Ordering Information	Options
<i>Example:</i> 8P4-2-A5GH-CGSBQ	<i>Specify:</i>	<i>Cylinder Height Options:</i>
8P4 RPM task, high performance arms	1. Pattern number	For height ranges see RPM Dimensions and Operating Instructions. Replace 5 in pattern with one of the following options:
2 Black finish and black levers	2. Upholstery selection	<i>CGSB high performance arms:</i> Powder coated aluminum die cast stem with integrally colored, textured glass-reinforced nylon shroud.
A5G Basic control	<i>Finish color:</i> Black	<i>Code: Upchg: Description:</i> L n/c low cylinder H n/c high cylinder
H Hard caster for carpet		<i>Caster and Glide Options:</i> Substitute H in pattern with one of the following:
CGSBQ Canadian General Standards Board Compliant		<i>Code: Upchg: Description:</i> R \$53 Soft casters for hard surfaces G n/c Glides
RAD 27 RPM upholstery Radial Black/Smoke		

RPM Grade Upholsteries	
<i>Radial</i>	
RAD7	Midnight/Huckleberry
RAD8	Black/Batik
RAD9	Black/Crimson
RAD10	Claret/Jute
RAD22	Spice/Jute
RAD23	Cappuccino/Pebble Beige
RAD25	Basil/Xanadu
RAD27	Black/Smoke
RAD28	Smoke/Black
RAD29	Smoke/Pebble Beige
<i>Speedway</i>	
SP2	Smoke
SP3	Steel Blue
SP5	Midnight
SP6	Crimson
SP7	Black
SP10	Basil
SP33	Wine
SP36	Chocolate

Textile Options		
<i>Ordering Samples/Viewing online:</i> To view RPM upholstery colors refer to the Surface Finish Library on knoll.com. Physical samples are the best representation of color. To order samples, contact a Knoll sales representative or Knoll dealer.		
KnollTextiles Fabrics and Spinneybeck Leathers		
Please refer to the textile matrices at the beginning of the price list for approved fabrics and leathers.		
COM/COL Textile Requirement		
	fabric yds.	leather sq. ft.
chair	1.4	25
<i>Cal 133:</i> ‡ = Cal 133 upholstery available. See textile matrices at the beginning of the price list for pre-approved Cal 133 textiles.		
To specify, add C after pattern number and 133 after upholstery code.		
<i>Code:</i> C()133	<i>Upchg:</i> \$139	<i>Description:</i> Cal 133 textile

Designer(s):
Carl Magnusson, 2000



arm	description	pattern no.
High performance arm 	Advanced control (sliding seat pan), CGSB compliant	8P4-2-A5KH-CGSBQ
Armless 	Advanced control (sliding seat pan), CGSB compliant	8C4-2-A5KH-CGSBQ

RPM grade	grade A	COM B	C	D	E	F	G	H	I	T	COL U	V	W	Y
\$1,215.	\$1,363.	\$1,415.	\$1,474.	\$1,503.	\$1,542.	\$1,585.	\$1,650.	\$1,732.	\$1,778.	\$2,109.	\$2,213.	\$2,340.	\$3,127.	\$3,285.
1,088.	1,236.	1,290.	1,348.	1,377.	1,415.	1,458.	1,526.	1,607.	1,650.	1,979.	2,079.	2,205.	2,991.	3,151.

Order Code	Ordering Information	Options
<i>Example:</i> 8P4-2-A5KH-CGSBQ	<i>Specify:</i>	<i>Cylinder Height Options:</i>
8P4 RPM task, high performance arms	1. Pattern number	For height ranges see RPM Dimensions and Operating Instructions. Replace 5 in pattern with one of the following options:
2 Black finish and black levers	2. Upholstery selection	<i>CGSB high performance arms:</i> Powder coated aluminum die cast stem with integrally colored, textured glass-reinforced nylon shroud.
A5K Advanced control with sliding seat	<i>Finish color:</i> Black	<i>Code: Upchg: Description:</i>
H Hard caster for carpet		L n/c low cylinder
CGSBQ Canadian General Standards Board Compliant		H n/c high cylinder
RAD 27 RPM upholstery Radial Black/Smoke		<i>Caster and Glide Options:</i> Substitute H in pattern with one of the following:
		<i>Code: Upchg: Description:</i>
		R \$53 Soft casters for hard surfaces
		G n/c Glides

RPM Grade Upholsteries	
<i>Radial</i>	
RAD7	Midnight/Huckleberry
RAD8	Black/Batik
RAD9	Black/Crimson
RAD10	Claret/Jute
RAD22	Spice/Jute
RAD23	Cappuccino/Pebble Beige
RAD25	Basil/Xanadu
RAD27	Black/Smoke
RAD28	Smoke/Black
RAD29	Smoke/Pebble Beige
<i>Speedway</i>	
SP2	Smoke
SP3	Steel Blue
SP5	Midnight
SP6	Crimson
SP7	Black
SP10	Basil
SP33	Wine
SP36	Chocolate

Textile Options		
KnollTextiles Fabrics and Spinneybeck Leathers		
Please refer to the textile matrices at the beginning of the price list for approved fabrics and leathers.		
COM/COL Requirement		
	fabric yds.	leather sq. ft.
chair	1.4	25
<i>Cal 133:</i>		
♣ = Cal 133 upholstery available. See textile matrices at the beginning of the price list for pre-approved Cal 133 textiles.		
To specify, add C after pattern number and 133 after upholstery code.		
<i>Code:</i> C()133	<i>Upchg:</i> \$139	<i>Description:</i> Cal 133 textile

	BIFMA G1-2002 Ergonomic Guidelines	RPM Ergonomic Dimensions	
Seat*		RPM	RPM High Task
Seat Height	15" - 19.9" minimum range (one or combination of chairs)	15" - 17.75" (low cylinder) 16.5" - 20.5" (medium cylinder) 18.75" - 23.75" (high cylinder)	23.5" - 31.25"
Seat Depth (Fixed)	16.9" or less	17.5" (basic control)	17.5" (basic control)
Seat Depth (Adjustable)	Include 16.9" or less in range	16.5" - 18.5" (advanced control)	16.5" - 18.5" (advanced control)
Seat Width	18" minimum	20.5"	20.5"
Seat Pan Angle (Adjustable)	Include part of 0° - +4° range	-3° - +2° (includes forward tilt)	-3° - +2° (includes forward tilt)
Back*			
Backrest Height	12.2" minimum	21" - 25"	21" - 25"
Backrest Width	14.2" minimum	19"	19"
Lumbar Support (Adjustable)	Include part of 5.9" - 9.8" range	5.9" - 9.9"	5.9" - 9.9"
Angle Between Seat and Back	≥90°, include 10° movement in 90° - 115° range	93° - 118°	93° - 118°
Tilt Range of Back	10° minimum	25°	25°
Arms*			
Armrest Height (Adjustable)	6.9" - 10.8" minimum range (single or multiple sets of arms)	7.25" - 10.5" (high performance)	7.25" - 10.5" (high performance)
Inside Distance Between Armrests (Adjustable)	Include 18" in range	17.75" - 19.75" (high performance)	17.75" - 19.75" (high performance)

* All measurements taken with BIFMA Chair Measuring Device using the Universal Measurement Procedure which has a measurement uncertainty of ± 5%

RPM Chair Measurements**

	RPM	RPM High Task	RPM Side
A. Overall Height	37.1" - 45.6" (medium cylinder)	43.75" - 51"	32.5"
B. Overall Width	27"	27"	22"
C. Overall Depth	26.5" (basic control) 25.5" - 26.5" (advanced control)	26.5" (basic control) 25.5" - 26.5" (advanced control)	23.5"
D. Arm Height from Floor	23.75" - 31.5" (high performance)	23.75" - 31.5" (high performance)	25"
E. Base Diameter	28"	28"	22.5" wide
Weight	44 lbs.	51 lbs.	28 lbs.

** With arms

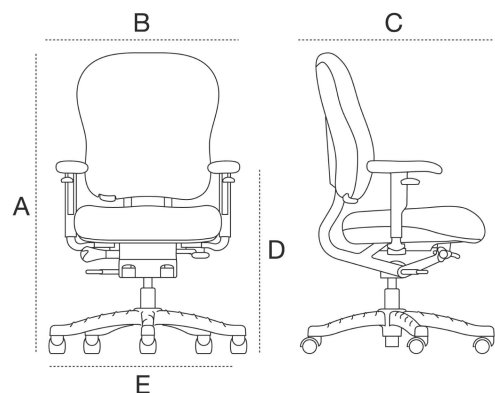

RPM - Additional Information

High performance arm pads pivot 30° (±15°, 3 fixed positions)

RPM High Task footring measures 20" in diameter and adjusts 9" - 18" in height

RPM Side chair seat is 17.75" from the floor; arms are 7.75" from seat; the inside distance between the arms is 19.9"

Compliance: ANSI/BIFMA X5.1 : 2011 (U.S. structural standard), ANSI/HFES 100-2007 (advanced control) (U.S. ergonomic standard), BIFMA G1 : 2002 (U.S. ergonomic guidelines), California T.B. 117 (U.S. flammability standard for foam), California T.B. 133 with approved FR textile (U.S. flammability standard for full chair)

The RPM chair line has been tested and is approved for use by individuals weighing up to 300 pounds.

RPM® Operating Instructions

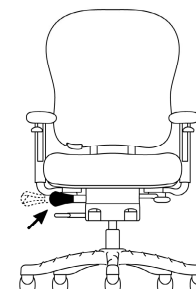

Tilt Tension

On the right side of the seat, there is a retractable knob which facilitates the adjustment when the knob is extended. Turn the knob forward to tighten and backward to loosen. When finished, tuck the knob under the seat.

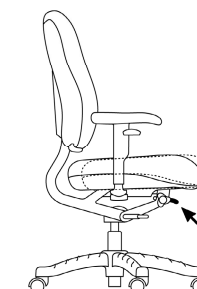

Seat Depth

The sliding seat activation is located underneath the seat on the front, left-hand side of the control. The adjustment mechanism is a button that has a space for two fingers. To activate, push up on the button and move the seat forward or backward. There are 4 positions within a 2" range. (on Advanced Models only)

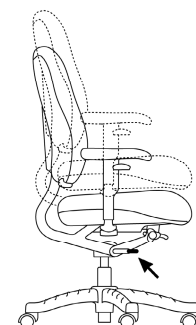

Seat Height

While seated, lift the lever on the right side of the chair to lower seat height. Remove your weight from the chair and lift the handle to raise the chair to the highest position.

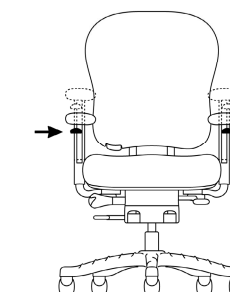

High Performance Arms

High Performance arms are controlled by the lever next to the armpad and from the knob beneath the arm support.

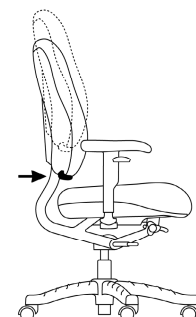

Back Height

Press the lever on the bottom of the right side of the back cushion to reposition the back height within a four inch range. It is necessary to press the lever to make the back move.

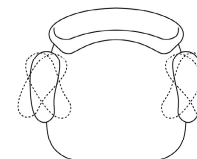

Arm Height and Armpad Pivot

Press the lever next to the armpad to adjust the arm height and to set the arm pivot in one of three fixed positions.

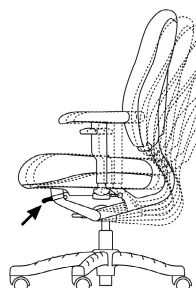

Multiple Stop Tilt Lock and Upright Tilt Lock

To lock the chair upright or in a reclined position, lift the lever on the front left side of the chair. Push down on the lever and recline to unlock the chair.

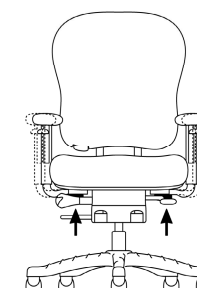

Arm Width

Loosen the knob under the arm support to adjust the arm support placement on the chair. There is a 2" total width adjustment.

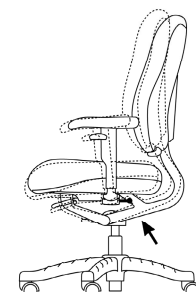

Forward Tilt

The forward tilt button is located on the rear, left-hand side of the control—to activate, push the lever in, lift your weight off the seat, and pull up on the rear of the seat to tilt it forward.

Control Index





Advanced Control	Features	Explanations
	Synchronized tilt (1:1.9)	Back reclines 1.9 times faster than seat
	Tilt lock (5 positions)	Chair back can be locked in upright and reclined positions
	Forward tilt (3°)	Chair locks in a forward tilting position for intensive keyboarding application
	4" back height adjustment	Allows for correct positioning of lumbar support
	2" seat depth adjustments	Seat adjusts in depth to provide proper support under the legs of both taller and shorter users
	Retractable tension knob	Tension knob is easy to reach and tucks out of the way when not in use
	Instructions	Easy to reach instruction card attached to chair makes adjusting the chair easy for everyone
	Dual J-Bar	Provides additional support for the back
	360° swivel	
Basic Control	Features	Explanations
	Synchronized tilt (1:1.9)	Back reclines 1.9 times faster than seat
	Tilt lock (5 positions)	Chair can be locked in upright and reclined positions
	Forward tilt (3°)	Chair locks in a forward tilting position for intensive keyboarding application
	4" back height adjustment	Allows for correct positioning of lumbar support
	Retractable tension knob	Tension knob is easy to reach and tucks out of the way when not in use
	Instructions	Easy to reach instruction card attached to chair makes adjusting the chair easy for everyone
	Dual J-Bar	Provides additional support for the back
	360° swivel	
RPM Task and High Task Construction Information	Part	Materials
	Outer shells:	Integrally colored, textured polypropylene.
	Seat structure:	Glass-reinforced nylon with steel connectors (for basic control, laminated plywood).
	Back and J-Bar structure:	Glass-reinforced nylon, ABS and steel connector plate.
	Cushions and upholstery:	Insert molded high resilient urethane foam. Back is permanently bonded to CFC free foam. RPM grade covers are knitted to fit the cushion.
	High performance arms:	Integrally colored, textured glass-reinforced nylon.
	Armpads:	Molded self skinning urethane and steel substructure.
	Base:	Integrally colored, textured, glass-reinforced nylon.
	Casters and glides:	Black, integrally colored, textured nylon.

This page intentionally left blank.

EWC Pro™
upholstered mid-back task chair
synchronized tilt control
fully assembled

Designer(s):
 Jeffrey Bennett and
 Nicholas Dodziuk, 2005



arm	description	pattern no.
Armless 	Upholstered mid-back task chair with plastic outer back, 2.5" back height adjustment, plastic base, synchronized control	77W-MB-2-SY-NA-5-ASMQ-()
Fixed arms 	Upholstered mid-back task chair with plastic outer back, 2.5" back height adjustment, plastic base, synchronized control	77W-MB-2-SY-FA-5-ASMQ-()
Height/width adjustable arms 	Upholstered mid-back task chair with plastic outer back, 2.5" back height adjustment, plastic base, synchronized control	77W-MB-2-SY-HA-5-ASMQ-()
High performance arms 	Upholstered mid-back task chair with plastic outer back, 2.5" back height adjustment, plastic base, synchronized control	77W-MB-2-SY-HP-5-ASMQ-()
Upholstered outer back	(insert U after MB in the pattern number)	U

list price	Presto base grade	A	COM B	C	D	E	F	G	H	I	T	COL U	V	W	X	Y
\$711.		\$718.	\$737.	\$762.	\$792.	\$819.	\$852.	\$871.	\$877.	\$897.	\$1,182.	\$1,332.	\$1,473.	\$1,719.	n/a	\$1,948.
771.		778.	797.	822.	851.	881.	913.	929.	936.	956.	1,244.	1,390.	1,534.	1,782.	n/a	2,010.
803.		810.	828.	853.	883.	912.	944.	960.	968.	989.	1,274.	1,423.	1,565.	1,813.	n/a	2,041.
819.		826.	845.	871.	900.	927.	960.	979.	985.	1,005.	1,291.	1,440.	1,581.	1,827.	n/a	2,056.
78.		80.	89.	99.	110.	120.	134.	142.	144.	152.	264.	322.	380.	478.	n/a	569.

Order Code	Ordering Information	Options
<i>Example:</i> 77W-MB-2-SY-HA-5-SL-ASMQ-HC K1000/8	<i>Specify:</i> 1. Pattern number 2. Seat and back upholstery	<i>Cylinder Height Option:</i> For low height cylinder (plastic base only), replace 5 in pattern number with L. See Dimensions page for seat height range.
77W Essentials Pro task chair	<i>Finish color:</i> Black	<i>Caster and Glide Options:</i> Substitute HC in pattern with one of the following options: <i>Code: Upchg: Description:</i> SC n/c soft black casters for hard surfaces GL n/c glides
MB Mid-back	Options <i>Polished Aluminum Base:</i> Replace 2 in pattern with 4. Only available with standard height cylinder.	<i>Sliding Seat Option:</i> For sliding seat with 2.75" of depth adjustment insert SL after cylinder choice in pattern number. Adds 0.5" to seat height.
2 Black finish	<i>Code: Upchg: Description:</i> 4 \$153 polished aluminum base	<i>Code: Upchg: Description:</i> SL \$40 sliding seat
SY Synchronized tilt control		
HA Height and width adjustable arms		
5 Standard height cylinder		
SL Sliding seat		
ASMQ Fully assembled		
HC Hard wheel black casters		
K1000/8 Presto Red Carpet		

Presto - Base Grade Fabric	Color options:	Split Upholstery:	CAL 133 Options:	COM/COL Upholstery Requirements
Presto Winter White K1000/1 Presto Sand K1000/2 Presto Stone K1000/3 Presto Saffron K1000/4 Presto Spring Green K1000/5 Presto Blue Chip K1000/6 Presto Scarlet K1000/7 Presto Red Carpet K1000/8 Presto Beige Taupe K1000/9 Presto Olive K1000/10 Presto Navy Blue K1000/11 Presto Clear Gray K1000/12 Presto Charcoal Gray K1000/13 Presto Black Tie K1000/14		EWC Pro seats and backs can be upholstered in any two approved KnollTextiles or Spinneybeck upholsteries. To specify, first indicate the seat upholstery (labeled "seat upholstery") and then indicate the back upholstery (labeled "back upholstery"). The list price of the chair equals the list price of the higher of the two upholstery grades.	<i>Code: Upchg: Description:</i> C133 \$80 CAL 133 textile on seat and back. No additional upcharge for upholstered outer back (add C133 to the end of the pattern number)	Textile yardage required: 2 yards Leather sq. ft. required: 28 sq. ft. Outer back shell: .8 yards or 12 sq. ft.
		For split upholstery on the upholstered outer back option, indicate "inner back" and "outer back" on upholstery selections. Add the list price upcharge of the grade selected for the upholstered outer back.		

EWC Pro™
upholstered mid-back task chair
swivel tilt control
fully assembled

Designer(s):
 Jeffrey Bennett and
 Nicholas Dodziuk, 2005



arm	description	pattern no.
Armless 	Upholstered mid-back task chair with plastic outer back, 2.5" back height adjustment, plastic base, swivel-tilt control	77W-MB-2-ST-NA-5-ASMQ-()
Fixed arms 	Upholstered mid-back task chair with plastic outer back, 2.5" back height adjustment, plastic base, swivel-tilt control	77W-MB-2-ST-FA-5-ASMQ-()
Height/width adjustable arms 	Upholstered mid-back task chair with plastic outer back, 2.5" back height adjustment, plastic base, swivel-tilt control	77W-MB-2-ST-HA-5-ASMQ-()
High performance arms 	Upholstered mid-back task chair with plastic outer back, 2.5" back height adjustment, plastic base, swivel-tilt control	77W-MB-2-ST-HP-5-ASMQ-()
Upholstered outer back	(insert U after MB in the pattern number)	U

list price	COM														COL	
Presto base grade	A	B	C	D	E	F	G	H	I	T	U	V	W	X	Y	
\$605.	\$612.	\$632.	\$659.	\$687.	\$716.	\$749.	\$766.	\$773.	\$794.	\$1,081.	\$1,232.	\$1,375.	\$1,626.	n/a	\$1,859.	
666.	672.	692.	718.	747.	777.	809.	826.	833.	854.	1,143.	1,292.	1,439.	1,689.	n/a	1,922.	
698.	705.	724.	750.	779.	808.	842.	858.	866.	887.	1,174.	1,325.	1,471.	1,721.	n/a	1,952.	
713.	720.	740.	767.	795.	824.	857.	874.	881.	902.	1,189.	1,340.	1,483.	1,734.	n/a	1,967.	
78.	80.	89.	99.	110.	120.	134.	142.	144.	152.	264.	322.	380.	478.	n/a	569.	

Order Code	Ordering Information	Options
<i>Example:</i> 77W-MB-2-ST-HA-5-SL-ASMQ-HC K1000/8	<i>Specify:</i> 1. Pattern number 2. Seat and back upholstery	<i>Cylinder Height Option:</i> For low height cylinder (plastic base only), replace 5 in pattern number with L. See Dimensions page for seat height range. <i>Code: Upchg: Description:</i> L \$72 low cylinder
77W Essentials Pro task chair		<i>Caster and Glide Options:</i> Substitute HC in pattern with one of the following options: <i>Code: Upchg: Description:</i> SC n/c soft black casters for hard surfaces GL n/c glides
MB Mid-back	<i>Finish color:</i> Black	
2 Black finish		
ST Swivel tilt control		
HA Height and width adjustable arms		
5 Standard height cylinder		<i>Sliding Seat Option:</i> For sliding seat with 2.75" of depth adjustment insert SL after cylinder choice in pattern number. Adds 0.5" to seat height. <i>Code: Upchg: Description:</i> SL \$40 sliding seat
SL Sliding seat	<i>Polished Aluminum Base:</i> Replace 2 in pattern with 4. Only available with standard height cylinder.	
ASMQ Fully assembled		
HC Hard wheel black casters	<i>Code: Upchg: Description:</i> 4 \$153 polished aluminum base	
K1000/8 Presto Red Carpet		

Presto - Base Grade Fabric	Split Upholstery:	CAL 133 Options:	COM/COL Upholstery Requirements
<i>Color options:</i> Presto Winter White K1000/1 Presto Sand K1000/2 Presto Stone K1000/3 Presto Saffron K1000/4 Presto Spring Green K1000/5 Presto Blue Chip K1000/6 Presto Scarlet K1000/7 Presto Red Carpet K1000/8 Presto Beige Taupe K1000/9 Presto Olive K1000/10 Presto Navy Blue K1000/11 Presto Clear Gray K1000/12 Presto Charcoal Gray K1000/13 Presto Black Tie K1000/14	<i>Split Upholstery:</i> EWC Pro seats and backs can be upholstered in any two approved KnollTextiles or Spinneybeck upholsteries. To specify, first indicate the seat upholstery (labeled "seat upholstery") and then indicate the back upholstery (labeled "back upholstery"). The list price of the chair equals the list price of the higher of the two upholstery grades. For split upholstery on the upholstered outer back option, indicate "inner back" and "outer back" on upholstery selections. Add the list price upcharge of the grade selected for the upholstered outer back.	<i>Code: Upchg: Description:</i> C133 \$80 CAL 133 textile on seat and back. No additional upcharge for upholstered outer back (add C133 to the end of the pattern number)	COM/COL Upholstery Requirements Textile yardage required: 2 yards Leather sq. ft. required: 28 sq. ft. Outer back shell: .8 yards or 12 sq. ft.

EWC Pro™
upholstered mid-back conference chair
synchronized tilt control
fully assembled

Designer(s):
 Jeffrey Bennett and
 Nicholas Dodziuk, 2007



arm	description	pattern no.
Fixed arms	Upholstered mid-back conference chair with plastic outer back, fixed back height, plastic base, synchronized control	77C-MB-2-SY-FA-5-ASMQ-()
Upholstered outer back	(insert U after MB in the pattern number)	U



list price	COM COL														
Presto base grade	A	B	C	D	E	F	G	H	I	T	U	V	W	X	Y
\$766.	\$773.	\$792.	\$816.	\$846.	\$875.	\$908.	\$923.	\$930.	\$951.	\$1,238.	\$1,384.	\$1,528.	\$1,776.	n/a	\$2,004.
78.	80.	89.	99.	110.	120.	134.	142.	144.	152.	264.	322.	380.	478.	n/a	569.

Order Code	Ordering Information	Options
<i>Example:</i> 77C-MB-2-SY-FA-5-SL-ASMQ-HC K1000/8	<i>Specify:</i> 1. Pattern number 2. Seat and back upholstery	<i>Cylinder Height Option:</i> For low height cylinder (plastic base only), replace 5 in pattern number with L. See Dimensions page for seat height range. <i>Code: Upchg: Description:</i> L \$72 low cylinder
77C EWC Pro conference chair	<i>Finish color:</i> Black	<i>Caster and Glide Options:</i> Substitute HC in pattern with one of the following options: <i>Code: Upchg: Description:</i> SC n/c soft black casters for hard surfaces GL n/c glides
MB Mid-back	Options <i>Polished Aluminum Base:</i> Replace 2 in pattern with 4. Only available with standard height cylinder.	<i>Sliding Seat Option:</i> For sliding seat with 2.75" of depth adjustment insert SL after cylinder choice in pattern number. Adds 0.5" to seat height. <i>Code: Upchg: Description:</i> SL \$40 sliding seat
2 Black finish	<i>Code: Upchg: Description:</i> 4 \$153 polished aluminum base	
SY Synchronized tilt control		
FA Fixed width adjustable arms		
5 Standard height cylinder		
SL Sliding seat		
ASMQ Fully assembled		
HC Hard wheel black casters		
K1000/8 Presto Red Carpet		

Presto - Base Grade Fabrics	Color options:	Split Upholstery:	CAL 133 Options:	COM/COL Upholstery Requirements
Presto Winter White K1000/1 Presto Sand K1000/2 Presto Stone K1000/3 Presto Saffron K1000/4 Presto Spring Green K1000/5 Presto Blue Chip K1000/6 Presto Scarlet K1000/7 Presto Red Carpet K1000/8 Presto Beige Taupe K1000/9 Presto Olive K1000/10 Presto Navy Blue K1000/11 Presto Clear Gray K1000/12 Presto Charcoal Gray K1000/13 Presto Black Tie K1000/14		EWC Pro seats and backs can be upholstered in any two approved KnollTextiles or Spinneybeck upholsteries. To specify, first indicate the seat upholstery (labeled "seat upholstery") and then indicate the back upholstery (labeled "back upholstery"). The list price of the chair equals the list price of the higher of the two upholstery grades.	<i>Code: Upchg: Description:</i> C133 \$80 CAL 133 textile on seat and back. No additional upcharge for upholstered outer back (add C133 to the end of the pattern number)	Textile yardage required: 2 yards Leather sq. ft. required: 28 sq. ft. Outer back shell: .8 yards or 12 sq. ft.
		For split upholstery on the upholstered outer back option, indicate "inner back" and "outer back" on upholstery selections. Add the list price upcharge of the grade selected for the upholstered outer back.		

EWC Pro™
upholstered mid-back conference chair
swivel tilt control
fully assembled

Designer(s):
 Jeffrey Bennett and
 Nicholas Dodziuk, 2007



arm	description	pattern no.
Fixed arms	Upholstered mid-back conference chair with plastic outer back, plastic base, fixed back height, swivel-tilt control	77C-MB-2-ST-FA-5-ASMQ-()
Upholstered outer back	(insert U after MB in the pattern number)	U



list price	COM														COL		
Presto base grade	A	B	C	D	E	F	G	H	I	T	U	V	W	X	Y		
\$661.	\$667.	\$687.	\$713.	\$741.	\$771.	\$804.	\$821.	\$827.	\$848.	\$1,137.	\$1,285.	\$1,432.	\$1,682.	n/a	\$1,916.		
78.	80.	89.	99.	110.	120.	134.	142.	144.	152.	264.	322.	380.	478.	n/a	569.		

Order Code	Ordering Information	Options
<i>Example:</i> 77C-MB-2-ST-FA-5-SL-ASMQ-HC K1000/8	<i>Specify:</i> 1. Pattern number 2. Seat and back upholstery	<i>Cylinder Height Option:</i> For low height cylinder (plastic base only), replace 5 in pattern number with L. See Dimensions page for seat height range. <i>Code: Upchg: Description:</i> L \$72 low cylinder
77C EWC Pro conference chair	<i>Finish color:</i> Black	<i>Caster and Glide Options:</i> Substitute HC in pattern with one of the following options: <i>Code: Upchg: Description:</i> SC n/c soft black casters for hard surfaces GL n/c glides
MB Mid-back	Options	<i>Sliding Seat Option:</i> For sliding seat with 2.75" of depth adjustment insert SL after cylinder choice in pattern number. Adds 0.5" to seat height. <i>Code: Upchg: Description:</i> SL \$40 sliding seat
2 Black finish	<i>Polished Aluminum Base:</i> Replace 2 in pattern with 4. Only available with standard height cylinder.	
ST Swivel tilt control	<i>Code: Upchg: Description:</i> 4 \$153 polished aluminum base	
FA Fixed width adjustable arms		
5 Standard height cylinder		
SL Sliding seat		
ASMQ Fully assembled		
HC Hard wheel black casters		
K1000/8 Presto Red Carpet		

Presto - Base Grade Fabrics		CAL 133 Options:		COM/COL Upholstery Requirements	
<i>Color options:</i>	<i>Split Upholstery:</i>	<i>Code: Upchg: Description:</i>			
Presto Winter White K1000/1 Presto Sand K1000/2 Presto Stone K1000/3 Presto Saffron K1000/4 Presto Spring Green K1000/5 Presto Blue Chip K1000/6 Presto Scarlet K1000/7 Presto Red Carpet K1000/8 Presto Beige Taupe K1000/9 Presto Olive K1000/10 Presto Navy Blue K1000/11 Presto Clear Gray K1000/12 Presto Charcoal Gray K1000/13 Presto Black Tie K1000/14	EWC Pro seats and backs can be upholstered in any two approved KnollTextiles or Spinneybeck upholsteries. To specify, first indicate the seat upholstery (labeled "seat upholstery") and then indicate the back upholstery (labeled "back upholstery"). The list price of the chair equals the list price of the higher of the two upholstery grades. For split upholstery on the upholstered outer back option, indicate "inner back" and "outer back" on upholstery selections. Add the list price upcharge of the grade selected for the upholstered outer back.	C133 \$80 CAL 133 textile on seat and back. No additional upcharge for upholstered outer back (add C133 to the end of the pattern number)			Textile yardage required: 2 yards Leather sq. ft. required: 28 sq. ft. Outer back shell: .8 yards or 12 sq. ft.

Seat*	BIFMA G1-2002 Ergonomic Guidelines	EWC Pro Mid-back Task Ergonomic Dimensions	EWC Pro Side
Seat Height**	15" - 19.9" minimum range (one or combination of chairs)	16.25" - 20.75" (std. cylinder) 15.5" - 19.6" (alum. base, std. cylinder) 15" - 19" (low cylinder)	17"
		**sliding seat option adds 0.5" to all seat height dimensions	
Seat Depth	16.9" or less fixed, include if adjustable	16.9" (fixed) 16.25" - 19" (adjustable)	16.9"
Seat Width	18" min	19"	19"
Seat Pan Angle (at rest)	0° - 4° rearward	2°	2°
Back*			
Backrest Height	12.2" min	22" - 24.5"	17.5"
Backrest Width	14.2" min	18"	18.5"
Lumbar Support	5.9" - 9.8" (adjustable include part of range)	5.75" - 8.75"	6.75"
Angle Between Seat and Back	90°-115°	96°	103°
Tilt Range of Back	10° min	24° (synchro) 14° (swivel)	N/A
Arms*			
Armrest Height (fixed)	7.9" - 9.8"	8.2" (fixed)	9.4"
Armrest Height (adjustable)	6.9" - 10.8"	7" - 10.5" (height adj.) 7.875" - 11" (high perf.)	N/A N/A
Inside Distance Between Armrests (fixed)	18" min	19.5" - 21.5" (fixed)	19.5"
Inside Distance Between Armrests (adjustable)	include 18"	19.5" - 21.5" (height adj.) 18.5" - 20.625" (high perf.)	N/A

*All measurements taken with BIFMA Chair Measuring Device using the Universal Measurement Procedure which as a measurement uncertainty of ±5%

Chair Measurements***			
A Overall Height		36.75" - 43.75" (plastic base) 36" - 42.6" (alum. base)	32"
B Overall Width		27"	21.75" (armless) 24.3" (with arms)
C Overall Depth		27" (plastic base) 26.75" (alum. base)	24"
D Fixed Arm Height from Floor		24.2" - 28.7"	25.8"
Height Adj. Arm Height from Floor		23" - 31.5"	N/A
High Perf. Arm Height from Floor		22.875" - 30.5"	N/A
E Recline Range		96° - 120° (synchro) 96° - 110° (swivel)	N/A N/A
Back Recline Ratio		1:3 (synchro); 1:1 (swivel)	N/A
F Base Diameter		27" (plastic); 26.75" (alum.)	N/A
G Weight		41.3 lbs. (plastic base) 43.3 lbs. (alum. base)	20.2 lbs. (armless) 23.5 lbs. (with arms)

***standard cylinder; sliding seat option adds 0.5" to overall height and arm height from floor

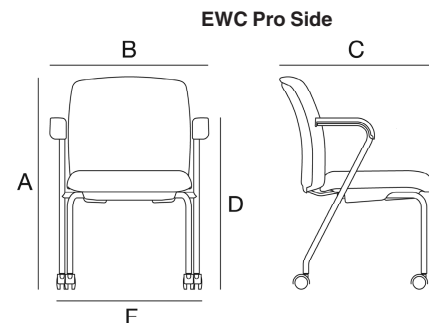
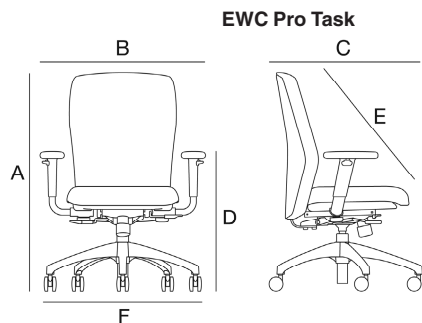

Compliance: ANSI/BIFMA X5.1 : 2011 (U.S. structural standard), ANSI/HFES 100-2007 (synchro control) (U.S. ergonomic standard), BIFMA G1 : 2002 (U.S. ergonomic guidelines), California T.B. 117 (U.S. flammability standard for foam), California T.B. 133 with approved FR textile (U.S. flammability standard for full chair), CAN/CGSB 44.232-2002 (except conference chairs); BS EN 13761 : 2002 (British visitor chair standard, EWC Pro side)

The EWC Pro chair line has been tested and is approved for use by individuals weighing up to 300 pounds.

EWC Pro High-back and Mid-back Task Chair Operating Instructions

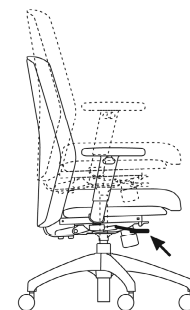

Seat Height

To raise the seat height, remove your weight from the chair while lifting the lever under the right side of the seat. To lower the seat height, lift the lever while sitting in the chair.

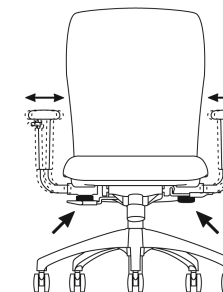

Adjustable Arm Width (All arm options)

To adjust the arm width, loosen the knob under the arm support by turning clockwise. Slide the arm support toward or away from the seat to adjust the arm width. Tighten the knob under the arm to secure.

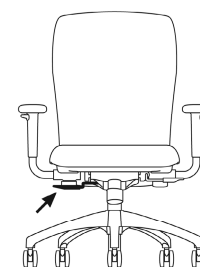

Tilt Lock

To recline, pull out the lever under the right side of the seat. To lock the chair upright, push the lever in.

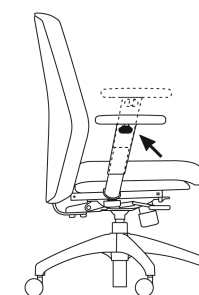

Height Adjustable Arm (Optional)

To adjust the arm pad height, lift the lever on the outside of the arm support and move the arm up or down. Release the lever to lock.



Tilt Tension

To adjust the tilt tension, turn the knob under the front of the seat. Turn counterclockwise to tighten, and clockwise to loosen. The tension adjustment provides a variable limiting function allowing the user to customize ranges of recline between upright and full recline.

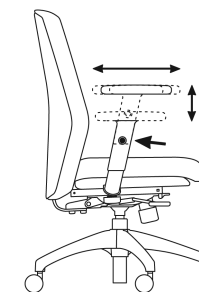

High Performance Arm (Optional)

To adjust the arm pad height, push the button on the outside of the arm support and move the arm up or down. Release the button to lock. To adjust arm pad depth, grasp arm pad and push forward or pull backward. The arm pad adjusts 2.5" in depth.

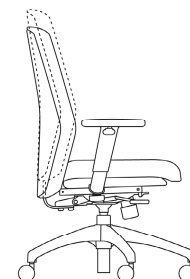

Back Height (Task chairs only)

To raise the back height, firmly hold both sides of the back and lift. The back height adjusts 9 notches upward. To lower the back height, first raise the back to the highest position; the top notch releases the back to the lowest position.

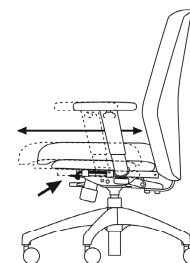

Sliding Seat Depth Adjustment (Optional)

To adjust the seat depth, lift the lever under the left side of the seat and slide the seat to the desired location. Release the lever to lock in one of the 6 positions

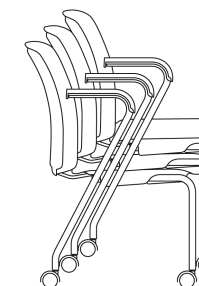

EWC Pro Side Chair

This is a stacking side chair.

Chairs should not be stacked more than 3 units high. To stack chairs, place the rear legs of the top chair in front of the rear legs of the bottom chair. The bottom of the top chair's seat should rest on the lower chair's seat.

Seat*	BIFMA G1-2002 Ergonomic Guidelines	EWC Pro Mid-back Conference Ergonomic Dimensions
Seat Height**	15" - 19.9" min range (one or combination of chairs)	16.25" - 20.75" (std. cylinder) 15.5" - 19.6" (alum. base, std. cylinder) 15" - 19" (low cylinder) **sliding seat option adds 0.5" to all seat height dimensions
Seat Depth	16.9" (or less fixed, include if adjustable)	16.9" (fixed) 16.25" - 19" (adjustable)
Seat Width	18" min	19"
Seat Pan Angle (at rest)	0° - 4° rearward	2°
Back*		
Backrest Height	12.2" min	22.75"
Backrest Width	14.2" min	18"
Lumbar Support	5.9" - 9.8"	7.25"
Angle Between Seat and Back	90° - 115°	92.5°
Tilt Range of Back	10° min	24° (synchro) 14° (swivel)
Arms*		
Armrest Height (fixed)	7.9" - 9.8"	8.2"
Inside Distance Between Armrest (fixed)	18" min	19.5" - 21.5"

*All measurements taken with BIFMA Chair Measuring Device using the Universal Measurement Procedure which has a measurement uncertainty of ±5%

Chair Measurements***

A Overall Height	36.75" - 41.25" (plastic base) 36" - 40.1" (alum. base)
B Overall Width	27"
C Overall Depth	27"
D Arm Height from Floor	24.2" - 28.7"
E Recline Range	92.5° - 116.5° (synchro) 92.5° - 106.5° (swivel) 1:3 (synchro); 1:1 (swivel)
Back Recline Ratio	1:3 (synchro); 1:1 (swivel)
F Base Diameter	27" (plastic); 26.75" (alum.)
G Weight	41.3 lbs. (plastic base) 43.3 lbs. (alum. base)

***standard cylinder; sliding seat adds 0.5" to overall height and arm height from floor

EWC Pro Conference

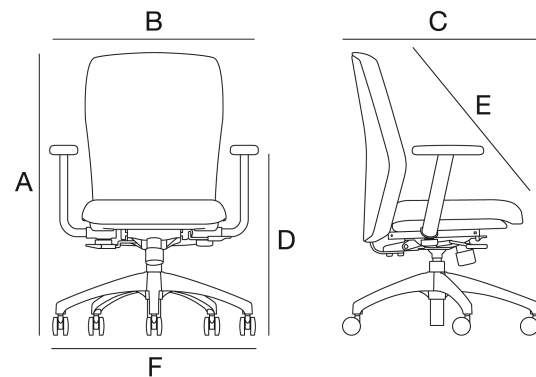

Compliance: ANSI/BIFMA X5.1 : 2011 (U.S. structural standard), ANSI/HFES 100-2007 (synchro control) (U.S. ergonomic standard), BIFMA G1 : 2002 (U.S. ergonomic guidelines), California T.B. 117 (U.S. flammability standard for foam), California T.B. 133 with approved FR textile (U.S. flammability standard for full chair)

The EWC Pro chair line has been tested and is approved for use by individuals weighing up to 300 pounds.

EWC Pro Mid-back Conference Chair Operating Instructions

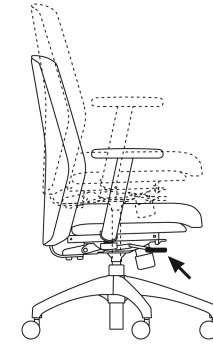

Seat Height

To raise the seat height, remove your weight from the chair while lifting the lever under the right side of the seat. To lower the seat height, lift the lever while sitting in the chair.

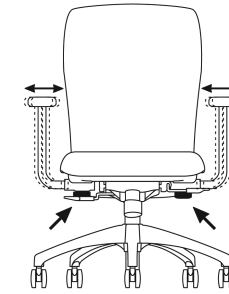

Adjustable Arm Width

To adjust the arm width, loosen the knob under the arm support by turning clockwise. Slide the arm support toward or away from the seat to adjust the arm width. Tighten the knob under the arm to secure.

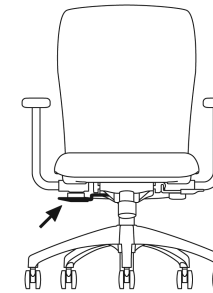

Tilt Lock

To recline, pull out the lever under the right side of the seat. To lock the chair upright, push the lever in.

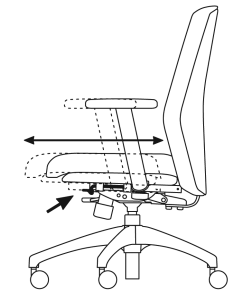

Sliding Seat Depth Adjustment (Optional)

To adjust the seat depth, lift the lever under the left side of the seat and slide the seat to the desired location. Release the lever to lock in one of the 6 positions.



Tilt Tension

To adjust the tilt tension, turn the knob under the front of the seat. Turn counterclockwise to tighten, and clockwise to loosen. The tension adjustment provides a variable limiting function allowing the user to customize ranges of recline between upright and full recline.

EWC Tech™
suspension back task chair
synchronized tilt control
fully assembled

Designer(s):
Jeffrey Bennett and
Nicholas Dodziuk, 2005



arm	description	pattern no.
Armless	Suspension mid-back task chair, plastic base, synchronized control	88W-MB-2-SY-NA-5-ASMQ(-)
Fixed arms	Suspension mid-back task chair, plastic base, synchronized control	88W-MB-2-SY-FA-5-ASMQ(-)
Height/width adjustable arms	Suspension mid-back task chair, plastic base, synchronized control	88W-MB-2-SY-HA-5-ASMQ(-)
High performance arms	Suspension mid-back task chair, plastic base, synchronized control	88W-MB-2-SY-HP-5-ASMQ(-)

list price	Presto base grade	A	COM B	C	D	E	F	G	H	I	T	COL U	V	W	X	Y
\$777.	\$791.	\$804.	\$819.	\$841.	\$859.	\$883.	\$894.	\$898.	\$913.	\$951.	\$1,006.	\$1,057.	\$1,147.	n/a	\$1,233.	
838.	850.	862.	881.	900.	920.	943.	953.	958.	972.	1,014.	1,065.	1,118.	1,209.	n/a	1,295.	
869.	882.	895.	912.	931.	951.	975.	984.	990.	1,005.	1,045.	1,099.	1,150.	1,239.	n/a	1,327.	
885.	899.	912.	927.	949.	967.	992.	1,002.	1,006.	1,021.	1,059.	1,115.	1,165.	1,256.	n/a	1,341.	

Order Code	Ordering Information	Options
<i>Example:</i> 88W-MB-2-SY-HA 5-SL-ASMQ-HC Seat: K1000/8 - Back: S08	<i>Specify:</i> 1. Pattern number 2. Seat and back upholstery 3. Suspension back color	<i>Cylinder Height Option:</i> For low height cylinder (plastic base only), replace 5 in pattern number with L. See Dimensions page for seat height range. <i>Caster and Glide Options:</i> Substitute HC in pattern with one of the following options: <i>Code: Upchg: Description:</i> SC n/c soft black casters for hard surfaces GL n/c glides
88W Essentials Tech suspension back task chair	<i>Finish color:</i> Black	<i>Code: Upchg: Description:</i> L \$72 low cylinder
MB Mid-back	<i>Options</i> <i>Polished Aluminum Base:</i> Replace 2 in pattern with 4. Only available with standard height cylinder.	<i>Sliding Seat Option:</i> For sliding seat with 2.75" of depth adjustment insert SL after cylinder choice in pattern number. Adds 0.5" to seat height. <i>Code: Upchg: Description:</i> SL \$40 sliding seat
2 Black finish	<i>Code: Upchg: Description:</i> 4 \$153 polished aluminum base	
SY Synchronized tilt control		
HA Height and width adjustable arms		
5 Standard height cylinder		
SL Sliding seat		
ASMQ Fully assembled		
HC Hard wheel black caster		
SEAT Presto Red Carpet		
K1000/8		
BACK S08 Red Carpet		

Presto - Base Grade Fabric	Suspension Back-Standard
FOR SEAT ONLY <i>Color options:</i> Presto Winter White K1000/1 Presto Sand K1000/2 Presto Stone K1000/3 Presto Saffron K1000/4 Presto Spring Green K1000/5 Presto Blue Chip K1000/6 Presto Scarlet K1000/7 Presto Red Carpet K1000/8 Presto Beige Taupe K1000/9 Presto Olive K1000/10 Presto Navy Blue K1000/11 Presto Clear Gray K1000/12 Presto Charcoal Gray K1000/13 Presto Black Tie K1000/14	FOR BACK ONLY <i>Color options:</i> Red Carpet S08 Beige Taupe S09 Olive S10 Navy Blue S11 Clear Gray S12 Charcoal Gray S13 Black Tie S14 EWC Tech Suspension Back is cleaning code W-S. It is rated Heavy Duty for abrasion (exceeds 30,000 double rubs with Wyzenbeek method).
	<i>CAL 133 Options:</i> <i>Code: Upchg: Description:</i> C133 \$51 CAL 133 textile on seat only. (add C133 to the end of the pattern number)
	COM/COL Upholstery Requirements Textile yardage required: .8 yards Leather sq. ft. required: 10 sq. ft.

EWC Tech™
suspension back task chair
swivel tilt control
fully assembled

Designer(s):
 Jeffrey Bernett and
 Nicholas Dodziuk, 2005



arm	description	pattern no.
Armless	Suspension mid-back task chair, plastic base, swivel-tilt control	88W-MB-2-ST-NA-5-ASMQ-()
Fixed arms	Suspension mid-back task chair, plastic base, swivel-tilt control	88W-MB-2-ST-FA-5-ASMQ-()
Height/width adjustable arms	Suspension mid-back task chair, plastic base, swivel-tilt control	88W-MB-2-ST-HA-5-ASMQ-()
High performance arms	Suspension mid-back task chair, plastic base, swivel-tilt control	88W-MB-2-ST-HP-5-ASMQ-()

list price	A	COM B	C	D	E	F	G	H	I	T	COL U	V	W	X	Y	
Presto base grade	\$671.	\$686.	\$700.	\$716.	\$737.	\$757.	\$779.	\$790.	\$795.	\$809.	\$846.	\$901.	\$955.	\$1,047.	n/a	\$1,131.
	732.	746.	760.	777.	799.	817.	841.	850.	855.	871.	910.	962.	1,017.	1,108.	n/a	1,196.
	765.	778.	792.	808.	828.	848.	872.	883.	888.	902.	942.	995.	1,049.	1,139.	n/a	1,228.
	779.	794.	808.	824.	845.	865.	888.	898.	904.	917.	954.	1,010.	1,063.	1,155.	n/a	1,239.

Order Code	Ordering Information	Options
<i>Example:</i> 88W-MB-2-ST-HA 5-SL-ASMQ-HC Seat: K1000/8 Back: S08	<i>Specify:</i> 1. Pattern number 2. Seat and back upholstery 3. Suspension back color	<i>Cylinder Height Option:</i> For low height cylinder (plastic base only), replace 5 in pattern number with L. See Dimensions page for seat height range. <i>Caster and Glide Options:</i> Substitute HC in pattern with one of the following options: <i>Code: Upchg: Description:</i> SC n/c soft black casters for hard surfaces GL n/c glides
88W Essentials Tech upholstered task chair	<i>Finish color:</i> Black	<i>Code: Upchg: Description:</i> L \$72 low cylinder
MB Mid-back	Options	<i>Sliding Seat Option:</i> For sliding seat with 2.75" of depth adjustment insert SL after cylinder choice in pattern number. Adds 0.5" to seat height. <i>Code: Upchg: Description:</i> SL \$40 sliding seat
2 Black finish	<i>Polished Aluminum Base:</i> Replace 2 in pattern with 4. Only available with standard height cylinder.	
ST Swivel tilt control	<i>Code: Upchg: Description:</i> 4 \$153 polished aluminum base	
HA Height and width adjustable arms		
5 Standard height cylinder		
SL Sliding seat		
ASMQ Fully assembled		
HC Hard wheel black caster		
SEAT Presto Red Carpet		
K1000/8		
BACK S08 Red Carpet		

Presto - Base Grade Fabric	Suspension Back-Standard
FOR SEAT ONLY <i>Color options:</i> Presto Winter White K1000/1 Presto Sand K1000/2 Presto Stone K1000/3 Presto Saffron K1000/4 Presto Spring Green K1000/5 Presto Blue Chip K1000/6 Presto Scarlet K1000/7 Presto Red Carpet K1000/8 Presto Beige Taupe K1000/9 Presto Olive K1000/10 Presto Navy Blue K1000/11 Presto Clear Gray K1000/12 Presto Charcoal Gray K1000/13 Presto Black Tie K1000/14	FOR BACK ONLY <i>Color options:</i> Red Carpet S08 Beige Taupe S09 Olive S10 Navy Blue S11 Clear Gray S12 Charcoal Gray S13 Black Tie S14 EWC Tech Suspension Back is cleaning code W-S. It is rated Heavy Duty for abrasion (exceeds 30,000 double rubs Wyzenbeek method). COM/COL Upholstery Requirements Textile yardage required: .8 yards Leather sq. ft. required: 10 sq. ft.
	<i>CAL 133 Options:</i> <i>Code: Upchg: Description:</i> C133 \$51 CAL 133 textile on seat only. (add C133 to the end of the pattern number)

EWC Tech™
suspension back conference chair
synchronized tilt control
fully assembled

Designer(s):
 Jeffrey Bennett and
 Nicholas Dodziuk, 2007



arm	description	pattern no.
Fixed arms	Suspension mid-back conference chair, plastic base, synchronized control	88C-MB-2-SY-FA-5-ASMQ-()



list price	A	COM B	C	D	E	F	G	H	I	T	COL U	V	W	X	Y
Presto base grade															
\$838.	\$850.	\$862.	\$881.	\$900.	\$920.	\$943.	\$953.	\$958.	\$972.	\$1,014.	\$1,065.	\$1,118.	\$1,209.	n/a	\$1,295.

Order Code	Ordering Information	Options
<i>Example:</i> 88C-MB-2-SY-FA 5-SL-ASMQ-HC Seat: K1000/8 - Back: S08	<i>Specify:</i> 1. Pattern number 2. Seat and back upholstery 3. Suspension back color	<i>Cylinder Height Option:</i> For low height cylinder (platic base only), replace 5 in pattern number with L. See Dimensions page for seat height range. <i>Caster and Glide Options:</i> Substitute HC in pattern with one of the following options: <i>Code: Upchg: Description:</i> SC n/c soft black casters for hard surfaces GL n/c glides
88C EWC Tech suspension back conference chair	<i>Finish color:</i> Black	<i>Code: Upchg: Description:</i> L \$72 low cylinder
MB Mid-back	Options	<i>Sliding Seat Option:</i> For sliding seat with 2.75" of depth adjustment insert SL after cylinder choice in pattern number. Adds 0.5" to seat height. <i>Code: Upchg: Description:</i> SL \$40 sliding seat
2 Black finish	<i>Polished Aluminum Base:</i> Replace 2 in pattern with 4. Only available with standard height cylinder.	
SY Synchronized tilt control	<i>Code: Upchg: Description:</i> 4 \$153 polished aluminum base	
FA Fixed width adjustable arms		
5 Standard height cylinder		
SL Sliding seat		
ASMQ Fully assembled		
HC Hard wheel black caster		
SEAT K1000/8 Presto Red Carpet		
BACK S08 Red Carpet		

Presto - Base Grade Fabric	Suspension Back-Standard
FOR SEAT ONLY <i>Color options:</i> Presto Winter White K1000/1 Presto Sand K1000/2 Presto Stone K1000/3 Presto Saffron K1000/4 Presto Spring Green K1000/5 Presto Blue Chip K1000/6 Presto Scarlet K1000/7 Presto Red Carpet K1000/8 Presto Beige Taupe K1000/9 Presto Olive K1000/10 Presto Navy Blue K1000/11 Presto Clear Gray K1000/12 Presto Charcoal Gray K1000/13 Presto Black Tie K1000/14	FOR BACK ONLY <i>Color options:</i> Red Carpet S08 Beige Taupe S09 Olive S10 Navy Blue S11 Clear Gray S12 Charcoal Gray S13 Black Tie S14 EWC Tech Suspension Back is cleaning code W-S. It is rated Heavy Duty for abrasion (exceeds 30,000 double rubs Wyzenbeek method). COM/COL Upholstery Requirements Textile yardage required: .8 yards Leather sq. ft. required: 10 sq. ft.
	<i>CAL 133 Options:</i> <i>Code: Upchg: Description:</i> C133 \$51 CAL 133 textile on seat only. (add C133 to the end of the pattern number)

EWC Tech™
suspension back conference chair
swivel tilt control
fully assembled

Designer(s):
 Jeffrey Bennett and
 Nicholas Dodziuk, 2007

Fixed arms



arm	description	pattern no.
Fixed arms	Suspension mid-back conference chair, plastic base, swivel-tilt control	88C-MB-2-ST-FA-5-ASMQ-()



list price	A	COM B	C	D	E	F	G	H	I	T	COL U	V	W	X	Y
Presto base grade															
\$732.	\$746.	\$760.	\$777.	\$799.	\$817.	\$841.	\$850.	\$855.	\$871.	\$910.	\$962.	\$1,017.	\$1,108.	n/a	\$1,196.

Order Code	Ordering Information	Options
<i>Example:</i> 88C-MB-2-ST-FA 5-SL-ASMQ-HC Seat: K1000/8 Back: S08	<i>Specify:</i> 1. Pattern number 2. Seat and back upholstery 3. Suspension back color	<i>Cylinder Height Option:</i> For low height cylinder (plastic base only), replace 5 in pattern number with L. See Dimensions page for seat height range. <i>Caster and Glide Options:</i> Substitute HC in pattern with one of the following options: <i>Code: Upchg: Description:</i> SC n/c soft black casters for hard surfaces GL n/c glides
88C	EWC Tech suspension back conference chair	
MB	Mid-back	
2	Black finish	
ST	Swivel tilt control	
FA	Fixed width adjustable arms	
5	Standard height cylinder	
SL	Sliding seat	
ASMQ	Fully assembled	
HC	Hard wheel black caster	
SEAT K1000/8	Presto Red Carpet	
BACK S08	Red Carpet	
	<i>Finish color:</i> Black	<i>Code: Upchg: Description:</i> L \$72 low cylinder
	Options	<i>Sliding Seat Option:</i> For sliding seat with 2.75" of depth adjustment insert SL after cylinder choice in pattern number. Adds 0.5" to seat height. <i>Code: Upchg: Description:</i> SL \$40 sliding seat
	<i>Polished Aluminum Base:</i> Replace 2 in pattern with 4. Only available with standard height cylinder.	
	<i>Code: Upchg: Description:</i> 4 \$153 polished aluminum base	

Presto - Base Grade Fabric	Suspension Back-Standard
FOR SEAT ONLY <i>Color options:</i>	FOR BACK ONLY <i>Color options:</i>
Presto Winter White K1000/1 Presto Sand K1000/2 Presto Stone K1000/3 Presto Saffron K1000/4 Presto Spring Green K1000/5 Presto Blue Chip K1000/6 Presto Scarlet K1000/7 Presto Red Carpet K1000/8 Presto Beige Taupe K1000/9 Presto Olive K1000/10 Presto Navy Blue K1000/11 Presto Clear Gray K1000/12 Presto Charcoal Gray K1000/13 Presto Black Tie K1000/14	Red Carpet S08 Beige Taupe S09 Olive S10 Navy Blue S11 Clear Gray S12 Charcoal Gray S13 Black Tie S14 EWC Tech Suspension Back is cleaning code W-S. It is rated Heavy Duty for abrasion (exceeds 30,000 double rubs Wyzenbeek method).
	<i>CAL 133 Options:</i> <i>Code: Upchg: Description:</i> C133 \$51 CAL 133 textile on seat only. (add C133 to the end of the pattern number)
	COM/COL Upholstery Requirements Textile yardage required: .8 yards Leather sq. ft. required: 10 sq. ft.

Seat*	BIFMA G1-2002 Ergonomic Guidelines	EWC Tech Mid-back Task Ergonomic Dimensions	EWC Tech Side
Seat Height**	15" - 19.9" minimum range (one or combination of chairs)	16.25" - 20.75" (std. cylinder) 15.5" - 19.6" (alum. base, std. cylinder) 15" - 19" (low cylinder)	17"
**sliding seat option adds 0.5" to all seat height dimensions			
Seat Depth	16.9" or less fixed, include if adjustable	16.9" (fixed) 16.25" - 19" (adjustable)	16.9"
Seat Width	18" min	19"	19"
Seat Pan Angle (at rest)	0° - 4° rearward	2°	2°

Back*			
Backrest Height	12.2" min	23"	17.5"
Backrest Width	14.2" min	19"	18.5"
Lumbar Support	5.9" - 9.8"	6.5"	6.25"
Angle Between Seat and Back	90° - 115°	96°	103°
Tilt Range of Back	10° min	24° (synchro) 14° (swivel)	N/A

Arms*			
Armrest Height (fixed)	7.9" - 9.8"	8.2" (fixed)	9.4"
Armrest Height (adjustable)	6.9" - 10.8"	7" - 10.5" (height adj.) 7.875" - 11" (high perf.)	N/A
Inside Distance Between Armrests (fixed)	18" min	19.5" - 21.5" (fixed)	19.5"
Inside Distance Between Armrests (adjustable)	include 18"	19.5" - 21.5" (height adj.) 18.5" - 20.625" (high perf.)	N/A

*All measurements taken with BIFMA Chair Measuring Device using the Universal Measurement Procedure which has a measurement uncertainty of ±5%

Chair Measurements ***

A Overall Height	38.25" - 42.75" (plastic base) 37.5" - 41.6" (alum. base)	32"
B Overall Width	27"	21.75" (armless) 24.3" (with arms)
C Overall Depth	27" (plastic base); 26.75" (alum. base)	24"
D Fixed Arm Height from Floor	24.2" - 28.7"	25.8"
Height Adj. Arm Height from Floor	23" - 31.5"	N/A
High Perf. Arm Height from Floor	22.875" - 30.5"	N/A
E Recline Range	96° - 120° (synchro) 96° - 110° (swivel)	N/A
Back Recline Ratio	1:3 (synchro); 1:1 (swivel)	N/A
F Base Diameter	27" (plastic); 26.75" (alum.)	N/A
G Weight	38.6 lbs. (plastic base) 40.6 lbs. (alum. base)	19.2 lbs. (armless) 22.5 lbs. (with arms)

***standard cylinder; sliding seat option adds 0.5" to overall height and arm height from floor

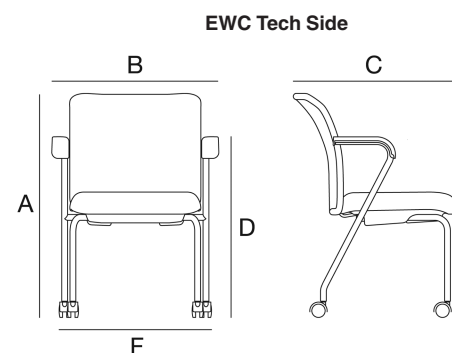
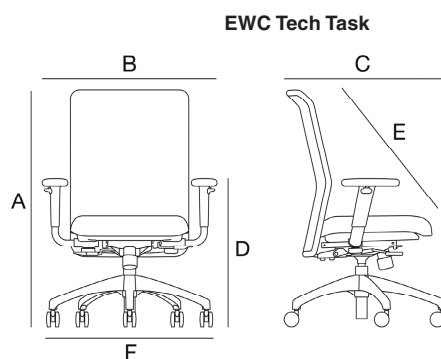

Compliance: ANSI/BIFMA X5.1 : 2011 (U.S. structural standard), ANSI/HFES 100-2007 (synchro control) (U.S. ergonomic standard), BIFMA G1 : 2002 (U.S. ergonomic guidelines), California T.B. 117 (U.S. flammability standard for foam), California T.B. 133 with approved FR textile (U.S. flammability standard for full chair), CAN/CSB 44.232-2002 (except conference chairs); BS EN 13761 : 2002 (British visitor chair standard, EWC Tech side)

The EWC Tech chair line has been tested and is approved for use by individuals weighing up to 300 pounds.

EWC Tech Task Chair Operating Instructions

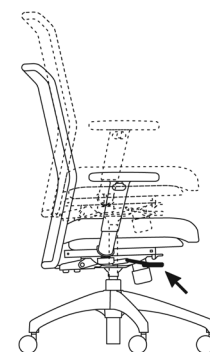

Seat Height

To raise the seat height, remove your weight from the chair while lifting the lever under the right side of the seat. To lower the seat height, lift the lever while sitting in the chair.

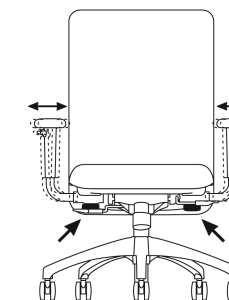

Adjustable Arm Width (All arm options)

To adjust the arm width, loosen the knob under the arm support by turning clockwise. Slide the arm support toward or away from the seat to adjust the arm width. Tighten the knob under the arm to secure.

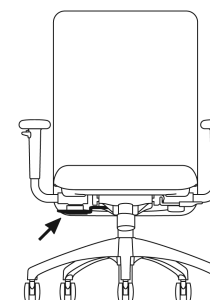

Tilt Lock

To recline, pull out the lever under the right side of the seat. To lock the chair upright, push the lever in.

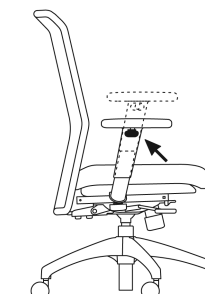

Height Adjustable Arm (Optional)

To adjust the arm pad height, lift the lever on the outside of the arm support and move the arm up or down. Release the lever to lock.

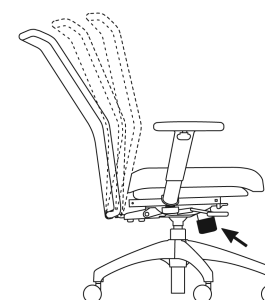

Tilt Tension

To adjust the tilt tension, turn the knob under the front of the seat. Turn counterclockwise to tighten, and clockwise to loosen. The tension adjustment provides a variable limiting function allowing the user to customize ranges of recline between upright and full recline.

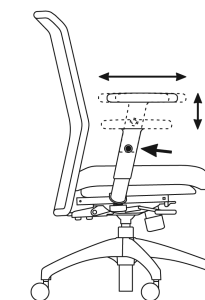

High Performance Arm (Optional)

To adjust the arm pad height, push the button on the outside of the arm support and move the arm up or down. Release the button to lock. To adjust arm pad depth, grasp arm pad and push forward or pull backward. The arm pad adjusts 2.5" in depth.

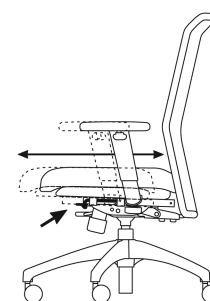

Sliding Seat Depth Adjustment (Optional)

To adjust the seat depth, lift the lever under the left side of the seat and slide the seat to the desired location. Release the lever to lock in one of the 6 positions.

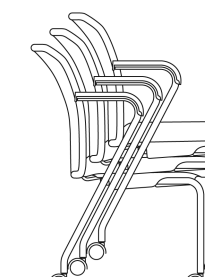

EWC Tech Side Chair

This is a stacking side chair.

Chairs should not be stacked more than 3 units high. To stack chairs, place the rear legs of the top chair in front of the rear legs of the bottom chair. The bottom of the top chair's seat should rest on the lower chair's seat.

Seat*	BIFMA G1-2002 Ergonomic Guidelines	EWC Tech Mid-back Conference Ergonomic Dimensions
Seat Height**	15" - 19.9 minimum range" (one or combination of chairs)	16.25" - 20.75" (std. cylinder) 15.5" - 19.6" (alum. base, std. cylinder) 15" - 19" (low cylinder) **sliding seat option adds 0.5" to all seat height dimensions
Seat Depth	16.9" or less fixed, include if adjustable	16.9" (fixed) 16.25" - 19" (adjustable)
Seat Width	18" min	19"
Seat Pan Angle (at rest)	0° - 4° rearward	2°
Back*		
Backrest Height	12.2" min	23"
Backrest Width	14.2" min	19"
Lumbar Support	5.9" - 9.8"	6.5"
Angle Between Seat and Back	90° - 115°	96°
Tilt Range of Back	10° min	24° (synchro) 14° (swivel)
Arms*		
Armrest Height (fixed)	7.9" - 9.8"	8.2"
Inside Distance Between Armrests (fixed)	18" min	19.5" - 21.5"

*All measurements taken with BIFMA Chair Measuring Device using the Universal Measurement Procedure which has a measurement uncertainty of ±5%

Chair Measurements***

A Overall Height	38.25" - 42.75" (plastic base) 37.5" - 41.6" (alum. base)
B Overall Width	27"
C Overall Depth	27" (plastic base) 26.75" (alum. base)
D Arm Height from Floor	24.2" - 28.7"
E Recline Range	96° - 120° (synchro) 96° - 110° (swivel)
Back Recline Ratio	1:3 (synchro); 1:1 (swivel)
F Base Diameter	27" (plastic); 26.75" (alum.)
G Weight	38.6 lbs. (plastic base) 40.6 lbs. (alum. base)

***standard cylinder; sliding seat adds 0.5" to overall height and arm height from floor

EWC Tech Conference

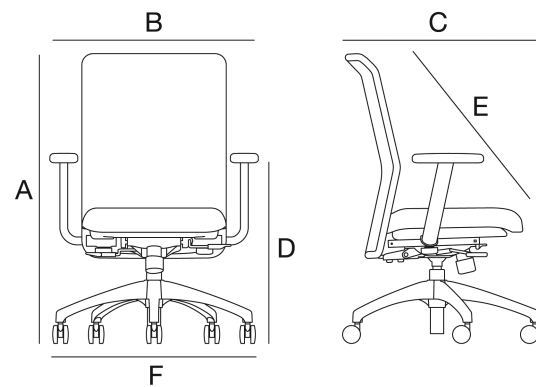

EWC Tech Conference Chair Operating Instructions

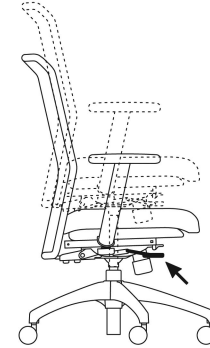

Seat Height

To raise the seat height, remove your weight from the chair while lifting the lever under the right side of the seat. To lower the seat height, lift the lever while sitting in the chair.

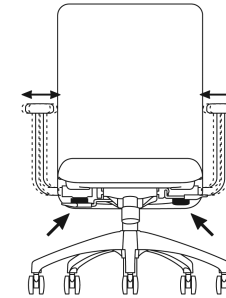

Adjustable Arm Width

To adjust the arm width, loosen the knob under the arm support by turning clockwise. Slide the arm support toward or away from the seat to adjust the arm width. Tighten the knob under the arm to secure.

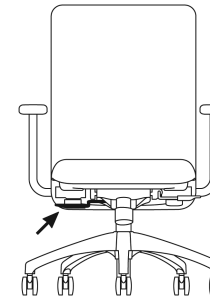

Tilt Lock

To recline, pull out the lever under the right side of the seat. To lock the chair upright, push the lever in.

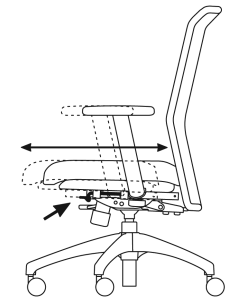

Sliding Seat Depth Adjustment (Optional)

To adjust the seat depth, lift the lever under the left side of the seat and slide the seat to the desired location. Release the lever to lock in one of the 6 positions.



Tilt Tension

To adjust the tilt tension, turn the knob under the front of the seat. Turn counterclockwise to tighten, and clockwise to loosen. The tension adjustment provides a variable limiting function allowing the user to customize ranges of recline between upright and full recline.

Compliance: ANSI/BIFMA X5.1 : 2011 (U.S. structural standard), ANSI/HFES 100-2007 (synchro control) (U.S. ergonomic standard), BIFMA G1 : 2002 (U.S. ergonomic guidelines), California T.B. 117 (U.S. flammability standard for foam), California T.B. 133 with approved FR textile (U.S. flammability standard for full chair)





The EWC Tech chair line has been tested and is approved for use by individuals weighing up to 300 pounds.

EWC Sport™
upholstered mid-back task chair
synchronized tilt control
fully assembled

Designer(s):
 Jeffrey Bernett and
 Nicholas Dodziuk, 2007



(Shown with EWC Sport Fabric
 Seat Accent Option)

arm	description	pattern no.
Armless 	Upholstered mid-back task chair with upholstered outer back, 2.5" back height adjustment, plastic base, synchronized control	99W-MBU-2-SY-NA-5-ASMQ-()
Fixed arms 	Upholstered mid-back task chair with upholstered outer back, 2.5" back height adjustment, plastic base, synchronized control	99W-MBU-2-SY-FA-5-ASMQ-()
Height/width adjustable arms 	Upholstered mid-back task chair with upholstered outer back, 2.5" back height adjustment, plastic base, synchronized control	99W-MBU-2-SY-HA-5-ASMQ-()
High performance arms 	Upholstered mid-back task chair with upholstered outer back, 2.5" back height adjustment, plastic base, synchronized control	99W-MBU-2-SY-HP-5-ASMQ-()

list price	COM														COL	
Presto base grade	A	B	C	D	E	F	G	H	I	T	U	V	W	X	Y	
\$776.	\$809.	\$844.	\$879.	\$923.	\$970.	\$1,016.	\$1,062.	\$1,131.	\$1,212.	\$1,253.	\$1,295.	\$1,475.	\$1,698.	n/a	\$1,908.	
833.	866.	901.	935.	981.	1,028.	1,074.	1,121.	1,190.	1,270.	1,311.	1,353.	1,532.	1,759.	n/a	1,966.	
864.	898.	932.	967.	1,013.	1,059.	1,106.	1,153.	1,222.	1,302.	1,342.	1,384.	1,563.	1,789.	n/a	1,997.	
883.	916.	951.	986.	1,030.	1,077.	1,123.	1,169.	1,238.	1,319.	1,360.	1,402.	1,582.	1,806.	n/a	2,015.	

Order Code	Ordering Information	Options
<i>Example:</i> 99W-MBU-2-SY-HA-5-SL-ASMQ-HC K1000/8 K1000/8 K1196/14	<i>Specify:</i> 1. Pattern number 2. Seat upholstery 3. Seat accent upholstery 4. Back upholstery 5. Back accent upholstery <i>Finish color:</i> Black Options <i>Polished Aluminum Base:</i> Replace 2 in pattern with 4. Only available with standard height cylinder. <i>Code: Upchg: Description:</i> 4 \$153 polished aluminum base	<i>Cylinder Height Option:</i> For low height cylinder (plastic base only), replace 5 in pattern number with L. See Dimensions page for seat height range. <i>Code: Upchg: Description:</i> L \$72 low cylinder <i>Sliding Seat Option:</i> For sliding seat with 2.75" of depth adjustment insert SL after cylinder choice in pattern number. Adds 0.5" to seat height. <i>Code: Upchg: Description:</i> SL \$40 sliding seat <i>Caster and Glide Options:</i> Substitute HC in pattern with one of the following options: <i>Code: Upchg: Description:</i> SC n/c soft black casters for hard surfaces GL n/c glides
99W	EWC Sport task chair	
MB	Mid-back	
U	Upholstered outer back	
2	Black finish	
SY	Synchronized tilt control	
HA	Height and width adjustable arms	
5	Standard height cylinder	
SL	Sliding seat	
ASMQ	Fully assembled	
HC	Hard wheel black casters	
K1000/8	Presto Red Carpet	
K1000/8	Presto Red Carpet	
K1000/8	Presto Red Carpet	
K1196/14	EWC Sport Black	





Presto - Base Grade Fabric	EWC Sport Fabric	COM/COL Upholstery Requirements
<i>Color options:</i> Presto Winter White K1000/1 Presto Sand K1000/2 Presto Stone K1000/3 Presto Saffron K1000/4 Presto Spring Green K1000/5 Presto Blue Chip K1000/6 Presto Scarlet K1000/7 Presto Red Carpet K1000/8 Presto Beige Taupe K1000/9 Presto Olive K1000/10 Presto Navy Blue K1000/11 Presto Clear Gray K1000/12 Presto Charcoal Gray K1000/13 Presto Black Tie K1000/14 For split seat and back upholstery, indicate the words "seat" and "back" before the selected color.	<i>Back and Seat Accent Options:</i> All EWC Sport chairs come standard with an EWC Sport fabric upholstered outer back accent. The back accent can only be specified in EWC Sport fabric. Optional EWC Sport fabric seat accents can be specified for an upcharge of \$28. EWC Sport fabric is available in three colors as outlined below. Chair can be fully upholstered in EWC Sport fabric at Grade A pricing. Color Options: EWC Sport Beige Taupe K1196/9 EWC Sport Charcoal Gray K1196/13 EWC Sport Black K1196/14 EWC Sport Fabric exceeds 100,000 double rubs Wyzenbeek method and is cleaning code W-S.	<i>Split Upholstery Option:</i> EWC Sport seats and backs can be upholstered in any two approved KnollTextiles or Spinneybeck upholsteries. To specify, first indicate the seat upholstery (labeled "seat upholstery") and then indicate the back upholstery (labeled "back upholstery"). The list price of the chair equals the list price of the higher of the two upholstery grades. COM/COL Upholstery Requirements Textile yardage required: 1.9 yards Leather sq. ft. required: 22 sq. ft. <i>CAL 133 Options:</i> <i>Code: Upchg: Description:</i> C133 \$80 CAL 133 textile on seat and back. Add C133 to the end of the pattern number

EWC Sport™
upholstered mid-back task chair
swivel tilt control
fully assembled

Designer(s):
 Jeffrey Bernett and
 Nicholas Dodziuk, 2007



(Shown with EWC Sport Fabric
 Seat Accent Option)

arm	description	pattern no.
Armless 	Upholstered mid-back task chair with upholstered outer back, 2.5" back height adjustment, plastic base, swivel-tilt control	99W-MBU-2-ST-NA-5-ASMQ-()
Fixed arms 	Upholstered mid-back task chair with upholstered outer back, 2.5" back height adjustment, plastic base, swivel-tilt control	99W-MBU-2-ST-FA-5-ASMQ-()
Height/width adjustable arms 	Upholstered mid-back task chair with upholstered outer back, 2.5" back height adjustment, plastic base, swivel-tilt control	99W-MBU-2-ST-HA-5-ASMQ-()
High performance arms 	Upholstered mid-back task chair with upholstered outer back, 2.5" back height adjustment, plastic base, swivel-tilt control	99W-MBU-2-ST-HP-5-ASMQ-()

list price	COM														COL	
Presto base grade	A	B	C	D	E	F	G	H	I	T	U	V	W	X	Y	
\$672.	\$705.	\$741.	\$776.	\$822.	\$869.	\$915.	\$962.	\$1,031.	\$1,115.	\$1,156.	\$1,198.	\$1,378.	\$1,606.	n/a	\$1,818.	
730.	764.	799.	834.	881.	927.	975.	1,021.	1,093.	1,173.	1,214.	1,257.	1,437.	1,665.	n/a	1,877.	
761.	795.	830.	865.	912.	958.	1,006.	1,053.	1,123.	1,206.	1,247.	1,286.	1,471.	1,697.	n/a	1,909.	
779.	812.	848.	883.	929.	976.	1,022.	1,069.	1,138.	1,222.	1,263.	1,305.	1,485.	1,713.	n/a	1,925.	

Order Code	Ordering Information	Options
<i>Example:</i> 99W-MBU-2-ST-HA-5-SL-ASMQ-HC K1000/8 K1000/8 K1196/14	<i>Specify:</i> 1. Pattern number 2. Seat upholstery 3. Seat accent upholstery 4. Back upholstery 5. Back accent upholstery <i>Finish color:</i> Black Options <i>Polished Aluminum Base:</i> Replace 2 in pattern with 4. Only available with standard height cylinder. <i>Code: Upchg: Description:</i> 4 \$153 polished aluminum base	<i>Cylinder Height Option:</i> For low height cylinder (plastic base only), replace 5 in pattern number with L. See Dimensions page for seat height range. <i>Code: Upchg: Description:</i> L \$72 low cylinder <i>Sliding Seat Option:</i> For sliding seat with 2.75" of depth adjustment insert SL after cylinder choice in pattern number. Adds 0.5" to seat height. <i>Code: Upchg: Description:</i> SL \$40 sliding seat
99W	EWC Sport task chair	
MB	Mid-back	
U	Upholstered outer back	
2	Black finish	
ST	Swivel tilt control	
HA	Height and width adjustable arms	
5	Standard height cylinder	
SL	Sliding seat	
ASMQ	Fully assembled	
HC	Hard wheel black casters	
K1000/8	Presto Red Carpet	
K1000/8	Presto Red Carpet	
K1000/8	Presto Red Carpet	
K1196/14	EWC Sport Black	

Presto - Base Grade Fabric	EWC Sport Fabric	COM/COL Upholstery Requirements
<i>Color options:</i> Presto Winter White K1000/1 Presto Sand K1000/2 Presto Stone K1000/3 Presto Saffron K1000/4 Presto Spring Green K1000/5 Presto Blue Chip K1000/6 Presto Scarlet K1000/7 Presto Red Carpet K1000/8 Presto Beige Taupe K1000/9 Presto Olive K1000/10 Presto Navy Blue K1000/11 Presto Clear Gray K1000/12 Presto Charcoal Gray K1000/13 Presto Black Tie K1000/14 <i>For split seat and back upholstery, indicate the words "seat" and "back" before the selected color.</i>	<i>Back and Seat Accent Options:</i> All EWC Sport chairs come standard with an EWC Sport fabric upholstered outer back accent. The back accent can only be specified in EWC Sport fabric. Optional EWC Sport fabric seat accents can be specified for an upcharge of \$28. EWC Sport fabric is available in three colors as outlined below. Chair can be fully upholstered in EWC Sport fabric at Grade A pricing. Color Options: EWC Sport Beige Taupe K1196/9 EWC Sport Charcoal Gray K1196/13 EWC Sport Black K1196/14 EWC Sport Fabric exceeds 100,000 double rubs Wyzenbeck method and is cleaning code W-S.	<i>Split Upholstery Option:</i> EWC Sport seats and backs can be upholstered in any two approved KnollTextiles or Spinneybeck upholsteries. To specify, first indicate the seat upholstery (labeled "seat upholstery") and then indicate the back upholstery (labeled "back upholstery"). The list price of the chair equals the list price of the higher of the two upholstery grades. COM/COL Upholstery Requirements Textile yardage required: 1.9 yards Leather sq. ft. required: 22 sq. ft. <i>CAL 133 Options:</i> <i>Code: Upchg: Description:</i> C133 \$80 CAL 133 textile on seat and back. Add C133 to the end of the pattern number

EWC Sport™
upholstered mid-back conference chair
synchronized tilt control
fully assembled

arm	description	pattern no.
Fixed arms	Upholstered mid-back conference chair with upholstered outer back, fixed back height, plastic base, synchronized control	99C-MBU-2-SY-FA-5-ASMQ()

Designer(s):
 Jeffrey Bernett and
 Nicholas Dodziuk, 2007



(Shown with EWC Sport Fabric
 Seat Accent Option)

list price	COM															
Presto base grade	A	B	C	D	E	F	G	H	I	T	COL		V	W	X	Y
\$826.	\$860.	\$896.	\$930.	\$976.	\$1,022.	\$1,068.	\$1,115.	\$1,185.	\$1,265.	\$1,306.	\$1,347.	\$1,527.	\$1,752.	n/a	\$1,961.	

Order Code	Ordering Information	Options
<i>Example:</i> 99C-MBU-2-SY-FA-5-SL-ASMQ-HC K1000/8 K1000/8 K1196/14	<i>Specify:</i> 1. Pattern number 2. Seat upholstery 3. Seat accent upholstery 4. Back upholstery 5. Back accent upholstery	<i>Cylinder Height Option:</i> For low height cylinder (plastic base only), replace 5 in pattern number with L. See Dimensions page for seat height range. <i>Code: Upchg: Description:</i> L \$72 low cylinder
99C	EWC Sport conference chair	
MB	Mid-back	
U	Upholstered outer back	
2	Black finish	
SY	Synchronized tilt control	
FA	Fixed width adjustable arms	
5	Standard height cylinder	
SL	Sliding seat	
ASMQ	Fully assembled	
HC	Hard wheel black casters	
K1000/8	Presto Red Carpet	
K1000/8	Presto Red Carpet	
K1000/8	Presto Red Carpet	
K1196/14	EWC Sport Black	

Presto - Base Grade Fabric	EWC Sport Fabric	COM/COL Upholstery Requirements
<i>Color options:</i> Presto Winter White K1000/1 Presto Sand K1000/2 Presto Stone K1000/3 Presto Saffron K1000/4 Presto Spring Green K1000/5 Presto Blue Chip K1000/6 Presto Scarlet K1000/7 Presto Red Carpet K1000/8 Presto Beige Taupe K1000/9 Presto Olive K1000/10 Presto Navy Blue K1000/11 Presto Clear Gray K1000/12 Presto Charcoal Gray K1000/13 Presto Black Tie K1000/14	<i>Back and Seat Accent Options:</i> All EWC Sport chairs come standard with an EWC Sport fabric upholstered outer back accent. The back accent can only be specified in EWC Sport fabric. Optional EWC Sport fabric seat accents can be specified for an upcharge of \$28. EWC Sport fabric is available in three colors as outlined below. Chair can be fully upholstered in EWC Sport fabric at Grade A pricing. Color Options: EWC Sport Beige Taupe K1196/9 EWC Sport Charcoal Gray K1196/13 EWC Sport Black K1196/14 EWC Sport Fabric exceeds 100,000 double rubs Wyzenbeek method and is cleaning code W-S.	<i>Split Upholstery Option:</i> EWC Sport seats and backs can be upholstered in any two approved KnollTextiles or Spinneybeck upholsteries. To specify, first indicate the seat upholstery (labeled "seat upholstery") and then indicate the back upholstery (labeled "back upholstery"). The list price of the chair equals the list price of the higher of the two upholstery grades. COM/COL Upholstery Requirements Textile yardage required: 1.9 yards Leather sq. ft. required: 22 sq. ft. <i>CAL 133 Options:</i> <i>Code: Upchg: Description:</i> C133 \$80 CAL 133 textile on seat and back. Add C133 to the end of the pattern number

For split seat and back upholstery, indicate the words "seat" and "back" before the selected color.

EWC Sport™
 upholstered mid-back conference chair
 swivel tilt control
 fully assembled

arm	description	pattern no.
Fixed arms	Upholstered mid-back conference chair with upholstered outer back, fixed back height, plastic base, swivel-tilt control	99C-MBU-2-ST-FA-5-ASMQ-()

Designer(s):
 Jeffrey Bennett and
 Nicholas Dodziuk, 2007



(Shown with EWC Sport Fabric
 Seat Accent Option)

list price	COM															
Presto base grade	A	B	C	D	E	F	G	H	I	T	COL		V	W	X	Y
\$723.	\$757.	\$793.	\$827.	\$876.	\$921.	\$969.	\$1,016.	\$1,086.	\$1,167.	\$1,208.	\$1,249.	\$1,432.	\$1,660.	n/a	\$1,871.	

Order Code	Ordering Information	Options
<i>Example:</i> 99C-MBU-2-ST-FA-5-SL-ASMQ-HC K1000/8 K1000/8 K1196/14	<i>Specify:</i> 1. Pattern number 2. Seat upholstery 3. Seat accent upholstery 4. Back upholstery 5. Back accent upholstery	<i>Cylinder Height Option:</i> For low height cylinder (plastic base only), replace 5 in pattern number with L. See Dimensions page for seat height range. <i>Code: Upchg: Description:</i> L \$72 low cylinder
99C	EWC Sport conference chair	
MB	Mid-back	
U	Upholstered outer back	
2	Black finish	
ST	Swivel tilt control	
FA	Fixed width adjustable arms	
5	Standard height cylinder	
SL	Sliding seat	
ASMQ	Fully assembled	
HC	Hard wheel black casters	
K1000/8	Presto Red Carpet	
K1000/8	Presto Red Carpet	
K1000/8	Presto Red Carpet	
K1196/14	EWC Sport Black	

Presto - Base Grade Fabric	EWC Sport Fabric	COM/COL Upholstery Requirements
<i>Color options:</i> Presto Winter White K1000/1 Presto Sand K1000/2 Presto Stone K1000/3 Presto Saffron K1000/4 Presto Spring Green K1000/5 Presto Blue Chip K1000/6 Presto Scarlet K1000/7 Presto Red Carpet K1000/8 Presto Beige Taupe K1000/9 Presto Olive K1000/10 Presto Navy Blue K1000/11 Presto Clear Gray K1000/12 Presto Charcoal Gray K1000/13 Presto Black Tie K1000/14	<i>Back and Seat Accent Options:</i> All EWC Sport chairs come standard with an EWC Sport fabric upholstered outer back accent. The back accent can only be specified in EWC Sport fabric. Optional EWC Sport fabric seat accents can be specified for an upcharge of \$28. EWC Sport fabric is available in three colors as outlined below. Chair can be fully upholstered in EWC Sport fabric at Grade A pricing. Color Options: EWC Sport Beige Taupe K1196/9 EWC Sport Charcoal Gray K1196/13 EWC Sport Black K1196/14 EWC Sport Fabric exceeds 100,000 double rubs Wyzenbeek method and is cleaning code W-S.	<i>Split Upholstery Option:</i> EWC Sport seats and backs can be upholstered in any two approved KnollTextiles or Spinneybeck upholsteries. To specify, first indicate the seat upholstery (labeled "seat upholstery") and then indicate the back upholstery (labeled "back upholstery"). The list price of the chair equals the list price of the higher of the two upholstery grades. Textile yardage required: 1.9 yards Leather sq. ft. required: 22 sq. ft. <i>CAL 133 Options:</i> Code: Upchg: Description: C133 \$80 CAL 133 textile on seat and back. Add C133 to the end of the pattern number

Seat*	BIFMA G1-2002 Ergonomic Guidelines	EWC Sport Mid-back Task Ergonomic Dimensions
Seat Height**	15" - 19.9" minimum range (one or combination of chairs)	15.6" - 20.25" (std. cylinder) 14.9" - 19" (alum. base, std. cylinder) 14.4" - 18.5" (low cylinder)
**sliding seat option adds 0.5" to all seat height dimensions		
Seat Depth	16.9" or less fixed, include if adjustable	16.9" (fixed) 16.25" - 19" (adjustable)
Seat Width	18" min	19.75"
Seat Pan Angle (at rest)	0° - 4° rearward	3.5°
Back*		
Backrest Height	12.2" min	22" - 24.5"
Backrest Width	14.2" min	19.25"
Lumbar Support	5.9" - 9.8" (adjustable include part of range)	6.5" - 9.25"
Angle Between Seat and Back	90° - 115°	98°
Tilt Range of Back	10° min	22° (synchro) 12° (swivel)
Arms*		
Armrest Height (fixed)	7.9" - 9.8"	8.2" (fixed)
Armrest Height (adjustable)	6.9" - 10.8"	7" - 10.5" (height adj.) 7.75" - 10.875" (high perf.)
Inside Distance Between Armrests (fixed)	18" min	18.4" - 20.4" (fixed)
Inside Distance Between Armrests (adjustable)	include 18"	18.4" - 20.4" (height adj.) 18.5" - 20.625" (high perf.)
*All measurements taken with BIFMA Chair Measuring Device using the Universal Measurement Procedure which has a measurement uncertainty of ±5%		
Chair Measurements ***		
A Overall Height		37.1" - 41.75" (plastic base) 36.35" - 40.45" (alum. base)
B Overall Width		29"
C Overall Depth		27" (plastic base); 26.75" (alum. base)
D Fixed Arm Height from Floor Height Adj. Arm Height from Floor High Perf. Arm Height from Floor		23.75" - 28.5" 22.5" - 30.75" 22.875" - 30.5"
E Recline Range Back Recline Ratio		98° - 120° (synchro) 98° - 110° (swivel) 1:3 (synchro); 1:1 (swivel)
F Base Diameter		27" (plastic); 26.75" (alum. base)
G Weight		46 lbs. (plastic base) 48 lbs. (alum. base)

***standard cylinder; sliding seat option adds 0.5" to overall height and arm height from floor

EWC Sport Task

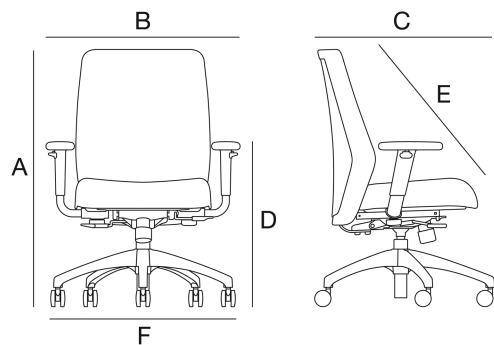

Compliance: ANSI/BIFMA X5.1 : 2011 (U.S. structural standard), ANSI/HFES 100-2007 (synchro control) (U.S. ergonomic standard), BIFMA G1 : 2002 (U.S. ergonomic guidelines), California T.B. 117 (U.S. flammability standard for foam), California T.B. 133 with approved FR textile (U.S. flammability standard for full chair)

The EWC Sport chair line has been tested and is approved for use by individuals weighing up to 300 pounds.

EWC Sport Task Chair Operating Instructions

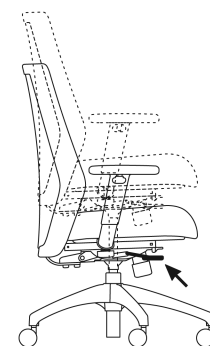

Seat Height

To raise the seat height, remove your weight from the chair while lifting the lever under the right side of the seat. To lower the seat height, lift the lever while sitting in the chair.

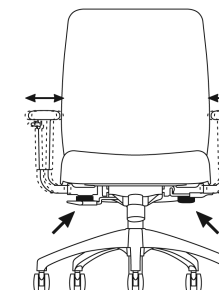

Adjustable Arm Width (All arm options)

To adjust the arm width, loosen the knob under the arm support by turning clockwise. Slide the arm support toward or away from the seat to adjust the arm width. Tighten the knob under the arm to secure.

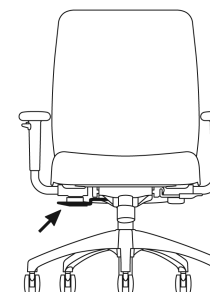

Tilt Lock

To recline, pull out the lever under the right side of the seat. To lock the chair upright, push the lever in.

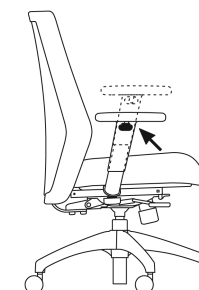

Height Adjustable Arm (Optional)

To adjust the arm pad height, lift the lever on the outside of the arm support and move the arm up or down. Release the lever to lock.

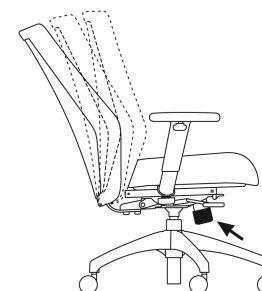

Tilt Tension

To adjust the tilt tension, turn the knob under the front of the seat. Turn counterclockwise to tighten, and clockwise to loosen. The tension adjustment provides a variable limiting function allowing the user to customize ranges of recline between upright and full recline.

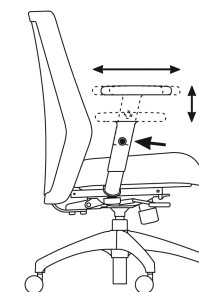

High Performance Arm (Optional)

To adjust the arm pad height, push the button on the outside of the arm support and move the arm up or down. Release the button to lock. To adjust arm pad depth, grasp arm pad and push forward or pull backward. The arm pad adjusts 2.5" in depth.

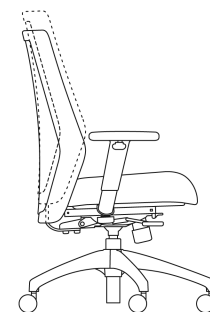

Back Height (Task chairs only)

To raise the back height, firmly hold both sides of the back and lift. The back height adjusts 9 notches upward. To lower the back height, first raise the back to the highest position; the top notch releases the back to the lowest position.

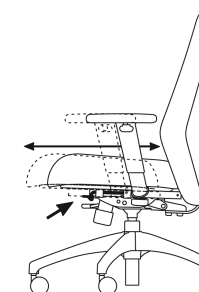

Sliding Seat Depth Adjustment (Optional)

To adjust the seat depth, lift the lever under the left side of the seat and slide the seat to the desired location. Release the lever to lock in one of the 6 positions.

Seat*	BIFMA G1-2002 Ergonomic Guidelines	EWC Sport Mid-back Conference Ergonomic Dimensions
Seat Height**	15" - 19.9" minimum range (one or combination of chairs)	15.6" - 20.25" (std. cylinder) 14.9" - 19" (alum. base, std. cylinder) 14.4" - 18.5" (low cylinder)
		**sliding seat option adds 0.5" to all seat height dimensions
Seat Depth	16.9" or less fixed, include if adjustable	16.9" (fixed) 16.25" - 19" (adjustable)
Seat Width	18" min	19.75"
Seat Pan Angle (at rest)	0° - 4° rearward	3.5°
Back*		
Backrest Height	12.2" min	22.75"
Backrest Width	14.2" min	19.25"
Lumbar Support	5.9" - 9.8"	8.25"
Angle Between Seat and Back	90° - 115°	94.8°
Tilt Range of Back	10° min	22° (synchro) 12° (swivel)
Arms*		
Armrests Height (fixed)	7.9" - 9.8"	8.2"
Inside Distance Between Armrests (fixed)	18" min	18.4" - 20.4"

*All measurements taken with BIFMA Chair Measuring Device using the Universal Measurement Procedure which has a measurement uncertainty of ±5%

Chair Measurements***		
A Overall Height		37.1" - 41.75" (plastic base) 36.35" - 40.45" (alum. base)
B Overall Width		29"
C Overall Depth		27" (plastic base); 26.75" (alum. base)
D Arm Height from Floor		23.75" - 28.5"
E Recline Range		94.8° - 116.8° (synchro) 94.8° - 106.8° (swivel) 1:3 (synchro); 1:1 (swivel)
Back Recline Ratio		
F Base Diameter		27" (plastic); 26.75" (alum. base)
G Weight		46 lbs. (plastic base) 48 lbs. (alum. base)

***standard cylinder; sliding seat option adds 0.5" to overall height and arm height from floor

EWC Sport Conference

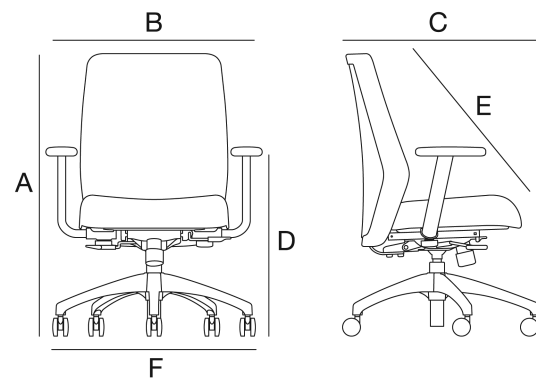

EWC Sport Conference Chair Operating Instructions

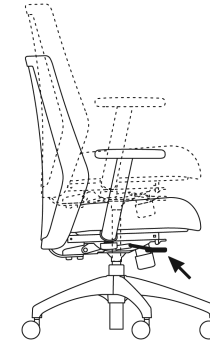

Seat Height

To raise the seat height, remove your weight from the chair while lifting the lever under the right side of the seat. To lower the seat height, lift the lever while sitting in the chair.

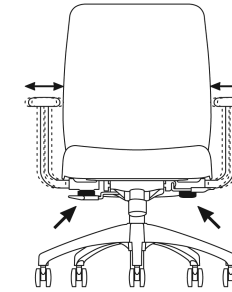

Adjustable Arm Width

To adjust the arm width, loosen the knob under the arm support by turning clockwise. Slide the arm support toward or away from the seat to adjust the arm width. Tighten the knob under the arm to secure.

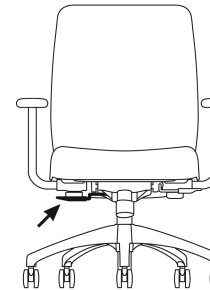

Tilt Lock

To recline, pull out the lever under the right side of the seat. To lock the chair upright, push the lever in.

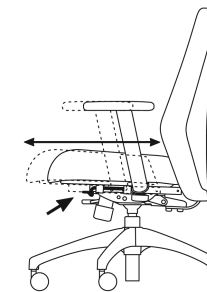

Sliding Seat Depth Adjustment (Optional)

To adjust the seat depth, lift the lever under the left side of the seat and slide the seat to the desired location. Release the lever to lock in one of the 6 positions.

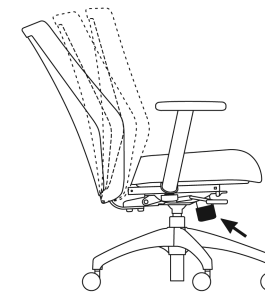

Tilt Tension

To adjust the tilt tension, turn the knob under the front of the seat. Turn counterclockwise to tighten, and clockwise to loosen. The tension adjustment provides a variable limiting function allowing the user to customize ranges of recline between upright and full recline.

Compliance: ANSI/BIFMA X5.1 : 2011 (U.S. structural standard), ANSI/HFES 100-2007 (synchro control) (U.S. ergonomic standard), BIFMA G1 : 2002 (U.S. ergonomic guidelines), California T.B. 117 (U.S. flammability standard for foam), California T.B. 133 with approved FR textile (U.S. flammability standard for full chair)

The EWC Sport chair line has been tested and is approved for use by individuals weighing up to 300 pounds.

Designer(s):
Jeffrey Bennett and
Nicholas Dodziuk, 2007



arm	description	pattern no.
fixed	Cantilevered side chair with painted frame, stacks 4 high on the floor	9-A-SL-S-CGSB
9RSEAT	Replacement upholstered seat assembly	9RSEAT-CGSB

list price	base grade	grades	A	B	C	D	E	F	G	H	I	T	COL	U	V	W	X	Y
\$524.	\$541.	\$564.	\$572.	\$595.	\$614.	\$630.	\$659.	\$697.	\$712.	\$767.	\$813.	\$913.	\$1,042.	\$1,098.	\$1,155.			
213.	237.	256.	273.	288.	308.	321.	339.	377.	408.	475.	526.	633.	773.	834.	895.			

Order Code	Ordering Information	Finish Options
<i>Example:</i> 9-A-SL-S-2-AB-K1000/14-CGSB	<i>Specify:</i> 1. Pattern number 2. Frame finish color 3. Back color 4. Upholstery selection	<i>Frame:</i> Select one of the following frame finishes <i>Code: Upchg: Description:</i> 2 n/c Black 3 n/c Metallic Grey 4 n/c Metallic Silver C \$153 Trivalent Chrome <i>Back:</i> Select one of the following back colors <i>Code: Upchg: Description:</i> AB n/c Almost Black CH n/c Charcoal RD n/c Red OR n/c Orange WH n/c White
9 Moment side chair		
A Arms		
SL Sled base		
S Upholstered seat		
2 Black frame finish		
AB Almost Black back		
K1000/14 Presto, Black Tie		
<i>Example for Cal 133:</i> 9-A-SL-S-2-AB-C-K1000/14-133-CGSB		

Presto - Base Grade Fabric	Textile Options
<i>Color options:</i> Presto, Winter White K1000/1 Presto, Sand K1000/2 Presto, Stone K1000/3 Presto, Saffron K1000/4 Presto, Spring Green K1000/5 Presto, Blue Chip K1000/6 Presto, Scarlet K1000/7 Presto, Red Carpet K1000/8 Presto, Beige Taupe K1000/9 Presto, Olive K1000/10 Presto, Navy Blue K1000/11 Presto, Clear Gray K1000/12 Presto, Charcoal Gray K1000/13 Presto, Black Tie K1000/14	<i>Knoll Textiles fabrics and Spinneybeck leathers:</i> Please refer to the textile matrices at the beginning of the price list for approved fabrics and leathers. <i>Cal 133:</i> See textile matrices at the beginning of the price list for pre-approved Cal 133 textiles. # = Cal 133 pre-approved Insert C after back color and 133 after upholstery selection <i>Code: Upchg: Description:</i> C()133 \$51 Cal 133 compliant textile
	<i>Customer's Own Material/Leather:</i> See Customer's Own Material Seating Process Overview at the beginning of the price list COM/COL Textile Requirements Fabric yards 0.8 yards Leather square feet 14 sq. ft.

Dimensions

A. Overall Height	32.5"
B. Overall Width	21"
C. Overall Depth	21"
D. Arm Height from Seat	8.5"
E. Arm Height from Floor	26.25"
F. Seat Height	17.75"
G. Seat Width	19"
H. Seat Depth	17.5"
Weight	24 lbs.

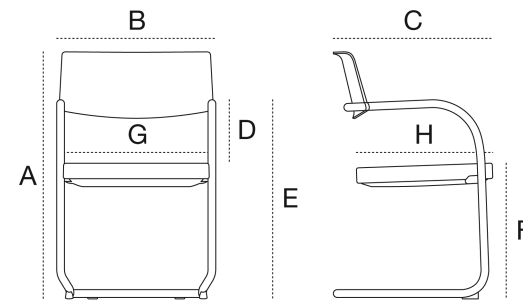

Operating Instructions

Moment stacks up to 4 units high on the floor and features a non-marking cosmetic cover under the seat that reduces fabric wear from stacking.

To stack chairs, place the top chair seat on top of the seat of the chair below. The base of the top chair fits between the legs of the lower chair and rests on top of the lower chair base.

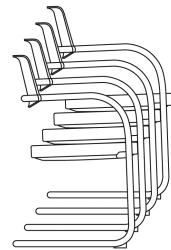

This page intentionally left blank.

Construction Information

Frame	Powder coat or trivalent chrome over steel
Back structure	Integrally colored, textured, glass reinforced nylon
Back bar	Powder coat or trivalent chrome over aluminum die cast
Seat upholstery plate	Integrally colored polypropylene
Seat cosmetic cover	Integrally colored, textured, impact modified polypropylene
Upholstery	High resiliency molded urethane foam with textile cover
Tip stops and glides	Black, integrally colored, molded nylon
Fasteners and hardware	Steel

Environmental Information

SMaRT®	Moment is SmaRT® Sustainable Gold Certified
GREENGUARD	Moment is GREENGUARD Indoor Air Quality Certified® and GREENGUARD Children & Schools SM
Powder Coat	Knoll metal powder coating processes are 99% VOC-free
Trivalent Chrome	Trivalent chrome uses a safer, more environmentally friendly process to achieve a chrome finish

Compliancy: ANSI/BIFMA X5.1 : 2011 (U.S. structural standard), California T.B. 117 (U.S. flammability standard for foam), California T.B. 133 with approved FR textile (U.S. flammability standard for full chair)

The Moment chair has been tested and is approved for use by individuals weighing up to 300 pounds.

Alpha-Numeric Index

<i>pattern no.</i>	<i>page</i>
11-1-FA-2-S-X-HC-ASMQ	22
11-1-HA-2-S-X-HC-ASMQ	22
11-1-HP-2-S-X-HC-ASMQ	22
11-1-NA-2-S-X-HC-ASMQ	22
33-AA-1-BK-B-S-X-HC-ASMQ	38
33-AA-1-BK-T-S-X-HC-ASMQ	36
33-FA-1-BK-B-S-X-HC-ASMQ	38
33-FA-1-BK-T-S-X-HC-ASMQ	36
33-NA-1-BK-B-S-X-HC-ASMQ	38
33-NA-1-BK-T-S-X-HC-ASMQ	36
44-1-HA-2-S-X-HC-ASMQ	28
44-1-HP-2-S-X-HC-ASMQ	28
44-1-NA-2-S-X-HC-ASMQ	28
44-2-HA-2-S-X-HC-ASMQ	30
44-2-HP-2-S-X-HC-ASMQ	30
44-2-NA-2-S-X-HC-ASMQ	30
77C-MB-2-ST-FA-5-ASMQ	62
77C-MB-2-SY-FA-5-ASMQ	60
77W-MB-2-ST-FA-5-ASMQ	58
77W-MB-2-ST-HA-5-ASMQ	58
77W-MB-2-ST-HP-5-ASMQ	58
77W-MB-2-ST-NA-5-ASMQ	58
77W-MB-2-SY-FA-5-ASMQ	56
77W-MB-2-SY-HA-5-ASMQ	56
77W-MB-2-SY-HP-5-ASMQ	56
77W-MB-2-SY-NA-5-ASMQ	56
88C-MB-2-ST-FA-5-ASMQ	74
88C-MB-2-SY-FA-5-ASMQ	72
88W-MB-2-ST-FA-5-ASMQ-	70
88W-MB-2-ST-HA-5-ASMQ	70
88W-MB-2-ST-HP-5-ASMQ	70
88W-MB-2-ST-NA-5-ASMQ	70
88W-MB-2-SY-FA-5-ASMQ	68
88W-MB-2-SY-HA-5-ASMQ	68
88W-MB-2-SY-HP-5-ASMQ	68
88W-MB-2-SY-NA-5-ASMQ	68
8C4-2-A5GH-ASMQ	44
8C4-2-A5GH-CGSBQ	48
8C4-2-A5KH-ASMQ	46
8C4-2-A5KH-CGSBQ	50
8P4-2-A5GH-ASMQ	44
8P4-2-A5GH-CGSBQ	48
8P4-2-A5KH-ASMQ	46
8P4-2-A5KH-CGSBQ	50
99C-MBU-2-ST-FA-5-ASMQ	86
99C-MBU-2-SY-FA-5-ASMQ	84
99W-MBU-2-ST-FA-5-ASMQ	82
99W-MBU-2-ST-HA-5-ASMQ	82
99W-MBU-2-ST-HP-5-ASMQ	82
99W-MBU-2-ST-NA-5-ASMQ	82
99W-MBU-2-SY-FA-5-ASMQ	80
99W-MBU-2-SY-HA-5-ASMQ	80
99W-MBU-2-SY-HP-5-ASMQ	80
99W-MBU-2-SY-NA-5-ASMQ	80
9-A-SL-S-CGSB	92
9RSEAT-CGSB	92
U	56, 58, 60, 62

Selling Policy

	<p>This Selling Policy supercedes all previous selling policies. Prices, discounts and product offerings are subject to change without notice.</p>
Terms & Conditions of Sales	<p>Sales by Knoll, Inc. or Knoll North America Corp. ("Seller") of Knoll Product Lines (hereinafter "Products") within the United States and Canada are made only on the terms which are contained in this Selling Policy. Seller hereby gives notice of its objection to any different or additional terms and conditions. This sale is expressly conditional upon Purchaser's assent to the terms and conditions set forth below. Additional terms and conditions may apply to KnollStudio and KnollTextiles orders. These terms and conditions may be modified or supplemented only by a written document signed by an authorized representative of Seller. These terms and conditions supercede any prior and/or contemporaneous agreements or correspondence between Purchaser and Seller. Written quotations expire thirty (30) days from the date of issuance and can be withdrawn by written notice anytime during that period. Where Purchaser and Seller have entered into the Knoll Electronic Terms and Conditions, all orders, acknowledgements, invoices and other business communications placed or transmitted in accordance with the Knoll Electronic Terms and Conditions shall be deemed to be in writing and signed and shall be valid for all purposes as if they were originated and maintained in documentary form.</p>
Ordering Information	<p>All orders must be in writing. The product pattern number(s) contained on Seller's order acknowledgement shall be the final expression of the order.</p>
Order Confirmation	<p>A purchase order is not binding on Seller until Purchaser has received Seller's order confirmation or acknowledgment.</p>
Pricing Policies	<p>List prices are subject to change without notice.</p> <p>List prices shall be those prices in effect on the date of receipt of a complete purchase order unless shipment is requested more than ninety (90) days after order entry in which case prices in effect on the date of shipment apply. List prices include specified freight costs. Unless specified in writing by Seller, no other charges are included in Seller's list prices.</p>
Taxes	<p>All sales, use, excise and other taxes applicable to the sale of the Products shall be paid by Purchaser. If Purchaser claims an exemption from any tax, Purchaser shall submit to Seller the appropriate exemption certificates.</p>
Terms of Payment	<p>Payment for one hundred percent (100%) of the net order amount is due within thirty (30) days of the date of invoice, which is generally issued upon shipment. In case of any discrepancies, such as shortages, and Seller is notified in writing within ten (10) days of receipt of Product, only that portion may be deducted and the balance paid. For orders greater than \$100,000 net, a fifty percent (50%) deposit is due at the time of order placement, with the remainder due within thirty (30) days of the date of invoice.</p> <p>KnollStudio orders less than \$2,000 require payment for one hundred percent (100%) of the net order amount (including any applicable sales tax and charges for inside delivery, special packaging, etc.), due at time of order placement. For KnollStudio orders greater than \$2,000, a one-half (50%) deposit is due at time of order placement with the remainder (including any applicable sales tax and charges for inside delivery, special packaging, etc.) due prior to shipment.</p> <p>If, in the judgment of Seller, Purchaser's financial condition does not justify the terms of the payment, Seller may require full or partial payment in advance.</p> <p>Past due accounts shall be charged one and one-half percent (1.5%) per month, or the highest rate permitted by law, whichever is less, and will be added to the outstanding balance. In the event Purchaser defaults on payment, Purchaser shall be liable for all collection costs, including reasonable attorney's fees and costs.</p>
Changes and Cancellation	<p>Purchase orders may not be changed or cancelled, in whole or in part, without prior written consent of Seller. Changes may effect delivery dates. Expenses incurred because of changes shall be charged to Purchaser. In the event of cancellations, Purchaser will be liable for reasonable cancellation charges established by Seller. Orders for special Product, orders including "COM" (hereinafter defined) material and orders pursuant to expedited delivery programs, may not be canceled.</p>
Freight Prepaid	<p>Freight is prepaid and included in the price of all Products, except KnollTextiles, within the 48 contiguous United States for orders placed with Knoll, Inc. and within Canada, excluding the Yukon, Northwest Territories, Nunavut and Newfoundland for orders placed with Knoll North America Corp. Packing is tested for rigorous motion and transportation but is not guaranteed to protect furniture from all conditions. If special packaging is required for any reason, please consult with your sales representative or dealer. Seller shall select the method of shipment and routing. Freight for all KnollTextiles orders is prepaid and added to the invoice.</p>
Delivery/Freight Charges	<p>Shipments outside the contiguous 48 United States and Canada shall be shipped F.O.B. Origin.</p> <p>For shipments outside the contiguous United States and Canada, Purchaser is responsible for the cost of freight from point of embarkation, including any handling and transportation charges incidental to loading at the point of departure and unloading at the final destination.</p> <p>Conditions beyond the control of Seller, including weather, available facilities and traffic conditions, may affect exact time of delivery. Seller shall not be responsible for specific carrier delivery date or time unless it has made a specific delivery commitment, in writing.</p> <p>Nonstandard methods of shipment and/or additional services are available upon request. Purchaser will be billed for the differential cost of any special services in excess of standard surface carrier freight costs. Premium charges, at Purchaser's request, will be added for airfreight, exclusive use of vehicle and extra, export or special packaging. Accessorial charges will be added for inside delivery, extra labor, reassignment and redelivery.</p> <p>Partial shipments may be made and invoiced by Seller.</p>
Claims	<p>All shipments for Knoll Products within the contiguous United States and Canada are F.O.B. Origin. All risk of loss passes to Purchaser at time of delivery to carrier. Purchaser shall inspect all Products upon receipt and notify Seller within ten (10) working days after receipt of any damage or defects which are, or should be, apparent from an inspection of the Product and its packaging. Failure of Purchaser to notify Seller during the ten (10) working day period shall constitute acceptance of the Products and waiver of any apparent defects, errors or shortages. For all claims relating to Product damaged in transit or for any other claims relating to or arising out of the transportation of the Product, Purchaser must seek recovery from the carrier and Seller has no liability to Purchaser for such claims. Seller may, upon request, assist Purchaser with filing of such claims with the carrier, but Seller will not be liable for any of these transportation related claims.</p>
Seller's Security Interest	<p>Until Seller receives the full payment for the Product, Seller shall have a security interest in the Product. Purchaser agrees to perform all acts, including but not limited to the execution and filing of documentation, which may be necessary to perfect and assure the security interest of Seller.</p>
Returns	<p>The return of Products without a written authorization by Seller shall not be accepted. To receive authorization for Product return, please call Customer Service. All Products that are returned pursuant to a valid authorization shall be subject to a twenty-five percent (25%) of list restocking charge. Products not currently offered for sale by Seller (including COM) shall not be authorized for return. All returned Products must be unused, in original condition and in the original Seller packing cartons. No refund or credit shall be given for damaged Products.</p>
Held Orders/Storage	<p>If Purchaser requests that an order be held or delayed, prices and terms and conditions in effect at the time of shipment shall apply. If Purchaser requests a delay after the time when Seller can defer production, Purchaser will be invoiced for the Product, payable in accordance with standard terms, when the order is ready for shipment. Seller may transfer the Product to storage, in which case all expenses incurred in connection with storage, including demurrage, preparation for storage, storage charges and handling shall be payable by Purchaser upon submission of invoices by Seller. Risk of loss to the Product shall pass to the Purchaser upon delivery of the Product into storage.</p>

Selling Policy

Customer's Own Material	<p>A Purchaser who requests a fabric or other surface material not standard to Seller's line of Products ("COM") must submit samples of the requested material to Seller prior to entry of a purchaser order. Seller shall determine if the material is suitable to its manufacturing processes and meets any requirements of Underwriters Laboratories. If the COM is acceptable, Seller will then establish a price for using the COM or the Product in question. For a description of the procedures for submitting samples and testing, contact customer resources or your sales representative. Seller shall have no responsibility for the appearance, condition, performance, durability, colorfastness or any other physical attribute of the COM. Purchaser shall indemnify and hold Seller harmless for any damages, injuries or losses arising out of or related to use of the COM on the Product.</p>
Warranty	<p>Seller warrants to the original Purchaser only that the Products Seller manufactures and sells to Purchaser are free of defects in workmanship and materials, during the applicable warranty period set forth below.</p> <p>Warranty period set forth below is for 24-hour, 7 days a week, multi shift use (includes parts and labor to repair).</p> <p>Should any failure to conform with this limited warranty appear to a Product listed below during the applicable warranty period from the date of shipment, Seller shall, upon prompt written notice, repair or replace, at its option and costs, the affected part or parts.</p> <p><i>Product and Period of Warranty</i></p> <p><i>Lifetime: Antenna Workspaces, AutoStrada, Calibre, Crinion Open Table, Currents, Dividends Horizon, Equity, Morrison, Reff Profiles laminate, Series 2 Storage, Template and other non-wood components (except cascade edge worksurfaces, operational parts, controls, electrical, Lighting, Series 2 Veneer Front Storage, special or custom products, see below)</i></p> <p><i>12 Years: Chadwick, Essentials Work Chairs, Generation by Knoll, Life, Moment, MultiGeneration by Knoll, ReGeneration by Knoll, RPM and Sapper seating (except seating upholstery, textiles, leathers and finishes, see below).</i></p> <p><i>10 Years: Antenna Workspaces, AutoStrada, Crinion Open Table, Dividends Horizon, Reff Profiles, Template wood components, Series 2 Veneer Front Storage, cascade edge worksurfaces, Wood Casegoods (The Graham Collection) (except wood casegoods upholstered surfaces, see below), Interaction tables (except height adjustment mechanisms for Counterforce, crank-adjustable, and split-top tables and worksurfaces, see below), Reuter overheads, Reuter vertical storage, KnollExtra Sapper Monitor Arm Collection, Adjustable keyboard mechanisms and platforms, Communication Boards (except fabric board textiles, see below), Smokador collection (except leathers, see below), and Orchestra Universal Systems Accessories.</i></p> <p><i>5 Years: Operational parts, controls, electrical, Lighting (except light ballasts, bulbs and power supply, see below), special or custom product, wood veneer products, Currents handcrank, Interaction Counterforce, Interaction crank-adjustable, and split-top mechanisms, KnollStudio, Spark Series seating structural elements, Richard Schultz outdoor products, KnollExtra CPU storage and all universal storage drawers.</i></p> <p><i>3 Years: Seating upholstery, textiles, leathers and finishes. Fabric boards textiles and Smokador Collection leathers.</i></p> <p><i>2 Years: All other KnollExtra product</i></p> <p><i>1 Year: Light ballasts, bulbs and power supply, seating upholstered armpads and soft armpads, wood casegoods upholstered surfaces. KnollStudio Maya Lin and Spark Series seating finishes.</i></p> <p>This warranty does not apply to:</p> <ul style="list-style-type: none"> • Damage caused by a carrier other than the Seller. • Normal wear and tear or acts or omissions of parties other than Seller (including user modification, improper use or installation of Products). • COM or other third party materials applied to Products. • Products not installed by or under the auspices of a Knoll Dealer. • Dramatic temperature variations or exposure to unusual conditions. • Changes in surface finishes, including colorfastness due to aging or exposure to light. • Except as specifically noted above, textiles and upholstery supplied by <i>KnollTextiles</i> (consult current <i>KnollTextiles</i> price list for applicable warranty). <p>Natural variations occurring in wood, marble, and leather shall not be considered defects, and the Seller does not guarantee the colorfastness or matching of the colors, grains or textures, or surface hardness of such materials. The Seller also does not guarantee the colorfastness of fiberglass panel surfaces. THE EXPRESS WARRANTIES CONTAINED HEREIN ARE IN LIEU OF ALL OTHER WARRANTIES, EXPRESS OR IMPLIED, INCLUDING ANY WARRANTIES OF MERCHANTABILITY AND FITNESS FOR PARTICULAR PURPOSE AND ALL OTHER WARRANTIES ARISING FROM COURSE OF DEALING OR USAGE OF TRADE.</p> <p>The remedies provided above are the Purchaser's sole remedies for any failure of Seller to comply with its obligations regarding the workmanship of its Products. Correction of any nonconformity in the manner and for the period of time provided shall constitute complete fulfillment of all liabilities of Seller, with respect to or arising out of the Product furnished hereunder.</p>
Delay/Force Majeure	<p>Seller shall not be liable for failure to perform or for delay in performance due to fire, flood, strike or other labor difficulty, act of God, act of any governmental authority or of the Purchaser, riot, embargo, fuel or energy shortage, wrecks or delay in transportation, inability to obtain necessary labor, materials or manufacturing facilities from usual sources or failure of suppliers to meet their contractual obligations, or due to any cause beyond its reasonable control. If any such event occurs, Seller may extend delivery dates by a period of time necessary to overcome the effect of such delay, allocate available Product or cancel any purchase order.</p>
Compliance with Law	<p>PURCHASER IS SOLELY RESPONSIBLE FOR COMPLIANCE WITH ALL APPLICABLE FEDERAL, STATE AND LOCAL LAWS, ORDINANCES, REGULATIONS, RULES AND STANDARDS RELATING TO THE INSTALLATION, MAINTENANCE, USE AND OPERATION OF THE PRODUCTS.</p>
Patents	<p>Subject to the following provisions, Seller shall, at its own expense, defend or, at its option, settle any claim, suit or proceeding brought against the Purchaser, and/or its vendees, mediate and immediate, so far as based on an allegation that any Product or any part thereof furnished hereunder constitutes a direct or a contributory infringement of any claim of any patent of the United States or Canada. This obligation shall be effective only if Purchaser shall have made all payments then due hereunder and if Seller is notified promptly in writing and given authority, information and assistance for the defense of said claim, suit or proceeding. Seller shall pay all damages and costs awarded in such suit or proceedings so defended.</p> <p>The foregoing indemnity does not apply to the following:</p> <ul style="list-style-type: none"> • Products supplied according to a design other than that of Seller, and which is required by the Purchaser. • Combination of the Product with another product not furnished hereunder unless Seller is a contributory infringer. • Any settlements of a suit or proceeding made without Seller's written consent.
Limitations of Liability	<p>SELLER, ITS CONTRACTORS, AUTHORIZED DEALERS AND SUBCONTRACTORS OR SUPPLIERS OF ANY TIER SHALL NOT BE LIABLE TO PURCHASER FOR ANY SPECIAL, INDIRECT, INCIDENTAL OR CONSEQUENTIAL DAMAGES ARISING FROM A BREACH OF THIS AGREEMENT.</p> <p>Purchaser's remedies set forth herein are exclusive and the liability of Seller with respect to the breach of this agreement or any contract entered into between the parties pursuant hereto shall not exceed the price of the Product or part on which such liability is based.</p>

General Ordering Information

The Products

This guide encompasses all standard products for this product group.

Sizes

Dimensions listed in this guide are indicated as:

H = height

W = width

D = depth

Dia. = diameter

Rad. = radius

Pricing

All prices shown are list.

How to Order

Select pattern numbers and quantities required for your complete installation. Product questions can be addressed in the specific sections of this guide or by contacting your sales representative or customer resource representative at 1-800-343-5665.

Next, select options (if required), along with colors and finishes appropriate to each product. Reference the Finishes and Fabrics pages for color designations.

On large installations, an item's "designated area" can be specified to assist in product organization and handling.

To expedite complete / correct entry of your order, be certain all pattern numbers, quantities, colors and area identifications are completely specified. Also, include complete purchase order numbers, bill-to and ship-to addresses, a contact name and specific factory shipping dates required.

Mail all orders to:

Knoll, Inc.

1235 Water Street

P.O. Box 157

East Greenville, PA 18041

Attention: Order Entry

Once your order is entered at Knoll, an acknowledgment will be mailed to you. You will be advised of your scheduled shipping date within five days of the original acknowledgment. If it is necessary to revise your order, please contact your customer resource representative.

Sustainability Statement

Sustainable design is a key component of Knoll's environmental focus. Our commitment to social responsibility and a healthy environment has prompted us to further articulate our longstanding environmental programs and, with encouragement and support from our colleagues in the industry, we have re-energized our focus on such "green" initiatives as life cycle analysis and LEED™ certification. Knoll is proud to have contributed to projects that have received LEED certification from the U.S. Green Building Council.

For the latest information on Knoll products that help our customers achieve LEED certification, log on to knoll.com, click on "About Knoll" and then "Environmental Focus."