

# Anchor

Price List  
March 2015



Knoll

Introduction	Knoll and Sustainable Design	2
	Finish Options	3
	KnollTextiles and Spinneybeck for Cushions	4
	Grain Direction Planning Guide	5
	Mixed Laminate Finishes	6
	Statement of Line	8
Credenzas	Credenza Specifications	11
	Credenza Planning & Stability Guidelines	12
	Credenzas	13
	Counterweight Kits	23
	Credenza Cushions	24
Pedestals	Pedestal Specifications	25
	Pedestal Planning & Stability Guidelines	27
	Pedestals	28
	Pedestal Shelves and Accessories	43
	Pedestal Tops	44
	Counterweight Kits	45
Stackers	Work Surface Stacker Specifications	46
	Credenza Stackers	47
	Work Surface Stackers	49
Towers	Tower Specifications	58
	Towers	60
	Tower Shelves	84
	Tower Accessories	85
	Tower Front Panel	86
Lockers	Locker Specifications	87
	Locker Interior Planning	90
	Lockers	92
	Locker Tops	97
	Locker Shelves	98
	Locker Accessories	99
Alpha-Numeric Index		100
Selling Policy		105
KnollKey Lock Program		107
General Ordering Information		108

# Knoll and Sustainable Design

---

Each year Knoll sets key initiatives in our journey to sustainability. We are members of a global consortium on energy, have adopted a scientific, metrics-based approach to sustainable product design, and maintain a leadership position in establishing universal, verifiable, sustainability standards for our industry.

Knoll promotes independent third-party certification because it provides the most impartial and trustworthy foundation for industry-wide environmental compliance. Certification by established and respected third parties ensures that all manufacturers are held to the same high standards and that customers can trust a company's declaration about the environmental benefits of its products. Knoll third-party partners include: the International Standards Organization (ISO); Forest Stewardship Council (FSC®); Rainforest Alliance; GREENGUARD® Environmental Institute; and The Business and Institutional Furniture Manufacturer's Association (BIFMA) level® certification from Scientific Certification Systems (SCS).

In addition, Knoll is aligned with the U.S. Green Building Council and can help companies, healthcare organizations and educational institutions achieve Leadership in Energy and Environmental Design (LEED®) workplace certification.

## Global Climate Change

- Knoll is a sponsor of the Clinton Global Initiative, which brings together a community of global leaders to devise and implement solutions to some of the world's most pressing challenges, including environmental change.
- Knoll has a comprehensive Energy Management Program to increase energy efficiency in products and processes.

## Life Cycle Assessment (LCA) Tool

- Life Cycle Assessment is a science-based measurement of a product's environmental impacts throughout its life cycle, from raw materials sourcing through manufacture, shipping, use and re-use or end-of-life. LCA enables cradle-to-cradle implementation of sustainable practices.
- Knoll has partnered with The Green Standard.org to develop an affordable, universal ISO-compliant computer-based LCA tool that can be used by the entire contract furniture industry and is partnering on the development of an Environmental Product Declaration System (EPDs) for Knoll products. EPDs are verified documents containing LCA results and additional environmental performance information about a product.

## Setting Industry Standards

- Knoll partners with MTS (The Institute for Market Transformation to Sustainability) to develop the SMaRT® Consensus Sustainable Products Standards, a set of consensus-based sustainable product standards based on the LEED® model, for all building products, fabric, apparel, flooring and carpet. MTS, the developer of SMaRT®, is an accredited American National Standards Institute (ANSI) standard developer.
- Knoll also partners with BIFMA (Business and Institutional Furniture Manufacturers Association) to promote level® sustainability standards for the contract furniture industry.
- Knoll has established FSC® (Forest Stewardship Council) certified wood as the standard for general office open plan office systems, casegoods and tables.
- Knoll has launched Full Circle, a resource recovery program developed with ANEW, to help customers extend the life cycle of surplus furniture, fixtures and equipment (FF&E) in an economically, socially and environmentally responsible manner.
- Our goal is to encourage all manufacturers in the contract furniture industry and related industries to adopt standards that will lead to sustainable products and practices.

*For more information about Knoll and sustainable design, visit [knoll.com/environment](http://knoll.com/environment).*

## KNOLL CORE LAMINATES

*Matching edge band unless noted otherwise*

### L1 - Solid Colors

- 114 Folkstone Grey
- 117 Soft Grey
- 118 Bright White
- 119 Pumice

### L2 - Solid Colors

- 111 Jet Black
- 115 Medium Grey
- 128 Fog

### L2 - Patterned

- 121 Micro Grey  
*with 114 Folkstone grey edge band*
- 122 Brushed Sand  
*with 119 Pumice edge band*
- 123 Brushed Grey  
*with 128 Fog edge band*
- 129 Micro Sand  
*with 119 Pumice edge band*

### L2 - Wood Grain

- 124 Medium Cherry
- 125 Natural Maple
- 126 Natural Cherry
- 127 Walnut
- 139 Light Ash
- 140 Warm Ash
- 141 Whitened Ash
- 142 Grey Ash
- 143 Classic Oak
- 144 Graphite Pear
- 145 Zebra

## PULL FINISHES

### Paint

- 111 Jet Black
- 114 Folkstone Grey
- 117 Soft Grey
- 118 Bright White
- 613 Silver

### Anodized

- AA Anodized Aluminum
- AN Anodized Nickel

*Anodized pulls have grooved underside.*

## LOCK FINISHES

### Standard Lock

- B Black
- C Chrome

### Digital Keypad Lock for Lockers

- NO Brushed Nickel

### for Credenzas, Doublewide

#### Pedestals

- NO Brushed Nickel
- B Black

**Knoll Textiles Options for Cushions****Grade A**

- C P** Alignment (K349) ♣
- C P** Beacon (W1597)
- C P** Bocce (K1255) ♣
- C P** Cats Cradle (K1290) ♣
- C P** Chance (K1552)
- C P** Common Ground (K448) ♣
- P** Commuter Cloth (K1778) ♣
- C P** Dristi (K872)
- P** Heavy Metal (W539)
- C P** Hourglass (K1523)
- C P** Mariner (K642)
- C P** Monarch (K1149) ♣
- C P** Prep (K1076) ♣
- C P** Presto (K1000) ♣
- C P** Soliloquy (K1458)
- C P** Sonnet (K1460) ♣
- C P** Stacks (K528)
- C P** Trophy (K1709) ♣

**Grade B**

- C P** Abacus (K715) ♣
- C P** Bank Shot (K134) ♣
- C P** Belize (K1165)
- P** Bistro (K1775) ♣
- C P** Boundary (K1828) ♣
- C P** Cameo (K1443)
- C P** Chroma (K345) ♣
- C P** Chronicle (K1525) ♣
- C P** Close Knit (K201)
- C P** Dovetail (K1150) ♣
- C P** Ferry (K1697)
- P** Forza (K584)
- C P** Framework (K1447) ♣
- C P** Gala II (K1520) ♣
- C P** Grande (K180)
- C P** Grandview (K1463)
- C P** Journey (K1806) ♣
- C P** Keaton (K1596)
- C P** Knoll Felt (K1207) ♣
- C P** Knoll Hopsack (K1206) ♣
- C P** Lyric (K698)
- C P** Mini Stitch (K1130) ♣
- C P** Night Life (K181)
- C P** Nonchalant CR (HC198)
- C P** Paradigm (K1101)
- C P** Pogo (K1100) ♣
- C P** Pop (K782)
- P** Prairie (K1925)
- C P** Prim (K1884) ♣
- C P** Ransom (K1298) ♣
- C P** Ricochet (K498) ♣
- C P** Roam (K1657)

- C P** Rush Hour (K1824)
- P** Soiree (K1616) ♣
- C P** Spark (K1075) ♣
- C P** Spotlight (K772)
- P** Spree (K1600) ♣
- C P** Sutton (K1750) ♣
- P** Synth (K1693) ♣
- C P** Utmost (K1325)
- C P** Venue (K1558)
- P** Versa (K1698) ♣
- P** Vinyl (K242)
- C P** Wide Angle (K244) ♣
- C P** Zipline (K1448) ♣

**Grade C**

- C P** Atlas (K1236)
- P** Axiom (K1650)
- C P** Baxter (K1557)
- C P** Biota (K1297) ♣
- C P** Charm (K1049)
- C P** Circa (K1054)
- C P** Classic Boucle (K162) ♣
- C P** Cricket (HC1279)
- C P** Dahlia CR (HC1660)
- C P** Durand (K1885)
- C P** Earthwork (K1238) ♣
- C P** Echo (K1019)
- C P** Empire Stripe (K1025)
- C P** Enmesh (K1092) ♣
- C P** Entourage (K1389) ♣
- C P** Fable CR (HC1122)
- C P** Fibra (K1105)
- C P** Fox Trot CR (HC777)
- C P** Greenwich (K1753)
- C P** Highline CR (HC1064)
- C P** Hudson (K1765)
- C** Hula Hoop (K753)
- C P** Kora CR (HC1010)
- C P** Legend CR (HC1124)
- C P** Lore CR (HC1123)
- C P** Metro (K1018)
- C P** Milestone (K1886)
- C P** Moto CR (HC1002)
- C P** Noble (K1556)
- C P** Panache CR (HC1047)
- C P** Parasol (HC1257)
- C P** Pony Up (K1323) ♣
- C P** Quark (K781)
- C P** Regard CR (HC1063)
- C P** Rio (K1164)
- C P** Roundtrip (K1430) ♣
- C P** Sahara (HC1269)
- C P** Sandpiper CR (HC1258)
- C P** Sequin CR (HC1009)
- C P** Sinclair (K1555)

- C P** Smart (K1268)
- C P** Spectator (K1391) ♣
- C P** Spot On (K1324)
- C P** Star Struck (K1048)
- C P** Stepping Stones (K346)
- C P** Swing (K479)
- C P** Tight Rope (K1798)
- C P** Tilden (K1779)
- C P** Tower Grid (K1887)
- C P** Transition (W816) ♣
- C P** Treble CR (HC1062)
- C P** Vibe (K1029)
- C P** Zari CR (HC1008)

**Grade D**

- C P** Cavalier (K217)
- C P** Compass CR (HC1183)
- P** Coterie (K1564)
- C P** Eclat Weave (K1104)
- C P** Harrison (K1084)
- C P** Hologram (K500)
- P** Ikat Stripe (K1701)
- C P** Masquerade (K806)
- C P** Menagerie (K1322)
- P** Origins (K1700)
- C P** Satellite (K503)
- P** Theory (K1656)
- C P** Zoom (K113)

**Grade E**

- C P** Cross Stitch (K1026) ♣
- P** Ikat Square (K1703)
- C P** Katazome (K1459)
- C P** Kimono (K1174)
- C P** Mamba (K549)
- C P** Marquee (K1608)
- C P** Sherman (K1789)
- C P** Tryst (K1522)
- C P** Whip (K1386)

**Grade F**

- P** Atelier (K1607)
- C P** Biscayne (K1771)
- C P** Century (K1051)
- C P** Coco (K1024)
- C P** Cornaro (K1320)
- C P** Cuddle Cloth (K231)
- C P** Glider (K1717)
- C P** Groove Line (K488)
- C P** Icon (K1028)
- C P** Intrigue (K1551)
- C P** Jubilee (K1445)
- C P** Kinship (K1465) ♣
- C P** Mod Plaid (K1630)
- C P** Rivington (K1080)
- C P** Soon (K1787)

- C P** Topography (K1052)
- C P** Totem (K1561)
- C P** Tweed Frieze (K754)

**Grade G**

- C P** Gibson (K1086)
- C P** Haze (K109)
- C P** Kinabalu (K1800)
- C P** Rattan (K138)
- C P** Serendipity (K1528)
- P** Spencer (K1106)
- P** Turner (K1820)
- C P** Ultrasuede (K1021) ♣
- C P** Utrillo (K1807)

**Grade H**

- C P** Arno (K128) ♣
- C P** Haiku (K1479)

**Grade I**

- P** Cato (K800)
- C P** Dynamic (K1617)

**Spinneybeck Leather Options for Cushions****Grade U**

- P** Volo

**Grade V**

- P** Andes
- P** Espana
- P** Maremma
- P** Velluto Pelle

**Grade W**

- P** Alaska
- P** Amazon
- P** Arizona
- P** Derby
- P** Sabrina

**Grade X**

- P** Ducale
- P** Ducale Velours

**Grade Y**

- P** Cervo
- P** Copenhagen
- P** Cordovan
- P** Distressed
- P** Marissa
- P** Prima
- P** Riva
- P** Saddle
- P** Salon

**C** = approved for use on credenza cushion

**P** = approved for use on mobile pedestal cushion

♣ = CAL 133 Pre-approved

**Credenza**

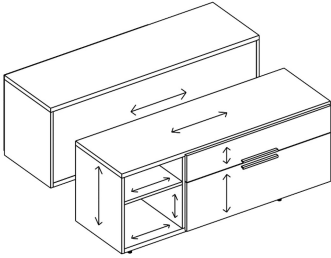

**Doublewide Pedestal**

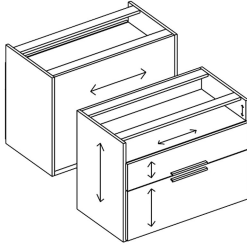

**Mobile Pedestal**

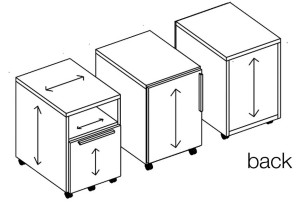

**Floorstanding Pedestal**

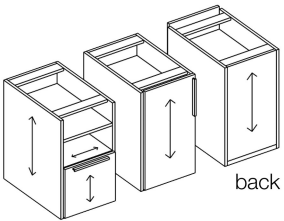

**Side Access Stacker**

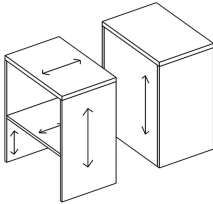

**Front Access Stacker**

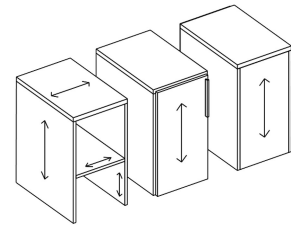

**Side Access Tower**

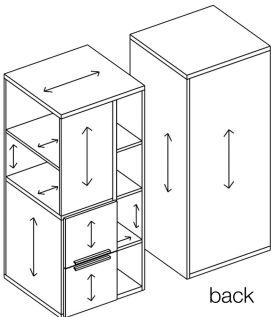

**Front Access Tower**

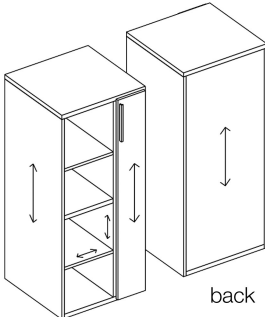

**Locker**

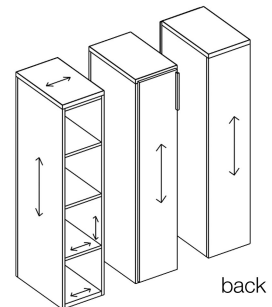

Anchor storage components may be specified with a maximum of two laminates per unit. Laminate mixing options are shown below and are all available at L2 prices.

- Laminate A (L1) + Laminate B (L1) = L2 price
- Laminate A (L1) + Laminate B (L2) or vice-versa = L2 price
- Laminate A (L2) + Laminate B (L2) = L2 price



**Credenzas**

Preconfigured including the top

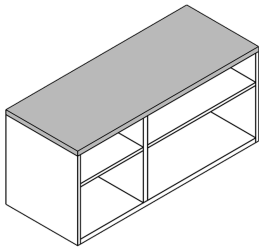

Case: A  
Top: B  
Price: L2

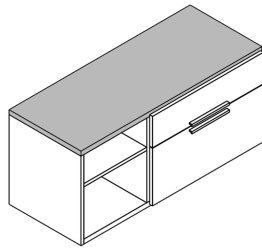

Case: A  
Front: A  
Top: B  
Price: L2

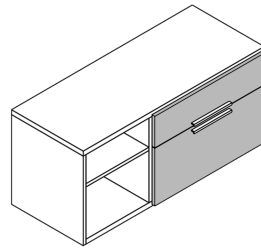

Case: A  
Front: B  
Top: A  
Price: L2

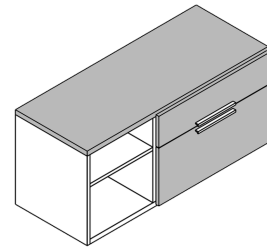

Case: A  
Front: B  
Top: B  
Price: L2

**Mobile Pedestals**

Preconfigured including the top

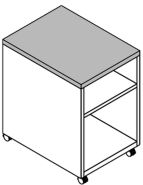

Case: A  
Top: B  
Price: L2

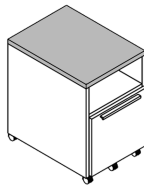

Case: A  
Front: A  
Top: B  
Price: L2

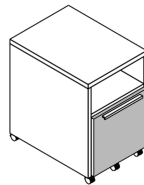

Case: A  
Front: B  
Top: A  
Price: L2

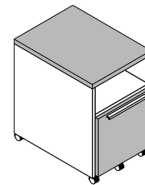

Case: A  
Front: B  
Top: B  
Price: L2

**Doublewide and Floorstanding Pedestals**

Preconfigured excluding a top or work surface

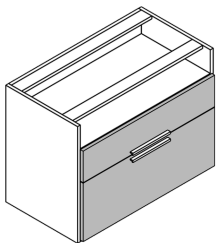

Case: A  
Front: B  
Price: L2

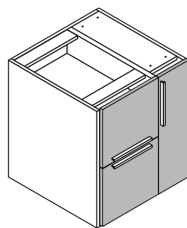

Case: A  
Front: B  
Price: L2

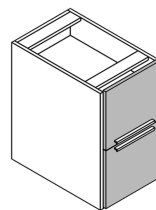

Case: A  
Front: B  
Price: L2

Anchor storage components may be specified with a maximum of two laminates per unit. Laminate mixing options are shown below and are all available at L2 prices.

- Laminate A (L1) + Laminate B (L1) = L2 price
- Laminate A (L1) + Laminate B (L2) or vice-versa = L2 price
- Laminate A (L2) + Laminate B (L2) = L2 price



### Work Surface Stackers

Preconfigured including the top

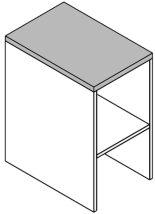

Case: A  
Top: B  
Price: L2

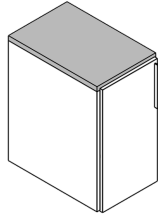

Case: A  
Front: A  
Top: B  
Price: L2

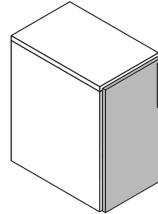

Case: A  
Front: B  
Top: A  
Price: L2

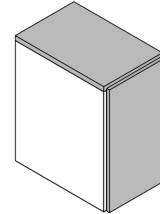

Case: A  
Front: B  
Top: B  
Price: L2

### Towers

Preconfigured including the top

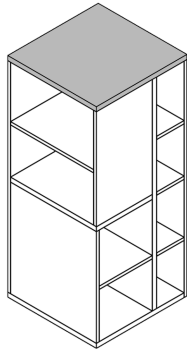

Case: A  
Top: B  
Price: L2

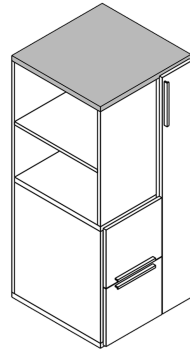

Case: A  
Front: A  
Top: B  
Price: L2

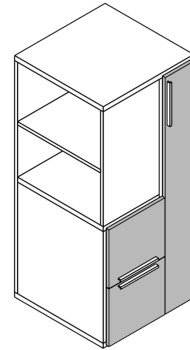

Case: A  
Front: B  
Top: A  
Price: L2

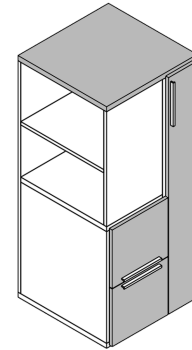

Case: A  
Front: B  
Top: B  
Price: L2

### Lockers

Preconfigured excluding the top

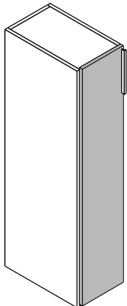

Case: A  
Front: B  
Price: L2



**48" Wide Credenzas**

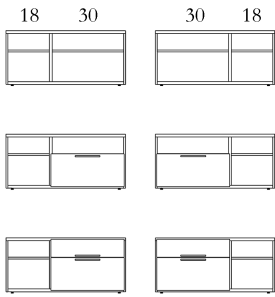

**60" Wide Credenzas**

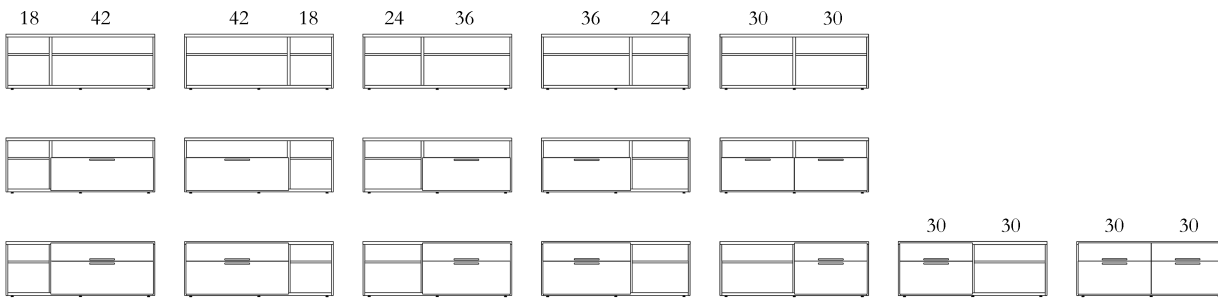

**72" Wide Credenzas**

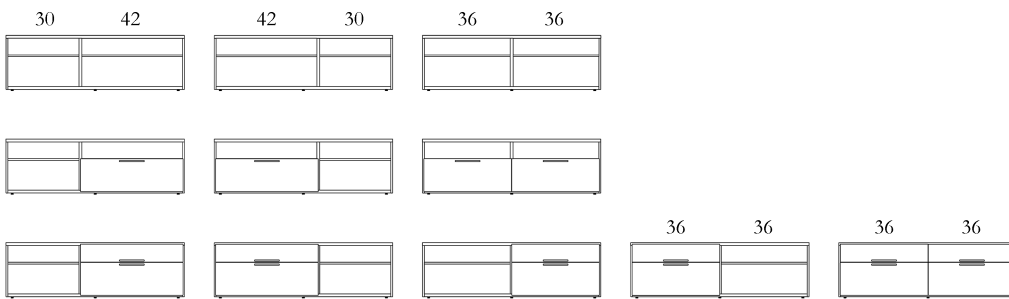

**84" Wide Credenzas**

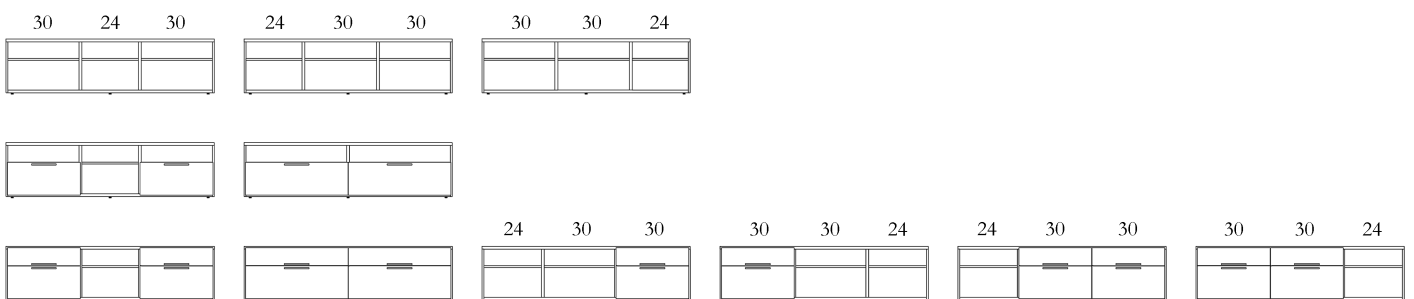

---

**30" Wide Doublewide Pedestals**



**36" Wide Doublewide Pedestals**

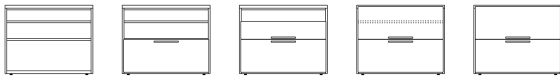

**42" Wide Doublewide Pedestals**



---

**42" High Lockers - 20, 24" Deep**

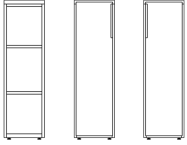

**50" High Lockers - 20, 24" Deep**

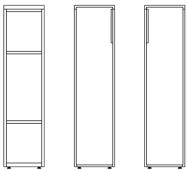

**57" High Lockers - 20, 24" Deep**

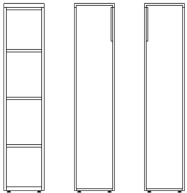

**64" High Lockers - 20, 24" Deep**

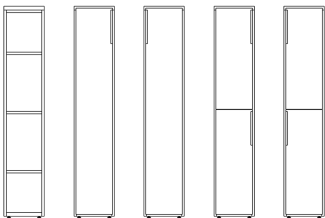

**71" High Lockers - 20, 24" Deep**

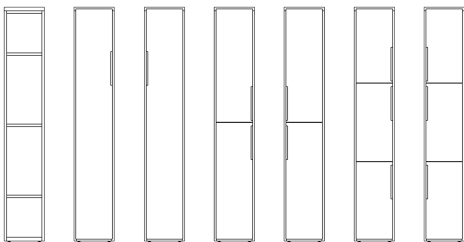

## Anchor Credenzas

Credenzas are 22" high wood construction cabinets sized to fit below and support one end of a desk top or be used as freestanding units. Credenzas feature one or two midpanels providing a unique combination of closed and open storage.

Credenzas are available in 4 widths with a variety of configurations. Reference the Statement of Line for full product scope.

### Available Sizes (nominal)

Height: 22"  
Widths: 18", 24", 30", 36", 42", 48", 60", 72", 84"  
Depth: 20"

Credenzas ship assembled including the top.

Credenzas may be used as freestanding units or provide support for a perpendicular worksurface when specified with a spacer bracket or support adapter.

Counterweight must be specified for certain credenzas when used in freestanding applications. Further information is detailed on pricing pages.

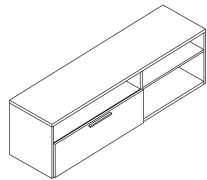

Freestanding unit

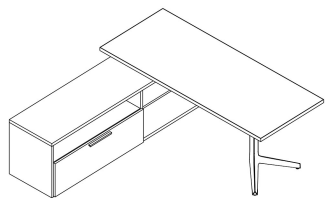

Credenza used as support for a perpendicular work surface

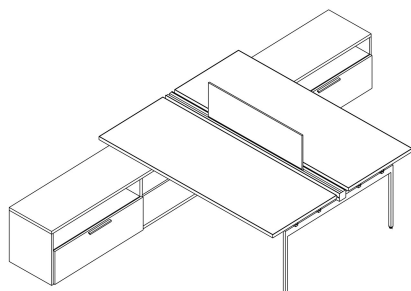

Credenzas used as supports in a benching application

## Construction

- Credenzas are constructed of wood core, laminate and ABS edge banding; cam and dowel construction.
- Material thickness: 1<sup>3</sup>/<sub>16</sub>" (nominal) on credenza bottom and midpanels, 3/4" on credenza back, sides, interior shelves and drawer fronts.
- Material thickness: 1<sup>3</sup>/<sub>16</sub>" (nominal) on credenza tops
- Box and File drawer suspension: Full extension, ball bearing slides
- Units include interlock to prevent more than one drawer (aligned vertically) opening at a time.
- Leveling glides: 3/16" diameter steel stem with 1/16" of height adjustment, 4 per unit up to 48" wide credenza, 5 per 60", 72" and 84" credenza. (Fifth glide centered under credenza.)
- Longer glides are included to provide an additional 1/16" of height adjustment; 2 per unit up to 48" credenza, 3 per 60", 72" and 84" credenza.

### Internal Drawer Dimensions \*

#### Box drawer

- Internal height: 3<sup>3</sup>/<sub>4</sub>" (5<sup>1</sup>/<sub>8</sub>" clearance)
- Internal width: 26<sup>3</sup>/<sub>4</sub>", 32<sup>3</sup>/<sub>4</sub>", 38<sup>3</sup>/<sub>4</sub>"
- Internal depth: 16<sup>1</sup>/<sub>4</sub>"

#### File drawer

- Internal height: 9<sup>3</sup>/<sub>4</sub>" (11<sup>3</sup>/<sub>4</sub>" clearance)
- Internal width: 26<sup>3</sup>/<sub>4</sub>", 32<sup>3</sup>/<sub>4</sub>", 38<sup>3</sup>/<sub>4</sub>"
- Internal depth: 16<sup>1</sup>/<sub>4</sub>"

### Internal Clearances – Open sections \*

- Internal height A: 6<sup>1</sup>/<sub>2</sub>"
- Internal height B: 11<sup>15</sup>/<sub>16</sub>"
- Internal width by nominal configuration size:  
18" w configuration = 16<sup>1</sup>/<sub>2</sub>" w  
24" w configuration = 22<sup>1</sup>/<sub>2</sub>" w  
30" w configuration = 28<sup>1</sup>/<sub>2</sub>" w  
36" w configuration = 34<sup>1</sup>/<sub>2</sub>" w  
42" w configuration = 40<sup>1</sup>/<sub>2</sub>" w
- Internal depth: 18<sup>1</sup>/<sub>4</sub>"

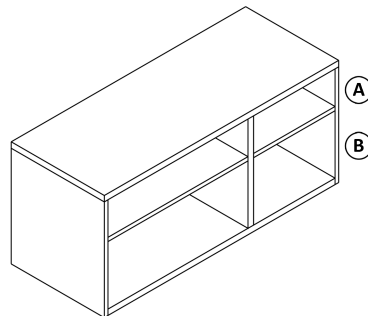

\*Actual dimensions to the nearest 1/16th of an inch.

## Filing

The credenza file drawer design allows for side-to-side letter or legal filing and front-to-back letter filing. Credenzas with a file drawer include a hanging file bar to accommodate front-to-back filing.

## Locks

Anchor Credenzas may be ordered with or without locks. No lock hole is drilled on units specified as non-locking.

Standard lock placement is the upper right hand corner of the bottom file drawer. Center of lock is 1<sup>1</sup>/<sub>16</sub>" from top edge, 1<sup>1</sup>/<sub>2</sub>" from side. Dual-tab lock design allows one shared lock core per box/file configuration.

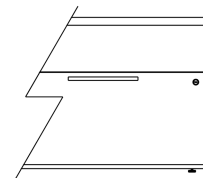

Single drawer, single-tab lock core

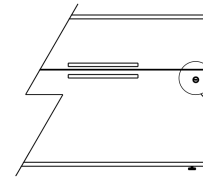

Two drawers share dual-tab lock core

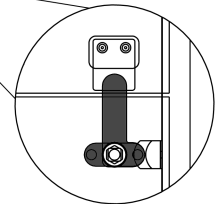

Locks are randomly keyed unless otherwise specified. Other keying options include keyed alike or keyed with lock cores K001-K250. To specify units as such, reference KnollKey Lock Program.

## Pulls

Finger Pull, 10" long; centered horizontally on drawers.

Top drawer: mounted 3/4" from bottom of drawer  
Bottom drawer: mounted 3/4" from top of drawer

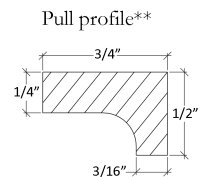
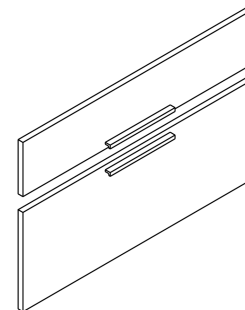

A variety of planning scenarios with the required connection or support brackets are shown below. Single freestanding credenzas may require counterweight kits; refer to pricing pages for specific requirements.

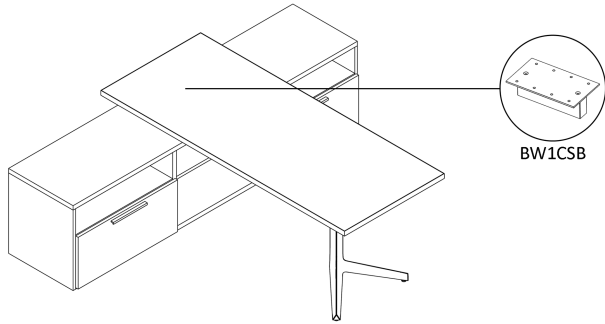

BW1CSB

Credenza supporting a Dividends Horizon desk. Specify a **Template BW1CSB Credenza Spacer** to support one end of the work surface. No counterweight kit required.  
\*In this application, a credenza with a centered midpanel will require the spacer to be mounted off-center.

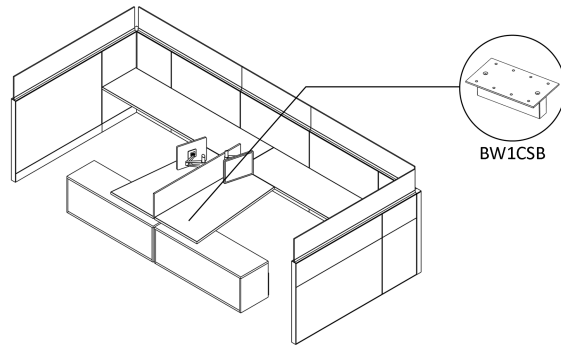

BW1CSB

Credenzas supporting work surfaces in a Dividends Horizon panel surround. Specify a **Template BW1CSB Credenza Spacer** per credenza. No counterweight kit required.

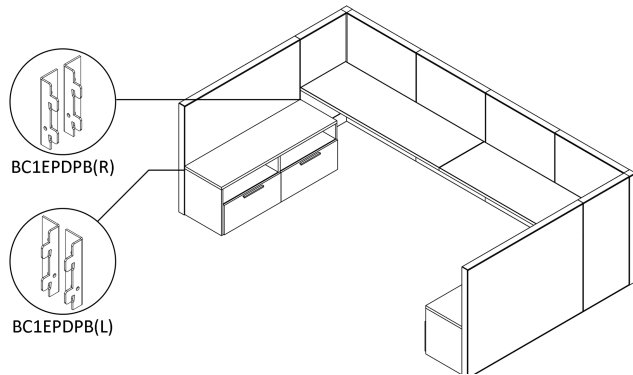

BC1EPDPB(R)

BC1EPDPB(L)

Credenzas mounted to Dividends Horizon panels. For each credenza, specify both the left and right hand **Dividends Horizon Panel brackets BC1EPDPB** to secure the unit to the panel. No counterweight kit required.

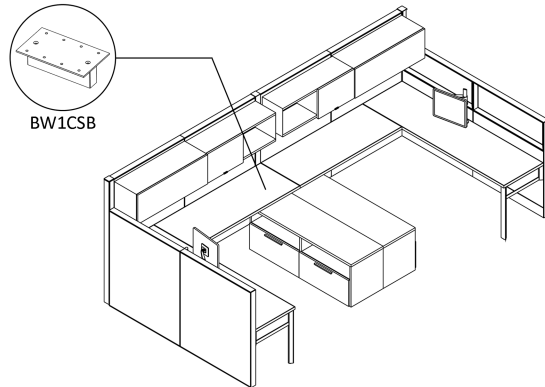

BW1CSB

Credenzas supporting work surfaces in a Dividends Horizon panel surround. Specify a **Template BW1CSB Credenza Spacer** for each credenza. No counterweight kit required. When used as freestanding units (not supporting the work surfaces), units may be ganged back-to-back for stability.

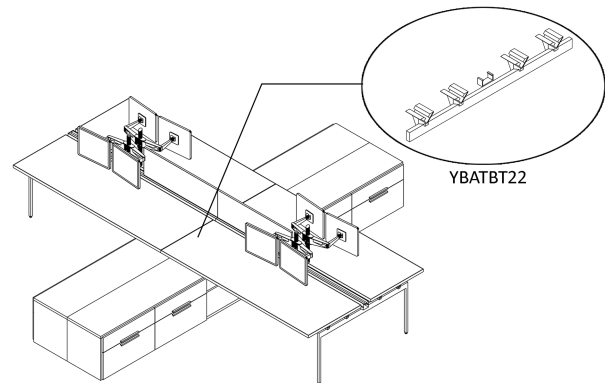

YBATBT22

Credenzas supporting Antenna Big Table. Specify **Template/Antenna YBATBT22 Floorstanding Cabinet Desk Support Adapters for Big Table** in place of an end leg. Two YBATBT22 adapters would be required for the configuration shown. Units may be ganged back-to-back and/or side-by-side for additional stability. No counterweight kit required.

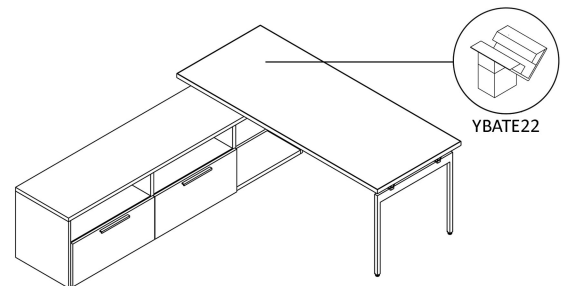

YBATE22

Credenzas supporting an Antenna desk. Specify **Template/Antenna YBATE22 (pair) Floorstanding Cabinet Desk Support Adapters** to support one end of the work surface. No counterweight kit required.

# Credenzas

## Credenzas 18" and 24" wide

Anchor Storage

description	w	h	d	pattern no.	L1	L2
All Open - 18" Wide Credenza	18"	22 <sup>3</sup> / <sub>16</sub> "	19 <sup>1</sup> / <sub>16</sub> "	<b>WC2218OL</b>	\$594.	\$848.

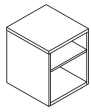

All Open - 24" Wide Credenza	24"	22 <sup>3</sup> / <sub>16</sub> "	19 <sup>1</sup> / <sub>16</sub> "	<b>WC2224OL</b>	696.	1,005.
------------------------------	-----	-----------------------------------	-----------------------------------	-----------------	------	--------

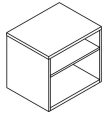

### Order Information

1. *Base Pattern Number*
2. *Case Finish*  
See Finish Options page
3. *Top Finish*  
See Finish Options page

### Order Code

Credenza , 48" wide, Open 18" -  
Open 30"

---

Example: **WC2248O18O30L**

<b>W</b>	Woodcore Storage
<b>C</b>	Credenza
<b>22</b>	22" High
<b>48</b>	48" Wide
<b>O18</b>	Left: Open 18"
<b>O30</b>	Right: Open 30"
<b>L</b>	Laminate case and front
<b>(118)</b>	Case Finish, Bright White
<b>(118)</b>	Top Finish, Bright White

### Specification Information

Credenzas with file drawers may require counterweights when used in freestanding applications. When applicable, corresponding counterweights kits are noted within the pricing section above.

Add \$40 to the list price per standard key lock. Add \$474 to the list price per lock for manual digital keypad lock. Digital keypad locks require program and manager key(s), specified separately.

Add \$15 to the list price per pull for Anodized Nickel (AN) or Aluminum (AA) finish.

Credenza specified with mixed laminate finishes are L2 pricing. Refer to Mixed Laminate Finishes for further details.

Dimensions listed under w h d are actual to the nearest <sup>1</sup>/<sub>16</sub>".

### Application Notes

Credenzas 20" deep (nominal) have a 19<sup>1</sup>/<sub>16</sub>" deep case. Credenzas with drawer fronts are 20" deep overall.

Credenzas are preassembled including top.

Rails included with file drawer for side-to-side and front-to-back filing.

# Credenzas

## Credenzas 30" wide

description	w	h	d	pattern no.	L1	L2
All Open - 30" Wide Credenza	30"	22 <sup>3</sup> / <sub>16</sub> "	19 <sup>1</sup> / <sub>16</sub> "	<b>WC2230OL</b>	\$798.	\$1,162.

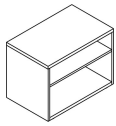

Open with File - 30" Wide Credenza	30"	22 <sup>3</sup> / <sub>16</sub> "	19 <sup>1</sup> / <sub>16</sub> "	<b>WC2230FL(N)</b>	1,327.	1,561.
------------------------------------	-----	-----------------------------------	-----------------------------------	--------------------	--------	--------

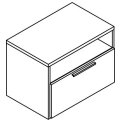

30" wide credenza with drawer(s) requires counterweight kit WCWKIT06 when used in a freestanding application

Open with Box/File - 30" Wide Credenza	30"	22 <sup>3</sup> / <sub>16</sub> "	19 <sup>1</sup> / <sub>16</sub> "	<b>WC2230BL(N)</b>	1,876.	2,081.
--	-----	-----------------------------------	-----------------------------------	--------------------	--------	--------

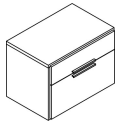

30" wide credenza with drawer(s) requires counterweight kit WCWKIT06 when used in a freestanding application

### Order Information

1. *Base Pattern Number*
2. *Case Finish*  
See Finish Options page
3. *Top Finish*  
See Finish Options page

### Order Code

Credenza , 48" wide, Open 18" -  
Open 30"

---

Example: **WC2248O18O30L**

<b>W</b>	Woodcore Storage
<b>C</b>	Credenza
<b>22</b>	22" High
<b>48</b>	48" Wide
<b>O18</b>	Left: Open 18"
<b>O30</b>	Right: Open 30"
<b>L</b>	Laminate case and front
<b>(118)</b>	Case Finish, Bright White
<b>(118)</b>	Top Finish, Bright White

### Specification Information

Credenzas with file drawers may require counterweights when used in freestanding applications. When applicable, corresponding counterweights kits are noted within the pricing section above.

Add \$40 to the list price per standard key lock. Add \$474 to the list price for manual digital keypad lock. Digital keypad locks require program and manager key(s), specified separately.

Add \$15 to the list price per pull for Anodized Nickel (AN) or Aluminum (AA) finish.

Credenza specified with mixed laminate finishes are L2 pricing. Refer to Mixed Laminate Finishes for further details.

Dimensions listed under w h d are actual to the nearest <sup>1</sup>/<sub>16</sub>".

### Application Notes

Credenzas 20" deep (nominal) have a 19<sup>1</sup>/<sub>16</sub>" deep case. Credenzas with drawer fronts are 20" deep overall.

Credenzas are preassembled including top.

Rails included with file drawer for side-to-side and front-to-back filing.

# Credenzas

## Credenzas 36" wide

Anchor Storage

description	w	h	d	pattern no.	L1	L2
-------------	---	---	---	-------------	----	----

All Open - 36" Wide Credenza	36"	22 <sup>3</sup> / <sub>16</sub> "	19 <sup>1</sup> / <sub>16</sub> "	<b>WC2236OL</b>	\$900.	\$1,319.
------------------------------	-----	-----------------------------------	-----------------------------------	-----------------	--------	----------

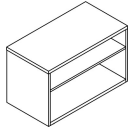

Open with File - 36" Wide Credenza	36"	22 <sup>3</sup> / <sub>16</sub> "	19 <sup>1</sup> / <sub>16</sub> "	<b>WC2236FL(N)</b>	1,439.	1,684.
------------------------------------	-----	-----------------------------------	-----------------------------------	--------------------	--------	--------

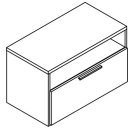

36" wide credenza with drawer(s) requires counterweight kit WCWKIT07 when used in a freestanding application

Open with Box/File - 36" Wide Credenza	36"	22 <sup>3</sup> / <sub>16</sub> "	19 <sup>1</sup> / <sub>16</sub> "	<b>WC2236BL(N)</b>	1,937.	2,159.
--	-----	-----------------------------------	-----------------------------------	--------------------	--------	--------

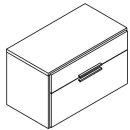

36" wide credenza with drawer(s) requires counterweight kit WCWKIT07 when used in a freestanding application

### Order Information

1. *Base Pattern Number*
2. *Case Finish*  
See Finish Options page
3. *Top Finish*  
See Finish Options page

### Order Code

Credenza , 48" wide, Open 18" -  
Open 30"

---

Example: **WC2248O18O30L**

<b>W</b>	Woodcore Storage
<b>C</b>	Credenza
<b>22</b>	22" High
<b>48</b>	48" Wide
<b>O18</b>	Left: Open 18"
<b>O30</b>	Right: Open 30"
<b>L</b>	Laminate case and front
<b>(118)</b>	Case Finish, Bright White
<b>(118)</b>	Top Finish, Bright White

### Specification Information

Credenzas with file drawers may require counterweights when used in freestanding applications. When applicable, corresponding counterweights kits are noted within the pricing section above.

Add \$40 to the list price per standard key lock. Add \$474 to the list price for manual digital keypad lock. Digital keypad locks require program and manager key(s), specified separately.

Add \$15 to the list price per pull for Anodized Nickel (AN) or Aluminum (AA) finish.

Credenza specified with mixed laminate finishes are L2 pricing. Refer to Mixed Laminate Finishes for further details.

Dimensions listed under w h d are actual to the nearest <sup>1</sup>/<sub>16</sub>".

### Application Notes

Credenzas 20" deep (nominal) have a 19<sup>1</sup>/<sub>16</sub>" deep case. Credenzas with drawer fronts are 20" deep overall.

Credenzas are preassembled including top.

Rails included with file drawer for side-to-side and front-to-back filing.



# Credenzas

## Credenzas 42" wide

description	w	h	d	pattern no.	L1	L2
All Open - 42" Wide Credenza	42"	22 <sup>3</sup> / <sub>16</sub> "	19 <sup>1</sup> / <sub>16</sub> "	<b>WC2242OL</b>	\$998.	\$1,472.

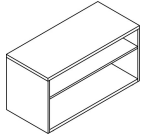

Open with File - 42" Wide Credenza	42"	22 <sup>3</sup> / <sub>16</sub> "	19 <sup>1</sup> / <sub>16</sub> "	<b>WC2242FL(N)</b>	1,552.	1,830.
------------------------------------	-----	-----------------------------------	-----------------------------------	--------------------	--------	--------

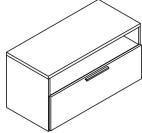

42" wide credenza with drawer(s) requires counterweight kit WCWKIT08 when used in a freestanding application

Open with Box/File - 42" Wide Credenza	42"	22 <sup>3</sup> / <sub>16</sub> "	19 <sup>1</sup> / <sub>16</sub> "	<b>WC2242BL(N)</b>	2,039.	2,290.
--	-----	-----------------------------------	-----------------------------------	--------------------	--------	--------

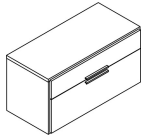

42" wide credenza with drawer(s) requires counterweight kit WCWKIT08 when used in a freestanding application

### Order Information

1. *Base Pattern Number*
2. *Case Finish*  
See Finish Options page
3. *Top Finish*  
See Finish Options page

### Order Code

Credenza , 48" wide, Open 18" - Open 30"	
Example:	<b>WC2248O18O30L</b>
<b>W</b>	Woodcore Storage
<b>C</b>	Credenza
<b>22</b>	22" High
<b>48</b>	48" Wide
<b>O18</b>	Left: Open 18"
<b>O30</b>	Right: Open 30"
<b>L</b>	Laminate case and front
<b>(118)</b>	Case Finish, Bright White
<b>(118)</b>	Top Finish, Bright White

### Specification Information

Credenzas with file drawers may require counterweights when used in freestanding applications. When applicable, corresponding counterweights kits are noted within the pricing section above.

Add \$40 to the list price per standard key lock. Add \$474 to the list price for manual digital keypad lock. Digital keypad locks require program and manager key(s), specified separately.

Add \$15 to the list price per pull for Anodized Nickel (AN) or Aluminum (AA) finish.

Credenza specified with mixed laminate finishes are L2 pricing. Refer to Mixed Laminate Finishes for further details.

Dimensions listed under w h d are actual to the nearest 1/16".

### Application Notes

Credenzas 20" deep (nominal) have a 19 1/16" deep case. Credenzas with drawer fronts are 20" deep overall.

Credenzas are preassembled including top.

Rails included with file drawer for side-to-side and front-to-back filing.

# Credenzas

## Credenzas 48" wide

description	configuration left-to-right	w	h	d	pattern no.	L1	L2
All Open - 48" Wide Credenza	Open 18" - Open 30" (shown)	48"	22 <sup>3</sup> / <sub>16</sub> "	19 <sup>1</sup> / <sub>16</sub> "	<b>WC2248O18O30L</b>	\$1,258.	\$1,471.
	Open 30" - Open 18"	48"	22 <sup>3</sup> / <sub>16</sub> "	19 <sup>1</sup> / <sub>16</sub> "	<b>WC2248O30O18L</b>	1,258.	1,471.

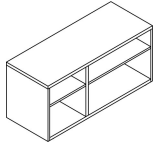

Open with File - 48" Wide Credenza	File 30" - Open 18" *	48"	22 <sup>3</sup> / <sub>16</sub> "	19 <sup>1</sup> / <sub>16</sub> "	<b>WC2248F30O18L(N)</b>	1,659.	1,854.
	Open 18" - File 30" *	48"	22 <sup>3</sup> / <sub>16</sub> "	19 <sup>1</sup> / <sub>16</sub> "	<b>WC2248O18F30L(N)</b>	1,659.	1,854.

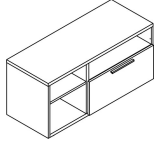

\* 48" wide credenza with 30" wide file drawer requires counterweight kit WCWKIT01 when used in a freestanding application

Open with Box/File - 48" Wide Credenza	Box/File 30" - Open 18"	48"	22 <sup>3</sup> / <sub>16</sub> "	19 <sup>1</sup> / <sub>16</sub> "	<b>WC2248B30O18L(N)</b>	1,966.	2,184.
	Open 18" - Box/File 30"	48"	22 <sup>3</sup> / <sub>16</sub> "	19 <sup>1</sup> / <sub>16</sub> "	<b>WC2248O18B30L(N)</b>	1,966.	2,184.

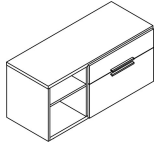

### Order Information

1. Base Pattern Number
2. Case Finish  
See Finish Options page
3. Top Finish  
See Finish Options page

### Order Code

Credenza , 48" wide, Open 18" - Open 30"

---

Example: **WC2248O18O30L**

<b>W</b>	Woodcore Storage
<b>C</b>	Credenza
<b>22</b>	22" High
<b>48</b>	48" Wide
<b>O18</b>	Left: Open 18"
<b>O30</b>	Right: Open 30"
<b>L</b>	Laminate case and front
<b>(118)</b>	Case Finish, Bright White
<b>(118)</b>	Top Finish, Bright White

### Specification Information

Credenzas with file drawers may require counterweights when used in freestanding applications. When applicable, corresponding counterweights kits are noted within the pricing section above.

Add \$40 to the list price per standard key lock. Add \$474 to the list price for manual digital keypad lock. Digital keypad locks require program and manager key(s), specified separately.

Add \$15 to the list price per pull for Anodized Nickel (AN) or Aluminum (AA) finish.

Credenza specified with mixed laminate finishes are L2 pricing. Refer to Mixed Laminate Finishes for further details.

Dimensions listed under w h d are actual to the nearest 1/16".

### Application Notes

Credenzas 20" deep (nominal) have a 19<sup>1</sup>/<sub>16</sub>" deep case. Credenzas with drawer fronts are 20" deep overall.

Credenzas are preassembled including top.

Rails included with file drawer for side-to-side and front-to-back filing.

# Credenzas

## Credenzas 60" wide

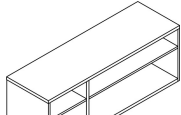
description	configuration left-to-right	w	h	d	pattern no.	L1	L2
	Open 18" - Open 42"	60"	22 <sup>3</sup> / <sub>16</sub> "	19 <sup>1</sup> / <sub>16</sub> "	<b>WC2260O18O42L</b>	\$1,446.	\$1,713.
	Open 24" - Open 36"	60"	22 <sup>3</sup> / <sub>16</sub> "	19 <sup>1</sup> / <sub>16</sub> "	<b>WC2260O24O36L</b>	1,446.	1,713.
	Open 30" - Open 30"	60"	22 <sup>3</sup> / <sub>16</sub> "	19 <sup>1</sup> / <sub>16</sub> "	<b>WC2260O30O30L</b>	1,446.	1,713.
	Open 36" - Open 24"	60"	22 <sup>3</sup> / <sub>16</sub> "	19 <sup>1</sup> / <sub>16</sub> "	<b>WC2260O36O24L</b>	1,446.	1,713.
	Open 42" - Open 18"(shown)	60"	22 <sup>3</sup> / <sub>16</sub> "	19 <sup>1</sup> / <sub>16</sub> "	<b>WC2260O42O18L</b>	1,446.	1,713.

	Open with File - 60" Wide Credenza	File 36" - Open 24"	60"	22 <sup>3</sup> / <sub>16</sub> "	19 <sup>1</sup> / <sub>16</sub> "	<b>WC2260F36O24L(N)</b>	1,879.	2,159.
	File 42" - Open 18" *	60"	22 <sup>3</sup> / <sub>16</sub> "	19 <sup>1</sup> / <sub>16</sub> "	<b>WC2260F42O18L(N)</b>	1,896.	2,188.	
	Open 18" - File 42" *	60"	22 <sup>3</sup> / <sub>16</sub> "	19 <sup>1</sup> / <sub>16</sub> "	<b>WC2260O18F42L(N)</b>	1,896.	2,188.	
	Open 24" - File 36"	60"	22 <sup>3</sup> / <sub>16</sub> "	19 <sup>1</sup> / <sub>16</sub> "	<b>WC2260O24F36L(N)</b>	1,879.	2,159.	

\* 60" wide credenza with 42" wide file drawer requires counterweight kit WCWKIT02 when used in a freestanding application

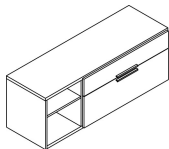
	Open with Box/File - 60" Wide Credenza	Box/File 30" - Open 30"	60"	22 <sup>3</sup> / <sub>16</sub> "	19 <sup>1</sup> / <sub>16</sub> "	<b>WC2260B30O30L(N)</b>	2,163.	2,418.
	Box/File 36" - Open 24"	60"	22 <sup>3</sup> / <sub>16</sub> "	19 <sup>1</sup> / <sub>16</sub> "	<b>WC2260B36O24L(N)</b>	2,186.	2,449.	
	Box/File 42" - Open 18"	60"	22 <sup>3</sup> / <sub>16</sub> "	19 <sup>1</sup> / <sub>16</sub> "	<b>WC2260B42O18L(N)</b>	2,203.	2,465.	
	Open 18" - Box/File 42"	60"	22 <sup>3</sup> / <sub>16</sub> "	19 <sup>1</sup> / <sub>16</sub> "	<b>WC2260O18B42L(N)</b>	2,203.	2,465.	
	Open 24" - Box/File 36"	60"	22 <sup>3</sup> / <sub>16</sub> "	19 <sup>1</sup> / <sub>16</sub> "	<b>WC2260O24B36L(N)</b>	2,186.	2,449.	
	Open 30" - Box/File 30"	60"	22 <sup>3</sup> / <sub>16</sub> "	19 <sup>1</sup> / <sub>16</sub> "	<b>WC2260O30B30L(N)</b>	2,163.	2,418.	

File, File Credenza	File 30" - File 30"	60"	22 <sup>3</sup> / <sub>16</sub> "	19 <sup>1</sup> / <sub>16</sub> "	<b>WC2260F30F30L(N)</b>	2,218.	2,512.
---------------------	---------------------	-----	-----------------------------------	-----------------------------------	-------------------------	--------	--------

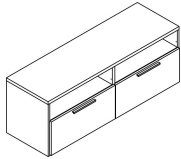

Box/File, Box/File Credenza	Box/File 30" - Box/File 30"	60"	22 <sup>3</sup> / <sub>16</sub> "	19 <sup>1</sup> / <sub>16</sub> "	<b>WC2260B30B30L(N)</b>	2,871.	3,131.
-----------------------------	-----------------------------	-----	-----------------------------------	-----------------------------------	-------------------------	--------	--------

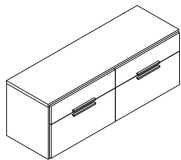

### Order Information

1. Base Pattern Number
2. Case Finish  
See Finish Options page
3. Top Finish  
See Finish Options page

### Order Code

Credenza , 48" wide, Open 18" - Open 30"
Example: <b>WC2248O18O30L</b>
<b>W</b> Woodcore Storage
<b>C</b> Credenza
<b>22</b> 22" High
<b>48</b> 48" Wide
<b>O18</b> Left: Open 18"
<b>O30</b> Right: Open 30"
<b>L</b> Laminate case and front
<b>(118)</b> Case Finish, Bright White
<b>(118)</b> Top Finish, Bright White

### Specification Information

Credenzas with file drawers may require counterweights when used in freestanding applications. When applicable, corresponding counterweights kits are noted within the pricing section above.

Add \$40 to the list price per standard key lock. Add \$474 to the list price for manual digital keypad lock. Digital keypad locks require program and manager key(s), specified separately.

Add \$15 to the list price per pull for Anodized Nickel (AN) or Aluminum (AA) finish.

Credenza specified with mixed laminate finishes are L2 pricing. Refer to Mixed Laminate Finishes for further details.

Dimensions listed under w h d are actual to the nearest 1/16".

### Application Notes

Credenzas 20" deep (nominal) have a 19<sup>1</sup>/<sub>16</sub>" deep case. Credenzas with drawer fronts are 20" deep overall.

Credenzas are preassembled including top.

Rails included with file drawer for side-to-side and front-to-back filing.

# Credenzas

## Credenzas 72" wide

Anchor Storage

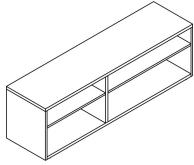
description	configuration left-to-right	w	h	d	pattern no.	L1	L2
	Open 30" - Open 42"(shown)	72"	22 <sup>3</sup> / <sub>16</sub> "	19 <sup>1</sup> / <sub>16</sub> "	<b>WC2272O30O42L</b>	\$1,648.	\$1,941.
	Open 36" - Open 36"	72"	22 <sup>3</sup> / <sub>16</sub> "	19 <sup>1</sup> / <sub>16</sub> "	<b>WC2272O36O36L</b>	1,640.	1,941.
	Open 42" - Open 30"	72"	22 <sup>3</sup> / <sub>16</sub> "	19 <sup>1</sup> / <sub>16</sub> "	<b>WC2272O42O30L</b>	1,648.	1,941.

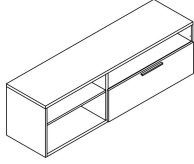
	File 42" - Open 30" *	72"	22 <sup>3</sup> / <sub>16</sub> "	19 <sup>1</sup> / <sub>16</sub> "	<b>WC2272F42O30L(N)</b>	2,090.	2,418.
	Open 30" - File 42" *	72"	22 <sup>3</sup> / <sub>16</sub> "	19 <sup>1</sup> / <sub>16</sub> "	<b>WC2272O30F42L(N)</b>	2,090.	2,418.

\* 72" wide credenza with 42" wide file drawer requires counterweight kit WCWKIT01 when used in a freestanding application

	Box/File 36" - Open 36"	72"	22 <sup>3</sup> / <sub>16</sub> "	19 <sup>1</sup> / <sub>16</sub> "	<b>WC2272B36O36L(N)</b>	2,372.	2,678.
	Box/File 42" - Open 30"	72"	22 <sup>3</sup> / <sub>16</sub> "	19 <sup>1</sup> / <sub>16</sub> "	<b>WC2272B42O30L(N)</b>	2,397.	2,704.
	Open 30" - Box/File 42"	72"	22 <sup>3</sup> / <sub>16</sub> "	19 <sup>1</sup> / <sub>16</sub> "	<b>WC2272O30B42L(N)</b>	2,397.	2,704.
	Open 36" - Box/File 36"	72"	22 <sup>3</sup> / <sub>16</sub> "	19 <sup>1</sup> / <sub>16</sub> "	<b>WC2272O36B36L(N)</b>	2,372.	2,678.

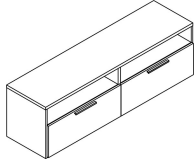
	File 36" - File 36"	72"	22 <sup>3</sup> / <sub>16</sub> "	19 <sup>1</sup> / <sub>16</sub> "	<b>WC2272F36F36L(N)</b>	2,448.	2,795.
---	---------------------	-----	-----------------------------------	-----------------------------------	-------------------------	--------	--------

### Order Information

1. Base Pattern Number
2. Case Finish  
See Finish Options page
3. Top Finish  
See Finish Options page

### Order Code

Credenza , 48" wide, Open 18" - Open 30"

---

Example: **WC2248O18O30L**

<b>W</b>	Woodcore Storage
<b>C</b>	Credenza
<b>22</b>	22" High
<b>48</b>	48" Wide
<b>O18</b>	Left: Open 18"
<b>O30</b>	Right: Open 30"
<b>L</b>	Laminate case and front
<b>(118)</b>	Case Finish, Bright White
<b>(118)</b>	Top Finish, Bright White

### Specification Information

Credenzas with file drawers may require counterweights when used in freestanding applications. When applicable, corresponding counterweights kits are noted within the pricing section above.

Add \$40 to the list price per standard key lock. Add \$474 to the list price for manual digital keypad lock. Digital keypad locks require program and manager key(s), specified separately.

Add \$15 to the list price per pull for Anodized Nickel (AN) or Aluminum (AA) finish.

Credenza specified with mixed laminate finishes are L2 pricing. Refer to Mixed Laminate Finishes for further details.

Dimensions listed under w h d are actual to the nearest 1/16".

### Application Notes

Credenzas 20" deep (nominal) have a 19 1/16" deep case. Credenzas with drawer fronts are 20" deep overall.

Credenzas are preassembled including top.

Rails included with file drawer for side-to-side and front-to-back filing.

# Credenzas

## *Credenzas 72" wide*

Anchor Storage

description	configuration left-to-right	w	h	d	pattern no.	L1	L2
Box/File, Box/File Credenza	Box/File 36" - Box/File 36"	72"	22 <sup>3</sup> / <sub>16</sub> "	19 <sup>1</sup> / <sub>16</sub> "	<b>WC2272B36B36L(N)</b>	\$3,111.	\$3,422.

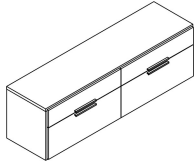

### Order Information

1. *Base Pattern Number*
2. *Case Finish*  
See Finish Options page
3. *Top Finish*  
See Finish Options page

### Order Code

Credenza , 48" wide, Open 18" -  
Open 30"

---

Example: **WC2248O18O30L**

<b>W</b>	Woodcore Storage
<b>C</b>	Credenza
<b>22</b>	22" High
<b>48</b>	48" Wide
<b>O18</b>	Left: Open 18"
<b>O30</b>	Right: Open 30"
<b>L</b>	Laminate case and front
<b>(118)</b>	Case Finish, Bright White
<b>(118)</b>	Top Finish, Bright White

### Specification Information

Credenzas with file drawers may require counterweights when used in freestanding applications. When applicable, corresponding counterweights kits are noted within the pricing section above.

Add \$40 to the list price per standard key lock. Add \$474 to the list price for manual digital keypad lock. Digital keypad locks require program and manager key(s), specified separately.

Add \$15 to the list price per pull for Anodized Nickel (AN) or Aluminum (AA) finish.

Credenza specified with mixed laminate finishes are L2 pricing. Refer to Mixed Laminate Finishes for further details.

Dimensions listed under w h d are actual to the nearest <sup>1</sup>/<sub>16</sub>".

### Application Notes

Credenzas 20" deep (nominal) have a 19<sup>1</sup>/<sub>16</sub>" deep case. Credenzas with drawer fronts are 20" deep overall.

Credenzas are preassembled including top.

Rails included with file drawer for side-to-side and front-to-back filing.

# Credenzas

## Credenzas 84" wide

Anchor Storage

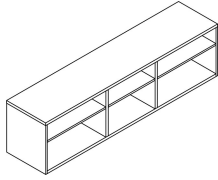
description	configuration left-to-right	w	h	d	pattern no.	L1	L2
All Open - 84" Wide Credenza 	Open 24" - Open 30" - Open 30"	84"	22 <sup>3</sup> / <sub>16</sub> "	19 <sup>1</sup> / <sub>16</sub> "	<b>WC2284O24O30O30L</b>	\$1,928.	\$2,370.
	Open 30" - Open 24" - Open 30"(shown)	84"	22 <sup>3</sup> / <sub>16</sub> "	19 <sup>1</sup> / <sub>16</sub> "	<b>WC2284O30O24O30L</b>	1,928.	2,370.
	Open 30" - Open 30" - Open 24"	84"	22 <sup>3</sup> / <sub>16</sub> "	19 <sup>1</sup> / <sub>16</sub> "	<b>WC2284O30O30O24L</b>	1,928.	2,370.

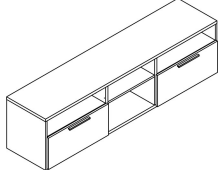
Open with File - 84" Wide Credenza 	File 30" - Open 24" - File 30"	84"	22 <sup>3</sup> / <sub>16</sub> "	19 <sup>1</sup> / <sub>16</sub> "	<b>WC2284F30O24F30L(N)</b>	2,699.	3,176.
---	--------------------------------	-----	-----------------------------------	-----------------------------------	----------------------------	--------	--------

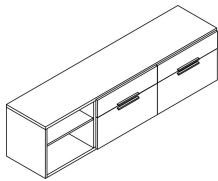
Open with 2 Box/File - 84" Wide Credenza 	Box/File 30" - Box/File 30" - Open 24"	84"	22 <sup>3</sup> / <sub>16</sub> "	19 <sup>1</sup> / <sub>16</sub> "	<b>WC2284B30B30O24L(N)</b>	3,377.	3,821.
	Box/File 30" - Open 24" - Box/File 30"	84"	22 <sup>3</sup> / <sub>16</sub> "	19 <sup>1</sup> / <sub>16</sub> "	<b>WC2284B30O24B30L(N)</b>	3,353.	3,804.
	Open 24" - Box/File 30" - Box/File 30"	84"	22 <sup>3</sup> / <sub>16</sub> "	19 <sup>1</sup> / <sub>16</sub> "	<b>WC2284O24B30B30L(N)</b>	3,377.	3,821.

File, File Credenza 	File 42" - File 42"	84"	22 <sup>3</sup> / <sub>16</sub> "	19 <sup>1</sup> / <sub>16</sub> "	<b>WC2284F42F42L(N)</b>	2,695.	3,167.
--	---------------------	-----	-----------------------------------	-----------------------------------	-------------------------	--------	--------

### Order Information

1. *Base Pattern Number*
2. *Case Finish*  
See Finish Options page
3. *Top Finish*  
See Finish Options page

### Order Code

Credenza , 48" wide, Open 18" - Open 30"

---

Example: **WC2248O18O30L**

<b>W</b>	Woodcore Storage
<b>C</b>	Credenza
<b>22</b>	22" High
<b>48</b>	48" Wide
<b>O18</b>	Left: Open 18"
<b>O30</b>	Right: Open 30"
<b>L</b>	Laminate case and front
<b>(118)</b>	Case Finish, Bright White
<b>(118)</b>	Top Finish, Bright White

### Specification Information

Credenzas with file drawers may require counterweights when used in freestanding applications. When applicable, corresponding counterweights kits are noted within the pricing section above.

Add \$40 to the list price per standard key lock. Add \$474 to the list price for manual digital keypad lock. Digital keypad locks require program and manager key(s), specified separately.

Add \$15 to the list price per pull for Anodized Nickel (AN) or Aluminum (AA) finish.

Credenza specified with mixed laminate finishes are L2 pricing. Refer to Mixed Laminate Finishes for further details.

Dimensions listed under w h d are actual to the nearest <sup>1</sup>/<sub>16</sub>".

### Application Notes

Credenzas 20" deep (nominal) have a 19<sup>1</sup>/<sub>16</sub>" deep case. Credenzas with drawer fronts are 20" deep overall.

Credenzas are preassembled including top.

Rails included with file drawer for side-to-side and front-to-back filing.

# Credenzas

## Credenzas 84" wide

Anchor Storage

description	configuration left-to-right	w	h	d	pattern no.	L1	L2
-------------	-----------------------------	---	---	---	-------------	----	----

Box/File, Box/File Credenza	Box/File 42" - Box/File 42"	84"	22 <sup>3</sup> / <sub>16</sub> "	19 <sup>1</sup> / <sub>16</sub> "	<b>WC2284B42B42L(N)</b>	\$3,342.	\$3,772.
-----------------------------	-----------------------------	-----	-----------------------------------	-----------------------------------	-------------------------	----------	----------

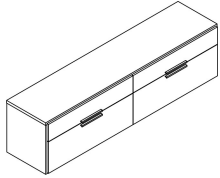

Open with Box/File - 84" Wide Credenza	Box/File 30" - Open 30" - Open 24"	84"	22 <sup>3</sup> / <sub>16</sub> "	19 <sup>1</sup> / <sub>16</sub> "	<b>WC2284B30O30O24L(N)</b>	2,645.	3,090.
	Open 24" - Open 30" - Box/File 30"	84"	22 <sup>3</sup> / <sub>16</sub> "	19 <sup>1</sup> / <sub>16</sub> "	<b>WC2284O24O30B30L(N)</b>	2,645.	3,090.

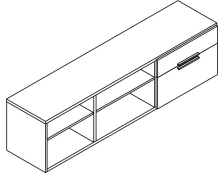

### Order Information

1. *Base Pattern Number*
2. *Case Finish*  
See Finish Options page
3. *Top Finish*  
See Finish Options page

### Order Code

Credenza , 48" wide, Open 18" - Open 30"

---

Example: **WC2248O18O30L**

<b>W</b>	Woodcore Storage
<b>C</b>	Credenza
<b>22</b>	22" High
<b>48</b>	48" Wide
<b>O18</b>	Left: Open 18"
<b>O30</b>	Right: Open 30"
<b>L</b>	Laminate case and front
<b>(118)</b>	Case Finish, Bright White
<b>(118)</b>	Top Finish, Bright White

### Specification Information

Credenzas with file drawers may require counterweights when used in freestanding applications. When applicable, corresponding counterweights kits are noted within the pricing section above.

Add \$40 to the list price per standard key lock. Add \$474 to the list price for manual digital keypad lock. Digital keypad locks require program and manager key(s), specified separately.

Add \$15 to the list price per pull for Anodized Nickel (AN) or Aluminum (AA) finish.

Credenza specified with mixed laminate finishes are L2 pricing. Refer to Mixed Laminate Finishes for further details.

Dimensions listed under w h d are actual to the nearest 1/16".

### Application Notes

Credenzas 20" deep (nominal) have a 19<sup>1</sup>/<sub>16</sub>" deep case. Credenzas with drawer fronts are 20" deep overall.

Credenzas are preassembled including top.

Rails included with file drawer for side-to-side and front-to-back filing.

# Counterweight Kits for Credenzas

description	type	pattern no.	list
Counterweight Kits	Counterweight Kit 01	<b>WCWKIT01</b>	\$96.
	Counterweight Kit 02	<b>WCWKIT02</b>	119.
	Counterweight Kit 06	<b>WCWKIT06</b>	227.
	Counterweight Kit 07	<b>WCWKIT07</b>	247.
	Counterweight Kit 08	<b>WCWKIT08</b>	271.

## Order Information

## Order Code

---



---



---

## Specification Information

Credenzas with file drawers may require counterweights when used in freestanding applications.

When applicable, reference the credenza pricing pages to identify the appropriate kit.

## Application Notes

Counterweight kits include hardware to mount the counterweight plates.

Counterweight plates are to be mounted to the back panel behind the file drawer(s) inside the credenza.



description	w	d	h	pattern no.	A	B	C	D	E	F	G	H	I
Credenza Cushion Top	30"	18"	1 1/4"	<b>WCCT3018</b>	\$384.	\$417.	\$441.	\$479.	\$489.	\$535.	\$564.	\$612.	\$691.
	36"	18"	1 1/4"	<b>WCCT3618</b>	403.	436.	460.	497.	507.	554.	583.	631.	709.

**Order Information**

1. *Base Pattern Number*
2. *Fabric*  
See Finish Options page

**Order Code**

Example: **RLCCT3018 ( )**

<b>RL</b>	Base Pattern Number
<b>CCT</b>	Credenza Cushion Top
<b>30</b>	30" Wide
<b>18</b>	18" Deep
<b>( )</b>	Fabric

**Application Notes**

Cushions are for use on credenzas only.

Cushions are preassembled with hook and loop tape for mounting to credenza.

# Pedestal Specifications

## Floorstanding Pedestal Technical Specifications

### Anchor Floorstanding Pedestals

Anchor Floorstanding Pedestals are desk height wood construction cabinets designed to support work surfaces in both panel wrapped and freestanding applications. No cantilevers or other supports are required at the end of the work surface supported by a pedestal. Opposite end of the extended work surface must be supported by support leg or a panel. **Floorstanding pedestals are not intended for freestanding use.** Floorstanding Pedestals ship assembled, excluding a finished top.

### Available Sizes (nominal)

Height: 28" overall height including work surface (specified separately)  
Widths: 12", 16", 24", 30"  
Depth: 24"

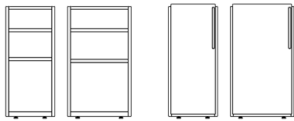

12" and 16" wide floorstanding pedestals open and with full door (left or right hand)



12" and 16" wide floorstanding pedestals with drawers:

- Open/File
- Open/Box/File
- Box(file front)/File
- Box/Box(file front)/File
- File/File

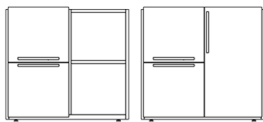

24" and 30" wide floorstanding combination pedestals (left or right hand, as determined by the pedestal locker position; right hand pedestals shown)

Pedestal configurations:

- Open
- Full door
- Open/File
- Open/Box/File
- Box(file front)/File
- Box/Box(file front)/File
- File/File

Pedestal locker configurations:

- Open
- Full Door

### Construction

- Floorstanding Pedestals are constructed of wood core, laminate and ABS edge banding; cam and dowel construction.
- Material thickness: 1<sup>3</sup>/<sub>16</sub>" (nominal) on pedestal bottom and midpanels (where applicable), 3/4" on pedestal back, sides, interior shelves and drawer fronts.
- 16" wide pedestal drawer bodies are metal; 12" wide pedestal drawer bodies are wood construction
- Box and File drawer suspension: Full extension, ball bearing slides
- Leveling glides: 3/16" diameter steel stem with 1/16" of height adjustment, 4 per pedestal.
- Longer glides are included to provide an additional 1/16" of height adjustment; 2 per pedestal.

### Internal Drawer Dimensions 16" wide

#### Box drawer

- Internal height: 4<sup>5</sup>/<sub>16</sub>" (4<sup>13</sup>/<sub>16</sub>" clearance)
- Internal width: 12<sup>7</sup>/<sub>16</sub>"
- Internal depth: 14<sup>7</sup>/<sub>16</sub>"

#### File drawer

- Internal height: 9<sup>1</sup>/<sub>4</sub>" (11<sup>5</sup>/<sub>16</sub>" clearance)
- Internal width: 12<sup>7</sup>/<sub>16</sub>"
- Internal depth: 14<sup>7</sup>/<sub>16</sub>"

### Internal Clearances \*

#### Pedestal with top shelf

- Internal height A: 4<sup>7</sup>/<sub>8</sub>"
- Internal height B: 6<sup>1</sup>/<sub>2</sub>"
- Internal height C: 11<sup>15</sup>/<sub>16</sub>"

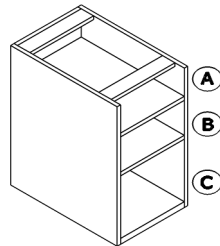

#### Pedestal with top shelf removed (where applicable)

- Internal height A: 12<sup>1</sup>/<sub>8</sub>"
- Internal height B: 11<sup>15</sup>/<sub>16</sub>"

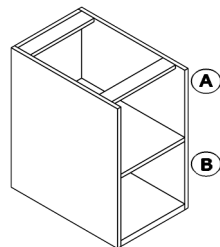

### Filing

16" wide pedestal file drawer allows for side-to-side letter filing. File Support Channel for legal filing must be specified separately. 12" wide pedestal file drawer allows for front-to-back letter or legal filing.

### Locks

Anchor Floorstanding Pedestals may be ordered with or without locks. No lock hole is drilled on units specified as non-locking.

Dual-tab lock design allows one shared lock core on units with 2 drawers in vertical alignment.

Locks are randomly keyed unless otherwise specified. Other keying options include keyed alike or keyed with lock cores K001-K250. To specify units as such, reference KnollKey Lock Program.

### Pulls

Finger Pull, centered horizontally on drawers, positioned vertically on doors.

Top drawer: 3/4" from bottom of drawer

Bottom drawer: 3/4" from top of drawer

Doors: 1 1/8" below top edge of door

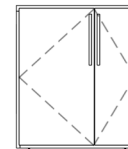
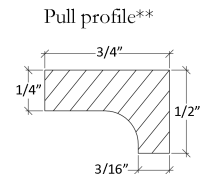
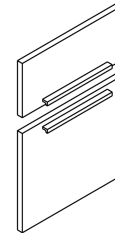

Combination pedestal doors open from midpanel; hinges are located on the end panels.

\*Actual dimensions to the nearest 1/16th of an inch.

### Anchor Doublewide Pedestals

Anchor Doublewide Pedestals are 28" high wood construction cabinets sized to align with desk height (when specified with top) and are designed to be used in a variety of applications.

Doublewide pedestals are available in 3 widths and 5 interior configurations. Reference the Statement of Line page for full product scope.

### Available Sizes (nominal)

Height: 28" (including top)  
Widths: 30", 36", 42"  
Depth: 20"

Doublewide Pedestals ship assembled excluding the top. **Doublewide pedestal tops must be specified separately.**

Doublewide pedestals may be specified with a full-width individual top, common top spanning two side-by-side units (facing the same or opposite direction) or with an extended top. Opposite end of the extended worksurface must be supported by a perpendicular work surface, support leg or a panel.

Counterweight kit must be specified for certain doublewide pedestals in applications that are not connected to a desk or another unit. Further information is detailed on pricing pages.

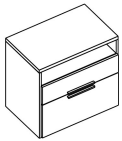

Individual top

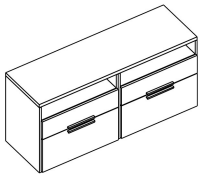

Common top, units facing same direction

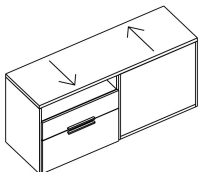

Common top, units facing opposite direction

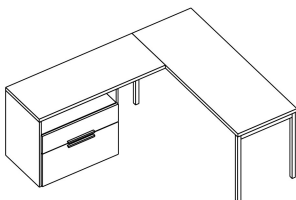

Extended top connected to a perpendicular surface.

### Construction

- Doublewide Pedestals are constructed of wood core, laminate and ABS edge banding; cam and dowel construction.
- Material thickness: 1<sup>3</sup>/<sub>16</sub>" (nominal) on pedestal bottom, 3/4" on pedestal back, sides, interior shelves and drawer fronts.
- Material thickness: 1<sup>3</sup>/<sub>16</sub>" (nominal) on pedestal tops (specified separately)
- Box and File drawer suspension: Full extension, ball bearing slides
- Units include interlock to prevent more than one drawer opening at a time.
- Leveling glides: 3/16" diameter steel stem with 1<sup>1</sup>/<sub>16</sub>" of height adjustment, 4 per doublewide pedestal.
- Longer glides are included to provide an additional 1<sup>1</sup>/<sub>16</sub>" of height adjustment; 2 per doublewide pedestal.

### Internal Drawer Dimensions \*

#### Box drawer

- Internal height: 3<sup>3</sup>/<sub>4</sub>" (5<sup>1</sup>/<sub>8</sub>" clearance)
- Internal width: 26<sup>3</sup>/<sub>4</sub>", 32<sup>3</sup>/<sub>4</sub>", 38<sup>3</sup>/<sub>4</sub>"
- Internal depth: 16<sup>1</sup>/<sub>4</sub>"

#### File drawer

- Internal height: 9<sup>3</sup>/<sub>4</sub>" (11<sup>3</sup>/<sub>4</sub>" clearance)
- Internal width: 26<sup>3</sup>/<sub>4</sub>", 32<sup>3</sup>/<sub>4</sub>", 38<sup>3</sup>/<sub>4</sub>"
- Internal depth: 16<sup>1</sup>/<sub>4</sub>"

### Internal Clearances \*

#### Pedestal with top shelf

- Internal height A: 4<sup>7</sup>/<sub>8</sub>"
- Internal height B: 6<sup>1</sup>/<sub>2</sub>"
- Internal height C: 11<sup>15</sup>/<sub>16</sub>"
- Internal width: 28<sup>1</sup>/<sub>2</sub>", 34<sup>1</sup>/<sub>2</sub>", 40<sup>1</sup>/<sub>2</sub>"
- Internal depth: 18<sup>1</sup>/<sub>4</sub>"

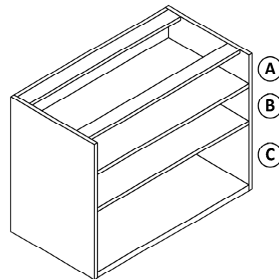

#### Pedestal with top shelf removed (where applicable)

- Internal height A: 12<sup>1</sup>/<sub>8</sub>"
- Internal height B: 11<sup>15</sup>/<sub>16</sub>"

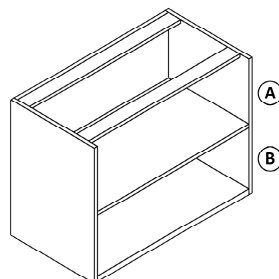

\*Actual dimensions to the nearest 1/16th of an inch.

### Filing

The pedestal file drawer design allows for side-to-side letter or legal filing and front-to-back letter filing. Pedestals with a file drawer include a hanging file bar to accommodate front-to-back filing.

### Locks

Anchor Doublewide Pedestals may be ordered with or without locks. No lock hole is drilled on units specified as non-locking.

Standard lock placement is the upper right hand corner of the bottom file drawer. Center of lock is 1<sup>1</sup>/<sub>16</sub>" from top edge, 1<sup>1</sup>/<sub>2</sub>" from side. Dual-tab lock design allows one shared lock core per box/file and file/file configuration.

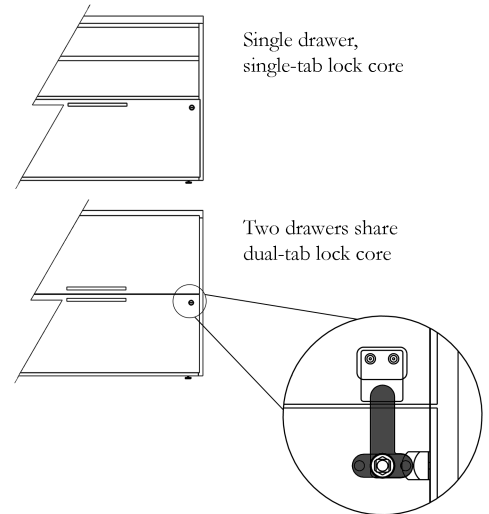

Locks are randomly keyed unless otherwise specified. Other keying options include keyed alike or keyed with lock cores K001-K250. To specify units as such, reference KnollKey Lock Program.

### Pulls

Finger Pull, 10" long, centered horizontally on drawers

Top drawer: 3/4" from bottom of drawer

Bottom drawer: 3/4" from top of drawer

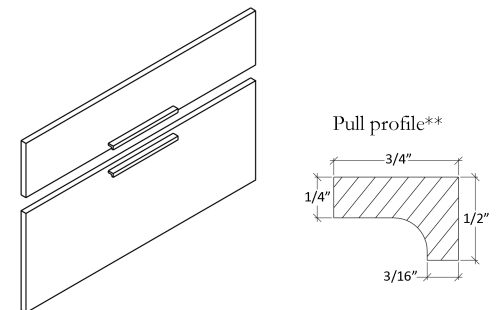

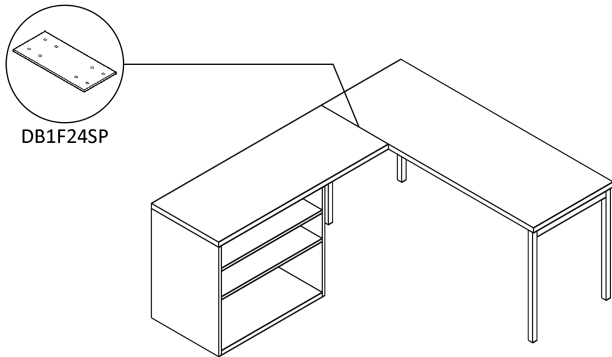

Doublewide pedestal with extended top. Specify **Dividends Horizon DB1F24SP flat bracket** for connection to perpendicular work surface.  
No counterweight kit required.

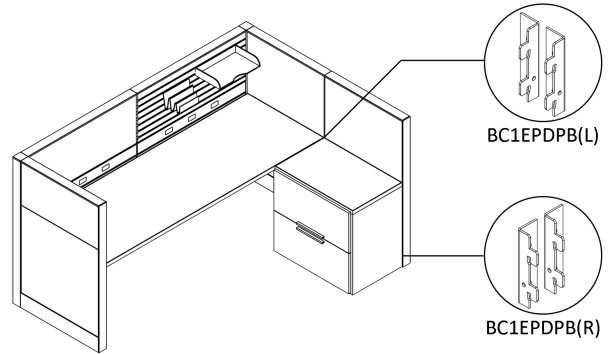

Doublewide pedestal with individual top. Specify both the left and right hand **Dividends Horizon Panel brackets BC1EPDPB** to secure the unit to the panel.  
No counterweight kit required.

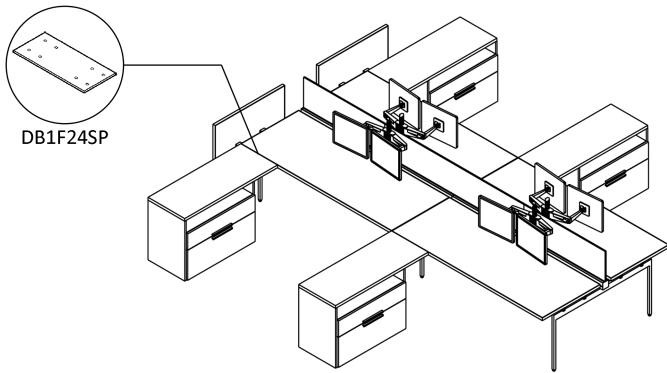

Doublewide pedestals with extended tops. Specify a **Dividends Horizon DB1F24SP flat bracket** where each extended top connects to a perpendicular work surface.  
No counterweight kits required.

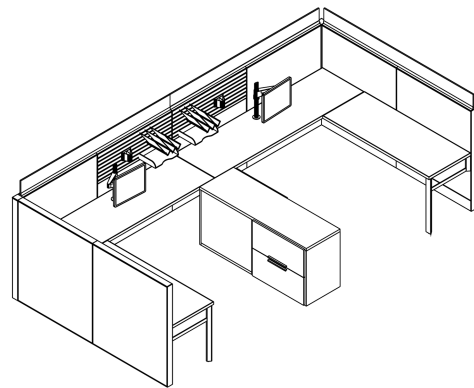

Common top spanning two doublewide pedestals facing opposite directions.  
No counterweight kits required.

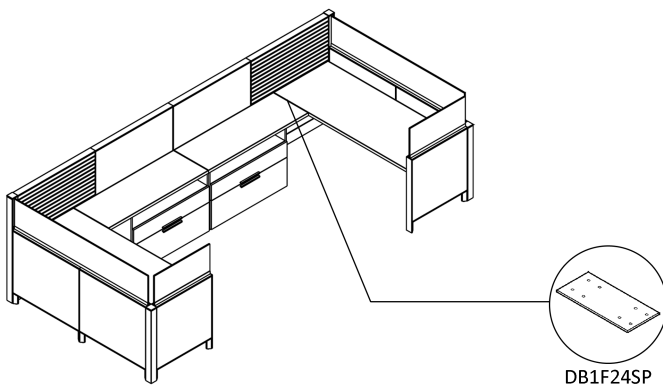

Doublewide pedestals each with extended top. Specify a **Dividends Horizon DB1F24SP flat bracket** where each extended top connects to a perpendicular work surface.  
No Counterweight kits required.

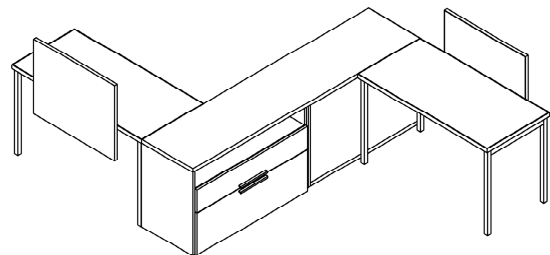



Doublewide Pedestals facing opposite directions with common top.  
No counterweight kits required.

# Pedestals

## Mobile Pedestals 12" wide

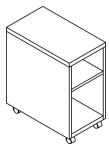
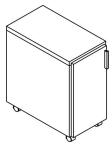
Anchor Storage

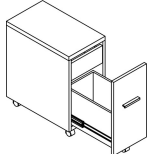
description	description	w	h	d	pattern no.	L1	L2
	Open	12"	23 7/8"	20 3/4"	<b>WPM2412OPL</b>	\$488.	\$585.
	Open, 1 Shelf (shown)	12"	23 7/8"	20 3/4"	<b>WPM2412O1L</b>	530.	640.
	Left Hand	12"	23 7/8"	20 3/4"	<b>WPM2412FDLHL(N)</b>	621.	734.
	Left Hand, 1 Shelf	12"	23 7/8"	20 3/4"	<b>WPM2412F1LHL(N)</b>	621.	734.
	Right Hand (shown)	12"	23 7/8"	20 3/4"	<b>WPM2412FDRHL(N)</b>	621.	734.
	Right Hand, 1 Shelf	12"	23 7/8"	20 3/4"	<b>WPM2412F1RHL(N)</b>	664.	788.
Open/File Mobile Pedestal		12"	23 7/8"	20 3/4"	<b>WPM2412OFL(N)</b>	787.	904.
		12"	23 7/8"	20 3/4"	<b>WPM2412BFL(N)</b>	883.	992.
Recessed Box/File Mobile Pedestal		12"	23 7/8"	20 3/4"	<b>WPM2412CML(N)</b>	899.	1,021.
							

Order Information	Order Code	Specification Information	Application Notes
1. <i>Base Pattern Number</i>	Mobile Pedestal, 12" Wide,	Add \$40 to the list price per lock.	Mobile pedestals 22" deep
2. <i>Lock option</i>	Open/File	Reference Pedestal Specifications for lock configuration.	(nominal) have a 20 3/4" deep case
L = Locking			Pedestals with drawer fronts or
N = Non-locking			doors are 21 7/8" deep overall.
3. <i>Case Finish</i>		Add \$15 to the list price per pull for Anodized Nickel (AN) or Aluminum (AA) finish.	
See Finish Options page	Example: <b>WPM2412OFL(L)</b>		
4. <i>Front Finish</i>	<b>WPM</b> Anchor Mobile Pedestal		
See Finish Options page	<b>24</b> 24" High	Mobile pedestals must be specified with a drilled top to accept pedestal cushion (specified separately.)	
5. <i>Pull style</i>	<b>12</b> 12" Wide		
T = 10" finger pull	<b>OF</b> Open/File		
6. <i>Pull finish</i>	<b>L</b> Laminate	Pedestals specified with mixed laminate finishes are L2 pricing. Refer to Mixed Laminate Finishes for further details.	
B = Black	<b>(L)</b> Lock option, Locking		
7. <i>Lock Finish</i>	<b>(118)</b> Case Finish		
C = Chrome	<b>(118)</b> Front Finish		
8. <i>Predrilled top for cushion</i>	<b>(T)</b> Pull Style	Dimensions listed under w h d are actual to the nearest 1/16".	
D = Drilled	<b>(118)</b> Pull Finish		
N = Non-drilled	<b>(C)</b> Lock finish, Chrome		
	<b>(D)</b> Drilled top for cushion		

# Pedestals

## Mobile Pedestals 16" wide

Anchor Storage

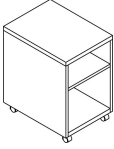
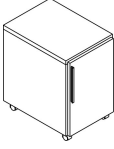
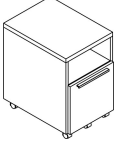
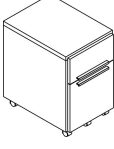
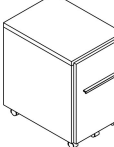
description	description	w	h	d	pattern no.	L1	L2
All Open Mobile Pedestal 	Open	15 <sup>9</sup> / <sub>16</sub> "	23 <sup>7</sup> / <sub>8</sub> "	20 <sup>3</sup> / <sub>4</sub> "	<b>WPM2416OPL</b>	\$490.	\$687.
	Open, 1 Shelf (shown)	15 <sup>9</sup> / <sub>16</sub> "	23 <sup>7</sup> / <sub>8</sub> "	20 <sup>3</sup> / <sub>4</sub> "	<b>WPM2416O1L</b>	536.	759.
Full Door Mobile Pedestal 	Left Hand	15 <sup>9</sup> / <sub>16</sub> "	23 <sup>7</sup> / <sub>8</sub> "	20 <sup>3</sup> / <sub>4</sub> "	<b>WPM2416FDLHL(N)</b>	628.	851.
	Left Hand, 1 Shelf	15 <sup>9</sup> / <sub>16</sub> "	23 <sup>7</sup> / <sub>8</sub> "	20 <sup>3</sup> / <sub>4</sub> "	<b>WPM2416F1LHL(N)</b>	673.	924.
	Right Hand (shown)	15 <sup>9</sup> / <sub>16</sub> "	23 <sup>7</sup> / <sub>8</sub> "	20 <sup>3</sup> / <sub>4</sub> "	<b>WPM2416FDRHL(N)</b>	628.	851.
	Right Hand, 1 Shelf	15 <sup>9</sup> / <sub>16</sub> "	23 <sup>7</sup> / <sub>8</sub> "	20 <sup>3</sup> / <sub>4</sub> "	<b>WPM2416F1RHL(N)</b>	673.	924.
Open/File Mobile Pedestal 		15 <sup>9</sup> / <sub>16</sub> "	23 <sup>7</sup> / <sub>8</sub> "	20 <sup>3</sup> / <sub>4</sub> "	<b>WPM2416OFL</b>	896.	1,168.
Box/File Mobile Pedestal 		15 <sup>9</sup> / <sub>16</sub> "	23 <sup>7</sup> / <sub>8</sub> "	20 <sup>3</sup> / <sub>4</sub> "	<b>WPM2416BFL(N)</b>	1,026.	1,270.
Recessed Box/File Mobile Pedestal 		15 <sup>9</sup> / <sub>16</sub> "	23 <sup>7</sup> / <sub>8</sub> "	20 <sup>3</sup> / <sub>4</sub> "	<b>WPM2416CML(N)</b>	1,040.	1,176.

### Order Information

1. Base Pattern Number
2. Lock option  
L = Locking  
N = Non-locking
3. Case Finish  
See Finish Options page
4. Front Finish  
See Finish Options page
5. Pull style  
T = 10" finger pull
6. Pull finish  
B = Black
7. Lock Finish  
C = Chrome
8. Predrilled top for cushion  
D = Drilled  
N = Non-drilled

### Order Code

Mobile Pedestal, 16" Wide,  
Open/File

---

Example: **WPM2416OFL(L)**

<b>WPM</b>	Anchor Mobile Pedestal
<b>24</b>	24" High
<b>16</b>	16" Wide
<b>OF</b>	Open/File
<b>L</b>	Laminate
<b>(L)</b>	Lock option, Locking
<b>(118)</b>	Case Finish
<b>(118)</b>	Front Finish
<b>(T)</b>	Pull Style
<b>(118)</b>	Pull Finish
<b>(C)</b>	Lock finish, Chrome
<b>(D)</b>	Drilled top for cushion

### Specification Information

Add \$40 to the list price per lock.  
Reference Pedestal Specifications for lock configuration.

Add \$15 to the list price per pull for Anodized Nickel (AN) or Aluminum (AA) finish.

Mobile pedestals must be specified with a drilled top to accept pedestal cushion (specified separately.)

Pedestals specified with mixed laminate finishes are L2 pricing. Refer to Mixed Laminate Finishes for further details.

Dimensions listed under w h d are actual to the nearest 1/16".

### Application Notes

Mobile pedestals 22" deep (nominal) have a 20<sup>3</sup>/<sub>4</sub>" deep case  
Pedestals with drawer fronts or doors are 21<sup>7</sup>/<sub>8</sub>" deep overall.

Pedestals  
*Mobile Pedestal Cushion*  
*Fabric*

description	type	w	d	h	pattern no.	A	B	C	D	E	F	G	H	I
Pedestal Cushion	For 12" wide Mobile Pedestal	12"	20 <sup>3</sup> / <sub>4</sub> "	1"	<b>WPMC12</b>	\$233.	\$261.	\$306.	\$320.	\$350.	\$380.	\$422.	\$466.	\$482.
	For 16" wide Mobile Pedestal	15 <sup>9</sup> / <sub>16</sub> "	20 <sup>3</sup> / <sub>4</sub> "	1"	<b>WPMC16</b>	251.	282.	330.	345.	377.	410.	455.	503.	520.

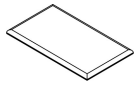

**Ordering Information**

**Seat Cushions**

1. Base Pattern Number
2. Fabric Finish

**Order Code**

**Mobile Pedestal Cushions**

<i>Example:</i> <b>WPMC16,Y351</b>	
<b>WPM</b>	Anchor Mobile Pedestal
<b>C</b>	Cushion
<b>16</b>	16" Wide
<b>Y351</b>	Foundation

**Specification Information**

For use on Anchor Mobile Pedestals.

**Mobile Pedestals must be specified with "D" drilled top option to attach pedestal cushion.**

**Application Notes**

Pedestal cushion includes hardware to attach to a mobile pedestal (which must be specified with predrilled top option.)

For CAL133 backing on the cushion, add \$80 to the list price.

Use Grade B pricing for COM.

Pedestals  
*Mobile Pedestal Cushion*  
*Leather*

description	type	w	d	h	pattern no.	U	V	W	X	Y
Pedestal Cushion	For 12" wide Mobile Pedestal	12"	20 <sup>3</sup> / <sub>4</sub> "	1"	<b>WPMC12</b>	\$466.	\$555.	\$683.	\$714.	\$756.
	For 16" wide Mobile Pedestal	15 <sup>7</sup> / <sub>16</sub> "	20 <sup>3</sup> / <sub>4</sub> "	1"	<b>WPMC16</b>	503.	599.	737.	771.	816.

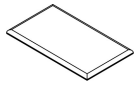

**Ordering Information**

**Seat Cushions**

1. Base Pattern Number
2. Fabric Finish

**Order Code**

**Mobile Pedestal Cushions**

*Example:* **WPMC16,VO**

<b>WPM</b>	Anchor Mobile Pedestal
<b>C</b>	Cushion
<b>16</b>	16" Wide
<b>VO</b>	Volo

**Specification Information**

For use on Anchor Mobile Pedestals.

**Mobile Pedestals must be specified with "D" drilled top option to attach pedestal cushion.**

**Application Notes**

Pedestal cushion includes hardware to attach to a mobile pedestal (which must be specified with predrilled top option.)

For perforated leather, add \$105 to the list price.

Use Grade U pricing for customer's own leather.



# Pedestals

## Floorstanding Pedestals 24" deep 12" wide

Anchor Storage

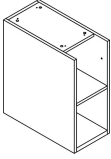
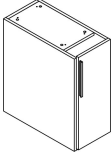
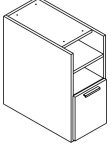
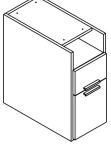
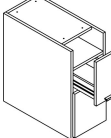
description	pedestal configuration	w	h	d	pattern no.	L1	L2	
	All Open Pedestal, 12" wide	Open	12"	27 1/16"	23 1/2"	<b>WP2812OPL</b>	\$499.	\$711.
		Open, 1 Shelf (shown)	12"	27 1/16"	23 1/2"	<b>WP2812O1L</b>	544.	781.
		Open, 2 Shelves	12"	27 1/16"	23 1/2"	<b>WP2812O2L</b>	600.	865.
	Full Door Pedestal 12" wide	Full Door, Left Hand	12"	27 1/16"	23 1/2"	<b>WP2812FDLHL(N)</b>	681.	921.
		Full Door, Right Hand (shown)	12"	27 1/16"	23 1/2"	<b>WP2812FDRHL(N)</b>	681.	921.
		Full Door, 1 Shelf Left Hand	12"	27 1/16"	23 1/2"	<b>WP2812F1LHL(N)</b>	726.	994.
		Full Door, 1 Shelf Right Hand	12"	27 1/16"	23 1/2"	<b>WP2812F1RHL(N)</b>	726.	994.
		Full Door, 2 Shelves Left Hand	12"	27 1/16"	23 1/2"	<b>WP2812F2LHL(N)</b>	772.	1,067.
		Full Door, 2 Shelves Right Hand	12"	27 1/16"	23 1/2"	<b>WP2812F2RHL(N)</b>	772.	1,067.
	Open/File Pedestal	Open/File	12"	27 1/16"	23 1/2"	<b>WP2812OFL(N)</b>	764.	905.
	Open/Box/File Pedestal	Open/Box/File	12"	27 1/16"	23 1/2"	<b>WP2812OBL(N)</b>	868.	1,001.
	Box (File Front)/File Pedestal	Concealed shelf/Box/File	12"	27 1/16"	23 1/2"	<b>WP2812CFL(N)</b>	882.	1,020.

Order Information	Order Code	Specification Information	Application Notes
1. <i>Base Pattern Number</i>	Pedestal, 16" Wide, Open/File	Floorstanding Pedestals do not include a finished top; they are designed to support one end of a work surface ( specified separately) and are not intended for freestanding use.	Floorstanding pedestals 24" deep (nominal) have a 23 1/2" deep case to align with a 23 1/2" deep work surface (specified separately). Pedestals with drawer fronts or door are 24 3/8" deep overall.
2. <i>Lock option</i> L = Locking N = Non-locking	Example: <b>WP2816OFL(L)</b>		
3. <i>Case Finish</i> See Finish Options page	<b>WP</b> Anchor Pedestal		
4. <i>Front Finish</i> See Finish Options page	<b>28</b> 27 1/16" High	Add \$40 to the list price per lock. Reference Pedestal Specifications for lock configuration.	Pedestals complete with top (specified separately) align with desk height.
5. <i>Pull style</i> T = 10" finger pull	<b>16</b> 16" Wide		
6. <i>Pull finish</i> See Finish Options page	<b>OF</b> Open/File		
7. <i>Lock finish</i> B = Black C = Chrome	<b>L</b> Laminate	Add \$15 to the list price per pull for Anodized Nickel (AN) or Aluminum (AA) finish.	Slide out Pedestal features bottom bin with slat wall above. Compatible slat wall accessories are listed in Pedestal Accessories, specified separately.
	<b>(L)</b> Lock option, Locking		
	<b>(118)</b> Case Finish		
	<b>(118)</b> Front Finish	Pedestals specified with mixed laminate finishes are L2 pricing. Refer to Mixed Laminate Finishes for further details.	
	<b>(T)</b> Pull Style		
	<b>(118)</b> Pull Finish		
	<b>(C)</b> Lock finish, Chrome	Dimensions listed under w h d are actual to the nearest 1/16".	

# Pedestals

## *Floorstanding Pedestals 24" deep 12" wide*

Anchor Storage

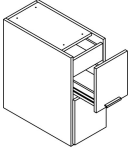
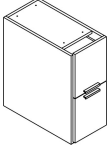
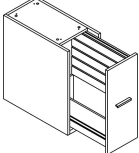
description	pedestal configuration	w	h	d	pattern no.	L1	L2
Box/Box (File Front)/File Pedestal	Recessed Box/Box/File	12"	27 1/16"	23 1/2"	<b>WP2812CBL(N)</b>	\$947.	\$1,075.
							
File/File Pedestal	File/File	12"	27 1/16"	23 1/2"	<b>WP2812FFL(N)</b>	884.	1,010.
							
Slide Out Pedestal	Slat wall with bin, left hand	12"	27 1/16"	23 1/2"	<b>WP2812SOLHL(N)</b>	1,040.	1,129.
	Slat wall with bin, right hand (shown)	12"	27 1/16"	23 1/2"	<b>WP2812SORHL(N)</b>	1,040.	1,129.
							

Order Information	Order Code	Specification Information	Application Notes
1. <i>Base Pattern Number</i>	Pedestal, 16" Wide, Open/File	Floorstanding Pedestals do not include a finished top; they are designed to support one end of a work surface ( specified separately) and are not intended for freestanding use.	Floorstanding pedestals 24" deep (nominal) have a 23 1/2" deep case to align with a 23 1/2" deep work surface (specified separately). Pedestals with drawer fronts or door are 24 3/8" deep overall.
2. <i>Lock option</i> L = Locking N = Non-locking	Example: <b>WP2816OFL(L)</b>		
3. <i>Case Finish</i> See Finish Options page	<b>WP</b> Anchor Pedestal		
4. <i>Front Finish</i> See Finish Options page	<b>28</b> 27 1/16" High	Add \$40 to the list price per lock. Reference Pedestal Specifications for lock configuration.	Pedestals complete with top (specified separately) align with desk height.
5. <i>Pull style</i> T = 10" finger pull	<b>16</b> 16" Wide		
6. <i>Pull finish</i> See Finish Options page	<b>OF</b> Open/File		
7. <i>Lock finish</i> B = Black C = Chrome	<b>L</b> Laminate	Add \$15 to the list price per pull for Anodized Nickel (AN) or Aluminum (AA) finish.	Slide out Pedestal features bottom bin with slat wall above. Compatible slat wall accessories are listed in Pedestal Accessories, specified separately.
	<b>(L)</b> Lock option, Locking		
	<b>(118)</b> Case Finish		
	<b>(118)</b> Front Finish	Pedestals specified with mixed laminate finishes are L2 pricing. Refer to Mixed Laminate Finishes for further details.	
	<b>(T)</b> Pull Style		
	<b>(118)</b> Pull Finish		
	<b>(C)</b> Lock finish, Chrome	Dimensions listed under w h d are actual to the nearest 1/16".	

# Pedestals

## Floorstanding Pedestals 24" deep 16" wide

Anchor Storage

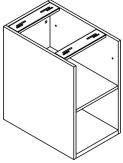
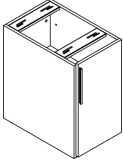
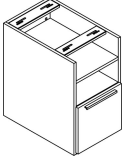
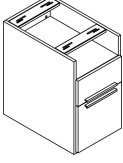
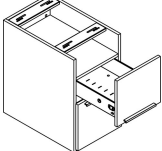
description	pedestal configuration	w	h	d	pattern no.	L1	L2
	All Open Pedestal, 16" wide	Open	15 <sup>9</sup> / <sub>16</sub> "	27 <sup>1</sup> / <sub>16</sub> "	23 <sup>1</sup> / <sub>2</sub> "	<b>WP2816OPL</b>	\$510. \$711.
	Open, 1 Shelf (shown)	Open, 1 Shelf (shown)	15 <sup>9</sup> / <sub>16</sub> "	27 <sup>1</sup> / <sub>16</sub> "	23 <sup>1</sup> / <sub>2</sub> "	<b>WP2816O1L</b>	567. 803.
	Open, 2 Shelves	Open, 2 Shelves	15 <sup>9</sup> / <sub>16</sub> "	27 <sup>1</sup> / <sub>16</sub> "	23 <sup>1</sup> / <sub>2</sub> "	<b>WP2816O2L</b>	623. 896.
	Full Door Pedestal 16" wide	Full Door, 1 Shelf Left Hand	15 <sup>9</sup> / <sub>16</sub> "	27 <sup>1</sup> / <sub>16</sub> "	23 <sup>1</sup> / <sub>2</sub> "	<b>WP2816F1LHL(N)</b>	724. 1,000.
	Full Door, 1 Shelf Right Hand	Full Door, 1 Shelf Right Hand	15 <sup>9</sup> / <sub>16</sub> "	27 <sup>1</sup> / <sub>16</sub> "	23 <sup>1</sup> / <sub>2</sub> "	<b>WP2816F1RHL(N)</b>	724. 1,000.
	Full Door, 2 Shelves Left Hand	Full Door, 2 Shelves Left Hand	15 <sup>9</sup> / <sub>16</sub> "	27 <sup>1</sup> / <sub>16</sub> "	23 <sup>1</sup> / <sub>2</sub> "	<b>WP2816F2LHL(N)</b>	781. 1,092.
	Full Door, 2 Shelves Right Hand	Full Door, 2 Shelves Right Hand	15 <sup>9</sup> / <sub>16</sub> "	27 <sup>1</sup> / <sub>16</sub> "	23 <sup>1</sup> / <sub>2</sub> "	<b>WP2816F2RHL(N)</b>	781. 1,092.
	Full Door, Left Hand	Full Door, Left Hand	15 <sup>9</sup> / <sub>16</sub> "	27 <sup>1</sup> / <sub>16</sub> "	23 <sup>1</sup> / <sub>2</sub> "	<b>WP2816FDLHL(N)</b>	668. 908.
	Full Door, Right Hand (shown)	Full Door, Right Hand (shown)	15 <sup>9</sup> / <sub>16</sub> "	27 <sup>1</sup> / <sub>16</sub> "	23 <sup>1</sup> / <sub>2</sub> "	<b>WP2816FDRHL(N)</b>	668. 908.
Open/File Pedestal		15 <sup>9</sup> / <sub>16</sub> "	27 <sup>1</sup> / <sub>16</sub> "	23 <sup>1</sup> / <sub>2</sub> "	<b>WP2816OFL(N)</b>	796. 1,087.	
							
Open/Box/File Pedestal		15 <sup>9</sup> / <sub>16</sub> "	27 <sup>1</sup> / <sub>16</sub> "	23 <sup>1</sup> / <sub>2</sub> "	<b>WP2816OBL(N)</b>	929. 1,194.	
							
Box (File Front)/File Pedestal		15 <sup>9</sup> / <sub>16</sub> "	27 <sup>1</sup> / <sub>16</sub> "	23 <sup>1</sup> / <sub>2</sub> "	<b>WP2816CFL(N)</b>	946. 1,221.	
							

Order Information	Order Code	Specification Information	Application Notes
1. <i>Base Pattern Number</i>	Pedestal, 16" Wide, Open/File	Floorstanding Pedestals do not include a finished top; they are designed to support one end of a work surface ( specified separately) and are not intended for freestanding use.	Floorstanding pedestals 24" deep (nominal) have a 23 <sup>1</sup> / <sub>2</sub> " deep case to align with a 23 <sup>1</sup> / <sub>2</sub> " deep work surface (specified separately). Pedestals with drawer fronts or door are 24 <sup>3</sup> / <sub>8</sub> " deep overall.
2. <i>Lock option</i> L = Locking N = Non-locking	Example: <b>WP2816OFL(L)</b>	Add \$40 to the list price per lock. Reference Pedestal Specifications for lock configuration.	Pedestals complete with top (specified separately) align with desk height.
3. <i>Case Finish</i> See Finish Options page	<b>WP</b> Anchor Pedestal	Add \$15 to the list price per pull for Anodized Nickel (AN) or Aluminum (AA) finish.	Slide out Pedestal features bottom bin with slat wall above. Compatible slat wall accessories are listed in Pedestal Accessories, specified separately.
4. <i>Front Finish</i> See Finish Options page	<b>28</b> 27 <sup>1</sup> / <sub>16</sub> " High	Pedestals specified with mixed laminate finishes are L2 pricing. Refer to Mixed Laminate Finishes for further details.	
5. <i>Pull style</i> T = 10" finger pull	<b>16</b> 16" Wide		
6. <i>Pull finish</i> See Finish Options page	<b>OF</b> Open/File		
7. <i>Lock finish</i> B = Black C = Chrome	<b>L</b> Laminate <b>(L)</b> Lock option, Locking <b>(118)</b> Case Finish <b>(118)</b> Front Finish <b>(T)</b> Pull Style <b>(118)</b> Pull Finish <b>(C)</b> Lock finish, Chrome		
		Dimensions listed under w h d are actual to the nearest <sup>1</sup> / <sub>16</sub> ".	

# Pedestals

## *Floorstanding Pedestals 24" deep 16" wide*

Anchor Storage

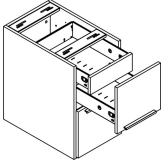
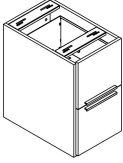
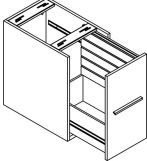
description	pedestal configuration	w	h	d	pattern no.	L1	L2
Box/Box (File Front)/File Pedestal		15 <sup>9</sup> / <sub>16</sub> "	27 <sup>1</sup> / <sub>16</sub> "	23 <sup>1</sup> / <sub>2</sub> "	<b>WP2816CBL(N)</b>	\$1,046.	\$1,294.
							
File/File Pedestal		15 <sup>9</sup> / <sub>16</sub> "	27 <sup>1</sup> / <sub>16</sub> "	23 <sup>1</sup> / <sub>2</sub> "	<b>WP2816FFL(N)</b>	914.	1,154.
							
Slide Out Pedestal	Slat wall with bin, left hand	15 <sup>9</sup> / <sub>16</sub> "	27 <sup>1</sup> / <sub>16</sub> "	23 <sup>1</sup> / <sub>2</sub> "	<b>WP2816SOLHL(N)</b>	1,087.	1,183.
	Slat wall with bin, left hand	15 <sup>9</sup> / <sub>16</sub> "	27 <sup>1</sup> / <sub>16</sub> "	23 <sup>1</sup> / <sub>2</sub> "	<b>WP2816SORHL(N)</b>	1,087.	1,183.
							

Order Information	Order Code	Specification Information	Application Notes
1. <i>Base Pattern Number</i>	Pedestal, 16" Wide, Open/File	Floorstanding Pedestals do not include a finished top; they are designed to support one end of a work surface ( specified separately) and are not intended for freestanding use.	Floorstanding pedestals 24" deep (nominal) have a 23 <sup>1</sup> / <sub>2</sub> " deep case to align with a 23 <sup>1</sup> / <sub>2</sub> " deep work surface (specified separately). Pedestals with drawer fronts or door are 24 <sup>3</sup> / <sub>8</sub> " deep overall.
2. <i>Lock option</i> L = Locking N = Non-locking	_____		
3. <i>Case Finish</i> See Finish Options page	Example: <b>WP2816OFL(L)</b>		
4. <i>Front Finish</i> See Finish Options page	<b>WP</b> Anchor Pedestal		
5. <i>Pull style</i> T = 10" finger pull	<b>28</b> 27 <sup>1</sup> / <sub>16</sub> " High	Add \$40 to the list price per lock. Reference Pedestal Specifications for lock configuration.	Pedestals complete with top (specified separately) align with desk height.
6. <i>Pull finish</i> See Finish Options page	<b>16</b> 16" Wide		
7. <i>Lock finish</i> B = Black C = Chrome	<b>OF</b> Open/File	Add \$15 to the list price per pull for Anodized Nickel (AN) or Aluminum (AA) finish.	Slide out Pedestal features bottom bin with slat wall above. Compatible slat wall accessories are listed in Pedestal Accessories, specified separately.
	<b>L</b> Laminate		
	<b>(L)</b> Lock option, Locking		
	<b>(118)</b> Case Finish		
	<b>(118)</b> Front Finish	Pedestals specified with mixed laminate finishes are L2 pricing. Refer to Mixed Laminate Finishes for further details.	
	<b>(T)</b> Pull Style		
	<b>(118)</b> Pull Finish		
	<b>(C)</b> Lock finish, Chrome	Dimensions listed under w h d are actual to the nearest 1/16".	

*Floorstanding Combination Pedestals 24" deep  
24" and 30" wide*

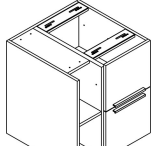
description	pedestal configuration	w	h	d	pattern no.	L1	L2
 Combination Pedestal with Open Pedestal Locker, Left Hand, 24" wide	Open Pedestal	24"	27 1/16"	23 1/2"	<b>WPC2824OSO1LHL</b>	\$1,033.	\$1,379.
	Full Door Pedestal	24"	27 1/16"	23 1/2"	<b>WPC2824OSFDLHL(N)</b>	1,212.	1,602.
	Open/File Pedestal	24"	27 1/16"	23 1/2"	<b>WPC2824OSOFLLHL(N)</b>	1,339.	1,733.
	File/File Pedestal ( shown)	24"	27 1/16"	23 1/2"	<b>WPC2824OSFFLHL(N)</b>	1,439.	1,792.
	Open/Box/File Pedestal	24"	27 1/16"	23 1/2"	<b>WPC2824OSOBLHL(N)</b>	1,462.	1,836.
	Box (File Front)/File Pedestal	24"	27 1/16"	23 1/2"	<b>WPC2824OSCFLLHL(N)</b>	1,506.	1,899.
	Box/Box(File Front) File Pedestal	24"	27 1/16"	23 1/2"	<b>WPC2824OSCBLLHL(N)</b>	1,588.	1,960.

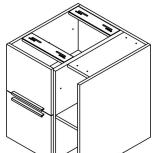
 Combination Pedestal with Open Pedestal Locker, Right Hand, 24" wide	Open Pedestal	24"	27 1/16"	23 1/2"	<b>WPC2824OSO1RHL</b>	1,033.	1,379.
	Full Door Pedestal	24"	27 1/16"	23 1/2"	<b>WPC2824OSFDRHL(N)</b>	1,212.	1,602.
	Open/File Pedestal	24"	27 1/16"	23 1/2"	<b>WPC2824OSOFRRHL(N)</b>	1,339.	1,733.
	File/File Pedestal ( shown)	24"	27 1/16"	23 1/2"	<b>WPC2824OSFFRHL(N)</b>	1,439.	1,792.
	Open/Box/File Pedestal	24"	27 1/16"	23 1/2"	<b>WPC2824OSOBRHL(N)</b>	1,462.	1,836.
	Box (File Front)/File Pedestal	24"	27 1/16"	23 1/2"	<b>WPC2824OSCFRRHL(N)</b>	1,506.	1,899.
	Box/Box(File Front) File Pedestal	24"	27 1/16"	23 1/2"	<b>WPC2824OSCBRRHL(N)</b>	1,588.	1,960.

**Order Information**

1. *Base Pattern Number*
2. *Lock option*  
L = Locking  
N = Non-locking
3. *Case Finish*  
See Finish Options page
4. *Front Finish*  
See Finish Options page
5. *Pull style*  
T = 10" finger pull
6. *Pull finish*  
See Finish Options page
7. *Lock finish*  
B = Black  
C = Chrome

**Order Code**

Combination Pedestal with Open Pedestal Locker, 24" wide, F/F pedestal, Left hand	
Example:	<b>WPC2824OSFFLHL</b>
<b>WPC</b>	Anchor Combination Pedestal
<b>28</b>	27 1/16" High
<b>24</b>	24" Wide
<b>OS</b>	Open Pedestal Locker
<b>FF</b>	File/File Pedestal
<b>LH</b>	Left hand (Pedestal Locker)
<b>L</b>	Laminate
<b>(L)</b>	Lock option, Locking
<b>(118)</b>	Case Finish
<b>(118)</b>	Front Finish
<b>(T)</b>	Pull Style
<b>(118)</b>	Pull Finish
<b>(C)</b>	Lock finish, Chrome

**Specification Information**

Floorstanding Combination Pedestals do not include a finished top; they are designed to support one end of a work surface ( specified separately) and are not intended for freestanding use.

Add \$40 to the list price per lock. Reference Pedestal Specifications for lock configuration.

Add \$15 to the list price per pull for Anodized Nickel (AN) or Aluminum (AA) finish.

Pedestals specified with mixed laminate finishes are L2 pricing. Refer to Mixed Laminate Finishes for further details.

**Application Notes**

Floorstanding pedestals 24" deep (nominal) have a 23 1/2" deep case to align with a 23 1/2" deep work surface (specified separately). Pedestals with drawer fronts or door are 24 3/8" deep overall.

Pedestals complete with top (specified separately) align with desk height.

*Floorstanding Combination Pedestals 24" deep  
24" and 30" wide*

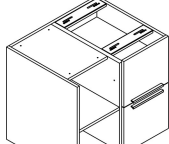
description	pedestal configuration	w	h	d	pattern no.	L1	L2
Combination Pedestal with Open Pedestal Locker, Left Hand, 30" wide 	Open Pedestal	30"	27 1/16"	23 1/2"	<b>WPC2830OSO1LHL</b>	\$1,142.	\$1,539.
	Full Door Pedestal	30"	27 1/16"	23 1/2"	<b>WPC2830OSFDLHL(N)</b>	1,321.	1,762.
	Open/File Pedestal	30"	27 1/16"	23 1/2"	<b>WPC2830OSOFLLHL(N)</b>	1,448.	1,893.
	File/File Pedestal ( shown)	30"	27 1/16"	23 1/2"	<b>WPC2830OSFFLHL(N)</b>	1,548.	1,952.
	Open/Box/File Pedestal	30"	27 1/16"	23 1/2"	<b>WPC2830OSOBLHL(N)</b>	1,571.	1,995.
	Box (File Front)/File Pedestal	30"	27 1/16"	23 1/2"	<b>WPC2830OSCFLLHL(N)</b>	1,616.	2,058.
	Box/Box(File Front) File Pedestal	30"	27 1/16"	23 1/2"	<b>WPC2830OSCBLLHL(N)</b>	1,697.	2,119.

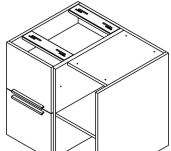
Combination Pedestal with Open Pedestal Locker, Right Hand, 30" wide 	Open Pedestal	30"	27 1/16"	23 1/2"	<b>WPC2830OSO1RHL</b>	1,142.	1,539.
	Full Door Pedestal	30"	27 1/16"	23 1/2"	<b>WPC2830OSFDRHL(N)</b>	1,321.	1,762.
	Open/File Pedestal	30"	27 1/16"	23 1/2"	<b>WPC2830OSOFRRHL(N)</b>	1,448.	1,893.
	File/File Pedestal ( shown)	30"	27 1/16"	23 1/2"	<b>WPC2830OSFFRHL(N)</b>	1,548.	1,952.
	Open/Box/File Pedestal	30"	27 1/16"	23 1/2"	<b>WPC2830OSOBRHL(N)</b>	1,571.	1,995.
	Box (File Front)/File Pedestal	30"	27 1/16"	23 1/2"	<b>WPC2830OSCFRRHL(N)</b>	1,616.	2,058.
	Box/Box(File Front) File Pedestal	30"	27 1/16"	23 1/2"	<b>WPC2830OSCBRRHL(N)</b>	1,697.	2,119.

**Order Information**

1. *Base Pattern Number*
2. *Lock option*  
L = Locking  
N = Non-locking
3. *Case Finish*  
See Finish Options page
4. *Front Finish*  
See Finish Options page
5. *Pull style*  
T = 10" finger pull
6. *Pull finish*  
See Finish Options page
7. *Lock finish*  
B = Black  
C = Chrome

**Order Code**

Combination Pedestal with Open Pedestal Locker, 24" wide, F/F pedestal, Left hand

---

Example: **WPC2824OSFFLHL**

<b>WPC</b>	Anchor Combination Pedestal
<b>28</b>	27 1/16" High
<b>24</b>	24" Wide
<b>OS</b>	Open Pedestal Locker
<b>FF</b>	File/File Pedestal
<b>LH</b>	Left hand (Pedestal Locker)
<b>L</b>	Laminate
<b>(L)</b>	Lock option, Locking
<b>(118)</b>	Case Finish
<b>(118)</b>	Front Finish
<b>(T)</b>	Pull Style
<b>(118)</b>	Pull Finish
<b>(C)</b>	Lock finish, Chrome

**Specification Information**

Floorstanding Combination Pedestals do not include a finished top; they are designed to support one end of a work surface ( specified separately) and are not intended for freestanding use.

Add \$40 to the list price per lock. Reference Pedestal Specifications for lock configuration.

Add \$15 to the list price per pull for Anodized Nickel (AN) or Aluminum (AA) finish.

Pedestals specified with mixed laminate finishes are L2 pricing. Refer to Mixed Laminate Finishes for further details.

**Application Notes**

Floorstanding pedestals 24" deep (nominal) have a 23 1/2" deep case to align with a 23 1/2" deep work surface (specified separately). Pedestals with drawer fronts or door are 24 3/8" deep overall.

Pedestals complete with top (specified separately) align with desk height.

*Floorstanding Combination Pedestals 24" deep  
24" and 30" wide*

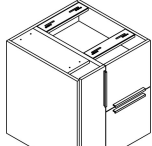
description	pedestal configuration	w	h	d	pattern no.	L1	L2
 Combination Pedestal with Full Door Pedestal Locker, Left Hand, 24" wide	Open Pedestal	24"	27 1/16"	23 1/2"	<b>WPC2824FDO1LHL(N)</b>	\$1,159.	\$1,522.
	Full Door Pedestal	24"	27 1/16"	23 1/2"	<b>WPC2824FDFDLHL(N)</b>	1,338.	1,745.
	Open/File Pedestal	24"	27 1/16"	23 1/2"	<b>WPC2824FDOFLHL(N)</b>	1,465.	1,876.
	File/File Pedestal (shown)	24"	27 1/16"	23 1/2"	<b>WPC2824FDFFLHL(N)</b>	1,565.	1,935.
	Open/File Pedestal	24"	27 1/16"	23 1/2"	<b>WPC2824FDOBLHL(N)</b>	1,587.	1,979.
	Box (File Front)/File Pedestal	24"	27 1/16"	23 1/2"	<b>WPC2824FDCFLHL(N)</b>	1,632.	2,042.
	Box/Box(File Front) File Pedestal	24"	27 1/16"	23 1/2"	<b>WPC2824FDCBLHL(N)</b>	1,714.	2,103.

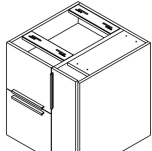
 Combination Pedestal with Full Door Pedestal Locker, Right Hand, 24" wide	Open Pedestal	24"	27 1/16"	23 1/2"	<b>WPC2824FDO1RHL(N)</b>	1,159.	1,522.
	Full Door Pedestal	24"	27 1/16"	23 1/2"	<b>WPC2824FDFDRHL(N)</b>	1,338.	1,745.
	Open/File Pedestal	24"	27 1/16"	23 1/2"	<b>WPC2824FDOFRHL(N)</b>	1,465.	1,876.
	File/File Pedestal (shown)	24"	27 1/16"	23 1/2"	<b>WPC2824FDFFRHL(N)</b>	1,565.	1,935.
	Open/File Pedestal	24"	27 1/16"	23 1/2"	<b>WPC2824FDOBRHL(N)</b>	1,587.	1,979.
	Box (File Front)/File Pedestal	24"	27 1/16"	23 1/2"	<b>WPC2824FDCFRHL(N)</b>	1,632.	2,042.
	Box/Box(File Front) File Pedestal	24"	27 1/16"	23 1/2"	<b>WPC2824FDCBRHL(N)</b>	1,714.	2,103.

**Order Information**

1. *Base Pattern Number*
2. *Lock option*  
L = Locking  
N = Non-locking
3. *Case Finish*  
See Finish Options page
4. *Front Finish*  
See Finish Options page
5. *Pull style*  
T = 10" finger pull
6. *Pull finish*  
See Finish Options page
7. *Lock finish*  
B = Black  
C = Chrome

**Order Code**

Combination Pedestal with Open Pedestal Locker, 24" wide, F/F pedestal, Left hand	
Example:	<b>WPC2824OSFFLHL</b>
<b>WPC</b>	Anchor Combination Pedestal
<b>28</b>	27 1/16" High
<b>24</b>	24" Wide
<b>OS</b>	Open Pedestal Locker
<b>FF</b>	File/File Pedestal
<b>LH</b>	Left hand (Pedestal Locker)
<b>L</b>	Laminate
<b>(L)</b>	Lock option, Locking
<b>(118)</b>	Case Finish
<b>(118)</b>	Front Finish
<b>(T)</b>	Pull Style
<b>(118)</b>	Pull Finish
<b>(C)</b>	Lock finish, Chrome

**Specification Information**

Floorstanding Combination Pedestals do not include a finished top; they are designed to support one end of a work surface ( specified separately) and are not intended for freestanding use.

Add \$40 to the list price per lock. Reference Pedestal Specifications for lock configuration.

Add \$15 to the list price per pull for Anodized Nickel (AN) or Aluminum (AA) finish.

Pedestals specified with mixed laminate finishes are L2 pricing. Refer to Mixed Laminate Finishes for further details.

**Application Notes**

Floorstanding pedestals 24" deep (nominal) have a 23 1/2" deep case to align with a 23 1/2" deep work surface (specified separately). Pedestals with drawer fronts or door are 24 3/8" deep overall.

Pedestals complete with top (specified separately) align with desk height.

*Floorstanding Combination Pedestals 24" deep  
24" and 30" wide*

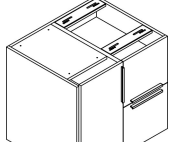
description	pedestal configuration	w	h	d	pattern no.	L1	L2
 Combination Pedestal with Full Door Pedestal Locker, Left Hand, 30" wide	Open Pedestal	30"	27 1/16"	23 1/2"	<b>WPC2830FDO1LHL(N)</b>	\$1,296.	\$1,723.
	Full Door Pedestal	30"	27 1/16"	23 1/2"	<b>WPC2830FDFDLHL(N)</b>	1,475.	1,946.
	Open/File Pedestal	30"	27 1/16"	23 1/2"	<b>WPC2830FDOFLHL(N)</b>	1,602.	2,077.
	File/File Pedestal (shown)	30"	27 1/16"	23 1/2"	<b>WPC2830FDFFLHL(N)</b>	1,701.	2,136.
	Open/File Pedestal	30"	27 1/16"	23 1/2"	<b>WPC2830FDOBLHL(N)</b>	1,724.	2,180.
	Box (File Front)/File Pedestal	30"	27 1/16"	23 1/2"	<b>WPC2830FDCFLHL(N)</b>	1,769.	2,242.
	Box/Box(File Front) File Pedestal	30"	27 1/16"	23 1/2"	<b>WPC2830FDCBLHL(N)</b>	1,851.	2,304.

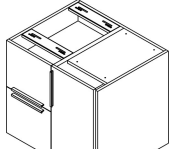
 Combination Pedestal with Full Door Pedestal Locker, Right Hand, 30" wide	Open Pedestal	30"	27 1/16"	23 1/2"	<b>WPC2830FDO1RHL(N)</b>	1,296.	1,723.
	Full Door Pedestal	30"	27 1/16"	23 1/2"	<b>WPC2830FDFDRHL(N)</b>	1,475.	1,946.
	Open/File Pedestal	30"	27 1/16"	23 1/2"	<b>WPC2830FDOFRHL(N)</b>	1,602.	2,077.
	File/File Pedestal (shown)	30"	27 1/16"	23 1/2"	<b>WPC2830FDFFRHL(N)</b>	1,701.	2,136.
	Open/File Pedestal	30"	27 1/16"	23 1/2"	<b>WPC2830FDOBRHL(N)</b>	1,724.	2,180.
	Box (File Front)/File Pedestal	30"	27 1/16"	23 1/2"	<b>WPC2830FDCFRHL(N)</b>	1,769.	2,242.
	Box/Box(File Front) File Pedestal	30"	27 1/16"	23 1/2"	<b>WPC2830FDCBRHL(N)</b>	1,851.	2,304.

**Order Information**

1. *Base Pattern Number*
2. *Lock option*  
L = Locking  
N = Non-locking
3. *Case Finish*  
See Finish Options page
4. *Front Finish*  
See Finish Options page
5. *Pull style*  
T = 10" finger pull
6. *Pull finish*  
See Finish Options page
7. *Lock finish*  
B = Black  
C = Chrome

**Order Code**

Combination Pedestal with Open Pedestal Locker, 24" wide, F/F pedestal, Left hand
Example: <b>WPC2824OSFFLHL</b>
<b>WPC</b> Anchor Combination Pedestal
<b>28</b> 27 1/16" High
<b>24</b> 24" Wide
<b>OS</b> Open Pedestal Locker
<b>FF</b> File/File Pedestal
<b>LH</b> Left hand (Pedestal Locker)
<b>L</b> Laminate
<b>(L)</b> Lock option, Locking
<b>(118)</b> Case Finish
<b>(118)</b> Front Finish
<b>(T)</b> Pull Style
<b>(118)</b> Pull Finish
<b>(C)</b> Lock finish, Chrome

**Specification Information**

Floorstanding Combination Pedestals do not include a finished top; they are designed to support one end of a work surface ( specified separately) and are not intended for freestanding use.

Add \$40 to the list price per lock. Reference Pedestal Specifications for lock configuration.

Add \$15 to the list price per pull for Anodized Nickel (AN) or Aluminum (AA) finish.

Pedestals specified with mixed laminate finishes are L2 pricing. Refer to Mixed Laminate Finishes for further details.

**Application Notes**

Floorstanding pedestals 24" deep (nominal) have a 23 1/2" deep case to align with a 23 1/2" deep work surface (specified separately). Pedestals with drawer fronts or door are 24 3/8" deep overall.

Pedestals complete with top (specified separately) align with desk height.



*Freestanding Doublewide Pedestals 20 deep  
18" and 24" wide units*

description	configuration left-to-right	w	h	d	pattern no.	L1	L2
All Open - Doublewide Pedestal	Open, 2 Shelves	18"	27 1/16"	19 1/16"	<b>WP2818OSL</b>	\$673.	\$821.
	Open, 2 Shelves	24"	27 1/16"	19 1/16"	<b>WP2824OSL</b>	770.	949.

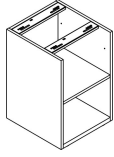

**Order Information**

1. *Base Pattern Number*
2. *Lock option*  
L = Locking  
N = Non-locking
3. *Case Finish*  
See Finish Options page
4. *Front Finish*  
See Finish Options page
5. *Pull style*  
T = 10" Finger pull
6. *Pull finish*  
See Finish Options page
7. *Lock finish*  
See Finish Options page

**Order Code**

Doublewide Pedestal, 30" wide,  
Open / File

---

Example: **WP2830OFL(L)**

<b>WP</b>	Anchor Pedestal
<b>28</b>	28" High
<b>30</b>	30" Wide
<b>OF</b>	Open / File
<b>L</b>	Laminate case and front
<b>(L)</b>	Lock option, Locking
<b>(118)</b>	Case Finish, Bright White
<b>(118)</b>	Front Finish, Bright White
<b>(T)</b>	Pull Style, 10" Finger pull
<b>(118)</b>	Pull Finish, Bright White
<b>(C)</b>	Lock finish, Chrome

**Specification Information**

Doublewide Pedestals with file drawers may require counterweights when used in freestanding applications. When applicable, corresponding counterweights kits are noted within the pricing section above.

Add \$40 to the list price per lock. Reference Pedestal Specifications for lock configuration.

Add \$15 to the list price per pull for Anodized Nickel (AN) or Aluminum (AA) finish.

Pedestals specified with mixed laminate finishes are L2 pricing. Refer to Mixed Laminate Finishes for further details.

Dimensions listed under w h d are actual to the nearest 1/16".

**Application Notes**

**Pedestal top must be specified separately, see "Pedestal Tops" section.**

Doublewide pedestals 20" deep (nominal) have a 19 1/16" deep case to align with doublewide pedestal tops (specified separately). Pedestals with drawer fronts are 20" deep overall.

Pedestals complete with top (specified separately) align with desk height.

Rails included with file drawer for side-to-side and front-to-back filing.

*Freestanding Doublewide Pedestals 20 deep  
30", 36" and 42" wide units*

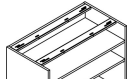
description	w	h	d	pattern no.	L1	L2
All Open - Doublewide Pedestal 	30"	27 1/16"	19 1/16"	<b>WP2830OSL</b>	\$949.	\$1,120.
	36"	27 1/16"	19 1/16"	<b>WP2836OSL</b>	1,056.	1,246.
	42"	27 1/16"	19 1/16"	<b>WP2842OSL</b>	1,123.	1,426.

*Top shelf is removable*

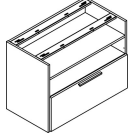
Open / File - Doublewide Pedestal 	30"*	27 1/16"	19 1/16"	<b>WP2830OFL(N)</b>	1,352.	1,542.
	36"*	27 1/16"	19 1/16"	<b>WP2836OFL(N)</b>	1,473.	1,686.
	42"*	27 1/16"	19 1/16"	<b>WP2842OFL(N)</b>	1,656.	1,901.

*\*30" wide Open/File unit requires counterweight kit WCWKIT03 when used in a freestanding application*

*\*36" wide Open/File unit requires counterweight kit WCWKIT04 when used in a freestanding application*

*\*42" wide Open/File unit requires counterweight kit WCWKIT05 when used in a freestanding application*

*Top shelf is removable*

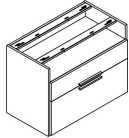
Open / Box / File - Doublewide Pedestal 	30"*	27 1/16"	19 1/16"	<b>WP2830OBL(N)</b>	1,641.	1,809.
	36"*	27 1/16"	19 1/16"	<b>WP2836OBL(N)</b>	1,771.	1,967.
	42"*	27 1/16"	19 1/16"	<b>WP2842OBL(N)</b>	1,938.	2,162.

*\*30" wide Open/Box/File unit requires counterweight kit WCWKIT03 when used in a freestanding application*

*\*36" wide Open/Box/File unit requires counterweight kit WCWKIT04 when used in a freestanding application*

*\*42" wide Open/Box/File unit requires counterweight kit WCWKIT05 when used in a freestanding application*

**Order Information**

1. *Base Pattern Number*
2. *Lock option*  
L = Locking  
N = Non-locking
3. *Case Finish*  
See Finish Options page
4. *Front Finish*  
See Finish Options page
5. *Pull style*  
T = 10" Finger pull
6. *Pull finish*  
See Finish Options page
7. *Lock finish*  
See Finish Options page

**Order Code**

Doublewide Pedestal, 30" wide, Open / File	
Example:	<b>WP2830OFL(L)</b>
<b>WP</b>	Anchor Pedestal
<b>28</b>	28" High
<b>30</b>	30" Wide
<b>OF</b>	Open / File
<b>L</b>	Laminate case and front
<b>(L)</b>	Lock option, Locking
<b>(118)</b>	Case Finish, Bright White
<b>(118)</b>	Front Finish, Bright White
<b>(T)</b>	Pull Style, 10" Finger pull
<b>(118)</b>	Pull Finish, Bright White
<b>(C)</b>	Lock finish, Chrome

**Specification Information**

Doublewide Pedestals with file drawers may require counterweights when used in freestanding applications. When applicable, corresponding counterweights kits are noted within the pricing section above.

Add \$40 to the list price per lock. Reference Pedestal Specifications for lock configuration.

Add \$15 to the list price per pull for Anodized Nickel (AN) or Aluminum (AA) finish.

Pedestals specified with mixed laminate finishes are L2 pricing. Refer to Mixed Laminate Finishes for further details.

Dimensions listed under w h d are actual to the nearest 1/16".

**Application Notes**

**Pedestal top must be specified separately, see "Pedestal Tops" section.**

Doublewide pedestals 20" deep (nominal) have a 19 1/16" deep case to align with doublewide pedestal tops (specified separately). Pedestals with drawer fronts are 20" deep overall.

Pedestals complete with top (specified separately) align with desk height.

Rails included with file drawer for side-to-side and front-to-back filing.

*Freestanding Doublewide Pedestals 20 deep  
30", 36" and 42" wide units*

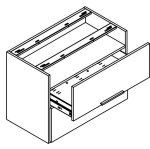
description	w	h	d	pattern no.	L1	L2
 <p>Top shelf is removable</p>	30"*	27 1/16"	19 1/16"	<b>WP2830CFL(N)</b>	\$1,675.	\$1,856.
	36"*	27 1/16"	19 1/16"	<b>WP2836CFL(N)</b>	1,812.	2,020.
	42"*	27 1/16"	19 1/16"	<b>WP2842CFL(N)</b>	1,997.	2,222.

\*30" wide Box (File Front)/File unit requires counterweight kit WCWKIT03 when used in a freestanding application  
 \*36" wide Box (File Front)/File unit requires counterweight kit WCWKIT04 when used in a freestanding application  
 \*42" wide Box (File Front)/File unit requires counterweight kit WCWKIT05 when used in a freestanding application

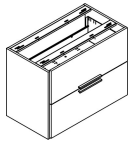
	30"*	27 1/16"	19 1/16"	<b>WP2830FFL(N)</b>	1,563.	1,712.
	36"*	27 1/16"	19 1/16"	<b>WP2836FFL(N)</b>	1,665.	1,838.
	42"*	27 1/16"	19 1/16"	<b>WP2842FFL(N)</b>	1,833.	2,030.

\*30" wide File/File unit requires counterweight kit WCWKIT02 when used in a freestanding application  
 \*36" wide File/File unit requires counterweight kit WCWKIT03 when used in a freestanding application  
 \*42" wide File/File unit requires counterweight kit WCWKIT04 when used in a freestanding application

**Order Information**

1. Base Pattern Number
2. Lock option  
L = Locking  
N = Non-locking
3. Case Finish  
See Finish Options page
4. Front Finish  
See Finish Options page
5. Pull style  
T = 10" Finger pull
6. Pull finish  
See Finish Options page
7. Lock finish  
See Finish Options page

**Order Code**

Doublewide Pedestal, 30" wide, File / File

---

Example: **WP2830FFL(L)**

<b>WP</b>	Anchor Pedestal
<b>28</b>	28" High
<b>30</b>	30" Wide
<b>FF</b>	File / File
<b>L</b>	Laminate case and front
<b>(L)</b>	Lock option, Locking
<b>(118)</b>	Case Finish, Bright White
<b>(118)</b>	Front Finish, Bright White
<b>(T)</b>	Pull Style, 10" Finger pull
<b>(118)</b>	Pull Finish, Bright White
<b>(C)</b>	Lock finish, Chrome

**Specification Information**

Doublewide Pedestals with file drawers may require counterweights when used in freestanding applications. When applicable, corresponding counterweights kits are noted within the pricing section above.

Add \$40 to the list price per lock. Reference Pedestal Specifications for lock configuration.

Add \$15 to the list price per pull for Anodized Nickel (AN) or Aluminum (AA) finish.

Pedestals specified with mixed laminate finishes are L2 pricing. Refer to Mixed Laminate Finishes for further details.

Dimensions listed under w h d are actual to the nearest 1/16".



**Application Notes**

**Pedestal top must be specified separately, see "Pedestal Tops" section.**

Doublewide pedestals 20" deep (nominal) have a 19 1/16" deep case to align with doublewide pedestal tops (specified separately). Pedestals with drawer fronts are 20" deep overall.

Pedestals complete with top (specified separately) align with desk height.

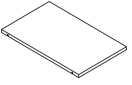
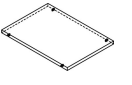
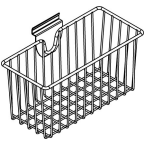
Rails included with file drawer for side-to-side and front-to-back filing.

description	description	w	d	h	pattern no.	L1	L2	list
	single shelf, for 12" w pedestal	10 1/2"	22 3/4"	3/4"	<b>WPSF1201L</b>	\$96.	\$108.	
	single shelf, for 16" w pedestal	14"	22 3/4"	3/4"	<b>WPSF1601L</b>	113.	130.	
	pack of 4 shelves, for 12" w pedestal	10 1/2"	22 3/4"	3/4"	<b>WPSF1204L</b>	268.	355.	
	pack of 4 shelves, for 16" w pedestal	14"	22 3/4"	3/4"	<b>WPSF1604L</b>	333.	455.	
	single shelf, for 12" w mobile pedestal				<b>WPMSF1201L</b>	80.	92.	
	single shelf, for 16" w mobile pedestal	16"			<b>WPMSF1601L</b>	97.	114.	
	pack of 4 pack shelves, for 12" w mobile pedestal	12"			<b>WPMSF1204L</b>	299.	347.	
	pack of 4 shelves, for 16" w mobile pedestal	16"			<b>WPMSF1604L</b>	366.	433.	
	Pedestal Basket, black				<b>WPSOB01</b>			77.
	Pedestal Basket, black				<b>WPSOB04</b>			373.
	Pedestal Hook, black, pack of 5				<b>WPSOH05</b>			57.
	Pedestal Hook, black, pack of 40				<b>WPSOH40</b>			330.

**Order Information**

1. *Base Pattern Number*
2. *Finish*  
See Finish Options page

**Order Code**

Full-depth pedestal shelf

---

Example: **WPSF1201L**

<b>WP</b>	Anchor Pedestal
<b>SF</b>	Shelf, full-depth
<b>12</b>	for 12" wide pedestal
<b>01</b>	single shelf
<b>L</b>	Laminate
<b>(118)</b>	Finish, Bright White

**Specification Information**

Each shelf includes 4 mounding pins.

Edgebanding preselected to match or coordinate with laminate; see "Finish Options" for further details.

Basket and Hook are compatible with 12" and 16" wide slide out pedestal.

**Application Notes**

12" wide pedestal shelves are for use in 12" wide floorstanding pedestals.

16" wide pedestal shelves are for use in 16" wide floorstanding pedestals and within the "pedestal" portion of combination pedestals; not for use within the "pedestal locker" portion of combination pedestals.

# Pedestal Tops

## For Freestanding Doublewide Pedestals

Anchor Storage

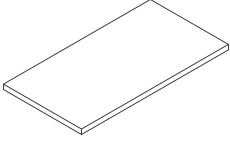
description	w	d	h	pattern no.	L1	L2
Doublewide Pedestal Tops 	30"	19 1/16"	1 1/8"	<b>WPT3020L</b>	\$180.	\$215.
	36"	19 1/16"	1 1/8"	<b>WPT3620L</b>	203.	241.
	42"	19 1/16"	1 1/8"	<b>WPT4220L</b>	232.	278.
	42"	19 1/16"	1 1/8"	<b>WPT4820L</b>	257.	311.
	54"	19 1/16"	1 1/8"	<b>WPT5420L</b>	277.	331.
	60"	19 1/16"	1 1/8"	<b>WPT6020L</b>	300.	361.
	66"	19 1/16"	1 1/8"	<b>WPT6620L</b>	322.	388.
	72"	19 1/16"	1 1/8"	<b>WPT7220L</b>	341.	409.
	78"	19 1/16"	1 1/8"	<b>WPT7820L</b>	364.	438.
	84"	19 1/16"	1 1/8"	<b>WPT8420L</b>	386.	462.

### Order Information

1. Base Pattern Number
2. Finish  
See Finish Options page

### Order Code

Doublewide Pedestal Top,  
30" wide x 19"

*Example:* **WPT3019 ( )**

<b>WPT</b>	Anchor Pedestal Top
<b>30</b>	30" Wide
<b>19</b>	20" deep
<b>(118)</b>	Finish, Bright White

### Specification Information

**For use with Anchor Doublewide Pedestals only.**

Mounting hardware included with Pedestals.

Edgebanding preselected to match or coordinate with laminate, see "Finish Options" page for further details.

See Pedestal Specifications for Pedestal Top planning.

### Application Notes

# Counterweight Kits

## *For Doublewide Pedestals*

description	type	w	h	pattern no.	list
Counterweight Kits	Counterweight Kit 02			<b>WCWKIT02</b>	\$119.
	Counterweight Kit 03			<b>WCWKIT03</b>	163.
	Counterweight Kit 04			<b>WCWKIT04</b>	182.
	Counterweight Kit 05			<b>WCWKIT05</b>	202.

### Order Information

### Order Code

---



---



---

### Specification Information

Pedestals with file drawers may require counterweights when used in freestanding applications.

When applicable, reference the pedestal pricing pages to identify the appropriate kit.

### Application Notes

Counterweight kits include hardware to mount the counterweight plates.

Counterweight plates are to be mounted to the back panel behind the file drawer(s) inside the pedestal.

### Anchor Work Surface Stackers

Anchor Work Surface Stackers are wood construction cabinets designed to provide privacy and offer above-desk storage. Elevation heights correspond with Dividends Horizon panel heights when installed on a standard height work surface. Work Surface Stackers are designed to be installed directly onto a work surface and do not include a base.

Stackers ship preassembled including a finished top. Tape for mounting to work surface is included.

### Available Sizes (nominal)

Elevation Heights: 42", 50", 57", 64" (when installed on standard height work surface)  
 Widths: 12", 16"  
 Depth: 24"

Configurations include:

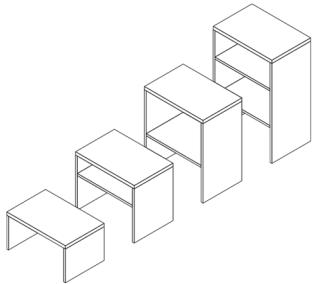

Side Access (open)

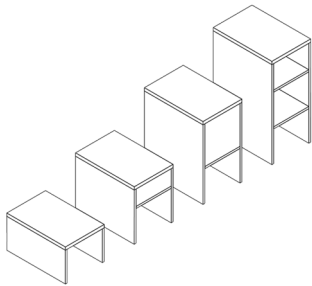

Front Access Open

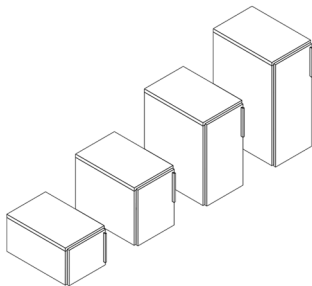

Front Access with Door

### Construction

- Work Surface Stackers are constructed of wood core, laminate and ABS edge banding; cam and dowel construction.
- Material thickness: 1<sup>3</sup>/<sub>16</sub>" (nominal) on stacker top; 3/4" on back, sides, interior shelves and door fronts.

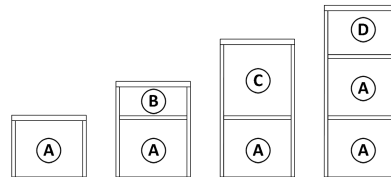

### Internal Clearances \*

Internal height:

- A: 11<sup>15</sup>/<sub>16</sub>"
- B: 6<sup>5</sup>/<sub>16</sub>"
- C: 13<sup>15</sup>/<sub>16</sub>"
- 8<sup>3</sup>/<sub>16</sub>"

Internal width: 10<sup>1</sup>/<sub>2</sub>", 14<sup>1</sup>/<sub>16</sub>"

Internal depth: 22<sup>3</sup>/<sub>4</sub>"

*\*Actual dimensions to the nearest 1/16th of an inch*

### Locks

Anchor Work Surface Stackers with full door may be ordered with or without locks. No lock hole is drilled on units specified as nonlocking.

Locks are randomly keyed unless otherwise specified. Other keying options include keyed alike or keyed with lock cores K001-K250. To specify units as such, reference KnollKey Lock Program.

### Pulls

Finger Pull, 10" long, positioned vertically on doors. Pulls on 42" high (elevation) stackers are 8" long.

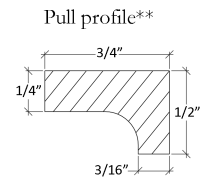

Credenza Stackers  
*Parallel Credenza Stackers*  
*12" deep*

description	height elevation	w	d	h	pattern no.	L1	L2
Parallel Credenza Stacker, 30" Wide, Front Access Open	42" high elevation	30"	12"	19 <sup>3</sup> / <sub>8</sub> "	<b>WSPCFO4230L</b>	\$450.	\$548.
	50" high elevation	30"	12"	26 <sup>1</sup> / <sub>16</sub> "	<b>WSPCFO5030L</b>	585.	727.
	57" high elevation	30"	12"	34"	<b>WSPCFO5730L</b>	653.	817.
	64" high elevation	30"	12"	41 <sup>1</sup> / <sub>4</sub> "	<b>WSPCFO6430L</b>	778.	983.

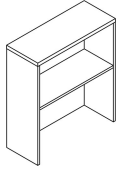

Parallel Credenza Stacker, 36" Wide, Front Access Open	42" high elevation	36"	12"	19 <sup>3</sup> / <sub>8</sub> "	<b>WSPCFO4236L</b>	501.	613.
	50" high elevation	36"	12"	26 <sup>1</sup> / <sub>16</sub> "	<b>WSPCFO5036L</b>	655.	819.
	57" high elevation	36"	12"	34"	<b>WSPCFO5736L</b>	730.	918.
	64" high elevation	36"	12"	41 <sup>1</sup> / <sub>4</sub> "	<b>WSPCFO6436L</b>	874.	1,110.

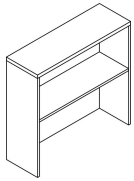

Parallel Credenza Stacker, 42" Wide, Front Access Open	42" high elevation	42"	12"	19 <sup>3</sup> / <sub>8</sub> "	<b>WSPCFO4242L</b>	552.	679.
	50" high elevation	42"	12"	26 <sup>1</sup> / <sub>16</sub> "	<b>WSPCFO5042L</b>	726.	911.
	57" high elevation	42"	12"	34"	<b>WSPCFO5742L</b>	807.	1,019.
	64" high elevation	42"	12"	41 <sup>1</sup> / <sub>4</sub> "	<b>WSPCFO6442L</b>	970.	1,236.

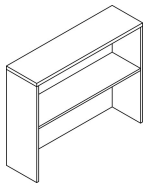

Order Information	Order Code	Specification Information	Application Notes
	_____	Parallel credenza stackers are designed to mount parallel onto a credenza.	Credenza stackers mount directly to a credenza; mounting kit included.
	_____	Parallel stackers are available with an inset back for use with a tackboard insert ( specified separately). To specify a stacker with inset back, replace "FO" with "FOB".	Elevation height represents the overall nominal height of a stacker when mounted to an Anchor credenza.
	_____	Credenza stacker shelf count: 42" high, 1 shelf, 50" and 57" high include 2 shelves, 64" high includes 3 shelves.	
	_____	Stackers specified with mixed laminate finishes are L2 pricing. Refer to Mixed Laminate Finishes for further details.	



*Tackboards for Parallel Credenza Stackers with inset back*

description	height elevation	thick	pattern no.	10	20	30	40	50	55
Tackboard insert for Parallel Credenza Stacker 30" wide with inset back	42" high elevation	1/2"	<b>WSPCT4230</b>	\$164.	\$177.	\$185.	\$192.	\$210.	\$213.
	50" high elevation	1/2"	<b>WSPCT5030</b>	175.	189.	198.	205.	224.	228.
	57" high elevation	1/2"	<b>WSPCT5730</b>	185.	200.	209.	216.	237.	241.
	64" high elevation	1/2"	<b>WSPCT6430</b>	194.	210.	219.	227.	248.	252.

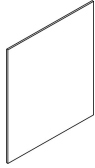

Tackboard insert for Parallel Credenza Stacker 36" wide with inset back	42" high elevation	1/2"	<b>WSPCT4236</b>	180.	194.	203.	211.	230.	234.
	50" high elevation	1/2"	<b>WSPCT5036</b>	195.	211.	220.	228.	250.	254.
	57" high elevation	1/2"	<b>WSPCT5736</b>	215.	232.	243.	252.	275.	280.
	64" high elevation	1/2"	<b>WSPCT6436</b>	228.	246.	258.	267.	292.	296.

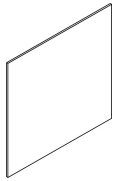

Tackboard insert for Parallel Credenza Stacker 42" wide with inset back	42" high elevation	1/2"	<b>WSPCT4242</b>	183.	198.	207.	214.	234.	238.
	50" high elevation	1/2"	<b>WSPCT5042</b>	199.	215.	225.	233.	255.	259.
	57" high elevation	1/2"	<b>WSPCT5742</b>	220.	238.	249.	257.	282.	286.
	64" high elevation	1/2"	<b>WSPCT6442</b>	235.	254.	266.	275.	301.	306.

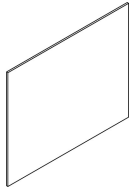

**Order Information**

1. Base Pattern Number
2. Fabric Finish

**Order Code**

---



---



---

**Specification Information**

Tackboards are designed to fit within the inset back of a parallel credenza stacker specified with inset back option.  
Tackboards are not compatible for use on stackers with standard back.

**Application Notes**

Elevation height represents the overall nominal height of a stacker when mounted to an Anchor credenza.

# Work Surface Stackers

## Side Access 20", 24" and 30" deep 12" and 16" wide

description	height elevation	w	d	h	pattern no.	L1	L2
Work Surface Stacker, Side Access, 20" deep, 12" wide	42" high elevation	12"	19 1/2"	13 3/8"	<b>WSWSA421220L</b>	\$349.	\$428.
	50" high elevation	12"	19 1/2"	20 11/16"	<b>WSWSA501220L</b>	420.	502.
	57" high elevation	12"	19 1/2"	28"	<b>WSWSA571220L</b>	482.	580.
	64" high elevation	12"	19 1/2"	35 1/4"	<b>WSWSA641220L</b>	545.	643.

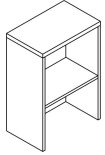

Work Surface Stacker, Side Access Open 24" deep, 12" wide	42" high elevation	12"	23 1/2"	13 3/8"	<b>WSWSA4212L</b>	355.	459.
	50" high elevation	12"	23 1/2"	20 11/16"	<b>WSWSA5012L</b>	426.	563.
	57" high elevation (shown)	12"	23 1/2"	28"	<b>WSWSA5712L</b>	489.	655.
	64" high elevation	12"	23 1/2"	35 1/4"	<b>WSWSA6412L</b>	551.	746.

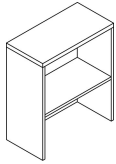

Work Surface Stacker, Side Access Open 24" deep, 16" wide	42" high elevation	15 9/16"	23 1/2"	13 3/8"	<b>WSWSA4216L</b>	415.	545.
	50" high elevation	15 9/16"	23 1/2"	20 11/16"	<b>WSWSA5016L</b>	497.	665.
	57" high elevation (shown)	15 9/16"	23 1/2"	28"	<b>WSWSA5716L</b>	568.	771.
	64" high elevation	15 9/16"	23 1/2"	35 1/4"	<b>WSWSA6416L</b>	640.	876.

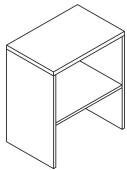

Work Surface Stacker, Side Access, 30" deep, 12" wide	42" high elevation	12"	29 1/2"	13 3/8"	<b>WSWSA421230L</b>	412.	503.
	50" high elevation	12"	29 1/2"	20 11/16"	<b>WSWSA501230L</b>	496.	590.
	57" high elevation	12"	29 1/2"	28"	<b>WSWSA571230L</b>	569.	680.
	64" high elevation	12"	29 1/2"	35 1/4"	<b>WSWSA641230L</b>	643.	754.

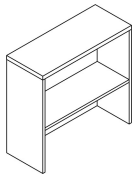

### Order Information

1. *Base Pattern Number*
2. *Case Finish*  
See Finish Options page
3. *Top Finish*  
See Finish Options page

### Order Code

Work Surface Stacker 42H elevation, 12W x 23.5D, Full Door, Left Hand

Example: **WSW4212FDLHL**

**WSW** Anchor Work Surface Stacker

**FD** Full Door

**42** 42" High Elevation

**12** 12" Wide

**LH** Left hand

**L** Laminate

**(L)** Lock option, Locking

**(118)** Case Finish

**(118)** Front Finish

**(118)** Top Finish

**(T)** Pull Style

**(118)** Pull Finish

**(C)** Lock finish, Chrome

### Specification Information

Side Access stackers are available with an inset back for use with a tackboard insert (specified separately). To specify a stacker with inset back, replace "SA" with "SAB".

Work surface stacker shelf count: 42" high, no shelf, 50" and 57" high include 1 shelf, 64" high includes 2 shelves.

Work surface stackers specified with mixed laminate finishes are L2 pricing. Refer to Mixed Laminate Finishes for further details.

### Application Notes

Work surface stackers 20", 24" and 30" deep (nominal) have 19 1/16", 23 1/2" and 29 1/2" deep cases respectively and mount directly to a work surface of matching depth. Not for use with Antenna tops. Mounting tape included.

Elevation height represents the overall nominal height of a stacker when mounted to a standard height work surface.

# Work Surface Stackers

## Side Access 20", 24" and 30" deep 12" and 16" wide

description	height elevation	w	d	h	pattern no.	L1	L2
Work Surface Stacker, Side Access, 30" deep, 16" wide	42" high elevation	15 <sup>9</sup> / <sub>16</sub> "	29 <sup>1</sup> / <sub>2</sub> "	13 <sup>3</sup> / <sub>8</sub> "	<b>WSWSA421630L</b>	\$482.	\$605.
	50" high elevation	15 <sup>9</sup> / <sub>16</sub> "	29 <sup>1</sup> / <sub>2</sub> "	20 <sup>11</sup> / <sub>16</sub> "	<b>WSWSA501630L</b>	579.	704.
	57" high elevation	15 <sup>9</sup> / <sub>16</sub> "	29 <sup>1</sup> / <sub>2</sub> "	28"	<b>WSWSA571630L</b>	663.	811.
	64" high elevation	15 <sup>9</sup> / <sub>16</sub> "	29 <sup>1</sup> / <sub>2</sub> "	35 <sup>1</sup> / <sub>4</sub> "	<b>WSWSA641630L</b>	747.	895.

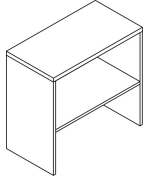

### Order Information

1. *Base Pattern Number*
2. *Case Finish*  
See Finish Options page
3. *Top Finish*  
See Finish Options page

### Order Code

Work Surface Stacker 42H elevation, 12W x 23.5D, Full Door, Left Hand

Example: **WSW4212FDLHL**

<b>WSW</b>	Anchor Work Surface Stacker
<b>FD</b>	Full Door
<b>42</b>	42" High Elevation
<b>12</b>	12" Wide
<b>LH</b>	Left hand
<b>L</b>	Laminate
<b>(L)</b>	Lock option, Locking
<b>(118)</b>	Case Finish
<b>(118)</b>	Front Finish
<b>(118)</b>	Top Finish
<b>(T)</b>	Pull Style
<b>(118)</b>	Pull Finish
<b>(C)</b>	Lock finish, Chrome

### Specification Information

Side Access stackers are available with an inset back for use with a tackboard insert (specified separately). To specify a stacker with inset back, replace "SA" with "SAB".

Work surface stacker shelf count: 42" high, no shelf, 50" and 57" high include 1 shelf, 64" high includes 2 shelves.

Work surface stackers specified with mixed laminate finishes are L2 pricing. Refer to Mixed Laminate Finishes for further details.

### Application Notes

Work surface stackers 20", 24" and 30" deep (nominal) have 19<sup>1</sup>/<sub>16</sub>", 23<sup>1</sup>/<sub>2</sub>" and 29<sup>1</sup>/<sub>2</sub>" deep cases respectively and mount directly to a work surface of matching depth. Not for use with Antenna tops. Mounting tape included.

Elevation height represents the overall nominal height of a stacker when mounted to a standard height work surface.

*Tackboards for Side Access Stackers with inset back*

description	height elevation	thick	pattern no.	grades					
				10	20	30	40	50	55
Tackboard insert for Side Access Stacker 20" deep with inset back	42" high elevation	1/2"	<b>WSWT4220</b>	\$151.	\$163.	\$171.	\$177.	\$194.	\$196.
	50" high elevation	1/2"	<b>WSWT5020</b>	151.	164.	172.	177.	193.	195.
	57" high elevation	1/2"	<b>WSWT5720</b>	166.	180.	187.	194.	213.	215.
	64" high elevation	1/2"	<b>WSWT6420</b>	174.	187.	196.	204.	222.	226.

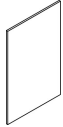

Tackboard insert for Side Access Stacker 24" deep with inset back	42" high elevation	1/2"	<b>WSWT4224</b>	153.	165.	173.	179.	196.	199.
	50" high elevation	1/2"	<b>WSWT5024</b>	158.	171.	179.	185.	202.	205.
	57" high elevation	1/2"	<b>WSWT5724</b>	171.	185.	193.	200.	219.	222.
	64" high elevation	1/2"	<b>WSWT6424</b>	180.	194.	203.	211.	230.	234.



Tackboard insert for Side Access Stacker 30" deep with inset back	42" high elevation	1/2"	<b>WSWT4230</b>	155.	167.	175.	181.	198.	202.
	50" high elevation	1/2"	<b>WSWT5030</b>	165.	178.	186.	193.	211.	215.
	57" high elevation	1/2"	<b>WSWT5730</b>	176.	190.	199.	206.	225.	229.
	64" high elevation	1/2"	<b>WSWT6430</b>	186.	201.	210.	218.	238.	242.

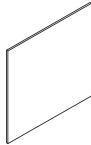

**Order Information**

1. *Base Pattern Number*
2. *Fabric Finish*

**Order Code**

---



---



---

**Specification Information**

Tackboards are designed to fit within the inset back of a side access stacker specified with back option.  
Tackboards are not compatible for use on stackers with a standard back.

Tackboard mounting tape included.

**Application Notes**

Elevation height represents the overall nominal height of a stacker when mounted to a standard height work surface.

# Work Surface Stackers

Anchor Storage

## Side Access for Antenna tops 24", 27" and 30" deep 12" wide

description	height elevation	w	d	h	pattern no.	L1	L2
Work Surface Stacker, Side Access 12" wide for 24" deep Antenna top	42" high elevation	12"	24"		<b>WSWSAY421224L</b>	\$355.	\$459.
	50" high elevation	12"	24"		<b>WSWSAY501224L</b>	426.	563.
	57" high elevation	12"	24"		<b>WSWSAY571224L</b>	489.	655.
	64" high elevation	12"	24"		<b>WSWSAY641224L</b>	551.	746.

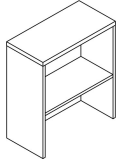

Work Surface Stacker, Side Access 12" wide for 27" deep Antenna top	42" high elevation	12"	27"		<b>WSWSAY421227L</b>	402.	491.
	50" high elevation	12"	27"		<b>WSWSAY501227L</b>	483.	575.
	57" high elevation	12"	27"		<b>WSWSAY571227L</b>	555.	663.
	64" high elevation	12"	27"		<b>WSWSAY641227L</b>	627.	750.

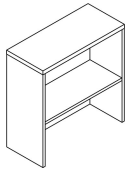

Work Surface Stacker, Side Access 12" wide for 30" deep Antenna top	42" high elevation	12"	30"		<b>WSWSAY421230L</b>	412.	503.
	50" high elevation	12"	30"		<b>WSWSAY501230L</b>	496.	590.
	57" high elevation	12"	30"		<b>WSWSAY571230L</b>	569.	680.
	64" high elevation	12"	30"		<b>WSWSAY641230L</b>	643.	754.

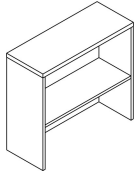

### Order Information

1. *Base Pattern Number*
2. *Case Finish*  
See Finish Options page
3. *Top Finish*  
See Finish Options page

### Order Code

Work Surface Stacker 42H  
elevation, 12W x 23.5D, Full Door,  
Left Hand

Example: **WSW4212FDLHL**

<b>WSW</b>	Anchor Work Surface Stacker
<b>FD</b>	Full Door
<b>42</b>	42" High Elevation
<b>12</b>	12" Wide
<b>LH</b>	Left hand
<b>L</b>	Laminate
<b>(L)</b>	Lock option, Locking
<b>(118)</b>	Case Finish
<b>(118)</b>	Front Finish
<b>(118)</b>	Top Finish
<b>(T)</b>	Pull Style
<b>(118)</b>	Pull Finish
<b>(C)</b>	Lock finish, Chrome

### Specification Information

Side Access stackers are available with an inset back for use with a tackboard insert (specified separately). To specify a stacker with inset back, replace "SA" with "SAB".

Work surface stacker shelf count: 42" high, no shelf, 50" and 57" high include 1 shelf, 64" high include 2 shelves.

Work surface stackers specified with mixed laminate finishes are L2 pricing. Refer to Mixed Laminate Finishes for further details.

### Application Notes

Antenna work surface stackers 24", 27" and 30" deep mount directly to an Antenna work surface of matching depth. Not for use with Antenna hinge door tops. Mounting tape included.

Elevation height represents the overall nominal height of a stacker when mounted to a standard height work surface.

*Tackboards for Side Access Antenna Stackers with inset back*

description	height elevation	thick	pattern no.	grades					
				10	20	30	40	50	55
Tackboard insert for Side Access Antenna Stacker 24" deep with inset back 	42" high elevation	1/2"	<b>WSWTY4224</b>	\$153.	\$165.	\$173.	\$179.	\$196.	\$199.
	50" high elevation	1/2"	<b>WSWTY5024</b>	158.	171.	179.	185.	202.	205.
	57" high elevation	1/2"	<b>WSWTY5724</b>	171.	185.	193.	200.	219.	222.
	64" high elevation	1/2"	<b>WSWTY6424</b>	180.	194.	203.	211.	230.	234.

Tackboard insert for Side Access Antenna Stacker 27" deep with inset back 	42" high elevation	1/2"	<b>WSWTY4227</b>	154.	166.	174.	180.	197.	201.
	50" high elevation	1/2"	<b>WSWTY5027</b>	162.	175.	183.	189.	207.	210.
	57" high elevation	1/2"	<b>WSWTY5727</b>	174.	188.	196.	203.	222.	226.
	64" high elevation	1/2"	<b>WSWTY6427</b>	183.	198.	207.	215.	234.	238.

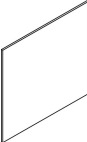
Tackboard insert for Side Access Antenna Stacker 30" deep with inset back 	42" high elevation	1/2"	<b>WSWTY4230</b>	155.	167.	175.	181.	198.	202.
	50" high elevation	1/2"	<b>WSWTY5030</b>	165.	178.	186.	193.	211.	215.
	57" high elevation	1/2"	<b>WSWTY5730</b>	176.	190.	199.	206.	225.	229.
	64" high elevation	1/2"	<b>WSWTY6430</b>	186.	201.	210.	218.	238.	242.

**Order Information**

1. *Base Pattern Number*
2. *Fabric Finish*

**Order Code**

---



---



---

**Specification Information**

Tackboards are designed to fit within the inset back of a side access stacker specified with inset back option.  
Tackboards are not compatible for use on stackers with a standard back.  
Antenna stacker tackboards are only compatible with Antenna stackers.

Work surface stacker shelf count:  
42" high, no shelf, 50" and 57" high include 1 shelf, 64" high includes 2 shelves.

**Application Notes**

Elevation height represents the overall nominal height of a stacker when mounted to a standard height work surface.  
Tackboard mounting tape included.

# Work Surface Stackers

## Front Access Open

### 12" and 16" wide

description	height elevation	w	d	h	pattern no.	L1	L2
Work Surface Stacker, Front Access Open 12" wide	42" high elevation	12"	23 1/2"	13 3/8"	<b>WSWFO4212L</b>	\$388.	\$506.
	50" high elevation	12"	23 1/2"	20 11/16"	<b>WSWFO5012L</b>	475.	635.
	57" high elevation (shown)	12"	23 1/2"	28"	<b>WSWFO5712L</b>	550.	747.
	64" high elevation	12"	23 1/2"	35 1/4"	<b>WSWFO6712L</b>	618.	851.

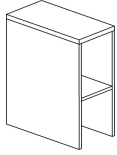

Work Surface Stacker, Front Access Open 16" wide	42" high elevation	15 9/16"	23 1/2"	13 3/8"	<b>WSWFO4216L</b>	437.	576.
	50" high elevation	15 9/16"	23 1/2"	20 11/16"	<b>WSWFO5016L</b>	529.	713.
	57" high elevation (shown)	15 9/16"	23 1/2"	28"	<b>WSWFO5716L</b>	609.	833.
	64" high elevation	15 9/16"	23 1/2"	35 1/4"	<b>WSWFO6716L</b>	688.	950.

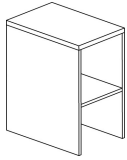

#### Order Information

1. *Base Pattern Number*
2. *Case Finish*  
See Finish Options page
3. *Top Finish*  
See Finish Options page

#### Order Code

Work Surface Stacker 42H  
elevation, 12W x 23.5D, Full Door,  
Left Hand

Example: **WSW4212FDLHL**

<b>WSW</b>	Anchor Work Surface Stacker
<b>FD</b>	Full Door
<b>42</b>	42" High Elevation
<b>12</b>	12" Wide
<b>LH</b>	Left hand
<b>L</b>	Laminate
<b>(L)</b>	Lock option, Locking
<b>(118)</b>	Case Finish
<b>(118)</b>	Front Finish
<b>(118)</b>	Top Finish
<b>(T)</b>	Pull Style
<b>(118)</b>	Pull Finish
<b>(C)</b>	Lock finish, Chrome

#### Specification Information

Work surface stacker shelf count:  
42" high, no shelf, 50" and 57" high  
include 1 shelf, 64" high includes 2  
shelves.

Add \$40 to the list price per  
standard key lock.

Add \$15 to the list price per pull for  
Anodized Nickel (AN) or Anodized  
Aluminum (AA) finish.

Work surface stackers specified  
with mixed laminate finishes are L2  
pricing. Refer to Mixed Laminate  
Finishes for further details.

#### Application Notes

Work surface stackers 24" deep  
(nominal) have a 23 1/2" deep case;  
24 3/8" overall depth including door.

Work surface stackers mount  
directly to a 23 1/2" deep work  
surface; mounting tape included.

Elevation height represents the  
overall nominal height of a stacker  
when mounted to a standard height  
work surface.

# Work Surface Stackers

## Front Access with Door

### 12" and 16" wide

description	height elevation	w	d	h	pattern no.	L1	L2
Work Surface Stacker, Front Access with Door 12" wide, Left Hand	42" high elevation	12"	23 1/2"	13 3/8"	<b>WSWFD4212LHL(N)</b>	\$508.	\$640.
	50" high elevation	12"	23 1/2"	20 11/16"	<b>WSWFD5012LHL(N)</b>	613.	795.
	57" high elevation (shown)	12"	23 1/2"	28"	<b>WSWFD5712LHL(N)</b>	709.	934.
	64" high elevation	12"	23 1/2"	35 1/4"	<b>WSWFD6712LHL(N)</b>	825.	1,094.

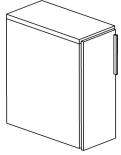

Work Surface Stacker, Front Access with Door 12" wide, Right Hand	42" high elevation	12"	23 1/2"	13 3/8"	<b>WSWFD4212RHL(N)</b>	508.	640.
	50" high elevation	12"	23 1/2"	20 11/16"	<b>WSWFD5012RHL(N)</b>	613.	795.
	57" high elevation (shown)	12"	23 1/2"	28"	<b>WSWFD5712RHL(N)</b>	709.	934.
	64" high elevation	12"	23 1/2"	35 1/4"	<b>WSWFD6712RHL(N)</b>	825.	1,094.

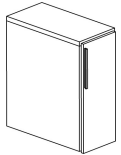

Work Surface Stacker, Front Access with Door 16" wide, Left Hand	42" high elevation	15 9/16"	23 1/2"	13 3/8"	<b>WSWFD4216LHL(N)</b>	568.	726.
	50" high elevation	15 9/16"	23 1/2"	20 11/16"	<b>WSWFD5016LHL(N)</b>	683.	897.
	57" high elevation (shown)	15 9/16"	23 1/2"	28"	<b>WSWFD5716LHL(N)</b>	788.	1,050.
	64" high elevation	15 9/16"	23 1/2"	35 1/4"	<b>WSWFD6716LHL(N)</b>	914.	1,224.

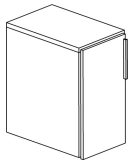

Work Surface Stacker, Front Access with Door 16" wide, Right Hand	42" high elevation	15 9/16"	23 1/2"	13 3/8"	<b>WSWFD4216RHL(N)</b>	568.	726.
	50" high elevation	15 9/16"	23 1/2"	20 11/16"	<b>WSWFD5016RHL(N)</b>	683.	897.
	57" high elevation (shown)	15 9/16"	23 1/2"	28"	<b>WSWFD5716RHL(N)</b>	788.	1,050.
	64" high elevation	15 9/16"	23 1/2"	35 1/4"	<b>WSWFD6716RHL(N)</b>	914.	1,224.

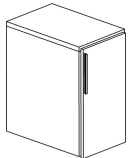

#### Order Information

1. *Base Pattern Number*
2. *Lock option*  
L = Locking  
N = Non-locking
3. *Case Finish*  
See Finish Options page
4. *Front Finish*  
See Finish Options page
5. *Top Finish*  
See Finish Options page
6. *Pull style*  
T = 10" finger pull
7. *Pull finish*  
See Finish Options page
8. *Lock finish*  
B = Black  
C = Chrome

#### Order Code

Work Surface Stacker 42H elevation, 12W x 23.5D, Full Door, Left Hand
Example: <b>WSW4212FDLHL</b>
<b>WSW</b> Anchor Work Surface Stacker
<b>FD</b> Full Door
<b>42</b> 42" High Elevation
<b>12</b> 12" Wide
<b>LH</b> Left hand
<b>L</b> Laminate
<b>(L)</b> Lock option, Locking
<b>(118)</b> Case Finish
<b>(118)</b> Front Finish
<b>(118)</b> Top Finish
<b>(T)</b> Pull Style
<b>(118)</b> Pull Finish
<b>(C)</b> Lock finish, Chrome

#### Specification Information

Work surface stacker shelf count: 42" high, no shelf, 50" and 57" high include 1 shelf, 64" high includes 2 shelves.

Add \$40 to the list price per standard key lock.

Add \$15 to the list price per pull for Anodized Nickel (AN) or Anodized Aluminum (AA) finish.

Work surface stackers specified with mixed laminate finishes are L2 pricing. Refer to Mixed Laminate Finishes for further details.

#### Application Notes

Work surface stackers 24" deep (nominal) have a 23 1/2" deep case; 24 3/8" overall depth including door.

Work surface stackers mount directly to a 23 1/2" deep work surface; mounting tape included.

Elevation height represents the overall nominal height of a stacker when mounted to a standard height work surface.



# Work Surface Stackers

## *Parallel work surface stackers*

### *12" deep*

description	height elevation	w	d	h	pattern no.	L1	L2
Parallel Work Surface Stacker, 30" Wide, Front Access Open	42" high elevation	30"	12"	13 <sup>3</sup> / <sub>8</sub> "	<b>WSPWFO4230L</b>	\$375.	\$471.
	50" high elevation	30"	12"	20 <sup>11</sup> / <sub>16</sub> "	<b>WSPWFO5030L</b>	488.	595.
	57" high elevation	30"	12"	28"	<b>WSPWFO5730L</b>	555.	685.
	64" high elevation	30"	12"	35 <sup>1</sup> / <sub>4</sub> "	<b>WSPWFO6430L</b>	689.	859.

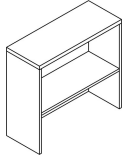

Parallel Work Surface Stacker, 36" Wide, Front Access Open	42" high elevation	36"	12"	13 <sup>3</sup> / <sub>8</sub> "	<b>WSPWFO4236L</b>	378.	450.
	50" high elevation	36"	12"	20 <sup>11</sup> / <sub>16</sub> "	<b>WSPWFO5036L</b>	541.	664.
	57" high elevation	36"	12"	28"	<b>WSPWFO5736L</b>	616.	763.
	64" high elevation	36"	12"	35 <sup>1</sup> / <sub>4</sub> "	<b>WSPWFO6436L</b>	768.	963.

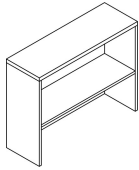

Parallel Work Surface Stacker, 42" Wide, Front Access Open	42" high elevation	42"	12"	13 <sup>3</sup> / <sub>8</sub> "	<b>WSPWFO4242L</b>	412.	493.
	50" high elevation	42"	12"	20 <sup>11</sup> / <sub>16</sub> "	<b>WSPWFO5042L</b>	595.	733.
	57" high elevation	42"	12"	28"	<b>WSPWFO5742L</b>	676.	842.
	64" high elevation	42"	12"	35 <sup>1</sup> / <sub>4</sub> "	<b>WSPWFO6442L</b>	847.	1,067.

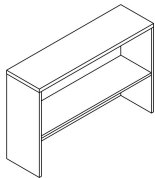

Order Information	Order Code	Specification Information	Application Notes
	_____	Parallel work surface stackers are designed to mount parallel onto a work surface.	Work surface stackers mount directly to a work surface; mounting tape include.
	_____	Parallel stackers are available with an inset back for use with a tackboard insert (specified separately). To specify a stacker with inset back, replace "FO" with "FOB".	Elevation height represents the overall nominal height of a stacker when mounted to a standard height work surface.
	_____	Work surface stacker shelf count: 42" high, no shelf, 50" and 57" high include 1 shelf, 64" high includes 2 shelves.	
	_____	Work surface stackers specified with mixed laminate finishes are L2 pricing. Refer to Mixed Laminate Finishes for further details.	

*Tackboards for Parallel Work Surface Stackers with inset back*

description	height elevation	thick	pattern no.	grades					
				10	20	30	40	50	55
Tackboard insert for Parallel Work Surface Stacker 30" wide with inset back	42" high elevation	1/2"	<b>WSPWT4230</b>	\$155.	\$167.	\$175.	\$181.	\$198.	\$202.
	50" high elevation	1/2"	<b>WSPWT5030</b>	165.	178.	186.	193.	211.	215.
	57" high elevation	1/2"	<b>WSPWT5730</b>	176.	190.	199.	206.	225.	229.
	64" high elevation	1/2"	<b>WSPWT6430</b>	186.	201.	210.	218.	238.	242.

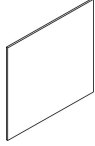

Tackboard insert for Parallel Work Surface Stacker 36" wide with inset back	42" high elevation	1/2"	<b>WSPWT4236</b>	167.	180.	189.	195.	214.	217.
	50" high elevation	1/2"	<b>WSPWT5036</b>	183.	198.	207.	214.	234.	238.
	57" high elevation	1/2"	<b>WSPWT5736</b>	200.	216.	226.	234.	256.	260.
	64" high elevation	1/2"	<b>WSPWT6436</b>	216.	233.	244.	253.	276.	281.

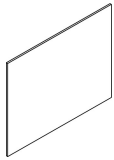

Tackboard insert for Parallel Work Surface Stacker 42" wide with inset back	42" high elevation	1/2"	<b>WSPWT4242</b>	169.	183.	191.	198.	216.	220.
	50" high elevation	1/2"	<b>WSPWT5042</b>	186.	201.	210.	218.	238.	242.
	57" high elevation	1/2"	<b>WSPWT5742</b>	204.	220.	231.	239.	261.	265.
	57" high elevation	1/2"	<b>WSPWT6442</b>	222.	240.	251.	260.	284.	289.

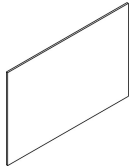

**Order Information**

1. Base Pattern Number
2. Fabric Finish

**Order Code**

---



---



---

**Specification Information**

Tackboards are designed to fit within the inset back of a parallel work surface stacker specified with inset back option.  
Tackboards are not compatible for use on stackers with standard back.

**Application Notes**

Elevation height represents the overall nominal height of a stacker when mounted on a standard height work surface.

### Anchor Towers

Anchor Towers are 24" and 30" wide wood construction cabinets offered in 4 heights designed to correspond with Dividends Horizon panel heights. Towers ship assembled including a finished top.

#### Available Sizes (nominal)

Height: 42", 50", 57", 64"  
Widths: 24", 30"  
Depth: 24"

Towers are categorized by the upper configuration (A) and include 7 pedestal options (B) and 2 locker options (C). Towers are available in left or right hand, defined by the location of the locker. (Right hand tower shown below.)

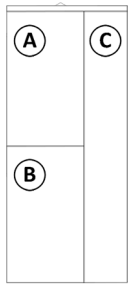

#### Configuration Options:

##### A: Upper Configuration

Side Access (open)  
Front Access Open  
Front Access with Door

##### B: Pedestal Configuration

Open  
Full Door  
Open/File  
Open/Box/File  
Box(file front)/File  
Box/Box(file front)/File  
File/File

##### C: Locker Configuration

Open with Shelves  
Full Door

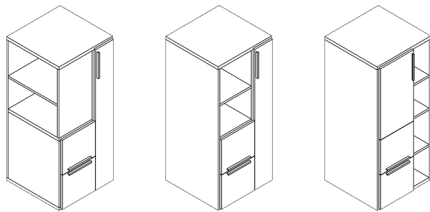

Side Access tower, Front Access Open tower, Front Access with Door tower

#### Front Panel for Side Access Tower

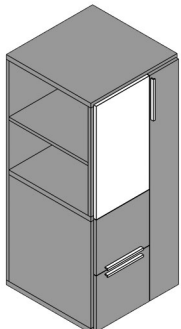

A laminate or markerboard front panel may be specified (separately) for Side Access towers. To accept front panel mounting, Side Access tower must be specified with a drilled front.

### Construction

- Towers are constructed of wood core, laminate and ABS edge banding; cam and dowel construction.
- Material thickness: 1 3/16" (nominal) on tower top, bottom, and vertical and horizontal midpanels, 3/4" on tower back, sides, all other interior shelves, doors and drawer fronts
- Leveling glides: 3/16" diameter steel stem with 1/16" of height adjustment, 4 per locker.
- Longer glides are included to provide an additional 1/16" of height adjustment; 2 per pedestal.

### Locks

Anchor Towers may be ordered with or without locks. No lock hole is drilled on units specified as non-locking.

Locks are randomly keyed unless otherwise specified. Other keying options include keyed alike or keyed with lock cores K001-K250. To specify units as such, reference KnollKey Lock Program.

### Pulls

Finger Pull, 10" long, vertical pulls on 42" towers are 8" long.

#### Pull Position:

Doors: vertical, 1 1/8" below top edge of door.

Drawers: centered horizontally  
Top drawer: 3/4" from bottom of drawer  
Bottom drawer: 3/4" from top of drawer

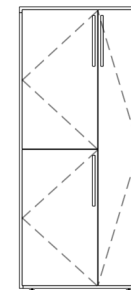
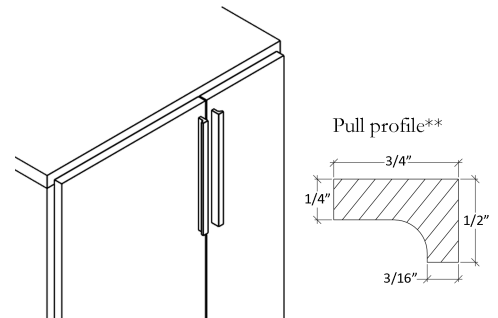

Tower doors open from midpanel; hinges are located on the end panels.

# Tower Specifications

## *Tower Shelf Count*

### Tower shelf count

Tower Interior Component	Configuration	42" high	50" high	57" high	64" high
Locker segment	Open	2	2	3	3
	Full Door	1	1	1	1
Upper segment	Side Access	0	1	1	2
	Front Access	0	1	1	2
	Front Access with Door	0	1	1	2
Pedestal segment	Open	1	1	1	1
	Full Door	0	0	0	0
	Open/File	1 (+1 fixed)	1 (+1 fixed)	1 (+1 fixed)	1 (+1 fixed)
	Open/Box/File	1 fixed	1 fixed	1 fixed	1 fixed
	Box (File Front)/File	1 fixed	1 fixed	1 fixed	1 fixed
	Box/Box(File Front) File	0	0	0	0
	File/File	0	0	0	0

*\*all shelves are removable unless noted as fixed*

# Towers

## 42" High Side Access Open, Open Locker

### 24" and 30" wide

description	pedestal configuration	w	d	h	pattern no.	L1	L2
Tower, Side Access Open, Open Locker Left Hand, 42" high, 24" wide 	Open Pedestal	24"	23 1/2"	41 9/16"	<b>W TSA4224OSO1LHL</b>	\$1,477.	\$2,024.
	Full Door Pedestal	24"	23 1/2"	41 9/16"	<b>W TSA4224OSFDLHL(N)</b>	1,625.	2,202.
	Open/File Pedestal	24"	23 1/2"	41 9/16"	<b>W TSA4224OSOFHLHL(N)</b>	1,782.	2,376.
	File/File Pedestal (shown)	24"	23 1/2"	41 9/16"	<b>W TSA4224OSFFLHL(N)</b>	1,885.	2,440.
	Open/Box/File Pedestal	24"	23 1/2"	41 9/16"	<b>W TSA4224OSOBHLHL(N)</b>	1,906.	2,481.
	Box (File Front)/File Pedestal	24"	23 1/2"	41 9/16"	<b>W TSA4224OSCFHLHL(N)</b>	1,951.	2,543.
	Box/Box(File Front) File Pedestal	24"	23 1/2"	41 9/16"	<b>W TSA4224OSCBHLHL(N)</b>	2,034.	2,608.

Tower, Side Access Open, Open Locker Right Hand, 42" high, 24" wide 	Open Pedestal	24"	23 1/2"	41 9/16"	<b>W TSA4224OSO1RHL</b>	1,477.	2,024.
	Full Door Pedestal	24"	23 1/2"	41 9/16"	<b>W TSA4224OSFDRHL(N)</b>	1,625.	2,202.
	Open/File Pedestal	24"	23 1/2"	41 9/16"	<b>W TSA4224OSOFRHL(N)</b>	1,781.	2,375.
	File/File Pedestal (shown)	24"	23 1/2"	41 9/16"	<b>W TSA4224OSFFRHL(N)</b>	1,885.	2,440.
	Open/Box/File Pedestal	24"	23 1/2"	41 9/16"	<b>W TSA4224OSOBRLHL(N)</b>	1,906.	2,481.
	Box (File Front)/File Pedestal	24"	23 1/2"	41 9/16"	<b>W TSA4224OSCFRHL(N)</b>	1,951.	2,543.
	Box/Box(File Front) File Pedestal	24"	23 1/2"	41 9/16"	<b>W TSA4224OSCBRLHL(N)</b>	2,034.	2,608.

Tower, Side Access Open, Open Locker Left Hand, 42" high, 30" wide 	Open Pedestal	30"	23 1/2"	41 9/16"	<b>W TSA4230OSO1LHL</b>	1,633.	2,249.
	Full Door Pedestal	30"	23 1/2"	41 9/16"	<b>W TSA4230OSFDLHL(N)</b>	1,781.	2,426.
	Open/File Pedestal	30"	23 1/2"	41 9/16"	<b>W TSA4230OSOFHLHL(N)</b>	1,937.	2,600.
	File/File Pedestal	30"	23 1/2"	41 9/16"	<b>W TSA4230OSFFLHL(N)</b>	2,041.	2,665.
	Open/Box/File Pedestal	30"	23 1/2"	41 9/16"	<b>W TSA4230OSOBHLHL(N)</b>	2,062.	2,705.
	Box (File Front)/File Pedestal	30"	23 1/2"	41 9/16"	<b>W TSA4230OSCFHLHL(N)</b>	2,106.	2,768.
	Box/Box(File Front) File Pedestal	30"	23 1/2"	41 9/16"	<b>W TSA4230OSCBHLHL(N)</b>	2,190.	2,833.

Tower, Side Access Open, Open Locker Right Hand, 42" high, 30" wide 	Open Pedestal	30"	23 1/2"	41 9/16"	<b>W TSA4230OSO1RHL</b>	1,633.	2,249.
	Full Door Pedestal	30"	23 1/2"	41 9/16"	<b>W TSA4230OSFDRHL(N)</b>	1,781.	2,426.
	Open/File Pedestal	30"	23 1/2"	41 9/16"	<b>W TSA4230OSOFRHL(N)</b>	1,937.	2,600.
	File/File Pedestal	30"	23 1/2"	41 9/16"	<b>W TSA4230OSFFRHL(N)</b>	2,041.	2,665.
	Open/Box/File Pedestal	30"	23 1/2"	41 9/16"	<b>W TSA4230OSOBRLHL(N)</b>	2,062.	2,705.
	Box (File Front)/File Pedestal	30"	23 1/2"	41 9/16"	<b>W TSA4230OSCFRHL(N)</b>	2,106.	2,768.
	Box/Box(File Front) File Pedestal	30"	23 1/2"	41 9/16"	<b>W TSA4230OSCBRLHL(N)</b>	2,190.	2,833.

Order Information	Order Code	Specification Information	Application Notes
1. <i>Base Pattern Number</i>	Tower, Side Access Open, Open Locker, 42" high, 24" wide, F/F pedestal, Left hand	Refer to Tower Shelf count for number of included shelves with each interior configuration.	Towers 24" deep (nominal) have a 23 1/2" deep case; 24 3/8" overall depth including door.
2. <i>Lock option</i> L = Locking N = Non-locking			
3. <i>Case Finish</i> See Finish Options page	Example: <b>W TSA4224OSFFLHL</b>	Add \$40 to the list price per standard key lock.	Towers with full door include a coat hook to be field installed.
4. <i>Front Finish</i> See Finish Options page	<b>W TSA</b> Anchor Tower, Side Access		
5. <i>Top Finish</i> See Finish Options page	<b>42</b> 42" High	Add \$15 to the list price per pull for Anodized Nickel (AN) or Aluminum (AA) finish.	
6. <i>Pull style</i> T = 10" finger pull	<b>24</b> 24" Wide		
7. <i>Pull finish</i> See Finish Options page	<b>OS</b> Locker configuration, Open with Shelves	Towers specified with mixed laminate finishes are L2 pricing. Refer to Mixed Laminate Finishes for further details.	
8. <i>Lock finish</i> B = Black C = Chrome	<b>FF</b> Pedestal configuration, File/File		
9. <i>Predrill for (optional) Front Panel</i> D = Drilled N = Non-drill	<b>LH</b> Left hand <b>L</b> Laminate <b>(L)</b> Lock option, Locking <b>(118)</b> Case Finish <b>(118)</b> Front Finish <b>(118)</b> Top Finish <b>(T)</b> Pull Style <b>(118)</b> Pull Finish <b>(C)</b> Lock finish, Chrome <b>(D)</b> Drilled for front panel	Dimensions listed under w h d are actual to the nearest 1/16".  A laminate or markerboard front panel may be specified (separately) for side access towers. To accept front panel mounting hardware, side access towers must be specified with "D" for a predrilled front.	

# Towers

## 42" High Side Access Open, Full Door Locker

### 24" and 30" wide

description	pedestal configuration	w	d	h	pattern no.	L1	L2
Tower, Side Access Open, Full Door Locker Left Hand, 42" high, 24" wide	Open Pedestal	24"	23 1/2"	41 9/16"	<b>W TSA4224FDO1LHL(N)</b>	\$1,640.	\$2,201.
	Full Door Pedestal	24"	23 1/2"	41 9/16"	<b>W TSA4224FDFDLHL(N)</b>	1,789.	2,378.
	Open/File Pedestal	24"	23 1/2"	41 9/16"	<b>W TSA4224FDOFLHL(N)</b>	1,944.	2,551.
	File/File Pedestal (shown)	24"	23 1/2"	41 9/16"	<b>W TSA4224FDFFLHL(N)</b>	2,048.	2,617.
	Open/Box/File Pedestal	24"	23 1/2"	41 9/16"	<b>W TSA4224FDOBLHL(N)</b>	2,069.	2,657.
	Box/Box(File Front) File Pedestal	24"	23 1/2"	41 9/16"	<b>W TSA4224FDCBLHL(N)</b>	2,072.	2,659.
	Box (File Front)/File Pedestal	24"	23 1/2"	41 9/16"	<b>W TSA4224FDCFLHL(N)</b>	2,113.	2,720.

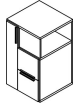

Tower, Side Access Open, Full Door Locker Right Hand, 42" high, 24" wide	Open Pedestal	24"	23 1/2"	41 9/16"	<b>W TSA4224FDO1RHL(N)</b>	1,640.	2,201.
	Full Door Pedestal	24"	23 1/2"	41 9/16"	<b>W TSA4224FDFDRHL(N)</b>	1,789.	2,378.
	Open/File Pedestal	24"	23 1/2"	41 9/16"	<b>W TSA4224FDOFRHL(N)</b>	1,944.	2,551.
	File/File Pedestal (shown)	24"	23 1/2"	41 9/16"	<b>W TSA4224FDFFRHL(N)</b>	2,048.	2,617.
	Open/Box/File Pedestal	24"	23 1/2"	41 9/16"	<b>W TSA4224FDOBRHL(N)</b>	2,069.	2,657.
	Box/Box(File Front) File Pedestal	24"	23 1/2"	41 9/16"	<b>W TSA4224FDCBRHL(N)</b>	2,072.	2,659.
	Box (File Front)/File Pedestal	24"	23 1/2"	41 9/16"	<b>W TSA4224FDCFRHL(N)</b>	2,113.	2,720.



Tower, Side Access Open, Full Door Locker Left Hand, 42" high, 30" wide	Open Pedestal	30"	23 1/2"	41 9/16"	<b>W TSA4230FDO1LHL(N)</b>	1,812.	2,451.
	Full Door Pedestal	30"	23 1/2"	41 9/16"	<b>W TSA4230FDFDLHL(N)</b>	1,961.	2,629.
	Open/File Pedestal	30"	23 1/2"	41 9/16"	<b>W TSA4230FDOFLHL(N)</b>	2,116.	2,802.
	File/File Pedestal	30"	23 1/2"	41 9/16"	<b>W TSA4230FDFFLHL(N)</b>	2,220.	2,867.
	Open/Box/File Pedestal	30"	23 1/2"	41 9/16"	<b>W TSA4230FDOBLHL(N)</b>	2,241.	2,908.
	Box (File Front)/File Pedestal	30"	23 1/2"	41 9/16"	<b>W TSA4230FDCBLHL(N)</b>	2,245.	2,910.
	Box/Box(File Front) File Pedestal	30"	23 1/2"	41 9/16"	<b>W TSA4230FDCFLHL(N)</b>	2,286.	2,970.

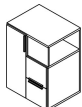

Tower, Side Access Open, Full Door Locker Right Hand, 42" high, 30" wide	Open Pedestal	30"	23 1/2"	41 9/16"	<b>W TSA4230FDO1RHL(N)</b>	1,812.	2,451.
	Full Door Pedestal	30"	23 1/2"	41 9/16"	<b>W TSA4230FDFDRHL(N)</b>	1,961.	2,629.
	Open/File Pedestal	30"	23 1/2"	41 9/16"	<b>W TSA4230FDOFRHL(N)</b>	2,116.	2,802.
	File/File Pedestal	30"	23 1/2"	41 9/16"	<b>W TSA4230FDFFRHL(N)</b>	2,220.	2,867.
	Open/Box/File Pedestal	30"	23 1/2"	41 9/16"	<b>W TSA4230FDOBRHL(N)</b>	2,241.	2,908.
	Box (File Front)/File Pedestal	30"	23 1/2"	41 9/16"	<b>W TSA4230FDCBRHL(N)</b>	2,245.	2,910.
	Box/Box(File Front) File Pedestal	30"	23 1/2"	41 9/16"	<b>W TSA4230FDCFRHL(N)</b>	2,286.	2,970.

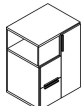

Order Information	Order Code	Specification Information	Application Notes
1. <i>Base Pattern Number</i>	Tower, Side Access Open, Full Door Locker, 42" high, 24" wide, F/F pedestal, Left hand	Refer to Tower Shelf count for number of included shelves with each interior configuration.	Towers 24" deep (nominal) have a 23 1/2" deep case; 24 3/8" overall depth including door.
2. <i>Lock option</i> L = Locking N = Non-locking			
3. <i>Case Finish</i> See Finish Options page	Example: <b>W TSA4224FDFFLHL</b>	Add \$40 to the list price per standard key lock.	Towers with full door include a coat hook to be field installed.
4. <i>Front Finish</i> See Finish Options page	<b>W TSA</b> Anchor Tower, Side Access		
5. <i>Top Finish</i> See Finish Options page	<b>42</b> 42" High	Add \$15 to the list price per pull for Anodized Nickel (AN) or Aluminum (AA) finish.	
6. <i>Pull style</i> T = 10" finger pull	<b>24</b> 24" Wide		
7. <i>Pull finish</i> See Finish Options page	<b>FD</b> Locker configuration, Full Door	Towers specified with mixed laminate finishes are L2 pricing. Refer to Mixed Laminate Finishes for further details.	
8. <i>Lock finish</i> B = Black C = Chrome	<b>FF</b> Pedestal configuration, File/File		
9. <i>Pre-drill for (optional) Front Panel</i> D = Drilled N = Non-drill	<b>LH</b> Left hand <b>L</b> Laminate <b>(L)</b> Lock option, Locking <b>(118)</b> Case Finish <b>(118)</b> Front Finish <b>(118)</b> Top Finish <b>(T)</b> Pull Style <b>(118)</b> Pull Finish <b>(C)</b> Lock finish, Chrome <b>(D)</b> Drilled for front panel	Dimensions listed under w h d are actual to the nearest 1/16".  A laminate or markerboard front panel may be specified (separately) for side access towers. To accept front panel mounting hardware, side access towers must be specified with "D" for a predrilled front.	

# Towers

## 50" High Side Access Open, Open Locker

### 24" and 30" wide

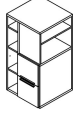
description	pedestal configuration	w	d	h	pattern no.	L1	L2
 Tower, Side Access Open, Open Locker Left Hand, 50" high, 24" wide	Open Pedestal	24"	23 1/2"	48 7/8"	<b>W TSA5024OSO1LHL</b>	\$1,661.	\$2,300.
	Full Door Pedestal	24"	23 1/2"	48 7/8"	<b>W TSA5024OSFDLHL(N)</b>	1,833.	2,512.
	Open/File Pedestal	24"	23 1/2"	48 7/8"	<b>W TSA5024OSOFHL(N)</b>	1,965.	2,651.
	File/File Pedestal (shown)	24"	23 1/2"	48 7/8"	<b>W TSA5024OSFFHL(N)</b>	2,069.	2,716.
	Open/Box/File Pedestal	24"	23 1/2"	48 7/8"	<b>W TSA5024OSOBHL(N)</b>	2,090.	2,757.
	Box (File Front)/File Pedestal	24"	23 1/2"	48 7/8"	<b>W TSA5024OSCFHL(N)</b>	2,134.	2,819.
	Box/Box(File Front) File Pedestal	24"	23 1/2"	48 7/8"	<b>W TSA5024OSCBHL(N)</b>	2,218.	2,884.

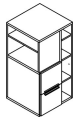
 Tower, Side Access Open, Open Locker Right Hand, 50" high, 24" wide	Open Pedestal	24"	23 1/2"	48 7/8"	<b>W TSA5024OSO1RHL</b>	1,661.	2,300.
	Full Door Pedestal	24"	23 1/2"	48 7/8"	<b>W TSA5024OSFDRHL(N)</b>	1,833.	2,512.
	Open/File Pedestal	24"	23 1/2"	48 7/8"	<b>W TSA5024OSOFRHL(N)</b>	1,965.	2,651.
	File/File Pedestal (shown)	24"	23 1/2"	48 7/8"	<b>W TSA5024OSFFRHL(N)</b>	2,069.	2,716.
	Open/Box/File Pedestal	24"	23 1/2"	48 7/8"	<b>W TSA5024OSOBRLHL(N)</b>	2,090.	2,757.
	Box (File Front)/File Pedestal	24"	23 1/2"	48 7/8"	<b>W TSA5024OSCFRHL(N)</b>	2,134.	2,819.
	Box/Box(File Front) File Pedestal	24"	23 1/2"	48 7/8"	<b>W TSA5024OSCBRLHL(N)</b>	2,218.	2,884.

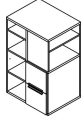
 Tower, Side Access Open, Open Locker Left Hand, 50" high, 30" wide	Open Pedestal	30"	23 1/2"	48 7/8"	<b>W TSA5030OSO1LHL</b>	1,824.	2,537.
	Full Door Pedestal	30"	23 1/2"	48 7/8"	<b>W TSA5030OSFDLHL(N)</b>	1,996.	2,749.
	Open/File Pedestal	30"	23 1/2"	48 7/8"	<b>W TSA5030OSOFHL(N)</b>	2,129.	2,888.
	File/File Pedestal (shown)	30"	23 1/2"	48 7/8"	<b>W TSA5030OSFFHL(N)</b>	2,232.	2,953.
	Open/Box/File Pedestal	30"	23 1/2"	48 7/8"	<b>W TSA5030OSOBHL(N)</b>	2,253.	2,994.
	Box (File Front)/File Pedestal	30"	23 1/2"	48 7/8"	<b>W TSA5030OSCFHL(N)</b>	2,298.	3,056.
	Box/Box(File Front) File Pedestal	30"	23 1/2"	48 7/8"	<b>W TSA5030OSCBHL(N)</b>	2,381.	3,121.

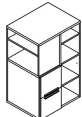
 Tower, Side Access Open, Open Locker Right Hand, 50" high, 30" wide	Open Pedestal	30"	23 1/2"	48 7/8"	<b>W TSA5030OSO1RHL</b>	1,824.	2,537.
	Full Door Pedestal	30"	23 1/2"	48 7/8"	<b>W TSA5030OSFDRHL(N)</b>	1,996.	2,749.
	Open/File Pedestal	30"	23 1/2"	48 7/8"	<b>W TSA5030OSOFRHL(N)</b>	2,129.	2,888.
	File/File Pedestal (shown)	30"	23 1/2"	48 7/8"	<b>W TSA5030OSFFRHL(N)</b>	2,232.	2,953.
	Open/Box/File Pedestal	30"	23 1/2"	48 7/8"	<b>W TSA5030OSOBRLHL(N)</b>	2,253.	2,994.
	Box (File Front)/File Pedestal	30"	23 1/2"	48 7/8"	<b>W TSA5030OSCFRHL(N)</b>	2,298.	3,056.
	Box/Box(File Front) File Pedestal	30"	23 1/2"	48 7/8"	<b>W TSA5030OSCBRLHL(N)</b>	2,381.	3,121.

Order Information	Order Code	Specification Information	Application Notes
1. <i>Base Pattern Number</i>	Tower, Side Access Open, Open Locker, 50" high, 24" wide, F/F pedestal, Left hand	Refer to Tower Shelf count for number of included shelves with each interior configuration.	Towers 24" deep (nominal) have a 23 1/2" deep case; 24 3/8" overall depth including door.
2. <i>Lock option</i> L = Locking N = Non-locking			
3. <i>Case Finish</i> See Finish Options page	Example: <b>W TSA5024OSFFLHL</b>	Add \$40 to the list price per standard key lock.	Towers with full door include a coat hook to be field installed.
4. <i>Front Finish</i> See Finish Options page	<b>W TSA</b> Anchor Tower, Side Access		
5. <i>Top Finish</i> See Finish Options page	<b>50</b> 50" High	Add \$15 to the list price per pull for Anodized Nickel (AN) or Aluminum (AA) finish.	
6. <i>Pull style</i> T = 10" finger pull	<b>24</b> 24" Wide		
7. <i>Pull finish</i> See Finish Options page	<b>OS</b> Locker configuration, Open with Shelves	Towers specified with mixed laminate finishes are L2 pricing. Refer to Mixed Laminate Finishes for further details.	
8. <i>Lock finish</i> B = Black C = Chrome	<b>FF</b> Pedestal configuration, File/File		
9. <i>Pre-drill for (optional) Front Panel</i> D = Drilled N = Non-drill	<b>LH</b> Left hand <b>L</b> Laminate <b>(L)</b> Lock option, Locking <b>(118)</b> Case Finish <b>(118)</b> Front Finish <b>(118)</b> Top Finish <b>(T)</b> Pull Style <b>(118)</b> Pull Finish <b>(C)</b> Lock finish, Chrome <b>(D)</b> Drilled for front panel	Dimensions listed under w h d are actual to the nearest 1/16".  A laminate or markerboard front panel may be specified (separately) for side access towers. To accept front panel mounting hardware, side access towers must be specified with "D" for a predrilled front.	

# Towers

## 50" High Side Access Open, Full Door Locker

### 24" and 30" wide

description	pedestal configuration	w	d	h	pattern no.	L1	L2
Tower, Side Access Open, Full Door Locker Left Hand, 50" high, 24" wide	Open Pedestal	24"	23 1/2"	48 7/8"	<b>W TSA5024FDO1LHL(N)</b>	\$1,837.	\$2,495.
	Full Door Pedestal	24"	23 1/2"	48 7/8"	<b>W TSA5024FDFDLHL(N)</b>	2,009.	2,707.
	Open/File Pedestal	24"	23 1/2"	48 7/8"	<b>W TSA5024FDOFLHL(N)</b>	2,141.	2,846.
	File/File Pedestal (shown)	24"	23 1/2"	48 7/8"	<b>W TSA5024FDFFLHL(N)</b>	2,245.	2,911.
	Open/Box/File Pedestal	24"	23 1/2"	48 7/8"	<b>W TSA5024FDOBLHL(N)</b>	2,266.	2,951.
	Box/Box(File Front) File Pedestal	24"	23 1/2"	48 7/8"	<b>W TSA5024FDCBLHL(N)</b>	2,269.	2,954.
	Box (File Front)/File Pedestal	24"	23 1/2"	48 7/8"	<b>W TSA5024FDCFLHL(N)</b>	2,310.	3,014.

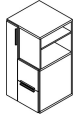

Tower, Side Access Open, Full Door Locker Right Hand, 50" high, 24" wide	Open Pedestal	24"	23 1/2"	48 7/8"	<b>W TSA5024FDO1RHL(N)</b>	1,837.	2,495.
	Full Door Pedestal	24"	23 1/2"	48 7/8"	<b>W TSA5024FDFDRHL(N)</b>	2,009.	2,707.
	Open/File Pedestal	24"	23 1/2"	48 7/8"	<b>W TSA5024FDOFRHL(N)</b>	2,141.	2,846.
	File/File Pedestal (shown)	24"	23 1/2"	48 7/8"	<b>W TSA5024FDFRHL(N)</b>	2,245.	2,911.
	Open/Box/File Pedestal	24"	23 1/2"	48 7/8"	<b>W TSA5024FDOBRHL(N)</b>	2,266.	2,951.
	Box/Box(File Front) File Pedestal	24"	23 1/2"	48 7/8"	<b>W TSA5024FDCBRHL(N)</b>	2,269.	2,954.
	Box (File Front)/File Pedestal	24"	23 1/2"	48 7/8"	<b>W TSA5024FDCFRHL(N)</b>	2,310.	3,014.



Tower, Side Access Open, Full Door Locker Left Hand, 50" high, 30" wide	Open Pedestal	30"	23 1/2"	48 7/8"	<b>W TSA5030FDO1LHL(N)</b>	2,025.	2,763.
	Full Door Pedestal	30"	23 1/2"	48 7/8"	<b>W TSA5030FDFDLHL(N)</b>	2,197.	2,982.
	Open/File Pedestal	30"	23 1/2"	48 7/8"	<b>W TSA5030FDOFLHL(N)</b>	2,329.	3,121.
	File/File Pedestal (shown)	30"	23 1/2"	48 7/8"	<b>W TSA5030FDFFLHL(N)</b>	2,433.	3,186.
	Open/Box/File Pedestal	30"	23 1/2"	48 7/8"	<b>W TSA5030FDOBLHL(N)</b>	2,453.	3,226.
	Box/Box(File Front) File Pedestal	30"	23 1/2"	48 7/8"	<b>W TSA5030FDCBLHL(N)</b>	2,457.	3,228.
	Box (File Front)/File Pedestal	30"	23 1/2"	48 7/8"	<b>W TSA5030FDCFLHL(N)</b>	2,498.	3,289.

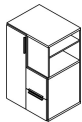

Tower, Side Access Open, Full Door Locker Right Hand, 50" high, 30" wide	Open Pedestal	30"	23 1/2"	48 7/8"	<b>W TSA5030FDO1RHL(N)</b>	2,025.	2,763.
	Full Door Pedestal	30"	23 1/2"	48 7/8"	<b>W TSA5030FDFDRHL(N)</b>	2,197.	2,982.
	Open/File Pedestal	30"	23 1/2"	48 7/8"	<b>W TSA5030FDOFRHL(N)</b>	2,329.	3,121.
	File/File Pedestal (shown)	30"	23 1/2"	48 7/8"	<b>W TSA5030FDFRHL(N)</b>	2,433.	3,186.
	Open/Box/File Pedestal	30"	23 1/2"	48 7/8"	<b>W TSA5030FDOBRHL(N)</b>	2,453.	3,226.
	Box/Box(File Front) File Pedestal	30"	23 1/2"	48 7/8"	<b>W TSA5030FDCBRHL(N)</b>	2,457.	3,228.
	Box (File Front)/File Pedestal	30"	23 1/2"	48 7/8"	<b>W TSA5030FDCFRHL(N)</b>	2,498.	3,289.

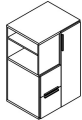

Order Information	Order Code	Specification Information	Application Notes
1. <i>Base Pattern Number</i>	Tower, Side Access Open, Full Door Locker, 50" high, 24" wide, F/F pedestal, Left hand	Refer to Tower Shelf count for number of included shelves with each interior configuration.	Towers 24" deep (nominal) have a 23 1/2" deep case; 24 3/8" overall depth including door.
2. <i>Lock option</i> L = Locking N = Non-locking			
3. <i>Case Finish</i> See Finish Options page	Example: <b>W TSA5024FDFFLHL</b>	Add \$40 to the list price per standard key lock.	Towers with full door include a coat hook to be field installed.
4. <i>Front Finish</i> See Finish Options page	<b>W TSA</b> Anchor Tower, Side Access		
5. <i>Top Finish</i> See Finish Options page	<b>50</b> 42" High	Add \$15 to the list price per pull for Anodized Nickel (AN) or Aluminum (AA) finish.	
6. <i>Pull style</i> T = 10" finger pull	<b>24</b> 24" Wide		
7. <i>Pull finish</i> See Finish Options page	<b>FD</b> Locker configuration, Full Door	Towers specified with mixed laminate finishes are L2 pricing. Refer to Mixed Laminate Finishes for further details.	
8. <i>Lock finish</i> B = Black C = Chrome	<b>FF</b> Pedestal configuration, File/File		
9. <i>Pre-drill for (optional) Front Panel</i> D = Drilled N = Non-drill	<b>LH</b> Left hand <b>L</b> Laminate <b>(L)</b> Lock option, Locking <b>(118)</b> Case Finish <b>(118)</b> Front Finish <b>(118)</b> Top Finish <b>(T)</b> Pull Style <b>(118)</b> Pull Finish <b>(C)</b> Lock finish, Chrome <b>(D)</b> Drilled for front panel	Dimensions listed under w h d are actual to the nearest 1/16".  A laminate or markerboard front panel may be specified (separately) for side access towers. To accept front panel mounting hardware, side access towers must be specified with "D" for a predrilled front.	



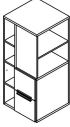

# Towers

## 57" High Side Access Open, Open Locker 24" and 30" wide

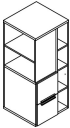
description	pedestal configuration	w	d	h	pattern no.	L1	L2
Tower, Side Access Open, Open Locker Left Hand, 57" high, 24" wide 	Open Pedestal	24"	23 1/2"	56 3/16"	<b>W TSA5724OSO1LHL</b>	\$1,805.	\$2,511.
	Full Door Pedestal	24"	23 1/2"	56 3/16"	<b>W TSA5724OSFDLHL(N)</b>	1,997.	2,753.
	Open/File Pedestal	24"	23 1/2"	56 3/16"	<b>W TSA5724OSOFHL(N)</b>	2,109.	2,862.
	File/File Pedestal (shown)	24"	23 1/2"	56 3/16"	<b>W TSA5724OSFFLHL(N)</b>	2,213.	2,927.
	Open/Box/File Pedestal	24"	23 1/2"	56 3/16"	<b>W TSA5724OSOBHL(N)</b>	2,234.	2,967.
	Box (File Front)/File Pedestal	24"	23 1/2"	56 3/16"	<b>W TSA5724OSCFHL(N)</b>	2,278.	3,030.
	Box/Box(File Front) File Pedestal	24"	23 1/2"	56 3/16"	<b>W TSA5724OSCBHL(N)</b>	2,362.	3,095.

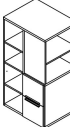
Tower, Side Access Open, Open Locker Right Hand, 57" high, 24" wide 	Open Pedestal	24"	23 1/2"	56 3/16"	<b>W TSA5724OSO1RHL</b>	1,805.	2,511.
	Full Door Pedestal	24"	23 1/2"	56 3/16"	<b>W TSA5724OSFDRHL(N)</b>	1,997.	2,753.
	Open/File Pedestal	24"	23 1/2"	56 3/16"	<b>W TSA5724OSOFRHL(N)</b>	2,109.	2,862.
	File/File Pedestal (shown)	24"	23 1/2"	56 3/16"	<b>W TSA5724OSFFRHL(N)</b>	2,213.	2,927.
	Open/Box/File Pedestal	24"	23 1/2"	56 3/16"	<b>W TSA5724OSOBRLHL(N)</b>	2,234.	2,967.
	Box (File Front)/File Pedestal	24"	23 1/2"	56 3/16"	<b>W TSA5724OSCFRHL(N)</b>	2,278.	3,030.
	Box/Box(File Front) File Pedestal	24"	23 1/2"	56 3/16"	<b>W TSA5724OSCBRLHL(N)</b>	2,362.	3,095.

Tower, Side Access Open, Open Locker Left Hand, 57" high, 30" wide 	Open Pedestal	30"	23 1/2"	56 3/16"	<b>W TSA5730OSO1LHL</b>	2,000.	2,795.
	Full Door Pedestal	30"	23 1/2"	56 3/16"	<b>W TSA5730OSFDLHL(N)</b>	2,192.	3,037.
	Open/File Pedestal	30"	23 1/2"	56 3/16"	<b>W TSA5730OSOFHL(N)</b>	2,303.	3,145.
	File/File Pedestal (shown)	30"	23 1/2"	56 3/16"	<b>W TSA5730OSFFLHL(N)</b>	2,408.	3,211.
	Open/Box/File Pedestal	30"	23 1/2"	56 3/16"	<b>W TSA5730OSOBHL(N)</b>	2,429.	3,252.
	Box (File Front)/File Pedestal	30"	23 1/2"	56 3/16"	<b>W TSA5730OSCFHL(N)</b>	2,473.	3,314.
	Box/Box(File Front) File Pedestal	30"	23 1/2"	56 3/16"	<b>W TSA5730OSCBHL(N)</b>	2,557.	3,379.

Tower, Side Access Open, Open Locker Right Hand, 57" high, 30" wide 	Open Pedestal	30"	23 1/2"	56 3/16"	<b>W TSA5730OSO1RHL</b>	2,000.	2,795.
	Full Door Pedestal	30"	23 1/2"	56 3/16"	<b>W TSA5730OSFDRHL(N)</b>	2,192.	3,037.
	Open/File Pedestal	30"	23 1/2"	56 3/16"	<b>W TSA5730OSOFRHL(N)</b>	2,303.	3,145.
	File/File Pedestal (shown)	30"	23 1/2"	56 3/16"	<b>W TSA5730OSFFRHL(N)</b>	2,408.	3,211.
	Open/Box/File Pedestal	30"	23 1/2"	56 3/16"	<b>W TSA5730OSOBRLHL(N)</b>	2,429.	3,252.
	Box (File Front)/File Pedestal	30"	23 1/2"	56 3/16"	<b>W TSA5730OSCFRHL(N)</b>	2,473.	3,314.
	Box/Box(File Front) File Pedestal	30"	23 1/2"	56 3/16"	<b>W TSA5730OSCBRLHL(N)</b>	2,557.	3,379.

Order Information	Order Code	Specification Information	Application Notes
1. <i>Base Pattern Number</i>	Tower, Side Access Open, Open Locker, 57" high, 24" wide, F/F pedestal, Left hand	Refer to Tower Shelf count for number of included shelves with each interior configuration.	Towers 24" deep (nominal) have a 23 1/2" deep case; 24 3/8" overall depth including door.
2. <i>Lock option</i> L = Locking N = Non-locking			
3. <i>Case Finish</i> See Finish Options page	Example: <b>W TSA5724OSFFLHL</b>	Add \$40 to the list price per standard key lock.	Towers with full door include a coat hook to be field installed.
4. <i>Front Finish</i> See Finish Options page	<b>W TSA</b> Anchor Tower, Side Access		
5. <i>Top Finish</i> See Finish Options page	<b>57</b> 50" High	Add \$15 to the list price per pull for Anodized Nickel (AN) or Aluminum (AA) finish.	
6. <i>Pull style</i> T = 10" finger pull	<b>24</b> 24" Wide		
7. <i>Pull finish</i> See Finish Options page	<b>OS</b> Locker configuration, Open with Shelves	Towers specified with mixed laminate finishes are L2 pricing. Refer to Mixed Laminate Finishes for further details.	
8. <i>Lock finish</i> B = Black C = Chrome	<b>FF</b> Pedestal configuration, File/File		
9. <i>Pre-drill for (optional) Front Panel</i> D = Drilled N = Non-drill	<b>LH</b> Left hand <b>L</b> Laminate <b>(L)</b> Lock option, Locking <b>(118)</b> Case Finish <b>(118)</b> Front Finish <b>(118)</b> Top Finish <b>(T)</b> Pull Style <b>(118)</b> Pull Finish <b>(C)</b> Lock finish, Chrome <b>(D)</b> Drilled for front panel	Dimensions listed under w h d are actual to the nearest 1/16".  A laminate or markerboard front panel may be specified (separately) for side access towers. To accept front panel mounting hardware, side access towers must be specified with "D" for a predrilled front.	

# Towers

## 57" High Side Access Open, Full Door Locker

### 24" and 30" wide

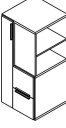
description	pedestal configuration	w	d	h	pattern no.	L1	L2
Tower, Side Access Open, Full Door Locker Left Hand, 57" high, 24" wide 	Open Pedestal	24"	23 1/2"	56 3/16"	<b>W TSA5724FDO1LHL(N)</b>	\$1,956.	\$2,673.
	Full Door Pedestal	24"	23 1/2"	56 3/16"	<b>W TSA5724FDFDLHL(N)</b>	2,149.	2,915.
	Open/File Pedestal	24"	23 1/2"	56 3/16"	<b>W TSA5724FDOFLHL(N)</b>	2,260.	3,024.
	File/File Pedestal (shown)	24"	23 1/2"	56 3/16"	<b>W TSA5724FDFFLHL(N)</b>	2,364.	3,089.
	Open/Box/File Pedestal	24"	23 1/2"	56 3/16"	<b>W TSA5724FDOBLHL(N)</b>	2,385.	3,129.
	Box (File Front)/File Pedestal	24"	23 1/2"	56 3/16"	<b>W TSA5724FDCFLHL(N)</b>	2,430.	3,192.
	Box/Box(File Front) File Pedestal	24"	23 1/2"	56 3/16"	<b>W TSA5724FDCBLHL(N)</b>	2,513.	3,256.

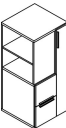
Tower, Side Access Open, Full Door Locker Right Hand, 57" high, 24" wide 	Open Pedestal	24"	23 1/2"	56 3/16"	<b>W TSA5724FDO1RHL(N)</b>	1,956.	2,673.
	Full Door Pedestal	24"	23 1/2"	56 3/16"	<b>W TSA5724FDFDRHL(N)</b>	2,149.	2,915.
	Open/File Pedestal	24"	23 1/2"	56 3/16"	<b>W TSA5724FDOFRHL(N)</b>	2,260.	3,024.
	File/File Pedestal (shown)	24"	23 1/2"	56 3/16"	<b>W TSA5724FDFFRHL(N)</b>	2,364.	3,089.
	Open/Box/File Pedestal	24"	23 1/2"	56 3/16"	<b>W TSA5724FDOBRHL(N)</b>	2,385.	3,129.
	Box (File Front)/File Pedestal	24"	23 1/2"	56 3/16"	<b>W TSA5724FDCFRHL(N)</b>	2,430.	3,192.
	Box/Box(File Front) File Pedestal	24"	23 1/2"	56 3/16"	<b>W TSA5724FDCBRHL(N)</b>	2,513.	3,256.

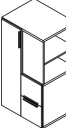
Tower, Side Access Open, Full Door Locker Left Hand, 57" high, 30" wide 	Open Pedestal	30"	23 1/2"	56 3/16"	<b>W TSA5730FDO1LHL(N)</b>	2,158.	2,969.
	Full Door Pedestal	30"	23 1/2"	56 3/16"	<b>W TSA5730FDFDLHL(N)</b>	2,350.	3,210.
	Open/File Pedestal	30"	23 1/2"	56 3/16"	<b>W TSA5730FDOFLHL(N)</b>	2,462.	3,319.
	File/File Pedestal (shown)	30"	23 1/2"	56 3/16"	<b>W TSA5730FDFFLHL(N)</b>	2,566.	3,385.
	Open/Box/File Pedestal	30"	23 1/2"	56 3/16"	<b>W TSA5730FDOBLHL(N)</b>	2,587.	3,425.
	Box (File Front)/File Pedestal	30"	23 1/2"	56 3/16"	<b>W TSA5730FDCFLHL(N)</b>	2,630.	3,487.
	Box/Box(File Front) File Pedestal	30"	23 1/2"	56 3/16"	<b>W TSA5730FDCBLHL(N)</b>	2,715.	3,552.

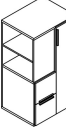
Tower, Side Access Open, Full Door Locker Right Hand, 57" high, 30" wide 	Open Pedestal	30"	23 1/2"	56 3/16"	<b>W TSA5730FDO1RHL(N)</b>	2,158.	2,969.
	Full Door Pedestal	30"	23 1/2"	56 3/16"	<b>W TSA5730FDFDRHL(N)</b>	2,350.	3,210.
	Open/File Pedestal	30"	23 1/2"	56 3/16"	<b>W TSA5730FDOFRHL(N)</b>	2,462.	3,319.
	File/File Pedestal (shown)	30"	23 1/2"	56 3/16"	<b>W TSA5730FDFFRHL(N)</b>	2,566.	3,385.
	Open/Box/File Pedestal	30"	23 1/2"	56 3/16"	<b>W TSA5730FDOBRHL(N)</b>	2,587.	3,425.
	Box (File Front)/File Pedestal	30"	23 1/2"	56 3/16"	<b>W TSA5730FDCFRHL(N)</b>	2,630.	3,487.
	Box/Box(File Front) File Pedestal	30"	23 1/2"	56 3/16"	<b>W TSA5730FDCBRHL(N)</b>	2,715.	3,552.

Order Information	Order Code	Specification Information	Application Notes
1. <i>Base Pattern Number</i>	Tower, Side Access Open, Full Door Locker, 57" high, 24" wide, F/F pedestal, Left hand	Refer to Tower Shelf count for number of included shelves with each interior configuration.	Towers 24" deep (nominal) have a 23 1/2" deep case; 24 3/8" overall depth including door.
2. <i>Lock option</i> L = Locking N = Non-locking			
3. <i>Case Finish</i> See Finish Options page	Example: <b>W TSA5724FDFFLHL</b>	Add \$40 to the list price per standard key lock.	Towers with full door include a coat hook to be field installed.
4. <i>Front Finish</i> See Finish Options page	<b>W TSA</b> Anchor Tower, Side Access		
5. <i>Top Finish</i> See Finish Options page	<b>57</b> 42" High	Add \$15 to the list price per pull for Anodized Nickel (AN) or Aluminum (AA) finish.	
6. <i>Pull style</i> T = 10" finger pull	<b>24</b> 24" Wide		
7. <i>Pull finish</i> See Finish Options page	<b>FD</b> Locker configuration, Full Door	Towers specified with mixed laminate finishes are L2 pricing. Refer to Mixed Laminate Finishes for further details.	
8. <i>Lock finish</i> B = Black C = Chrome	<b>FF</b> Pedestal configuration, File/File		
9. <i>Pre-drill for (optional) Front Panel</i> D = Drilled N = Non-drill	<b>LH</b> Left hand <b>L</b> Laminate <b>(L)</b> Lock option, Locking <b>(118)</b> Case Finish <b>(118)</b> Front Finish <b>(118)</b> Top Finish <b>(T)</b> Pull Style <b>(118)</b> Pull Finish <b>(C)</b> Lock finish, Chrome <b>(D)</b> Drilled for front panel	Dimensions listed under w h d are actual to the nearest 1/16".  A laminate or markerboard front panel may be specified (separately) for side access towers. To accept front panel mounting hardware, side access towers must be specified with "D" for a predrilled front.	

# Towers

## 64" High Side Access Open, Open Locker

### 24" and 30" wide

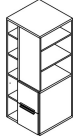
description	pedestal configuration	w	d	h	pattern no.	L1	L2
 Tower, Side Access Open, Open Locker Left Hand, 64" high, 24" wide	Open Pedestal	24"	23 1/2"	63 7/16"	<b>W TSA6424OSO1LHL</b>	\$1,973.	\$2,764.
	Full Door Pedestal	24"	23 1/2"	63 7/16"	<b>W TSA6424OSFDLHL(N)</b>	2,186.	3,036.
	Open/File Pedestal	24"	23 1/2"	63 7/16"	<b>W TSA6424OSOFHL(N)</b>	2,277.	3,115.
	File/File Pedestal (shown)	24"	23 1/2"	63 7/16"	<b>W TSA6424OSFFHL(N)</b>	2,381.	3,180.
	Open/Box/File Pedestal	24"	23 1/2"	63 7/16"	<b>W TSA6424OSOBHL(N)</b>	2,402.	3,221.
	Box (File Front)/File Pedestal	24"	23 1/2"	63 7/16"	<b>W TSA6424OSCFHL(N)</b>	2,447.	3,283.
	Box/Box(File Front) File Pedestal	24"	23 1/2"	63 7/16"	<b>W TSA6424OSCBHL(N)</b>	2,531.	3,348.

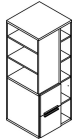
 Tower, Side Access Open, Open Locker Right Hand, 64" high, 24" wide	Open Pedestal	24"	23 1/2"	63 7/16"	<b>W TSA6424OSO1RHL</b>	1,973.	2,764.
	Full Door Pedestal	24"	23 1/2"	63 7/16"	<b>W TSA6424OSFDRHL(N)</b>	2,186.	3,036.
	Open/File Pedestal	24"	23 1/2"	63 7/16"	<b>W TSA6424OSOFRHL(N)</b>	2,277.	3,115.
	File/File Pedestal (shown)	24"	23 1/2"	63 7/16"	<b>W TSA6424OSFFRHL(N)</b>	2,381.	3,180.
	Open/Box/File Pedestal	24"	23 1/2"	63 7/16"	<b>W TSA6424OSOBRLHL(N)</b>	2,402.	3,221.
	Box (File Front)/File Pedestal	24"	23 1/2"	63 7/16"	<b>W TSA6424OSCFRHL(N)</b>	2,447.	3,283.
	Box/Box(File Front) File Pedestal	24"	23 1/2"	63 7/16"	<b>W TSA6424OSCBRLHL(N)</b>	2,531.	3,348.

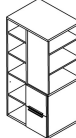
 Tower, Side Access Open, Open Locker Left Hand, 64" high, 30" wide	Open Pedestal	30"	23 1/2"	63 7/16"	<b>W TSA6430OSO1LHL</b>	2,175.	3,059.
	Full Door Pedestal	30"	23 1/2"	63 7/16"	<b>W TSA6430OSFDLHL(N)</b>	2,388.	3,331.
	Box (File Front)/File Pedestal	30"	23 1/2"	63 7/16"	<b>W TSA6430OSCFHL(N)</b>	2,479.	3,409.
	Open/File Pedestal	30"	23 1/2"	63 7/16"	<b>W TSA6430OSOFHL(N)</b>	2,479.	3,409.
	File/File Pedestal (shown)	30"	23 1/2"	63 7/16"	<b>W TSA6430OSFFHL(N)</b>	2,583.	3,475.
	Open/Box/File Pedestal	30"	23 1/2"	63 7/16"	<b>W TSA6430OSOBHL(N)</b>	2,604.	3,515.
	Box/Box(File Front) File Pedestal	30"	23 1/2"	63 7/16"	<b>W TSA6430OSCBHL(N)</b>	2,732.	3,642.

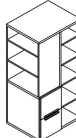
 Tower, Side Access Open, Open Locker Right Hand, 64" high, 30" wide	Open Pedestal	30"	23 1/2"	63 7/16"	<b>W TSA6430OSO1RHL</b>	2,175.	3,059.
	Full Door Pedestal	30"	23 1/2"	63 7/16"	<b>W TSA6430OSFDRHL(N)</b>	2,388.	3,331.
	Box (File Front)/File Pedestal	30"	23 1/2"	63 7/16"	<b>W TSA6430OSCFRHL(N)</b>	2,479.	3,409.
	Open/File Pedestal	30"	23 1/2"	63 7/16"	<b>W TSA6430OSOFRHL(N)</b>	2,479.	3,409.
	File/File Pedestal (shown)	30"	23 1/2"	63 7/16"	<b>W TSA6430OSFFRHL(N)</b>	2,583.	3,475.
	Open/Box/File Pedestal	30"	23 1/2"	63 7/16"	<b>W TSA6430OSOBRLHL(N)</b>	2,604.	3,515.
	Box/Box(File Front) File Pedestal	30"	23 1/2"	63 7/16"	<b>W TSA6430OSCBRLHL(N)</b>	2,732.	3,642.

Order Information	Order Code	Specification Information	Application Notes
1. <i>Base Pattern Number</i>	Tower, Side Access Open, Open Locker, 64" high, 24" wide, F/F pedestal, Left hand	Refer to Tower Shelf count for number of included shelves with each interior configuration.	Towers 24" deep (nominal) have a 23 1/2" deep case; 24 3/8" overall depth including door.
2. <i>Lock option</i> L = Locking N = Non-locking			
3. <i>Case Finish</i> See Finish Options page	Example: <b>W TSA6424OSFFLHL</b>	Add \$40 to the list price per standard key lock.	Towers with full door include a coat hook to be field installed.
4. <i>Front Finish</i> See Finish Options page	<b>W TSA</b> Anchor Tower, Side Access		
5. <i>Top Finish</i> See Finish Options page	<b>64</b> 50" High	Add \$15 to the list price per pull for Anodized Nickel (AN) or Aluminum (AA) finish.	
6. <i>Pull style</i> T = 10" finger pull	<b>24</b> 24" Wide		
7. <i>Pull finish</i> See Finish Options page	<b>OS</b> Locker configuration, Open with Shelves	Towers specified with mixed laminate finishes are L2 pricing. Refer to Mixed Laminate Finishes for further details.	
8. <i>Lock finish</i> B = Black C = Chrome	<b>FF</b> Pedestal configuration, File/File		
9. <i>Pre-drill for (optional) Front Panel</i> D = Drilled N = Non-drill	<b>LH</b> Left hand <b>L</b> Laminate <b>(L)</b> Lock option, Locking <b>(118)</b> Case Finish <b>(118)</b> Front Finish <b>(118)</b> Top Finish <b>(T)</b> Pull Style <b>(118)</b> Pull Finish <b>(C)</b> Lock finish, Chrome <b>(D)</b> Drilled for front panel	Dimensions listed under w h d are actual to the nearest 1/16".  A laminate or markerboard front panel may be specified (separately) for side access towers. To accept front panel mounting hardware, side access towers must be specified with "D" for a predrilled front.	

# Towers

## 64" High Side Access Open, Full Door Locker

### 24" and 30" wide

description	pedestal configuration	w	d	h	pattern no.	L1	L2
Tower, Side Access Open, Full Door Locker Left Hand, 64" high, 24" wide	Open Pedestal	24"	23 1/2"	63 7/16"	<b>W TSA6424FDO1LHL(N)</b>	\$2,136.	\$2,942.
	Full Door Pedestal	24"	23 1/2"	63 7/16"	<b>W TSA6424FDFDLHL(N)</b>	2,349.	3,214.
	Open/File Pedestal	24"	23 1/2"	63 7/16"	<b>W TSA6424FDOFLHL(N)</b>	2,440.	3,292.
	File/File Pedestal (shown)	24"	23 1/2"	63 7/16"	<b>W TSA6424FDFFLHL(N)</b>	2,544.	3,358.
	Open/Box/File Pedestal	24"	23 1/2"	63 7/16"	<b>W TSA6424FDOBLHL(N)</b>	2,565.	3,398.
	Box/Box(File Front) File Pedestal	24"	23 1/2"	63 7/16"	<b>W TSA6424FDCBLHL(N)</b>	2,568.	3,401.
	Box (File Front)/File Pedestal	24"	23 1/2"	63 7/16"	<b>W TSA6424FDCFLHL(N)</b>	2,610.	3,461.

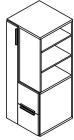

Tower, Side Access Open, Full Door Locker Right Hand, 64" high, 24" wide	Open Pedestal	24"	23 1/2"	63 7/16"	<b>W TSA6424FDO1RHL(N)</b>	2,136.	2,942.
	Full Door Pedestal	24"	23 1/2"	63 7/16"	<b>W TSA6424FDFDRHL(N)</b>	2,349.	3,214.
	Open/File Pedestal	24"	23 1/2"	63 7/16"	<b>W TSA6424FDOFRHL(N)</b>	2,440.	3,292.
	File/File Pedestal (shown)	24"	23 1/2"	63 7/16"	<b>W TSA6424FDFFRHL(N)</b>	2,544.	3,358.
	Open/Box/File Pedestal	24"	23 1/2"	63 7/16"	<b>W TSA6424FDOBRHL(N)</b>	2,565.	3,398.
	Box/Box(File Front) File Pedestal	24"	23 1/2"	63 7/16"	<b>W TSA6424FDCBRHL(N)</b>	2,568.	3,401.
	Box (File Front)/File Pedestal	24"	23 1/2"	63 7/16"	<b>W TSA6424FDCFRHL(N)</b>	2,610.	3,461.

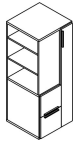

Tower, Side Access Open, Full Door Locker Left Hand, 64" high, 30" wide	Open Pedestal	30"	23 1/2"	63 7/16"	<b>W TSA6430FDO1LHL(N)</b>	2,351.	3,259.
	Full Door Pedestal	30"	23 1/2"	63 7/16"	<b>W TSA6430FDFDLHL(N)</b>	2,564.	3,531.
	Open/File Pedestal	30"	23 1/2"	63 7/16"	<b>W TSA6430FDOFLHL(N)</b>	2,655.	3,609.
	File/File Pedestal (shown)	30"	23 1/2"	63 7/16"	<b>W TSA6430FDFFLHL(N)</b>	2,759.	3,675.
	Open/Box/File Pedestal	30"	23 1/2"	63 7/16"	<b>W TSA6430FDOBLHL(N)</b>	2,780.	3,715.
	Box/Box(File Front) File Pedestal	30"	23 1/2"	63 7/16"	<b>W TSA6430FDCBLHL(N)</b>	2,783.	3,717.
	Box (File Front)/File Pedestal	30"	23 1/2"	63 7/16"	<b>W TSA6430FDCFLHL(N)</b>	2,824.	3,778.

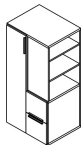

Tower, Side Access Open, Full Door Locker Right Hand, 64" high, 30" wide	Open Pedestal	30"	23 1/2"	63 7/16"	<b>W TSA6430FDO1RHL(N)</b>	2,351.	3,259.
	Full Door Pedestal	30"	23 1/2"	63 7/16"	<b>W TSA6430FDFDRHL(N)</b>	2,564.	3,531.
	Open/File Pedestal	30"	23 1/2"	63 7/16"	<b>W TSA6430FDOFRHL(N)</b>	2,655.	3,609.
	File/File Pedestal (shown)	30"	23 1/2"	63 7/16"	<b>W TSA6430FDFFRHL(N)</b>	2,759.	3,675.
	Open/Box/File Pedestal	30"	23 1/2"	63 7/16"	<b>W TSA6430FDOBRHL(N)</b>	2,780.	3,715.
	Box/Box(File Front) File Pedestal	30"	23 1/2"	63 7/16"	<b>W TSA6430FDCBRHL(N)</b>	2,783.	3,717.
	Box (File Front)/File Pedestal	30"	23 1/2"	63 7/16"	<b>W TSA6430FDCFRHL(N)</b>	2,824.	3,778.

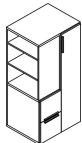

Order Information	Order Code	Specification Information	Application Notes
1. <i>Base Pattern Number</i>	Tower, Side Access Open, Full Door Locker, 64" high, 24" wide, F/F pedestal, Left hand	Refer to Tower Shelf count for number of included shelves with each interior configuration.	Towers 24" deep (nominal) have a 23 1/2" deep case; 24 3/8" overall depth including door.
2. <i>Lock option</i> L = Locking N = Non-locking			
3. <i>Case Finish</i> See Finish Options page	Example: <b>W TSA6424FDFFLHL</b>	Add \$40 to the list price per standard key lock.	Towers with full door include a coat hook to be field installed.
4. <i>Front Finish</i> See Finish Options page	<b>W TSA</b> Anchor Tower, Side Access		
5. <i>Top Finish</i> See Finish Options page	<b>64</b> 42" High	Add \$15 to the list price per pull for Anodized Nickel (AN) or Aluminum (AA) finish.	
6. <i>Pull style</i> T = 10" finger pull	<b>24</b> 24" Wide		
7. <i>Pull finish</i> See Finish Options page	<b>FD</b> Locker configuration, Full Door	Towers specified with mixed laminate finishes are L2 pricing. Refer to Mixed Laminate Finishes for further details.	
8. <i>Lock finish</i> B = Black C = Chrome	<b>FF</b> Pedestal configuration, File/File		
9. <i>Pre-drill for (optional) Front Panel</i> D = Drilled N = Non-drill	<b>LH</b> Left hand <b>L</b> Laminate <b>(L)</b> Lock option, Locking <b>(118)</b> Case Finish <b>(118)</b> Front Finish <b>(118)</b> Top Finish <b>(T)</b> Pull Style <b>(118)</b> Pull Finish <b>(C)</b> Lock finish, Chrome <b>(D)</b> Drilled for front panel	Dimensions listed under w h d are actual to the nearest 1/16".  A laminate or markerboard front panel may be specified (separately) for side access towers. To accept front panel mounting hardware, side access towers must be specified with "D" for a predrilled front.	

# Towers

## 42 High Front Access Open, Open Locker

### 24" and 30" wide

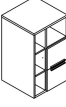
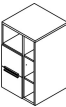
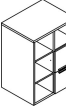
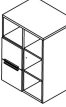
description	pedestal configuration	w	d	h	pattern no.	L1	L2
Tower, Front Access Open, Open Locker Left Hand, 42" high, 24" wide 	Open Pedestal	24"	23 1/2"	41 9/16"	<b>WTFO4224OSO1LHL</b>	\$1,433.	\$1,937.
	Full Door Pedestal	24"	23 1/2"	41 9/16"	<b>WTFO4224OSFDLHL(N)</b>	1,532.	2,043.
	Open/File Pedestal	24"	23 1/2"	41 9/16"	<b>WTFO4224OSOFLLHL(N)</b>	1,737.	2,288.
	File/File Pedestal (shown)	24"	23 1/2"	41 9/16"	<b>WTFO4224OSFFLHL(N)</b>	1,839.	2,350.
	Open/Box/File Pedestal	24"	23 1/2"	41 9/16"	<b>WTFO4224OSOBLHL(N)</b>	1,862.	2,393.
	Box (File Front)/File Pedestal	24"	23 1/2"	41 9/16"	<b>WTFO4224OSCFLLHL(N)</b>	1,948.	2,497.
	Box/Box(File Front) File Pedestal	24"	23 1/2"	41 9/16"	<b>WTFO4224OSCBLLHL(N)</b>	1,989.	2,517.
Tower, Front Access Open, Open Locker Right Hand, 42" high, 24" wide 	Open Pedestal	24"	23 1/2"	41 9/16"	<b>WTFO4224OSO1RHL</b>	1,433.	1,937.
	Full Door Pedestal	24"	23 1/2"	41 9/16"	<b>WTFO4224OSFDRHL(N)</b>	1,532.	2,043.
	Open/File Pedestal	24"	23 1/2"	41 9/16"	<b>WTFO4224OSOFRRHL(N)</b>	1,737.	2,288.
	File/File Pedestal (shown)	24"	23 1/2"	41 9/16"	<b>WTFO4224OSFRRHL(N)</b>	1,839.	2,350.
	Open/Box/File Pedestal	24"	23 1/2"	41 9/16"	<b>WTFO4224OSOBRHL(N)</b>	1,862.	2,393.
	Box (File Front)/File Pedestal	24"	23 1/2"	41 9/16"	<b>WTFO4224OSCFRRHL(N)</b>	1,948.	2,497.
	Box/Box(File Front) File Pedestal	24"	23 1/2"	41 9/16"	<b>WTFO4224OSCBRRHL(N)</b>	1,989.	2,517.
Tower, Front Access Open, Open Locker Left Hand, 42" high, 30" wide 	Open Pedestal	30"	23 1/2"	41 9/16"	<b>WTFO4230OSO1LHL</b>	1,589.	2,162.
	Full Door Pedestal	30"	23 1/2"	41 9/16"	<b>WTFO4230OSFDLHL(N)</b>	1,687.	2,268.
	Open/File Pedestal	30"	23 1/2"	41 9/16"	<b>WTFO4230OSOFLLHL(N)</b>	1,893.	2,513.
	File/File Pedestal (shown)	30"	23 1/2"	41 9/16"	<b>WTFO4230OSFFLHL(N)</b>	1,995.	2,575.
	Open/Box/File Pedestal	30"	23 1/2"	41 9/16"	<b>WTFO4230OSOBLHL(N)</b>	2,018.	2,618.
	Box (File Front)/File Pedestal	30"	23 1/2"	41 9/16"	<b>WTFO4230OSCFLLHL(N)</b>	2,104.	2,722.
	Box/Box(File Front) File Pedestal	30"	23 1/2"	41 9/16"	<b>WTFO4230OSCBLLHL(N)</b>	2,144.	2,742.
Tower, Front Access Open, Open Locker Right Hand, 42" high, 30" wide 	Open Pedestal	30"	23 1/2"	41 9/16"	<b>WTFO4230OSO1RHL</b>	1,589.	2,162.
	Full Door Pedestal	30"	23 1/2"	41 9/16"	<b>WTFO4230OSFDRHL(N)</b>	1,687.	2,268.
	Open/File Pedestal	30"	23 1/2"	41 9/16"	<b>WTFO4230OSOFRRHL(N)</b>	1,893.	2,513.
	File/File Pedestal (shown)	30"	23 1/2"	41 9/16"	<b>WTFO4230OSFRRHL(N)</b>	1,995.	2,575.
	Open/Box/File Pedestal	30"	23 1/2"	41 9/16"	<b>WTFO4230OSOBRHL(N)</b>	2,018.	2,618.
	Box (File Front)/File Pedestal	30"	23 1/2"	41 9/16"	<b>WTFO4230OSCFRRHL(N)</b>	2,104.	2,722.
	Box/Box(File Front) File Pedestal	30"	23 1/2"	41 9/16"	<b>WTFO4230OSCBRRHL(N)</b>	2,144.	2,742.

Order Information	Order Code	Specification Information	Application Notes
1. <i>Base Pattern Number</i>	Tower, Front Access Open, Open Locker, 42" high, 24" wide, F/F pedestal, Left hand	Refer to Tower Shelf count for number of included shelves with each interior configuration.	Towers 24" deep (nominal) have a 23 1/2" deep case; 24 3/8" overall depth including door.
2. <i>Lock option</i> L = Locking N = Non-locking			
3. <i>Case Finish</i> See Finish Options page	Example: <b>WTFO4224OSFFLHL</b>	Add \$40 to the list price per standard key lock.	Towers with full door include a coat hook to be field installed.
4. <i>Front Finish</i> See Finish Options page	<b>WTFO</b> Anchor Tower, Front Access Open		
5. <i>Top Finish</i> See Finish Options page	<b>42</b> 42" High	Add \$15 to the list price per pull for Anodized Nickel (AN) or Aluminum (AA) finish.	
6. <i>Pull style</i> T = 10" finger pull	<b>24</b> 24" Wide		
7. <i>Pull finish</i> See Finish Options page	<b>OS</b> Locker configuration, open with shelves	Towers specified with mixed laminate finishes are L2 pricing. Refer to Mixed Laminate Finishes for further details.	
8. <i>Lock finish</i> B = Black C = Chrome	<b>FF</b> Pedestal configuration, File/File		
	<b>LH</b> Left hand	Dimensions listed under w h d are actual to the nearest 1/16".	
	<b>L</b> Laminate		
	<b>(L)</b> Lock option, Locking		
	<b>(118)</b> Case Finish		
	<b>(118)</b> Front Finish		
	<b>(118)</b> Top Finish		
	<b>(T)</b> Pull Style		
	<b>(118)</b> Pull Finish		
	<b>(C)</b> Lock finish, Chrome		

# Towers

## 42 High Front Access Open, Full Door Locker

### 24" and 30" wide

description	pedestal configuration	w	d	h	pattern no.	L1	L2
Tower, Front Access Open, Full Door Locker Left Hand, 42" high, 24" wide 	Open Pedestal	24"	23 1/2"	41 9/16"	<b>WTFO4224FDO1LHL(N)</b>	\$1,593.	\$2,108.
	Full Door Pedestal	24"	23 1/2"	41 9/16"	<b>WTFO4224FDFDLHL(N)</b>	1,691.	2,215.
	Open/File Pedestal	24"	23 1/2"	41 9/16"	<b>WTFO4224FDOFLHL(N)</b>	1,897.	2,460.
	File/File Pedestal	24"	23 1/2"	41 9/16"	<b>WTFO4224FDFFLHL(N)</b>	1,999.	2,521.
	Open/Box/File Pedestal	24"	23 1/2"	41 9/16"	<b>WTFO4224FDOBLHL(N)</b>	2,022.	2,565.
	Box (File Front)/File Pedestal	24"	23 1/2"	41 9/16"	<b>WTFO4224FDCFLHL(N)</b>	2,067.	2,628.
	Box/Box(File Front) File Pedestal	24"	23 1/2"	41 9/16"	<b>WTFO4224FDCBLHL(N)</b>	2,190.	2,730.

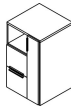
Tower, Front Access Open, Full Door Locker Right Hand, 42" high, 24" wide 	Open Pedestal	24"	23 1/2"	41 9/16"	<b>WTFO4224FDO1RHL(N)</b>	1,593.	2,108.
	Full Door Pedestal	24"	23 1/2"	41 9/16"	<b>WTFO4224FDFDRHL(N)</b>	1,691.	2,215.
	Open/File Pedestal	24"	23 1/2"	41 9/16"	<b>WTFO4224FDOFRHL(N)</b>	1,897.	2,460.
	File/File Pedestal	24"	23 1/2"	41 9/16"	<b>WTFO4224FDFFRHL(N)</b>	1,999.	2,521.
	Open/Box/File Pedestal	24"	23 1/2"	41 9/16"	<b>WTFO4224FDOBRHL(N)</b>	2,022.	2,565.
	Box (File Front)/File Pedestal	24"	23 1/2"	41 9/16"	<b>WTFO4224FDCFRHL(N)</b>	2,067.	2,628.
	Box/Box(File Front) File Pedestal	24"	23 1/2"	41 9/16"	<b>WTFO4224FDCBRHL(N)</b>	2,190.	2,730.

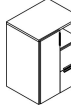
Tower, Front Access Open, Full Door Locker Left Hand, 42" high, 30" wide 	Open Pedestal	30"	23 1/2"	41 9/16"	<b>WTFO4230FDO1LHL(N)</b>	1,766.	2,359.
	Full Door Pedestal	30"	23 1/2"	41 9/16"	<b>WTFO4230FDFDLHL(N)</b>	1,864.	2,465.
	Open/File Pedestal	30"	23 1/2"	41 9/16"	<b>WTFO4230FDOFLHL(N)</b>	2,070.	2,711.
	File/File Pedestal	30"	23 1/2"	41 9/16"	<b>WTFO4230FDFFLHL(N)</b>	2,172.	2,772.
	Open/Box/File Pedestal	30"	23 1/2"	41 9/16"	<b>WTFO4230FDOBLHL(N)</b>	2,195.	2,815.
	Box (File Front)/File Pedestal	30"	23 1/2"	41 9/16"	<b>WTFO4230FDCFLHL(N)</b>	2,239.	2,878.
	Box/Box(File Front) File Pedestal	30"	23 1/2"	41 9/16"	<b>WTFO4230FDCBLHL(N)</b>	2,362.	2,981.

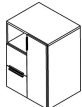
Tower, Front Access Open, Full Door Locker Right Hand, 42" high, 30" wide 	Open Pedestal	30"	23 1/2"	41 9/16"	<b>WTFO4230FDO1RHL(N)</b>	1,766.	2,359.
	Full Door Pedestal	30"	23 1/2"	41 9/16"	<b>WTFO4230FDFDRHL(N)</b>	1,864.	2,465.
	Open/File Pedestal	30"	23 1/2"	41 9/16"	<b>WTFO4230FDOFRHL(N)</b>	2,070.	2,711.
	File/File Pedestal	30"	23 1/2"	41 9/16"	<b>WTFO4230FDFFRHL(N)</b>	2,172.	2,772.
	Open/Box/File Pedestal	30"	23 1/2"	41 9/16"	<b>WTFO4230FDOBRHL(N)</b>	2,195.	2,815.
	Box (File Front)/File Pedestal	30"	23 1/2"	41 9/16"	<b>WTFO4230FDCFRHL(N)</b>	2,239.	2,878.
	Box/Box(File Front) File Pedestal	30"	23 1/2"	41 9/16"	<b>WTFO4230FDCBRHL(N)</b>	2,362.	2,981.

Order Information	Order Code	Specification Information	Application Notes
1. <i>Base Pattern Number</i>	Tower, Front Access Open, Full Door Locker, 42" high, 24" wide, F/F pedestal, Left hand	Refer to Tower Shelf count for number of included shelves with each interior configuration.	Towers 24" deep (nominal) have a 23 1/2" deep case; 24 3/8" overall depth including door.
2. <i>Lock option</i> L = Locking N = Non-locking			
3. <i>Case Finish</i> See Finish Options page	Example: <b>WTFO4224FDFFLHL</b>	Add \$40 to the list price per standard key lock.	Towers with full door include a coat hook to be field installed.
4. <i>Front Finish</i> See Finish Options page	<b>WTFO</b> Anchor Tower, Front Access Open		
5. <i>Top Finish</i> See Finish Options page	<b>42</b> 42" High	Add \$15 to the list price per pull for Anodized Nickel (AN) or Aluminum (AA) finish.	
6. <i>Pull style</i> T = 10" finger pull	<b>24</b> 24" Wide		
7. <i>Pull finish</i> See Finish Options page	<b>FD</b> Locker configuration, Full Door	Towers specified with mixed laminate finishes are L2 pricing. Refer to Mixed Laminate Finishes for further details.	
8. <i>Lock finish</i> B = Black C = Chrome	<b>FF</b> Pedestal configuration, File/File		
	<b>LH</b> Left hand	Dimensions listed under w h d are actual to the nearest 1/16".	
	<b>L</b> Laminate		
	<b>(L)</b> Lock option, Locking		
	<b>(118)</b> Case Finish		
	<b>(118)</b> Front Finish		
	<b>(118)</b> Top Finish		
	<b>(T)</b> Pull Style		
	<b>(118)</b> Pull Finish		
	<b>(C)</b> Lock finish, Chrome		

# Towers

## 50" High Front Access Open, Open Locker

### 24" and 30" wide

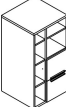
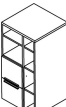
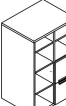
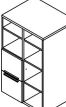
description	pedestal configuration	w	d	h	pattern no.	L1	L2
Tower, Front Access Open, Open Locker Left Hand, 50" high, 24" wide 	Open Pedestal	24"	23 1/2"	48 7/8"	<b>WTFO5024OSO1LHL</b>	\$1,633.	\$2,231.
	Full Door Pedestal	24"	23 1/2"	48 7/8"	<b>WTFO5024OSFDLHL(N)</b>	1,731.	2,337.
	Open/File Pedestal	24"	23 1/2"	48 7/8"	<b>WTFO5024OSOFLLHL(N)</b>	1,936.	2,582.
	File/File Pedestal	24"	23 1/2"	48 7/8"	<b>WTFO5024OSFFLHL(N)</b>	2,039.	2,644.
	Open/Box/File Pedestal	24"	23 1/2"	48 7/8"	<b>WTFO5024OSOBLHL(N)</b>	2,062.	2,687.
	Box (File Front)/File Pedestal	24"	23 1/2"	48 7/8"	<b>WTFO5024OSCFLLHL(N)</b>	2,148.	2,791.
	Box/Box(File Front) File Pedestal	24"	23 1/2"	48 7/8"	<b>WTFO5024OSCBLLHL(N)</b>	2,188.	2,811.
Tower, Front Access Open, Open Locker Right Hand, 50" high, 24" wide 	Open Pedestal	24"	23 1/2"	48 7/8"	<b>WTFO5024OSO1RHL</b>	1,633.	2,231.
	Full Door Pedestal	24"	23 1/2"	48 7/8"	<b>WTFO5024OSFDRHL(N)</b>	1,731.	2,337.
	Open/File Pedestal	24"	23 1/2"	48 7/8"	<b>WTFO5024OSOFRRHL(N)</b>	1,936.	2,582.
	File/File Pedestal	24"	23 1/2"	48 7/8"	<b>WTFO5024OSFRRHL(N)</b>	2,039.	2,644.
	Open/Box/File Pedestal	24"	23 1/2"	48 7/8"	<b>WTFO5024OSOBRHL(N)</b>	2,062.	2,687.
	Box (File Front)/File Pedestal	24"	23 1/2"	48 7/8"	<b>WTFO5024OSCFRRHL(N)</b>	2,148.	2,791.
	Box/Box(File Front) File Pedestal	24"	23 1/2"	48 7/8"	<b>WTFO5024OSCBRRHL(N)</b>	2,188.	2,811.
Tower, Front Access Open, Open Locker Left Hand, 50" high, 30" wide 	Open Pedestal	30"	23 1/2"	48 7/8"	<b>WTFO5030OSO1LHL</b>	1,796.	2,468.
	Full Door Pedestal	30"	23 1/2"	48 7/8"	<b>WTFO5030OSFDLHL(N)</b>	1,895.	2,574.
	Open/File Pedestal	30"	23 1/2"	48 7/8"	<b>WTFO5030OSOFLLHL(N)</b>	2,100.	2,819.
	File/File Pedestal	30"	23 1/2"	48 7/8"	<b>WTFO5030OSFFLHL(N)</b>	2,202.	2,881.
	Open/Box/File Pedestal	30"	23 1/2"	48 7/8"	<b>WTFO5030OSOBLHL(N)</b>	2,225.	2,924.
	Box (File Front)/File Pedestal	30"	23 1/2"	48 7/8"	<b>WTFO5030OSCFLLHL(N)</b>	2,311.	3,028.
	Box/Box(File Front) File Pedestal	30"	23 1/2"	48 7/8"	<b>WTFO5030OSCBLLHL(N)</b>	2,351.	3,048.
Tower, Front Access Open, Open Locker Right Hand, 50" high, 30" wide 	Open Pedestal	30"	23 1/2"	48 7/8"	<b>WTFO5030OSO1RHL</b>	1,796.	2,468.
	Full Door Pedestal	30"	23 1/2"	48 7/8"	<b>WTFO5030OSFDRHL(N)</b>	1,895.	2,574.
	Open/File Pedestal	30"	23 1/2"	48 7/8"	<b>WTFO5030OSOFRRHL(N)</b>	2,100.	2,819.
	File/File Pedestal	30"	23 1/2"	48 7/8"	<b>WTFO5030OSFRRHL(N)</b>	2,202.	2,881.
	Open/Box/File Pedestal	30"	23 1/2"	48 7/8"	<b>WTFO5030OSOBRHL(N)</b>	2,225.	2,924.
	Box (File Front)/File Pedestal	30"	23 1/2"	48 7/8"	<b>WTFO5030OSCFRRHL(N)</b>	2,311.	3,028.
	Box/Box(File Front) File Pedestal	30"	23 1/2"	48 7/8"	<b>WTFO5030OSCBRRHL(N)</b>	2,351.	3,048.

Order Information	Order Code	Specification Information	Application Notes
1. <i>Base Pattern Number</i>	Tower, Front Access Open,	Refer to Tower Shelf count for	Towers 24" deep (nominal) have a
2. <i>Lock option</i>	Open Locker, 50" high, 24" wide,	number of included shelves with	23 1/2" deep case; 24 3/8" overall
	L = Locking	each interior configuration.	depth including door.
	N = Non-locking		
3. <i>Case Finish</i>	Example: <b>WTFO5024FDFFLHL</b>	Add \$40 to the list price per	Towers with full door include a coat
	<b>WTFO</b> Anchor Tower, Front	standard key lock.	hook to be field installed.
	Access Open		
4. <i>Front Finish</i>	<b>50</b> 50" High	Add \$15 to the list price per pull for	
	<b>24</b> 24" Wide	Anodized Nickel (AN) or Aluminum	
5. <i>Top Finish</i>	<b>FD</b> Locker configuration,	(AA) finish.	
	Full Door	Towers specified with mixed	
6. <i>Pull style</i>	<b>FF</b> Pedestal configuration,	laminates finishes are L2 pricing.	
	File/File	Refer to Mixed Laminate Finishes	
7. <i>Pull finish</i>	<b>LH</b> Left hand	for further details.	
	<b>L</b> Laminate	Dimensions listed under w h d are	
8. <i>Lock finish</i>	<b>(L)</b> Lock option, Locking	actual to the nearest 1/16".	
	<b>(118)</b> Case Finish		
	<b>(118)</b> Front Finish		
	<b>(118)</b> Top Finish		
	<b>(T)</b> Pull Style		
	<b>(118)</b> Pull Finish		
	<b>(C)</b> Lock finish, Chrome		

# Towers

## 50" High Front Access Open, Full Door Locker

### 24" and 30" wide

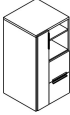
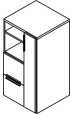
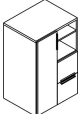
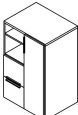
description	pedestal configuration	w	d	h	pattern no.	L1	L2
Tower, Front Access Open, Full Door Locker Left Hand, 50" high, 24" wide 	Open Pedestal	24"	23 1/2"	48 7/8"	<b>WTFO5024FDO1LHL</b>	\$1,806.	\$2,421.
	Full Door Pedestal	24"	23 1/2"	48 7/8"	<b>WTFO5024FDFDLHL(N)</b>	1,904.	2,527.
	Open/File Pedestal	24"	23 1/2"	48 7/8"	<b>WTFO5024FDOFLHL(N)</b>	2,109.	2,772.
	File/File Pedestal	24"	23 1/2"	48 7/8"	<b>WTFO5024FDFFLHL(N)</b>	2,212.	2,834.
	Open/Box/File Pedestal	24"	23 1/2"	48 7/8"	<b>WTFO5024FDOBLHL(N)</b>	2,235.	2,877.
	Box (File Front)/File Pedestal	24"	23 1/2"	48 7/8"	<b>WTFO5024FDCFLHL(N)</b>	2,279.	2,940.
	Box/Box(File Front) File Pedestal	24"	23 1/2"	48 7/8"	<b>WTFO5024FDCBLHL(N)</b>	2,402.	3,043.
Tower, Front Access Open, Full Door Locker Right Hand, 50" high, 24" wide 	Open Pedestal	24"	23 1/2"	48 7/8"	<b>WTFO5024FDO1RHL</b>	1,806.	2,421.
	Full Door Pedestal	24"	23 1/2"	48 7/8"	<b>WTFO5024FDFDRHL(N)</b>	1,904.	2,527.
	Open/File Pedestal	24"	23 1/2"	48 7/8"	<b>WTFO5024FDOFRHL(N)</b>	2,109.	2,772.
	File/File Pedestal	24"	23 1/2"	48 7/8"	<b>WTFO5024FDFFRHL(N)</b>	2,212.	2,834.
	Open/Box/File Pedestal	24"	23 1/2"	48 7/8"	<b>WTFO5024FDOBRHL(N)</b>	2,235.	2,877.
	Box (File Front)/File Pedestal	24"	23 1/2"	48 7/8"	<b>WTFO5024FDCFRHL(N)</b>	2,279.	2,940.
	Box/Box(File Front) File Pedestal	24"	23 1/2"	48 7/8"	<b>WTFO5024FDCBRHL(N)</b>	2,402.	3,043.
Tower, Front Access Open, Full Door Locker Left Hand, 50" high, 30" wide 	Open Pedestal	30"	23 1/2"	48 7/8"	<b>WTFO5030FDO1LHL</b>	1,993.	2,695.
	Full Door Pedestal	30"	23 1/2"	48 7/8"	<b>WTFO5030FDFDLHL(N)</b>	2,092.	2,802.
	Open/File Pedestal	30"	23 1/2"	48 7/8"	<b>WTFO5030FDOFLHL(N)</b>	2,297.	3,047.
	File/File Pedestal	30"	23 1/2"	48 7/8"	<b>WTFO5030FDFFLHL(N)</b>	2,400.	3,108.
	Open/Box/File Pedestal	30"	23 1/2"	48 7/8"	<b>WTFO5030FDOBLHL(N)</b>	2,422.	3,152.
	Box (File Front)/File Pedestal	30"	23 1/2"	48 7/8"	<b>WTFO5030FDCFLHL(N)</b>	2,467.	3,215.
	Box/Box(File Front) File Pedestal	30"	23 1/2"	48 7/8"	<b>WTFO5030FDCBLHL(N)</b>	2,590.	3,317.
Tower, Front Access Open, Full Door Locker Right Hand, 50" high, 30" wide 	Open Pedestal	30"	23 1/2"	48 7/8"	<b>WTFO5030FDO1RHL</b>	1,993.	2,695.
	Full Door Pedestal	30"	23 1/2"	48 7/8"	<b>WTFO5030FDFDRHL(N)</b>	2,092.	2,802.
	Open/File Pedestal	30"	23 1/2"	48 7/8"	<b>WTFO5030FDOFRHL(N)</b>	2,297.	3,047.
	File/File Pedestal	30"	23 1/2"	48 7/8"	<b>WTFO5030FDFFRHL(N)</b>	2,400.	3,108.
	Open/Box/File Pedestal	30"	23 1/2"	48 7/8"	<b>WTFO5030FDOBRHL(N)</b>	2,422.	3,152.
	Box (File Front)/File Pedestal	30"	23 1/2"	48 7/8"	<b>WTFO5030FDCFRHL(N)</b>	2,467.	3,215.
	Box/Box(File Front) File Pedestal	30"	23 1/2"	48 7/8"	<b>WTFO5030FDCBRHL(N)</b>	2,590.	3,317.

Order Information	Order Code	Specification Information	Application Notes
1. <i>Base Pattern Number</i>	Tower, Front Access Open, Full Door Locker, 50" high, 24" wide, F/F pedestal, Left hand	Refer to Tower Shelf count for number of included shelves with each interior configuration.	Towers 24" deep (nominal) have a 23 1/2" deep case; 24 3/8" overall depth including door.
2. <i>Lock option</i> L = Locking N = Non-locking			
3. <i>Case Finish</i> See Finish Options page	Example: <b>WTFO5024FDFFLHL</b>	Add \$40 to the list price per standard key lock.	Towers with full door include a coat hook to be field installed.
4. <i>Front Finish</i> See Finish Options page	<b>WTFO</b> Anchor Tower, Front Access Open		
5. <i>Top Finish</i> See Finish Options page	<b>50</b> 50" High	Add \$15 to the list price per pull for Anodized Nickel (AN) or Aluminum (AA) finish.	
6. <i>Pull style</i> T = 10" finger pull	<b>24</b> 24" Wide		
7. <i>Pull finish</i> See Finish Options page	<b>FD</b> Locker configuration, Full Door	Towers specified with mixed laminate finishes are L2 pricing. Refer to Mixed Laminate Finishes for further details.	
8. <i>Lock finish</i> B = Black C = Chrome	<b>FF</b> Pedestal configuration, File/File		
	<b>LH</b> Left hand	Dimensions listed under w h d are actual to the nearest 1/16".	
	<b>L</b> Laminate		
	<b>(L)</b> Lock option, Locking		
	<b>(118)</b> Case Finish		
	<b>(118)</b> Front Finish		
	<b>(118)</b> Top Finish		
	<b>(T)</b> Pull Style		
	<b>(118)</b> Pull Finish		
	<b>(C)</b> Lock finish, Chrome		



# Towers

## 57" High Front Access Open, Open Locker

### 24" and 30" wide

description	pedestal configuration	w	d	h	pattern no.	L1	L2
Tower, Front Access Open, Open Locker Left Hand, 57" high, 24" wide	Open Pedestal	24"	23 1/2"	56 3/16"	<b>WTFO5724OSO1LHL</b>	\$1,797.	\$2,467.
	Full Door Pedestal	24"	23 1/2"	56 3/16"	<b>WTFO5724OSFDLHL(N)</b>	1,895.	2,573.
	Open/File Pedestal	24"	23 1/2"	56 3/16"	<b>WTFO5724OSOFHL(N)</b>	2,101.	2,818.
	File/File Pedestal	24"	23 1/2"	56 3/16"	<b>WTFO5724OSFFHL(N)</b>	2,203.	2,880.
	Open/Box/File Pedestal	24"	23 1/2"	56 3/16"	<b>WTFO5724OSOBHL(N)</b>	2,226.	2,923.
	Box (File Front)/File Pedestal	24"	23 1/2"	56 3/16"	<b>WTFO5724OSCFHL(N)</b>	2,312.	3,027.
	Box/Box(File Front) File Pedestal	24"	23 1/2"	56 3/16"	<b>WTFO5724OSCBHL(N)</b>	2,352.	3,047.

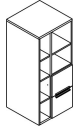

Tower, Front Access Open, Open Locker Right Hand, 57" high, 24" wide	Open Pedestal	24"	23 1/2"	56 3/16"	<b>WTFO5724OSO1RHL</b>	1,797.	2,467.
	Full Door Pedestal	24"	23 1/2"	56 3/16"	<b>WTFO5724OSFDRHL(N)</b>	1,895.	2,573.
	Open/File Pedestal	24"	23 1/2"	56 3/16"	<b>WTFO5724OSOFRHL(N)</b>	2,101.	2,818.
	File/File Pedestal	24"	23 1/2"	56 3/16"	<b>WTFO5724OSFRHL(N)</b>	2,203.	2,880.
	Open/Box/File Pedestal	24"	23 1/2"	56 3/16"	<b>WTFO5724OSOBRLHL(N)</b>	2,226.	2,923.
	Box (File Front)/File Pedestal	24"	23 1/2"	56 3/16"	<b>WTFO5724OSCFRHL(N)</b>	2,312.	3,027.
	Box/Box(File Front) File Pedestal	24"	23 1/2"	56 3/16"	<b>WTFO5724OSCBRLHL(N)</b>	2,352.	3,047.

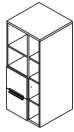

Tower, Front Access Open, Open Locker Left Hand, 57" high, 30" wide	Open Pedestal	30"	23 1/2"	56 3/16"	<b>WTFO5730OSO1LHL</b>	1,992.	2,751.
	Full Door Pedestal	30"	23 1/2"	56 3/16"	<b>WTFO5730OSFDLHL(N)</b>	2,090.	2,857.
	Open/File Pedestal	30"	23 1/2"	56 3/16"	<b>WTFO5730OSOFHL(N)</b>	2,296.	3,102.
	File/File Pedestal	30"	23 1/2"	56 3/16"	<b>WTFO5730OSFFHL(N)</b>	2,398.	3,164.
	Open/Box/File Pedestal	30"	23 1/2"	56 3/16"	<b>WTFO5730OSOBHL(N)</b>	2,421.	3,207.
	Box (File Front)/File Pedestal	30"	23 1/2"	56 3/16"	<b>WTFO5730OSCFHL(N)</b>	2,507.	3,311.
	Box/Box(File Front) File Pedestal	30"	23 1/2"	56 3/16"	<b>WTFO5730OSCBHL(N)</b>	2,547.	3,331.

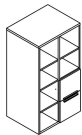

Tower, Front Access Open, Open Locker Right Hand, 57" high, 30" wide	Open Pedestal	30"	23 1/2"	56 3/16"	<b>WTFO5730OSO1RHL</b>	1,992.	2,751.
	Full Door Pedestal	30"	23 1/2"	56 3/16"	<b>WTFO5730OSFDRHL(N)</b>	2,090.	2,857.
	Open/File Pedestal	30"	23 1/2"	56 3/16"	<b>WTFO5730OSOFRHL(N)</b>	2,296.	3,102.
	File/File Pedestal	30"	23 1/2"	56 3/16"	<b>WTFO5730OSFRHL(N)</b>	2,398.	3,164.
	Open/Box/File Pedestal	30"	23 1/2"	56 3/16"	<b>WTFO5730OSOBRLHL(N)</b>	2,421.	3,207.
	Box (File Front)/File Pedestal	30"	23 1/2"	56 3/16"	<b>WTFO5730OSCFRHL(N)</b>	2,507.	3,311.
	Box/Box(File Front) File Pedestal	30"	23 1/2"	56 3/16"	<b>WTFO5730OSCBRLHL(N)</b>	2,547.	3,331.

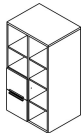

Order Information	Order Code	Specification Information	Application Notes
1. <i>Base Pattern Number</i>	Tower, Front Access Open, Open Locker, 57" high, 24" wide, F/F pedestal, Left hand	Refer to Tower Shelf count for number of included shelves with each interior configuration.	Towers 24" deep (nominal) have a 23 1/2" deep case; 24 3/8" overall depth including door.
2. <i>Lock option</i> L = Locking N = Non-locking			
3. <i>Case Finish</i> See Finish Options page	Example: <b>WTFO5724FDFFLHL</b>	Add \$40 to the list price per standard key lock.	Towers with full door include a coat hook to be field installed.
4. <i>Front Finish</i> See Finish Options page	<b>WTFO</b> Anchor Tower, Front Access Open		
5. <i>Top Finish</i> See Finish Options page	<b>57</b> 57" High	Add \$15 to the list price per pull for Anodized Nickel (AN) or Aluminum (AA) finish.	
6. <i>Pull style</i> T = 10" finger pull	<b>24</b> 24" Wide		
7. <i>Pull finish</i> See Finish Options page	<b>FD</b> Locker configuration, Full Door	Towers specified with mixed laminates finishes are L2 pricing. Refer to Mixed Laminates Finishes for further details.	
8. <i>Lock finish</i> B = Black C = Chrome	<b>FF</b> Pedestal configuration, File/File		
	<b>LH</b> Left hand	Dimensions listed under w h d are actual to the nearest 1/16".	
	<b>L</b> Laminate		
	<b>(L)</b> Lock option, Locking		
	<b>(118)</b> Case Finish		
	<b>(118)</b> Front Finish		
	<b>(118)</b> Top Finish		
	<b>(T)</b> Pull Style		
	<b>(118)</b> Pull Finish		
	<b>(C)</b> Lock finish, Chrome		

# Towers

## 57" High Front Access Open, Full Door Locker

### 24" and 30" wide

description	pedestal configuration	w	d	h	pattern no.	L1	L2
Tower, Front Access Open, Full Door Locker Left Hand, 57" high, 24" wide	Open Pedestal	24"	23 1/2"	56 3/16"	<b>WTF05724FDO1LHL(N)</b>	\$1,942.	\$2,619.
	Full Door Pedestal	24"	23 1/2"	56 3/16"	<b>WTF05724FDFDLHL(N)</b>	2,040.	2,725.
	Open/File Pedestal	24"	23 1/2"	56 3/16"	<b>WTF05724FDOFLHL(N)</b>	2,246.	2,970.
	File/File Pedestal (shown)	24"	23 1/2"	56 3/16"	<b>WTF05724FDFFLHL(N)</b>	2,348.	3,032.
	Box (File Front)/File Pedestal	24"	23 1/2"	56 3/16"	<b>WTF05724FDOBLHL(N)</b>	2,371.	3,075.
	Open/Box/File Pedestal	24"	23 1/2"	56 3/16"	<b>WTF05724FDCFLHL(N)</b>	2,416.	3,138.
	Box/Box(File Front) File Pedestal	24"	23 1/2"	56 3/16"	<b>WTF05724FDCBLHL(N)</b>	2,539.	3,241.

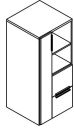

Tower, Front Access Open, Full Door Locker Right Hand, 57" high, 24" wide	Open Pedestal	24"	23 1/2"	56 3/16"	<b>WTF05724FDO1RHL(N)</b>	1,942.	2,619.
	Full Door Pedestal	24"	23 1/2"	56 3/16"	<b>WTF05724FDFDRHL(N)</b>	2,040.	2,725.
	Open/File Pedestal	24"	23 1/2"	56 3/16"	<b>WTF05724FDOFRHL(N)</b>	2,246.	2,970.
	File/File Pedestal (shown)	24"	23 1/2"	56 3/16"	<b>WTF05724FDFFRHL(N)</b>	2,348.	3,032.
	Box (File Front)/File Pedestal	24"	23 1/2"	56 3/16"	<b>WTF05724FDOBRHL(N)</b>	2,371.	3,075.
	Open/Box/File Pedestal	24"	23 1/2"	56 3/16"	<b>WTF05724FDCFRHL(N)</b>	2,416.	3,138.
	Box/Box(File Front) File Pedestal	24"	23 1/2"	56 3/16"	<b>WTF05724FDCBRHL(N)</b>	2,539.	3,241.

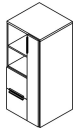

Tower, Front Access Open, Full Door Locker Left Hand, 57" high, 30" wide	Open Pedestal	30"	23 1/2"	56 3/16"	<b>WTF05730FDO1LHL(N)</b>	2,144.	2,915.
	Full Door Pedestal	30"	23 1/2"	56 3/16"	<b>WTF05730FDFDLHL(N)</b>	2,242.	3,021.
	Open/File Pedestal	30"	23 1/2"	56 3/16"	<b>WTF05730FDOFLHL(N)</b>	2,448.	3,266.
	File/File Pedestal (shown)	30"	23 1/2"	56 3/16"	<b>WTF05730FDFFLHL(N)</b>	2,550.	3,328.
	Box (File Front)/File Pedestal	30"	23 1/2"	56 3/16"	<b>WTF05730FDOBLHL(N)</b>	2,573.	3,371.
	Open/Box/File Pedestal	30"	23 1/2"	56 3/16"	<b>WTF05730FDCFLHL(N)</b>	2,617.	3,434.
	Box/Box(File Front) File Pedestal	30"	23 1/2"	56 3/16"	<b>WTF05730FDCBLHL(N)</b>	2,740.	3,537.

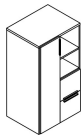

Tower, Front Access Open, Full Door Locker Right Hand, 57" high, 30" wide	Open Pedestal	30"	23 1/2"	56 3/16"	<b>WTF05730FDO1RHL(N)</b>	2,144.	2,915.
	Full Door Pedestal	30"	23 1/2"	56 3/16"	<b>WTF05730FDFDRHL(N)</b>	2,242.	3,021.
	Open/File Pedestal	30"	23 1/2"	56 3/16"	<b>WTF05730FDOFRHL(N)</b>	2,448.	3,266.
	File/File Pedestal (shown)	30"	23 1/2"	56 3/16"	<b>WTF05730FDFFRHL(N)</b>	2,550.	3,328.
	Box (File Front)/File Pedestal	30"	23 1/2"	56 3/16"	<b>WTF05730FDOBRHL(N)</b>	2,573.	3,371.
	Open/Box/File Pedestal	30"	23 1/2"	56 3/16"	<b>WTF05730FDCFRHL(N)</b>	2,617.	3,434.
	Box/Box(File Front) File Pedestal	30"	23 1/2"	56 3/16"	<b>WTF05730FDCBRHL(N)</b>	2,740.	3,537.

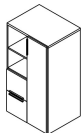

Order Information	Order Code	Specification Information	Application Notes
1. <i>Base Pattern Number</i>	Tower, Front Access Open, Full Door Locker, 57" high, 24" wide, F/F pedestal, Left hand	Refer to Tower Shelf count for number of included shelves with each interior configuration.	Towers 24" deep (nominal) have a 23 1/2" deep case; 24 3/8" overall depth including door.
2. <i>Lock option</i> L = Locking N = Non-locking			
3. <i>Case Finish</i> See Finish Options page	Example: <b>WTF05724FDFFLHL</b>	Add \$40 to the list price per standard key lock.	Towers with full door include a coat hook to be field installed.
4. <i>Front Finish</i> See Finish Options page	<b>WTFO</b> Anchor Tower, Front Access Open	Add \$15 to the list price per pull for Anodized Nickel (AN) or Aluminum (AA) finish.	
5. <i>Top Finish</i> See Finish Options page	<b>57</b> 57" High		
6. <i>Pull style</i> T = 10" finger pull	<b>24</b> 24" Wide		
7. <i>Pull finish</i> See Finish Options page	<b>FD</b> Locker configuration, Full Door	Towers specified with mixed laminate finishes are L2 pricing. Refer to Mixed Laminate Finishes for further details.	
8. <i>Lock finish</i> B = Black C = Chrome	<b>FF</b> Pedestal configuration, File/File		
	<b>LH</b> Left hand	Dimensions listed under w h d are actual to the nearest 1/16".	
	<b>L</b> Laminate		
	<b>(L)</b> Lock option, Locking		
	<b>(118)</b> Case Finish		
	<b>(118)</b> Front Finish		
	<b>(118)</b> Top Finish		
	<b>(T)</b> Pull Style		
	<b>(118)</b> Pull Finish		
	<b>(C)</b> Lock finish, Chrome		

# Towers

## 64" High Front Access Open, Open Locker

### 24" and 30" wide

description	pedestal configuration	w	d	h	pattern no.	L1	L2
Tower, Front Access Open, Open Locker Left Hand, 64" high, 24" wide	Open Pedestal	24"	23 1/2"	63 7/16"	<b>WTF06424OSO1LHL</b>	\$1,979.	\$2,735.
	Full Door Pedestal	24"	23 1/2"	63 7/16"	<b>WTF06424OSFDLHL(N)</b>	2,077.	2,841.
	Open/File Pedestal	24"	23 1/2"	63 7/16"	<b>WTF06424OSOFHL(N)</b>	2,282.	3,086.
	File/File Pedestal	24"	23 1/2"	63 7/16"	<b>WTF06424OSFFLHL(N)</b>	2,385.	3,148.
	Open/Box/File Pedestal	24"	23 1/2"	63 7/16"	<b>WTF06424OSOBLHL(N)</b>	2,408.	3,191.
	Box (File Front)/File Pedestal	24"	23 1/2"	63 7/16"	<b>WTF06424OSCFHL(N)</b>	2,493.	3,295.
	Box/Box(File Front) File Pedestal	24"	23 1/2"	63 7/16"	<b>WTF06424OSCBHL(N)</b>	2,534.	3,315.

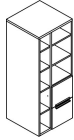

Tower, Front Access Open, Open Locker Right Hand, 64" high, 24" wide	Open Pedestal	24"	23 1/2"	63 7/16"	<b>WTF06424OSO1RHL</b>	1,979.	2,735.
	Full Door Pedestal	24"	23 1/2"	63 7/16"	<b>WTF06424OSFDRHL(N)</b>	2,077.	2,841.
	Open/File Pedestal	24"	23 1/2"	63 7/16"	<b>WTF06424OSOFRHL(N)</b>	2,282.	3,086.
	File/File Pedestal	24"	23 1/2"	63 7/16"	<b>WTF06424OSFRHL(N)</b>	2,385.	3,148.
	Open/Box/File Pedestal	24"	23 1/2"	63 7/16"	<b>WTF06424OSOBRHL(N)</b>	2,408.	3,191.
	Box (File Front)/File Pedestal	24"	23 1/2"	63 7/16"	<b>WTF06424OSCFRHL(N)</b>	2,493.	3,295.
	Box/Box(File Front) File Pedestal	24"	23 1/2"	63 7/16"	<b>WTF06430OSCBRHL(N)</b>	2,735.	3,609.

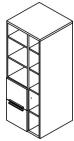

Tower, Front Access Open, Open Locker Left Hand, 64" high, 30" wide	Open Pedestal	30"	23 1/2"	63 7/16"	<b>WTF06430OSO1LHL</b>	2,180.	3,029.
	Full Door Pedestal	30"	23 1/2"	63 7/16"	<b>WTF06430OSFDLHL(N)</b>	2,278.	3,135.
	Open/File Pedestal	30"	23 1/2"	63 7/16"	<b>WTF06430OSOFHL(N)</b>	2,484.	3,381.
	File/File Pedestal	30"	23 1/2"	63 7/16"	<b>WTF06430OSFFLHL(N)</b>	2,586.	3,442.
	Open/Box/File Pedestal	30"	23 1/2"	63 7/16"	<b>WTF06430OSOBLHL(N)</b>	2,609.	3,485.
	Box (File Front)/File Pedestal	30"	23 1/2"	63 7/16"	<b>WTF06430OSCFHL(N)</b>	2,695.	3,590.
	Box/Box(File Front) File Pedestal	30"	23 1/2"	63 7/16"	<b>WTF06430OSCBHL(N)</b>	2,735.	3,609.

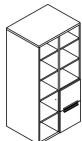

Tower, Front Access Open, Open Locker Right Hand, 64" high, 30" wide	Open Pedestal	30"	23 1/2"	63 7/16"	<b>WTF06430OSO1RHL</b>	2,180.	3,029.
	Full Door Pedestal	30"	23 1/2"	63 7/16"	<b>WTF06430OSFDRHL(N)</b>	2,278.	3,135.
	Open/File Pedestal	30"	23 1/2"	63 7/16"	<b>WTF06430OSOFRHL(N)</b>	2,484.	3,381.
	Box/Box(File Front) File Pedestal	30"	23 1/2"	63 7/16"	<b>WTF06424OSCBRHL(N)</b>	2,534.	3,315.
	File/File Pedestal	30"	23 1/2"	63 7/16"	<b>WTF06430OSFRHL(N)</b>	2,586.	3,442.
	Open/Box/File Pedestal	30"	23 1/2"	63 7/16"	<b>WTF06430OSOBRHL(N)</b>	2,609.	3,485.
	Box (File Front)/File Pedestal	30"	23 1/2"	63 7/16"	<b>WTF06430OSCFRHL(N)</b>	2,695.	3,590.

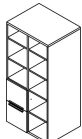

Order Information	Order Code	Specification Information	Application Notes
1. <i>Base Pattern Number</i>	Tower, Front Access Open,	Refer to Tower Shelf count for	Towers 24" deep (nominal) have a
2. <i>Lock option</i>	Open Locker, 64" high, 24" wide,	number of included shelves with	23 1/2" deep case; 24 3/8" overall
	L = Locking	each interior configuration.	depth including door.
	N = Non-locking		
3. <i>Case Finish</i>	Example: <b>WTF06424FDFFLHL</b>	Add \$40 to the list price per	Towers with full door include a coat
	<b>WTF0</b> Anchor Tower, Front	standard key lock.	hook to be field installed.
	<b>Anchor</b> Access Open		
4. <i>Front Finish</i>	<b>64</b> 64" High	Add \$15 to the list price per pull for	
	<b>24</b> 24" Wide	Anodized Nickel (AN) or Aluminum	
5. <i>Top Finish</i>	<b>FD</b> Locker configuration,	(AA) finish.	
	Full Door	Towers specified with mixed	
6. <i>Pull style</i>	<b>FF</b> Pedestal configuration,	laminates finishes are L2 pricing.	
	File/File	Refer to Mixed Laminate Finishes	
7. <i>Pull finish</i>	<b>LH</b> Left hand	for further details.	
	<b>L</b> Laminate	Dimensions listed under w h d are	
8. <i>Lock finish</i>	<b>(L)</b> Lock option, Locking	actual to the nearest 1/16".	
	<b>(118)</b> Case Finish		
	<b>(118)</b> Front Finish		
	<b>(118)</b> Top Finish		
	<b>(T)</b> Pull Style		
	<b>(118)</b> Pull Finish		
	<b>(C)</b> Lock finish, Chrome		

# Towers

## 64" High Front Access Open, Full Door Locker

### 24" and 30" wide

description	pedestal configuration	w	d	h	pattern no.	L1	L2
Tower, Front Access Open, Full Door Locker Left Hand, 64" high, 24" wide	Open Pedestal	24"	23 1/2"	63 7/16"	<b>WTF06424FDO1LHL(N)</b>	\$2,135.	\$2,903.
	Full Door Pedestal	24"	23 1/2"	63 7/16"	<b>WTF06424FDFDLHL(N)</b>	2,234.	3,009.
	Open/File Pedestal	24"	23 1/2"	63 7/16"	<b>WTF06424FDOFLHL(N)</b>	2,439.	3,255.
	File/File Pedestal (shown)	24"	23 1/2"	63 7/16"	<b>WTF06424FDFFLHL(N)</b>	2,541.	3,316.
	Open/Box/File Pedestal	24"	23 1/2"	63 7/16"	<b>WTF06424FDOBLHL(N)</b>	2,564.	3,359.
	Box (File Front)/File Pedestal	24"	23 1/2"	63 7/16"	<b>WTF06424FDCFLHL(N)</b>	2,609.	3,422.
	Box/Box(File Front) File Pedestal	24"	23 1/2"	63 7/16"	<b>WTF06424FDCBLHL(N)</b>	2,732.	3,525.

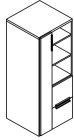

Tower, Front Access Open, Full Door Locker Right Hand, 64" high, 24" wide	Open Pedestal	24"	23 1/2"	63 7/16"	<b>WTF06424FDO1RHL(N)</b>	2,135.	2,903.
	Full Door Pedestal	24"	23 1/2"	63 7/16"	<b>WTF06424FDFDRHL(N)</b>	2,234.	3,009.
	Open/File Pedestal	24"	23 1/2"	63 7/16"	<b>WTF06424FDOFRHL(N)</b>	2,439.	3,255.
	File/File Pedestal (shown)	24"	23 1/2"	63 7/16"	<b>WTF06424FDFFRHL(N)</b>	2,541.	3,316.
	Open/Box/File Pedestal	24"	23 1/2"	63 7/16"	<b>WTF06424FDOBRHL(N)</b>	2,564.	3,359.
	Box (File Front)/File Pedestal	24"	23 1/2"	63 7/16"	<b>WTF06424FDCFRHL(N)</b>	2,609.	3,422.
	Box/Box(File Front) File Pedestal	24"	23 1/2"	63 7/16"	<b>WTF06424FDCBRHL(N)</b>	2,732.	3,525.

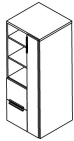

Tower, Front Access Open, Full Door Locker Left Hand, 64" high, 30" wide	Open Pedestal	30"	23 1/2"	63 7/16"	<b>WTF06430FDO1LHL(N)</b>	2,349.	3,219.
	Full Door Pedestal	30"	23 1/2"	63 7/16"	<b>WTF06430FDFDLHL(N)</b>	2,448.	3,326.
	Open/File Pedestal	30"	23 1/2"	63 7/16"	<b>WTF06430FDOFLHL(N)</b>	2,654.	3,571.
	File/File Pedestal (shown)	30"	23 1/2"	63 7/16"	<b>WTF06430FDFFLHL(N)</b>	2,756.	3,633.
	Open/Box/File Pedestal	30"	23 1/2"	63 7/16"	<b>WTF06430FDOBLHL(N)</b>	2,779.	3,676.
	Box (File Front)/File Pedestal	30"	23 1/2"	63 7/16"	<b>WTF06430FDCFLHL(N)</b>	2,824.	3,739.
	Box/Box(File Front) File Pedestal	30"	23 1/2"	63 7/16"	<b>WTF06430FDCBLHL(N)</b>	2,946.	3,841.

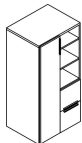

Tower, Front Access Open, Full Door Locker Right Hand, 64" high, 30" wide	Open Pedestal	30"	23 1/2"	63 7/16"	<b>WTF06430FDO1RHL(N)</b>	2,349.	3,219.
	Full Door Pedestal	30"	23 1/2"	63 7/16"	<b>WTF06430FDFDRHL(N)</b>	2,448.	3,326.
	Open/File Pedestal	30"	23 1/2"	63 7/16"	<b>WTF06430FDOFRHL(N)</b>	2,654.	3,571.
	File/File Pedestal (shown)	30"	23 1/2"	63 7/16"	<b>WTF06430FDFFRHL(N)</b>	2,756.	3,633.
	Open/Box/File Pedestal	30"	23 1/2"	63 7/16"	<b>WTF06430FDOBRHL(N)</b>	2,779.	3,676.
	Box (File Front)/File Pedestal	30"	23 1/2"	63 7/16"	<b>WTF06430FDCFRHL(N)</b>	2,824.	3,739.
	Box/Box(File Front) File Pedestal	30"	23 1/2"	63 7/16"	<b>WTF06430FDCBRHL(N)</b>	2,946.	3,841.

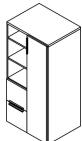

Order Information	Order Code	Specification Information	Application Notes
1. <i>Base Pattern Number</i>	Tower, Front Access Open, Full Open Door, 64" high, 24" wide, F/F pedestal, Left hand	Refer to Tower Shelf count for number of included shelves with each interior configuration.	Towers 24" deep (nominal) have a 23 1/2" deep case; 24 3/8" overall depth including door.
2. <i>Lock option</i> L = Locking N = Non-locking			
3. <i>Case Finish</i> See Finish Options page	Example: <b>WTF06424FDFFLHL</b>	Add \$40 to the list price per standard key lock.	Towers with full door include a coat hook to be field installed.
4. <i>Front Finish</i> See Finish Options page	<b>WTFO</b> Anchor Tower, Front Access Open		
5. <i>Top Finish</i> See Finish Options page	<b>64</b> 64" High	Add \$15 to the list price per pull for Anodized Nickel (AN) or Aluminum (AA) finish.	
6. <i>Pull style</i> T = 10" finger pull	<b>24</b> 24" Wide		
7. <i>Pull finish</i> See Finish Options page	<b>FD</b> Locker configuration, Full Door	Towers specified with mixed laminate finishes are L2 pricing. Refer to Mixed Laminate Finishes for further details.	
8. <i>Lock finish</i> B = Black C = Chrome	<b>FF</b> Pedestal configuration, File/File		
	<b>LH</b> Left hand	Dimensions listed under w h d are actual to the nearest 1/16".	
	<b>L</b> Laminate		
	<b>(L)</b> Lock option, Locking		
	<b>(118)</b> Case Finish		
	<b>(118)</b> Front Finish		
	<b>(118)</b> Top Finish		
	<b>(T)</b> Pull Style		
	<b>(118)</b> Pull Finish		
	<b>(C)</b> Lock finish, Chrome		

# Towers

## 42" High Front Access with Door, Open Locker

### 24" and 30" wide

description	pedestal configuration	w	d	h	pattern no.	L1	L2
Tower, Front Access with Door, Open Locker Left Hand, 42" high, 24" wide	Full Door Pedestal	24"	23 1/2"	41 9/16"	<b>WTFD4224OSFDLHL(N)</b>	\$1,658.	\$2,188.
	Open/File Pedestal	24"	23 1/2"	41 9/16"	<b>WTFD4224OSOFLHL(N)</b>	1,866.	2,435.
	File/File Pedestal	24"	23 1/2"	41 9/16"	<b>WTFD4224OSFFLHL(N)</b>	1,966.	2,495.
	Open/Box/File Pedestal	24"	23 1/2"	41 9/16"	<b>WTFD4224OSOBLHL(N)</b>	1,989.	2,538.
	Box (File Front)/File Pedestal	24"	23 1/2"	41 9/16"	<b>WTFD4224OSCFHL(N)</b>	2,034.	2,600.
	Box/Box(File Front) File Pedestal	24"	23 1/2"	41 9/16"	<b>WTFD4224OSCBHL(N)</b>	2,115.	2,662.

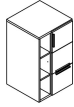

Tower, Front Access with Door, Open Locker Right Hand, 42" high, 24" wide	Full Door Pedestal	24"	23 1/2"	41 9/16"	<b>WTFD4224OSFDRHL(N)</b>	1,658.	2,188.
	Open/File Pedestal	24"	23 1/2"	41 9/16"	<b>WTFD4224OSOFRHL(N)</b>	1,866.	2,435.
	File/File Pedestal	24"	23 1/2"	41 9/16"	<b>WTFD4224OSFFRHL(N)</b>	1,966.	2,495.
	Open/Box/File Pedestal	24"	23 1/2"	41 9/16"	<b>WTFD4224OSOBRHL(N)</b>	1,989.	2,538.
	Box (File Front)/File Pedestal	24"	23 1/2"	41 9/16"	<b>WTFD4224OSCFRHL(N)</b>	2,034.	2,600.
	Box/Box(File Front) File Pedestal	24"	23 1/2"	41 9/16"	<b>WTFD4224OSCBRHL(N)</b>	2,115.	2,662.

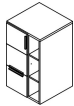

Tower, Front Access with Door, Open Locker Left Hand, 42" high, 30" wide	Full Door Pedestal	30"	23 1/2"	41 9/16"	<b>WTFD4230OSFDLHL(N)</b>	1,814.	2,413.
	Open/File Pedestal	30"	23 1/2"	41 9/16"	<b>WTFD4230OSOFLHL(N)</b>	2,022.	2,660.
	File/File Pedestal	30"	23 1/2"	41 9/16"	<b>WTFD4230OSFFLHL(N)</b>	2,122.	2,720.
	Open/Box/File Pedestal	30"	23 1/2"	41 9/16"	<b>WTFD4230OSOBLHL(N)</b>	2,145.	2,763.
	Box (File Front)/File Pedestal	30"	23 1/2"	41 9/16"	<b>WTFD4230OSCFHL(N)</b>	2,189.	2,826.
	Box/Box(File Front) File Pedestal	30"	23 1/2"	41 9/16"	<b>WTFD4230OSCBHL(N)</b>	2,271.	2,887.

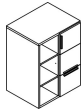

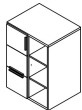

Tower, Front Access with Door, Open Locker Right Hand, 42" high, 30" wide	Full Door Pedestal	30"	23 1/2"	41 9/16"	<b>WTFD4230OSFDRHL(N)</b>	1,814.	2,413.
	Open/File Pedestal	30"	23 1/2"	41 9/16"	<b>WTFD4230OSOFRHL(N)</b>	2,022.	2,660.
	File/File Pedestal	30"	23 1/2"	41 9/16"	<b>WTFD4230OSFFRHL(N)</b>	2,122.	2,720.
	Open/Box/File Pedestal	30"	23 1/2"	41 9/16"	<b>WTFD4230OSOBRHL(N)</b>	2,145.	2,763.
	Box (File Front)/File Pedestal	30"	23 1/2"	41 9/16"	<b>WTFD4230OSCFRHL(N)</b>	2,189.	2,826.
	Box/Box(File Front) File Pedestal	30"	23 1/2"	41 9/16"	<b>WTFD4230OSCBRHL(N)</b>	2,271.	2,887.

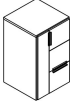

Order Information	Order Code	Specification Information	Application Notes
1. <i>Base Pattern Number</i>	Tower, Front Access with Door, Open Locker, 42" high, 24" wide, F/F pedestal, Left hand	Refer to Tower Shelf count for number of included shelves with each interior configuration.	Towers 24" deep (nominal) have a 23 1/2" deep case; 24 3/8" overall depth including door.
2. <i>Lock option</i> L = Locking N = Non-locking			
3. <i>Case Finish</i> See Finish Options page	Example: <b>WTFD4224OSFFLHL</b>	Add \$40 to the list price per standard key lock.	Towers with full door include a coat hook to be field installed.
4. <i>Front Finish</i> See Finish Options page	<b>WTFD</b> Anchor Tower, Front Access with Door	Add \$15 to the list price per pull for Anodized Nickel (AN) or Aluminum (AA) finish.	
5. <i>Top Finish</i> See Finish Options page	<b>42</b> 42" High		
6. <i>Pull style</i> T = 10" finger pull	<b>24</b> 24" Wide		
7. <i>Pull finish</i> See Finish Options page	<b>OS</b> Locker configuration, Open with Shelves	Towers specified with mixed laminates finishes are L2 pricing. Refer to Mixed Laminate Finishes for further details.	
8. <i>Lock finish</i> B = Black C = Chrome	<b>FF</b> Pedestal configuration, File/File		
	<b>LH</b> Left hand	Dimensions listed under w h d are actual to the nearest 1/16".	
	<b>L</b> Laminate		
	<b>(L)</b> Lock option, Locking		
	<b>(118)</b> Case Finish		
	<b>(118)</b> Front Finish		
	<b>(118)</b> Top Finish		
	<b>(T)</b> Pull Style		
	<b>(118)</b> Pull Finish		
	<b>(C)</b> Lock finish, Chrome		

## 42" High Front Access with Door, Full Door Locker 24" and 30" wide

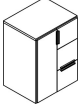
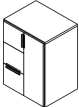
description	pedestal configuration	w	d	h	pattern no.	L1	L2
Tower, Front Access with Door, Full Door Locker Left Hand, 42" high, 24" wide 	Open Pedestal	24"	23 1/2"	41 1/16"	<b>WTFD4224FDO1LHL(N)</b>	\$1,720.	\$2,254.
	Full Door Pedestal	24"	23 1/2"	41 1/16"	<b>WTFD4224FDFDLHL(N)</b>	1,818.	2,360.
	Open/File Pedestal	24"	23 1/2"	41 1/16"	<b>WTFD4224FDOFLHL(N)</b>	2,026.	2,607.
	File/File Pedestal (shown)	24"	23 1/2"	41 1/16"	<b>WTFD4224FDFFLHL(N)</b>	2,126.	2,667.
	Open/Box/File Pedestal	24"	23 1/2"	41 1/16"	<b>WTFD4224FDOBLHL(N)</b>	2,149.	2,710.
	Box (File Front)/File Pedestal	24"	23 1/2"	41 1/16"	<b>WTFD4224FDCFLHL(N)</b>	2,194.	2,773.
	Box/Box(File Front) File Pedestal	24"	23 1/2"	41 1/16"	<b>WTFD4224FDCBLHL(N)</b>	2,275.	2,834.
Tower, Front Access with Door, Full Door Locker Right Hand, 42" high, 24" wide 	Open Pedestal	24"	23 1/2"	41 1/16"	<b>WTFD4224FDO1RHL(N)</b>	1,720.	2,254.
	Full Door Pedestal	24"	23 1/2"	41 1/16"	<b>WTFD4224FDFDRHL(N)</b>	1,818.	2,360.
	Open/File Pedestal	24"	23 1/2"	41 1/16"	<b>WTFD4224FDOFRHL(N)</b>	2,026.	2,607.
	File/File Pedestal (shown)	24"	23 1/2"	41 1/16"	<b>WTFD4224FDFFRHL(N)</b>	2,126.	2,667.
	Open/Box/File Pedestal	24"	23 1/2"	41 1/16"	<b>WTFD4224FDOBRHL(N)</b>	2,149.	2,710.
	Box (File Front)/File Pedestal	24"	23 1/2"	41 1/16"	<b>WTFD4224FDCFRHL(N)</b>	2,194.	2,773.
	Box/Box(File Front) File Pedestal	24"	23 1/2"	41 1/16"	<b>WTFD4224FDCBRHL(N)</b>	2,275.	2,834.
Tower, Front Access with Door, Full Door Locker Left Hand, 42" high, 30" wide 	Open Pedestal	30"	23 1/2"	41 1/16"	<b>WTFD4230FDO1LHL(N)</b>	1,892.	2,504.
	Full Door Pedestal	30"	23 1/2"	41 1/16"	<b>WTFD4230FDFDLHL(N)</b>	1,991.	2,610.
	Open/File Pedestal	30"	23 1/2"	41 1/16"	<b>WTFD4230FDOFLHL(N)</b>	2,198.	2,858.
	File/File Pedestal (shown)	30"	23 1/2"	41 1/16"	<b>WTFD4230FDFFLHL(N)</b>	2,298.	2,917.
	Open/Box/File Pedestal	30"	23 1/2"	41 1/16"	<b>WTFD4230FDOBLHL(N)</b>	2,321.	2,961.
	Box (File Front)/File Pedestal	30"	23 1/2"	41 1/16"	<b>WTFD4230FDCFLHL(N)</b>	2,366.	3,023.
	Box/Box(File Front) File Pedestal	30"	23 1/2"	41 1/16"	<b>WTFD4230FDCBLHL(N)</b>	2,447.	3,085.
Tower, Front Access with Door, Full Door Locker Right Hand, 42" high, 30" wide 	Open Pedestal	30"	23 1/2"	41 1/16"	<b>WTFD4230FDO1RHL(N)</b>	1,892.	2,504.
	Full Door Pedestal	30"	23 1/2"	41 1/16"	<b>WTFD4230FDFDRHL(N)</b>	1,991.	2,610.
	Open/File Pedestal	30"	23 1/2"	41 1/16"	<b>WTFD4230FDOFRHL(N)</b>	2,198.	2,858.
	File/File Pedestal (shown)	30"	23 1/2"	41 1/16"	<b>WTFD4230FDFFRHL(N)</b>	2,298.	2,917.
	Open/Box/File Pedestal	30"	23 1/2"	41 1/16"	<b>WTFD4230FDOBRHL(N)</b>	2,321.	2,961.
	Box (File Front)/File Pedestal	30"	23 1/2"	41 1/16"	<b>WTFD4230FDCFRHL(N)</b>	2,366.	3,023.
	Box/Box(File Front) File Pedestal	30"	23 1/2"	41 1/16"	<b>WTFD4230FDCBRHL(N)</b>	2,447.	3,085.

Order Information	Order Code	Specification Information	Application Notes
1. <i>Base Pattern Number</i>	Tower, Front Access with Door, Full Door Locker, 42" high, 24" wide, F/F pedestal, Left hand	Refer to Tower Shelf count for number of included shelves with each interior configuration.	Towers 24" deep (nominal) have a 23 1/2" deep case; 24 3/8" overall depth including door.
2. <i>Lock option</i> L = Locking N = Non-locking			
3. <i>Case Finish</i> See Finish Options page	Example: <b>WTFD4224FDFFLHL</b>	Add \$40 to the list price per standard key lock.	Towers with full door include a coat hook to be field installed.
4. <i>Front Finish</i> See Finish Options page	<b>WTFD</b> Anchor Tower, Front Access with Door	Add \$15 to the list price per pull for Anodized Nickel (AN) or Aluminum (AA) finish.	
5. <i>Top Finish</i> See Finish Options page	<b>42</b> 42" High		
6. <i>Pull style</i> T = 10" finger pull	<b>24</b> 24" Wide		
7. <i>Pull finish</i> See Finish Options page	<b>FD</b> Locker configuration, Full Door	Towers specified with mixed laminate finishes are L2 pricing. Refer to Mixed Laminate Finishes for further details.	
8. <i>Lock finish</i> B = Black C = Chrome	<b>FF</b> Pedestal configuration, File/File		
	<b>LH</b> Left hand	Dimensions listed under w h d are actual to the nearest 1/16".	
	<b>L</b> Laminate		
	<b>(L)</b> Lock option, Locking		
	<b>(118)</b> Case Finish		
	<b>(118)</b> Front Finish		
	<b>(118)</b> Top Finish		
	<b>(T)</b> Pull Style		
	<b>(118)</b> Pull Finish		
	<b>(C)</b> Lock finish, Chrome		

# Towers

## 50" High Front Access with Door, Open Locker

### 24" and 30" wide

description	pedestal configuration	w	d	h	pattern no.	L1	L2
Tower, Front Access with Door, Open Locker Left Hand, 50" high, 24" wide	Full Door Pedestal	24"	23 1/2"	48 7/8"	<b>WTFD5024OSFDLHL(N)</b>	\$1,881.	\$2,516.
	Open/File Pedestal	24"	23 1/2"	48 7/8"	<b>WTFD5024OSOFHLHL(N)</b>	2,089.	2,764.
	File/File Pedestal (shown)	24"	23 1/2"	48 7/8"	<b>WTFD5024OSFFLHL(N)</b>	2,189.	2,823.
	Open/Box/File Pedestal	24"	23 1/2"	48 7/8"	<b>WTFD5024OSOBLHL(N)</b>	2,212.	2,866.
	Box (File Front)/File Pedestal	24"	23 1/2"	48 7/8"	<b>WTFD5024OSCFHLHL(N)</b>	2,256.	2,929.
	Box/Box(File Front) File Pedestal	24"	23 1/2"	48 7/8"	<b>WTFD5024OSCBHLHL(N)</b>	2,338.	2,991.

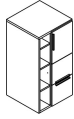

Tower, Front Access with Door, Open Locker Right Hand, 50" high, 24" wide	Full Door Pedestal	24"	23 1/2"	48 7/8"	<b>WTFD5024OSFDRHL(N)</b>	1,881.	2,516.
	Open/File Pedestal	24"	23 1/2"	48 7/8"	<b>WTFD5024OSOFRHL(N)</b>	2,089.	2,764.
	File/File Pedestal (shown)	24"	23 1/2"	48 7/8"	<b>WTFD5024OSFFRHL(N)</b>	2,189.	2,823.
	Open/Box/File Pedestal	24"	23 1/2"	48 7/8"	<b>WTFD5024OSOBRHL(N)</b>	2,212.	2,866.
	Box (File Front)/File Pedestal	24"	23 1/2"	48 7/8"	<b>WTFD5024OSCFRHL(N)</b>	2,256.	2,929.
	Box/Box(File Front) File Pedestal	24"	23 1/2"	48 7/8"	<b>WTFD5024OSCBRHL(N)</b>	2,338.	2,991.

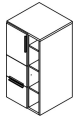

Tower, Front Access with Door, Open Locker Left Hand, 50" high, 30" wide	Full Door Pedestal	30"	23 1/2"	48 7/8"	<b>WTFD5030OSFDLHL(N)</b>	2,044.	2,753.
	Open/File Pedestal	30"	23 1/2"	48 7/8"	<b>WTFD5030OSOFHLHL(N)</b>	2,252.	3,001.
	File/File Pedestal (shown)	30"	23 1/2"	48 7/8"	<b>WTFD5030OSFFLHL(N)</b>	2,352.	3,060.
	Open/Box/File Pedestal	30"	23 1/2"	48 7/8"	<b>WTFD5030OSOBLHL(N)</b>	2,375.	3,103.
	Box (File Front)/File Pedestal	30"	23 1/2"	48 7/8"	<b>WTFD5030OSCFHLHL(N)</b>	2,420.	3,166.
	Box/Box(File Front) File Pedestal	30"	23 1/2"	48 7/8"	<b>WTFD5030OSCBHLHL(N)</b>	2,502.	3,227.



Tower, Front Access with Door, Open Locker Right Hand, 50" high, 30" wide	Full Door Pedestal	30"	23 1/2"	48 7/8"	<b>WTFD5030OSFDRHL(N)</b>	2,044.	2,753.
	Open/File Pedestal	30"	23 1/2"	48 7/8"	<b>WTFD5030OSOFRHL(N)</b>	2,252.	3,001.
	File/File Pedestal (shown)	30"	23 1/2"	48 7/8"	<b>WTFD5030OSFFRHL(N)</b>	2,352.	3,060.
	Open/Box/File Pedestal	30"	23 1/2"	48 7/8"	<b>WTFD5030OSOBRHL(N)</b>	2,375.	3,103.
	Box (File Front)/File Pedestal	30"	23 1/2"	48 7/8"	<b>WTFD5030OSCFRHL(N)</b>	2,420.	3,166.
	Box/Box(File Front) File Pedestal	30"	23 1/2"	48 7/8"	<b>WTFD5030OSCBRHL(N)</b>	2,502.	3,227.

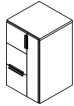

Order Information	Order Code	Specification Information	Application Notes
1. <i>Base Pattern Number</i>	Tower, Front Access with Door, Open Locker, 50" high, 24" wide, F/F pedestal, Left hand	Refer to Tower Shelf count for number of included shelves with each interior configuration.	Towers 24" deep (nominal) have a 23 1/2" deep case; 24 3/8" overall depth including door.
2. <i>Lock option</i> L = Locking N = Non-locking			
3. <i>Case Finish</i> See Finish Options page	Example: <b>WTFD5024OSFFLHL</b>	Add \$40 to the list price per standard key lock.	Towers with full door include a coat hook to be field installed.
4. <i>Front Finish</i> See Finish Options page	<b>WTFD</b> Anchor Tower, Front Access with Door	Add \$15 to the list price per pull for Anodized Nickel (AN) or Aluminum (AA) finish.	
5. <i>Top Finish</i> See Finish Options page	<b>50</b> 50" High		
6. <i>Pull style</i> T = 10" finger pull	<b>24</b> 24" Wide		
7. <i>Pull finish</i> See Finish Options page	<b>OS</b> Locker configuration, Open with Shelves	Towers specified with mixed laminates finishes are L2 pricing. Refer to Mixed Laminate Finishes for further details.	
8. <i>Lock finish</i> B = Black C = Chrome	<b>FF</b> Pedestal configuration, File/File		
	<b>LH</b> Left hand	Dimensions listed under w h d are actual to the nearest 1/16".	
	<b>L</b> Laminate		
	<b>(L)</b> Lock option, Locking		
	<b>(118)</b> Case Finish		
	<b>(118)</b> Front Finish		
	<b>(118)</b> Top Finish		
	<b>(T)</b> Pull Style		
	<b>(118)</b> Pull Finish		
	<b>(C)</b> Lock finish, Chrome		

## 50" High Front Access with Door, Full Door Locker 24" and 30" wide

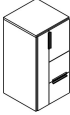
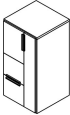
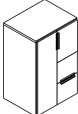
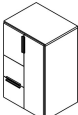
description	pedestal configuration	w	d	h	pattern no.	L1	L2
Tower, Front Access with Door, Full Door Locker Left Hand, 50" high, 24" wide 	Open Pedestal	24"	23 1/2"	48 7/8"	<b>WTFD5024FDO1LHL(N)</b>	\$1,956.	\$2,600.
	Full Door Pedestal	24"	23 1/2"	48 7/8"	<b>WTFD5024FDFDLHL(N)</b>	2,054.	2,706.
	Open/File Pedestal	24"	23 1/2"	48 7/8"	<b>WTFD5024FDOFLHL(N)</b>	2,262.	2,954.
	File/File Pedestal (shown)	24"	23 1/2"	48 7/8"	<b>WTFD5024FDFFLHL(N)</b>	2,362.	3,013.
	Open/Box/File Pedestal	24"	23 1/2"	48 7/8"	<b>WTFD5024FDOBLHL(N)</b>	2,385.	3,057.
	Box (File Front)/File Pedestal	24"	23 1/2"	48 7/8"	<b>WTFD5024FDCFLHL(N)</b>	2,429.	3,119.
	Box/Box(File Front) File Pedestal	24"	23 1/2"	48 7/8"	<b>WTFD5024FDCBLHL(N)</b>	2,511.	3,181.
Tower, Front Access with Door, Full Door Locker Right Hand, 50" high, 24" wide 	Open Pedestal	24"	23 1/2"	48 7/8"	<b>WTFD5024FDO1RHL(N)</b>	1,956.	2,600.
	Full Door Pedestal	24"	23 1/2"	48 7/8"	<b>WTFD5024FDFDRHL(N)</b>	2,054.	2,706.
	Open/File Pedestal	24"	23 1/2"	48 7/8"	<b>WTFD5024FDOFRHL(N)</b>	2,262.	2,954.
	File/File Pedestal (shown)	24"	23 1/2"	48 7/8"	<b>WTFD5024FDFFRHL(N)</b>	2,362.	3,013.
	Open/Box/File Pedestal	24"	23 1/2"	48 7/8"	<b>WTFD5024FDOBRHL(N)</b>	2,385.	3,057.
	Box (File Front)/File Pedestal	24"	23 1/2"	48 7/8"	<b>WTFD5024FDCFRHL(N)</b>	2,429.	3,119.
	Box/Box(File Front) File Pedestal	24"	23 1/2"	48 7/8"	<b>WTFD5024FDCBRHL(N)</b>	2,511.	3,181.
Tower, Front Access with Door, Full Door Locker Left Hand, 50" high, 30" wide 	Open Pedestal	30"	23 1/2"	48 7/8"	<b>WTFD5030FDO1LHL(N)</b>	2,144.	2,875.
	Full Door Pedestal	30"	23 1/2"	48 7/8"	<b>WTFD5030FDFDLHL(N)</b>	2,242.	2,981.
	Open/File Pedestal	30"	23 1/2"	48 7/8"	<b>WTFD5030FDOFLHL(N)</b>	2,450.	3,229.
	File/File Pedestal (shown)	30"	23 1/2"	48 7/8"	<b>WTFD5030FDFFLHL(N)</b>	2,549.	3,288.
	Open/Box/File Pedestal	30"	23 1/2"	48 7/8"	<b>WTFD5030FDOBLHL(N)</b>	2,573.	3,331.
	Box (File Front)/File Pedestal	30"	23 1/2"	48 7/8"	<b>WTFD5030FDCFLHL(N)</b>	2,617.	3,394.
	Box/Box(File Front) File Pedestal	30"	23 1/2"	48 7/8"	<b>WTFD5030FDCBLHL(N)</b>	2,699.	3,455.
Tower, Front Access with Door, Full Door Locker Right Hand, 50" high, 30" wide 	Open Pedestal	30"	23 1/2"	48 7/8"	<b>WTFD5030FDO1RHL(N)</b>	2,144.	2,875.
	Full Door Pedestal	30"	23 1/2"	48 7/8"	<b>WTFD5030FDFDRHL(N)</b>	2,242.	2,981.
	Open/File Pedestal	30"	23 1/2"	48 7/8"	<b>WTFD5030FDOFRHL(N)</b>	2,450.	3,229.
	File/File Pedestal (shown)	30"	23 1/2"	48 7/8"	<b>WTFD5030FDFFRHL(N)</b>	2,549.	3,288.
	Open/Box/File Pedestal	30"	23 1/2"	48 7/8"	<b>WTFD5030FDOBRHL(N)</b>	2,573.	3,331.
	Box (File Front)/File Pedestal	30"	23 1/2"	48 7/8"	<b>WTFD5030FDCFRHL(N)</b>	2,617.	3,394.
	Box/Box(File Front) File Pedestal	30"	23 1/2"	48 7/8"	<b>WTFD5030FDCBRHL(N)</b>	2,699.	3,455.

**Order Information**

1. *Base Pattern Number*
2. *Lock option*  
L = Locking  
N = Non-locking
3. *Case Finish*  
See Finish Options page
4. *Front Finish*  
See Finish Options page
5. *Top Finish*  
See Finish Options page
6. *Pull style*  
T = 10" finger pull
7. *Pull finish*  
See Finish Options page
8. *Lock finish*  
B = Black  
C = Chrome

**Order Code**

Tower, Front Access with Door, Full Door Locker, 50" high, 24" wide, F/F pedestal, Left hand	
Example: <b>WTFD5024FDFFLHL</b>	
<b>WTFD</b> Anchor Tower, Front Access with Door	
<b>50</b> 50" High	
<b>24</b> 24" Wide	
<b>FD</b> Locker configuration, Full Door	
<b>FF</b> Pedestal configuration, File/File	
<b>LH</b> Left hand	
<b>L</b> Laminate	
<b>(L)</b> Lock option, Locking	
<b>(118)</b> Case Finish	
<b>(118)</b> Front Finish	
<b>(118)</b> Top Finish	
<b>(T)</b> Pull Style	
<b>(118)</b> Pull Finish	
<b>(C)</b> Lock finish, Chrome	

**Specification Information**

Refer to Tower Shelf count for number of included shelves with each interior configuration.

Add \$40 to the list price per standard key lock.

Add \$15 to the list price per pull for Anodized Nickel (AN) or Aluminum (AA) finish.

Towers specified with mixed laminate finishes are L2 pricing. Refer to Mixed Laminate Finishes for further details.

Dimensions listed under w h d are actual to the nearest 1/16".

**Application Notes**

Towers 24" deep (nominal) have a 23 1/2" deep case; 24 3/8" overall depth including door.

Towers with full door include a coat hook to be field installed.



# Towers

## 57" High Front Access with Door, Open Locker

### 24" and 30" wide

description	pedestal configuration	w	d	h	pattern no.	L1	L2
Tower, Front Access with Door, Open Locker Left Hand, 57" high, 24" wide	Full Door Pedestal	24"	23 1/2"	56 3/16"	<b>WTFD5724OSFDLHL(N)</b>	\$2,066.	\$2,782.
	Open/File Pedestal	24"	23 1/2"	56 3/16"	<b>WTFD5724OSOFLHL(N)</b>	2,274.	3,030.
	File/File Pedestal (shown)	24"	23 1/2"	56 3/16"	<b>WTFD5724OSFFLHL(N)</b>	2,374.	3,089.
	Open/Box/File Pedestal	24"	23 1/2"	56 3/16"	<b>WTFD5724OSOBLHL(N)</b>	2,396.	3,132.
	Box (File Front)/File Pedestal	24"	23 1/2"	56 3/16"	<b>WTFD5724OSCFHL(N)</b>	2,441.	3,195.
	Box (File Front)/File Pedestal	24"	23 1/2"	56 3/16"	<b>WTFD5724OSCBHL(N)</b>	2,523.	3,257.

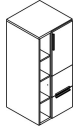

Tower, Front Access with Door, Open Locker Right Hand, 57" high, 24" wide	Full Door Pedestal	24"	23 1/2"	56 3/16"	<b>WTFD5724OSFDRHL(N)</b>	2,066.	2,782.
	Open/File Pedestal	24"	23 1/2"	56 3/16"	<b>WTFD5724OSOFRHL(N)</b>	2,274.	3,030.
	File/File Pedestal (shown)	24"	23 1/2"	56 3/16"	<b>WTFD5724OSFFRHL(N)</b>	2,374.	3,089.
	Open/Box/File Pedestal	24"	23 1/2"	56 3/16"	<b>WTFD5724OSOBRHL(N)</b>	2,396.	3,132.
	Box (File Front)/File Pedestal	24"	23 1/2"	56 3/16"	<b>WTFD5724OSCFRHL(N)</b>	2,441.	3,195.
	Box (File Front)/File Pedestal	24"	23 1/2"	56 3/16"	<b>WTFD5724OSCBRHL(N)</b>	2,523.	3,257.

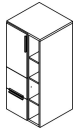

Tower, Front Access with Door, Open Locker Left Hand, 57" high, 30" wide	Full Door Pedestal	30"	23 1/2"	56 3/16"	<b>WTFD5730OSFDLHL(N)</b>	2,261.	3,066.
	Open/File Pedestal	30"	23 1/2"	56 3/16"	<b>WTFD5730OSOFLHL(N)</b>	2,469.	3,314.
	File/File Pedestal (shown)	30"	23 1/2"	56 3/16"	<b>WTFD5730OSFFLHL(N)</b>	2,568.	3,373.
	Open/Box/File Pedestal	30"	23 1/2"	56 3/16"	<b>WTFD5730OSOBLHL(N)</b>	2,591.	3,417.
	Box (File Front)/File Pedestal	30"	23 1/2"	56 3/16"	<b>WTFD5730OSCFHL(N)</b>	2,636.	3,479.
	Box (File Front)/File Pedestal	30"	23 1/2"	56 3/16"	<b>WTFD5730OSCBHL(N)</b>	2,718.	3,541.

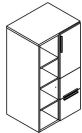

Tower, Front Access with Door, Open Locker Right Hand, 57" high, 30" wide	Full Door Pedestal	30"	23 1/2"	56 3/16"	<b>WTFD5730OSFDRHL(N)</b>	2,261.	3,066.
	Open/File Pedestal	30"	23 1/2"	56 3/16"	<b>WTFD5730OSOFRHL(N)</b>	2,469.	3,314.
	File/File Pedestal (shown)	30"	23 1/2"	56 3/16"	<b>WTFD5730OSFFRHL(N)</b>	2,568.	3,373.
	Open/Box/File Pedestal	30"	23 1/2"	56 3/16"	<b>WTFD5730OSOBRHL(N)</b>	2,591.	3,417.
	Box (File Front)/File Pedestal	30"	23 1/2"	56 3/16"	<b>WTFD5730OSCFRHL(N)</b>	2,636.	3,479.
	Box (File Front)/File Pedestal	30"	23 1/2"	56 3/16"	<b>WTFD5730OSCBRHL(N)</b>	2,718.	3,541.

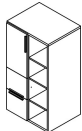

Order Information	Order Code	Specification Information	Application Notes
1. <i>Base Pattern Number</i>	Tower, Front Access with Door, Open Locker, 57" high, 24" wide, F/F pedestal, Left hand	Refer to Tower Shelf count for number of included shelves with each interior configuration.	Towers 24" deep (nominal) have a 23 1/2" deep case; 24 3/8" overall depth including door.
2. <i>Lock option</i> L = Locking N = Non-locking	Example: <b>WTFD5724OSFFLHL</b>	Add \$40 to the list price per standard key lock.	Towers with full door include a coat hook to be field installed.
3. <i>Case Finish</i> See Finish Options page	<b>WTFD</b> Anchor Tower, Front Access with Door	Add \$15 to the list price per pull for Anodized Nickel (AN) or Aluminum (AA) finish.	
4. <i>Front Finish</i> See Finish Options page	<b>57</b> 57" High		
5. <i>Top Finish</i> See Finish Options page	<b>24</b> 24" Wide		
6. <i>Pull style</i> T = 10" finger pull	<b>OS</b> Locker configuration, Open with Shelves	Towers specified with mixed laminates finishes are L2 pricing. Refer to Mixed Laminate Finishes for further details.	
7. <i>Pull finish</i> See Finish Options page	<b>FF</b> Pedestal configuration, File/File		
8. <i>Lock finish</i> B = Black C = Chrome	<b>LH</b> Left hand <b>L</b> Laminate <b>(L)</b> Lock option, Locking <b>(118)</b> Case Finish <b>(118)</b> Front Finish <b>(118)</b> Top Finish <b>(T)</b> Pull Style <b>(118)</b> Pull Finish <b>(C)</b> Lock finish, Chrome	Dimensions listed under w h d are actual to the nearest 1/16".	

## 57" High Front Access with Door, Full Door Locker 24" and 30" wide

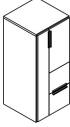
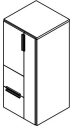
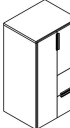
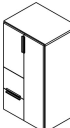
description	pedestal configuration	w	d	h	pattern no.	L1	L2
Tower, Front Access with Door, Full Door Locker Left Hand, 57" high, 24" wide 	Open Pedestal	24"	23 1/2"	56 3/16"	<b>WTFD5724FDO1LHL(N)</b>	\$2,113.	\$2,829.
	Full Door Pedestal	24"	23 1/2"	56 3/16"	<b>WTFD5724FDFDLHL(N)</b>	2,211.	2,935.
	Open/File Pedestal	24"	23 1/2"	56 3/16"	<b>WTFD5724FDOFLHL(N)</b>	2,419.	3,182.
	File/File Pedestal (shown)	24"	23 1/2"	56 3/16"	<b>WTFD5724FDFFLHL(N)</b>	2,519.	3,242.
	Open/Box/File Pedestal	24"	23 1/2"	56 3/16"	<b>WTFD5724FDOBLHL(N)</b>	2,542.	3,285.
	Box (File Front)/File Pedestal	24"	23 1/2"	56 3/16"	<b>WTFD5724FDCFLHL(N)</b>	2,586.	3,348.
	Box/Box(File Front) File Pedestal	24"	23 1/2"	56 3/16"	<b>WTFD5724FDCBLHL(N)</b>	2,668.	3,409.
Tower, Front Access with Door, Full Door Locker Right Hand, 57" high, 24" wide 	Open Pedestal	24"	23 1/2"	56 3/16"	<b>WTFD5724FDO1RHL(N)</b>	2,113.	2,829.
	Full Door Pedestal	24"	23 1/2"	56 3/16"	<b>WTFD5724FDFDRHL(N)</b>	2,211.	2,935.
	Open/File Pedestal	24"	23 1/2"	56 3/16"	<b>WTFD5724FDOFRHL(N)</b>	2,419.	3,182.
	File/File Pedestal (shown)	24"	23 1/2"	56 3/16"	<b>WTFD5724FDFRHL(N)</b>	2,519.	3,242.
	Open/Box/File Pedestal	24"	23 1/2"	56 3/16"	<b>WTFD5724FDOBRHL(N)</b>	2,542.	3,285.
	Box (File Front)/File Pedestal	24"	23 1/2"	56 3/16"	<b>WTFD5724FDCFRHL(N)</b>	2,586.	3,348.
	Box/Box(File Front) File Pedestal	24"	23 1/2"	56 3/16"	<b>WTFD5724FDCBRHL(N)</b>	2,668.	3,409.
Tower, Front Access with Door, Full Door Locker Left Hand, 57" high, 30" wide 	Open Pedestal	30"	23 1/2"	56 3/16"	<b>WTFD5730FDO1LHL(N)</b>	2,314.	3,124.
	Full Door Pedestal	30"	23 1/2"	56 3/16"	<b>WTFD5730FDFDLHL(N)</b>	2,412.	3,231.
	Open/File Pedestal	30"	23 1/2"	56 3/16"	<b>WTFD5730FDOFLHL(N)</b>	2,620.	3,478.
	File/File Pedestal (shown)	30"	23 1/2"	56 3/16"	<b>WTFD5730FDFFLHL(N)</b>	2,720.	3,537.
	Open/Box/File Pedestal	30"	23 1/2"	56 3/16"	<b>WTFD5730FDOBLHL(N)</b>	2,743.	3,581.
	Box (File Front)/File Pedestal	30"	23 1/2"	56 3/16"	<b>WTFD5730FDCFLHL(N)</b>	2,788.	3,643.
	Box/Box(File Front) File Pedestal	30"	23 1/2"	56 3/16"	<b>WTFD5730FDCBLHL(N)</b>	2,869.	3,705.
Tower, Front Access with Door, Full Door Locker Right Hand, 57" high, 30" wide 	Open Pedestal	30"	23 1/2"	56 3/16"	<b>WTFD5730FDO1RHL(N)</b>	2,314.	3,124.
	Full Door Pedestal	30"	23 1/2"	56 3/16"	<b>WTFD5730FDFDRHL(N)</b>	2,412.	3,231.
	Open/File Pedestal	30"	23 1/2"	56 3/16"	<b>WTFD5730FDOFRHL(N)</b>	2,620.	3,478.
	File/File Pedestal (shown)	30"	23 1/2"	56 3/16"	<b>WTFD5730FDFRHL(N)</b>	2,720.	3,537.
	Open/Box/File Pedestal	30"	23 1/2"	56 3/16"	<b>WTFD5730FDOBRHL(N)</b>	2,743.	3,581.
	Box (File Front)/File Pedestal	30"	23 1/2"	56 3/16"	<b>WTFD5730FDCFRHL(N)</b>	2,788.	3,643.
	Box/Box(File Front) File Pedestal	30"	23 1/2"	56 3/16"	<b>WTFD5730FDCBRHL(N)</b>	2,869.	3,705.

Order Information	Order Code	Specification Information	Application Notes
1. <i>Base Pattern Number</i>	Tower, Front Access with Door, Full Door Locker, 57" high, 24" wide, F/F pedestal, Left hand	Refer to Tower Shelf count for number of included shelves with each interior configuration.	Towers 24" deep (nominal) have a 23 1/2" deep case; 24 3/8" overall depth including door.
2. <i>Lock option</i> L = Locking N = Non-locking			
3. <i>Case Finish</i> See Finish Options page	Example: <b>WTFD5724FDFFLHL</b>	Add \$40 to the list price per standard key lock.	Towers with full door include a coat hook to be field installed.
4. <i>Front Finish</i> See Finish Options page	<b>WTFD</b> Anchor Tower, Front Access with Door	Add \$15 to the list price per pull for Anodized Nickel (AN) or Aluminum (AA) finish.	
5. <i>Top Finish</i> See Finish Options page	<b>57</b> 57" High		
6. <i>Pull style</i> T = 10" finger pull	<b>24</b> 24" Wide		
7. <i>Pull finish</i> See Finish Options page	<b>FD</b> Locker configuration, Full Door	Towers specified with mixed laminate finishes are L2 pricing. Refer to Mixed Laminate Finishes for further details.	
8. <i>Lock finish</i> B = Black C = Chrome	<b>FF</b> Pedestal configuration, File/File	Dimensions listed under w h d are actual to the nearest 1/16".	
	<b>LH</b> Left hand		
	<b>L</b> Laminate		
	<b>(L)</b> Lock option, Locking		
	<b>(118)</b> Case Finish		
	<b>(118)</b> Front Finish		
	<b>(118)</b> Top Finish		
	<b>(T)</b> Pull Style		
	<b>(118)</b> Pull Finish		
	<b>(C)</b> Lock finish, Chrome		

# Towers

## 64" High Front Access with Door, Open Locker

### 24" and 30" wide

description	pedestal configuration	w	d	h	pattern no.	L1	L2
Tower, Front Access with Door, Open Locker Left Hand, 64" high, 24" wide	Full Door Pedestal	24"	23 1/2"	63 7/16"	<b>WTFD6424OSFDLHL(N)</b>	\$2,268.	\$3,080.
	Open/File Pedestal	24"	23 1/2"	63 7/16"	<b>WTFD6424OSOFLHL(N)</b>	2,476.	3,328.
	File/File Pedestal (shown)	24"	23 1/2"	63 7/16"	<b>WTFD6424OSFFLHL(N)</b>	2,575.	3,387.
	Open/Box/File Pedestal	24"	23 1/2"	63 7/16"	<b>WTFD6424OSOBLHL(N)</b>	2,598.	3,430.
	Box (File Front)/File Pedestal	24"	23 1/2"	63 7/16"	<b>WTFD6424OSCFHL(N)</b>	2,643.	3,493.
	Box/Box(File Front) File Pedestal	24"	23 1/2"	63 7/16"	<b>WTFD6424OSCBHL(N)</b>	2,725.	3,554.

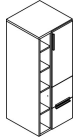

Tower, Front Access with Door, Open Locker Right Hand, 64" high, 24" wide	Full Door Pedestal	24"	23 1/2"	63 7/16"	<b>WTFD6424OSFDRHL(N)</b>	2,268.	3,080.
	Open/File Pedestal	24"	23 1/2"	63 7/16"	<b>WTFD6424OSOFRHL(N)</b>	2,476.	3,328.
	File/File Pedestal (shown)	24"	23 1/2"	63 7/16"	<b>WTFD6424OSFFRHL(N)</b>	2,575.	3,387.
	Open/Box/File Pedestal	24"	23 1/2"	63 7/16"	<b>WTFD6424OSOBRHL(N)</b>	2,598.	3,430.
	Box (File Front)/File Pedestal	24"	23 1/2"	63 7/16"	<b>WTFD6424OSCFRHL(N)</b>	2,643.	3,493.
	Box/Box(File Front) File Pedestal	24"	23 1/2"	63 7/16"	<b>WTFD6424OSCBRHL(N)</b>	2,725.	3,554.

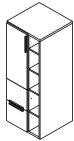

Tower, Front Access with Door, Open Locker Left Hand, 64" high, 30" wide	Full Door Pedestal	30"	23 1/2"	63 7/16"	<b>WTFD6430OSFDLHL(N)</b>	2,469.	3,375.
	Open/File Pedestal	30"	23 1/2"	63 7/16"	<b>WTFD6430OSOFLHL(N)</b>	2,677.	3,622.
	File/File Pedestal (shown)	30"	23 1/2"	63 7/16"	<b>WTFD6430OSFFLHL(N)</b>	2,777.	3,682.
	Open/Box/File Pedestal	30"	23 1/2"	63 7/16"	<b>WTFD6430OSOBLHL(N)</b>	2,800.	3,725.
	Box (File Front)/File Pedestal	30"	23 1/2"	63 7/16"	<b>WTFD6430OSCFHL(N)</b>	2,845.	3,788.
	Box/Box(File Front) File Pedestal	30"	23 1/2"	63 7/16"	<b>WTFD6430OSCBHL(N)</b>	2,926.	3,849.

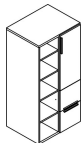

Tower, Front Access with Door, Open Locker Right Hand, 64" high, 30" wide	Full Door Pedestal	30"	23 1/2"	63 7/16"	<b>WTFD6430OSFDRHL(N)</b>	2,469.	3,375.
	Open/File Pedestal	30"	23 1/2"	63 7/16"	<b>WTFD6430OSOFRHL(N)</b>	2,677.	3,622.
	File/File Pedestal (shown)	30"	23 1/2"	63 7/16"	<b>WTFD6430OSFFRHL(N)</b>	2,777.	3,682.
	Open/Box/File Pedestal	30"	23 1/2"	63 7/16"	<b>WTFD6430OSOBRHL(N)</b>	2,800.	3,725.
	Box (File Front)/File Pedestal	30"	23 1/2"	63 7/16"	<b>WTFD6430OSCFRHL(N)</b>	2,845.	3,788.
	Box/Box(File Front) File Pedestal	30"	23 1/2"	63 7/16"	<b>WTFD6430OSCBRHL(N)</b>	2,926.	3,849.

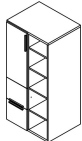

Order Information	Order Code	Specification Information	Application Notes
1. <i>Base Pattern Number</i>	Tower, Front Access with Door, Open Locker, 64" high, 24" wide, F/F pedestal, Left hand	Refer to Tower Shelf count for number of included shelves with each interior configuration.	Towers 24" deep (nominal) have a 23 1/2" deep case; 24 3/8" overall depth including door.
2. <i>Lock option</i> L = Locking N = Non-locking			
3. <i>Case Finish</i> See Finish Options page	Example: <b>WTFD6424OSFFLHL</b>	Add \$40 to the list price per standard key lock.	Towers with full door include a coat hook to be field installed.
4. <i>Front Finish</i> See Finish Options page	<b>WTFD</b> Anchor Tower, Front Access with Door	Add \$15 to the list price per pull for Anodized Nickel (AN) or Aluminum (AA) finish.	
5. <i>Top Finish</i> See Finish Options page	<b>64</b> 64" High		
6. <i>Pull style</i> T = 10" finger pull	<b>24</b> 24" Wide		
7. <i>Pull finish</i> See Finish Options page	<b>OS</b> Locker configuration, Open with Shelves	Towers specified with mixed laminates finishes are L2 pricing. Refer to Mixed Laminate Finishes for further details.	
8. <i>Lock finish</i> B = Black C = Chrome	<b>FF</b> Pedestal configuration, File/File		
	<b>LH</b> Left hand	Dimensions listed under w h d are actual to the nearest 1/16".	
	<b>L</b> Laminate		
	<b>(L)</b> Lock option, Locking		
	<b>(118)</b> Case Finish		
	<b>(118)</b> Front Finish		
	<b>(118)</b> Top Finish		
	<b>(T)</b> Pull Style		
	<b>(118)</b> Pull Finish		
	<b>(C)</b> Lock finish, Chrome		

## 64" High Front Access with Door, Full Door Locker 24" and 30" wide

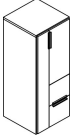
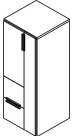
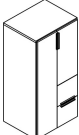
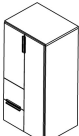
description	pedestal configuration	w	d	h	pattern no.	L1	L2
Tower, Front Access with Door, Full Door Locker Left Hand, 64" high, 24" wide 	Open Pedestal	24"	23 1/2"	63 7/16"	<b>WTFD6424FDO1LHL(N)</b>	\$2,326.	\$3,143.
	Full Door Pedestal	24"	23 1/2"	63 7/16"	<b>WTFD6424FDFDLHL(N)</b>	2,424.	3,249.
	Open/File Pedestal	24"	23 1/2"	63 7/16"	<b>WTFD6424FDOFLHL(N)</b>	2,632.	3,496.
	File/File Pedestal (shown)	24"	23 1/2"	63 7/16"	<b>WTFD6424FDFFLHL(N)</b>	2,732.	3,556.
	Open/Box/File Pedestal	24"	23 1/2"	63 7/16"	<b>WTFD6424FDOBLHL(N)</b>	2,755.	3,599.
	Box (File Front)/File Pedestal	24"	23 1/2"	63 7/16"	<b>WTFD6424FDCFLHL(N)</b>	2,799.	3,662.
	Box/Box(File Front) File Pedestal	24"	23 1/2"	63 7/16"	<b>WTFD6424FDCBLHL(N)</b>	2,881.	3,723.
Tower, Front Access with Door, Full Door Locker Right Hand, 64" high, 24" wide 	Open Pedestal	24"	23 1/2"	63 7/16"	<b>WTFD6424FDO1RHL(N)</b>	2,326.	3,143.
	Full Door Pedestal	24"	23 1/2"	63 7/16"	<b>WTFD6424FDFDRHL(N)</b>	2,424.	3,249.
	Open/File Pedestal	24"	23 1/2"	63 7/16"	<b>WTFD6424FDOFRHL(N)</b>	2,632.	3,496.
	File/File Pedestal (shown)	24"	23 1/2"	63 7/16"	<b>WTFD6424FDFFRHL(N)</b>	2,732.	3,556.
	Open/Box/File Pedestal	24"	23 1/2"	63 7/16"	<b>WTFD6424FDOBRHL(N)</b>	2,755.	3,599.
	Box (File Front)/File Pedestal	24"	23 1/2"	63 7/16"	<b>WTFD6424FDCFRHL(N)</b>	2,799.	3,662.
	Box/Box(File Front) File Pedestal	24"	23 1/2"	63 7/16"	<b>WTFD6424FDCBRHL(N)</b>	2,881.	3,723.
Tower, Front Access with Door, Full Door Locker Left Hand, 64" high, 30" wide 	Open Pedestal	30"	23 1/2"	63 7/16"	<b>WTFD6430FDO1LHL(N)</b>	2,541.	3,460.
	Full Door Pedestal	30"	23 1/2"	63 7/16"	<b>WTFD6430FDFDLHL(N)</b>	2,639.	3,565.
	Open/File Pedestal	30"	23 1/2"	63 7/16"	<b>WTFD6430FDOFLHL(N)</b>	2,847.	3,813.
	File/File Pedestal (shown)	30"	23 1/2"	63 7/16"	<b>WTFD6430FDFFLHL(N)</b>	2,947.	3,872.
	Open/Box/File Pedestal	30"	23 1/2"	63 7/16"	<b>WTFD6430FDOBLHL(N)</b>	2,970.	3,916.
	Box (File Front)/File Pedestal	30"	23 1/2"	63 7/16"	<b>WTFD6430FDCFLHL(N)</b>	3,015.	3,978.
	Box/Box(File Front) File Pedestal	30"	23 1/2"	63 7/16"	<b>WTFD6430FDCBLHL(N)</b>	3,096.	4,040.
Tower, Front Access with Door, Full Door Locker Right Hand, 64" high, 30" wide 	Open Pedestal	30"	23 1/2"	63 7/16"	<b>WTFD6430FDO1RHL(N)</b>	2,541.	3,460.
	Full Door Pedestal	30"	23 1/2"	63 7/16"	<b>WTFD6430FDFDLHR(N)</b>	2,639.	3,565.
	Open/File Pedestal	30"	23 1/2"	63 7/16"	<b>WTFD6430FDOFRHL(N)</b>	2,847.	3,813.
	File/File Pedestal (shown)	30"	23 1/2"	63 7/16"	<b>WTFD6430FDFFRHL(N)</b>	2,947.	3,872.
	Open/Box/File Pedestal	30"	23 1/2"	63 7/16"	<b>WTFD6430FDOBRHL(N)</b>	2,970.	3,916.
	Box (File Front)/File Pedestal	30"	23 1/2"	63 7/16"	<b>WTFD6430FDCFRHL(N)</b>	3,015.	3,978.
	Box/Box(File Front) File Pedestal	30"	23 1/2"	63 7/16"	<b>WTFD6430FDCBRHL(N)</b>	3,096.	4,040.

**Order Information**

1. *Base Pattern Number*
2. *Lock option*  
L = Locking  
N = Non-locking
3. *Case Finish*  
See Finish Options page
4. *Front Finish*  
See Finish Options page
5. *Top Finish*  
See Finish Options page
6. *Pull style*  
T = 10" finger pull
7. *Pull finish*  
See Finish Options page
8. *Lock finish*  
B = Black  
C = Chrome

**Order Code**

Tower, Front Access with Door, Full Door Locker, 64" high, 24" wide, F/F pedestal, Left hand	
Example: <b>WTFD6424FDFFLHL</b>	
<b>WTFD</b> Anchor Tower, Front Access with Door	
<b>64</b> 64" High	
<b>24</b> 24" Wide	
<b>FD</b> Locker configuration, Full Door	
<b>FF</b> Pedestal configuration, File/File	
<b>LH</b> Left hand	
<b>L</b> Laminate	
<b>(L)</b> Lock option, Locking	
<b>(118)</b> Case Finish	
<b>(118)</b> Front Finish	
<b>(118)</b> Top Finish	
<b>(T)</b> Pull Style	
<b>(118)</b> Pull Finish	
<b>(C)</b> Lock finish, Chrome	

**Specification Information**

Refer to Tower Shelf count for number of included shelves with each interior configuration.

Add \$40 to the list price per standard key lock.

Add \$15 to the list price per pull for Anodized Nickel (AN) or Aluminum (AA) finish.



Towers specified with mixed laminate finishes are L2 pricing. Refer to Mixed Laminate Finishes for further details.

Dimensions listed under w h d are actual to the nearest 1/16".

**Application Notes**

Towers 24" deep (nominal) have a 23 1/2" deep case; 24 3/8" overall depth including door.

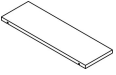
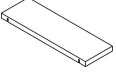
Towers with full door include a coat hook to be field installed.

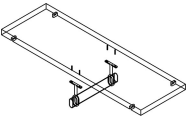
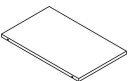
description	description	w	d	h	pattern no.	L1	L2
Full-depth tower locker shelf 	single shelf, for 24" w tower	7 1/4"	22 3/4"	3/4"	<b>WTLSF2401L</b>	\$77.	\$87.
	single shelf, for 30" w tower	13 1/4"	22 3/4"	3/4"	<b>WTLSF3001L</b>	104.	119.
	pack of 4 shelves, for 24" w tower	7 1/4"	22 3/4"	3/4"	<b>WTLSF2404L</b>	224.	294.
	pack of 4 shelves, for 30" w tower	13 1/4"	22 3/4"	3/4"	<b>WTLSF3004L</b>	305.	418.
Full-depth tower locker shelf, work surface thickness 	single shelf, for 24" w tower	7 1/4"	22 3/4"	1 1/8"	<b>WTLST2401L</b>	87.	95.
	single shelf, for 30" w tower	13 1/4"	22 3/4"	1 1/8"	<b>WTLST3001L</b>	113.	126.
	pack of 4 shelves, for 24" w tower	7 1/4"	22 3/4"	1 1/8"	<b>WTLST2404L</b>	265.	328.
	pack of 4 shelves, for 30" w tower	13 1/4"	22 3/4"	1 1/8"	<b>WTLST3004L</b>	372.	470.
Partial-depth tower locker shelf 	single shelf, for 24" w tower	7 1/4"	11 3/8"	3/4"	<b>WTLSP2401L</b>	56.	61.
	single shelf, for 30" w tower	13 1/4"	11 3/8"	3/4"	<b>WTLSP3001L</b>	67.	75.
	pack of 4 shelves, for 24" w tower	7 1/4"	11 3/8"	3/4"	<b>WTLSP2404L</b>	143.	178.
	pack of 4 shelves, for 30" w tower	13 1/4"	11 3/8"	3/4"	<b>WTLSP3004L</b>	187.	243.
Full-depth tower locker shelf with coat rod 	single shelf, for 24" w tower	7 1/4"	22 3/4"	3/4"	<b>WTLCKRKIT2401L</b>	127.	137.
	single shelf, for 30" w tower	13 1/4"	22 3/4"	3/4"	<b>WTLCKRKIT3001L</b>	157.	173.
	pack of 4 shelves, for 24" w tower	7 1/4"	22 3/4"	3/4"	<b>WTLCKRKIT2404L</b>	337.	408.
	pack of 4 shelves, for 30" w tower	13 1/4"	22 3/4"	3/4"	<b>WTLCKRKIT3004L</b>	431.	543.
Full-depth Tower Pedestal/Upper Shelf, for 24" or 30" wide tower 	single shelf	14"	22 3/4"	3/4"	<b>WPSF1601L</b>	113.	130.
	pack of 4 shelves	14"	22 3/4"	3/4"	<b>WPSF1604L</b>	333.	455.

### Order Information

1. *Base Pattern Number*
2. *Finish*  
See Finish Options page

### Order Code

Full-depth shelf for 24" w tower locker

Example:	<b>WTLSF2401L</b>
<b>WT</b>	Anchor Tower
<b>LSF</b>	Locker Shelf (full depth)
<b>24</b>	for 24" wide tower
<b>01</b>	single shelf
<b>L</b>	Laminate
<b>(118)</b>	Finish, Bright White

### Specification Information

Each shelf includes 4 mounding pins.

Edgebanding preselected to match or coordinate with laminate; see "Finish Options" for further details.

### Application Notes

Tower Locker shelves are for use with open or full door lockers within Anchor Towers only; not for use with Anchor Lockers

Tower Pedestal/Upper shelves are for use within the pedestal segment of towers and upper segment of Front Access towers. **Not for use in upper segment of Side Access towers.**

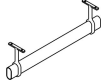
description	description	finish	pattern no.	list
Coat Hook, side mount 	Anodized Silver		<b>WACH</b>	\$35.
Coat Rod, top mount 	For locker in 24" wide tower	Chrome	<b>WTLCRTM24</b>	46.
	For locker in 30" wide tower	Chrome	<b>WTLCRTM30</b>	54.

**Order Information**

**Order Code**

**Specification Information**

**Application Notes**

Coat rods are for use with open or full door lockers within Anchor Towers only; not for use with Anchor Lockers.

# Tower Front Panel for Side Access Tower

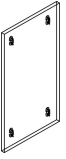
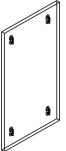
description	description	pattern no.	L1	L2	List
 Laminated Front Panel	for 42" high side access tower	<b>WTFP42L</b>	\$132.	\$145.	
	for 50" high side access tower	<b>WTFP50L</b>	156.	174.	
	for 57" high side access tower	<b>WTFP57L</b>	181.	206.	
	for 64" high side access tower	<b>WTFP64L</b>	202.	233.	
 Markerboard Front Panel	for 42" high side access tower	<b>WTFP42M</b>			207.
	for 50" high side access tower	<b>WTFP50M</b>			252.
	for 57" high side access tower	<b>WTFP57M</b>			298.
	for 64" high side access tower	<b>WTFP64M</b>			339.

### Order Information

1. *Base Pattern Number*
2. *Finish*  
See Finish Options page

### Order Code

Markerboard front panel for SA Tower

Example: **WTFP57M**

**WT** Anchor Tower

**FP** Front panel

**57** for 57" high side access tower

**M** Markerboard laminate

### Specification Information

Front panels include mounting bracket to install on side access tower. **Side access towers must be specified with a drilled front to accept front panel mounting hardware.**

### Application Notes

Markerboard front panel is finished with 118 Bright White edgebanding.

### Anchor Lockers

Anchor Lockers are 12" wide wood construction cabinets offered in 2 depths and 5 heights designed to correspond with Dividends Horizon panel heights.

Locker configurations include all open with shelves or enclosed with a door. Multiple door option is available in limited heights. Reference the Statement of Line for full product scope.

### Available Sizes (nominal)

Height: 42", 50", 57", 64" 71"

Widths: 12"

Depth: 20", 24"

Lockers ship assembled excluding the top.

**Locker tops must be specified separately.**

Lockers may be specified with a full-width individual top or specified in banks with a common top spanning up to eight units. They may be installed facing the same or opposite direction. Lockers may also be used to support one end of a work surface utilizing the accessory L-bracket.

Lockers must be ganged to a locker, another Anchor storage unit or connected to a work surface for stability.

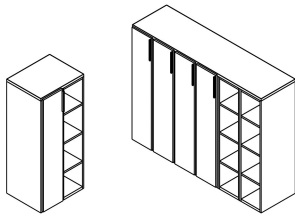

Lockers with common top (specified separately) spanning up to eight lockers

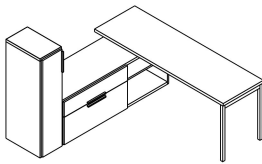

Locker connected to a workstation, ganged to another Anchor storage unit

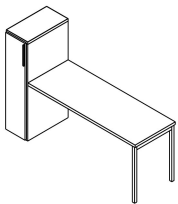

Locker supporting one end of a work surface utilizing L-bracket accessory

### Construction

- Lockers are constructed of wood core, laminate and ABS edge banding; cam and dowel construction.
- Material thickness: 1 3/16" (nominal) on locker bottom, 3/4" on locker back, sides, subtop, interior shelves and doors.
- Material thickness: 1 3/16" (nominal) on locker tops (specified separately)
- Leveling glides: 5/16" diameter steel stem with 1/16" of height adjustment, 4 per locker.

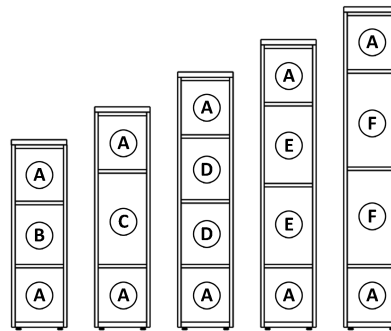

### Internal Clearances\*

#### All Open with Shelves

Internal height:

- 42" high: A: 11 15/16", B: 12 1/4"
- 50" high: A: 11 15/16", C: 19 5/16"
- 57" high: A: 11 15/16", D: 13 3/8"
- 64" high: A: 11 15/16", E: 16 5/8"
- 71" high: A: 11 15/16", F: 20 1/8"

Internal width: 10 1/2"

Internal depth: 18 5/16", 22 3/4"

\*Actual dimensions to the nearest 1/16th of an inch

### Locks

Anchor Lockers may be ordered with or without locks. No lock hole is drilled on units specified as non-locking.

Locks are randomly keyed unless otherwise specified. Other keying options include keyed alike or keyed with lock cores K001-K250. To specify units as such, reference KnollKey Lock Program.

### Pulls

Finger Pull, 10" long; vertically positioned 1 1/8" below top edge of door; exceptions shown below.

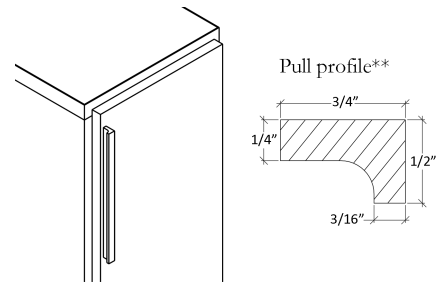

Standard Pull Position

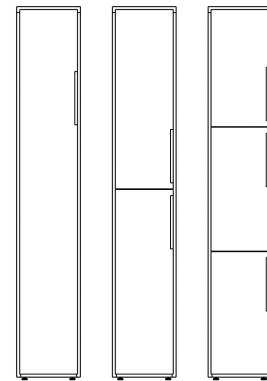

Pull positions on 71" high lockers standard except the following:

- Full Door: 11 3/8" below top edge of door
- Double Door locker, top door: 1 1/8" above bottom edge of door
- Triple Door locker, top door: 11 1/8" below top edge of door





### Specifications and Features

#### Digital Keypad Lock

- Brushed Nickel finish
- Black keypad with white numbers
- Vertical body orientation
- Recessed-mount, factory installed
- All metal lock housing
- Automatic (motorized) 1/2" dead bolt
- Powered by 4 premium AA batteries
- Operated with a user-selected 4-digit code
- Shared use application
- Tamper guard
- Audible and visible usage indicators
- Programmable automatic unlock
- Programmable LED usage indicator

To specify a locker with a digital keypad lock, select "D" in the pattern number for the lock option.

*Example:* WL5724FDRHL(D) - Locker with full height door, 57H x 24D, laminate, **digital keypad lock**

When specified, digital keypad lock is factory installed. Instructions for programming are included.

- Batteries can be changed without removing the lock mounting hardware.
- Locks can be programmed to auto unlock after a set amount of hours. The default setting for this feature is OFF (does not auto-unlock), but if desired this feature can be activated with the programming key at any time.

#### Manager Key

- Manager key is used to bypass a locked unit.
- Manager keys are registered to locks using the program key.
- One or more manager keys may be registered to each lock. This allows the client to design a lock system that suits their management access requirements.
- Additional manager key(s) may be registered to a lock without erasing previously registered manager keys.
- Provides external power in case of battery failure.
- Each lock accepts up to (25) manager keys.

#### Programming Key

- The programming key is a communication device used to initialize locks out of factory default mode and to register manager keys to the locks. It is used to transfer, but not store information.
- Only one programming key should be specified per installation site. Multiple programming keys cannot be used in conjunction with each other.
- If a programming key is lost, a new one may be ordered but the original programming key will become obsolete.
- Add-on or phased orders for digital keypad locks should be initialized and programmed using the original programming key.
- Used to turn on/off features such as LED usage indicator and auto unlock.
- Provides external power in case of battery failure.

### Application

Anchor lockers with digital keypad lock option support applications where lockers are shared by multiple users.

The digital keypad lock option provides secure storage alternative to a standard key lock with a user-selected 4-digit code to lock and unlock the unit. This eliminates the use of a standard key which can easily be misplaced or taken off site. If a code is forgotten, a manager key (specified separately) can be used to bypass the code and unlock the unit.

**Each installation site with digital keypad locks requires one programming key and at least one manager key, specified separately.**

- Digital keypad automatically locks and unlocks a unit with a user-selected 4 digit code.
- Lock can be bypassed with a manager key if code is forgotten or in case of battery failure.
- LED usage indicator prompts the lock's LED to flash when the unit is locked, indicating the locker is in use. The default setting for this feature is ON, however the LED usage indicator can be turned off with the program key at any time.
- Typical battery life is 3-5 years (based on length of usage). Turning the LED usage indicator feature off extends battery life.
- Four (4) AA batteries are included with the locks.

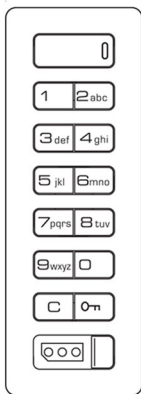

digital keypad lock

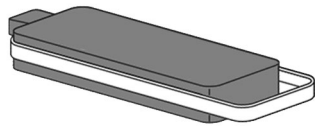

programming key (yellow)



manager key (black)

# Locker Specifications

## Digital Keypad Lock Details

### Calculating the total number of manager keys

The digital keypad lock system is flexible, allowing the client to choose the number of manager keys required. Solutions may range from simple to complex, depending on client needs. It may be helpful to create a chart to organize and calculate the number of manager keys required, similar to the examples shown below.

Considerations:

- If units will be located on different floors, consider ordering keys that can be registered to bypass all locks as a floor-specific “master key”.
- If units will be located within different zones or areas, consider ordering keys that can be registered to locks within specific zones on each floor.
- If the client would like to create a “master key”, one or more manager keys can be registered to all locks to act as a “master key”.

### Manager key count examples

Sample project is a three story space, each floor is divided into three zones containing a varied number of lockers. Example 1 is a simple lock system showing two manager keys registered to all locks, regardless of floor or zone. Example 2 is a more complex solution showing manager keys registered to locks in a layered approach. At the lowest management level, keys are registered specific to zone, followed by keys that are floor-specific and at the top level, keys are registered to all locks to be used as overall master keys.

The manager key counts shown in the examples are sample numbers; the ratio of manager keys to the number of locks is decided by the client.

Example 1:

Two (2) manager keys registered to all locks throughout the space. No manager keys registered specific to floor or zone.

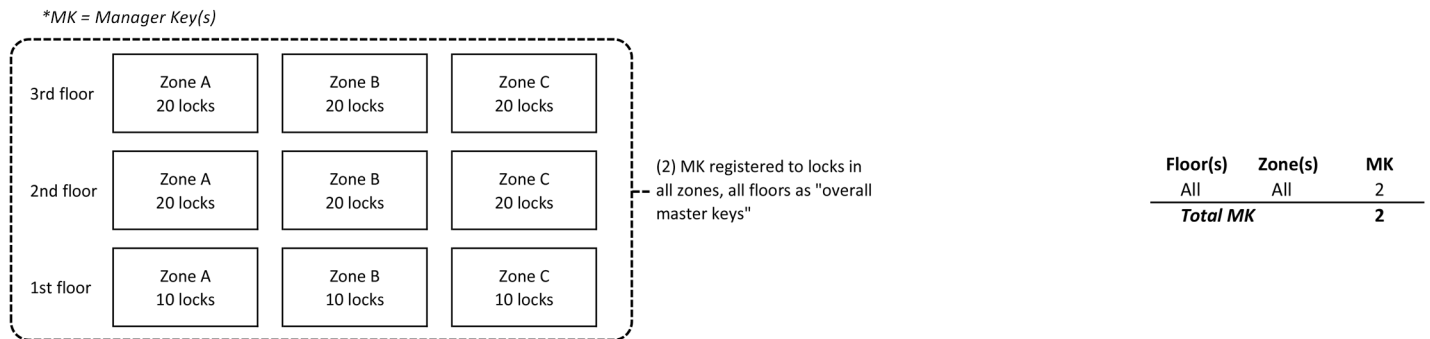

Example 2:

- Manager keys registered to all locks within each specific zone on each floor. Number of manager keys is decided by client. Once registered, these manager keys may be used to bypass any lock within that zone on that floor, but will not be able to bypass any of the other units.
- One (1) manager key for each floor registered to all locks in all zones on that floor, used as first, second and third floor “master keys”.
- Two (2) manager keys registered to all locks, in all zones on all floors used as “overall master keys”.

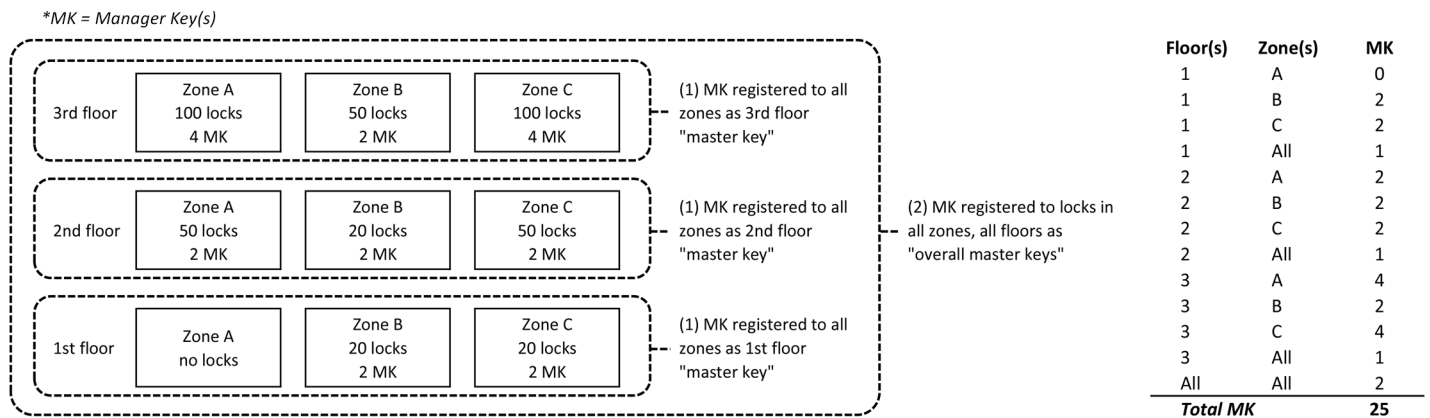

Locker Shelf Positions

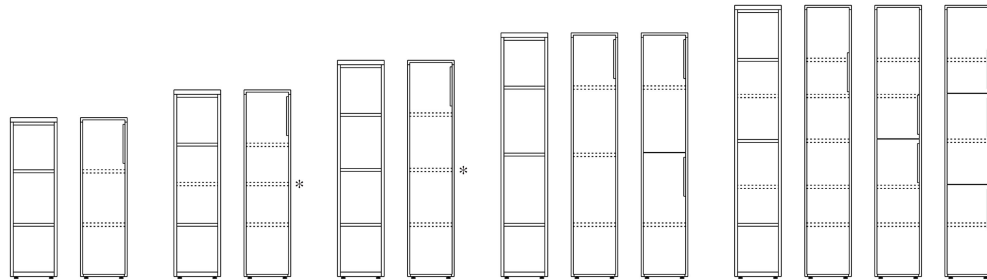

Height	42"	42"	50"	50"	57"	57"	64"	64"	64"	71"	71"	71"	71"
Configuration	Open	Full Door	Open	Full Door	Open	Full Door	Open	Full Door	Double Door	Open	Full Door	Double Door	Triple Door
Number of shelves included standard	2	1	2	1*	3	1*	3	1	0	3	1	0	0
Total shelf positions predrilled	2	2	3	3*	3	3*	3	3	2**	5	5	4***	3**

\* Middle shelf position can only accept a partial-depth shelf

\*\* One shelf position per interior section

\*\*\* Two shelf positions per interior section

**Locker Coat Hook and Coat Rod specifications**

**Locker with coat hook factory-installed**

Sample pattern number: WL5724FHRHL(N)

*Locker, Full Door, including coat hook*

Includes:

- One full-depth shelf
- Coat hook, factory-installed, see hook location details below

Also shown:

- Two partial-depth shelves (**must be specified separately**)
- Locker top (**must be specified separately**)

This configuration allows for storage shelves at the back of the locker and coat storage at the front of the locker to maximize internal space.

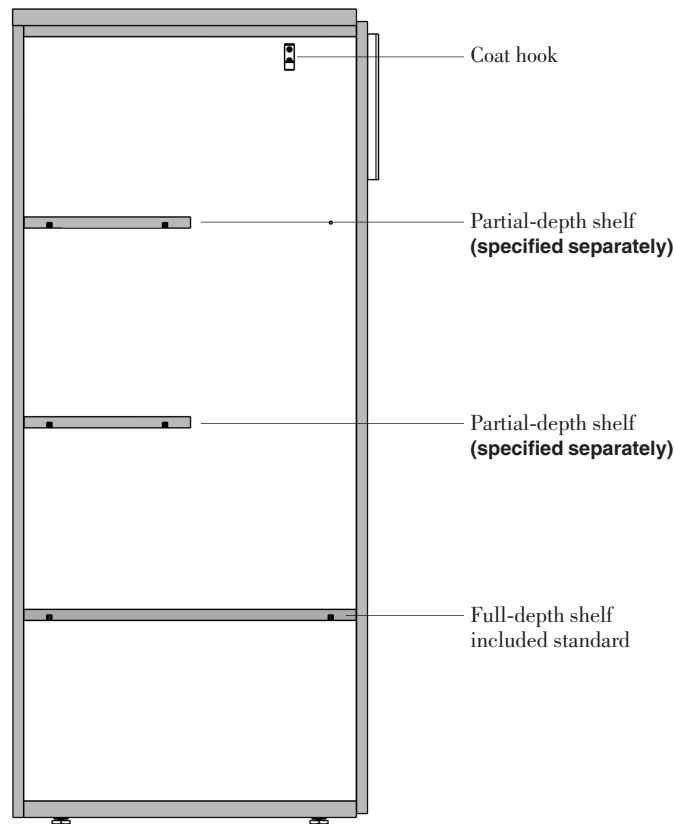

*Locker cross-section*

**Coat hook standard location:**

Coat hook is located on the same side panel as the door hinges.

3 1/2" (on center) from front edge of 20" deep locker case

5 5/8" (on center) from front edge of 24" deep locker case

1/2" below inner top (42", 50", 57", 64" high lockers)

1/2" below top shelf location (71" high locker)

**To specify a locker with custom coat hook location:**

- Locker (not including a hook) - sample pattern number WL5724FDRHL(N)
- Coat hook (pattern number WACH); field-installed
- Locker top specified separately



**To specify a locker with a coat rod:**

- Locker (not including a hook) - sample pattern number WL5724FDRHL(N)
- Coat rod (pattern number WLCR); field-installed
- Locker top specified separately

# Lockers

## Open with Shelves

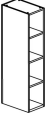
### 20" and 24" deep

description	nominal height	h	w	d	pattern no.	L1	L2
Open with Shelves, 20" deep 	42"	41 1/4"	12"	19 1/16"	<b>WL4220OSL</b>	\$807.	\$1,021.
	50"	48 5/16"	12"	19 1/16"	<b>WL5020OSL</b>	885.	1,123.
	57"	55 15/16"	12"	19 1/16"	<b>WL5720OSL</b>	1,013.	1,297.
	64"	63"	12"	19 1/16"	<b>WL6420OSL</b>	1,078.	1,386.
	71"	70 1/16"	12"	19 1/16"	<b>WL7120OSL</b>	1,141.	1,476.
Open with Shelves, 24" deep 	42"	41 1/4"	12"	23 1/2"	<b>WL4224OSL</b>	902.	1,171.
	50"	48 5/16"	12"	23 1/2"	<b>WL5024OSL</b>	983.	1,289.
	57"	55 15/16"	12"	23 1/2"	<b>WL5724OSL</b>	1,135.	1,491.
	64"	63"	12"	23 1/2"	<b>WL6424OSL</b>	1,210.	1,597.
	71"	70 1/16"	12"	23 1/2"	<b>WL7124OSL</b>	1,283.	1,703.

#### Order Information

1. Base Pattern Number
2. Finish  
See Finish Options page

#### Order Code

Locker ,	12W, 42H, 20D Open with Shelves
Example:	<b>WL4220OSL</b>
<b>WL</b>	Anchor Locker
<b>42</b>	42" High
<b>20</b>	20" Deep
<b>OS</b>	Open with Shelves
<b>L</b>	Laminate
<b>(118)</b>	Case Finish, Bright White

#### Specification Information

**Locker top must be specified separately, see "Locker Tops" section.**

Open lockers 42" and 50" high include 2 shelves; 57", 64" and 71" high include 3 shelves. Lockers with full-height door include 1 adjustable shelf. Additional full-depth and half-depth shelves may be ordered separately.

Add \$40 to the list price per standard key lock. Add \$560 to the list price per digital keypad lock. Lockers with double doors require two locks; lockers with triple doors require three locks. Digital keypad locks require program and manager key(s), specified separately. See specification page for details.

Add \$15 to the list price per pull for Anodized Nickel (AN) or Anodized Aluminum (AA) finish.

Lockers specified with mixed laminate finishes are L2 pricing. Refer to Mixed Laminate Finishes for further details.

Dimensions listed under w h d are actual to the nearest 1/16".

#### Application Notes

Lockers must be connected to another unit, a work surface or a panel for stability. Refer to the Locker Planning and Stability Guidelines for further information.

Lockers 20" deep (nominal) have a 19 1/16" deep case; 20" overall depth including door. Lockers 24" deep (nominal) have a 23 1/2" deep case; 24 3/8" overall depth including door.

Heights shown indicate the overall height of a locker complete with a top (specified separately).

Lockers including coat hook have a factory-installed coat hook on the end panel. Hook is located on the same side as the door hinges. See Locker Planning for details. Additional coat hooks may be specified separately (field installed). On units without a hook, coat hook or coat rod may be specified separately (field installed).

# Lockers

## Full Door including coat hook 20" and 24" deep

description	configuration	nominal height	h	w	d	pattern no.	L1	L2
Locker with Full Height Door, including coat hook, 20" deep  (right hand shown)	left hand	42"	41 1/4"	12"	19 1/16"	<b>WL4220FHLHL(N)</b>	\$1,002.	\$1,236.
	left hand	50"	48 5/16"	12"	19 1/16"	<b>WL5020FHLHL(N)</b>	1,096.	1,366.
	left hand	57"	55 15/16"	12"	19 1/16"	<b>WL5720FHLHL(N)</b>	1,178.	1,477.
	left hand	64"	63"	12"	19 1/16"	<b>WL6420FHLHL(N)</b>	1,288.	1,617.
	left hand	71"	70 1/16"	12"	19 1/16"	<b>WL7120FHLHL(N)</b>	1,370.	1,729.
	right hand	42"	41 1/4"	12"	19 1/16"	<b>WL4220FHRHL(N)</b>	1,002.	1,236.
	right hand	50"	48 5/16"	12"	19 1/16"	<b>WL5020FHRHL(N)</b>	1,096.	1,366.
	right hand	57"	55 15/16"	12"	19 1/16"	<b>WL5720FHRHL(N)</b>	1,178.	1,477.
	right hand	64"	63"	12"	19 1/16"	<b>WL6420FHRHL(N)</b>	1,288.	1,617.
	right hand	71"	70 1/16"	12"	19 1/16"	<b>WL7120FHRHL(N)</b>	1,370.	1,729.

Locker with Full Height Door, including coat hook, 24" deep  (right hand shown)	left hand	42"	41 1/4"	12"	23 1/2"	<b>WL4224FHLHL(N)</b>	1,088.	1,352.
	left hand	50"	48 5/16"	12"	23 1/2"	<b>WL5024FHLHL(N)</b>	1,191.	1,498.
	left hand	57"	55 15/16"	12"	23 1/2"	<b>WL5724FHLHL(N)</b>	1,281.	1,620.
	left hand	64"	63"	12"	23 1/2"	<b>WL6424FHLHL(N)</b>	1,401.	1,772.
	left hand	71"	70 1/16"	12"	23 1/2"	<b>WL7124FHLHL(N)</b>	1,491.	1,896.
	right hand	42"	41 1/4"	12"	23 1/2"	<b>WL4224FHRHL(N)</b>	1,088.	1,352.
	right hand	50"	48 5/16"	12"	23 1/2"	<b>WL5024FHRHL(N)</b>	1,191.	1,498.
	right hand	57"	55 15/16"	12"	23 1/2"	<b>WL5724FHRHL(N)</b>	1,281.	1,620.
	right hand	64"	63"	12"	23 1/2"	<b>WL6424FHRHL(N)</b>	1,401.	1,772.
	right hand	71"	70 1/16"	12"	23 1/2"	<b>WL7124FHRHL(N)</b>	1,491.	1,896.



Order Information	Order Code	Specification Information	Application Notes
1. <i>Base Pattern Number</i>	Locker , 42H, 20D, full door, incl. coat hook, left hand, laminate, locking	<b>Locker top must be specified separately, see "Locker Tops" section.</b>	Lockers must be connected to another unit, a work surface or a panel for stability. Refer to the Locker Planning and Stability Guidelines for further information.
2. <i>Lock option</i> L = Locking N = Non-locking D = Digital keypad lock	Example: <b>WL4220FHLHLL</b>	Open lockers 42" and 50" high include 2 shelves; 57", 64" and 71" high include 3 shelves. Lockers with full-height door include 1 adjustable shelf. Additional full-depth and half-depth shelves may be ordered separately.	Lockers 20" deep (nominal) have a 19 1/16" deep case; 20" overall depth including door. Lockers 24" deep (nominal) have a 23 1/2" deep case; 24 3/8" overall depth including door.
3. <i>Case Finish</i> See Finish Options page	<b>WL</b> Anchor Locker	Add \$40 to the list price per standard key lock. Add \$560 to the list price per digital keypad lock. Lockers with double doors require two locks; lockers with triple doors require three locks. Digital keypad locks require program and manager key(s), specified separately. See specification page for details.	Lockers 20" deep (nominal) have a 19 1/16" deep case; 20" overall depth including door. Lockers 24" deep (nominal) have a 23 1/2" deep case; 24 3/8" overall depth including door.
4. <i>Door Finish</i> See Finish Options page	<b>42</b> 42" High		Heights shown indicate the overall height of a locker complete with a top (specified separately).
5. <i>Pull style</i> T = 10" Finger pull	<b>20</b> 20" Deep		Lockers including coat hook have a factory-installed coat hook on the end panel. Hook is located on the same side as the door hinges. See Locker Planning for details. Additional coat hooks may be specified separately (field installed). On units without a hook, coat hook or coat rod may be specified separately (field installed).
6. <i>Pull finish</i> See Finish Options page	<b>FH</b> Full Door, with Coat Hook		
7. <i>Lock finish</i> See Finish Options page	<b>LH</b> Left Hand <b>L</b> Laminate <b>(L)</b> Locking <b>(118)</b> Case Finish, Bright White <b>(118)</b> Door Finish, Bright White <b>(T)</b> Pull Style, 10" Finger pull <b>(118)</b> Pull Finish, Bright White <b>(C)</b> Lock finish, Chrome	Add \$15 to the list price per pull for Anodized Nickel (AN) or Anodized Aluminum (AA) finish.  Lockers specified with mixed laminate finishes are L2 pricing. Refer to Mixed Laminate Finishes for further details.	

Dimensions listed under w h d are actual to the nearest 1/16".

# Lockers

## Full Door

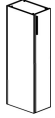
### 20" and 24" deep

description	configuration	nominal height	h	w	d	pattern no.	L1	L2
 <p>(right hand shown)</p>	Locker with Full Height Door, 20" deep	left hand	42"	41 1/4"	12"	19 1/16"	<b>WL4220FDLHL(N)</b>	\$968. \$1,201.
	left hand	50"	48 3/16"	12"	19 1/16"	<b>WL5020FDLHL(N)</b>	1,061. 1,331.	
	left hand	57"	55 13/16"	12"	19 1/16"	<b>WL5720FDLHL(N)</b>	1,142. 1,442.	
	left hand	64"	63"	12"	19 1/16"	<b>WL6420FDLHL(N)</b>	1,254. 1,583.	
	left hand	71"	70 1/16"	12"	19 1/16"	<b>WL7120FDLHL(N)</b>	1,336. 1,694.	
	right hand	42"	41 1/4"	12"	19 1/16"	<b>WL4220FDRHL(N)</b>	968. 1,201.	
	right hand	50"	48 3/16"	12"	19 1/16"	<b>WL5020FDRHL(N)</b>	1,061. 1,331.	
	right hand	64"	63"	12"	19 1/16"	<b>WL6420FDRHL(N)</b>	1,254. 1,583.	
	right hand	71"	70 1/16"	12"	19 1/16"	<b>WL7120FDRHL(N)</b>	1,336. 1,694.	
 <p>(right hand shown)</p>	Locker with Full Height Door, 24" deep	left hand	42"	41 1/4"	12"	23 1/2"	<b>WL4224FDLHL(N)</b>	1,053. 1,317.
	left hand	50"	48 3/16"	12"	23 1/2"	<b>WL5024FDLHL(N)</b>	1,156. 1,462.	
	left hand	57"	55 13/16"	12"	23 1/2"	<b>WL5724FDLHL(N)</b>	1,246. 1,584.	
	left hand	64"	63"	12"	23 1/2"	<b>WL6424FDLHL(N)</b>	1,366. 1,737.	
	left hand	71"	70 1/16"	12"	23 1/2"	<b>WL7124FDLHL(N)</b>	1,457. 1,861.	
	right hand	42"	41 1/4"	12"	23 1/2"	<b>WL4224FDRHL(N)</b>	1,053. 1,317.	
	right hand	50"	48 3/16"	12"	23 1/2"	<b>WL5024FDRHL(N)</b>	1,156. 1,462.	
	right hand	57"	55 13/16"	12"	23 1/2"	<b>WL5724FDRHL(N)</b>	1,246. 1,584.	
	right hand	64"	63"	12"	23 1/2"	<b>WL6424FDRHL(N)</b>	1,366. 1,737.	
right hand	71"	70 1/16"	12"	23 1/2"	<b>WL7124FDRHL(N)</b>	1,457. 1,861.		

#### Order Information

1. *Base Pattern Number*
2. *Lock option*  
L = Locking  
N = Non-locking  
D = Digital keypad lock
3. *Case Finish*  
See Finish Options page
4. *Door Finish*  
See Finish Options page
5. *Pull style*  
T = 10" Finger pull
6. *Pull finish*  
See Finish Options page
7. *Lock finish*  
See Finish Options page

#### Order Code

Locker ,	42H, 20D, full door, left hand, laminate, locking
Example:	<b>WL4220FDLHLL</b>
<b>WL</b>	Anchor Locker
<b>42</b>	42" High
<b>20</b>	20" Deep
<b>FD</b>	Full Door
<b>LH</b>	Left Hand
<b>L</b>	Laminate
<b>(L)</b>	Locking
<b>(118)</b>	Case Finish, Bright White
<b>(118)</b>	Door Finish, Bright White
<b>(T)</b>	Pull Style, 10" Finger pull
<b>(118)</b>	Pull Finish, Bright White
<b>(C)</b>	Lock finish, Chrome

#### Specification Information

**Locker top must be specified separately, see "Locker Tops" section.**

Open lockers 42" and 50" high include 2 shelves; 57", 64" and 71" high include 3 shelves. Lockers with full-height door include 1 adjustable shelf. Additional full-depth and half-depth shelves may be ordered separately.

Add \$40 to the list price per standard key lock. Add \$560 to the list price per digital keypad lock. Lockers with double doors require two locks; lockers with triple doors require three locks. Digital keypad locks require program and manager key(s), specified separately. See specification page for details.

Add \$15 to the list price per pull for Anodized Nickel (AN) or Anodized Aluminum (AA) finish.

Lockers specified with mixed laminate finishes are L2 pricing. Refer to Mixed Laminate Finishes for further details.

Dimensions listed under w h d are actual to the nearest 1/16".

#### Application Notes

Lockers must be connected to another unit, a work surface or a panel for stability. Refer to the Locker Planning and Stability Guidelines for further information.

Lockers 20" deep (nominal) have a 19 1/16" deep case; 20" overall depth including door. Lockers 24" deep (nominal) have a 23 1/2" deep case; 24 3/8" overall depth including door.

Heights shown indicate the overall height of a locker complete with a top (specified separately).

Lockers including coat hook have a factory-installed coat hook on the end panel. Hook is located on the same side as the door hinges. See Locker Planning for details. Additional coat hooks may be specified separately (field installed). On units without a hook, coat hook or coat rod may be specified separately (field installed).

# Lockers

## Double Door and Triple Door

### 20" and 24" deep

description	configuration	nominal height	h	w	d	pattern no.	L1	L2
Locker with Double Door, 20" deep	left hand	64"	63"	12"	19 1/16"	<b>WL6420DDLHL(N)</b>	\$1,298.	\$1,627.
	left hand	71"	70 1/16"	12"	19 1/16"	<b>WL7120DDLHL(N)</b>	1,380.	1,738.
	right hand	64"	63"	12"	19 1/16"	<b>WL6420DDRHL(N)</b>	1,298.	1,627.
	right hand	71"	70 1/16"	12"	19 1/16"	<b>WL7120DDRHL(N)</b>	1,380.	1,738.

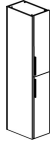

(right hand shown)

Locker with Double Door, 24" deep	left hand	64"	63"	12"	23 1/2"	<b>WL6424DDLHL(N)</b>	1,410.	1,759.
	left hand	71"	70 1/16"	12"	23 1/2"	<b>WL7124DDLHL(N)</b>	1,501.	1,905.
	right hand	64"	63"	12"	23 1/2"	<b>WL6424DDRHL(N)</b>	1,410.	1,759.
	right hand	71"	70 1/16"	12"	23 1/2"	<b>WL7124DDRHL(N)</b>	1,501.	1,905.



(right hand shown)

Locker with Triple Door, 20" deep	left hand	71"	70 1/16"	12"	19 1/16"	<b>WL7120TDLHL(N)</b>	1,543.	1,919.
	right hand	71"	70 1/16"	12"	19 1/16"	<b>WL7120TDRHL(N)</b>	1,543.	1,919.

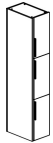

(right hand shown)

Order Information	Order Code	Specification Information	Application Notes
1. <i>Base Pattern Number</i>	Locker , 64H, 12W, 20D, double door, left hand, laminate, locking	<b>Locker top must be specified separately, see "Locker Tops" section.</b>	Lockers must be connected to another unit, a work surface or a panel for stability. Refer to the Locker Planning and Stability Guidelines for further information.
2. <i>Lock option</i> L = Locking N = Non-locking D = Digital keypad lock	Example: <b>WL6420DDLHL</b>	Open lockers 42" and 50" high include 2 shelves; 57", 64" and 71" high include 3 shelves. Lockers with full-height door include 1 adjustable shelf. Additional full-depth and half-depth shelves may be ordered separately.	Lockers 20" deep (nominal) have a 19 1/16" deep case; 20" overall depth including door. Lockers 24" deep (nominal) have a 23 1/2" deep case; 24 3/8" overall depth including door.
3. <i>Case Finish</i> See Finish Options page	<b>WL</b> Anchor Locker	Add \$40 to the list price per standard key lock. Add \$560 to the list price per digital keypad lock. Lockers with double doors require two locks; lockers with triple doors require three locks.	Lockers including coat hook have a factory-installed coat hook on the end panel. Hook is located on the same side as the door hinges. See Locker Planning for details.
4. <i>Door Finish</i> See Finish Options page	<b>64</b> 64" High	Digital keypad locks require program and manager key(s), specified separately. See specification page for details.	Additional coat hooks may be specified separately (field installed). On units without a hook, coat hook or coat rod may be specified separately (field installed).
5. <i>Pull style</i> T = 10" Finger pull	<b>20</b> 20" Deep	Add \$15 to the list price per pull for Anodized Nickel (AN) or Anodized Aluminum (AA) finish.	
6. <i>Pull finish</i> See Finish Options page	<b>DD</b> Double Door	Lockers specified with mixed laminate finishes are L2 pricing. Refer to Mixed Laminate Finishes for further details.	
7. <i>Lock finish</i> See Finish Options page	<b>LH</b> Left Hand		
	<b>L</b> Laminate		
	<b>(L)</b> Locking		
	<b>(118)</b> Case Finish, Bright White		
	<b>(118)</b> Door Finish, Bright White		
	<b>(T)</b> Pull Style, 10" Finger pull		
	<b>(118)</b> Pull Finish, Bright White		
	<b>(C)</b> Lock finish, Chrome		



# Lockers

## Double Door and Triple Door

### 20" and 24" deep

description	configuration	nominal height	h	w	d	pattern no.	L1	L2
Locker with Triple Door, 24" deep	left hand	71"	70 1/16"	12"	23 1/2"	<b>WL7124TDLHL(N)</b>	\$1,673.	\$2,097.
	right hand	71"	70 1/16"	12"	23 1/2"	<b>WL7124TDRHL(N)</b>	1,673.	2,097.

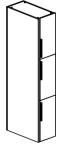



(right hand shown)

Order Information	Order Code	Specification Information	Application Notes
<ol style="list-style-type: none"> <li>1. <i>Base Pattern Number</i></li> <li>2. <i>Lock option</i> L = Locking N = Non-locking D = Digital keypad lock</li> <li>3. <i>Case Finish</i> See Finish Options page</li> <li>4. <i>Door Finish</i> See Finish Options page</li> <li>5. <i>Pull style</i> T = 10" Finger pull</li> <li>6. <i>Pull finish</i> See Finish Options page</li> <li>7. <i>Lock finish</i> See Finish Options page</li> </ol>	<p>Locker , 64H, 12W, 20D, double door, left hand, laminate, locking</p> <hr/> <p>Example: <b>WL6420DDLHLL</b></p> <hr/> <p><b>WL</b> Anchor Locker</p> <hr/> <p><b>64</b> 64" High</p> <hr/> <p><b>20</b> 20" Deep</p> <hr/> <p><b>DD</b> Double Door</p> <hr/> <p><b>LH</b> Left Hand</p> <hr/> <p><b>L</b> Laminate</p> <hr/> <p><b>(L)</b> Locking</p> <hr/> <p><b>(118)</b> Case Finish, Bright White</p> <hr/> <p><b>(118)</b> Door Finish, Bright White</p> <hr/> <p><b>(T)</b> Pull Style, 10" Finger pull</p> <hr/> <p><b>(118)</b> Pull Finish, Bright White</p> <hr/> <p><b>(C)</b> Lock finish, Chrome</p>	<p><b>Locker top must be specified separately, see "Locker Tops" section.</b></p> <p>Open lockers 42" and 50" high include 2 shelves; 57", 64" and 71" high include 3 shelves. Lockers with full-height door include 1 adjustable shelf. Additional full-depth and half-depth shelves may be ordered separately.</p> <p>Add \$40 to the list price per standard key lock. Add \$560 to the list price per digital keypad lock. Lockers with double doors require two locks; lockers with triple doors require three locks. Digital keypad locks require program and manager key(s), specified separately. See specification page for details.</p> <p>Add \$15 to the list price per pull for Anodized Nickel (AN) or Anodized Aluminum (AA) finish.</p> <p>Lockers specified with mixed laminate finishes are L2 pricing. Refer to Mixed Laminate Finishes for further details.</p> <p>Dimensions listed under w h d are actual to the nearest 1/16".</p>	<p>Lockers must be connected to another unit, a work surface or a panel for stability. Refer to the Locker Planning and Stability Guidelines for further information.</p> <p>Lockers 20" deep (nominal) have a 19 1/16" deep case; 20" overall depth including door. Lockers 24" deep (nominal) have a 23 1/2" deep case; 24 3/8" overall depth including door.</p> <p>Heights shown indicate the overall height of a locker complete with a top (specified separately).</p> <p>Lockers including coat hook have a factory-installed coat hook on the end panel. Hook is located on the same side as the door hinges. See Locker Planning for details. Additional coat hooks may be specified separately (field installed). On units without a hook, coat hook or coat rod may be specified separately (field installed).</p>

# Locker Tops

For 20" and 24" deep lockers

description	application	w	d	h	pattern no.	L1	L2
 Tops for 20" deep lockers	top for 1 locker	12"	19 1/16"	1 1/8"	<b>WLT1220L</b>	\$88.	\$114.
	common top for 2 lockers	24"	19 1/16"	1 1/8"	<b>WLT2420L</b>	140.	191.
	common top for 3 lockers	36"	19 1/16"	1 1/8"	<b>WLT3620L</b>	202.	278.
	common top for 4 lockers	48"	19 1/16"	1 1/4"	<b>WLT4820L</b>	253.	355.
	common top for 5 lockers	60"	19 1/16"	1 1/8"	<b>WLT6020L</b>	311.	437.
	common top for 6 lockers	72"	19 1/16"	1 1/8"	<b>WLT7220L</b>	371.	524.
	common top for 7 lockers	84"	19 1/16"	1 1/8"	<b>WLT8420L</b>	433.	610.
	common top for 8 lockers	96"	19 1/16"	1 1/8"	<b>WLT9620L</b>	489.	692.
 Tops for 24" deep lockers	top for 1 locker	12"	23 1/2"	1 1/8"	<b>WLT1224L</b>	98.	131.
	common top for 2 lockers	24"	23 1/2"	1 1/8"	<b>WLT2424L</b>	162.	227.
	common top for 3 lockers	36"	23 1/2"	1 1/8"	<b>WLT3624L</b>	233.	330.
	common top for 4 lockers	48"	23 1/2"	1 1/8"	<b>WLT4824L</b>	296.	425.
	common top for 5 lockers	60"	23 1/2"	1 1/8"	<b>WLT6024L</b>	363.	525.
	common top for 6 lockers	72"	23 1/2"	1 1/8"	<b>WLT7224L</b>	435.	629.
	common top for 7 lockers	84"	23 1/2"	1 1/8"	<b>WLT8424L</b>	506.	733.
	common top for 8 lockers	96"	23 1/2"	1 1/8"	<b>WLT9624L</b>	574.	832.

### Order Information

1. Base Pattern Number
2. Finish  
See Finish Options page

### Order Code



Locker Top, 12W x 20D	
Example:	<b>WLT1220L</b>
<b>WLT</b>	Anchor Locker Top
<b>12</b>	12" Wide
<b>20</b>	20" Deep
<b>L</b>	Laminate
<b>(118)</b>	Finish, Bright White

### Specification Information

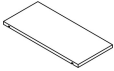

**For use with Anchor Lockers only.**  
Edgebanding preselected to match or coordinate with laminate, see "Finish Options" page for further details.

### Application Notes

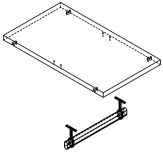
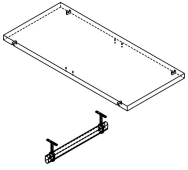
Locker tops are 19" and 23" deep nominal.  
Locker tops include hardware kit to secure to locker.  
Common locker tops include hardware to gang lockers together. Individual tops do not include ganging hardware.

description	w	d	h	pattern no.	L1	L2
Full-depth shelf for 20" deep locker 	10 1/2"	18 3/8"	3/4"	<b>WLSF1220L</b>	\$95.	\$112.
Full-depth shelf for 24" deep locker 	10 1/2"	22 3/4"	3/4"	<b>WLSF1224L</b>	105.	123.
Partial-depth shelf for 20" and 24" deep locker 	10 1/2"	11 3/8"	3/4"	<b>WLSH1224L</b>	77.	86.
Shelf kit with coat rod for 24" deep locker 	12"	24"		<b>WLCRKIT1224L</b>	167.	187.
Shelf kit with coat rod for 20" deep locker 	12"	19 1/16"		<b>WLCRKIT1220L</b>	158.	174.

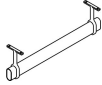
Order Information	Order Code	Specification Information	Application Notes
1. <i>Base Pattern Number</i>	Locker Shelf, 12W x 20D	<b>For use with Anchor Lockers only.</b>  Edgebanding preselected to match or coordinate with laminate, see "Finish Options" page for further details.	
2. <i>Finish</i> See Finish Options page	Example: <b>WLSF1220L</b>		
	<b>WLS</b> Anchor Locker Shelf		
	<b>12</b> 12" Wide locker		
	<b>20</b> 20" Deep locker		
	<b>L</b> Laminate		
	<b>(118)</b> Finish, Bright White		

description	finish	pattern no.	list
Coat Hook, side mount 	Anodized Silver	<b>WACH</b>	\$35.
Coat Rod, side mount	Chrome	<b>WLCR12</b>	26.
Coat Rod, top mount 	Chrome	<b>WLCRTM12</b>	49.
L-bracket for side-mounted work surface 20" and 24" deep (nominal) 	Black	<b>WLLB</b>	41.
Programming key for digital keypad lock	n/a	<b>WDKEYP</b>	241.
Manager key for digital keypad lock	n/a	<b>WDKEYM</b>	175.

**Order Information****Order Code****Specification Information****Application Notes**

Programming and manager key(s) must be specified for lockers with digital keypad locks. See specification page for further details.

WLLB L-bracket allows for a work surface to be mounted to the side of a locker (of matching depth).

# Alpha-Numeric Index

<i>pattern no.</i>	<i>page</i>	<i>pattern no.</i>	<i>page</i>	<i>pattern no.</i>	<i>page</i>	<i>pattern no.</i>	<i>page</i>
WACH	85, 99	WCWKIT03	45	WL7124DDRHL(N)	95	WP2816OPL	34
WC22180L	13	WCWKIT04	45	WL7124FDLHL(N)	94	WP2816SOLHL(N)	35
WC22240L	13	WCWKIT05	45	WL7124FDRHL(N)	94	WP2816SORHL(N)	35
WC2230BL(N)	14	WCWKIT06	23	WL7124FHLHL(N)	93	WP28180SL	40
WC2230FL(N)	14	WCWKIT07	23	WL7124FHRHL(N)	93	WP28240SL	40
WC22300L	14	WCWKIT08	23	WL71240SL	92	WP2830CFL(N)	42
WC2236BL(N)	15	WDKEYM	99	WL7124TDLHL(N)	96	WP2830FFL(N)	42
WC2236FL(N)	15	WDKEYP	99	WL7124TDRHL(N)	96	WP2830OBL(N)	41
WC22360L	15	WL4220FDLHL(N)	94	WLCR12	99	WP2830OFL(N)	41
WC2242BL(N)	16	WL4220FDRHL(N)	94	WLCRKIT1220L	98	WP28300SL	41
WC2242FL(N)	16	WL4220FHLHL(N)	93	WLCRKIT1224L	98	WP2836CFL(N)	42
WC22420L	16	WL4220FHRHL(N)	93	WLCRTM12	99	WP2836FFL(N)	42
WC2248B30018L(N)	17	WL42200SL	92	WLLB	99	WP2836OBL(N)	41
WC2248F30018L(N)	17	WL4224FDLHL(N)	94	WLSF1220L	98	WP2836OFL(N)	41
WC2248018B30L(N)	17	WL4224FDRHL(N)	94	WLSF1224L	98	WP28360SL	41
WC2248018F30L(N)	17	WL4224FHLHL(N)	93	WLSH1224L	98	WP2842CFL(N)	42
WC2248018030L	17	WL4224FHRHL(N)	93	WLT1220L	97	WP2842FFL(N)	42
WC2248030018L	17	WL42240SL	92	WLT1224L	97	WP2842OBL(N)	41
WC2260B30B30L(N)	18	WL5020FDLHL(N)	94	WLT2420L	97	WP2842OFL(N)	41
WC2260B30030L(N)	18	WL5020FDRHL(N)	94	WLT2424L	97	WP28420SL	41
WC2260B36024L(N)	18	WL5020FHLHL(N)	93	WLT3620L	97	WPC2824FDCBLHL(N)	38
WC2260B42018L(N)	18	WL5020FHRHL(N)	93	WLT3624L	97	WPC2824FDCBRHL(N)	38
WC2260F30F30L(N)	18	WL50200SL	92	WLT4820L	97	WPC2824FDCFLHL(N)	38
WC2260F36024L(N)	18	WL5024FDLHL(N)	94	WLT4824L	97	WPC2824FDCFRHL(N)	38
WC2260F42018L(N)	18	WL5024FDRHL(N)	94	WLT6020L	97	WPC2824FDFDLHL(N)	38
WC2260018B42L(N)	18	WL5024FHLHL(N)	93	WLT6024L	97	WPC2824FDFDRHL(N)	38
WC2260018F42L(N)	18	WL5024FHRHL(N)	93	WLT7220L	97	WPC2824FDFLHL(N)	38
WC2260018042L	18	WL50240SL	92	WLT7224L	97	WPC2824FDFFRHL(N)	38
WC2260024B36L(N)	18	WL5720FDLHL(N)	94	WLT8420L	97	WPC2824FDO1LHL(N)	38
WC2260024F36L(N)	18	WL5720FHLHL(N)	93	WLT8424L	97	WPC2824FDO1RHL(N)	38
WC2260024036L	18	WL5720FHRHL(N)	93	WLT9620L	97	WPC2824FDOBLHL(N)	38
WC2260030B30L(N)	18	WL57200SL	92	WLT9624L	97	WPC2824FDOBRHL(N)	38
WC2260030030L	18	WL5724FDLHL(N)	94	WP2812CBL(N)	33	WPC2824FDOFLHL(N)	38
WC2260036024L	18	WL5724FDRHL(N)	94	WP2812CFL(N)	32	WPC2824FDOFRHL(N)	38
WC2260042018L	18	WL5724FHLHL(N)	93	WP2812F1LHL(N)	32	WPC2824OSCBLHL(N)	36
WC2272B36B36L(N)	20	WL5724FHRHL(N)	93	WP2812F1RHL(N)	32	WPC2824OSCBRHL(N)	36
WC2272B36036L(N)	19	WL57240SL	92	WP2812F2LHL(N)	32	WPC2824OSCFHL(N)	36
WC2272B42030L(N)	19	WL6420DDLHL(N)	95	WP2812F2RHL(N)	32	WPC2824OSCFRHL(N)	36
WC2272F36F36L(N)	19	WL6420DDRHL(N)	95	WP2812FDLHL(N)	32	WPC2824OSFDLHL(N)	36
WC2272F42030L(N)	19	WL6420FDLHL(N)	94	WP2812FDRHL(N)	32	WPC2824OSFDRHL(N)	36
WC2272030B42L(N)	19	WL6420FDRHL(N)	94	WP2812FFL(N)	33	WPC2824OSFHL(N)	36
WC2272030F42L(N)	19	WL6420FHLHL(N)	93	WP2812O1L	32	WPC2824OSFFRHL(N)	36
WC2272030042L	19	WL6420FHRHL(N)	93	WP2812O2L	32	WPC2824OSO1LHL	36
WC2272036B36L(N)	19	WL64200SL	92	WP2812OBL(N)	32	WPC2824OSO1RHL	36
WC2272036036L	19	WL6424DDLHL(N)	95	WP2812OFL(N)	32	WPC2824OSOBHLHL(N)	36
WC2272042030L	19	WL6424DDRHL(N)	95	WP2812OPL	32	WPC2824OSOBRLHL(N)	36
WC2284B30B30024L(N)	21	WL6424FDLHL(N)	94	WP2812SOLHL(N)	33	WPC2824OSOFHLHL(N)	36
WC2284B30024B30L(N)	21	WL6424FDRHL(N)	94	WP2812SORHL(N)	33	WPC2824OSOFRHL(N)	36
WC2284B30030024L(N)	22	WL6424FHLHL(N)	93	WP2816CBL(N)	35	WPC2830FDCBLHL(N)	39
WC2284B42B42L(N)	22	WL6424FHRHL(N)	93	WP2816CFL(N)	34	WPC2830FDCBRHL(N)	39
WC2284F30024F30L(N)	21	WL64240SL	92	WP2816F1LHL(N)	34	WPC2830FDCFLHL(N)	39
WC2284F42F42L(N)	21	WL7120DDLHL(N)	95	WP2816F1RHL(N)	34	WPC2830FDCFRHL(N)	39
WC2284024B30B30L(N)	21	WL7120DDRHL(N)	95	WP2816F2LHL(N)	34	WPC2830FDFDLHL(N)	39
WC2284024030B30L(N)	22	WL7120FDLHL(N)	94	WP2816F2RHL(N)	34	WPC2830FDFDRHL(N)	39
WC2284024030030L	21	WL7120FDRHL(N)	94	WP2816FDLHL(N)	34	WPC2830FDFLHL(N)	39
WC2284030024030L	21	WL7120FHLHL(N)	93	WP2816FDRHL(N)	34	WPC2830FDFFRHL(N)	39
WC2284030030024L	21	WL7120FHRHL(N)	93	WP2816FFL(N)	35	WPC2830FDO1LHL(N)	39
WCCT3018	24	WL71200SL	92	WP2816O1L	34	WPC2830FDO1RHL(N)	39
WCCT3618	24	WL7120TDLHL(N)	95	WP2816O2L	34	WPC2830FDOBLHL(N)	39
WCWKIT01	23	WL7120TDRHL(N)	95	WP2816OBL(N)	34	WPC2830FDOBRHL(N)	39
WCWKIT02	23, 45	WL7124DDLHL(N)	95	WP2816OFL(N)	34	WPC2830FDOFLHL(N)	39

<i>pattern no.</i>	<i>page</i>	<i>pattern no.</i>	<i>page</i>	<i>pattern no.</i>	<i>page</i>	<i>pattern no.</i>	<i>page</i>
WPC2830FDOFRHL(N)	39	WSPCF05742L	47	WSWSA421230L	49	WTFD4224FDOBLHL(N)	77
WPC2830OCSBLHL(N)	37	WSPCF06430L	47	WSWSA4212L	49	WTFD4224FDOBRHL(N)	77
WPC2830OCSBRHL(N)	37	WSPCF06436L	47	WSWSA421630L	50	WTFD4224FDOFLHL(N)	77
WPC2830OSCFLHL(N)	37	WSPCF06442L	47	WSWSA4216L	49	WTFD4224FDOFRHL(N)	77
WPC2830OSCFRHL(N)	37	WSPCT4230	48	WSWSA501220L	49	WTFD4224OSCBHL(N)	76
WPC2830OSFDLHL(N)	37	WSPCT4236	48	WSWSA501230L	49	WTFD4224OSCBRHL(N)	76
WPC2830OSFDRHL(N)	37	WSPCT4242	48	WSWSA5012L	49	WTFD4224OSCFLHL(N)	76
WPC2830OSFFLHL(N)	37	WSPCT5030	48	WSWSA501630L	50	WTFD4224OSCFRHL(N)	76
WPC2830OSFFRHL(N)	37	WSPCT5036	48	WSWSA5016L	49	WTFD4224OSFDLHL(N)	76
WPC2830OSO1LHL	37	WSPCT5042	48	WSWSA571220L	49	WTFD4224OSFDRHL(N)	76
WPC2830OSO1RHL	37	WSPCT5730	48	WSWSA571230L	49	WTFD4224OSFFLHL(N)	76
WPC2830OSOBLHL(N)	37	WSPCT5736	48	WSWSA5712L	49	WTFD4224OSFFRHL(N)	76
WPC2830OSOBRLHL(N)	37	WSPCT5742	48	WSWSA571630L	50	WTFD4224OSOBHL(N)	76
WPC2830OSOFHLHL(N)	37	WSPCT6430	48	WSWSA5716L	49	WTFD4224OSOBRLHL(N)	76
WPC2830OSOFDRHL(N)	37	WSPCT6436	48	WSWSA641220L	49	WTFD4224OSOFHLHL(N)	76
WPM2412BFL(N)	28	WSPCT6442	48	WSWSA641230L	49	WTFD4224OSOFRHL(N)	76
WPM2412CML(N)	28	WSPWFO4230L	56	WSWSA6412L	49	WTFD4230FDCBLHL(N)	77
WPM2412F1LHL(N)	28	WSPWFO4236L	56	WSWSA641630L	50	WTFD4230FDCBRHL(N)	77
WPM2412F1RHL(N)	28	WSPWFO4242L	56	WSWSA6416L	49	WTFD4230FDCFLHL(N)	77
WPM2412FDLHL(N)	28	WSPWFO5030L	56	WSWSAY421224L	52	WTFD4230FDCFRHL(N)	77
WPM2412FDRHL(N)	28	WSPWFO5036L	56	WSWSAY421227L	52	WTFD4230FDFDLHL(N)	77
WPM2412O1L	28	WSPWFO5042L	56	WSWSAY421230L	52	WTFD4230FDFDRHL(N)	77
WPM2412OFL(N)	28	WSPWFO5730L	56	WSWSAY501224L	52	WTFD4230FDFFLHL(N)	77
WPM2412OPL	28	WSPWFO5736L	56	WSWSAY501227L	52	WTFD4230FDFRHL(N)	77
WPM2416BFL(N)	29	WSPWFO5742L	56	WSWSAY501230L	52	WTFD4230FDO1LHL(N)	77
WPM2416CML(N)	29	WSPWFO6430L	56	WSWSAY571224L	52	WTFD4230FDO1RHL(N)	77
WPM2416F1LHL(N)	29	WSPWFO6436L	56	WSWSAY571227L	52	WTFD4230FDOBLHL(N)	77
WPM2416F1RHL(N)	29	WSPWFO6442L	56	WSWSAY571230L	52	WTFD4230FDOBRHL(N)	77
WPM2416FDLHL(N)	29	WSPWT4230	57	WSWSAY641224L	52	WTFD4230FDOFLHL(N)	77
WPM2416FDRHL(N)	29	WSPWT4236	57	WSWSAY641227L	52	WTFD4230FDOFRHL(N)	77
WPM2416O1L	29	WSPWT4242	57	WSWSAY641230L	52	WTFD4230OSCBHLHL(N)	76
WPM2416OFL	29	WSPWT5030	57	WSWT4220	51	WTFD4230OSCBRHL(N)	76
WPM2416OPL	29	WSPWT5036	57	WSWT4224	51	WTFD4230OSCFLHL(N)	76
WPMC12	30, 31	WSPWT5042	57	WSWT4230	51	WTFD4230OSCFRHL(N)	76
WPMC16	30, 31	WSPWT5730	57	WSWT5020	51	WTFD4230OSFDLHL(N)	76
WPMSF1201L	43	WSPWT5736	57	WSWT5024	51	WTFD4230OSFDRHL(N)	76
WPMSF1204L	43	WSPWT5742	57	WSWT5030	51	WTFD4230OSFFLHL(N)	76
WPMSF1601L	43	WSPWT6430	57	WSWT5720	51	WTFD4230OSFFRHL(N)	76
WPMSF1604L	43	WSPWT6436	57	WSWT5724	51	WTFD4230OSBLHL(N)	76
WPSF1201L	43	WSPWT6442	57	WSWT5730	51	WTFD4230OSBRHL(N)	76
WPSF1204L	43	WSWFD4212LHL(N)	55	WSWT6420	51	WTFD4230OSFLHL(N)	76
WPSF1601L	43, 84	WSWFD4212RHL(N)	55	WSWT6424	51	WTFD4230OSFRHL(N)	76
WPSF1604L	43, 84	WSWFD4216LHL(N)	55	WSWT6430	51	WTFD5024FDCBLHL(N)	79
WPSOB01	43	WSWFD4216RHL(N)	55	WSWTY4224	53	WTFD5024FDCBRHL(N)	79
WPSOB04	43	WSWFD5012LHL(N)	55	WSWTY4227	53	WTFD5024FDCFLHL(N)	79
WPSOH05	43	WSWFD5012RHL(N)	55	WSWTY4230	53	WTFD5024FDCFRHL(N)	79
WPSOH40	43	WSWFD5016LHL(N)	55	WSWTY5024	53	WTFD5024FDFDLHL(N)	79
WPT3020L	44	WSWFD5016RHL(N)	55	WSWTY5027	53	WTFD5024FDFDRHL(N)	79
WPT3620L	44	WSWFD5712LHL(N)	55	WSWTY5030	53	WTFD5024FDFFLHL(N)	79
WPT4220L	44	WSWFD5712RHL(N)	55	WSWTY5724	53	WTFD5024FDFRHL(N)	79
WPT4820L	44	WSWFD5716LHL(N)	55	WSWTY5727	53	WTFD5024FDO1LHL(N)	79
WPT5420L	44	WSWFD5716RHL(N)	55	WSWTY5730	53	WTFD5024FDO1RHL(N)	79
WPT6020L	44	WSWFD6712LHL(N)	55	WSWTY6424	53	WTFD5024FDOBLHL(N)	79
WPT6620L	44	WSWFD6712RHL(N)	55	WSWTY6427	53	WTFD5024FDOBRHL(N)	79
WPT7220L	44	WSWFD6716LHL(N)	55	WSWTY6430	53	WTFD5024FDOFLHL(N)	79
WPT7820L	44	WSWFD6716RHL(N)	55	WTFD4224FDCBLHL(N)	77	WTFD5024FDOFRHL(N)	79
WPT8420L	44	WSWFO4212L	54	WTFD4224FDCBRHL(N)	77	WTFD5024OSCBHLHL(N)	78
WSPCF04230L	47	WSWFO4216L	54	WTFD4224FDCFLHL(N)	77	WTFD5024OSCBRHL(N)	78
WSPCF04236L	47	WSWFO5012L	54	WTFD4224FDCFRHL(N)	77	WTFD5024OSCFLHL(N)	78
WSPCF04242L	47	WSWFO5016L	54	WTFD4224FDFDLHL(N)	77	WTFD5024OSCFRHL(N)	78
WSPCF05030L	47	WSWFO5712L	54	WTFD4224FDFDRHL(N)	77	WTFD5024OSFDLHL(N)	78
WSPCF05036L	47	WSWFO5716L	54	WTFD4224FDFFLHL(N)	77	WTFD5024OSFDRHL(N)	78
WSPCF05042L	47	WSWFO6712L	54	WTFD4224FDFFRHL(N)	77	WTFD5024OSFFLHL(N)	78
WSPCF05730L	47	WSWFO6716L	54	WTFD4224FDO1LHL(N)	77	WTFD5024OSFFRHL(N)	78
WSPCF05736L	47	WSWSA421220L	49	WTFD4224FDO1RHL(N)	77	WTFD5024OSOBHLHL(N)	78







<i>pattern no.</i>	<i>page</i>	<i>pattern no.</i>	<i>page</i>
W TSA5724OSOBRHL(N)	64	W TSA6430FDFFLHL(N)	67
W TSA5724OSOFHLHL(N)	64	W TSA6430FDFFRHL(N)	67
W TSA5724OSOFRHL(N)	64	W TSA6430FDO1LHL(N)	67
W TSA5730FDCBLHL(N)	65	W TSA6430FDO1RHL(N)	67
W TSA5730FDCBRHL(N)	65	W TSA6430FDOBLHL(N)	67
W TSA5730FDCFLHL(N)	65	W TSA6430FDOBRHL(N)	67
W TSA5730FDCFRHL(N)	65	W TSA6430FDOFLHL(N)	67
W TSA5730FDFDLHL(N)	65	W TSA6430FDOFRHL(N)	67
W TSA5730FDFDRHL(N)	65	W TSA6430OSCBLHL(N)	66
W TSA5730FDFFLHL(N)	65	W TSA6430OSCBRHL(N)	66
W TSA5730FDFFRHL(N)	65	W TSA6430OSCFHLHL(N)	66
W TSA5730FDO1LHL(N)	65	W TSA6430OSCFRHL(N)	66
W TSA5730FDO1RHL(N)	65	W TSA6430OSFDLHL(N)	66
W TSA5730FDOBLHL(N)	65	W TSA6430OSFDRHL(N)	66
W TSA5730FDOBRHL(N)	65	W TSA6430OSFFLHL(N)	66
W TSA5730FDOFLHL(N)	65	W TSA6430OSFFRHL(N)	66
W TSA5730FDOFRHL(N)	65	W TSA6430OSO1LHL	66
W TSA5730OSCBLHL(N)	64	W TSA6430OSO1RHL	66
W TSA5730OSCBRHL(N)	64	W TSA6430OSOBLHL(N)	66
W TSA5730OSCFHLHL(N)	64	W TSA6430OSOBRHL(N)	66
W TSA5730OSCFRHL(N)	64	W TSA6430OSOFHLHL(N)	66
W TSA5730OSFDLHL(N)	64	W TSA6430OSOFRHL(N)	66
W TSA5730OSFDRHL(N)	64		
W TSA5730OSFFLHL(N)	64		
W TSA5730OSFFRHL(N)	64		
W TSA5730OSO1LHL	64		
W TSA5730OSO1RHL	64		
W TSA5730OSOBLHL(N)	64		
W TSA5730OSOBRHL(N)	64		
W TSA5730OSOFHLHL(N)	64		
W TSA5730OSOFRHL(N)	64		
W TSA6424FDCBLHL(N)	67		
W TSA6424FDCBRHL(N)	67		
W TSA6424FDCFLHL(N)	67		
W TSA6424FDCFRHL(N)	67		
W TSA6424FDFDLHL(N)	67		
W TSA6424FDFDRHL(N)	67		
W TSA6424FDFFLHL(N)	67		
W TSA6424FDFFRHL(N)	67		
W TSA6424FDO1LHL(N)	67		
W TSA6424FDO1RHL(N)	67		
W TSA6424FDOBLHL(N)	67		
W TSA6424FDOBRHL(N)	67		
W TSA6424FDOFLHL(N)	67		
W TSA6424FDOFRHL(N)	67		
W TSA6424OSCBLHL(N)	66		
W TSA6424OSCBRHL(N)	66		
W TSA6424OSCFHLHL(N)	66		
W TSA6424OSCFRHL(N)	66		
W TSA6424OSFDLHL(N)	66		
W TSA6424OSFDRHL(N)	66		
W TSA6424OSFFLHL(N)	66		
W TSA6424OSFFRHL(N)	66		
W TSA6424OSO1LHL	66		
W TSA6424OSO1RHL	66		
W TSA6424OSOBLHL(N)	66		
W TSA6424OSOBRHL(N)	66		
W TSA6424OSOFHLHL(N)	66		
W TSA6424OSOFRHL(N)	66		
W TSA6430FDCBLHL(N)	67		
W TSA6430FDCBRHL(N)	67		
W TSA6430FDCFLHL(N)	67		
W TSA6430FDCFRHL(N)	67		
W TSA6430FDFDLHL(N)	67		
W TSA6430FDFDRHL(N)	67		

# Selling Policy

	<p>This Selling Policy supercedes all previous selling policies. Prices, discounts and product offerings are subject to change without notice.</p>
<b>Terms &amp; Conditions of Sales</b>	<p>Sales by Knoll, Inc. or Knoll North America Corp. ("Seller") of Knoll Product Lines (hereinafter "Products") within the United States and Canada are made only on the terms which are contained in this Selling Policy. Seller hereby gives notice of its objection to any different or additional terms and conditions. This sale is expressly conditional upon Purchaser's assent to the terms and conditions set forth below. Additional terms and conditions may apply to KnollStudio and KnollTextiles orders. These terms and conditions may be modified or supplemented only by a written document signed by an authorized representative of Seller. These terms and conditions supercede any prior and/or contemporaneous agreements or correspondence between Purchaser and Seller. Written quotations expire thirty (30) days from the date of issuance and can be withdrawn by written notice anytime during that period. Where Purchaser and Seller have entered into the Knoll Electronic Terms and Conditions, all orders, acknowledgements, invoices and other business communications placed or transmitted in accordance with the Knoll Electronic Terms and Conditions shall be deemed to be in writing and signed and shall be valid for all purposes as if they were originated and maintained in documentary form.</p>
<b>Ordering Information</b>	<p>All orders must be in writing. The product pattern number(s) contained on Seller's order acknowledgement shall be the final expression of the order.</p>
<b>Order Confirmation</b>	<p>A purchase order is not binding on Seller until Purchaser has received Seller's order confirmation or acknowledgment.</p>
<b>Pricing Policies</b>	<p>List prices are subject to change without notice.</p> <p>List prices shall be those prices in effect on the date of receipt of a complete purchase order unless shipment is requested more than ninety (90) days after order entry in which case prices in effect on the date of shipment apply. List prices include specified freight costs. Unless specified in writing by Seller, no other charges are included in Seller's list prices.</p>
<b>Taxes</b>	<p>All sales, use, excise and other taxes applicable to the sale of the Products shall be paid by Purchaser. If Purchaser claims an exemption from any tax, Purchaser shall submit to Seller the appropriate exemption certificates.</p>
<b>Terms of Payment</b>	<p>Payment for one hundred percent (100%) of the net order amount is due within thirty (30) days of the date of invoice, which is generally issued upon shipment. In case of any discrepancies, such as shortages, and Seller is notified in writing within ten (10) days of receipt of Product, only that portion may be deducted and the balance paid. For orders greater than \$100,000 net, a fifty percent (50%) deposit is due at the time of order placement, with the remainder due within thirty (30) days of the date of invoice.</p> <p>KnollStudio orders less than \$2,000 require payment for one hundred percent (100%) of the net order amount (including any applicable sales tax and charges for inside delivery, special packaging, etc.), due at time of order placement. For KnollStudio orders greater than \$2,000, a one-half (50%) deposit is due at time of order placement with the remainder (including any applicable sales tax and charges for inside delivery, special packaging, etc.) due prior to shipment.</p> <p>If, in the judgment of Seller, Purchaser's financial condition does not justify the terms of the payment, Seller may require full or partial payment in advance.</p> <p>Past due accounts shall be charged one and one-half percent (1.5%) per month, or the highest rate permitted by law, whichever is less, and will be added to the outstanding balance. In the event Purchaser defaults on payment, Purchaser shall be liable for all collection costs, including reasonable attorney's fees and costs.</p>
<b>Changes and Cancellation</b>	<p>Purchase orders may not be changed or cancelled, in whole or in part, without prior written consent of Seller. Changes may effect delivery dates. Expenses incurred because of changes shall be charged to Purchaser. In the event of cancellations, Purchaser will be liable for reasonable cancellation charges established by Seller. Orders for special Product, orders including "COM" (hereinafter defined) material and orders pursuant to expedited delivery programs, may not be canceled.</p>
<b>Freight Prepaid</b>	<p>Freight is prepaid and included in the price of all Products, except KnollTextiles, within the 48 contiguous United States for orders placed with Knoll, Inc. and within Canada, excluding the Yukon, Northwest Territories, Nunavut and Newfoundland for orders placed with Knoll North America Corp. Packing is tested for rigorous motion and transportation but is not guaranteed to protect furniture from all conditions. If special packaging is required for any reason, please consult with your sales representative or dealer. Seller shall select the method of shipment and routing. Freight for all KnollTextiles orders is prepaid and added to the invoice.</p>
<b>Delivery/Freight Charges</b>	<p>Shipments outside the contiguous 48 United States and Canada shall be shipped F.O.B. Origin.</p> <p>For shipments outside the contiguous United States and Canada, Purchaser is responsible for the cost of freight from point of embarkation, including any handling and transportation charges incidental to loading at the point of departure and unloading at the final destination.</p> <p>Conditions beyond the control of Seller, including weather, available facilities and traffic conditions, may affect exact time of delivery. Seller shall not be responsible for specific carrier delivery date or time unless it has made a specific delivery commitment, in writing.</p> <p>Nonstandard methods of shipment and/or additional services are available upon request. Purchaser will be billed for the differential cost of any special services in excess of standard surface carrier freight costs. Premium charges, at Purchaser's request, will be added for airfreight, exclusive use of vehicle and extra, export or special packaging. Accessorial charges will be added for inside delivery, extra labor, reassignment and redelivery.</p> <p>Partial shipments may be made and invoiced by Seller.</p>
<b>Claims</b>	<p>All shipments for Knoll Products within the contiguous United States and Canada are F.O.B. Origin. All risk of loss passes to Purchaser at time of delivery to carrier. Purchaser shall inspect all Products upon receipt and notify Seller within ten (10) working days after receipt of any damage or defects which are, or should be, apparent from an inspection of the Product and its packaging. Failure of Purchaser to notify Seller during the ten (10) working day period shall constitute acceptance of the Products and waiver of any apparent defects, errors or shortages. For all claims relating to Product damaged in transit or for any other claims relating to or arising out of the transportation of the Product, Purchaser must seek recovery from the carrier and Seller has no liability to Purchaser for such claims. Seller may, upon request, assist Purchaser with filing of such claims with the carrier, but Seller will not be liable for any of these transportation related claims.</p>
<b>Seller's Security Interest</b>	<p>Until Seller receives the full payment for the Product, Seller shall have a security interest in the Product. Purchaser agrees to perform all acts, including but not limited to the execution and filing of documentation, which may be necessary to perfect and assure the security interest of Seller.</p>
<b>Returns</b>	<p>The return of Products without a written authorization by Seller shall not be accepted. To receive authorization for Product return, please call Customer Service. All Products that are returned pursuant to a valid authorization shall be subject to a twenty-five percent (25%) of list restocking charge. Products not currently offered for sale by Seller (including COM) shall not be authorized for return. All returned Products must be unused, in original condition and in the original Seller packing cartons. No refund or credit shall be given for damaged Products.</p>
<b>Held Orders/Storage</b>	<p>If Purchaser requests that an order be held or delayed, prices and terms and conditions in effect at the time of shipment shall apply. If Purchaser requests a delay after the time when Seller can defer production, Purchaser will be invoiced for the Product, payable in accordance with standard terms, when the order is ready for shipment. Seller may transfer the Product to storage, in which case all expenses incurred in connection with storage, including demurrage, preparation for storage, storage charges and handling shall be payable by Purchaser upon submission of invoices by Seller. Risk of loss to the Product shall pass to the Purchaser upon delivery of the Product into storage.</p>

# Selling Policy

<b>Customer's Own Material</b>	<p>A Purchaser who requests a fabric or other surface material not standard to Seller's line of Products ("COM") must submit samples of the requested material to Seller prior to entry of a purchaser order. Seller shall determine if the material is suitable to its manufacturing processes and meets any requirements of Underwriters Laboratories. If the COM is acceptable, Seller will then establish a price for using the COM or the Product in question. For a description of the procedures for submitting samples and testing, contact customer resources or your sales representative. Seller shall have no responsibility for the appearance, condition, performance, durability, colorfastness or any other physical attribute of the COM. Purchaser shall indemnify and hold Seller harmless for any damages, injuries or losses arising out of or related to use of the COM on the Product.</p>
<b>Warranty</b>	<p>Seller warrants to the original Purchaser only that the Products Seller manufactures and sells to Purchaser are free of defects in workmanship and materials, during the applicable warranty period set forth below.</p> <p>Warranty period set forth below is for 24-hour, 7 days a week, multi shift use (includes parts and labor to repair).</p> <p>Should any failure to conform with this limited warranty appear to a Product listed below during the applicable warranty period from the date of shipment, Seller shall, upon prompt written notice, repair or replace, at its option and costs, the affected part or parts.</p> <p><i>Product and Period of Warranty</i></p> <p><i>Lifetime: Antenna Workspaces, AutoStrada, Calibre, Crinion Open Table, Currents, Dividends Horizon, Morrison, Reff Profiles laminate, Series 2 Storage, Template and other non-wood components (except cascade edge worksurfaces, operational parts, controls, electrical, Lighting, Series 2 Veneer Front Storage, special or custom products, see below)</i></p> <p><i>12 Years: Chadwick, Essentials Work Chairs, Generation by Knoll, Life, Moment, MultiGeneration by Knoll, ReGeneration by Knoll, Remix, RPM, Sapper and Toboggan seating (except seating upholstery, textiles, leathers and finishes, see below).</i></p> <p><i>10 Years: Anchor Storage except digital keypad lock, Antenna Workspaces, AutoStrada, Crinion Open Table, Dividends Horizon, Dividends Horizon Satellite Surfaces, Reff Profiles, Template wood components, Series 2 Veneer Front Storage, cascade edge worksurfaces, Wood Casegoods (The Graham Collection) (except wood casegoods upholstered surfaces, see below), Reuter overheads, Reuter vertical storage, KnollExtra Sapper Monitor Arm Collection, Sapper XYZ Monitor Arm, Adjustable keyboard mechanisms and platforms, Communication Boards (except fabric board textiles, see below), Smokador collection (except leathers, see below), and Orchestra Universal Systems Accessories, k. lounge structural components.</i></p> <p><i>5 Years: Operational parts, controls, electrical, Lighting (except light ballasts, bulbs and power supply, see below), special or custom product, wood veneer products, Currents handcrank, Interaction Counterforce, KnollStudio, Spark Series seating structural elements, structural elements of all KnollStudio outdoor products including all Richard Schultz designed products, KnollExtra CPU storage and all universal storage drawers and Power Collection, Tone Tables.</i></p> <p><i>3 Years: Seating upholstery, textiles, leathers and finishes. Fabric boards textiles and Smokador Collection leathers.</i></p> <p><i>2 Years: Anchor Storage digital keypad lock, all other KnollExtra product</i></p> <p><i>1 Year: Light ballasts, bulbs and power supply, seating upholstered amp pads and soft amp pads, wood casegoods upholstered surfaces. KnollStudio, outdoor product finishes, k. lounge upholstery and k. lounge fabric.</i></p> <p>This warranty does not apply to:</p> <ul style="list-style-type: none"><li>• Damage caused by a carrier other than the Seller.</li><li>• Normal wear and tear or acts or omissions of parties other than Seller (including user modification, improper use or installation of Products).</li><li>• COM or other third party materials applied to Products.</li><li>• Products not installed by or under the auspices of a Knoll Dealer.</li><li>• Dramatic temperature variations or exposure to unusual conditions.</li><li>• Changes in surface finishes, including colorfastness due to aging or exposure to light.</li><li>• Clear paint finish applied to Antenna Workspaces steel or aluminum part.</li><li>• Except as specifically noted above, textiles and upholstery supplied by <i>KnollTextiles</i> (consult current <i>KnollTextiles</i> price list for applicable warranty).</li></ul> <p>Natural variations occurring in wood, marble, and leather shall not be considered defects, and the Seller does not guarantee the colorfastness or matching of the colors, grains or textures, or surface hardness of such materials. The Seller also does not guarantee the colorfastness of fiberglass panel surfaces. THE EXPRESS WARRANTIES CONTAINED HEREIN ARE IN LIEU OF ALL OTHER WARRANTIES, EXPRESS OR IMPLIED, INCLUDING ANY WARRANTIES OF MERCHANTABILITY AND FITNESS FOR PARTICULAR PURPOSE AND ALL OTHER WARRANTIES ARISING FROM COURSE OF DEALING OR USAGE OF TRADE.</p> <p>The remedies provided above are the Purchaser's sole remedies for any failure of Seller to comply with its obligations regarding the workmanship of its Products. Correction of any nonconformity in the manner and for the period of time provided shall constitute complete fulfillment of all liabilities of Seller, with respect to or arising out of the Product furnished hereunder.</p>
<b>Delay/Force Majeure</b>	<p>Seller shall not be liable for failure to perform or for delay in performance due to fire, flood, strike or other labor difficulty, act of God, act of any governmental authority or of the Purchaser, riot, embargo, fuel or energy shortage, wrecks or delay in transportation, inability to obtain necessary labor, materials or manufacturing facilities from usual sources or failure of suppliers to meet their contractual obligations, or due to any cause beyond its reasonable control. If any such event occurs, Seller may extend delivery dates by a period of time necessary to overcome the effect of such delay, allocate available Product or cancel any purchase order.</p>
<b>Compliance with Law</b>	<p>PURCHASER IS SOLELY RESPONSIBLE FOR COMPLIANCE WITH ALL APPLICABLE FEDERAL, STATE AND LOCAL LAWS, ORDINANCES, REGULATIONS, RULES AND STANDARDS RELATING TO THE INSTALLATION, MAINTENANCE, USE AND OPERATION OF THE PRODUCTS.</p>
<b>Patents</b>	<p>Subject to the following provisions, Seller shall, at its own expense, defend or, at its option, settle any claim, suit or proceeding brought against the Purchaser, and/or its vendees, mediate and immediate, so far as based on an allegation that any Product or any part thereof furnished hereunder constitutes a direct or a contributory infringement of any claim of any patent of the United States or Canada. This obligation shall be effective only if Purchaser shall have made all payments then due hereunder and if Seller is notified promptly in writing and given authority, information and assistance for the defense of said claim, suit or proceeding. Seller shall pay all damages and costs awarded in such suit or proceedings so defended.</p> <p>The foregoing indemnity does not apply to the following:</p> <ul style="list-style-type: none"><li>• Products supplied according to a design other than that of Seller, and which is required by the Purchaser.</li><li>• Combination of the Product with another product not furnished hereunder unless Seller is a contributory infringer.</li><li>• Any settlements of a suit or proceeding made without Seller's written consent.</li></ul>
<b>Limitations of Liability</b>	<p><b>SELLER, ITS CONTRACTORS, AUTHORIZED DEALERS AND SUBCONTRACTORS OR SUPPLIERS OF ANY TIER SHALL NOT BE LIABLE TO PURCHASER FOR ANY SPECIAL, INDIRECT, INCIDENTAL OR CONSEQUENTIAL DAMAGES ARISING FROM A BREACH OF THIS AGREEMENT.</b></p> <p>Purchaser's remedies set forth herein are exclusive and the liability of Seller with respect to the breach of this agreement or any contract entered into between the parties pursuant hereto shall not exceed the price of the Product or part on which such liability is based.</p>

# KnollKey Lock Program

## KnollKey Lock Program General Information

Following is the KnollKey lock policy, applicable to all products.

Knoll furniture can be ordered keyed-alike or random keyed. Key-alike and random keying instructions cannot be mixed on any single order. Only one of the two instructions can be used on an individual order. When an order is submitted with mixed (key-alike and random) instructions, Knoll will release the order as key-alike only and lock cores will have to be specified separately.

### Key-alike

For the convenience of the user, furniture may be keyed alike at no charge. Write "Key-alike" in the description of your purchase order for any pedestal, overhead, file or other item you wish to have keyed alike.

Using the key-alike instructions, order cores and keys as line items on your purchase order. Do NOT submit a key-alike form. The Knoll East Greenville Lock Center will select key numbers from the standard range of K 001 - K 250. Key numbers will not be repeated unless over 250 sets are ordered. Lock cores keyed-alike will ship separately from the product, ready for field installation.

There is no charge for key-alike orders if placed with the furniture order.

**IF THE KEY-ALIKE ORDER IS NOT PLACED AT LEAST TWO WEEKS PRIOR TO THE FURNITURE SHIP DATE, A \$50 HANDLING CHARGE AND AIR FREIGHT CHARGES WILL APPLY.**

**If product is ordered and shipped random-keyed, additional lock cores for key-alike are billable.**

### Random-Keying

To specify product keyed-random, write "key-random" in the product description. Random-keyed product is shipped with the lock core factory installed. A shrouded key is included. Random means no effort has been made to match key numbers, or to make them different.

### Keys

A Knoll shrouded key is shipped with every lock core. 250 Key numbers are available. For numbers above 250, contact Custom Product Development. Additional keys and key blanks are available. See service parts for more information.

### Master Keying

Knoll locks can be controlled by means of a master key. There is no additional per-lock charge for master keying. A letter of approval from the client must accompany orders for master keys.

### Installing Lock Cores

Lock cores can be installed or removed in the field by using a change key. Cores must be in the unlocked position to be removed. See service parts for change key pattern number and pricing.

### Lock Distribution

All orders for key-alike lock cores/keys are packaged and shipped from the East Greenville Lock Center, regardless of where the pedestals, overhead, or other units are produced. Random keyed product will have cores factory-installed.

## How to Specify Key-Alike

Following is an example of how to specify key-alike for a cluster of 10 workstations.

**Step 1** - Using the project floorplan, count the number of locks in each workstation.

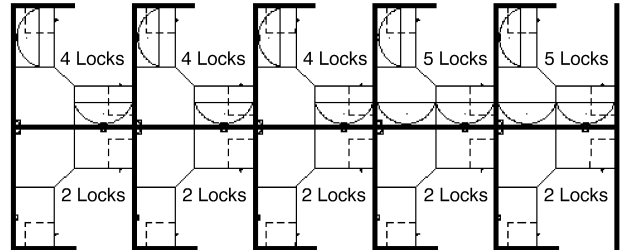

**Step 2** - Count the number of workstations with the same quantity of locks. Group together the workstations with a like number of locks.

5 workstations with 2 locks per station  
3 workstations with 4 locks per station  
2 workstations with 5 locks per station

**Step 3** - For the first group (5 sets of 2 locks), enter the number of workstations in the quantity column.

Qty	Pattern #	Description	Unit List	Ext. List
5				

**Step 4** - Then enter the pattern number "KSPEC\_ \_" and add a suffix for the number of locks for that group (i.e., for 2 locks per station, add the suffix "2"). Up to 30 lock cores are available in a set (i.e., KSPEC 30).

Qty	Pattern #	Description	Unit List	Ext. List
5	KSPEC 2	Set of 2 cores/keys	N / C	N / C

**Step 5** - Repeat for other groups.

Qty	Pattern #	Description	Unit List	Ext. List
5	KSPEC 2	Set of 2 cores/keys	N / C	N / C
3	KSPEC 4	Set of 4 cores/keys	N / C	N / C
2	KSPEC 5	Set of 5 cores/keys	N / C	N / C

Your Key instructions are complete.

Knoll will select key numbers for each set from 250 available numbers. Additional key numbers are available through Custom Product Development. **For additions to existing installations, specify desired key numbers in the description.**

## Service Parts

Pattern #	Description	List Price
KKEY_ _ _	Shrouded Key Specify key number desired	\$10
KBLANK	Shrouded Key Blank	\$10
KSPECB_ _ _	Retrofit Universal Core/Key Specify key number desired	\$22
KCHANGE	Change Key	\$10
HLKRKMASTER*	Master Key	\$10

\*Note: A letter of approval on company letterhead from the client must accompany all orders for master keys.

# General Ordering Information

---

## **The Products**

This guide encompasses all standard products for this product group.

## **Sizes**

Dimensions listed in this guide are indicated as:

H = height

W = width

D = depth

Dia. = diameter

Rad. = radius

## **Pricing**

All prices shown are list.

## **How to Order**

Select pattern numbers and quantities required for your complete installation. Product questions can be addressed in the specific sections of this guide or by contacting your sales representative or customer resource representative at 1-800-343-5665.

Next, select options (if required), along with colors and finishes appropriate to each product. Reference the Finishes and Fabrics pages for color designations.

On large installations, an item's "designated area" can be specified to assist in product organization and handling.

To expedite complete / correct entry of your order, be certain all pattern numbers, quantities, colors and area identifications are completely specified. Also, include complete purchase order numbers, bill-to and ship-to addresses, a contact name and specific factory shipping dates required.

## **Mail all orders to:**

Knoll, Inc.

1235 Water Street

P.O. Box 157

East Greenville, PA 18041

Attention: Order Entry

Once your order is entered at Knoll, an acknowledgment will be mailed to you. You will be advised of your scheduled shipping date within five days of the original acknowledgment. If it is necessary to revise your order, please contact your customer resource representative.

## Sustainability Statement

---

Sustainable design is a key component of Knoll's environmental focus. Our commitment to social responsibility and a healthy environment has prompted us to further articulate our longstanding environmental programs and, with encouragement and support from our colleagues in the industry, we have re-energized our focus on such "green" initiatives as life cycle analysis and LEED™ certification. Knoll is proud to have contributed to projects that have received LEED certification from the U.S. Green Building Council.

For the latest information on Knoll products that help our customers achieve LEED certification, log on to [knoll.com](http://knoll.com), click on "About Knoll" and then "Environmental Focus."