

Currents

Price List
February 2015



Knoll

Introduction	Knoll and Sustainable Design	3
	Introduction to Currents	4
	Currents Textiles	7
	Currents Color Program	8
	Currents Legacy Finishes	9
	Introduction to Upstart	10
	Original Upstart Planning Examples	11
	Upstart Color Program	13
	Upstart Legacy Finishes	14
Service Walls and components	Service Wall frames	15
	Fence frames	16
	Crown and raceway covers	17
	Structural base cover kits	18
	Access covers	20
	Wall ends and connectors	27
	Wall frame accessories	33
	Spine ends and connectors	35
	End Starters	39
	Panel system starters and T-ends	41
	Panel system starters for Dividends Horizon	49
	Power, data and communications components for Service Walls	50
Screens and add-up panels	Linkable screens	58
	Mobile screens	66
	Add-up panels	67
	Add up glass panels, for spine	68
	Add-up panel connectors and fillers	69
	Stackable add-up panels	71
	Stackable add-up connectors and fillers	75
Worksurfaces	Worksurfaces, universal	80
	Currents worksurfaces for Morrison panels and linkable screens	86
	Cascade edge worksurfaces	92
	Worksurface, samples	99
	Worksurface supports	100
Floorstanding storage	Pedestals	102
	Pedestal accessories	104
	Vertical storage cabinets	107
Service Wall-mounted storage and lighting	Reuter overhead cabinet	109
	Reuter open overhead	110
	Reuter open shelf	111
	Reuter ganging bracket	112
	Overhead brackets	113
	Task Lights for Reuter Overhead Storage	114
	Counter surface	115
	Ambient lighting	116
Desks and worktables	Desks	117
	Above-desk storage and lighting for desks	125
	Worktables	126
Upstart table desks and storage	Upstart Tables	129
	Plannable Upstart Tables	134
	Accessories	143
	Upstart Privacy Screens	144
	Plannable Upstart Privacy Screens	145
Wall Mounting of Knoll Products		147

Alpha-Numeric Index	149
Selling Policy	155
KnollKey Lock Program	157
General Ordering Information	158

Knoll and Sustainable Design

Each year Knoll sets key initiatives in our journey to sustainability. We are members of a global consortium on energy, have adopted a scientific, metrics-based approach to sustainable product design, and maintain a leadership position in establishing universal, verifiable, sustainability standards for our industry.

Knoll promotes independent third-party certification because it provides the most impartial and trustworthy foundation for industry-wide environmental compliance. Certification by established and respected third parties ensures that all manufacturers are held to the same high standards and that customers can trust a company's declaration about the environmental benefits of its products. Knoll third-party partners include: the International Standards Organization (ISO); Forest Stewardship Council (FSC®); Rainforest Alliance; GREENGUARD® Environmental Institute; and The Business and Institutional Furniture Manufacturer's Association (BIFMA) level® certification from Scientific Certification Systems (SCS).

In addition, Knoll is aligned with the U.S. Green Building Council and can help companies, healthcare organizations and educational institutions achieve Leadership in Energy and Environmental Design (LEED®) workplace certification.

Global Climate Change

- Knoll is a sponsor of the Clinton Global Initiative, which brings together a community of global leaders to devise and implement solutions to some of the world's most pressing challenges, including environmental change.
- Knoll has a comprehensive Energy Management Program to increase energy efficiency in products and processes.

Life Cycle Assessment (LCA) Tool

- Life Cycle Assessment is a science-based measurement of a product's environmental impacts throughout its life cycle, from raw materials sourcing through manufacture, shipping, use and re-use or end-of-life. LCA enables cradle-to-cradle implementation of sustainable practices.
- Knoll has partnered with The Green Standard.org to develop an affordable, universal ISO-compliant computer-based LCA tool that can be used by the entire contract furniture industry and is partnering on the development of an Environmental Product Declaration System (EPDs) for Knoll products. EPDs are verified documents containing LCA results and additional environmental performance information about a product.

Setting Industry Standards

- Knoll partners with MTS (The Institute for Market Transformation to Sustainability) to develop the SMaRT® Consensus Sustainable Products Standards, a set of consensus-based sustainable product standards based on the LEED® model, for all building products, fabric, apparel, flooring and carpet. MTS, the developer of SMaRT®, is an accredited American National Standards Institute (ANSI) standard developer.
- Knoll also partners with BIFMA (Business and Institutional Furniture Manufacturers Association) to promote level® sustainability standards for the contract furniture industry.
- Knoll has established FSC® (Forest Stewardship Council) certified wood as the standard for general office open plan office systems, casegoods and tables.
- Knoll has launched Full Circle, a resource recovery program developed with ANEW, to help customers extend the life cycle of surplus furniture, fixtures and equipment (FF&E) in an economically, socially and environmentally responsible manner.
- Our goal is to encourage all manufacturers in the contract furniture industry and related industries to adopt standards that will lead to sustainable products and practices.

For more information about Knoll and sustainable design, visit knoll.com/environment.

Currents creates dynamic, advanced performance work environments from coordinated, independent elements – Service Walls, Fence frames, plannable desks, mobile storage – and existing Knoll office products.

Currents workspaces may be spine-supported or freestanding, or planned in combination with conventional panel systems.

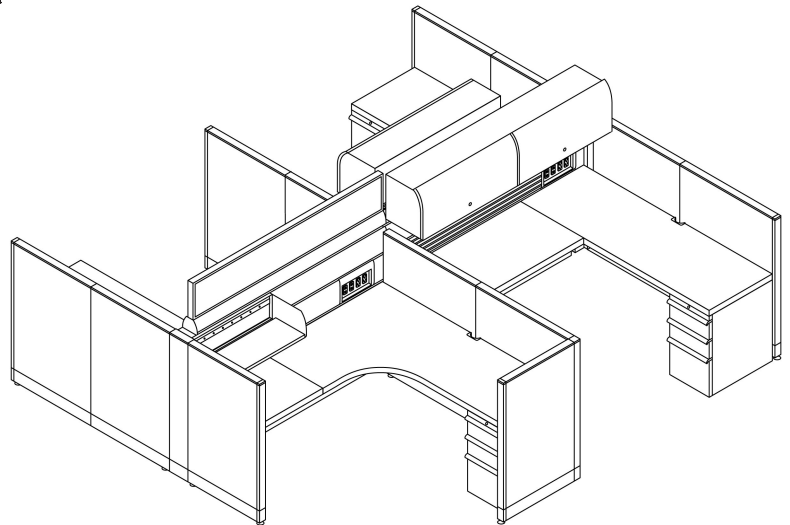
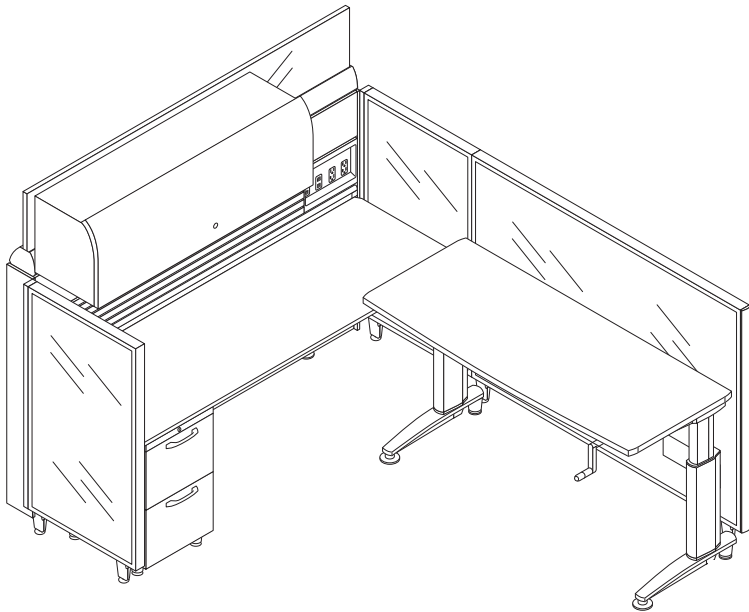
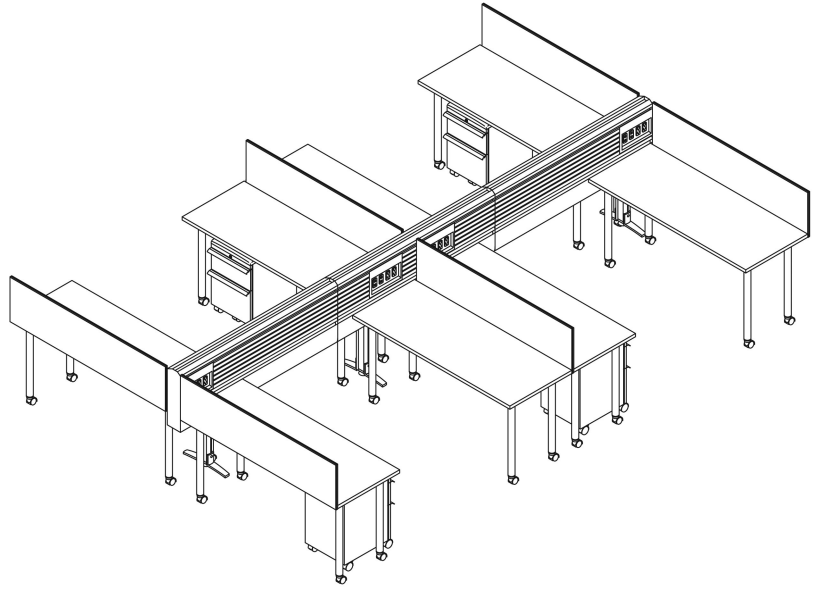

Currents Service Walls

Currents Service Walls form the structural core and primary path of services distribution for a cluster of workstations. Currents Service Walls may also create borders for team workspaces, conference areas, or corridors. Service Walls are 5" thick, and are available in three heights: 39" for seated visual access; 48" for seated privacy, the most versatile height for open plan areas requiring some overhead storage; and 64" for standing privacy in executive or conference areas.

Service Walls are composed of frames and covers. Frames include studs on 12" centers, base raceway with levelling glides, crown and base. Frames may be specified with 1"H compact crown or 4"H standard crown. All studs have brackets to support covers at 5", 21", 30", 39", 48" and 64" above the floor. Crown and raceway covers, structural base covers from 5" to 21" above the floor, and covers above 21" must be specified separately.

Structural base covers enable perpendicular panels, worksurface supports, or outriggers to be attached at any point. Structural base covers may be painted steel, perforated, or upholstered.

Wall covers above 21" snap into wall frame brackets at 12" intervals, and are removable without tools. Covers may be painted, upholstered, acoustical/tackable upholstered, cable tray, slat wall, or marker surface.

Currents Walls plan in any combination of 48", 60" or 72" widths corresponding to the total length of Wall required. Add outriggers, T-end and L-end panels, or 90° or 120° post connections at each end of Service Wall spine. Straight connectors are included with each frame kit to join frames of the same height in a straight line. High-low straight connectors are available separately. Service Walls require outriggers or perpendicular systems panels every 8'.

Power components are specified separately. Knoll universal 2+2 or 3+3 power components may be installed in the base of the Wall or at worksurface height. Base power rails accept two duplex outlets on each side of a panel at raceway height. Desk-height outlet modules accept two duplex outlets on each face above or below the worksurface. One or two modules (four duplex outlets each side) may be located in any 12" wide stud bay. Locate outlet modules and related 12"W outlet covers before specifying widths of adjacent panel covers.

The interior of the Wall between 21" and the crown offers unobstructed, 1" deep, lay-in cabling on each surface. Vertical wire management and excess cord capability is unobstructed 2½" x 10" between studs.

Service Walls with standard 4"H crown enable upmounted shelves, overhead storage cabinets, and canopy lighting at any point on one or both sides. Upholstered or frameless glass add-up panels fit into a center channel anywhere along the crown for 12", 21" or 28" of additional enclosure.

Stackable add-up panels are also available in upholstered, marker or glazed surface. First up panels are 12", 21" or 28" high; next up stacking panels are 16" high.

First up panels can be mounted on any 3" increment along Service Wall crown, or correspond in width to linkable screens.

Wall mounted components

Worksurface supports, perpendicular linkable screens, and systems panels may be connected to the Currents Wall at any point. Mobile screens are also available, in an upholstered surface.

Currents linkable screens, in glazed, upholstered or marker surface, define workstations and extend the Service Wall horizon. Linkable screens connect in L, T, X, Y and V configurations and accept stackable add-up panels. First up panels are 16", 25" or 32"H. Next up panels are 16"H.

Currents worksurfaces are designed for computer use as the primary work activity. Deep corners are shaped for large monitors, and include wide keyboard/mouse areas. Straight worksurfaces feature softly curved or flat fronts. Extended corners incorporate an adjacent work area and a computer corner into a single, uninterrupted surface. Universal worksurfaces include a steel stiffener for high load capacity and cord management.

Service Walls cantilever worksurfaces up to 24"D, or provide end support for any size worksurface. Support columns, independent C-legs, and floorstanding pedestals are also available for worksurface support. Cantilevers are adjustable in 1" increments for 24"-34"H worksurface. End support brackets and C-legs are fixed height for 28"H worksurface, or adjust for 24"-34" worksurface height.

Service Wall standard height 4"H crowns can upmount open shelves, overhead storage, task and ambient lighting, and add-up panels.

Service Wall standard height 4"H crowns can upmount or downmount Reuter overhead storage, open shelves, or Equity overhead at any point. Reuter storage and Equity overheads can only be downmounted from Walls with 1"H compact crown. Brackets are available to downmount Morrison Options, Series 2 for Morrison, Dividends, Series for Dividends or Equity overhead cabinets from 64"H Service Wall with either compact or standard crown.

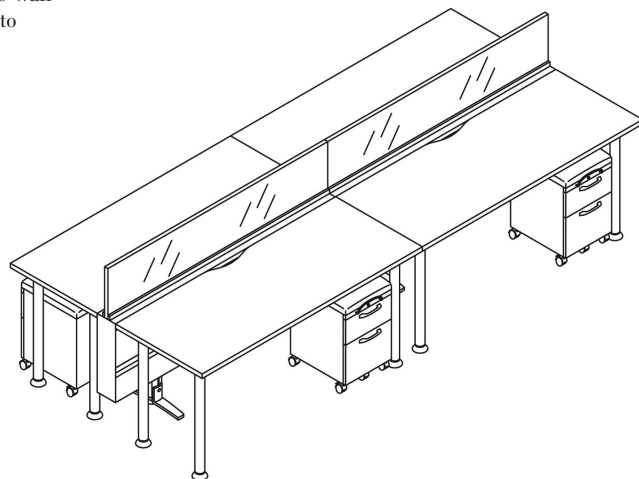

Currents Desks

Currents desks are freestanding furniture elements optimized for the high-mobility, computer-based office. Currents corner desks and mobile pedestals can work together to form efficient, two-element workstations.

Currents desks are height-adjustable. Pin-set version has range of 24" to 30"H in 1" increments. Handcrank version lets the user adjust continuously from 24" to 34"H. Desks have C-legs for knee clearance, and have interchangeable rear casters or glides for easy mobility.

All desks include horizontal and vertical cable managers.

Desks are available in corner, extended corner, and curved-front straight shapes. Worksurface corners are eased to make alignment of mobile units less critical.

Desks and wall-mounted worksurfaces accept clamp-on workshelves. Workshelves provide convenient binder/book access adjacent to computer displays.

Currents Worktables

Currents mobile worktables extend the worksurface area and provide flexible guest/conference spaces. Rounded corners enable informal placement near other worksurfaces. All worktables are available with casters or levelling glides.

Adjustable height worktables adjust from 24" to 30" high in 1" increments.

Currents Storage

Currents freestanding storage components are designed for mobility and space efficiency.

Pedestals are available mobile or fixed, with 2 files or combination 4" personal, 7" data, and 11" file drawer fronts, fitting below standard 28" worksurface height. Data/file mobile pedestals are low enough to roll under desks set lower than 28".

Mobile pedestals include top, casters and handle. Fixed pedestals include 2" levelling glides.

Reuter vertical storage has a rotating door, shelves and pull-out file frames, and a wardrobe area. Reuter storage is 21" wide so open door fits within 24" planning footprint.

Reuter vertical storage is available 48"H, with painted or worksurface top, or 64"H with painted top only.

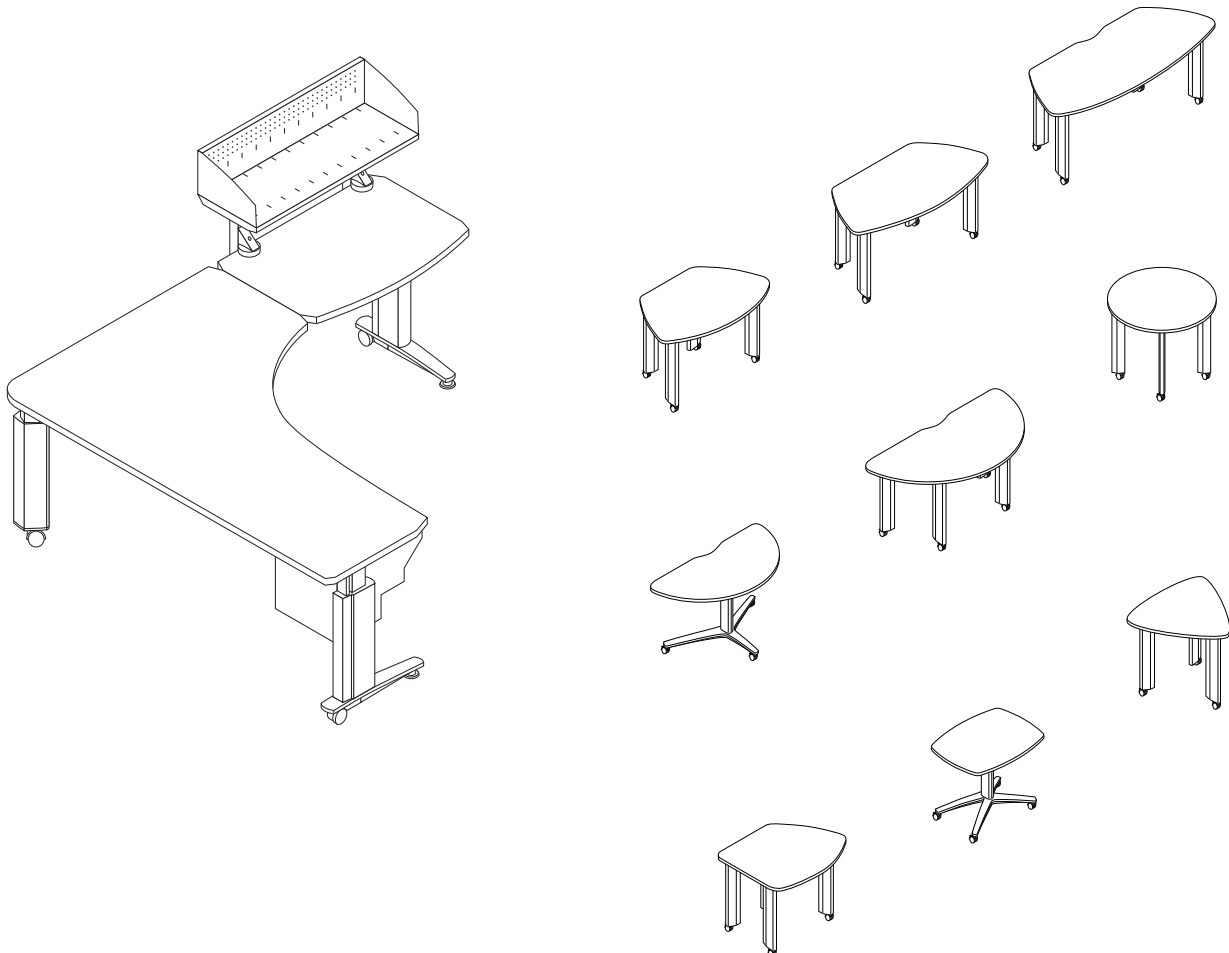

Approved for Wall covers, mobile screens and privacy screens.

Fabric Group 10

Annex (W1360)
Beacon (W1597)
Broadcloth II (W1619)
Circuit (W1754)
Element (W1077)
Foundation (W351)
Symbolic Details (W693)
Skylark (W1718)
Tailor Made II (W1610)
Versatility (W432)

Fabric Group 20

Bauhaus Block (W296A)
Circle Line (W1146)
Clarity (W281)
Criss Cross (W305)
Logic (W1318)
Mainframe (W1783)
Nematic II (W1620)
Photon II (W1695)
Reflect (W884)
Resolution (W280)
Weave Three (W298)

Fabric Group 30

Basket Draft (W249)
Flow (W565)
Harmony (W232)
Match Point (W1145)
Micro (W465)
Relay (W1020)

Fabric Group 40

Amplify (W1215)
Bandwidth (W1219)
Ornament (W1078)
Palladium (W1030)
Spellbound (W1464)

Fabric Group 50

Presto (K1000)

Fabric Group 55

Ransom (K1298)
Transition (W816)

* Screen only

Additional textiles are available on linkable screens and stackable add-up panels: see Morrison price list for approved fabrics.

Customer's Own Material is subject to an application testing fee of \$750 per fabric and a \$2500 fee for UL testing. Fabric requirements - application test, 10 yards; UL test, 15 yards. COM is also subject to extended leadtimes. COM panels are priced at Group 10 plus cost of fabric.

Approved textiles for Currents Mobile Pedestal Cushions

Abacus 🍷
Alignment 🍷

Arno 🍷
Atelier
Atlas
Axiom
Backdrop
Bank Shot 🍷
Basket Draft
Baxter
Beacon
Belize
Biota 🍷
Biscayne
Bistro 🍷
Bocce 🍷
Boundary 🍷
Cameo
Cato
Cats Cradle 🍷
Cavalier
Century
Chance
Charm
Chroma 🍷
Chronicle 🍷
Circa
Classic Boucle 🍷
Close Knit
Coco
Common Ground 🍷
Commuter Cloth 🍷
Compass CR
Cornaro
Coterie
Cricket
Cross Stitch 🍷
Cuddle Cloth
Dahlia CR
Dovetail 🍷
Dristi
Durand
Dynamic
Earthwork 🍷
Eclat Weave
Empire Stripe
Entourage 🍷
Fable CR
Fast Forward
Ferry
Fibra
Forza
Fox Trot CR
Framework 🍷
Galla II 🍷
Gibson
Glider
Grande
Grandview
Greenwich
Groove Line
Haiku
Harrison
Haze
Heavy Metal
Highline CR
Hologram
Hourglass
Hudson
Icon

Ikat Squat
Ikat Stripe
Innuendo
Intrigue
Journey 🍷
Jubilee
Katazome
Keaton
Kimono
Kinabalu
Kinship 🍷
Knoll Felt 🍷
Knoll Hopsack 🍷
Kora CR
Legend CR
Lore CR
Lyric
Mamba
Mariner
Marquee
Masquerade
Menagerie
Metro
Milestone
Mini Stitch 🍷
Mod Plaid
Monarch 🍷
Moto CR
Night Life
Noble
Nonchalant CR
Obi
Origins
Panache CR
Paradigm
Parasol
Pedal Pusher
Pogo 🍷
Pony Up 🍷
Pop
Prairie
Prep 🍷
Presto 🍷
Prim
Quark
Ransom 🍷
Rattan
Reflect
Regard CR
Ricochet 🍷
Rio
Rivington
Roam
Roundtrip 🍷
Rush Hour
Sahara CR
Sandpiper CR
Satellite
Sequin CR
Serendipity
Sherman
Sinclair
Smart
Soiree 🍷
Soliloquy
Sonnet 🍷
Soon
Spark 🍷

Spectator 🍷
Spencer
Spot On
Spotlight
Spree 🍷
Stacks
Star Struck
Stepping Stones
Sutton 🍷
Swing
Synth 🍷
Theory
Tight Rope
Tilden
Topography
Totem
Tower Grid
Treble CR
Trophy
Tryst
Turner
Tweed Frieze
Ultrasuede 🍷
Utmost
Utrillo
Venue
Versa 🍷
Versatility
Vibe
Vinyl
Westwood
Whip
Wide Angle 🍷
Zari CR
Zipline 🍷
Zoom

Pedestal cushions are upholstered (from the front to the back of the pedestal) with the fabric direction matching the textile sample.

Approved Spinneybeck Leathers for Currents Mobile Pedestal Cushions

Alaska
Amazon
Andes
Arizona
Cervo
Copenhagen
Cordovan
Derby
Distressed
Ducale
Ducale Velours
España
Maremma
Marissa
Prima
Riva
Sabrina
Saddle
Salon
Velluto Pelle
Volo

🍷 = CAL 133 Pre-approved

Core finishes

Specify Core finishes for all new customers

Core	Legacy	Wall covers	Wall ends, trim, brackets and outriggers	Storage fronts	Storage cases	Work-surfaces and shelves	Currents worksurface edges	Currents for Morrison worksurface edges	Pedestals and Reuter Over-head
611	Beige Mist Metallic	•	•	•	•				P2
118	Bright White	•	•	•	•	•		•	P3
112	Brown	•	•	•	•				P1
123	Brushed Grey					•			
122	Brushed Sand					•			
113	Dark Grey	Y3	•	•	•				P1
128	Fog					•		•	
114	Folkstone Grey	LA/U	•	•	•	•		•	P1
111	Jet Black		•	•	•	•		•	P1
124	Medium Cherry					•			
115	Medium Grey	Y2	•	•	•				P1
612	Medium Metallic Grey	J	•	•	•				P2
121	Micro Grey					•			
129	Micro Sand					•			
126	Natural Cherry					•			
125	Natural Maple					•			
119	Pumice	F				•		•	
116	Sandstone		•	•	•				P1
613	Silver	3	•	•	•				P3
117	Soft Grey	E/M42	•	•	•	•		•	P1
813	Trim Grey	5					•	•	
127	Walnut					•			
V1	Maple Techgrain®	4/M			Y821	Y821			Y821
V1	Cherry Techgrain®	6/R			Y831	Y831			Y831
V2	Maple	K			V316	V316			V316

Default trim information:

Trim Grey is the integral color for worksurface, desk and worktable top edge, mobile screens, linkable screen and add-up panel trim, privacy screen and window trim, pedestal pulls.

Black: wall frames and drawers interior, wall, screen, storage glides and casters.

Light grey: Ambient lights

Translucent crystal: fiberglass surfaces for mobile screens, linkable screens and add-up panels

The new Core finish 113 Dark Grey is not a match to the Currents Legacy finish NV. It is a match to the Dividends Legacy finish Y3.

The new Core finish 115 Medium Grey is not a match to the Currents Legacy finish NJ. It is a match to the Dividends Legacy finish Y2.

Veneer finishes for Currents worksurfaces and storage fronts are available through Custom Product Development.

		Work-surfaces	Wall and Structural Base covers	Crown Covers	Crown end caps, connectors and connector top caps, raceway covers, worksurface brackets and outriggers	Straight legs, C-legs, corner legs, desk screen clamps, window frames (textured only)	Storage fronts	Storage Cases
Plastic Laminates	Light Grey	L						
	Pumice	F						
	Winter grey	V						
	Slate	S						
	Snow	B						
	Folkstone Grey	U						
	Pearwood	PA						
	Fiber	E						
	Sand	D						
	Medium Grey	G						
	Soft grey	M42						
Wood Grain Laminates	Clear Maple	CM						
Veneer Group 3	Maple	K					K	
	American cherry	X					X	
	Medium red mahogany	Z					Z	
Paint Group 2	Metallic Flint *		2	2	2	2	2	2
	Light metallic grey *		U	U	U	U	U	U
	Medium metallic grey *		J	J	J	J	J	J
	Dark metallic grey *		V	V	V	V	V	V
	Light metallic tan *		W	W	W	W	W	W
	Metallic beige *		H	H	H	H	H	H
	Soft Grey *		E	E	E			
	Medium Grey (Slate) *		Y2	Y2	Y2			
	Taupe *		R	R	R			
Aluminum			A					
Paint Group 3	Silver *		3	3	3	3	3	3
	White *		B	B	B	B	B	B

Specify legacy finishes to match existing product only. Legacy finishes are not available for new customers.

Trim grey is the integral color for worksurface, desk and worktable top edge, mobile screen and add-up panel trim, privacy screen and window trim, pedestal pulls Wall, screen and storage glides, glide cones and casters are integral color Black.

Wall frames and pedestal drawer interiors are painted Black.

Ambient lights are painted Light grey

Fiberglass surfaces for mobile screens, linkable screens and add-up panels is Translucent crystal

Linkable screen feet are painted Trim grey

Note: Add 10% to the list price of any laminate product when specifying a legacy laminate.

Knoll Upstart is a collection of tables, screens and services distribution components for computer-intensive, active, and open work environments.

Upstart plans as single-surface, L- or U-shape workstations, or freestanding worktables in combination with other systems furniture. Tables are available on casters or glides and are adjustable in height.

Original Upstart tops have a plastic laminate surface with a continuous T-mold edge. The corners of Original Upstart tops are rounded. Original Upstart legs are curved.

New Plannable Upstart tops have a plastic laminate or Veneer surface with a T-mold edge on the front and a thin edgeband on the sides and back. The corners of Plannable Upstart tops are 90 degrees and allow two tables to meet at right angles. Plannable Upstart legs are straight.

Complementary products include Currents workshelves, which clamp on to Upstart tables, mobile screens, linkable screens and Service Wall, monitor supports and desktop accessories. Consult the Currents and KnollExtra price lists for product details and pricing.

Screens

Upstart screens mount to the back edge of Original Upstart tables to provide seated visual privacy at a horizon of 39 or 48 inches. Upstart Screens are available in translucent or marker surface, and may be combined with magnet rail.

Plannable Upstart tables use Morrison Network upholstered screens, which are available in a variety of sizes.

Accessories

Flat Bracket

Bracket joins 2-legged table to another Upstart table at same height.

Cable Tray

Cable tray adds on to worksurface stiffener to control cable bundles and power strips (where permitted by code).

Important Note: Plannable Upstart straight legs may not be used with Original Upstart tops due to stability issues.

Note to Knoll Dealer Sellers:

The products contained in this price list are also available through the Knoll Essentials program, with limited exceptions. For additional information, please contact your customer service representative or visit Knoll Exchange.

Primary and Secondary Worksurfaces

Original Upstart

Rectangular table desk/Return

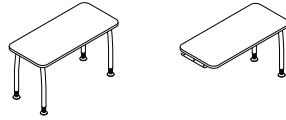

Corner table desk, 120°

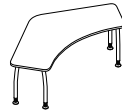

Extended Corner table desk

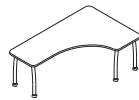

Y-shape table desk, M-shape table desk

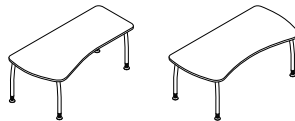

Conference Worksurfaces

Original Upstart

Round, Half round table desk

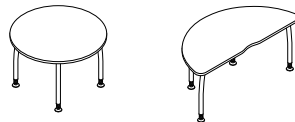

Oval table desk



Wiper table desk, Tripod table

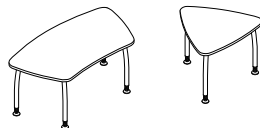

48 x 24 Original Upstart

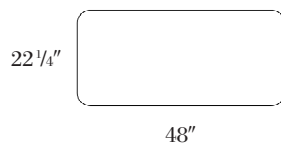

New Plannable Upstart

Rectangular table desk/Return

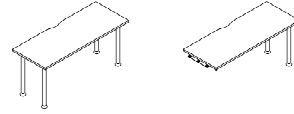

Corner table desk, 90°

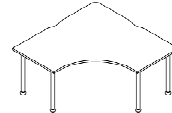

Extended Corner table desk

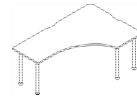

P-shape table desk

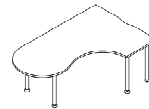

New Plannable Upstart

Half round table desk

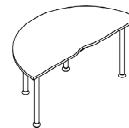

48 x 24 Plannable Upstart

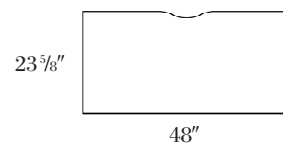

Basic stand-alone Y desk

- the core Upstart application
- 30" x 72" nominal shown; conference depth is approximately 36"

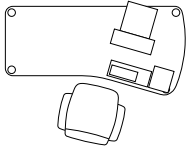

Oval table with Y desk

- 36" x 66" oval table
- 30" x 72" Y return

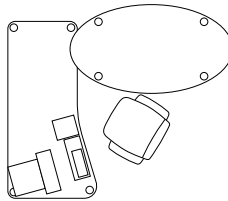

Curved wiper with Y desk

- wiper 66" W
- 30" x 72" Y return

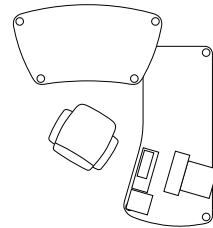

Y desk with 42" round table

- conference table

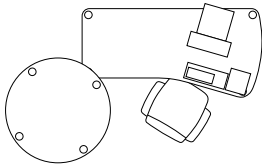

Rectangular table with bracketed return surface

- 72" x 76" approximate footprint
- optional work shelf

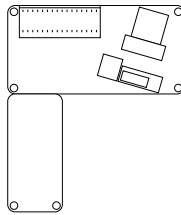

Y and M back-to-back, with 42" conference tables

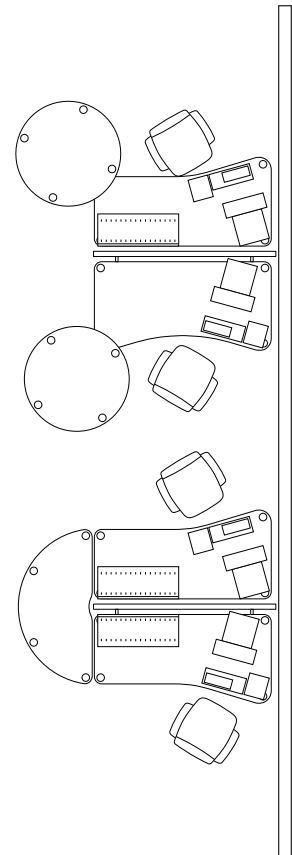

Y desk with tripod table

- 30" x 72" Y desk, work shelf, and mobile pedestal

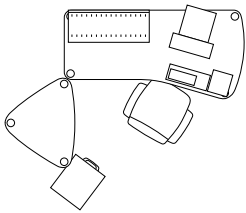

Dual-monitor M desk workstation

- 72" x 100" approximate footprint
- optional work shelf
- flat ends allow placement along wall

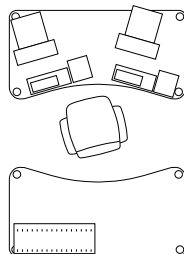

Dual-monitor M desk with tripod table

- 30" x 72" nominal M desk

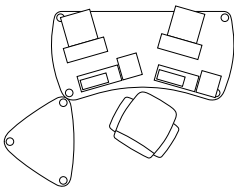

Y desks back-to-back, with half-round shared table

- please note 1.75" setback from the back edge of each top to module line, same as Currents desks.

Y desk with Upstart storage

- 72" x 96" footprint
- 72" table with screen
- mobile pedestal and tower

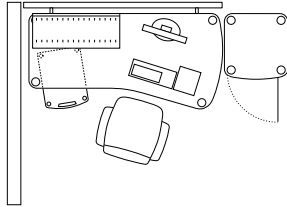

Extended corner desk and tower

- 72" x 72" footprint
- 48" and 72" screens
- mobile pedestal and tower

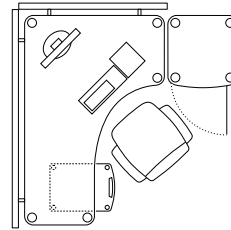

Extended corner desk and adjacent worktable

- 72" x 96" footprint
- 72" x 48" corner and 48" straight desks
- mobile pedestal and privacy screen

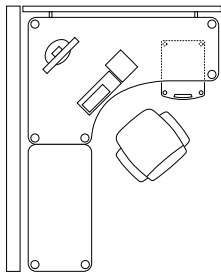

Upstart 120° planning

- group of three 120° corners
- 48" shared privacy screens
- mobile pedestals

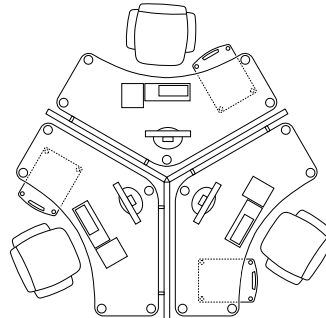

U-shape plannable desks

- 96" x 96" footprint
- two 48" x 72" extended corners
- mobile pedestal and tower
- 72" privacy screen

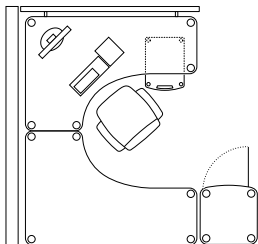

Upstart work group

- 120° corners and shared worktable 48 x 24"
- mobile pedestals and towers
- 48" privacy screens

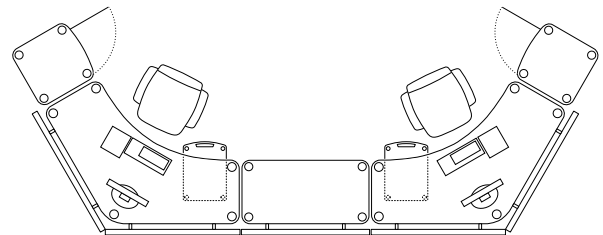

Core finishes

Specify Core finishes for all new customers

Core	Legacy	Table legs, screen brackets, magnet rail	Upstart Worksurfaces	Plannable Upstart Worksurfaces	Upstart Worksurface edges	Plannable Upstart Worksurface edges
611	Beige Mist Metallic	•				
118	Bright White	•	•	•	•	•
112	Brown	•				
123	Brushed Grey		•	•		
122	Brushed Sand		•	•		
113	Dark Grey Y3	•				
128	Fog		•	•	•	•
114	Folkstone Grey LA/U	•	•	•	•	•
111	Jet Black	•	•	•	•	•
124	Medium Cherry		•	•		
115	Medium Grey Y2	•				
612	Medium Metallic Grey J	•				
121	Micro Grey		•	•		
129	Micro Sand		•	•		
126	Natural Cherry		•	•		
125	Natural Maple		•	•		
119	Pumice F		•	•	•	•
116	Sandstone	•				
613	Silver 3	•				
117	Soft Grey E/M42	•	•	•	•	•
813	Trim grey 5				•	•
127	Walnut		•	•		
	Translucent orange O				•	
	Translucent blue P				•	
	Frosty white W				•	
	Light grey (integral) U					
	Glider grey (integral) G1					
Y821	Blond Maple 4/M			•		
Y831	Light Cherry 6/R			•		
V316	Maple K					

Default trim information:

Trim Grey is the integral color for caster and glide leg levellers and screen corners

Black: flat bracket, cable tray and casters

Screen available in Ribbed Polycarbonate or Marker surface

Veneer finishes for Plannable Upstart worksurfaces are available through Custom Product Development.

For Plannable Upstart Veneer Group 1, only black or trim grey edgebands can be specified.

Translucent orange, Translucent blue, and Frosty white edgebands are not available for Plannable Upstart tables.

Specify Legacy Finishes for existing customers only. Legacy Finishes are not available for new customers.

		Table legs, screen brackets, magnet rail	Worksurfaces	Worksurface edges
B	Snow		•	
L	Light grey		•	•
E	Fiber		•	
V	Winter grey		•	
S	Slate		•	
F	Pumice		•	•
U	Folkstone grey		•	•
M42	Soft grey		•	•
D	Sand		•	•
CM	Clear Maple		•	
PA	Pearwood		•	
WM	Warm Cherry		•	
5	Trim grey			•
N	Black			•
O	Translucent orange			•
P	Translucent blue			•
W	Frosty white			•
N2	Flint			
NU	Light grey			
NJ	Medium grey			
NV	Dark grey			
NW	Light Tan			
NH	Beige			
3	Silver	•		
B	White	•		
2	Metallic flint	•		
U	Light metallic grey	•		
J	Medium metallic grey	•		
V	Dark metallic grey	•		
H	Metallic beige	•		
W	Light metallic tan	•		
E	Soft grey	•		
K	Maple			
U	Light grey (integral)			
G1	Glider grey (integral)			

Default trim information:

Trim Grey is the integral color for caster and glide leg levellers and screen corners

Black: flat bracket, cable tray and casters

Screen available in Ribbed Polycarbonate or Marker surface



For Plannable Upstart Veneer Group 1, only black or trim grey edgebands can be specified.

Translucent orange, Translucent blue, and Frosty white edgebands are not available for Plannable Upstart tables.

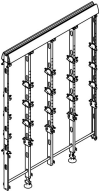
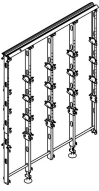
NOTE: Add 10% to the list price of any laminate product when specifying a legacy laminate.

description	type	w	d	h	pattern no.	black
 <p>Wall frame, standard crown</p>	39"H	48"	5"	43"	APF1 3948	\$554.
		60"	5"	43"	APF1 3960	637.
		72"	5"	43"	APF1 3972	789.
	48"H	48"	5"	52"	APF1 4848	610.
		60"	5"	52"	APF1 4860	697.
		72"	5"	52"	APF1 4872	870.
	64"H	48"	5"	68"	APF1 6448	725.
		60"	5"	68"	APF1 6460	829.
		72"	5"	68"	APF1 6472	1,038.
 <p>Wall frame, compact crown</p>	39"H	48"	5"	40"	APFA1 3948	444.
		60"	5"	40"	APFA1 3960	509.
		72"	5"	40"	APFA1 3972	628.
	48"H	48"	5"	49"	APFA1 4848	486.
		60"	5"	49"	APFA1 4860	557.
		72"	5"	49"	APFA1 4872	696.
	64"H	48"	5"	65"	APFA1 6448	580.
		60"	5"	65"	APFA1 6460	662.
		72"	5"	65"	APFA1 6472	829.

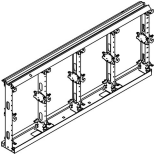
Order Code	Specification Information	Application Notes
Example: APF1 4860	Wall frame pattern numbers begin with APF prefix.	Service Wall frames are the structural component of a Currents spine. Specify frames in any combination of widths to create the overall wall length required.
APF1 Wall frame		Crown is bored to accept stackable add-up panels at 3" increments.
48 Height	<i>Specify:</i> <i>Fifth position: height</i>	Wall frames include two levelling feet with 2" travel, 12" from each side edge.
60 Width	39 39"H 48 48"H 64 64"H	The base of the wall accepts Knoll 2 + 2 or 3 + 3 raceway power rails, and allows cables to enter or exit anywhere between glides.
	<i>Seventh position: width</i>	Specify crown covers, raceway covers, structural base covers, and wall covers for each face of frame, and specify power components separately.
	48 48"W 60 60"W 72 72"W	
	All wall frames include two 3" diameter, 2" levelling glides and one set of connectors to adjacent frame or wall connector. Frames are black painted finish.	Frames include vertical studs every 12" on center, with cover mounting clips and cable manager inserts on both sides. Frames also include 4"H or 1" top crown with continuous channel for add-up panels. 4"H Standard crown frames include shaped crowns for upmounting shelves and overhead storage cabinets or canopy lighting at any point. Compact crown frames feature a slim profile crown with downmounting capability only.

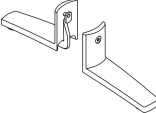
description	width	depth	height	pattern number	black
Fence frames (legs not included) 	48"	5"	20 1/2"	APF 1848	\$507.
	60"	5"	20 1/2"	APF 1860	608.
	72"	5"	20 1/2"	APF 1872	729.
Leg with glide 	2 3/4"	4"	5"	AX1LEG5 ()	79.
	2 3/4"	4"	6"	AX1LEG6 ()	79.
	2 3/4"	4"	18 1/2"	AX1LEG ()	79.
Stabilizer feet (set of 2) 	2 1/2"	7 1/2"	4 1/2"	AX1 FF ()	121.

Order Code

Example: APF 1872
APF Wall frame
18 Height
72 Width

Specification Information

Specify painted finishes for legs and feet.

Fence frames include four barrel connectors, crown and bottom rail covers in trim grey. Frames must be enclosed with two rows of 9"H Currents or AutoStrada wall covers on each face.

Specify Currents power components separately. Outlet modules mount at any point along the top row only.

Cable tray access covers mount in bottom row only.

Application Notes

Currents Fence provides independent services distribution to a cluster of tables, desks or workstations.

Fence legs may be specified at three heights to deliver an overall height of 40"H, 28"H or 27"H to the top of the crown. Specify AX1LEG() leg to get to 40"H; specify AX1LEG6() leg to get to 28"H; and specify AX1LEG5() leg to get to 27"H to the top of the crown.

Installed Fence frames include vertical studs with cover mounting clips and cable manager inserts every 12".

A continuous top channel accepts Currents or AutoStrada crown top caps and supports frameless glass add up panels, add up panels or stackable add up panels 12" high. 21"H stackable add up panels may be used on Fence runs supported by perpendicular panels or linkable screens.



Fence legs with glides mount 12" from each frame side edge under the first full vertical stud. Stabilizer feet mount on both faces of Fence legs. For freestanding Fence runs, specify a leg with feet 12" from each run end plus a leg with feet for each intermediate frame connection. Intermediate legs may be positioned on either side of the frame connection.

Legs with feet 12" from each end of connected Fence frames can be replaced by stabilizer end cabinets or T-ends with panels or linkable screens. Intermediate support may also be provided by legs without feet in combination with perpendicular panels or linkable screens with Fence panel starters.

Fence frames can end support worksurfaces but cannot cantilever worksurfaces or upmounted storage.

When specifying frameless glass add-up panels on Fence, each Fence frame requires two legs.

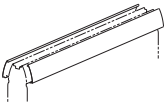
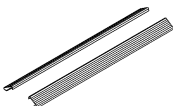
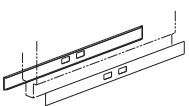
Fence T-end adaptors, stabilizer end cabinet adaptors, high-low straight connectors, panel starters for Morrison panels and linkable screens, universal panel starters, and panel starter end trim for Morrison panels and linkable screens are only compatible with Fence frames that are specified at 40 inch high with the 18- 1/2" high leg (AX1 LEG). To use these components when Fence is planned with shorter legs that deliver overall heights of 27 or 28 inches high, please contact Knoll Custom Product Development for assistance.

description	type	w	d	h	pattern no.	paint	metal finish (A)	list
Crown covers (pair) 		48"	5"	4"	APT 48 ()	\$39.	\$47.	
		60"	5"	4"	APT 60 ()	47.	52.	
		72"	5"	4"	APT 72 ()	52.	65.	
Crown covers, compact (pair) integral color 		48"	5"	1"	APTA 48 ()			62.
		60"	5"	1"	APTA 60 ()			74.
		72"	5"	1"	APTA 72 ()			126.
Raceway covers (pair) 	no outlets	48"	–	3 1/3"	APR 480 ()	39.		
		60"	–	3 1/3"	APR 600 ()	47.		
		72"	–	3 1/3"	APR 720 ()	52.		
	outlets	48"	–	3 1/3"	APR 48 ()()	47.		
		60"	–	3 1/3"	APR 60 ()()	52.		
		72"	–	3 1/3"	APR 72 ()()	65.		
Crown top cap 		24"	2"	–	APT C24 ()			9.
		24"	2"	–	APT1 C24 ()			9.
		36"	2"	–	APT C36 ()			17.
		36"	2"	–	APT1 C36 ()			17.
		48"	2"	–	APT C48 ()			29.
		48"	2"	–	APT1 C48 ()			29.
		60"	2"	–	APT C60 ()			32.
		60"	2"	–	APT1 C60 ()			32.
		72"	2"	–	APT C72 ()			39.
	72"	2"	–	APT1 C72 ()			39.	

integral color only, plastic

Order Code	Specification Information	Application Notes
Example: APR 480 612 APR Raceway 48 Width 0 Outlet openings 612 Finish	Wall crown pattern numbers begin with APT-prefix, then frame width. Specify: Sixth position: paint or metal finish Raceway Covers begin with APR-prefix, then frame width. Specify: Sixth position: outlet openings 0 no outlets 2 two outlets, each side (48", 60" only) 4 four outlets, each side 6 six outlets (72" only), each side Seventh position: Raceway cover finish	Crown, raceway, and structural base covers are required for every wall frame in corresponding widths. Covers are specified in pairs to cover both sides of a frame. Raceway covers may be specified with no openings (desk-height raceway), two openings in the center, or four outlets at all possible locations in 48" or 60"W raceway. 72"W raceway may have four outlet openings in the center or six in all, each side. Raceway cover sets with outlet openings include black filler plates for one cover only.

Structural base cover kits *non-upholstered*

description	type	w	d	h	pattern no.	smooth solid	textured solid	perforated	textured perforated
Structural base covers (pair)	non upholstered	48"	1"	16"	APC AZ48 () ()	\$263.	\$291.	\$374.	\$410.
		60"	1"	16"	APC AZ60 () ()	303.	337.	427.	473.
		72"	1"	16"	APC AZ72 () ()	344.	380.	483.	532.

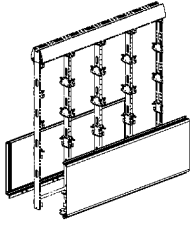

Order Code

Example:	APC AZ48 H 612
APC	Wall cover
AZ	Attachment zone
48	Width
H	Perforated
612	Finish

Specification Information

Structural base cover kit pattern numbers begin with APC AZ prefix, then cover width.

Specify:

Eighth position:

- P painted
- PT textured painted
- H perforated painted
- HT textured perforated painted

Ninth position: paint finish or fabric group

Specify paint finish for all covers.

Textured paint finishes for structural base covers only.

Application Notes

Crown, raceway, and structural base covers are required for every wall frame in corresponding widths. Covers are specified in pairs to cover both sides of a frame.

Structural base covers bolt to each side of the wall frame up to 21"H for structure and continuous attachment capability.

Structural base cover kits *upholstered*

description	type	w	d	h	pattern no.	10	15	20	30	35	40	45	50	55
Structural base covers (pair)	upholstered	48"	1"	16"	APC AZ48 F ()	\$378.	\$394.	\$406.	\$434.	\$446.	\$462.	\$475.	\$500.	\$530.
		60"	1"	16"	APC AZ60 F ()	446.	462.	477.	509.	528.	540.	559.	585.	623.
		72"	1"	16"	APC AZ72 F ()	n/a	530.	n/a	n/a	n/a	n/a	n/a	n/a	n/a

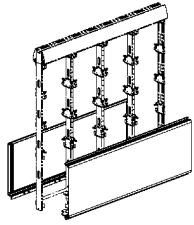

Order Code

Example: APC AZ48 F 10
APC Wall cover
AZ Attachment zone
48 Width
F Upholstered
10 Fabric

Specification Information

Structural base cover kit pattern numbers begin with APC AZ prefix, then cover width.

Specify:
Eighth position:

F fabric

Ninth position: paint finish or fabric group

Fabric groups:
Specify two-digit fabric group number

Application Notes

Crown, raceway, and structural base covers are required for every wall frame in corresponding widths. Covers are specified in pairs to cover both sides of a frame.

Structural base covers bolt to each side of the wall frame up to 21"H for structure and continuous attachment capability.

When ordering 60" wide or greater width upholstered structural base covers, please check the width of the fabric selected.

Access covers

outlets cover

Currents

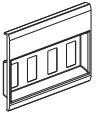
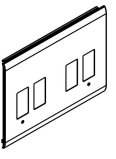
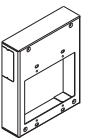
description	type	w	d	h	pattern no.	black	no finish	smooth
Outlets cover	9"H cover	12"	1"	9"	APC OC ()			\$32.
								
Hinged outlet flap (each)					APC OCF			32.
Outlet fillers (Set of 10)					AR OF			37.
Hardwire outlets cover		12"	9"		APC HOC ()			50.
								
Hardwire outlet box, desk height	quad	2"			AR1 HOB			226.
	two quad	12"			AR1 HOB2			298.

Order Code

Example:	APC OC 612
APC	Service wall cover
OC	Outlets cover
612	Finish

Specification Information

Specify finish.

Application Notes

Locate outlets covers on Service Wall or Fence frames before specifying other wall covers.

Outlets cover mounts between 21" and 30" (below standard desk height), 30" - 39" (above desk height) or 39" - 48" on Service Wall frame. Outlet cover mounts in top row of Fence only.

Outlets cover is 12" wide, and mounts anywhere on Service Wall frame between 21" and 48" above the floor. Outlets cover corresponds to power components (specified separately) mounted on Service Wall frame.

Outlets covers have four openings for power or PDC outlets. Specify outlet fillers for unused outlet openings in cover. Specify hinged outlet flap to conceal power or data outlet plugs. Each flap covers two openings; two flaps conceal all four openings in outlets cover.

For hardwire power applications (required in City of Chicago) specify hardwire outlets cover and hardwire outlets box. Do not specify cable tray covers at same level as hardwire power.

Hardwire outlet box accepts two Decora-style duplex outlets, and includes mounting brackets for one face of Service Wall between 21" and 48"H or one face of top row of Fence frames. Two quad hardwire outlet box accepts four duplex outlets on one face. Also specify hardwire outlets cover, which has four outlet openings. Specify outlet fillers for any unused outlet openings.

Outlet boxes include openings to permit continuous lay-in wiring with Wiremold® raceway. Electrical contractor supplies infeed cable, Wiremold 2400®, and duplex outlets. Outlet boxes can be planned back to back, with distribution on one side of Service Wall.

NOTE: Currents cable tray access covers and all AutoStrada access covers cannot be used in the same 9"H zone as the wiremold raceway as the wiremold will not fit behind the covers.

Access covers

cable tray and slat wall covers

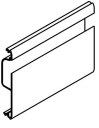
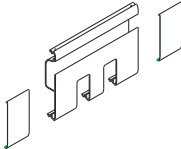
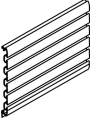
description	w	d	h	pattern no.	smooth
 9"H cable tray covers	12"	1"	9"	APC 0912 C ()	\$77.
	24"	1"	9"	APC 0924 C ()	91.
	36"	1"	9"	APC 0936 C ()	106.
	48"	1"	9"	APC 0948 C ()	138.
	60"	1"	9"	APC 0960 C ()	177.
	72"	1"	9"	APC 0972 C ()	215.
 9"H cable tray exit cover	12"	1"	9"	APC 0912 CX ()	153.
 9"H slat wall covers	12"	1"	9"	APC 0912 S ()	69.
	24"	1"	9"	APC 0924 S ()	80.
	36"	1"	9"	APC 0936 S ()	92.
	48"	1"	9"	APC 0948 S ()	122.
	60"	1"	9"	APC 0960 S ()	153.
	72"	1"	9"	APC 0972 S ()	184.

Order Code

Example:	APC 0948 C 612
APC	Service wall cover
09	Height
48	Width
C	Surface type
612	Finish

Specification Information

Specify finish.

Application Notes

Cable tray and slat wall covers provide integral performance surface on one or both sides of a Service Wall or Fence frame. Cable tray and slat wall may be planned in combination with other painted or upholstered covers to enclose frames between 21"H and 48"H.

Cable tray mounts from 21" - 30" only on any Service Wall frame. Adjacent trays form continuous, easily accessible cable management at worksurface or table height. Shorter segments provide local cable management below outlet modules. Covers may span across a straight wall frame connection.

Bottom half of cable tray cover permits cables to be managed on surface of studs with one cable holder (55 CAT5 cables) or two clips (28 cables).

Cable tray exit cover permits power jumpers and data/communication cables to pass from wall to Currents desk service beam. Cable tray exit cover, 12"W only, has two openings with sliding covers.

Slat wall supports KnollExtra task lights, monitor arms, paper trays, file holders and other accessories.

Slat wall covers will support flat panel monitor arms with varying weight limitations based on mounting and application. Please refer to the KnollExtra price list for comprehensive mounting and weight limitation information by application.

Access covers

marker surface and painted steel covers

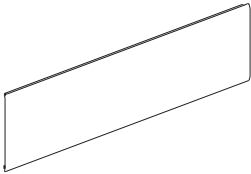
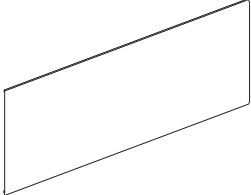
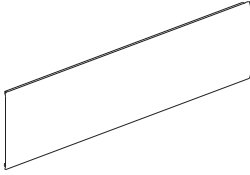
description	type	w	d	h	pattern no.	M	smooth	textured
9"H Marker surface covers 		24"	1	9"	APC 0924 M	\$45.		
		36"	1	9"	APC 0936 M	53.		
		48"	1	9"	APC 0948 M	62.		
		60"	1	9"	APC 0960 M	70.		
		72"	1	9"	APC 0972 M	76.		
16"H Marker surface covers 		48"	1	16"	APC 1648 M	89.		
		60"	1	16"	APC 1660 M	106.		
		72"	1	16"	APC 1672 M	122.		
9"H Painted steel covers 	smooth	12"	1"	9"	APC 0912 P ()		35.	
		24"	1"	9"	APC 0924 P ()		42.	
		36"	1"	9"	APC 0936 P ()		46.	
		48"	1"	9"	APC 0948 P ()		56.	
		60"	1"	9"	APC 0960 P ()		63.	
	textured	72"	1"	9"	APC 0972 P ()		72.	
		12"	1"	9"	APC 0912 PT ()			37.
		24"	1"	9"	APC 0924 PT ()			45.
		36"	1"	9"	APC 0936 PT ()			53.
		48"	1"	9"	APC 0948 PT ()			62.
	60"	1"	9"	APC 0960 PT ()			70.	
	72"	1"	9"	APC 0972 PT ()			76.	

Order Code	Specification Information	Application Notes
Example: APC 0948 P 117 APC Service wall cover 09 Height 48 Width P Surface type 117 Finish	9"H covers plan at any 9"H level in 39", 48", or 64" Service Walls or Fence Frames. For active face of 39"H Service Wall frame, specify two 9"H covers each side. For active face of 48"H Service Wall frame, specify three 9"H covers each side. For active face of 64"H Service Wall frame, specify three 9"H covers and one 16"H cover each side. For active face of Fence frames, specify two 9" covers each side. <i>Surface type:</i> P Painted PT Textured painted M Marker <i>Specify smooth or textured painted finish for steel covers.</i>	Marker surface covers are steel with a bright white dry-erase marker finish. Painted steel covers provide a durable wall-like surface in smooth or textured finish. Service Wall covers enclose frames between 21"H and the top crown. Covers may be specified in any combination of widths corresponding to the total Service Wall length. Covers may span across a straight wall frame connection. For active surfaces with access to cables and power/data/communications outlets, specify 9" and 16"H segmented covers as described in Specification Information. Normally, 9" cover from 21" to 30" above floor is cable tray or painted steel, and higher covers are painted, marker, upholstered, tackable, or slat wall surfaces.

Access covers

marker surface and painted steel covers

description	type	w	d	h	pattern no.	M	smooth	textured
16"H Painted steel covers	smooth	48"	1"	16"	APC 1648 P ()		\$82.	
		60"	1"	16"	APC 1660 P ()		98.	
		72"	1"	16"	APC 1672 P ()		110.	
	textured	48"	1"	16"	APC 1648 PT ()			89.
		60"	1"	16"	APC 1660 PT ()			106.
		72"	1"	16"	APC 1672 PT ()			122.

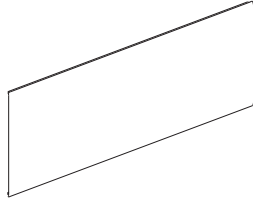

Order Code	Specification Information	Application Notes
<p>Example: APC 0948 P 117</p> <p>APC Service wall cover</p> <p>09 Height</p> <p>48 Width</p> <p>P Surface type</p> <p>117 Finish</p>	<p>9"H covers plan at any 9"H level in 39", 48", or 64" Service Walls or Fence Frames.</p> <p>For active face of 39"H Service Wall frame, specify two 9"H covers each side.</p> <p>For active face of 48"H Service Wall frame, specify three 9"H covers each side.</p> <p>For active face of 64"H Service Wall frame, specify three 9"H covers and one 16"H cover each side.</p> <p>For active face of Fence frames, specify two 9" covers each side.</p> <p><i>Surface type:</i></p> <p>P Painted PT Textured painted M Marker</p> <p><i>Specify smooth or textured painted finish for steel covers.</i></p>	<p>Marker surface covers are steel with a bright white dry-erase marker finish.</p> <p>Painted steel covers provide a durable wall-like surface in smooth or textured finish.</p> <p>Service Wall covers enclose frames between 21"H and the top crown. Covers may be specified in any combination of widths corresponding to the total Service Wall length. Covers may span across a straight wall frame connection.</p> <p>For active surfaces with access to cables and power/data/communications outlets, specify 9" and 16"H segmented covers as described in Specification Information. Normally, 9" cover from 21" to 30" above floor is cable tray or painted steel, and higher covers are painted, marker, upholstered, tackable, or slat wall surfaces.</p>

Access covers upholstered

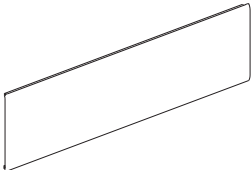
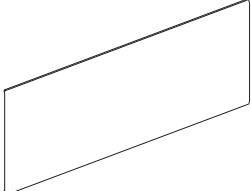
description	w	d	h	pattern no.	10	15	20	30	40	45	50	55
9"H Wall covers 	12"	1"	9"	APC 0912 F ()	\$68.	\$68.	\$72.	\$75.	\$76.	\$77.	\$80.	\$84.
	24"	1"	9"	APC 0924 F ()	83.	84.	87.	91.	95.	99.	105.	111.
	36"	1"	9"	APC 0936 F ()	99.	104.	105.	112.	121.	124.	129.	139.
	48"	1"	9"	APC 0948 F ()	110.	112.	118.	129.	137.	141.	148.	156.
	60"	1"	9"	APC 0960 F ()	130.	137.	142.	154.	165.	174.	181.	189.
	72"	1"	9"	APC 0972 F ()	n/a	155.	n/a	n/a	n/a	n/a	n/a	n/a
16"H Wall covers 	36"	1"	16"	APC 1636 F ()	148.	154.	157.	169.	181.	185.	191.	204.
	48"	1"	16"	APC 1648 F ()	161.	174.	180.	191.	204.	214.	222.	236.
	60"	1"	16"	APC 1660 F ()	195.	204.	216.	230.	245.	254.	269.	287.
	72"	1"	16"	APC 1672 F ()	n/a	231.	n/a	n/a	n/a	n/a	n/a	n/a

Order Code	Specification Information	Application Notes
Example: APC 0948 F15		
APC Service wall cover	For active face of 39"H Service Wall frame, specify two 9"H covers.	Upholstered Service Wall covers enclose frame between 21" and the top crown.
09 Height	For active face of 48"H Service Wall frame, specify three 9"H covers.	Specify widths corresponding to wall frame width, or in any 12" increment to accommodate 12"W outlets covers or slat wall covers. Covers may span across a straight wall frame connection.
48 Width	For active face of 64"H Service Wall frame, specify three 9"H covers and one 16"H cover.	
F Surface type	For full fabric surface between 5" and 21", order upholstered structural base cover.	For active surfaces with access to cables and power/data/communications outlets, specify 9" and 16"H segmented covers as described in Specification Information. Normally, 9" cover from 21" to 30" above floor is cable tray or painted steel, and higher covers are painted, marker, upholstered, tackable, or slat wall surfaces.
15 Fabric group	For active face of Fence frames, specify two 9" covers each side. <i>Surface type:</i> F Upholstered <i>Specify fabric group:</i> 10 Fabric group 10 15 Fabric group 15 20 Fabric group 20 30 Fabric group 30 40 Fabric group 40 50 Fabric group 50 55 Fabric group 55	When ordering 60" or wider covers, please check width of fabric specified.

Access covers tackable upholstered

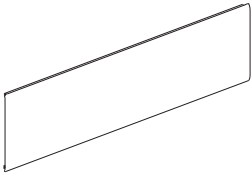
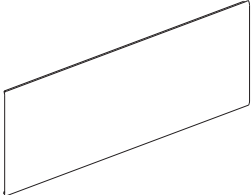
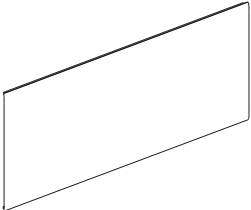
description	w	d	h	pattern no.	10	15	20	30	40	45	50	55
9"H Wall covers 	12"	1"	9"	APC 0912 A ()	\$130.	\$135.	\$138.	\$146.	\$156.	\$159.	\$166.	\$180.
	24"	1"	9"	APC 0924 A ()	130.	135.	138.	146.	156.	159.	166.	180.
	36"	1"	9"	APC 0936 A ()	130.	135.	138.	146.	156.	159.	166.	180.
	48"	1"	9"	APC 0948 A ()	141.	149.	154.	165.	178.	183.	192.	205.
	60"	1"	9"	APC 0960 A ()	168.	178.	184.	198.	216.	222.	233.	248.
	72"	1"	9"	APC 0972 A ()	n/a	202.	n/a	n/a	n/a	n/a	n/a	n/a
16"H Wall covers 	36"	1"	16"	APC 1636 A ()	192.	198.	207.	219.	232.	239.	251.	267.
	48"	1"	16"	APC 1648 A ()	215.	222.	231.	248.	267.	274.	290.	305.
	60"	1"	16"	APC 1660 A ()	254.	267.	278.	300.	321.	335.	347.	375.
	72"	1"	16"	APC 1672 A ()	n/a	302.	n/a	n/a	n/a	n/a	n/a	n/a
18"H Wall cover (replaces (2) 9"H) 	36"	1"	18"	APC 1836 A ()	230.	237.	244.	258.	272.	282.	295.	311.
	48"	1"	18"	APC 1848 A ()	289.	295.	304.	321.	339.	347.	363.	383.
	60"	1"	18"	APC 1860 A ()	343.	355.	366.	385.	408.	416.	428.	451.
	72"	1"	18"	APC 1872 A ()	n/a	400.	n/a	n/a	n/a	n/a	n/a	n/a

Order Code

Example: APC 0948 A20
APC Service wall cover
09 Height
48 Width
A Surface type
20 Fabric group

Specification Information

For active face of 39"H Service Wall frame, specify two 9"H covers. For passive face (along corridor or wall) specify one 18" cover.

For active face of 48"H Service Wall frame, specify three 9"H covers or one 9"H and one 18"H cover. For passive face, specify 27"H cover.

For active face of 64"H Service Wall frame, specify three 9"H covers and one 16"H cover or one 9"H, one 18"H, and one 16"H cover. For passive face, specify one 27" and one 16"H cover.

For full fabric surface between 5' and 21", order upholstered structural base cover.

For active face of Fence frames, specify two 9" covers each side. For passive face, specify one 18" cover.

Surface type:

A tackable upholstered

Specify fabric group:

- 10 Fabric group 10
- 15 Fabric group 15
- 20 Fabric group 20
- 30 Fabric group 30
- 40 Fabric group 40
- 50 Fabric group 50
- 55 Fabric group 55

Application Notes

Tackable upholstered Service Wall covers enclose wall frames between 21" and the top crown. Covers incorporate a tackable, acoustical core in the same outward profile as other upholstered covers.

Specify widths corresponding to wall frame width, or in any 12" increment to accommodate 12"W outlets covers or slat wall covers. Covers may span across a straight wall frame connection.

For active surfaces with access to cables and power/data/communications outlets, specify 9" and 16"H segmented covers as described in Specification Information. Normally, 9" cover from 21" to 30" above floor is cable tray or painted steel, and higher covers are painted, marker, upholstered, tackable, or slat wall surfaces.

For passive Service Wall surfaces (corridors or conference areas) specify 18"H or 27"H covers in place of two or three 9"H covers.

18"H covers may also be specified above 9"H covers including outlets covers below desk height on 48" or 64"H Service Walls.

Service Wall with upholstered tackable covers has been tested to NRC .40 and STC 22.

When ordering 60" or wider covers, please check width of fabric specified.

Access covers
tackable upholstered

description	w	d	h	pattern no.	10	15	20	30	40	45	50	55
27"H Wall cover (replaces (3) 9"H)	36"	1"	27"	APC 2736 A ()	\$343.	\$355.	\$366.	\$385.	\$408.	\$416.	\$428.	\$451.
	48"	1"	27"	APC 2748 A ()	431.	445.	454.	479.	501.	515.	533.	555.
	60"	1"	27"	APC 2760 A ()	522.	533.	537.	572.	598.	612.	628.	650.
	72"	1"	27"	APC 2772 A ()	n/a	606.	n/a	n/a	n/a	n/a	n/a	n/a

Order Code

Example: APC 0948 A20
APC Service wall cover
09 Height
48 Width
A Surface type
20 Fabric group

Specification Information

For active face of 39"H Service Wall frame, specify two 9"H covers. For passive face (along corridor or wall) specify one 18" cover.

For active face of 48"H Service Wall frame, specify three 9"H covers or one 9"H and one 18"H cover. For passive face, specify 27"H cover.

For active face of 64"H Service Wall frame, specify three 9"H covers and one 16"H cover or one 9"H, one 18"H, and one 16"H cover. For passive face, specify one 27" and one 16"H cover.

For full fabric surface between 5" and 21", order upholstered structural base cover.

For active face of Fence frames, specify two 9" covers each side. For passive face, specify one 18" cover.

Surface type:
A tackable upholstered

Specify fabric group:
10 Fabric group 10
15 Fabric group 15
20 Fabric group 20
30 Fabric group 30
40 Fabric group 40
50 Fabric group 50
55 Fabric group 55

Application Notes

Tackable upholstered Service Wall covers enclose wall frames between 21" and the top crown. Covers incorporate a tackable, acoustical core in the same outward profile as other upholstered covers.

Specify widths corresponding to wall frame width, or in any 12" increment to accommodate 12"W outlets covers or slat wall covers. Covers may span across a straight wall frame connection.

For active surfaces with access to cables and power/data/communications outlets, specify 9" and 16"H segmented covers as described in Specification Information. Normally, 9" cover from 21" to 30" above floor is cable tray or painted steel, and higher covers are painted, marker, upholstered, tackable, or slat wall surfaces.

For passive Service Wall surfaces (corridors or conference areas) specify 18"H or 27"H covers in place of two or three 9"H covers.

18"H covers may also be specified above 9"H covers including outlets covers below desk height on 48" or 64"H Service Walls.

Service Wall with upholstered tackable covers has been tested to NRC .40 and STC 22.



When ordering 60" or wider covers, please check width of fabric specified.

Wall ends and connectors

90° and 120° spine connectors

Currents

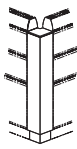
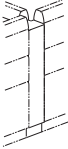
Service Walls and
components

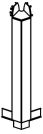
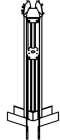
description	w	d	h	pattern no.	paint
 L connector, 90°	6"	6"	39"	AX1 L39 () ()	\$393.
	6"	6"	48"	AX1 L48 () ()	472.
	6"	6"	64"	AX1 L64 () ()	551.
 T connector, 90°	6"	7"	39"	AX1 T39 () ()	393.
	6"	7"	48"	AX1 T48 () ()	472.
	6"	7"	64"	AX1 T64 () ()	551.
 X connector, 90°	7"	7"	39"	AX1 X39 () ()	393.
	7"	7"	48"	AX1 X48 () ()	428.
	7"	7"	64"	AX1 X64 () ()	472.
 V connector, 120°	5 1/2"	5 1/2"	39"	AX1 V39 () ()	393.
	5 1/2"	5 1/2"	48"	AX1 V48 () ()	472.
	5 1/2"	5 1/2"	64"	AX1 V64 () ()	551.
 Y connector, 120°	6 1/2"	5 1/2"	39"	AX1 Y39 () ()	393.
	6 1/2"	5 1/2"	48"	AX1 Y48 () ()	472.
	6 1/2"	5 1/2"	64"	AX1 Y64 () ()	551.

Order Code

Example:	AX1 L39 612 612
AX1	Currents connector
L	Type
39	Height
612	Trim/raceway cover finish
612	Top/end cap finish

Specification Information

For L, T, V, Y connectors specify:

Seventh position:
painted finish for vertical trim cover and raceway cover

Eighth position, and X connectors:
painted finish for top cap and crown end caps

Specify painted finishes for connector trim covers and crown end caps.

When ordering connectors for the Service Wall with 1"H compact crown, specify compact crown end caps separately.

Application Notes

L, T, and X connectors join Currents Service Wall frames at 90° angles and include vertical trim covers, top cap and standard crown end caps, and one spare set of straight connectors.

V and Y connectors join Currents Service Wall frames at 120° angles and include vertical trim covers, top cap and standard crown end cap.

Wall ends and connectors

other ends and connectors

Currents

description	type	w	d	h	pattern no.	paint	list price
Outrigger 	deep	3"	15"	21"	AA1ORD()	\$186.	
	standard	3"	8"	21"	AA1OR()	135.	
High low straight connector	48 - 39"	-	5"	48"	AX1 HLS4839 ()()	214.	
	64 - 39"	-	5"	64"	AX1 HLS6439 ()()	363.	
	64 - 48"	-	5"	64"	AX1 HLS6448 ()()	244.	
Service Wall starter	39"	1"	2"	39"	AX1 SWS39 ()	121.	
	48"	1"	2"	48"	AX1 SWS48 ()	135.	
	64"	1"	2"	64"	AX1 SWS64 ()	155.	
Straight connector kit (replacement)		-	-	-	AX1 S	25.	

Order Code

Example:	AX1 HLS4839 612 612
AX1	Currents connector
HLS	Type
4839	Height
612	Vertical cover finish
612	Crown end finish

Specification Information

Specify painted finishes for outrigger, high low straight connector and Service Wall starter.

Application Notes

Outrigger connects to structural base cover at any point. Outriggers (or perpendicular systems panels) are required every 8' and adjacent to flat end for adequate support. Specify deep outriggers when cantilevering 24"D worksurfaces without adjacent perpendicular systems panels or Service Wall connectors.

Standard outrigger should be specified when desks with service beam are positioned along Service Wall.

High-low straight connectors join Service Wall of different heights in a straight line.

Service Wall starter connects Service Wall to building wall.



Straight connector is replacement hardware kit to join Currents Wall frames of the same height end to end. Kit includes four barrel-shape connectors and hardware.

Wall ends and connectors

flat ends and crown end caps

Currents

Service Walls and
components

description	type	d	h	pattern no.	paint	list price
 Flat end		5"	39"	AX1 F39 () ()		\$125.
		5"	48"	AX1 F48 () ()		141.
		5"	64"	AX1 F64 () ()		158.
 Crown end cap				APT ()		5.
 Crown end cap compact	Kit of 1			APTA CC1 ()		15.
	Kit of 10			APTA CC ()		127.

Order Code

Example:	AX1 F48
AX1	Currents connector
F	Flat End
48	Height
612	Vertical cover finish
612	Crown end finish

Specification Information

For flat ends specify:

Seventh position:
Painted finish for outside trim cover and raceway cover

Eighth position:
Painted finish for crown end cap

When specifying a flat end for a Service Wall frame with the 1 inch compact crown, compact crown end caps must be ordered separately.

Specify painted finish for standard crown end cap.

Specify trim grey or easy grey integral color for compact crown end cap.

Application Notes

Flat end finishes end of corresponding height Service Wall when end of Service Wall is supported by outriggers.

Wall ends and connectors
Fence ends and connectors
connectors

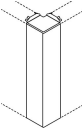
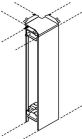
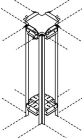
description	w	d	h	pattern no.	list price
L connector, 90 degrees 	6"	6"	19"	AX1 L18 ()	\$395.
T connector, 90 degrees 	6"	7"	19"	AX1 T18 ()	402.
X connector, 90 degrees 	7"	7"	19"	AX1 X18	332.
V connector, 120 degrees 	5 1/2"	5 1/2"	19"	AX1 V18 ()	361.
Y connector, 120 degrees 	6 1/2"	5 1/2"	19"	AX1 Y18 ()	166.

Order Code	Specification Notes	Application Notes
Example: AX1 L 18 613	<i>Specify painted finishes for connector trim covers.</i>	L, T and X connectors join Fence frames at 90° angles and include vertical trim covers, top cap and crown end caps and one set of straight connectors.
AX1 Fence connector	For L, T, V and Y connectors specify finish for vertical trim.	Y and V connectors join Fence frames at 120° angles.
L Type	All top caps and crown covers are trim grey. Specify finish for outside trim of flat end.	Flat end finishes end of Fence frames and includes crown end detail.
18 Height		Specify AX1 F18 () for use with sloped crown covers. Specify AX1A F18L () for use with AutoStrada flat, low profile crown covers.
613 Trim finish		Specify AX1A F18H () for use with AutoStrada flat, high profile crown covers.

Wall ends and connectors
*Fence ends and connectors
connectors*

description	w	d	h	pattern no.	list price
Flat end for use with sloped crown covers	–	5"	21"	AX1 F18 ()	\$151.



Flat end for use with flat crown covers	–	5"	21"	AX1A F18H ()	151.
	–	5"	21"	AX1A F18L ()	151.



Order Code

Example: AX1 L 18 613
AX1 Fence connector
L Type
18 Height
613 Trim finish

Specification Notes

Specify painted finishes for connector trim covers.

For L, T, V and Y connectors specify finish for vertical trim.

All top caps and crown covers are trim grey. Specify finish for outside trim of flat end.

Application Notes





L, T and X connectors join Fence frames at 90° angles and include vertical trim covers, top cap and crown end caps and one set of straight connectors.

Y and V connectors join Fence frames at 120° angles.

Flat end finishes end of Fence frames and includes crown end detail.

Specify AX1 F18 () for use with sloped crown covers. Specify AX1A F18L () for use with AutoStrada flat, low profile crown covers. Specify AX1A F18H () for use with AutoStrada flat, high profile crown covers.

Wall ends and connectors
Fence ends and connectors
other hardware

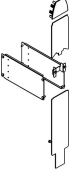
description	type	w	d	h	pattern no.	list price
T-end adapter 	0" or 1 1/8" extension	1 3/8"	2 1/8"	2 3/8"	AX1 AK1 ()	\$25.
						
T-end and stabilizer end cabinet adapter 	3 1/2" extension	4"	5"	16 1/2"	AX1 AK3 ()	91.
Flat wall starter 	48"H service wall		3 1/4"	27"	AX1 FWS 48	79.
	64"H service wall		3 1/4"	43"	AX1 FWS 64	85.
	Fence and 39"H wall		3 1/4"	18"	AX1 FWS 39	72.
High-low straight connector 	48"H wall - Fence				AX1 FHLS4818 ()	446.

Order Code	Specification Information	Application Notes
Example: AX1 FWS 39	<i>Specify painted finishes for T-end adapter kits.</i>	Standard 39"H fence accepts Currents T-ends for 39" Service Wall.
AX1 Fence end	Flat wall starter is black only.	Specify AX1 AK1 adapter kit to complete bottom trim and crown end of T-ends with 0" or 1 1/8" extension.
FWS Type	Crown end covers are trim grey.	Specify AX1 AK3 adapter kit to complete bottom trim and crown end of T-ends with 3" extension.
39 Height		Flat wall starter connects Fence frames and Service Wall to building wall.
		High-low Fence connector joins standard 39"H Fence and 48"H Currents Service Wall.
		Fence T-ends adaptors, stabilizer end cabinet adaptors, high-low straight connectors, panel starters for Morrison panels and linkable screens, universal panel starters, and panel starter end trim for Morrison panels and linkable screens are only compatible with Fence frames that are specified at 40 inches high with the 18-1/2" high leg (AX1 LEG). To use these components when Fence is planned with shorter legs that deliver overall heights of 27 or 28 inches high, please contact Knoll Custom Product Development for assistance.

Wall frame accessories

Wall frame

Currents

Service Walls and
components

description	type	w	d	h	pattern no.	list price
Acoustical inserts	39"H	12"	2"	34"	APA 39	\$32.
	48"H	12"	2"	43"	APA 48	38.
	64"H	12"	2"	59"	APA 64	51.

Order Code

Specification Information

Application Notes

Example: APT 612	
APT	Service wall trim
612	Painted finish

Acoustical inserts fit between studs in Service Wall frame to increase control of sound transmission. Inserts are bagged in heights corresponding to wall frame. Specify four inserts for 48"W Service Wall frame, five for 60"W Service Wall frame, and six for 72"W Service Wall frame. Service Walls with acoustical inserts have been tested to STC 33.

Wall frame accessories

Fence frame

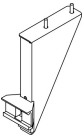

Currents

description	type	w	d	h	pattern no.	list price
 Wire manager cover (set of 2)		3 1/2"	3"	5"	AR1VCM5	\$66.
		3 1/2"	3"	6"	AR1VCM6	66.
		3 1/2"	3"	18 3/8"	AR1VCM	66.
Carpet grips (set of 10)					AA1CG	15.
Non-skid pads (set of 10)					AA1NSK	38.
Hardwire fence infeed (NYC)	2 + 2				AR1 EPHF	529.
	3 + 3				AR1 TPHF	562.
Fence to desk brackets	27"h Fence				AA1FDB27()	73.
	28"h Fence				AA1FDB28()	73.
Fence end bracket kit					AB1FAE ()	207.



Order Code	Specification Information	Application Notes
Example AR1 VCM AR1 Raceway VCM Type	Wire manager covers are integral color trim grey.	<p>Wire manager covers snap into the sides of the Fence legs to guide cables from the floor to the underside of the frame.</p> <p>Carpet grips and/or non-skid pads snap onto bottom of stabilizer feet to prevent legs from sliding.</p> <p>Hardwire fence infeed is approved for City of New York installation. Infeed includes wire manager cover, junction box and connector to desk height outlet module.</p> <p>Fence to desk brackets connect Fence frames to freestanding tables to stabilize Fence. Fence to desk brackets are specified as an alternative to stabilizer feet as a means of stabilizing freestanding Fence runs.</p>
		<p>Fence to desk brackets are only compatible with Fence frames specified with shorter Fence legs (AX1LEG5, AX1LEG6) where the total height of Fence is 27" or 28" to the top of the crown.</p> <p>Fence to desk brackets may not be specified as a means of end supporting worksurfaces. Fence to desk brackets may only be specified for use with freestanding tables.</p> <p>Fence end brackets attach to the Currents Fence to support one end of rectilinear or one back edge of a corner worksurface when the other ends are properly supported by legs, storage or panel brackets. Refer to the specific worksurface Application Notes for support requirements.</p> <p>Fence end brackets support the underside of the worksurface in 1" increments from 26" to 28" (27" to 29" top height).</p>

Spine end connectors for linkable screens and Morrison panels

description	application	h	w	d	pattern no.	list
 Spine end connector	39" h spine	39"	5"	1/2"	AX1SEC3939 () () ()	\$259.
	48" h spine	48"	5"	1/2"	AX1SEC4848 () () ()	272.
	64" h spine	64"	5"	1/2"	AX1SEC6464 () () ()	325.
 Spine end connector to top of compact 1" h crown	39" h spine	40"	5"	1/2"	AX1SEC4039 L () ()	259.
	48" h spine	49"	5"	1/2"	AX1SEC4948 L () ()	272.
	64" h spine	65"	5"	1/2"	AX1SEC6564 L () ()	325.
 Spine end connector to top of Currents 4" h crown	39" h spine	43"	5"	1/2"	AX1SEC4339 C () ()	259.
	48" h spine	52"	5"	1/2"	AX1SEC5248 C () ()	272.
	64" h spine	68"	5"	1/2"	AX1SEC6864 C () ()	325.
Inside base trim cover for Currents raceway		4"	5"		AX1SECBT ()	51.

Order Code	Specification Information	Application Notes
Example: AX1 SEC 3939 L 613 613 812 AX1 Spine connector SEC Type 39 Connector height 39 Spine height L Crown type 613 Crown end cap finish 613 Vertical cover finish 812 Top cap finish	For spine end connectors specify: 1.Crown type C=Currents standard 4" h L=low profile flat 1" H=high profile flat 1 1/4" F=compact crown 1" 2.Crown end cap finish Standard, low and high profile flat and compact crown end caps are available in all standard paint finishes and 813 Trim Grey. Compact crown end caps are also available in 812 Easy Grey. 3.Vertical cover finish: All standard paint finishes 4.Top cap for vertical cover: 812=Easy Grey 813=Trim Grey And all standard paint finishes Spine end connectors on this page align with spine base covers ^{13/16"} above the floor.	Spine end connectors are complete vertical cover and top trim for the end of an AutoStrada or Currents spine. Side edges of end connectors accept end starters for linkable screens and other systems panels of the same height or lower. Spine end connectors include painted aluminum cover with beveled top cap and the specified flat, compact, or standard crown end cap. Spine end connectors to top of compact crown are a visual alternative that replaces the crown end cap with a taller aluminum end cover and flat top cap. Spine end connectors to top of Currents crown are recommended when attaching any end started panel that is between the nominal height of the spine and the actual height with crown, such as 42" h panel to 39" h spine with 4" h crown. Spine end connectors to top of Currents crown enclose the end of spine and standard crown and include flat top cap and inside top trim cover.

Spine ends and connectors
*High-low spine end connectors
 for linkable screens and Morrison panels*

description	application	h	w	d	pattern no.	list
	42" h panel/39" h spine	39"	5"	1/2"	AX1SEC4239 () ()	\$259.
	48" h panel/39" h spine	48"	5"	1/2"	AX1SEC4839 () ()	272.
	56" h panel/39" h spine	56"	5"	1/2"	AX1SEC5639 () ()	313.
	64" h panel/39" h spine	64"	5"	1/2"	AX1SEC6439 () ()	325.
	56" h panel/48" h spine	56"	5"	1/2"	AX1SEC5648 () ()	313.
	64" h panel/48" h spine	64"	5"	1/2"	AX1SEC6448 () ()	325.
	80" h panel/48" h spine	80"	5"	1/2"	AX1SEC8048 () ()	494.
	80" h panel/64" h spine	80"	5"	1/2"	AX1SEC8064 () ()	473.
Inside base trim cover for Currents raceway		4"	5"		AX1SECBT ()	51.

Order Code	Specification Information	Application Notes
Example: AX1 SEC 6448 613 812 AX1 Spine connector SEC Type 64 Panel height 48 Spine height 613 Painted finish 613 Trim finish	For spine end connectors specify: 1. Vertical cover finish: All standard paint finishes 2. Top cap for vertical cover 812=Easy Grey 813=Trim Grey And all standard painted finishes Spine end connectors on this page align with spine base covers ¹³ / ₁₆ " above the floor.	High low spine end connectors are complete end cover and trim for an AutoStrada or Currents spine, when attached panels are taller than the spine. High low spine end connectors match the height of the attached linkable screen or Morrison panel. Side edges of spine end connectors accept end starters for linkable screens and Morrison panels of the same height or lower. High low spine end connectors include painted aluminum outside cover with flat top cap and inside cover over the end of the spine. Inside base trim for Currents raceway is recommended to finish inside of any spine end connector when combined with standard Currents recessed base raceway covers. Base trim is not required with AutoStrada spine base covers.

Note: 42" h panel/39" h spine combination (AX1SEC4239) can only be specified with compact or flat crown versions of the spine. For combination of 39" h spine with standard 4" h crown and 42" h panels specify AX1SEC4339C () ().

Spine end connectors for Dividends Horizon panels and screens

description	application	h	w	d	pattern no.	list
Spine end connector	36" h panel/39" h spine	39"	5"	1/2"	AX1SED3939 () () ()	\$259.
	36" h-42" h panel/ 48" h spine	48"	5"	1/2"	AX1SED4848 () () ()	272.
	36" h-64" h panel/ 64" h spine	64"	5"	1/2"	AX1SED6464 () () ()	325.
	42" h panel/ 39" h spine + 1" crown	42"	5"	1/2"	AX1SED4239 () ()	259.
	42" h panel/ 39" h spine + 4" crown	43"	5"	1/2"	AX1SED4339C () ()	259.
	50" h panel/ 39" h spine	50"	5"	1/2"	AX1SED5039 () ()	272.
	50" h panel/ 48" h spine + 1" crown	50"	5"	1/2"	AX1SED5048 () ()	286.
	50" h panel/ 48" h spine + 4" crown	52"	5"	1/2"	AX1SED5248C () ()	272.
	57" h panel/ 39" h spine	57"	5"	1/2"	AX1SED5739 () ()	313.
	57" h panel/ 48" h spine	57"	5"	1/2"	AX1SED5748 () ()	313.
	64" h panel/ 39" h spine	64"	5"	1/2"	AX1SED6439 () ()	325.
	64" h panel/ 48" h spine	64"	5"	1/2"	AX1SED6448 () ()	325.
	78" h panel/ 48" h spine	78"	5"	1/2"	AX1SED7848 () ()	494.
78" h panel/ 64" h spine	78"	5"	1/2"	AX1SED7864 () ()	473.	
Inside base trim cover for Currents raceway		4"	5"		AX1SECBT ()	51.

Order Code	Specification Information	Application Notes
Example: AX1 SED 6448 613 812		
AX1 Spine connector	For spine end connectors with panel lower than spine specify crown type and finish for crown end cap.	Spine end connectors are complete end cover and trim for an AutoStrada or Currents spine. Side edges of spine end connectors accept end starters for Dividends Horizon panels and screens.
SED Type	1. Crown type: C=Currents standard 4" h L=low profile flat 1" h H=high profile flat 1 1/4" h F=compact 1" h	In most cases spine end connectors match the height of the attached Dividends Horizon panel/screen. When attached panel/screen is lower than the spine, the spine end connector is as high as the nominal height of the spine and the crown requires an end cap.
64 Panel height	2. All crown end caps are available in all painted finishes.	When attached panel/screen is between the nominal height of the spine and the top of the Currents 4" h crown, spine end connector must cover the entire height of the spine with crown.
48 Spine height	For all spine end connectors specify vertical cover and top trim finish:	Spine end connectors include painted aluminum outside cover with flat top cap and inside cover (where applicable) over the end of the spine.
613 Vertical cover finish	3. Vertical cover finish: All standard paint finishes	Inside base trim for Currents raceway is recommended to finish inside when combined with standard Currents recessed base raceway covers. Base trim is not required with AutoStrada spine base covers.
812 Top cap finish	4. Top cap for vertical cover: 812=Easy Grey 813=Trim Grey And all standard painted finishes	

End connectors on this page begin 1/2" above floor.

3 1/2" spine extender kit for use with ceiling infeed or panels

description	application	h	w	d	pattern no.	list
Spine extender kit for use with Currents Spine	39"h spine	39"	5"	4"	AX1SX39 C (L/C/P)() ()	\$532.
	48"h spine	48"	5"	4"	AX1SX48 C (L/C/P)() ()	550.
	64"h spine	64"	5"	4"	AX1SX64 C (L/C/P)() ()	650.
Spine extender kit for use with AutoStrada Spine	39"h spine	39"	5"	4"	AX1SX39 A (L/C/P)() ()	650.
	48"h spine	48"	5"	4"	AX1SX48 A (L/C/P)() ()	667.
	64"h spine	64"	5"	4"	AX1SX64 A (L/C/P)() ()	774.

Order Code	Specification Information	Application Notes
Example: AX1 SX 48 AL 613 613	For all 3 1/2" spine extenders specify spine base type:	Spine extenders include brackets, side and top trim covers between the end of a spine and any spine end connector to add 3 1/2" to the length of a spine.
AX1 Spine connector	A AutoStrada C Currents	Spine end connector must be specified separately to finish off face of spine extender.
SX Type		
48 Spine height	Then specify crown end type.	Spine extender dimension matches that of the Currents 3 1/2" x 5" ceiling infeed panel which may be added between nominal spine height and ceiling for connection to building power, data and communications supply.
A Spine type	L=Flat low/high profile metal crown end cap C=Standard and compact sloped end cap	
L Crown end type	P=Power Pole	This extension can also make up for the dimensional gain of one Dividends Horizon panel or screen in the middle of a cluster of workstations.
613 Vertical finish	Then specify finish for vertical trim covers, all standard painted finishes.	
613 Base trim finish		
613 Top cap finish	Then specify base cover finish. AutoStrada spine base covers are clear anodized aluminum (AA) or painted finish excluding silver. Currents spine raceway covers are available in any painted finish only.	In most cases the spine end connector matches the height of the attached Dividends Horizon panel or screen, but the extending area is only as high as the nominal height of the spine (bottom of crown) so the crown always requires an end cap.
	Then specify top cap finish (if applicable).	

To attach linkable screens or Morrison panels to spine end connector

description	application	h	w	d	pattern no.	00	02	04
End starters for linkable screens	30" h screen	25"	1"	1/2" - 4 1/2"	AX1LES30 () ()	\$156.	\$169.	\$181.
	39" h screen	34"	1"	1/2" - 4 1/2"	AX1LES39 () ()	169.	181.	202.
	48" h screen	43"	1"	1/2" - 4 1/2"	AX1LES48 () ()	195.	220.	246.
	64" h screen	59"	1"	1/2" - 4 1/2"	AX1LES64 () ()	229.	265.	304.
End starters for Morrison panels	30" h panel	30"	1"	1/2" - 4 1/2"	AX1MES30 () ()	162.	169.	181.
	39" h panel	39"	1"	1/2" - 4 1/2"	AX1MES39 () ()	195.	202.	220.
	42" h panel	42"	1"	1/2" - 4 1/2"	AX1MES42 () ()	195.	202.	229.
	48" h panel	48"	1"	1/2" - 4 1/2"	AX1MES48 () ()	202.	207.	236.
	56" h panel	56"	1"	1/2" - 4 1/2"	AX1MES56 () ()	236.	259.	293.
	64" h panel	64"	1"	1/2" - 4 1/2"	AX1MES64 () ()	236.	259.	293.
	80" h panel	80"	1"	1/2" - 4 1/2"	AX1MES80 () ()	337.	388.	467.
End starter top cap for Morrison panel with linkable screen trim	00, 02 or 04 offset		1"	2 1/4"	AX1LES E ()	11.	11.	n/a

Order Code	Specification Information	Application Notes
Example: AX1 LES48 02 613 812	For spine end starters specify:	End starters connect a linkable screen or panel to either side of a spine end connector of the same height or taller.
AX1 Spine connector	1.Configuration	For full access to entire width of spine surface specify end starters offset one panel thickness (02 suffix).
L for linkable screens	00=Flush	For a cluster of two workstations with one screen or panel between specify one end starter offset two panel thicknesses (04 suffix) and one offset one thickness (02 suffix).
ES End starter	02=Offset one panel	For a cluster of three workstations (two intermediate panels) specify two end starters offset two panel thicknesses (04 suffix).
48 Panel height	04=Offset two panels	For a cluster of four workstations (three intermediate panels) extend the spine 12" and specify two flush end starters (00 suffix).
02 Offset	2.Paint finish for end starter: All standard paint finishes	When specifying an end starter top cap for a Morrison panel with linkable screen trim, note that the 02 offset top cap will also work in an 04 offset application.
613 Painted finish	3.Trim finish for top cap: 812=Easy Grey 813=Trim Grey Or all standard paint finishes for Morrison top cap.	
812 Trim finish	End starters on this page align with spine base covers 13/16" above the floor.	

To attach Dividends Horizon panels and screens to spine end connector

description	application	h	w	d	pattern no.	list
End starters for Dividends Horizon panels and screens	36"h panel, flush, left end of Service Wall	36"	1"	3"	AX1DHES3600L(5)()	\$206.
	36"h panel, flush, right end of Service Wall	36"	1"	3"	AX1DHES3600R(5)()	206.
	36"h panel, offset 1 panel thickness, left end of Service Wall	36"	1"	3"	AX1DHES3603L(5)()	206.
	36"h panel, offset 1 panel thickness, right end of Service Wall	36"	1"	3"	AX1DHES3603R(5)()	206.
	42"h panel, flush, left end of Service Wall	42"	1"	3"	AX1DHES4200L(5)()	206.
	42"h panel, flush, right end of Service Wall	42"	1"	3"	AX1DHES4200R(5)()	206.
	42"h panel, offset 1 panel thickness, left end of Service Wall	42"	1"	3"	AX1DHES4203L(5)()	206.
	42"h panel, offset 1 panel thickness, right end of Service Wall	42"	1"	3"	AX1DHES4203R(5)()	206.
	50"h panel, flush, left end of Service Wall	50"	1"	3"	AX1DHES5000L(5)()	206.
	50"h panel, flush, right end of Service Wall	50"	1"	3"	AX1DHES5000R(5)()	206.
	50"h panel, offset 1 panel thickness, left end of Service Wall	50"	1"	3"	AX1DHES5003L(5)()	206.
	50"h panel, offset 1 panel thickness, right end of Service Wall	50"	1"	3"	AX1DHES5003R(5)()	206.
	57"h panel, flush, left end of Service Wall	57"	1"	3"	AX1DHES5700L(5)()	206.
	57"h panel, flush, right end of Service Wall	57"	1"	3"	AX1DHES5700R(5)()	206.
	57"h panel, offset 1 panel thickness, left end of Service Wall	57"	1"	3"	AX1DHES5703L(5)()	206.
	57"h panel, offset 1 panel thickness, right end of Service Wall	57"	1"	3"	AX1DHES5703R(5)()	206.
	64"h panel, flush, left end of Service Wall	64"	1"	3"	AX1DHES6400L(5)()	206.
	64"h panel, flush, right end of Service Wall	64"	1"	3"	AX1DHES6400R(5)()	206.
	64"h panel, offset 1 panel thickness, left end of Service Wall	64"	1"	3"	AX1DHES6403L(5)()	206.
	64"h panel, offset 1 panel thickness, right end of Service Wall	64"	1"	3"	AX1DHES6403R(5)()	206.

Order Code	Specification Information	Application Notes
Example: AX1 DHES 36 00 L (5)	1. Offset	End starters connect a Dividends Horizon panel or screen to either side of a same height or taller spine end connector. End starters for Dividends Horizon panels and screens include specified end top cap.
AX1 Spine connector	00=Flush	
DH Dividends Horizon	03=Offset 1 panel thickness	End starters may be positioned in either of two configurations: flush with end of spine or offset one panel thickness beyond end of spine. For full access to entire width of spine surface, position end starters offset one panel thickness.
ES End starter	2. Top cap type	
36 Panel height	5=Metal flat	For a single workstation (0 intermediate panels), specify 2 spine end connectors and 2 end starters positioned offset by 1 panel thickness.
00 Offset	3. Paint finish	
5 Top cap type	All standard paint finishes	For a cluster of 2 workstations (1 intermediate panel), specify 1 panel starter, 2 spine end connectors, 1 spine extender, and 2 end starters positioned offset by 1 panel thickness.
613 Painted finish		
		For a cluster of 3 workstations, (2 intermediate panels), extend the spine another 12", specify 2 panel starters, 2 spine end connectors, and 2 end starters positioned flush.
		For a cluster of 4 workstations (3 intermediate panels), extend the spine 12" and specify 3 panel starters, 2 spine end connectors, and 2 end starters (1 end starter flush and the other offset by 1 panel thickness).
		For a cluster of 5 workstations (4 intermediate panels) extend the spine by 12" and specify 4 panel starters, 2 spine end connectors, and 2 end starters positioned offset by 1 panel thickness.

Panel system starters and T-ends

Morrison or linkable screen panel starters

Currents

Service Walls and components

description	type	w	d	h	pattern no.	paint	
	Morrison and linkable screen panel starters	30"H panel	4"	1"	26"	AA1MPS30()	\$121.
	39"H panel/screen	4"	1"	35"	AA1MPS39()	121.	
	42"H panel	4"	1"	38"	AA1MPS42()	121.	
	48"H panel/screen	4"	1"	44"	AA1MPS48()	127.	
	56"H panel	4"	1"	52"	AA1MPS56()	132.	
	64"H panel/screen	4"	1"	60"	AA1MPS64()	137.	
	74"H panel	4"	1"	70"	AA1MPS74()	142.	
	80"H panel	4"	1"	76"	AA1MPS80()	142.	
	Morrison raceway shroud	2 1/4"	3"	4"	AA1MRS()	51.	
	panel/screen top clip				AA2 MTC ()	60.	

	Morrison end trim	30"H panel	1"	2 1/4"	9"	AA1MET30()	43.
	39"H panel	1"	2 1/4"	18"	AA1MET39()	43.	
	42"H panel	1"	2 1/4"	21"	AA1MET42()	46.	
	48"H panel	1"	2 1/4"	27"	AA1MET48()	48.	
	56"H panel	1"	2 1/4"	35"	AA1MET56()	51.	
	64"H panel	1"	2 1/4"	43"	AA1MET64()	60.	
	74"H panel	1"	2 1/4"	53"	AA1MET74()	68.	
	80"H panel	1"	2 1/4"	59"	AA1MET80()	72.	

Currents end trim	39" linkable screen	1"	2"	18"	AA1CET39()	43.
	48" linkable screen	1"	2"	27"	AA1CET48()	48.
	64" linkable screen	1"	2"	43"	AA1CET64()	60.

Order Code	Specification Information	Application Notes
Example: AA1 MPS48 612		
AA1 Accessory	<i>Specify paint finishes for panel starters, Morrison raceway shroud and end trim.</i>	Panel starters attach perpendicular panels or linkable screens to Service Wall structural base covers (5" - 21"H).
M Morrison		
PS Panel starter	Specify trim grey or easy grey integral color for Currents end trim.	Panel starters include clamp bracket to any height Service Wall and full height connector track with modified top wedge block. For Morrison also specify high/low corner top cap MT5 HLC () in width of first panel.
48 Panel height		
612 Finish		
		Optional Morrison end trim fills 5/8" reveal between panel end and Service Wall surface. End trim also includes end top cap (high/low corner top cap is not required in this application).
		Currents end trims are optional fillers for linkable screen starters. End trims may interfere with easy access to Service Wall covers.
		Top clip connects panel connector track to Service Wall crown. Specify top clip for added stiffness of panels higher than 48" or whenever cantilevering components from panel. Top clip is not compatible with end trim.
		Specify raceway shroud if connecting power from Service Wall to Morrison panel.

Panel system starters and T-ends

Currents

Morrison, Currents screens and linkable screen T-ends non-upholstered

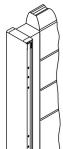
description	type	w	d	h	pattern no.	0" or 1 1/8" extension	3 1/2" extension
 T ends for Currents screens and linkable screens	39" screen/39" spine	2 1/4"-5 3/4"	7"	39"	AX2 C3939 () ()	\$822.	\$922.
	48" screen/39" spine	2 1/4"-5 3/4"	7"	48"	AX2 C4839 () ()	955.	1,054.
	48" screen/48" spine	2 1/4"-5 3/4"	7"	48"	AX2 C4848 () ()	889.	987.
	64" screen/39" spine	2 1/4"-5 3/4"	7"	64"	AX2 C6439 () ()	1,089.	1,185.
	64" screen/48" spine	2 1/4"-5 3/4"	7"	64"	AX2 C6448 () ()	1,022.	1,119.
	64" screen/64" spine	2 1/4"-5 3/4"	7"	64"	AX2 C6464 () ()	1,022.	1,119.

description	type	w	d	h	pattern no.	0" or 1 1/8" extension	3 1/2" extension
 T ends for Morrison panels	39" panel/39" spine	6"	7"	39"	AX1 M3939 () ()	822.	923.
	42" panel/39" spine	6"	7"	42"	AX1 M4239 () ()	889.	987.
	48" panel/39" spine	6"	7"	48"	AX1 M4839 () ()	955.	1,054.
	48" panel/48" spine	6"	7"	48"	AX1 M4848 () ()	889.	987.
	56" panel/39" spine	6"	7"	56"	AX1 M5639 () ()	1,022.	1,119.
	56" panel/48" spine	6"	7"	56"	AX1 M5648 () ()	955.	1,054.
	64" panel/39" spine	6"	7"	64"	AX1 M6439 () ()	1,089.	1,185.
	64" panel/48" spine	6"	7"	64"	AX1 M6448 () ()	1,022.	1,119.
	64" panel/64" spine	6"	7"	64"	AX1 M6464 () ()	1,022.	1,119.
	80" panel/39" spine	6"	7"	80"	AX1 M8039 () ()	1,316.	1,448.
	80" panel/48" spine	6"	7"	80"	AX1 M8048 () ()	1,316.	1,448.
	80" panel/64" spine	6"	7"	80"	AX1 M8064 () ()	1,316.	1,448.





Order Code	Specification Information	Application Notes
Example: AX1 M6448 3 612, 612	<i>T ends begin with AX1-prefix.</i>	T-end encloses the end of a Service Wall and connects to perpendicular Currents wall-attached screens, linkable screens or panels on one or both sides. T-ends include Morrison-style top trim for the 7" wide connection to panels or screens.
AX1 Currents connector	<i>Fourth position indicates attached panel system:</i>	Specify Morrison end connector, top cap and raceway cover kits separately to finish side edge of Morrison T-ends without a connected panel.
M Morrison	C Currents screen/linkable screen	Specify Morrison straight connector separately to attach linkable screen or panel.
64 Morrison height	M Morrison panel	Specify T-ends for Morrison or Currents to capture the end of the Service Wall (no extension) or to extend the Service Wall 1 1/8" or 3 1/2". This extension enables precise planning of multiple workstations and intermediate panels between workstations.
48 Currents height	<i>Fifth/sixth position: height of panel.</i>	Use 5" wide trim and two end caps when connecting Currents screens on both sides.
3 Extension	<i>Seventh/eighth position: height of service wall.</i>	Use 6" wide trim and one end cap when connecting to Currents screens on one side only. Specify Morrison end connector separately to finish side edge without a connected screen.
612 Top cap finish	<i>Ninth position: extension at end of spine.</i>	Use 7" wide trim when connecting to Morrison panels.
612 Vertical trim cover	0 0" extension 1 1 1/8" extension 3 3 1/2" extension	Specify two 0" T-ends for a single workstation on each side (no intermediate panels).
	<i>Tenth position: painted finish for Morrison top caps and crown end.</i>	Specify two 1 1/8" T-ends for one intermediate panel, one 1 1/8" and one 3 1/2" for two panels, and two 3 1/2" for three intermediate panels.
	<i>Eleventh position: painted finish for vertical trim cover.</i>	T-ends with 3 1/2" extension have removable inside covers and accept ceiling infed panel.
	When ordering T-ends for Service Wall, specify crown end caps separately.	

Panel system starters and T-ends

Equity panel starters, end starters and trim kits

Currents

Service Walls and components

description	type	pattern no.	list price
 Equity panel starters	40"	AA1EPS40	\$291.
	41"	AA3EPS41	340.
	48"	AA1EPS48	302.
	49"	AA3EPS49	357.
	53"	AA1EPS53	316.
	54"	AA3EPS54	374.
	60"	AA1EPS60	330.
	61"	AA3EPS61	388.
	64"	AA3EPS64	402.
	65"	AA1EPS65	341.
 Equity end starters	40"	AX1 E40	291.
	41"	AX3E41	340.
	48"	AX1 E48	302.
	49"	AX3E49	357.
	53"	AX1 E53	316.
	54"	AX3E54	374.
	60"	AX1 E60	330.
	61"	AX3E61	388.
	64"	AX3E64	402.
	65"	AX1 E65	341.
 Equity end trim kits	39"H wall	AX1 EET39(T,R,L)	121.
	48"H wall	AX1 EET48(T,R,L)	159.
	64"H wall	AX1 EET64(T,R,L)	198.
	Crown end cap	APT ()	5.
 Gap filler	40"/64"	AX1 EGF24	26.
	48"/64"	AX1 EGF16	11.
	53"/64"	AX1 EGF11	8.
	60"/64"	AX1 EGF4	6.

Order Code

Example:	AX1EET64T 612
AX1	Accessory
EET	Equity end trim
64	Panel height
T	"T" both sides
612	Trim finish

Specification Information

Specify paint finish for Equity end and panel starters, trim kits and crown end cap.

Note:
For more specific application information, please refer to the 1999 Equity Planning Guide. Additional finishes are available for crown end cap.

Application Notes

Equity panel starters attach perpendicular panels to Service Wall structural base covers. Equity panel starter includes clamp bracket and adapter. Both end and panel starters include top clip for added stiffness. No connector post is required for either starter.

Equity end starter supports perpendicular panel run on the centerline of the end of the Service Wall. Perpendicular panels should be at the same height or higher than the Service Wall.

The Equity end trim kit encloses and flushes out the end of the Service Wall with attached, end started Equity panels.

Specify trim kit suffix "T" for panels on both sides, "L" or "R" for attached panels only on left or right side of end of the Service Wall (as seen from outside of "T" end). Also specify crown end cap for all end conditions.

Gap fillers fill the gap when attaching a lower height Equity panel at the end of a 64"H Service Wall.

Panel system starters and T-ends

Reff panel starters and T-ends

Currents

description	type	pattern no.	price	0" or 1 1/8" extension	3 1/2" extension
 Reff panel starter	34"H (includes AA1RTC bracket)	AA1RPS34 () () ()	\$138.		
	42"H (includes AA1RTC bracket)	AA1RPS42 () () ()	241.		
	49"H (includes AA1RTC bracket)	AA1RPS49 () () ()	247.		
	64"H (includes AA1RTC bracket)	AA1RPS64 () () ()	263.		
	79"H (includes AA1RTC bracket)	AA1RPS79 () () ()	274.		

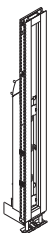
 T-end frame for Reff panels	42" Reff panel to 39" Currents	AX1 R34239 () ()		987.	1,089.
	49" Reff panel to 39" Currents	AX1 R34939 () ()		998.	1,100.
	49" Reff panel to 48" Currents	AX1 R34948 () ()		936.	1,033.
	64" Reff panel to 39" Currents	AX1 R36439 () ()		1,104.	1,202.
	64" Reff panel to 48" Currents	AX1 R36448 () ()		1,039.	1,140.
	64" Reff panel to 64" Currents	AX1 R36464 () ()		1,039.	1,140.
	79" Reff panel to 39" Currents	AX1 R37939 () ()		1,113.	1,214.
	79" Reff panel to 48" Currents	AX1 R37948 () ()		1,047.	1,146.
	79" Reff panel to 64" Currents	AX1 R37964 () ()		1,014.	1,113.

Top clip (replacement part)	AA1RTC ()	98.
-----------------------------	-------------------	-----

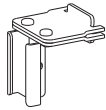



Order Code	Specification Information	Application Notes
Example: AA1-RPS64 48 A 613	<i>For T-end specify extension at end of spine, then paint finish. Extension at end of Service Wall:</i>	Panel starters attach perpendicular Reff panels to Service Wall. Panel starter includes clamp bracket to structural base cover, top clip, vertical extrusion corresponding to Reff panel height and top trim for adjoining panel. T-end encloses the end of a Service Wall and connects to perpendicular Reff panels on one or both sides. Specify Reff straight connector separately to attach panel. Specify Reff end connector to finish side edge without a connected wall.
AA1 Accessory	0 0" extension	
R Reff	1 1 1/8" extension	
PS Panel starter	3 3 1/2" extensions	
64 Panel height	<i>Specify following for panel starter:</i>	Specify two 0" T-ends for a single workstation on each side (no intermediate panels). Specify two 1 1/8" T-ends for one intermediate panel, one 1 1/8" and one 3 1/2" for two panels, and two 3 1/2" for three intermediate panels. T-ends with 3 1/2" extension have removable inside covers and accept ceiling infeed panel. Only Reff finishes are available for AA1RTC() top clip.
48 Adjoining panel width	1 Adjoining panel width	
A Panel top trim profile	2 Top trim profile of adjoining panel	
613 Finish, panel starter	3 Painted finish for panel starter	
613 Panel top trim finish	4 Top trim finish	Specify T-end with 0", 1 1/8", or 3 1/2" of extension to accommodate the "creep" of panels between workstations on each side of Service Wall.
	In addition to Currents finishes, all standard Reff system painted finishes are available.	
	When ordering T-ends for the Service Wall, specify crown end caps separately.	

Panel system starters and T-ends

Reff T-end fabric and wood cover sets

Currents

Service Walls and components

description	type	height	pattern no.	list price
Monolithic cover set 	Fabric	42"	R3B0P0F4207	\$153.
		49"	R3B0P0F4907	174.
		64"	R3B0P0F6407	204.
		79"	R3B0P0F7907	234.
	Wood	42"	R3B0P0H4207	157.
		49"	R3B0P0H4907	178.
		64"	R3B0P0H6407	210.
		79"	R3B0P0H7907	239.
Tiled cover set 	Fabric	42"	R3B0T0F4207	153.
		49"	R3B0T0F4907	174.
		64"	R3B0T0F6407	204.
		79"	R3B0T0F7907	234.
	Wood	42"	R3B0T0H4207	157.
		49"	R3B0T0H4907	178.
		64"	R3B0T0H6407	210.
		79"	R3B0T0H7907	239.

Order Code

Example:	R3B0P0F4207
R3B	Reff
0P0F	Monolithic
42	Panel height
07	Width

Specification Information

See Reff System for full selection of painted finishes, fabrics and wood veneers for T-end cover sets.

Specify:

1. Top trim profile
2. Panel finishes
3. Top trim finish
4. Base finish

Top trim profile:

- A Flat
- B Square
- C Bullnose

Base height:

- 4 4" base height

6" base height is currently not available.

Application Notes

Specify covers in monolithic or tiled sets to complete T-end frames for Reff.

Monolithic cover sets include a raceway cover and a single snap-in panel above.

Tiled sets include raceway cover and segmented tiles corresponding to adjacent Reff tiled panels.



Reff tiled module horizontal reveals are at nominal 19", 34", 49" and 64" above the floor and do not align with service wall cover reveals.

When ordering T-ends for the Service Wall, specify crown end caps separately.

Panel system starters and T-ends

Universal panel starters and T-ends

Currents

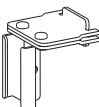
description	w	d	h	pattern no.	paint
 Universal T-end adapter	2-6"	7"	39"	AA1UA39()	\$85.
	2-6"	7"	48"	AA1UA48()	104.
	2-6"	7"	64"	AA1UA64()	114.
 Universal panel starters	3"	1"	39"	AA1UPS39()	192.
	3"	1"	48"	AA1UPS48()	207.
	3"	1"	64"	AA1UPS64()	220.
 Universal top clip				AA2 UTC ()	83.

Order Code

Example:	AA1 UPS48 612
AA1	Accessory
UPS	Panel starter
48	Panel height
612	Finish

Specification Information

Specify paint finishes for Universal end and panel starter.

Application Notes

Universal adapters and starters integrate other panel systems with the Service Wall. Vertical surface accepts architectural wall starter of most other systems.

T-end adapters include connector to corresponding height T-end for Currents screen (specified separately).

Panel starter includes clamp bracket to structural base cover on Service Wall.





Top clip gives added stability to attached panels of the same height or higher than the Service Wall.

Panel system starters and T-ends

Fence panel starters

Currents

Service Walls and components



description	type	w	d	h	pattern no.	list price
 Panel starter for Morrison panels/ Currents linkable screens	30"H panel	4"	1"	26"	AA1FMPS30()	\$79.
	39"H panel/screen	4"	1"	35"	AA1FMPS39()	80.
	42"H panel	4"	1"	38"	AA1FMPS42()	80.
	48" H panel/screen	4"	1"	44"	AA1FMPS48()	86.
	56"H panel	4"	1"	52"	AA1FMPS56()	86.
	64" H panel/screen	4"	1"	60"	AA1FMPS64()	91.
Universal panel starter		3"	1"	35"	AA1FUPS39()	124.
 Universal panel starter						
Universal top clip					AA2 UTC ()	83.
 Universal top clip						
Morrison and linkable screen panel starters	panel/screen top clip				AA2 MTC ()	60.
 Morrison and linkable screen panel starters						

Order Code	Specification Information	Application Notes
Example: AA1 FMPS48 613	<i>Specify paint finish for panel starters and top clip.</i>	Panel starters attach perpendicular panels to the Fence bottom rail. Panel starters include clamp bracket and full height connector track with modified top wedge block. For Morrison also specify high/low corner topcap in width of first panel. Top clip connects panel connector track with the Fence or Service Wall crown. Specify top clip for added stiffness of panels higher than 48" or whenever cantilevering components from panel. Top clip is not compatible with end trim.
AA1 Accessory		
F Fence		
MPS Morrison panel starter		
48 Panel height		
613 Finish	Universal panel starters integrate other panel systems with Fence. Vertical surface accepts architectural wall starters of most other systems. Fence T-ends adaptors, stabilizer end cabinet adaptors, high-low straight connectors, panel starters for Morrison panels and linkable screens, universal panel starters, and panel starter end trim for Morrison panels and linkable screens are only compatible with Fence frames that are specified at 40 inches high with the 18-1/2" high leg (AX1 LEG). To use these components when Fence is planned with shorter legs that deliver overall heights of 27 or 28 inches high, please contact Knoll Custom Product Development for assistance.	

Panel system starters and T-ends

end trim for Fence panel starters

Currents

description	type	w	d	h	pattern no.	list price
 End trim for Morrison panels	30"H panel	1"	2 1/4"	30"	AA1FMET30()	\$107.
	39"H panel	1"	2 1/4"	39"	AA1FMET39()	107.
	42"H panel	1"	2 1/4"	42"	AA1FMET42()	110.
	48" H panel	1"	2 1/4"	48"	AA1FMET48()	113.
	56" H panel	1"	2 1/4"	56"	AA1FMET56()	115.
	64" H panel	1"	2 1/4"	64"	AA1FMET64()	125.
 End trim for linkable screens	39" H screen	1"	2"	35"	AA1FCET39	87.
	48" H screen	1"	2"	44"	AA1FCET48	98.
	64" H screen	1"	2"	60"	AA1FCET64	110.

Order Code

Example: **AA1 FMET39 612**

AA1	Accessory
F	Fence
MET	Morrison end trim
39	Panel height
612	Finish

Specification Notes

Specify paint finish for end trim for Morrison panels.

Morrison end trim includes end raceway cover in matching color.

Linkable screen end trim is trim grey integral color.

Application Notes

Optional end trim is available for the panel starter connector track. End trim covers the connector track above and below the panel starter clamp bracket.

Fence T-ends adaptors, stabilizer end cabinet adaptors, high-low straight connectors, panel starters for Morrison panels and linkable screens, universal panel starters, and panel starter end trim for Morrison panels and linkable screens are only compatible with Fence frames that are specified at 40 inches high with the 18-1/2" high leg (AX1 LEG). To use these components when Fence is planned with shorter legs that deliver overall heights of 27 or 28 inches high, please contact Knoll Custom Product Development for assistance.

Panel system starters for Dividends Horizon

Dividends Horizon panel and screen starters

Currents

Service Walls and components

description	application	h	w	d	pattern no.	list
Service Wall starters for Dividends Horizon panels and screens	36" high Dividends Horizon Panel or Screen	36"	1"	3"	AA1DHPS36(5)()	\$337.
	42" high Dividends Horizon Panel or Screen	42"	1"	3"	AA1DHPS42(5)()	337.
	50" high Dividends Horizon Panel or Screen	50"	1"	3"	AA1DHPS50(5)()	337.
	57" high Dividends Horizon Panel or Screen	57"	1"	3"	AA1DHPS57(5)()	337.
	64" high Dividends Horizon Panel or Screen	64"	1"	3"	AA1DHPS64(5)()	337.
Top clip for Dividends Horizon panels and screens to lower Service Wall	Top clip for Dividends Horizon Panel/Screen to Service Wall				AA1DHTC()	88.

Order Code	Specification Information	Application Notes
Example: AA1 DHPS 36 (5)	1.Top cap type 5=Metal flat	Panel/screen starter includes a clamp bracket that attaches to the structural base cover of the Service Wall to start a Dividends panel/screen run perpendicular to the face of the Service Wall anywhere other than at the end of the Service Wall.
AA1 Accessory	2.Paint finish All standard paint finishes	
DH Dividends Horizon		Top clip, which secures top edge of panel to underside of Service Wall crown, is required in addition to panel starter for stability of 57" or higher panels or 50"H panels with cantilevered shelves overhead storage.
PS Panel starter		
36 Panel height		
5 Top cap type		
613 Painted finish		

Power, data and communications components for
 Service Walls
 2+2 raceway
 outlet module, central switch and outlets

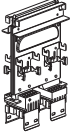
description	type	w	d	h	pattern no.	black	orange (-O) or orange triangle (-T)	no finish
Desk height outlet module	21-48"H	5"	-	6"	AR1 EOM			\$176.
								
Central switch	21-48"H				AR1-ELS-B			490.
Duplex outlet	Circuit A				AR1 DA	43.		
	Circuit B				AR1 DB	43.		
	Circuit X				AR1 DX	43.	48.	
	Circuit Y				AR1 DY	43.	48.	

Order Code	Specification Information	Application Notes
Example: AR1 EOM	Raceway components distribute four 20-amp circuits at desk height or service wall base: two convenience circuits and two protected circuits, with separate grounds and heavy duty #10 neutrals.	Service Wall power may be distributed point-to-point between outlet modules at desk height or in the base raceway.
AR1 Raceway		
E 2+2		
OM Outlet module		
		Central switch includes white rocker switch, connector to adjacent outlet module, and three simplex outlets on circuit B (2+2 or 3+3).
		Outlet modules and power rails accept two duplex outlets on each face. Specify outlets with black face for convenience circuits. Specify orange face or black with orange triangle for protected circuits with separate ground and neutral in building power supply.
		Outlet housings and power rails accept two duplex outlets on each face and four connector/jumper cables.
		Modular desk-height outlet module mounts between frame studs at any height from 21" - 48", above or below adjacent worksurfaces. Each 12"W frame bay can accept two outlet housings (up to four duplex outlets on each side.)
		Central switch controls three outlets inside Service Wall frame for task or ambient lights. Switch occupies right-hand outlet opening in outlets cover on one side of Service Wall.
		Switches cannot be positioned back-to-back in combination with an outlet module.

Power, data and communications components for
 Service Walls
 2+2 raceway
 other hardware

description	type	w	d	h	pattern no.	no finish
Power infeeds, modular	Base power	49"			AR1 EPI2	\$168.
	Desk height power	85"			AR1 EPI5	203.
	Ceiling infeed	145"			AR1 EPIC	252.
Hardwire base infeeds (NYC)	One connector				AR1 EPH1	337.
	Two connectors				AR1 EPH2	505.
Transitional connectors for Morrison or Reff	12"	61"			AR1 ET1	186.
	36"	85"			AR1 ET3	236.
	60"	109"			AR1 ET5	270.
	96"	133"			AR1 ET8	300.
Jumper cable	12" wall/36" desk	37"			AR1 EJ1	101.
	24" wall/48" desk	49"			AR1 EJ2	133.
	36" wall/60" desk	61"			AR1 EJ3	153.
	48" wall/72" desk	73"			AR1 EJ4	166.
	60" wall/84" desk	85"			AR1 EJ5	186.
	72" wall/96" desk	97"			AR1 EJ6	203.
	96" wall/120" desk	121"			AR1 EJ8	236.
	120" wall/144" desk	145"			AR1 EJ10	269.
	144" wall	169"			AR1 EJ12	300.

Order Code	Specification Information	Application Notes
Example: AR1 ET1	<p>Raceway components distribute four 20-amp circuits at desk height or panel base; two convenience circuits and two protected circuits, with separate grounds and heavy duty #10 neutrals.</p> <p>NOTE: The City of New York does not approve use of liquid-tight PVC conduit. For installations anywhere in the City of New York, specify NYC infeed kits (AR1 EPH1 or 2, AR1 TPH1 or 2), which do not contain PVC. To connect power from the Service Wall to wall-started panels: specify standard (not transitional) jumper cables. Also specify Raceway Cable Managers (AR1 RCM) to support power jumpers within the Service Wall base between the base or desk-height power module and the attached panel.</p>	<p>Desk height power infeed connects from floor box to desk height outlets module inside Service Wall.</p> <p>Ceiling infeed connects from ceiling junction box to desk height outlet module or to base power rail. Specify Currents ceiling infeed panel separately.</p> <p>Base power infeed connects building power to either end of base raceway power rail.</p> <p>Hardwire base infeed is approved for City of New York installations. Infeed includes junction box for base raceway and connector to desk height outlet module, or two connectors to adjacent base raceway power rails.</p> <p>Transitional connectors connect Service Wall power components to powered Morrison or Reff panels or Morrison Network desks. Application dimension indicates distance</p>
AR1 Raceway		
E 2+2		
T Transitional		
1 Length		
	<p>from Service Wall desk-height outlet module to perpendicular panel with powered base.</p> <p>Specify jumper cables between outlet modules. Application dimension indicates maximum Service Wall cover width between outlets covers at the same height. Excess cable may be stored in interior of wall frame.</p> <p>Base raceway power rail is suspended between panel supports 3" above floor. 48" Service Wall accepts one 12" rail, 60" Service Wall accepts one 24" rail, 72" accepts two 12" rails. 12" rails may also be inserted at any straight connection.</p> <p>Specify 12" base power connector between 12" rails in a 72"W Service Wall base, or straddling a Service Wall connection. Specify 36" base power connector to pass through a connection between adjacent powered bases.</p>	

Power, data and communications components for
 Service Walls
 2+2 raceway
 other hardware

description	type	w	d	h	pattern no.	no finish
Base raceway power rail	48" or 72" frame	12"	–	2"	AR1 E2	\$186.
	60" frame	24"	–	2"	AR1 E3	219.
Base power connector	Within a frame	12"			AR1 EPC1	84.
	Frame to frame	36"			AR1 EPC2	101.

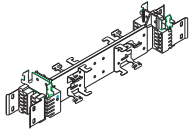

Order Code	Specification Information	Application Notes
Example: AR1 ET1		
AR1 Raceway		
E 2+2		
T Transitional		
1 Length		
	<p>Raceway components distribute four 20-amp circuits at desk height or panel base; two convenience circuits and two protected circuits, with separate grounds and heavy duty #10 neutrals.</p> <p>NOTE: The City of New York does not approve use of liquid-tight PVC conduit. For installations anywhere in the City of New York, specify NYC infeed kits (AR1 EPH1 or 2, AR1 TPH1 or 2), which do not contain PVC. To connect power from the Service Wall to wall-started panels: specify standard (not transitional) jumper cables. Also specify Raceway Cable Managers (AR1 RCM) to support power jumpers within the Service Wall base between the base or desk-height power module and the attached panel.</p>	<p>Desk height power infeed connects from floor box to desk height outlets module inside Service Wall.</p> <p>Ceiling infeed connects from ceiling junction box to desk height outlet module or to base power rail. Specify Currents ceiling infeed panel separately.</p> <p>Base power infeed connects building power to either end of base raceway power rail.</p> <p>Hardwire base infeed is approved for City of New York installations. Infeed includes junction box for base raceway and connector to desk height outlet module, or two connectors to adjacent base raceway power rails.</p> <p>Transitional connectors connect Service Wall power components to powered Morrison or Reff panels or Morrison Network desks. Application dimension indicates distance</p>
		<p>from Service Wall desk-height outlet module to perpendicular panel with powered base.</p> <p>Specify jumper cables between outlet modules. Application dimension indicates maximum Service Wall cover width between outlets covers at the same height. Excess cable may be stored in interior of wall frame.</p> <p>Base raceway power rail is suspended between panel supports 3" above floor. 48" Service Wall accepts one 12" rail, 60" Service Wall accepts one 24" rail, 72" accepts two 12" rails. 12" rails may also be inserted at any straight connection.</p> <p>Specify 12" base power connector between 12" rails in a 72"W Service Wall base, or straddling a Service Wall connection. Specify 36" base power connector to pass through a connection between adjacent powered bases.</p>

Power, data and communications components for
 Service Walls
 3+3 raceway
 outlet module, central switch and outlets

description	type	w	d	h	pattern no.	black	orange (-O) or orange triangle (-T)	no finish
Desk-height outlet module	21"-48"H	6"	1"	9"	AR1 TOM			\$203.

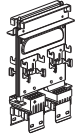

Central switch	21-48"H				AR1-ELS-B			490.
Duplex outlet	Circuit A				AR1 DA	43.		
	Circuit B				AR1 DB	43.		
	Circuit C				AR1 DC	43.		
	Circuit X				AR1 DX	43.	48.	
	Circuit Y				AR1 DY	43.	48.	
	Circuit Z				AR1 DZ	43.	48.	

Order Code	Specification Information	Application Notes
Example: AR1 TOM		
AR1 Raceway	Raceway components distribute six 20-amp circuits at desk height or wall base: three convenience circuits and three protected circuits, with separate grounds and heavy-duty #10 neutrals.	Service Wall power may be distributed point-to-point between outlet modules at desk height or in the base raceway. Outlet modules and power rails accept two duplex outlets on each face and four connector/jumper cables. Modular desk-height outlet module mounts between frame studs at any height from 21" - 48", above or below adjacent worksurfaces. Each 12"W frame bay can accept two outlet housings (up to four duplex outlets on each side.) Central switch controls three outlets inside Service Wall frame for task or ambient lights. Switch occupies right-hand outlet opening in outlets cover on one side of wall. Central switch includes white rocker switch, connector to adjacent outlet module, and three simplex outlets on circuit B (2+2 or 3+3).
T 3+3		
OM Outlet Module		
		Outlet modules and power rails accept two duplex outlets on each face. Specify outlets with black face for convenience circuits. Specify orange face or black with orange triangle for protected circuits with separate ground and neutral in building power supply.

Power, data and communications components for
Service Walls
3+3 raceway
other hardware

description	type	w	d	h	pattern no.	no finish
Power infeeds	Base power	49"			AR1 TPI2	\$203.
	Desk height power	85"			AR1 TPI5	236.
	Ceiling infeed	145"			AR1 TPIC	287.
Hardwire base infeeds (NYC)	One connector				AR1 TPH1	372.
	Two connectors				AR1 TPH2	575.
Jumper cable	12" wall/36" desk	37"			AR1 TJ1	116.
	24" wall/48" desk	49"			AR1 TJ2	153.
	36" wall/60" desk	61"			AR1 TJ3	186.
	48" wall/72" desk	73"			AR1 TJ4	203.
	60" wall/84" desk	85"			AR1 TJ5	219.
	72" wall/96" desk	97"			AR1 TJ6	236.
	96" wall/120" desk	121"			AR1 TJ8	269.
	120" wall/144" desk	145"			AR1 TJ10	300.
Transitional connectors for Morrison or Reff	12" wall	169"			AR1 TJ12	336.
	12"	61"			AR1 TT1	219.
	36"	85"			AR1 TT3	270.
	60"	109"			AR1 TT5	300.
Base raceway power rail	48" or 72" frame	12"			AR1 T2	219.
	60" frame	24"			AR1 T3	252.
Base power connectors	Within a frame	13"			AR1 TPC1	101.
	Frame to frame	37"			AR1 TPC2	116.

Order Code	Specification Information	Application Notes
Example: AR1 TT5	<p>Raceway components distribute six 20-amp circuits at desk height or wall base: three convenience circuits and three protected circuits, with separate grounds and heavy-duty #10 neutrals.</p> <p>NOTE: The City of New York does not approve use of liquid-tight PVC conduit. For installations anywhere in the City of New York, specify NYC infeed kits (AR1 EPH1 or 2, AR1 TPH1 or 2), which do not contain PVC. To connect power from the Service Wall to wall-started panels: specify standard (not transitional) jumper cables. Also specify Raceway Cable Managers (AR1 RCM) to support power jumpers within the Service Wall base between the base or desk-height power module and the attached panel.</p>	<p>Desk height power infeed connects from floor box to desk height outlets module inside Service Wall.</p> <p>Ceiling infeed connects from ceiling junction box to desk height outlet module or to base power rail. Specify Currents ceiling infeed panel separately.</p> <p>Base power infeed connects building power to either end of base raceway power rail.</p> <p>Hardwire base infeed is approved for City of New York installations. Infeed includes junction box for base raceway and connector to desk height outlet module, or two connectors to adjacent base raceway power rails.</p> <p>Transitional connectors connect Currents Service Wall power components to powered Morrison or Reff panels or Morrison Network desks.</p> <p>Application dimension indicates distance from Service Wall outlet module to perpendicular panel.</p>
AR1 Raceway		
T 3+3		
T Transitional		
5 Length		
	<p>Specify jumper cables between outlet modules. Application dimension indicates maximum wall cover width between outlets covers at the same height. Excess cable may be stored in interior of Service Wall frame.</p> <p>Base raceway power rail is suspended between panel supports 3" above floor. 48" Service Wall accepts one 12" rail, 60" Service Wall accepts one 24" rail, 72" accepts two 12" rails. 12" rails may also be inserted at any straight connection.</p> <p>Specify 12" base power connector between 12" rails in a 72"W Service Wall base, or straddling a Service Wall connection. Specify 36" base power connector to pass through a connection between adjacent powered bases.</p>	

Power, data and communications components for
Service Walls
replacement components for Equity

Currents

Service Walls and
components

description	type	w	d	h	pattern no.	no finish	black	orange (-O) or orange triangle (-T)
Replacement duplexes for Equity	Circuit A				ARE1 DA		\$43.	
	Circuit B				ARE1 DB		43.	
	Circuit C				ARE1 DC		43.	
	Circuit X				ARE1 DX		43.	
	Circuit X, orange face or orange triangle				ARE1 DX (O or T)			48.
	Circuit Y				ARE1 DY		43.	
	Circuit Y, orange face or orange triangle				ARE1 DY (O or T)			48.
	Circuit Z				ARE1 DZ		43.	
	Circuit Z, orange face or orange triangle				ARE1 DZ (O or T)			48.
Transitional power connector Equity 2+2	12"		61"		ARE1 ET1		186.	
	36"		85"		ARE1 ET3		236.	
	60"		109"		ARE1 ET5		270.	
Transitional power connector Equity 3+3	12"		61"		ARE1 TT1		219.	
	36"		85"		ARE1 TT3		270.	
	60"		109"		ARE1 TT5		300.	
Replacement power infeed, Equity panel	2+2				ARE1 EP1		277.	
	3+3				ARE1 TP1		320.	

Order Code

Specification Information

Application Notes

Example: ARE1 ET3
ARE1 Currents/Equity raceway
E Eight wire 2+2
T Transitional connector
3 Width





Replacement duplexes for Equity convert existing 3+1 terminal blocks in Equity panels to 2+2 when connected to and supplied by Service Wall 2+2 or 3+3 power.

Transitional power connector connects Service Wall power components to Equity panel base power.

Application dimension indicates distance between Service Wall outlet module (at 30"-39"H) and perpendicular panel.

Specify replacement power infeed when supplying power to Service Wall from Equity panel base infeed.

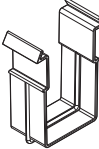
Power, data and communications components for
Service Walls
accessories, ceiling infeed panel

description	w	d	h	pattern no.	no finish	paint
Cable clips for wall studs (100) 	1/4"	1/2"	1 1/2"	AR1 PCC 100	\$84.	
High capacity cable holders (10) 	1"	3/4"	2 1/2"	AR1 HCC H10	35.	
Raceway cable managers (10) 				AR1 RCM 10	68.	
Ceiling infeed panel for stabilizer end cabinet, T-end or power monument 	3 1/2"	5"	48"	APX CIP4 ()		515.
	3 1/2"	5"	72"	APX CIP6 ()		602.
	3 1/2"	5"	96"	APX CIP8 ()		688.

Order Code

Example: AR1 PCC 100	
AR1	Raceway
PCC	Cable clip
100	Size/Quantity

Specification Information

Cable clips and cable managers are black plastic.
Cable holders are light grey plastic.
Specify painted finish for hardwire outlets cover or ceiling infeed panel.
High capacity cable holders may not be used in conjunction with AutoStrada access covers.

Application Notes

Specify cable clips, approximately 50 per wall frame to support and manage cables on the face of studs in the Service Wall frame. Each clip manages up to 14 Category 5 or fiber optic cables; four clips attach between 21"-30", 30"-39", 39"-48"; six between 48"-64"H. Only two clips fit behind a cable tray cover at the 21"-30" height.
Specify high capacity cable holders approximately 20 per Service Wall frame to support and manage larger bundles of cables. Each holds up to 55 Cat 5 cables; two holders attach to studs at each 9" level; three holders at the 16" level of a 64"H Service Wall. Only one holder fits behind a cable tray cover at the 21"-30" height (upside down).

Raceway cable managers are U-shape cable supports that snap into the underside of the Service Wall frame. Plan one per foot to contain data cables or power jumpers in the base raceway.
Ceiling infeed panel attaches to end of Service Wall adjacent to Currents, Morrison, or Reff T-end panel with 3 1/2" extension, or to power monument. Center channel, 2" x 2 1/2", accommodates one or two power infeed cables. Each side channel is 1 1/2" x 3 1/2" lay-in cable raceway, for continuous lay-in cabling from ceiling to Service Wall surface.
Specify ceiling infeed separately.

Power, data and communications components for Service Walls

PDC modules, modular communications

Currents

Service Walls and
components

description	type	application	pattern no.	black
PDC Module accessories	PDC Module extender (set of 10)		MR3 PDCX	\$174.
AMP PDC Modules	Faceplate and 4 Enhanced Category 5 outlets		AMC PDC 5E4N	226.
AMP Modular components	Blank insert (10)		AMC B10	26.
	Category 3 outlet (RJ11 six position)	Punch-down back	AMC O3	26.
	Category 6 quantum (RJ45, 110)	Punch-down back	AMC O6	53.
	Communications faceplates	AMP outlet faceplate, 2-port	AMC FP2 (L or N)	26.
	Communications faceplates	AMP outlet faceplate, 3-port	AMC FP3 (L or N)	26.
	Enhanced Category 5 outlet (RJ45, 110)	Punch-down back	AMC O5E	36.
	Fiber optics outlet 50/125 micron fiber jack		AMC OF500	181.
	Fiber optics outlet 62.5/125 micron fiber jack		AMC OF625	181.
AMP modular communications/ zone distribution	AMP NetConnect consolidation point, 12-port		AMC5 CP12	715.
	AMP NetConnect mounting bracket		AMB CP12-AMP	48.
	AMP pre-terminated outlet cable, 20'		AMC5 OC20(A or B)	90.
	AMP pre-terminated outlet cable, 30'		AMC5 OC30(A or B)	101.
	AMP pre-terminated outlet cable, 40'		AMC5 OC40(A or B)	109.
	AMP pre-terminated outlet cable, 50'		AMC5 OC50(A or B)	115.
Lucent zone distribution	Hinged mounting brackets for 24-port consolidation point (pair)		AMB CP24 LUC	131.
Outlet fillers (Set of 10)			AR OF	37.

Order Code	Specification Information	Application Notes
Example: MR3 AMP3B	<i>For AMP pre-terminated outlet cables specify:</i>	PDC Modules are preconfigured or created from modular components and faceplate that snaps into Service Wall outlets cover, raceway cover.
MR3 Raceway/PDC	T568A or T568B wiring.	
AMP Type	<i>For AMP outlet faceplates specify:</i>	See Morrison price list for additional PDC module configurations.
3B Configuration	L Light grey N Black	
	Amp outlets are black. Lucent faceplates are light grey.	Specify PDC Module extenders for adequate clearance between modules in back-to-back applications, or for fiber optics ST connectors.
		Specify blank filler plates for any unused outlet openings in outlets covers or raceway covers.
		AMP NetConnect mounting bracket supports one 12-port consolidation point on stud or two in stabilizer end cabinet.
		AMP pre-terminated outlet cables include outlet and plug into consolidation point. AMP outlet faceplate snaps into outlets cover and supports cable outlet.
		Each Lucent mounting bracket supports one 24-port consolidation point and is hinged for easy access. Bracket mounts on Service Wall frame or stabilizer end cabinet.

Linkable screens *glazed and translucent*

Currents

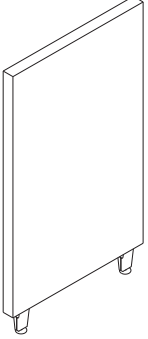
description	type	w	d	h	pattern no.	glazed G(C/T)
	39"H	24"	2"	39"	AP1 3924 () ()	\$911.
		36"	2"	39"	AP1 3936 () ()	1,093.
		48"	2"	39"	AP1 3948 () ()	1,314.
	48"H	18"	2"	48"	AP1 4818 () ()	910.
		24"	2"	48"	AP1 4824 () ()	1,003.
		30"	2"	48"	AP1 4830 () ()	1,114.
		36"	2"	48"	AP1 4836 () ()	1,204.
		42"	2"	48"	AP1 4842 () ()	1,342.
		48"	2"	48"	AP1 4848 () ()	1,446.
	64"H	18"	2"	64"	AP1 6418 () ()	1,059.
		24"	2"	64"	AP1 6424 () ()	1,187.
		30"	2"	64"	AP1 6430 () ()	1,298.
		36"	2"	64"	AP1 6436 () ()	1,427.
		42"	2"	64"	AP1 6442 () ()	1,537.
		48"	2"	64"	AP1 6448 () ()	1,707.

Order Code

Example: **AP1 3924 GT 612 813**

AP1	Currents screen
39	Height
24	Width
G	Surface type
T	Surface finish
612	Frame finish
813	Trim color

Specification Information

Surface types:
G Glazed
For glazed panels specify:
C Clear tempered glass
T Acid etched tempered glass
Specify painted finish for glazed panel frame.
Specify trim grey or easy grey integral color for top cap.
 Linkable screen legs are trim grey.

Application Notes

Linkable screens divide workstations perpendicular to Service Wall where base raceway is not required. Linkable screens connect with standard Morrison/Currents wall starters and Currents linkable screen connectors.
 Screens are supported by two legs with leveling glides and include Currents top cap. Specify connectors separately.
 Glazed linkable screens use Morrison glazed panel construction.

Linkable screens upholstered

Currents

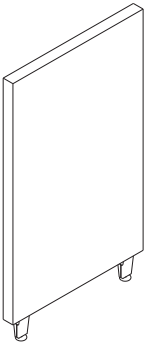
description	type	w	d	h	pattern no.	10	15	20	30	35	40	45	50	55	
Screens 	39"H	18"	2 1/4"	39"	AP1 3918 N() ()	\$317.	\$352.	\$369.	\$424.	\$441.	\$465.	\$515.	\$540.	\$566.	
		24"	2 1/4"	39"	AP1 3924 N() ()	359.	397.	419.	479.	498.	528.	582.	612.	640.	
		30"	2 1/4"	39"	AP1 3930 N() ()	388.	432.	452.	518.	540.	575.	630.	664.	695.	
		36"	2 1/4"	39"	AP1 3936 N() ()	434.	482.	507.	579.	602.	639.	704.	740.	775.	
		42"	2 1/4"	39"	AP1 3942 N() ()	487.	543.	574.	654.	679.	723.	797.	835.	876.	
		48"	2 1/4"	39"	AP1 3948 N() ()	533.	590.	620.	709.	739.	784.	865.	909.	953.	
			60"	2 1/4"	39"	AP1 3960 N() ()	619.	686.	722.	822.	857.	913.	1,006.	n/a	n/a
		48"H	18"	2 1/4"	48"	AP1 4818 N() ()	371.	414.	433.	495.	515.	548.	605.	633.	667.
	24"		2 1/4"	48"	AP1 4824 N() ()	422.	465.	490.	560.	584.	621.	683.	715.	753.	
	30"		2 1/4"	48"	AP1 4830 N() ()	456.	508.	534.	611.	634.	674.	743.	777.	818.	
	36"		2 1/4"	48"	AP1 4836 N() ()	513.	570.	597.	682.	709.	756.	831.	873.	915.	
	42"		2 1/4"	48"	AP1 4842 N() ()	577.	638.	671.	768.	802.	851.	937.	982.	1,032.	
	48"		2 1/4"	48"	AP1 4848 N() ()	625.	695.	732.	834.	869.	925.	1,017.	1,068.	1,123.	
			60"	2 1/4"	48"	AP1 4860 N() ()	730.	810.	851.	975.	1,012.	1,075.	1,185.	n/a	n/a
		64"H	18"	2 1/4"	64"	AP1 6418 A() ()	483.	538.	563.	642.	671.	711.	783.	822.	865.
	24"		2 1/4"	64"	AP1 6424 A() ()	533.	590.	620.	709.	739.	784.	865.	909.	953.	
	30"		2 1/4"	64"	AP1 6430 A() ()	597.	665.	696.	798.	830.	882.	975.	1,018.	1,069.	
	36"		2 1/4"	64"	AP1 6436 A() ()	644.	717.	755.	863.	900.	954.	1,051.	1,103.	1,161.	
	42"		2 1/4"	64"	AP1 6442 A() ()	711.	792.	831.	950.	990.	1,054.	1,161.	1,219.	1,278.	
	48"		2 1/4"	64"	AP1 6448 A() ()	764.	849.	888.	1,016.	1,061.	1,126.	1,241.	1,303.	1,365.	
			60"	2 1/4"	64"	AP1 6460 A() ()	865.	958.	1,009.	1,153.	1,201.	1,276.	1,404.	n/a	n/a

Screens and add-up panels

Order Code

Example:	AP1 3924 N15 813
AP1	Currents screen
39	Height
24	Width
N	Surface type
15	Fabric group
813	Trim color

Specification Information

Surface types:

N	Upholstered
A	High performance acoustical upholstered

Specify fabric group:

10	Fabric group 10
15	Fabric group 15
20	Fabric group 20
30	Fabric group 30
35	Fabric group 35
40	Fabric group 40
45	Fabric group 45
50	Fabric group 50
55	Fabric group 55

Specify trim grey or easy grey integral color for top cap.

Linkable screen legs are trim grey.

Application Notes

Linkable screens divide workstations perpendicular to Service Wall where base raceway is not required. Linkable screens connect with standard Morrison/Currents wall starters and Currents linkable screen connectors.

Screens are supported by two legs with leveling glides and include Currents top cap. Specify connectors separately.

Upholstered 39" and 48" screens use Morrison Options panel construction. Upholstered 64" screens use high performance acoustical Morrison panel construction.

Linkable screens

marker surface both sides

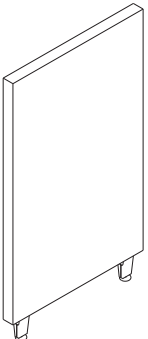
description	type	w	d	h	pattern no.	list price
Linkable screens 	48"H	24"	2 1/8"	48"	AP1 4824M()	\$721.
		30"	2 1/8"	48"	AP1 4830M()	775.
		36"	2 1/8"	48"	AP1 4836M()	856.
		42"	2 1/8"	48"	AP1 4842M()	959.
		48"	2 1/8"	48"	AP1 4848M()	1,074.
	64"H	24"	2 1/8"	64"	AP1 6424M()	817.
		30"	2 1/8"	64"	AP1 6430M()	927.
		36"	2 1/8"	64"	AP1 6436M()	1,052.
		42"	2 1/8"	64"	AP1 6442M()	1,170.
		48"	2 1/8"	64"	AP1 6448M()	1,306.

Order Code

Example: AP1 4824M 813
AP1 Currents screen
48 Height
24 Width
M Surface type
813 Trim color

Specification Information

Surface types:
M Marker surface
 Specify trim grey or easy grey integral color for top cap.
 Linkable screen legs are trim grey.

Application Notes

Linkable screens divide workstations perpendicular to Service Wall where base raceway is not required. Linkable screens connect with standard Morrison/Currents wall starters and Currents linkable screen connectors.
 Screens are supported by two legs with leveling glides and include Currents top cap. Specify connectors separately.
 Marker surface linkable screens use Morrison veneer panel construction.

Linkable screens marker/upholstered combination

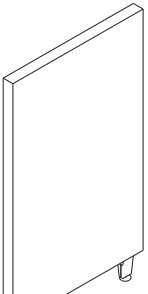
description	type	w	d	h	pattern no.	10	15	20	30	35	40	45	50	55
Linkable screens 	48"H	24"	2 1/8"	48"	AP1 4824M() ()	\$670.	\$701.	\$715.	\$759.	\$772.	\$795.	\$833.	\$850.	\$878.
		30"	2 1/8"	48"	AP1 4830M() ()	729.	756.	770.	818.	831.	854.	902.	921.	954.
		36"	2 1/8"	48"	AP1 4836M() ()	803.	836.	847.	902.	915.	950.	996.	1,022.	1,057.
		42"	2 1/8"	48"	AP1 4842M() ()	906.	941.	953.	1,017.	1,030.	1,065.	1,119.	1,146.	1,187.
		48"	2 1/8"	48"	AP1 4848M() ()	1,001.	1,038.	1,054.	1,120.	1,148.	1,195.	1,236.	1,269.	1,312.
	64"H	24"	2 1/8"	64"	AP1 6424M() ()	789.	835.	846.	904.	927.	972.	1,021.	1,041.	1,081.
		30"	2 1/8"	64"	AP1 6430M() ()	885.	940.	949.	1,017.	1,038.	1,083.	1,130.	1,158.	1,197.
		36"	2 1/8"	64"	AP1 6436M() ()	984.	1,038.	1,057.	1,121.	1,151.	1,205.	1,249.	1,283.	1,325.
		42"	2 1/8"	64"	AP1 6442M() ()	1,078.	1,150.	1,166.	1,243.	1,269.	1,314.	1,369.	1,405.	1,453.
		48"	2 1/8"	64"	AP1 6448M() ()	1,231.	1,307.	1,324.	1,404.	1,435.	1,488.	1,557.	1,596.	1,647.

Screens and add-up panels

Order Code

Example:	AP1 4824M20 813
AP1	Currents screen
48	Height
24	Width
M	Surface type
20	Fabric group
813	Trim color

Specification Information

Specify fabric group:

10	Fabric group 10
15	Fabric group 15
20	Fabric group 20
30	Fabric group 30
35	Fabric group 35
40	Fabric group 40
45	Fabric group 45
50	Fabric group 50
55	Fabric group 55

Specify trim grey or easy grey integral color for top cap.

Linkable screen legs are trim grey.

Application Notes

Linkable screens divide workstations perpendicular to Service Wall where base raceway is not required. Linkable screens connect with standard Morrison/Currents wall starters and Currents linkable screen connectors.

Screens are supported by two legs with leveling glides and include Currents top cap. Specify connectors separately.

Combination upholstered screens use Morrison veneer/combination panel construction.

Linkable screens trim

Currents

description	type	w	d	h	pattern no.	price
End trim, linkable screens (no connector)	39" screen	–	2"	39"	AA139E()	\$46.
	48" screen	–	2"	48"	AA148E()	48.
	64" screen	–	2"	64"	AA164E()	49.
Raceway cover for Currents end connector or end trim on Morrison panel					AA1RE()	32.
Top trim, linkable screens (replacement part)		6"	2"	–	AA1T06()	9.
		18"	2"	–	AA1T18()	12.
		24"	2"	–	AA1T24()	15.
		30"	2"	–	AA1T30()	25.
		36"	2"	–	AA1T36()	27.
		42"	2"	–	AA1T42()	28.
		48"	2"	–	AA1T48()	30.
	60"	2"	–	AA1T60()	33.	
Linkable screen feet, pair (replacement part)					AP1 LF	63.
Carpet grips (set of 10)					MM2-CG	25.
Non-skid pads (set of 10)					AA1NSK	38.
Screen starter		4"	1"	16"	AA1B()	158.

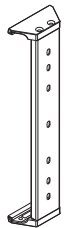
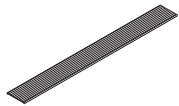

Order Code	Specification Information	Application Notes
Example: AA1 T06 813	<i>Specify painted finish for raceway cover for Currents end connector.</i>	End trim is economical vertical trim cover for linkable screen where no end connector (or cantilever track) is required. End trim includes top cap.
AA1 T Top trim, panel	Specify trim grey or easy grey integral color for end trim and top trim.	Raceway cover encloses end of Morrison panel raceway under Currents end trim or end connector.
06 Width	Linkable screen legs are trim grey.	Top trim corresponds in width to linkable screens or Morrison panels. No Currents top trim is available for Morrison connectors (specify linkable screen connectors).
813 Trim color		Top caps are included with Currents screen connectors.
		Linkable screen feet may be ordered to convert Morrison panels with raceway to Currents linkable screens.
		Specify screen starter to connect Wall-connected screen perpendicular to Service Wall face. Clamp bracket attaches Wall-connected screen anywhere along structural base. Outside surface of screen at end of Wall will be approximately 1" from end.
		No screen starter is needed to attach Service Wall-connected screen to corresponding height Currents T-end at end of spine.
		Screen-to-worksurface bracket stabilizes Wall-connected screen by attaching to underside of worksurface at any height.
		Specify left or right end of worksurface.

Linkable screens trim



description	type	w	d	h	pattern no.	price
Screen-to-worksurface bracket					AFWB	\$84.



Order Code	Specification Information	Application Notes
Example: AA1 T06 813		
AA1 T Top trim, panel	<i>Specify painted finish for raceway cover for Currents end connector.</i>	End trim is economical vertical trim cover for linkable screen where no end connector (or cantilever track) is required. End trim includes top cap.
06 Width	Specify trim grey or easy grey integral color for end trim and top trim.	Raceway cover encloses end of Morrison panel raceway under Currents end trim or end connector.
813 Trim color	Linkable screen legs are trim grey.	Top trim corresponds in width to linkable screens or Morrison panels. No Currents top trim is available for Morrison connectors (specify linkable screen connectors). Top caps are included with Currents screen connectors. Linkable screen feet may be ordered to convert Morrison panels with raceway to Currents linkable screens.
		Specify screen starter to connect Wall-connected screen perpendicular to Service Wall face. Clamp bracket attaches Wall-connected screen anywhere along structural base. Outside surface of screen at end of Wall will be approximately 1" from end. No screen starter is needed to attach Service Wall-connected screen to corresponding height Currents T-end at end of spine. Screen-to-worksurface bracket stabilizes Wall-connected screen by attaching to underside of worksurface at any height. Specify left or right end of worksurface.

Linkable screens

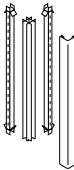
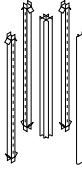
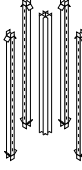
90° and end connectors

description	type	w	d	h	pattern no.	no finish	trim grey
Connector track 	No trim	–	–	39"	MC1-39S1	\$57.	
	No trim	–	–	48"	MC1-48S1	66.	
	No trim	–	–	64"	MC1-64S1	70.	
90° 2-way L 		2"	2"	39"	AC1 39L2()		165.
		2"	2"	48"	AC1 48L2()		174.
		2"	2"	64"	AC1 64L2()		187.
90° 3-way T 		2 1/4"	2"	39"	AC1 39T3()		210.
		2 1/4"	2"	48"	AC1 48T3()		220.
		2 1/4"	2"	64"	AC1 64T3()		237.
90° 4-way X 		2 1/4"	2 1/4"	39"	AC1 39X4()	245.	
		2 1/4"	2 1/4"	48"	AC1 48X4()	273.	
		2 1/4"	2 1/4"	64"	AC1 64X4()	304.	
End connector (with connector track) 		1"	2"	39"	AC1 39E1()		74.
		1"	2"	48"	AC1 48E1()		78.
		1"	2"	64"	AC1 64E1()		87.

Order Code	Specification Information	Application Notes
Example: AC1 39L2 813		
AC1 Linkable screen connector	Specify trim grey or easy grey integral color for top and vertical trim.	Connectors join linkable screens or Morrison panels in straight, 90° or 120° post configurations.
39 Height	Connector post is painted black extrusion.	Linkable screen connectors include connector tracks, universal posts and top and vertical trim (where required).
L2 90° 2-way L	Carpet grips are black integral color surface.	Connector tracks have cantilever slots for worksurface and storage support.
813 Trim color		L, T and X connectors include a universal post and 2, 3 or 4 connector tracks and top cap.
		End trim may be specified instead of an end connector if cantilever capability is not required.
		Carpet grips snap into linkable screen glides to prevent components from sliding. Glide rotates in carpet grip to permit levelling.
		Non-skid grips snap into glides to prevent sliding on hard surface floors.

Linkable screens

120° connectors

Currents

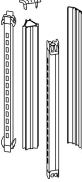
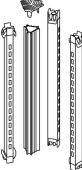
description	h	pattern no.	list price
120°, 2-way 	39"	AC1 39V2()	\$183.
	48"	AC1 48V2()	191.
	64"	AC1 64V2()	209.
120°, 3-way 	39"	AC1 39Y3()	223.
	48"	AC1 48Y3()	233.
	64"	AC1 64Y3()	249.

Screens and add-up panels

Order Code

Example: AC1 39V2 813
AC1 Linkable screen connector
39 Height
V2 120° 2-way
813 Trim color

Specification Information

Specify trim grey or easy grey integral color for top and vertical trim.

Connector post is painted black extrusion.

Carpet grips are black integral color surface.

Application Information

Connectors join linkable screens or Morrison panels in straight, 90° or 120° post configurations.

The connectors include connector tracks, a triangular post and top and vertical trim (where required).

Mobile screens upholstered surfaces

description	type	w	d	h	pattern no.	10	15	20	30	35	40	45	50	55
Mobile screen, upholstered	48"H	48"	2"	48"	AF 4848 AM () ()	\$1,624.	\$1,671.	\$1,715.	\$1,807.	\$1,851.	\$1,898.	\$1,942.	\$2,035.	\$2,126.
		60"	2"	48"	AF 4860 AM () ()	1,774.	1,819.	1,869.	1,962.	2,005.	2,050.	2,094.	2,186.	2,278.
	64"H	48"	2"	64"	AF 6448 AM () ()	1,763.	1,819.	1,883.	2,005.	2,063.	2,126.	2,186.	2,307.	2,429.
		60"	2"	64"	AF 6460 AM () ()	2,063.	2,126.	2,186.	2,307.	2,369.	2,429.	2,488.	2,611.	2,735.

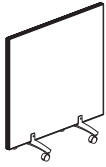

Order Code

Example:	AF 4872 TCM 612
AF	Screen
48	Height
72	Width
T	Surface type
C	Surface finish
M	Base type
612	Base finish

Specification Information

Surface types:

A	Tackable upholstered
---	----------------------

Surface finishes:

C	Crystal
---	---------

Specify base finish.

Base type:

M	Mobile
---	--------

Specify fabric group:

10	Fabric group 10
15	Fabric group 15
20	Fabric group 20
30	Fabric group 30
35	Fabric group 35
40	Fabric group 40
50	Fabric group 50
55	Fabric group 55

Application Notes

Upholstered screens are tackable, acoustical surface both sides. Continuous edge trim is trim grey.



The bottom 15" of upholstered mobile screens consists of supporting ballast board and is not tackable area.

Mobile screens are supported by stabilizer feet.

Non-locking casters to meet BIFMA stability standards.

When ordering 60" wide upholstered screens, please check width of fabric selected.

Add-up panels
 upholstered surface
 Service Wall crown applications

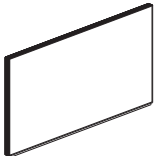
description	w	d	h	pattern no.	10	15	20	30	35	40	45	50	55
12"H add-up panels 	24"	2"	12"	AU 1224 A ()	\$426.	\$444.	\$459.	\$490.	\$508.	\$523.	\$539.	\$572.	\$601.
	36"	2"	12"	AU 1236 A ()	490.	508.	523.	555.	572.	585.	601.	632.	667.
	48"	2"	12"	AU 1248 A ()	555.	572.	585.	618.	632.	649.	667.	696.	729.
	60"	2"	12"	AU 1260 A ()	649.	667.	682.	714.	729.	745.	759.	792.	824.
21"H add-up panels 	24"	2"	21"	AU 2124 A ()	530.	555.	578.	624.	649.	673.	696.	745.	792.
	36"	2"	21"	AU 2136 A ()	612.	632.	658.	703.	729.	753.	777.	824.	870.
	48"	2"	21"	AU 2148 A ()	688.	714.	737.	782.	809.	830.	855.	903.	950.
	60"	2"	21"	AU 2160 A ()	809.	830.	855.	903.	928.	950.	975.	1,020.	1,069.
28"H add-up panels 	24"	2"	28"	AU 2824 A ()	632.	667.	696.	759.	792.	824.	855.	918.	981.
	36"	2"	28"	AU 2836 A ()	729.	759.	792.	855.	889.	918.	950.	1,012.	1,075.
	48"	2"	28"	AU 2848 A ()	824.	855.	889.	950.	981.	1,012.	1,046.	1,109.	1,172.
	60"	2"	28"	AU 2860 A ()	966.	996.	1,032.	1,092.	1,124.	1,158.	1,187.	1,252.	1,315.

Order Code	Specification Information	Application Notes																														
Example: AU 2848 A20	<i>Surface types:</i>	Add-up panels add visual and acoustical privacy above any height Service Wall. Bottom edge, with wedge-shape plugs, inserts in center of crown at any point, regardless of upmounted storage. Add-up panels include continuous edge trim. Upholstered add-up panels have been tested to NRC .60 and STC 21. When ordering 60" wide panels, please check width of fabric selected.																														
AU Add up panel	A Tackable upholstered																															
28 Height	<i>Specify fabric group for upholstered add-up panels:</i>																															
48 Width	10 Fabric group 10																															
A Surface type	15 Fabric group 15																															
20 Fabric group	20 Fabric group 20																															
	30 Fabric group 30																															
	35 Fabric group 35																															
	40 Fabric group 40																															
	45 Fabric group 45																															
	50 Fabric group 50	Overall height of service wall with 4" standard crown and Add-up panels: <table border="1"> <thead> <tr> <th>Nominal wall height</th> <th>Add-up height</th> <th>Overall height</th> </tr> </thead> <tbody> <tr> <td>39"</td> <td>12"</td> <td>55"</td> </tr> <tr> <td>39"</td> <td>21"</td> <td>64"</td> </tr> <tr> <td>39"</td> <td>28"</td> <td>71"</td> </tr> <tr> <td>48"</td> <td>12"</td> <td>64"</td> </tr> <tr> <td>48"</td> <td>21"</td> <td>73"</td> </tr> <tr> <td>48"</td> <td>28"</td> <td>80"</td> </tr> <tr> <td>64"</td> <td>12"</td> <td>80"</td> </tr> <tr> <td>64"</td> <td>21"</td> <td>89"</td> </tr> <tr> <td>64"</td> <td>28"</td> <td>96"</td> </tr> </tbody> </table>	Nominal wall height	Add-up height	Overall height	39"	12"	55"	39"	21"	64"	39"	28"	71"	48"	12"	64"	48"	21"	73"	48"	28"	80"	64"	12"	80"	64"	21"	89"	64"	28"	96"
Nominal wall height	Add-up height		Overall height																													
39"	12"		55"																													
39"	21"		64"																													
39"	28"	71"																														
48"	12"	64"																														
48"	21"	73"																														
48"	28"	80"																														
64"	12"	80"																														
64"	21"	89"																														
64"	28"	96"																														
	55 Fabric group 55																															
	Edge trim is integral color trim grey finish.																															
	Specify wide add-up panels for use on long Service Wall and Fence runs.																															

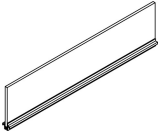
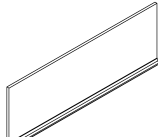
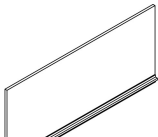
description	type	width	depth	height	pattern number	clear tempered	powder
Add up panels	frameless glass, 8"h 	24"	1/2"	8"	AUA1 0824 G () ()	\$276.	\$336.
		36"	1/2"	8"	AUA1 0836 G () ()	314.	450.
		48"	1/2"	8"	AUA1 0848 G () ()	406.	562.
		60"	1/2"	8"	AUA1 0860 G () ()	499.	724.
		72"	1/2"	8"	AUA1 0872 G () ()	562.	874.
	frameless glass, 12"h 	24"	1/2"	12"	AUA1 1224 G () ()	330.	379.
		36"	1/2"	12"	AUA1 1236 G () ()	468.	536.
		48"	1/2"	12"	AUA1 1248 G () ()	596.	688.
		72"	1/2"	12"	AUA1 1272 G () ()	862.	990.
	frameless glass, 15"h 	24"	1/2"	15"	AUA1 1524 G () ()	336.	591.
		36"	1/2"	15"	AUA1 1536 G () ()	468.	655.
		48"	1/2"	15"	AUA1 1548 G () ()	599.	942.
		60"	1/2"	15"	AUA1 1560 G () ()	737.	1,062.
		72"	1/2"	15"	AUA1 1572 G () ()	868.	1,243.
	frameless glass, 12"h	60"	1/2"	12"	AUA1 1260 G () ()	727.	841.

Order Code	Specification Information	Application Notes
Example: AUA1 1248 G TEMP AA	<i>Add up type:</i>	Add-up panels add acoustical privacy and light control above any height Service Wall.
AUA1 Autostrada add up panel	G Glass	Anodized aluminum or painted base frame inserts in center of any Service Wall crown and is secured by bolts within crown.
12 Height	Glass add-ups are available with the following glass options:	Frameless glass add-ups can be positioned at any 3" increment in standard or compact crown with any cover type.
48 Width	TEMP Clear tempered	
G Type	GL13 Powder	
TEMP Glass Finish	Specify wide add-up panels for use on long Service Wall and Fence runs.	Any height add up can be used on any height AutoStrada or Currents Service Wall or Fence.
AA Trim Finish		<ul style="list-style-type: none"> 8"h Add ups are designed primarily for use on 39"h spine with 1"h crown to create a 48"h horizon. 12"h Add ups are designed for use on 48"h spine for a 61" horizon with 1"h crown or a 64" horizon with 4"h crown. 15"h Add ups are designed primarily for use on 48"h spine with 1"h crown for a 64" horizon.

Add-up panel connectors and fillers

field retrofit kits

Currents

description	type	pattern no.	list price
Field Retrofit Trim Kit for non-stackable add-up panels	12 x 24	AUA1224	n/c
	12 x 36	AUA1236	n/c
	12 x 48	AUA1248	n/c
	12 x 60	AUA1260	n/c
	12 x 72	AUA1272	n/c
	21 x 24	AUA2124	n/c
	21 x 36	AUA2136	n/c
	21 x 48	AUA2148	n/c
	21 x 60	AUA2160	n/c
	21 x 72	AUA2172	n/c
	28 x 24	AUA2824	n/c
	28 x 36	AUA2836	n/c
	28 x 48	AUA2848	n/c
	28 x 60	AUA2860	n/c
28 x 72	AUA2872	n/c	

Screens and add-up panels

Order Code

Example: **AUA1224**

AU Add-up

A Type

12 Height

24 Width

Specification Information

Finish is trim grey.





Fillers require retrofitting add-up panels with new trim.

Retrofit trim kits are no-charge (n/c) items specified separately.

Add-up panel connectors and fillers

Service Wall applications

Currents

description	w	d	h	pattern no.	list price
Straight alignment clip 	3"	2"	–	AU1 CS	\$12.
L connector add-up fillers 	6"	6"	16"	AU1 CL12	382.
	6"	6"	25"	AU1 CL21	458.
	6"	6"	32"	AU1 CL28	536.
T connector add-up fillers 	6"	6"	16"	AU1 CT12	382.
	6"	6"	25"	AU1 CT21	458.
	6"	6"	32"	AU1 CT28	536.
T-end 1 1/8" extension fillers 	2"	1 1/8"	16"	AU1 X112	230.
	2"	1 1/8"	25"	AU1 X121	265.
	2"	1 1/8"	32"	AU1 X128	304.
T-end 3 1/2" extension fillers 	2"	3 1/2"	16"	AU1 X312	304.
	2"	3 1/2"	25"	AU1 X321	343.
	2"	3 1/2"	32"	AU1 X328	382.

Order Code

Example:	AU1 CL12
AU1	Add-up
CL	Connector type
12	Application

Specification Information

Add-up fillers and alignment clip are painted trim grey finish.

Pattern numbers correspond to add-up panel height.

Application Notes

Straight connector clips over adjacent non-stackable add-up panels.

Add-up fillers join between add-up panels over a service wall connection or a T-end to extend enclosure from bottom of crown to top of add-up. Fillers require retrofitting add-up panels with new trim.

Retrofit kits are no-charge items that are specified separately.

Stackable add-up panels
glazed, translucent fiberglass and marker surface
first up panels

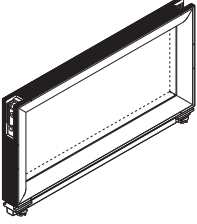
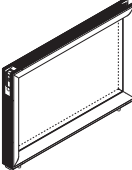
description	w	d	h	pattern no.	acrylic W (C)	acrylic W (T)	marker (M)	
First up panel on service wall crown 	24"	2"	12"	AY1 1224C()	\$614.	\$668.	\$639.	
	36"	2"	12"	AY1 1236C()	711.	776.	744.	
	48"	2"	12"	AY1 1248C()	814.	889.	884.	
	60"	2"	12"	AY1 1260C()	868.	953.	n/a	
	24"	2"	21"	AY1 2124C()	667.	725.	721.	
	36"	2"	21"	AY1 2136C()	775.	851.	841.	
	48"	2"	21"	AY1 2148C()	887.	977.	1,005.	
	60"	2"	21"	AY1 2160C()	1,012.	1,113.	n/a	
	24"	2"	28"	AY1 2824C()	925.	1,016.	771.	
	36"	2"	28"	AY1 2836C()	1,095.	1,205.	906.	
	48"	2"	28"	AY1 2848C()	1,267.	1,397.	1,078.	
	60"	2"	28"	AY1 2860C()	1,376.	1,512.	n/a	
	First up panel on linkable screen or Morrison panel 	18"	2"	16"	AY1 1618M()	579.	628.	n/a
		24"	2"	16"	AY1 1624M()	628.	682.	671.
30"		2"	16"	AY1 1630M()	679.	741.	722.	
36"		2"	16"	AY1 1636M()	734.	802.	781.	
42"		2"	16"	AY1 1642M()	780.	854.	848.	
48"		2"	16"	AY1 1648M()	833.	912.	930.	
60"		2"	16"	AY1 1660M()	906.	986.	n/a	
18"		2"	25"	AY1 2518M()	736.	804.	n/a	
24"		2"	25"	AY1 2524M()	804.	879.	747.	
30"		2"	25"	AY1 2530M()	873.	957.	812.	
36"		2"	25"	AY1 2536M()	944.	1,040.	876.	
42"		2"	25"	AY1 2542M()	1,015.	1,115.	959.	
48"		2"	25"	AY1 2548M()	1,089.	1,198.	1,047.	
60"		2"	25"	AY1 2560M()	1,158.	1,272.	n/a	

Screens and add-up panels

Order Code	Specification Information	Application Notes
Example: AY1 1636M WC 117	Top and edge trim are trim grey.	<i>For glazed panels specify acrylic:</i> C Clear tempered glass T Acid etched tempered glass
AY1 Stackable add-up	<i>Specify surface type.</i>	
16 Height	W Glazed	<i>For glazed panels also specify frame finish.</i>
36 Width	M Marker surface (both sides)	
M Mounting kit	Specify wide add-up panels for use on long Service Wall and Fence runs.	Stackable add-up panels provide adaptable privacy on Service Walls, linkable screens or Morrison panels. First up panels include top and edge trims and bayonet supports that bolt on to Service Wall frame or top of screen or panel. All stackable add-up panels may be removed without tools.
W Surface type		Specify trim caps and connectors separately.
C Acrylic finish		
117 Frame finish		

Stackable add-up panels
glazed, translucent fiberglass and marker surface
next up panels

description	w	d	h	pattern no.	acrylic W (C)	acrylic W (T)	marker (M)
Next up panel on stackable add-up panels	18"	2"	16"	AY1 1618S()	\$574.	\$621.	n/a
	24"	2"	16"	AY1 1624S()	621.	674.	665.
	30"	2"	16"	AY1 1630S()	672.	735.	715.
	36"	2"	16"	AY1 1636S()	727.	794.	774.
	42"	2"	16"	AY1 1642S()	773.	847.	838.
	48"	2"	16"	AY1 1648S()	825.	904.	920.
	60"	2"	16"	AY1 1660S()	898.	978.	n/a

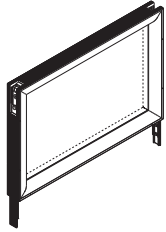

Order Code

Example: AY1 1636S WC 117
AY1 Stackable add-up
16 Height
36 Width
S Mounting kit
W Surface type
C Acrylic finish
117 Frame finish

Specification Information

Top and edge trim are trim grey.
Specify surface type.
 W Glazed
 M Marker surface (both sides)

Specify wide add-up panels for use on long Service Wall and Fence runs.

A maximum of one next up stackable add-up panel may be used on top of a first up stackable add-up panel.

For glazed panels specify acrylic:
 C Clear tempered glass
 T Acid etched tempered glass

For glazed panels also specify frame finish.

Application Notes

Stackable add-up panels provide adaptable privacy on Service Walls, linkable screens or Morrison panels. Next up panels include intermediate masts that engage into sides of corresponding width first up or next-up panels. All stackable add-up panels may be removed without tools.

Specify trim caps and connectors separately.

Stackable add-up panels
upholstered
first up panels

description	w	d	h	pattern no.	10	15	20	30	35	40	45	50	55
	24"	2 1/4"	12"	AY1 1224C A()	\$480.	\$518.	\$527.	\$581.	\$607.	\$644.	\$682.	\$708.	\$744.
	36"	2 1/4"	12"	AY1 1236C A()	557.	610.	620.	685.	718.	769.	816.	850.	894.
	48"	2 1/4"	12"	AY1 1248C A()	648.	711.	732.	810.	849.	909.	972.	1,010.	1,065.
	60"	2 1/4"	12"	AY1 1260C A()	729.	801.	818.	911.	954.	1,025.	1,096.	1,142.	1,206.
	24"	2 1/4"	21"	AY1 2124C A()	524.	572.	582.	639.	671.	712.	761.	785.	830.
	36"	2 1/4"	21"	AY1 2136C A()	616.	672.	686.	764.	801.	854.	911.	947.	1,000.
	48"	2 1/4"	21"	AY1 2148C A()	721.	792.	812.	907.	947.	1,017.	1,084.	1,132.	1,196.
	60"	2 1/4"	21"	AY1 2160C A()	809.	889.	912.	1,019.	1,071.	1,153.	1,230.	1,286.	1,358.

description	w	d	h	pattern no.	10	15	20	30	35	40	45	50	55
	18"	2 1/4"	16"	AY1 1618M A()	468.	510.	519.	575.	595.	634.	672.	699.	735.
	24"	2 1/4"	16"	AY1 1624M A()	495.	538.	543.	602.	629.	671.	709.	738.	774.
	30"	2 1/4"	16"	AY1 1630M A()	538.	585.	597.	662.	690.	738.	780.	812.	854.
	36"	2 1/4"	16"	AY1 1636M A()	578.	630.	642.	711.	747.	802.	851.	885.	935.
	42"	2 1/4"	16"	AY1 1642M A()	633.	694.	709.	791.	828.	886.	945.	984.	1,041.
	48"	2 1/4"	16"	AY1 1648M A()	674.	741.	761.	845.	884.	948.	1,011.	1,052.	1,112.
	60"	2 1/4"	16"	AY1 1660M A()	756.	831.	853.	949.	997.	1,072.	1,144.	1,195.	1,261.
	18"	2 1/4"	25"	AY1 2518M A()	514.	558.	574.	630.	661.	703.	744.	773.	815.
	24"	2 1/4"	25"	AY1 2524M A()	542.	590.	605.	667.	696.	743.	789.	819.	864.
	30"	2 1/4"	25"	AY1 2530M A()	590.	644.	662.	732.	767.	818.	870.	908.	954.
	36"	2 1/4"	25"	AY1 2536M A()	636.	699.	711.	792.	830.	889.	948.	986.	1,044.
	42"	2 1/4"	25"	AY1 2542M A()	702.	771.	789.	880.	920.	992.	1,060.	1,103.	1,166.
	48"	2 1/4"	25"	AY1 2548M A()	748.	822.	847.	943.	986.	1,062.	1,132.	1,182.	1,251.
	60"	2 1/4"	25"	AY1 2560M A()	841.	927.	950.	1,065.	1,119.	1,203.	1,287.	1,341.	1,419.

Screens and add-up panels

Order Code

Example: AY1 1660M A20	
AY1	Stackable panel
16	Height
60	Width
M	Mounting kit
A	Surface type
20	Fabric group

Specification Information

Top and trim edge are trim grey.

Surface type:
A Tackable upholstered

Specify fabric group:
10 Fabric group 10
15 Fabric group 15
20 Fabric group 20
30 Fabric group 30
35 Fabric group 35
40 Fabric group 40
50 Fabric group 50
55 Fabric group 55

Application Notes

Stackable add-up panels provide adaptable privacy on Service Walls, linkable screens or Morrison panels. First up panels include top and edge trims and bayonet supports that bolt on to Service Wall frame or top of screen or panel. All stackable add-up panels may be removed without tools.

Specify wide add-up panels for use on long Service Wall and Fence runs.

Stackable add-up panels
upholstered
next up panels

description	w	d	h	pattern no.	10	15	20	30	35	40	45	50	55
 Next up panel on stackable add-up panels	18"	2 1/4"	16"	AY1 1618S A()	\$463.	\$506.	\$514.	\$566.	\$590.	\$629.	\$667.	\$692.	\$728.
	24"	2 1/4"	16"	AY1 1624S A()	488.	533.	541.	596.	622.	665.	702.	731.	768.
	30"	2 1/4"	16"	AY1 1630S A()	533.	580.	591.	656.	683.	731.	773.	804.	847.
	36"	2 1/4"	16"	AY1 1636S A()	572.	623.	636.	704.	740.	794.	843.	874.	926.
	42"	2 1/4"	16"	AY1 1642S A()	628.	688.	702.	781.	820.	876.	937.	976.	1,032.
	48"	2 1/4"	16"	AY1 1648S A()	669.	735.	753.	835.	873.	939.	1,001.	1,043.	1,100.
	60"	2 1/4"	16"	AY1 1660S A()	749.	824.	846.	940.	988.	1,063.	1,135.	1,182.	1,249.

Order Code

Example:	AY1 1660S A20
AY1	Stackable panel
16	Height
60	Width
S	Mounting kit
A	Surface type
20	Fabric group

Specification Information

Top and trim edge are trim grey.

Surface type:
 A Tackable upholstered

Specify fabric group:

10	Fabric group 10
15	Fabric group 15
20	Fabric group 20
30	Fabric group 30
35	Fabric group 35
40	Fabric group 40
50	Fabric group 50
55	Fabric group 55

Application Notes

Stackable add-up panels provide adaptable privacy on Service Walls, linkable screens or Morrison panels. Next up panels include intermediate masts that engage into sides of corresponding width first up or next-up panels. All stackable add-up panels may be removed without tools.

Specify wide add-up panels for use on long Service Wall and Fence runs.

A maximum of one next up stackable add-up panel may be used on top of a first up stackable add-up panel.

Stackable add-up connectors and fillers
*stackable add-up panels or
 Morrison panels perpendicular to service wall*

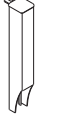
description	type	w	d	h	pattern no.	list price
Crown fillers for stackable add-up panels perpendicular to service wall 	First up	2"	2"	16"	AY1 PC16	\$245.
	First up	2"	2"	25"	AY1 PC25	260.
	First up	2"	2"	32"	AY1 PC32	273.
	Next up	2"	2"	16"	AY1 SPC16	230.
Crown fillers for Morrison perpendicular to service wall 		2 1/4"	2 1/4"	16"	AU1 PC12()	153.
		2 1/4"	2 1/4"	25"	AU1 PC21()	192.
		2 1/4"	2 1/4"	32"	AU1 PC28()	230.

Screens and add-up panels

Order Code	
Example: AU1 PC12 613	
AU1	Add-up panel
PC	Crown filler
12	Height
613	Finish





Specification Information
 Specify finish for vertical cover and top cap.

Application Notes
 Crown fillers extend from stackable add-up panel or Morrison panel or add-on panel connector to surface of crown-mounted add-up panels.
 Specify connector separately.
 Crown filler includes top cap.

Stackable add-up connectors and fillers

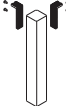
crown and linkable screen applications

Currents

description	type	w	d	h	pattern no.	price
Trim caps 	End cap				AY1 CE	\$5.
	Straight cap	2"	2"	–	AY1 CS	5.
Corner first up stackable connectors over linkable screens 		2"	2"	16"	AY1 LL16	230.
		2"	2"	25"	AY1 LL25	260.
		2"	2"	32"	AY1 LL32	290.
Corner next up stackable connectors over linkable screens 		2"	2"	16"	AY1 SL16	273.
T first up stackable connectors over linkable screens 		2"	2"	16"	AY1 LT16	290.
		2"	2"	25"	AY1 LT25	321.
		2"	2"	32"	AY1 LT32	352.
T next up stackable connectors over linkable screens 		2"	2"	16"	AY1 ST16	336.

Order Code

Example: AY1 LL16
AY1 Stackable add-up
L Screen application
L Configuration
16 Height

Specification Information

Connector caps and connector trims are integral color trim grey.

Application Notes





Trim caps are specified by application to fill top corners of stackable add-up panels. Straight cap aligns adjacent add-up panels. End cap finishes the end of a run of add-up panels.

Stackable connectors join stackable add-up panels over a linkable screen connector. Next up connectors correspond to next up panels.

Stackable add-up connectors and fillers

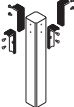
crown and linkable screen applications

Currents

description	type	w	d	h	pattern no.	price
X first up stackable connectors over linkable screens 		2"	2"	16"	AY1 LX16	\$336.
		2"	2"	25"	AY1 LX25	382.
		2"	2"	32"	AY1 LX32	412.
X next up stackable connectors over linkable screens - X next up 		2"	2"	16"	AY1 SX16	382.
First up straight post 		2"	2"	16"	AY1 LP16	260.
		2"	2"	25"	AY1 LP25	290.
		2"	2"	32"	AY1 LP32	321.
Next up straight post 		2"	2"	16"	AY1 SP16	304.

Screens and add-up panels

Order Code	Specification Information	Application Notes
Example: AY1 LL16 AY1 Stackable add-up L Screen application L Configuration 16 Height	Connector caps and connector trims are integral color trim grey.	Trim caps are specified by application to fill top corners of stackable add-up panels. Straight cap aligns adjacent add-up panels. End cap finishes the end of a run of add-up panels. Stackable connectors join stackable add-up panels over a linkable screen connector. Next up connectors correspond to next up panels.

Stackable add-up connectors and fillers

service wall, T-end and linkable screen applications

Currents

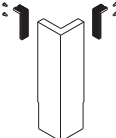
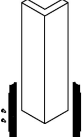
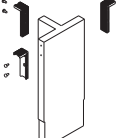
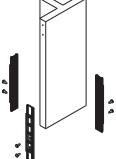
description	type	w	d	h	pattern no.	list price
 Stackable accessories	Crown-mount masts (replacement)				AY1 CMK	\$62.
	High-low adapter kit				AY1 HLA	77.
	Linkable screen masts (replacement)				AY1 MMK	62.
	Stacking hardware kit (replacement)				AY1 SMK	44.
 90° 2-way L first up corner fillers		6"	6"	16"	AY1 CL12	458.
		6"	6"	25"	AY1 CL21	536.
		6"	6"	32"	AY1 CL28	612.
 90° 2-way L next up corner fillers		6"	6"	16"	AY1 SCL16	505.
 90° 3-way T corner fillers		7"	6"	16"	AY1 CT12	536.
		7"	6"	25"	AY1 CT21	612.
		7"	6"	32"	AY1 CT28	688.
 90° 3-way T next up corner fillers		7"	6"	16"	AY1 SCT16	581.

Order Code

Example: AY1 CL28
AY1 Stackable add-up
CL Connector type
28 Height

Specification Information

Stackable add-up fillers and trim are trim grey finish.

Application Notes

Hi-low adapter kit includes an end cap and a bayonet with attachment holes to join stackable add-up panels in a straight high/low configuration. The adapter also adapts a corner, T, or X post for high/low corner configurations.

Corner fillers join stackable add-ups and fill the space above a Service Wall L or T connection.

T-end extension fillers fill the 1 1/8" or 3 1/2" space above the extending area of a T-end connection at the end of a Service Wall with stackable add-up panels.

T-end stackable fillers fill the 7"-wide space above a T-end when attached linkable screens or Morrison panels have stackable add-ups.





All fillers engage into the top corners of corresponding height stackable add-up panels.

Stackable add-up connectors and fillers

service wall, T-end and linkable screen applications

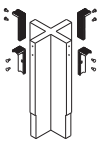
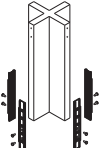
Currents

Screens and add-up panels

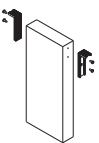
description	type	w	d	h	pattern no.	list price
 90° 4-way X corner fillers		7"	7"	16"	AY1 CX12	\$612.
		7"	7"	25"	AY1 CX21	688.
		7"	7"	32"	AY1 CX28	765.
 90° 4-way next up corner fillers		7"	7"	16"	AY1 SCX16	658.
 First up, T-end extension fillers	1" extension	1"	2"	16"	AY1 X112	214.
	1" extension	1"	2"	25"	AY1 X121	230.
	1" extension	1"	2"	32"	AY1 X128	245.
	3 1/2" extension	3 1/2"	2"	16"	AY1 X312	230.
	3 1/2" extension	3 1/2"	2"	25"	AY1 X321	245.
	3 1/2" extension	3 1/2"	2"	32"	AY1 X328	260.
 Next up 1" fillers		1"	2"	16"	AY1 SX116	230.
 Next up 3 1/2" fillers		3 1/2"	2"	16"	AY1 SX316	245.
 T-end stackable fillers	First up	7"	2"	16"	AY1 AXT16	321.
	First up	7"	2"	25"	AY1 AXT25	352.
	First up	7"	2"	32"	AY1 AXT32	382.
	Next up	7"	2"	16"	AY1 AXST16	321.

Order Code

Example: AY1 CL28	
AY1	Stackable add-up
CL	Connector type
28	Height

Specification Information

Stackable add-up fillers and trim are trim grey finish.

Application Notes

Hi-low adapter kit includes an end cap and a bayonet with attachment holes to join stackable add-up panels in a straight high/low configuration. The adapter also adapts a corner, T, or X post for high/low corner configurations.

Corner fillers join stackable add-ups and fill the space above a Service Wall L or T connection.

T-end extension fillers fill the 1 1/8" or 3 1/2" space above the extending area of a T-end connection at the end of a Service Wall with stackable add-up panels.

T-end stackable fillers fill the 7"-wide space above a T-end when attached linkable screens or Morrison panels have stackable add-ups.

All fillers engage into the top corners of corresponding height stackable add-up panels.

Worksurfaces, universal
straight, curved and flat front
1 3/4" wire drop

Currents

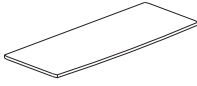
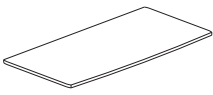
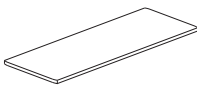
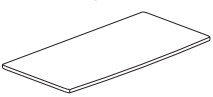
description	w	d	h	pattern no.	lam.
24"D straight worksurface, curved front 	24"	22 1/4"	1"	AW1 S2424 ()	\$295.
	30"	22 1/4"	1"	AW1 S3024 ()	324.
	36"	22 1/4"	1"	AW1 S3624 ()	354.
	42"	22 1/4"	1"	AW1 S4224 ()	385.
	48"	22 1/4"	1"	AW1 S4824 ()	412.
	60"	22 1/4"	1"	AW1 S6024 ()	472.
	66"	22 1/4"	1"	AW1 S6624 ()	502.
	72"	22 1/4"	1"	AW1 S7224 ()	533.
84"	22 1/4"	1"	AW1 S8424 ()	590.	
30"D straight worksurface, curved front 	36"	28 1/4"	1"	AW1 S3630 ()	399.
	48"	28 1/4"	1"	AW1 S4830 ()	455.
	60"	28 1/4"	1"	AW1 S6030 ()	533.
	72"	28 1/4"	1"	AW1 S7230 ()	619.
	84"	28 1/4"	1"	AW1 S8430 ()	710.
24"D Straight worksurface, flat front 	24"	22 1/4"	1"	AW1 F2424 ()	295.
	30"	22 1/4"	1"	AW1 F3024 ()	324.
	36"	22 1/4"	1"	AW1 F3624 ()	354.
	42"	22 1/4"	1"	AW1 F4224 ()	385.
	48"	22 1/4"	1"	AW1 F4824 ()	412.
	60"	22 1/4"	1"	AW1 F6024 ()	472.
	66"	22 1/4"	1"	AW1 F6624 ()	502.
	72"	22 1/4"	1"	AW1 F7224 ()	533.
84"	22 1/4"	1"	AW1 F8424 ()	590.	
30"D straight worksurface, flat front 	36"	28 1/4"	1"	AW1 F3630 ()	399.
	48"	28 1/4"	1"	AW1 F4830 ()	455.
	60"	28 1/4"	1"	AW1 F6030 ()	533.
	72"	28 1/4"	1"	AW1 F7230 ()	619.
	84"	28 1/4"	1"	AW1 F8430 ()	710.

Order Code

Example: AW1 S4830 117
AW1 Worksurface
S Straight
48 Width
30 Depth
117 Top finish

Specification Information

Worksurface edges are trim grey.
Specify top finish
Veneer finishes for Currents worksurfaces are available through Custom Product Development.

Application Notes

Worksurfaces may be end-supported, cantilevered from Service Wall, or supported by C-leg or pedestal at each end. Universal worksurfaces are interchangeable with Currents desks. Specify supports separately.
Straight worksurfaces have a 1"D curved front for additional surface area, or a flat front. Flat front allows two straight worksurfaces to meet at right angles.

24"D straight worksurfaces may be cantilevered with two cantilever brackets.
24" and 30"D straight worksurfaces may be end supported with two Currents end support brackets.
Universal straight worksurfaces 36" wide and greater include a steel stiffener that doubles as a horizontal cable manager.

corner



1 3/4" wire drop

description	w	d	h	pattern no.	lam.
24"D both sides corner worksurfaces 	42"	42"	1"	AW1 C4242 S ()	\$659.
	48"	48"	1"	AW1 C4848 S ()	730.
	60"	60"	1"	AW1 C6060 S ()	1,021.
30"D both sides corner worksurfaces	42"	42"	1"	AW1 C4242 D ()	659.
	48"	48"	1"	AW1 C4848 D ()	730.
	60"	60"	1"	AW1 C6060 D ()	1,021.
30"D left/24"D right corner worksurfaces	42"	42"	1"	AW1 C4242 L ()	659.
	48"	48"	1"	AW1 C4848 L ()	730.
	60"	60"	1"	AW1 C6060 L ()	1,021.
24"D left/30"D right corner worksurfaces	42"	42"	1"	AW1 C4242 R ()	659.
	48"	48"	1"	AW1 C4848 R ()	730.
	60"	60"	1"	AW1 C6060 R ()	1,021.

Order Code	Specification Information	Application Notes
Example: AW1 C4848S 117 AW1 Worksurface C Corner 48 Width left 48 Width right S Depth left and right 117 Top finish	Dimensions shown in "w" column are nominal width of left back edge. Dimensions shown in "d" column are nominal width of right back edge. <i>Worksurface depths:</i> S 24"D both sides L 30"D left/24"D right R 24"D left/30"D right D 30"D both sides Specify top finish.	Worksurface edges are trim grey. Clear maple laminate is not available on 60w x 60d corner tops. Veneer finishes for Currents worksurfaces are available through Custom Product Development. Universal worksurfaces are interchangeable with Currents desks. Specify worksurface supports separately. Corner worksurfaces may be supported by two cantilever brackets on one back edges in combination with C-leg or pedestal support on other end. Universal corner worksurfaces include a steel stiffener on both back edges that doubles as a horizontal cable manager.

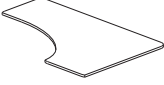

Worksurfaces, universal
extended corner
1 3/4" wire drop
extended left

Currents

description	w	d	h	pattern no.	lam.
24"D both sides corner worksurfaces, extended left 	60"	36"	1"	AW1 C6036 S ()	\$730.
	60"	42"	1"	AW1 C6042 S ()	806.
	60"	48"	1"	AW1 C6048 S ()	878.
	72"	36"	1"	AW1 C7236 S ()	878.
	72"	42"	1"	AW1 C7242 S ()	948.
	72"	48"	1"	AW1 C7248 S ()	1,021.
	84"	36"	1"	AW1 C8436 S ()	1,021.
	84"	42"	1"	AW1 C8442 S ()	1,095.
84"	48"	1"	AW1 C8448 S ()	1,169.	
30"D both sides corner worksurfaces, extended left 	60"	48"	1"	AW1 C6048 D ()	950.
	72"	48"	1"	AW1 C7248 D ()	1,095.
	84"	48"	1"	AW1 C8448 D ()	1,242.
30"D left/24"D right corner worksurfaces, extended left 	60"	42"	1"	AW1 C6042 L ()	878.
	60"	48"	1"	AW1 C6048 L ()	950.
	72"	42"	1"	AW1 C7242 L ()	1,021.
	72"	48"	1"	AW1 C7248 L ()	1,095.
	84"	42"	1"	AW1 C8442 L ()	1,169.
	84"	48"	1"	AW1 C8448 L ()	1,242.
24"D left/30"D right corner worksurfaces, extended left	60"	42"	1"	AW1 C6042 R ()	878.
	60"	48"	1"	AW1 C6048 R ()	950.
	72"	42"	1"	AW1 C7242 R ()	1,021.
	72"	48"	1"	AW1 C7248 R ()	1,095.
	84"	42"	1"	AW1 C8442 R ()	1,169.
	84"	48"	1"	AW1 C8448 R ()	1,242.

Order Code	Specification Information	Application Notes
Example: AW1 C6036S 117 AW1 Worksurface C Corner 60 Width left 36 Width right S Depth left and right 117 Top finish	Dimensions shown in "w" column are nominal width of left back edge. Dimensions shown in "d" column are nominal width of right back edge. <i>Worksurface depths:</i> S 24"D both sides L 30"D left/24"D right R 24"D left/30"D right D 30"D both sides Specify top finish.	Worksurface edges are trim grey. Veneer finishes for Currents worksurfaces are available through Custom Product Development. Universal worksurfaces are interchangeable with Currents desks. Specify worksurface supports separately. Corner worksurfaces may be supported by two cantilever brackets on one back edge in combination with C-leg or pedestal support on other end. Universal extended corner worksurfaces include a steel stiffener on both back edges that doubles as a horizontal cable manager.

Worksurfaces, universal
extended corner
1 3/4" wire drop
extended right

description	w	d	h	pattern no.	lam.
24"D both sides corner worksurfaces, extended right 	36"	60"	1"	AW1 C3660 S ()	\$730.
	36"	72"	1"	AW1 C3672 S ()	878.
	36"	84"	1"	AW1 C3684 S ()	1,021.
	42"	60"	1"	AW1 C4260 S ()	806.
	42"	72"	1"	AW1 C4272 S ()	948.
	42"	84"	1"	AW1 C4284 S ()	1,095.
	48"	60"	1"	AW1 C4860 S ()	878.
	48"	72"	1"	AW1 C4872 S ()	1,021.
48"	84"	1"	AW1 C4884 S ()	1,169.	
30"D both sides corner worksurfaces, extended right	48"	60"	1"	AW1 C4860 D ()	950.
	48"	72"	1"	AW1 C4872 D ()	1,095.
	48"	84"	1"	AW1 C4884 D ()	1,242.
24"D left/30"D right corner worksurfaces, extended right 	42"	60"	1"	AW1 C4260 R ()	878.
	42"	72"	1"	AW1 C4272 R ()	1,021.
	42"	84"	1"	AW1 C4284 R ()	1,169.
	48"	60"	1"	AW1 C4860 R ()	950.
	48"	72"	1"	AW1 C4872 R ()	1,095.
	48"	84"	1"	AW1 C4884 R ()	1,242.
30"D left/24"D right corner worksurfaces, extended right	42"	60"	1"	AW1 C4260 L ()	878.
	42"	72"	1"	AW1 C4272 L ()	1,021.
	42"	84"	1"	AW1 C4284 L ()	1,169.
	48"	60"	1"	AW1 C4860 L ()	950.
	48"	72"	1"	AW1 C4872 L ()	1,095.
	48"	84"	1"	AW1 C4884 L ()	1,242.

Worksurfaces

Order Code

Example: AW1 C3660S 117
AW1 Worksurface
C Corner
36 Width left
60 Width right
S Depth left and right
117 Top finish

Specification Information

Dimensions shown in "w" column are nominal width of left back edge. Dimensions shown in "d" column are nominal width of right back edge.

Worksurface depths:
 S 24"D both sides
 L 30"D left/24"D right
 R 24"D left/30"D right
 D 30"D both sides

Specify top finish.

Worksurface edges are trim grey.

Veneer finishes for Currents worksurfaces are available through Custom Product Development.

Application Notes

Universal worksurfaces are interchangeable with Currents desks. Specify worksurface supports separately.

Corner worksurfaces may be supported by two cantilever brackets on one back edge in combination with C-leg or pedestal support on other end.



Universal extended corner worksurfaces include a steel stiffener on both back edges that doubles as a horizontal cable manager.

Worksurfaces, universal

Currents

P-shape

1 3/4" wire drop

description	w	d	h	pattern no.	lam.
P-shape surfaces, extended left 	75"	48"	1"	AW1 P7548 S ()	\$1,169.
	87"	48"	1"	AW1 P8748 S ()	1,315.
P-shape surfaces, extended right 	48"	75"	1"	AW1 P4875 S ()	1,169.
	48"	87"	1"	AW1 P4887 S ()	1,315.

Order Code

Example: AW1 P7548S 117
AW1 Worksurface
P P-shape
75 Width left
48 Width right
S Depth of return
117 Top finish

Specification Information

Dimensions shown in "w" column are nominal width of left back edge. Dimensions shown in "d" column are nominal width of right back edge.

Specify top finish.

Worksurface edges are trim grey.

Veneer finishes for Currents worksurfaces are available through Custom Product Development.

Application Notes

P-shape worksurfaces may be cantilevered from service wall along 48" edge, and supported by 24"D C-leg at conference end. Specify two cantilever brackets and C-leg separately.

All P-shape worksurfaces correspond to a 24"D adjacent straight or corner worksurface.

Universal P-shape worksurfaces include a steel stiffener on both back edges that doubles as a horizontal cable manager.

Worksurfaces, universal
shared and arc-shape
1 3/4" wire drop

Currents

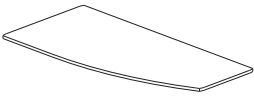
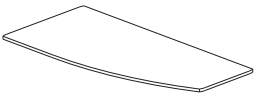
description	w	d	h	pattern no.	lam.
36"D shared worksurface	36"	72"	1"	AW1 R7236 ()	\$964.
					
36"D left, 24"D right arc shape surface	60"	34 1/4"	1"	AW1 A60L ()	807.
	72"	34 1/4"	1"	AW1 A72L ()	964.
					
36"D right, 24"D left arc shape surface	60"	34 1/4"	1"	AW1 A60R ()	807.
	72"	34 1/4"	1"	AW1 A72R ()	964.
					

Worksurfaces

Order Code	Specification Information	Application Notes
Example: AW1 P7548S 117	Specify top finish.	36"D shared worksurface requires two straight legs and two end support brackets, or four straight legs.
AW1 Worksurface	Veneer finishes for Currents worksurfaces are available through Custom Product Development.	Arc shape worksurfaces require 18"D floorstanding pedestal or 24"D C-leg at 24"D end and two end support brackets or straight legs at 36"D end.
P P-shape		
75 Width left		
48 Width right		
S Depth of return		
117 Top finish		

Universal shared and arc-shape worksurfaces include a steel stiffener that doubles as a horizontal cable manager.

Currents worksurfaces for Morrison panels and linkable screens
straight, flat front
3/8" wire drop and grommet

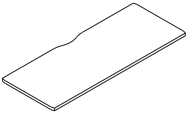
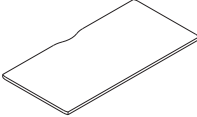
description	w	d	h	pattern no.	lam.
24"D straight worksurface, flat front 	24"	23 5/8"	1"	AWM2 F2424 () ()	\$295.
	30"	23 5/8"	1"	AWM2 F3024 () ()	324.
	36"	23 5/8"	1"	AWM2 F3624 () ()	354.
	42"	23 5/8"	1"	AWM2 F4224 () ()	385.
	48"	23 5/8"	1"	AWM2 F4824 () ()	412.
	54"	23 5/8"	1"	AWM2 F5424 () ()	442.
	60"	23 5/8"	1"	AWM2 F6024 () ()	472.
	66"	23 5/8"	1"	AWM2 F6624 () ()	502.
	72"	23 5/8"	1"	AWM2 F7224 () ()	533.
	78"	23 5/8"	1"	AWM2 F7824 () ()	559.
	84"	23 5/8"	1"	AWM2 F8424 () ()	590.
	90"	23 5/8"	1"	AWM2 F9024 () ()	618.
96"	23 5/8"	1"	AWM2 F9624 () ()	650.	
30"D straight worksurface, flat front 	30"	29 5/8"	1"	AWM2 F3030 () ()	368.
	36"	29 5/8"	1"	AWM2 F3630 () ()	399.
	42"	29 5/8"	1"	AWM2 F4230 () ()	430.
	48"	29 5/8"	1"	AWM2 F4830 () ()	455.
	54"	29 5/8"	1"	AWM2 F5430 () ()	492.
	60"	29 5/8"	1"	AWM2 F6030 () ()	533.
	66"	29 5/8"	1"	AWM2 F6630 () ()	577.
	72"	29 5/8"	1"	AWM2 F7230 () ()	619.
	78"	29 5/8"	1"	AWM2 F7830 () ()	663.
	84"	29 5/8"	1"	AWM2 F8430 () ()	710.
	90"	29 5/8"	1"	AWM2 F9030 () ()	752.
	96"	29 5/8"	1"	AWM2 F9630 () ()	795.

Order Code	Specification Information	Application Notes
Example: AWM2 F4830 117 111 AWM2 Worksurface F Flat 48 Width 30 Depth 117 Top finish 111 Trim finish	Specify top finish first, followed by trim finish. Veneer finishes for Currents worksurfaces are available through Custom Product Development.	<p>Worksurfaces are sized for Morrison panel-based applications and may be supported by Morrison panel planning brackets or end-supported from Currents Wall. 24"D straight tops may also be cantilevered from Currents Service Wall. Underside of worksurfaces is drilled to accept all Morrison panel-planning brackets, Morrison and Currents pedestals, and worksurface stiffeners. 24"D straight tops are also drilled to accept Currents Wall cantilever brackets.</p> <p>Currents worksurfaces for Morrison accept wood screws.</p> <p>Currents worksurfaces for Morrison require stiffener when the span between structural supports exceeds 36". Specify worksurface stiffeners and supports separately.</p> <p>Currents worksurfaces for Morrison cannot be used in conjunction with Morrison Network desk supports.</p>

Actual worksurface depth is 3/8" less than nominal 24" and 30" for cable clearance.



All worksurfaces include one edge grommet, centered at rear of worksurface, with maximum clearance of 1 5/8".

Currents for Morrison worksurfaces feature crisp 90° corners eliminating the corner kick detail typical of Currents universal and desk tops. Eliminating the corner kick will facilitate the use of brackets, pedestals and end panels at the side edge of worksurfaces and will eliminate undesired gaps at worksurface joints.

24"D straight Currents worksurfaces for Morrison up to 84" wide may be cantilevered from the Service Wall with two cantilever brackets and applicable width worksurface stiffener.

24"D straight Currents worksurfaces for Morrison wider than 84" require three cantilever brackets and applicable width worksurface stiffeners.



Currents worksurfaces for Morrison panels and linkable screens
extended corner
3/8" wire drop and grommet
extended left

description	w	d	h	pattern no.	lam.
24"D both sides corner worksurfaces, extended left 	60"	36"	1"	AWM2 C6036 S () ()	\$730.
	60"	42"	1"	AWM2 C6042 S () ()	806.
	60"	48"	1"	AWM2 C6048 S () ()	878.
	72"	36"	1"	AWM2 C7236 S () ()	878.
	72"	42"	1"	AWM2 C7242 S () ()	948.
	72"	48"	1"	AWM2 C7248 S () ()	1,021.
	84"	48"	1"	AWM2 C8448 S () ()	1,169.
30"D both sides corner worksurfaces, extended left	60"	48"	1"	AWM2 C6048 D () ()	950.
	72"	48"	1"	AWM2 C7248 D () ()	1,095.
	84"	48"	1"	AWM2 C8448 D () ()	1,242.
30"D left/24"D right corner worksurfaces, extended left 	60"	42"	1"	AWM2 C6042 L () ()	878.
	60"	48"	1"	AWM2 C6048 L () ()	950.
	72"	42"	1"	AWM2 C7242 L () ()	1,021.
	72"	48"	1"	AWM2 C7248 L () ()	1,095.
	84"	48"	1"	AWM2 C8448 L () ()	1,242.
24"D left/30"D right corner worksurfaces, extended left	60"	42"	1"	AWM2 C6042 R () ()	878.
	60"	48"	1"	AWM2 C6048 R () ()	950.
	72"	42"	1"	AWM2 C7242 R () ()	1,021.
	72"	48"	1"	AWM2 C7248 R () ()	1,095.
	84"	48"	1"	AWM2 C8448 R () ()	1,242.

Worksurfaces

Order Code	Specification Information	Application Notes
Example: AWM2 C6036S 117 111 AWM2 Worksurface C Corner 60 Width left 36 Width right S Depth left and right 117 Top finish 111 Trim finish	Dimensions shown in "w" column are nominal width of left back edge. Dimensions shown in "d" column are nominal width of right back edge. <i>Worksurface depths:</i> S 24"D both sides L 30"D left/24"D right R 24"D left/30"D right D 30"D both sides Specify top finish first, followed by trim finish. Veneer finishes for Currents worksurfaces are available through Custom Product Development.	Currents for Morrison worksurfaces feature crisp 90° corners eliminating the corner kick detail typical of Currents universal and desk tops. Eliminating the corner kick will facilitate the use of brackets, pedestals and end panels at the side edge of worksurfaces and will eliminate undesired gaps at worksurface joints. Currents worksurfaces for Morrison accept wood screws. Worksurfaces are sized for Morrison panel-based applications and may be supported by Morrison panel-planning brackets or end-supported and cantilevered from Currents Wall. Extended side may also be supported with Currents C-legs. Underside of work surface is drilled to accept all Morrison panel-planning brackets, Morrison and Currents pedestals, work surface stiffeners and Currents C-leg on the extended side. Currents worksurfaces for Morrison require stiffener when the span between structural supports exceeds 36". Specify work surface stiffeners and supports separately. Currents worksurfaces for Morrison cannot be used in conjunction with Morrison Network desk supports. Actual work surface is 3/8" less than nominal 24" and 30" for cable clearance. All worksurfaces include two edge grommets, centered on back edges of work surface, with maximum clearance of 1 3/8".



Currents worksurfaces for Morrison panels and linkable screens
extended corner
3/8" wire drop and grommet
extended right

description	w	d	h	pattern no.	lam.
24"D both sides corner worksurfaces extended right 	36"	60"	1"	AWM2 C3660 S () ()	\$730.
	36"	72"	1"	AWM2 C3672 S () ()	878.
	42"	60"	1"	AWM2 C4260 S () ()	806.
	42"	72"	1"	AWM2 C4272 S () ()	948.
	48"	60"	1"	AWM2 C4860 S () ()	878.
	48"	72"	1"	AWM2 C4872 S () ()	1,021.
	48"	84"	1"	AWM2 C4884 S () ()	1,169.
30"D both sides corner worksurfaces, extended right	48"	60"	1"	AWM2 C4860 D () ()	950.
	48"	72"	1"	AWM2 C4872 D () ()	1,095.
	48"	84"	1"	AWM2 C4884 D () ()	1,242.
24"D left/30"D right corner worksurfaces, extended right 	42"	60"	1"	AWM2 C4260 R () ()	878.
	42"	72"	1"	AWM2 C4272 R () ()	1,021.
	48"	60"	1"	AWM2 C4860 R () ()	950.
	48"	72"	1"	AWM2 C4872 R () ()	1,095.
	48"	84"	1"	AWM2 C4884 R () ()	1,242.
30"D left/24"D right corner worksurfaces, extended right	42"	60"	1"	AWM2 C4260 L () ()	878.
	42"	72"	1"	AWM2 C4272 L () ()	1,021.
	48"	60"	1"	AWM2 C4860 L () ()	950.
	48"	72"	1"	AWM2 C4872 L () ()	1,095.
	48"	84"	1"	AWM2 C4884 L () ()	1,242.

Order Code	Specification Information	Application Notes
Example: AWM2 C3660S 117 111 AWM2 Worksurface C Corner 36 Width left 60 Width right S Depth left and right 117 Top finish 111 Trim finish	Dimensions shown in "w" column are nominal width of left back edge. Dimensions shown in "d" column are nominal width of right back edge. <i>Worksurface depths:</i> S 24"D both sides L 30"D left/24"D right R 24"D left/30"D right D 30"D both sides Specify top finish first, followed by trim finish. Veneer finishes for Currents worksurfaces are available through Custom Product Development.	Currents for Morrison worksurfaces feature crisp 90° corners eliminating the corner kick detail typical of Currents universal and desk tops. Eliminating the corner kick will facilitate the use of brackets, pedestals and end panels at the side edge of worksurfaces and will eliminate undesired gaps at worksurface joints. Currents worksurfaces for Morrison accept wood screws. Worksurfaces are sized for Morrison panel-based applications and may be supported by Morrison panel-planning brackets or end-supported and cantilevered from Currents Wall. Extended side may also be supported with Currents C-legs. Underside of work surface is drilled to accept all Morrison panel-planning brackets, Morrison and Currents pedestals, work surface stiffeners and Currents C-leg on the extended side. Currents worksurfaces for Morrison require stiffener when the span between structural supports exceeds 36". Specify work surface stiffeners and supports separately. Currents worksurfaces for Morrison cannot be used in conjunction with Morrison Network desk supports. Actual work surface is 3/8" less than nominal 24" and 30" for cable clearance. All worksurfaces include two edge grommets, centered on back edges of work surface, with maximum clearance of 1 3/8".

Currents worksurfaces for Morrison panels and linkable screens

corner 3/8" wire drop and grommet

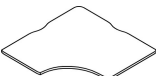
description	w	d	h	pattern no.	lam.
 24"D both sides corner worksurfaces	42"	42"	1"	AWM2 C4242 S () ()	\$659.
	48"	48"	1"	AWM2 C4848 S () ()	730.
	60"	60"	1"	AWM2 C6060 S () ()	1,021.
 30"D both sides corner worksurfaces	42"	42"	1"	AWM2 C4242 D () ()	659.
	48"	48"	1"	AWM2 C4848 D () ()	730.
	60"	60"	1"	AWM2 C6060 D () ()	1,021.
 30"D left/24"D right corner worksurfaces	42"	42"	1"	AWM2 C4242 L () ()	659.
	48"	48"	1"	AWM2 C4848 L () ()	730.
	60"	60"	1"	AWM2 C6060 L () ()	1,021.
 24"D left/30"D right corner worksurfaces	42"	42"	1"	AWM2 C4242 R () ()	659.
	48"	48"	1"	AWM2 C4848 R () ()	730.
	60"	60"	1"	AWM2 C6060 R () ()	1,021.

Order Code	Specification Information	Application Notes
Example: AWM2 C4848S 117 111 AWM2 Worksurface C Corner 48 Width left 48 Width right S Depth left and right 117 Top finish 111 Trim finish	Dimensions shown in "w" column are nominal width of left back edge. Dimensions shown in "d" column are nominal width of right back edge. <i>Worksurface depths:</i> S 24"D both sides L 30"D left/24"D right R 24"D left/30"D right D 30"D both sides Specify top finish first, followed by trim finish. Veneer finishes for Currents worksurfaces are available through Custom Product Development.	Currents for Morrison worksurfaces feature crisp 90° corners eliminating the corner kick detail typical of Currents universal and desk tops. Eliminating the corner kick will facilitate the use of brackets, pedestals and end panels at the side edge of worksurfaces and will eliminate undesired gaps at worksurface joints. Clear Maple is not available on 60"W x 60"D corner worksurfaces. Currents worksurfaces for Morrison accept wood screws. Currents worksurfaces for Morrison require stiffener when the span between structural supports exceeds 36". Specify worksurface stiffeners and supports separately. All P-shaped worksurfaces correspond to a 24"D adjacent straight or corner worksurface. Currents worksurfaces for Morrison cannot be used in conjunction with Morrison Network desk supports. Actual worksurface depth is 3/8" less than nominal 24" and 30" for cable clearance. All worksurfaces include two edge grommets, centered on back edges of worksurface, with maximum clearance of 1 5/8".

Currents worksurfaces for Morrison panels and linkable screens

P-shapes

3/8" wire drop and grommet

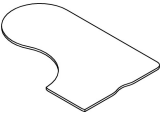
description	w	d	h	pattern no.	lam.
P-shape surfaces, extended right 	48"	75"	1"	AWM2 P4875 S () ()	\$1,169.
	48"	87"	1"	AWM2 P4887 S () ()	1,315.
P-shape surfaces, extended left 	75"	48"	1"	AWM2 P7548 S () ()	1,169.
	87"	48"	1"	AWM2 P8748 S () ()	1,315.

Order Code	Specification Information	Application Notes
<p>Example: AWM2 C4848S 117 111</p> <p>AWM2 Worksurface</p> <p>C Corner</p> <p>48 Width left</p> <p>48 Width right</p> <p>S Depth left and right</p> <p>117 Top finish</p> <p>111 Trim finish</p>	<p>Dimensions shown in "w" column are nominal width of left back edge.</p> <p>Dimensions shown in "d" column are nominal width of right back edge.</p> <p><i>Worksurface depths:</i></p> <p>S 24"D both sides L 30"D left/24"D right R 24"D left/30"D right D 30"D both sides</p> <p>Specify top finish first, followed by trim finish.</p> <p>Veneer finishes for Currents worksurfaces are available through Custom Product Development.</p>	<p>Currents for Morrison worksurfaces feature crisp 90° corners eliminating the corner kick detail typical of Currents universal and desk tops. Eliminating the corner kick will facilitate the use of brackets, pedestals and end panels at the side edge of worksurfaces and will eliminate undesired gaps at worksurface joints.</p> <p>Clear Maple is not available on 60"W x 60"D corner worksurfaces.</p> <p>Currents worksurfaces for Morrison accept wood screws.</p> <p>Currents worksurfaces for Morrison panel-based applications and may be supported by Morrison panel-planning brackets or end-supported and cantilevered from Currents Wall. Underside of worksurfaces is drilled to accept all Morrison panel-planning brackets, Morrison and Currents pedestals, and worksurface stiffeners. 24"D worksurfaces are also drilled to accept Currents wall cantilever brackets.</p> <p>Currents worksurfaces for Morrison require stiffener when the span between structural supports exceeds 36". Specify worksurface stiffeners and supports separately.</p> <p>All P-shaped worksurfaces correspond to a 24"D adjacent straight or corner worksurface.</p> <p>Currents worksurfaces for Morrison cannot be used in conjunction with Morrison Network desk supports.</p> <p>Actual worksurface depth is 3/8" less than nominal 24" and 30" for cable clearance.</p> <p>All worksurfaces include two edge grommets, centered on back edges of worksurface, with maximum clearance of 1 5/8".</p>

Currents worksurfaces for Morrison panels and linkable screens stiffeners

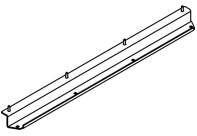
description	type	w	d	h	pattern no.	price
	36"	20"	1 1/2"	1"	AWM1 S36	\$58.
	42"	26"	1 1/2"	1"	AWM1 S42	62.
	48"	32"	1 1/2"	1"	AWM1 S48	64.
	60"	44"	1 1/2"	1"	AWM1 S60	66.
	66"	50"	1 1/2"	1"	AWM1 S66	70.
	72"	56"	1 1/2"	1"	AWM1 S72	72.
	78"	62"	1 1/2"	1"	AWM1 S78	75.
	84"	68"	1 1/2"	1"	AWM1 S84	77.

Order Code	Specification Information	Application Notes
Example: AWM1 S36 AWM1 Stiffener S Straight 36 Application	Stiffeners are black painted finish.	<p>Currents worksurfaces for Morrison require stiffeners when the span between structural supports (end supports, cantilevers, pedestals, or C-legs) exceeds 36". Stiffener also serves as horizontal cable manager.</p> <p>Stiffener corresponds in width to straight or corner worksurface back edge.</p> <p>For 90" application span, use AWM1-S84 stiffener.</p> <p>Stiffener mounts 18" from front edge of worksurface and will interfere with mobile or floorstanding pedestals greater than 18" deep.</p> <p>To accommodate a floorstanding pedestal greater than 18" deep at one end of worksurface, specify stiffener for 12" narrower worksurface. To accommodate two floorstanding pedestals or double-wide at one end of worksurface, specify stiffener for 24" narrower worksurface.</p>

Cascade edge worksurfaces

Rectangular

Currents

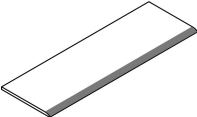
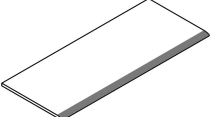
description	w	d	h	pattern no.	Solid	Woodgrain
24"D Rectangular 	24"	24"	1 1/8"	ACE1R2424N	\$228.	\$261.
	30"	24"	1 1/8"	ACE1R3024N	261.	300.
	36"	24"	1 1/8"	ACE1R3624N	288.	332.
	42"	24"	1 1/8"	ACE1R4224N	332.	382.
	48"	24"	1 1/8"	ACE1R4824N	373.	429.
	54"	24"	1 1/8"	ACE1R5424N	401.	460.
	60"	24"	1 1/8"	ACE1R6024N	435.	500.
	66"	24"	1 1/8"	ACE1R6624N	470.	539.
	72"	24"	1 1/8"	ACE1R7224N	491.	565.
	78"	24"	1 1/8"	ACE1R7824N	528.	606.
	84"	24"	1 1/8"	ACE1R8424N	558.	641.
90"	24"	1 1/8"	ACE1R9024N	629.	722.	
96"	24"	1 1/8"	ACE1R9624N	687.	789.	
30"D Rectangular 	24"	30"	1 1/8"	ACE1R2430N	289.	334.
	30"	30"	1 1/8"	ACE1R3030N	325.	373.
	36"	30"	1 1/8"	ACE1R3630N	362.	416.
	42"	30"	1 1/8"	ACE1R4230N	393.	450.
	48"	30"	1 1/8"	ACE1R4830N	435.	500.
	54"	30"	1 1/8"	ACE1R5430N	492.	566.
	60"	30"	1 1/8"	ACE1R6030N	541.	621.
	66"	30"	1 1/8"	ACE1R6630N	604.	694.
	72"	30"	1 1/8"	ACE1R7230N	629.	722.
	78"	30"	1 1/8"	ACE1R7830N	670.	771.
	84"	30"	1 1/8"	ACE1R8430N	713.	820.
90"	30"	1 1/8"	ACE1R9030N	767.	882.	
96"	30"	1 1/8"	ACE1R9630N	820.	942.	

Order Code	Specification Information	Application Notes
Example: ACE1 R4824N 118 ACE1 Cascade edge worksurface R Rectangular 48 Width 24 Depth N No grommet 118 Top finish	<i>Specify:</i> Grommet / No grommet. Replace the "N" suffix from the pattern number with "G". Add \$20. Available finishes: Solid: 114 Folkstone Grey 117 Soft Grey 118 Bright White 119 Pumice Woodgrain: 124 Medium Cherry 125 Natural Maple 126 Natural Cherry 127 Walnut	Cascade Edge worksurfaces are wrapped with a 3D laminate sheet heated and pressed around an FSC-certified substrate. 3D laminate is more susceptible to denting, impact, tearing and marring than conventional high-pressure laminate and should be handled with care. Do not drag worksurfaces across any flooring surface. Treat Cascade Edge worksurfaces like veneer worksurfaces for optimum performance under normal conditions. Cascade Edge worksurfaces have a 10 year warranty on defects in workmanship and materials. This warranty does not cover damage occurring during or after installation. Cascade edge worksurfaces in solid colors utilize a non-PVC construction and are also free of any plasticizers, phthalates and lead content. Cascade Edge worksurfaces are not drilled for stiffeners, pedestals or brackets. Cascade Edge worksurfaces are sized for panel-based applications and may be supported by linkable screen in conjunction with Morrison panel planning brackets, or end support from the Currents wall. 24" D straight tops may also be cantilevered from the Service Wall.

Cascade Edge worksurfaces are not interchangeable with Currents desks surfaces and should not be used to create freestanding Currents desks. Worksurfaces are 1/16" less than nominal width and 3/8" less than nominal depth for rear wire clearance. Edge grommets are centered at rear edges of worksurface for maximum clearance of 1 3/8".

Worksurfaces require support every 48" in width. All supporting hardware is ordered separately. Use Morrison brackets with wood screws for Currents Linkable screen applications.

Worksurfaces may be supported at each end by pedestals or end support "EC" brackets and cantilever brackets matching the worksurface depth. 24" D rectangular worksurfaces may also be cantilevered from the Currents service wall. Panel supported worksurfaces over 48" must be mid-span supported by cantilever brackets, specified separately.

Cascade edge worksurfaces

Curvilinear corner

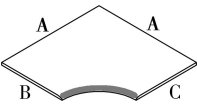
description	A	B	C	h	pattern no.	Solid	Woodgrain
	36"	24"	24"	1 1/8"	ACE1L3636SSN	\$568.	\$655.
	42"	24"	24"	1 1/8"	ACE1L4242SSN	687.	789.
	42"	24"	30"	1 1/8"	ACE1L4242SDN	816.	936.
	42"	30"	24"	1 1/8"	ACE1L4242DSN	816.	936.
	48"	24"	24"	1 1/8"	ACE1L4848SSN	771.	887.
	48"	24"	30"	1 1/8"	ACE1L4848SDN	924.	1,062.
	48"	30"	24"	1 1/8"	ACE1L4848DSN	924.	1,062.
	48"	30"	30"	1 1/8"	ACE1L4848DDN	828.	953.

Worksurfaces

Order Code

Example:	ACE1 L4848SSG 114
ACE1	Cascade edge worksurface
L	Curvilinear "L" top
48	Width left
48	Width right
S	24" depth left side
S	24" depth right side
G	Grommets
114	Top finish

Specification Information

Specify:
Grommet / No grommet.
Replace the "N" suffix from the pattern number with "G". Add \$40.

Available finishes:

Solid:

114	Folkstone Grey
117	Soft Grey
118	Bright White
119	Pumice

Woodgrain:

124	Medium Cherry
125	Natural Maple
126	Natural Cherry
127	Walnut

Note: When wood grain or brushed finishes are specified on Cascade corner worksurfaces with two "A" sides of equal length that do not exceed 42" you must select one of three grain direction options. Insert the desired grain direction "L"= Left hand, "R"= Right hand or "D"= Diagonal after the worksurface finish code to indicate the appropriate grain direction. When the "D" option is selected please add \$25.00 to the worksurface list price. 48" Cascade corners are not available with a diagonal grain option.

Application Notes

Cascade Edge worksurfaces are wrapped with a 3D laminate sheet heated and pressed around an FSC-certified substrate. 3D laminate is more susceptible to denting, impact, tearing and marring than conventional high-pressure laminate and should be handled with care. Do not drag worksurfaces across any flooring surface. Treat Cascade Edge worksurfaces like veneer worksurfaces for optimum performance under normal conditions. Cascade Edge worksurfaces have a 10 year warranty on defects in workmanship and materials. This warranty does not cover damage occurring during or after installation. Cascade edge worksurfaces in solid colors utilize a non-PVC construction and are also free of any plasticizers, phthalates and lead content.

Cascade Edge worksurfaces are not drilled for stiffeners, pedestals or brackets. Cascade Edge worksurfaces are sized for panel-based applications and may be supported by linkable screen in conjunction with Morrison panel planning brackets, or end support from the Currents wall. 24" D straight tops may also be cantilevered from the Service Wall.

Cascade Edge worksurfaces are not interchangeable with Currents desks surfaces and should not be used to create freestanding Currents desks. Worksurfaces are 1/16" less than nominal width and 3/8" less than nominal depth for rear wire clearance. Edge grommets are centered at rear edges of worksurface for maximum clearance of 1 3/8".

Worksurfaces require support every 48" in width. All supporting hardware is ordered separately. Use Morrison brackets with wood screws for Currents Linkable screen applications.

Worksurfaces may be supported by left or right hand 18" cantilever bracket at the rear corner, and cantilever bridging brackets on each side edge. Worksurfaces may also be end supported or cantilever-bracket supported from Currents wall. Extended side of blended L may also be supported with Currents C-legs.

Panel supported worksurfaces over 48" must be mid-span supported by cantilever brackets, specified separately.

Cascade edge worksurfaces

Blended "D"

Currents

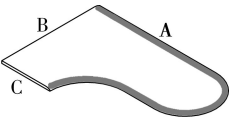
description	A	B	C	h	pattern no.	Solid	Woodgrain
 <p>right hand shown</p>	66"	48"	24"	1 1/8"	ACE1BD6648S(L/R)	\$920.	\$1,058.
	66"	48"	30"	1 1/8"	ACE1BD6648D(L/R)	967.	1,113.
	72"	48"	24"	1 1/8"	ACE1BD7248S(L/R)	940.	1,083.
	72"	48"	30"	1 1/8"	ACE1BD7248D(L/R)	1,002.	1,153.
	78"	48"	24"	1 1/8"	ACE1BD7848S(L/R)	1,087.	1,249.
	78"	48"	30"	1 1/8"	ACE1BD7848D(L/R)	1,123.	1,290.
	84"	48"	24"	1 1/8"	ACE1BD8448S(L/R)	1,116.	1,283.
	84"	48"	30"	1 1/8"	ACE1BD8448D(L/R)	1,187.	1,363.

Order Code

Example:	ACE1BD6648SL 118
ACE1	Cascade edge worksurface
BD	Blended "D"
66	Width
48	Depth
S	24" d return
L	Extended left
118	Top finish

Specification Information

Available finishes:	
Solid:	
114	Folkstone Grey
117	Soft Grey
118	Bright White
119	Pumice
Woodgrain:	
124	Medium Cherry
125	Natural Maple
126	Natural Cherry
127	Walnut

Application Notes

Cascade Edge worksurfaces are wrapped with a 3D laminate sheet heated and pressed around an FSC-certified substrate. 3D laminate is more susceptible to denting, impact, tearing and marring than conventional high-pressure laminate and should be handled with care. Do not drag worksurfaces across any flooring surface. Treat Cascade Edge worksurfaces like veneer worksurfaces for optimum performance under normal conditions. Cascade Edge worksurfaces have a 10 year warranty on defects in workmanship and materials. This warranty does not cover damage occurring during or after installation. Cascade edge worksurfaces in solid colors utilize a non-PVC construction and are also free of any plasticizers, phthalates and lead content.

Cascade Edge worksurfaces are not interchangeable with Currents desks surfaces and should not be used to create freestanding Currents desks. Worksurfaces are 1/16" less than nominal width and 3/8" less than nominal depth for rear wire clearance. Edge grommets are centered at rear edges of worksurface for maximum clearance of 1 3/8".

Worksurfaces require support every 48" in width. All supporting hardware is ordered separately. Use Morrison brackets with wood screws for Currents Linkable screen applications.

Blended D worksurfaces are supported by a 48" VDT support bracket kit for cantilevering from the Currents wall in conjunction with Currents C-leg. Use flat bracket or bridging bracket to join to adjacent worksurface.

Cascade Edge worksurfaces are not drilled for stiffeners, pedestals or brackets. Cascade Edge worksurfaces are sized for panel-based applications and may be supported by linkable screen in conjunction with Morrison panel planning brackets, or end support from the Currents wall. 24" D straight tops may also be cantilevered from the Service Wall.

Cascade edge worksurfaces

Blended "L"

Currents

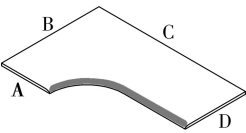
description	B	C	A	D	h	pattern no.	Solid	Woodgrain
	42"	60"	24"	24"	1 1/8"	ACE1L4260SSN	\$942.	\$1,084.
	42"	66"	24"	24"	1 1/8"	ACE1L4266SSN	967.	1,113.
	42"	72"	24"	24"	1 1/8"	ACE1L4272SSN	1,003.	1,155.
	42"	78"	24"	24"	1 1/8"	ACE1L4278SSN	1,016.	1,166.
	48"	60"	24"	24"	1 1/8"	ACE1L4860SSN	955.	1,097.
	48"	60"	24"	30"	1 1/8"	ACE1L4860SDN	936.	1,078.
	48"	60"	30"	24"	1 1/8"	ACE1L4860DSN	936.	1,078.
	48"	66"	24"	24"	1 1/8"	ACE1L4866SSN	989.	1,137.
	48"	66"	24"	30"	1 1/8"	ACE1L4866SDN	985.	1,134.
	48"	66"	30"	24"	1 1/8"	ACE1L4866DSN	985.	1,134.
	48"	72"	24"	24"	1 1/8"	ACE1L4872SSN	1,025.	1,179.
	48"	72"	24"	30"	1 1/8"	ACE1L4872SDN	1,031.	1,187.
	48"	72"	30"	24"	1 1/8"	ACE1L4872DSN	1,031.	1,187.
	48"	78"	24"	24"	1 1/8"	ACE1L4878SSN	1,130.	1,300.
	48"	84"	24"	24"	1 1/8"	ACE1L4884SSN	1,270.	1,462.
	60"	42"	24"	24"	1 1/8"	ACE1L6042SSN	942.	1,084.
	60"	48"	24"	24"	1 1/8"	ACE1L6048SSN	955.	1,097.

Worksurfaces

Order Code	Specification Information	Application Notes
<p>Example: ACE1 L4260SSN 114</p> <p>ACE1 Cascade edge worksurface</p> <p>L Blended "L" top</p> <p>42 Width</p> <p>60 Depth</p> <p>S 24"d, left side</p> <p>S 24"d, right side</p> <p>N No Grommet</p> <p>114 Top finish</p>	<p><i>Specify:</i></p> <p>Grommet / No grommet. Replace the "N" suffix from the pattern number with "G". Add \$40.</p> <p>Available finishes:</p> <p>Solid:</p> <p>114 Folkstone Grey 117 Soft Grey 118 Bright White 119 Pumice</p> <p>Woodgrain:</p> <p>124 Medium Cherry 125 Natural Maple 126 Natural Cherry 127 Walnut</p>	<p>Cascade Edge worksurfaces are wrapped with a 3D laminate sheet heated and pressed around an FSC-certified substrate. 3D laminate is more susceptible to denting, impact, tearing and marring than conventional high-pressure laminate and should be handled with care. Do not drag worksurfaces across any flooring surface. Treat Cascade Edge worksurfaces like veneer worksurfaces for optimum performance under normal conditions. Cascade Edge worksurfaces have a 10 year warranty on defects in workmanship and materials. This warranty does not cover damage occurring during or after installation. Cascade edge worksurfaces in solid colors utilize a non-PVC construction and are also free of any plasticizers, phthalates and lead content.</p> <p>Cascade Edge worksurfaces are not drilled for stiffeners, pedestals or brackets. Cascade Edge worksurfaces are sized for panel-based applications and may be supported by linkable screen in conjunction with Morrison panel planning brackets, or end support from the Currents wall. 24" D straight tops may also be cantilevered from the Service Wall.</p>

Cascade Edge worksurfaces are not interchangeable with Currents desks surfaces and should not be used to create freestanding Currents desks. Worksurfaces are 1/16" less than nominal width and 3/8" less than nominal depth for rear wire clearance. Edge grommets are centered at rear edges of worksurface for maximum clearance of 1 3/8".

Worksurfaces require support every 48" in width. All supporting hardware is ordered separately. Use Morrison brackets with wood screws for Currents Linkable screen applications.

Worksurfaces may be supported by left or right hand 18" cantilever bracket at the rear corner, and cantilever bridging brackets on each side edge. Worksurfaces may also be end supported or cantilever-bracket supported from Currents wall. Extended side of blended L may also be supported with Currents C-legs. Panel supported worksurfaces over 48" must be mid-span supported by cantilever brackets, specified separately.

Cascade edge worksurfaces

Blended "L"

Currents

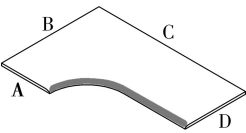
description	B	C	A	D	h	pattern no.	Solid	Woodgrain
	60"	48"	24"	30"	1 1/8"	ACE1L6048SDN	\$936.	\$1,078.
	60"	48"	30"	24"	1 1/8"	ACE1L6048DSN	936.	1,078.
	66"	42"	24"	24"	1 1/8"	ACE1L6642SSN	967.	1,113.
	66"	48"	24"	24"	1 1/8"	ACE1L6648SSN	989.	1,137.
	66"	48"	24"	30"	1 1/8"	ACE1L6648SDN	985.	1,134.
	66"	48"	30"	24"	1 1/8"	ACE1L6648DSN	985.	1,134.
	72"	42"	24"	24"	1 1/8"	ACE1L7242SSN	1,003.	1,155.
	72"	48"	24"	24"	1 1/8"	ACE1L7248SSN	1,025.	1,179.
	72"	48"	24"	30"	1 1/8"	ACE1L7248SDN	1,031.	1,187.
	72"	48"	30"	24"	1 1/8"	ACE1L7248DSN	1,031.	1,187.
	78"	42"	24"	24"	1 1/8"	ACE1L7842SSN	1,016.	1,166.
	78"	48"	24"	24"	1 1/8"	ACE1L7848SSN	1,130.	1,300.
	84"	48"	24"	24"	1 1/8"	ACE1L8448SSN	1,270.	1,462.

Order Code	Specification Information	Application Notes
<p>Example: ACE1 L4260SSN 114</p> <p>ACE1 Cascade edge worksurface</p> <p>L Blended "L" top</p> <p>42 Width</p> <p>60 Depth</p> <p>S 24"d, left side</p> <p>S 24"d, right side</p> <p>N No Grommet</p> <p>114 Top finish</p>	<p><i>Specify:</i> Grommet / No grommet. Replace the "N" suffix from the pattern number with "G". Add \$40.</p> <p>Available finishes:</p> <p>Solid:</p> <p>114 Folkstone Grey 117 Soft Grey 118 Bright White 119 Pumice</p> <p>Woodgrain:</p> <p>124 Medium Cherry 125 Natural Maple 126 Natural Cherry 127 Walnut</p>	<p>Cascade Edge worksurfaces are wrapped with a 3D laminate sheet heated and pressed around an FSC-certified substrate. 3D laminate is more susceptible to denting, impact, tearing and marring than conventional high-pressure laminate and should be handled with care. Do not drag worksurfaces across any flooring surface. Treat Cascade Edge worksurfaces like veneer worksurfaces for optimum performance under normal conditions. Cascade Edge worksurfaces have a 10 year warranty on defects in workmanship and materials. This warranty does not cover damage occurring during or after installation. Cascade edge worksurfaces in solid colors utilize a non-PVC construction and are also free of any plasticizers, phthalates and lead content.</p> <p>Cascade Edge worksurfaces are not drilled for stiffeners, pedestals or brackets. Cascade Edge worksurfaces are sized for panel-based applications and may be supported by linkable screen in conjunction with Morrison panel planning brackets, or end support from the Currents wall. 24" D straight tops may also be cantilevered from the Service Wall.</p>

Cascade Edge worksurfaces are not interchangeable with Currents desks surfaces and should not be used to create freestanding Currents desks. Worksurfaces are 1/16" less than nominal width and 3/8" less than nominal depth for rear wire clearance. Edge grommets are centered at rear edges of worksurface for maximum clearance of 1 3/8".

Worksurfaces require support every 48" in width. All supporting hardware is ordered separately. Use Morrison brackets with wood screws for Currents Linkable screen applications.

Worksurfaces may be supported by left or right hand 18" cantilever bracket at the rear corner, and cantilever bridging brackets on each side edge. Worksurfaces may also be end supported or cantilever-bracket supported from Currents wall. Extended side of blended L may also be supported with Currents C-legs. Panel supported worksurfaces over 48" must be mid-span supported by cantilever brackets, specified separately.

Cascade edge worksurfaces

Half round and corner round

Currents

description	w	d	h	pattern no.	Solid	Woodgrain
 Half Round	48"	18"	1 1/8"	ACE1H4818	\$491.	\$565.
	49 1/2"	18"	1 1/8"	ACE1H4818P	491.	565.
	60"	24"	1 1/8"	ACE1H6024	675.	779.
	61 1/2"	24"	1 1/8"	ACE1H6024P	675.	779.
LH Corner Round	24"	24"	1 1/8"	ACE1CR24L	261.	300.
RH Corner Round	24"	24"	1 1/8"	ACE1CR24R	261.	300.
Notched Corner Round	24"	24"	1 1/8"	ACE1CR24N	261.	300.
Sample	12"	12"	1 1/8"	ACE1R1212G	140.	163.

Worksurfaces

Order Code	Specification Information	Application Information
Example: ACE1 H4818P 117 ACE1 Cascade edge worksurface H Half round 48 Width 18 Depth P Notched for panel 117 Top finish	Available finishes: Solid: 114 Folkstone Grey 117 Soft Grey 118 Bright White 119 Pumice Woodgrain: 124 Medium Cherry 125 Natural Maple 126 Natural Cherry 127 Walnut	<p>Cascade Edge worksurfaces are wrapped with a 3D laminate sheet heated and pressed around an FSC-certified substrate. 3D laminate is more susceptible to denting, impact, tearing and marring than conventional high-pressure laminate and should be handled with care. Do not drag worksurfaces across any flooring surface. Treat Cascade Edge worksurfaces like veneer worksurfaces for optimum performance under normal conditions. Cascade Edge worksurfaces have a 10 year warranty on defects in workmanship and materials. This warranty does not cover damage occurring during or after installation. Cascade edge worksurfaces in solid colors utilize a non-PVC construction and are also free of any plasticizers, phthalates and lead content.</p> <p>Cascade Edge worksurfaces are not drilled for stiffeners, pedestals or brackets. Cascade Edge worksurfaces are sized for panel-based applications and may be supported by linkable screen in conjunction with Morrison panel planning brackets, or end support from the Currents wall. 24" D straight tops may also be cantilevered from the Service Wall. Cascade Edge worksurfaces are not interchangeable with Currents desks surfaces and should not be used to create freestanding Currents desks.</p> <p>Worksurfaces are 1/16" less than nominal width and 3/8" less than nominal depth for rear wire clearance. Edge grommets are centered at rear edges of worksurface for maximum clearance of 1 3/8".</p> <p>Worksurfaces require support every 48" in width. All supporting hardware is ordered separately. Use Morrison brackets with wood screws for Currents Linkable screen applications.</p> <p><i>Half round</i> Half round worksurfaces may be supported by cantilever bridging brackets in conjunction with a rounded end support column.</p> <p><i>Corner round</i> Notched corner round worksurfaces are supported by cantilever bridging brackets on both side edges. End run Left- and Right-hand corner round worksurfaces are supported by a combination of an "EC" end bracket along the panel edge and a cantilever bridging bracket to the adjacent worksurface side edge.</p>

Cascade edge worksurfaces

Wave end

Currents

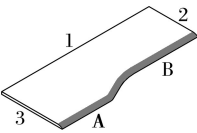
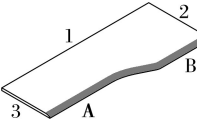
description	1	2	3	A	B	h	pattern no.	Solid	Woodgrain
Wave End, LH 	36"	24"	30"	15"	3"	1 1/8"	ACE1W363024N	\$611.	\$702.
	42"	24"	30"	15"	9"	1 1/8"	ACE1W423024N	642.	739.
	48"	24"	30"	15"	15"	1 1/8"	ACE1W483024N	688.	791.
	72"	24"	30"	23 1/2"	30 1/2"	1 1/8"	ACE1W723024N	875.	1,004.
Wave End, RH 	36"	30"	24"	3"	15"	1 1/8"	ACE1W362430N	611.	702.
	42"	30"	24"	9"	15"	1 1/8"	ACE1W422430N	642.	739.
	48"	30"	24"	15"	15"	1 1/8"	ACE1W482430N	688.	791.
	72"	30"	24"	23 1/2"	30 1/2"	1 1/8"	ACE1W722430N	875.	1,004.

Order Code

Example:	ACE1W483024N 118
ACE1	Cascade edge worksurface
W	Wave end
48	Width
30	Depth, right side
24	Depth, left side
N	No grommet
118	Top finish

Specification Information

Specify:
 Grommet / No grommet.
 Replace the "N" suffix from the pattern number with "G". Add \$20.

Available finishes:
 Solid:

114	Folkstone Grey
117	Soft Grey
118	Bright White
119	Pumice

Woodgrain:

124	Medium Cherry
125	Natural Maple
126	Natural Cherry
127	Walnut

Application Notes

Cascade Edge worksurfaces are wrapped with a 3D laminate sheet heated and pressed around an FSC-certified substrate. 3D laminate is more susceptible to denting, impact, tearing and marring than conventional high-pressure laminate and should be handled with care. Do not drag worksurfaces across any flooring surface. Treat Cascade Edge worksurfaces like veneer worksurfaces for optimum performance under normal conditions. Cascade Edge worksurfaces have a 10 year warranty on defects in workmanship and materials. This warranty does not cover damage occurring during or after installation. Cascade edge worksurfaces in solid colors utilize a non-PVC construction and are also free of any plasticizers, phthalates and lead content.

Cascade Edge worksurfaces are not drilled for stiffeners, pedestals or brackets. Cascade Edge worksurfaces are sized for panel-based applications and may be supported by linkable screen in conjunction with Morrison panel planning brackets, or end support from the Currents wall. 24" D straight tops may also be cantilevered from the Service Wall.

Cascade Edge worksurfaces are not interchangeable with Currents desks surfaces and should not be used to create freestanding Currents desks. Worksurfaces are 1/16" less than nominal width and 3/8" less than nominal depth for rear wire clearance. Edge grommets are centered at rear edge of worksurface for maximum clearance of 1 3/8".

Worksurfaces require support every 48" in width. All supporting hardware is ordered separately. Use Morrison brackets with wood screws for Currents Linkable screen applications.

Worksurfaces may be supported at each end by pedestals or end support "EC" brackets and cantilever brackets matching the worksurface depth. Use cantilever bridging bracket to join to adjacent worksurface. Panel supported worksurfaces over 48" must be mid-span supported by cantilever brackets, specified separately.

description	w	d	h	pattern no.	L
Currents	16"	16"	1"	CSAMP1616 ()	\$92.
Currents for Morrison	16"	16"	1"	AWMSAMP1616 () ()	92.
Original Upstart	16"	16"	1"	USAMP1616 () ()	92.

Order Code

Specification Information

Example:	AWMSAMP1616 118
AWM	Currents for Morrison
SAMP	Worksurface Sample
16	Width
16	Depth
118	Top finish
118	Edge finish

Specify:
 Top and edge finish for Currents for Morrison and Original Upstart worksurface samples. Specify top finish for Currents worksurface samples.

Veneer finishes for Currents worksurfaces are available through Custom Product Development.

Worksurface supports

Service Wall and Fence-Mounted

Currents

description	type	w	d	h	pattern no.	paint
Adjustable cantilever bracket (up to 24"D)		3"	20"	23-33"	AB1 AC24 ()	\$218.

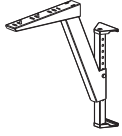

Adjustable cantilever bridging bracket		3"	20"	23-33"	AB1-ABC24()	283.
--	--	----	-----	--------	---------------------	------

Fixed end support bracket		3"	6"	27"	AB1 FE ()	141.
---------------------------	--	----	----	-----	-------------------	------



Adjustable end support bracket		3"	6"	23-33"	AB2 AE ()	176.
--------------------------------	--	----	----	--------	-------------------	------

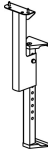

Compact fixed end support bracket	for 28"h worksurface		6"	27"	AB2 FE27 ()	149.
	for 29 ⁵ / ₈ " h worksurface		6"	28"	AB2 FE28 ()	149.





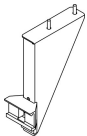

Fence end bracket kit					AB1FAE ()	207.
-----------------------	--	--	--	--	-------------------	------



Order Code	Specification Information	Application Notes
Example: AB1 AC24 117	<i>Specify painted finishes for support column, C-leg, and brackets.</i>	Specify worksurface cantilever and end support brackets to attach worksurfaces to Service Walls.
AB1 Bracket	Fence end bracket kit includes a left and a right handed bracket.	Adjustable bridging cantilever supports adjacent 48"W straight or corner worksurfaces.
AC Type	<i>Specify paint finish for end bracket.</i>	Specify two cantilever brackets to support any 24"D Currents, Morrison, Reff, Equity, Dividends, or Cascade worksurface up to 84" wide, or one back edge of corner worksurface. Specify three cantilever brackets to support any 24"D Currents, Morrison, Reff, Equity, Dividends or Cascade worksurface greater than 84" wide. Specify two end support brackets to support one end of straight, conference, or arc-shape surface.
24 Depth		End support brackets adjust 23"-33"H (24" to 34" top height). Fixed height brackets support worksurface at 28"H and 29 ⁵ / ₈ " H.
117 Finish		Fence end brackets attach to Fence to support one end of rectilinear or one back edge of a corner worksurface when the other ends are properly supported by legs, storage or panel brackets.
		Fence end brackets support the underside of the worksurface in 1" increments from 26" to 28" (27" to 29" top height).
		Adjustable height cantilever and bridging cantilever brackets support underside of worksurface in 1" increments from 23" to 33"H (24" to 34" top height).

Worksurface supports freestanding

Currents

description	type	application	w	d	h	pattern no.	paint
 Straight leg	Adjustable		2"	4"	23-29"	AB1 I27A(G/C) ()	\$400.
	Fixed		2"	4"	27"	AB1 I27F(G/C) ()	206.
	Low		2"	4"	25"	AB1 I25(G/C) ()	206.
 C-leg, adjustable	24"D	Left	2"	21"	23-29"	AB1 CL24L () ()	443.
		Right	2"	21"	23-29"	AB1 CL24R () ()	443.
	30"D	Left	2"	27"	23-29"	AB1 CL30L () ()	486.
		Right	2"	27"	23-29"	AB1 CL30R () ()	486.
 C-leg, fixed height	24"D	Left	2"	21"	27"	AB1 CLF24L () ()	370.
		Right	2"	21"	27"	AB1 CLF24R () ()	370.
	30"D	Left	2"	27"	27"	AB1 CLF30L () ()	405.
		Right	2"	27"	27"	AB1 CLF30R () ()	405.
 Corner leg	Corner worksurfaces		4"	4"	23-29"	AB1 VL () ()	370.

Worksurfaces

Order Code

Example:	AB1 CL24L 612 G
AB1	Support
CL	C-leg
24	Depth
L	Left
612	Finish
G	Glides

Specification Information

Specify painted finishes for support column, C-leg, and brackets.

C-Leg casters/glides:

C	Rear casters/front glides
G	All glides

Casters/glides combination has no levelling. All-glides version provides 1 3/4" levelling range.

Application Notes

Specify two straight legs under shared worksurface. Straight legs are fixed at 27"H (28" top height) or adjustable 23"-29" (24"-30" top height).

C-legs support one end of any corresponding depth Currents worksurface. Corner legs support only the back corner of a Currents corner worksurface. Specify C-legs for side edges of Currents corner and extended corner worksurfaces.

Adjustable C-legs and corner legs are adjustable in height to support underside of worksurface at 1" increments from 23" to 29" (24" to 30" Currents top height). Fixed height C-legs support desk at 28"H. Fixed height C-legs do not accept service beams.

Straight legs may not be used with Currents universal worksurfaces or Currents worksurfaces for Morrison to create freestanding tables.

Pedestals mobile

Currents

description	type	w	d	h	pattern no.	P1 / P2	P3
	2 file	15"	17"	26 1/2"	AS1 SFF M () ()	\$1,188.	\$1,247.
	Data/file	15"	17"	22"	AS1 SDF M () ()	1,125.	1,182.
	Personal/data/file	15"	17"	26 1/2"	AS1 SPDF M () ()	1,311.	1,379.

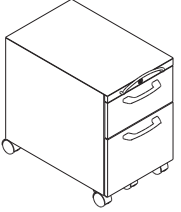
	2 file	15"	23"	26 1/2"	AS1 DFF M () ()	1,338.	1,402.
	Data/file	15"	23"	22"	AS1 DDF M () ()	1,275.	1,340.
	Personal/data/file	15"	23"	26 1/2"	AS1 DPDF M () ()	1,460.	1,535.

Standard mobile pedestal open top, with pull	Data/file	15"	17"	22"	AS1 SDFO () ()	1,050.	1,103.
--	-----------	-----	-----	-----	-------------------------	--------	--------

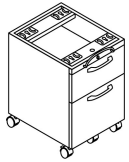

Deep mobile pedestal open top, with pull	Data/file	15"	23"	22"	AS1 DDFO () ()	1,170.	1,229.
--	-----------	-----	-----	-----	-------------------------	--------	--------

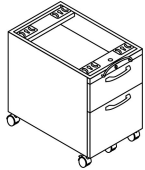

Order Code

Example: **AS1 SDFM 612 612**

AS1	Pedestal
S	Depth
DF	Configuration
M	Mobile
612	Finish for case
612	Finish for fronts

Specification Information

Specify painted finish for case and for fronts.

Veneer finishes for pedestal fronts are available through Custom Product Development.

All pedestals include front lock with KnollKey lock system. Personal drawer is 4"H. Data drawer is 7"H. File drawers are 11"H. Deep file drawers include file support for letter (width) or legal (depth) suspended file folders. All drawers have full extension, ball bearing drawer slides.

Application Notes

Mobile pedestals are independent storage components with locking casters and pull. Standard mobile pedestals roll under Currents worksurfaces set at 28" or higher. Deep mobile pedestals with two files or personal/data/file will not fit under stiffener of universal worksurface or Currents desk set at 29" or lower. Specify data/file mobile pedestal under worksurfaces adjusted lower than 28"H.

Pedestals floorstanding

Currents

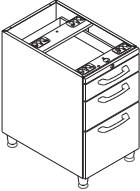
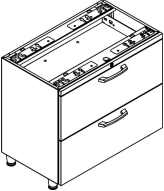
description	type	w	d	h	pattern no.	P1 / P2	P3
18"D Floorstanding pedestal 	2 file	15"	17"	27"	AS1 SFF G () ()	\$861.	\$903.
	personal/data/file	15"	17"	27"	AS1 SPDFG () ()	985.	1,036.
24"D Floorstanding pedestal 	2 file	15"	23"	27"	AS1 DFF G () ()	980.	1,030.
	personal/data/file	15"	23"	27"	AS1 DPDFG () ()	1,105.	1,160.
18"D Floorstanding pedestal Double wide 	2 file	30"	17"	27"	AS1FF30G () ()	1,509.	1,580.
		36"	17"	27"	AS1FF36G () ()	1,839.	1,927.
	2 door	30"	17"	27"	AS1DD30G () ()	1,509.	1,580.
		36"	17"	27"	AS1DD36G () ()	1,839.	1,927.
	data/file	30"	17"	23"	AS1DF30G () ()	1,432.	1,502.
		36"	17"	23"	AS1DF36G () ()	1,749.	1,833.
	personal/data/file	30"	17"	27"	AS1PDF30G () ()	1,724.	1,813.
		36"	17"	27"	AS1PDF36G () ()	2,103.	2,211.

Floorstanding storage

Order Code

Example: **AS1 SPDFG 612 612**

AS1	Pedestal
S	Depth
PDF	Configuration
G	Floorstanding
612	Finish for case
612	Finish for fronts

Specification Information

Specify painted finish for case and for fronts.

Veneer finishes for pedestal fronts are available through Custom Product Development.

All pedestals include front lock with KnollKey lock system. Personal drawer is 4"H. Data drawer is 7"H. File drawers are 11"H. Deep file drawers include file support for letter (width) or legal (depth) suspended file folders. All drawers have full extension, ball bearing drawer slides.

Application Notes

Floorstanding pedestals include levelling glides and open top to support one end of a worksurface at 28"H. 18"D pedestals fit under any Currents worksurface with standard stiffener. Deep floorstanding pedestals fit under Currents worksurfaces for Morrison with properly sized replacement worksurface stiffener.

Pedestals may not be used in freestanding applications.

Pedestal accessories

pencil tray, drawer divider, file support rail, bumper kits

Currents

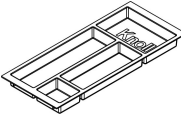
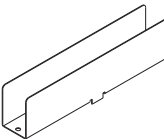
description	type	w	d	h	pattern no.	price
Pencil tray 	Personal or data drawer	13 1/4"	5 7/8"	1"	AS2 PT(C)	\$48.
	Personal or data drawer	13 1/4"	5 7/8"	1"	AS2 PT(N)	41.
Drawer divider 	Personal or data drawer				MD6-BD	40.
File support rail	File drawer, set of 2				MD6-FS	14.
Bumper kits for mobile pedestal	21"H pedestal			21"	AS1 BKL	48.
	26"H pedestal			26"	AS1 BKH	57.

Order Code

Example: **AS2 PT**

AS2 Pedestal

PT Pencil tray

Specification Information

Pencil tray is molded plastic and is available in black or clear.

Black : N

Clear : C

Drawer divider is black painted steel.

Replacement worksurface stiffeners are black painted steel.

Bumper kit is trim grey plastic.

Application Notes

Pencil tray sets in top of personal or data drawer. Moveable dividers organize pencils, pens, and paper clips in separate compartments.

Drawer divider mounts in slots in bottom of personal or data drawer. U-shaped divider supports two rows of four CDs with titles visible in data drawer.

File support spans width of file drawer to support side-to-side letter or legal width suspended files.

Bumper kit protects back corners of mobile pedestals and adjacent furniture. Bumper kit includes two corner-bead shape extrusions with self-adhesive backer.

Pedestal accessories
cushion
fabric

Description	type	w	d	pattern no.	A	COM		C	D	E	F	G	H	I
						B								
Cushion	Deep	15"	23"	AS1 DPAD ()	\$241.	\$270.	\$316.	\$330.	\$362.	\$393.	\$436.	\$481.	\$498.	
	Standard	15"	17"	AS1 SPAD ()	195.	224.	256.	270.	286.	316.	345.	393.	406.	

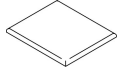

Order Code

Example:	AS1 SPAD
AS1	Pedestal
S	Depth
PAD	Cushion

Specification Information

There is a \$77 upcharge on CAL133 backing on the cushion.

Pedestal cushions are upholstered (from the front to the back of the pedestal) with the fabric direction matching the textile sample.

Application Notes

Pedestal cushions are for use on Currents open top mobile pedestals as well as on open top mobile pedestals in other Knoll systems lines.

For Customers Own Material (COM) applications, specify .75 yards of fabric for 17 inch deep mobile pedestal seat cushions, and .90 yards for 23 inch deep seat cushion.

Pedestal accessories
cushion
leather

Currents

Description	type	w	d	pattern no.	COL U	V	W	X	Y
Cushion	Deep	15"	23"	AS1 DPAD ()	\$481.	\$572.	\$705.	\$738.	\$780.
	Standard	15"	17"	AS1 SPAD ()	376.	450.	555.	572.	601.

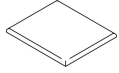

Order Code

Example:	AS1 SPAD
AS1	Pedestal
S	Depth
PAD	Cushion

Specification Information

There is a \$105 upcharge for perforated leather.

Application Notes

Pedestal cushions are for use on Currents open top mobile pedestals as well as on open top mobile pedestals in other Knoll systems lines.

For Customers Own Leather (COL) applications, specify 11.5 sq. feet of leather for 17 inch deep mobile pedestal seat cushions, and 14.5 sq. feet for 23 inch deep seat cushion.

Vertical storage cabinets

Reuter rotating door cabinets

Currents

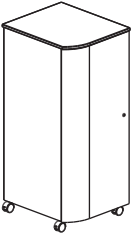
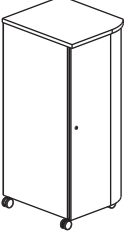
description	type	w	d	h	pattern no.	laminate	paint
 Cabinet, left opening door	painted top	21"	24"	48"	A2 R48 LP () () ()		\$3,395.
		21"	24"	64"	A2 R64 LP () () ()		3,835.
	worksurface top, plastic laminate	21"	24"	48"	A2 R48 LL () () ()	3,687.	n/a
 Cabinet, right opening door	painted top	21"	24"	48"	A2 R48 RP () () ()		3,395.
		21"	24"	64"	A2 R64 RP () () ()		3,835.
	worksurface top, plastic laminate	21"	24"	48"	A2 R48 RL () () ()	3,687.	n/a
Accessories	shelf insert				A1 R1 SI		148.
Replacement top	left				A1 RTOPL () ()	364.	288.
	right				A1 RTOPR () ()	364.	288.

Floorstanding storage

Order Code	Specification Information	Application Notes
Example: A2R 64 LP 117 117 117 G	<i>For cabinets, specify:</i>	Rotating door cabinets are portable enclosed freestanding storage. Cabinets feature full-height door, two file drawer frames, and a protected 4½"W wardrobe area. 48"H includes one adjustable shelf, 64"H includes two shelves. Cabinet top is painted finish. 48"H cabinet is also available with plastic laminate or veneer worksurface top. Cabinets with veneer front are available with painted or veneer top only. Additional shelves may be specified separately. Painted front cabinets may be changed from left-hand to right-hand in field but replacement top is required. Cabinet width is designed to enable open door in 24"W footprint.
A2R Reuter vertical storage	Top finish	
64 Height	Case finish	
L Left door	Front finish	
P Painted top	<i>Casters/glides:</i>	
117 Top finish	C Casters	
117 Case finish	G Glides	
117 Front finish	<i>For replacement tops, specify:</i>	
G Glides	<i>Top type</i>	
	P Painted	
	L Plastic laminate	
	Worksurface top edges are trim grey T-mold.	
	Veneer finishes for rotating door cabinets are available through Custom Product Development.	

Vertical storage cabinets

Reuter options rotating door cabinets

Currents

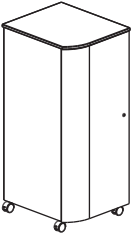
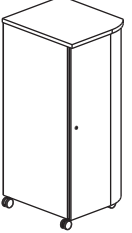
description	type	w	d	h	pattern no.	laminate	paint
 Cabinet, left opening door	painted top	21"	24"	48"	A2L 48 LP () () ()		\$2,919.
		21"	24"	64"	A2L 64 LP () () ()		3,350.
	worksurface top, plastic laminate	21"	24"	48"	A2L 48 LL () () ()	3,206.	n/a
 Cabinet, right opening door	painted top	21"	24"	48"	A2L 48 RP () () ()		2,919.
		21"	24"	64"	A2L 64 RP () () ()		3,350.
	worksurface top, plastic laminate	21"	24"	48"	A2L 48 RL () () ()	3,206.	n/a
Accessories	shelf insert				A1 R1 SI		148.
Replacement top	left				A1 RTOPL () ()	364.	288.
	right				A1 RTOPR () ()	364.	288.

Order Code	Specification Information	Application Notes
Example: A2L 64 LP 117 117 117 G	<i>For cabinets, specify:</i>	Rotating door cabinets are portable enclosed freestanding storage. Cabinets feature full-height door, two file drawer frames, and a protected 4½"W wardrobe area. 48"H includes one adjustable shelf, 64"H includes two shelves. Cabinet top is painted finish. 48"H cabinet is also available with plastic laminate or veneer worksurface top. Cabinets with veneer front are available with painted or veneer top only. Additional shelves may be specified separately. Painted front cabinets may be changed from left-hand to right-hand in field but replacement top is required. Cabinet width is designed to enable open door in 24"W footprint.
A2L Reuter vertical storage	Top finish	
64 Height	Case finish	
L Left door	Front finish	
P Painted top	<i>Casters/glides:</i>	
117 Top finish	C Casters	
117 Case finish	G Glides	
117 Front finish	<i>For replacement tops, specify:</i>	
G Glides	<i>Top type</i>	
	P Painted	
	L Plastic laminate	
	Worksurface top edges are trim grey T-mold.	
	Veneer finishes for rotating door cabinets are available through Custom Product Development.	

Reuter overhead cabinet
desk, wall, or other Knoll system mounted
Designed by Robert Reuter

description	type	w	d	h	pattern no.	P1	P2	P3	V1
Enclosed cabinet, with lock (no mounting hardware) - One door		24"	14 1/4"	14 3/4"	RO3-N24() ()L	\$848.	\$848.	\$889.	\$1,277.
		30"	14 1/4"	14 3/4"	RO3-N30() ()L	943.	943.	994.	1,377.
		36"	14 1/4"	14 3/4"	RO3-N36() ()L	1,091.	1,091.	1,147.	1,543.
		42"	14 1/4"	14 3/4"	RO3-N42() ()L	1,266.	1,266.	1,332.	1,716.
		48"	14 1/4"	14 3/4"	RO3-N48() ()L	1,415.	1,415.	1,483.	1,885.

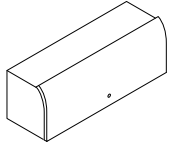

Enclosed cabinet, with lock (no mounting hardware) - Two doors		60"	14 1/4"	14 3/4"	RO3-N60() ()L	1,790.	1,790.	1,882.	2,597.
		66"	14 1/4"	14 3/4"	RO3-N66() ()L	1,960.	1,960.	2,053.	2,784.
		72"	14 1/4"	14 3/4"	RO3-N72() ()L	2,093.	2,093.	2,198.	2,938.

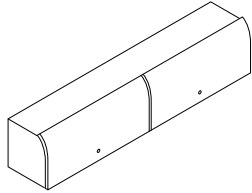

Enclosed cabinet, no lock (no mounting hardware) - One door		24"	14 1/4"	14 3/4"	RO3-N24() ()N	761.	761.	798.	n/a
		30"	14 1/4"	14 3/4"	RO3-N30() ()N	863.	863.	905.	n/a
		36"	14 1/4"	14 3/4"	RO3-N36() ()N	1,009.	1,009.	1,059.	n/a
		42"	14 1/4"	14 3/4"	RO3-N42() ()N	1,185.	1,185.	1,243.	n/a
		48"	14 1/4"	14 3/4"	RO3-N48() ()N	1,329.	1,329.	1,398.	n/a

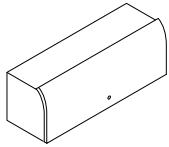

Enclosed cabinet, no lock (no mounting hardware) - Two doors		60"	14 1/4"	14 3/4"	RO3-N60() ()N	1,623.	1,623.	1,705.	n/a
		66"	14 1/4"	14 3/4"	RO3-N66() ()N	1,788.	1,788.	1,879.	n/a
		72"	14 1/4"	14 3/4"	RO3-N72() ()N	1,930.	1,930.	2,026.	n/a

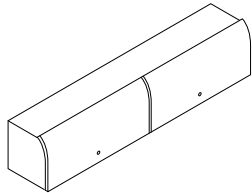

Order Code

Example:	RO3-N48-613-613-L
RO3	Reuter overhead cabinet
N	No brackets
48	Width
613	Case finish
613	Front finish
L	With lock

Specification Information

Specify finish for case and door.

Application Notes

Reuter storage is a universal product applicable on Knoll systems.

Cabinet door rotates above cabinet on side pivots, counterbalanced by two pneumatic cylinders. Two-door cabinets have center divider and four pneumatic cylinders. Vertical interior partitions may be positioned on 1 1/2" increments of width anywhere across shelf, 1 1/2" in from each side. Vertical partitions contain cutouts for mounting up to five horizontal partitions at 2" increments on either or both sides.



Horizontals are suspended between two verticals, and may be positioned end-to-end in any combination up to 3" less than cabinet width. Available in sets of 10; 6", 9", 12", 15" widths.

Order locks for overheads with a KnollKey order form. Please note that Reuter overhead cabinets 60"W or wider require two lock cores.

Reuter overhead doors without locks include black, Knoll-logo insert, in the same position. Insert may be removed to retrofit a lock later.

Reuter open overhead

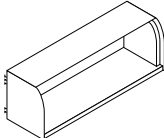
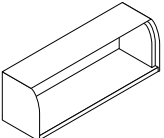

Designed by Robert Reuter

description	type	w	d	h	pattern no.	black	P1	P2	P3	V1
 Open overhead Morrison panel brackets		30"	13"	14 ³ / ₄ "	RO3-OM30()		\$623.	\$623.	\$656.	
		36"	13"	14 ³ / ₄ "	RO3-OM36()		715.	715.	748.	
		42"	13"	14 ³ / ₄ "	RO3-OM42()		807.	807.	848.	
		48"	13"	14 ³ / ₄ "	RO3-OM48()		895.	895.	942.	
		60"	13"	14 ³ / ₄ "	RO3-OM60()		1,044.	1,044.	1,095.	
		72"	13"	14 ³ / ₄ "	RO3-OM72()		1,228.	1,228.	1,290.	
 Open overhead no mounting hardware		30"	13"	14 ³ / ₄ "	RO3-ON30()		606.	606.	635.	
		36"	13"	14 ³ / ₄ "	RO3-ON36()		694.	694.	730.	
		42"	13"	14 ³ / ₄ "	RO3-ON42()		788.	788.	828.	
		48"	13"	14 ³ / ₄ "	RO3-ON48()		881.	881.	923.	
		60"	13"	14 ³ / ₄ "	RO3-ON60()		1,024.	1,024.	1,078.	
		72"	13"	14 ³ / ₄ "	RO3-ON72()		1,207.	1,207.	1,267.	
 Interior partitions	Vertical, set of 5	–	11"	12"	RO3-VP	107.				
	Horizontal, set of 10	6"	11"	–	RO1-HP6	166.				
		9"	11"	–	RO1-HP9	208.				
		12"	11"	–	RO1-HP12	248.				
		15"	11"	–	RO1-HP15	289.				
Door retrofit kit, with lock	For open overhead	30"			RO3-RD30()L	423.	423.	447.	819.	
		36"			RO3-RD36()L	459.	459.	481.	889.	
		42"			RO3-RD42()L	536.	536.	561.	964.	
		48"			RO3-RD48()L	586.	586.	613.	1,035.	
		60"			RO3-RD60()L	894.	894.	940.	1,662.	
		72"			RO3-RD72()L	1,005.	1,005.	1,055.	1,812.	
Door retrofit kit, no lock	For open overhead	30"			RO3-RD30()N	324.	324.	340.	n/a	
		36"			RO3-RD36()N	375.	375.	393.	n/a	
		42"			RO3-RD42()N	454.	454.	474.	n/a	
		48"			RO3-RD48()N	501.	501.	526.	n/a	
		60"			RO3-RD60()N	728.	728.	767.	n/a	
		72"			RO3-RD72()N	840.	840.	885.	n/a	

Order Code	Specification Information	Application Notes
Example: RO3-ON30-612	<i>Specify finish for case and door.</i>	<p>Interior partitions are black painted steel finish.</p> <p>Door retrofit kits convert an open overhead to an enclosed cabinet and include Reuter overhead door, left and right arm mechanisms, and lock or lock plug.</p> <p>Reuter storage is a universal product applicable on Morrison or other Knoll systems. Open overheads may be mounted on any combination of vertical panels the same width or up to 12" less than shelf width.</p> <p>Reuter open overheads may be desk-mounted, mounted on other Knoll systems, cantilevered above panels, or wall-mounted. Specify open overhead with no mounting hardware and brackets separately.</p> <p>Vertical interior partitions may be positioned on 1 1/2" increments of width anywhere across shelf, 1 1/2" in from each side. Vertical partitions contain cutouts for mounting three horizontal partitions at 2" increments on either or both sides. Horizontals are suspended between two verticals, and may be positioned end-to-end in any combination up to 3" less than shelf width. Available in sets of 10; 6", 9", 12", 15" widths.</p>
RO3-O Reuter open overhead		
N No mounting hardware		
30 Width		
612 Finish		

Reuter open shelf

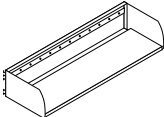
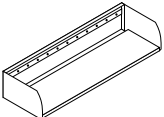
Designed by Robert Reuter

description	type	w	d	h	pattern no.	black	P1	P2	P3
 Open shelf Morrison panel brackets		24"	13"	8"	RS1-M24()		\$383.	\$383.	\$404.
		30"	13"	8"	RS1-M30()		420.	420.	442.
		36"	13"	8"	RS1-M36()		474.	474.	499.
		42"	13"	8"	RS1-M42()		513.	513.	538.
		48"	13"	8"	RS1-M48()		550.	550.	577.
		60"	13"	8"	RS1-M60()		642.	642.	675.
 Open shelf no mounting hardware		24"	13"	8"	RS1-N24()		366.	366.	383.
		30"	13"	8"	RS1-N30()		405.	405.	423.
		36"	13"	8"	RS1-N36()		459.	459.	481.
		42"	13"	8"	RS1-N42()		495.	495.	518.
		48"	13"	8"	RS1-N48()		532.	532.	558.
		60"	13"	8"	RS1-N60()		623.	623.	656.
 Interior partitions	Vertical, set of 5	–	12"	6"	RS1-VP	100.			
	Horizontal, set of 10	6"	12"	–	RO1-HP6	166.			
		9"	12"	–	RO1-HP9	208.			
		12"	12"	–	RO1-HP12	248.			
		15"	12"	–	RO1-HP15	289.			

Order Code

Example:	RS1-N48-612
RS1	Reuter shelf
N	No mounting hardware
48	Width
612	Finish

Specification Information

Specify paint finishes for shelf.

Application Notes

Interior partitions are black painted steel finish.

Reuter storage is a universal product applicable on Morrison or other Knoll systems.

Open shelves may be mounted on any combination of vertical panels the same width. Reuter open shelves may be Morrison Network desk-mounted, mounted on other Knoll systems, cantilevered above panels, or wall-mounted. Specify Reuter shelves with no mounting hardware, and brackets separately.

Vertical interior partitions may be positioned on 1 1/2" increments of width anywhere across shelf, 1 1/2" in from each side. Vertical partitions contain cutouts for mounting three horizontal partitions at 2" increments on either or both sides. Horizontals are suspended between two verticals, and may be positioned end-to-end in any combination up to 3" less than shelf width. Available in sets of 10; 6", 9", 12", 15" widths.

Reuter ganging bracket
wall-mounting options and ADA pull
Designed by Robert Reuter

description	type	w	d	h	pattern no.	black
Ganging bracket					RO1-GB	\$15.
ADA pull					RO1-PULL	60.

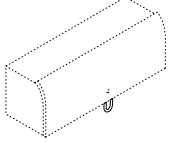

Order Code	Specification Information	Application Notes
Example: RO1-GB	Wall mount frames are painted black finish.	Wall mount frames secure Reuter overhead cabinet or shelf to wall (frame/wall mounting hardware is not included). Frame is concealed behind storage. Use two RO1-WMF2 to wall-mount 66"- and 72"-wide Reuter overheads.
RO1 Reuter overhead	ADA pull is stainless steel.	Reuter open shelves 66" and 72"W are for stanchion support only.
GB Ganging bracket		Wall mount wire manager is two-part wire concealment kit, 22"H (medium grey only). Ganging bracket joins adjacent Reuter overheads or shelves for additional stiffness and alignment when storage is planned on only one side of a panel run.
		ADA pull mounts to Reuter painted front overhead door to allow seated users to close door easily. Specify one for each cabinet 24" - 48", two for cabinets 60" - 72". ADA pull cannot be mounted on wood front Reuter doors.

description	type	w	d	h	pattern no.	black	paint
Morrison Options and Series 2 Morrison overhead downmount brackets and back panel (64"H wall only)		24"			AA1LO24DN()		\$295.
		30"			AA1LO30DN()		305.
		36"			AA1LO36DN()		312.
		42"			AA1LO42DN()		320.
		48"			AA1LO48DN()		328.
Morrison shelf downmount brackets (64"H wall only)					AA1RSXDN()		211.
Reuter overhead brackets	Downmount brackets (pair) (64"H wall only)				AA1RODN()		253.
	Extended upmount brackets (pair) (39"H wall)				AA1ROXUP()		483.
	Upmount brackets (pair)				AA1ROUP()		242.
Reuter shelf brackets	Extended downmount brackets (pair) (64"H wall only)				AA1RSXDN()		211.
	Reuter shelf adapter brackets				RS1 MPB		46.
	Shelf downmount brackets (pair) (39"H or 48"H wall only)				AA1RSDN()		253.
	Shelf extended upmount brackets (pair) (39"H wall)				AA1RSXUP()		506.
	Shelf upmount brackets (pair)				AA1RSUP()		253.

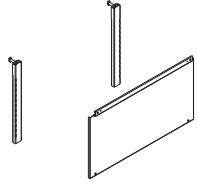

Order Code	Specification Information	Application Notes
Example: AA1 LO48 DN 612	<i>Specify painted finish for shelf downmount brackets and overhead downmount kit.</i>	<p>Morrison downmount brackets support Morrison or Options shelves and brackets on 64"H Service Wall.</p> <p>Overhead downmount bracket kits include back panel and brackets to suspend Options overhead cabinets from 64"H Service Wall crown.</p> <p>Reuter upmount brackets attach overhead cabinet or shelf anywhere along Service Wall crown, lifting 1" above nominal Service Wall height. Extended upmount brackets lift self to 10" above nominal Service Wall height.</p>
AA1 Currents accessory		
LO Options overhead		
48 Size		
DN Configuration		
612 Finish		
		<p>Downmount brackets attach overheads within the upper 16" of 64"H Service Walls and open shelves within the upper 9" of 48" or 39"H Service Walls.</p> <p>Specify an extra bracket (one-half pair) for center support of overhead cabinets wider than 60" and shelves wider than 54".</p> <p>Upmount or downmount brackets may be inset to permit overhead to extend 1" or 3" and shelf to extend 3" beyond the end of the Service Wall at T-ends.</p> <p>Extended downmount brackets enable the Reuter open shelf to be mounted from 49"-56"H on 64" Service Wall. Specify shelf adapter brackets separately.</p> <p>For brackets for use with DividendsHorizon and Series 2 for Dividends overheads, please consult the Dividends Horizon price list.</p>

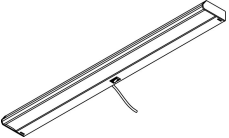
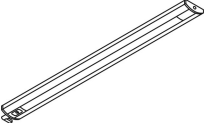
description	type	w	d	h	pattern no.	list
 <p>T5 Standard Task Light</p>	Use with 24" and wider overhead	19"	4"	1 1/2"	RTAT5E19S	\$260.
	Use with 30" and wider overhead	25"	4"	1 1/2"	RTAT5E25S	280.
	Use with 42" and wider overhead	37"	4"	1 1/2"	RTAT5E37S	302.
	Use with 60" and wider overhead	49"	4"	1 1/2"	RTAT5E49S	327.
	Use with 66" and wider overhead	61"	4"	1 1/2"	RTAT5E61S	348.
 <p>T5 Advanced Task Light</p>	Use with 30" and wider overhead	25"	4"	1 1/2"	RTAT5E25A	483.
	Use with 42" and wider overhead	37"	4"	1 1/2"	RTAT5E37A	508.
	Use with 60" and wider overhead	49"	4"	1 1/2"	RTAT5E49A	528.
	Use with 66" and wider overhead	61"	4"	1 1/2"	RTAT5E61A	550.
 <p>LED Task Light</p>	Use with 24" and wider overhead (24 LED's)	17"	2"	1/2"	ML4L17	507.
	Use with 36" and wider overhead (48 LED's)	31"	2"	1/2"	ML4L31	846.
	Use with 48" and wider overhead (72 LED's)	44"	2"	1/2"	ML4L44	1,102.
	Use with 66" and wider overhead (96 LED's)	58"	2"	1/2"	ML4L58	1,384.

Order Code	
T5 Standard Task Light	
Example:	RTAT5E25S
RTA	Task Light
T5	T5 lamp
E	Electronic ballast
25	Width
S	Standard
LED Task Light	
Example:	ML4L17
ML4	Task Light
L	LED
17	Width

Specification Information
<p>T5 Task Lights: 120v and includes T5 cool white (4100K) fluorescent lamp, electronic ballast, 9' grounded cordset, prismatic lens, rocker switch, one cord exit management clip and mounting hardware. Housings are black.</p> <p>LED Task Lights: Includes LED's, power supply with 9-12' cord and mounting hardware. Housings are clear anodized aluminum with white color end-caps.</p>

Application Notes
<p>T5 Task Lights: Specify suffix -CH and add \$45 list for City of Chicago installations. Example: DL3T5E25S-CH</p> <p>Cordset is center exit. On smaller units cord exit is off-center, but still not handed.</p> <p>T5 advanced task lights are fitted with ballasts and lamps compliant with LEED requirements, meeting the LEED EB standard for mercury content.</p> <p>Notes: All task lights mount into the recess in the underside of overhead cabinets and shelves at least 6" wider than task light width.</p> <p>All task lights are TCLP compliant and meet requirements of California Title 20 and Title 24.</p>

Counter surface

counter surface

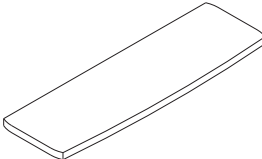
description	w	d	h	pattern no.	lam.	paint
	36"	12"	1"	AW1 CS3612 ()	\$265.	
	48"	12"	1"	AW1 CS4812 ()	295.	
	60"	12"	1"	AW1 CS6012 ()	324.	
	72"	12"	1"	AW1 CS7212 ()	355.	
Counter surface bracket kit				AB1 CS ()		265.

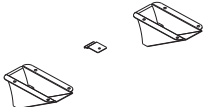

Order Code	Specification Information	Application Notes
Example: AA1 PS24 612	<i>Specify surface finish for counter.</i>	Counter surface with curved front is designed to mount on either side of 39"H Service Wall with standard 4" crown with counter surface brackets. Kit includes two brackets and center support.
AA1 Currents accessory	<i>Specify paint finish for counter surface brackets.</i>	
PS Personal shelf	Veneer finishes for counter surface are available through Custom Product Development.	
24 Width		
612 Finish		

Ambient lighting canopy, uplights

Currents

description	type	w	d	h	watts	pattern no.	light grey
	39" H wall	24"	24"	40"	32	AL1 C39	\$1,623.
	48" H wall	24"	24"	31"	32	AL1 C48	1,623.
	64" H wall	24"	24"	15"	32	AL1 C64	1,623.

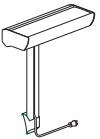
	39" H wall	18"	8"	30"	72	AL1 A3918	1,623.
	48" H wall	18"	8"	21"	72	AL1 A4818	1,623.
	64" H wall	18"	8"	5"	72	AL1 A6418	1,623.

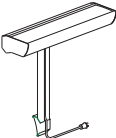
	39" H wall	24"	8"	30"	100	AL1 A3924	2,212.
	48" H wall	24"	8"	21"	100	AL1 A4824	2,212.
	64" H wall	24"	8"	5"	100	AL1 A6424	2,212.

Order Code

Example: AL1 C48
AL1 Lighting
C Canopy
48 Mounting height

Specification Information

Canopy is white perforated aluminum. Light fixtures and posts are light grey finish.

Canopy and uplights utilize electronic ballasts, and 9' cordset.

Canopy uplight has a single 32 watt tri-biaxial compact fluorescent lamp.

18" linear uplight has two 36 watt biaxial compact fluorescent lamps.

24" linear uplight has two 50 watt biaxial compact fluorescent lamps.

For City of Chicago applications, specify fused cordset (suffix -CH), and add \$82 list.

Application Notes

Canopy, linear, uplights attach to standard height Service Wall crown, on either side at any point. Lights mounted back-to-back allow space between for add-up panels.

Canopy and linear uplight include rectangular post to position top of light fixture at 73"H.

Canopy light is designed for interiors with high ceilings.

Integral white reflector of canopy is supported at 80"H.

Linear ambient uplights are designed for interiors with ceilings from 8' to 10' high.

All lights include vertical cord manager from crown to fixture.

Consult your Knoll representative for photometric information on Currents ambient lighting.

Desks
pin-set adjustable
extended left

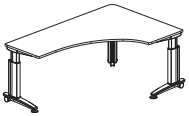
description	w (l)	w (r)	h	pattern no.	lam.
 24"D both sides corner desk, extended left	60"	36"	24-30"	AD C53 SF () ()	\$2,032.
	60"	48"	24-30"	AD C54 SF () ()	2,184.
	72"	36"	24-30"	AD C63 SF () ()	2,184.
	72"	48"	24-30"	AD C64 SF () ()	2,333.
	84"	48"	24-30"	AD C74 SF () ()	2,483.
30"D left/24"D right corner desk, extended left	60"	48"	24-30"	AD C54 LF () ()	2,301.
	72"	48"	24-30"	AD C64 LF () ()	2,452.
	84"	48"	24-30"	AD C74 LF () ()	2,600.
30"D both sides corner desk, extended left	60"	48"	24-30"	AD C54 DF () ()	2,422.
	72"	48"	24-30"	AD C64 DF () ()	2,573.
	84"	48"	24-30"	AD C74 DF () ()	2,720.

Order Code	Specification Information	Application Notes
Example: AD C64 LF 117 117 G	<i>Specify desk shape:</i>	<i>Specify glides/casters:</i>
AD Desk	C Corner	C Rear casters
C Shape	<i>Width left/width right:</i>	G Glides
6 Width left	3 36"	Worksurface edges are trim grey.
4 Width right	4 48"	
L Depth (30"D left)	5 60"	Desks incorporate universal worksurface and adjustable C legs. Pin-set desk surface can be set at installation from 24" - 30" high, in 1" increments.
F Base type	6 72"	
117 Desktop finish	7 84"	
117 Desk base finish	<i>Worksurface depth:</i>	Integral cable tray under worksurface and channels in legs provide basic lay-in wire management.
G Glides	S 24"D both sides	
	L 30"D left, 24"D right	
	R 30"D right, 24"D left	
	D 30"D both sides	Extended corner desks provide computer corner and adjacent work area in one unit. Nominal worksurface depths include 1 3/4" cable/connector space along back edges. Clearance under worksurfaces (for pedestals, BackPack or other accessories) is 18".
	<i>Base type:</i>	
	F Manually adjustable	Desks may be specified with fixed front glides and rear casters or 1 3/4" levelling glides. Casters and glides are interchangeable in the field.
	<i>Specify desk top and base finish.</i>	
	Veneer finishes for desks are available through Custom Product Development.	
		Desks accept clamp-on workshelves and privacy screens.
		Currents C-Legs mount with machine screws into metal inserts on the underside of Currents worksurfaces.

Desks
pin-set adjustable
extended right

Currents

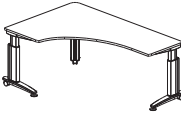
description	w(l)	w(r)	h	pattern no.	lam.
 24"D both sides corner desk, extended right	36"	60"	24-30"	AD C35 SF () ()	\$2,032.
	36"	72"	24-30"	AD C36 SF () ()	2,184.
	48"	60"	24-30"	AD C45 SF () ()	2,184.
	48"	72"	24-30"	AD C46 SF () ()	2,333.
	48"	84"	24-30"	AD C47 SF () ()	2,483.
30"D right/24"D left corner desk, extended right	48"	60"	24-30"	AD C45 RF () ()	2,301.
	48"	72"	24-30"	AD C46 RF () ()	2,452.
	48"	84"	24-30"	AD C47 RF () ()	2,600.
30"D both sides	48"	60"	24-30"	AD C45 DF () ()	2,422.
	48"	72"	24-30"	AD C46 DF () ()	2,573.
	48"	84"	24-30"	AD C47 DF () ()	2,720.

Order Code	Specification Information	Application Notes
Example: AD C46 SF 117 117 G	<i>Specify desk shape:</i>	<i>Specify glides/casters:</i>
AD Desk	C Corner	C Rear casters
C Shape	<i>Width left/width right:</i>	G Glides
4 Width left	3 36"	Worksurface edges are trim grey.
6 Width right	4 48"	
S Depth (24" both sides)	5 60"	Desks incorporate universal worksurface and adjustable C legs. Pin-set desk surface can be set at installation from 24" - 30" high, in 1" increments.
F Base type	6 72"	
117 Desktop finish	7 84"	
117 Desk base finish	<i>Worksurface depth:</i>	Integral cable tray under worksurface and channels in legs provide basic lay-in wire management.
G Glides	S 24"D both sides	
	L 30"D left, 24"D right	
	R 30"D right, 24"D left	
	D 30"D both sides	Extended corner desks provide computer corner and adjacent work area in one unit. Nominal worksurface depths include 1 3/4" cable/connector space along back edges. Clearance under worksurfaces (for pedestals, BackPack or other accessories) is 18".
	<i>Base type:</i>	
	F Manually adjustable	Desks may be specified with fixed front glides and rear casters or 1 3/4" levelling glides. Casters and glides are interchangeable in the field.
	<i>Specify desk top and base finish.</i>	
	Veneer finishes for desks are available through Custom Product Development.	
		Desks accept clamp-on workshelves and privacy screens.
		Currents C-Legs mount with machine screws into metal inserts on the underside of Currents worksurfaces.

Desks
pin-set adjustable
corner desk

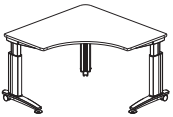
description	w(l)	w(r)	h	pattern number	lam.
24"D both sides corner desk 	42"	42"	24-30"	AD C4242 SF () ()	\$1,955.
	48"	48"	24-30"	AD C44 SF () ()	2,032.
	60"	60"	24-30"	AD C55 SF () ()	2,258.
30"D left/24"D right corner desk	42"	42"	24-30"	AD C4242 LF () ()	2,002.
	48"	48"	24-30"	AD C44 LF () ()	2,076.
	60"	60"	24-30"	AD C55 LF () ()	2,301.
24"D left/30"D right corner desk	42"	42"	24-30"	AD C4242 RF () ()	2,002.
	48"	48"	24-30"	AD C44 RF () ()	2,076.
	60"	60"	24-30"	AD C55 RF () ()	2,301.
30"D both sides corner desk	42"	42"	24-30"	AD C4242 DF () ()	2,047.
	48"	48"	24-30"	AD C44 DF () ()	2,122.
	60"	60"	24-30"	AD C55 DF () ()	2,346.

Order Code	Specification Information	Application Notes
Example: AD C44 LF 117 117 G	<i>Specify desk shape:</i>	<i>Specify glides/casters:</i>
AD Desk	C Corner	C Rear casters
C Shape	<i>Width left/width right:</i>	G Glides
4 Width left	4 48"	Worksurface edges are trim grey. Clear Maple not available on 60"W x 60"D corner desks.
4 Width right	5 60"	
L Depth (30"D left)	<i>Worksurface depth:</i>	Desks incorporate universal worksurface and adjustable C legs. Pin-set desk surface can be set at installation from 24" - 30" high, in 1" increments.
F Base type	S 24"D both sides	Corner desks provide up to 45" diagonal depth for large monitors, keyboard and mouse. Nominal worksurface depths include 1 3/4" cable/connector space along back edge. Clearance under worksurfaces (for pedestals, BackPack or other accessories) is 18".
117 Desktop finish	L 30"D left, 24"D right	Desks may be specified with fixed front glides and rear casters or 1 3/4" levelling glides. Casters and glides are interchangeable in the field.
117 Desk base finish	R 30"D right, 24"D left	
G Glides	D 30"D both sides	Desks accept clamp-on workshelves and privacy screens.
	<i>Base type:</i>	Currents C-Legs mount with machine screws into metal inserts on the underside of Currents worksurfaces.
	F Manually adjustable	
	<i>Specify desk top and base finish.</i>	
	Veneer finishes for desks are available through Custom Product Development.	

Desks
*pin-set adjustable
 straight desk*

Currents

description	w(l)	w(r)	h	pattern number	lam.
 24"D straight desk, curved front	36"	24"	24-30"	AD S36 SF () () ()	\$1,264.
	42"	24"	24-30"	AD S42 SF () () ()	1,296.
	48"	24"	24-30"	AD S48 SF () () ()	1,322.
	60"	24"	24-30"	AD S60 SF () () ()	1,384.
	72"	24"	24-30"	AD S72 SF () () ()	1,444.
	84"	24"	24-30"	AD S84 SF () () ()	1,503.
30"D straight desk, curved front	36"	30"	24-30"	AD S36 DF () () ()	1,398.
	42"	30"	24-30"	AD S42 DF () () ()	1,429.
	48"	30"	24-30"	AD S48 DF () () ()	1,459.
	60"	30"	24-30"	AD S60 DF () () ()	1,535.
	72"	30"	24-30"	AD S72 DF () () ()	1,624.

Order Code	Specification Information	Application Notes
Example: AD S48 DF 117 117 G	<i>Specify desk shape:</i>	<i>Specify glides/casters:</i>
AD Desk	S Straight	C Rear casters
S Shape		G Glides
48 Width	<i>Worksurface depth:</i>	Worksurface edges are trim grey.
D Depth	S 24"D both sides	
F Base type	D 30"D both sides	
117 Desktop finish	<i>Base type:</i>	
117 Desk base finish	F Manually adjustable	
G Glides	<i>Specify desk top and base finish.</i>	

Veneer finishes for desks are available through Custom Product Development.

Desks incorporate universal worksurface and adjustable C legs. Pin-set desk surface can be set at installation from 24" - 30" high, in 1" increments.

Straight desks have slightly curved front edges, to a maximum of 1" extra depth at the center. Nominal worksurface depths include 1 3/4" cable/connector space along back edge. Clearance under worksurfaces (for pedestals, Backpack or other accessories) is 18".

Desks may be specified with fixed front glides and rear casters or 1 3/4" levelling glides. Casters and glides are interchangeable in the field.

Desks accept clamp-on workshelves and privacy screens.

Currents C-Legs mount with machine screws into metal inserts on the underside of Currents worksurfaces.

Desks

*handcrank adjustable
extended left*

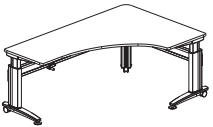
description	w(l)	w(r)	h	pattern no.	lam.
 24"D both sides corner desk, extended left	60"	36"	24-34"	AD C53 SH () ()	\$3,082.
	60"	48"	24-34"	AD C54 SH () ()	3,233.
	72"	36"	24-34"	AD C63 SH () ()	3,233.
	72"	48"	24-34"	AD C64 SH () ()	3,384.
	84"	48"	24-34"	AD C74 SH () ()	3,537.
30"D left/24"D right corner desk, extended left	60"	48"	24-34"	AD C54 LH () ()	3,355.
	72"	48"	24-34"	AD C64 LH () ()	3,506.
	84"	48"	24-34"	AD C74 LH () ()	3,654.
30"D both sides corner desk, extended left	60"	48"	24-34"	AD C54 DH () ()	3,355.
	72"	48"	24-34"	AD C64 DH () ()	3,506.
	84"	48"	24-34"	AD C74 DH () ()	3,654.

Order Code

Example: AD C53 SH 117 117 G
AD Desk
C Shape
5 Width left
3 Width right
S Depth
H Base type
117 Desktop finish
117 Base finish
G Glides

Specification Information

Specify desk shape:
 C Corner

Width left, width right:
 3 36"
 4 48"
 5 60"
 6 72"
 7 84"

Worksurface depth:
 S 24"D both sides
 L 30"D left, 24"D right
 R 30"D right, 24"D left
 D 30"D both sides

Base type:
 H Handcrank adjustable

Specify desk top and base finish.
 Veneer finishes for desks are available through Custom Product Development.

Specify:
 C Rear casters
 G Glides

Worksurface edges are trim grey.

Application Notes

Handcrank desks incorporate synchronized, adjustable C legs and corner legs. Handcrank mechanism enables user to adjust worksurface from 24" - 34" high (continuous) with collapsible crank under front edge. Handcrank is located on the extended side of desks.

Integral cable tray under worksurface and channels in legs provide basic lay-in wire management. Crossbeam stiffens legs through upper height range. Crossbeam is 4"H, 14" above floor.

Desks may be specified with fixed front glides and rear casters or 1 3/4" levelling glides. Casters and glides are interchangeable in the field.

Extended corner desks provide computer corner and adjacent work area in one unit. Nominal worksurface depths include 1 3/4" cable/connector clearance along back edge.

Handcrank mechanism is rated at 300 lbs. maximum weight.

Desks accept clamp-on workshelves and privacy screens.

Currents C-Legs mount with machine screws into metal inserts on the underside of Currents worksurfaces.

Desks

*handcrank adjustable
extended right*

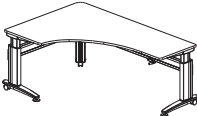
description	w(l)	w(r)	h	pattern no.	lam.
 24"D both sides corner desk, extended right	36"	60"	24-34"	AD C35 SH () ()	\$3,082.
	36"	72"	24-34"	AD C36 SH () ()	3,233.
	48"	60"	24-34"	AD C45 SH () ()	3,233.
	48"	72"	24-34"	AD C46 SH () ()	3,384.
	48"	84"	24-34"	AD C47 SH () ()	3,537.
30"D right/24"D left corner desk, extended left	48"	60"	24-34"	AD C45 RH () ()	3,355.
	48"	72"	24-34"	AD C46 RH () ()	3,506.
	48"	84"	24-34"	AD C47 RH () ()	3,654.
30"D both sides corner desk, extended left	48"	60"	24-34"	AD C45 DH () ()	3,355.
	48"	72"	24-34"	AD C46 DH () ()	3,506.
	48"	84"	24-34"	AD C47 DH () ()	3,654.

Order Code

Example: AD C35 SH 117 117 G
AD Desk
C Shape
3 Width left
5 Width right
S Depth
H Base type
117 Desktop finish
117 Base finish
G Glides

Specification Information

Specify desk shape:
 C Corner

Width left, width right:
 3 36"
 4 48"
 5 60"
 6 72"
 7 84"

Worksurface depth:
 S 24"D both sides
 L 30"D left, 24"D right
 R 30"D right, 24"D left
 D 30"D both sides

Base type:
 H Handcrank adjustable

Specify desk top and base finish.
 Veneer finishes for desks are available through Custom Product Development.

Specify:
 C Rear casters
 G Glides

Worksurface edges are trim grey.

Application Notes

Handcrank desks incorporate synchronized, adjustable C legs and corner legs. Handcrank mechanism enables user to adjust worksurface from 24" - 34" high (continuous) with collapsible crank under front edge. Handcrank is located on the extended side of desks.

Integral cable tray under worksurface and channels in legs provide basic lay-in wire management. Crossbeam stiffens legs through upper height range. Crossbeam is 4"H, 14" above floor.

Desks may be specified with fixed front glides and rear casters or 1 3/4" levelling glides. Casters and glides are interchangeable in the field.

Extended corner desks provide computer corner and adjacent work area in one unit. Nominal worksurface depths include 1 3/4" cable/connector clearance along back edge.

Handcrank mechanism is rated at 300 lbs. maximum weight.

Desks accept clamp-on workshelves and privacy screens.

Currents C-Legs mount with machine screws into metal inserts on the underside of Currents worksurfaces.

Desks

handcrank adjustable corner desk

Currents

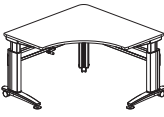
description	w(l)	w(r)	h	pattern no.	lam.
 24"D both sides corner desk	42"	42"	24-34"	AD C4242 SH () ()	\$2,953.
	48"	48"	24-34"	AD C44 SH () ()	3,082.
	60"	60"	24-34"	AD C55 SH () ()	3,307.
30"D left/24"D right corner desk	42"	42"	24-34"	AD C4242 LH () ()	2,995.
	48"	48"	24-34"	AD C44 LH () ()	3,125.
	60"	60"	24-34"	AD C55 LH () ()	3,355.
24"D left/30"D right corner desk	42"	42"	24-34"	AD C4242 RH () ()	2,995.
	48"	48"	24-34"	AD C44 RH () ()	3,125.
	60"	60"	24-34"	AD C55 RH () ()	3,355.
30"D both sides corner desk	48"	48"	24-34"	AD C44 DH () ()	3,175.
	60"	60"	24-34"	AD C55 DH () ()	3,402.

Order Code	Specification Information	Application Notes
Example: AD C44 SH 117 117 G	<i>Specify desk shape:</i>	<i>Specify:</i>
AD Desk	C Corner	C Rear casters
C Shape	<i>Width left, width right:</i>	G Glides
4 Width left	4 48"	Worksurface edges are trim grey.
4 Width right	5 60"	Clear Maple is not available on 60"W x 60"D corner desks.
S Depth	<i>Worksurface depth:</i>	Desks may be specified with fixed front glides and rear casters or 1 3/4" levelling glides. Casters and glides are interchangeable in the field.
H Base type	S 24"D both sides	Integral cable tray under worksurface and channels in legs provide basic lay-in wire management.
117 Desktop finish	L 30"D left, 24"D right	Corner desks provide up to 45" diagonal depth for large monitors, keyboard and mouse. Nominal worksurface depths include 1 3/4" cable/connector clearance along back edge.
117 Base finish	R 30"D right, 24"D left	Handcrank mechanism is rated at 300 lbs. maximum weight.
G Glides	D 30"D both sides	Desks accept clamp-on workshelves and privacy screens.
	<i>Base type:</i>	Currents C-Legs mount with machine screws into metal inserts on the underside of Currents worksurfaces.
	H Handcrank adjustable	
	<i>Specify desk top and base finish.</i>	
	Veneer finishes for desks are available through Custom Product Development.	

Desks and worktables

Desks

*handcrank adjustable
straight desk*

description	w(l)	w(r)	h	pattern no.	lam.
 24"D straight desk, curved front	36"	24"	24-34"	AD S36 SH () ()	\$2,014.
	42"	24"	24-34"	AD S42 SH () ()	2,046.
	48"	24"	24-34"	AD S48 SH () ()	2,076.
	60"	24"	24-34"	AD S60 SH () ()	2,135.
	72"	24"	24-34"	AD S72 SH () ()	2,196.
	84"	24"	24-34"	AD S84 SH () ()	2,258.
30"D straight desk, curved front	36"	30"	24-34"	AD S36 DH () ()	2,151.
	42"	30"	24-34"	AD S42 DH () ()	2,184.
	48"	30"	24-34"	AD S48 DH () ()	2,209.
	60"	30"	24-34"	AD S60 DH () ()	2,289.
	72"	30"	24-34"	AD S72 DH () ()	2,377.

Order Code	Specification Information	Application Notes
Example: AD S48 DH 117 117 G AD Desk S Shape 48 Width D Depth H Base type 117 Desktop finish 117 Base finish G Glides	<p><i>Specify desk shape:</i></p> <p>S Straight</p> <p><i>For straight desks specify:</i></p> <p><i>Width:</i></p> <p>36 36" 42 42" 48 48" 60 60" 72 72" 84 84"</p> <p><i>Worksurface depth:</i></p> <p>S 24"D D 30"D</p> <p><i>Base type:</i></p> <p>H Handcrank adjustable</p> <p><i>Specify desk top and base finish.</i></p> <p>Veneer finishes for desks are available through Custom Product Development.</p>	<p><i>Specify:</i></p> <p>C Rear casters G Glides</p> <p>Worksurface edges are trim grey.</p> <p>Handcrank desks incorporate synchronized, adjustable C legs and corner legs. Handcrank mechanism enables user to adjust worksurface from 24" - 34" high (continuous) with collapsible crank under front edge. Hand crank may be installed on the left or right side of any straight or symmetrical corner desk.</p> <p>Desks may be specified with fixed front glides and rear casters or levelling glides with 1 3/4" travel. Integral cable tray under worksurface and channels in legs provide basic lay-in wire management.</p> <p>Straight desks have slightly curved front edges, to a maximum of 1" extra depth at the center. Nominal worksurface depths include 1 3/4" cable/connector clearance along back edge.</p> <p>Handcrank mechanism is rated at 300 lbs. maximum weight.</p> <p>Desks accept clamp-on workshelves and privacy screens.</p> <p>Currents C-Legs mount with machine screws into metal inserts on the underside of Currents worksurfaces.</p>

Above-desk storage and lighting for desks

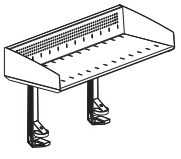

workshelf and T5 task light

description	type	w	d	h	pattern no.	paint	Standard	Advanced
		21"	13"	6"	AA1WS24()	\$569.		
		27"	13"	6"	AA1WS30()	598.		
		33"	13"	6"	AA1WS36()	630.		
		45"	13"	6"	AA1WS48()	678.		
Workshelf dividers (set of 5)					AA1WSD()	156.		
Task Light	Used with 24" and wider workshelf	19"	4"	1 1/2"	AA2T5E19()		177.	n/a
	Used with 30" and wider workshelf	25"	4"	1 1/2"	AA2T5E25()		223.	437.
	Used with 48" and wider workshelf	37"	4"	1 1/2"	AA2T5E37()		249.	478.

Order Code	Specification Information	Application Notes								
<p>Example: AA1 WS24 117</p> <table border="1"> <tr> <td>AA1</td> <td>Accessory</td> </tr> <tr> <td>WS</td> <td>Workshelf</td> </tr> <tr> <td>24</td> <td>Width</td> </tr> <tr> <td>117</td> <td>Finish</td> </tr> </table>	AA1	Accessory	WS	Workshelf	24	Width	117	Finish	<p><i>Specify painted finishes for workshelf and dividers.</i></p> <p><i>Specify:</i></p> <p>Width - Task Lights mount in cabinets and shelves at least 6" wider than light width.</p> <p>Type:</p> <p>S Standard A Advanced</p> <p>Specify suffix -CH and add \$45 list for City of Chicago installations. Example: AA2T5E19S-CH</p> <p>All housings are black.</p>	<p>Workshelf mounts anywhere along back of desk independent of privacy screens. Workshelf includes uprights and clamps for Currents, Equity, or Morrison, Reff or Dividends Horizon 1 1/4" worksurfaces.</p> <p>Task lights mount into the recess in the underside of overhead cabinets and shelves at least 6" wider than task light width.</p> <p>Task lights include T5 cool white (4100K) fluorescent lamp, electronic ballast, 9' grounded corset, prismatic lens, rocker switch, one cord exit management clip and mounting hardware.</p> <p>Task light cordset is center exit. On smaller units cord exit is off-center, but still not handed.</p> <p>Task lights are TCLP compliant and meet requirements of California Title 24.</p> <p>Advanced task lights are fitted with ballast and lamp compliant with LEED requirements.</p>
AA1	Accessory									
WS	Workshelf									
24	Width									
117	Finish									

Worktables

personal, tripod, wiper

description	type	w	d	h	pattern no.	lam.
Personal worktable 	Adjustable	36"	28"	24-30"	AT1 P36A () ()	\$1,475.
	Fixed height	36"	28"	28"	AT1 P36F () ()	1,254.
Tripod worktable 	Adjustable	36"	36"	24-30"	AT1 TA () ()	1,807.
	Fixed height (low)	36"	36"	26"	AT1 TL () ()	1,254.
Small wiper 	Adjustable	47"	30"	24-30"	AT1 W24A () ()	1,992.
	Fixed height	47"	30"	28"	AT1 W24F () ()	1,254.

Order Code	Specification Information	Application Notes
Example: AT1 W24F 117 117 C AT1 Table W Shape 24 Depth F Base type 117 Desktop finish 117 Base finish C Casters	F Fixed height A Adjustable height <i>Specify top and base finish.</i> Veneer finishes for worktables are available through Custom Product Development.	<i>Specify:</i> C Casters G Glides Fixed height tables are 28"H except Tripod, 26"H. Adjustable height worktables adjust 24"-30"H in one-inch increments. Glides adjust 1 3/4". All casters are lockable. Worktable top edge is trim grey.
		Worktables are independent, mobile tables designed for use with desks and panel-mounted worksurfaces. Personal worktable is rounded rectangle shape, sized to fit within small workstations. Personal worktable has center column, four-star base for clear knee space support. Tripod is rounded triangle shape designed to roll under Currents 48" corner desks set at 28"H. Small wiper and half wiper are conference extensions for 24"D worksurfaces. Medium wiper corresponds to 30"D worksurfaces. Wiper and half wiper tables have four legs with integral wire-manager channels.

Worktables

personal, tripod, wiper

description	type	w	d	h	pattern no.	lam.
Medium wiper	Adjustable	54"	30"	24-30"	AT1 W30A () ()	\$2,063.
	Fixed height	54"	30"	28"	AT1 W30F () ()	1,326.



Half wiper end table	Left, adjustable	33"	36"	24-30"	AT1 E24LA () ()	1,992.
	Left, fixed height	33"	36"	28"	AT1 E24LF () ()	1,254.
	Right, adjustable	33"	36"	24-30"	AT1 E24RA () ()	1,992.
	Right, fixed height	33"	36"	28"	AT1 E24RF () ()	1,254.



right

Order Code	Specification Information	Application Notes
Example: AT1 W24F 117 117 C	F Fixed height	Worktables are independent, mobile tables designed for use with desks and panel-mounted worksurfaces.
AT1 Table	A Adjustable height	
W Shape	<i>Specify top and base finish.</i>	Personal worktable is rounded rectangle shape, sized to fit within small workstations. Personal worktable has center column, four-star base for clear knee space support.
24 Depth	Veneer finishes for worktables are available through Custom Product Development.	
F Base type		Tripod is rounded triangle shape designed to roll under Currents 48" corner desks set at 28"H.
117 Desktop finish		
117 Base finish		Small wiper and half wiper are conference extensions for 24"D worksurfaces. Medium wiper corresponds to 30"D worksurfaces.
C Casters		

Specify:





C Casters
G Glides

Fixed height tables are 28"H except Tripod, 26"H. Adjustable height worktables adjust 24"-30"H in one-inch increments. Glides adjust 1 3/4". All casters are lockable. Worktable top edge is trim grey.

Wiper and half wiper tables have four legs with integral wire-manager channels.

Worktables

half-round, large wiper, round

description	type	w	d	h	pattern no.	lam.
Half round worktable 	Adjustable	50"	28"	24-30"	AT1 D50A () ()	\$1,697.
	Fixed height	50"	28"	28"	AT1 D50F () ()	1,475.
Large half round worktable 	Adjustable	62"	30"	24-30"	AT1 D62A () ()	2,212.
	Fixed height	62"	30"	28"	AT1 D62F () ()	1,475.
Large wiper end table 	Adjustable	72"	32"	24-30"	AT1 W50A () ()	2,212.
	Fixed height	72"	32"	28"	AT1 W50F () ()	1,475.
Round worktable 	Adjustable	42"		24-30"	AT1 R42A () ()	2,063.
	Adjustable	48"		24-30"	AT1 R48A () ()	2,142.
	Fixed height	42"		28"	AT1 R42F () ()	1,326.
	Fixed height	48"		28"	AT1 R48F () ()	1,402.

Order Code

Example:	AT1 D50F 117 117 C
AT1	Table
D	Shape
50	Depth
F	Base type
117	Desktop finish
117	Base finish
C	Casters

Specification Information

F	Fixed height
A	Adjustable height
<i>Specify top and base finish.</i>	
Veneer finishes for worktables are available through Custom Product Development.	

Specify:

C	Casters
G	Glides

Fixed height tables are 28"H.
Adjustable height worktables adjust 24"-30"H in one-inch increments.
Glides adjust 1 3/4". Worktable top edge is trim grey.

Application Notes

Worktables are independent, mobile tables designed for use with desks and panel-mounted worksurfaces.

Half round worktable aligns with back-to-back 24"D Currents desks or worksurfaces plus a Currents screen or Knoll systems panel between. Large half round table aligns with back-to-back 30"D desks or worksurfaces. Large wiper is shared conference extension for back-to-back 24"D desks. All tables have center edge offset to clear panel end trim.

Large half-round, round, and wiper tables have four legs with integral wire-manager channels. Half round worktable has center column, three-star base for clear knee space support.

Upstart Tables

primary worksurfaces
table desks

Currents

type	application	w	d	h	pattern no.	list price
Y-shape table desk, curved end (left hand shown)	left	72"	28-36"	25-30"	AUP Y72DCL4 () () ()	\$958.
	right	72"	28-36"	25-30"	AUP Y72DCR4 () () ()	958.



M-shape table desk, curved ends		72"	30-36"	25-30"	AUP M72DC4 () () ()	958.
---------------------------------	--	-----	--------	--------	-------------------------------	------

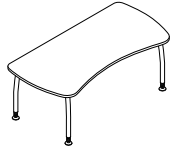

Y-shape table desk, flat ends	left	72"	28-36"	25-30"	AUP Y72DFL4 () () ()	958.
	right	72"	28-36"	25-30"	AUP Y72DFR4 () () ()	958.

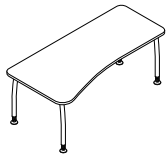

M-shape table desk, flat ends		72"	31-36"	25-30"	AUP M72DF4 () () ()	958.
-------------------------------	--	-----	--------	--------	-------------------------------	------

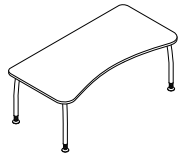

Order Code	Specification Information	Application Notes
Example: AUP Y72DCL4 117 117 117 G	Specify top, edge and leg finishes.	Upstart Y and M shape tables include a worksurface stiffener that doubles as a horizontal cable manager.
A Currents	<i>Casters/glides</i>	Upstart Y and M shape tables combine computer support and adjacent work area in a basic table desk.
UP Upstart	C Casters	Curved end tops facilitate conferencing in open planning. Flat ends plan close to system panels. Overall width is the same for curved and flat end tops.
Y Table shape	G Glides	Upstart tops have plastic laminate surface with continuous T-mold edge.
72 Width		Upstart tables have four legs with 5" adjustable leveler glides or 4" adjustable casters. Adjustment range is 25-30" for glides and 27-31" for casters.
D Depth		Adjustment range enables Upstart tables to overlap or slide under adjacent tables and worksurfaces.
C Curved end		
L Left hand		
4 Leg quantity		
117 Top finish		
117 Edge finish		
117 Leg finish		
G Glides		

Upstart Tables
primary worksurfaces
corner table desks

Currents

type	w	d	h	pattern no.	list price
Extended corner table desk, 90° extended left	72"	48"	25-30"	AUP C7248S5 () () ()	\$1,096.

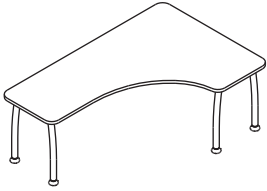

Extended corner table desk, 90° extended right	48"	72"	25-30"	AUP C4872S5 () () ()	1,096.
--	-----	-----	--------	--------------------------------	--------

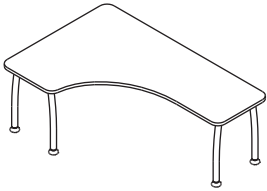

Corner table desk, 120°	48", 48"	22"	25-30"	AUP V48S5 () () ()	1,028.
-------------------------	----------	-----	--------	------------------------------	--------



Order Code	Specification Information	Application Notes
Example: AUP C7248S5 117 117 117 C	Specify top, edge and leg finishes.	Upstart extended corner and corner shape tables include worksurface stiffeners that double as horizontal cable managers.
A Currents	<i>Casters/glides</i>	Upstart extended corner and corner shape tables combine computer support and adjacent work area in a basic table desk.
UP Upstart	C Casters	Upstart tops have plastic laminate surface with continuous T-mold edge.
C Table shape	G Glides	Upstart tables have four or five legs with 5" adjustable leveler glides or 4" adjustable casters. Adjustment range is 25-30" for glides and 27-31" for casters.
72 Width, extended left		Adjustment range enables Upstart tables to overlap or slide under adjacent worksurfaces.
48 Width		
S Depth		
4 Leg quantity		
117 Top finish		
117 Edge finish		
117 Leg finish		
C Casters		

Extended corner table desks and 120° corner table desk are 22" deep on each side edge. Each back edge of 120° corner desk corresponds to 48" wide Currents linkable screens connected at a 120° angle.

Upstart Tables

secondary workspaces

Currents

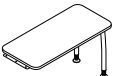
type	w	d	h	pattern no.	list price
 Rectangular table desk, four legs	48"	22"	25-30"	AUP S48S4 () () ()	\$616.
	48"	28"	25-30"	AUP S48D4 () () ()	686.
	60"	28"	25-30"	AUP S60D4 () () ()	754.
	72"	28"	25-30"	AUP S72D4 () () ()	789.
	72"	36"	25-30"	AUP S72E4 () () ()	822.
 Rectangular return, two legs	48"	22"	25-30"	AUP S48S2 () () G	480.





Order Code	Specification Information	Application Notes
Example: AUP S72E4 117 117 117 C	Specify top, edge and leg finishes.	Upstart rectangular and rectangular return include a worksurface stiffener that doubles as a horizontal cable manager.
A Currents	<i>Casters/glides</i>	Upstart tops have plastic laminate surface with continuous T-mold edge.
UP Upstart	C Casters	Upstart tables have four or five legs with 5" adjustable leveler glides or 4" adjustable casters. Adjustment range is 25-30" for glides and 27-31" for casters.
S Table shape	G Glides	Adjustment range enables Upstart tables to overlap or slide under adjacent workspaces.
72 Width		Rectangular return with two legs includes flat bracket for attachment to primary worksurface at right angle.
E Depth		
4 Leg quantity		
117 Top finish		
117 Edge finish		
117 Leg finish		
C Casters		

Upstart table desks and storage

Upstart Tables

conference worksurfaces

Currents



type	w	d	h	pattern no.	list price
Wiper table desk 	61"	32½"	25-30"	AUP W60D4 () () ()	\$754.
Oval table desk, four legs 	66"	36"	25-30"	AUP O664 () () ()	958.
Round table desk, four legs 	42"		25-30"	AUP R424 () () ()	714.
Half round table desk, four legs 	62"	30"	25-30"	AUP D624 () () ()	754.
Tripod table, three legs 	36"	36"	25-30"	AUP T363 () () ()	616.

Order Code	Specification Information	Application Notes
Example: AUP O664 117 117 117 G	Specify top, edge and leg finishes.	Upstart wiper, oval and half round tables include a worksurface stiffener that doubles as a horizontal cable manager.
A Currents	<i>Casters/glides</i>	Upstart conference table desks are designed to support conference work in combination with other worktables or systems furniture.
UP Upstart	C Casters	Upstart tops have plastic laminate surface with continuous T-mold edge.
O Table shape	G Glides	Upstart tables have four legs with 5" adjustable leveler glides or 4" adjustable casters. Adjustment range is 25-30" for glides and 27-31" for casters.
66 Size		Tops adjust in height to permit conference tops to overlap or roll under adjacent tables.
4 Leg quantity		Half round corresponds to back-to-back Y-shape tables or 30" deep straight tables.
117 Top finish		
117 Edge finish		
117 Leg finish		
G Glides		

Upstart Tables

curved leg only

Currents

description	h	pattern no.	Paint
Curved leg with glide 	23 ⁷ / ₈ " - 28 ⁷ / ₈ "	AUPCGV ()	\$99.
Curved leg with caster 	25 ⁷ / ₈ " - 29 ⁷ / ₈ "	AUPCCV ()	99.

Order Code	Specification Information	Application Notes
Example: AUPCC 114	Specify:	Each curved Upstart leg comes with four (4) metal inserts and four (4) screws.
A Currents	<i>Casters/glides</i>	When creating a freestanding table using Upstart legs, Upstart legs must be attached using metal inserts.
UP Upstart	C Casters	
C Curved leg	G Glides	Curved Upstart legs must be positioned in accordance with BIFMA guidelines.
C Casters	<i>Leg finishes, paint</i>	Upstart tables have four or five curved legs with 5" adjustable leveler glides or 4" adjustable casters. Adjustment range is 27" - 31" for casters and 25" - 30" for glides.
114 Leg finish	See Color Program Page	

Upstart table desks and storage

Plannable Upstart Tables

Rectangular Table Desk

Currents

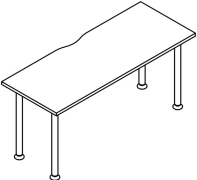
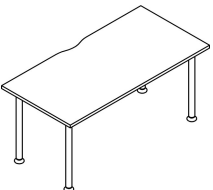
description	w	d	h	pattern no.	lam.
	30"	23 5/8"	27 3/4" - 32 3/4"	AUPM S30S4 () G () ()	\$491.
	36"	23 5/8"	27 3/4" - 32 3/4"	AUPM S36S4 () G () ()	518.
	42"	23 5/8"	27 3/4" - 32 3/4"	AUPM S42S4 () G () ()	548.
	48"	23 5/8"	27 3/4" - 32 3/4"	AUPM S48S4 () G () ()	576.
	54"	23 5/8"	27 3/4" - 32 3/4"	AUPM S54S4 () G () ()	602.
	60"	23 5/8"	27 3/4" - 32 3/4"	AUPM S60S4 () G () ()	630.
	66"	23 5/8"	27 3/4" - 32 3/4"	AUPM S66S4 () G () ()	660.
	72"	23 5/8"	27 3/4" - 32 3/4"	AUPM S72S4 () G () ()	688.
	84"	23 5/8"	27 3/4" - 32 3/4"	AUPM S84S4 () G () ()	743.
	30"	29 5/8"	27 3/4" - 32 3/4"	AUPM S30D4 () G () ()	555.
	36"	29 5/8"	27 3/4" - 32 3/4"	AUPM S36D4 () G () ()	584.
	42"	29 5/8"	27 3/4" - 32 3/4"	AUPM S42D4 () G () ()	613.
	48"	29 5/8"	27 3/4" - 32 3/4"	AUPM S48D4 () () () ()	639.
	54"	29 5/8"	27 3/4" - 32 3/4"	AUPM S54D4 () () () ()	672.
	60"	29 5/8"	27 3/4" - 32 3/4"	AUPM S60D4 () () () ()	702.
	66"	29 5/8"	27 3/4" - 32 3/4"	AUPM S66D4 () () () ()	719.
	72"	29 5/8"	27 3/4" - 32 3/4"	AUPM S72D4 () () () ()	734.
	84"	29 5/8"	27 3/4" - 32 3/4"	AUPM S84D4 () () () ()	817.

Order Code	Specification Information	Application Notes
Example: AUPM S72S4 AG 118 114 114	Specify:	<i>Edge finishes, T-mold</i> See Color Program Page
A Currents	<i>Grommet/No grommet</i>	<i>Leg finishes, paint</i> See Color Program Page
UP Upstart	A Grommet	24" deep rectangular table desks can only be ordered with glides.
M Plannable	B No grommet	30" deep rectangular table desks in 30", 36" and 42" width can only be ordered with glides.
S Table Shape	<i>Casters/glides</i>	For Veneer Group 1, only black or trim grey edgebands can be specified.
72 Width	C Casters	Translucent orange, Translucent blue and Frosty white edgebands are not available on Plannable Upstart tables.
S Depth	G Glides	Suspended pedestals may not be used on Upstart tables.
4 Leg quantity	<i>Top finish, plastic laminates</i> See Color Program Page	
A Grommet	<i>Veneer Group 1</i> See Color Program Page. Veneer finishes are available through Custom Product Development.	
G Glides		
118 Top finish		
114 Edge finish		
114 Leg finish		

Plannable Upstart Tables

Rectangular Return

Currents

description	w	d	h	pattern no.	lam.
	36"	23 ⁵ / ₈ "	27 ³ / ₄ " - 32 ³ / ₄ "	AUPM S36S2 () () () ()	\$392.
	42"	23 ⁵ / ₈ "	27 ³ / ₄ " - 32 ³ / ₄ "	AUPM S42S2 () () () ()	420.
	48"	23 ⁵ / ₈ "	27 ³ / ₄ " - 32 ³ / ₄ "	AUPM S48S2 () () () ()	447.
	60"	23 ⁵ / ₈ "	27 ³ / ₄ " - 32 ³ / ₄ "	AUPM S60S2 () () () ()	540.

Order Code	Specification Information	Application Notes
Example: AUPM S36S2 AC 118 114 114	Specify:	<i>Edge finishes, T-mold</i> See Color Program Page
A Currents	<i>Grommet/No grommet</i>	
UP Upstart	A Grommet	<i>Leg finishes, paint</i> See Color Program Page
M Plannable	B No grommet	For Veneer Group 1, only black or trim grey edgebands can be specified.
S Table Shape	<i>Casters/glides</i>	Translucent orange, Translucent blue and Frosty white edgebands are not available on Plannable Upstart tables.
36 Width	C Casters	Suspended pedestals may not be used on Upstart tables.
S Depth	G Glides	
2 Leg quantity	<i>Top finish, plastic laminates</i> See Color Program Page	Plannable Upstart tops have flat fronts allowing 2 tables to meet at right angles.
A Grommet	<i>Veneer Group 1</i> See Color Program Page. Veneer finishes are available through Custom Product Development.	Plannable Upstart tables have four or five straight legs with 5" adjustable leveler glides or 4" adjustable casters. Adjustment range is 27 ³ / ₄ " - 31 ³ / ₄ " for casters and 27 ³ / ₄ " - 32 ³ / ₄ " for glides.
C Casters		Rectangular return with two legs includes flat bracket for attachment to primary worksurfaces at right angle.
118 Top finish		Plannable Upstart rectangular and rectangular return include a worksurface stiffener that doubles as a horizontal cable manager.
114 Edge finish		
114 Leg finish		

Upstart table desks and storage

Plannable Upstart Tables

corner

Currents

description	w	d	h	pattern no.	lam.
24" D both sides corner worksurfaces	42"	42"	27 ³ / ₄ " - 32 ³ / ₄ "	AUPM C4242S5 () () () ()	\$842.
	48"	48"	27 ³ / ₄ " - 32 ³ / ₄ "	AUPM C4848S5 () () () ()	909.
	60"	60"	27 ³ / ₄ " - 32 ³ / ₄ "	AUPM C6060S5 () C () ()	1,185.

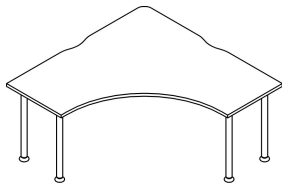

30" D both sides corner worksurfaces	42"	42"	27 ³ / ₄ " - 32 ³ / ₄ "	AUPM C4242D5 () () () ()	888.
	48"	48"	27 ³ / ₄ " - 32 ³ / ₄ "	AUPM C4848D5 () () () ()	956.
	60"	60"	27 ³ / ₄ " - 32 ³ / ₄ "	AUPM C6060D5 () C () ()	1,233.

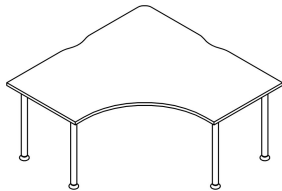

Order Code	Specification Information	Application Notes
Example: AUPM C4242S5 AC 118 114 114	Specify:	<i>Edge finishes, T-mold</i> See Color Program Page
A Currents	<i>Grommet/No grommet</i>	<i>Leg finishes, paint</i> See Color Program Page
UP Upstart	A Grommet	For Veneer Group 1, only black or trim grey edgebands can be specified.
M Plannable	B No grommet	Translucent orange, Translucent blue and Frosty white edgebands are not available on Plannable Upstart tables.
C Table Shape	<i>Casters/glides</i>	Suspended pedestals may not be used on Upstart tables.
4242 Width	C Casters	
S Depth	G Glides	
5 Leg quantity	<i>Top finish, plastic laminates</i> See Color Program Page	Plannable Upstart tops have flat fronts allowing 2 tables to meet at right angles.
A Grommet	<i>Veneer Group 1</i> See Color Program Page. Veneer finishes are available through Custom Product Development.	Plannable Upstart tables have four or five straight legs with 5" adjustable leveler glides or 4" adjustable casters. Adjustment range is 27 ³ / ₄ " - 31 ³ / ₄ " for casters and 27 ³ / ₄ " - 32 ³ / ₄ " for glides.
C Casters		Rectangular return with two legs includes flat bracket for attachment to primary worksurfaces at right angle.
118 Top finish		Plannable Upstart corner and extended corner include worksurface stiffeners that double as horizontal cable managers.
114 Edge finish		
114 Leg finish		

Plannable Upstart Tables

Currents

extended corner

extended left

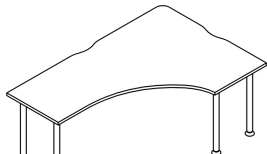
description	w	d	h	pattern no.	lam.
24" D both sides corner worksurface, extended left 	60"	36"	27 ³ / ₄ " - 32 ³ / ₄ "	AUPM C6036S5 () () () ()	\$744.
	60"	42"	27 ³ / ₄ " - 32 ³ / ₄ "	AUPM C6042S5 () () () ()	812.
	60"	48"	27 ³ / ₄ " - 32 ³ / ₄ "	AUPM C6048S5 () C () () ()	883.
	72"	36"	27 ³ / ₄ " - 32 ³ / ₄ "	AUPM C7236S5 () () () ()	883.
	72"	42"	27 ³ / ₄ " - 32 ³ / ₄ "	AUPM C7242S5 () C () () ()	952.
	72"	48"	27 ³ / ₄ " - 32 ³ / ₄ "	AUPM C7248S5 () C () () ()	1,021.
	84"	48"	27 ³ / ₄ " - 32 ³ / ₄ "	AUPM C8448S5 () C () () ()	1,158.

30" D both sides corner worksurface, extended left 	60"	48"	27 ³ / ₄ " - 32 ³ / ₄ "	AUPM C6048D5 () C () () ()	953.
	72"	48"	27 ³ / ₄ " - 32 ³ / ₄ "	AUPM C7248D5 () C () () ()	1,090.
	84"	48"	27 ³ / ₄ " - 32 ³ / ₄ "	AUPM C8448D5 () C () () ()	1,229.

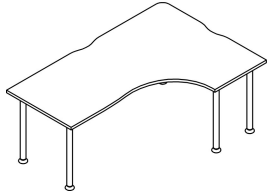
30" D left/24" D right corner worksurface, extended left 	60"	42"	27 ³ / ₄ " - 32 ³ / ₄ "	AUPM C6042L5 () C () () ()	883.
	60"	48"	27 ³ / ₄ " - 32 ³ / ₄ "	AUPM C6048L5 () C () () ()	953.
	72"	42"	27 ³ / ₄ " - 32 ³ / ₄ "	AUPM C7242L5 () C () () ()	1,021.
	72"	48"	27 ³ / ₄ " - 32 ³ / ₄ "	AUPM C7248L5 () C () () ()	1,090.
	84"	48"	27 ³ / ₄ " - 32 ³ / ₄ "	AUPM C8448L5 () C () () ()	1,229.

Order Code	Specification Information	Application Notes
Example: AUPM C7236S5 AC 118 114 114	Specify:	<i>Edge finishes, T-mold</i> See Color Program Page
A Currents	<i>Grommet/No grommet</i>	<i>Leg finishes, paint</i> See Color Program Page
UP Upstart	A Grommet	For Veneer Group 1, only black or trim grey edgebands can be specified.
M Plannable	B No grommet	Translucent orange, Translucent blue and Frosty white edgebands are not available on Plannable Upstart tables.
C Table Shape	<i>Casters/glides</i>	Suspended pedestals may not be used on Upstart tables.
7236 Width	C Casters	
S Depth	G Glides	
5 Leg quantity	<i>Top finish, plastic laminates</i> See Color Program Page	Plannable Upstart tops have flat fronts allowing 2 tables to meet at right angles.
A Grommet	<i>Veneer Group 1</i> See Color Program Page. Veneer finishes are available through Custom Product Development.	Plannable Upstart tables have four or five straight legs with 5" adjustable leveler glides or 4" adjustable casters. Adjustment range is 27 ³ / ₄ " - 31 ³ / ₄ " for casters and 27 ³ / ₄ " - 32 ³ / ₄ " for glides.
C Casters		Rectangular return with two legs includes flat bracket for attachment to primary worksurfaces at right angle.
118 Top finish		Plannable Upstart corner and extended corner include worksurface stiffeners that double as horizontal cable managers.
114 Edge finish		
114 Leg finish		

Plannable Upstart Tables

Currents

extended corner

extended left

description	w	d	h	pattern no.	lam.
24" D left/30" D right corner worksurface, extended left	60"	42"	27 ³ / ₄ " - 32 ³ / ₄ "	AUPM C6042R5 () C () () ()	\$883.
	60"	48"	27 ³ / ₄ " - 32 ³ / ₄ "	AUPM C6048R5 () C () () ()	953.
	72"	42"	27 ³ / ₄ " - 32 ³ / ₄ "	AUPM C7242R5 () C () () ()	1,021.
	72"	48"	27 ³ / ₄ " - 32 ³ / ₄ "	AUPM C7248R5 () C () () ()	1,090.
	84"	48"	27 ³ / ₄ " - 32 ³ / ₄ "	AUPM C8448R5 () C () () ()	1,229.

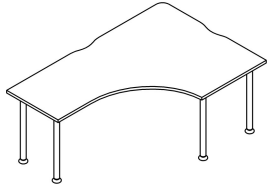

Order Code	Specification Information	Application Notes
Example: AUPM C7236S5 AC 118 114 114	Specify:	<i>Edge finishes, T-mold</i> See Color Program Page
A Currents	<i>Grommet/No grommet</i>	<i>Leg finishes, paint</i> See Color Program Page
UP Upstart	A Grommet	For Veneer Group 1, only black or trim grey edgebands can be specified.
M Plannable	B No grommet	Translucent orange, Translucent blue and Frosty white edgebands are not available on Plannable Upstart tables.
C Table Shape	<i>Casters/glides</i>	Suspended pedestals may not be used on Upstart tables.
7236 Width	C Casters	Plannable Upstart tops have flat fronts allowing 2 tables to meet at right angles.
S Depth	G Glides	Plannable Upstart tables have four or five straight legs with 5" adjustable leveler glides or 4" adjustable casters. Adjustment range is 27 ³ / ₄ " - 31 ³ / ₄ " for casters and 27 ³ / ₄ " - 32 ³ / ₄ " for glides.
5 Leg quantity	<i>Top finish, plastic laminates</i> See Color Program Page	Rectangular return with two legs includes flat bracket for attachment to primary worksurfaces at right angle.
A Grommet	<i>Veneer Group 1</i> See Color Program Page. Veneer finishes are available through Custom Product Development.	Plannable Upstart corner and extended corner include worksurface stiffeners that double as horizontal cable managers.
C Casters		
118 Top finish		
114 Edge finish		
114 Leg finish		

Plannable Upstart Tables

Currents

extended corner

extended right

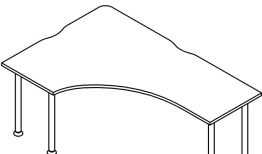
description	w	d	h	pattern no.	lam.
24" D both sides corner worksurface, extended right 	36"	60"	27 ³ / ₄ " - 32 ³ / ₄ "	AUPM C3660S5 () () () ()	\$744.
	36"	72"	27 ³ / ₄ " - 32 ³ / ₄ "	AUPM C3672S5 () () () ()	883.
	42"	60"	27 ³ / ₄ " - 32 ³ / ₄ "	AUPM C4260S5 () () () ()	812.
	42"	72"	27 ³ / ₄ " - 32 ³ / ₄ "	AUPM C4272S5 () C () () ()	952.
	48"	60"	27 ³ / ₄ " - 32 ³ / ₄ "	AUPM C4860S5 () C () () ()	883.
	48"	72"	27 ³ / ₄ " - 32 ³ / ₄ "	AUPM C4872S5 () C () () ()	1,021.
	48"	84"	27 ³ / ₄ " - 32 ³ / ₄ "	AUPM C4884S5 () C () () ()	1,158.

30" D both sides corner worksurface, extended right 	48"	60"	27 ³ / ₄ " - 32 ³ / ₄ "	AUPM C4860D5 () C () () ()	953.
	48"	72"	27 ³ / ₄ " - 32 ³ / ₄ "	AUPM C4872D5 () C () () ()	1,090.
	48"	84"	27 ³ / ₄ " - 32 ³ / ₄ "	AUPM C4884D5 () C () () ()	1,229.

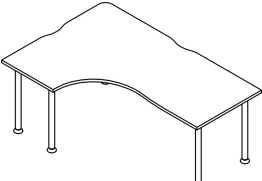
24" D left/30" D right corner worksurface, extended right 	42"	60"	27 ³ / ₄ " - 32 ³ / ₄ "	AUPM C4260R5 () C () () ()	883.
	42"	72"	27 ³ / ₄ " - 32 ³ / ₄ "	AUPM C4272R5 () C () () ()	1,021.
	48"	60"	27 ³ / ₄ " - 32 ³ / ₄ "	AUPM C4860R5 () C () () ()	953.
	48"	72"	27 ³ / ₄ " - 32 ³ / ₄ "	AUPM C4872R5 () C () () ()	1,090.
	48"	84"	27 ³ / ₄ " - 32 ³ / ₄ "	AUPM C4884R5 () C () () ()	1,229.

Order Code	Specification Information	Application Notes
Example: AUPM C4872S5 AC 118 114 114	Specify:	<i>Edge finishes, T-mold</i> See Color Program Page
A Currents	<i>Grommet/No grommet</i>	<i>Leg finishes, paint</i> See Color Program Page
UP Upstart	A Grommet	For Veneer Group I, only black or trim grey edgebands can be specified.
M Plannable	B No grommet	Translucent orange, Translucent blue and Frosty white edgebands are not available on Plannable Upstart tables.
C Table Shape	<i>Casters/glides</i>	Suspended pedestals may not be used on Upstart tables.
4872 Width	C Casters	
S Depth	G Glides	
5 Leg quantity	<i>Top finish, plastic laminates</i> See Color Program Page	
A Grommet	<i>Veneer Group I</i> See Color Program Page. Veneer finishes are available through Custom Product Development.	
C Casters		
118 Top finish		
114 Edge finish		
114 Leg finish		

Plannable Upstart tops have flat fronts allowing 2 tables to meet at right angles.

Plannable Upstart tables have four or five straight legs with 5" adjustable leveler glides or 4" adjustable casters. Adjustment range is 27³/₄" - 31³/₄" for casters and 27³/₄" - 32³/₄" for glides.

Rectangular return with two legs includes flat bracket for attachment to primary worksurfaces at right angle.

Plannable Upstart corner and extended corner include worksurface stiffeners that double as horizontal cable managers.

Upstart table desks and storage

Plannable Upstart Tables

Currents

extended corner

extended right

description	w	d	h	pattern no.	lam.
30" D left/24" D right corner worksurface, extended right	42"	60"	27 ³ / ₄ " - 32 ³ / ₄ "	AUPM C4260L5 () C () ()	\$883.
	42"	72"	27 ³ / ₄ " - 32 ³ / ₄ "	AUPM C4272L5 () C () ()	1,021.
	48"	60"	27 ³ / ₄ " - 32 ³ / ₄ "	AUPM C4860L5 () C () ()	953.
	48"	72"	27 ³ / ₄ " - 32 ³ / ₄ "	AUPM C4872L5 () C () ()	1,090.
	48"	84"	27 ³ / ₄ " - 32 ³ / ₄ "	AUPM C4884L5 () C () ()	1,229.

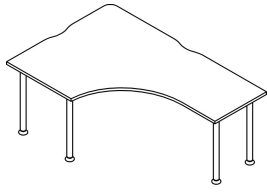

Order Code	Specification Information	Application Notes
Example: AUPM C4872S5 AC 118 114 114	Specify:	<i>Edge finishes, T-mold</i> See Color Program Page
A Currents	<i>Grommet/No grommet</i>	<i>Leg finishes, paint</i> See Color Program Page
UP Upstart	A Grommet	For Veneer Group 1, only black or trim grey edgebands can be specified.
M Plannable	B No grommet	Translucent orange, Translucent blue and Frosty white edgebands are not available on Plannable Upstart tables.
C Table Shape	<i>Casters/glides</i>	Suspended pedestals may not be used on Upstart tables.
4872 Width	C Casters	
S Depth	G Glides	
5 Leg quantity	<i>Top finish, plastic laminates</i> See Color Program Page	
A Grommet	<i>Veneer Group 1</i> See Color Program Page. Veneer finishes are available through Custom Product Development.	
C Casters		
118 Top finish		
114 Edge finish		
114 Leg finish		

Plannable Upstart tops have flat fronts allowing 2 tables to meet at right angles.

Plannable Upstart tables have four or five straight legs with 5" adjustable leveler glides or 4" adjustable casters. Adjustment range is 27³/₄" - 31³/₄" for casters and 27³/₄" - 32³/₄" for glides.

Rectangular return with two legs includes flat bracket for attachment to primary worksurfaces at right angle.

Plannable Upstart corner and extended corner include worksurface stiffeners that double as horizontal cable managers.

Plannable Upstart Tables half round and P-shapes

description	w	d	h	pattern no.	lam.
Half round table desk, four legs	59"	30"	27 ³ / ₄ " - 32 ³ / ₄ "	AUPM D594 () G () ()	\$702.
	60"	30"	27 ³ / ₄ " - 32 ³ / ₄ "	AUPM D604 () G () ()	702.



P-shape surface, extended right	48"	75"	27 ³ / ₄ " - 32 ³ / ₄ "	AUPM P4875S5 () C () ()	1,173.
---------------------------------	-----	-----	---	-----------------------------------	--------

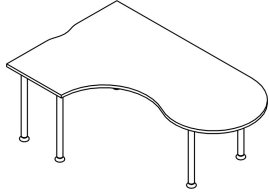

P-shape surface, extended left	75"	48"	27 ³ / ₄ " - 32 ³ / ₄ "	AUPM P7548S5 () C () ()	1,173.
--------------------------------	-----	-----	---	-----------------------------------	--------

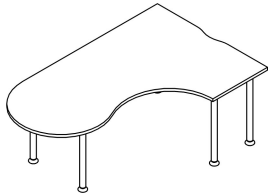

Order Code	Specification Information	Application Notes
Example: AUPM P4875S5 AC 118 114 114	Specify:	<i>Edge finishes, T-mold</i> See Color Program Page
A Currents	<i>Grommet/No grommet</i>	<i>Leg finishes, paint</i> See Color Program Page
UP Upstart	A Grommet	For Veneer Group 1, only black or trim grey edgebands can be specified.
M Plannable	B No grommet	Translucent orange, Translucent blue and Frosty white edgebands are not available on Plannable Upstart tables.
P Table Shape	<i>Casters/glides</i>	Suspended pedestals may not be used on Upstart tables.
4875 Width	C Casters	
S Depth	G Glides	
5 Leg quantity	<i>Top finish, plastic laminates</i> See Color Program Page	
A Grommet	<i>Veneer Group 1</i> See Color Program Page. Veneer finishes are available through Custom Product Development.	
C Casters		
118 Top finish		
114 Edge finish		
114 Leg finish		

Plannable Upstart tops have flat fronts allowing 2 tables to meet at right angles.



Plannable Upstart tables have four or five straight legs with 5" adjustable leveler glides or 4" adjustable casters. Adjustment range is 27³/₄" - 31³/₄" for casters and 27³/₄" - 32³/₄" for glides.

Rectangular return with two legs includes flat bracket for attachment to primary worksurfaces at right angle.

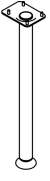

Plannable Upstart half round and P-shape tables include worksurface stiffeners that double as horizontal cable managers.

Plannable Upstart Tables

straight leg only

description	h	pattern no.	Paint
Straight leg with glide 	26 ⁵ / ₈ " - 31 ⁵ / ₈ "	AUPM SGV ()	\$99.
Straight leg with caster 	26 ⁵ / ₈ " - 30 ⁵ / ₈ "	AUPM SCV ()	99.

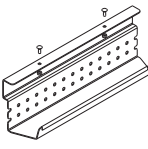
Order Code	Specification Information	Application Notes
Example: AUPM SC 114	Specify:	Plannable Upstart straight leg may not be used with Original Upstart tables due to stability issues.
A Currents	<i>Casters/glides</i>	
UP Upstart	C Casters	Each straight Plannable Upstart leg comes with four (4) metal inserts and four (4) screws.
M Plannable	G Glides	
S Straight leg	<i>Leg finishes, paint</i>	When creating a freestanding table using Upstart legs, Upstart legs must be attached using metal inserts.
C Casters	See Color Program Page	Straight Plannable Upstart legs must be positioned in accordance with BIFMA guidelines.
114 Leg finish		Plannable Upstart tables have four or five straight legs with 5" adjustable leveler glides or 4" adjustable casters. Adjustment range is 27 ³ / ₄ " - 31 ³ / ₄ " for casters and 27 ³ / ₄ " - 32 ³ / ₄ " for glides.

type	w	d	h	pattern no.	list price
Flat bracket 	3 1/2"	14"		AB1 F24	\$35.
Cable tray 	20"	2"	6"	AR1 CB	139.
Carpet grips (set of 10) 				MM2CG	24.
Non skid grips (set of 10) 				AA1NSK	38.
Lockable caster (set of 4)	2"	2"	2 1/4"	AUPLC4	45.
Lockable caster (set of 5)	2"	2"	2 1/4"	AUPLC5	56.

Order Code

Example: AA1-NSK
A Currents
A1 Accessory
NSK Non skid grips

Specification Information

Flat bracket and cable tray are black, painted steel.

Application Notes

Flat bracket attaches return worksurface to primary worksurface at right angle.

Cable tray attaches beneath stiffener under table surface to accommodate transformers or a bundle of cable.

Carpet grips snap into underside of Upstart leveling glides for traction on carpeted floors.

Non-skid grips snap into leveling glides for traction on hard-surface floors.

Locking casters replace standard non-locking casters.

Upstart Privacy Screens for Upstart tables

Currents

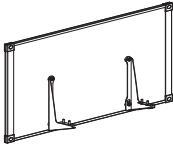
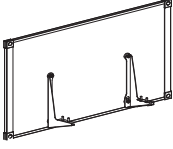
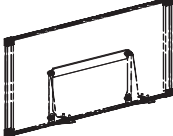
type	application	w	d	h	pattern no.	list price	
	Polycarbonate screen, back of table	36"	3/4"	24"	AUP B3624RC ()	\$492.	
		48"	3/4"	24"	AUP B4824RC ()	561.	
		60"	3/4"	24"	AUP B6024RC ()	648.	
		72"	3/4"	24"	AUP B7224RC ()	707.	
	Marker surface screen, back of table	36"	3/4"	24"	AUP B3624M ()	492.	
		48"	3/4"	24"	AUP B4824M ()	561.	
		60"	3/4"	24"	AUP B6024M ()	648.	
		72"	3/4"	24"	AUP B7224M ()	707.	
	Magnet rail	36" screen	18"	1/4"	2"	AUP MR36 ()	56.
		48" screen	30"	1/4"	2"	AUP MR48 ()	65.
		60" screen	36"	1/4"	2"	AUP MR60 ()	72.
		72" screen	48"	1/4"	2"	AUP MR72 ()	77.

Order Code

Example:	AUP B7224 RC 117
A	Currents
UP	Upstart
B	Back of worksurface
72	Width
24	Height
RC	Polycarbonate
117	Paint finish

Specification Information

Specify surface type and painted finish for screen frame, brackets and magnet rail.

Surface type:

RC Ribbed polycarbonate
M Marker Surface

Application Notes

Upstart screens mount on the back of Upstart tables to provide partial enclosure above and below worksurface height.

Screens have a translucent, ribbed polycarbonate or marker surface core. Perimeter frame is painted steel with trim grey molded corner blocks.

Screens include brackets that mount to matching holes under Upstart tables of the same width. Bracket holes are also provided for mounting two 36" wide screens on a 72" wide Upstart table.

Screen mounts in two positions, creating enclosure to a height of 39" or 48" when the table top is adjusted to 28".

Screens may be shared between desks in back to back configurations.

Magnet rails span between screen mounting brackets to hang paper documents.

Magnet rails correspond in width to privacy screens.

Please refer to Introduction page for table and screen dimensions.

Plannable Upstart Privacy Screens

back screens

Currents

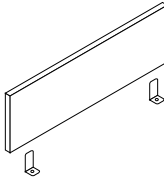
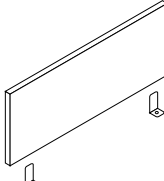
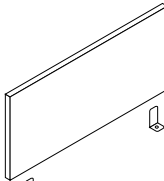
description	type	w	d	h	pattern no.	10	15	20	30	40	45
 Back of worksurface screens to 42"H		30"	3/4"	15"	MZ1-B3015-(-)	\$258.	\$291.	\$298.	\$327.	\$367.	\$408.
		36"	3/4"	15"	MZ1-B3615-(-)	310.	338.	346.	380.	418.	449.
		42"	3/4"	15"	MZ1-B4215-(-)	380.	397.	410.	451.	492.	526.
		48"	3/4"	15"	MZ1-B4815-(-)	427.	444.	457.	502.	562.	600.
		54"	3/4"	15"	MZ1-B5415-(-)	498.	513.	527.	583.	636.	675.
		60"	3/4"	15"	MZ1-B6015-(-)	549.	559.	579.	634.	707.	752.
		66"	3/4"	15"	MZ1-B6615-(-)	*	603.	*	*	*	*
		72"	3/4"	15"	MZ1-B7215-(-)	*	669.	*	*	*	*
	78"	3/4"	15"	MZ1-B7815-(-)	*	733.	*	*	*	*	
 Back of worksurface screens to overhead support height, 46"H		30"	3/4"	19"	MZ1-B3019-(-)	328.	357.	367.	402.	442.	481.
		36"	3/4"	19"	MZ1-B3619-(-)	405.	426.	437.	482.	514.	546.
		42"	3/4"	19"	MZ1-B4219-(-)	480.	490.	501.	555.	612.	648.
		48"	3/4"	19"	MZ1-B4819-(-)	544.	557.	570.	629.	726.	740.
		54"	3/4"	19"	MZ1-B5419-(-)	620.	623.	645.	708.	760.	808.
		60"	3/4"	19"	MZ1-B6019-(-)	669.	687.	707.	782.	831.	886.
		66"	3/4"	19"	MZ1-B6619-(-)	*	753.	*	*	*	*
		72"	3/4"	19"	MZ1-B7219-(-)	*	823.	*	*	*	*
	78"	3/4"	19"	MZ1-B7819-(-)	*	892.	*	*	*	*	
 Back of worksurface screens, to Reuter overhead support height, 49"H		30"	3/4"	22"	MZ1-B3022-(-)	402.	422.	432.	481.	514.	549.
		36"	3/4"	22"	MZ1-B3622-(-)	497.	513.	527.	581.	622.	645.
		42"	3/4"	22"	MZ1-B4222-(-)	570.	581.	600.	659.	733.	768.
		48"	3/4"	22"	MZ1-B4822-(-)	669.	670.	690.	762.	814.	887.
		54"	3/4"	22"	MZ1-B5422-(-)	734.	735.	762.	845.	897.	947.
		60"	3/4"	22"	MZ1-B6022-(-)	782.	819.	845.	931.	985.	1,020.
		66"	3/4"	22"	MZ1-B6622-(-)	*	910.	*	*	*	*
		72"	3/4"	22"	MZ1-B7222-(-)	*	976.	*	*	*	*
	78"	3/4"	22"	MZ1-B7822-(-)	*	1,051.	*	*	*	*	

Order Code	Specification Information	Application Notes
Example: MZ1-B6619-15-W210/20 MZ1 Morrison Network privacy screen B Back of worksurface 66 Width 19 Height 15 Surface type and group no. W210/20 Upholstery	<i>Surface type:</i> 10- Fabric group 10 15- Fabric group 15 20- Fabric group 20 30- Fabric group 30 40- Fabric group 40 45- Fabric group 45 Morrison Network screens may be used with Plannable Upstart tables. Refer to front of Upstart price book for planning information. * Screens 66"w and wider are available with fabric railroaded to fit the screens' width. Please contact Knoll Custom Product Development to establish pattern numbers.	Back of worksurface screens provide visual barrier and tackable surface from underside of worksurface to a height of 42", 46" or 49". Screen widths should correspond to straight worksurface width, or sum of VDT corner and return widths. Use back of worksurface screen for VDT applications where one side is backed by a vertical panel. VDT worksurfaces will accept back screens on only one back edge. Back screens may not be used at the end of a straight worksurface; use end screens in this application. Privacy screens are not available in a combination of fabrics. Back of worksurface screens are full dimension: two smaller screens may be substituted for a larger one. For example, if using fabric grades 20-70, specify two 36" screens for a 72" surface.
		Between back-to-back straight or VDT worksurfaces specify a single 3/4" back screen. This allows back-to-back 23 5/8"D or 29 5/8"D worksurfaces to plan on a precise 6" module. 15" high screens are used for a 42" horizon. 19"H screens are used to fill in space between worksurface and Morrison overhead. 22"H screens fill the space between worksurface and Reuter overhead. All but shared end screens start at the bottom of the worksurface. Privacy screens are supported by brackets fastened at worksurface inserts. Privacy screens include mounting brackets, insert kit, and stiffener clip. For replacement screen stiffeners see Accessories page. Privacy screens may be specified to achieve ASTM E-84 Class "A" flamespread rating.

Upstart table desks and storage

Plannable Upstart Privacy Screens

VDT screens

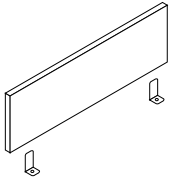
description	type	w	d	h	pattern no.	10	15	20	30	40	45
	To 42"H	35 ⁵ / ₈ "	3/4"	15"	MZ1-V3615-()	\$310.	\$338.	\$346.	\$367.	\$408.	\$449.
		41 ⁵ / ₈ "	3/4"	15"	MZ1-V4215-()	380.	397.	410.	442.	481.	526.
		47 ⁵ / ₈ "	3/4"	15"	MZ1-V4815-()	427.	444.	457.	492.	546.	600.
		59 ⁵ / ₈ "	3/4"	15"	MZ1-V6015-()	542.	562.	581.	621.	686.	743.
		71 ⁵ / ₈ "	3/4"	15"	MZ1-V7215-()	*	676.	*	*	*	*
	To 46"H	35 ⁵ / ₈ "	3/4"	19"	MZ1-V3619-()	409.	423.	437.	465.	499.	546.
		41 ⁵ / ₈ "	3/4"	19"	MZ1-V4219-()	480.	490.	501.	535.	600.	648.
		47 ⁵ / ₈ "	3/4"	19"	MZ1-V4819-()	544.	559.	579.	616.	670.	740.
		59 ⁵ / ₈ "	3/4"	19"	MZ1-V6019-()	683.	706.	732.	793.	878.	951.
		71 ⁵ / ₈ "	3/4"	19"	MZ1-V7219-()	*	852.	*	*	*	*
	To 49"H	35 ⁵ / ₈ "	3/4"	22"	MZ1-V3622-()	497.	513.	527.	564.	600.	645.
		41 ⁵ / ₈ "	3/4"	22"	MZ1-V4222-()	570.	581.	600.	629.	718.	768.
		47 ⁵ / ₈ "	3/4"	22"	MZ1-V4822-()	669.	672.	692.	735.	740.	887.
		59 ⁵ / ₈ "	3/4"	22"	MZ1-V6022-()	792.	822.	847.	922.	1,017.	1,104.
		71 ⁵ / ₈ "	3/4"	22"	MZ1-V7222-()	*	985.	*	*	*	*

Order Code	Specification Information	Application Notes
<p>Example: MZ1-V4822-15-W210/20</p> <p>MZ1 Morrison Network privacy screen</p> <hr/> <p>V VDT</p> <hr/> <p>48 Width</p> <hr/> <p>22 Height</p> <hr/> <p>15 Surface type and group no.</p> <hr/> <p>W210/20 Upholstery</p>	<p><i>Surface type:</i></p> <p>10- Fabric group 10 15- Fabric group 15 20- Fabric group 20 30- Fabric group 30 40- Fabric group 40 45- Fabric group 45</p> <p>VDT worksurfaces will not accept back screens on both back edges. Use VDT screens on at least one back edge.</p> <p>VDT screens are not in pairs; specify one for each back edge or one VDT screen and one back screen.</p> <p>* Screens 66" w and wider are available with fabric railroaded to fit the screens' width. Please contact Knoll Custom Product Development to establish pattern numbers.</p>	<p>Privacy screens are supported by brackets fastened at worksurface inserts. Privacy screens include mounting brackets, insert kit and stiffener clip.</p> <p>15" high screens are used for a 42" horizon.</p> <p>19"H screens are used to fill in space between worksurface and desk mounted Morrison Network overheads.</p> <p>22"H screens fill the space between worksurface and desk mounted Reuter overheads.</p> <p>Privacy screens may be specified to achieve ASTM E-84 Class "A" flamespread rating.</p>

Wall Mounting Suggestions

The following information is provided only as a guide, and represents minimum recommendations only. Knoll does not accept responsibility for the attachment of any Knoll product to a Customer's site wall. Wall specification/construction is the responsibility of the Customer and its structural engineer/architect. Failure to properly attach Knoll products to adequate wall structures can lead to property damage and/or personal injury.

You should consult your own structural engineers and/or architects and must not rely on the information provided herein.

It is the responsibility of the Customer and its structural engineers/architects to verify that the permanent structural walls (studs, blocks, solid masonry, etc.) on which the Knoll products are intended to be mounted are designed appropriately to support the product weight, PLUS 3 lbs. per linear inch for each useable shelf length

NOTE: A cabinet's top is considered a "useable shelf" and MUST be included in the calculation of the total load for an overhead cabinet.

It is the responsibility of the Customer and its structural engineer/architects to specify the fasteners and method for attaching the Knoll supplied wall mounting cleat, bracket, frame, etc. to the supporting wall and to confirm that the installers have adhered to these specifications. For all local building standards and codes, and additional requirements (including, but not limited to, seismic conditions) the Customer should always consult local code agencies.

	EXISTING CONSTRUCTION					
	NEW CONSTRUCTION	Cinder Block or Poured Concrete Masonry Wall	Wood Stud Wall, the studs being FULL HEIGHT to the roof/floor above	Wood Stud Wall, the studs being only Ceiling Height	Steel Stud Wall, the studs being FULL HEIGHT to the roof/floor above	Steel Stud Wall, the studs being only Ceiling Height
Stud Specification	Wood studs, grade #2 or better, 3 1/2" minimum width, OR Metal studs, minimum 25 gage thickness, 3 5/8" minimum width	The wall must be a minimum of 6" thick, and must be full height to the roof/ floor structure above	Wood studs must be Grade #2, or better, 3 1/2" minimum width	Wood studs must be Grade #2, or better, 3 1/2" minimum width	Metal studs must be minimum 25 gage thickness, 3 5/8" minimum width	Metal studs must be minimum 25 gage thickness, 3 5/8" minimum width
Stud Centers	Metal and wood studs must be spaced at 16" c/c maximum	N/A	Wood studs must be spaced at 16" c/c maximum	Wood studs must be spaced at 16" c/c maximum"	Metal studs must be spaced at 16" c/c maximum	Metal studs must be spaced at 16" c/c maximum
Stud Height	Metal and wood studs must extend upwards, and be securely attached to the roof/ floor structure above			Wood studs must be braced above the ceiling, and be securely attached to the roof/floor structure above Affix #2 grade 'cap' across the top of the studs, then place diagonal studs from the top cap up to underside of the roof/ floor structure above		Metal studs must be braced above the ceiling, and be securely attached to the roof/floor structure above Affix metal bracing 'cap' across the top of the studs, then place diagonal studs from the top cap up to underside of the roof / floor structure above
Mounting the Knoll Supplied Cleat, Bracket, Frame, etc*	Insert a 2" X 6" wood block, #2 grade or better, [or a Danback™ flexible wood backing system] horizontally between each of the studs to accommodate the full width of the cabinet, and beyond to the next stud. Fasten the wood block to each stud using three screws at the ends of each block. (Fasten the Danback™ as directed by the manufacturer) Fasten the Knoll supplied wall mounting cleat, bracket, frame, etc directly to each wood block every 6" For wall mounting structures that have a rectangular frame-like configuration: fasten the top horizontal element of the frame to the wood blocking every 6", and fasten the lower horizontal element to each wall stud, using one fastener per stud.	Fasten the Knoll supplied cabinet wall mounting cleat, bracket, frame, etc. directly to the masonry wall every 6" For wall mounting structures that have a rectangular frame-like configuration: fasten the top horizontal element of the frame to the wall every 6", and fasten the lower horizontal element to the wall every 16"	In the desired location of the cabinet mounting rail, remove an 8" high section of drywall the width of the cabinet, and beyond to the next stud. Insert a 2" X 6" wood block, #2 grade or better, horizontally between each of the exposed studs. Fasten the wood block to each stud using three screws at the ends of each block. Replace the drywall and repair as desired. Fasten the Knoll supplied wall mounting cleat, rail, frame, etc directly to the wood block every 6" For wall mounting structures that have a rectangular frame-like configuration: fasten the top horizontal element of the frame to the wood blocking every 6", and fasten the lower horizontal element to each wall stud, using one fastener per stud.	In the desired location of the cabinet mounting rail, remove an 8" high section of drywall the width of the cabinet, and beyond to the next stud. Insert a 2" X 6" wood block, #2 grade or better, horizontally between each of the exposed studs. Fasten the wood block to each stud using three screws at the ends of each block. Replace the drywall and repair as desired. Fasten the Knoll supplied wall mounting cleat, rail, frame, etc directly to the wood block every 6" For wall mounting structures that have a rectangular frame-like configuration: fasten the top horizontal element of the frame to the wood blocking every 6", and fasten the lower horizontal element to each wall stud, using one fastener per stud.	In the desired location of the cabinet mounting rail, remove an 8" high section of drywall the width of the cabinet, and beyond to the next stud. Insert a 2" X 6" wood block, #2 grade or better, [or a Danback™ flexible wood backing system] horizontally between each of the exposed studs. Fasten the wood block to each stud using three screws at the ends of each block. Replace the drywall and repair as desired. Fasten the Knoll supplied wall mounting cleat, rail, frame, etc directly to the wood block every 6" For wall mounting structures that have a rectangular frame-like configuration: fasten the top horizontal element of the frame to the wood blocking every 6", and fasten the lower horizontal element to each wall stud, using one fastener per stud.	In the desired location of the cabinet mounting rail, remove an 8" high section of drywall the width of the cabinet, and beyond to the next stud. Insert a 2" X 6" wood block, #2 grade or better, [or a Danback™ flexible wood backing system] horizontally between each of the exposed studs. Fasten the wood block to each stud using three screws at the ends of each block. Replace the drywall and repair as desired. Fasten the Knoll supplied wall mounting cleat, rail, frame, etc directly to the wood block every 6" For wall mounting structures that have a rectangular frame-like configuration: fasten the top horizontal element of the frame to the wood blocking every 6", and fasten the lower horizontal element to each wall stud, using one fastener per stud.
*Graham Wall Hung Shelf	The Graham Wall Hung Shelf Bracket (and others like it) requires full support behind the full height of the bracket This should be accomplished by insertion of additional 2"X 6" wood blocking between the studs as defined above	Fasten the Knoll supplied wall mounting brackets directly to the masonry wall, using the holes provided in each bracket	The Graham Wall Hung Shelf Bracket (and others like it) requires full support behind the full height of the bracket This should be accomplished by insertion of additional 2"X 6" wood blocking between the studs as defined above	The Graham Wall Hung Shelf Bracket (and others like it) requires full support behind the full height of the bracket This should be accomplished by insertion of additional 2"X 6" wood blocking between the studs as defined above	The Graham Wall Hung Shelf Bracket (and others like it) requires full support behind the full height of the bracket This should be accomplished by insertion of additional 2"X 6" wood blocking between the studs as defined above	The Graham Wall Hung Shelf Bracket (and others like it) requires full support behind the full height of the bracket This should be accomplished by insertion of additional 2"X 6" wood blocking between the studs as defined above
Fasten the Knoll supplied wall cleat with...	#10 x 2 1/2" Grabber Woodys Screws or equiv. @ 6" c/c, screwed directly into the wood blocking	3/16" x 3 1/2" Tapcon Masonry Screws or equiv. @ 6" c/c with 1-1/4" embedment, screwed directly into the masonry wall	#10 x 2 1/2" Grabber Woodys Screws or equiv. @ 6" c/c, screwed directly into the wood blocking	#10 x 2 1/2" Grabber Woodys Screws or equiv. @ 6" c/c, screwed directly into the wood blocking	#10 x 2 1/2" Grabber Woodys Screws or equiv. @ 6" c/c, screwed directly into the wood blocking	#10 x 2 1/2" Grabber Woodys Screws or equiv. @ 6" c/c, screwed directly into the wood blocking

Alpha-Numeric Index

<i>pattern no.</i>	<i>page</i>	<i>pattern no.</i>	<i>page</i>	<i>pattern no.</i>	<i>page</i>	<i>pattern no.</i>	<i>page</i>
A1 R1 SI	107, 108	AA1MET56	41	AB1 CL24L	101	ACE1L4848DDN	93
A1 RTOPL	107, 108	AA1MET64	41	AB1 CL24R	101	ACE1L4848DSN	93
A1 RTOPR	107, 108	AA1MET74	41	AB1 CL30L	101	ACE1L4848SDN	93
A2 R48 LL	107	AA1MET80	41	AB1 CL30R	101	ACE1L4848SSN	93
A2 R48 LP	107	AA1MPS30	41	AB1 CLF24L	101	ACE1L4860DSN	95
A2 R48 RL	107	AA1MPS39	41	AB1 CLF24R	101	ACE1L4860SDN	95
A2 R48 RP	107	AA1MPS42	41	AB1 CLF30L	101	ACE1L4860SSN	95
A2 R64 LP	107	AA1MPS48	41	AB1 CLF30R	101	ACE1L4866DSN	95
A2 R64 RP	107	AA1MPS56	41	AB1 CS	115	ACE1L4866SDN	95
A2L 48 LL	108	AA1MPS64	41	AB1 F24	143	ACE1L4866SSN	95
A2L 48 LP	108	AA1MPS74	41	AB1 FE	100	ACE1L4872DSN	95
A2L 48 RL	108	AA1MPS80	41	AB1 I25(G/C)	101	ACE1L4872SDN	95
A2L 48 RP	108	AA1MRS	41	AB1 I27A(G/C)	101	ACE1L4872SSN	95
A2L 64 LP	108	AA1NSK	34, 62, 143	AB1 I27F(G/C)	101	ACE1L4878SSN	95
A2L 64 RP	108	AA1OR	28	AB1 VL	101	ACE1L4884SSN	95
AA139E	62	AA1ORD	28	AB1-ABC24	100	ACE1L6042SSN	95
AA148E	62	AA1RE	62	AB1FAE	34, 100	ACE1L6048DSN	96
AA164E	62	AA1RODN	113	AB2 AE	100	ACE1L6048SDN	96
AA1B	62	AA1ROUP	113	AB2 FE27	100	ACE1L6048SSN	95
AA1CET39	41	AA1ROXUP	113	AB2 FE28	100	ACE1L6642SSN	96
AA1CET48	41	AA1RPS34	44	AC1 39E1	64	ACE1L6648DSN	96
AA1CET64	41	AA1RPS42	44	AC1 39L2	64	ACE1L6648SDN	96
AA1CG	34	AA1RPS49	44	AC1 39T3	64	ACE1L6648SSN	96
AA1DHPS36(5)	49	AA1RPS64	44	AC1 39V2	65	ACE1L7242SSN	96
AA1DHPS42(5)	49	AA1RPS79	44	AC1 39X4	64	ACE1L7248DSN	96
AA1DHPS50(5)	49	AA1RSDN	113	AC1 39Y3	65	ACE1L7248SDN	96
AA1DHPS57(5)	49	AA1RSUP	113	AC1 48E1	64	ACE1L7248SSN	96
AA1DHPS64(5)	49	AA1RSXDN	113	AC1 48L2	64	ACE1L7842SSN	96
AA1DHTC	49	AA1RSXDN	113	AC1 48T3	64	ACE1L7848SSN	96
AA1EPS40	43	AA1RSXUP	113	AC1 48V2	65	ACE1L8448SSN	96
AA1EPS48	43	AA1RTC	44	AC1 48X4	64	ACE1R1212G	97
AA1EPS53	43	AA1T06	62	AC1 48Y3	65	ACE1R2424N	92
AA1EPS60	43	AA1T18	62	AC1 64E1	64	ACE1R2430N	92
AA1EPS65	43	AA1T24	62	AC1 64L2	64	ACE1R3024N	92
AA1FCET39	48	AA1T30	62	AC1 64T3	64	ACE1R3030N	92
AA1FCET48	48	AA1T36	62	AC1 64V2	65	ACE1R3624N	92
AA1FCET64	48	AA1T42	62	AC1 64X4	64	ACE1R3630N	92
AA1FDB27	34	AA1T48	62	AC1 64Y3	65	ACE1R4224N	92
AA1FDB28	34	AA1T60	62	ACE1BD6648D(L/R)	94	ACE1R4230N	92
AA1FMET30	48	AA1UA39	46	ACE1BD6648S(L/R)	94	ACE1R4824N	92
AA1FMET39	48	AA1UA48	46	ACE1BD7248D(L/R)	94	ACE1R4830N	92
AA1FMET42	48	AA1UA64	46	ACE1BD7248S(L/R)	94	ACE1R5424N	92
AA1FMET48	48	AA1UPS39	46	ACE1BD7848D(L/R)	94	ACE1R5430N	92
AA1FMET56	48	AA1UPS48	46	ACE1BD7848S(L/R)	94	ACE1R6024N	92
AA1FMET64	48	AA1UPS64	46	ACE1BD8448D(L/R)	94	ACE1R6030N	92
AA1FMPS30	47	AA1WS24	125	ACE1BD8448S(L/R)	94	ACE1R6624N	92
AA1FMPS39	47	AA1WS30	125	ACE1CR24L	97	ACE1R6630N	92
AA1FMPS42	47	AA1WS36	125	ACE1CR24N	97	ACE1R7224N	92
AA1FMPS48	47	AA1WS48	125	ACE1CR24R	97	ACE1R7230N	92
AA1FMPS56	47	AA1WSD	125	ACE1H4818	97	ACE1R7824N	92
AA1FMPS64	47	AA2 MTC	41, 47	ACE1H4818P	97	ACE1R7830N	92
AA1FUPS39	47	AA2 UTC	46, 47	ACE1H6024	97	ACE1R8424N	92
AA1LO24DN	113	AA2T5E19	125	ACE1H6024P	97	ACE1R8430N	92
AA1LO30DN	113	AA2T5E25	125	ACE1L3636SSN	93	ACE1R9024N	92
AA1LO36DN	113	AA2T5E37	125	ACE1L4242DSN	93	ACE1R9030N	92
AA1LO42DN	113	AA3EPS41	43	ACE1L4242SDN	93	ACE1R9624N	92
AA1LO48DN	113	AA3EPS49	43	ACE1L4242SSN	93	ACE1R9630N	92
AA1MET30	41	AA3EPS54	43	ACE1L4260SSN	95	ACE1W362430N	98
AA1MET39	41	AA3EPS61	43	ACE1L4266SSN	95	ACE1W363024N	98
AA1MET42	41	AA3EPS64	43	ACE1L4272SSN	95	ACE1W422430N	98
AA1MET48	41	AB1 AC24	100	ACE1L4278SSN	95	ACE1W423024N	98

<i>pattern no.</i>	<i>page</i>	<i>pattern no.</i>	<i>page</i>	<i>pattern no.</i>	<i>page</i>	<i>pattern no.</i>	<i>page</i>
ACE1W482430N	98	AD C74 DF	117	API 3948	58	APC 0948 C	21
ACE1W483024N	98	AD C74 DH	121	API 3948 N	59	APC 0948 F	24
ACE1W722430N	98	AD C74 LF	117	API 3960 N	59	APC 0948 M	22
ACE1W723024N	98	AD C74 LH	121	API 4818	58	APC 0948 P	22
AD C35 SF	118	AD C74 SF	117	API 4818 N	59	APC 0948 PT	22
AD C35 SH	122	AD C74 SH	121	API 4824	58	APC 0948 S	21
AD C36 SF	118	AD S36 DF	120	API 4824 N	59	APC 0960 A	25
AD C36 SH	122	AD S36 DH	124	API 4824M	60, 61	APC 0960 C	21
AD C4242 DF	119	AD S36 SF	120	API 4830	58	APC 0960 F	24
AD C4242 LF	119	AD S36 SH	124	API 4830 N	59	APC 0960 M	22
AD C4242 LH	123	AD S42 DF	120	API 4830M	60, 61	APC 0960 P	22
AD C4242 RF	119	AD S42 DH	124	API 4836	58	APC 0960 PT	22
AD C4242 RH	123	AD S42 SF	120	API 4836 N	59	APC 0960 S	21
AD C4242 SF	119	AD S42 SH	124	API 4836M	60, 61	APC 0972 A	25
AD C4242 SH	123	AD S48 DF	120	API 4842	58	APC 0972 C	21
AD C44 DF	119	AD S48 DH	124	API 4842 N	59	APC 0972 F	24
AD C44 DH	123	AD S48 SF	120	API 4842M	60, 61	APC 0972 M	22
AD C44 LF	119	AD S48 SH	124	API 4848	58	APC 0972 P	22
AD C44 LH	123	AD S60 DF	120	API 4848 N	59	APC 0972 PT	22
AD C44 RF	119	AD S60 DH	124	API 4848M	60, 61	APC 0972 S	21
AD C44 RH	123	AD S60 SF	120	API 4860 N	59	APC 1636 A	25
AD C44 SH	119	AD S60 SH	124	API 6418	58	APC 1636 F	24
AD C45 DF	118	AD S72 DF	120	API 6418 A	59	APC 1648 A	25
AD C45 DH	122	AD S72 DH	124	API 6424	58	APC 1648 F	24
AD C45 RF	118	AD S72 SF	120	API 6424 A	59	APC 1648 M	22
AD C45 RH	122	AD S72 SH	124	API 6424M	60, 61	APC 1648 P	23
AD C45 SF	118	AD S84 SF	120	API 6430	58	APC 1648 PT	23
AD C45 SH	122	AD S84 SH	124	API 6430 A	59	APC 1660 A	25
AD C46 DF	118	AF 4848 AM	66	API 6430M	60, 61	APC 1660 F	24
AD C46 DH	122	AF 4860 AM	66	API 6436	58	APC 1660 M	22
AD C46 RF	118	AF 6448 AM	66	API 6436 A	59	APC 1660 P	23
AD C46 RH	122	AF 6460 AM	66	API 6436M	60, 61	APC 1660 PT	23
AD C46 SF	118	AFWB	63	API 6442	58	APC 1672 A	25
AD C46 SH	122	ALI A3918	116	API 6442 A	59	APC 1672 F	24
AD C47 DF	118	ALI A3924	116	API 6442M	60, 61	APC 1672 M	22
AD C47 DH	122	ALI A4818	116	API 6448	58	APC 1672 P	23
AD C47 RF	118	ALI A4824	116	API 6448 A	59	APC 1672 PT	23
AD C47 RH	122	ALI A6418	116	API 6448M	60, 61	APC 1836 A	25
AD C47 SF	118	ALI A6424	116	API 6460 A	59	APC 1848 A	25
AD C47 SH	122	ALI C39	116	API LF	62	APC 1860 A	25
AD C53 SF	117	ALI C48	116	APA 39	33	APC 1872 A	25
AD C53 SH	121	ALI C64	116	APA 48	33	APC 2736 A	26
AD C54 DF	117	AMB CP12-AMP	57	APA 64	33	APC 2748 A	26
AD C54 DH	121	AMB CP24 LUC	57	APC 0912 A	25	APC 2760 A	26
AD C54 LF	117	AMC B10	57	APC 0912 C	21	APC 2772 A	26
AD C54 LH	121	AMC FP2 (L or N)	57	APC 0912 CX	21	APC AZ48	18
AD C54 SF	117	AMC FP3 (L or N)	57	APC 0912 F	24	APC AZ48 F	19
AD C54 SH	121	AMC O3	57	APC 0912 P	22	APC AZ60	18
AD C55 DF	119	AMC O5E	57	APC 0912 PT	22	APC AZ60 F	19
AD C55 DH	123	AMC O6	57	APC 0912 S	21	APC AZ72	18
AD C55 LF	119	AMC OF500	57	APC 0924 A	25	APC AZ72 F	19
AD C55 LH	123	AMC OF625	57	APC 0924 C	21	APC HOC	20
AD C55 RF	119	AMC PDC 5E4N	57	APC 0924 F	24	APC OC	20
AD C55 RH	123	AMC5 CP12	57	APC 0924 M	22	APC OCF	20
AD C55 SF	119	AMC5 OC20(A or B)	57	APC 0924 P	22	APF 1848	16
AD C55 SH	123	AMC5 OC30(A or B)	57	APC 0924 PT	22	APF 1860	16
AD C63 SF	117	AMC5 OC40(A or B)	57	APC 0924 S	21	APF 1872	16
AD C63 SH	121	AMC5 OC50(A or B)	57	APC 0936 A	25	APF1 3948	15
AD C64 DF	117	API 3918 N	59	APC 0936 C	21	APF1 3960	15
AD C64 DH	121	API 3924	58	APC 0936 F	24	APF1 3972	15
AD C64 LF	117	API 3924 N	59	APC 0936 M	22	APF1 4848	15
AD C64 LH	121	API 3930 N	59	APC 0936 P	22	APF1 4860	15
AD C64 SF	117	API 3936	58	APC 0936 PT	22	APF1 4872	15
AD C64 SH	121	API 3936 N	59	APC 0936 S	21	APF1 6448	15
		API 3942 N	59	APC 0948 A	25	APF1 6460	15

<i>pattern no.</i>	<i>page</i>	<i>pattern no.</i>	<i>page</i>	<i>pattern no.</i>	<i>page</i>	<i>pattern no.</i>	<i>page</i>
APF1 6472	15	AR1 EPIC	51	AS1 SDFO	102	AU1 X328	70
APFA1 3948	15	AR1 ET1	51	AS1 SFF G	103	AUA1 0824 G	68
APFA1 3960	15	AR1 ET3	51	AS1 SFF M	102	AUA1 0836 G	68
APFA1 3972	15	AR1 ET5	51	AS1 SPAD	105, 106	AUA1 0848 G	68
APFA1 4848	15	AR1 ET8	51	AS1 SPDF M	102	AUA1 0860 G	68
APFA1 4860	15	AR1 HCC H10	56	AS1 SPDFG	103	AUA1 0872 G	68
APFA1 4872	15	AR1 HOB	20	AS1DD30G	103	AUA1 1224 G	68
APFA1 6448	15	AR1 HOB2	20	AS1DD36G	103	AUA1 1236 G	68
APFA1 6460	15	AR1 PCC 100	56	AS1DF30G	103	AUA1 1248 G	68
APFA1 6472	15	AR1 RCM 10	56	AS1DF36G	103	AUA1 1260 G	68
APR 48	17	AR1 T2	54	AS1FF30G	103	AUA1 1272 G	68
APR 480	17	AR1 T3	54	AS1FF36G	103	AUA1 1524 G	68
APR 60	17	AR1 TJ1	54	AS1PDF30G	103	AUA1 1536 G	68
APR 600	17	AR1 TJ10	54	AS1PDF36G	103	AUA1 1548 G	68
APR 72	17	AR1 TJ12	54	AS2 PT(C)	104	AUA1 1560 G	68
APR 720	17	AR1 TJ2	54	AS2 PT(N)	104	AUA1 1572 G	68
APT	29, 43	AR1 TJ3	54	ATI D50A	128	AUA1224	69
APT 48	17	AR1 TJ4	54	ATI D50F	128	AUA1236	69
APT 60	17	AR1 TJ5	54	ATI D62A	128	AUA1248	69
APT 72	17	AR1 TJ6	54	ATI D62F	128	AUA1260	69
APT C24	17	AR1 TJ8	54	ATI E24LA	127	AUA1272	69
APT C36	17	AR1 TOM	53	ATI E24LF	127	AUA2124	69
APT C48	17	AR1 TPC1	54	ATI E24RA	127	AUA2136	69
APT C60	17	AR1 TPC2	54	ATI E24RF	127	AUA2148	69
APT C72	17	AR1 TPH1	54	ATI P36A	126	AUA2160	69
APT1 C24	17	AR1 TPH2	54	ATI P36F	126	AUA2172	69
APT1 C36	17	AR1 TPHF	34	ATI R42A	128	AUA2824	69
APT1 C48	17	AR1 TPI2	54	ATI R42F	128	AUA2836	69
APT1 C60	17	AR1 TPI5	54	ATI R48A	128	AUA2848	69
APT1 C72	17	AR1 TPIC	54	ATI R48F	128	AUA2860	69
APTA 48	17	AR1 TT1	54	ATI TA	126	AUA2872	69
APTA 60	17	AR1 TT3	54	ATI TL	126	AUP B3624M	144
APTA 72	17	AR1 TT5	54	ATI W24A	126	AUP B3624RC	144
APTA CC	29	AR1 TT8	54	ATI W24F	126	AUP B4824M	144
APTA CC1	29	AR1-ELS-B	50, 53	ATI W30A	127	AUP B4824RC	144
APX CIP4	56	AR1VCM	34	ATI W30F	127	AUP B6024M	144
APX CIP6	56	AR1VCM5	34	ATI W50A	128	AUP B6024RC	144
APX CIP8	56	AR1VCM6	34	ATI W50F	128	AUP B7224M	144
AR OF	20, 57	ARE1 DA	55	AU 1224 A	67	AUP B7224RC	144
AR1 CB	143	ARE1 DB	55	AU 1236 A	67	AUP C4872S5	130
AR1 DA	50, 53	ARE1 DC	55	AU 1248 A	67	AUP C7248S5	130
AR1 DB	50, 53	ARE1 DX	55	AU 1260 A	67	AUP D624	132
AR1 DC	53	ARE1 DX (O or T)	55	AU 2124 A	67	AUP M72DC4	129
AR1 DX	50, 53	ARE1 DY	55	AU 2136 A	67	AUP M72DF4	129
AR1 DY	50, 53	ARE1 DY (O or T)	55	AU 2148 A	67	AUP MR36	144
AR1 DZ	53	ARE1 DZ	55	AU 2160 A	67	AUP MR48	144
AR1 E2	52	ARE1 DZ (O or T)	55	AU 2824 A	67	AUP MR60	144
AR1 E3	52	ARE1 EP1	55	AU 2836 A	67	AUP MR72	144
AR1 EJ1	51	ARE1 ET1	55	AU 2848 A	67	AUP O664	132
AR1 EJ10	51	ARE1 ET3	55	AU 2860 A	67	AUP R424	132
AR1 EJ12	51	ARE1 ET5	55	AU1 CL12	70	AUP S48D4	131
AR1 EJ2	51	ARE1 TP1	55	AU1 CL21	70	AUP S48S2	131
AR1 EJ3	51	ARE1 TT1	55	AU1 CL28	70	AUP S48S4	131
AR1 EJ4	51	ARE1 TT3	55	AU1 CS	70	AUP S60D4	131
AR1 EJ5	51	ARE1 TT5	55	AU1 CT12	70	AUP S72D4	131
AR1 EJ6	51	AS1 BKH	104	AU1 CT21	70	AUP S72E4	131
AR1 EJ8	51	AS1 BKL	104	AU1 CT28	70	AUP T363	132
AR1 EOM	50	AS1 DDF M	102	AU1 PC12	75	AUP V48S5	130
AR1 EPC1	52	AS1 DDFO	102	AU1 PC21	75	AUP W60D4	132
AR1 EPC2	52	AS1 DFF G	103	AU1 PC28	75	AUP Y72DCL4	129
AR1 EPH1	51	AS1 DFF M	102	AU1 X112	70	AUP Y72DCR4	129
AR1 EPH2	51	AS1 DPAD	105, 106	AU1 X121	70	AUP Y72DFL4	129
AR1 EPHF	34	AS1 DPDF M	102	AU1 X128	70	AUP Y72DFR4	129
AR1 EPI2	51	AS1 DPDFG	103	AU1 X312	70	AUPCCV	133
AR1 EPI5	51	AS1 SDF M	102	AU1 X321	70	AUPCGV	133

<i>pattern no.</i>	<i>page</i>	<i>pattern no.</i>	<i>page</i>	<i>pattern no.</i>	<i>page</i>	<i>pattern no.</i>	<i>page</i>
AUPLC4	143	AUPM S60D4	134	AW1 C7248 R	82	AWM2 C4272 R	88
AUPLC5	143	AUPM S60S2	135	AW1 C7248 S	82	AWM2 C4272 S	88
AUPM C3660S5	139	AUPM S60S4	134	AW1 C8436 S	82	AWM2 C4848 D	89
AUPM C3672S5	139	AUPM S66D4	134	AW1 C8442 L	82	AWM2 C4848 L	89
AUPM C4242D5	136	AUPM S66S4	134	AW1 C8442 R	82	AWM2 C4848 R	89
AUPM C4242S5	136	AUPM S72D4	134	AW1 C8442 S	82	AWM2 C4848 S	89
AUPM C4260L5	140	AUPM S72S4	134	AW1 C8448 D	82	AWM2 C4860 D	88
AUPM C4260R5	139	AUPM S84D4	134	AW1 C8448 L	82	AWM2 C4860 L	88
AUPM C4260S5	139	AUPM S84S4	134	AW1 C8448 R	82	AWM2 C4860 R	88
AUPM C4272L5	140	AUPM SCV	142	AW1 C8448 S	82	AWM2 C4860 S	88
AUPM C4272R5	139	AUPM SGV	142	AW1 CS3612	115	AWM2 C4872 D	88
AUPM C4272S5	139	AW1 A60L	85	AW1 CS4812	115	AWM2 C4872 L	88
AUPM C4848D5	136	AW1 A60R	85	AW1 CS6012	115	AWM2 C4872 R	88
AUPM C4848S5	136	AW1 A72L	85	AW1 CS7212	115	AWM2 C4872 S	88
AUPM C4860D5	139	AW1 A72R	85	AW1 F2424	80	AWM2 C4884 D	88
AUPM C4860L5	140	AW1 C3660 S	83	AW1 F3024	80	AWM2 C4884 L	88
AUPM C4860R5	139	AW1 C3672 S	83	AW1 F3624	80	AWM2 C4884 R	88
AUPM C4860S5	139	AW1 C3684 S	83	AW1 F3630	80	AWM2 C4884 S	88
AUPM C4872D5	139	AW1 C4242 D	81	AW1 F4224	80	AWM2 C6036 S	87
AUPM C4872L5	140	AW1 C4242 L	81	AW1 F4824	80	AWM2 C6042 L	87
AUPM C4872R5	139	AW1 C4242 R	81	AW1 F4830	80	AWM2 C6042 R	87
AUPM C4872S5	139	AW1 C4242 S	81	AW1 F6024	80	AWM2 C6042 S	87
AUPM C4884D5	139	AW1 C4260 L	83	AW1 F6030	80	AWM2 C6048 D	87
AUPM C4884L5	140	AW1 C4260 R	83	AW1 F6624	80	AWM2 C6048 L	87
AUPM C4884R5	139	AW1 C4260 S	83	AW1 F7224	80	AWM2 C6048 R	87
AUPM C4884S5	139	AW1 C4272 L	83	AW1 F7230	80	AWM2 C6048 S	87
AUPM C6036S5	137	AW1 C4272 R	83	AW1 F8424	80	AWM2 C6060 D	89
AUPM C6042L5	137	AW1 C4272 S	83	AW1 F8430	80	AWM2 C6060 L	89
AUPM C6042R5	138	AW1 C4284 L	83	AW1 P4875 S	84	AWM2 C6060 R	89
AUPM C6042S5	137	AW1 C4284 R	83	AW1 P4887 S	84	AWM2 C6060 S	89
AUPM C6048D5	137	AW1 C4284 S	83	AW1 P7548 S	84	AWM2 C7236 S	87
AUPM C6048L5	137	AW1 C4848 D	81	AW1 P8748 S	84	AWM2 C7242 L	87
AUPM C6048R5	138	AW1 C4848 L	81	AW1 R7236	85	AWM2 C7242 R	87
AUPM C6048S5	137	AW1 C4848 R	81	AW1 S2424	80	AWM2 C7242 S	87
AUPM C6060D5	136	AW1 C4848 S	81	AW1 S3024	80	AWM2 C7248 D	87
AUPM C6060S5	136	AW1 C4860 D	83	AW1 S3624	80	AWM2 C7248 L	87
AUPM C7236S5	137	AW1 C4860 L	83	AW1 S3630	80	AWM2 C7248 R	87
AUPM C7242L5	137	AW1 C4860 R	83	AW1 S4224	80	AWM2 C7248 S	87
AUPM C7242R5	138	AW1 C4860 S	83	AW1 S4824	80	AWM2 C8448 D	87
AUPM C7242S5	137	AW1 C4872 D	83	AW1 S4830	80	AWM2 C8448 L	87
AUPM C7248D5	137	AW1 C4872 L	83	AW1 S6024	80	AWM2 C8448 R	87
AUPM C7248L5	137	AW1 C4872 R	83	AW1 S6030	80	AWM2 C8448 S	87
AUPM C7248R5	138	AW1 C4872 S	83	AW1 S6624	80	AWM2 F2424	86
AUPM C7248S5	137	AW1 C4884 D	83	AW1 S7224	80	AWM2 F3024	86
AUPM C8448D5	137	AW1 C4884 L	83	AW1 S7230	80	AWM2 F3030	86
AUPM C8448L5	137	AW1 C4884 R	83	AW1 S8424	80	AWM2 F3624	86
AUPM C8448R5	138	AW1 C4884 S	83	AW1 S8430	80	AWM2 F3630	86
AUPM C8448S5	137	AW1 C6036 S	82	AWM1 S36	91	AWM2 F4224	86
AUPM D594	141	AW1 C6042 L	82	AWM1 S42	91	AWM2 F4230	86
AUPM D604	141	AW1 C6042 R	82	AWM1 S48	91	AWM2 F4824	86
AUPM P4875S5	141	AW1 C6042 S	82	AWM1 S60	91	AWM2 F4830	86
AUPM P7548S5	141	AW1 C6048 D	82	AWM1 S66	91	AWM2 F5424	86
AUPM S30D4	134	AW1 C6048 L	82	AWM1 S72	91	AWM2 F5430	86
AUPM S30S4	134	AW1 C6048 R	82	AWM1 S78	91	AWM2 F6024	86
AUPM S36D4	134	AW1 C6048 S	82	AWM1 S84	91	AWM2 F6030	86
AUPM S36S2	135	AW1 C6060 D	81	AWM2 C3660 S	88	AWM2 F6624	86
AUPM S36S4	134	AW1 C6060 L	81	AWM2 C3672 S	88	AWM2 F6630	86
AUPM S42D4	134	AW1 C6060 R	81	AWM2 C4242 D	89	AWM2 F7224	86
AUPM S42S2	135	AW1 C6060 S	81	AWM2 C4242 L	89	AWM2 F7230	86
AUPM S42S4	134	AW1 C7236 S	82	AWM2 C4242 R	89	AWM2 F7824	86
AUPM S48D4	134	AW1 C7242 L	82	AWM2 C4242 S	89	AWM2 F7830	86
AUPM S48S2	135	AW1 C7242 R	82	AWM2 C4260 L	88	AWM2 F8424	86
AUPM S48S4	134	AW1 C7242 S	82	AWM2 C4260 R	88	AWM2 F8430	86
AUPM S54D4	134	AW1 C7248 D	82	AWM2 C4260 S	88	AWM2 F9024	86
AUPM S54S4	134	AW1 C7248 L	82	AWM2 C4272 L	88	AWM2 F9030	86

<i>pattern no.</i>	<i>page</i>	<i>pattern no.</i>	<i>page</i>	<i>pattern no.</i>	<i>page</i>	<i>pattern no.</i>	<i>page</i>
AWM2 F9624	86	AX1 T64	27	AX1SEC8048	36	AY1 1648S A	74
AWM2 F9630	86	AX1 V18	30	AX1SEC8064	36	AY1 1660M	71
AWM2 P4875 S	90	AX1 V39	27	AX1SECBT	35, 36, 37	AY1 1660M A	73
AWM2 P4887 S	90	AX1 V48	27	AX1SED3939	37	AY1 1660S	72
AWM2 P7548 S	90	AX1 V64	27	AX1SED4239	37	AY1 1660S A	74
AWM2 P8748 S	90	AX1 X18	30	AX1SED4339C	37	AY1 2124C	71
AWMSAMP1616	99	AX1 X39	27	AX1SED4848	37	AY1 2124C A	73
AX1 AK1	32	AX1 X48	27	AX1SED5039	37	AY1 2136C	71
AX1 AK3	32	AX1 X64	27	AX1SED5048	37	AY1 2136C A	73
AX1 E40	43	AX1 Y18	30	AX1SED5248C	37	AY1 2148C	71
AX1 E48	43	AX1 Y39	27	AX1SED5739	37	AY1 2148C A	73
AX1 E53	43	AX1 Y48	27	AX1SED5748	37	AY1 2160C	71
AX1 E60	43	AX1 Y64	27	AX1SED6439	37	AY1 2160C A	73
AX1 E65	43	AX1A F18H	31	AX1SED6448	37	AY1 2518M	71
AX1 EET39(TR,L)	43	AX1A F18L	31	AX1SED6464	37	AY1 2518M A	73
AX1 EET48(TR,L)	43	AX1DHES3600L(5)	40	AX1SED7848	37	AY1 2524M	71
AX1 EET64(TR,L)	43	AX1DHES3600R(5)	40	AX1SED7864	37	AY1 2524M A	73
AX1 EGF11	43	AX1DHES3603L(5)	40	AX1SX39 A (L/C/P)	38	AY1 2530M	71
AX1 EGF16	43	AX1DHES3603R(5)	40	AX1SX39 C (L/C/P)	38	AY1 2530M A	73
AX1 EGF24	43	AX1DHES4200L(5)	40	AX1SX48 A (L/C/P)	38	AY1 2536M	71
AX1 EGF4	43	AX1DHES4200R(5)	40	AX1SX48 C (L/C/P)	38	AY1 2536M A	73
AX1 F18	31	AX1DHES4203L(5)	40	AX1SX64 A (L/C/P)	38	AY1 2542M	71
AX1 F39	29	AX1DHES4203R(5)	40	AX1SX64 C (L/C/P)	38	AY1 2542M A	73
AX1 F48	29	AX1DHES5000L(5)	40	AX2 C3939	42	AY1 2548M	71
AX1 F64	29	AX1DHES5000R(5)	40	AX2 C4839	42	AY1 2548M A	73
AX1 FF	16	AX1DHES5003L(5)	40	AX2 C4848	42	AY1 2560M	71
AX1 FHLS4818	32	AX1DHES5003R(5)	40	AX2 C6439	42	AY1 2560M A	73
AX1 FWS 39	32	AX1DHES5700L(5)	40	AX2 C6448	42	AY1 2824C	71
AX1 FWS 48	32	AX1DHES5700R(5)	40	AX2 C6464	42	AY1 2836C	71
AX1 FWS 64	32	AX1DHES5703L(5)	40	AX3E41	43	AY1 2848C	71
AX1 HLS4839	28	AX1DHES5703R(5)	40	AX3E49	43	AY1 2860C	71
AX1 HLS6439	28	AX1DHES6400L(5)	40	AX3E54	43	AY1 AXST16	79
AX1 HLS6448	28	AX1DHES6400R(5)	40	AX3E61	43	AY1 AXT16	79
AX1 L18	30	AX1DHES6403L(5)	40	AX3E64	43	AY1 AXT25	79
AX1 L39	27	AX1DHES6403R(5)	40	AY1 1224C	71	AY1 AXT32	79
AX1 L48	27	AX1LEG	16	AY1 1224C A	73	AY1 CE	76
AX1 L64	27	AX1LEG5	16	AY1 1236C	71	AY1 CL12	78
AX1 M3939	42	AX1LEG6	16	AY1 1236C A	73	AY1 CL21	78
AX1 M4239	42	AX1LES E	39	AY1 1248C	71	AY1 CL28	78
AX1 M4839	42	AX1LES30	39	AY1 1248C A	73	AY1 CMK	78
AX1 M4848	42	AX1LES39	39	AY1 1260C	71	AY1 CS	76
AX1 M5639	42	AX1LES48	39	AY1 1260C A	73	AY1 CT12	78
AX1 M5648	42	AX1LES64	39	AY1 1618M	71	AY1 CT21	78
AX1 M6439	42	AX1MES30	39	AY1 1618M A	73	AY1 CT28	78
AX1 M6448	42	AX1MES39	39	AY1 1618S	72	AY1 CX12	79
AX1 M6464	42	AX1MES42	39	AY1 1618S A	74	AY1 CX21	79
AX1 M8039	42	AX1MES48	39	AY1 1624M	71	AY1 CX28	79
AX1 M8048	42	AX1MES56	39	AY1 1624M A	73	AY1 HLA	78
AX1 M8064	42	AX1MES64	39	AY1 1624S	72	AY1 LL16	76
AX1 R34239	44	AX1MES80	39	AY1 1624S A	74	AY1 LL25	76
AX1 R34939	44	AX1SEC3939	35	AY1 1630M	71	AY1 LL32	76
AX1 R34948	44	AX1SEC4039 L	35	AY1 1630M A	73	AY1 LP16	77
AX1 R36439	44	AX1SEC4239	36	AY1 1630S	72	AY1 LP25	77
AX1 R36448	44	AX1SEC4339 C	35	AY1 1630S A	74	AY1 LP32	77
AX1 R36464	44	AX1SEC4839	36	AY1 1636M	71	AY1 LT16	76
AX1 R37939	44	AX1SEC4848	35	AY1 1636M A	73	AY1 LT25	76
AX1 R37948	44	AX1SEC4948 L	35	AY1 1636S	72	AY1 LT32	76
AX1 R37964	44	AX1SEC5248 C	35	AY1 1636S A	74	AY1 LX16	77
AX1 S	28	AX1SEC5639	36	AY1 1642M	71	AY1 LX25	77
AX1 SWS39	28	AX1SEC5648	36	AY1 1642M A	73	AY1 LX32	77
AX1 SWS48	28	AX1SEC6439	36	AY1 1642S	72	AY1 MMK	78
AX1 SWS64	28	AX1SEC6448	36	AY1 1642S A	74	AY1 PC16	75
AX1 T18	30	AX1SEC6464	35	AY1 1648M	71	AY1 PC25	75
AX1 T39	27	AX1SEC6564 L	35	AY1 1648M A	73	AY1 PC32	75
AX1 T48	27	AX1SEC6864 C	35	AY1 1648S	72	AY1 SCL16	78

<i>pattern no.</i>	<i>page</i>	<i>pattern no.</i>	<i>page</i>	<i>pattern no.</i>	<i>page</i>
AY1 SCT16	78	MZ1-V6015	146	RS1-N42	111
AY1 SCX16	79	MZ1-V6019	146	RS1-N48	111
AY1 SL16	76	MZ1-V6022	146	RS1-N60	111
AY1 SMK	78	MZ1-V7215	146	RS1-VP	111
AY1 SP16	77	MZ1-V7219	146	RTAT5E19S	114
AY1 SPC16	75	MZ1-V7222	146	RTAT5E25A	114
AY1 ST16	76	R3B0P0F4207	45	RTAT5E25S	114
AY1 SX116	79	R3B0P0F4907	45	RTAT5E37A	114
AY1 SX16	77	R3B0P0F6407	45	RTAT5E37S	114
AY1 SX316	79	R3B0P0F7907	45	RTAT5E49A	114
AY1 X112	79	R3B0P0H4207	45	RTAT5E49S	114
AY1 X121	79	R3B0P0H4907	45	RTAT5E61A	114
AY1 X128	79	R3B0P0H6407	45	RTAT5E61S	114
AY1 X312	79	R3B0P0H7907	45	USAMP1616	99
AY1 X321	79	R3B0T0F4207	45		
AY1 X328	79	R3B0T0F4907	45		
CSAMP1616	99	R3B0T0F6407	45		
MC1-39S1	64	R3B0T0F7907	45		
MC1-48S1	64	R3B0T0H4207	45		
MC1-64S1	64	R3B0T0H4907	45		
MD6-BD	104	R3B0T0H6407	45		
MD6-FS	104	R3B0T0H7907	45		
ML4L17	114	RO1-GB	112		
ML4L31	114	RO1-HP12	110, 111		
ML4L44	114	RO1-HP15	110, 111		
ML4L58	114	RO1-HP6	110, 111		
MM2-CG	62	RO1-HP9	110, 111		
MM2CG	143	RO1-PULL	112		
MR3 PDCX	57	RO3-N24	109		
MZ1-B3015	145	RO3-N30	109		
MZ1-B3019	145	RO3-N36	109		
MZ1-B3022	145	RO3-N42	109		
MZ1-B3615	145	RO3-N48	109		
MZ1-B3619	145	RO3-N60	109		
MZ1-B3622	145	RO3-N66	109		
MZ1-B4215	145	RO3-N72	109		
MZ1-B4219	145	RO3-OM30	110		
MZ1-B4222	145	RO3-OM36	110		
MZ1-B4815	145	RO3-OM42	110		
MZ1-B4819	145	RO3-OM48	110		
MZ1-B4822	145	RO3-OM60	110		
MZ1-B5415	145	RO3-OM72	110		
MZ1-B5419	145	RO3-ON30	110		
MZ1-B5422	145	RO3-ON36	110		
MZ1-B6015	145	RO3-ON42	110		
MZ1-B6019	145	RO3-ON48	110		
MZ1-B6022	145	RO3-ON60	110		
MZ1-B6615	145	RO3-ON72	110		
MZ1-B6619	145	RO3-RD30	110		
MZ1-B6622	145	RO3-RD36	110		
MZ1-B7215	145	RO3-RD42	110		
MZ1-B7219	145	RO3-RD48	110		
MZ1-B7222	145	RO3-RD60	110		
MZ1-B7815	145	RO3-RD72	110		
MZ1-B7819	145	RO3-VP	110		
MZ1-B7822	145	RS1 MPB	113		
MZ1-V3615	146	RS1-M24	111		
MZ1-V3619	146	RS1-M30	111		
MZ1-V3622	146	RS1-M36	111		
MZ1-V4215	146	RS1-M42	111		
MZ1-V4219	146	RS1-M48	111		
MZ1-V4222	146	RS1-M60	111		
MZ1-V4815	146	RS1-N24	111		
MZ1-V4819	146	RS1-N30	111		
MZ1-V4822	146	RS1-N36	111		

Selling Policy

	<p>This Selling Policy supercedes all previous selling policies. Prices, discounts and product offerings are subject to change without notice.</p>
Terms & Conditions of Sales	<p>Sales by Knoll, Inc. or Knoll North America Corp. ("Seller") of Knoll Product Lines (hereinafter "Products") within the United States and Canada are made only on the terms which are contained in this Selling Policy. Seller hereby gives notice of its objection to any different or additional terms and conditions. This sale is expressly conditional upon Purchaser's assent to the terms and conditions set forth below. Additional terms and conditions may apply to KnollStudio and KnollTextiles orders. These terms and conditions may be modified or supplemented only by a written document signed by an authorized representative of Seller. These terms and conditions supercede any prior and/or contemporaneous agreements or correspondence between Purchaser and Seller. Written quotations expire thirty (30) days from the date of issuance and can be withdrawn by written notice anytime during that period. Where Purchaser and Seller have entered into the Knoll Electronic Terms and Conditions, all orders, acknowledgements, invoices and other business communications placed or transmitted in accordance with the Knoll Electronic Terms and Conditions shall be deemed to be in writing and signed and shall be valid for all purposes as if they were originated and maintained in documentary form.</p>
Ordering Information	<p>All orders must be in writing. The product pattern number(s) contained on Seller's order acknowledgement shall be the final expression of the order.</p>
Order Confirmation	<p>A purchase order is not binding on Seller until Purchaser has received Seller's order confirmation or acknowledgment.</p>
Pricing Policies	<p>List prices are subject to change without notice.</p> <p>List prices shall be those prices in effect on the date of receipt of a complete purchase order unless shipment is requested more than ninety (90) days after order entry in which case prices in effect on the date of shipment apply. List prices include specified freight costs. Unless specified in writing by Seller, no other charges are included in Seller's list prices.</p>
Taxes	<p>All sales, use, excise and other taxes applicable to the sale of the Products shall be paid by Purchaser. If Purchaser claims an exemption from any tax, Purchaser shall submit to Seller the appropriate exemption certificates.</p>
Terms of Payment	<p>Payment for one hundred percent (100%) of the net order amount is due within thirty (30) days of the date of invoice, which is generally issued upon shipment. In case of any discrepancies, such as shortages, and Seller is notified in writing within ten (10) days of receipt of Product, only that portion may be deducted and the balance paid. For orders greater than \$100,000 net, a fifty percent (50%) deposit is due at the time of order placement, with the remainder due within thirty (30) days of the date of invoice.</p> <p>KnollStudio orders less than \$2,000 require payment for one hundred percent (100%) of the net order amount (including any applicable sales tax and charges for inside delivery, special packaging, etc.), due at time of order placement. For KnollStudio orders greater than \$2,000, a one-half (50%) deposit is due at time of order placement with the remainder (including any applicable sales tax and charges for inside delivery, special packaging, etc.) due prior to shipment.</p> <p>If, in the judgment of Seller, Purchaser's financial condition does not justify the terms of the payment, Seller may require full or partial payment in advance.</p> <p>Past due accounts shall be charged one and one-half percent (1.5%) per month, or the highest rate permitted by law, whichever is less, and will be added to the outstanding balance. In the event Purchaser defaults on payment, Purchaser shall be liable for all collection costs, including reasonable attorney's fees and costs.</p>
Changes and Cancellation	<p>Purchase orders may not be changed or cancelled, in whole or in part, without prior written consent of Seller. Changes may effect delivery dates. Expenses incurred because of changes shall be charged to Purchaser. In the event of cancellations, Purchaser will be liable for reasonable cancellation charges established by Seller. Orders for special Product, orders including "COM" (hereinafter defined) material and orders pursuant to expedited delivery programs, may not be canceled.</p>
Freight Prepaid	<p>Freight is prepaid and included in the price of all Products, except KnollTextiles, within the 48 contiguous United States for orders placed with Knoll, Inc. and within Canada, excluding the Yukon, Northwest Territories, Nunavut and Newfoundland for orders placed with Knoll North America Corp. Packing is tested for rigorous motion and transportation but is not guaranteed to protect furniture from all conditions. If special packaging is required for any reason, please consult with your sales representative or dealer. Seller shall select the method of shipment and routing. Freight for all KnollTextiles orders is prepaid and added to the invoice.</p>
Delivery/Freight Charges	<p>Shipments outside the contiguous 48 United States and Canada shall be shipped F.O.B. Origin.</p> <p>For shipments outside the contiguous United States and Canada, Purchaser is responsible for the cost of freight from point of embarkation, including any handling and transportation charges incidental to loading at the point of departure and unloading at the final destination.</p> <p>Conditions beyond the control of Seller, including weather, available facilities and traffic conditions, may affect exact time of delivery. Seller shall not be responsible for specific carrier delivery date or time unless it has made a specific delivery commitment, in writing.</p> <p>Nonstandard methods of shipment and/or additional services are available upon request. Purchaser will be billed for the differential cost of any special services in excess of standard surface carrier freight costs. Premium charges, at Purchaser's request, will be added for airfreight, exclusive use of vehicle and extra, export or special packaging. Accessorial charges will be added for inside delivery, extra labor, reassignment and redelivery.</p> <p>Partial shipments may be made and invoiced by Seller.</p>
Claims	<p>All shipments for Knoll Products within the contiguous United States and Canada are F.O.B. Origin. All risk of loss passes to Purchaser at time of delivery to carrier. Purchaser shall inspect all Products upon receipt and notify Seller within ten (10) working days after receipt of any damage or defects which are, or should be, apparent from an inspection of the Product and its packaging. Failure of Purchaser to notify Seller during the ten (10) working day period shall constitute acceptance of the Products and waiver of any apparent defects, errors or shortages. For all claims relating to Product damaged in transit or for any other claims relating to or arising out of the transportation of the Product, Purchaser must seek recovery from the carrier and Seller has no liability to Purchaser for such claims. Seller may, upon request, assist Purchaser with filing of such claims with the carrier, but Seller will not be liable for any of these transportation related claims.</p>
Seller's Security Interest	<p>Until Seller receives the full payment for the Product, Seller shall have a security interest in the Product. Purchaser agrees to perform all acts, including but not limited to the execution and filing of documentation, which may be necessary to perfect and assure the security interest of Seller.</p>
Returns	<p>The return of Products without a written authorization by Seller shall not be accepted. To receive authorization for Product return, please call Customer Service. All Products that are returned pursuant to a valid authorization shall be subject to a twenty-five percent (25%) of list restocking charge. Products not currently offered for sale by Seller (including COM) shall not be authorized for return. All returned Products must be unused, in original condition and in the original Seller packing cartons. No refund or credit shall be given for damaged Products.</p>
Held Orders/Storage	<p>If Purchaser requests that an order be held or delayed, prices and terms and conditions in effect at the time of shipment shall apply. If Purchaser requests a delay after the time when Seller can defer production, Purchaser will be invoiced for the Product, payable in accordance with standard terms, when the order is ready for shipment. Seller may transfer the Product to storage, in which case all expenses incurred in connection with storage, including demurrage, preparation for storage, storage charges and handling shall be payable by Purchaser upon submission of invoices by Seller. Risk of loss to the Product shall pass to the Purchaser upon delivery of the Product into storage.</p>

Selling Policy

Customer's Own Material	A Purchaser who requests a fabric or other surface material not standard to Seller's line of Products ("COM") must submit samples of the requested material to Seller prior to entry of a purchaser order. Seller shall determine if the material is suitable to its manufacturing processes and meets any requirements of Underwriters Laboratories. If the COM is acceptable, Seller will then establish a price for using the COM or the Product in question. For a description of the procedures for submitting samples and testing, contact customer resources or your sales representative. Seller shall have no responsibility for the appearance, condition, performance, durability, colorfastness or any other physical attribute of the COM. Purchaser shall indemnify and hold Seller harmless for any damages, injuries or losses arising out of or related to use of the COM on the Product.
Warranty	<p>Seller warrants to the original Purchaser only that the Products Seller manufactures and sells to Purchaser are free of defects in workmanship and materials, during the applicable warranty period set forth below.</p> <p>Warranty period set forth below is for 24-hour, 7 days a week, multi shift use (includes parts and labor to repair).</p> <p>Should any failure to conform with this limited warranty appear to a Product listed below during the applicable warranty period from the date of shipment, Seller shall, upon prompt written notice, repair or replace, at its option and costs, the affected part or parts.</p> <p><i>Product and Period of Warranty</i></p> <p><i>Lifetime: Antenna Workspaces, AutoStrada, Calibre, Crinion Open Table, Currents, Dividends Horizon, Morrison, Reff Profiles laminate, Series 2 Storage, Template and other non-wood components (except cascade edge worksurfaces, operational parts, controls, electrical, Lighting, Series 2 Veneer Front Storage, special or custom products, see below)</i></p> <p><i>12 Years: Chadwick, Essentials Work Chairs, Generation by Knoll, Life, Moment, MultiGeneration by Knoll, ReGeneration by Knoll, Remix, RPM, Sapper and Toboggan seating (except seating upholstery, textiles, leathers and finishes, see below).</i></p> <p><i>10 Years: Anchor Storage except digital keypad lock, Antenna Workspaces, AutoStrada, Crinion Open Table, Dividends Horizon, Dividends Horizon Satellite Surfaces, Reff Profiles, Template wood components, Series 2 Veneer Front Storage, cascade edge worksurfaces, Wood Casegoods (The Graham Collection) (except wood casegoods upholstered surfaces, see below), Reuter overheads, Reuter vertical storage, KnollExtra Sapper Monitor Arm Collection, Sapper XYZ Monitor Arm, Adjustable keyboard mechanisms and platforms, Communication Boards (except fabric board textiles, see below), Smokador collection (except leathers, see below), and Orchestra Universal Systems Accessories, k. lounge structural components.</i></p> <p><i>5 Years: Operational parts, controls, electrical, Lighting (except light ballasts, bulbs and power supply, see below), special or custom product, wood veneer products, Currents handcrank, Interaction Counterforce, KnollStudio, Spark Series seating structural elements, structural elements of all KnollStudio outdoor products including all Richard Schultz designed products, KnollExtra CPU storage and all universal storage drawers and Power Collection, Tone Tables.</i></p> <p><i>3 Years: Seating upholstery, textiles, leathers and finishes. Fabric boards textiles and Smokador Collection leathers.</i></p> <p><i>2 Years: Anchor Storage digital keypad lock, all other KnollExtra product</i></p> <p><i>1 Year: Light ballasts, bulbs and power supply, seating upholstered amp pads and soft amp pads, wood casegoods upholstered surfaces. KnollStudio, outdoor product finishes, k. lounge upholstery and k. lounge fabric.</i></p> <p>This warranty does not apply to:</p> <ul style="list-style-type: none">• Damage caused by a carrier other than the Seller.• Normal wear and tear or acts or omissions of parties other than Seller (including user modification, improper use or installation of Products).• COM or other third party materials applied to Products.• Products not installed by or under the auspices of a Knoll Dealer.• Dramatic temperature variations or exposure to unusual conditions.• Changes in surface finishes, including colorfastness due to aging or exposure to light.• Clear paint finish applied to Antenna Workspaces steel or aluminum part.• Except as specifically noted above, textiles and upholstery supplied by <i>KnollTextiles</i> (consult current <i>KnollTextiles</i> price list for applicable warranty). <p>Natural variations occurring in wood, marble, and leather shall not be considered defects, and the Seller does not guarantee the colorfastness or matching of the colors, grains or textures, or surface hardness of such materials. The Seller also does not guarantee the colorfastness of fiberglass panel surfaces. THE EXPRESS WARRANTIES CONTAINED HEREIN ARE IN LIEU OF ALL OTHER WARRANTIES, EXPRESS OR IMPLIED, INCLUDING ANY WARRANTIES OF MERCHANTABILITY AND FITNESS FOR PARTICULAR PURPOSE AND ALL OTHER WARRANTIES ARISING FROM COURSE OF DEALING OR USAGE OF TRADE.</p> <p>The remedies provided above are the Purchaser's sole remedies for any failure of Seller to comply with its obligations regarding the workmanship of its Products. Correction of any nonconformity in the manner and for the period of time provided shall constitute complete fulfillment of all liabilities of Seller, with respect to or arising out of the Product furnished hereunder.</p>
Delay/Force Majeure	Seller shall not be liable for failure to perform or for delay in performance due to fire, flood, strike or other labor difficulty, act of God, act of any governmental authority or of the Purchaser, riot, embargo, fuel or energy shortage, wrecks or delay in transportation, inability to obtain necessary labor, materials or manufacturing facilities from usual sources or failure of suppliers to meet their contractual obligations, or due to any cause beyond its reasonable control. If any such event occurs, Seller may extend delivery dates by a period of time necessary to overcome the effect of such delay, allocate available Product or cancel any purchase order.
Compliance with Law	PURCHASER IS SOLELY RESPONSIBLE FOR COMPLIANCE WITH ALL APPLICABLE FEDERAL, STATE AND LOCAL LAWS, ORDINANCES, REGULATIONS, RULES AND STANDARDS RELATING TO THE INSTALLATION, MAINTENANCE, USE AND OPERATION OF THE PRODUCTS.
Patents	Subject to the following provisions, Seller shall, at its own expense, defend or, at its option, settle any claim, suit or proceeding brought against the Purchaser, and/or its vendees, mediate and immediate, so far as based on an allegation that any Product or any part thereof furnished hereunder constitutes a direct or a contributory infringement of any claim of any patent of the United States or Canada. This obligation shall be effective only if Purchaser shall have made all payments then due hereunder and if Seller is notified promptly in writing and given authority, information and assistance for the defense of said claim, suit or proceeding. Seller shall pay all damages and costs awarded in such suit or proceedings so defended. <p>The foregoing indemnity does not apply to the following:</p> <ul style="list-style-type: none">• Products supplied according to a design other than that of Seller, and which is required by the Purchaser.• Combination of the Product with another product not furnished hereunder unless Seller is a contributory infringer.• Any settlements of a suit or proceeding made without Seller's written consent.
Limitations of Liability	<p>SELLER, ITS CONTRACTORS, AUTHORIZED DEALERS AND SUBCONTRACTORS OR SUPPLIERS OF ANY TIER SHALL NOT BE LIABLE TO PURCHASER FOR ANY SPECIAL, INDIRECT, INCIDENTAL OR CONSEQUENTIAL DAMAGES ARISING FROM A BREACH OF THIS AGREEMENT.</p> <p>Purchaser's remedies set forth herein are exclusive and the liability of Seller with respect to the breach of this agreement or any contract entered into between the parties pursuant hereto shall not exceed the price of the Product or part on which such liability is based.</p>

KnollKey Lock Program

KnollKey Lock Program General Information

Following is the KnollKey lock policy, applicable to all products.

Knoll furniture can be ordered keyed-alike or random keyed. Key-alike and random keying instructions cannot be mixed on any single order. Only one of the two instructions can be used on an individual order. When an order is submitted with mixed (key-alike and random) instructions, Knoll will release the order as key-alike only and lock cores will have to be specified separately.

Key-alike

For the convenience of the user, furniture may be keyed alike at no charge. Write "Key-alike" in the description of your purchase order for any pedestal, overhead, file or other item you wish to have keyed alike.

Using the key-alike instructions, order cores and keys as line items on your purchase order. Do NOT submit a key-alike form. The Knoll East Greenville Lock Center will select key numbers from the standard range of K 001 - K 250. Key numbers will not be repeated unless over 250 sets are ordered. Lock cores keyed-alike will ship separately from the product, ready for field installation.

There is no charge for key-alike orders if placed with the furniture order.

IF THE KEY-ALIKE ORDER IS NOT PLACED AT LEAST TWO WEEKS PRIOR TO THE FURNITURE SHIP DATE, A \$50 HANDLING CHARGE AND AIR FREIGHT CHARGES WILL APPLY.

If product is ordered and shipped random-keyed, additional lock cores for key-alike are billable.

Random-Keying

To specify product keyed-random, write "key-random" in the product description. Random-keyed product is shipped with the lock core factory installed. A shrouded key is included. Random means no effort has been made to match key numbers, or to make them different.

Keys

A Knoll shrouded key is shipped with every lock core. 250 Key numbers are available. For numbers above 250, contact Custom Product Development. Additional keys and key blanks are available. See service parts for more information.

Master Keying

Knoll locks can be controlled by means of a master key. There is no additional per-lock charge for master keying. A letter of approval from the client must accompany orders for master keys.

Installing Lock Cores

Lock cores can be installed or removed in the field by using a change key. Cores must be in the unlocked position to be removed. See service parts for change key pattern number and pricing.

Lock Distribution

All orders for key-alike lock cores/keys are packaged and shipped from the East Greenville Lock Center, regardless of where the pedestals, overhead, or other units are produced. Random keyed product will have cores factory-installed.

How to Specify Key-Alike

Following is an example of how to specify key-alike for a cluster of 10 workstations.

Step 1 - Using the project floorplan, count the number of locks in each workstation.

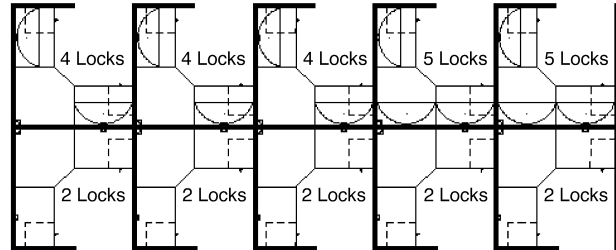

Step 2 - Count the number of workstations with the same quantity of locks. Group together the workstations with a like number of locks.

5 workstations with 2 locks per station
3 workstations with 4 locks per station
2 workstations with 5 locks per station

Step 3 - For the first group (5 sets of 2 locks), enter the number of workstations in the quantity column.

Qty	Pattern #	Description	Unit List	Ext. List
5				

Step 4 - Then enter the pattern number "KSPEC_ _" and add a suffix for the number of locks for that group (i.e., for 2 locks per station, add the suffix "2"). Up to 30 lock cores are available in a set (i.e., KSPEC 30).

Qty	Pattern #	Description	Unit List	Ext. List
5	KSPEC 2	Set of 2 cores/keys	N / C	N / C

Step 5 - Repeat for other groups.

Qty	Pattern #	Description	Unit List	Ext. List
5	KSPEC 2	Set of 2 cores/keys	N / C	N / C
3	KSPEC 4	Set of 4 cores/keys	N / C	N / C
2	KSPEC 5	Set of 5 cores/keys	N / C	N / C

Your Key instructions are complete.

Knoll will select key numbers for each set from 250 available numbers. Additional key numbers are available through Custom Product Development. **For additions to existing installations, specify desired key numbers in the description.**

Service Parts

Pattern #	Description	List Price
KKEY_ _ _	Shrouded Key Specify key number desired	\$10
KBLANK	Shrouded Key Blank	\$10
KSPECB_ _ _	Retrofit Universal Core/Key Specify key number desired	\$22
KCHANGE	Change Key	\$10
HLKRKMASTER*	Master Key	\$10

*Note: A letter of approval on company letterhead from the client must accompany all orders for master keys.

General Ordering Information

The Products

This guide encompasses all standard products for this product group.

Sizes

Dimensions listed in this guide are indicated as:

H = height

W = width

D = depth

Dia. = diameter

Rad. = radius

Pricing

All prices shown are list.

How to Order

Select pattern numbers and quantities required for your complete installation. Product questions can be addressed in the specific sections of this guide or by contacting your sales representative or customer resource representative at 1-800-343-5665.

Next, select options (if required), along with colors and finishes appropriate to each product. Reference the Finishes and Fabrics pages for color designations.

On large installations, an item's "designated area" can be specified to assist in product organization and handling.

To expedite complete / correct entry of your order, be certain all pattern numbers, quantities, colors and area identifications are completely specified. Also, include complete purchase order numbers, bill-to and ship-to addresses, a contact name and specific factory shipping dates required.

Mail all orders to:

Knoll, Inc.

1235 Water Street

P.O. Box 157

East Greenville, PA 18041

Attention: Order Entry

Once your order is entered at Knoll, an acknowledgment will be mailed to you. You will be advised of your scheduled shipping date within five days of the original acknowledgment. If it is necessary to revise your order, please contact your customer resource representative.

Sustainability Statement

Sustainable design is a key component of Knoll's environmental focus. Our commitment to social responsibility and a healthy environment has prompted us to further articulate our longstanding environmental programs and, with encouragement and support from our colleagues in the industry, we have re-energized our focus on such "green" initiatives as life cycle analysis and LEED™ certification. Knoll is proud to have contributed to projects that have received LEED certification from the U.S. Green Building Council.

For the latest information on Knoll products that help our customers achieve LEED certification, log on to knoll.com, click on "About Knoll" and then "Environmental Focus."