

|                                  |   |    |
|----------------------------------|---|----|
| Introduction                     | Knoll and Sustainable Design  | 2  |
|                                  | Introduction  | 3  |
|                                  | Specifications  | 4  |
|                                  | Crinion Open Table Finishes   | 5  |
| Worksurfaces                     | Worksurfaces with center hinged power access                            | 7  |
|                                  | Worksurfaces with edge grommet  | 8  |
|                                  | Worksurfaces with cord drop   | 9  |
|                                  | End counters  | 10 |
|                                  | Extended end counters   | 11 |
| File tops                        | File tops   | 13 |
| Complete base assemblies         | Complete base assemblies fixed height 24" D dual                        | 14 |
|                                  | Complete base assemblies fixed height 24" D single sided                | 15 |
|                                  | Complete base assemblies fixed height 30" D dual                        | 16 |
|                                  | Complete base assemblies fixed height 30" D single sided                | 17 |
|                                  | Complete base assemblies adjustable height 30" D dual                   | 18 |
|                                  | Complete base assemblies adjustable height 30" D single sided           | 19 |
|                                  | Complete base assemblies fixed height 36" D dual                        | 20 |
|                                  | Complete base assemblies fixed height 36" D single sided                | 21 |
|                                  | Complete base assemblies adjustable height 36" D dual                   | 22 |
|                                  | Complete base assemblies adjustable height 36" D single sided           | 23 |
| Base components                  | Top channels  | 24 |
|                                  | Beams for single sided or dual tables                                   | 25 |
|                                  | Beams for dual tables   | 26 |
|                                  | Beams for single sided tables   | 27 |
|                                  | End legs, intermediate leg sets for dual tables                         | 28 |
|                                  | End legs, intermediate leg sets for single sided tables                 | 30 |
|                                  | End panels for dual tables and single sided tables, painted             | 31 |
|                                  | End panels for dual tables and single sided tables, laminate and veneer | 32 |
|                                  | Beam trusses  | 33 |
|                                  | Worksurface support   | 34 |
| Power components                 | Modular Raceway   | 36 |
|                                  | Hardwire Raceway  | 42 |
|                                  | Cable tray and cable clips  | 43 |
|                                  | Beam mounted cable trays and cable baskets                              | 44 |
| Screens                          | Center screens  | 45 |
|                                  | Shelves, adapters and buttresses for slatwall screens                   | 47 |
|                                  | Side screens  | 48 |
|                                  | Return screens  | 50 |
|                                  | Dual end screens  | 52 |
|                                  | Single sided end screen   | 54 |
|                                  | Frameless glass Add up  | 56 |
| Morrison Network privacy screens | 57  |    |
| Alpha-Numeric Index              |   | 58 |
| Selling Policy                   |   | 61 |
| General Ordering Information     |   | 63 |

# Knoll and Sustainable Design

---

Each year Knoll sets key initiatives in our journey to sustainability. We are members of a global consortium on energy, have adopted a scientific, metrics-based approach to sustainable product design, and maintain a leadership position in establishing universal, verifiable, sustainability standards for our industry.

Knoll promotes independent third-party certification because it provides the most impartial and trustworthy foundation for industry-wide environmental compliance. Certification by established and respected third parties ensures that all manufacturers are held to the same high standards and that customers can trust a company's declaration about the environmental benefits of its products. Knoll third-party partners include: the International Standards Organization (ISO); Forest Stewardship Council (FSC®); Rainforest Alliance; GREENGUARD® Environmental Institute; and Chicago Climate Exchange (CCX®).

In addition, Knoll is aligned with the U.S. Green Building Council and can help companies, healthcare organizations and educational institutions achieve Leadership in Energy and Environmental Design (LEED®) workplace certification.

## 1. Global Climate Change

- Knoll is a sponsor of the Clinton Global Initiative, which brings together a community of global leaders to devise and implement solutions to some of the world's most pressing challenges, including environmental change.
- Knoll is a member of the Chicago Climate Exchange, which promotes greenhouse gas reduction through the trading of credits earned for reducing emissions.
- Knoll has a comprehensive Energy Management Program to increase energy efficiency in products and processes.

## 2. Life Cycle Assessment (LCA) Tool

- Life Cycle Assessment is a science-based measurement of a product's environmental impacts throughout its life cycle, from raw materials sourcing through manufacture, shipping, use and re-use or end-of-life. LCA enables cradle-to-cradle implementation of sustainable practices.
- Knoll has partnered with The Green Standard.org to develop an affordable, universal ISO-compliant computer-based LCA tool that can be used by the entire contract furniture industry and is partnering on the development of an Environmental Product Declaration System (EPDs) for Knoll products. EPDs are verified documents containing LCA results and additional environmental performance information about a product.

## 3. Setting Industry Standards

- Knoll partners with MTS (The Institute for Market Transformation to Sustainability) to develop the SMaRT® Consensus Sustainable Products Standards, a set of consensus-based sustainable product standards based on the LEED® model, for all building products, fabric, apparel, flooring and carpet. MTS, the developer of SMaRT®, is an accredited American National Standards Institute (ANSI) standard developer.
- Knoll has established FSC® (Forest Stewardship Council) certified wood as the standard for general office open plan office systems, casegoods and tables.
- Knoll also participates in an ongoing BIFMA (Business and Institutional Furniture Manufacturers Association) initiative to establish level™ sustainability standards for the contract furniture industry.
- Our goal is to encourage all manufacturers in the contract furniture industry and related industries to adopt standards that will lead to sustainable products and practices.

For more information about Knoll and sustainable design, visit [knoll.com/environment](http://knoll.com/environment).

This Order Guide provides basic planning, specifications and pricing information for Crinion Open Tables.

Refer to KnollExtra price list for compatible accessories such as flat screen monitor supports, task lights, paper management accessories, keyboard and storage drawers.

Refer to Calibre, Reff or Currents price lists for shared and individual storage options. Additional information can be found at [www.knoll.com](http://www.knoll.com).

Crinion Open Table is the straightforward alternative for open, collaborative work environments.

Crinion Open Table typically consists of deep worksurfaces end-to-end and back-to-back, cantilever supported by parallel beams between end legs or end panels. The beams form a technology corridor for flat screen monitor supports, outlets and power/data distribution. Also available is a single-sided configuration, with a single main beam and a smaller back beam, and a single beam configuration for tables with shallower (24" deep) worksurface.

The center of dual tables or back of single-sided tables features a top channel which supports privacy screens above the table and modular power distribution below the worksurface.

Crinion Open Table is appropriate for libraries and education environments, laboratories, finance and trading desks, teaming areas and design offices.

Crinion Open Table is unique in offering individual height-adjustability and extraordinarily deep worksurfaces. Overall dual table depth is 48", 60" or 72".

The table structure is strong enough to span 16 feet between end legs or intermediate supports to build tables of any length.

The continuous worksurfaces and clear kneespace enable varying numbers of workers to sit on each side. Storage is typically separated from the table in parallel, shared file-and-storage islands, perpendicular files as returns or mobile pedestals.

Crinion is distinguished by a minimalist, modern design, and details like square or tapered edge worksurfaces, plastic laminate, Techwood or natural veneers, and aluminum fittings.

Crinion Open Table simplifies the planning and specifications of an open office, and it can make a dramatic visual and functional statement of collaboration.

The quality and classic design of Crinion work well in virtually any interior.

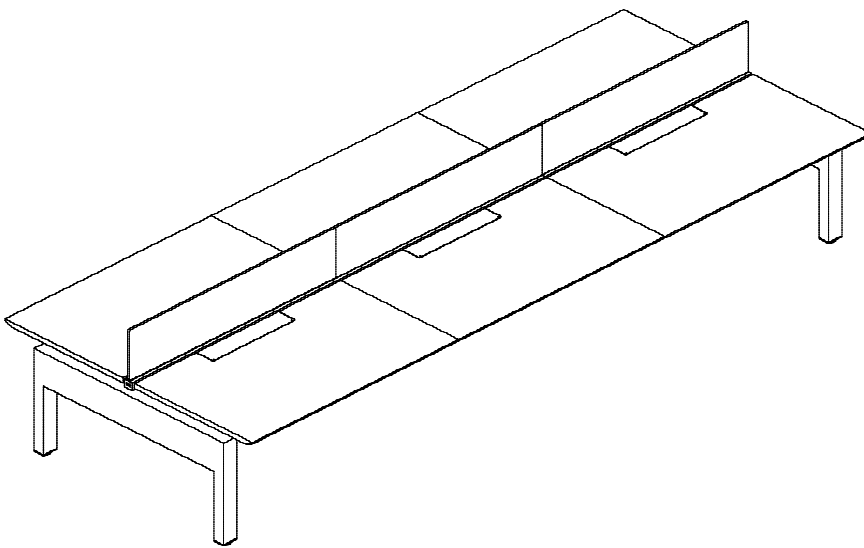

Crinion Open Tables are comprised of worksurfaces, table base assemblies, power components and screens.

### **Worksurfaces**

Individual worksurfaces are available in four standard widths (48", 60", 72", 96") and three depths (nominal 24", 30", 36"), which may be combined to form single-sided or dual-sided groups of two to ten or more positions.

#### *Worksurface edge options*

Worksurfaces are 1 1/4" thick, with three front edge options: Tapered edge, laminate, veneer or mixed.

Square edge, veneer

Postformed edge, laminate only

### **Power and accessory options**

Worksurfaces may be specified with hinged power access door and continuous 1/2" cord drop, or edge grommet and continuous cord drop, or just cord drop.

Hinged power access door is 24"W and 5"D, centered on worksurface width. Door hinges toward user for continuity between access opening and cord drop.

Any worksurface (except end counters) accepts clamp on KnollExtra accessories such as flat screen monitor arm or task light.

#### *Other worksurface types*

End counters have front edge detail on side edges as well and are designed to extend dual tables 24" or 30" beyond the end leg. End counters also include 3" wide center grommet. Extended end counters are 36"D surfaces with center grommet or hinged power access door. Base of the table must be extended 12" under the back of each extended end counter (although top channels should be specified only as wide as the worksurfaces on each side of the table).

All end counters must be supported by end counter cantilevers and endlegs for end counters.

#### *Worksurface heights*

Fixed height cantilevers support worksurfaces at 28 1/2"H, with 27" clear below the top (except directly below cantilevers).

Adjustable height cantilevers enable worksurfaces to be independently set at 27", 27 3/4", 28 1/2", 29 1/4", or 30"H.

### **Open Table base assemblies**

Complete base assemblies simplify specifications for most common configurations of dual or single-sided open tables. Base assemblies include top channels and end caps, beams, end legs and intermediate legs (where required), trusses and top channel supports, cantilever brackets (specify fixed or adjustable height) and midspan supports. Specify worksurfaces, screens, power components, cable trays and accessories separately.

Complete base assemblies are available for the following typical tables, combinations of 60" or 72" worksurfaces.

*Single-sided or dual, 24"D, 30"D, or 36"D, with continuous beam span between end legs*

10' W two/four positions 60"W

12' W two/four positions 72"W

15' W three/six positions 60"W

*Single sided or dual 24"D, 30"D, or 36"D, with intermediate leg*

18' W three/six positions 72"W

20' W four/eight positions 60"W

24' W four/eight positions 72"W

25' W five/ten positions 60"W

### **Open Table base components**

Base assemblies may also be specified by individual components to create configurations other than those listed above, or to create tables with end counters or frameless glass add ups.

In addition to worksurfaces Open tables require top channel, starter beams for spans up to 15', extension beams for additional spans of 4' to 15', intermediate legs every 16' or less, two end legs or end panels, trusses at every worksurface junction and at each end leg or end panel.

Adjustable tables require two cantilevers per worksurface (or three for 96"W). Fixed height tables may be supported by a fixed height cantilever at each end, shared cantilevers at each worksurface joint, and a midspan support bracket at the center of each worksurface greater than 48" wide. For 96"W worksurfaces the midspan support should be a 24"D cantilever.

Power components, cable trays and screens are optional.

### **Power distribution**

Optional modular raceway distributes 2+2 four circuit or 3+3 six circuit configuration from a single point of supply. Bundles of cables can be managed from the floor in a cable infeed shroud located at any intermediate leg. Raceway provides power outlets and data/communications outlet openings on one or both sides, accessed through hinged access doors in worksurfaces or from under table. Specify 30" raceway for two duplex outlets each side or 42" raceway for four duplex outlets each side. Specify compact power module for outlets under an extended end counter. Duplex outlets, power infeed and jumpers between raceways must be specified separately.

### **Privacy screens**

There are four screen options for Crinion Open Table.

The standard screens are 14"H (42" horizon) or 21"H (49" horizon) in acrylic, slat wall or combination surfaces, tackable fabric, marker or veneer. Center screens include mounting hardware to attach to the standard top channel. Center screens are available full width, 48", 60" or 72", or shorter by 1" to leave space at either end of the table for a dual end screen. Side screens attach to the front and back of a worksurface at any point other than at a hinged access door. Mounting brackets are specified separately to correspond to each worksurface edge detail. Dual end screens span across the end of a table (or above an end counter) from worksurface front edges.

Frameless glass add ups are available in 12" height only, 48", 60", and 72"W. Add ups can only mount to a top channel for frameless glass add ups, which may be at the center of a dual table or back of a single-sided table.

Original Crinion privacy screens are 12"H or 19"H (41" or 48" horizons) and mount to a standard top channel only.

Morrison Network fabric screens (15"H or 22"H) can also be mounted to the standard top channel with Crinion Open Table mast kit.

### **Accessories and storage**

All Crinion worksurfaces accept clamp base KnollExtra flat screen monitor arms and task lights at any point except behind the hinged power access door. Worksurfaces also accept suspended accessories like adjustable keyboard supports, BackPack center file or keyboard drawers, or CPU holders. Beam location under most tables prevents pedestals deeper than 20" underneath. However 36"D tops can be planned on 30"D table bases to create additional kneespace depth and room for 24"D pedestals.

Crinion Open Table file tops are available for 27"H Calibre files positioned perpendicular to the table to act as returns. Tapered front and back edges assure consistent detail with tapered worksurface edges. File tops are also available for pairs of files and back to back files.

**Finishes**

**L - Laminate**

*Matching edge band unless noted otherwise*

- 117 Soft Grey
- 118 Bright White
- 114 Folkstone Grey
- 111 Jet Black
- 119 Pumice
- 121 Micro Grey with 114 Folkstone grey edge band
- 122 Brushed Sand with 119 Pumice edge band
- 123 Brushed Grey with 128 Fog edge band
- 128 Fog
- 129 Micro Sand with 119 Pumice edge band

*Additional wood grain laminates for application on postformed laminate tops only.*

*(not available on end counters or tapered edge tops):*

- 125 Natural Maple
- 126 Natural Cherry
- 124 Medium Cherry
- 127 Walnut

**V1 - Techwood Veneer**

- Y316 Maple
- Y319 Cherry
- Y323 Medium Walnut
- Y326 Dark Mahogany
- Y327 Light Oak
- Y329 Medium Oak
- Y341 Wenge
- Y342 Medium Teak
- Y343 Dark Grey Oak
- Y344 Espresso
- Y811 Natural
- Y821 Blond Maple
- Y831 Light Cherry
- Y851 Black Oak

**V2 – Natural Veneer/Premium**

**Techwood Veneer**

- V312 Bronze Cherry
  - V316 Maple
  - V411 Light Walnut
  - V415 Peacock Green Walnut
  - V417 Old English Walnut
  - V418 Smoked Walnut
  - V433 Light Fawn Cherry
  - V436 Medium Brown Cherry
- (above V2's are flat cut)*

- V421 Chalk Oak
  - V423 Light Oak
  - V425 Amber Oak
  - V427 Brown Oak
- (above V2 Oaks are rift cut)*

- V439 Straight Anigre
  - V440 Natural Hemock
- (above V2's are quarter cut)*

- Y841 Ebony
  - Y861 Grigio
  - Y871 Iced Sycamore
- (above Premium Techwoods are straight grain)*

**V3 – Natural Exotic veneer**

- V512 Figured Anigre
  - V513 Graphite Oak
- Rift cut*
- V514 Makore
  - V515 Figured Sycamore
  - V517 Sapele
  - V518 Natural Chestnut
- (all remaining V3s are quarter cut)*

**Paint**

- P1**
- 111 Jet Black
  - 112 Brown
  - 113 Dark Grey
  - 114 Folkstone Grey
  - 115 Medium Grey
  - 116 Sandstone
  - 117 Soft Grey

**P2**

- 611 Beige Mist Metallic
- 612 Medium Metallic Grey

**P3**

- 118 Bright White
- 613 Silver

**Anodized**

- AA Anodized Aluminum

**Glass**

- TEMP Clear Tempered
- GL13 Powder

**Acrylic**

- O Opal
- T Translucent

**Architectural**

- GL13 Powder

**Fabric Options**

*Grade 10*

- Annex (W1360)
- Bailey II (W359)
- Broadcloth (W288)
- Element (W1077)
- Foundation (W351)
- Growth Spurt (W692)
- Solid Crepe (W257)
- Symbolic Detail (W693)
- Tailor Made (W133)
- Versatility (W432)

*Grade 15*

- Regency (W210)

**Fabric Options**

*Grade 20*

- Banyan (W443)
- Bauhaus Block (W296A)
- Circle Line (W1146)
- Clarity (W281)
- Criss Cross (W305)
- Devon (W809)
- Logic (W1318)
- Melbourne (W228)
- Nematic (W1292)
- Outback (W229)
- Reflect (W884)
- Resolution (W280)
- Walkabout (W230)
- Weave Three (W298)

*Grade 30*

- Basket Draft (W249)
- Flow (W565)
- Harmony (W232)
- Interknit (W1090)
- Match Point (W1145)
- Micro (W465)
- Progression (W403)
- Relay (W1020)

*Grade 40*

- Amplify (W1215)
- Bandwidth (W1219)
- Clarkson (W1218)
- Ornament (W1078)

*Grade 45*

- Dristi (K872)
- Macro (W544)
- Mezzo (W543)

*Grade 50*

- Knoll Hopsack (K1206)
- Presto (K1000)

*Grade 55*

- Transition (W816)

Customers Own Material

Prices for panels that are to be manufactured with a customer supplied fabric will follow Grade 10 panel pricing. COM fabrics are subject to a testing charge prior to acceptance for use on panels. Panels bearing COM fabrics are subject to extended leadtimes. It is the responsibility of the customer's purchasing agent to ensure COM fabric is supplied for testing and manufacturing. Delays in receiving COM fabric for manufacturing will result in rescheduled delivery dates.

**Mixed Finish work surfaces:**

*To order mixed finishes, enter four digit finish code as follows:*

*Use 2 digit prefix to indicate surface finish (laminate)*

- |    |                |
|----|----------------|
| 11 | Jet Black      |
| 14 | Folkstone Grey |
| 17 | Soft Grey      |
| 18 | Bright White   |
| 19 | Pumice         |
| 21 | Micro Grey     |
| 22 | Brushed Sand   |
| 23 | Brushed Grey   |
| 28 | Fog            |
| 29 | Micro Sand     |

*Use 2 digit suffix to indicate edge finish (wood)*

- |    |                |
|----|----------------|
| 16 | for V316, Y316 |
| Y9 | for Y319       |
| Y3 | for Y323       |
| 26 | for Y326       |
| 27 | for Y327       |
| 29 | for Y329       |
| 43 | for V433       |
| 45 | for V415       |
| 46 | for V436       |
| 47 | for V417       |
| 48 | for V418       |
| 52 | for V512       |
| 53 | for V513       |
| 54 | for V514       |
| 55 | for V515       |
| 57 | for V517       |
| 61 | for V411       |
| 71 | for V421       |
| 73 | for V423       |
| 75 | for V425       |
| 77 | for V427       |

**Example:**

For a Micro Grey laminate surface with Bronzed Cherry edge, enter finish code 2112

For a Jet Black laminate surface with Light Maple edge, enter finish code 1116

**This page intentionally left blank**

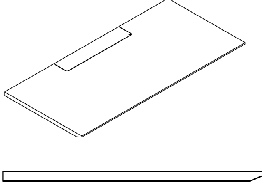
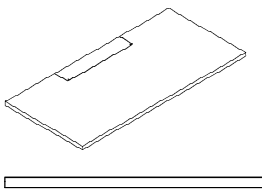
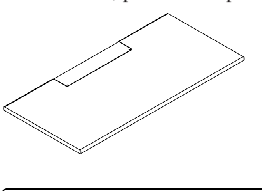
| description  | nominal depth  | w   | d   | h      | pattern number                       | L                                | M      | V1     | V2     | V3       |
|--|--|-----|-----|--------|--------------------------------------|----------------------------------|--------|--------|--------|----------|
| Worksurface, tapered edge<br>         | 24"  | 48" | 22" | 1 1/4" | <b>XTTK4824A (L/M/1/2/3) ( ) ( )</b> | \$766.                           | \$895. | \$895. | \$981. | \$1,186. |
|  | 24"  | 60" | 22" | 1 1/4" | <b>XTTK6024A (L/M/1/2/3) ( ) ( )</b> | 794.                             | 979.   | 979.   | 1,079. | 1,313.   |
|  | 24"  | 72" | 22" | 1 1/4" | <b>XTTK7224A (L/M/1/2/3) ( ) ( )</b> | 848.                             | 1,033. | 1,033. | 1,145. | 1,400.   |
|  | 24"  | 96" | 22" | 1 1/4" | <b>XTTK9624A (L/M/1/2/3) ( ) ( )</b> | 945.                             | 1,165. | 1,165. | 1,299. | 1,600.   |
|  | 30"  | 48" | 28" | 1 1/4" | <b>XTTK4830A (L/M/1/2/3) ( ) ( )</b> | 778.                             | 969.   | 969.   | 1,070. | 1,301.   |
|  | 30"  | 60" | 28" | 1 1/4" | <b>XTTK6030A (L/M/1/2/3) ( ) ( )</b> | 819.                             | 1,049. | 1,049. | 1,160. | 1,417.   |
|  | 30"  | 72" | 28" | 1 1/4" | <b>XTTK7230A (L/M/1/2/3) ( ) ( )</b> | 877.                             | 1,085. | 1,085. | 1,202. | 1,473.   |
|  | 30"  | 96" | 28" | 1 1/4" | <b>XTTK9630A (L/M/1/2/3) ( ) ( )</b> | 979.                             | 1,227. | 1,227. | 1,366. | 1,685.   |
|  | 36"  | 48" | 34" | 1 1/4" | <b>XTTK4836A (L/M/1/2/3) ( ) ( )</b> | 815.                             | 1,054. | 1,054. | 1,172. | 1,434.   |
|  | 36"  | 60" | 34" | 1 1/4" | <b>XTTK6036A (L/M/1/2/3) ( ) ( )</b> | 838.                             | 1,129. | 1,129. | 1,251. | 1,535.   |
|  | 36"  | 72" | 34" | 1 1/4" | <b>XTTK7236A (L/M/1/2/3) ( ) ( )</b> | 915.                             | 1,142. | 1,142. | 1,264. | 1,552.   |
|  | 36"  | 96" | 34" | 1 1/4" | <b>XTTK9636A (L/M/1/2/3) ( ) ( )</b> | 1,041.                           | 1,290. | 1,290. | 1,438. | 1,779.   |
|  | Worksurface, veneer square edge<br> | 24" | 48" | 22"    | 1 1/4"                               | <b>XTTS4824A (1/2/3) ( ) ( )</b> | n/a    | n/a    | 732.   | 805.     |
| 24"  |  | 60" | 22" | 1 1/4" | <b>XTTS6024A (1/2/3) ( ) ( )</b>     | n/a                              | n/a    | 767.   | 841.   | 952.     |
| 24"  |  | 72" | 22" | 1 1/4" | <b>XTTS7224A (1/2/3) ( ) ( )</b>     | n/a                              | n/a    | 805.   | 878.   | 1,002.   |
| 24"  |  | 96" | 22" | 1 1/4" | <b>XTTS9624A (1/2/3) ( ) ( )</b>     | n/a                              | n/a    | 866.   | 940.   | 1,087.   |
| 30"  |  | 48" | 28" | 1 1/4" | <b>XTTS4830A (1/2/3) ( ) ( )</b>     | n/a                              | n/a    | 841.   | 916.   | 1,038.   |
| 30"  |  | 60" | 28" | 1 1/4" | <b>XTTS6030A (1/2/3) ( ) ( )</b>     | n/a                              | n/a    | 866.   | 946.   | 1,088.   |
| 30"  |  | 72" | 28" | 1 1/4" | <b>XTTS7230A (1/2/3) ( ) ( )</b>     | n/a                              | n/a    | 891.   | 978.   | 1,185.   |
| 30"  |  | 96" | 28" | 1 1/4" | <b>XTTS9630A (1/2/3) ( ) ( )</b>     | n/a                              | n/a    | 940.   | 1,038. | 1,347.   |
| 36"  |  | 48" | 34" | 1 1/4" | <b>XTTS4836A (1/2/3) ( ) ( )</b>     | n/a                              | n/a    | 916.   | 1,007. | 1,161.   |
| 36"  |  | 60" | 34" | 1 1/4" | <b>XTTS6036A (1/2/3) ( ) ( )</b>     | n/a                              | n/a    | 952.   | 1,045. | 1,190.   |
| 36"  |  | 72" | 34" | 1 1/4" | <b>XTTS7236A (1/2/3) ( ) ( )</b>     | n/a                              | n/a    | 989.   | 1,102. | 1,302.   |
| 36"  |  | 96" | 34" | 1 1/4" | <b>XTTS9636A (1/2/3) ( ) ( )</b>     | n/a                              | n/a    | 1,063. | 1,210. | 1,505.   |
| Worksurface, postformed plastic<br> |  | 24" | 48" | 22"    | 1 1/4"                               | <b>XTPP4824A (L) ( ) ( )</b>     | 562.   | n/a    | n/a    | n/a      |
|  | 24"  | 60" | 22" | 1 1/4" | <b>XTPP6024A (L) ( ) ( )</b>         | 641.                             | n/a    | n/a    | n/a    | n/a      |
|  | 24"  | 72" | 22" | 1 1/4" | <b>XTPP7224A (L) ( ) ( )</b>         | 702.                             | n/a    | n/a    | n/a    | n/a      |
|  | 24"  | 96" | 22" | 1 1/4" | <b>XTPP9624A (L) ( ) ( )</b>         | 768.                             | n/a    | n/a    | n/a    | n/a      |
|  | 30"  | 48" | 28" | 1 1/4" | <b>XTPP4830A (L) ( ) ( )</b>         | 586.                             | n/a    | n/a    | n/a    | n/a      |
|  | 30"  | 60" | 28" | 1 1/4" | <b>XTPP6030A (L) ( ) ( )</b>         | 671.                             | n/a    | n/a    | n/a    | n/a      |
|  | 30"  | 72" | 28" | 1 1/4" | <b>XTPP7230A (L) ( ) ( )</b>         | 738.                             | n/a    | n/a    | n/a    | n/a      |
|  | 30"  | 96" | 28" | 1 1/4" | <b>XTPP9630A (L) ( ) ( )</b>         | 817.                             | n/a    | n/a    | n/a    | n/a      |
|  | 36"  | 48" | 34" | 1 1/4" | <b>XTPP4836A (L) ( ) ( )</b>         | 618.                             | n/a    | n/a    | n/a    | n/a      |
|  | 36"  | 60" | 34" | 1 1/4" | <b>XTPP6036A (L) ( ) ( )</b>         | 738.                             | n/a    | n/a    | n/a    | n/a      |
|  | 36"  | 72" | 34" | 1 1/4" | <b>XTPP7236A (L) ( ) ( )</b>         | 797.                             | n/a    | n/a    | n/a    | n/a      |
|  | 36"  | 96" | 34" | 1 1/4" | <b>XTPP9636A (L) ( ) ( )</b>         | 884.                             | n/a    | n/a    | n/a    | n/a      |

| Order Code                               | Specifications   | Application Notes   |
|--|--|---|
| Example: <b>XTPP6030AL 118 118</b>       | Worksurfaces are 1 1/4" thick with square edge or tapered edge option tapering to 1/2" thick front edge. | Crinion 30"D worksurfaces correspond in width to table bases, which are specified separately. 48"W worksurfaces plan on 12' wide or 20' wide bases. 60"W worksurfaces plan on 5', 10', 15' and 20' wide bases. 72" W worksurfaces plan on 6', 12' and 18' wide bases. |
| <b>XT</b> Crinion Open Table             |  | Power access door is 24" wide, 5" deep, centered at back edge of worksurface.   |
| <b>T</b> Worksurface                     |  |   |
| <b>P</b> Postformed plastic              |  | Continous 1/2" wire drop accommodates clamp-on flat screen monitor arm or most power cords plugs.   |
| <b>60</b> Width                          | 1. Specify finish group:<br>L - Laminate<br>M - Laminate/veneer edge                                     |   |
| <b>30</b> Depth                          | 1 - Veneer group 1<br>2 - Veneer group 2<br>3 - Veneer group 3   | Actual worksurface depth is 22.35", 28.35" or 34.35".   |
| <b>A</b> With center hinged power access | 2. Specify worksurface finish.   |   |
| <b>L</b> Finish Type                     | 3. Specify hinged access cover finish.   | Worksurfaces with hinged power access enable access to suspended modular raceway.   |
| <b>118</b> Work Surface finish           | AA anodized aluminum and all P1,P2 and P3 paint finishes are available except 613 Silver.                |   |
| <b>118</b> Access door finish            |  |   |

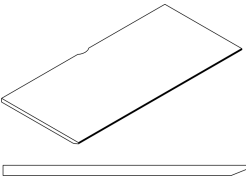
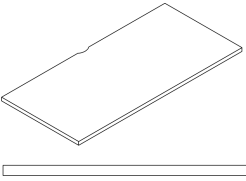
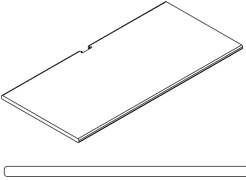
| description  | nominal depth  | w   | d   | h      | pattern number                       | L                                | M      | V1     | V2     | V3     |      |
|--|--|-----|-----|--------|--------------------------------------|----------------------------------|--------|--------|--------|--------|------|
| Worksurface, tapered edge<br>         | 24"  | 48" | 22" | 1 1/4" | <b>XTTK4824U (L/M/1/2/3) ( ) ( )</b> | \$506.                           | \$635. | \$635. | \$721. | \$926. |      |
|  | 24"  | 60" | 22" | 1 1/4" | <b>XTTK6024U (L/M/1/2/3) ( ) ( )</b> | 534.                             | 719.   | 719.   | 819.   | 1,053. |      |
|  | 24"  | 72" | 22" | 1 1/4" | <b>XTTK7224U (L/M/1/2/3) ( ) ( )</b> | 588.                             | 773.   | 773.   | 885.   | 1,140. |      |
|  | 24"  | 96" | 22" | 1 1/4" | <b>XTTK9624U (L/M/1/2/3) ( ) ( )</b> | 685.                             | 905.   | 905.   | 1,039. | 1,340. |      |
|  | 30"  | 48" | 28" | 1 1/4" | <b>XTTK4830U (L/M/1/2/3) ( ) ( )</b> | 518.                             | 709.   | 709.   | 810.   | 1,041. |      |
|  | 30"  | 60" | 28" | 1 1/4" | <b>XTTK6030U (L/M/1/2/3) ( ) ( )</b> | 559.                             | 789.   | 789.   | 900.   | 1,157. |      |
|  | 30"  | 72" | 28" | 1 1/4" | <b>XTTK7230U (L/M/1/2/3) ( ) ( )</b> | 617.                             | 825.   | 825.   | 942.   | 1,213. |      |
|  | 30"  | 96" | 28" | 1 1/4" | <b>XTTK9630U (L/M/1/2/3) ( ) ( )</b> | 719.                             | 967.   | 967.   | 1,106. | 1,425. |      |
|  | 36"  | 48" | 34" | 1 1/4" | <b>XTTK4836U (L/M/1/2/3) ( ) ( )</b> | 555.                             | 794.   | 794.   | 912.   | 1,174. |      |
|  | 36"  | 60" | 34" | 1 1/4" | <b>XTTK6036U (L/M/1/2/3) ( ) ( )</b> | 578.                             | 869.   | 869.   | 991.   | 1,275. |      |
|  | 36"  | 72" | 34" | 1 1/4" | <b>XTTK7236U (L/M/1/2/3) ( ) ( )</b> | 655.                             | 882.   | 882.   | 1,004. | 1,292. |      |
|  | 36"  | 96" | 34" | 1 1/4" | <b>XTTK9636U (L/M/1/2/3) ( ) ( )</b> | 781.                             | 1,030. | 1,030. | 1,178. | 1,519. |      |
|  | Worksurface, veneer square edge<br> | 24" | 48" | 22"    | 1 1/4"                               | <b>XTTS4824U (1/2/3) ( ) ( )</b> | n/a    | n/a    | 472.   | 545.   | 644. |
|  |  | 24" | 60" | 22"    | 1 1/4"                               | <b>XTTS6024U (1/2/3) ( ) ( )</b> | n/a    | n/a    | 507.   | 581.   | 692. |
| 24"  |  | 72" | 22" | 1 1/4" | <b>XTTS7224U (1/2/3) ( ) ( )</b>     | n/a                              | n/a    | 545.   | 618.   | 742.   |      |
| 24"  |  | 96" | 22" | 1 1/4" | <b>XTTS9624U (1/2/3) ( ) ( )</b>     | n/a                              | n/a    | 606.   | 680.   | 827.   |      |
| 30"  |  | 48" | 28" | 1 1/4" | <b>XTTS4830U (1/2/3) ( ) ( )</b>     | n/a                              | n/a    | 581.   | 656.   | 778.   |      |
| 30"  |  | 60" | 28" | 1 1/4" | <b>XTTS6030U (1/2/3) ( ) ( )</b>     | n/a                              | n/a    | 606.   | 686.   | 828.   |      |
| 30"  |  | 72" | 28" | 1 1/4" | <b>XTTS7230U (1/2/3) ( ) ( )</b>     | n/a                              | n/a    | 631.   | 718.   | 925.   |      |
| 30"  |  | 96" | 28" | 1 1/4" | <b>XTTS9630U (1/2/3) ( ) ( )</b>     | n/a                              | n/a    | 680.   | 778.   | 1,087. |      |
| 36"  |  | 48" | 34" | 1 1/4" | <b>XTTS4836U (1/2/3) ( ) ( )</b>     | n/a                              | n/a    | 656.   | 747.   | 901.   |      |
| 36"  |  | 60" | 34" | 1 1/4" | <b>XTTS6036U (1/2/3) ( ) ( )</b>     | n/a                              | n/a    | 692.   | 785.   | 930.   |      |
| 36"  |  | 72" | 34" | 1 1/4" | <b>XTTS7236U (1/2/3) ( ) ( )</b>     | n/a                              | n/a    | 729.   | 842.   | 1,042. |      |
| 36"  |  | 96" | 34" | 1 1/4" | <b>XTTS9636U (1/2/3) ( ) ( )</b>     | n/a                              | n/a    | 803.   | 950.   | 1,245. |      |
| Worksurface, postformed plastic<br> |  | 24" | 48" | 22"    | 1 1/4"                               | <b>XTPP4824B (L) ( ) ( )</b>     | 302.   | n/a    | n/a    | n/a    | n/a  |
|  |  | 24" | 60" | 22"    | 1 1/4"                               | <b>XTPP6024B (L) ( ) ( )</b>     | 381.   | n/a    | n/a    | n/a    | n/a  |
|  | 24"  | 72" | 22" | 1 1/4" | <b>XTPP7224B (L) ( ) ( )</b>         | 442.                             | n/a    | n/a    | n/a    | n/a    |      |
|  | 24"  | 96" | 22" | 1 1/4" | <b>XTPP9624B (L) ( ) ( )</b>         | 508.                             | n/a    | n/a    | n/a    | n/a    |      |
|  | 30"  | 48" | 28" | 1 1/4" | <b>XTPP4830B (L) ( ) ( )</b>         | 326.                             | n/a    | n/a    | n/a    | n/a    |      |
|  | 30"  | 60" | 28" | 1 1/4" | <b>XTPP6030B (L) ( ) ( )</b>         | 411.                             | n/a    | n/a    | n/a    | n/a    |      |
|  | 30"  | 72" | 28" | 1 1/4" | <b>XTPP7230B (L) ( ) ( )</b>         | 478.                             | n/a    | n/a    | n/a    | n/a    |      |
|  | 30"  | 96" | 28" | 1 1/4" | <b>XTPP9630B (L) ( ) ( )</b>         | 557.                             | n/a    | n/a    | n/a    | n/a    |      |
|  | 36"  | 48" | 34" | 1 1/4" | <b>XTPP4836B (L) ( ) ( )</b>         | 358.                             | n/a    | n/a    | n/a    | n/a    |      |
|  | 36"  | 60" | 34" | 1 1/4" | <b>XTPP6036B (L) ( ) ( )</b>         | 478.                             | n/a    | n/a    | n/a    | n/a    |      |
|  | 36"  | 72" | 34" | 1 1/4" | <b>XTPP7236B (L) ( ) ( )</b>         | 537.                             | n/a    | n/a    | n/a    | n/a    |      |
|  | 36"  | 96" | 34" | 1 1/4" | <b>XTPP9636B (L) ( ) ( )</b>         | 624.                             | n/a    | n/a    | n/a    | n/a    |      |

| Order Code                         | Specifications   | Application Notes   |
|------------------------------------|--|---|
| Example: <b>XTPP6030BL 118 812</b> |  |   |
| <b>XT</b> Crinion Open Table       | Worksurfaces are 1 1/4" thick with square edge or tapered edge option tapering to 1/2" thick front edge. | Crinion 30"D worksurfaces correspond in width to table bases, which are specified separately.   |
| <b>T</b> Worksurface               |  | 48"W worksurfaces plan on 12" wide or 20" wide bases. 60"W worksurfaces plan on 5', 10', 15' and 20' wide bases. 72" W worksurfaces plan on 6', 12' and 18' wide bases. |
| <b>P</b> Postformed plastic        | 1. Specify finish group:<br>L - Laminate<br>M - Laminate/veneer edge                                     |   |
| <b>60</b> Width                    | 1 - Veneer group 1<br>2 - Veneer group 2<br>3 - Veneer group 3   |   |
| <b>30</b> Depth                    | 2. Specify worksurface finish.   |   |
| <b>B</b> With edge grommet         | 3. Specify grommet color:<br>812 - Easy grey<br>111 - Black  | Edge grommet accommodates most power cord plugs up to 1" deep.  |
| <b>L</b> Finish type               |  |   |
| <b>118</b> Surface finish          |  |   |
| <b>812</b> Grommet finish          |  | Actual worksurface depth is 21.85", 27.85" or 33.85".   |

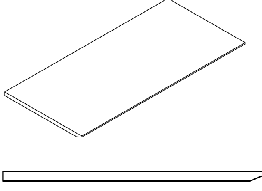
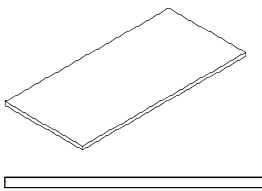
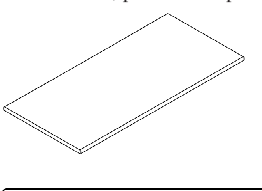

| description  | nominal depth  | w   | d   | h      | pattern number                   | L                            | M      | V1     | V2     | V3     |      |
|--|--|-----|-----|--------|----------------------------------|------------------------------|--------|--------|--------|--------|------|
| Worksurface, tapered edge<br>         | 24"  | 48" | 22" | 1 1/4" | <b>XTTK4824C (L/M/1/2/3) ( )</b> | \$466.                       | \$595. | \$595. | \$681. | \$886. |      |
|  | 24"  | 60" | 22" | 1 1/4" | <b>XTTK6024C (L/M/1/2/3) ( )</b> | 494.                         | 679.   | 679.   | 779.   | 1,013. |      |
|  | 24"  | 72" | 22" | 1 1/4" | <b>XTTK7224C (L/M/1/2/3) ( )</b> | 548.                         | 733.   | 733.   | 845.   | 1,100. |      |
|  | 24"  | 96" | 22" | 1 1/4" | <b>XTTK9624C (L/M/1/2/3) ( )</b> | 645.                         | 865.   | 865.   | 999.   | 1,300. |      |
|  | 30"  | 48" | 28" | 1 1/4" | <b>XTTK4830C (L/M/1/2/3) ( )</b> | 478.                         | 669.   | 669.   | 770.   | 1,001. |      |
|  | 30"  | 60" | 28" | 1 1/4" | <b>XTTK6030C (L/M/1/2/3) ( )</b> | 519.                         | 749.   | 749.   | 860.   | 1,117. |      |
|  | 30"  | 72" | 28" | 1 1/4" | <b>XTTK7230C (L/M/1/2/3) ( )</b> | 577.                         | 785.   | 785.   | 902.   | 1,173. |      |
|  | 30"  | 96" | 28" | 1 1/4" | <b>XTTK9630C (L/M/1/2/3) ( )</b> | 679.                         | 927.   | 927.   | 1,066. | 1,385. |      |
|  | 36"  | 48" | 34" | 1 1/4" | <b>XTTK4836C (L/M/1/2/3) ( )</b> | 515.                         | 754.   | 754.   | 872.   | 1,134. |      |
|  | 36"  | 60" | 34" | 1 1/4" | <b>XTTK6036C (L/M/1/2/3) ( )</b> | 538.                         | 829.   | 829.   | 951.   | 1,235. |      |
|  | 36"  | 72" | 34" | 1 1/4" | <b>XTTK7236C (L/M/1/2/3) ( )</b> | 615.                         | 842.   | 842.   | 964.   | 1,252. |      |
|  | 36"  | 96" | 34" | 1 1/4" | <b>XTTK9636C (L/M/1/2/3) ( )</b> | 741.                         | 990.   | 990.   | 1,138. | 1,479. |      |
|  | Worksurface, veneer square edge<br> | 24" | 48" | 22"    | 1 1/4"                           | <b>XTTS4824C (1/2/3) ( )</b> | n/a    | n/a    | 432.   | 505.   | 604. |
|  |  | 24" | 60" | 22"    | 1 1/4"                           | <b>XTTS6024C (1/2/3) ( )</b> | n/a    | n/a    | 467.   | 541.   | 652. |
| 24"  |  | 72" | 22" | 1 1/4" | <b>XTTS7224C (1/2/3) ( )</b>     | n/a                          | n/a    | 505.   | 578.   | 702.   |      |
| 24"  |  | 96" | 22" | 1 1/4" | <b>XTTS9624C (1/2/3) ( )</b>     | n/a                          | n/a    | 566.   | 640.   | 787.   |      |
| 30"  |  | 48" | 28" | 1 1/4" | <b>XTTS4830C (1/2/3) ( )</b>     | n/a                          | n/a    | 541.   | 616.   | 738.   |      |
| 30"  |  | 60" | 28" | 1 1/4" | <b>XTTS6030C (1/2/3) ( )</b>     | n/a                          | n/a    | 566.   | 646.   | 788.   |      |
| 30"  |  | 72" | 28" | 1 1/4" | <b>XTTS7230C (1/2/3) ( )</b>     | n/a                          | n/a    | 591.   | 678.   | 885.   |      |
| 30"  |  | 96" | 28" | 1 1/4" | <b>XTTS9630C (1/2/3) ( )</b>     | n/a                          | n/a    | 640.   | 738.   | 1,047. |      |
| 36"  |  | 48" | 34" | 1 1/4" | <b>XTTS4836C (1/2/3) ( )</b>     | n/a                          | n/a    | 616.   | 707.   | 861.   |      |
| 36"  |  | 60" | 34" | 1 1/4" | <b>XTTS6036C (1/2/3) ( )</b>     | n/a                          | n/a    | 652.   | 745.   | 890.   |      |
| 36"  |  | 72" | 34" | 1 1/4" | <b>XTTS7236C (1/2/3) ( )</b>     | n/a                          | n/a    | 689.   | 802.   | 1,002. |      |
| 36"  |  | 96" | 34" | 1 1/4" | <b>XTTS9636C (1/2/3) ( )</b>     | n/a                          | n/a    | 763.   | 910.   | 1,205. |      |
| Worksurface, postformed plastic<br> |  | 24" | 48" | 22"    | 1 1/4"                           | <b>XTTP4824C (L) ( )</b>     | 262.   | n/a    | n/a    | n/a    | n/a  |
|  |  | 24" | 60" | 22"    | 1 1/4"                           | <b>XTTP6024C (L) ( )</b>     | 341.   | n/a    | n/a    | n/a    | n/a  |
|  | 24"  | 72" | 22" | 1 1/4" | <b>XTTP7224C (L) ( )</b>         | 402.                         | n/a    | n/a    | n/a    | n/a    |      |
|  | 24"  | 96" | 22" | 1 1/4" | <b>XTTP9624C (L) ( )</b>         | 468.                         | n/a    | n/a    | n/a    | n/a    |      |
|  | 30"  | 48" | 28" | 1 1/4" | <b>XTTP4830C (L) ( )</b>         | 286.                         | n/a    | n/a    | n/a    | n/a    |      |
|  | 30"  | 60" | 28" | 1 1/4" | <b>XTTP6030C (L) ( )</b>         | 371.                         | n/a    | n/a    | n/a    | n/a    |      |
|  | 30"  | 72" | 28" | 1 1/4" | <b>XTTP7230C (L) ( )</b>         | 438.                         | n/a    | n/a    | n/a    | n/a    |      |
|  | 30"  | 96" | 28" | 1 1/4" | <b>XTTP9630C (L) ( )</b>         | 517.                         | n/a    | n/a    | n/a    | n/a    |      |
|  | 36"  | 48" | 34" | 1 1/4" | <b>XTTP4836C (L) ( )</b>         | 318.                         | n/a    | n/a    | n/a    | n/a    |      |
|  | 36"  | 60" | 34" | 1 1/4" | <b>XTTP6036C (L) ( )</b>         | 438.                         | n/a    | n/a    | n/a    | n/a    |      |
|  | 36"  | 72" | 34" | 1 1/4" | <b>XTTP7236C (L) ( )</b>         | 497.                         | n/a    | n/a    | n/a    | n/a    |      |
|  | 36"  | 96" | 34" | 1 1/4" | <b>XTTP9636C (L) ( )</b>         | 584.                         | n/a    | n/a    | n/a    | n/a    |      |

| Order Code                     | Specifications |
|--------------------------------|----------------|
| Example: <b>XTTP6030CL 118</b> |                |
| <b>XT</b> Crinion Open Table   |                |
| <b>T</b> Worksurface           |                |
| <b>P</b> Postformed plastic    |                |
| <b>60</b> Width                |                |
| <b>30</b> Depth                |                |
| <b>C</b> With cord drop        |                |
| <b>L</b> Finish type           |                |
| <b>118</b> Surface             |                |

Worksurfaces are 1 1/4" thick with square edge or tapered edge option tapering to 1/2" thick front edge.

Specify finishes:  
 L - Laminate  
 M - Laminate/veneer edge  
 1 - Veneer group 1  
 2 - Veneer group 2  
 3 - Veneer group 3

**Application Notes**

Crinion 30"D worksurfaces correspond in width to table bases, which are specified separately. 48"W worksurfaces plan on 12' wide or 20' wide bases. 60"W worksurfaces plan on 5', 10', 15' and 20' wide bases. 72" W worksurfaces plan on 6', 12' and 18' wide bases.

Continuous 1/2" cord drop accommodates clamp-on flat screen monitor arm or most power cords.

Actual worksurface depth is 21.85", 27.85" or 33.85".

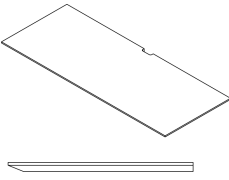
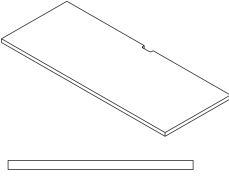
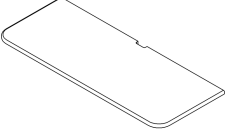
| description   | nominal depth | w   | l   | h      | pattern number                   | L      | M      | V1     | V2     | V3       |
|---|---------------|-----|-----|--------|----------------------------------|--------|--------|--------|--------|----------|
| End counter, tapered edge<br>          | 24"           | 48" | 24" | 1 1/4" | <b>XTTK4824E (L/M/1/2/3) ( )</b> | \$653. | \$841. | \$841. | \$927. | \$1,131. |
|   | 24"           | 60" | 24" | 1 1/4" | <b>XTTK6024E (L/M/1/2/3) ( )</b> | 773.   | 924.   | 924.   | 1,026. | 1,259.   |
|   | 24"           | 72" | 24" | 1 1/4" | <b>XTTK7224E (L/M/1/2/3) ( )</b> | 803.   | 978.   | 978.   | 1,091. | 1,345.   |
|   | 30"           | 48" | 30" | 1 1/4" | <b>XTTK4830E (L/M/1/2/3) ( )</b> | 731.   | 915.   | 915.   | 1,017. | 1,247.   |
|   | 30"           | 60" | 30" | 1 1/4" | <b>XTTK6030E (L/M/1/2/3) ( )</b> | 796.   | 994.   | 994.   | 1,106. | 1,364.   |
|   | 30"           | 72" | 30" | 1 1/4" | <b>XTTK7230E (L/M/1/2/3) ( )</b> | 831.   | 1,031. | 1,031. | 1,148. | 1,419.   |
| End counter, veneer square edge<br>    | 24"           | 48" | 24" | 1 1/4" | <b>XTTS4824E (1/2/3) ( )</b>     | n/a    | n/a    | 432.   | 505.   | 604.     |
|   | 24"           | 60" | 24" | 1 1/4" | <b>XTTS6024E (1/2/3) ( )</b>     | n/a    | n/a    | 467.   | 541.   | 652.     |
|   | 24"           | 72" | 24" | 1 1/4" | <b>XTTS7224E (1/2/3) ( )</b>     | n/a    | n/a    | 505.   | 578.   | 702.     |
|   | 30"           | 48" | 30" | 1 1/4" | <b>XTTS4830E (1/2/3) ( )</b>     | n/a    | n/a    | 541.   | 616.   | 738.     |
|   | 30"           | 60" | 30" | 1 1/4" | <b>XTTS6030E (1/2/3) ( )</b>     | n/a    | n/a    | 566.   | 646.   | 788.     |
|   | 30"           | 72" | 30" | 1 1/4" | <b>XTTS7230E (1/2/3) ( )</b>     | n/a    | n/a    | 591.   | 678.   | 885.     |
| End counter for postformed plastic<br> | 24"           | 48" | 24" | 1 1/4" | <b>XTTP4824E (L) ( )</b>         | 487.   | n/a    | n/a    | n/a    | n/a      |
|   | 24"           | 60" | 24" | 1 1/4" | <b>XTTP6024E (L) ( )</b>         | 578.   | n/a    | n/a    | n/a    | n/a      |
|   | 24"           | 72" | 24" | 1 1/4" | <b>XTTP7224E (L) ( )</b>         | 651.   | n/a    | n/a    | n/a    | n/a      |
|   | 30"           | 48" | 30" | 1 1/4" | <b>XTTP4830E (L) ( )</b>         | 547.   | n/a    | n/a    | n/a    | n/a      |
|   | 30"           | 60" | 30" | 1 1/4" | <b>XTTP6030E (L) ( )</b>         | 651.   | n/a    | n/a    | n/a    | n/a      |
|   | 30"           | 72" | 30" | 1 1/4" | <b>XTTP7230E (L) ( )</b>         | 779.   | n/a    | n/a    | n/a    | n/a      |

\* Note

| Order Code                     | Specifications   | Application Notes  |
|--------------------------------|--|--|
| Example: <b>XTTP6024EL 118</b> |  |  |
| <b>XT</b> Crinion Open Table   | End counters are 1 1/4" thick with square edge or tapered edge option tapering to 1/2" thick front edge. End counters are tapered front and side edges only. | End counters mount at the ends of dual tables with two end counter cantilever brackets. Specify dual end legs for end counters instead of standard dual end legs (tables with end counters must be specified from components, not assemblies). |
| <b>T</b> Worksurface           |  | Specify added length of 24" or 30" beyond end leg for end counters.  |
| <b>P</b> Postformed plastic    |  | * Note - End counters for postformed plastic are not available in these finishes:  |
| <b>60</b> Width                | Specify finishes:  | 121 Micro grey   |
| <b>24</b> Length               | L - Laminate   | 129 Micro sand   |
| <b>E</b> End counter           | M- Laminate/veneer edge  | 122 Brushed sand   |
| <b>L</b> Finish Type           | 1 - Veneer group 1   | 123 Brushed grey   |
| <b>118</b> Surface             | 2 - Veneer group 2   |  |
|                                | 3 - Veneer group 3   |  |
|                                |  | End counters may not be used with end panel kits.  |

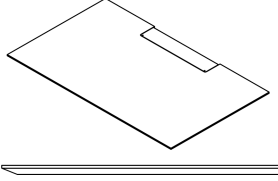
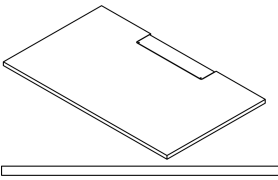
| description  | nominal depth | w   | l   | h      | pattern no.                          | L        | M        | V1       | V2       | V3       |
|--|---------------|-----|-----|--------|--------------------------------------|----------|----------|----------|----------|----------|
| Extended end counter, tapered edge with hinged power access<br>       | 36"           | 48" | 36" | 1 1/4" | <b>XTTK4836D (L/M/1/2/3) ( ) ( )</b> | \$1,085. | \$1,260. | \$1,260. | \$1,373. | \$1,627. |
|  | 36"           | 60" | 36" | 1 1/4" | <b>XTTK6036D (L/M/1/2/3) ( ) ( )</b> | 1,113.   | 1,313.   | 1,313.   | 1,430.   | 1,701.   |
|  | 36"           | 72" | 36" | 1 1/4" | <b>XTTK7236D (L/M/1/2/3) ( ) ( )</b> | 1,195.   | 1,414.   | 1,414.   | 1,537.   | 1,838.   |
| Extended end counter, tapered edge with grommet  | 36"           | 48" | 36" | 1 1/4" | <b>XTTK4836E (L/M/1/2/3) ( )</b>     | 803.     | 978.     | 978.     | 1,091.   | 1,345.   |
|  | 36"           | 60" | 36" | 1 1/4" | <b>XTTK6036E (L/M/1/2/3) ( )</b>     | 831.     | 1,031.   | 1,031.   | 1,148.   | 1,419.   |
|  | 36"           | 72" | 36" | 1 1/4" | <b>XTTK7236E (L/M/1/2/3) ( )</b>     | 913.     | 1,132.   | 1,132.   | 1,255.   | 1,556.   |
| Extended end counter, veneer square edge with hinged power access<br> | 36"           | 48" | 36" | 1 1/4" | <b>XTTS4836D (1/2/3) ( ) ( )</b>     | n/a      | n/a      | 763.     | 832.     | 950.     |
|  | 36"           | 60" | 36" | 1 1/4" | <b>XTTS6036D (1/2/3) ( ) ( )</b>     | n/a      | n/a      | 873.     | 960.     | 1,167.   |
|  | 36"           | 72" | 36" | 1 1/4" | <b>XTTS7236D (1/2/3) ( ) ( )</b>     | n/a      | n/a      | 960.     | 1,050.   | 1,298.   |
| Extended end counter, veneer square edge with grommet  | 36"           | 48" | 36" | 1 1/4" | <b>XTTS4836E (1/2/3) ( )</b>         | n/a      | n/a      | 481.     | 550.     | 668.     |
|  | 36"           | 60" | 36" | 1 1/4" | <b>XTTS6036E (1/2/3) ( )</b>         | n/a      | n/a      | 591.     | 678.     | 885.     |
|  | 36"           | 72" | 36" | 1 1/4" | <b>XTTS7236E (1/2/3) ( )</b>         | n/a      | n/a      | 678.     | 768.     | 1,016.   |

| Order Code                                       | Specifications   | Application Notes  |
|--|--|--|
| Example: <b>XTTP6036DL 118 AA</b>                |  |  |
| <b>XT</b> Crinion Open Table                     | End counters are 1 1/4" thick with square edge or tapered edge option tapering to 1/2" thick front edge. End counters are tapered front and side edges only.<br>1. Specify finish group:<br>L - Laminate<br>M - Laminate/veneer edge<br>1 - Veneer group 1<br>2 - Veneer group 2<br>3 - Veneer group 3<br>2. Specify worksurface finish.<br>3. Specify hinged access cover finish. | End counters mount at the ends of dual tables with two end counter cantilever brackets. Specify dual end legs for end counters instead of standard dual end legs (tables with end counters must be specified from components, not assemblies).<br><br>Specify 48" W for dual 24" tables, 60" W for dual 30" tables and 72" W for dual 36" tables.<br><br>End counters may not be used with end panel kits. |
| <b>T</b> Worksurface                             |  |  |
| <b>P</b> Postformed plastic                      |  |  |
| <b>60</b> Width                                  |  |  |
| <b>36</b> Length                                 |  |  |
| <b>D</b> End counter, center hinged power access |  |  |
| <b>L</b> Finish Type                             |  |  |
| <b>118</b> Surface finish                        |  |  |
| <b>AA</b> Access door finish                     |  |  |
|  |  |  |

Hinged access covers are available in AA anodized aluminum and all standard paint finishes except 613 Silver.

| description   | nominal depth | w   | l   | h      | pattern no.                  | L      | M   | V1  | V2  | V3  |
|---|---------------|-----|-----|--------|------------------------------|--------|-----|-----|-----|-----|
| Extended end counter, postformed plastic with hinged power access | 36"           | 48" | 36" | 1 1/4" | <b>XTTP4836D (L) ( ) ( )</b> | \$933. | n/a | n/a | n/a | n/a |
|   | 36"           | 60" | 36" | 1 1/4" | <b>XTTP6036D (L) ( ) ( )</b> | 1,061. | n/a | n/a | n/a | n/a |
|   | 36"           | 72" | 36" | 1 1/4" | <b>XTTP7236D (L) ( ) ( )</b> | 1,153. | n/a | n/a | n/a | n/a |

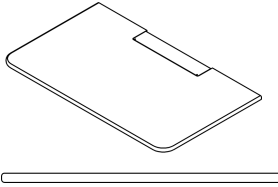

\* Note

|   |     |     |     |        |                          |      |     |     |     |     |
|---|-----|-----|-----|--------|--------------------------|------|-----|-----|-----|-----|
| Extended end counter, postformed plastic with grommet | 36" | 48" | 36" | 1 1/4" | <b>XTTP4836E (L) ( )</b> | 651. | n/a | n/a | n/a | n/a |
|   | 36" | 60" | 36" | 1 1/4" | <b>XTTP6036E (L) ( )</b> | 779. | n/a | n/a | n/a | n/a |
|   | 36" | 72" | 36" | 1 1/4" | <b>XTTP7236E (L) ( )</b> | 871. | n/a | n/a | n/a | n/a |

\* Note

| Order Code                                       | Specifications   | Application Notes  |
|--|--|--|
| Example: <b>XTTP6036DL 118 AA</b>                |  |  |
| <b>XT</b> Crinion Open Table                     | End counters are 1 1/4" thick with square edge or tapered edge option tapering to 1/2" thick front edge. End counters are tapered front and side edges only.<br>1. Specify finish group:<br>L - Laminate<br>M - Laminate/veneer edge<br>1 - Veneer group 1<br>2 - Veneer group 2<br>3 - Veneer group 3<br>2. Specify worksurface finish.<br>3. Specify hinged access cover finish. | End counters mount at the ends of dual tables with two end counter cantilever brackets. Specify dual end legs for end counters instead of standard dual end legs (tables with end counters must be specified from components, not assemblies).<br><br>Specify 48" W for dual 24" tables, 60" W for dual 30" tables and 72" W for dual 36" tables.<br><br>End counters may not be used with end panel kits. |
| <b>T</b> Worksurface                             |  |  |
| <b>P</b> Postformed plastic                      |  |  |
| <b>60</b> Width                                  |  |  |
| <b>36</b> Length                                 |  |  |
| <b>D</b> End counter, center hinged power access |  |  |
| <b>L</b> Finish Type                             |  |  |
| <b>118</b> Surface finish                        |  |  |
| <b>AA</b> Access door finish                     |  |  |
|  |  |  |

Hinged access covers are available in AA anodized aluminum and all standard paint finishes except 613 Silver.

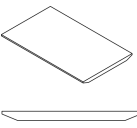
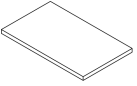
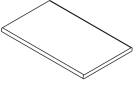
| description   | w   | d   | h      | pattern number                   | L      | M      | V1     | V2     | V3     |
|---|-----|-----|--------|----------------------------------|--------|--------|--------|--------|--------|
| File top, tapered edge<br>       | 30" | 18" | 1 1/4" | <b>XTTK3018F (L/M/1/2/3) ( )</b> | \$341. | \$578. | \$566. | \$604. | \$874. |
|   | 30" | 36" | 1 1/4" | <b>XTTK3036F (L/M/1/2/3) ( )</b> | 467.   | 730.   | 730.   | 818.   | 1,027. |
|   | 36" | 18" | 1 1/4" | <b>XTTK3618F (L/M/1/2/3) ( )</b> | 354.   | 591.   | 578.   | 610.   | 931.   |
|   | 36" | 36" | 1 1/4" | <b>XTTK3636F (L/M/1/2/3) ( )</b> | 487.   | 800.   | 800.   | 895.   | 1,128. |
|   | 42" | 18" | 1 1/4" | <b>XTTK4218F (L/M/1/2/3) ( )</b> | 366.   | 604.   | 591.   | 621.   | 988.   |
|   | 42" | 36" | 1 1/4" | <b>XTTK4236F (L/M/1/2/3) ( )</b> | 509.   | 830.   | 830.   | 938.   | 1,183. |
|   | 60" | 18" | 1 1/4" | <b>XTTK6018F (L/M/1/2/3) ( )</b> | 578.   | 892.   | 892.   | 984.   | 1,230. |
|   | 60" | 36" | 1 1/4" | <b>XTTK6036F (L/M/1/2/3) ( )</b> | 626.   | 951.   | 951.   | 1,074. | 1,358. |
|   | 72" | 18" | 1 1/4" | <b>XTTK7218F (L/M/1/2/3) ( )</b> | 608.   | 923.   | 923.   | 1,033. | 1,294. |
|   | 72" | 36" | 1 1/4" | <b>XTTK7236F (L/M/1/2/3) ( )</b> | 669.   | 965.   | 965.   | 1,087. | 1,375. |
|   | 84" | 18" | 1 1/4" | <b>XTTK8418F (L/M/1/2/3) ( )</b> | 657.   | 984.   | 984.   | 1,107. | 1,354. |
|   | 84" | 36" | 1 1/4" | <b>XTTK8436F (L/M/1/2/3) ( )</b> | 715.   | 1,036. | 1,036. | 1,181. | 1,498. |
| File top, veneer square edge<br> | 30" | 18" | 1 1/4" | <b>XTTS3018F (1/2/3) ( )</b>     | n/a    | n/a    | 252.   | 277.   | 460.   |
|   | 36" | 18" | 1 1/4" | <b>XTTS3618F (1/2/3) ( )</b>     | n/a    | n/a    | 259.   | 283.   | 496.   |
|   | 42" | 18" | 1 1/4" | <b>XTTS4218F (1/2/3) ( )</b>     | n/a    | n/a    | 265.   | 290.   | 536.   |
| File top, postformed plastic<br> | 30" | 18" | 1 1/4" | <b>XTTP3018F (L) ( )</b>         | 232.   | n/a    | n/a    | n/a    | n/a    |
|   | 36" | 18" | 1 1/4" | <b>XTTP3618F (L) ( )</b>         | 244.   | n/a    | n/a    | n/a    | n/a    |
|   | 42" | 18" | 1 1/4" | <b>XTTP4218F (L) ( )</b>         | 255.   | n/a    | n/a    | n/a    | n/a    |

| Order Code                     |                    |
|--------------------------------|--------------------|
| Example: <b>XTTP4218FL 118</b> |                    |
| <b>XT</b>                      | Crinion Open Table |
| <b>T</b>                       | Worksurface        |
| <b>P</b>                       | Postformed         |
| <b>42</b>                      | Width              |
| <b>18</b>                      | Depth              |
| <b>F</b>                       | File top           |
| <b>L</b>                       | Finish type        |
| <b>118</b>                     | Surface            |

| Specifications  |
|---|
| File tops are 1 1/4" thick with square edge or tapered edge option tapering to 1/2" thick front edge. Tapered edge file tops are tapered front and back edges only. |
| Specify finishes:<br>L - Laminate<br>M - Laminate/veneer edge<br>1 - Veneer group 1<br>2 - Veneer group 2<br>3 - Veneer group 3                                     |

| Application Notes   |
|---|
| File tops correspond to 30", 36" or 42"W lateral files. File tops on 2 high Calibre files positioned perpendicular to the Crinion Open Table serve as a worksurface return. |

# Complete base assemblies fixed height 24" D dual

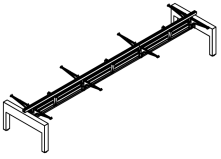
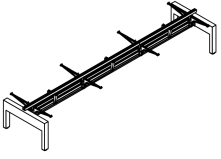
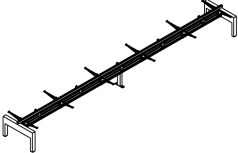
| description  | nominal        | w    | d   | h       | pattern number                  | P1/P2    | P3       |
|--|----------------|------|-----|---------|---------------------------------|----------|----------|
|  Base assembly, continuous            | 10' dual       | 120" | 44" | 28 1/2" | <b>XTB1 BAS 24D10CF</b> ( ) ( ) | \$8,744. | \$8,975. |
|  | 12' dual       | 144" | 44" | 28 1/2" | <b>XTB1 BAS 24D12CF</b> ( ) ( ) | 9,110.   | 9,343.   |
|  | 15' dual       | 180" | 44" | 28 1/2" | <b>XTB1 BAS 24D15CF</b> ( ) ( ) | 10,542.  | 10,782.  |
|  Base assembly, segmented             | 10' + 5' dual  | 180" | 44" | 28 1/2" | <b>XTB1 BAS 24D15SF</b> ( ) ( ) | 11,309.  | 11,551.  |
|  Base assembly, with intermediate leg | 12' + 6' dual  | 216" | 44" | 28 1/2" | <b>XTB1 BAS 24D18SF</b> ( ) ( ) | 12,478.  | 12,719.  |
|  | 10' + 10' dual | 240" | 44" | 28 1/2" | <b>XTB1 BAS 24D20SF</b> ( ) ( ) | 13,639.  | 13,888.  |
|  | 12' + 12' dual | 288" | 44" | 28 1/2" | <b>XTB1 BAS 24D24SF</b> ( ) ( ) | 14,371.  | 14,621.  |
|  | 15' + 10' dual | 300" | 44" | 28 1/2" | <b>XTB1 BAS 24D25SF</b> ( ) ( ) | 15,437.  | 15,695.  |

## Order Code

Example: **XTB1BAS24D10CF 613 AA**

|            |                    |
|------------|--------------------|
| <b>XT</b>  | Crinion Open Table |
| <b>B1</b>  | Base components    |
| <b>BAS</b> | Assembly           |
| <b>24</b>  | Depth              |
| <b>D</b>   | Dual               |
| <b>10</b>  | Width              |
| <b>C</b>   | Continuous         |
| <b>F</b>   | Fixed height       |
| <b>613</b> | Base finish        |
| <b>AA</b>  | Top channel finish |

## Specifications

Base assemblies include end legs, beams, trusses, cantilever brackets, channels and end caps.

Fixed height base assemblies have shared cantilever brackets for adjacent worksurfaces and midspan support brackets for every worksurface.

- Specify painted finish for base assembly.  
For leg and cantilever brackets specify one paint finish for all.
- Specify finish for top channel.  
AA anodized aluminum and all paint finishes are available except 613 Silver.  
Beams are anodized aluminum only.



## Application Notes

Complete base assemblies include all base components necessary to support worksurfaces. Specify screens, power components and cable trays separately. Base assemblies include end legs, intermediate leg (where required), beams, trusses, cantilever brackets, mid span support brackets, top channel and end caps.

Base assemblies correspond to:  
 10': four 60"x24"D worksurfaces  
 12': four 72"x24"D worksurfaces  
 15': six 60"x24"D worksurfaces  
 18': six 72"x24"D worksurfaces  
 20': eight 60"x24"D worksurfaces  
 24': eight 72"x24"D worksurfaces  
 25': ten 60"x24"D worksurfaces

No table on this page has beams longer than 15'.

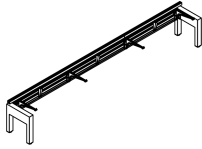
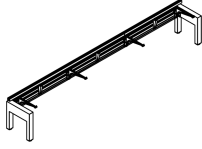
# Complete base assemblies fixed height 24" D single sided

| description  | nominal                | w    | d   | h       | pattern number                  | P1/P2    | P3       |
|--|------------------------|------|-----|---------|---------------------------------|----------|----------|
|  Base assembly, continuous            | 10' single sided       | 120" | 24" | 28 1/2" | <b>XTB1 BAS 24S10CF</b> ( ) ( ) | \$7,867. | \$8,091. |
|  | 12' single sided       | 144" | 24" | 28 1/2" | <b>XTB1 BAS 24S12CF</b> ( ) ( ) | 8,235.   | 8,456.   |
|  | 15' single sided       | 180" | 24" | 28 1/2" | <b>XTB1 BAS 24S15CF</b> ( ) ( ) | 9,340.   | 9,566.   |
|  Base assembly, segmented             | 10' + 5' single sided  | 180" | 24" | 28 1/2" | <b>XTB1 BAS 24S15SF</b> ( ) ( ) | 10,108.  | 10,334.  |
|  Base assembly, with intermediate leg | 12' + 6' single sided  | 216" | 24" | 28 1/2" | <b>XTB1 BAS 24S18SF</b> ( ) ( ) | 11,276.  | 11,504.  |
|  | 10' + 10' single sided | 240" | 24" | 28 1/2" | <b>XTB1 BAS 24S20SF</b> ( ) ( ) | 12,110.  | 12,342.  |
|  | 12' + 12' single sided | 288" | 24" | 28 1/2" | <b>XTB1 BAS 24S24SF</b> ( ) ( ) | 12,842.  | 13,073.  |
|  | 15' + 10' single sided | 300" | 24" | 28 1/2" | <b>XTB1 BAS 24S25SF</b> ( ) ( ) | 13,581.  | 13,818.  |

## Order Code

|            |                               |
|------------|-------------------------------|
| Example:   | <b>XTB1BAS24S10CF 613 118</b> |
| <b>XT</b>  | Crinion Open Table            |
| <b>B1</b>  | Base components               |
| <b>BAS</b> | Assembly                      |
| <b>24</b>  | Depth                         |
| <b>S</b>   | Single                        |
| <b>10</b>  | Width                         |
| <b>C</b>   | Continuous                    |
| <b>F</b>   | Fixed height                  |
| <b>613</b> | Base finish                   |
| <b>118</b> | Top channel finish            |

## Specifications

Base assemblies include end legs, beams, trusses, cantilever brackets, channels and end caps.

Fixed height base assemblies have shared cantilever brackets for adjacent worksurfaces and midspan support brackets for every worksurface.

- Specify base finish for base assembly.  
For legs and cantilever brackets specify one paint finish for all.
- Specify top channel finish.  
AA anodized aluminum and all paint finishes are available except 613 Silver.  
Beams are anodized aluminum only.

## Application Notes

Complete base assemblies include all base components necessary to support worksurfaces. Specify screens, power components and cable trays separately. Base assemblies include end legs, intermediate leg (where required), beams, trusses, cantilever brackets, mid span support brackets, top channel and end caps.

No table on this page has beams longer than 15'.

Base assemblies correspond to:  
 10': two 60"x24"D worksurfaces  
 12': two 72"x24"D worksurfaces  
 15': three 60"x24"D worksurfaces  
 18': three 72"x24"D worksurfaces  
 20': four 60"x24"D worksurfaces  
 24': four 72"x24"D worksurfaces  
 25': five 60"x24"D worksurfaces

# Complete base assemblies fixed height 30" D dual

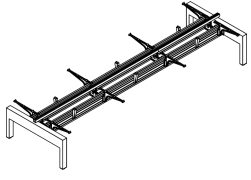
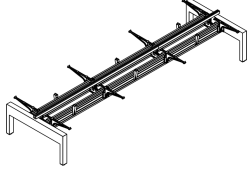
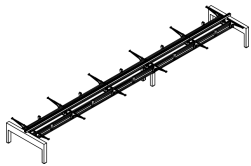
| description  | nominal        | w    | d   | h    | pattern number                  | P1/P2     | P3        |
|--|----------------|------|-----|------|---------------------------------|-----------|-----------|
|  Base assembly, continuous            | 10' dual       | 120" | 54" | 28½" | <b>XTB1 BAS 30D10CF</b> ( ) ( ) | \$10,405. | \$10,700. |
|  | 12' dual       | 144" | 54" | 28½" | <b>XTB1 BAS 30D12CF</b> ( ) ( ) | 10,829.   | 11,123.   |
|  | 15' dual       | 180" | 54" | 28½" | <b>XTB1 BAS 30D15CF</b> ( ) ( ) | 12,606.   | 12,932.   |
|  Base assembly, segmented             | 10' + 5' dual  | 180" | 54" | 28½" | <b>XTB1 BAS 30D15SF</b> ( ) ( ) | 13,669.   | 13,995.   |
|  Base assembly, with intermediate leg | 12' + 6' dual  | 216" | 54" | 28½" | <b>XTB1 BAS 30D18SF</b> ( ) ( ) | 15,145.   | 15,519.   |
|  | 10' + 10' dual | 240" | 54" | 28½" | <b>XTB1 BAS 30D20SF</b> ( ) ( ) | 16,886.   | 17,290.   |
|  | 12' + 12' dual | 288" | 54" | 28½" | <b>XTB1 BAS 30D24CF</b> ( ) ( ) | 17,737.   | 18,140.   |
|  | 15' + 10' dual | 300" | 54" | 28½" | <b>XTB1 BAS 30D25CF</b> ( ) ( ) | 19,087.   | 19,522.   |

## Order Code

|            |                               |
|------------|-------------------------------|
| Example:   | <b>XTB1BAS30D18SF 613 111</b> |
| <b>XT</b>  | Crinion Open Table            |
| <b>B1</b>  | Base components               |
| <b>BAS</b> | Assembly                      |
| <b>30</b>  | Depth                         |
| <b>D</b>   | Dual                          |
| <b>18</b>  | Width                         |
| <b>S</b>   | Segmented                     |
| <b>F</b>   | Fixed height                  |
| <b>613</b> | Base finish                   |
| <b>111</b> | Top channel finish            |

## Specifications

Base assemblies include end legs, beams, trusses, cantilever brackets, channels and end caps.

Fixed height base assemblies have shared cantilever brackets for adjacent worksurfaces and midspan support brackets for every worksurface.

- Specify base finish for base assembly.  
For legs and cantilever brackets specify one paint finish for all.
- Specify top channel finish.  
AA anodized aluminum and all paint finishes are available except 613 Silver.  
Beams are anodized aluminum only.

## Application Notes



Complete base assemblies include all base components necessary to support worksurfaces. Specify screens, power components and cable trays separately. Base assemblies include end legs, intermediate leg (where required), beams, trusses, cantilever brackets, mid span support brackets, top channel and end caps.

Base assemblies correspond to:  
 10': four 60"x30"D worksurfaces  
 12': four 72"x30"D worksurfaces  
 15': six 60"x30"D worksurfaces  
 18': six 72"x30"D worksurfaces  
 20': eight 60"x30"D worksurfaces  
 24': eight 72"x30"D worksurfaces  
 25': ten 60"x30"D worksurfaces

No table on this page has beams longer than 15'.

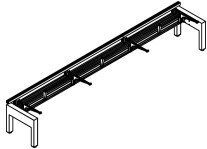
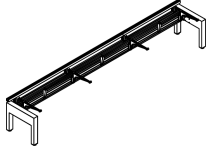

# Complete base assemblies fixed height 30" D single sided

| description  | nominal                | w    | d                                | h                                | pattern number                  | P1/P2    | P3       |
|--|------------------------|------|----------------------------------|----------------------------------|---------------------------------|----------|----------|
|  Base assembly, continuous            | 10' single sided       | 120" | 28 <sup>3</sup> / <sub>4</sub> " | 28 <sup>1</sup> / <sub>2</sub> " | <b>XTB1 BAS 30S10CF</b> ( ) ( ) | \$9,158. | \$9,414. |
|  | 12' single sided       | 144" | 28 <sup>3</sup> / <sub>4</sub> " | 28 <sup>1</sup> / <sub>2</sub> " | <b>XTB1 BAS 30S12CF</b> ( ) ( ) | 9,583.   | 9,837.   |
|  | 15' single sided       | 180" | 28 <sup>3</sup> / <sub>4</sub> " | 28 <sup>1</sup> / <sub>2</sub> " | <b>XTB1 BAS 30S15CF</b> ( ) ( ) | 10,902.  | 11,173.  |
|  Base assembly, segmented             | 10' + 5' single sided  | 180" | 28 <sup>3</sup> / <sub>4</sub> " | 28 <sup>1</sup> / <sub>2</sub> " | <b>XTB1 BAS 30S15SF</b> ( ) ( ) | 10,194.  | 10,463.  |
|  Base assembly, with intermediate leg | 12' + 6' single sided  | 216" | 28 <sup>3</sup> / <sub>4</sub> " | 28 <sup>1</sup> / <sub>2</sub> " | <b>XTB1 BAS 30S18SF</b> ( ) ( ) | 11,069.  | 11,337.  |
|  | 10' + 10' single sided | 240" | 28 <sup>3</sup> / <sub>4</sub> " | 28 <sup>1</sup> / <sub>2</sub> " | <b>XTB1 BAS 30S20SF</b> ( ) ( ) | 12,587.  | 12,873.  |
|  | 12' + 12' single sided | 288" | 28 <sup>3</sup> / <sub>4</sub> " | 28 <sup>1</sup> / <sub>2</sub> " | <b>XTB1 BAS 30S24SF</b> ( ) ( ) | 15,210.  | 15,494.  |
|  | 15' + 10' single sided | 300" | 28 <sup>3</sup> / <sub>4</sub> " | 28 <sup>1</sup> / <sub>2</sub> " | <b>XTB1 BAS 30S25SF</b> ( ) ( ) | 16,105.  | 16,404.  |

## Order Code

|            |                               |
|------------|-------------------------------|
| Example:   | <b>XTB1BAS30S15CF 613 115</b> |
| <b>XT</b>  | Crinion Open Table            |
| <b>B1</b>  | Base components               |
| <b>BAS</b> | Assembly                      |
| <b>30</b>  | Depth                         |
| <b>S</b>   | Single                        |
| <b>15</b>  | Width                         |
| <b>C</b>   | Continuous                    |
| <b>F</b>   | Fixed height                  |
| <b>613</b> | Base finish                   |
| <b>115</b> | Top channel finish            |

## Specifications

Base assemblies include end legs, beams, trusses, cantilever brackets, channels and end caps.

Fixed height base assemblies have shared cantilever brackets for adjacent worksurfaces and midspan support brackets for every worksurface.

- Specify base finish for base assembly.  
For legs and cantilever brackets specify one paint finish for all.
- Specify top channel finish.  
AA anodized aluminum and all paint finishes are available except 613 Silver.  
Beams are anodized aluminum only.

## Application Notes

Complete base assemblies include all base components necessary to support worksurfaces. Specify screens, power components and cable trays separately. Base assemblies include end legs, intermediate leg (where required), beams, trusses, cantilever brackets, mid span support brackets, top channel and end caps.

No table on this page has beams longer than 15'.

Base assemblies correspond to:  
 10': two 60"x30"D worksurfaces  
 12': two 72"x30"D worksurfaces  
 15': three 60"x30"D worksurfaces  
 18': three 72"x30"D worksurfaces  
 20': four 60"x30"D worksurfaces  
 24': four 72"x30"D worksurfaces  
 25': five 60"x30"D worksurfaces

# Complete base assemblies adjustable height 30" D dual

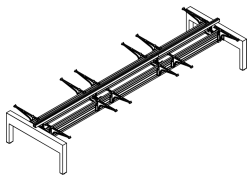
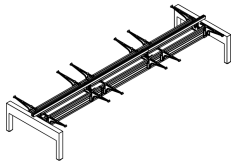
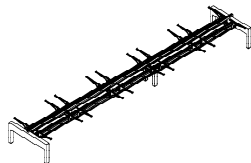
| description   | nominal        | w    | d   | h       | pattern number                  | P1/P2     | P3        |
|---|----------------|------|-----|---------|---------------------------------|-----------|-----------|
| <br>Base assembly, continuous            | 10' dual       | 120" | 54" | 28 1/2" | <b>XTB1 BAS 30D10CA</b> ( ) ( ) | \$10,559. | \$10,865. |
|   | 12' dual       | 144" | 54" | 28 1/2" | <b>XTB1 BAS 30D12CA</b> ( ) ( ) | 10,984.   | 11,290.   |
|   | 15' dual       | 180" | 54" | 28 1/2" | <b>XTB1 BAS 30D15CA</b> ( ) ( ) | 13,050.   | 13,404.   |
| <br>Base assembly, segmented             | 10' + 5' dual  | 180" | 54" | 28 1/2" | <b>XTB1 BAS 30D15SA</b> ( ) ( ) | 14,113.   | 14,468.   |
| <br>Base assembly, with intermediate leg | 12' + 6' dual  | 216" | 54" | 28 1/2" | <b>XTB1 BAS 30D18SA</b> ( ) ( ) | 15,589.   | 15,992.   |
|   | 10' + 10' dual | 240" | 54" | 28 1/2" | <b>XTB1 BAS 30D20SA</b> ( ) ( ) | 17,620.   | 18,070.   |
|   | 12' + 12' dual | 288" | 54" | 28 1/2" | <b>XTB1 BAS 30D24CA</b> ( ) ( ) | 18,471.   | 18,919.   |
|   | 15' + 10' dual | 300" | 54" | 28 1/2" | <b>XTB1 BAS 30D25CA</b> ( ) ( ) | 20,113.   | 20,609.   |

| Order Code                             | Specifications  | Application Notes   |
|--|---|---|
| Example: <b>XTB1BAS30D18SA 613 118</b> | Base assemblies include end legs, beams, trusses, cantilever brackets, channels and end caps. | Complete base assemblies include all base components necessary to support worksurfaces. Specify screens, power components and cable trays separately. Base assemblies include end legs, intermediate leg (where required), beams, trusses, cantilever brackets, top channel and end caps. |
| <b>XT</b> Crinion Open Table           | 1. Specify base finish for base assembly.   | Base assemblies correspond to:<br>10': four 60"x30"D worksurfaces<br>12': four 72"x30"D worksurfaces<br>15': six 60"x30"D worksurfaces<br>18': six 72"x30"D worksurfaces<br>20': eight 60"x30"D worksurfaces<br>24': eight 72"x30"D worksurfaces<br>25': ten 60"x30"D worksurfaces        |
| <b>B1</b> Base components              | For legs and cantilever brackets specify one paint finish for all.                            | No table on this page has beams longer than 15'.  |
| <b>BAS</b> Assembly                    | 2. Specify top channel finish.  |   |
| <b>30</b> Depth                        | AA anodized aluminum and all paint finishes are available except 613 Silver.                  |   |
| <b>D</b> Dual                          | Beams are anodized aluminum only.   |   |
| <b>18</b> Width                        |   |   |
| <b>S</b> Segmented                     |   |   |
| <b>A</b> Adjustable height             |   |   |
| <b>613</b> Base finish                 |   |   |
| <b>118</b> Top channel finish          |   |   |

# Complete base assemblies adjustable height 30" D single sided

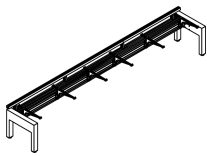
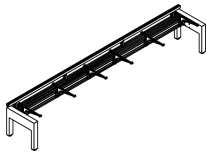
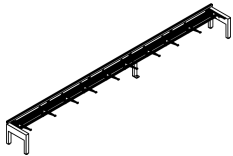
| description  | nominal                | w    | d                                | h                                | pattern number                  | P1/P2    | P3       |
|--|------------------------|------|----------------------------------|----------------------------------|---------------------------------|----------|----------|
|  Base assembly, continuous            | 10' single sided       | 120" | 28 <sup>3</sup> / <sub>4</sub> " | 28 <sup>1</sup> / <sub>2</sub> " | <b>XTB1 BAS 30S10CA ( ) ( )</b> | \$9,260. | \$9,518. |
|  | 12' single sided       | 144" | 28 <sup>3</sup> / <sub>4</sub> " | 28 <sup>1</sup> / <sub>2</sub> " | <b>XTB1 BAS 30S12CA ( ) ( )</b> | 9,684.   | 9,943.   |
|  | 15' single sided       | 180" | 28 <sup>3</sup> / <sub>4</sub> " | 28 <sup>1</sup> / <sub>2</sub> " | <b>XTB1 BAS 30S15CA ( ) ( )</b> | 11,160.  | 11,443.  |
|  Base assembly, segmented             | 10' +5' single sided   | 180" | 28 <sup>3</sup> / <sub>4</sub> " | 28 <sup>1</sup> / <sub>2</sub> " | <b>XTB1 BAS 30S15SA ( ) ( )</b> | 10,453.  | 10,736.  |
|  Base assembly, with intermediate leg | 12' + 6' single sided  | 216" | 28 <sup>3</sup> / <sub>4</sub> " | 28 <sup>1</sup> / <sub>2</sub> " | <b>XTB1 BAS 30S18SA ( ) ( )</b> | 11,562.  | 11,846.  |
|  | 10' + 10' single sided | 240" | 28 <sup>3</sup> / <sub>4</sub> " | 28 <sup>1</sup> / <sub>2</sub> " | <b>XTB1 BAS 30S20SA ( ) ( )</b> | 13,002.  | 13,311.  |
|  | 12' + 12' single sided | 288" | 28 <sup>3</sup> / <sub>4</sub> " | 28 <sup>1</sup> / <sub>2</sub> " | <b>XTB1 BAS 30S24SA ( ) ( )</b> | 15,624.  | 15,932.  |
|  | 15' + 10' single sided | 300" | 28 <sup>3</sup> / <sub>4</sub> " | 28 <sup>1</sup> / <sub>2</sub> " | <b>XTB1 BAS 30S25SA ( ) ( )</b> | 16,675.  | 17,006.  |

| Order Code                            | Specifications  | Application Notes   |   |
|---------------------------------------|---|---|---|
| Example: <b>XTB1BAS30S18SA 613 AA</b> | Base assemblies include end legs, beams, trusses, cantilever brackets, channels and end caps.<br>1. Specify base finish for base assembly.<br>For legs and cantilever brackets specify one paint finish for all.<br>2. Specify top channel finish.<br>AA anodized aluminum and all paint finishes are available except 613 Silver.<br>Beams are anodized aluminum only. | Complete base assemblies include all base components necessary to support worksurfaces. Specify screens, power components and cable trays separately. Base assemblies include end legs, intermediate leg (where required), beams, trusses, cantilever brackets, top channel and end caps.<br><br>No table on this page has beams longer than 15'. |   |
| <b>XT</b> Crinion Open Table          |   |   |   |
| <b>B1</b> Base components             |   |   |   |
| <b>BAS</b> Assembly                   |   |   |   |
| <b>30</b> Depth                       |   |   |   |
| <b>S</b> Single                       |   |   |   |
| <b>18</b> Width                       |   |   |   |
| <b>S</b> Segmented                    |   |   |   |
| <b>A</b> Adjustable height            |   |   |   |
| <b>613</b> Base finish                |   |   |   |
| <b>AA</b> Top channel finish          |   |   |   |
|                                       |   |   | Base assemblies correspond to:<br>10': two 60"x30"D worksurfaces<br>12': two 72"x30"D worksurfaces<br>15': three 60"x30"D worksurfaces<br>18': three 72"x30"D worksurfaces<br>20': four 60"x30"D worksurfaces<br>24': four 72"x30"D worksurfaces<br>25': five 60"x30"D worksurfaces |

# Complete base assemblies fixed height 36" D dual

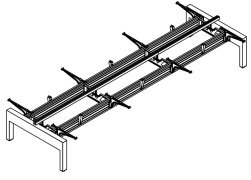
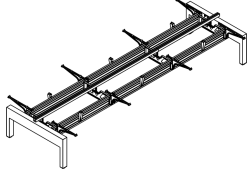
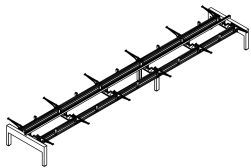
| description  | nominal        | w    | h       | d   | pattern number                  | P1/P2     | P3        |
|--|----------------|------|---------|-----|---------------------------------|-----------|-----------|
|  Base assembly, continuous            | 10' dual       | 120" | 28 1/2" | 54" | <b>XTB1 BAS 36D10CF</b> ( ) ( ) | \$10,546. | \$10,842. |
|  | 12' dual       | 144" | 28 1/2" | 54" | <b>XTB1 BAS 36D12CF</b> ( ) ( ) | 10,971.   | 11,266.   |
|  | 15' dual       | 180" | 28 1/2" | 54" | <b>XTB1 BAS 36D15CF</b> ( ) ( ) | 12,794.   | 13,121.   |
|  Base assembly, segmented             | 10' + 5' dual  | 180" | 28 1/2" | 54" | <b>XTB1 BAS 36D15SF</b> ( ) ( ) | 13,858.   | 14,185.   |
|  Base assembly, with intermediate leg | 12' + 6' dual  | 216" | 28 1/2" | 54" | <b>XTB1 BAS 36D18SF</b> ( ) ( ) | 15,334.   | 15,707.   |
|  | 10' + 10' dual | 240" | 28 1/2" | 54" | <b>XTB1 BAS 36D20SF</b> ( ) ( ) | 17,122.   | 17,526.   |
|  | 12' + 12' dual | 288" | 28 1/2" | 54" | <b>XTB1 BAS 36D24CF</b> ( ) ( ) | 17,971.   | 18,375.   |
|  | 15' + 10' dual | 300" | 28 1/2" | 54" | <b>XTB1 BAS 36D25CF</b> ( ) ( ) | 19,370.   | 19,805.   |

## Order Code

|            |                               |
|------------|-------------------------------|
| Example:   | <b>XTB1BAS36D18SF 613 111</b> |
| <b>XT</b>  | Crinion Open Table            |
| <b>B1</b>  | Base components               |
| <b>BAS</b> | Assembly                      |
| <b>36</b>  | Depth                         |
| <b>D</b>   | Dual                          |
| <b>18</b>  | Width                         |
| <b>S</b>   | Segmented                     |
| <b>F</b>   | Fixed height                  |
| <b>613</b> | Base finish                   |
| <b>111</b> | Top channel finish            |

## Specifications

Base assemblies include end legs, beams, trusses, cantilever brackets, channels and end caps.

Fixed height base assemblies have shared cantilever brackets for adjacent worksurfaces and midspan support brackets for every worksurface.

- Specify base finish for base assembly.  
For legs and cantilever brackets specify one paint finish for all.
- Specify top channel finish.  
AA anodized aluminum and all paint finishes are available except 613 Silver.  
Beams are anodized aluminum only.

## Application Notes

Complete base assemblies include all base components necessary to support worksurfaces. Specify screens, power components and cable trays separately. Base assemblies include end legs, intermediate leg (where required), beams, trusses, cantilever brackets, mid span support brackets, top channel and end caps.

No table on this page has beams longer than 15'.

Base assemblies correspond to:  
 10': four 60"x36"D worksurfaces  
 12': four 72"x36"D worksurfaces  
 15': six 60"x36"D worksurfaces  
 18': six 72"x36"D worksurfaces  
 20': eight 60"x36"D worksurfaces  
 24': eight 72"x36"D worksurfaces  
 25': ten 60"x36"D worksurfaces

# Complete base assemblies fixed height 36" D single sided

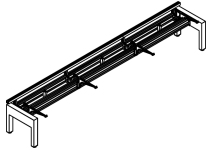
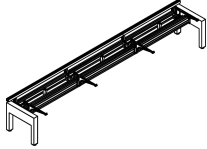
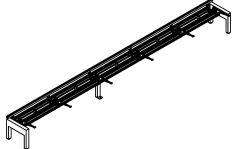
| description   | nominal                | w    | d                                | h                                | pattern number                  | P1/P2    | P3       |
|---|------------------------|------|----------------------------------|----------------------------------|---------------------------------|----------|----------|
|  | 10' single sided       | 120" | 28 <sup>3</sup> / <sub>4</sub> " | 28 <sup>1</sup> / <sub>2</sub> " | <b>XTB1 BAS 36S10CF</b> ( ) ( ) | \$9,300. | \$9,554. |
|   | 12' single sided       | 144" | 28 <sup>3</sup> / <sub>4</sub> " | 28 <sup>1</sup> / <sub>2</sub> " | <b>XTB1 BAS 36S12CF</b> ( ) ( ) | 9,724.   | 9,979.   |
|   | 15' single sided       | 180" | 28 <sup>3</sup> / <sub>4</sub> " | 28 <sup>1</sup> / <sub>2</sub> " | <b>XTB1 BAS 36S15CF</b> ( ) ( ) | 11,092.  | 11,361.  |
|  | 10' + 5' single sided  | 180" | 28 <sup>3</sup> / <sub>4</sub> " | 28 <sup>1</sup> / <sub>2</sub> " | <b>XTB1 BAS 36S15SF</b> ( ) ( ) | 10,383.  | 10,653.  |
|  | 12' + 6' single sided  | 216" | 28 <sup>3</sup> / <sub>4</sub> " | 28 <sup>1</sup> / <sub>2</sub> " | <b>XTB1 BAS 36S18SF</b> ( ) ( ) | 11,493.  | 11,763.  |
|   | 10' + 10' single sided | 240" | 28 <sup>3</sup> / <sub>4</sub> " | 28 <sup>1</sup> / <sub>2</sub> " | <b>XTB1 BAS 36S20SF</b> ( ) ( ) | 12,825.  | 13,109.  |
|   | 12' + 12' single sided | 288" | 28 <sup>3</sup> / <sub>4</sub> " | 28 <sup>1</sup> / <sub>2</sub> " | <b>XTB1 BAS 36S24SF</b> ( ) ( ) | 15,447.  | 15,731.  |
|   | 15' + 10' single sided | 300" | 28 <sup>3</sup> / <sub>4</sub> " | 28 <sup>1</sup> / <sub>2</sub> " | <b>XTB1 BAS 36S25SF</b> ( ) ( ) | 16,387.  | 16,688.  |

## Order Code

|            |                              |
|------------|------------------------------|
| Example:   | <b>XTB1BAS36S18SF 613 AA</b> |
| <b>XT</b>  | Crinion Open Table           |
| <b>B1</b>  | Base components              |
| <b>BAS</b> | Assembly                     |
| <b>36</b>  | Depth                        |
| <b>S</b>   | Single                       |
| <b>18</b>  | Width                        |
| <b>S</b>   | Segmented                    |
| <b>F</b>   | Fixed height                 |
| <b>613</b> | Base finish                  |
| <b>AA</b>  | Top channel finish           |

## Specifications

Base assemblies include end legs, beams, trusses, cantilever brackets, channels and end caps.

Fixed height base assemblies have shared cantilever brackets for adjacent worksurfaces and midspan support brackets for every worksurface.

- Specify base finish for base assembly.  
For legs and cantilever brackets specify one paint finish for all.
- Specify top channel finish.  
AA anodized aluminum and all paint finishes are available except 613 Silver.  
Beams are anodized aluminum only.

## Application Notes

Complete base assemblies include all base components necessary to support worksurfaces. Specify screens, power components and cable trays separately. Base assemblies include end legs, intermediate leg (where required), beams, trusses, cantilever brackets, mid span support brackets, top channel and end caps.

No table on this page has beams longer than 15'.

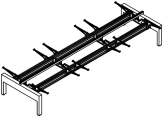
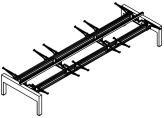
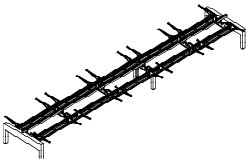

Base assemblies correspond to:  
 10': two 60"x36"D worksurfaces  
 12': two 72"x36"D worksurfaces  
 15': three 60"x36"D worksurfaces  
 18': three 72"x36"D worksurfaces  
 20': four 60"x36"D worksurfaces  
 24': four 72"x36"D worksurfaces  
 25': five 60"x36"D worksurfaces

# Complete base assemblies adjustable height 36" D dual

| description  | nominal        | w    | d   | h       | pattern number                  | P1/P2     | P3        |
|--|----------------|------|-----|---------|---------------------------------|-----------|-----------|
|  Base assembly, continuous            | 10' dual       | 120" | 54" | 28 1/2" | <b>XTB1 BAS 36D10CA</b> ( ) ( ) | \$10,700. | \$11,006. |
|  | 12' dual       | 144" | 54" | 28 1/2" | <b>XTB1 BAS 36D12CA</b> ( ) ( ) | 11,123.   | 11,433.   |
|  | 15' dual       | 180" | 54" | 28 1/2" | <b>XTB1 BAS 36D15CA</b> ( ) ( ) | 13,240.   | 13,594.   |
|  Base assembly, segmented             | 10' + 5' dual  | 180" | 54" | 28 1/2" | <b>XTB1 BAS 36D15SA</b> ( ) ( ) | 14,302.   | 14,655.   |
|  Base assembly, with intermediate leg | 12' + 6' dual  | 216" | 54" | 28 1/2" | <b>XTB1 BAS 36D18SA</b> ( ) ( ) | 15,778.   | 16,180.   |
|  | 10' + 10' dual | 240" | 54" | 28 1/2" | <b>XTB1 BAS 36D20SA</b> ( ) ( ) | 17,856.   | 18,305.   |
|  | 12' + 12' dual | 288" | 54" | 28 1/2" | <b>XTB1 BAS 36D24CA</b> ( ) ( ) | 18,707.   | 19,155.   |
|  | 15' + 10' dual | 300" | 54" | 28 1/2" | <b>XTB1 BAS 36D25CA</b> ( ) ( ) | 20,395.   | 20,892.   |

| Order Code                             | Specifications  | Application Notes   |  |
|--|---|---|--|
| <b>Example: XTB1BAS36D18SA 613 115</b> | Base assemblies include end legs, beams, trusses, cantilever brackets, channels and end caps.<br><br>1. Specify base finish for base assembly.<br>For legs and cantilever brackets specify one paint finish for all.<br><br>2. Specify top channel finish.<br>AA anodized aluminum and all paint finishes are available except 613 Silver.<br>Beams are anodized aluminum only. | Complete base assemblies include all base components necessary to support worksurfaces. Specify screens, power components and cable trays separately. Base assemblies include end legs, intermediate leg (where required), beams, trusses, cantilever brackets, top channel and end caps.<br><br>No table on this page has beams longer than 15'. |  |
| <b>XT</b> Crinion Open Table           |   |   |  |
| <b>B1</b> Base components              |   |   |  |
| <b>BAS</b> Assembly                    |   |   |  |
| <b>36</b> Depth                        |   |   |  |
| <b>D</b> Dual                          |   |   |  |
| <b>18</b> Width                        |   |   |  |
| <b>S</b> Segmented                     |   |   |  |
| <b>A</b> Adjustable height             |   |   |  |
| <b>613</b> Base finish                 |   |   |  |
| <b>115</b> Top channel finish          |   |   |  |
|  |   |   | Base assemblies correspond to:<br>10': four 60"x36"D worksurfaces<br>12': four 72"x36"D worksurfaces<br>15': six 60"x36"D worksurfaces<br>18': six 72"x36"D worksurfaces<br>20': eight 60"x36"D worksurfaces<br>24': eight 72"x36"D worksurfaces<br>25': ten 60"x36"D worksurfaces |

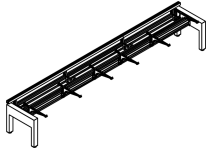
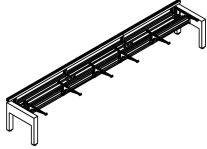
# Complete base assemblies adjustable height 36" D single sided

| description  | nominal                | w    | d                                | h                                | pattern number                  | P1/P2    | P3       |
|--|------------------------|------|----------------------------------|----------------------------------|---------------------------------|----------|----------|
|  Base assembly, continuous            | 10' single sided       | 120" | 28 <sup>3</sup> / <sub>4</sub> " | 28 <sup>1</sup> / <sub>2</sub> " | <b>XTB1 BAS 36S10CA</b> ( ) ( ) | \$9,401. | \$9,661. |
|  | 12' single sided       | 144" | 28 <sup>3</sup> / <sub>4</sub> " | 28 <sup>1</sup> / <sub>2</sub> " | <b>XTB1 BAS 36S12CA</b> ( ) ( ) | 9,826.   | 10,085.  |
|  | 15' single sided       | 180" | 28 <sup>3</sup> / <sub>4</sub> " | 28 <sup>1</sup> / <sub>2</sub> " | <b>XTB1 BAS 36S15CA</b> ( ) ( ) | 11,350.  | 11,634.  |
|  Base assembly, segmented             | 10' + 5' single sided  | 180" | 28 <sup>3</sup> / <sub>4</sub> " | 28 <sup>1</sup> / <sub>2</sub> " | <b>XTB1 BAS 36S15SA</b> ( ) ( ) | 10,641.  | 10,925.  |
|  Base assembly, with intermediate leg | 12' + 6' single sided  | 216" | 28 <sup>3</sup> / <sub>4</sub> " | 28 <sup>1</sup> / <sub>2</sub> " | <b>XTB1 BAS 36S18SA</b> ( ) ( ) | 11,751.  | 12,035.  |
|  | 10' + 10' single sided | 240" | 28 <sup>3</sup> / <sub>4</sub> " | 28 <sup>1</sup> / <sub>2</sub> " | <b>XTB1 BAS 36S20SA</b> ( ) ( ) | 13,240.  | 13,545.  |
|  | 12' + 12' single sided | 288" | 28 <sup>3</sup> / <sub>4</sub> " | 28 <sup>1</sup> / <sub>2</sub> " | <b>XTB1 BAS 36S24SA</b> ( ) ( ) | 15,861.  | 16,167.  |
|  | 15' + 10' single sided | 300" | 28 <sup>3</sup> / <sub>4</sub> " | 28 <sup>1</sup> / <sub>2</sub> " | <b>XTB1 BAS 36S25SA</b> ( ) ( ) | 16,960.  | 17,290.  |

| Order Code                            | Specifications  | Application Notes   |   |
|---------------------------------------|---|---|---|
| <b>Example: XTB1BAS36S18SA 613 AA</b> | Base assemblies include end legs, beams, trusses, cantilever brackets, channels and end caps.<br>1. Specify base finish for base assembly.<br>For legs and cantilever brackets specify one paint finish for all.<br>2. Specify top channel finish.<br>AA anodized aluminum and all paint finishes are available except 613 Silver.<br>Beams are anodized aluminum only. | Complete base assemblies include all base components necessary to support worksurfaces. Specify screens, power components and cable trays separately. Base assemblies include end legs, intermediate leg (where required), beams, trusses, cantilever brackets, top channel and end caps.<br><br>No table on this page has beams longer than 15'. |   |
| <b>XT</b> Crinion Open Table          |   |   |   |
| <b>B1</b> Base components             |   |   |   |
| <b>BAS</b> Assembly                   |   |   |   |
| <b>36</b> Depth                       |   |   |   |
| <b>S</b> Single                       |   |   |   |
| <b>18</b> Width                       |   |   |   |
| <b>S</b> Segmented                    |   |   |   |
| <b>A</b> Adjustable height            |   |   |   |
| <b>613</b> Base finish                |   |   |   |
| <b>AA</b> Top channel finish          |   |   |   |
|                                       |   |   | Base assemblies correspond to:<br>10': two 60"x36"D worksurfaces<br>12': two 72"x36"D worksurfaces<br>15': three 60"x36"D worksurfaces<br>18': three 72"x36"D worksurfaces<br>20': four 60"x36"D worksurfaces<br>24': four 72"x36"D worksurfaces<br>25': five 60"x36"D worksurfaces |

| description  | nominal | w    | d      | h  | pattern number     | list price |
|--|---------|------|--------|----|--------------------|------------|
|  <p>Top channel</p> | 4'      | 48"  | 2 1/2" | 2" | <b>XTC1 48 ( )</b> | \$158.     |
|  | 5'      | 60"  | 2 1/2" | 2" | <b>XTC1 60 ( )</b> | 201.       |
|  | 6'      | 72"  | 2 1/2" | 2" | <b>XTC1 72 ( )</b> | 236.       |
|  | 8'      | 96"  | 2 1/2" | 2" | <b>XTC1 96 ( )</b> | 320.       |
|  | 10'     | 120" | 2 1/2" | 2" | <b>XTC1 120 AA</b> | 402.       |
|  | 12'     | 144" | 2 1/2" | 2" | <b>XTC1 144 AA</b> | 473.       |

|                     |  |  |        |    |                     |     |
|---------------------|--|--|--------|----|---------------------|-----|
| Top channel end cap |  |  | 2 1/2" | 2" | <b>XTC1 END ( )</b> | 36. |
|---------------------|--|--|--------|----|---------------------|-----|

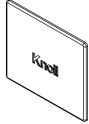

|   |     |      |        |    |                     |      |
|---|-----|------|--------|----|---------------------|------|
|  <p>Top channel for frameless glass addups</p> | 4'  | 48"  | 2 1/2" | 2" | <b>XTCA1 48 ( )</b> | 236. |
|   | 5'  | 60"  | 2 1/2" | 2" | <b>XTCA1 60 ( )</b> | 284. |
|   | 6'  | 72"  | 2 1/2" | 2" | <b>XTCA1 72 ( )</b> | 336. |
|   | 8'  | 96"  | 2 1/2" | 2" | <b>XTCA1 96 ( )</b> | 437. |
|   | 10' | 120" | 2 1/2" | 2" | <b>XTCA1 120 AA</b> | 532. |
|   | 12' | 144" | 2 1/2" | 2" | <b>XTCA1 144 AA</b> | 662. |

|  |  |     |  |  |                    |     |
|--|--|-----|--|--|--------------------|-----|
|  <p>Top channel filler</p> |  | 48" |  |  | <b>XTCF 48 ( )</b> | 30. |
|  |  | 60" |  |  | <b>XTCF 60 ( )</b> | 41. |
|  |  | 72" |  |  | <b>XTCF 72 ( )</b> | 41. |

**Order Code**

|                              |
|------------------------------|
| Example: <b>XTC1120AA</b>    |
| <b>XT</b> Crinion open table |
| <b>C1</b> Top channel        |
| <b>120</b> Width             |
| <b>AA</b> Finish             |

**Specifications**

Top channels are extruded aluminum with natural anodized finish AA or any standard painted finish except 613 Silver.

Top channel end caps are die cast aluminum AA or any standard painted finish except 613 Silver.

Top channel filler is 812 Easy Grey or 111 Black.

**Application Notes**

Crinion Open Table top channel supports privacy screens and suspended raceway components at any point. Top channel is required at the center of dual tables.

Top channels and end caps are included in complete base assemblies.

Top channels correspond in width to one or two worksurface widths.



# Beams for single sided or dual tables

## 24" D

Crinion Open Table

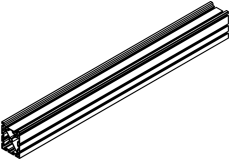
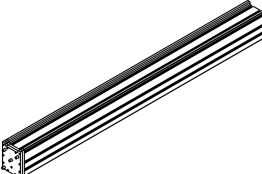
| description  | nominal | w    | d  | h  | pattern number   | list price |
|--|---------|------|----|----|------------------|------------|
| Starter beam set for 24" D<br>          | 5'      | 52"  | 3" | 8" | <b>XTB1TB5C</b>  | \$1,063.   |
|  | 6'      | 64"  | 3" | 8" | <b>XTB1TB6C</b>  | 1,181.     |
|  | 8'      | 88"  | 3" | 8" | <b>XTB1TB8C</b>  | 1,418.     |
|  | 10'     | 112" | 3" | 8" | <b>XTB1TB10C</b> | 1,714.     |
|  | 12'     | 136" | 3" | 8" | <b>XTB1TB12C</b> | 2,008.     |
|  | 15'     | 172" | 3" | 8" | <b>XTB1TB15C</b> | 2,479.     |
| Extension beam set for 24" D tables<br> | 4'      | 48"  | 3" | 8" | <b>XTB1TB4E</b>  | 1,418.     |
|  | 5'      | 60"  | 3" | 8" | <b>XTB1TB5E</b>  | 1,535.     |
|  | 6'      | 72"  | 3" | 8" | <b>XTB1TB6E</b>  | 1,653.     |
|  | 8'      | 96"  | 3" | 8" | <b>XTB1TB8E</b>  | 1,889.     |
|  | 10'     | 120" | 3" | 8" | <b>XTB1TB10E</b> | 2,185.     |
|  | 12'     | 144" | 3" | 8" | <b>XTB1TB12E</b> | 2,479.     |
|  | 15'     | 180" | 3" | 8" | <b>XTB1TB15E</b> | 2,953.     |

### Order Code

|           |                    |
|-----------|--------------------|
| Example:  | <b>XTB1TB15C</b>   |
| <b>XT</b> | Crinion Open Table |
| <b>B1</b> | Base components    |
| <b>TB</b> | Dual beam set      |
| <b>15</b> | Width              |
| <b>C</b>  | Starter            |

### Specifications

Beams are extruded aluminum with natural anodized finish.

### Application Notes

Crinion Open Table bases are assembled from beams, end legs or end panels, intermediate legs and trusses.

Beam sets can be used with either dual or single sided tables. Table bases require one starter beam and extension beam adding up to the length as the sum of the worksurface widths on one side.

Extension beam sets are specified only to add on to starter sets or other extension beams.

Beam sets must be supported by intermediate legs at least every 16'. Intermediate leg must be positioned at beam truss location, where two worksurfaces meet.

# Beams for dual tables

## 30" and 36" D

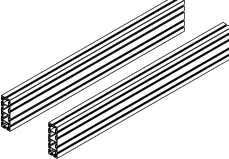
| description   | nominal | w    |    | h  | pattern number   | list price |
|---|---------|------|----|----|------------------|------------|
| Starter beam set for dual table<br>30" or 36" (pair of beams)  | 5'      | 52"  | 3" | 8" | <b>XTB1DB5C</b>  | \$1,418.   |
|   | 6'      | 64"  | 3" | 8" | <b>XTB1DB6C</b>  | 1,535.     |
|   | 8'      | 88"  | 3" | 8" | <b>XTB1DB8C</b>  | 2,008.     |
|   | 10'     | 112" | 3" | 8" | <b>XTB1DB10C</b> | 2,362.     |
|   | 12'     | 136" | 3" | 8" | <b>XTB1DB12C</b> | 2,716.     |
|   | 15'     | 172" | 3" | 8" | <b>XTB1DB15C</b> | 3,189.     |

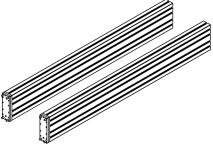
|   |     |      |    |    |                  |        |
|---|-----|------|----|----|------------------|--------|
| Extension beam set for dual table<br>30" or 36" (pair of beams)  | 4'  | 48"  | 3" | 8" | <b>XTB1DB4E</b>  | 1,889. |
|   | 5'  | 60"  | 3" | 8" | <b>XTB1DB5E</b>  | 1,889. |
|   | 6'  | 72"  | 3" | 8" | <b>XTB1DB6E</b>  | 2,008. |
|   | 8'  | 96"  | 3" | 8" | <b>XTB1DB8E</b>  | 2,479. |
|   | 10' | 120" | 3" | 8" | <b>XTB1DB10E</b> | 2,834. |
|   | 12' | 144" | 3" | 8" | <b>XTB1DB12E</b> | 3,189. |
|   | 15' | 180" | 3" | 8" | <b>XTB1DB15E</b> | 3,662. |

### Order Code

|                              |
|------------------------------|
| Example: <b>XTB1DB15C</b>    |
| <b>XT</b> Crinion Open Table |
| <b>B1</b> Base components    |
| <b>DB</b> Dual beam set      |
| <b>15</b> Width              |
| <b>C</b> Starter             |

### Specifications

Beams are extruded aluminum with natural anodized finish.

Beam sets are starter or extension.

Extension beam sets are specified only to add on to starter sets or other extension beams.

### Application Notes

Crinion Open Table bases are assembled from beams, end legs or end panels, intermediate legs and trusses. Beam sets may be used with either worksurface depth. Dual tables require one pair of main beams of the same nominal width as the sum of the worksurfaces on each side.

Beam sets must be supported by intermediate legs at least every 16'. Intermediate leg must be positioned at beam truss location, where two worksurfaces meet.

# Beams for single sided tables 30" and 36" D

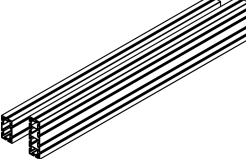
| description   | nominal | w    | d | h  | pattern number   | list price |
|---|---------|------|---|----|------------------|------------|
| Starter beam set for single sided table<br>30" or 36" ( main and back beam )<br> | 5'      | 52"  |   | 8" | <b>XTB1SB5C</b>  | \$1,241.   |
|   | 6'      | 64"  |   | 8" | <b>XTB1SB6C</b>  | 1,299.     |
|   | 8'      | 88"  |   | 8" | <b>XTB1SB8C</b>  | 1,714.     |
|   | 10'     | 112" |   | 8" | <b>XTB1SB10C</b> | 2,008.     |
|   | 12'     | 136" |   | 8" | <b>XTB1SB12C</b> | 2,362.     |
|   | 15'     | 172" |   | 8" | <b>XTB1SB15C</b> | 2,716.     |

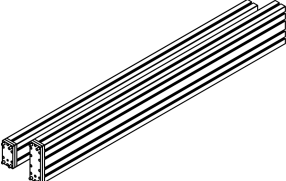
|   |     |      |  |    |                  |        |
|---|-----|------|--|----|------------------|--------|
| Extension beam set for single sided table<br>30" or 36" ( main and back beam )<br> | 4'  | 48"  |  | 8" | <b>XTB1SB4E</b>  | 1,653. |
|   | 5'  | 60"  |  | 8" | <b>XTB1SB5E</b>  | 1,714. |
|   | 6'  | 72"  |  | 8" | <b>XTB1SB6E</b>  | 1,772. |
|   | 8'  | 96"  |  | 8" | <b>XTB1SB8E</b>  | 2,185. |
|   | 10' | 120" |  | 8" | <b>XTB1SB10E</b> | 2,479. |
|   | 12' | 144" |  | 8" | <b>XTB1SB12E</b> | 2,834. |
|   | 15' | 180" |  | 8" | <b>XTB1SB15E</b> | 3,189. |

## Order Code

|                           |                    |
|---------------------------|--------------------|
| Example: <b>XTB1DB15C</b> |                    |
| <b>XT</b>                 | Crinion Open Table |
| <b>B1</b>                 | Base components    |
| <b>DB</b>                 | Dual beam set      |
| <b>15</b>                 | Width              |
| <b>C</b>                  | Starter            |

## Specifications

Beams are extruded aluminum with natural anodized finish.

Beam sets are starter or extension.

Extension beam sets are specified only to add on to starter sets or other extension beams.

## Application Notes

Crinion Open Table bases are assembled from beams, end legs or end panels, intermediate legs and trusses. Beam sets may be used with either worksurface depth. Single sided tables require one pair of main beams of the same nominal width as the sum of the worksurfaces on each side.

Beam sets must be supported by intermediate legs at least every 16'. Intermediate leg must be positioned at beam truss location, where two worksurfaces meet.

| description   | application       | w  | d   | h   | pattern number       | P1/P2    | P3       |
|---|-------------------|----|-----|-----|----------------------|----------|----------|
| End leg for dual tables<br>(pair of legs for 36" D worksurface) | 24" D worksurface | 4" | 44" | 24" | <b>XTB1EDD24 ( )</b> | \$4,275. | \$4,488. |
|   | 30" D worksurface | 4" | 54" | 24" | <b>XTB1EDD30 ( )</b> | 4,275.   | 4,488.   |
|   | 36" D worksurface | 4" | 54" | 24" | <b>XTB1EDD36 ( )</b> | 4,275.   | 4,488.   |

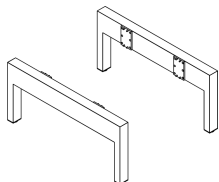

|   |                        |    |        |     |                      |      |      |
|---|------------------------|----|--------|-----|----------------------|------|------|
| Intermediate leg for dual table<br>(pair of legs for 30" and 36" D) | 24" D worksurfaces     | 4" | 2 3/4" | 16" | <b>XTB2LDD24 ( )</b> | 513. | 513. |
|   | 30"&36" D worksurfaces | 4" | 2 3/4" | 16" | <b>XTB2LDD ( )</b>   | 564. | 564. |

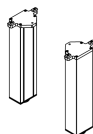

|  |                       |        |        |     |                        |      |      |
|--|-----------------------|--------|--------|-----|------------------------|------|------|
| Shroud for intermediate leg infeed kit | 24" D or single sided | 3 3/4" | 2 1/2" | 15" | <b>XTB1 SLIK ( )</b>   | 161. | 169. |
|  | 30" D                 | 11"    | 4"     | 15" | <b>XTB1 SLIK30 ( )</b> | 203. | 213. |
|  | 36" D                 | 23"    | 4"     | 15" | <b>XTB1 SLIK36 ( )</b> | 238. | 251. |

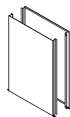

|  |                   |    |     |     |                      |        |        |
|--|-------------------|----|-----|-----|----------------------|--------|--------|
| End leg for end counters both ends<br>(pair of legs for 36" D worksurface) | 48" W end counter | 4" | 44" | 24" | <b>XTB1XDD24 ( )</b> | 4,570. | 4,784. |
|  | 60" W end counter | 4" | 54" | 24" | <b>XTB1XDD30 ( )</b> | 4,570. | 4,784. |
|  | 72" W end counter | 4" | 54" | 24" | <b>XTB1XDD36 ( )</b> | 4,570. | 4,784. |

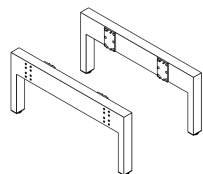

### Order Code

|            |                      |
|------------|----------------------|
| Example:   | <b>XTB1EDD30 118</b> |
| <b>XT</b>  | Crinion Open Table   |
| <b>B1</b>  | Base components      |
| <b>E</b>   | End leg              |
| <b>D</b>   | Dual                 |
| <b>D</b>   | Desk height          |
| <b>30</b>  | Depth of tops        |
| <b>118</b> | Finish               |

### Specifications

Specify paint finish code after pattern number.

### Application Notes

Crinion Open Table bases are assembled from main beams, end legs or end panels, intermediate legs and trusses. After selecting starter or segmented beam sets, specify legs to support each end of beams. End legs support main beams at each end of a table.

Dual end legs for end counters have threaded metal inserts on the outside of the leg to accept two fixed height or adjustable cantilevers for end counters.

Intermediate legs must be specified to provide support under beam sets spanning longer than 16'.

Intermediate legs may be positioned under beams at any beam truss location. End legs include beam end plates and hardware.

Shroud for intermediate leg kit encloses the space between legs to protect power, data and communication cables between floor and table base. Side covers may be removed for access.

Shroud for 24" d intermediate leg is U-shaped cover that attaches to side of intermediate leg for 24" d or any single sided intermediate leg.

End legs for 24" D worksurfaces and end legs for 48" W end counters have only one end plate for attaching a single centered beam for 24" D tables.

End legs for 30" D and 36" D worksurfaces and end legs for 60" W and 72" W end counters have two end plates for attaching two beams for 30" D and 36" D tables.

| description  | application       | w  | d   | h   | pattern number       | P1/P2    | P3       |
|--|-------------------|----|-----|-----|----------------------|----------|----------|
| End leg for end counters one end only<br>(pair of legs for 36"D worksurface) | 48" W end counter | 4" | 44" | 24" | <b>XTB1YDD24</b> ( ) | \$4,423. | \$4,636. |
|  | 60" W end counter | 4" | 54" | 24" | <b>XTB1YDD30</b> ( ) | 4,423.   | 4,636.   |
|  | 72" W end counter | 4" | 54" | 24" | <b>XTB1YDD36</b> ( ) | 4,423.   | 4,636.   |

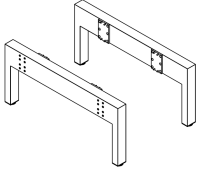

### Order Code

|            |                      |
|------------|----------------------|
| Example:   | <b>XTB1EDD30 118</b> |
| <b>XT</b>  | Crinion Open Table   |
| <b>B1</b>  | Base components      |
| <b>E</b>   | End leg              |
| <b>D</b>   | Dual                 |
| <b>D</b>   | Desk height          |
| <b>30</b>  | Depth of tops        |
| <b>118</b> | Finish               |

### Specifications

Specify paint finish code after pattern number.

### Application Notes

Crinion Open Table bases are assembled from main beams, end legs or end panels, intermediate legs and trusses. After selecting starter or segmented beam sets, specify legs to support each end of beams. End legs support main beams at each end of a table.

Dual end legs for end counters have threaded metal inserts on the outside of the leg to accept two fixed height or adjustable cantilevers for end counters.

Intermediate legs must be specified to provide support under beam sets spanning longer than 16'.

Intermediate legs may be positioned under beams at any beam truss location. End legs include beam end plates and hardware.

Shroud for intermediate leg kit encloses the space between legs to protect power, data and communication cables between floor and table base. Side covers may be removed for access.

Shroud for 24"d intermediate leg is U-shaped cover that attaches to side of intermediate leg for 24"d or any single sided intermediate leg.

End legs for 24"D worksurfaces and end legs for 48"W end counters have only one end plate for attaching a single centered beam for 24"D tables.

End legs for 30"D and 36"D worksurfaces and end legs for 60"W and 72"W end counters have two end plates for attaching two beams for 30"D and 36"D tables.

| description                                       | application       | width | depth                            | height | pattern number       | P1/P2    | P3       |
|---|-------------------|-------|----------------------------------|--------|----------------------|----------|----------|
| End leg for single sided tables<br>(pair of legs) | 24" D worksurface | 4"    | 24"                              | 24"    | <b>XTB1ESD24 ( )</b> | \$4,275. | \$4,488. |
|   | 30" D worksurface | 4"    | 28 <sup>3</sup> / <sub>4</sub> " | 24"    | <b>XTB1ESD30 ( )</b> | 4,275.   | 4,488.   |
|   | 36" D worksurface | 4"    | 28 <sup>3</sup> / <sub>4</sub> " | 24"    | <b>XTB1ESD36 ( )</b> | 4,275.   | 4,488.   |

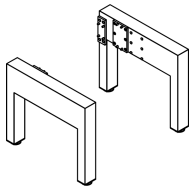

|   |                        |    |                                 |     |                      |      |      |
|---|------------------------|----|---------------------------------|-----|----------------------|------|------|
| Intermediate leg for single sided table | 24" D worksurfaces     | 4" | 2 <sup>3</sup> / <sub>4</sub> " | 16" | <b>XTB2LSD24 ( )</b> | 461. | 461. |
|   | 30"&36" D worksurfaces | 4" | 2 <sup>3</sup> / <sub>4</sub> " | 16" | <b>XTB2LSD ( )</b>   | 564. | 564. |



**Order Code**

|                               |                    |
|-------------------------------|--------------------|
| Example: <b>XTB1ESD30 118</b> |                    |
| <b>XT</b>                     | Crinion Open Table |
| <b>B1</b>                     | Base components    |
| <b>E</b>                      | End leg            |
| <b>S</b>                      | Single             |
| <b>D</b>                      | Desk height        |
| <b>30</b>                     | Depth of tops      |
| <b>118</b>                    | Finish             |

**Specifications**

Specify paint finish code after pattern number.

**Application Notes**

Crinion Open Table bases are assembled from main beams, end legs or end panels, intermediate legs and trusses. After selecting starter or segmented beam sets, specify legs to support each end of beams. End legs support main beams at each end of a table.

Dual end legs for end counters have threaded metal inserts on the outside of the leg to accept two fixed height or adjustable cantilvers for end counters.

Intermediate legs must be specified to provide support under beam sets spanning longer than 16'. Intermediate legs may be positioned under beams at any beam truss location. End legs include beam end plates and hardware.

Shroud for intermediate leg kit encloses the space between legs to protect power, data and communication cables between floor and table base. Side covers may be removed for access.

# End panels for dual tables and single sided tables, painted Crinion Open Table

| description  | application       | width  | depth | height  | pattern no.                 | P1/P2/P3 |
|--|-------------------|--------|-------|---------|-----------------------------|----------|
| End panels for dual tables<br>(pair of end panels) | 24" D worksurface | 1 1/4" | 46"   | 25 1/2" | <b>XTB1EP2DD24P</b> ( ) ( ) | \$2,255. |
|  | 30" D worksurface | 1 1/4" | 58"   | 25 1/2" | <b>XTB1EP2DD30P</b> ( ) ( ) | 3,178.   |
|  | 36" D worksurface | 1 1/4" | 70"   | 25 1/2" | <b>XTB1EP2DD36P</b> ( ) ( ) | 3,383.   |

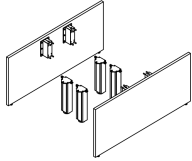

|  |                   |        |     |         |                             |        |
|--|-------------------|--------|-----|---------|-----------------------------|--------|
| End panels for dual tables<br>(single end panel) | 24" D worksurface | 1 1/4" | 46" | 25 1/2" | <b>XTB1EP1DD24P</b> ( ) ( ) | 1,128. |
|  | 30" D worksurface | 1 1/4" | 58" | 25 1/2" | <b>XTB1EP1DD30P</b> ( ) ( ) | 1,589. |
|  | 36" D worksurface | 1 1/4" | 70" | 25 1/2" | <b>XTB1EP1DD36P</b> ( ) ( ) | 1,691. |

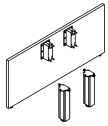

|  |                   |        |          |         |                             |        |
|--|-------------------|--------|----------|---------|-----------------------------|--------|
| End panels for single sided tables<br>(pair of end panels) | 24" D worksurface | 1 1/4" | 25 3/16" | 25 1/2" | <b>XTB1EP2SD24P</b> ( ) ( ) | 1,999. |
|  | 30" D worksurface | 1 1/4" | 30 3/16" | 25 1/2" | <b>XTB1EP2SD30P</b> ( ) ( ) | 2,870. |
|  | 36" D worksurface | 1 1/4" | 36 3/16" | 25 1/2" | <b>XTB1EP2SD36P</b> ( ) ( ) | 2,973. |

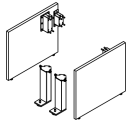

|  |                          |        |          |         |                             |        |
|--|--------------------------|--------|----------|---------|-----------------------------|--------|
| End panels for single sided tables<br>(single end panel) | 24" D worksurface, Left  | 1 1/4" | 25 3/16" | 25 1/2" | <b>XTB1EP1LD24P</b> ( ) ( ) | 999.   |
|  | 24" D worksurface, Right | 1 1/4" | 25 3/16" | 25 1/2" | <b>XTB1EP1RD24P</b> ( ) ( ) | 999.   |
|  | 30" D worksurface, Left  | 1 1/4" | 30 3/16" | 25 1/2" | <b>XTB1EP1LD30P</b> ( ) ( ) | 1,435. |
|  | 30" D worksurface, Right | 1 1/4" | 30 3/16" | 25 1/2" | <b>XTB1EP1RD30P</b> ( ) ( ) | 1,435. |
|  | 36" D worksurface, Right | 1 1/4" | 36 3/16" | 25 1/2" | <b>XTB1EP1RD36P</b> ( ) ( ) | 1,486. |
|  | 36" D worksurface, Left  | 1 1/4" | 36 3/16" | 25 1/2" | <b>XTB1EP1LD36P</b> ( ) ( ) | 1,486. |

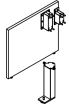

LH Shown  
RH Opposite

| Order Code                       | Specification   | Application Notes   |
|----------------------------------|---|---|
| Example: <b>XTB1EP2DD 24P118</b> | Specify paint finish for brackets, then specify paint finish for end panel. | End panels may be specified as an alternative to End legs to support each end of beams. |
| <b>XT</b>                        | Crinion Open Table  |   |
| <b>B1</b>                        | Base components   | End panel kits include end panel, connecting hardware and support legs.                 |
| <b>EP2</b>                       | End panel   |   |
| <b>D</b>                         | Dual  | End panel kits are not compatible with end counters.                                    |
| <b>D</b>                         | Desk Height   |   |
| <b>24</b>                        | Depth of tops   |   |
| <b>P</b>                         | Finish  |   |
| <b>118</b>                       | Finish  |   |
| <b>118</b>                       | Finish  |   |

# End panels for dual tables and single sided tables, laminate and veneer Crinion Open Table

| description  | application       | w      | d   | h       | pattern no.                | L        | V1       | V2       | V3       |
|--|-------------------|--------|-----|---------|----------------------------|----------|----------|----------|----------|
| End panels for dual tables<br>(pair of end panels) | 24" D worksurface | 1 1/4" | 46" | 25 1/2" | <b>XTB1EP2DD24</b> ( ) ( ) | \$2,358. | \$2,460. | \$2,973. | \$3,075. |
|  | 30" D worksurface | 1 1/4" | 58" | 25 1/2" | <b>XTB1EP2DD30</b> ( ) ( ) | 3,280.   | 3,485.   | 3,998.   | 4,203.   |
|  | 36" D worksurface | 1 1/4" | 70" | 25 1/2" | <b>XTB1EP2DD36</b> ( ) ( ) | 3,485.   | 3,588.   | 4,203.   | 4,408.   |

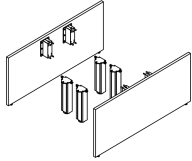

|   |                   |        |     |         |                            |        |        |        |        |
|---|-------------------|--------|-----|---------|----------------------------|--------|--------|--------|--------|
| End panel for dual tables<br>(single end panel) | 24" D worksurface | 1 1/4" | 46" | 25 1/2" | <b>XTB1EP1DD24</b> ( ) ( ) | 1,179. | 1,230. | 1,486. | 1,538. |
|   | 30" D worksurface | 1 1/4" | 58" | 25 1/2" | <b>XTB1EP1DD30</b> ( ) ( ) | 1,640. | 1,743. | 1,999. | 2,101. |
|   | 36" D worksurface | 1 1/4" | 70" | 25 1/2" | <b>XTB1EP1DD36</b> ( ) ( ) | 1,743. | 1,794. | 2,101. | 2,204. |

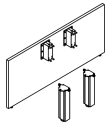

|  |                   |        |          |         |                            |        |        |        |        |
|--|-------------------|--------|----------|---------|----------------------------|--------|--------|--------|--------|
| End panels for single sided tables<br>(pair of end panels) | 24" D worksurface | 1 1/4" | 25 3/16" | 25 1/2" | <b>XTB1EP2SD24</b> ( ) ( ) | 2,101. | 2,255. | 2,563. | 2,665. |
|  | 30" D worksurface | 1 1/4" | 30 3/16" | 25 1/2" | <b>XTB1EP2SD30</b> ( ) ( ) | 2,973. | 3,178. | 3,485. | 3,690. |
|  | 36" D worksurface | 1 1/4" | 36 3/16" | 25 1/2" | <b>XTB1EP2SD36</b> ( ) ( ) | 3,075. | 3,280. | 3,690. | 3,895. |

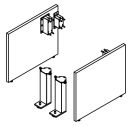

|   |                          |        |          |         |                            |        |        |        |        |
|---|--------------------------|--------|----------|---------|----------------------------|--------|--------|--------|--------|
| End panel for single sided tables<br>(single end panel) | 24" D worksurface, Right | 1 1/4" | 25 3/16" | 25 1/2" | <b>XTB1EP1RD24</b> ( ) ( ) | 1,051. | 1,128. | 1,281. | 1,333. |
|   | 24" D worksurface, Left  | 1 1/4" | 25 3/16" | 25 1/2" | <b>XTB1EP1LD24</b> ( ) ( ) | 1,051. | 1,128. | 1,281. | 1,333. |
|   | 30" D worksurface, Right | 1 1/4" | 30 3/16" | 25 1/2" | <b>XTB1EP1RD30</b> ( ) ( ) | 1,486. | 1,589. | 1,743. | 1,845. |
|   | 30" D worksurface, Left  | 1 1/4" | 30 3/16" | 25 1/2" | <b>XTB1EP1LD30</b> ( ) ( ) | 1,486. | 1,589. | 1,743. | 1,845. |
|   | 36" D worksurface, Left  | 1 1/4" | 36 3/16" | 25 1/2" | <b>XTB1EP1LD36</b> ( ) ( ) | 1,538. | 1,640. | 1,845. | 1,948. |
|   | 36" D worksurface, Right | 1 1/4" | 36 3/16" | 25 1/2" | <b>XTB1EP1RD36</b> ( ) ( ) | 1,538. | 1,640. | 1,845. | 1,948. |

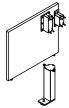

LH Shown  
RH Opposite

| Order Code                          | Specifications  | Application Notes   |
|-------------------------------------|---|---|
| Example: <b>XTB1EP2DD 24118 118</b> |   |   |
| <b>XT</b> Crinion Open Table        | Specify paint finish for brackets, then specify laminate or veneer finish for end panel.                    | End panels may be specified as an alternative to End legs to support each end of beams. |
| <b>B1</b> Base components           |   |   |
| <b>EP2</b> End panel                | Brushed and woodgrain laminates are not available on 70" wide end panels for use on 36"D dual sided tables. | End panel kits include end panel, connecting hardware and support legs.                 |
| <b>D</b> Dual                       |   |   |
| <b>D</b> Desk Height                |   |   |
| <b>24</b> Depth of tops             |   | End panel kits are not compatible with end counters.                                    |
| <b>118</b> Finish                   |   |   |
| <b>118</b> Finish                   |   |   |



| description                | application       | w  | d   | h   | pattern number      | P1/P2/P3 |
|----------------------------|-------------------|----|-----|-----|---------------------|----------|
| Beam truss for dual tables | 30" D worksurface | 3" | 11" | 10" | <b>XTB1XD30 ( )</b> | \$521.   |
|                            | 36" D worksurface | 3" | 23" | 10" | <b>XTB1XD36 ( )</b> | 567.     |

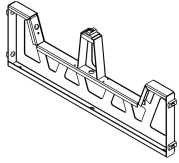

|                     |                   |  |  |  |                    |      |
|---------------------|-------------------|--|--|--|--------------------|------|
| Top channel support | 24" D worksurface |  |  |  | <b>XTB1T24 ( )</b> | 188. |
|---------------------|-------------------|--|--|--|--------------------|------|



|                                    |                   |    |  |  |                     |      |
|------------------------------------|-------------------|----|--|--|---------------------|------|
| Beam truss for single sided tables | 30" D worksurface | 3" |  |  | <b>XTB1XS30 ( )</b> | 521. |
|                                    | 36" D worksurface | 3" |  |  | <b>XTB1XS36 ( )</b> | 567. |

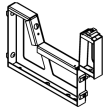

|  |                   |    |     |    |                      |      |
|--|-------------------|----|-----|----|----------------------|------|
| Beam truss for dual tables<br>no top channel support | 30" D worksurface | 3" | 11" | 8" | <b>XTB1XD30N ( )</b> | 403. |
|  | 36" D worksurface | 3" | 23" | 8" | <b>XTB1XD36N ( )</b> | 462. |

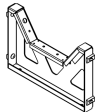

|  |                   |    |  |  |                      |      |
|--|-------------------|----|--|--|----------------------|------|
| Beam truss for single sided tables<br>no top channel support | 30" D worksurface | 3" |  |  | <b>XTB1XS30N ( )</b> | 403. |
|  | 36" D worksurface | 3" |  |  | <b>XTB1XS36N ( )</b> | 462. |

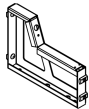

**Order Code**

|                              |                           |
|------------------------------|---------------------------|
| Example: <b>XTB1XD30 613</b> |                           |
| <b>XT</b>                    | Crinion Open Table        |
| <b>B1</b>                    | Base components           |
| <b>XD</b>                    | Beam truss for dual table |
| <b>30</b>                    | Depth                     |
| <b>613</b>                   | Finish                    |

**Specifications**

Beam trusses are available in all standard painted finishes.

**Application Notes**

Crinion Open Table bases are assembled from beams, end legs or end panels, intermediate legs and trusses. After selecting beams and leg kits, specify trusses between beams.



Specify beam trusses adjacent to each end leg and at each worksurface junction.

For 24"D tables specify top channel support instead of truss.

Beam trusses with no top channel support must be specified in combination with intermediate legs planned other than at worksurface junctions (as for cable infeed shrouds).

# Worksurface support cantilever and mid span support

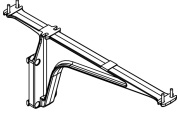
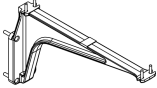
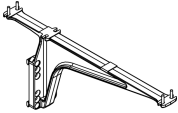
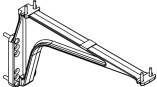
Crinion Open Table

| description   | w  | d   | h        | pattern number      | P1/P2  | P3     |
|---|----|-----|----------|---------------------|--------|--------|
| Cantilever, fixed height 30" or 36" D<br>      | 3" | 24" | 9"       | <b>XTB1FC ( )</b>   | \$214. | \$223. |
| Cantilever, fixed height 24" D<br>             | 3" | 19" | 9"       | <b>XTB1FC24 ( )</b> | 214.   | 223.   |
| Cantilever, adjustable height 30" or 36" D<br> | 3" | 24" | 9" - 12" | <b>XTB1AC ( )</b>   | 236.   | 249.   |
| Cantilever, adjustable height 24" D<br>        | 3" | 24" | 9" - 12" | <b>XTB1AC24 ( )</b> | 236.   | 249.   |
| Mid span support<br>                         | 2  | 2   | 8        | <b>XTB1MB ( )</b>   | 101.   | 107.   |

| Order Code                        | Specifications   | Application Notes  |
|-----------------------------------|--|--|
| Example: <b>XTB1FC 118</b>        | Specify paint finish code after pattern number.  | Cantilever brackets are required to support each end of worksurfaces.  |
| <b>XT</b> Crinion Open Table      |  |  |
| <b>B1</b> Base components         |  | Brackets can be positioned at ends of worksurface, or inset at legs or floorstanding pedestal locations.   |
| <b>FC</b> Fixed height cantilever | <b>48" worksurfaces:</b> shared cantilevers each end or two adjustable per worksurface.                                    | Fixed height cantilevers can be shared between adjacent worksurfaces. Mid span support bracket must be specified for worksurface spans exceeding 4'. |
| <b>118</b> Finish                 | <b>60" and 72" worksurfaces:</b> shared cantilevers each end plus mid span support or two adjustable cantilevers inset 8". | Fixed height cantilever supports worksurface at 28 1/2" H.   |
|                                   | <b>96" worksurfaces:</b> shared cantilevers at ends plus one in center or three adjustable cantilevers.                    | Adjustable cantilevers enable worksurfaces to be set at 27", 27 3/4", 28 1/2", 29 1/4" or 30" H.   |
|                                   | <b>96"x 24" with hinged door:</b> shared cantilever each end plus two mid span supports.                                   |  |
|                                   | <b>96"x 30" with hinged door:</b> shared cantilever each end plus 24"d cantilever as center support.                       |  |
|                                   | <b>96"x 36" with hinged door:</b> shared cantilever each end plus 24", 30" or 36"d cantilever as center support.           |  |

# Worksurface support

## *linking plate and cantilever for end counters*

Crinion Open Table

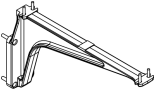
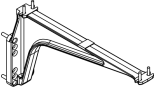
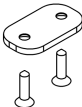
| description   | w  | d   | h        | pattern no.          | P1/P2  | P3     |
|---|----|-----|----------|----------------------|--------|--------|
| Cantilever for end counters, fixed height   | 3" | 19" | 9"       | <b>XTB1FCEND ( )</b> | \$214. | \$223. |
|  |    |     |          |                      |        |        |
| Cantilever for end counters, adjustable height                                    | 3" | 19" | 9" - 12" | <b>XTB1ACEND ( )</b> | 236.   | 249.   |
|  |    |     |          |                      |        |        |
| Worksurface linking plate   |    |     |          | <b>XTB1LP</b>        |        | 29.    |
|  |    |     |          |                      |        |        |

| Order Code                        | Specification                                   | Application Notes   |
|-----------------------------------|---|---|
| Example: <b>XTB1FCEND 613</b>     | Specify paint finish code after pattern number. | Cantilever brackets are required to support each end of worksurface.  |
| <b>XT</b> Crinion Open Table      |   | Brackets attach to inserts on the outside face of end legs for end counters.  |
| <b>B1</b> Base components         |   | Fixed height cantilever supports for end counter at 28 1/2" H.  |
| <b>FC</b> Fixed height cantilever |   | Adjustable cantilevers for end counter enables end counter to be set at 28 1/2", 29 1/4" or 30" H.  |
| <b>END</b> for end counter        |   | A linking plate is recommended to join adjacent worksurfaces that are independently supported at the same height. Specify two linking plates at the junction of two worksurfaces, or four total for each end counter to two worksurfaces. A linking plate is not required where adjacent tops are supported by a shared fixed height cantilever bracket, as with complete fixed height base assemblies. Linking plates are recommended for complete adjustable height base assemblies in which tops are set at the same height. |
| <b>613</b> Finish                 |   |   |

# Modular Raceway

## 2 + 2 eight-wire Raceway with covers

Crinion Open Table

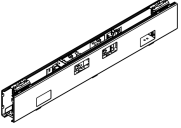
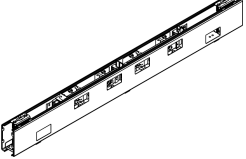
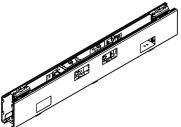
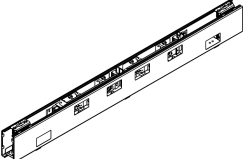

| description   | type | h  | w   | d  | pattern number       | list price |
|---|------|----|-----|----|----------------------|------------|
| Dual raceway, two power + two data outlets each side                                |      | 4" | 30" | 2" | <b>XTR1E30D ( )</b>  | \$280.     |
|    |      |    |     |    |                      |            |
| Dual raceway, four power + two data outlets each side                               |      | 4" | 42" | 2" | <b>XTR1E424D ( )</b> | 402.       |
|    |      |    |     |    |                      |            |
| Flat end cover  |      |    |     |    | <b>XTR1FE ( )</b>    | 24.        |
| Extended end cover  |      |    |     |    | <b>XTR1EE ( )</b>    | 24.        |
| Single sided raceway<br>two power + two data outlets one side                       |      | 4" | 30" | 2" | <b>XTR1E30S ( )</b>  | 280.       |
|   |      |    |     |    |                      |            |
| Single sided raceway<br>four power + two data outlets one side                      |      | 4" | 42" | 2" | <b>XTR1E424S ( )</b> | 402.       |
|  |      |    |     |    |                      |            |

| Order Code                    | Specifications  | Applications notes   |
|-------------------------------|---|--|
| Example: <b>XTR1E424D 613</b> |   |  |
| <b>XT</b> Crinion Open Table  | Eight wire 2+2 has two sets of circuits, each set with a separate ground and neutral.     | Raceway for Crinion Open Table is suspended from the top channel. For ideal access, worksurfaces should be specified with hinged power access. |
| <b>R1</b> Raceway             | Specify paint finish code after pattern number.   | Each raceway requires four or eight duplex outlets, on any of four circuits.   |
| <b>E</b> Eight wire system    | Covers have two openings for data/com outlet modules (Decora-size, specified separately). | Jumpers connect power from one raceway to another.   |
| <b>42</b> Width               |   | To join power between 30" raceways: specify 30" jumper for 60" desks and specify 42" jumper for 72" desks.                                     |
| <b>4</b> Extra outlets        |   | To join power between 42" raceways: specify 18" jumper for 60" desks and 30" jumper for 72" desks.   |
| <b>D</b> Dual Raceway         |   | Flat end covers enclose the end of a raceway at the end of a table.  |
| <b>613</b> Finish             |   | Extended end covers enclose the end of a raceway at the end of a table where power infeed is located.  |
|                               |   | Specify outlet fillers separately for unused outlet openings.  |

# Modular Raceway

## 2 + 2 eight-wire Raceway components

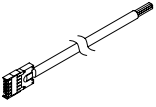
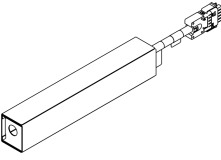
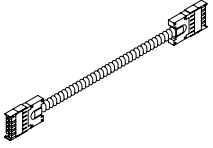
Crinion Open Table

| description   | type              | h | w   | d | pattern number      | list price |
|---|-------------------|---|-----|---|---------------------|------------|
| Modular infeed  |                   |   |     |   | <b>XTR1EPI</b>      | \$211.     |
|    |                   |   |     |   |                     |            |
| NYC infeed kit  |                   |   |     |   | <b>XTR1EPH</b>      | 483.       |
|    |                   |   |     |   |                     |            |
| Jumper  |                   |   | 18" |   | <b>XTR1EJ18</b>     | 97.        |
|    |                   |   | 30" |   | <b>XTR1EJ30</b>     | 111.       |
|   |                   |   | 42" |   | <b>XTR1EJ42</b>     | 127.       |
| Duplex outlet   | Circuit B         |   |     |   | <b>XTR1DB</b>       | 36.        |
|    | Circuit A         |   |     |   | <b>XTR1DA</b>       | 36.        |
|   | Circuit X, orange |   |     |   | <b>XTR1DXO</b>      | 41.        |
|   | Circuit Y, orange |   |     |   | <b>XTR1DYO</b>      | 41.        |
| Outlet filler   | Set of 10         |   |     |   | <b>XTR1OF</b>       | 30.        |
| PDC module extension kit  | Set of 10         |   |     |   | <b>XTR1PDCX</b>     | 123.       |
| Compact Power Module  |                   |   |     |   | <b>XTR1ECPM ( )</b> | 521.       |
|  |                   |   |     |   |                     |            |

| Order Code                   | Specifications  | Application Notes   |
|------------------------------|---|---|
| Example: <b>XTR1EJ18</b>     |   |   |
| <b>XT</b> Crinion Open Table | Eight wire 2+2 has two sets of circuits, each set with a separate ground and neutral.                             | Raceway for Crinion Open Table is suspended from the top channel. For ideal access, worksurfaces should be specified with hinged power access.  |
| <b>R1</b> Raceway            |   |   |
| <b>E</b> Eight wire          |   |   |
| <b>J</b> Jumper              |   |   |
| <b>18</b> Width              |   |   |
|                              | Each raceway requires four or eight duplex outlets, on any of four circuits.                                      | <p>Jumper length is difference between worksurface width and specified raceway width.</p> <p>Compact power module is designed to supply power outlets under extended end counter worksurfaces, or additional outlets under desks.</p> <p>Compact power module can be suspended from top channel or attached to inside face of beams.</p> <p>Each face of compact power module accepts two duplex outlets.</p> |
|                              | Power infeed includes pigtail for connection to building power supply and connector to either end of any raceway. |   |
|                              | NYC infeed kit includes junction box that mounts to inside face of beams in table base.                           |   |

# Modular Raceway

## 3 + 3 ten-wire Raceway with covers

Crinion Open Table

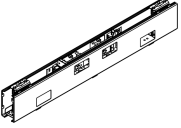
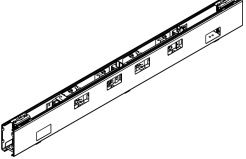
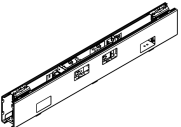
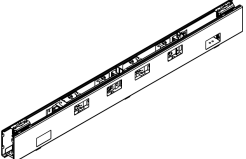
| description   | type | h  | w   | d  | pattern number       | list price |
|---|------|----|-----|----|----------------------|------------|
| Dual raceway, two power + two data outlets each side                                |      | 4" | 30" | 2" | <b>XTR1T30D ( )</b>  | \$293.     |
|    |      |    |     |    |                      |            |
| Dual raceway, four power + two data outlets each side                               |      | 4" | 42" | 2" | <b>XTR1T424D ( )</b> | 415.       |
|    |      |    |     |    |                      |            |
| Flat end cover  |      |    |     |    | <b>XTR1FE ( )</b>    | 24.        |
| Extended end cover  |      |    |     |    | <b>XTR1EE ( )</b>    | 24.        |
| Single sided raceway<br>two power + two data outlets one side                       |      | 4" | 30" | 2" | <b>XTR1T30S ( )</b>  | 293.       |
|   |      |    |     |    |                      |            |
| Single sided raceway<br>four power + two data outlets one side                      |      | 4" | 42" | 2" | <b>XTR1T424S ( )</b> | 415.       |
|  |      |    |     |    |                      |            |

### Order Code

|                               |                    |
|-------------------------------|--------------------|
| Example: <b>XTR1T424D 613</b> |                    |
| <b>XT</b>                     | Crinion Open Table |
| <b>R1</b>                     | Raceway            |
| <b>T</b>                      | Ten wire system    |
| <b>42</b>                     | Width              |
| <b>4</b>                      | Extra outlets      |
| <b>D</b>                      | Dual Raceway       |
| <b>613</b>                    | Finish             |

### Specifications

Ten wire 3+3 has two sets of three circuits, each set with a separate ground and neutral.

Specify paint finish code after pattern number.

Covers have two openings for data/com outlet modules (Decora-size, specified separately).

### Application Notes

Raceway for Crinion Open Table is suspended from the top channel. For ideal access, worksurfaces should be specified with hinged power access.

Each raceway requires four or eight duplex outlets, on any of six circuits.

Jumpers connect power from one raceway to another.

To join power between 30" raceways: specify 30" jumper for 60" desks and specify 42" jumper for 72" desks.

To join power between 42" raceways: specify 18" jumper for 60" desks and 30" jumper for 72" desks.

Flat end covers enclose the end of a raceway at the end of a table.



Extended end covers enclose the end of a raceway at the end of a table where power infeed is located.

Specify outlet fillers separately for unused outlet openings.

# Modular Raceway

## 3 + 3 ten-wire Raceway components

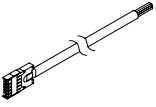
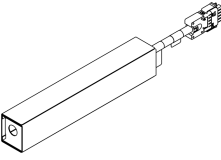
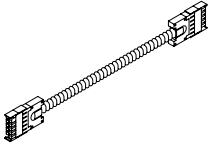
Crinion Open Table

| description   | type              | h | w   | d | pattern number      | list pricing |
|---|-------------------|---|-----|---|---------------------|--------------|
| Modular infeed  |                   |   |     |   | <b>XTR1TPI</b>      | \$237.       |
|    |                   |   |     |   |                     |              |
| NYC infeed kit  |                   |   |     |   | <b>XTR1TPH</b>      | 483.         |
|    |                   |   |     |   |                     |              |
| Jumper  |                   |   | 18" |   | <b>XTR1TJ18</b>     | 111.         |
|    |                   |   | 30" |   | <b>XTR1TJ30</b>     | 127.         |
|   |                   |   | 42" |   | <b>XTR1TJ42</b>     | 147.         |
| Duplex outlet   | Circuit B         |   |     |   | <b>XTR1DB</b>       | 36.          |
|    | Circuit A         |   |     |   | <b>XTR1DA</b>       | 36.          |
|   | Circuit C         |   |     |   | <b>XTR1DC</b>       | 36.          |
|   | Circuit X, orange |   |     |   | <b>XTR1DXO</b>      | 41.          |
|   | Circuit Y, orange |   |     |   | <b>XTR1DYO</b>      | 41.          |
|   | Circuit Z, orange |   |     |   | <b>XTR1DZO</b>      | 41.          |
| Outlet filler   | Set of 10         |   |     |   | <b>XTR1OF</b>       | 30.          |
| PDC module extension kit  | Set of 10         |   |     |   | <b>XTR1PDCX</b>     | 123.         |
| Compact Power Module  |                   |   |     |   | <b>XTR1TCPM ( )</b> | 536.         |
|  |                   |   |     |   |                     |              |

| Order Code                   | Specifications  | Application Notes  |
|------------------------------|---|--|
| Example: <b>XTR1TJ18</b>     |   |  |
| <b>XT</b> Crinion Open Table | Ten wire 3+3 has two sets of three circuits, each set with a separate ground and neutral. | Raceway for Crinion Open Table is suspended from the top channel. For ideal access, worksurfaces should be specified with hinged power access.   |
| <b>R1</b> Raceway            |   | Each raceway requires four or eight duplex outlets, on any of six circuits.  |
| <b>T</b> Ten wire            |   | Power infeed includes pigtail for connection to building power supply and connector to either end of any raceway.  |
| <b>J</b> Jumper              |   | NYC infeed kit includes junction box that mounts to inside face of beams in table base.  |
| <b>18</b> Width              |   | Jumper length is difference between worksurface width and specified raceway width.<br><br>Compact power module is designed to supply power outlets under extended end counter worksurfaces, or additional outlets under desks.<br><br>Compact power module can be suspended from top channel or attached to inside face of beams.<br><br>Each face of compact power module accepts two duplex outlets. |

# Modular Raceway

## 4-4-2 ten-wire Raceway with covers

Crinion Open Table

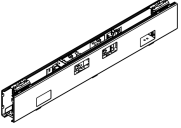
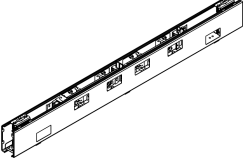
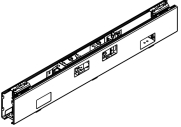
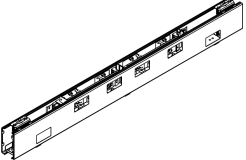
| description   | type | h  | w   | d  | pattern number       | list price |
|---|------|----|-----|----|----------------------|------------|
| Dual raceway, two power + two data outlets each side<br>             |      | 4" | 30" | 2" | <b>XTR1X30D ( )</b>  | \$309.     |
| Dual raceway, four power + two data outlets each side<br>            |      | 4" | 42" | 2" | <b>XTR1X424D ( )</b> | 436.       |
| Single sided raceway<br>two power + two data outlets one side<br>    |      | 4" | 30" | 2" | <b>XTR1X30S ( )</b>  | 309.       |
| Single sided raceway<br>four power + two data outlets one side<br> |      | 4" | 42" | 2" | <b>XTR1X424S ( )</b> | 436.       |



| Order Code                    | Specifications  | Application Notes  |
|-------------------------------|---|--|
| Example: <b>XTR1X424D 613</b> |   |  |
| <b>XT</b> Crinion Open Table  | Ten wire 4-4-2 has four circuits each with a separate neutral, plus a ground wire for circuit 1 and 2 and another ground for circuit 3 and 4. | Raceway for Crinion Open Table is suspended from the top channel. For ideal access, worksurfaces should be specified with hinged power access. |
| <b>R1</b> Raceway             |   |  |
| <b>X</b> Ten wire 4-4-2       | Specify paint finish code after pattern number.   | Each raceway requires four or eight duplex outlets, on any of six circuits.  |
| <b>42</b> Width               |   |  |
| <b>4</b> Extra outlets        | Covers have two openings for data/com outlet modules (Decora-size, specified separately).   | Jumpers connect power from one raceway to another.   |
| <b>D</b> Dual Raceway         |   |  |
| <b>613</b> Finish             |   |  |
|                               |   | To join power between 42" raceways: specify 18" jumper for 60" desks and 30" jumper for 72" desks.   |
|                               |   | Flat end covers enclose the end of a raceway at the end of a table.  |
|                               |   | Extended end covers enclose the end of a raceway at the end of a table where power infeed is located.  |
|                               |   | Specify outlet fillers separately for unused outlet openings.  |
|                               |   | To join power between 30" raceways: specify 30" jumper for 60" desks and specify 42" jumper for 72" desks.                                     |



# Modular Raceway

## 4-4-2 ten-wire Raceway components

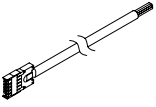
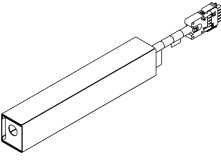
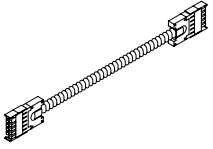
Crinion Open Table

| description   | type      | h | w   | d | pattern number      | list price |
|---|-----------|---|-----|---|---------------------|------------|
| Modular infeed  |           |   |     |   | <b>XTR1XPI</b>      | \$249.     |
|    |           |   |     |   |                     |            |
| NYC infeed kit  |           |   |     |   | <b>XTR1XPH</b>      | 506.       |
|    |           |   |     |   |                     |            |
| Jumper  |           |   | 18" |   | <b>XTR1XJ18</b>     | 116.       |
|    |           |   | 30" |   | <b>XTR1XJ30</b>     | 133.       |
|   |           |   | 42" |   | <b>XTR1XJ42</b>     | 152.       |
| Duplex outlet   | Circuit 2 |   |     |   | <b>XTR1D2</b>       | 38.        |
|    | Circuit 1 |   |     |   | <b>XTR1D1</b>       | 38.        |
|   | Circuit 3 |   |     |   | <b>XTR1D3</b>       | 38.        |
|   | Circuit 4 |   |     |   | <b>XTR1D4</b>       | 38.        |
| Compact Power Module  |           |   |     |   | <b>XTR1XCPM ( )</b> | 536.       |
|  |           |   |     |   |                     |            |

### Order Code

|           |                    |
|-----------|--------------------|
| Example:  | <b>XTR1XJ18</b>    |
| <b>XT</b> | Crinion Open Table |
| <b>R1</b> | Raceway            |
| <b>X</b>  | Ten wire 4-4-2     |
| <b>J</b>  | Jumper             |
| <b>18</b> | Width              |

### Specifications

Ten wire 4-4-2 has four circuits each with a separate neutral, plus a ground wire for circuit 1 and 2 and another ground for circuit 3 and 4.

All duplex outlets are black.

### Application Notes

Raceway for Crinion Open Table is suspended from the top channel. For ideal access, worksurfaces should be specified with hinged power access.

Each raceway requires four or eight duplex outlets, on any of six circuits.

Power infeed includes pigtail for connection to building power supply and connector to either end of any raceway.

NYC infeed kit includes junction box that mounts to inside face of beams in table base.

Jumper length is difference between worksurface width and specified raceway width.

Compact power module is designed to supply power outlets under extended end counter worksurfaces, or additional outlets under desks.

Compact power module can be suspended from top channel or attached to inside face of beams.

Each face of compact power module accepts two duplex outlets.

| description  | type      | h  | w   | d  | pattern number      | list price |
|--|-----------|----|-----|----|---------------------|------------|
| Dual raceway, two power + two data outlets each side |           | 4" | 30" | 2" | <b>XTR1H30D ( )</b> | \$610.     |
| Flat end cover                                       |           |    |     |    | <b>XTR1FE ( )</b>   | 24.        |
| Extended end cover                                   |           |    |     |    | <b>XTR1EE ( )</b>   | 24.        |
| Outlet filler  | Set of 10 |    |     |    | <b>XTR1OF</b>       | 30.        |

**Order Code**

|                              |
|------------------------------|
| Example: <b>XTR1H30D 613</b> |
| <b>XT</b> Crinion Open Table |
| <b>R1</b> Raceway            |
| <b>H</b> Hard wire system    |
| <b>30</b> Width              |
| <b>D</b> Dual Raceway        |
| <b>613</b> Finish            |

**Specifications**

Specify paint finish code after pattern number.

Hardwired raceway components are designed for use in City of Chicago installations.

Covers have two openings for data/com outlet modules (Decora-size, by others).

**Application Notes**

Raceway for Crinion Open Table is suspended from the top channel. For ideal access, worksurfaces should be specified with hinged power access.

Dual raceways are code-approved boxed with openings for two or four duplex outlets on each face, plus two additional openings for data/communications faceplates on each face. A continuous horizontal metal septum divides power wires and connections from data and communications cables. Each raceway requires Decora-type architectural power outlets, internal wiring and connecting cables, supplied by electrical contractor.

Flat end covers enclose the raceway at the end of a table. Extended end covers provide an opening on the underside to permit cables to enter the raceway.

Specify outlet filler plates for unused outlet openings. Specify PDC extenders to create space behind data/com for cable distribution inside dual raceway.

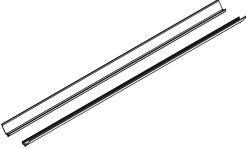
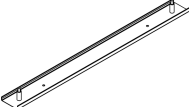
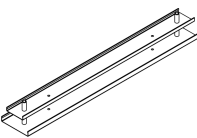
| description  | table size | w   | d  | pattern number        | list price |
|--|------------|-----|----|-----------------------|------------|
| Cable trays, leg position, pair<br> | 5', 30"D   | 53" | 1" | <b>XTCT6030LD ( )</b> | \$253.     |
|  | 5', 36"D   | 53" | 4" | <b>XTCT6036LD ( )</b> | 345.       |
|  | 6', 30"D   | 65" | 1" | <b>XTCT7230LD ( )</b> | 275.       |
|  | 6', 36"D   | 65" | 4" | <b>XTCT7236LD ( )</b> | 401.       |
| Cable trays, full width, pair<br>   | 5', 30"D   | 60" | 1" | <b>XTCT6030D ( )</b>  | 253.       |
|  | 5', 36"D   | 60" | 4" | <b>XTCT6036D ( )</b>  | 345.       |
|  | 6', 30"D   | 72" | 1" | <b>XTCT7230D ( )</b>  | 275.       |
|  | 6', 36"D   | 72" | 4" | <b>XTCT7236D ( )</b>  | 401.       |
| Data tray kit<br>                   |            | 42" |    | <b>XTDT42 ( )</b>     | 178.       |
| Data + excess cable tray kit<br>   |            | 42" |    | <b>XTDTX42 ( )</b>    | 295.       |
| Truss cable clips, set of 25   |            |     |    | <b>XTR1TCC25</b>      | 15.        |
| Beam cable clips, set of 50  |            |     |    | <b>XTR1BCC50</b>      | 236.       |
| Random attachment kit, set of 10   |            |     |    | <b>XTB1RAK</b>        | 82.        |

| Order Code                    | Specifications  | Applications notes   |
|-------------------------------|---|--|
| Example: <b>XTCT7230D 613</b> | Cable trays and Data tray kits are available in all standard paint finishes.  | Cable trays are optional kits to manage cables on each side of dual table bases. Specify cable trays for leg position at each end of the table. Specify cable trays, full width for other positions.<br><br>Data tray kit provides 3" wide horizontal open cable tray directly below either 30" or 42"W raceway module (at center of 60" or 72" desks). Data + excess tray kit provides two open trays below either raceway module, one 3"W and one 5"W. |
| <b>XT</b> Crinion Open Table  |   |  |
| <b>CT</b> Cable tray          |   |  |
| <b>72</b> Width               |   |  |
| <b>30</b> Depth               |   |  |
| <b>D</b> Dual table           |   |  |
| <b>613</b> Finish             | Truss cable clips manage cables between raceway. Specify 2 clips per truss (one set of 10 for each five trusses).<br><br>Beam cable clips manage cables along the inside faces of each beam set.<br><br>Random attachment kit is a set of ten M8 slot nuts for attaching various products to the Crinion Open Table beams or top channel. Specify appropriate M8 screws separately. |  |

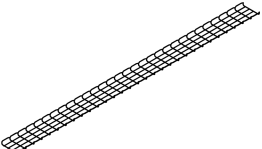
| description   | application          | w                             | d  | h    | pattern no.          | list  |
|---|----------------------|-------------------------------|----|------|----------------------|-------|
|  | 24"D tables          | 18"                           | 2" | 3/4" | <b>XTBT18 ( )</b>    | \$81. |
|   | 24"D tables          | 24"                           | 2" | 3/4" | <b>XTBT24 ( )</b>    | 90.   |
|   | 24"D tables          | 36"                           | 2" | 3/4" | <b>XTBT36 ( )</b>    | 98.   |
|   | 24"D tables          | 48"                           | 2" | 3/4" | <b>XTBT48 ( )</b>    | 108.  |
|   | 24"D tables          | 60"                           | 2" | 3/4" | <b>XTBT60 ( )</b>    | 116.  |
| Cable basket, 10'   |                      | 120"                          | 8" | 1"   | <b>XTWB120</b>       | 439.  |
|  | Cable basket hangers | From truss 30/36D only        |    |      | <b>XTWTX ( )</b>     | 70.   |
|   |                      | From truss at infeed shroud   |    |      | <b>XTWTBSLIK ( )</b> | 214.  |
|   |                      | From main beam, 24D only      |    |      | <b>XTWTB ( )</b>     | 70.   |
|   |                      | From top channel, 30/36D only |    |      | <b>XTWTC ( )</b>     | 91.   |

| Order Code                        | Specifications   | Application Notes  |
|-----------------------------------|--|--|
| Example: <b>XTBT36 118</b>        |  |  |
| <b>XT</b> Crinion Open Table      | Beam mounted cable trays are available in any standard painted finish. | Beam mounted cable trays may be inserted in slots on either face of Crinion Open Table main beams. On 24"D dual or single sided tables beam mounted cable trays are the only option for cable management other than the shallow channel on top of the beam or a cable basket. On 30"D and 36"D tables beam mounted trays may complement other cable tray options.  |
| <b>BT</b> Beam mounted cable tray | Cable basket is zinc metal finish only.                                | For 48"W worksurfaces with shared cantilevers specify 36"W trays. For 60"W worksurfaces with shared cantilevers and midspan supports specify 24"W trays adjacent to end legs specify 18"W trays.   |
| <b>36</b> Width                   | Basket hangers can be specified in any standard painted finish.        | For 72"W worksurfaces with shared cantilevers and midspan supports specify 24"W trays.   |
| <b>118</b> Paint finish           |  | For 96"W worksurfaces specify 36"W trays between supports. Specify 48"W trays for additional cable management between trusses on the inside face of beams on dual 30"D and 36"D tables with 60" worksurfaces. Specify 60"W trays on the inside face of beams on dual 30"D and 36"D tables with 72"W worksurfaces.  |
|                                   |  | Beam mounted cable trays must be segmented to fit between cantilever and midspan support brackets.   |
|                                   |  | Cable basket is suspended below the center of dual tables instead of or in addition to cable trays. Cable basket offers the most flexibility for managing large bundles of cables and for entering or exiting the tray at any point. Cable basket ships in 10' lengths and is cut to size in field. Specify cable basket hangers separately. Each hanger can suspend one end of a tray or two adjacent trays. Hanger from trusses is for 30" or 36"D dual or single sided tables. Hanger from main beam is for 24"D dual tables only. Hangers from top channel are for 30" or 36"D dual tables only. |

# Center screens

## Acrylic, slatwall, combination, marker or veneer surface

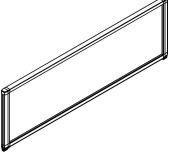
| description   | appl. | w   | d      | h   | pattern no.                   | Opal acrylic | Trans. acrylic / Marker | slatwall | Comb. acrylic / slatwall | V1       | V2       | V3       |
|---|-------|-----|--------|-----|-------------------------------|--------------|-------------------------|----------|--------------------------|----------|----------|----------|
| Center screen to 43" H<br> | 48"   | 48" | 1 1/4" | 14" | <b>XTCS1 4814</b> ( ) ( ) ( ) | \$856.       | \$885.                  | \$1,359. | n/a                      | \$1,181. | \$1,294. | \$1,515. |
|   | 60"   | 60" | 1 1/4" | 14" | <b>XTCS1 6014</b> ( ) ( ) ( ) | 1,122.       | 1,178.                  | 1,476.   | n/a                      | 1,277.   | 1,409.   | 1,689.   |
|   | 72"   | 72" | 1 1/4" | 14" | <b>XTCS1 7214</b> ( ) ( ) ( ) | 1,181.       | 1,237.                  | 1,595.   | n/a                      | 1,342.   | 1,495.   | 1,829.   |

acrylic shown

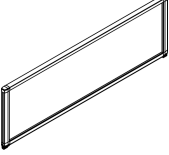
|  |     |     |        |     |                               |        |        |        |     |        |        |        |
|--|-----|-----|--------|-----|-------------------------------|--------|--------|--------|-----|--------|--------|--------|
| Center screen to 43" H adjacent to end screen<br> | 48" | 47" | 1 1/4" | 14" | <b>XTCS1 4714</b> ( ) ( ) ( ) | 856.   | 885.   | 1,359. | n/a | 1,181. | 1,294. | 1,515. |
|  | 60" | 59" | 1 1/4" | 14" | <b>XTCS1 5914</b> ( ) ( ) ( ) | 1,122. | 1,178. | 1,476. | n/a | 1,277. | 1,409. | 1,689. |
|  | 72" | 71" | 1 1/4" | 14" | <b>XTCS1 7114</b> ( ) ( ) ( ) | 1,181. | 1,237. | 1,595. | n/a | 1,342. | 1,495. | 1,829. |

acrylic shown

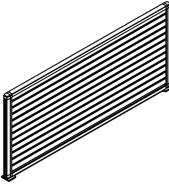
|  |     |     |        |     |                               |        |        |        |        |        |        |        |
|--|-----|-----|--------|-----|-------------------------------|--------|--------|--------|--------|--------|--------|--------|
| Center screen to 50" H<br> | 48" | 48" | 1 1/4" | 21" | <b>XTCS1 4821</b> ( ) ( ) ( ) | 1,003. | 1,049. | 1,595. | 1,476. | 1,295. | 1,442. | 1,761. |
|  | 60" | 60" | 1 1/4" | 21" | <b>XTCS1 6021</b> ( ) ( ) ( ) | 1,299. | 1,383. | 1,772. | 1,714. | 1,393. | 1,571. | 1,970. |
|  | 72" | 72" | 1 1/4" | 21" | <b>XTCS1 7221</b> ( ) ( ) ( ) | 1,359. | 1,441. | 1,950. | 1,831. | 1,443. | 1,650. | 2,133. |

slatwall shown

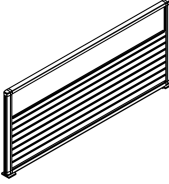
|  |     |     |        |     |                               |        |        |        |        |        |        |        |
|--|-----|-----|--------|-----|-------------------------------|--------|--------|--------|--------|--------|--------|--------|
| Center screen to 50" H adjacent to end screen<br> | 48" | 47" | 1 1/4" | 21" | <b>XTCS1 4721</b> ( ) ( ) ( ) | 1,003. | 1,049. | 1,595. | 1,476. | 1,295. | 1,442. | 1,761. |
|  | 60" | 59" | 1 1/4" | 21" | <b>XTCS1 5921</b> ( ) ( ) ( ) | 1,299. | 1,383. | 1,772. | 1,714. | 1,393. | 1,571. | 1,970. |
|  | 72" | 71" | 1 1/4" | 21" | <b>XTCS1 7121</b> ( ) ( ) ( ) | 1,359. | 1,441. | 1,950. | 1,831. | 1,443. | 1,650. | 2,133. |

combination shown

### Order Code

|            |                         |
|------------|-------------------------|
| Example:   | <b>XTCS16014A O 111</b> |
| <b>XT</b>  | Crinion Open Table      |
| <b>CS1</b> | Center screen           |
| <b>60</b>  | Width                   |
| <b>14</b>  | Height                  |
| <b>A</b>   | Surface                 |
| <b>O</b>   | Opal                    |
| <b>111</b> | Frame finish            |

### Specifications

Acrylic surface is AO opal or AT translucent.

For Marker surface both sides specify suffix M.

For Slatwall screens specify slatwall and frame finish.

For combination acrylic/slatwall screens specify suffixes CO (opal) or CT (translucent), slatwall and frame finish.

Slatwall surface is available in (AA) or any standard painted finish except 613 Silver.

For veneer surface specify suffix V and finish code from list on page 5.

Frame is clear anodized aluminum or any standard paint finish except 613 Silver.

### Application Notes

Center screens mount to continuous channel at center of tables. Specify 14" H screens for a 42" horizon. Specify 21" H screens for a 49" horizon. Horizons are maintained regardless of worksurface height.

Combination screens include 14" high slatwall with acrylic above.

Center screens include mounting hardware for standard top channel only.

Center screens adjacent to end screens allow space for dual or single sided end screens.

Slatwall screens require buttresses to support Knoll Extra flat screen monitor arm. Specify one buttress per monitor arm, up to four buttresses per screen.

Slatwall screens will support flat panel monitor arms with varying weight limitations based on mounting and application. Please refer to the Knoll Extra price list for comprehensive mounting and weight limitation information by application.

Veneer grain direction is horizontal.

Marker surface has wood core.

Center screens  
Tackable fabric surface

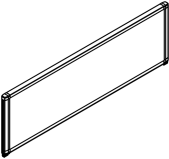
| description   | application | w   | d      | h   | pattern no.                | 10     | 15     | 20     | 30     | 35     | 40     | 45     |
|---|-------------|-----|--------|-----|----------------------------|--------|--------|--------|--------|--------|--------|--------|
|  | 48"         | 48" | 1 1/4" | 14" | <b>XTCS1 4814F</b> ( ) ( ) | \$904. | \$921. | \$925. | \$945. | \$959. | \$959. | \$992. |
|   | 60"         | 60" | 1 1/4" | 14" | <b>XTCS1 6014F</b> ( ) ( ) | 987.   | 1,009. | 1,013. | 1,036. | 1,055. | 1,055. | 1,096. |
|   | 72"         | 72" | 1 1/4" | 14" | <b>XTCS1 7214F</b> ( ) ( ) | 1,011. | 1,037. | 1,041. | 1,071. | 1,094. | 1,094. | 1,142. |

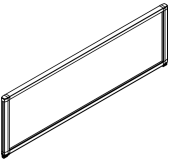
|   |     |     |        |     |                            |        |        |        |        |        |        |        |
|---|-----|-----|--------|-----|----------------------------|--------|--------|--------|--------|--------|--------|--------|
|  | 48" | 47" | 1 1/4" | 14" | <b>XTCS1 4714F</b> ( ) ( ) | 895.   | 913.   | 916.   | 934.   | 950.   | 950.   | 983.   |
|   | 60" | 59" | 1 1/4" | 14" | <b>XTCS1 5914F</b> ( ) ( ) | 987.   | 1,009. | 1,013. | 1,036. | 1,055. | 1,055. | 1,096. |
|   | 72" | 71" | 1 1/4" | 14" | <b>XTCS1 7114F</b> ( ) ( ) | 1,011. | 1,037. | 1,041. | 1,071. | 1,094. | 1,094. | 1,142. |

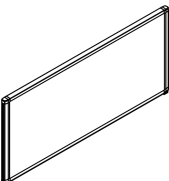

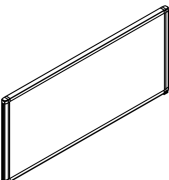

|   |     |     |        |     |                            |        |        |        |        |        |        |        |
|---|-----|-----|--------|-----|----------------------------|--------|--------|--------|--------|--------|--------|--------|
|  | 48" | 48" | 1 1/4" | 21" | <b>XTCS1 4821F</b> ( ) ( ) | 958.   | 976.   | 979.   | 997.   | 1,013. | 1,013. | 1,044. |
|   | 60" | 60" | 1 1/4" | 21" | <b>XTCS1 6021F</b> ( ) ( ) | 1,069. | 1,093. | 1,096. | 1,118. | 1,138. | 1,138. | 1,179. |
|   | 72" | 72" | 1 1/4" | 21" | <b>XTCS1 7221F</b> ( ) ( ) | 1,080. | 1,107. | 1,112. | 1,141. | 1,164. | 1,164. | 1,212. |

|   |     |     |        |     |                            |        |        |        |        |        |        |        |
|---|-----|-----|--------|-----|----------------------------|--------|--------|--------|--------|--------|--------|--------|
|  | 48" | 47" | 1 1/4" | 21" | <b>XTCS1 4721F</b> ( ) ( ) | 958.   | 976.   | 979.   | 997.   | 1,013. | 1,013. | 1,044. |
|   | 60" | 59" | 1 1/4" | 21" | <b>XTCS1 5921F</b> ( ) ( ) | 1,069. | 1,093. | 1,096. | 1,118. | 1,138. | 1,138. | 1,179. |
|   | 72" | 71" | 1 1/4" | 21" | <b>XTCS1 7121F</b> ( ) ( ) | 1,080. | 1,107. | 1,112. | 1,141. | 1,164. | 1,164. | 1,212. |

| Order Code                   |                    |
|------------------------------|--------------------|
| Example: <b>XTCS16014F20</b> |                    |
| <b>(W2801) AA</b>            |                    |
| <b>XT</b>                    | Crinion Open Table |
| <b>CS1</b>                   | Center screen      |
| <b>60</b>                    | Width              |
| <b>14</b>                    | Height             |
| <b>F</b>                     | Surface            |
| <b>20</b>                    | Fabric grade       |
| <b>W2801</b>                 | Fabric             |
| <b>AA</b>                    | Frame finish       |

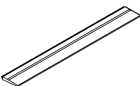
| Specifications   |
|--|
| 1. Tackable fabric surface is suffix F.  |
| 2. Select fabric surface finish code from list on page 5.                        |
| Frame is clear anodized aluminum or any standard paint finish except 613 Silver. |
| Fabric is railroaded.  |

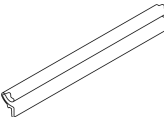
| Application Notes  |
|--|
| Fabric center screens mount to continuous channel at center of tables. Specify 14" H screens for a 43" horizon. Specify 21" H screens for a 50" horizon. Horizons are maintained regardless of worksurface height. |
| Center screens adjacent to end screens allow space for dual or single sided end screens.   |
| Center screens include mounting hardware for standard top channel only.  |

| description  | application  | w   | d   | h  | pattern no.             | list               | AA/paint | L    | V1   | V2   | V3   |
|--|--------------|-----|-----|----|-------------------------|--------------------|----------|------|------|------|------|
| Display shelf 5"D<br>aluminum only<br>                | 48" slatwall | 45" | 5"  | 1" | <b>XT1DS4505 ( )</b>    |                    | \$262.   |      |      |      |      |
|  | 60" slatwall | 57" | 5"  | 1" | <b>XT1DS5705 ( )</b>    |                    | 294.     |      |      |      |      |
|  | 72" slatwall | 69" | 5"  | 1" | <b>XT1DS6905 ( )</b>    |                    | 318.     |      |      |      |      |
| Open shelf 9"D<br>laminate or veneer only<br>         | 48" slatwall | 45" | 9"  | 1" | <b>XT1LS4509 ( )( )</b> |                    |          | 294. | 384. | 441. | 596. |
|  | 60" slatwall | 57" | 9"  | 1" | <b>XT1LS5709 ( )( )</b> |                    |          | 338. | 440. | 505. | 684. |
|  | 72" slatwall | 69" | 9"  | 1" | <b>XT1LS6909 ( )( )</b> |                    |          | 383. | 497. | 571. | 771. |
| Slatwall adapters for<br>applied wall accessories<br> |              | 24" |     |    | <b>XT1SA24 ( )</b>      |                    |          | 27.  |      |      |      |
|  |              |     | 30" |    |                         | <b>XT1SA30 ( )</b> |          | 32.  |      |      |      |
|  |              |     | 36" |    |                         | <b>XT1SA36 ( )</b> |          | 38.  |      |      |      |
|  |              |     | 42" |    |                         | <b>XT1SA42 ( )</b> |          | 43.  |      |      |      |
|  |              |     | 48" |    |                         | <b>XT1SA48 ( )</b> |          | 48.  |      |      |      |
|  |              |     | 54" |    |                         | <b>XT1SA54 ( )</b> |          | 54.  |      |      |      |
|  |              |     | 60" |    |                         | <b>XT1SA60 ( )</b> |          | 59.  |      |      |      |
|  |              |     | 66" |    |                         | <b>XT1SA66 ( )</b> |          | 65.  |      |      |      |
|  |              | 72" |     |    | <b>XT1SA72 ( )</b>      |                    | 70.      |      |      |      |      |
| Buttress for slatwall screen<br>                     |              |     |     |    | <b>XTCS1 SBA ( )</b>    |                    |          | 236. |      |      |      |

| Order Code                       | Specifications   | Application Notes   |
|----------------------------------|--|---|
| Example: <b>XT1LS5709 118 AA</b> |  |   |
| <b>XT1</b> Crinion Open Table    | Display shelves are anodized aluminum (AA) or any standard painted finish except silver. | Open shelves and display shelves for slatwall are designed for use on Crinion Open Table center screens with slatwall inserts.  |
| <b>LS</b> Open shelf             |  |   |
| <b>57</b> Width                  | For open shelves specify any standard laminate or veneer finish, then platform finish.   | Shelves include adapter that snaps into horizontal channels in slatwall, approximately every 2" vertically.   |
| <b>09</b> Depth                  | Shelf platform may be AA or any standard paint finish except silver.                     | Shelf width fits either full width center screens or screens adjacent to end screens.   |
| <b>118</b> Shelf finish          |  |   |
| <b>AA</b> Platform finish        | Slatwall adapters are integral color 812 Easy grey or 111 Black only.                    | Slatwall adapters enable other Applied Wall System shelves and accessories to be mounted to Crinion Open Table slatwall. Adapter will also fit other Knoll system slatwalls, such as AutoStrada spine or panels, but use of shelves in these applications may not comply with ANSI/BIFMA safety standards for anti-dislodgment. |

# Side screens

*Acrylic, Marker or veneer surface*

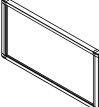
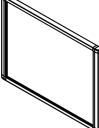
| description  | application       | w   | d      | h   | pattern no.                   | list | Opal acrylic | Trans. acrylic / Marker | V1     | V2       | V3       |
|--|-------------------|-----|--------|-----|-------------------------------|------|--------------|-------------------------|--------|----------|----------|
|  Side screen to 43" H | 24" D worksurface | 22" | 1 1/4" | 14" | <b>XTSS1 2414</b> ( ) ( ) ( ) |      | \$620.       | \$637.                  | \$934. | \$1,002. | \$1,104. |
|  | 30" D worksurface | 28" | 1 1/4" | 14" | <b>XTSS1 3014</b> ( ) ( ) ( ) |      | 650.         | 672.                    | 964.   | 1,041.   | 1,172.   |
|  | 36" D worksurface | 34" | 1 1/4" | 14" | <b>XTSS1 3614</b> ( ) ( ) ( ) |      | 708.         | 737.                    | 989.   | 1,077.   | 1,236.   |
|  | acrylic shown     |     |        |     |                               |      |              |                         |        |          |          |
|  Side screen to 50" H | 24" D worksurface | 22" | 1 1/4" | 21" | <b>XTSS1 2421</b> ( ) ( ) ( ) |      | 708.         | 737.                    | 1,000. | 1,084.   | 1,230.   |
|  | 30" D worksurface | 28" | 1 1/4" | 21" | <b>XTSS1 3021</b> ( ) ( ) ( ) |      | 739.         | 772.                    | 1,032. | 1,131.   | 1,316.   |
|  | 36" D worksurface | 34" | 1 1/4" | 21" | <b>XTSS1 3621</b> ( ) ( ) ( ) |      | 796.         | 835.                    | 1,061. | 1,176.   | 1,402.   |
|  | acrylic shown     |     |        |     |                               |      |              |                         |        |          |          |
| Side screen brackets ( pair )  | tapered edge      |     |        |     | <b>XTSM1K</b> ( )             |      | 177.         |                         |        |          |          |
|  | squared edge      |     |        |     | <b>XTSM1S</b> ( )             |      | 177.         |                         |        |          |          |
|  | postformed edge   |     |        |     | <b>XTSM1P</b> ( )             |      | 249.         |                         |        |          |          |

### Order Code

|            |                        |
|------------|------------------------|
| Example:   | <b>XTSS13014A O AA</b> |
| <b>XT</b>  | Crinion Open Table     |
| <b>SS1</b> | Side screen            |
| <b>30</b>  | Width                  |
| <b>14</b>  | Height                 |
| <b>A</b>   | Surface                |
| <b>O</b>   | Opal                   |
| <b>AA</b>  | Frame finish           |

### Specifications

- Specify surface  
*A = Acrylic*  
*V = Veneer*  
*M = Marker*
- For Acrylic surface specify  
*O = Opal*  
*T = Translucent*  
 Veneer surfaces may be any standard AutoStrada V1, V2 or V3 veneer.  
 Specify veneer finish code from page 5.

Frame is clear anodized aluminum or any standard paint finish except 613 Silver.

Brackets are available in all paint finishes

### Application Notes

Side screens clamp to front and back edge of worksurface at any point (except at hinged access door). Specify side screen brackets separately. Specify 14" H screens for a 42" horizon. Specify 21" H screens for a 49" horizon. Side screens align in height with center screens when worksurfaces are set at 28 3/8" H.

Veneer grain direction is horizontal.



# Side screens

## Tackable fabric surface

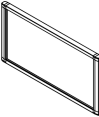
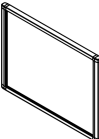
| description   | application          | w                 | d   | h      | pattern no.       | list                       | 10     | 15     | 20     | 30     | 35     | 40     | 45     |
|---|----------------------|-------------------|-----|--------|-------------------|----------------------------|--------|--------|--------|--------|--------|--------|--------|
|  | Side screen to 43" H | 24" D worksurface | 22" | 1 1/4" | 14"               | <b>XTSS1 2414F</b> ( ) ( ) | \$704. | \$712. | \$714. | \$725. | \$732. | \$732. | \$748. |
|   |                      | 30" D worksurface | 28" | 1 1/4" | 14"               | <b>XTSS1 3014F</b> ( ) ( ) | 725.   | 737.   | 739.   | 750.   | 760.   | 760.   | 779.   |
|   |                      | 36" D worksurface | 34" | 1 1/4" | 14"               | <b>XTSS1 3614F</b> ( ) ( ) | 746.   | 760.   | 776.   | 786.   | 786.   | 786.   | 812.   |
|  | Side screen to 50" H | 24" D worksurface | 22" | 1 1/4" | 21"               | <b>XTSS1 2421F</b> ( ) ( ) | 736.   | 744.   | 745.   | 755.   | 763.   | 763.   | 779.   |
|   |                      | 30" D worksurface | 28" | 1 1/4" | 21"               | <b>XTSS1 3021F</b> ( ) ( ) | 767.   | 777.   | 779.   | 791.   | 801.   | 801.   | 821.   |
|   |                      | 36" D worksurface | 34" | 1 1/4" | 21"               | <b>XTSS1 3621F</b> ( ) ( ) | 781.   | 794.   | 796.   | 812.   | 822.   | 822.   | 847.   |
| Side screen brackets ( pair )   | tapered edge         |                   |     |        | <b>XTSM1K</b> ( ) | 177.                       |        |        |        |        |        |        |        |
|   | squared edge         |                   |     |        | <b>XTSM1S</b> ( ) | 177.                       |        |        |        |        |        |        |        |
|   | postformed edge      |                   |     |        | <b>XTSM1P</b> ( ) | 249.                       |        |        |        |        |        |        |        |

| Order Code   | Specifications   | Application Notes   |
|--|--|---|
| Example: <b>XTSS13014F20</b><br><b>(W2801) 115</b> | 1. Tackable fabric surface is suffix F.  | Side screens clamp to front and back edge of worksurface at any point (except at hinged access door). Specify side screen brackets separately. Specify 14" H screens for a 43" horizon. Specify 21" H screens for a 50" horizon. Side screens align in height with center screens when worksurfaces are set at 28 3/8" H. |
| <b>XT</b> Crinion Open Table                       | 2. Select fabric surface finish code from list on page 5.                        |   |
| <b>SS1</b> Side screen                             | 3. Specify frame finish.   |   |
| <b>30</b> Width                                    | Frame is clear anodized aluminum or any standard paint finish except 613 Silver. |   |
| <b>14</b> Height                                   | Fabric is railroaded.  |   |
| <b>F</b> Surface                                   | Brackets are available in all paint finishes.                                    |   |
| <b>20</b> Fabric grade                             |  |   |
| <b>W2801</b> Fabric                                |  |   |
| <b>115</b> Frame finish                            |  |   |

# Return screens

*Acrylic, Marker or veneer surface*

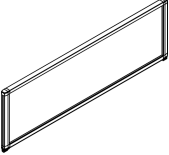
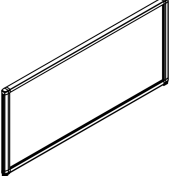
| description   | application            | w   | d   | h      | pattern no.       | list                          | Opal acrylic | Trans. acrylic / Marker | V1       | V2       | V3       |
|---|------------------------|-----|-----|--------|-------------------|-------------------------------|--------------|-------------------------|----------|----------|----------|
|  | Return screen to 43" H | 54" | 52" | 1 1/4" | 14"               | <b>XTRS1 5414</b> ( ) ( ) ( ) | \$1,033.     | \$1,089.                | \$1,126. | \$1,245. | \$1,485. |
|   |                        | 60" | 58" | 1 1/4" | 14"               | <b>XTRS1 6014</b> ( ) ( ) ( ) | 1,033.       | 1,089.                  | 1,141.   | 1,271.   | 1,540.   |
|   |                        | 66" | 64" | 1 1/4" | 14"               | <b>XTRS1 6614</b> ( ) ( ) ( ) | 1,033.       | 1,089.                  | 1,165.   | 1,303.   | 1,603.   |
|   |                        | 72" | 70" | 1 1/4" | 14"               | <b>XTRS1 7214</b> ( ) ( ) ( ) | 1,033.       | 1,089.                  | 1,180.   | 1,328.   | 1,656.   |
|   |                        | 78" | 76" | 1 1/4" | 14"               | <b>XTRS1 7814</b> ( ) ( ) ( ) | 1,151.       | 1,206.                  | 1,397.   | 1,523.   | 1,879.   |
|  | Return screen to 50" H | 54" | 52" | 1 1/4" | 21"               | <b>XTRS1 5421</b> ( ) ( ) ( ) | 1,211.       | 1,294.                  | 1,235.   | 1,392.   | 1,740.   |
|   |                        | 60" | 58" | 1 1/4" | 21"               | <b>XTRS1 6021</b> ( ) ( ) ( ) | 1,211.       | 1,294.                  | 1,256.   | 1,430.   | 1,819.   |
|   |                        | 66" | 64" | 1 1/4" | 21"               | <b>XTRS1 6621</b> ( ) ( ) ( ) | 1,211.       | 1,294.                  | 1,277.   | 1,465.   | 1,895.   |
|   |                        | 72" | 70" | 1 1/4" | 21"               | <b>XTRS1 7221</b> ( ) ( ) ( ) | 1,211.       | 1,294.                  | 1,298.   | 1,501.   | 1,971.   |
|   |                        | 78" | 76" | 1 1/4" | 21"               | <b>XTRS1 7821</b> ( ) ( ) ( ) | 1,359.       | 1,441.                  | 1,521.   | 1,706.   | 2,215.   |
| Side screen brackets ( pair )   | squared edge           |     |     |        | <b>XTSM1S</b> ( ) | 177.                          |              |                         |          |          |          |
|   | postformed edge        |     |     |        | <b>XTSM1P</b> ( ) | 249.                          |              |                         |          |          |          |

| Order Code                       |                    |
|----------------------------------|--------------------|
| Example: <b>XTRS16014A O 118</b> |                    |
| <b>XT</b>                        | Crinion Open Table |
| <b>RS1</b>                       | Return screen      |
| <b>60</b>                        | Width              |
| <b>14</b>                        | Height             |
| <b>A</b>                         | Acrylic            |
| <b>O</b>                         | Opal               |
| <b>118</b>                       | Frame finish       |

- Specifications**
- Specify surface  
*A = Acrylic*  
*V = Veneer*  
*M = Marker*
  - For Acrylic surface specify  
*O = Opal*  
*T = Translucent*  
 Veneer surfaces may be any standard AutoStrada V1, V2 or V3 veneer.  
 Specify veneer finish code from page 5.
  - Specify frame finish.  
  
 Frame is clear anodized aluminum (AA) or any standard paint finish except 613 Silver.  
  
 Brackets are available in all paint finishes.

- Application Notes**
- Return screens span the depth of Crinion Open Table worksurfaces and the width of a 30", 36" or 42" worksurface planned as perpendicular return. Specify 14" H screens for 42" horizon. Specify 21" H screens for a 49" horizon. Returns ( file tops or AutoStrada worksurfaces) must be at the same height as worksurface.
- Specify side brackets separately.
- Veneer grain direction is horizontal.

# Return screens

## Tackable fabric surface

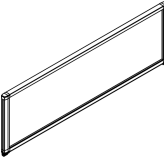
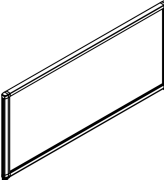
| description  | application     | w   | d      | h   | pattern no.                | list   | 10     | 15     | 20     | 30     | 35     | 40     | 45 |
|--|-----------------|-----|--------|-----|----------------------------|--------|--------|--------|--------|--------|--------|--------|----|
|  Return screen to 43" H | 54"             | 52" | 1 1/4" | 14" | <b>XTRS1 5414F</b> ( ) ( ) | \$859. | \$880. | \$885. | \$905. | \$921. | \$921. | \$959. |    |
|  | 60"             | 58" | 1 1/4" | 14" | <b>XTRS1 6014F</b> ( ) ( ) | 866.   | 888.   | 892.   | 916.   | 934.   | 934.   | 976.   |    |
|  | 66"             | 64" | 1 1/4" | 14" | <b>XTRS1 6614F</b> ( ) ( ) | 884.   | 907.   | 912.   | 939.   | 958.   | 958.   | 1,002. |    |
|  | 72"             | 70" | 1 1/4" | 14" | <b>XTRS1 7214F</b> ( ) ( ) | 889.   | 915.   | 920.   | 951.   | 970.   | 970.   | 1,021. |    |
|  | 78"             | 76" | 1 1/4" | 14" | <b>XTRS1 7814F</b> ( ) ( ) | 1,023. | 1,051. | 1,057. | 1,088. | 1,110. | 1,110. | 1,164. |    |
|  Return screen to 50" H | 54"             | 52" | 1 1/4" | 21" | <b>XTRS1 5421F</b> ( ) ( ) | 841.   | 859.   | 863.   | 887.   | 903.   | 903.   | 940.   |    |
|  | 60"             | 58" | 1 1/4" | 21" | <b>XTRS1 6021F</b> ( ) ( ) | 872.   | 894.   | 897.   | 923.   | 941.   | 941.   | 981.   |    |
|  | 66"             | 64" | 1 1/4" | 21" | <b>XTRS1 6621F</b> ( ) ( ) | 878.   | 902.   | 906.   | 932.   | 953.   | 953.   | 997.   |    |
|  | 72"             | 70" | 1 1/4" | 21" | <b>XTRS1 7221F</b> ( ) ( ) | 884.   | 909.   | 915.   | 944.   | 966.   | 966.   | 1,015. |    |
|  | 78"             | 76" | 1 1/4" | 21" | <b>XTRS1 7821F</b> ( ) ( ) | 1,042. | 1,071. | 1,077. | 1,108. | 1,132. | 1,132. | 1,184. |    |
| Side screen brackets ( pair )  | squared edge    |     |        |     | <b>XTSM1S</b> ( )          | 177.   |        |        |        |        |        |        |    |
|  | postformed edge |     |        |     | <b>XTSM1P</b> ( )          | 249.   |        |        |        |        |        |        |    |

### Order Code

|              |                     |
|--------------|---------------------|
| Example:     | <b>XTRS16014F20</b> |
|              | <b>(W2801) 611</b>  |
| <b>XT</b>    | Crinion Open Table  |
| <b>RS1</b>   | Return screen       |
| <b>60</b>    | Width               |
| <b>14</b>    | Height              |
| <b>F</b>     | Surface             |
| <b>20</b>    | Fabric grade        |
| <b>W2801</b> | Fabric              |
| <b>611</b>   | Frame finish        |

### Specifications

1. Tackable fabric surface is suffix F.
  2. Select fabric surface finish code from list on page 5.
  3. Specify frame finish.
- Frame is clear anodized aluminum or any standard paint finish except 613 Silver.
- Fabric is railroaded.
- Brackets are available in all paint finishes.

### Application Notes

Fabric return screens span the depth of Crinion Open Table worksurfaces and the width of a 30", 36" or 42" worksurface planned as perpendicular return. Specify 14" H screens for 43" horizon. Specify 21" H screens for a 50" horizon. Returns must be at the same height as worksurface.

Specify mounting brackets separately.

# Dual end screens

*Acrylic, Marker or veneer surface*

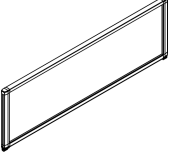
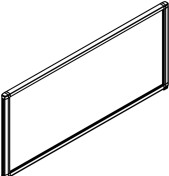
| description   | application               | w          | d   | h      | pattern no. | list                          | Opal acrylic | Trans. acrylic / Marker | V1       | V2       | V3       |  |
|---|---------------------------|------------|-----|--------|-------------|-------------------------------|--------------|-------------------------|----------|----------|----------|--|
|  | Dual end screens to 43" H | 24" D dual | 48" | 1 1/4" | 14"         | <b>XTES1 4814</b> ( ) ( ) ( ) | \$769.       | \$795.                  | \$1,080. | \$1,192. | \$1,415. |  |
|   |                           | 30" D dual | 60" | 1 1/4" | 14"         | <b>XTES1 6014</b> ( ) ( ) ( ) | 1,003.       | 1,060.                  | 1,177.   | 1,311.   | 1,589.   |  |
|   |                           | 36" D dual | 72" | 1 1/4" | 14"         | <b>XTES1 7214</b> ( ) ( ) ( ) | 1,033.       | 1,089.                  | 1,242.   | 1,394.   | 1,728.   |  |
|   | acrylic shown             |            |     |        |             |                               |              |                         |          |          |          |  |
|  | Dual end screens to 50" H | 24" D dual | 48" | 1 1/4" | 21"         | <b>XTES1 4821</b> ( ) ( ) ( ) | 915.         | 959.                    | 1,193.   | 1,342.   | 1,662.   |  |
|   |                           | 30" D dual | 60" | 1 1/4" | 21"         | <b>XTES1 6021</b> ( ) ( ) ( ) | 1,181.       | 1,263.                  | 1,293.   | 1,470.   | 1,870.   |  |
|   |                           | 36" D dual | 72" | 1 1/4" | 21"         | <b>XTES1 7221</b> ( ) ( ) ( ) | 1,211.       | 1,403.                  | 1,344.   | 1,549.   | 2,032.   |  |
|   | acrylic shown             |            |     |        |             |                               |              |                         |          |          |          |  |
| Replacement mast Kit  | acrylic center screen     |            |     |        |             | <b>XTSM1C</b> ( )             | 100.         |                         |          |          |          |  |
|   | slatwall center screen    |            |     |        |             | <b>XTSM1SLAT</b> ( )          | 265.         |                         |          |          |          |  |
| End screen brackets ( pair )  | tapered edge worksurface  |            |     |        |             | <b>XTSM1KK</b> ( )            | 177.         |                         |          |          |          |  |
| Side screen brackets ( pair )   | squared edge              |            |     |        |             | <b>XTSM1S</b> ( )             | 177.         |                         |          |          |          |  |
|   | postformed edge           |            |     |        |             | <b>XTSM1P</b> ( )             | 249.         |                         |          |          |          |  |

| Order Code                      | Specifications  | Application Notes   |
|---------------------------------|---|---|
| Example: <b>XTES16014A O AA</b> |   |   |
| <b>XT</b> Crinion Open Table    | 1. Specify surface<br><i>A = Acrylic</i><br><i>V = Veneer</i><br><i>M = Marker</i>  | Dual end screens clamp to front edge of worksurface on either side of table. Specify 14" H screens for a 42" horizon. Specify 21" H screens for a 49" horizon. Side screens align with center screens when worksurfaces are set at 28 3/8" H. |
| <b>ES1</b> End screen           | 2. For Acrylic surface specify<br><i>O = Opal</i><br><i>T = Translucent</i><br>Veneer surfaces may be any standard AutoStrada V1, V2 or V3 veneer.<br>Specify veneer finish code from page 5. |   |
| <b>60</b> Width                 | 3. Specify frame finish.  |   |
| <b>14</b> Height                | Frame is clear anodized aluminum or any standard paint finish except 613 Silver.  | Specify end screen brackets separately for each screen.   |
| <b>A</b> Surface                | Brackets are available in all paint finishes.   | Veneer grain direction is horizontal.   |
| <b>O</b> Opal                   | Replacement mast kit for acrylic center screen is 812 Easy Grey or 111 Black.   |   |
| <b>AA</b> Frame finish          |   |   |

# Dual end screens

## Tackable fabric surface

Crinion Open Table

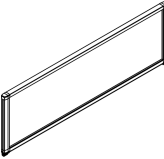
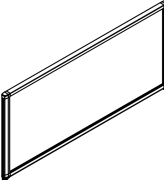
| description   | application               | w          | d   | h      | pattern no.          | list                       | 10     | 15     | 20     | 30     | 35     | 40     | 45     |
|---|---------------------------|------------|-----|--------|----------------------|----------------------------|--------|--------|--------|--------|--------|--------|--------|
|  | Dual end screens to 43" H | 24" D dual | 48" | 1 1/4" | 14"                  | <b>XTES1 4814F</b> ( ) ( ) | \$791. | \$811. | \$814. | \$833. | \$848. | \$848. | \$882. |
|   |                           | 30" D dual | 60" | 1 1/4" | 14"                  | <b>XTES1 6014F</b> ( ) ( ) | 866.   | 888.   | 892.   | 916.   | 934.   | 934.   | 976.   |
|   |                           | 36" D dual | 72" | 1 1/4" | 14"                  | <b>XTES1 7214F</b> ( ) ( ) | 889.   | 915.   | 920.   | 950.   | 970.   | 970.   | 1,021. |
|  | Dual end screens to 50" H | 24" D dual | 48" | 1 1/4" | 21"                  | <b>XTES1 4821F</b> ( ) ( ) | 855.   | 873.   | 878.   | 896.   | 912.   | 912.   | 945.   |
|   |                           | 30" D dual | 60" | 1 1/4" | 21"                  | <b>XTES1 6021F</b> ( ) ( ) | 929.   | 952.   | 956.   | 980.   | 998.   | 998.   | 1,039. |
|   |                           | 36" D dual | 72" | 1 1/4" | 21"                  | <b>XTES1 7221F</b> ( ) ( ) | 942.   | 968.   | 972.   | 1,001. | 1,024. | 1,024. | 1,071. |
| Replacement mast Kit  | acrylic center screen     |            |     |        | <b>XTSM1C</b> ( )    | 100.                       |        |        |        |        |        |        |        |
|   | slatwall center screen    |            |     |        | <b>XTSM1SLAT</b> ( ) | 265.                       |        |        |        |        |        |        |        |
| End screen brackets ( pair )  | tapered edge              |            |     |        | <b>XTSM1KK</b> ( )   | 177.                       |        |        |        |        |        |        |        |
|   | worksurface               |            |     |        |                      |                            |        |        |        |        |        |        |        |
| Side screen brackets ( pair )   | squared edge              |            |     |        | <b>XTSM1S</b> ( )    | 177.                       |        |        |        |        |        |        |        |
|   | postformed edge           |            |     |        | <b>XTSM1P</b> ( )    | 249.                       |        |        |        |        |        |        |        |

### Order Code

|              |                     |
|--------------|---------------------|
| Example:     | <b>XTES16014F20</b> |
|              | <b>(W2801) 112</b>  |
| <b>XT</b>    | Crinion Open Table  |
| <b>ES1</b>   | End screen          |
| <b>60</b>    | Width               |
| <b>14</b>    | Height              |
| <b>F</b>     | Surface             |
| <b>20</b>    | Fabric grade        |
| <b>W2801</b> | Fabric              |
| <b>112</b>   | Frame finish        |

### Specifications

1. Tackable fabric surface is suffix F.
  2. Select fabric surface finish code from list on page 5.
  3. Specify frame finish.
- Frame is clear anodized aluminum or any standard paint finish except 613 Silver.
- Fabric is railroaded.
- Brackets are available in all paint finishes.
- Replacement mast kit is 812 Easy Grey or 111 Black.

### Application Notes

Dual end screens clamp to front edge of worksurface on either side of table. Specify 14" H screens for a 43" horizon. Specify 21" H screens for a 50" horizon. Side screens align with center screens when worksurfaces are set at 28 3/8" H.

Specify end screen brackets separately for each screen.

# Single sided end screen

## Acrylic, Marker or veneer surface

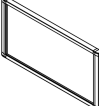
| description   | application                       | w                  | d       | h      | pattern no. | list                      | Opal acrylic | Trans. acrylic / Marker | V1     | V2       | V3       |
|---|-----------------------------------|--------------------|---------|--------|-------------|---------------------------|--------------|-------------------------|--------|----------|----------|
|  | Single sided end screens to 43" H | 24" D Single sided | 24 1/2" | 1 1/4" | 14"         | <b>XTES1 2414</b> ( ) ( ) | \$620.       | \$637.                  | \$934. | \$1,002. | \$1,104. |
|   |                                   | 30" D Single sided | 30 1/2" | 1 1/4" | 14"         | <b>XTES1 3014</b> ( ) ( ) | 650.         | 672.                    | 964.   | 1,041.   | 1,172.   |
|   |                                   | 36" D Single sided | 36 1/2" | 1 1/4" | 14"         | <b>XTES1 3614</b> ( ) ( ) | 708.         | 737.                    | 989.   | 1,077.   | 1,236.   |
|   | acrylic shown                     |                    |         |        |             |                           |              |                         |        |          |          |

|   |                                  |                    |         |        |     |                           |      |      |        |        |        |
|---|----------------------------------|--------------------|---------|--------|-----|---------------------------|------|------|--------|--------|--------|
|  | Single sided end screen to 50" H | 24" D single sided | 24 1/2" | 1 1/4" | 21" | <b>XTES1 2421</b> ( ) ( ) | 708. | 737. | 1,000. | 1,084. | 1,230. |
|   |                                  | 30" D single sided | 30 1/2" | 1 1/4" | 21" | <b>XTES1 3021</b> ( ) ( ) | 739. | 772. | 1,032. | 1,131. | 1,316. |
|   |                                  | 36" D single sided | 36 1/2" | 1 1/4" | 21" | <b>XTES1 3621</b> ( ) ( ) | 796. | 835. | 1,061. | 1,176. | 1,402. |
|   | acrylic shown                    |                    |         |        |     |                           |      |      |        |        |        |

|  |                 |                    |      |
|--|-----------------|--------------------|------|
| Single sided end screen brackets ( set ) | tapered edge    | <b>XTSM1KC</b> ( ) | 131. |
|  | square edge     | <b>XTSM1SC</b> ( ) | 131. |
|  | postformed edge | <b>XTSM1PC</b> ( ) | 178. |

| Order Code                       | Specifications   | Application Notes  |
|----------------------------------|--|--|
| Example: <b>XTES13614A O 114</b> |  |  |
| <b>XT</b> Crinion Open Table     |  |  |
| <b>ES1</b> End screen            |  |  |
| <b>36</b> Width                  |  |  |
| <b>14</b> Height                 |  |  |
| <b>A</b> Surface                 |  |  |
| <b>O</b> Opal                    |  |  |
| <b>114</b> Frame finish          |  |  |
|                                  | <ol style="list-style-type: none"> <li>Specify surface<br/> <i>A = Acrylic</i><br/> <i>V = Veneer</i><br/> <i>M = Marker</i> </li> <li>For Acrylic surface specify<br/> <i>O = Opal</i><br/> <i>T = Translucent</i><br/> Veneer surfaces may be any standard AutoStrada V1, V2 or V3 veneer.<br/> Specify veneer finish code from page 5. </li> <li>Specify frame finish.<br/><br/> Frame is clear anodized aluminum or any standard paint finish except 613 Silver.<br/><br/> Brackets are available in all paint finishes. </li> </ol> | Single sided end screens clamp to front edge of worksurface and attach to top of channel. Specify 14" H screens for a 42" horizon. Specify 21" H screens for a 49" horizon. Side screens align with center screens when worksurfaces are set at 28 3/8" H.<br><br>Specify end screen brackets separately for each screen.<br><br>Veneer grain direction is horizontal. |

# Single sided end screen

## Tackable fabric surface

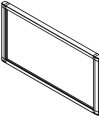
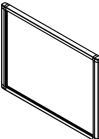
| description   | application        | w       | d      | h   | pattern no.                    | list   | 10     | 15     | 20     | 30     | 35     | 40     | 45 |
|---|--------------------|---------|--------|-----|--------------------------------|--------|--------|--------|--------|--------|--------|--------|----|
|  | 24" D Single sided | 24 1/2" | 1 1/4" | 14" | <b>XTES1 2414F</b> ( ) ( ) ( ) | \$704. | \$712. | \$714. | \$725. | \$732. | \$732. | \$748. |    |
|   | 30" D Single sided | 30 1/2" | 1 1/4" | 14" | <b>XTES1 3014F</b> ( ) ( ) ( ) | 725.   | 737.   | 739.   | 750.   | 760.   | 760.   | 779.   |    |
|   | 36" D Single sided | 36 1/2" | 1 1/4" | 14" | <b>XTES1 3614F</b> ( ) ( ) ( ) | 746.   | 760.   | 776.   | 786.   | 786.   | 786.   | 812.   |    |
|  | 24" D single sided | 24 1/2" | 1 1/4" | 21" | <b>XTES1 2421F</b> ( ) ( ) ( ) | 736.   | 744.   | 745.   | 755.   | 763.   | 763.   | 779.   |    |
|   | 30" D single sided | 30 1/2" | 1 1/4" | 21" | <b>XTES1 3021F</b> ( ) ( ) ( ) | 767.   | 777.   | 779.   | 791.   | 801.   | 801.   | 821.   |    |
|   | 36" D single sided | 36 1/2" | 1 1/4" | 21" | <b>XTES1 3621F</b> ( ) ( ) ( ) | 781.   | 794.   | 796.   | 812.   | 822.   | 822.   | 847.   |    |
| Single sided end screen brackets ( set )  | tapered edge       |         |        |     | <b>XTSM1KC</b> ( )             | 131.   |        |        |        |        |        |        |    |
|   | square edge        |         |        |     | <b>XTSM1SC</b> ( )             | 131.   |        |        |        |        |        |        |    |
|   | postformed edge    |         |        |     | <b>XTSM1PC</b> ( )             | 178.   |        |        |        |        |        |        |    |

| Order Code   | Specifications   | Application Notes  |
|--|--|--|
| Example: <b>XTES13614F20</b><br><b>(W2801) 111</b> | 1. Tackable fabric surface is suffix F.<br>2. Select fabric surface finish code from list on page 5.<br>3. Specify frame finish. | Single sided end screens clamp to front edge of worksurface and attach to top of channel. Specify 14" H screens for a 43" horizon. Specify 21" H screens for a 50" horizon. Side screens align with center screens when worksurfaces are set at 28 3/8" H. |
| <b>XT</b> Crinion Open Table                       |  |  |
| <b>ES1</b> End screen                              |  |  |
| <b>36</b> Width                                    |  |  |
| <b>14</b> Height                                   |  |  |
| <b>F</b> Surface                                   | Frame is clear anodized aluminum or any paint finish except 613 Silver.  | Specify end screen brackets separately for each screen.  |
| <b>20</b> Fabric grade                             |  |  |
| <b>W2801</b> Fabric                                | Fabric is railroaded.  |  |
| <b>111</b> Frame finish                            | Brackets are available in all paint finishes.  |  |

# Frameless glass Add up for Crinion Open Table

| description             | w   | d    | h   | pattern number            | clear tempered | powder |
|-------------------------|-----|------|-----|---------------------------|----------------|--------|
| Frameless glass Add ups | 48" | 1/2" | 12" | <b>XAUA 1248G ( ) ( )</b> | \$527.         | \$547. |
|                         | 60" | 1/2" | 12" | <b>XAUA 1260G ( ) ( )</b> | 644.           | 670.   |
|                         | 72" | 1/2" | 12" | <b>XAUA 1272G ( ) ( )</b> | 761.           | 790.   |

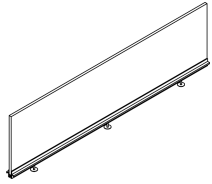

| Order Code                         | Specifications  | Application Notes  |
|------------------------------------|---|--|
| Example: <b>XAUA 1248G TEMP AA</b> | <i>Add up type:</i>   | Frameless glass addups for Crinion Open Table match those available for the AutoStrada spine.  |
| <b>X</b> Crinion Open Table        | G Glass   |  |
| <b>AUA</b> Frameless addup screen  | Glass add-ups are available with the following glass options:                                     | Tempered glass in clear or powered finish is 1/2" thick. Base frame is secured with bolts to top channel for frameless glass addups. |
| <b>48</b> Width                    |   |  |
| <b>12</b> Height                   |   |  |
| <b>G</b> Glass                     | TEMP Clear tempered   | Frameless addups cannot be mounted to standard top channel included with base assemblies.  |
| <b>TEMP</b> Finish                 | GL13 Powder   |  |
| <b>AA</b> Base finish              | Specify base finish:<br>AA anodized aluminum and all standard painted finishes except 613 Silver. |  |



# Morrison Network privacy screens mounting kit for Crinion Open Table

Crinion Open Table

| description                | w | d | h | pattern number    | list price |
|----------------------------|---|---|---|-------------------|------------|
| Fabric screen mounting kit |   |   |   | <b>XTPS1MZKIT</b> | \$120.     |



| Order Code                 | Specifications     | Applications notes   |
|----------------------------|--------------------|--|
| Example: <b>XTPS1MZKIT</b> |                    |  |
| <b>XT</b>                  | Crinion Open Table | <p>Crinion Open Tables are designed to accept Morrison Network privacy screens with fabric screen mounting kit. Screens are tackable fabric, <math>\frac{3}{4}</math>" thick, in widths corresponding to Crinion worksurfaces 48", 60" or 72" wide. Specify screens MZ1-B4815F, MZ1B6015F or MZ1B7215F.</p> <p>Specify one mounting kit for each screen. Fabric screen mounting kits include two uprights that fasten to the top channel at any point. Uprights slide into internal channels in screens. Fabric screens do not align in height with acrylic privacy screens.</p> |
| <b>PS1</b>                 | Privacy Screen     |  |
| <b>MZ</b>                  | Fabric             |  |
| <b>KIT</b>                 | Kit                |  |

# Alpha-Numeric Index

| <i>pattern no.</i> | <i>page</i> | <i>pattern no.</i> | <i>page</i> | <i>pattern no.</i> | <i>page</i> | <i>pattern no.</i> | <i>page</i> |
|--------------------|-------------|--------------------|-------------|--------------------|-------------|--------------------|-------------|
| XAUA 1248G         | 56          | XTB1 BAS 30S20SF   | 17          | XTB1EP1DD30        | 32          | XTB1TB6E           | 25          |
| XAUA 1260G         | 56          | XTB1 BAS 30S24SA   | 19          | XTB1EP1DD30P       | 31          | XTB1TB8C           | 25          |
| XAUA 1272G         | 56          | XTB1 BAS 30S24SF   | 17          | XTB1EP1DD36        | 32          | XTB1TB8E           | 25          |
| XT1DS4505          | 47          | XTB1 BAS 30S25SA   | 19          | XTB1EP1DD36P       | 31          | XTB1XD30           | 33          |
| XT1DS5705          | 47          | XTB1 BAS 30S25SF   | 17          | XTB1EP1LD24        | 32          | XTB1XD30N          | 33          |
| XT1DS6905          | 47          | XTB1 BAS 36D10CA   | 22          | XTB1EP1LD24P       | 31          | XTB1XD36           | 33          |
| XT1LS4509          | 47          | XTB1 BAS 36D10CF   | 20          | XTB1EP1LD30        | 32          | XTB1XD36N          | 33          |
| XT1LS5709          | 47          | XTB1 BAS 36D12CA   | 22          | XTB1EP1LD30P       | 31          | XTB1XDD24          | 28          |
| XT1LS6909          | 47          | XTB1 BAS 36D12CF   | 20          | XTB1EP1LD36        | 32          | XTB1XDD30          | 28          |
| XT1SA24            | 47          | XTB1 BAS 36D15CA   | 22          | XTB1EP1LD36P       | 31          | XTB1XDD36          | 28          |
| XT1SA30            | 47          | XTB1 BAS 36D15CF   | 20          | XTB1EP1RD24        | 32          | XTB1XS30           | 33          |
| XT1SA36            | 47          | XTB1 BAS 36D15SA   | 22          | XTB1EP1RD24P       | 31          | XTB1XS30N          | 33          |
| XT1SA42            | 47          | XTB1 BAS 36D15SF   | 20          | XTB1EP1RD30        | 32          | XTB1XS36           | 33          |
| XT1SA48            | 47          | XTB1 BAS 36D18SA   | 22          | XTB1EP1RD30P       | 31          | XTB1XS36N          | 33          |
| XT1SA54            | 47          | XTB1 BAS 36D18SF   | 20          | XTB1EP1RD36        | 32          | XTB1YDD24          | 29          |
| XT1SA60            | 47          | XTB1 BAS 36D20SA   | 22          | XTB1EP1RD36P       | 31          | XTB1YDD30          | 29          |
| XT1SA66            | 47          | XTB1 BAS 36D20SF   | 20          | XTB1EP2DD24        | 32          | XTB1YDD36          | 29          |
| XT1SA72            | 47          | XTB1 BAS 36D24CA   | 22          | XTB1EP2DD24P       | 31          | XTB2LDD            | 28          |
| XTB1 BAS 24D10CF   | 14          | XTB1 BAS 36D24CF   | 20          | XTB1EP2DD30        | 32          | XTB2LDD24          | 28          |
| XTB1 BAS 24D12CF   | 14          | XTB1 BAS 36D25CA   | 22          | XTB1EP2DD30P       | 31          | XTB2LS             | 30          |
| XTB1 BAS 24D15CF   | 14          | XTB1 BAS 36D25CF   | 20          | XTB1EP2DD36        | 32          | XTB2LS24           | 30          |
| XTB1 BAS 24D15SF   | 14          | XTB1 BAS 36S10CA   | 23          | XTB1EP2DD36P       | 31          | XTBT18             | 44          |
| XTB1 BAS 24D18SF   | 14          | XTB1 BAS 36S10CF   | 21          | XTB1EP2SD24        | 32          | XTBT24             | 44          |
| XTB1 BAS 24D20SF   | 14          | XTB1 BAS 36S12CA   | 23          | XTB1EP2SD24P       | 31          | XTBT36             | 44          |
| XTB1 BAS 24D24SF   | 14          | XTB1 BAS 36S12CF   | 21          | XTB1EP2SD30        | 32          | XTBT48             | 44          |
| XTB1 BAS 24D25SF   | 14          | XTB1 BAS 36S15CA   | 23          | XTB1EP2SD30P       | 31          | XTBT60             | 44          |
| XTB1 BAS 24S10CF   | 15          | XTB1 BAS 36S15CF   | 21          | XTB1EP2SD36        | 32          | XTC1 120 AA        | 24          |
| XTB1 BAS 24S12CF   | 15          | XTB1 BAS 36S15SA   | 23          | XTB1EP2SD36P       | 31          | XTC1 144 AA        | 24          |
| XTB1 BAS 24S15CF   | 15          | XTB1 BAS 36S15SF   | 21          | XTB1ESD24          | 30          | XTC1 48            | 24          |
| XTB1 BAS 24S15SF   | 15          | XTB1 BAS 36S18SA   | 23          | XTB1ESD30          | 30          | XTC1 60            | 24          |
| XTB1 BAS 24S18SF   | 15          | XTB1 BAS 36S18SF   | 21          | XTB1ESD36          | 30          | XTC1 72            | 24          |
| XTB1 BAS 24S20SF   | 15          | XTB1 BAS 36S20SA   | 23          | XTB1FC             | 34          | XTC1 96            | 24          |
| XTB1 BAS 24S24SF   | 15          | XTB1 BAS 36S20SF   | 21          | XTB1FC24           | 34          | XTC1 END           | 24          |
| XTB1 BAS 24S25SF   | 15          | XTB1 BAS 36S24SA   | 23          | XTB1FCEND          | 35          | XTCA1 120 AA       | 24          |
| XTB1 BAS 30D10CA   | 18          | XTB1 BAS 36S24SF   | 21          | XTB1LP             | 35          | XTCA1 144 AA       | 24          |
| XTB1 BAS 30D10CF   | 16          | XTB1 BAS 36S25SA   | 23          | XTB1MB             | 34          | XTCA1 48           | 24          |
| XTB1 BAS 30D12CA   | 18          | XTB1 BAS 36S25SF   | 21          | XTB1RAK            | 43          | XTCA1 60           | 24          |
| XTB1 BAS 30D12CF   | 16          | XTB1 SLIK          | 28          | XTB1SB10C          | 27          | XTCA1 72           | 24          |
| XTB1 BAS 30D15CA   | 18          | XTB1 SLIK30        | 28          | XTB1SB10E          | 27          | XTCA1 96           | 24          |
| XTB1 BAS 30D15CF   | 16          | XTB1 SLIK36        | 28          | XTB1SB12C          | 27          | XTCF 48            | 24          |
| XTB1 BAS 30D15SA   | 18          | XTB1 IAC           | 34          | XTB1SB12E          | 27          | XTCF 60            | 24          |
| XTB1 BAS 30D15SF   | 16          | XTB1 IAC24         | 34          | XTB1SB15C          | 27          | XTCF 72            | 24          |
| XTB1 BAS 30D18SA   | 18          | XTB1 ACEND         | 35          | XTB1SB15E          | 27          | XTCS1 4714         | 45          |
| XTB1 BAS 30D18SF   | 16          | XTB1DB10C          | 26          | XTB1SB4E           | 27          | XTCS1 4714F        | 46          |
| XTB1 BAS 30D20SA   | 18          | XTB1DB10E          | 26          | XTB1SB5C           | 27          | XTCS1 4721         | 45          |
| XTB1 BAS 30D20SF   | 16          | XTB1DB12C          | 26          | XTB1SB5E           | 27          | XTCS1 4721F        | 46          |
| XTB1 BAS 30D24CA   | 18          | XTB1DB12E          | 26          | XTB1SB6C           | 27          | XTCS1 4814         | 45          |
| XTB1 BAS 30D24CF   | 16          | XTB1DB15C          | 26          | XTB1SB6E           | 27          | XTCS1 4814F        | 46          |
| XTB1 BAS 30D25CA   | 18          | XTB1DB15E          | 26          | XTB1SB8C           | 27          | XTCS1 4821         | 45          |
| XTB1 BAS 30D25CF   | 16          | XTB1DB4E           | 26          | XTB1SB8E           | 27          | XTCS1 4821F        | 46          |
| XTB1 BAS 30S10CA   | 19          | XTB1DB5C           | 26          | XTB1T24            | 33          | XTCS1 5914         | 45          |
| XTB1 BAS 30S10CF   | 17          | XTB1DB5E           | 26          | XTB1TB10C          | 25          | XTCS1 5914F        | 46          |
| XTB1 BAS 30S12CA   | 19          | XTB1DB6C           | 26          | XTB1TB10E          | 25          | XTCS1 5921         | 45          |
| XTB1 BAS 30S12CF   | 17          | XTB1DB6E           | 26          | XTB1TB12C          | 25          | XTCS1 5921F        | 46          |
| XTB1 BAS 30S15CA   | 19          | XTB1DB8C           | 26          | XTB1TB12E          | 25          | XTCS1 6014         | 45          |
| XTB1 BAS 30S15CF   | 17          | XTB1DB8E           | 26          | XTB1TB15C          | 25          | XTCS1 6014F        | 46          |
| XTB1 BAS 30S15SA   | 19          | XTB1EDD24          | 28          | XTB1TB15E          | 25          | XTCS1 6021         | 45          |
| XTB1 BAS 30S15SF   | 17          | XTB1EDD30          | 28          | XTB1TB4E           | 25          | XTCS1 6021F        | 46          |
| XTB1 BAS 30S18SA   | 19          | XTB1EDD36          | 28          | XTB1TB5C           | 25          | XTCS1 7114         | 45          |
| XTB1 BAS 30S18SF   | 17          | XTB1EP1DD24        | 32          | XTB1TB5E           | 25          | XTCS1 7114F        | 46          |
| XTB1 BAS 30S20SA   | 19          | XTB1EP1DD24P       | 31          | XTB1TB6C           | 25          | XTCS1 7121         | 45          |

| <i>pattern no.</i> | <i>page</i> | <i>pattern no.</i>    | <i>page</i>            | <i>pattern no.</i>    | <i>page</i> | <i>pattern no.</i> | <i>page</i> |
|--------------------|-------------|-----------------------|------------------------|-----------------------|-------------|--------------------|-------------|
| XTCS1 7121F        | 46          | XTR10F                | 37, 39, 42             | XTTK3036F (L/M/1/2/3) | 13          | XTPP4824E (L)      | 10          |
| XTCS1 7214         | 45          | XTR1PDCX              | 37, 39                 | XTTK3618F (L/M/1/2/3) | 13          | XTPP4830A (L)      | 7           |
| XTCS1 7214F        | 46          | XTR1T30D              | 38                     | XTTK3636F (L/M/1/2/3) | 13          | XTPP4830B (L)      | 8           |
| XTCS1 7221         | 45          | XTR1T30S              | 38                     | XTTK4218F (L/M/1/2/3) | 13          | XTPP4830C (L)      | 9           |
| XTCS1 7221F        | 46          | XTR1T424D             | 38                     | XTTK4236F (L/M/1/2/3) | 13          | XTPP4830E (L)      | 10          |
| XTCS1 SBA          | 47          | XTR1T424S             | 38                     | XTTK4824A (L/M/1/2/3) | 7           | XTPP4836A (L)      | 7           |
| XTCT6030D          | 43          | XTR1TCC25             | 43                     | XTTK4824C (L/M/1/2/3) | 9           | XTPP4836B (L)      | 8           |
| XTCT6030LD         | 43          | XTR1TCPM              | 39                     | XTTK4824E (L/M/1/2/3) | 10          | XTPP4836C (L)      | 9           |
| XTCT6036D          | 43          | XTR1TJ18              | 39                     | XTTK4824U (L/M/1/2/3) | 8           | XTPP4836D (L)      | 12          |
| XTCT6036LD         | 43          | XTR1TJ30              | 39                     | XTTK4830A (L/M/1/2/3) | 7           | XTPP4836E (L)      | 12          |
| XTCT7230D          | 43          | XTR1TJ42              | 39                     | XTTK4830C (L/M/1/2/3) | 9           | XTPP6024A (L)      | 7           |
| XTCT7230LD         | 43          | XTR1TPH               | 39                     | XTTK4830E (L/M/1/2/3) | 10          | XTPP6024B (L)      | 8           |
| XTCT7236D          | 43          | XTR1TPI               | 39                     | XTTK4830U (L/M/1/2/3) | 8           | XTPP6024C (L)      | 9           |
| XTCT7236LD         | 43          | XTR1X30D              | 40                     | XTTK4836A (L/M/1/2/3) | 7           | XTPP6024E (L)      | 10          |
| XTDT42             | 43          | XTR1X30S              | 40                     | XTTK4836C (L/M/1/2/3) | 9           | XTPP6030A (L)      | 7           |
| XTDTX42            | 43          | XTR1X424D             | 40                     | XTTK4836D (L/M/1/2/3) | 11          | XTPP6030B (L)      | 8           |
| XTES1 2414         | 54          | XTR1X424S             | 40                     | XTTK4836E (L/M/1/2/3) | 11          | XTPP6030C (L)      | 9           |
| XTES1 2414F        | 55          | XTR1XCPM              | 41                     | XTTK4836U (L/M/1/2/3) | 8           | XTPP6030E (L)      | 10          |
| XTES1 2421         | 54          | XTR1XJ18              | 41                     | XTTK6018F (L/M/1/2/3) | 13          | XTPP6036A (L)      | 7           |
| XTES1 2421F        | 55          | XTR1XJ30              | 41                     | XTTK6024A (L/M/1/2/3) | 7           | XTPP6036B (L)      | 8           |
| XTES1 3014         | 54          | XTR1XJ42              | 41                     | XTTK6024C (L/M/1/2/3) | 9           | XTPP6036C (L)      | 9           |
| XTES1 3014F        | 55          | XTR1XPH               | 41                     | XTTK6024E (L/M/1/2/3) | 10          | XTPP6036D (L)      | 12          |
| XTES1 3021         | 54          | XTR1XPI               | 41                     | XTTK6024U (L/M/1/2/3) | 8           | XTPP6036E (L)      | 12          |
| XTES1 3021F        | 55          | XTRS1 5414            | 50                     | XTTK6030A (L/M/1/2/3) | 7           | XTPP7224A (L)      | 7           |
| XTES1 3614         | 54          | XTRS1 5414F           | 51                     | XTTK6030C (L/M/1/2/3) | 9           | XTPP7224B (L)      | 8           |
| XTES1 3614F        | 55          | XTRS1 5421            | 50                     | XTTK6030E (L/M/1/2/3) | 10          | XTPP7224C (L)      | 9           |
| XTES1 3621         | 54          | XTRS1 5421F           | 51                     | XTTK6030U (L/M/1/2/3) | 8           | XTPP7224E (L)      | 10          |
| XTES1 3621F        | 55          | XTRS1 6014            | 50                     | XTTK6036A (L/M/1/2/3) | 7           | XTPP7230A (L)      | 7           |
| XTES1 4814         | 52          | XTRS1 6014F           | 51                     | XTTK6036C (L/M/1/2/3) | 9           | XTPP7230B (L)      | 8           |
| XTES1 4814F        | 53          | XTRS1 6021            | 50                     | XTTK6036D (L/M/1/2/3) | 11          | XTPP7230C (L)      | 9           |
| XTES1 4821         | 52          | XTRS1 6021F           | 51                     | XTTK6036E (L/M/1/2/3) | 11          | XTPP7230E (L)      | 10          |
| XTES1 4821F        | 53          | XTRS1 6614            | 50                     | XTTK6036F (L/M/1/2/3) | 13          | XTPP7236A (L)      | 7           |
| XTES1 6014         | 52          | XTRS1 6614F           | 51                     | XTTK6036U (L/M/1/2/3) | 8           | XTPP7236B (L)      | 8           |
| XTES1 6014F        | 53          | XTRS1 6621            | 50                     | XTTK7218F (L/M/1/2/3) | 13          | XTPP7236C (L)      | 9           |
| XTES1 6021         | 52          | XTRS1 6621F           | 51                     | XTTK7224A (L/M/1/2/3) | 7           | XTPP7236D (L)      | 12          |
| XTES1 6021F        | 53          | XTRS1 7214            | 50                     | XTTK7224C (L/M/1/2/3) | 9           | XTPP7236E (L)      | 12          |
| XTES1 7214         | 52          | XTRS1 7214F           | 51                     | XTTK7224E (L/M/1/2/3) | 10          | XTPP9624A (L)      | 7           |
| XTES1 7214F        | 53          | XTRS1 7221            | 50                     | XTTK7224U (L/M/1/2/3) | 8           | XTPP9624B (L)      | 8           |
| XTES1 7221         | 52          | XTRS1 7221F           | 51                     | XTTK7230A (L/M/1/2/3) | 7           | XTPP9624C (L)      | 9           |
| XTES1 7221F        | 53          | XTRS1 7814            | 50                     | XTTK7230C (L/M/1/2/3) | 9           | XTPP9630A (L)      | 7           |
| XTPS1MZKIT         | 57          | XTRS1 7814F           | 51                     | XTTK7230E (L/M/1/2/3) | 10          | XTPP9630B (L)      | 8           |
| XTR1BCC50          | 43          | XTRS1 7821            | 50                     | XTTK7230U (L/M/1/2/3) | 8           | XTPP9630C (L)      | 9           |
| XTR1D1             | 41          | XTRS1 7821F           | 51                     | XTTK7236A (L/M/1/2/3) | 7           | XTPP9636A (L)      | 7           |
| XTR1D2             | 41          | XTSM1C                | 52, 53                 | XTTK7236C (L/M/1/2/3) | 9           | XTPP9636B (L)      | 8           |
| XTR1D3             | 41          | XTSM1K                | 48, 49                 | XTTK7236D (L/M/1/2/3) | 11          | XTPP9636C (L)      | 9           |
| XTR1D4             | 41          | XTSM1KC               | 54, 55                 | XTTK7236E (L/M/1/2/3) | 11          | XTTS3018F (1/2/3)  | 13          |
| XTR1DA             | 37, 39      | XTSM1KK               | 52, 53                 | XTTK7236F (L/M/1/2/3) | 13          | XTTS3618F (1/2/3)  | 13          |
| XTR1DB             | 37, 39      | XTSM1P                | 48, 49, 50, 51, 52, 53 | XTTK7236U (L/M/1/2/3) | 8           | XTTS4218F (1/2/3)  | 13          |
| XTR1DC             | 39          | XTSM1PC               | 54, 55                 | XTTK8418F (L/M/1/2/3) | 13          | XTTS4824A (1/2/3)  | 7           |
| XTR1DXO            | 37, 39      | XTSM1S                | 48, 49, 50, 51, 52, 53 | XTTK8436F (L/M/1/2/3) | 13          | XTTS4824C (1/2/3)  | 9           |
| XTR1DYO            | 37, 39      | XTSM1SC               | 54, 55                 | XTTK9624A (L/M/1/2/3) | 7           | XTTS4824E (1/2/3)  | 10          |
| XTR1DZO            | 39          | XTSM1SLAT             | 52, 53                 | XTTK9624C (L/M/1/2/3) | 9           | XTTS4824U (1/2/3)  | 8           |
| XTR1E30D           | 36          | XTSS1 2414            | 48                     | XTTK9624U (L/M/1/2/3) | 8           | XTTS4830A (1/2/3)  | 7           |
| XTR1E30S           | 36          | XTSS1 2414F           | 49                     | XTTK9630A (L/M/1/2/3) | 7           | XTTS4830C (1/2/3)  | 9           |
| XTR1E424D          | 36          | XTSS1 2421            | 48                     | XTTK9630C (L/M/1/2/3) | 9           | XTTS4830E (1/2/3)  | 10          |
| XTR1E424S          | 36          | XTSS1 2421F           | 49                     | XTTK9630U (L/M/1/2/3) | 8           | XTTS4830U (1/2/3)  | 8           |
| XTR1ECPM           | 37          | XTSS1 3014            | 48                     | XTTK9636A (L/M/1/2/3) | 7           | XTTS4836A (1/2/3)  | 7           |
| XTR1EE             | 36, 38, 42  | XTSS1 3014F           | 49                     | XTTK9636C (L/M/1/2/3) | 9           | XTTS4836C (1/2/3)  | 9           |
| XTR1EJ18           | 37          | XTSS1 3021            | 48                     | XTTK9636U (L/M/1/2/3) | 8           | XTTS4836D (1/2/3)  | 11          |
| XTR1EJ30           | 37          | XTSS1 3021F           | 49                     | XTPP3018F (L)         | 13          | XTTS4836E (1/2/3)  | 11          |
| XTR1EJ42           | 37          | XTSS1 3614            | 48                     | XTPP3618F (L)         | 13          | XTTS4836U (1/2/3)  | 8           |
| XTR1EPH            | 37          | XTSS1 3614F           | 49                     | XTPP4218F (L)         | 13          | XTTS6024A (1/2/3)  | 7           |
| XTR1EPI            | 37          | XTSS1 3621            | 48                     | XTPP4824A (L)         | 7           | XTTS6024C (1/2/3)  | 9           |
| XTR1FE             | 36, 38, 42  | XTSS1 3621F           | 49                     | XTPP4824B (L)         | 8           | XTTS6024E (1/2/3)  | 10          |
| XTR1H30D           | 42          | XTTK3018F (L/M/1/2/3) | 13                     | XTPP4824C (L)         | 9           | XTTS6024U (1/2/3)  | 8           |

| <i>pattern no.</i> | <i>page</i> |
|--------------------|-------------|
| XTTS6030A (1/2/3)  | 7           |
| XTTS6030C (1/2/3)  | 9           |
| XTTS6030E (1/2/3)  | 10          |
| XTTS6030U (1/2/3)  | 8           |
| XTTS6036A (1/2/3)  | 7           |
| XTTS6036C (1/2/3)  | 9           |
| XTTS6036D (1/2/3)  | 11          |
| XTTS6036E (1/2/3)  | 11          |
| XTTS6036U (1/2/3)  | 8           |
| XTTS7224A (1/2/3)  | 7           |
| XTTS7224C (1/2/3)  | 9           |
| XTTS7224E (1/2/3)  | 10          |
| XTTS7224U (1/2/3)  | 8           |
| XTTS7230A (1/2/3)  | 7           |
| XTTS7230C (1/2/3)  | 9           |
| XTTS7230E (1/2/3)  | 10          |
| XTTS7230U (1/2/3)  | 8           |
| XTTS7236A (1/2/3)  | 7           |
| XTTS7236C (1/2/3)  | 9           |
| XTTS7236D (1/2/3)  | 11          |
| XTTS7236E (1/2/3)  | 11          |
| XTTS7236U (1/2/3)  | 8           |
| XTTS9624A (1/2/3)  | 7           |
| XTTS9624C (1/2/3)  | 9           |
| XTTS9624U (1/2/3)  | 8           |
| XTTS9630A (1/2/3)  | 7           |
| XTTS9630C (1/2/3)  | 9           |
| XTTS9630U (1/2/3)  | 8           |
| XTTS9636A (1/2/3)  | 7           |
| XTTS9636C (1/2/3)  | 9           |
| XTTS9636U (1/2/3)  | 8           |
| XTWB120            | 44          |
| XTWTB              | 44          |
| XTWTBSLIK          | 44          |
| XTWTC              | 44          |
| XTWTX              | 44          |

# Selling Policy

|  |   |
|--|---|
|  | <p>This Selling Policy supercedes all previous selling policies. Prices, discounts and product offerings are subject to change without notice.</p>  |
| <b>Terms &amp; Conditions of Sales</b> | <p>Sales by Knoll, Inc. or Knoll North America Corp. ("Seller") of Knoll Product Lines (hereinafter "Products") within the United States and Canada are made only on the terms which are contained in this Selling Policy. Seller hereby gives notice of its objection to any different or additional terms and conditions. This sale is expressly conditional upon Purchaser's assent to the terms and conditions set forth below. Additional terms and conditions may apply to KnollStudio and KnollTextiles orders. These terms and conditions may be modified or supplemented only by a written document signed by an authorized representative of Seller. These terms and conditions supercede any prior and/or contemporaneous agreements or correspondence between Purchaser and Seller. Written quotations expire thirty (30) days from the date of issuance and can be withdrawn by written notice anytime during that period. Where Purchaser and Seller have entered into the Knoll Electronic Terms and Conditions, all orders, acknowledgements, invoices and other business communications placed or transmitted in accordance with the Knoll Electronic Terms and Conditions shall be deemed to be in writing and signed and shall be valid for all purposes as if they were originated and maintained in documentary form.</p>  |
| <b>Ordering Information</b>            | <p>All orders must be in writing. The product pattern number(s) contained on Seller's order acknowledgement shall be the final expression of the order.</p>   |
| <b>Order Confirmation</b>              | <p>A purchase order is not binding on Seller until Purchaser has received Seller's order confirmation or acknowledgment.</p>  |
| <b>Pricing Policies</b>                | <p>List prices are subject to change without notice.</p> <p>List prices shall be those prices in effect on the date of receipt of a complete purchase order unless shipment is requested more than ninety (90) days after order entry in which case prices in effect on the date of shipment apply. List prices include specified freight costs. Unless specified in writing by Seller, no other charges are included in Seller's list prices.</p>  |
| <b>Taxes</b>                           | <p>All sales, use, excise and other taxes applicable to the sale of the Products shall be paid by Purchaser. If Purchaser claims an exemption from any tax, Purchaser shall submit to Seller the appropriate exemption certificates.</p>  |
| <b>Terms of Payment</b>                | <p>Payment for one hundred percent (100%) of the net order amount is due within thirty (30) days of the date of invoice, which is issued upon shipment. In case of any discrepancies, such as shortages, and Seller is notified in writing within ten (10) days of receipt of Product, only that portion may be deducted and the balance paid. For orders greater than \$100,000 net, a fifty percent (50%) deposit is due at the time of order placement, with the remainder due within thirty (30) days of the date of invoice.</p> <p>KnollStudio orders less than \$2,000 require payment for one hundred percent (100%) of the net order amount (including any applicable sales tax and charges for inside delivery, special packaging, etc.), due at time of order placement. For KnollStudio orders greater than \$2,000, a one-half (50%) deposit is due at time of order placement with the remainder (including any applicable sales tax and charges for inside delivery, special packaging, etc.) due prior to shipment.</p> <p>If, in the judgment of Seller, Purchaser's financial condition does not justify the terms of the payment, Seller may require full or partial payment in advance.</p> <p>Past due accounts shall be charged one and one-half percent (1.5%) per month, or the highest rate permitted by law, whichever is less, and will be added to the outstanding balance. In the event Purchaser defaults on payment, Purchaser shall be liable for all collection costs, including reasonable attorney's fees and costs.</p> |
| <b>Changes and Cancellation</b>        | <p>Purchase orders may not be changed or cancelled, in whole or in part, without prior written consent of Seller. Changes may effect delivery dates. Expenses incurred because of changes shall be charged to Purchaser. In the event of cancellations, Purchaser will be liable for reasonable cancellation charges established by Seller. Orders for special Product, orders including "COM" (hereinafter defined) material and orders pursuant to expedited delivery programs, may not be canceled.</p>  |
| <b>Freight Prepaid</b>                 | <p>Freight is prepaid and included in the price of all Products, except KnollTextiles, within the 48 contiguous United States for orders placed with Knoll, Inc. and within Canada, excluding the Yukon, Northwest Territories, Nunavut and Newfoundland for orders placed with Knoll North America Corp. Packing is tested for rigorous motion and transportation but is not guaranteed to protect furniture from conditions over which the Seller has no control. If special packaging is required for any reason, please consult with your sales representative or dealer. Seller shall select the method of shipment and routing. All shipments shall be tailgate deliveries. Freight for all KnollTextiles orders is prepaid and added to the invoice.</p>   |
| <b>Delivery/Freight Charges</b>        | <p>Shipments outside the contiguous 48 United States and Canada shall be shipped F.O.B. Origin.</p> <p>For shipments outside the contiguous United States and Canada, Purchaser is responsible for the cost of freight from point of embarkation, including any handling and transportation charges incidental to loading at the point of departure and unloading at the final destination.</p> <p>Conditions beyond the control of Seller, including weather, available facilities and traffic conditions, may affect exact time of delivery. Seller shall not be responsible for specific carrier delivery date or time unless it has made a specific delivery commitment, in writing.</p> <p>Nonstandard methods of shipment and/or additional services are available upon request. Purchaser will be billed for the differential cost of any special services in excess of standard surface carrier freight costs. Premium charges, at Purchaser's request, will be added for airfreight, exclusive use of vehicle and extra, export or special packaging. Accessorial charges will be added for inside delivery, extra labor, reassignment and redelivery.</p> <p>Partial shipments may be made and invoiced by Seller.</p>  |
| <b>Claims</b>                          | <p>All shipments for all Knoll Products within the contiguous United States and Canada are F.O.B. Origin. Risk of loss passes to Purchaser at time of delivery to carrier. Purchaser shall inspect all Products upon receipt and notify Seller within ten (10) working days after receipt of any damage or defects which are, or should be, apparent from an inspection of the Product and its packaging. Failure of Purchaser to make a claim against carrier or notify Seller during the ten (10) working day period shall constitute acceptance of the Products and waiver of any apparent defects, errors or shortages. Seller will agree to repair or replace Product damaged in shipment if Purchaser has notified Seller of freight damage within ten (10) working days after receipt and assigns its rights against the carrier.</p>  |
| <b>Seller's Security Interest</b>      | <p>Until Seller receives the full payment for the Product, Seller shall have a security interest in the Product. Purchaser agrees to perform all acts, including but not limited to the execution and filing of documentation, which may be necessary to perfect and assure the security interest of Seller.</p>  |
| <b>Returns</b>                         | <p>The return of Products without a written authorization by Seller shall not be accepted. To receive authorization for Product return, please call Customer Service. All Products that are returned pursuant to a valid authorization shall be subject to a twenty-five percent (25%) of list restocking charge. Products not currently offered for sale by Seller (including COM) shall not be authorized for return. All returned Products must be unused, in original condition and in the original Seller packing cartons. No refund or credit shall be given for damaged Products.</p>  |
| <b>Held Orders/Storage</b>             | <p>If Purchaser requests that an order be held or delayed, prices and terms and conditions in effect at the time of shipment shall apply. If Purchaser requests a delay after the time when Seller can defer production, Purchaser will be invoiced for the Product, payable in accordance with standard terms, when the order is ready for shipment. Seller may transfer the Product to storage, in which case all expenses incurred in connection with storage, including demurrage, preparation for storage, storage charges and handling shall be payable by Purchaser upon submission of invoices by Seller. Risk of loss to the Product shall pass to the Purchaser upon delivery of the Product into storage.</p>  |

# Selling Policy

|                                 |  |
|---------------------------------|--|
| <b>Customer's Own Material</b>  | A Purchaser who requests a fabric or other surface material not standard to Seller's line of Products ("COM") must submit samples of the requested material to Seller prior to entry of a purchaser order. Seller shall determine if the material is suitable to its manufacturing processes and meets any requirements of Underwriters Laboratories. If the COM is acceptable, Seller will then establish a price for using the COM or the Product in question. For a description of the procedures for submitting samples and testing, contact customer resources or your sales representative. Seller shall have no responsibility for the appearance, condition, performance, durability, colorfastness or any other physical attribute of the COM. Purchaser shall indemnify and hold Seller harmless for any damages, injuries or losses arising out of or related to use of the COM on the Product.   |
| <b>Warranty</b>                 | <p>Seller warrants to the original Purchaser only that the Products Seller manufactures and sells to Purchaser are free of defects in workmanship and materials, during the applicable warranty period set forth below.</p> <p>Warranty period set forth below is for 24-hour, 7 days a week, multi shift use (includes parts and labor to repair).</p> <p>Should any failure to conform with this limited warranty appear to a Product listed below during the applicable warranty period from the date of shipment, Seller shall, upon prompt written notice, repair or replace, at its option and costs, the affected part or parts.</p> <p><i>Product and Period of Warranty</i></p> <p><i>Lifetime: Antenna Workspaces, AutoStrada, Calibre, Crinion Open Table, Currents, Dividends Horizon, Equity, Morrison, Reff Profiles laminate, Series 2 Storage, Template, Antenna Workspaces and other non-wood components (except cascade edge worksurfaces, operational parts, controls, electrical, Lighting, Series 2 Veneer Front Storage, special or custom products, see below)</i></p> <p><i>12 Years: Chadwick, Essentials Work Chairs, Generation by Knoll, Life, Moment, MultiGeneration by Knoll, RPM and Sapper seating (except seating upholstery, textiles, leathers and finishes, see below).</i></p> <p><i>10 Years: Antenna Workspaces, AutoStrada, Crinion Open Table, Reff Profiles wood components, Series 2 Veneer Front Storage, cascade edge worksurfaces, Wood Casegoods (Magnusson, The Graham Collection) (except wood casegoods upholstered surfaces, see below), Interaction tables (except height adjustment mechanisms for Counterforce, crank-adjustable, and split-top tables and worksurfaces, see below), Reuter overheads, Reuter vertical storage, KnollExtra Sapper Monitor Arm Collection, Adjustable keyboard mechanisms and platforms, Communication Boards (except fabric board textiles, see below), Smokador collection (except leathers, see below), and Orchestra Universal Systems Accessories.</i></p> <p><i>5 Years: Operational parts, controls, electrical, Lighting (except light ballasts, bulbs and power supply, see below), special or custom product, wood veneer products, Currents handcrank, Interaction Counterforce, Interaction crank-adjustable, and split-top mechanisms, KnollStudio, CPU storage and all universal storage drawers.</i></p> <p><i>3 Years: Seating upholstery, textiles, leathers and finishes. Fabric boards textiles and Smokador Collection leathers.</i></p> <p><i>2 Years: All other KnollExtra product</i></p> <p><i>1 Year: Light ballasts, bulbs and power supply, seating upholstered armpads and soft armpads, wood casegoods upholstered surfaces.</i></p> <p>This warranty does not apply to:</p> <ul style="list-style-type: none"><li>• Damage caused by a carrier other than the Seller.</li><li>• Normal wear and tear or acts or omissions of parties other than Seller (including user modification, improper use or installation of Products).</li><li>• COM or other third party materials applied to Products.</li><li>• Products not installed by or under the auspices of a Knoll Dealer.</li><li>• Dramatic temperature variations or exposure to unusual conditions.</li><li>• Changes in surface finishes, including colorfastness due to aging or exposure to light.</li><li>• Except as specifically noted above, textiles and upholstery supplied by <i>KnollTextiles</i> (consult current <i>KnollTextiles</i> price list for applicable warranty).</li></ul> <p>Natural variations occurring in wood, marble, and leather shall not be considered defects, and the Seller does not guarantee the colorfastness or matching of the colors, grains or textures, or surface hardness of such materials. The Seller also does not guarantee the colorfastness of fiberglass panel surfaces.</p> <p>THE EXPRESS WARRANTIES CONTAINED HEREIN ARE IN LIEU OF ALL OTHER WARRANTIES, EXPRESS OR IMPLIED, INCLUDING ANY WARRANTIES OF MERCHANTABILITY AND FITNESS FOR PARTICULAR PURPOSE AND ALL OTHER WARRANTIES ARISING FROM COURSE OF DEALING OR USAGE OF TRADE.</p> <p>The remedies provided above are the Purchaser's sole remedies for any failure of Seller to comply with its obligations regarding the workmanship of its Products. Correction of any nonconformity in the manner and for the period of time provided shall constitute complete fulfillment of all liabilities of Seller, with respect to or arising out of the Product furnished hereunder.</p> |
| <b>Delay/Force Majeure</b>      | Seller shall not be liable for failure to perform or for delay in performance due to fire, flood, strike or other labor difficulty, act of God, act of any governmental authority or of the Purchaser, riot, embargo, fuel or energy shortage, wrecks or delay in transportation, inability to obtain necessary labor, materials or manufacturing facilities from usual sources or failure of suppliers to meet their contractual obligations, or due to any cause beyond its reasonable control. If any such event occurs, Seller may extend delivery dates by a period of time necessary to overcome the effect of such delay, allocate available Product or cancel any purchase order.  |
| <b>Compliance with Law</b>      | PURCHASER IS SOLELY RESPONSIBLE FOR COMPLIANCE WITH ALL APPLICABLE FEDERAL, STATE AND LOCAL LAWS, ORDINANCES, REGULATIONS, RULES AND STANDARDS RELATING TO THE INSTALLATION, MAINTENANCE, USE AND OPERATION OF THE PRODUCTS.   |
| <b>Patents</b>                  | <p>Subject to the following provisions, Seller shall, at its own expense, defend or, at its option, settle any claim, suit or proceeding brought against the Purchaser, and/or its vendees, mediate and immediate, so far as based on an allegation that any Product or any part thereof furnished hereunder constitutes a direct or a contributory infringement of any claim of any patent of the United States or Canada. This obligation shall be effective only if Purchaser shall have made all payments then due hereunder and if Seller is notified promptly in writing and given authority, information and assistance for the defense of said claim, suit or proceeding. Seller shall pay all damages and costs awarded in such suit or proceedings so defended.</p> <p>The foregoing indemnity does not apply to the following:</p> <ul style="list-style-type: none"><li>• Products supplied according to a design other than that of Seller, and which is required by the Purchaser.</li><li>• Combination of the Product with another product not furnished hereunder unless Seller is a contributory infringer.</li><li>• Any settlements of a suit or proceeding made without Seller's written consent.</li></ul>   |
| <b>Limitations of Liability</b> | <p><b>SELLER, ITS CONTRACTORS, AUTHORIZED DEALERS AND SUBCONTRACTORS OR SUPPLIERS OF ANY TIER SHALL NOT BE LIABLE TO PURCHASER FOR ANY SPECIAL, INDIRECT, INCIDENTAL OR CONSEQUENTIAL DAMAGES ARISING FROM A BREACH OF THIS AGREEMENT.</b></p> <p>Purchaser's remedies set forth herein are exclusive and the liability of Seller with respect to the breach of this agreement or any contract entered into between the parties pursuant hereto shall not exceed the price of the Product or part on which such liability is based.</p>  |

# General Ordering Information

---

## **The Products**

This guide encompasses all standard products for this product group.

## **Sizes**

Dimensions listed in this guide are indicated as:

H = height

W = width

D = depth

Dia. = diameter

Rad. = radius

## **Pricing**

All prices shown are list.

## **How to Order**

Select pattern numbers and quantities required for your complete installation. Product questions can be addressed in the specific sections of this guide or by contacting your sales representative or customer resource representative at 1-800-343-5665.

Next, select options (if required), along with colors and finishes appropriate to each product. Reference the Finishes and Fabrics pages for color designations.

On large installations, an item's "designated area" can be specified to assist in product organization and handling.

To expedite complete / correct entry of your order, be certain all pattern numbers, quantities, colors and area identifications are completely specified. Also, include complete purchase order numbers, bill-to and ship-to addresses, a contact name and specific factory shipping dates required.

## **Mail all orders to:**

Knoll, Inc.

1235 Water Street

P.O. Box 157

East Greenville, PA 18041

Attention: Order Entry

Once your order is entered at Knoll, an acknowledgment will be mailed to you. You will be advised of your scheduled shipping date within five days of the original acknowledgment. If it is necessary to revise your order, please contact your customer resource representative.

## Sustainability Statement

---

Sustainable design is a key component of Knoll's environmental focus. Our commitment to social responsibility and a healthy environment has prompted us to further articulate our longstanding environmental programs and, with encouragement and support from our colleagues in the industry, we have re-energized our focus on such "green" initiatives as life cycle analysis and LEED™ certification. Knoll is proud to have contributed to projects that have received LEED certification from the U.S. Green Building Council.

For the latest information on Knoll products that help our customers achieve LEED certification, log on to [knoll.com](http://knoll.com), click on "About Knoll" and then "Environmental Focus."